

R&S®OSP

Open Switch and Control Platform

User Manual



1178710002
Version 05

ROHDE & SCHWARZ
Make ideas real



The R&S®OSP is a high-performance switch platform from Rohde & Schwarz. It facilitates RF tests by eliminating the need to rearrange coaxial cable connections repeatedly during measurements. Instead, the application-specific modules in the base unit automatically switch the required signal paths.

This document describes the following R&S®OSP base units with firmware version 2.10 and later:

- **R&S®OSP220** Base Unit 2HU without Touchscreen (order no. 1528.3105.02)
- **R&S®OSP230** Base Unit 2HU with Touchscreen (order no. 1528.3105.03)
- **R&S®OSP320** Base Unit 3HU without Touchscreen (order no. 1528.3111.02)
- **R&S®OSP-B200S2** Satellite 2HU for Base Units (order no. 1528.3134.02/.04)

The document also describes all optional standard modules, but no custom or system modules. For standard modules, see [Chapter 3, "Modules"](#), on page 51.

The software contained in this product uses several valuable open source software packages. For information, see the "Open Source Acknowledgment" document, which is available for download from the R&S OSP product page at <https://www.rohde-schwarz.com/product/osp-n> > Firmware.

Rohde & Schwarz would like to thank the open source community for their valuable contribution to embedded computing.

© 2021 Rohde & Schwarz GmbH & Co. KG

Mühlhofstr. 15, 81671 München, Germany

Phone: +49 89 41 29 - 0

Email: info@rohde-schwarz.com

Internet: www.rohde-schwarz.com

Subject to change – data without tolerance limits is not binding.

R&S® is a registered trademark of Rohde & Schwarz GmbH & Co. KG.

Trade names are trademarks of the owners.

1178.7100.02 | Version 05 | R&S®OSP

In this manual, products from Rohde & Schwarz are indicated without the ® symbol, e.g. R&S®OSP is indicated as R&S OSP.

Contents

1	Welcome.....	7
1.1	Safety and Regulatory Information.....	7
1.2	Key Features.....	12
1.3	Documentation Overview.....	12
2	Getting Started.....	15
2.1	Preparing for Use.....	15
2.2	Instrument Tour.....	25
2.3	Trying Out the Switch Unit.....	32
2.4	Mounting a Module.....	41
3	Modules.....	51
3.1	R&S OSP-B011 and R&S OSP-B012 RF Feedthroughs.....	55
3.2	R&S OSP-BM6x RF Switch Module.....	58
3.3	R&S OSP-BM6xE RF Switch Module.....	59
3.4	R&S OSP-BM6xH RF Switch Module.....	60
3.5	R&S OSP-BM6xU RF Switch Module.....	61
3.6	R&S OSP-B101 RF Switch Module.....	62
3.7	R&S OSP-B101L RF Switch Module.....	63
3.8	R&S OSP-B102 RF Switch Module.....	65
3.9	R&S OSP-B102L RF Switch Module.....	66
3.10	R&S OSP-B103 Digital I/O Module.....	68
3.11	R&S OSP-B104 Digital I/O Module (EMS).....	70
3.12	R&S OSP-B106 RF Switch Module.....	74
3.13	R&S OSP-B107 RF SSR Module.....	76
3.14	R&S OSP-B108 DC Multiplexer Module.....	78
3.15	R&S OSP-B111E RF Switch Module.....	81
3.16	R&S OSP-B111H RF Switch Module.....	83
3.17	R&S OSP-B111U RF Switch Module.....	84
3.18	R&S OSP-B111UL RF Switch Module.....	85
3.19	R&S OSP-B111V RF Switch Module.....	86
3.20	R&S OSP-B111VL RF Switch Module.....	87

3.21	R&S OSP-B112E RF Switch Module.....	89
3.22	R&S OSP-B112H RF Switch Module.....	91
3.23	R&S OSP-B112U RF Switch Module.....	92
3.24	R&S OSP-B112UL RF Switch Module.....	93
3.25	R&S OSP-B114 EMS Test Control Module.....	95
3.26	R&S OSP-B116 RF Switch Module.....	99
3.27	R&S OSP-B116E RF Switch Module.....	101
3.28	R&S OSP-B116H RF Switch Module.....	101
3.29	R&S OSP-B116U RF Switch Module.....	102
3.30	R&S OSP-B119 RF Switch Module.....	103
3.31	R&S OSP-B119E RF Switch Module.....	105
3.32	R&S OSP-B121 RF Switch Module.....	105
3.33	R&S OSP-B121E RF Switch Module.....	107
3.34	R&S OSP-B121H RF Switch Module.....	108
3.35	R&S OSP-B121U RF Switch Module.....	108
3.36	R&S OSP-B121VL RF Switch Module.....	110
3.37	R&S OSP-B122 RF Switch Module.....	111
3.38	R&S OSP-B122E RF Switch Module.....	113
3.39	R&S OSP-B122H RF Switch Module.....	113
3.40	R&S OSP-B122U RF Switch Module.....	114
3.41	R&S OSP-B123 RF Switch Module.....	115
3.42	R&S OSP-B124 RF Switch Module.....	117
3.43	R&S OSP-B125 RF Switch Module.....	119
3.44	R&S OSP-B125E RF Switch Module.....	121
3.45	R&S OSP-B125H RF Switch Module.....	122
3.46	R&S OSP-B126 RF Switch Module.....	122
3.47	R&S OSP-B127 RF SSR Module.....	124
3.48	R&S OSP-B128 RF SSR Module.....	126
3.49	R&S OSP-B129 RF Switch Module.....	128
3.50	R&S OSP-B129E RF Switch Module.....	130
3.51	R&S OSP-B131 RF Switch Module.....	131
3.52	R&S OSP-B132 RF Switch Module.....	133
3.53	R&S OSP-B133 RF Switch Module.....	135

3.54	R&S OSP-B136 RF Switch Module.....	136
3.55	R&S OSP-B142 RF SSR Power Module.....	138
3.56	R&S OSP-B200R Remote Control Module.....	142
3.57	R&S OSP-B171H RF Digital Attenuators Module.....	144
3.58	R&S OSP-B300M Touchscreen Module.....	145
3.59	R&S OSP-PM-I Power Sensor Integration.....	146
4	Operation.....	147
4.1	How to Work with a Switch Unit.....	147
4.2	Instrument Control.....	148
4.3	LAN Connection.....	149
4.4	Operation in Interconnection Mode.....	150
4.5	Virtual Mode.....	154
4.6	Trigger Mode.....	154
5	Functions.....	155
5.1	Main.....	155
5.2	Module Operation.....	166
5.3	Path Switching.....	181
5.4	Configuration.....	195
6	Application Examples.....	227
6.1	Applications of Module R&S OSP-B103.....	227
6.2	Applications of Module R&S OSP-B104.....	231
6.3	Applications of Module R&S OSP-B114.....	235
7	Remote Operation.....	240
7.1	Long and Short Form.....	243
7.2	Optional Keywords.....	243
7.3	SCPI Parameters.....	244
8	RC Commands.....	246
8.1	Common Commands.....	247
8.2	SYSTem Commands.....	250
8.3	ROUte Commands.....	252
8.4	READ Commands.....	262
8.5	CONFigure Commands.....	266

8.6	TRIGger Commands.....	282
8.7	MMEMory Commands.....	289
8.8	DIAGnostic Commands.....	290
8.9	Legacy System Commands from R&S OSP1x0.....	293
8.10	List of Remote Commands.....	296
9	Programming Examples.....	298
9.1	Switching Relays by SCPI Commands.....	298
9.2	Switching Output Channel Paths by SCPI Commands.....	300
10	Troubleshooting.....	301
10.1	Collecting Information for Technical Support.....	303
10.2	Contacting Customer Support.....	303
11	Transporting.....	304
12	Maintenance.....	305
12.1	Replacing Fuses.....	305
12.2	Cleaning.....	306
12.3	Firmware Update.....	307
13	Storage and Disposal.....	315
13.1	Storage.....	315
13.2	Disposal.....	315
	Annex.....	316
A	Technical Drawings of Device Geometry.....	316
B	Motherboard Interfaces.....	318
C	Off/On Switching States of Various Relays.....	320
	Glossary: Frequently used Terms and Abbreviations.....	322
	Index.....	325

1 Welcome

The R&S OSP is a high-performance switch platform from Rohde & Schwarz. It facilitates RF tests by eliminating the need to rearrange coaxial cable connections repeatedly during measurements. Instead, the application-specific modules in the base unit automatically switch the required signal paths.

This user manual contains a description of the functionality that the switch platform and its various modules provide, including remote control operation. The latest version of the manual is available for download at www.rohde-schwarz.com/manual/osp-n.

1.1 Safety and Regulatory Information

The product documentation helps you use the product safely and efficiently. Follow the instructions provided here and in the [Chapter 1.1.2, "Safety Instructions"](#), on page 8.

Intended use

The R&S OSP is designated for switching and control applications, including RF switching, in industrial, administrative, and laboratory environments. Use the R&S OSP only for its designated purpose.

Observe the operating conditions and performance limits stated in the data sheet.

Target audience

This document is targeted at all users, including installers, operators, and maintenance personnel.

Where do I find safety information?

Safety information is part of the product documentation. It warns you of potential dangers and gives instructions on how to prevent personal injury or damage caused by dangerous situations. Safety information is provided as follows:

- In [Chapter 1.1.2, "Safety Instructions"](#), on page 8. The same information is provided in many languages as printed "Safety Instructions". The printed "Safety Instructions" are delivered with the product.
- Throughout the documentation, safety instructions are provided when you need to take care during setup or operation.

1.1.1 Korea Certification Class B



이 기기는 가정용(B급) 전자파 적합기기로서 주로 가정에서 사용하는 것을 목적으로 하며, 모든 지역에서 사용할 수 있습니다.

1.1.2 Safety Instructions

Products from the Rohde & Schwarz group of companies are manufactured according to the highest technical standards. To use the products safely, follow the instructions provided here and in the product documentation. Keep the product documentation nearby and offer it to other users.

Use the product only for its intended use and within its performance limits. Intended use and limits are described in the product documentation such as the data sheet, manuals and the printed safety instructions. If you are unsure about the appropriate use, contact Rohde & Schwarz customer service.

Using the product requires specialists or specially trained personnel. These users also need sound knowledge of at least one of the languages in which the user interfaces and the product documentation are available.

If any part of the product is damaged or broken, stop using the product. Never open the casing of the product. Only service personnel authorized by Rohde & Schwarz are allowed to repair the product. Contact Rohde & Schwarz customer service at <http://www.customersupport.rohde-schwarz.com>.

Lifting and carrying the product

The maximum weight of the product is provided in the data sheet. To move the product safely, you can use lifting or transporting equipment such as lift trucks and forklifts. Follow the instructions provided by the equipment manufacturer.

Choosing the operating site

Only use the product indoors. The product casing is not waterproof. Water that enters can electrically connect the casing with live parts, which can lead to electric shock, serious personal injury or death if you touch the casing. If Rohde & Schwarz provides a carrying bag designed for your product, you can use the product outdoors.

Unless otherwise specified, you can operate the product up to an altitude of 2000 m above sea level. The product is suitable for pollution degree 2 environments where nonconductive contamination can occur. For more information on environmental conditions such as ambient temperature and humidity, see the data sheet.

Setting up the product

Always place the product on a stable, flat and level surface with the bottom of the product facing down. If the product is designed for different positions, secure the product so that it cannot fall over.

If the product has foldable feet, always fold the feet completely in or out to ensure stability. The feet can collapse if they are not folded out completely or if the product is moved without lifting it. The foldable feet are designed to carry the weight of the product, but not an extra load.

If stacking is possible, keep in mind that a stack of products can fall over and cause injury.

If you mount products in a rack, ensure that the rack has sufficient load capacity and stability. Observe the specifications of the rack manufacturer. Always install the products from the bottom shelf to the top shelf so that the rack stands securely. Secure the product so that it cannot fall off the rack.

Connecting to power

The product is an overvoltage category II product and has to be connected to a fixed installation used to supply energy-consuming equipment such as household appliances and similar loads. Be aware that electrically powered products have risks, such as electric shock, fire, personal injury or even death.

Take the following measures for your safety:





- Before switching on the product, ensure that the voltage and frequency indicated on the product match the available power source. If the power adapter does not adjust automatically, set the correct value and check the rating of the fuse.
- If a product has an exchangeable fuse, its type and characteristics are indicated next to the fuse holder. Before changing the fuse, switch off the instrument and disconnect it from the power source. How to change the fuse is described in the product documentation.
- Only use the power cable delivered with the product. It complies with country-specific safety requirements. Only insert the plug into an outlet with protective conductor terminal.
- Only use intact cables and route them carefully so that they cannot be damaged. Check the power cables regularly to ensure that they are undamaged. Also ensure that nobody can trip over loose cables.
- If the product needs an external power supply, use the power supply that is delivered with the product or that is recommended in the product documentation or a power supply that conforms to the country-specific regulations.
- Only connect the product to a power source with a fuse protection of maximum 20 A.
- Ensure that you can disconnect the product from the power source at any time. Pull the power plug to disconnect the product. The power plug must be easily accessible. If the product is integrated into a system that does not meet these requirements, provide an easily accessible circuit breaker at the system level.

Cleaning the product

Use a dry, lint-free cloth to clean the product. When cleaning, keep in mind that the casing is not waterproof. Do not use liquid cleaning agents.

Meaning of safety labels

Safety labels on the product warn against potential hazards.



	<p>Potential hazard</p> <p>Read the product documentation to avoid personal injury or product damage.</p>
	<p>Electrical hazard</p> <p>Indicates live parts. Risk of electric shock, fire, personal injury or even death.</p>
	<p>Hot surface</p> <p>Do not touch. Risk of skin burns. Risk of fire.</p>
	<p>Protective conductor terminal</p> <p>Connect this terminal to a grounded external conductor or to protective ground. This protects you against electric shock should an electric problem occur.</p>

1.1.3 Labels on the Product

Labels on the casing inform about:

- Personal safety, see ["Meaning of safety labels"](#) on page 9
- Product and environment safety, see [Table 1-1](#)
- Identification of the product, for example as in the top left of [Figure 2-3](#)

Table 1-1: Labels regarding product and environment safety

	<p>Potential hazard</p> <p>Read the product documentation to avoid personal injury or product damage.</p>
	<p>China RoHS certification, certifies compliance with the Chinese government's regulation on the restriction of hazardous substances (RoHS).</p>
	<p>Labeling in line with EN 50419 for disposal of electrical and electronic equipment after the product has come to the end of its service life.</p> <p>For more information, see "Disposing electrical and electronic equipment" on page 315.</p>

1.1.4 Warning Messages in the Documentation

A warning message points out a risk or danger that you need to be aware of. The signal word indicates the severity of the safety hazard and how likely it will occur if you do not follow the safety precautions.

WARNING

Potentially hazardous situation. Could result in death or serious injury if not avoided.

CAUTION

Potentially hazardous situation. Could result in minor or moderate injury if not avoided.

NOTICE

Potential risks of damage. Could result in damage to the supported product or to other property.

1.1.5 Restrictions on Opening a Switch Unit

Do not open an R&S OSP, to avoid personal injury and instrument damage.

- If opening is required for mounting a module (see [Table 2-4](#)), let Rohde & Schwarz service personnel mount this module.
- If opening is not required for mounting a module, follow the mounting instructions in [Chapter 2.4, "Mounting a Module"](#), on page 41.

1.1.6 Safety Considerations for SSRs

Risk of injury and damage due to inappropriate SSR usage

At power loss, solid-state relays (SSRs) have **no defined** switching state. Hence, other than an electromechanical [monostable relay](#), if there is a malfunction (for example, missing supply voltage), typically the SSR ports go to a high-impedance state. But the relay does not actively switch off a connected load. This failure can lead to a risk of personal injury and damage of equipment.

To prevent this risk, you must implement a dedicated concept for failsafe operation of your system in a competent manner.

Risk of damage due to inappropriate SSR usage

Solid-state relays (SSRs) are intended for high-frequency and high-speed switching, but their semiconductor elements are damaged easily by excess current, voltage peaks or a short circuit. Hence, inappropriate conditions or usage can damage SSRs or connected components and lead to associated problems.

To prevent this risk, avoid excess current, voltage peaks and short circuits.

Risk of SSR damage due to inappropriate operating conditions

Solid-state relays (SSRs) for RF applications are intended for switching low powers. To avoid damage due to overload, refer to the operating conditions according to the data sheet.

Monostable vs. failsafe

Without power, a solid-state relay (SSR) quits operating as a switch:

- It is in a **non-defined** high-impedance state
- It does not have any stable switching state

Sometimes, SSRs are considered as behaving like a monostable relay. And the term "monostable relay" is often considered to be equivalent with the term "failsafe relay". However, this interpretation is misleading.

See also "[Monostable and bistable relays](#)" on page 53.

See also "[FS \(open\)*](#)" on page 53.

See also "[Off/On Switching States of Various Relays](#)" on page 320.

1.2 Key Features

The R&S OSP is a highly flexible, modular switch and control platform. Each switch unit can be equipped with several application-specific [switch modules](#).

The platform meets the requirements of diverse test scenarios in production, labs and development environments. Scenarios range from desktop configurations for laboratory measurements to complex, rack-integrated test systems.

The R&S OSP220/230/320 described in this manual are the second generation of switch units from Rohde & Schwarz, replacing the R&S OSP120/130/150.

Outstanding key features are:

- 5 to 10 module slots and up to 16 module buses provide maximum flexibility
- Fast setup of test and measurement configurations
- Replace complex wirings by a single switch and control platform
- Easy interconnection configuration of primary and secondary switch units
- Optional installation of several [remotely controlled](#) satellite units ([Figure 2-6](#))
- Reliable measurements and reproducible tests
- Automation for cost-efficient test sequences
- Electromechanical relay modules up to 67 GHz
- Solid-state relay modules with switching and settling times down to the μs range
- Backward compatible to all standard [modules](#) of the previous switch unit generation R&S OSP120/130/150, see [Compatibility Mode](#) and `CONFigure: COMPAtible[:MODE]`

For a detailed specification of the R&S OSP, refer to the [data sheet](#).



Note that switch units are no measurement instruments. They support efficient working with test and measurement setups, but switch units do not display measurement results or power levels.

1.3 Documentation Overview

This section provides an overview of the R&S OSP user documentation. Unless specified otherwise, you find the documents on the R&S OSP product page at:

www.rohde-schwarz.com/product/osp-n

1.3.1 Getting Started Manual

Introduces the R&S OSP and describes how to set up and start working with it. Includes, e.g., basic operations and safety instructions. A printed version is delivered with the switch unit. A PDF version is available for download on the Internet.

1.3.2 User Manual

Contains the description of all switch unit modes and functions. It also provides an introduction to remote control, a complete description of the remote control commands with programming examples, and information on maintenance, interfaces and error messages. Includes the contents of the getting started manual.

A separate R&S OSP-B200R/B200S2 Satellite System user manual is also available for download at www.rohde-schwarz.com/manual/osp-n.

1.3.3 Data Sheets and Brochures

The data sheet contains the technical specifications of the R&S OSP. It also lists the firmware applications and their order numbers, and optional accessories.

The brochure provides an overview of the instrument and deals with the specific characteristics.

See www.rohde-schwarz.com/brochure-datasheet/osp-n

If there is a data mismatch between the data sheet and other documentation, the information given in the data sheet is valid.

1.3.4 Service Manual

Describes handling failed modules, module replacement, troubleshooting and special remote control commands for service purposes. The document also contains spare part lists and mechanical drawings. The service manual ("Classified Service Document") is available for Rohde & Schwarz personnel, only.

1.3.5 Printed Safety Instructions

Provides safety information in many languages. The printed document is delivered with the product.

1.3.6 Release Notes, Open Source Acknowledgment

The release notes list new features, improvements and known issues of the current firmware version, and describe the firmware installation. The open-source acknowledgment document (OSA) provides verbatim license texts of the used open-source software. See www.rohde-schwarz.com/firmware/osp-n

1.3.7 Application Notes & Cards, White Papers, etc.

These documents deal with special applications or background information on particular topics. See www.rohde-schwarz.com/application/osp and www.rohde-schwarz.com/application/osp-n.

Also, we recommend reading the application note "Guidance on Selecting and Handling Coaxial RF Connectors", which is available on the Internet at www.rohde-schwarz.com/appnote/1MA99.

1.3.8 Tutorials

Tutorials offer guided examples and demonstrations on operating the R&S OSP. They are provided on the product page of the internet.

2 Getting Started

Note: the sections [Preparing for Use](#), [Instrument Tour](#) and [Trying Out the Switch Unit](#) are reproduced equivalently in the printed Getting Started manual of the R&S OSP.

• Preparing for Use	15
• Instrument Tour	25
• Trying Out the Switch Unit	32
• Mounting a Module	41

2.1 Preparing for Use

Here, you can find basic information about setting up the instrument for the first time.

• Lifting and Carrying	15
• Unpacking and Checking	16
• Choosing the Operating Site	16
• Setting Up the Product	17
• Accessory List	18
• Considerations for Test Setups	19
• Connecting to Power	20
• Connecting to LAN	20
• Connecting Monitor, Mouse and Keyboard	21
• Connecting RF Cables	21
• Connecting Control Cables	22
• Switching On or Off	22
• Checking the Installed Modules	23
• Configuring the Initial Instrument Settings	24

2.1.1 Lifting and Carrying

See "[Lifting and carrying the product](#)" on page 8.

The R&S OSP has protruding handles at the left and right of its front panel. Each handle is designed to carry the weight of the switch unit. Also, the handles provide some mechanical protection for the front panel.



Figure 2-1: Handles (1) for lifting and carrying the R&S OSP. Underneath: foldable feet (2)

2.1.2 Unpacking and Checking

1. Unpack the product carefully.
2. Retain the original packing material. Use it when transporting or shipping the product later.
3. Using the delivery notes, check the equipment for completeness.
4. Check the equipment for damage.

If the delivery is incomplete or equipment is damaged, contact Rohde & Schwarz.

2.1.3 Choosing the Operating Site

Specific operating conditions ensure proper operation and avoid damage to the product and connected devices. For information on environmental conditions such as ambient temperature and humidity, see the data sheet.

See also "[Choosing the operating site](#)" on page 8.

Electromagnetic compatibility classes

The electromagnetic compatibility (EMC) class indicates where you can operate the product. The EMC class of the product is given in the data sheet under "General data".

- Class B equipment is suitable for use in:
 - Residential environments
 - Environments that are directly connected to a low-voltage supply network that supplies residential buildings
- Class A equipment is intended for use in industrial environments. It can cause radio disturbances in residential environments due to possible conducted and radiated disturbances. It is therefore not suitable for class B environments. If class A equipment causes radio disturbances, take appropriate measures to eliminate them.

2.1.4 Setting Up the Product

See also "Intended use" on page 7 and "Setting up the product" on page 8.

2.1.4.1 Placing the Product on a Bench Top

To place the product on a bench top

1. Place the product on a stable, flat and level surface. Ensure that the surface can support the weight of the product. For information on the weight, see the data sheet.
2. **CAUTION!** Foldable feet can collapse. See "Setting up the product" on page 8. Always fold the feet completely in or out. With folded-out feet, do not place anything on top or underneath the product.
3. **WARNING!** A stack of products can fall over and cause injury. Never stack more than three products on top of each other. Instead, mount them in a rack.

Stack as follows:

- If the products have foldable feet, fold them in completely.
- It is best if all products have the same dimensions (width and length). If the products have different dimensions, stack according to size and place the smallest product on top.
- Do not exceed the permissible total load placed on the product at the bottom of the stack:
 - 50 kg when stacking products of identical dimensions (left figure).
 - 25 kg when stacking smaller products on top (middle figure).

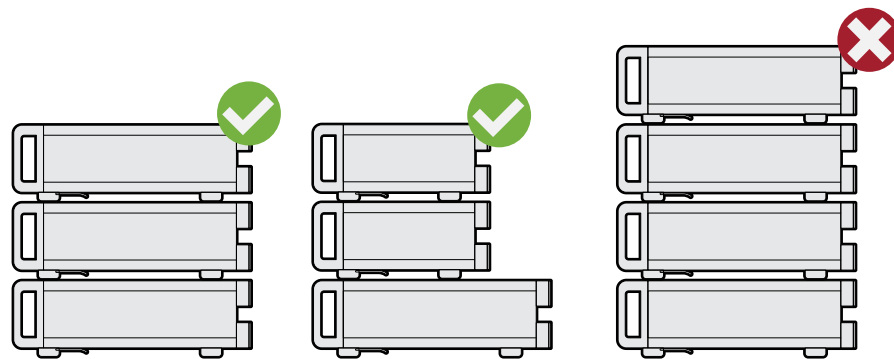

Left = Stacked correctly, same dimensions
 Middle = Stacked correctly, different dimensions
 Right = Stacked incorrectly, too many products

4. **NOTICE!** Overheating can damage the product.

Prevent overheating as follows:

- Keep a minimum distance of 10 cm between the fan openings of the product and any object in the vicinity.

- Do not place the product next to heat-generating equipment such as radiators or other products.

2.1.4.2 Mounting the Product in a Rack

Note that the satellite unit R&S OSP-B200S2 is not designed for rack-mounting.

To prepare the rack

1. Observe the requirements and instructions in "[Setting up the product](#)" on page 8.
2. **NOTICE!** Insufficient airflow can cause overheating and damage the product. Design and implement an efficient ventilation concept for the rack.

To mount the product in a 19" rack

1. Use an adapter kit to prepare the product for rack mounting.
 - a) Order the rack adapter kit designed for the product:
 - For 2 HU (R&S OSP220 and R&S OSP230), use R&S ZZA-KNA21 (order no. 1177.8026.00)
 - For 3 HU (R&S OSP320), use R&S ZZA-KNA31 (order no. 1177.8032.00)
 - b) Mount the adapter kit. Follow the assembly instructions provided with the adapter kit.
2. Grab the R&S OSP by its handles ([Figure 2-1](#)).
3. Insert it onto the shelf until the rack brackets fit closely to the rack.
4. Tighten all screws on the rack brackets, typically with a torque of 4.6 Nm, to secure the product in the rack.

To unmount the product from a rack

1. Loosen the screws at the rack brackets.
2. Remove the product from the rack.
3. If placing the product on a bench top again, unmount the adapter kit from the product. Follow the instructions provided with the adapter kit.

2.1.5 Accessory List

The R&S OSP base unit comes with the following accessories:

- Printed "Getting Started" manual, English (order no. 1178.7117.02)
- Ethernet (LAN) cable, 2 m, RJ45 (1:1), category 6 (order no. 0041.9748.00)
- Power supply cable, delivered country-specific to fit your local wall outlet format, see [Table 2-1](#)

Table 2-1: Power cords

Power supply cables according to country-specific standards	Order no.
European standard	0025.2365.00
Angular adapter for European standard	0086.4400.44
British standard	0006.7013.00
Swiss standard	0006.7020.00
US American standard	0006.7036.00
Australian standard	0006.7107.00
Chinese standard	0041.4752.00
Japanese standard	0041.6232.00
Brazilian standard	3587.8102.00

2.1.6 Considerations for Test Setups

Preventing electrostatic discharge (ESD)

Electrostatic discharge is most likely to occur when you connect or disconnect a DUT.

- ▶ **NOTICE!** Risk of electrostatic discharge. Electrostatic discharge can damage the electronic components of the product and the device under test (DUT).

Ground yourself to prevent electrostatic discharge damage:

- a) Use a wrist strap and cord to connect yourself to ground.
- b) Use a conductive floor mat and heel strap combination.

A risk of damage due to ESD is typically limited to switch units that are equipped with modules that have one or more of the following features:

- Digital input or output ports (I/O ports)
- Solid-state relays (SSR)
- Integrated amplifiers in special modules that are delivered as part of a test system

Preventing electromagnetic interference (EMI)

Electromagnetic interference (EMI) can affect the measurement results.

To suppress electromagnetic radiation during operation:

- Use high-quality shielded cables, for example, double-shielded RF, LAN and HDMI cables.
Note: USB cables are of varying and often poor quality. Therefore, consider the quality of each individual USB cable.
- Always terminate open cable ends.
- Note the EMC classification in the data sheet.
- Ensure that connected external devices comply with EMC regulations.

Preventing overload on internal terminations

Overloading an electromechanical RF relay with internal port termination can damage or destroy the relay.

The maximum load that the internal termination of one port can handle is approximately 1 W. However, if the relay has several terminated ports, their cumulative maximum load is less than the sum. For example, an SP6T relay with 6 internally terminated ports cannot handle 6 W, but typically 3 W, only.

To avoid the risk of damage due to overloading internal terminations, limit the load to the "Max. termination power per relay" that is specified in the [data sheet](#).

2.1.7 Connecting to Power

The switch unit is equipped with an AC power supply connector and can be used with different AC voltages. The R&S OSP adapts itself automatically to the voltage. Refer to the data sheet for the voltage and frequency requirements. The AC power connector is on the rear panel of the switch unit.

- ▶ Connect the R&S OSP to an AC power supply using the supplied power cable. As the switch unit's assembly is in line with the specifications for safety class EN61010, you must connect it only to an outlet that has a ground contact.

For replacing the fuses, refer to [Chapter 12.1, "Replacing Fuses"](#), on page 305.

2.1.8 Connecting to LAN

The LAN connector (RJ45) of the R&S OSP is on its rear panel, shown in [Figure 2-16](#).

Network environment

Before connecting the product to a local area network (LAN), consider the following:

- Install the latest firmware to reduce security risks. See [Chapter 12.3, "Firmware Update"](#), on page 307.
- For internet or remote access, use secured connections if applicable. For example, use HTTPS, SFTP, FTPS instead of HTTP, FTP.
- Ensure that the network settings comply with the security policies of your company. Contact your local system administrator or IT department before connecting your product to your company LAN.
- When connected to the LAN, the product may potentially be accessed from the internet, which may be a security risk. For example, attackers might misuse or damage the product.

For more information on how to connect the switch unit to the LAN, and for the IP address, see [Chapter 4.3, "LAN Connection"](#), on page 149.

2.1.9 Connecting Monitor, Mouse and Keyboard

The HDMI and USB connectors for an external monitor, a mouse and a keyboard are on the front panel of the R&S OSP, shown in [Figure 2-16](#).

For connecting these devices, see [Chapter 4.2, "Instrument Control"](#), on page 148.

2.1.10 Connecting RF Cables

Many [modules](#) are designed for connecting test equipment via RF cables.

Excessive tightening of coaxial RF connections can damage the connectors of both cables and modules. Too weak tightening leads to inaccurate measurement results.

Connecting RF cables / TORQUE RECOMMENDATIONS

For best connections, proceed as follows:

1. Carefully **align** the connectors along a common axis.
2. Mate the connectors along the common axis until the male pin of the inner connector engages with the female socket of the outer connector.
3. When fastening the connectors, **only turn the nut** of the outer connector until the connectors are firmly coupled.
Avoid rotating the body of the outer connector.
4. If the inner connector is on a cable, hold it stationary with a spanner.
5. For fastening the connection, use a calibrated **torque wrench** suitable for the connector type.
Never use a standard open-end wrench.
6. Fasten the nut of the outer connector to the specified torque limit.
For specifications, refer to **application note 1MA99**, which is available on the Internet at www.rohde-schwarz.com.

For N, SMA and PC connectors, we recommend applying the following torque limits:

- **150 N·cm** for **N** connectors
- **56 N·cm** for **SMA** connectors (standard, PTFE-filled)
- **90 N·cm** for **PC** connectors (3.5 mm / 2.92 mm / 2.4 mm / 1.85 mm, air-filled)

Rohde & Schwarz offers torque wrenches for various connectors. For ordering information, also refer to the application note 1MA99

7. Note that 3.5 & 2.92 mm PC connectors are **incompatible** with 2.4 & 1.85 mm PC connectors.

2.1.11 Connecting Control Cables

Many [modules](#) are designed for connecting test equipment via control cables. Typically, these connections are straight forward and require no precautions.

However, **take special care** in the following cases:

- In I/O modules (input / output), avoid overloading the **digital input lines**. The maximum voltage to be applied directly to the input connectors is TTL level: standard 3.3 V DC, tolerating up to 5 V DC. For voltages > 5 V DC up to 28 V DC, insert a resistor in series with a minimum resistance of **22 kΩ**.
- In the satellite system, use the **[Wired Link]** connectors **only** for connecting the remote control module R&S OSP-B200R with the satellite unit R&S OSP-B200S2. Connecting a [Wired Link] connector to any other device's connector can damage your equipment.
See [Chapter 2.2.2.4, "Rear Panel of the R&S OSP-B200S2 Satellite Unit"](#), on page 31, and [Chapter 3.56, "R&S OSP-B200R Remote Control Module"](#), on page 142.

2.1.12 Switching On or Off

Table 2-2: Overview of power states

Status	LED above [Pwr] key	Position of rear power switch
Off	Off	[0]
Standby	● orange	[I]
Ready	● green	[I]

To switch on the R&S OSP

The product is off but connected to power.

- ▶ Set the AC power switch on the rear panel to position [I].

The instrument is supplied with AC power. After booting, the instrument is ready for operation. A green LED above the [Pwr] key on the front panel indicates the operating mode.

To shut down the R&S OSP

1. **NOTICE!** Risk of data loss. See ["How to avoid losing settings"](#) on page 23.
Check the LED above the [Pwr] key on the front panel (labeled 7 in [Figure 2-16](#)).
 - If the LED emits orange light ●, do not press the [Pwr] key.
The switch unit is already in standby mode.
 - Otherwise, if the LED emits green light ●, set the switch unit to standby mode by pressing the [Pwr] key.
The LED changes from green to orange light, indicating **standby mode**. The switch unit is now unavailable via LAN, even if connected.
2. Optionally, set the AC power switch on the rear panel to position [O].

The R&S OSP changes into **off mode**.

To disconnect from power

1. Shut down the switch unit.
2. Disconnect it from the power source.

How to avoid losing settings

While the R&S OSP is in operating mode, if you switch it off using the rear panel switch or by disconnecting the power cord, the instrument loses its current settings. (Operating mode is indicated by a green LED above the [Pwr] key.)

For example, if you have selected signal paths previously, you must select and enable these paths again, when you restart the switch unit.

To avoid a loss of settings, press the [Pwr] key first to set the switch unit into standby mode. Then shut it down properly by setting the rear AC power switch to position [O].

- If "Configuration" > "General" > "Switch-On Reset" is activated, the R&S OSP resets all internal latching switches during the startup procedure.
- If "Configuration" > "General" > "Switch-On Action" is set to "Switch Path", the R&S OSP loads the previously set path while booting. The switch unit activates this path when the startup procedure is completed.



Display timeout

The **OLED status display** of a switch unit R&S OSP220 or R&S OSP320 serves for showing you the network connection. The LAN connection is set typically at power-up.

The status display switches off automatically after setting the LAN connection with a timeout specified by the [Status Display Period](#). Without a network connection, the status display switches off with the same timeout after power-up. This feature helps to prevent burn-in effects often seen in OLED displays.

When the switch unit is connected via a new network address, the status display is switched on again for the next 30 minutes. (Your server can assign a new address, for example, when you change the switch unit's [network settings](#) from static IP to DHCP.)

The RGB-LED **touchscreen display** in the R&S OSP230 and in the module R&S OSP-B300M needs no burn-in protection. Thus, it has no timeout.

2.1.13 Checking the Installed Modules

The instrument is typically equipped with one or more optional [switch modules](#).

You can visually check whether the modules listed on your delivery note correspond with the installed modules. Each module's name is printed on its panel.



You can also view the installed modules in the "Module Operation" dialog (touchscreen display or "WebGUI", see [Chapter 2.3.2, "User Interface and Functional Elements"](#), on page 34):



Figure 2-2: The module operation dialog, here with a single switch unit and 5 modules

The information in this dialog is updated during the booting process, when the R&S OSP automatically scans all its installed modules. The switch unit stores the information on these modules in its internal flash memory (SD card).

If you have **mounted** additional modules or removed original ones, the switch unit detects and stores this changed configuration of modules. If **Module Check** is enabled, the R&S OSP automatically prompts you with information on the changed modules.

If the **Virtual Mode** is enabled, you can **edit** the list of frames (switch units) and their modules.

To check the installed options from a remote computer in the same local area network as the R&S OSP, you can use the remote control command `ROUTE:MODule:CATalog?` on page 295.

2.1.14 Configuring the Initial Instrument Settings

After startup, the switch unit is fully configured automatically, and ready for use.

However, you have many options to change the configuration, for example:

- Edit the network settings, see [Chapter 5.4.3, "Network"](#), on page 210
- Define or modify a setup of primary and secondary switch units, see [Chapter 5.4.4, "Interconnection"](#), on page 212
- Restore a previous setting, see ["Backup/Restore"](#) on page 215
- Define switching paths and output channels, see ["Manage path selection:"](#) on page 185

Configuring a setup of primary and secondary switch units is described in [Chapter 5.4.4, "Interconnection"](#), on page 212.

2.2 Instrument Tour

- [Front Panel View](#).....25
- [Rear Panel View](#).....29

2.2.1 Front Panel View

The following chapters describe the front panels of all models of the R&S OSP switch unit family. For the functional elements, refer to [Chapter 2.3.2](#).

2.2.1.1 Front Panel of the R&S OSP220

The front panel of the R&S OSP220 features 3 module slots, a monochrome non-touch status display, a power switch and various connectors.

The R&S OSP220 occupies 2 height units (2HU) in a standard 19" rack. You can insert 1-slot, 2-slot or 3-slot modules into the 3 front slots:



Figure 2-3: Front view of the R&S OSP220 (2HU)

FS01 = Front slot 01, here with a blind plate

FS02 = Front slot 02, here with a 1-slot switch module

FS03 = Front slot 03, here with a blind plate

F Int = Front interfaces and status display (OLED, 128 x 64 pixels), see [Figure 2-16](#)

2.2.1.2 Front Panel of the R&S OSP230

The front panel of the R&S OSP230 features 2 module slots, an integrated [touch-screen display](#), a power switch and various connectors.

The R&S OSP230 occupies 2 height units (2HU) in a standard 19" rack. You can insert two 1-slot modules or one 2-slot module into the 2 front slots:



Figure 2-4: Front view of the R&S OSP230 (2HU)

FS01 = Front slot 01, here with a blind plate
 FS02 = Front slot 02, here with a 1-slot switch module
 Disp. = Integrated touchscreen display (and no front slot 03)
 F Int = Front interfaces, see [Figure 2-16](#)

2.2.1.3 Front Panel of the R&S OSP320

The R&S OSP320 is higher than all other switch units from Rohde & Schwarz. With its 3 height units (3HU), it enables a more dense fitting of 1-slot switch modules within the same instrument width. Hence, its front panel features 5 module slots, along with a power switch, a status display and various connectors.

2 of the 5 front slots (labeled FS04 and FS05 in [Figure 2-5](#)) can hold the factory-mounted optional touchscreen display module R&S OSP-B300M:



Figure 2-5: Front view of the R&S OSP320 (3HU)

FS01 to FS03 = Front slots 01 to 03, here each with a 1-slot switch module
 FS04 + FS05 = Front slot 04 and 05, here with mounted touchscreen display module
 F Int = Front interfaces and status display (OLED, 128 x 64 pixels), see [Figure 2-16](#)

The dedicated [touchscreen display](#) module [R&S OSP-B300M](#) shown in [Figure 2-5](#) is optional. It can only be factory-mounted in the R&S OSP320 with 3 height units (3HU) in position FS04 + FS05.

You cannot insert any modules into the R&S OSP320 that are designed as 2-slot or 3-slot modules for a switch unit with 2 height units (2HU, see above).

For details on mounting limitations, refer to [Chapter 2.4.1, "Module Integration Overview"](#), on page 46.

2.2.1.4 Front Panel of the R&S OSP-B200S2 Satellite Unit



For a comprehensive description of this unit, also refer to the **R&S OSP-B200R/B200S2 Satellite System user manual**, available for download at www.rohde-schwarz.com/manual/osp-n.

The R&S OSP-B200S2 is a standalone device, only, not to be mounted into a 19" rack. The front panel of satellite unit features 2 module slots, into which you can insert 1-slot or 2-slot modules:



Figure 2-6: Front view of the R&S OSP-B200S2 (2HU)

SlotA = Front slot A, here with a 1-slot switch module
SlotB = Front slot B, here with a 1-slot switch module

This unit is designed to serve as a satellite with up to 2 switch modules, controlled from a base switch unit with remote control module [R&S OSP-B200R](#).

For example, you can use the satellite unit inside a shielded chamber for EMC tests that do not tolerate electrical wiring. In this scenario, use the satellite with local battery power supply, and control the switch modules fitted in the unit via a fiber-optic link. See also ["Wired Link versus Fiber-Optic Link"](#) on page 31.

2.2.1.5 Touchscreen



Figure 2-7: Touchscreen display, here showing the Main menu

- The R&S OSP230 is equipped with an **integrated** touchscreen display on the front panel.
- The R&S OSP320 can be equipped with the touchscreen display **module R&S OSP-B300M**.

Touch the screen gently with your fingers or use a stylus pen with a smooth soft tip.

For instructions on cleaning the screen, see [Chapter 12.2, "Cleaning"](#), on page 306.

Both the *integrated display* and the *display module* are based on a touch-sensitive RGB LCD with a resolution of 800 x 480 pixels.

The touchscreen display offers one out of several means of user interaction for easily handling the switch unit. It shows the relay and switch-path settings, provides status information and allows configuring and controlling your measurement tasks.



The touchscreen reacts in a defined way when you tap a particular element on the screen with a finger or with a pointing device, for example an external USB mouse. Any user interface element that reacts to a click by a mouse pointer also reacts to a tap on the screen, and vice versa. Using the touchscreen, you can perform all tasks by the tap of your finger.

For the remainder of this manual, all interactions are described for a "click" action. These descriptions also mean the equivalent "tap" action using the touchscreen.

On-screen keyboard

The on-screen keyboard is an additional means of direct interaction with the switch unit R&S OSP230 or R&S OSP320, the latter if equipped with touchscreen module [R&S OSP-B300M](#).



Figure 2-8: Different versions of the on-screen keyboard

Left = Numbers and characters allowed
 Center = Decimal numbers, only
 Right = Hexadecimal numbers

The touchscreen automatically opens an on-screen keyboard, if your current action requires entering numbers or characters. The cancel button or the OK button closes the on-screen keyboard.

Instead of using the on-screen keyboard, you can enter data with a connected external keyboard (Figure 2-13) or via the user interface in a browser (Figure 2-14).

2.2.2 Rear Panel View

The following chapters describe the rear panels of all models of the R&S OSP switch unit family. For the functional elements, refer to Chapter 2.3.2.

The meanings of the labels on the product are described in Chapter 1.1.3, "Labels on the Product", on page 10.

2.2.2.1 Rear Panel of the R&S OSP220

The rear panel of the R&S OSP220 features 3 module slots, an on/off switch, fuses, power supply connector, LAN and USB connectors and a micro SD card slot. You can insert 1-slot, 2-slot or 3-slot modules into the 3 rear slots:



Figure 2-9: Rear view of the R&S OSP220 (2HU)

R Int = Rear interfaces, see Figure 2-16
 RS01 to RS03 = Rear slots 01 to 03, here each with a blind plate

2.2.2.2 Rear Panel of the R&S OSP230

The rear panel of the R&S OSP230 features 3 module slots, an on/off switch, fuses, power supply connector, LAN and USB connectors and a micro SD card slot. You can insert 1-slot, 2-slot or 3-slot modules into the 3 rear slots:



Figure 2-10: Rear view of the R&S OSP230 (2HU)

R Int = Rear interfaces, see [Figure 2-16](#)

RS01 to RS03 = Rear slots 01 to 03, here each with a 1-slot switch module

2.2.2.3 Rear Panel of the R&S OSP320

The rear panel of the R&S OSP320 features 5 module slots, an on/off switch, fuses, power supply connector, LAN and USB connectors and a micro SD card slot:

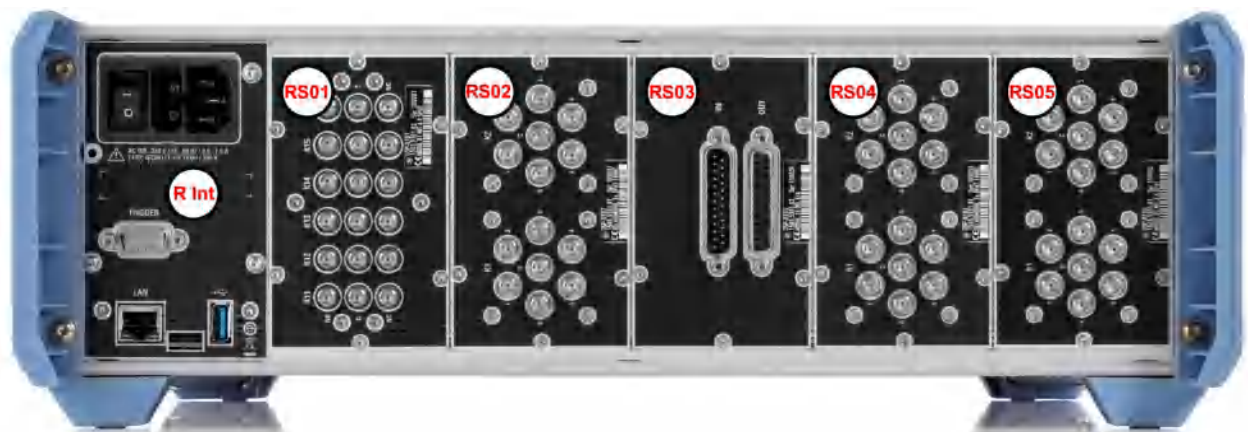

Figure 2-11: Rear view of the R&S OSP320 (3HU)

R Int = Rear interfaces, see [Figure 2-16](#), with an additional D-Sub 9 trigger connector

RS01 to RS05 = Rear slots 01 to 05, here each with a 1-slot switch module

You cannot insert any modules into the R&S OSP320 that are designed as 2-slot or 3-slot modules for a switch unit with 2 height units (2HU, see above).



The D-Sub 9 trigger connector (next to the label "R Int" in [Figure 2-11](#)) is only available in the rear interface panel of the R&S OSP320, not in any other switch unit. This connector enables the [Addressed](#) hardware trigger.

2.2.2.4 Rear Panel of the R&S OSP-B200S2 Satellite Unit



For a comprehensive description of this unit, also refer to the **R&S OSP-B200R/B200S2 Satellite System user manual**, available for download at www.rohde-schwarz.com/manual/osp-n.

The rear panel of the R&S OSP-B200S2 features various connectors and LEDs. You cannot insert any modules into the rear panel of the R&S OSP-B200S2.



Figure 2-12: Rear view of the R&S OSP-B200S2 (2HU)

- 1 = DC power supply connector
- 2 = Fiber-optic link (FOL) connector for optical remote control
- 3 = Wired link connector for electrical remote control
- 4 = Status LEDs for indicating [Power] and [Overheat]
- 5 = Status LED for indicating [Link / Busy]

Wired Link versus Fiber-Optic Link

The link connectors (labeled 2 and 3 in [Figure 2-12](#)) allow choosing either an electrical or an optical control connection.

- **Wired link**

For remote operation of the satellite unit R&S OSP-B200S2 across distances up to 10 m, use the D-Sub cable R&S OSP-Z200x. Connect this cable **exclusively** to the remote control interface module [R&S OSP-B200R](#) in your base switch unit. Connecting it to any other device or module can harm your equipment.

The wired link cable supplies power from the base switch unit to the satellite.
- **Fiber-optic link**

For remote operation of the satellite unit R&S OSP-B200S2 across larger distances up to 20 m, or inside a shielded room, use the fiber-optic cable R&S OSP-Z201x or R&S OSP-Z202x.

As the fiber-optic link cable does not supply power to the satellite unit, you must also use the 28 V DC power supply R&S OSP-B200P.

2.3 Trying Out the Switch Unit

This chapter introduces the most important basic operations and settings of the R&S OSP step by step. The complete description of the functionality and its usage is given in [Chapter 5, "Functions"](#), on page 155.

Prerequisite: the instrument is set up, connected to mains power supply and [started up](#). The next sections describe:

- [Manual and Remote Modes of Operation](#)..... 32
- [User Interface and Functional Elements](#)..... 34
- [Main Action Buttons](#)..... 37
- [Elements of the Status Bar](#)..... 38
- [Manual Module Operation: Switching / Selecting](#).....39

2.3.1 Manual and Remote Modes of Operation

You can operate the switch unit by any of the following modes:

- [Direct Manual Operation](#)..... 32
- [Manual Remote Operation](#)..... 33
- [Remote Operation by SCPI Commands](#)..... 33

2.3.1.1 Direct Manual Operation

If you use an R&S OSP230 or an R&S OSP320 with display module R&S OSP-B300M, you can control your switch unit by the user interface on the integrated touch-screen display.

Alternatively, with any of the R&S OSP models, you can control your switch unit via an external mouse and keyboard, connected to the USB interfaces (see 4 in [Figure 2-16](#)). Optionally (especially without integrated touchscreen), you can connect an external monitor to the switch unit's HDMI interface (see 5).



Figure 2-13: Operation by integrated touchscreen (1) or by external USB / HDMI devices (2)



For scrolling the touchscreen, swipe it with your finger. With an external monitor, click and use the mouse wheel or the keyboard's up/down keys.

For connecting external devices, see [Figure 2-16](#).

2.3.1.2 Manual Remote Operation

You can control one or more switch units by working with the user interface in a web browser ("WebGUI") on a remote computer that is connected via LAN. Refer to [Chapter 4, "Operation"](#), on page 147.



Figure 2-14: Manual remote operation via "WebGUI" and LAN

RJ45 = Ethernet (LAN) connector on the rear panel of each switch unit

For [interconnecting](#) several switch units, see [Chapter 4.4, "Operation in Interconnection Mode"](#), on page 150.



Note that the legacy software R&S OSP Panel is not compatible with the switch units R&S OSP220, R&S OSP230 and R&S OSP320.

2.3.1.3 Remote Operation by SCPI Commands

You can control the R&S OSP by SCPI commands sent from a remote computer that is connected via LAN. Refer to [Chapter 4, "Operation"](#), on page 147.

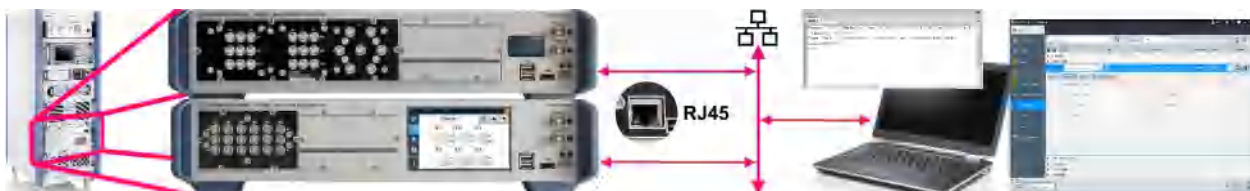

Figure 2-15: Remote operation by SCPI commands

RJ45 = Ethernet (LAN) connector on the rear panel of each switch unit
Far left = Two switch units integrated in a test system like R&S CEMS

To do so, you have the following options:

- For SCPI command communication, use a terminal program like R&S Forum or similar programming interface (for example with R&S VISA driver), see [Chapter 7, "Remote Operation"](#), on page 240. For remote control commands, refer to [Chapter 8, "RC Commands"](#), on page 246.
- Use your own application to communicate with the R&S OSP via a VISA interface or directly via a TCP/IP raw socket connection.
- Let a test system software like [R&S EMC32](#) or [R&S ELEKTRA](#) send the required commands.

The R&S OSP can handle up to 5 open SCPI command connections simultaneously.

See also ["Remote operation vs. GUI operation"](#) on page 241.

2.3.2 User Interface and Functional Elements



The switch unit R&S OSP230 and the display module R&S OSP-B300M have a **touchscreen display**.

For a description of the functions of this interface, refer to [Chapter 5, "Functions"](#), on page 155.



The switch units R&S OSP220 and R&S OSP320 have a **status display**.

For a description of the information shown in the status display, see below.

See also ["Display timeout"](#) on page 23.

When you switch on an R&S OSP220 or R&S OSP320 with status display, it originally shows the following information, before the device is operational:

- 1st line: **device type**, for example "OSP320"
- 2nd line: **firmware version**, for example "FW Ver. 2.0"
- 3rd line: **subnet mask**, for example "FPGA Ver. 7.1 A"
- 4th line: "Booting...", then "Scanning Mxx..."

After booting and scanning, the status display shows the following information:

- 1st line: **hostname** or "Hostname N/A"
- 2nd line: **IP address** or "Address N/A" or "Auto-DHCP" (if [Auto-DHCP](#) is enabled, but the switch unit is "Disconnected")
- 3rd line: **subnet mask** or "Mask N/A"
- 4th line: **device status information**

Not all applicable device status information may fit into the 4th line. Therefore, this line shows only the 1 most relevant information from up to 2 of the following groups in an order of relevance as listed here:

- **Connection mode** information:
 - "SEC" (secondary device in an [Interconnection](#) setup)
 - "LLO" (remotely controlled with local lock-out)
 - "Remote" (without LLO)
 - "PRIM" (primary device in an [Interconnection](#) setup)
 - "Disconnected" (which also implies "Single" state)

If the switch unit is in none of these modes, it is in "Single" mode (which is not displayed).

- **"Device messages"** (see [Figure 5-4](#)):
 - Errors
 - Warnings

If no errors and no warnings are available, no device message is displayed.

- **Additional information:**

- "Trigger"
- "Locked"

If the switch unit is not **triggered** and not **locked**, no additional information is displayed. Also, if both a connection message and a device message are shown already, additional information (which has lower relevance) is skipped due to a lack of space.

- **Connection state** information:

If none of the above is valid, the 4th line of the status display shows one of the following states of the switch unit:

- "Auto DHCP" (which also implies "Single" state)
- "Static IP" (which also implies "Single" state)
- "Disconnected"

During shutdown, the status display displays "Terminating...".

You cannot operate the switch units R&S OSP220 – and the R&S OSP320 without display module R&S OSP-B300M – by their status displays. To operate these switch units without the graphical user interface of a built-in full touchscreen display, use one of the following alternatives:

- As on the right-hand side in [Figure 2-13](#), connect an external monitor to the HDMI connector on the unit's front panel (labeled 5 in [Figure 2-16](#)). Also connect a mouse and keyboard to the USB connectors, labeled (4).
- Use the switch unit as a secondary device in [interconnection](#) mode, as described in [Chapter 4.4, "Operation in Interconnection Mode"](#), on page 150.
- Connect the switch unit to a local area network (LAN) by the RJ45 connector on the unit's rear panel. The connector is labeled (1) in [Figure 2-16](#). Read the unit's IP address from the status display and proceed as described in [Chapter 2.3.1.2, "Manual Remote Operation"](#), on page 33, or [Chapter 2.3.1.3, "Remote Operation by SCPI Commands"](#), on page 33.

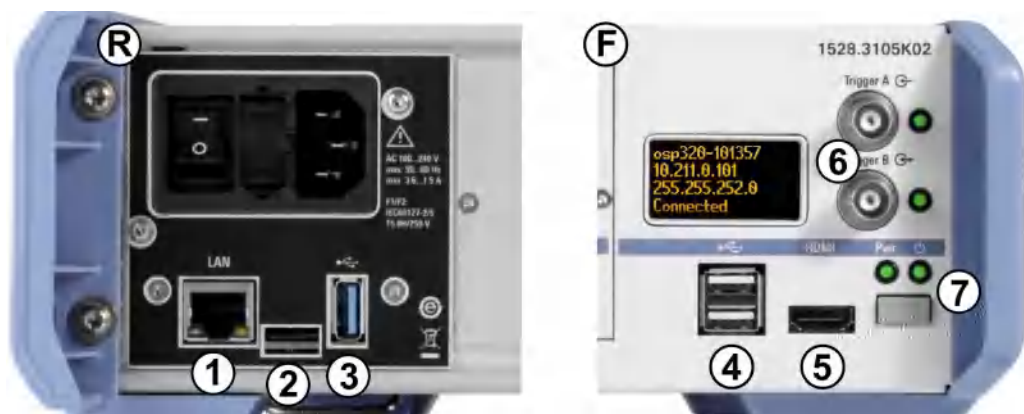

Figure 2-16: Connectors and functional elements on the switch unit's rear and front panel

- R = Rear interfaces (where the R&S OSP320 has an additional trigger port, see [Figure 2-11](#))
- F = Front interfaces (where the R&S OSP230 has no OLED status display, see [Chapter 2.3, "Trying Out the Switch Unit"](#), on page 32)
- I/O = Main power switch with fuse holder and power connector
- 1 = LAN connector (RJ45)
- 2 = Slot for the micro SD card that holds the switch unit's operating system
- 3 = USB 3.1 connector
- 4 = Two USB 2.0 connectors (for external mouse and keyboard)
- 5 = HDMI connector (for an external monitor)
- 6 = Two BNC trigger input connectors (A and B, with two trigger status LEDs), see below
- 7 = Front power switch with [Pwr] and LAN status LEDs



If you connect an external monitor to the **HDMI** connector (5), use a monitor that is compatible with this port's DVI signal. This signal is configured for the touchscreen's resolution of 800 x 480 pixels. Incompatible monitors cannot display the graphical user interface.



With the **trigger** connectors (6), the R&S OSP is prepared for external triggering, which requires the [hardware trigger option R&S OSP-K100](#). Firmware versions below version 2.00 do not support this trigger option.

Note that the rear interface panel of the R&S OSP320 has an additional D-Sub 9 trigger connector, as shown in [Figure 2-11](#).

In any of these configurations, you can operate a switch unit by its user interface: either on an external monitor or in a web browser (we recommend using **Chrome** as browser). The same holds true for the R&S OSP230 and R&S OSP320 with integrated display module R&S OSP-B300M, which allow touchscreen operation.

Using any of these options, you get access to the graphical user interface (GUI):



Figure 2-17: Main menu of the graphical user interface ("WebGUI"), here in the recommended Chrome browser



In the "Main" menu of the user interface, clicking the "Help" icon  in the top right area opens an overview of the available functions:

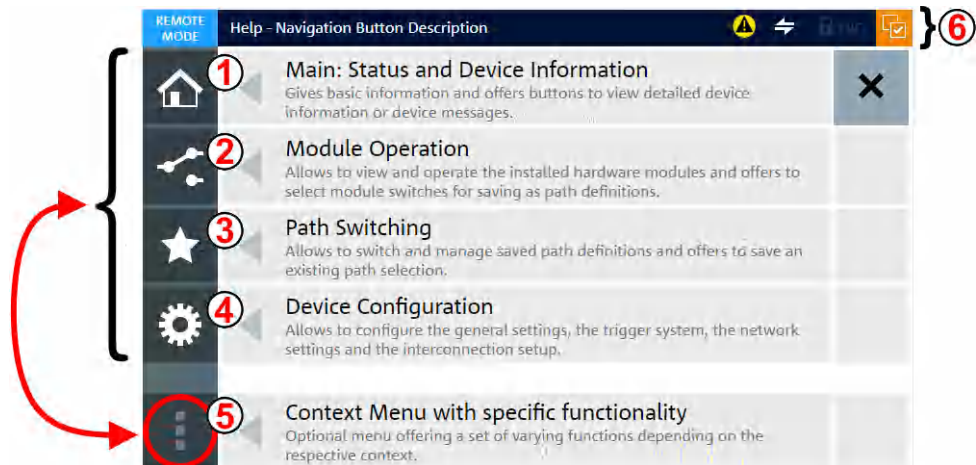

Figure 2-18: Main elements of the graphical user interface (GUI)

- 1 = Main menu
- 2 = Module operation
- 3 = Path switching
- 4 = Device configuration
- 5 = Context menu, always used together with one of the menu buttons above
- 6 = Status bar with varying elements, see [Chapter 2.3.4](#)

The main GUI elements listed above are briefly described in [Chapter 2.3.3, "Main Action Buttons"](#), on page 37, and [Chapter 2.3.4, "Elements of the Status Bar"](#), on page 38. For more information, refer to [Chapter 5, "Functions"](#), on page 155.

2.3.3 Main Action Buttons

The user interface includes the following main action buttons:



The **"Main"** menu provides status information, as host name and IP address. The context menu (5) for the main menu gives additional details, for example the device's serial number and the network gateway.

For more information, refer to [Chapter 5.1, "Main"](#), on page 155.



The **"Module Operation"** dialog allows immediate interaction with the relay switches, including switch selection for a path definition. You can also define output patterns, if available in an installed switch module.

For a brief overview, see [Chapter 2.3.5, "Manual Module Operation: Switching / Selecting"](#). For more information, refer to [Chapter 5.2, "Module Operation"](#), on page 166.



The "**Path Switching**" dialog allows defining, editing and activating paths. You can also export and import paths.

For more information, refer to [Chapter 5.3, "Path Switching"](#), on page 181.



The "**Configuration**" dialog allows configuring the general settings, the optional trigger system, the network settings and the interconnection setup.

(*) Triggering is available only, if you have [activated a license](#) for option R&S OSP-K100.

For more information, refer to [Chapter 5.4, "Configuration"](#), on page 195.

Context Menu



The "**Context Menu**" button calls specific functionality for any of the menu items shown above and listed as (1) to (4) in [Figure 2-18](#). Hence, this button is always used **together** with one of the other buttons.

For more information, refer to the "Context Functions" subchapters of the chapters that are referenced above.

2.3.4 Elements of the Status Bar

The status bar is shown on top in [Figure 2-17](#) and [Figure 2-18](#). The various indicator icons have the following meanings:



Left: the R&S OSP is controlled by its graphical user interface ([locally](#) or [via LAN](#)).

Right: the R&S OSP is controlled remotely by [SCPI commands](#) or as the secondary device in [interconnection](#) mode.



Virtual Mode:

If this label is displayed in the status bar, the R&S OSP is in [Virtual Mode](#).



If the lock icon is highlighted (right), it indicates the [Lock Mode](#).



If the trigger icon is highlighted (right), the [software option R&S OSP-K100](#) is enabled and the [trigger](#) is activated.



If the selection indicator icon is highlighted (right), at least one relay or output channel is [selected](#).

2.3.5 Manual Module Operation: Switching / Selecting



This chapter outlines only the most basic features of the dialogs for manual **Module Operation** that allow immediate interaction with **Switchable items** (relays, output channels).





Click the "Module Operation" button  to see a **list** of all installed switch modules or  to open the **interaction dialog** of one switch module:

Table 2-3: Left overview: list of modules in virtual mode. / Right: interaction dialog of one module in physical mode.

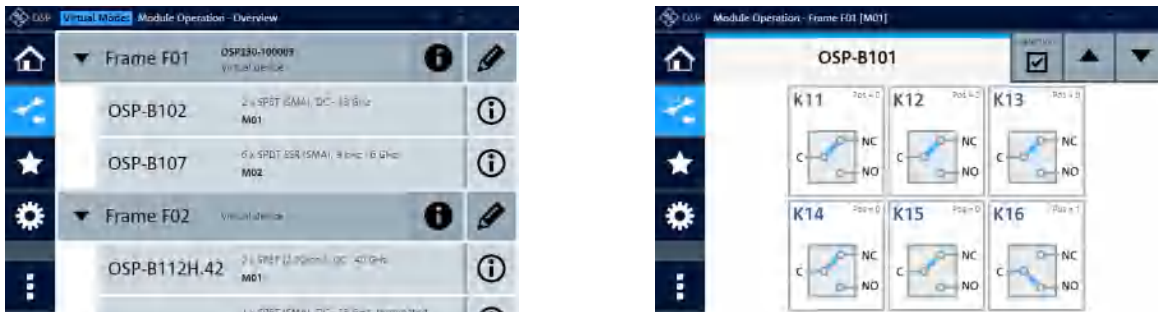

If you see the interaction dialog of one switch module (as in the right picture above), click the "Module Operation" button  to see the list of installed modules (as in the left picture above, here a screenshot in virtual mode). In the icon of the "Module Operation" button, the "back" arrow (available with firmware versions from 1.40) indicates that it brings you back to the list. To see the interaction dialog of any module, click its name in the list.

2.3.5.1 Switching Mode

Allows switching **Switchable items**.

The switching mode is active, as long as the **Selection Mode** is deactivated. In switching mode, clicking the icon of a relay or channel changes its state:

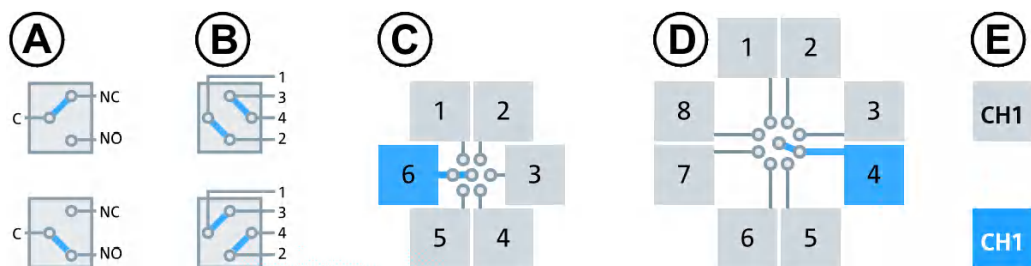

Figure 2-19: Various relay types and the effect of clicking them

- (A) SPDT relays, and (B) DPDT relays: Clicking toggles the state
- (C) SP6T relays, and (D) SP8T relays (or SPxT relays): Clicking a terminal port selects it to be connected to the common port
- (E) Output channels: Clicking toggles the state



For switching relays, output channels or other [Switchable items](#), the "Selection" button (orange, described below) must **not** be active.

2.3.5.2 Selection Mode

Allows selecting [Switchable items](#).

The "Selection" button switches the "Selection Mode" on or off. This button (marked by a red circle in [Figure 2-20](#)) is only available in a view that shows at least one module and its details.

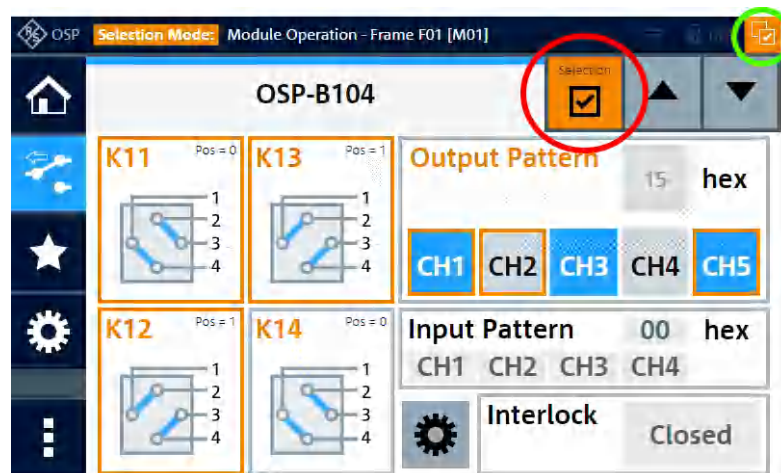

Figure 2-20: Relay or channel selection dialog

- Red circle = If the "Selection" button (mouse-over: "Toggle select mode") is orange, the "Selection Mode" is activated, also indicated by the name color of the selectable items changing from black to orange.
- Green circle = "Items selected" indicator. The icon is highlighted, if at least one relay or output channel in any module is selected.
- Orange frames = Selected relays and output channels are highlighted in the module's interaction dialog

While the "Selection Mode" is active, tapping or clicking the icon of a relay, output channel or other [Switchable items](#) **does not change** its state, but only **selects or deselects** it. This selection is indicated by the icon's name and frame color changing from gray to orange.



Use the selection mode for defining paths and output patterns. To select or deselect all relays and output channels, go to "Module Operation" (or "Path Switching") > "Context Menu" > "Path Selection" > "Select All" or "Deselect All".



In a full-screen window of your web browser, the module interaction dialog can display several modules at the same time:

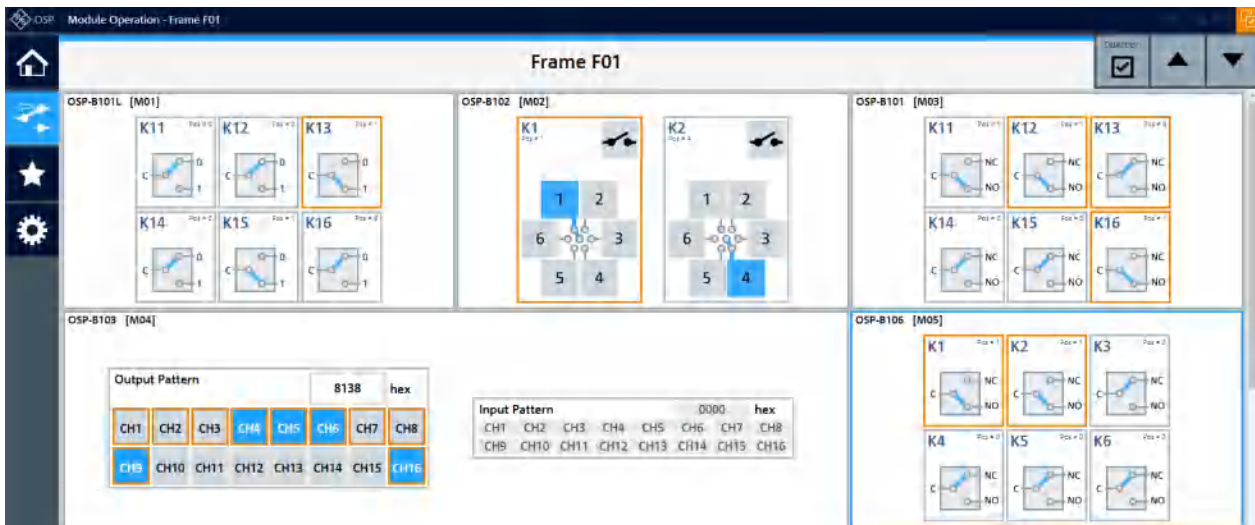

Figure 2-21: Full-screen representation of several modules in a browser window

On the contrary, to reproduce the original size of the touchscreen display, set your browser window to 800 × 480 pixels. Optionally, press [F12] to enter this setting.

Sometimes, the representation at the size of the touchscreen display differs significantly from the representation at full-screen size. For example, the system module R&S OSP-B157WX (which is not described in this user manual) has a touchscreen representation (left in Figure 2-22) that is merely large enough to allow operating the switches. However, the full-screen representation (right in Figure 2-22) also shows the interconnections among the switches:

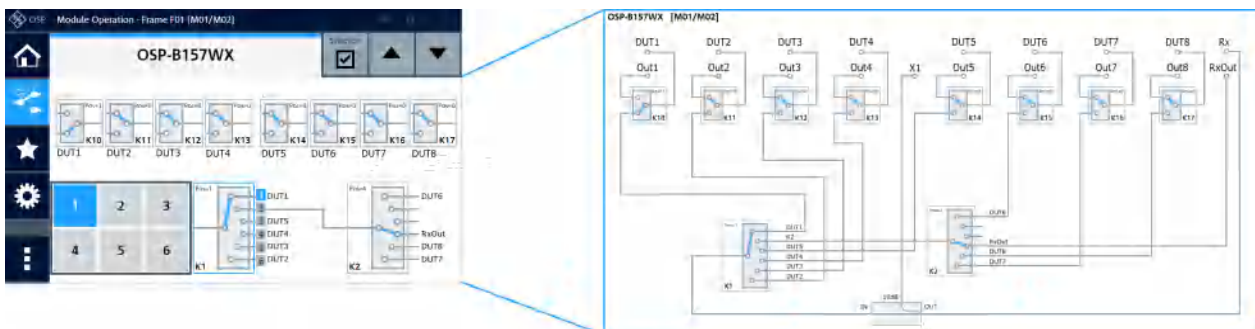

Figure 2-22: Touchscreen (left) and full-screen representation (right) of module R&S OSP-B157WX

For a more detailed description, refer to [Chapter 5, "Functions"](#), on page 155.

2.4 Mounting a Module

If you have ordered your R&S OSP together with [switch modules](#), these modules are already factory-mounted in the base unit and tested by the manufacturer.

However, you can order and mount additional modules.



Limitations in module mounting

Before you order a module, refer to [Table 2-4](#) and to [Table 3-1](#), and consult with Rohde & Schwarz [sales representatives](#) for possible configurations.

The modules R&S OSP-B104 and R&S OSP-B106 must be mounted by Rohde & Schwarz service personnel, as mounting these items requires opening the switch unit's casing. If you try to mount the feedthroughs R&S OSP-B011/R&S OSP-B012, but you cannot feed the cables through the switch unit's casing without opening it, let Rohde & Schwarz service personnel mount the feedthroughs.

The display module R&S OSP-B300M can be mounted into the R&S OSP320 only by the manufacturer and only into the front panel.

If you mount the R&S OSP-B200R for controlling any modules remotely that require two control cables, you must connect the remote control module to two flat-ribbon control cables. If available, use the control cable of a neighboring slot. If no flat-ribbon control cable of a neighboring slot is available, contact Rohde & Schwarz service for mounting it with a second control cable connected to an additional connector on the motherboard.

Never open a switch unit

If opening is required for mounting a module into the switch unit (see [Table 2-4](#)), let Rohde & Schwarz service personnel mount this module.

Risk of injury during module mounting

You can mount modules that do **not require opening** the switch unit. However, mounting a module requires removing at least one blank plate or a previously mounted module, which partly opens the switch unit's casing. The electrical connection required for a new module is via one or two low-voltage flat-ribbon module bus cables, which are easy to reach.

Observe the following:

- Before mounting a module, disconnect the switch unit from power.
- Adhere to the [step-by-step instructions](#) for module mounting.
- Do not use pointed or sharp tools, which can damage internal components or cables, especially their isolation. Any such damage can lead to a short and to accessible life components inside the switch unit.
- Avoid touching possibly life components, which can lead to electric shock.
- Avoid touching any exposed sharp edges or points inside the switch unit, which can lead to personal injury, especially cuts in your fingers. Consider wearing protective gloves, especially when you take module bus cables out of their clamps behind the slot opening (see [step 7 on page 44](#)).
- Avoid interacting with the switch unit's interior in an unintended way, which can lead to unpredictable situations.
- If you drop a metal screw or a similar electrically conductive item into the switch unit, do not turn it on before removing the item, to avoid a short.

Automatic module recognition

Whether a module is mounted by the manufacturer or by you, the switch unit automatically recognizes the module type, as described in [Chapter 2.1.13, "Checking the Installed Modules"](#), on page 23.

Module dimensions

The various modules occupy a **width of 1, 2 or 3 slots** in a 2-HU switch unit.

- The size of a one-slot module's panel (H x W) is 65.5 mm x 107.6 mm
- The size of a two-slot (double-width) module's panel is 65.5 mm x 216.2 mm
- The size of a three-slot (triple-width) module's panel is 65.5 mm x 324.8 mm

The depth of the modules is given as "Dimension (D)" in the data sheet. Most modules are 54 mm to 88 mm deep.



Deep modules

The following standard modules are significantly deeper than the others:

- The R&S OSP-B104 has a depth of **265 mm**
- The R&S OSP-B106 has a depth of **152 mm**
- The R&S OSP-PM-I has a depth of approximately **200 mm** (with cable loop)

The module R&S OSP-B104 occupies more than half of the depth of the switch unit. Therefore, in a slot **opposite** of it (front versus rear), you **cannot install** another **R&S OSP-B104** or a **R&S OSP-PM-I** into the same switch unit. Anyway, the module R&S OSP-B104 must be mounted by Rohde & Schwarz service. If you mount the module R&S OSP-PM-I, mount it opposite of a shorter module or opposite of a blank plate. You cannot mount any deep module into a satellite switch unit R&S OSP-B200S2, as this unit is not deep enough. Also, you cannot mount any three-slot (triple-width) modules into a satellite switch unit. Mounting RF feedthrough panels R&S OSP-B011 or R&S OSP-B012 into a satellite switch unit makes no sense.

To mount a module into a switch unit

1. **WARNING!** The following procedure requires partly opening the switch unit's casing. Doing so while the power is on can lead to electric shock. See ["Risk of injury during module mounting"](#) on page 42.
Before mounting a module:
 - a) Shut down the switch unit, see ["To shut down the R&S OSP"](#) on page 22.
 - b) Set the power switch to position [0] ([Figure 2-16](#)).
 - c) Disconnect the power cable.
2. Optionally disconnect all other cables, too.
3. Select a slot, ideally covered by a blank plate, for mounting the new module on the front or rear side of the switch unit.
If no blank plate is available, consider removing an existing module, instead.

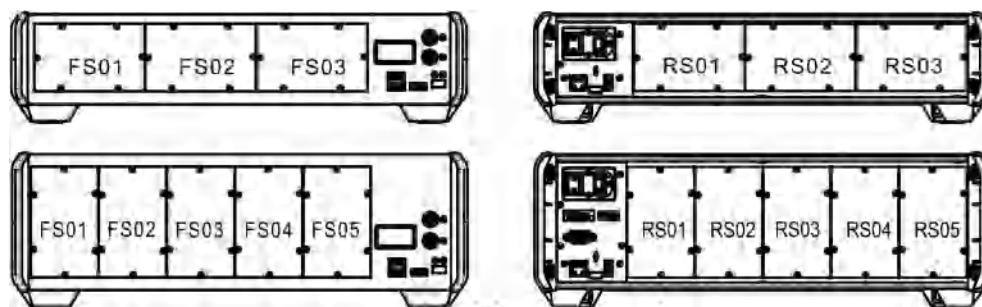

Figure 2-23: Selecting a slot

Top = 2 HU switch unit R&S OSP220 or R&S OSP230

Below = 3 HU switch unit R&S OSP320

Left = Front view

Right = Rear view

FS = Front slots FS01 to FS05

RS = Rear slots RS01 to RS05

FS03 = In the 2 HU switch units, this slot is only available in the R&S OSP220, not in the R&S OSP230

4. Unscrew the six Torx 8 screws from the blank plate or existing module.
5. Remove the blank plate or existing module, keeping the six screws.
6. If you mount a two-slot (double-width) or three-slot (triple-width) module, remove a 2nd or 3rd blank plate or existing module.
Between the slots, also remove the 1 or 2 vertical panel struts (labeled 6 in [Figure 2-25](#)) by removing the Torx 8 screws).
7. **CAUTION!** Avoid touching any exposed sharp edges or points inside the switch unit, which can lead to personal injury, especially cuts in your fingers. Consider wearing protective gloves.
Find a flat-ribbon cable (module bus cable) in the open slot of the switch unit.
8. If a clamp fixes the flat-ribbon cable, remove the cable from the clamp.
9. **NOTICE!** Avoid bad contact with open cable ends. The 26-pin flat-ribbon cable (module bus cable) has open cable ends, which can be live with up to 28 V DC. If the cable ends contact any conductive parts, for example a switch unit's casing, this short connection can cause damage in the switch unit's electronic components.
Avoid any contact of the cable ends with conductive parts.
 - Fix each unused flat-ribbon cable by its clamp (labeled 5 in [Figure 2-25](#)).
 - When clamped, ensure that the open cable ends **point away** from the casing.
 - If an accidental short contact happens and leads to device damage or malfunction, call Rohde & Schwarz service.
10. **NOTICE!** Avoid bad connector mating. Each module is connected to the switch unit by one or two 26-pin flat-ribbon cables (up to 28 V DC, [Figure 2-24](#)). The connector shape serves as protection against reversed (180° rotated) connector mating. Nevertheless, if you use increased force, you can mate the flat-ribbon cable's connector in reversed orientation. This bad connection can damage the electronic components of the switch unit and the module. It can damage also the connector pins.

To avoid this risk, always mate the connector in the correct orientation, with moderate force. Do not rotate or tilt the connector.

Connect the flat-ribbon cable to your module's connector.



Figure 2-24: To attach or release the cable, press the latches on the sides of its connector

11. If you mount a module that has connectors for 2 control cables, connect the module to 2 neighboring flat-ribbon cables of the base unit.

Adhere to the following rules:

- Do not cross-over two flat-ribbon cables (see also the example at the end of the description of [DIAGnostic:SERVICE:HWInfo?](#))
- If you mount a three-slot (triple-width) module, do not skip the flat-ribbon cable of the middle slot
- If you must connect 2 module bus cables (flat-ribbon cables) to a module, connect the cable with the lowest name value (e.g., [M01], see [Figure 2-26](#)) to the module's bus connector with the lowest number (e.g., [X100]). Then connect the second cable [M02] to [X101].
- If you mount the one-slot module R&S OSP-B200R, which requires connecting 2 flat-ribbon module bus cables, we recommend mounting this module in the slot associated to the cable with the highest name value.

For example, in an R&S OSP220, mount it in slot [FS03], which has a module bus cable connected to module bus connector [M08] on the motherboard (see [Figure 2-26](#)). If your application requires connecting 2 module bus cables, use the cable of a neighboring slot (for example [M07] in slot [FS02]) as the additional cable. Connect this cable to connector [X100] on the module, and connect [M08] to [X101].

If necessary, you can use 2 non-neighboring cables for the R&S OSP-B200R. If no cable of a neighboring slot is available, let Rohde & Schwarz service mount this module.

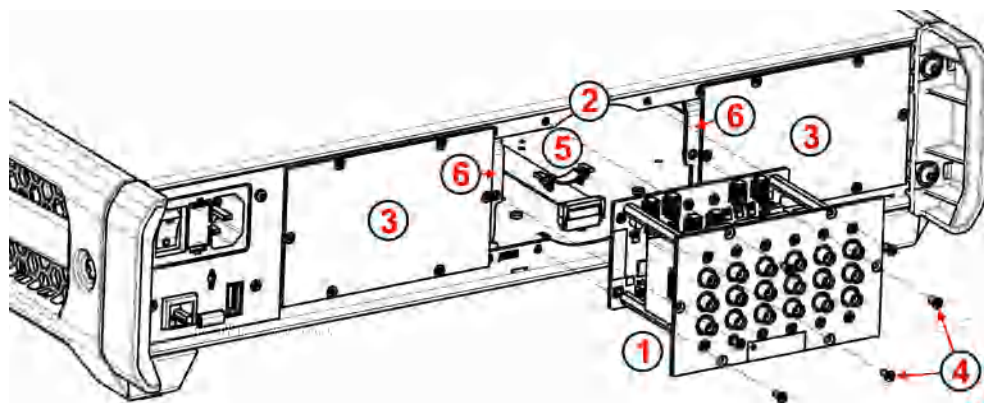
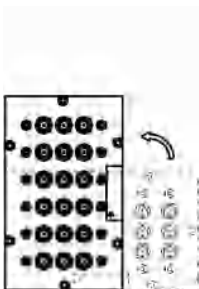

Figure 2-25: Mounting a module

- 1 = The module that you mount (here: on the rear side of an R&S OSP220 or R&S OSP230)
- 2 = Rear slot RS02, opened for mounting the module
- 3 = Rear slots RS01 and RS03, covered by blank plates
- 4 = Six torx 8 screws
- 5 = Module bus cable (flat-ribbon cable), held by its clamp
- 6 = Removable panel struts, fixed by 2 Torx 8 screws



12. Carefully insert the module into the open slot.

Special issues with the 3-HU switch unit R&S OSP320:

- If you insert a module into the switch unit R&S OSP320, insert the module rotated counterclockwise by 90°. Hence, if you face the panel of the module that you mount, rotate it to the left.
- Note that you can mount only one-slot modules (panel size 65.5 mm x 107.6 mm) into the R&S OSP320.

13. Fix the inserted module with the six original screws (or more screws, if you mount a larger module).
14. Reconnect the switch unit (see [step 1](#) and [step 2](#)).
15. Switch on the switch unit.

During start-up, all modules automatically register in the switch unit. You do not have to interact with this process. No manual registration or testing is required.

The switch unit and its mounted modules are ready for use.

2.4.1 Module Integration Overview

The following table shows, which **modules** occupy 1, 2 or 3 slots, and which modules can be mounted into which switch unit. It also shows, if you must open the switch unit for mounting a module, and how many module bus cables each module requires.

Table 2-4: Module integration parameters

Module name	Order no.	Width (number of slots)	Suited for integration into				Requires opening the switch unit	Number of mod- ule bus cables ¹
			OSP 220	OSP 230	OSP 320	OSP- B200S2		
R&S OSP-B011	1505.4763.02	1	yes (+ RF cables)			no	yes ²	0
R&S OSP-B012	1505.4770.02	1	yes (+ RF cables)			no	yes ²	0
R&S OSP-BM6x	1528.1625.11 / .12 / .13	1	yes				no	1
R&S OSP-BM6xE	1528.1625.21 / .22 / .23	1	yes				no	1
R&S OSP-BM6xH	1528.1625.41 / .42 / .43	1	yes				no	1
R&S OSP-BM6xU	1528.1625.51 / .52 / .53	1	yes				no	1
R&S OSP-B101	1505.5101.02	1	yes				no	1
R&S OSP-B101L	1505.5101.52	1	yes				no	1
R&S OSP-B102	1505.5201.02	1	yes				no	1

Module name	Order no.	Width (number of slots)	Suited for integration into				Requires opening the switch unit	Number of mod- ule bus cables ¹
			OSP 220	OSP 230	OSP 320	OSP- B200S2		
R&S OSP-B102L	1505.5201.52	1	yes				no	1
R&S OSP-B103	1505.5301.02	1	yes				no	1
R&S OSP-B104	1505.5401.02	1	yes		yes ³	no	yes ⁴	1
R&S OSP-B106	1505.5601.02	2	yes		no	no	yes ⁴	1
R&S OSP-B107	1505.5901.02	1	yes				no	1
R&S OSP-B108	1505.5718.02	1	yes				no	1
R&S OSP-B111E	1505.4605.26	1	yes				no	1
R&S OSP-B111H	1505.4605.43 / .46	1	yes				no	1
R&S OSP-B111U	1505.4605.53 / .56	1	yes				no	1
R&S OSP-B111UL	1528.1531.13 / .16	1	yes				no	1
R&S OSP-B111V	1505.4605.61/.62/.../.66	1	yes				no	1
R&S OSP-B111VL	1515.5991.13 / .16	1	yes				no	1
R&S OSP-B112E	1528.1560.11 / .12	1	yes				no	1
R&S OSP-B112H	1528.1560.41 / .42	1	yes				no	1
R&S OSP-B112U	1528.1560.51 / .52	1	yes				no	1
R&S OSP-B112UL	1528.1548.11	1	yes				no	1
R&S OSP-B114	1505.4711.02	1	yes				no	1
R&S OSP-B116	1515.5827.02	1	yes				no	1
R&S OSP-B116E	1515.5827.26	1	yes				no	1
R&S OSP-B116H	1515.5827.40	1	yes				no	1
R&S OSP-B116U	1515.5827.51 / .52	1	yes				no	1
R&S OSP-B119	1515.5856.02	1	yes				no	1
R&S OSP-B119E	1515.5856.26	1	yes				no	1
R&S OSP-B121	1515.5504.02	1	yes				no	1
R&S OSP-B121E	1515.5504.26	1	yes				no	1
R&S OSP-B121H	1515.5504.40	1	yes				no	1
R&S OSP-B121U	1515.5504.51 / .52 / .53	1	yes				no	1
R&S OSP-B121VL	1528.1654.61 / .62 / .63	1	yes				no	1
R&S OSP-B122	1515.5510.02	1	yes				no	1
R&S OSP-B122E	1528.1525.26	1	yes				no	1
R&S OSP-B122H	1528.1525.02	1	yes				no	1
R&S OSP-B122U	1528.1525.51	1	yes				no	1

Module name	Order no.	Width (number of slots)	Suited for integration into				Requires opening the switch unit	Number of mod- ule bus cables ¹
			OSP 220	OSP 230	OSP 320	OSP- B200S2		
R&S OSP-B123	1515.5527.02	2	yes		no	yes	no	2
R&S OSP-B124	1515.5533.02	2	yes		no	yes	no	1
R&S OSP-B125	1515.5540.02	3	yes	yes ⁵	no		no	2
R&S OSP-B125E	1515.5540.26	3	yes	yes ⁵	no		no	2
R&S OSP-B125H	1515.5540.40	3	yes	yes ⁵	no		no	2
R&S OSP-B126	1515.5556.02	3	yes	yes ⁵	no		no	2
R&S OSP-B127	1505.4728.02	1	yes				no	1
R&S OSP-B128	1505.4734.11 / .12 / .13	1	yes				no	1
R&S OSP-B129	1517.7004.02	1	yes				no	1
R&S OSP-B129E	1517.7004.26	1	yes				no	1
R&S OSP-B131	1505.4740.02	1	yes				no	1
R&S OSP-B132	1505.4757.02	2	yes		no	yes	no	2
R&S OSP-B133	1528.3157.02	1	yes				no	1
R&S OSP-B136	1522.4500.02	1	yes				no	1
R&S OSP-B142	1505.4792.03 / .11 / .12 / .13	1	yes				no	1
R&S OSP-B171H	1528.1577.42 / .44	1	yes				no	1
R&S OSP-B200R	1528.3140.02 / .04	1	yes			no	no ⁶	up to 2 ⁷
R&S OSP-PM-I	1515.5985.02	1	yes			no	no	0

(1) Number of module bus cables (26-pin flat-ribbon cables) required for controlling this module.

(2) Let Rohde & Schwarz service mount the [feedthrough panels](#), as it requires opening the switch unit's casing, to feed the also required RF cables across the switch unit, and to fix the cables.

(3) Let Rohde & Schwarz service mount the module R&S OSP-B104 into the R&S OSP320, as it requires opening the switch unit's casing to fix the module with an additional mounting kit (included in the delivery). Mounting this module also requires connecting an additional power supply cable inside the switch unit's casing.

(4) Let Rohde & Schwarz service personnel mount this module, as it requires opening the switch unit's casing to fix the module. Mounting the module R&S OSP-B104 also requires connecting an additional power supply cable inside the switch unit's casing.

(5) In the R&S OSP230, you can install a three-slot (triple-width) module only in the rear side.

(6) For connecting 2 module bus cables to the R&S OSP-B200R, use also the module bus cable of a neighboring slot or let Rohde & Schwarz service personnel mount this module (see "[Limitations in module mounting](#)" on page 42).

(7) Depending on the 1 or 2 switch modules that you want to connect to the R&S OSP-B200R, this remote-control module requires 1 or 2 module bus cables.

The touchscreen display module [R&S OSP-B300M](#) can only be factory-mounted by Rohde & Schwarz.

Both the R&S OSP220 and the R&S OSP230 are equipped inside with 6 module bus cables (flat-ribbon cables), hence, one per module slot (disregarding the touchscreen

display of the R&S OSP220). The R&S OSP320 is equipped with 10 module bus cables.

When you open a blind plate or remove an existing module, you get easy access to one module bus cable per slot.

The motherboard, which is identical in all switch units, has 16 module bus connectors, labeled M01 to M16. In the standard configuration of all switch units, either 6 or 10 of the connectors (as stated above) are equipped with module bus cables:

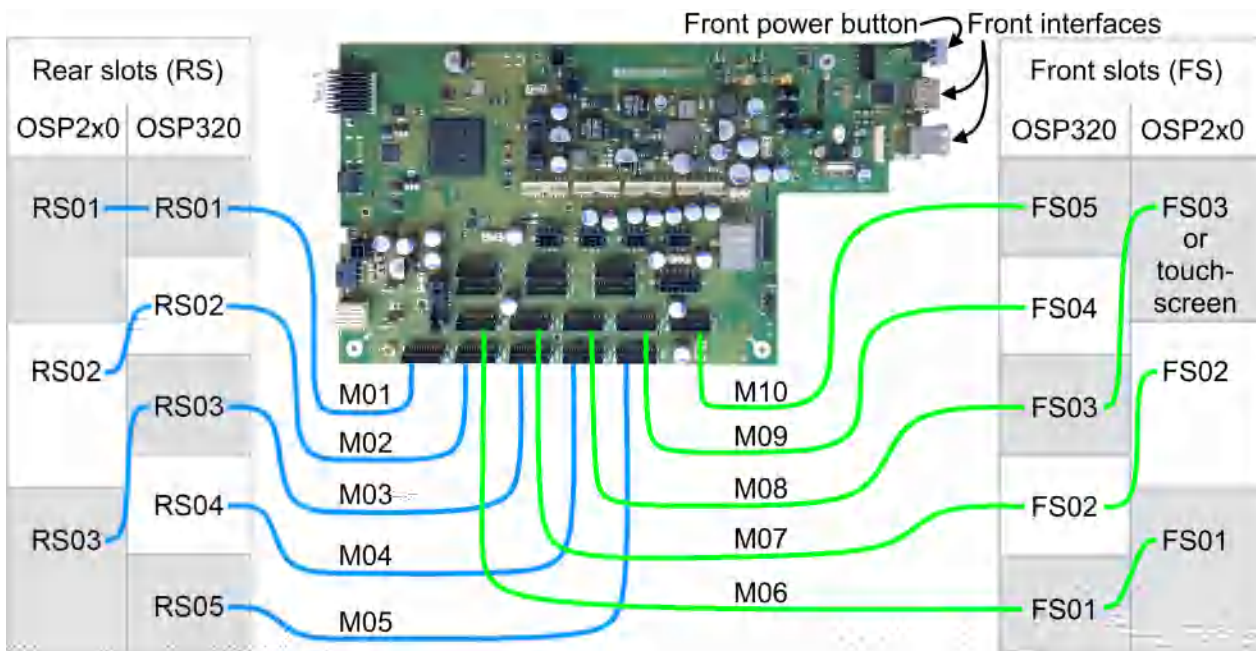

Figure 2-26: Top view of the motherboard with its connectors for module bus cables

RS = Rear slots RS01, RS02, etc.
 FS = Front slots FS01, FS02, etc.
 OSP2x0 = 6 slots in the R&S OSP220, 5 slots in the R&S OSP230
 OSP320 = 10 slots in the R&S OSP320
 M01 - M10 = Numbers of the module bus cables = Labels of the module bus connectors on the motherboard
 (M11 - M16: unused)

Hence, the R&S OSP220 with 6 slots and the R&S OSP230 with 5 slots both have 6 module bus cables, connected to M01 - M03 and M06 - M08.

The R&S OSP320 with 10 slots has 10 module bus cables, connected to M01 - M10.

For more details, see also [Chapter B, "Motherboard Interfaces"](#), on page 318.



The software uses M01, M02, etc. instead of RS01, RS02, etc., as it cannot detect a module's mounting position. It detects only to the module bus connector on the motherboard, to which a module is connected.

Hence, a module information dialog addresses a module by its module bus connector, for example, "Module Connector: M01".

In a factory configuration, the correlation of slot positions and module bus connectors follows the scheme in [Figure 2-26](#). If you mount modules yourself, we recommend that you adhere to the same correlation.

The positions of the front and rear slots in the different switch unit models are also shown in [Chapter 2.2.1, "Front Panel View"](#), on page 25, and [Chapter 2.2.2, "Rear Panel View"](#), on page 29.

3 Modules

The broad range of R&S OSP modules differs in type, functions and technology. The following table summarizes basic properties of the available standard modules:

Table 3-1: Optional general-purpose hardware modules

Designation	Page	Module type	Relays	Powerless behavior	Terminated (50 Ω)	Connector types	f _{Min} [kHz]	f _{Max} [GHz]
R&S OSP-B011/12	55	Feedthroughs	--	--	--	(12 / 4 holes)	--	--
R&S OSP-BM6x	58	RF, e.m.	SP6T + 1/2/3×SPDT	failsafe	no	SMA	0	18
R&S OSP-BM6xE	59	RF, e.m.	SP6T + 1/2/3×SPDT	failsafe	no	SMA	0	26.5
R&S OSP-BM6xH	60	RF, e.m.	SP6T + 1/2/3×SPDT	failsafe	no	PC 2.92	0	40
R&S OSP-BM6xU	61	RF, e.m.	SP6T + 1/2/3×SPDT	failsafe	no	PC 2.4	0	50
R&S OSP-B101	62	RF, e.m.	6× SPDT	failsafe	no	SMA	0	18
R&S OSP-B101L	63	RF, e.m.	6× SPDT	latching	no	SMA	0	18
R&S OSP-B102	65	RF, e.m.	2x SP6T	FS (open)*	no	SMA	0	18
R&S OSP-B102L	66	RF, e.m.	2x SP6T	latching	no	SMA	0	18
R&S OSP-B103	68	Digital I/O	--	--	--	D-Sub 25	--	--
R&S OSP-B104	70	EMS	4x 3 rd party DPDT	latching	3 rd party	D-Sub 9 / 15	0	2/3.5/5
R&S OSP-B106	74	RF, e.m.	3xSPDT + 3xSPDT	failsafe	no	3xN + 3xBNC	0	12.4/0.9
R&S OSP-B107	76	RF, SSR	6× SPDT	non def.	internal	SMA	9	6
R&S OSP-B108	78	Multiplexer	1× 4P6T	failsafe	--	D-Sub 9	--	--
R&S OSP-B111E	81	RF, e.m.	6× SPDT	failsafe	no	SMA	0	26.5
R&S OSP-B111H	83	RF, e.m.	3× / 6× SPDT	failsafe	no	PC 2.92	0	40
R&S OSP-B111U	84	RF, e.m.	3× / 6× SPDT	failsafe	no	PC 2.4	0	50
R&S OSP-B111UL	85	RF, e.m.	3× / 6× SPDT	latching	no	PC 2.4	0	50
R&S OSP-B111V	86	RF, e.m.	1/2/3/4/5/6× SPDT	failsafe	no	PC 1.85	0	67
R&S OSP-B111VL	87	RF, e.m.	3× / 6× SPDT	latching	no	PC 1.85	0	67
R&S OSP-B112E	89	RF, e.m.	1x / 2x SP6T	FS (open)*	no	SMA	0	26.5
R&S OSP-B112H	91	RF, e.m.	1x / 2x SP6T	FS (open)*	no	PC 2.92	0	40
R&S OSP-B112U	92	RF, e.m.	1x / 2x SP6T	FS (open)*	no	PC 2.4	0	50
R&S OSP-B112UL	93	RF, e.m.	1x SP6T	latching	no	PC 2.4	0	50
R&S OSP-B114	95	EMS/em/SSR	1xDPDT + 1xSPDT	FS/non def.	no/internal	4N+3SMA+etc.	0 / 9	12.4/10
R&S OSP-B116	99	RF, e.m.	2x DPDT	failsafe	no	SMA	0	18
R&S OSP-B116E	101	RF, e.m.	2x DPDT	failsafe	no	SMA	0	26.5
R&S OSP-B116H	101	RF, e.m.	2x DPDT	failsafe	no	PC 2.92	0	40

Designation	Page	Module type	Relays	Powerless behavior	Terminated (50 Ω)	Connector types	f _{Min} [kHz]	f _{Max} [GHz]
R&S OSP-B116U	102	RF, e.m.	1x / 2x DPDT	failsafe	no	PC 2.4	0	50
R&S OSP-B119	103	RF, e.m.	1xSP8T + 2xSPDT	FS / FS-o*	no	SMA	0	18
R&S OSP-B119E	105	RF, e.m.	1xSP8T + 2xSPDT	FS / FS-o*	no	SMA	0	26.5
R&S OSP-B121	105	RF, e.m.	3x SPDT	failsafe	internal	SMA	0	18
R&S OSP-B121E	107	RF, e.m.	3x SPDT	failsafe	external	SMA	0	26.5
R&S OSP-B121H	108	RF, e.m.	3x SPDT	failsafe	external	PC 2.92	0	40
R&S OSP-B121U	108	RF, e.m.	1x / 2x / 3x SPDT	failsafe	external	PC 2.4	0	50
R&S OSP-B121VL	110	RF, e.m.	1x / 2x / 3x SPDT	latching	internal	PC 1.85	0	67
R&S OSP-B122	111	RF, e.m.	1x SP6T	FS (open)*	internal	SMA	0	18
R&S OSP-B122E	113	RF, e.m.	1x SP6T	FS (open)*	internal	SMA	0	26.5
R&S OSP-B122H	113	RF, e.m.	1x SP6T	FS (open)*	internal	PC 2.92	0	40
R&S OSP-B122U	114	RF, e.m.	1x SP6T	FS (open)*	internal	PC 2.4	0	50
R&S OSP-B123	115	RF, e.m.	6xSPDT + 1xSP6T	FS / FS-o*	internal	SMA	0	18
R&S OSP-B124	117	RF, e.m.	3xSPDT + 2xSP6T	FS / FS-o*	internal	SMA	0	18
R&S OSP-B125	119	RF, e.m.	6xSPDT + 3xSP6T	FS / FS-o*	internal	SMA	0	18
R&S OSP-B125E	121	RF, e.m.	6xSPDT + 3xSP6T	FS / FS-o*	internal	PC 3.5	0	26.5
R&S OSP-B125H	122	RF, e.m.	6xSPDT + 3xSP6T	FS / FS-o*	internal	PC 2.92	0	40
R&S OSP-B126	122	RF, e.m.	3x SP6T	FS (open)*	internal	SMA	0	18
R&S OSP-B127	124	RF, SSR	6x SPDT	non def.	internal	SMA	9	10
R&S OSP-B128	126	RF, SSR	1x / 2x / 3x SP6T	non def.	internal	SMA	9	10
R&S OSP-B129	128	RF, e.m.	1xSP8T + 2xSPDT	FS-o* / FS	internal/no	SMA	0	18
R&S OSP-B129E	130	RF, e.m.	1xSP8T + 2xSPDT	FS-o* / FS	internal/no	SMA	0	26.5
R&S OSP-B131	131	RF, e.m.	2x SPDT	failsafe	no	N	0	12.4
R&S OSP-B132	133	RF, e.m.	6x SPDT	failsafe	no	N	0	12.4
R&S OSP-B133	135	RF, e.m.	1x SP6T	FS (open)*	no	N	0	12.4
R&S OSP-B136	136	RF, e.m.	2x DPDT	failsafe	no	N	0	12.4
R&S OSP-B142 (1+3 versions)	138	RF, SSR	3x DP3T, 10W or 1x/2x/3x SPDT,10W	non def.	no external	SMA	9	8
R&S OSP-B171H	144	Solid-state RF digital attenuators		non def.	--	PC 2.92	9	40
R&S OSP-B200R	142	Remote control module for R&S OSP-B200S2 <i>Satellite Unit</i>				Other	= satellite	
R&S OSP-B300M	145	Touchscreen for R&S OSP320		--	--	--	--	--
R&S OSP-PM-I	146	Power sensor integration module				(N + USB)	= R&S NRP-Zxx	

For connecting modules, see [Chapter 2.1.10, "Connecting RF Cables"](#), on page 21, and [Chapter 2.1.11, "Connecting Control Cables"](#), on page 22.

There are modules with electromechanical relays and with solid-state relays (SSRs) of the types [SPDT](#), [DPDT](#) and [SPxT](#). Also, some modules feature input and output channels, multiplexers or attenuators. For details of the modules, refer to the subchapters linked from the table above. See also the data sheet and the product brochure of the R&S OSP.

For system modules R&S OSP-B15x(x) and R&S OSP-BSxx(x) (not included in this manual), refer to the individual user manuals of these modules and to the data sheets of the test systems.

For the dimensions and installation of modules in a base unit, see [Chapter 2.4, "Mounting a Module"](#), on page 41, and [Chapter 2.4.1, "Module Integration Overview"](#), on page 46.

For information on the base units, see [Chapter 2.2, "Instrument Tour"](#), on page 25.

FS (open)*

If there is a (partial or full) system blackout, a monostable (failsafe, non-latching) electromechanical [SPDT](#) switch opens the connection between C (common port) and NO (normally open port). It goes to its default state of connecting C with NC (normally closed port). Similarly, a monostable (failsafe, non-latching) electromechanical [DPDT](#) switch goes to its default connection pattern, typically connecting ports 1+2 and 3+4. But a monostable (failsafe, non-latching) electromechanical [SPxT](#) switch connects C to no terminal at all. This behavior is called "**failsafe (open)**" (or "**FS (open)**" or "**FS-o**" for short). Solid-state relays (SSRs) have no defined state at power loss, see [Safety Considerations for SSRs](#).

Monostable and bistable relays

Electromechanical relays can be a monostable or a bistable type:

- A **monostable** electromechanical relay has two or more switching states, of which only **one** is stable. The relay remains in this stable state (default state), unless it is activated, typically by a control voltage. When the control voltage or even the supply voltage is cut, the relay automatically returns to its default state. Monostable electromechanical RF relays are called "**failsafe**", because at power loss the switches automatically return to their disabled (safe) state:
 - An [SPDT](#) relay opens the connection from C (common) to the NO (normally open) port and closes the connection from C to NC (normally closed)
 - An [SPxT](#) relay opens the connection from C to all ports, see also [FS \(open\)*](#)
 - A [DPDT](#) relay switches all ports to their default connection pattern
- A **bistable** electromechanical relay ([SPDT](#) or [DPDT](#)) has two switching states, of which **both** are stable, even when there is no power. The same holds true for **multistable** electromechanical [SPxT](#) relays: one stable state is with all ports open (reset), the other states are with C connected to one of the ports. Switching a bistable or multistable relay from one state to the other or back always requires an input of energy.

Manufacturing an electromechanical relay of this type is more complex and hence more expensive than a monostable electromechanical relay. However, operating a bistable or multistable electromechanical relay can be significantly more economic, because it does not consume electrical power between the switching procedures. Bistable electromechanical RF relays are called "**latching**", because the switching state persists, if without power.

Both monostable and bistable electromechanical relays have their own drawbacks and advantages, which you must observe for reaching a defined switching state at power failure. Disregarding these relay properties can lead to undefined and possibly dangerous situations, for example human exposure to amplified RF radiation in a test system. It is in your responsibility to avoid such situations. We recommend that you safely avoid any possibly dangerous situation by the design of your system, in which you use the relays.

Solid-state relays (SSR) are sometimes considered monostable, too, but SSRs are not "failsafe".



Refer also to [Chapter C, "Off/On Switching States of Various Relays"](#), on page 320.

Terminated vs. non-terminated ports

Terminating a non-activated RF port with a load of matched impedance (here: 50 Ω) avoids reflection of RF power and hence avoids possible detrimental effects on system performance.

The ports of electromechanical RF relays can have internal or external termination. See also "[Preventing overload on internal terminations](#)" on page 20.

Termination in SSRs:

- In an SSR, terminated ports are called "**absorptive**" or "absorbing".

In contrast, the following SSR ports are called "**reflective**":

- Open (non-activated) ports
 - With a short to ground
 - With a non-matched termination
 - Without termination
- Ports with a non-matched external termination

For information on modules with port termination, refer to the R&S OSP data sheet.



The R&S OSP can supply a maximum current of 800 mA at 28 V DC per module bus cable to the modules. The maximum total current for all slots in the switch unit is 10 A. For module data and base unit data, refer to the data sheet.



Naming conventions

To help identify frequency ranges and functions, R&S OSP switches use suffixes to show the following:

- **Function:** "L" denotes a **"latching"** (bistable or multistable) relay, the current state of the relay does not change if power is switched off. In contrast, monostable relays switch back to their initial state in the absence of a control voltage, and are not denoted with a suffix. A monostable electromechanical (non-SSR) relay does so even without any voltage applied, which is called **failsafe** behavior.
- **Frequency:** The suffixes "E", "H", "U" and "V" (as in [R&S OSP-B125E](#), for example) stand for increasing maximum frequencies above 18 GHz.
- **Termination** of relay ports (**reflective vs. absorptive** behavior) is not denoted with a suffix.
- **Relay names:** On most module panels, the relays are labeled with names such as "K11" or "K2".

3.1 R&S OSP-B011 and R&S OSP-B012 RF Feedthroughs

The R&S OSP-B011 (order no. 1505.4763.02) is a feedthrough panel for up to **12 RF cables with SMA connectors**:



Figure 3-1: R&S OSP-B011

Left = The R&S OSP-B011 SMA feedthrough panel alone

Right = Configuration with 2 SMA feedthrough panels, connected by 3 cable sets R&S OSP-Z012

The R&S OSP-B012 (order no. 1505.4770.02) is a feedthrough panel for up to **4 RF cables with N-type connectors**:



Figure 3-2: R&S OSP-B012

Left = The R&S OSP-B012 N feedthrough panel alone

Right = Configuration with 2 N feedthrough panels, connected by the cable set R&S OSP-Z010

A **combination of N and SMA feedthroughs** is also possible:

R&S OSP-B011 and R&S OSP-B012 RF Feedthroughs



Figure 3-3: R&S OSP-B011 and R&S OSP-B012, connected by the cable set R&S OSP-Z011

The R&S OSP-B011 SMA feedthrough panel is delivered with 8 polymer plugs for closing unused holes.

The following cable sets are available for the R&S OSP feedthrough panels:

Table 3-2: RF feedthrough cable sets

Cable set	4 cables per set, with the following connectors:	Order no.
R&S OSP-Z010	N (female) to N (female)	1505.4534.02
R&S OSP-Z011	N (female) to SMA (female)	1505.4540.02
R&S OSP-Z012	SMA (female) to SMA (female)	1505.4557.02

The cable sets are delivered without protective caps for the connectors.

If you use 2 N feedthrough panels (Figure 3-2) or 1 N and 1 SMA feedthrough panel (Figure 3-3), 1 cable set (R&S OSP-Z010 or R&S OSP-Z011) is sufficient.

Only in a combination of 2 SMA feedthrough panels (Figure 3-1), you can select to use 1, 2 or 3 cable sets R&S OSP-Z012, hence 4, 8 or 12 cables.

3.1.1 Mounting the R&S OSP-B011 and R&S OSP-B012

You can mount feedthrough panels in any module slot of each switch unit.

Typically, two feedthrough panels are used to feed cables through from the front to the rear of a rack-mounted switch unit.

In this setup, avoid mounting the feedthrough panels with a lateral offset of more than 1 slot position. Hence, do not feed cables through from front left-hand slot to the rear right-hand slot, or vice versa.

Mounting procedure

To mount a combination of 2 feedthrough panels and one or more cable sets from Table 3-2 into a switch unit, proceed as follows:

1. Turn off the switch unit.
2. Unplug the power supply cable from the switch unit.
3. Select a front and rear slot, ideally covered by a blank plate, for mounting the feedthrough panels.

If no blank plates are available, consider removing existing modules, instead.

4. Remove an existing blank plate or single-slot module from the front of the switch unit, keeping the 6 screws.
5. Remove an existing blank plate or single-slot module from the rear of the switch unit, keeping the 6 screws.
Note: Avoid feedthrough setups with a lateral offset of more than 1 slot position. If you remove a module that is more than 1 slot wide, close the excess slots with blank plates.
6. Remove the lock nuts from all cable ends that go into the 1st feedthrough panel.
7. Insert the connectors into the feedthrough panel's holes from the rear side.
8. Make sure that the machined flats of the connectors meet with their counterpart in the panel hole.
9. Fix the connectors with their lock nuts, using a standard open-end wrench.
10. Insert the cables into one open module slot.
11. From there, feed the cables through the switch unit to the other open module slot. If you cannot feed the cables through the switch unit's casing without opening it, quit or revert this procedure and let Rohde & Schwarz service personnel mount the feedthroughs.
12. Remove the lock nuts from these cable ends.
13. Make sure not to have the cables twisted.
14. Insert the connectors into the 2nd feedthrough panel's holes from the rear side.
15. Make sure that the machined flats of the connectors meet with their counterpart in the panel hole.
Note: The flats in the opposite feedthrough panels help you to fix the cables in a non-twisted position.
16. Fix the connectors with their lock nuts.
17. Fix both feedthrough panels with the screws that you kept in [step 4](#) and [step 5](#).
18. Reconnect the switch unit to power.
19. Switch on the switch unit.
The switch unit is ready for use.

3.2 R&S OSP-BM6x RF Switch Module



Figure 3-4: R&S OSP-BM6x (here with 1 SP6T + 3 SPDT relays)

The one-slot [module](#) R&S OSP-BM6x (order no. 1528.1625.11/.12/.13) consists of 1 failsafe electromechanical SP6T relay and up to 3 failsafe electromechanical SPDT relays, frequency range DC to 18 GHz, with non-terminated SMA (female) connectors.

The module is available in three versions:

- R&S OSP-BM61, 1528.1625.11 with 1 SP6T relay (K1) and 1 SPDT relays (K11)
- R&S OSP-BM62, 1528.1625.12 with 1 SP6T relay (K1) and 2 SPDT relays (K11, K12)
- R&S OSP-BM63, 1528.1625.13 with 1 SP6T relay (K1) and 3 SPDT relays (K11 to K13)

Note: Mind the [torque limit recommendation](#) of **56 N·cm** for **SMA** connectors.

SP6T relay

The terminal port is labeled with C (common), the other relay ports are labeled with numbers.

The relay type is monostable (or "failsafe open"). Hence, with no voltage applied to the relay, no RF connection is provided from terminal C to any of the numbered ports. To establish an RF connection between C and one of the numbered ports, a continuous voltage must be applied to the corresponding power terminal of the relay.

The relay is mounted directly into the module's panel and soldered to the module's printed board, to avoid relay cabling and allow a compact module size.

SPDT relays

The relays operate independently from each other. The terminal port is labeled with C (common), the other relay ports are labeled with NC (normally closed) and NO (normally open). Terminal C is connected either with relay port NC or NO.

The type of relays is monostable (or "failsafe"), hence, with no voltage applied, an RF connection is provided from C to NC, while NO is not connected to C ("Pos = 0"). To disconnect NC and connect C to NO ("Pos = 1"), a continuous voltage must be applied to the relay.

The relays are mounted directly into the module's panel and soldered to the module's printed board, to avoid relay cabling and allow a compact module size.

The switch unit provides power supply and control via a single module bus cable to a module bus connector on the module's printed board. The module's on-board memory stores its configuration data.

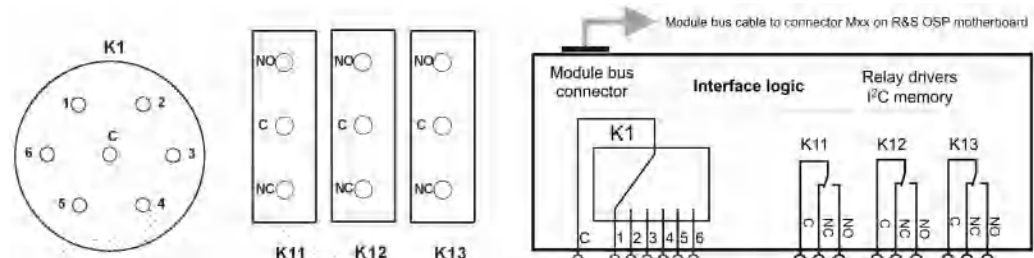

Figure 3-5: Pinout and block diagram of RF switch module R&S OSP-BM6x (here with 3 SPDT relays)



Figure 3-6: Representation of the module on the control screen (left: 1 SPDT, right: 3 SPDT)

For operation, see [Chapter 4, "Operation"](#), on page 147 and [Chapter 5, "Functions"](#), on page 155.

For remote control, refer to the chapters [Remote Operation](#) and [RC Commands](#). For an example, see [ROUTE:CLOSE](#) on page 253.

3.3 R&S OSP-BM6xE RF Switch Module



Figure 3-7: R&S OSP-BM6xE (here with 1 SP6T + 3 SPDT relays)

The one-slot [module](#) R&S OSP-BM6xE (order no. 1528.1625.21/.22/.23) consists of 1 failsafe electromechanical SP6T relay and up to 3 failsafe electromechanical SPDT relays, with non-terminated SMA (female) connectors.

The module is available in three versions:

- R&S OSP-BM61E, 1528.1625.**21** with 1 SP6T relay (K1) and 1 SPDT relays (K11)
- R&S OSP-BM62E, 1528.1625.**22** with 1 SP6T relay (K1) and 2 SPDT relays (K11, K12)
- R&S OSP-BM63E, 1528.1625.**23** with 1 SP6T relay (K1) and 3 SPDT relays (K11 to K13)

It is based on the module [BM6x](#), with the following difference:

- Frequency range from DC to **26.5 GHz** (instead of 18 GHz)

Note: Mind the [torque limit recommendation](#) of **56 N·cm** for **SMA** connectors.

The pinout and block diagram of the module R&S OSP-BM6xE is the same as in [Figure 3-5](#). But in the module versions with less than 3 SPDT relays, the relays with the highest Kxx numbers in the range from K11 to K13 are not available.

The control screen representation of the module R&S OSP-BM6xE is the same as in [Figure 3-6](#).

3.4 R&S OSP-BM6xH RF Switch Module



Figure 3-8: R&S OSP-BM6xH (here with 1 SP6T + 3 SPDT relays)

The one-slot [module](#) R&S OSP-BM6xH (order no. 1528.1625.41/.42/.43) consists of 1 failsafe electromechanical SP6T relay and up to 3 failsafe electromechanical SPDT relays.

The module is available in three versions:

- R&S OSP-BM61H, 1528.1625.**41** with 1 SP6T relay (K1) and 1 SPDT relays (K11)
- R&S OSP-BM62H, 1528.1625.**42** with 1 SP6T relay (K1) and 2 SPDT relays (K11, K12)
- R&S OSP-BM63H, 1528.1625.**43** with 1 SP6T relay (K1) and 3 SPDT relays (K11 to K13)

It is based on the module [BM6x](#), with the following differences:

- Frequency range from DC to **40 GHz** (instead of 18 GHz)
- **PC 2.92** (female) connectors (instead of SMA connectors)

Note: Mind the [torque limit recommendation](#) of **90 N·cm** for **PC** connectors.

The pinout and block diagram of the module R&S OSP-BM6xH is the same as in [Figure 3-5](#). But in the module versions with less than 3 SPDT relays, the relays with the highest Kxx numbers in the range from K11 to K13 are not available.

The control screen representation of the module R&S OSP-BM6xH is the same as in [Figure 3-6](#).

3.5 R&S OSP-BM6xU RF Switch Module



Figure 3-9: R&S OSP-BM6xU (here with 1 SP6T + 3 SPDT relays)

The one-slot [module](#) R&S OSP-BM6xU (order no. 1528.1625.51/.52/.53) consists of 1 failsafe electromechanical SP6T relay and up to 3 failsafe electromechanical SPDT relays.

The module is available in three versions:

- R&S OSP-BM61U, 1528.1625.51 with 1 SP6T relay (K1) and 1 SPDT relays (K11)
- R&S OSP-BM62U, 1528.1625.52 with 1 SP6T relay (K1) and 2 SPDT relays (K11, K12)
- R&S OSP-BM63U, 1528.1625.53 with 1 SP6T relay (K1) and 3 SPDT relays (K11 to K13)

It is based on the module [BM6x](#), with the following differences:

- Frequency range from DC to **50 GHz** (instead of 18 GHz)
- **PC 2.4** (female) connectors (instead of SMA connectors)

Note: Mind the [torque limit recommendation](#) of **90 N·cm** for **PC** connectors.

The pinout and block diagram of the module R&S OSP-BM6xU is the same as in [Figure 3-5](#). But in the module versions with less than 3 SPDT relays, the relays with the highest Kxx numbers in the range from K11 to K13 are not available.

The control screen representation of the module R&S OSP-BM6xU is the same as in [Figure 3-6](#).

3.6 R&S OSP-B101 RF Switch Module



Figure 3-10: R&S OSP-B101

The one-slot [module](#) R&S OSP-B101 (order no. 1505.5101.02) consists of 6 failsafe electromechanical SPDT relays, frequency range DC to 18 GHz, with non-terminated SMA (female) connectors.

Note: Mind the [torque limit recommendation](#) of **56 N·cm** for **SMA** connectors.

The relays operate independently from each other. The terminal port is labeled with C (common), the other relay ports are labeled with NC (normally closed) and NO (normally open). Terminal C is connected either with relay port NC or NO.

The type of relays is monostable (or "failsafe"), hence, with no voltage applied, an RF connection is provided from C to NC, while NO is not connected to C ("Pos = 0"). To disconnect NC and connect C to NO ("Pos = 1"), a continuous voltage must be applied to the relay.

The relays are mounted directly into the module's panel and soldered to the module's printed board, to avoid relay cabling and allow a compact module size.

The switch unit provides power supply and control via a single module bus cable to a module bus connector on the module's printed board. The module's on-board memory stores its configuration data.

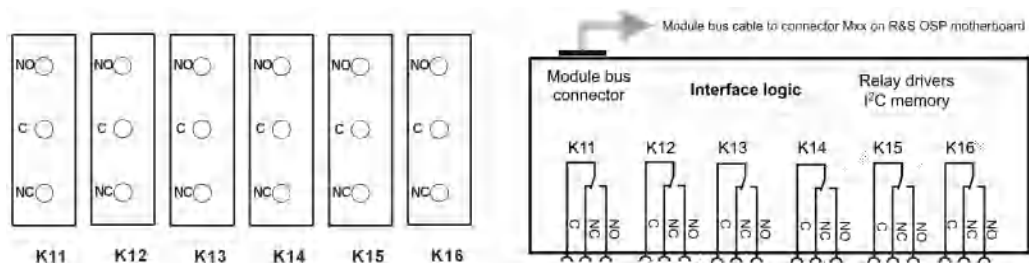

Figure 3-11: Pinout and block diagram of RF switch module R&S OSP-B101



Figure 3-12: Representation of the module on the control screen

For operation, see [Chapter 4, "Operation"](#), on page 147 and [Chapter 5, "Functions"](#), on page 155.

For remote control, refer to the chapters [Remote Operation](#) and [RC Commands](#). For an example, see [ROUTE:CLOSE](#) on page 253.

3.7 R&S OSP-B101L RF Switch Module



Figure 3-13: R&S OSP-B101L

The one-slot [module](#) R&S OSP-B101L (order no. 1505.5101.52) consists of 6 latching electromechanical SPDT relays, frequency range DC to 18 GHz, with non-terminated SMA (female) connectors.

Note: Mind the [torque limit recommendation](#) of **56 N·cm** for **SMA** connectors.

The relays operate independently from each other. The terminal port is labeled with C (common), the other relay ports are labeled with numbers "0" (= default port) and "1". Terminal C is connected either with relay port "1" or "0". (In modules manufactured before 2021, the default port was labeled "2" instead of "0".)

Note that the hardware labels "0" and "1" are represented in the software as positions "0" (= default) and "1", respectively. In [RC Commands](#), the corresponding switching states are encoded by the SCPI parameters "00" (= default) and "01".

The relay type is bistable (or "latching"), hence, with no voltage applied, a relay remains in its current position.

To change the connection, the controller must send a voltage pulse to the appropriate switch coil in the relay. After that, no energy is consumed by this relay type.

You can configure two different [Power Up reset conditions](#) to determine, how latching relays behave after booting the switch unit.

The relays are mounted directly into the module's panel and soldered to the module's printed board, to avoid relay cabling and allow a compact module size.

The switch unit provides power supply and control via a single module bus cable to a module bus connector on the module's printed board. The module's on-board memory stores its configuration data.

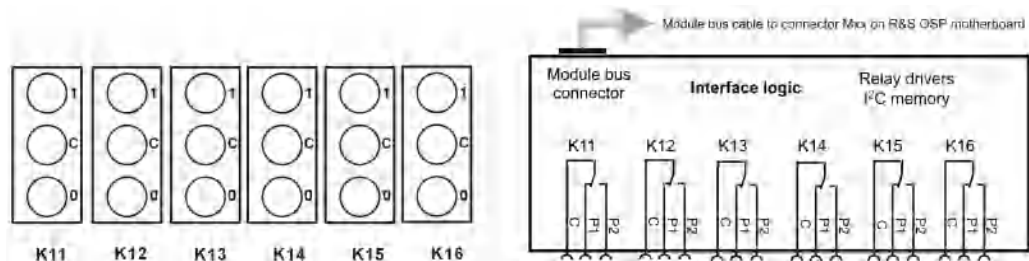

Figure 3-14: Pinout and block diagram of RF switch module R&S OSP-B101L

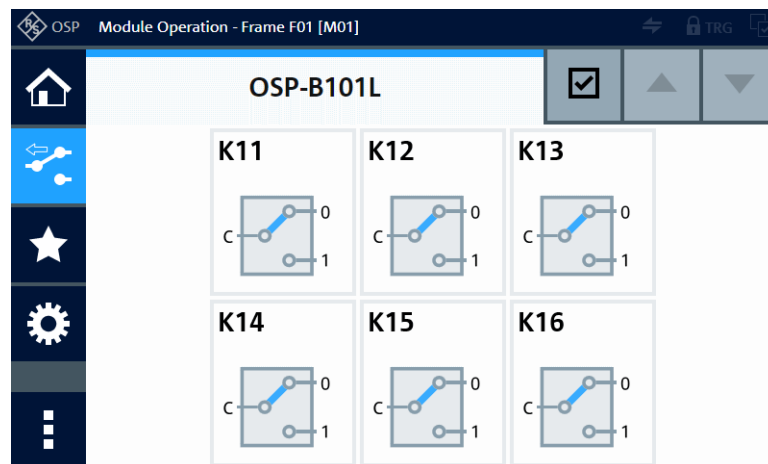

Figure 3-15: Representation of the module on the control screen

For operation, see [Chapter 4, "Operation"](#), on page 147 and [Chapter 5, "Functions"](#), on page 155.

For remote control, refer to the chapters [Remote Operation](#) and [RC Commands](#). For an example, see [ROUTE : CLOSe](#) on page 253.

3.8 R&S OSP-B102 RF Switch Module



Figure 3-16: R&S OSP-B102

The one-slot module R&S OSP-B102 (order no. 1505.5201.02) consists of 2 **failsafe (open)** electromechanical SP6T relays, frequency range DC to 18 GHz, with non-terminated SMA (female) connectors.

Note: Mind the **torque limit recommendation** of **56 N·cm** for **SMA** connectors.

The relays operate independently from each other. The terminal port is labeled with C (common), the other relay ports are labeled with numbers.

The relay type is monostable (or "failsafe open"). Hence, with no voltage applied to a relay, no RF connection is provided from terminal C to any of the numbered ports. To establish an RF connection between C and one of the numbered ports, a continuous voltage must be applied to the corresponding power terminal of the relay.

The relays are mounted directly into the module's panel and soldered to the module's printed board, to avoid relay cabling and allow a compact module size.

The switch unit provides power supply and control via a single module bus cable to a module bus connector on the module's printed board. The module's on-board memory stores its configuration data.

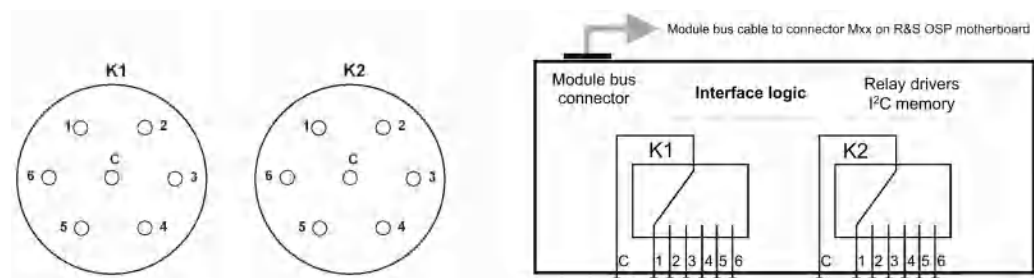

Figure 3-17: Pinout and block diagram of RF switch module R&S OSP-B102

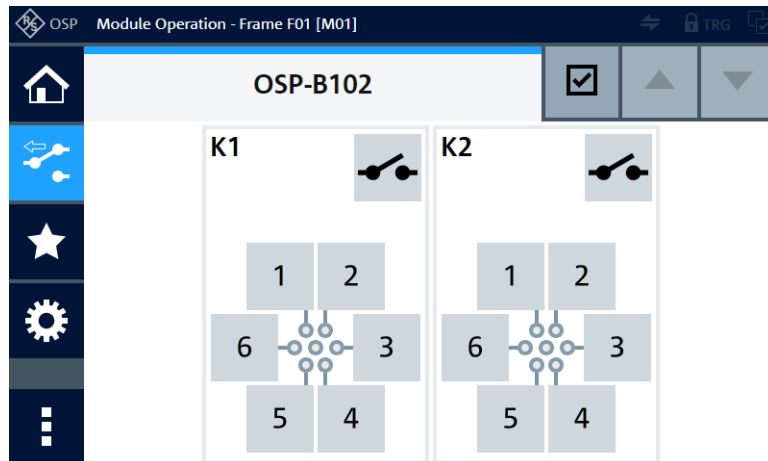

Figure 3-18: Representation of the module on the control screen

For operation, see [Chapter 4, "Operation"](#), on page 147 and [Chapter 5, "Functions"](#), on page 155.

For remote control, refer to the chapters [Remote Operation](#) and [RC Commands](#). For an example, see [ROUTE:CLOSE](#) on page 253.

3.9 R&S OSP-B102L RF Switch Module

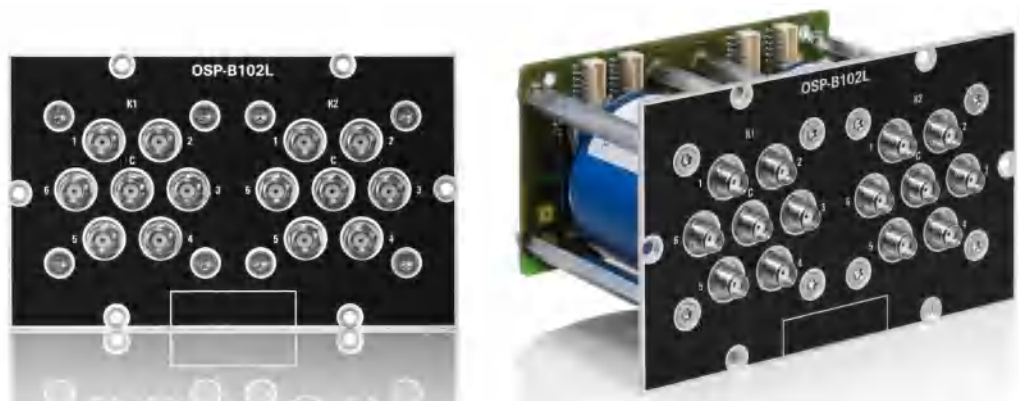

Figure 3-19: R&S OSP-B102L

The one-slot [module](#) R&S OSP-B102L (order no. 1505.5201.52) consists of 2 latching electromechanical SP6T relays, frequency range DC to 18 GHz, with non-terminated SMA (female) connectors.

Note: Mind the [torque limit recommendation](#) of **56 N·cm** for **SMA** connectors.

The terminal port is labeled with C (common), the other relay ports are labeled with numbers.

The relay type is multi-stable (or "latching"). Hence, with no voltage applied, a relay remains in its current position. It also remains in its current position, if the voltage is maintained after switching is accomplished.

To change the connection, the controller must send a voltage pulse to the appropriate switch coil in the relay. After that, no energy is consumed by this relay type.

You can configure two different [Power Up reset conditions](#) to determine, how the latching relay behaves after booting the switch unit.

The relay is mounted directly into the module's panel and soldered to the module's printed board, to avoid relay cabling and allow a compact module size.

The switch unit provides power supply and control via a single module bus cable to a module bus connector on the module's printed board. The module's on-board memory stores its configuration data.

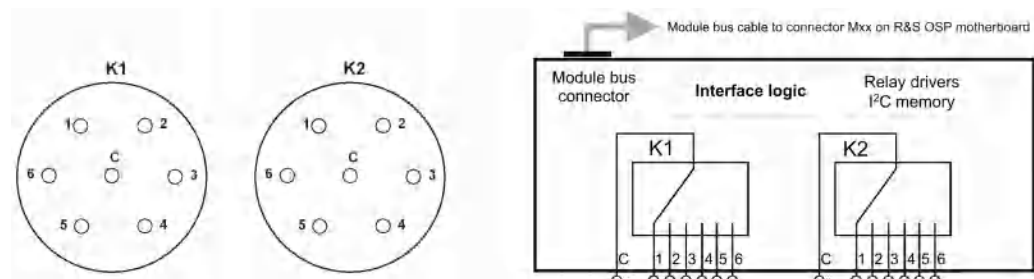

Figure 3-20: Pinout and block diagram of RF switch module R&S OSP-B102L

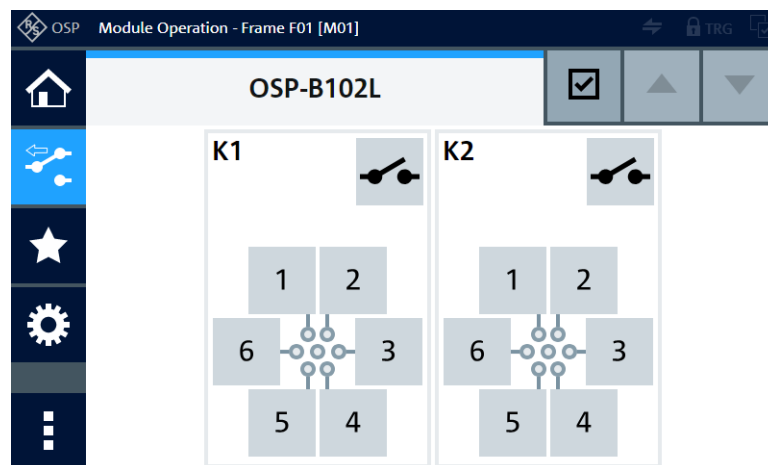

Figure 3-21: Representation of the module on the control screen

For operation, see [Chapter 4, "Operation"](#), on page 147 and [Chapter 5, "Functions"](#), on page 155.

For remote control, refer to the chapters [Remote Operation](#) and [RC Commands](#). For an example, see [ROUTE:CLOSE](#) on page 253.

3.10 R&S OSP-B103 Digital I/O Module



Figure 3-22: R&S OSP-B103

The digital input/output one-slot module R&S OSP-B103 (order no. 1505.5301.02) consists of a 16-bit input port and a 16-bit output port, controlled by a logic interface.



See also [Chapter 6.1, "Applications of Module R&S OSP-B103"](#), on page 227.

The input and output channels are independent of each other. The output pattern ([Figure 3-24](#)) depends on your settings, the input pattern ([Figure 3-25](#)) can be arbitrary.

- The **output** channels are available on the first 16 sockets of the lower D-Sub connector (female). The remaining sockets 17 to 25 are connected to +28 V. All output channels can be programmed independently from each other. You can use the output port for external relays that require up to 28 V switching voltage, as, for example, in [Figure 6-2](#).
Each output channel is designed as a MOS-FET (open drain) that leaves the channel's pin on high impedance in the inactive state. When activated, the FET switches the pin to internal ground. Each output is protected by two TVS diodes against transient disturbances, which can occur when switching inductive loads such as relay coils.
- The **input** channels for +3.3 V TTL signals (tolerating up to +5 V, see below) are available on the first 16 pins of the upper D-Sub connector (male). The remaining pins 17 to 25 are connected to ground (GND). The module's dialog in the firmware and the SCPI command `READ:IO:IN?` can read and show the state of the input channels at any time. Each input channel is protected by a lowpass filter and two TVS diodes against transient disturbances. If your application requires a voltage together with the input channels, you can use the 28 V supplied by the output connector, or use an external voltage source.

Do not **overload** the input: for voltages > 5 V DC up to 28 V DC, insert a **22 kΩ** resistor, see [Chapter 2.1.11, "Connecting Control Cables"](#), on page 22.

The switch unit provides power supply and control via a single module bus cable to a module bus connector on the module's printed board. The module's on-board memory stores its configuration data.

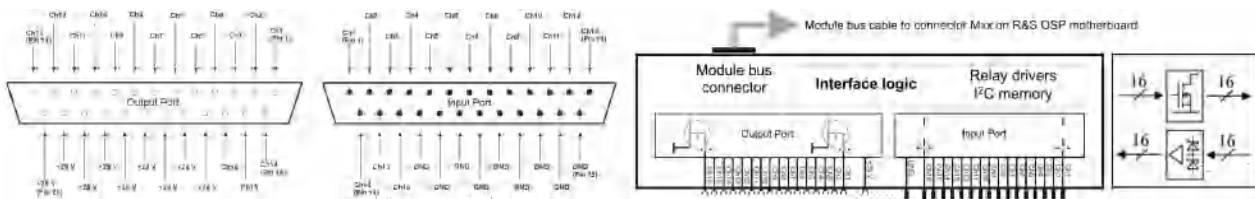

Figure 3-23: Pinout and block diagram of RF switch module R&S OSP-B103

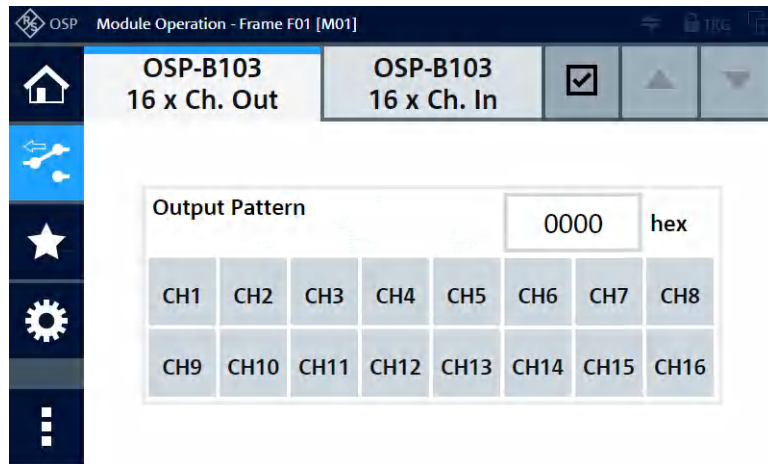

Figure 3-24: Representation of the module's output channels on the control screen

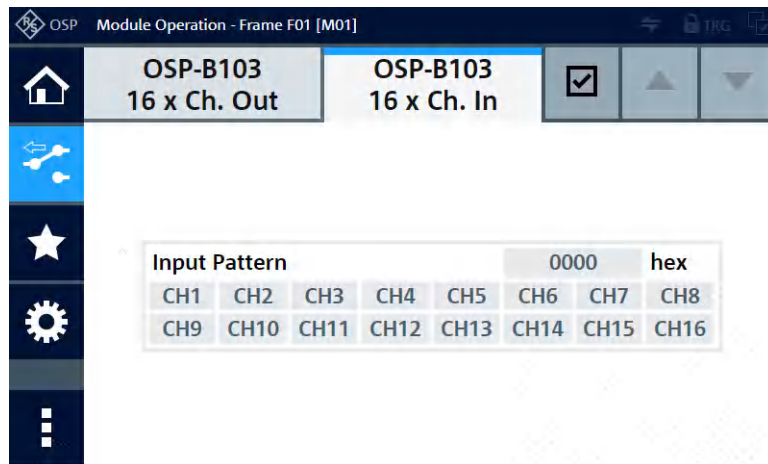

Figure 3-25: Representation of the module's input channels on the control screen

For operation, see [Chapter 4, "Operation"](#), on page 147 and [Chapter 5, "Functions"](#), on page 155.

For remote control, refer to the chapters [Remote Operation](#) and [RC Commands](#). For an example, see [ROUTE:CLOSE](#) on page 253.

You can use the RC command `READ:IO:IN?` for reading the 16 input channels.



For application examples, see also [Chapter 6.1, "Applications of Module R&S OSP-B103"](#), on page 227.

3.11 R&S OSP-B104 Digital I/O Module (EMS)



Figure 3-26: R&S OSP-B104 (detail on the right: 3rd-party Spinner relays)



If this module is not factory-mounted, contact Rohde & Schwarz [service](#) for mounting it.

The digital input/output one-slot [module](#) R&S OSP-B104 (order no. 1505.5401.02) is designed for special applications in electromagnetic susceptibility (EMS) measurements.



See also [Chapter 6.2, "Applications of Module R&S OSP-B104"](#), on page 231.

Its **4 [RELAY] ports** are female 9-pin D-Sub connectors that allow controlling up to 4 of the following external power-transfer relays from a [third-party manufacturer](#):

- Spinner GmbH, model [BN 512690C0002](#) (replacing BN 512670), Rohde & Schwarz order no. 0546.2300.00. The type is DPDT, latching, DC to 5 GHz, with female RF connectors of type 7/16 and impulse solenoid drive. RF input power up to 2 kW @ 100 MHz (details see [Figure 6-5](#)).
- Spinner GmbH, model [BN 640082](#) (replacing BN 640075), Rohde & Schwarz order no. 2108.9517.00. The type is DPDT, latching, DC to 2 GHz, with female RF flange connectors of type 1 5/8" EIA and motor drive. RF input power up to 20 kW @ 100 MHz.
- Spinner GmbH, model [BN 512698](#), Rohde & Schwarz order no. 2108.9500.00. The type is DPDT, latching, DC to 3.5 GHz, with female RF flange connectors of type 7/8" EIA and motor drive. RF input power up to 7.5 kW @ 100 MHz.



For connecting the Spinner relays, see [Chapter 6.2.1, "Controlling External Power Relays with R&S OSP-B104"](#), on page 231.

You can use other transfer relays, if they are compatible with the output of the R&S OSP-B104 control lines. For specifications, refer to the R&S OSP data sheet.

The **5th port** of the R&S OSP-B104 (in the module panel's top position) is a female 15-pin D-Sub connector, labeled **[IN / OUT]**. The input and output channels are described in [Chapter 6.2.3, "Input Ports of R&S OSP-B104"](#), on page 234 and [Chapter 6.2.4, "Output Ports of R&S OSP-B104"](#), on page 234. This port is independent from the [RELAY] ports. It supports basic simultaneous monitoring functions, including interlock handling.

- The module's dialog in the firmware ([Figure 3-28](#)) and the SCPI command `READ:IO:IN?` can display and query the state of the input channels at any time.
- You can use the output pins 2 to 6 and the input pins 10 to 13 as auxiliary lines. Each output channel is designed as a MOS-FET (open drain) that leaves the channel's pin on high impedance in the inactive state. When activated, the FET switches the pin to internal ground. You can use pin 1 (+28 V DC) or an external voltage source (maximum 28 V DC). The maximum current load is 200 mA per output channel.

Do not **overload** the input: for voltages > 5 V DC up to 28 V DC, insert a **22 kΩ** resistor, see [Chapter 2.1.11, "Connecting Control Cables"](#), on page 22.



Transfer switches

The external DPDT power-transfer relays require being switched by control pulses (rather than by constant levels). The R&S OSP supports this control scheme by two lines ("Set A" and "Set B") that set the switch to each position.

- If an external relay is **not activated** ("Set B" pulse sent to the relay), the terminals **1 + 4** and **2 + 3** are connected and remain latched
- If an external relay is **activated** ("Set A" pulse sent to the relay), the terminals **1 + 2** and **3 + 4** are connected and remain latched

Note that these activation or connection states are in contrast with other DPDT switches, like R&S OSP-B114, R&S OSP-B116x and R&S OSP-B136.

The user interface ([Figure 3-28](#)) displays the state of the external relays.

All external relays connected to the R&S OSP-B104 (up to 4 relays) operate independently from each other.

Note that the functions [Reset All Switches](#) and [General > Switch-On Reset](#) in the user interface and the RC command `CONFigure:POWerup:RESet` do **not** change the state of the external relays. Also, the output channels of the module R&S OSP-B104 remain unchanged upon these reset commands.

The Spinner power-transfer relays support the "carrier safety contact" concept. While turning from one switch position to the other, the carrier safety contact remains open. If you include this contact into the interlock path, the power amplifier connected to the interlock control is deactivated while the relay is turning. In the final relay position, the carrier safety contact closes again, thus closing the full interlock chain. Only then, the power amplifier can return to operational mode.



Delay time

The external power-transfer relays connected to the R&S OSP-B104 can have a significant settling time. Especially transfer relays with a motor drive can require tens of milliseconds to reach their final position.

To prevent sending a new command before a relay has reached its final position, the switch unit allows defining a delay time between sending two consecutive commands.

Per default, a delay time of 100 ms is set for the R&S OSP-B104 module. If the controller brings up a switching error, possibly the delay time is set too short.

Refer to [Figure 3-29](#) and to `CONFigure:RELAy:DELAy` on page 269 for further information on how to change the delay time.

The Spinner power-transfer relays have an output contact indicating their position. If you connect this contact to the "Status" pin (pin 2) of the corresponding [RELAY] connector, the R&S OSP can read and display the current state of the external relay.

The module has 6 status LEDs:

- For each [RELAY] connector, left and right of these connectors, there is a "[PWR]" LED, labeled 1 to 4.
 - If a [PWR] LED shows green light, the voltage on pin 1 of this connector is OK (+24 V).
 - If the LED is off, there is a problem with the power on the corresponding connector. In such a case, turn off the R&S OSP, eliminate possible errors in the cabling or the connected relay, turn the switch unit back on and check the LED again.
- Centered between the lower [RELAY] connectors, there are two more LEDs: The upper "[PWR I/O]" LED gives the same voltage status information as described above for pin 1 (+28 V) of the I/O connector.
 - If the LED shows green light, the power is OK.
 - If the LED is off, there is a problem with the power on the corresponding connector. In such a case, turn off the R&S OSP, eliminate possible errors in the cabling or the connected device, turn the switch unit back on and check the LED again.
- The lower "[INTERLOCK]" LED shows the state of the interlock (pins 7 and 15).
 - If the LED is off, it indicates that the interlock is closed. In this state, the remote control command `READ:MOD:INT?` returns the value "1".
 - If the LED shows red light, there is no connection between the pins 7 and 15. This state either indicates an open interlock, or at least in one of the [RELAY] connectors, pins 3 and 4 are not connected. If the interlock is open, the remote control command `READ:MOD:INT?` returns the value "0".

Use a **bridge** between the interlock pins or "carrier safety contacts" of unused relay connectors, see [Figure 6-5](#). Bridging is especially relevant, if the interlock pins of all connectors (also unused connectors) are used in a serial interlock loop. For example, use a special bridging connector to bridge the pins, as described in [Chapter 6.2.1, "Controlling External Power Relays with R&S OSP-B104"](#), on page 231.

The module's on-board memory stores its configuration data.

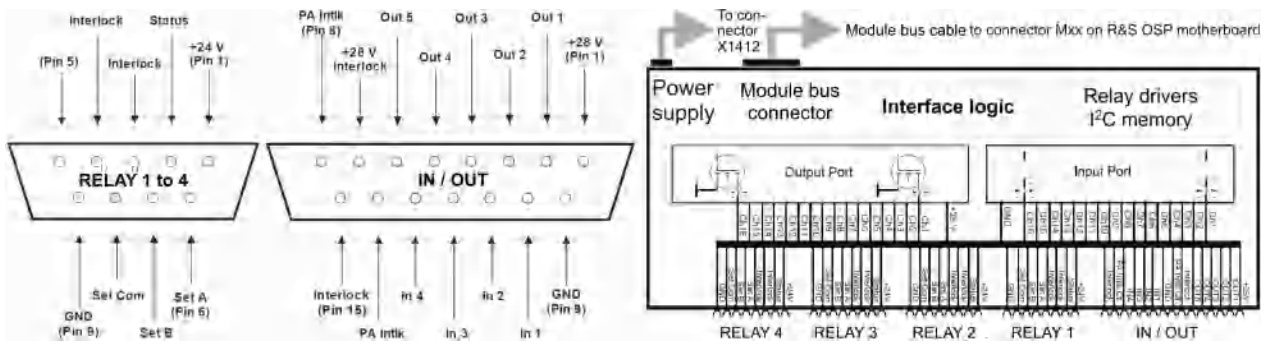

Figure 3-27: Pinout and block diagram of RF switch module R&S OSP-B104

Left = 9-pin [RELAY n] connectors (4x), see also Figure 6-5
 Center = 15-pin [INTERLOCK] I/O connector (1x)
 Right = Block diagram



For connection details, see Chapter 6.2.1, "Controlling External Power Relays with R&S OSP-B104", on page 231.

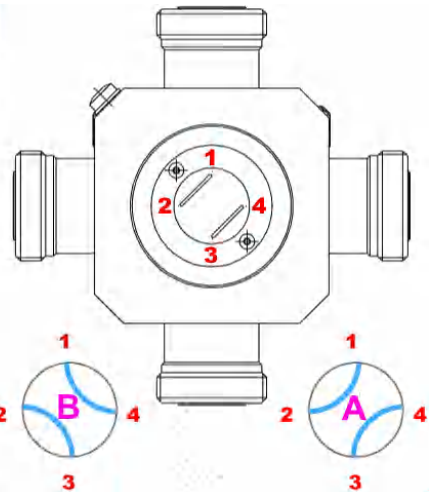
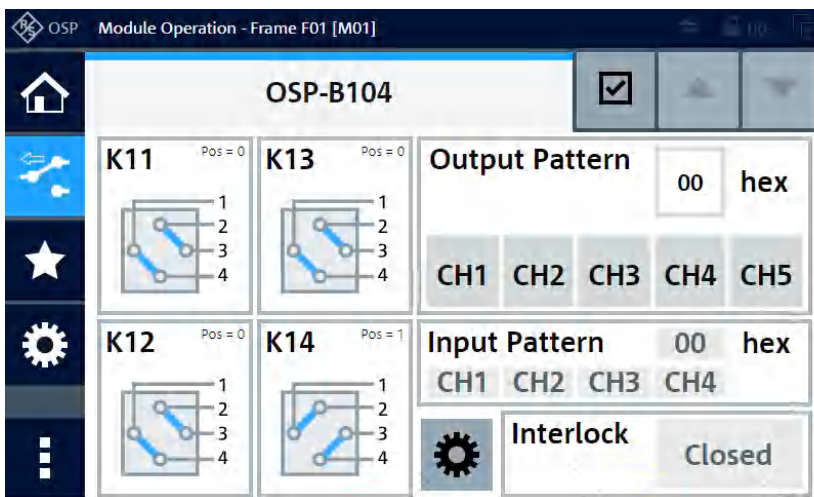

Figure 3-28: Representation of the module on the control screen, the external relays are K11 to K14

Right = Schematic of an external Spinner relay with port labels (red) and position indicator (center dial)
 B = Relay not activated ("Set B" pulse), terminals 1 + 4 and 2 + 3 are connected
 A = Relay activated ("Set A" pulse), terminals 1 + 2 and 3 + 4 are connected

You can read the interlock state of the R&S OSP-B104 (shown on the lower right in Figure 3-28) with the command `READ:MODUle:INTerlock?`.



To set individual delay times for each external transfer relay K11 to K14, click the button "Configure Relay Delay Times" in the control screen shown in Figure 3-28. The following dialog opens:

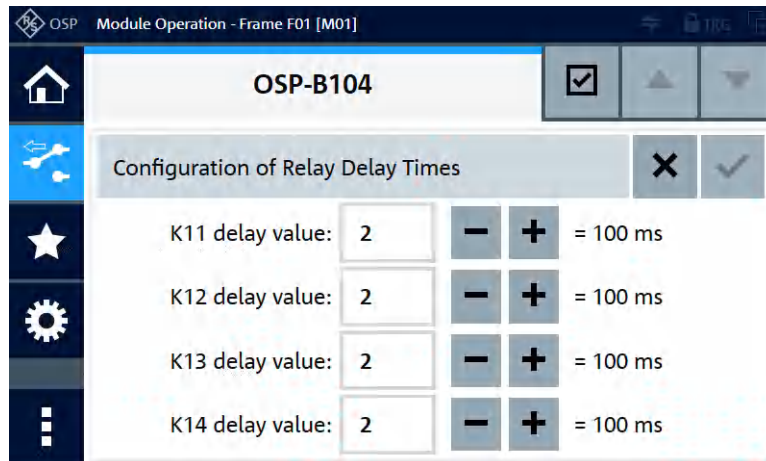

Figure 3-29: Dialog for configuring the delay times of the external relays

Enter delay values to set the delay times, or click the "-/+" buttons to decrease or increase the delay values in steps of 1. A delay value of 1 is equivalent with a command delay time of 50 ms. Hence, you can set the delay times in multiples of 50 ms.

The default delay value of 2 is equivalent with 100 ms.

The range of allowable delay values is 0 to 19, equivalent with delay times ranging from 0 ms to 950 ms.

For further information on command delay times for transfer relays connected to the R&S OSP-B104, refer to [CONFigure:RELAy:DELAy](#) on page 269.

For operation, see [Chapter 4, "Operation"](#), on page 147 and [Chapter 5, "Functions"](#), on page 155.

For remote control, refer to the chapters [Remote Operation](#) and [RC Commands](#). For an example, see [ROUTE:CLOSE](#) on page 253.

3.12 R&S OSP-B106 RF Switch Module



Figure 3-30: R&S OSP-B106

Lower row = 3 SPDT relays K1 to K3 with N connectors

Upper row = 3 SPDT relays K4 to K6 with BNC connectors



If this module is not factory-mounted, contact Rohde & Schwarz [service](#) for mounting it.

The two-slot (double-width) [module](#) R&S OSP-B106 (order no. 1505.5601.02) consists of 6 failsafe electromechanical non-terminated SPDT relays: 3 with BNC (female) connectors and 3 with N (female) connectors.

The SPDT relays K1 to K3 with N-type connectors are suited for a frequency range from DC to 12.4 GHz.

The SPDT relays K4 to K6 with BNC connectors can be used at frequencies up to 900 MHz. At DC voltages up to a maximum of 30 V DC, these relays are suited for currents of up to 2 A.

Note: Mind the [torque limit recommendation](#) of **150 N·cm** for N connectors.

The relays operate independently from each other. The terminal port is labeled with C (common), the other relay ports are labeled with NC (normally closed) and NO (normally open). Terminal C is connected either with relay port NC or NO.

The type of relays is monostable (or "failsafe"), hence, with no voltage applied, an RF connection is provided from C to NC, while NO is not connected to C ("Pos = 0"). To disconnect NC and connect C to NO ("Pos = 1"), a continuous voltage must be applied to the relay.

The relays are mounted directly into the module's panel and soldered to the module's printed board, to avoid relay cabling and allow a compact module size.

The switch unit provides power supply and control via a single module bus cable to a module bus connector on the module's printed board. The module's on-board memory stores its configuration data.

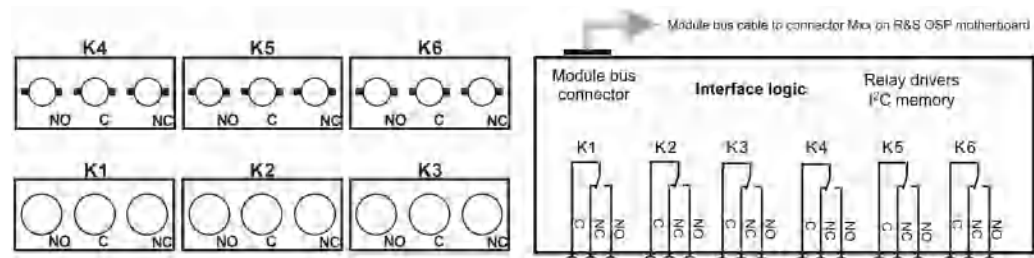

Figure 3-31: Pinout and block diagram of RF switch module R&S OSP-B106

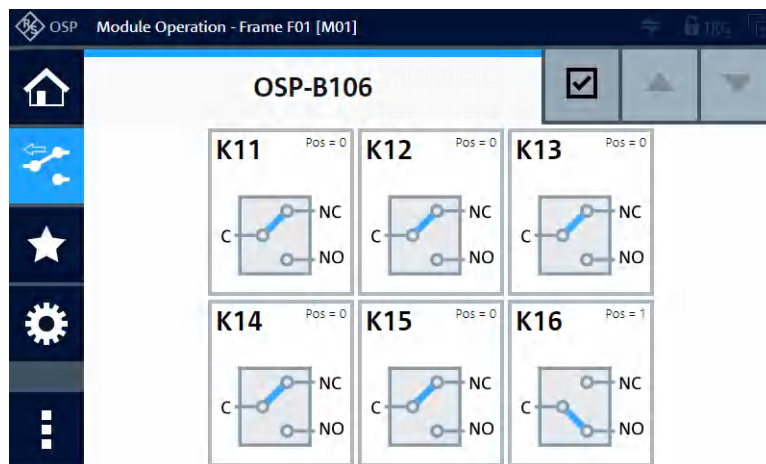

Figure 3-32: Representation of the module on the control screen

For operation, see [Chapter 4, "Operation"](#), on page 147 and [Chapter 5, "Functions"](#), on page 155.

For remote control, refer to the chapters [Remote Operation](#) and [RC Commands](#). For an example, see [ROUTE:CLOSE](#) on page 253.

3.13 R&S OSP-B107 RF SSR Module



Figure 3-33: R&S OSP-B107

The one-slot [module](#) R&S OSP-B107 (order no. 1505.5901.02) consists of 6 solid-state relays (SSRs) of SPDT type, frequency range 9 kHz to 6 GHz, with SMA (female) connectors. Open ports are [reflective](#) with an internal short connection to chassis ground.

Note: Mind the [torque limit recommendation](#) of **56 N·cm** for **SMA** connectors.

The relays operate independently from each other. The terminal port is labeled with C (common), the other relay ports are labeled with NC (normally closed) and NO (normally open). Terminal C is connected either with relay port NC or NO.

After a reset, SSRs automatically go to the default state (control voltage = logical 0) with an RF connection from C to NC, while NO is not connected to C. To disconnect NC and connect C to NO, an SSR must be activated (control voltage = logical 1).

Without power supplied to the relay, it has no defined switching state. Therefore, SSRs are not inherently failsafe, see ["Monostable vs. failsafe"](#) on page 11.

The relays are mounted directly into the module's panel and soldered to the module's printed board, to avoid relay cabling and allow a compact module size.

The switch unit provides power supply and control via a single module bus cable to a module bus connector on the module's printed board. The module's on-board memory stores its configuration data.

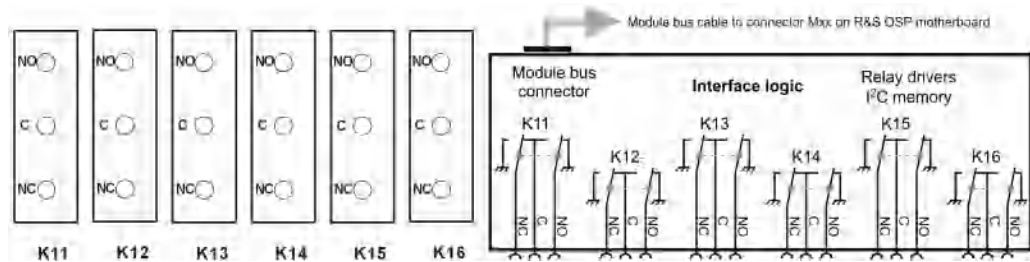

Figure 3-34: Pinout and block diagram of RF switch module R&S OSP-B107

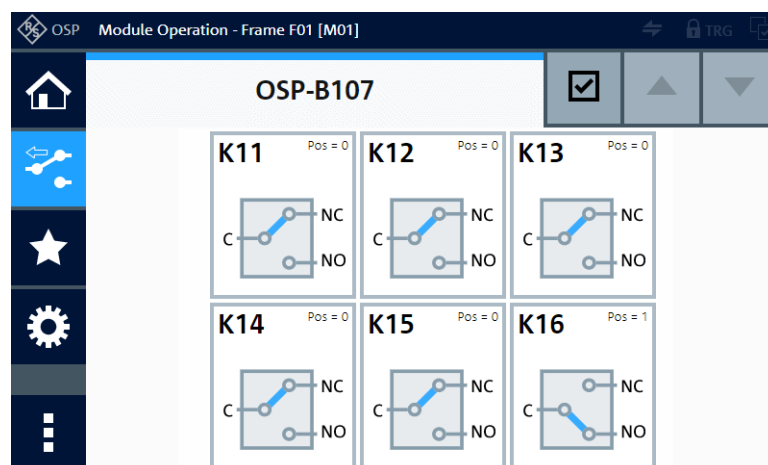

Figure 3-35: Representation of the module on the control screen

For operation, see [Chapter 4, "Operation"](#), on page 147 and [Chapter 5, "Functions"](#), on page 155.

For remote control, refer to the chapters [Remote Operation](#) and [RC Commands](#). For an example, see [ROUTE : CLOSe](#) on page 253.

3.14 R&S OSP-B108 DC Multiplexer Module

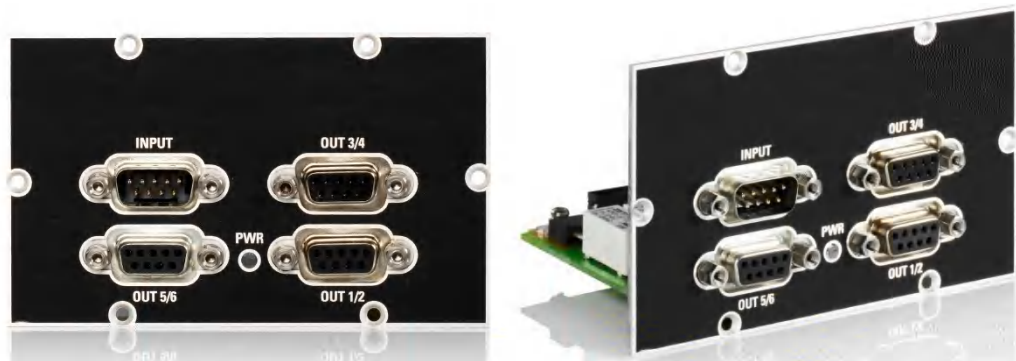

Figure 3-36: R&S OSP-B108

The one-slot [module](#) R&S OSP-B108 (order no. 1505.5718.02) is a four-pole, one-to-six multiplexer (4P6T) for DC signals from 0 V to 60 V, with 30 VA maximum power (same level for all pins).

The module has 1 male input connector and 3 female output connectors. It is controlled by a logic interface and switches up to 4 input channels to one out of 6 output positions.

A typical application example with this module is multiplexing of power supply (two power lines with force and sense wires, hence 4 wires all together) to up to 6 DUTs.

The relay type is electromechanical [failsafe \(open\)](#). Hence, without a control signal no connections are made and the relay goes to its reset state, in which the common terminals are not connected to any output pins.

- The 4 **input** channels are available on the first 8 pins (in groups of 2) of the upper left 9-pin D-Sub connector (male). The remaining pin 9 is connected to ground (GND), see [Figure 3-37](#).
Note that these input pins are not read-out in any way by the switch unit. Instead, the inputs are only switched in a direct connection to the selected output ports, as described below. Also, signals can travel in a bidirectional way, hence, you can use the output ports as inputs, and vice versa.
- The **output** channels are available on the first 8 sockets, each, of the 3 other 9-pin D-Sub connectors (female). The remaining socket 9 of each output port is connected to GND, see [Figure 3-37](#).

The channels are grouped on the connectors:

- Channel 1+2 are on the lower right OUT connector
- Channel 3+4 are on the upper right OUT connector
- Channel 5+6 are on the lower left OUT connector

The switch unit provides power supply and control via a single module bus cable to a module bus connector on the module's printed board. The module's on-board memory stores its configuration data.

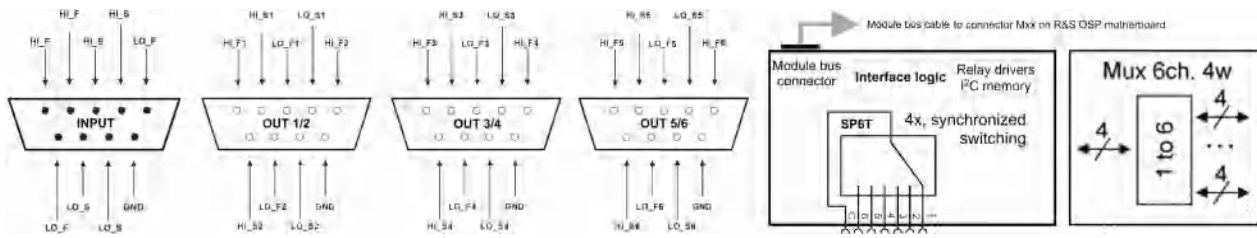

Figure 3-37: Pinout and block diagram of DC multiplexer module R&S OSP-B108

HI = High, positive pole
 LO = Low, negative pole
 F = Force
 S = Sense
 GND = Ground, pin 9

The "HI_F", "HI_S", "LO-F" and "LO-S" lines have identical electrical properties.

There are 6 switching positions (n = 1...6), in which the four coupled SP6T relays can be switched synchronously to connect their common terminals to one of their n output pins:

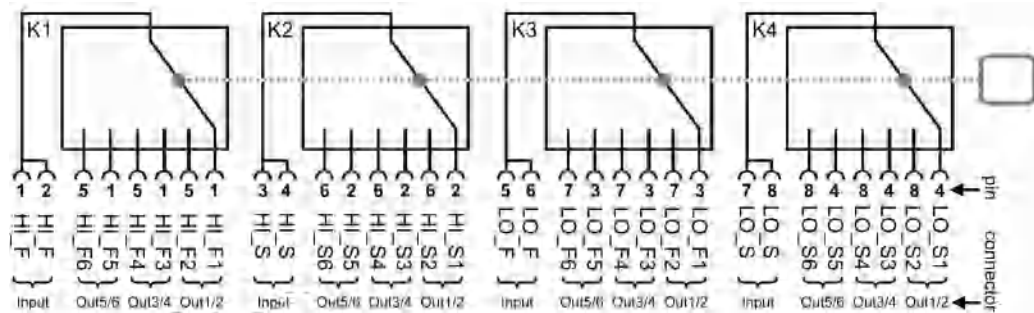

Figure 3-38: Here, all switches (K1 to K4) are in position 1 of 6

The 6 positions result in the following connections:

- Position 1:
 - Signal at "HI_F" INPUT pins 1 & 2 is switched to "HI_F1" (pin 1) of OUT1/2
 - Signal at "HI_S" INPUT pins 3 & 4 is switched to "HI_S1" (pin 2) of OUT1/2
 - Signal at "LO_F" INPUT pins 5 & 6 is switched to "LO_F1" (pin 3) of OUT1/2
 - Signal at "LO_S" INPUT pins 7 & 8 is switched to "LO_S1" (pin 4) of OUT1/2
- Position 2:
 - Signal at "HI_F" INPUT pins 1 & 2 is switched to "HI_F2" (pin 5) of OUT1/2
 - Signal at "HI_S" INPUT pins 3 & 4 is switched to "HI_S2" (pin 6) of OUT1/2
 - Signal at "LO_F" INPUT pins 5 & 6 is switched to "LO_F2" (pin 7) of OUT1/2
 - Signal at "LO_S" INPUT pins 7 & 8 is switched to "LO_S2" (pin 8) of OUT1/2
- Position 3:
 - Signal at "HI_F" INPUT pins 1 & 2 is switched to "HI_F3" (pin 1) of OUT3/4
 - Signal at "HI_S" INPUT pins 3 & 4 is switched to "HI_S3" (pin 2) of OUT3/4
 - Signal at "LO_F" INPUT pins 5 & 6 is switched to "LO_F3" (pin 3) of OUT3/4
 - Signal at "LO_S" INPUT pins 7 & 8 is switched to "LO_S3" (pin 4) of OUT3/4

- Position 4:
 - Signal at "HI_F" INPUT pins 1 & 2 is switched to "HI_F4" (pin 5) of OUT3/4
 - Signal at "HI_S" INPUT pins 3 & 4 is switched to "HI_S4" (pin 6) of OUT3/4
 - Signal at "LO_F" INPUT pins 5 & 6 is switched to "LO_F4" (pin 7) of OUT3/4
 - Signal at "LO_S" INPUT pins 7 & 8 is switched to "LO_S4" (pin 8) of OUT3/4
- Position 5:
 - Signal at "HI_F" INPUT pins 1 & 2 is switched to "HI_F5" (pin 1) of OUT5/6
 - Signal at "HI_S" INPUT pins 3 & 4 is switched to "HI_S5" (pin 2) of OUT5/6
 - Signal at "LO_F" INPUT pins 5 & 6 is switched to "LO_F5" (pin 3) of OUT5/6
 - Signal at "LO_S" INPUT pins 7 & 8 is switched to "LO_S5" (pin 4) of OUT5/6
- Position 6:
 - Signal at "HI_F" INPUT pins 1 & 2 is switched to "HI_F6" (pin 5) of OUT5/6
 - Signal at "HI_S" INPUT pins 3 & 4 is switched to "HI_S6" (pin 6) of OUT5/6
 - Signal at "LO_F" INPUT pins 5 & 6 is switched to "LO_F6" (pin 7) of OUT5/6
 - Signal at "LO_S" INPUT pins 7 & 8 is switched to "LO_S6" (pin 8) of OUT5/6

The switch unit supplies 28 V to the module, where a voltage controller converts it down to 12 V, required to supply power to the relays. The [PWR] LED between the lower output ports shows the status of this power supply.

- If the LED shows green light, the internal 12 V power supply is OK and the relays are operational.
- If the LED is off, there is a problem with the internal power supply. Contact Rohde & Schwarz [Customer Support](#) for service.

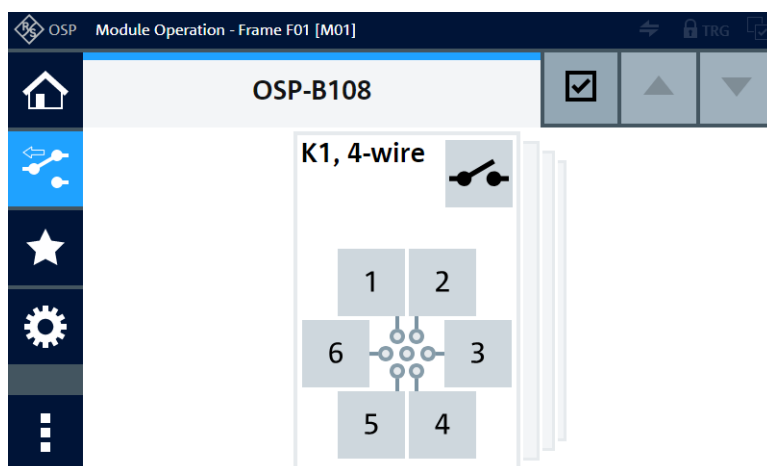

Figure 3-39: Representation of the module on the control screen

The shades behind the dialog of relay K1 are there to indicate that the other relays K2, K3 and K4 are switched synchronously with K1.

For operation, see [Chapter 4, "Operation"](#), on page 147 and [Chapter 5, "Functions"](#), on page 155.

For remote control, refer to the chapters [Remote Operation](#) and [RC Commands](#). For an example, see [ROUTE:CLOSE](#) on page 253.

3.15 R&S OSP-B111E RF Switch Module



Figure 3-40: R&S OSP-B111E

The one-slot module R&S OSP-B111E (order no. 1505.4605.26) consists of 6 failsafe electromechanical SPDT relays, frequency range DC to 26.5 GHz, with non-terminated SMA (female) connectors.

The module's SMA connectors are geometrically compatible with 3.5 mm and 2.92 mm connectors of RF cables that support 26.5 GHz.

Note: Mind the [torque limit recommendation](#) of **56 N·cm** for **SMA** connectors.

The relays operate independently from each other. The terminal port is labeled with C (common), the other relay ports are labeled with NC (normally closed) and NO (normally open). Terminal C is connected either with relay port NC or NO.

The type of relays is monostable (or "failsafe"), hence, with no voltage applied, an RF connection is provided from C to NC, while NO is not connected to C ("Pos = 0"). To disconnect NC and connect C to NO ("Pos = 1"), a continuous voltage must be applied to the relay.

The relays are mounted directly into the module's panel and soldered to the module's printed board, to avoid relay cabling and allow a compact module size.

The switch unit provides power supply and control via a single module bus cable to a module bus connector on the module's printed board. The module's on-board memory stores its configuration data.

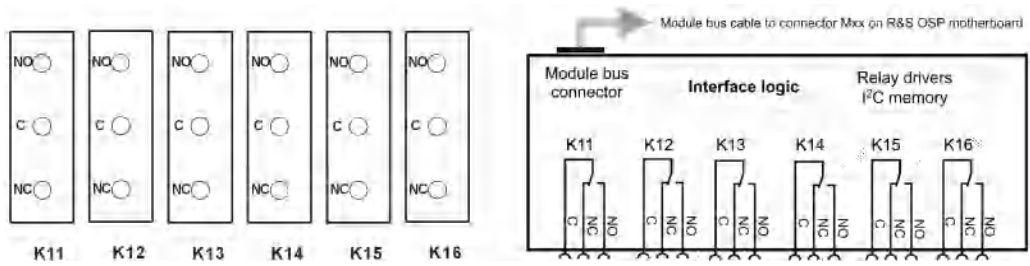

Figure 3-41: Pinout and block diagram of RF switch module R&S OSP-B111E

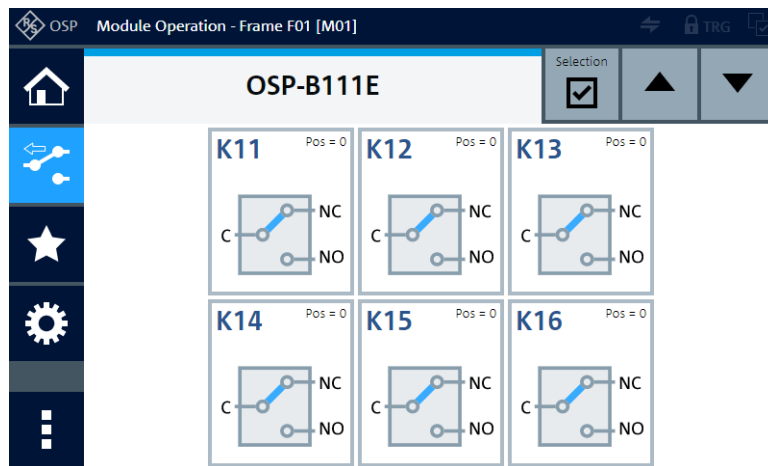

Figure 3-42: Representation of the module on the control screen

For operation, see [Chapter 4, "Operation"](#), on page 147 and [Chapter 5, "Functions"](#), on page 155.

For remote control, refer to the chapters [Remote Operation](#) and [RC Commands](#). For an example, see [ROUTE:CLOSE](#) on page 253.

3.16 R&S OSP-B111H RF Switch Module



Figure 3-43: R&S OSP-B111H (here with 6 SPDT relays)

The one-slot [module](#) R&S OSP-B111H (order no. 1505.4605.43/.46) consists of failsafe electromechanical SPDT relays with non-terminated connectors.

It is based on the module [B111E](#), with the following differences:

- Frequency range from DC to **40 GHz** (instead of 26.5 GHz)
- **PC 2.92** (female) connectors (instead of SMA connectors)
- Availability of two versions:
 - Version 1505.4605.**43** with 3 SPDT relays (K11 to K13)
 - Version 1505.4605.**46** with 6 SPDT relays (K11 to K16)

Note: Mind the [torque limit recommendation](#) of **90 N·cm** for **PC** connectors.



The module R&S OSP-B111H replaces the module R&S OSP-B111 (order no. 1505.4605.02), to comply with the [naming convention](#) for modules with a frequency range up to 40 GHz.

The pinout and block diagram of the module R&S OSP-B111H is the same as in [Figure 3-41](#). But in the module version **.43** with 3 SPDT relays (K11 to K13), the relays K14, K15 and K16 are not available.

The control screen representation of the module R&S OSP-B111H is the same as in [Figure 3-42](#), but with 3 SPDT relays, only, in version 1505.4605.43:



Figure 3-44: Representation of the module on the control screen, with 3 or 6 SPDT relays

3.17 R&S OSP-B111U RF Switch Module



Figure 3-45: R&S OSP-B111U (left with 3 SPDT relays, right with 6 SPDT relays)

The one-slot [module](#) R&S OSP-B111U (order no. 1505.4605.53/.56) consists of failsafe electromechanical SPDT relays with non-terminated connectors.

It is based on the module [B111E](#), with the following differences:

- Frequency range from DC to **50 GHz** (instead of 26.5 GHz)
- PC **2.4** (female) connectors (instead of SMA connectors)
- Availability of two versions:
 - Version 1505.4605.**53** with 3 SPDT relays (K11 to K13)
 - Version 1505.4605.**56** with 6 SPDT relays (K11 to K16)

Note: Mind the [torque limit recommendation](#) of **90 N·cm** for PC connectors.

The pinout and block diagram of the module R&S OSP-B111U is the same as in [Figure 3-41](#). But in the module version **.53** with 3 SPDT relays (K11 to K13), the relays K14, K15 and K16 are not available.

The control screen representation of the module R&S OSP-B111U is the same as in [Figure 3-44](#).

3.18 R&S OSP-B111UL RF Switch Module

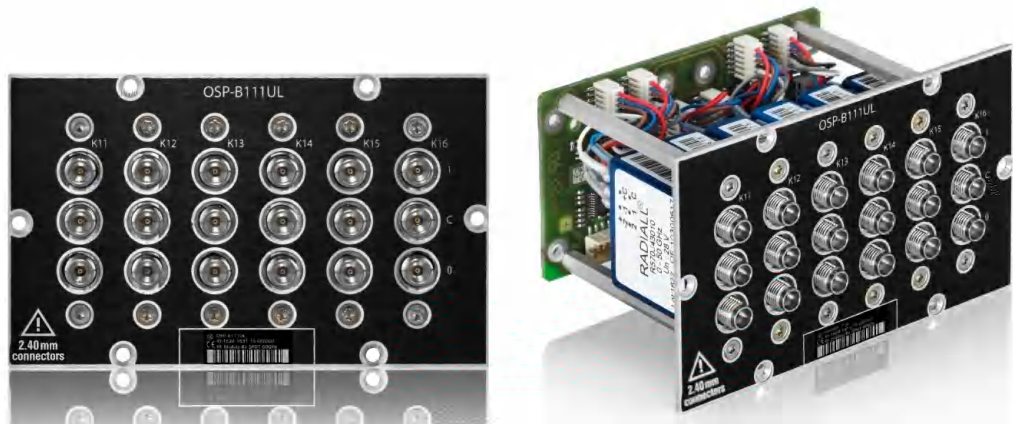

Figure 3-46: R&S OSP-B111UL (here with 6 SPDT relays)

The one-slot module R&S OSP-B111UL (order no. 1528.1531.13/.16) consists of latching electromechanical SPDT relays, frequency range DC to 50 GHz, with non-terminated PC 2.4 (female) connectors.

There are module versions with 3 and with 6 SPDT relays:

- 3 relays: order no. 1528.1531.13
- 6 relays: order no. 1528.1531.16

Note: Mind the [torque limit recommendation](#) of **90 N·cm** for PC connectors.

The relays operate independently from each other. The terminal port is labeled with C (common), the other relay ports are labeled with numbers "0" (= default port) and "1". Terminal C is connected either with relay port "1" or "0". (In modules manufactured before 2021, the default port was labeled "2" instead of "0".)

Note that the hardware labels "0" and "1" are represented in the software as positions "0" (= default) and "1", respectively. In [RC Commands](#), the corresponding switching states are encoded by the SCPI parameters "00" (= default) and "01".

The relay type is bistable (or "latching"), hence, with no voltage applied, a relay remains in its current position.

To change the connection, the controller must send a voltage pulse to the appropriate switch coil in the relay. After that, no energy is consumed by this relay type.

You can configure two different [Power Up reset conditions](#) to determine, how latching relays behave after booting the switch unit.

The relays are mounted directly into the module's panel and soldered to the module's printed board, to avoid relay cabling and allow a compact module size.

The switch unit provides power supply and control via a single module bus cable to a module bus connector on the module's printed board. The module's on-board memory stores its configuration data.

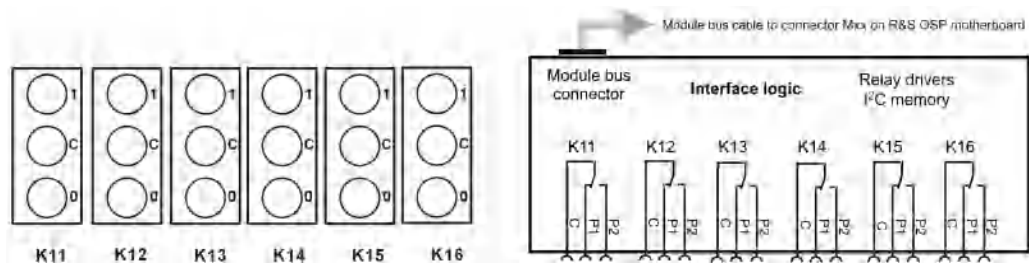

Figure 3-47: Pinout and block diagram of RF switch module R&S OSP-B111UL (here: 6 relays)

In the module version with 3 SPDT relays, the relays K14, K15 and K16 are not available.



Figure 3-48: Representation of the module on the control screen, with 3 or 6 SPDT relays

For operation, see [Chapter 4, "Operation"](#), on page 147 and [Chapter 5, "Functions"](#), on page 155.

For remote control, refer to the chapters [Remote Operation](#) and [RC Commands](#). For an example, see [ROUTE:CLOSE](#) on page 253.

3.19 R&S OSP-B111V RF Switch Module



Figure 3-49: R&S OSP-B111V (left with 3 SPDT relays, center and right with 6 SPDT relays)

The one-slot [module](#) R&S OSP-B111V (order no. 1505.4605.61 to 1505.4605.66) consists of failsafe electromechanical SPDT relays, frequency range DC to 67 GHz, with non-terminated PC 1.85 (female) connectors.

It is based on the module [B111E](#), with the following differences:

- Frequency range from DC to **67 GHz** (instead of 26.5 GHz)
- PC **1.85** (female) connectors (instead of SMA connectors)
- Availability of six versions:
 - Version 1505.4605.**61** with 1 SPDT relays (K11)
 - Version 1505.4605.**62** with 2 SPDT relays (K11, K12)
 - Version 1505.4605.**63** with 3 SPDT relays (K11 to K13)
 - Version 1505.4605.**64** with 4 SPDT relays (K11 to K14)
 - Version 1505.4605.**65** with 5 SPDT relays (K11 to K15)
 - Version 1505.4605.**66** with 6 SPDT relays (K11 to K16)

Note: Mind the [torque limit recommendation](#) of **90 N·cm** for PC connectors.

The pinout and block diagram of the module R&S OSP-B111V is the same as in [Figure 3-41](#). But in the module versions with less than 6 SPDT relays, the relays with the highest Kxx numbers in the range from K11 to K16 are not available.

The control screen representation of the module R&S OSP-B111V is similar to [Figure 3-44](#), but with six different versions as listed above. [Figure 3-50](#) shows two of these six versions:



Figure 3-50: Representation of the module on the control screen, here with 4 or 5 SPDT relays

3.20 R&S OSP-B111VL RF Switch Module



Figure 3-51: R&S OSP-B111VL (left with 3 SPDT relays, center and right with 6 SPDT relays)

The one-slot [module](#) R&S OSP-B111VL (order no. 1515.5991.13/.16) consists of latching electromechanical SPDT relays, frequency range DC to 67 GHz, with non-terminated PC 1.85 (female) connectors.

There are module versions with 3 and with 6 SPDT relays:

- 3 relays: order no. 1515.5991.13
- 6 relays: order no. 1515.5991.16

Note: Mind the [torque limit recommendation](#) of **90 N·cm** for **PC** connectors.

The relays operate independently from each other. The terminal port is labeled with C (common), the other relay ports are labeled with numbers "0" (= default port) and "1". Terminal C is connected either with relay port "1" or "0". (In modules manufactured before 2021, the default port was labeled "2" instead of "0".)

Note that the hardware labels "0" and "1" are represented in the software as positions "0" (= default) and "1", respectively. In [RC Commands](#), the corresponding switching states are encoded by the SCPI parameters "00" (= default) and "01".

The relay type is bistable (or "latching"), hence, with no voltage applied, a relay remains in its current position.

To change the connection, the controller must send a voltage pulse to the appropriate switch coil in the relay. After that, no energy is consumed by this relay type.

You can configure two different [Power Up reset conditions](#) to determine, how latching relays behave after booting the switch unit.

The relays are mounted directly into the module's panel and soldered to the module's printed board, to avoid relay cabling and allow a compact module size.

The switch unit provides power supply and control via a single module bus cable to a module bus connector on the module's printed board. The module's on-board memory stores its configuration data.

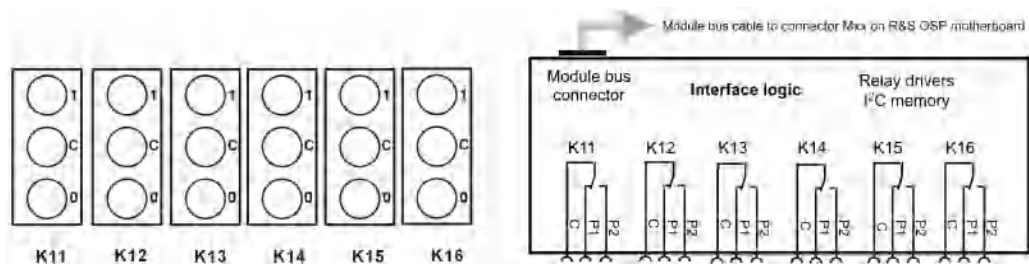

Figure 3-52: Pinout and block diagram of RF switch module R&S OSP-B111VL (here: 6 relays)

In the module version with 3 SPDT relays, the relays K14, K15 and K16 are not available.



Figure 3-53: Representation of the module on the control screen, with 3 or 6 SPDT relays

For operation, see [Chapter 4, "Operation"](#), on page 147 and [Chapter 5, "Functions"](#), on page 155.

For remote control, refer to the chapters [Remote Operation](#) and [RC Commands](#). For an example, see [ROUTE:CLOSE](#) on page 253.

3.21 R&S OSP-B112E RF Switch Module



Figure 3-54: R&S OSP-B112E (left with 1 SP6T relay, center and right with 2 SP6T relays)

The one-slot [module](#) R&S OSP-B112E (order no. 1528.1560.11 or .12) consists of 1 or 2 [failsafe \(open\)](#) electromechanical SP6T relays, frequency range DC to 26.5 GHz, with non-terminated SMA (female) connectors.

The module is available in two versions:

- Version 1528.1560.11 with 1 SP6T relay (K1)
- Version 1528.1560.12 with 2 SP6T relays (K1 and K2)

The module's SMA connectors are geometrically compatible with 3.5 mm and 2.92 mm connectors of RF cables that support 26.5 GHz.

Note: Mind the [torque limit recommendation](#) of **56 N·cm** for **SMA** connectors.

The relays operate independently from each other. The terminal port is labeled with C (common), the other relay ports are labeled with numbers.

The relay type is monostable (or "failsafe open"). Hence, with no voltage applied to a relay, no RF connection is provided from terminal C to any of the numbered ports. To establish an RF connection between C and one of the numbered ports, a continuous voltage must be applied to the corresponding power terminal of the relay.

The relays are mounted directly into the module's panel and soldered to the module's printed board, to avoid relay cabling and allow a compact module size.

The switch unit provides power supply and control via a single module bus cable to a module bus connector on the module's printed board. The module's on-board memory stores its configuration data.

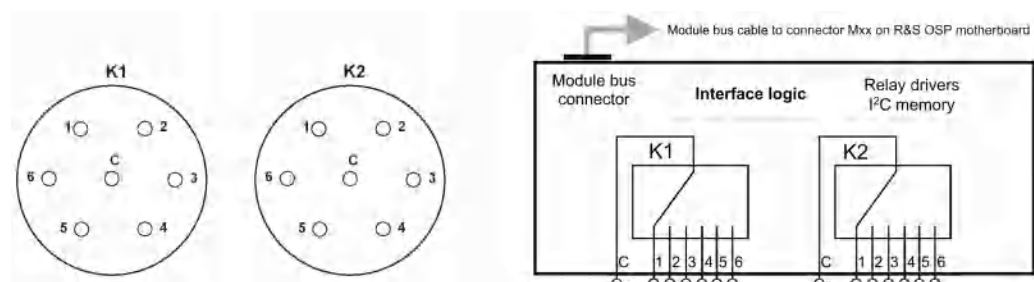

Figure 3-55: Pinout and block diagram of RF switch module R&S OSP-B112E

In the module version .11 with 1 SP6T relay (K1), the relay K2 is not available.



Figure 3-56: Representation of the module on the control screen, with 1 or 2 relays

For operation, see [Chapter 4, "Operation"](#), on page 147 and [Chapter 5, "Functions"](#), on page 155.

For remote control, refer to the chapters [Remote Operation](#) and [RC Commands](#). For an example, see [ROUTE:CLOSE](#) on page 253.

3.22 R&S OSP-B112H RF Switch Module



Figure 3-57: R&S OSP-B112H (here with 2 SP6T relays)

The one-slot module R&S OSP-B112H (order no. 1528.1560.41/.42) consists of **fail-safe (open)** electromechanical SP6T relays with non-terminated connectors.

The module is available in two versions:

- Version 1528.1560.**41** with 1 SP6T relay (K1)
- Version 1528.1560.**42** with 2 SP6T relays (K1 and K2)

It is based on the module **B112**, with the following differences:

- Frequency range from DC to **40 GHz** (instead of 26.5 GHz)
- **PC 2.92** (female) connectors (instead of SMA connectors)

Note: Mind the **torque limit recommendation** of **90 N·cm** for **PC** connectors.



The module R&S OSP-B112H replaces the module R&S OSP-B112 (order no. 1505.4611.02), to comply with the **naming convention** for modules with a frequency range up to 40 GHz.

The pinout and block diagram of the module R&S OSP-B112H is the same as in **Figure 3-55**, with 1 SP6T relay, only, in version 1528.1560.41.

The control screen representation of the module R&S OSP-B112H is the same as in **Figure 3-56**.

3.23 R&S OSP-B112U RF Switch Module



Figure 3-58: R&S OSP-B112U (left with 1 SP6T relay, right with 2 SP6T relays)

The one-slot [module](#) R&S OSP-B112U (order no. 1528.1560.51/.52) consists of [fail-safe \(open\)](#) electromechanical SP6T relays with non-terminated connectors.

The module is available in two versions:

- Version 1528.1560.**51** with 1 SP6T relay (K1)
- Version 1528.1560.**52** with 2 SP6T relays (K1 and K2)

It is based on the module [B112E](#), with the following differences:

- Frequency range from DC to **50 GHz** (instead of 40 GHz)
- PC **2.4** (female) connectors (instead of PC 2.92 connectors)

Note: Mind the [torque limit recommendation](#) of **90 N·cm** for PC connectors.

The pinout and block diagram of the module R&S OSP-B112U is the same as in [Figure 3-55](#).

In the module version **.51** with 1 SP6T relay (K1), the relay K2 is not available.

The control screen representation of the module R&S OSP-B112U is the same as in [Figure 3-56](#).

3.24 R&S OSP-B112UL RF Switch Module

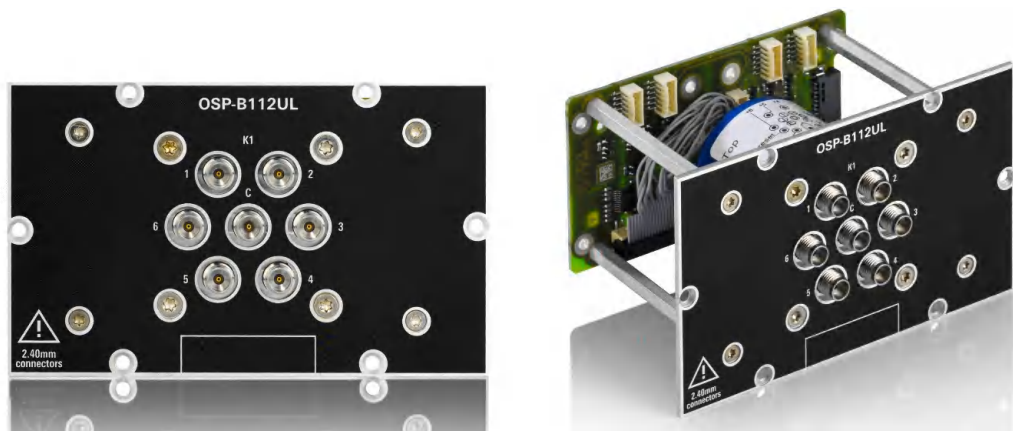

Figure 3-59: R&S OSP-B112UL

The one-slot [module](#) R&S OSP-B112UL (order no. 1528.1548.11) consists of 1 latching electromechanical SP6T relay, frequency range DC to 50 GHz, with non-terminated PC 2.4 (female) connectors.

Note: Mind the [torque limit recommendation](#) of **90 N·cm** for **PC** connectors.

The terminal port is labeled with C (common), the other relay ports are labeled with numbers.

The relay type is multi-stable (or "latching"). Hence, with no voltage applied, a relay remains in its current position. It also remains in its current position, if the voltage is maintained after switching is accomplished.

To change the connection, the controller must send a voltage pulse to the appropriate switch coil in the relay. After that, no energy is consumed by this relay type.

You can configure two different [Power Up reset conditions](#) to determine, how the latching relay behaves after booting the switch unit.

The relay is mounted directly into the module's panel and soldered to the module's printed board, to avoid relay cabling and allow a compact module size.

The switch unit provides power supply and control via a single module bus cable to a module bus connector on the module's printed board. The module's on-board memory stores its configuration data.

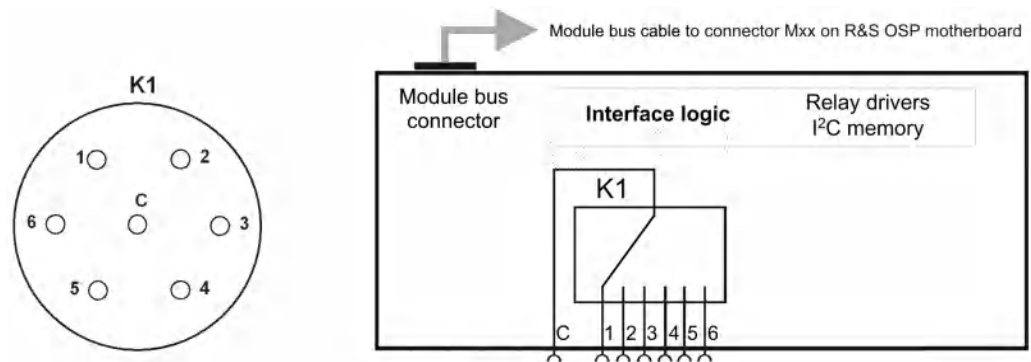

Figure 3-60: Pinout and block diagram of RF switch module R&S OSP-B112UL

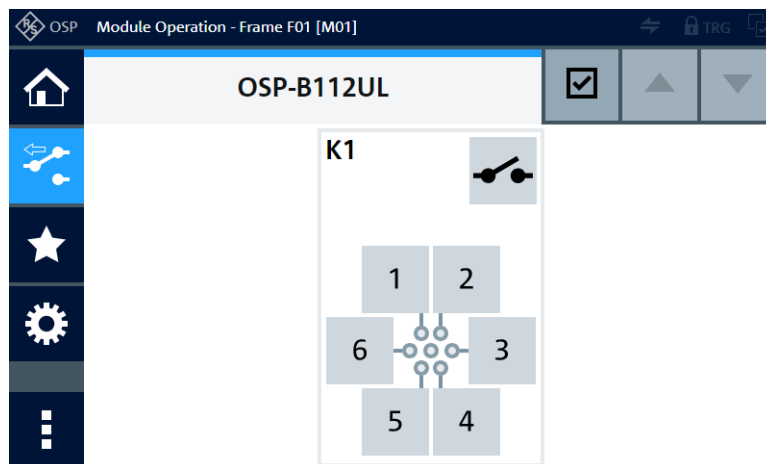

Figure 3-61: Representation of the module on the control screen

For operation, see [Chapter 4, "Operation"](#), on page 147 and [Chapter 5, "Functions"](#), on page 155.

For remote control, refer to the chapters [Remote Operation](#) and [RC Commands](#). For an example, see [ROUTE : CLOSe](#) on page 253.

3.25 R&S OSP-B114 EMS Test Control Module



Figure 3-62: R&S OSP-B114

The one-slot module R&S OSP-B114 (order no. 1505.4711.02) has 2 D-Sub I/O connectors, interlock LED, solid-state SPDT relay (SSR, K14) with 3 female SMA connectors and electromechanical DPDT power relay (K11) with 4 female N connectors.

Note: Mind the [torque limit recommendation](#) of **150 N-cm** for **N** connectors.

Note: Mind the [torque limit recommendation](#) of **56 N-cm** for **SMA** connectors.



See also [Chapter 6.3, "Applications of Module R&S OSP-B114"](#), on page 235.

The module is designed for the following tasks in small or medium systems for electromagnetic susceptibility (EMS) measurements:

- **IN**

The male D-Sub 9 connector labeled "IN" provides 4 input channels and 5 other lines, as shown in [Figure 3-63](#):

- The 4 digital input channels (input lines at pins 4, 5, 8 and 9) have no influence on the module's internal interface logic. Instead, you can read out the state of these universal IN channels to your external computer. You can use these IN channels, for example, for controlling your application by the state of various door contacts or light grids.

These 4 input channels are specified for up to 5 V (TTL). If you use a higher voltage level up to +28 V DC (as provided by pin 6, for example), do not **over-load** the input: for voltages > 5 V DC up to 28 V DC, insert a **22 kΩ** resistor, see [Chapter 2.1.11, "Connecting Control Cables"](#), on page 22.

The input channels can be read at any time. Each channel is protected by a lowpass filter and two TVS diodes against transient disturbances.

- Pin 1 is a ground contact.
- Use the "Interlock Loop" line on pin 2 together with pin 6 ("+28 V DC") to connect the interlock door contact. Hence, pin 2 provides the basic door-state information to the module's interlock logic.

- The "PA Interlock Control 1" circuit between pin 3 and pin 7 is controlled by the module's interlock logic. This circuit can, for example, shut down (power off) an external RF power amplifier, if the interlock loop is open.

The module's dialog in the firmware ([Figure 3-64](#)) and the SCPI command `READ:IO:IN?` can display and query the state of the input channels at any time.

- **OUT**

The female D-Sub 9 connector labeled "OUT" provides 4 output channels and 5 other lines, as shown in [Figure 3-63](#):

- The 4 digital output channels at pins 1, 2, 6 and 7 can be programmed independently from each other. You can use the OUT channels, for example, for controlling the position and polarization of the transmitting antennas. These lines are specified, each, for a maximum load of 200 mA at 28 V DC. The maximum total load on the module is 600 mA, as specified in the data sheet. Each output channel is designed as a MOS-FET (open drain) that leaves the channel's pin on high impedance in the inactive state. When activated, the FET switches the pin to internal ground. Each output is protected by two TVS diodes against transient disturbances, which can occur when switching inductive loads, such as relay coils.
- Pin 5 is a ground contact.
- Pin 3 of the output port ("Interlock LED" in [Figure 3-63](#)) is controlled by the module's interlock logic and activated together with the "INTLK LED". It is specified at a maximum of 100 mA. Hence, you can use pin 3 and pin 9 ("+28 V DC") of the output port to control a remote LED or a different indicator in a separate location, as in [Figure 3-63](#). For example, this indicator can be on the front panel of a rack or in an office.
- The "PA Interlock Control 2" circuit between pins 4 and 8 is controlled by the module's interlock logic, too. This circuit can, for example, shut down (power off) another external RF power amplifier, if the input port's interlock loop is open.

- **DPDT**

The electromechanical DPDT power relay R1 can switch the RF output of two power amplifiers to one or two transmitting antennas or other transducers. It has 4 numbered terminal ports and is suited for a frequency range from DC to 12.4 GHz. For power ratings, refer to the data sheet.

The type of relays is monostable (or "failsafe"), showing the following behavior:

- When the relay is **not activated** (no voltage applied) and after a reset, the terminals **1 + 2** and **3 + 4** are connected (this state is also the automatic default)
- When the relay is **activated**, the terminals **1 + 3** and **2 + 4** are connected

- **SPDT**

The internally terminated solid-state relay (SSR) K14 of SPDT type is controlled by the interlock and suited for a frequency range from 9 kHz to 10 GHz.

The terminal port is labeled with C (common), the other relay ports are labeled with NC (normally closed) and NO (normally open). Terminal C is connected either with relay port NC or NO.

The relay shows the following behavior:

- When the relay is *activated* (control voltage = logical 1, typically when the *interlock loop is closed*), the relay connects C to NO, while disconnecting NC.
- When the relay is *not activated* (control voltage = logical 0, typically when the *interlock loop is open*) and after reset, the relay automatically falls back to its default state: It has an RF connection from C to NC, while NO is not connected to C.

You can use this relay position to disconnect the signal generator from the power amplifier. Hence, K14 can implement an additional safety feature, if the D-Sub output cannot shut down the amplifier. In this case, you can use the SPDT switch for directly interrupting the RF signal, typically between the signal generator and the power amplifier.

However, without power supplied to the relay, it has no defined switching state.

Therefore, SSRs are not inherently failsafe, see "[Monostable vs. failsafe](#)" on page 11.

- **INTLK LED**

The status LED that is labeled [INTLK] can display the current state of the interlock loop:

- If the LED is off, it indicates that the interlock is closed.
- If the LED shows red light, there is no connection between the input port's pins 2 ("Interlock Loop") and 6 (" +28 V DC") of the input port (see [Figure 3-63](#)). It indicates that the interlock is open.

The relays and I/O ports are mounted directly into the module's panel and soldered to the module's printed board, to avoid relay cabling and allow compact module size.

The switch unit provides power supply and control via a single module bus cable to a module bus connector on the module's printed board. The module's on-board memory stores its configuration data.

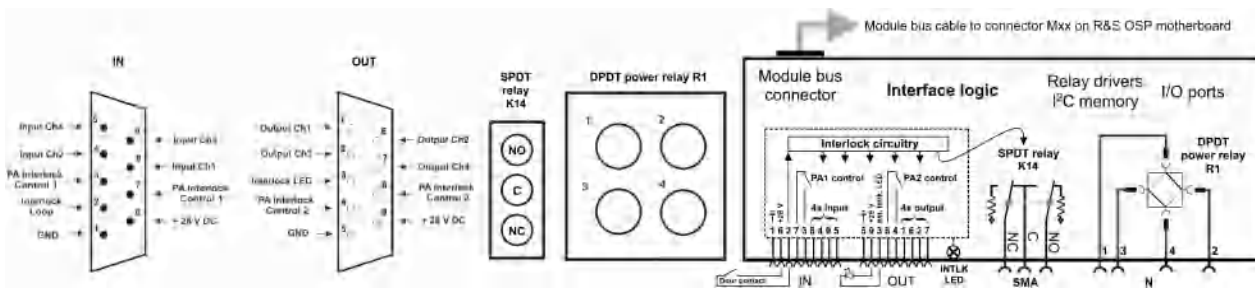

Figure 3-63: Pinout and block diagram of RF switch module R&S OSP-B114

- Left = Pins of the input and output ports
- Center = Relay ports
- Right = Block diagram of SPDT and DPDT relays and circuitry

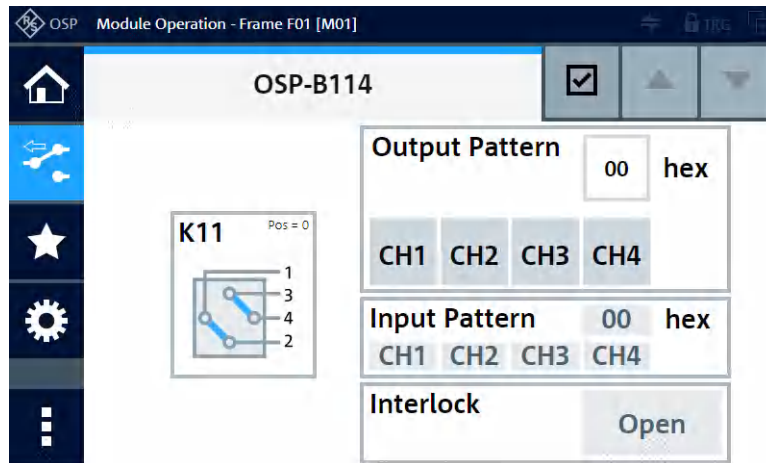

Figure 3-64: Representation of the module on the control screen



From this dialog, you cannot control the SPDT relay (center position in [Figure 3-62](#)), because it is controlled only by the module's internal interlock circuitry:

- If the "Interlock" state is "Closed", the SPDT relay connects C to NO.
- If the "Interlock" state is "Open", the SPDT relay connects C to NC.

For operation, see [Chapter 4, "Operation"](#), on page 147 and [Chapter 5, "Functions"](#), on page 155.

For remote control, refer to the chapters [Remote Operation](#) and [RC Commands](#). For an example, see [ROUTE:CLOSE](#) on page 253.

You can use the RC command [READ:IO:IN?](#) for reading the 4 input channels.

You can use the RC command [READ:MODULE:INTERlock?](#) for reading the interlock state.

3.26 R&S OSP-B116 RF Switch Module

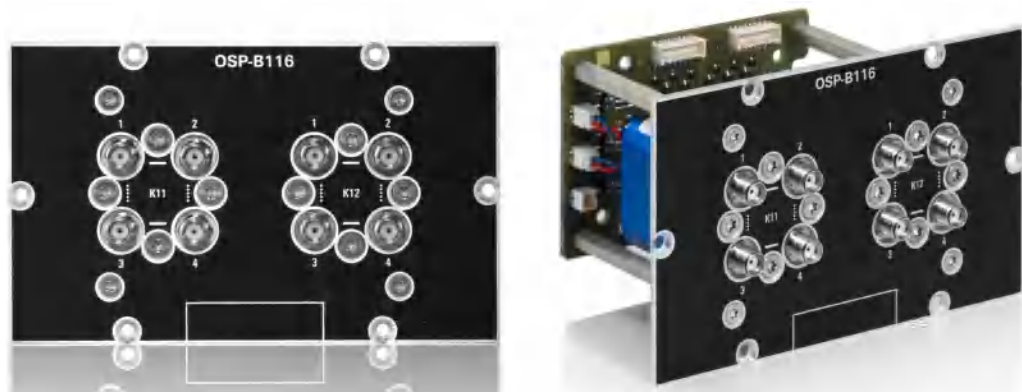

Figure 3-65: R&S OSP-B116

The one-slot [module](#) R&S OSP-B116 (order no. 1515.5827.02) has two failsafe electromechanical DPDT relays (K11 and K12), frequency range DC to 18 GHz, with non-terminated SMA (female) connectors.

Note: Mind the [torque limit recommendation](#) of **56 N·cm** for **SMA** connectors.

The relays operate independently from each other.

The type of relays is monostable (or "failsafe"), hence, with no voltage applied to a relay, its RF connections automatically go to the "not activated" state, as described below:

- When a DPDT relay is **not activated** (no voltage applied to the relay) and after a reset, the terminals **1 + 2** and **3 + 4** are connected. The user interface (control screen / "WebGUI") labels this state as "Pos = 0".
In the remote control command `ROUTE:CLOSE`, this deactivated state of the relay is represented by "00".
- When the relay is **activated** (continuous voltage applied to the relay), the terminals **1 + 3** and **2 + 4** are connected. The user interface (control screen / "WebGUI") labels this state as "Pos = 1".
In the remote control command `ROUTE:CLOSE`, this activated state of the relay is represented by "01".

The relays are mounted directly into the module's panel and soldered to the module's printed board, to avoid relay cabling and allow a compact module size.

The switch unit provides power supply and control via a single module bus cable to a module bus connector on the module's printed board. The module's on-board memory stores its configuration data.

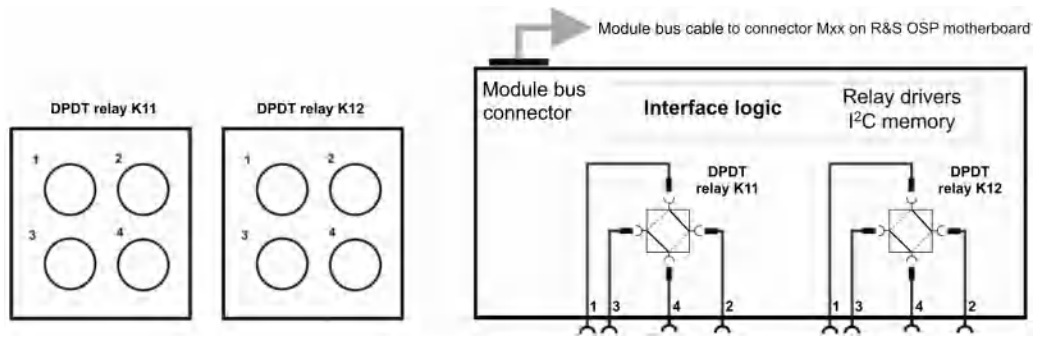

Figure 3-66: Pinout and block diagram of RF switch module R&S OSP-B116

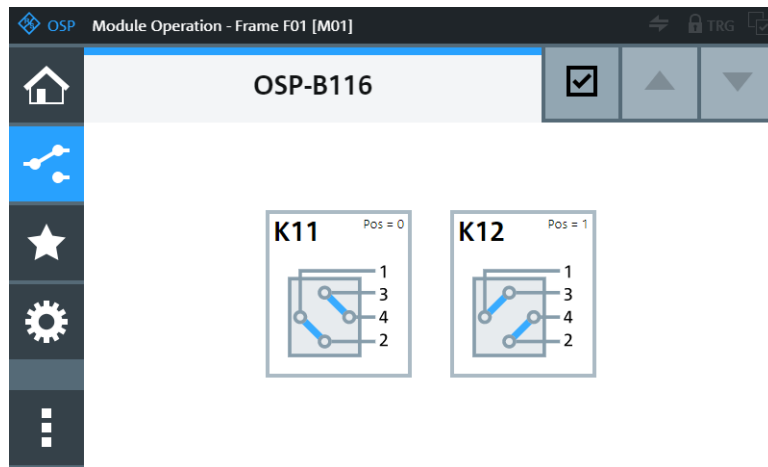

Figure 3-67: Representation of the module on the control screen

For operation, see [Chapter 4, "Operation"](#), on page 147 and [Chapter 5, "Functions"](#), on page 155.

For remote control, refer to the chapters [Remote Operation](#) and [RC Commands](#). For an example, see [ROUTE:CLOSE](#) on page 253.

3.27 R&S OSP-B116E RF Switch Module

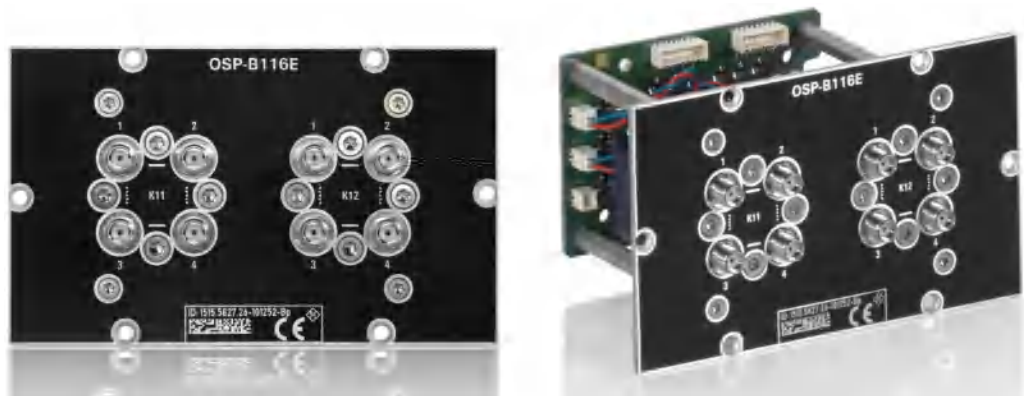

Figure 3-68: R&S OSP-B116E

The one-slot [module](#) R&S OSP-B116E (order no. 1515.5827.26) is based on the module [B116](#), with the following difference:

- Frequency range from DC to **26.5 GHz** (instead of 18 GHz)

It has also non-terminated SMA (female) connectors.

Note: Mind the [torque limit recommendation](#) of **56 N·cm** for **SMA** connectors.

The pinout and block diagram of the module R&S OSP-B116E is the same as in [Figure 3-66](#).

The control screen representation of the module R&S OSP-B116E is the same as in [Figure 3-67](#).

3.28 R&S OSP-B116H RF Switch Module



Figure 3-69: R&S OSP-B116H

The one-slot [module](#) R&S OSP-B116H (order no. 1515.5827.40) is based on the module [B116](#), with the following differences:

- Frequency range from DC to **40 GHz** (instead of 18 GHz)
- **PC 2.92** instead of SMA connectors (also female, non-terminated)

Note: Mind the [torque limit recommendation](#) of **90 N·cm** for **PC** connectors.

The pinout and block diagram of the module R&S OSP-B116H is the same as in [Figure 3-66](#).

The control screen representation of the module R&S OSP-B116H is the same as in [Figure 3-67](#).

3.29 R&S OSP-B116U RF Switch Module



Figure 3-70: R&S OSP-B116U (left with 1 DPDT relay, right with 2 DPDT relays)

The one-slot [module](#) R&S OSP-B116U (order no. 1515.5827.51/.52) is based on the module [B116](#), with the following differences:

- Frequency range from DC to **50 GHz** (instead of 18 GHz)
- **PC 2.4** instead of SMA connectors (also female, non-terminated)
- Availability of two versions:
 - Version 1515.5827.**51** with 1 DPDT relay (K11)
 - Version 1515.5827.**52** with 2 DPDT relays (K11 and K12)

Note: Mind the [torque limit recommendation](#) of **90 N·cm** for **PC** connectors.

The pinout and block diagram of the module R&S OSP-B116U is the same as in [Figure 3-66](#), but with 1 DPDT relay, only, in version 1515.5827.51 (here, relay K12 is not available).

The control screen representation of the module R&S OSP-B116U is the same as in [Figure 3-67](#), but with 1 DPDT relay, only, in version 1515.5827.51:

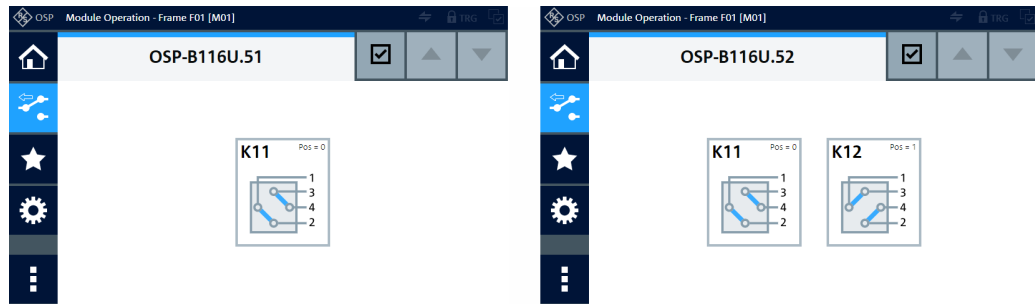

Figure 3-71: Representation of the module on the control screen, with 1 or 2 relays

3.30 R&S OSP-B119 RF Switch Module



Figure 3-72: R&S OSP-B119

The one-slot module R&S OSP-B119 (order no. 1515.5856.02) consists of 1 **failsafe (open)** SP8T relay and 2 failsafe SPDT relays, all electromechanical, frequency range DC to 18 GHz, with non-terminated SMA (female) connectors.

Note: Mind the **torque limit recommendation** of **56 N·cm** for **SMA** connectors.

SPDT relays:

The relays operate independently from each other. The terminal port is labeled with C (common), the other relay ports are labeled with NC (normally closed) and NO (normally open). Terminal C is connected either with relay port NC or NO.

The type of relays is monostable (or "failsafe"), hence, with no voltage applied, an RF connection is provided from C to NC, while NO is not connected to C ("Pos = 0"). To disconnect NC and connect C to NO ("Pos = 1"), a continuous voltage must be applied to the relay.

The relays are mounted directly into the module's panel and soldered to the module's printed board, to avoid relay cabling and allow a compact module size.

SP8T relay:

The terminal port is labeled with C (common), the other relay ports are labeled with numbers.

The relay type is monostable (or "failsafe open"). Hence, with no voltage applied to the relay, no RF connection is provided from terminal C to any of the numbered ports. To establish an RF connection between C and one of the numbered ports, a continuous voltage must be applied to the corresponding power terminal of the relay.

The relay is mounted directly into the module's panel and soldered to the module's printed board, to avoid relay cabling and allow a compact module size.

The firmware of the switch unit ensures to activate only one out of the eight terminal connections in the SP8T relay at a time.

The switch unit provides power supply and control via a single module bus cable to a module bus connector on the module's printed board. The module's on-board memory stores its configuration data.

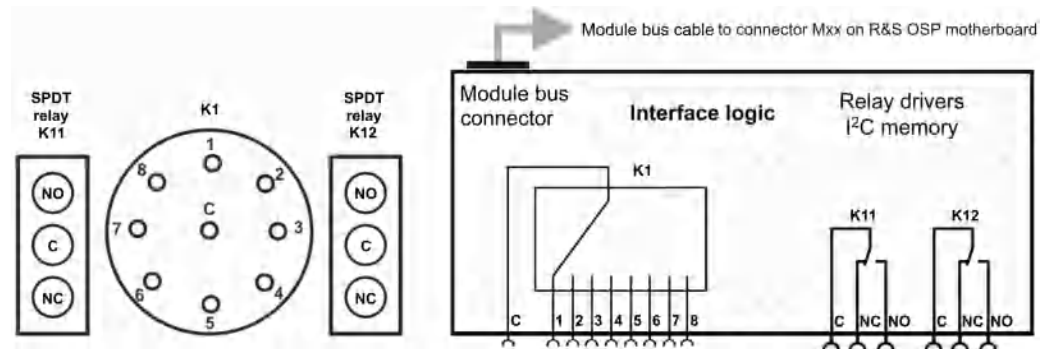

Figure 3-73: Pinout and block diagram of RF switch module R&S OSP-B119

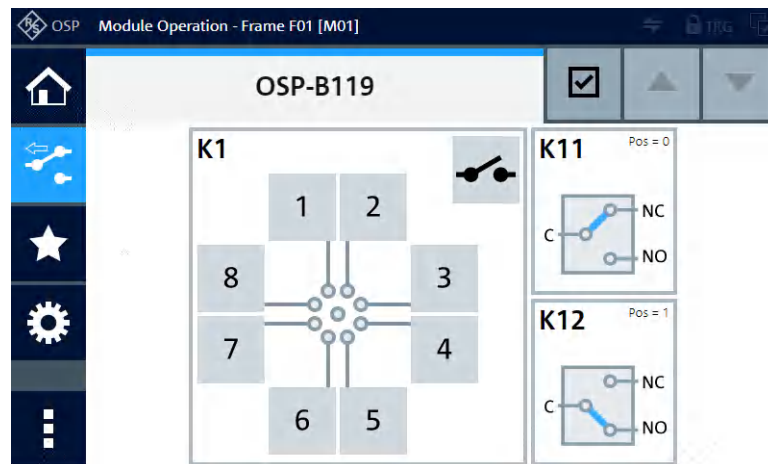

Figure 3-74: Representation of the module on the control screen

For operation, see [Chapter 4, "Operation"](#), on page 147 and [Chapter 5, "Functions"](#), on page 155.

For remote control, refer to the chapters [Remote Operation](#) and [RC Commands](#). For an example, see [ROUTE: CLOSe](#) on page 253.

3.31 R&S OSP-B119E RF Switch Module



Figure 3-75: R&S OSP-B119E

The one-slot [module](#) R&S OSP-B119E (order no. 1515.5856.26) is based on the [module B119](#).

The only difference is the frequency range from DC to **26.5 GHz**, also with SMA (female) connectors.

Note: Mind the [torque limit recommendation](#) of **56 N·cm** for **SMA** connectors.

The pinout and block diagram of the module R&S OSP-B119E is the same as in [Figure 3-73](#).

The control screen representation of the module R&S OSP-B119E is the same as in [Figure 3-74](#).

3.32 R&S OSP-B121 RF Switch Module



Figure 3-76: R&S OSP-B121

The one-slot [module](#) R&S OSP-B121 (order no. 1515.5504.02) consists of 3 failsafe electromechanical SPDT relays, frequency range DC to 18 GHz, with internally terminated SMA (female) connectors.

Note: Mind the [torque limit recommendation](#) of **56 N·cm** for **SMA** connectors.

The relays operate independently from each other. The terminal port is labeled with C (common), the other relay ports are labeled with NC (normally closed) and NO (normally open). Terminal C is connected either with relay port NC or NO.

The type of relays is monostable (or "failsafe"), hence, with no voltage applied, an RF connection is provided from C to NC, while NO is not connected to C ("Pos = 0"). To disconnect NC and connect C to NO ("Pos = 1"), a continuous voltage must be applied to the relay.

The relays are mounted directly into the module's panel and soldered to the module's printed board, to avoid relay cabling and allow a compact module size.

The switch unit provides power supply and control via a single module bus cable to a module bus connector on the module's printed board. The module's on-board memory stores its configuration data.

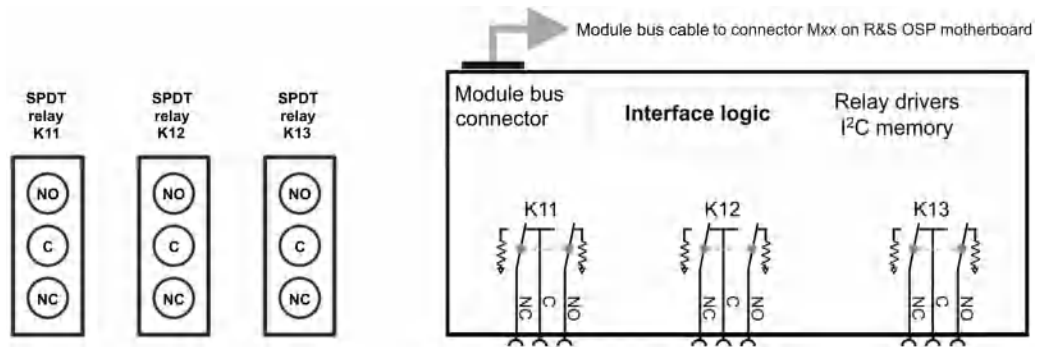

Figure 3-77: Pinout and block diagram of RF switch module R&S OSP-B121

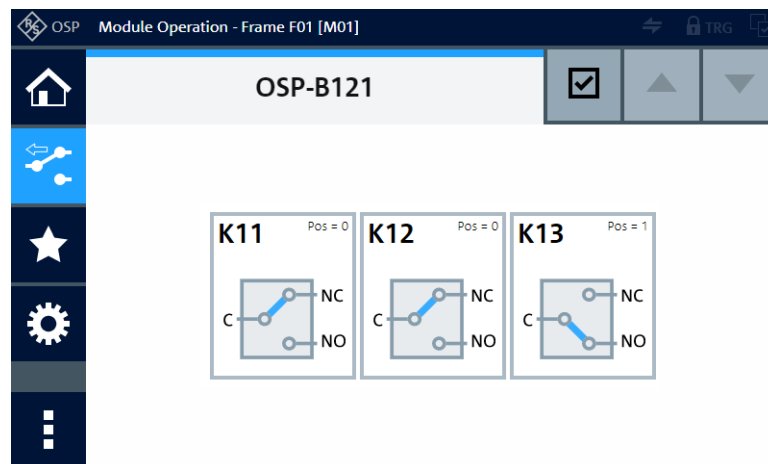

Figure 3-78: Representation of the module on the control screen

For operation, see [Chapter 4, "Operation"](#), on page 147 and [Chapter 5, "Functions"](#), on page 155.

For remote control, refer to the chapters [Remote Operation](#) and [RC Commands](#). For an example, see [ROUTE: CLOSe](#) on page 253.

3.33 R&S OSP-B121E RF Switch Module



Figure 3-79: R&S OSP-B121E

The one-slot module R&S OSP-B121E (order no. 1515.5504.26) with 3 failsafe electro-mechanical SPDT relays (K11 to K13).

It is based on the module B121, with the following differences:

- Frequency range from DC to **26.5 GHz** (instead of 18 GHz), also with SMA (female) connectors
- **External** termination of the NO and NC ports, see Figure 3-80

Note: Mind the [torque limit recommendation](#) of **56 N·cm** for **SMA** connectors.

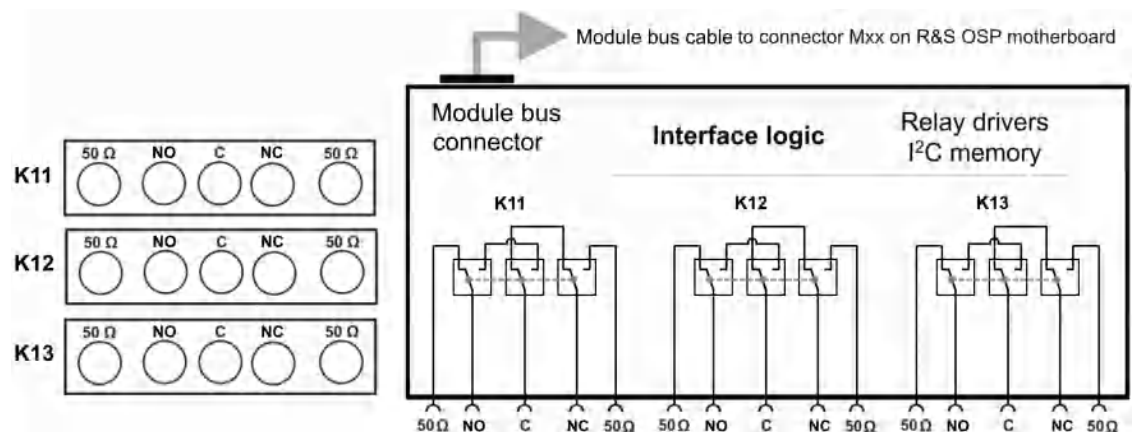

Figure 3-80: Pinout and block diagram of RF switch module R&S OSP-B121E

The control screen representation of the module R&S OSP-B121E is the same as in [Figure 3-78](#).

3.34 R&S OSP-B121H RF Switch Module



Figure 3-81: R&S OSP-B121H

The one-slot module R&S OSP-B121H (order no. 1515.5504.40) consists of 3 failsafe electromechanical SPDT relays, frequency range DC to 40 GHz, with terminated PC 2.92 (female) connectors.

It is based on the module [B121](#), with the following differences:

- Frequency range from DC to **40 GHz** (instead of 18 GHz)
- PC **2.92** (female) connectors (instead of SMA connectors)
- **External** termination of the NO and NC ports, see [Figure 3-80](#)

Note: Mind the [torque limit recommendation](#) of **90 N·cm** for PC connectors.

The pinout and block diagram of the module R&S OSP-B121H is the same as in [Figure 3-80](#).

The control screen representation of the module R&S OSP-B121H is the same as in [Figure 3-78](#).

3.35 R&S OSP-B121U RF Switch Module



Figure 3-82: R&S OSP-B121U (here with 3 SPDT relays)

The one-slot module R&S OSP-B121U (order no. 1515.5504.51/.52/.53) consists of failsafe electromechanical SPDT relays.

It is based on the module B121, with the following differences:

- Frequency range from DC to **50 GHz** (instead of 18 GHz)
- PC **2.4** (female) connectors (instead of SMA connectors)
- **External** termination of the NO and NC ports, see [Figure 3-80](#)
- Availability of three versions:
 - Version 1515.5504.**51** with 1 SPDT relays (K11)
 - Version 1515.5504.**52** with 2 SPDT relays (K11, K12)
 - Version 1515.5504.**53** with 3 SPDT relays (K11 to K13)

Note: Mind the [torque limit recommendation](#) of **90 N·cm** for PC connectors.

The pinout and block diagram of the module R&S OSP-B121U is the same as in [Figure 3-80](#). But in the module versions with less than 3 SPDT relays, the relays with the highest Kxx numbers in the range from K11 to K13 are not available.

The control screen representation of the module R&S OSP-B121U is similar to [Figure 3-78](#), but with three different versions as listed above. [Figure 3-83](#) shows two of these three versions:

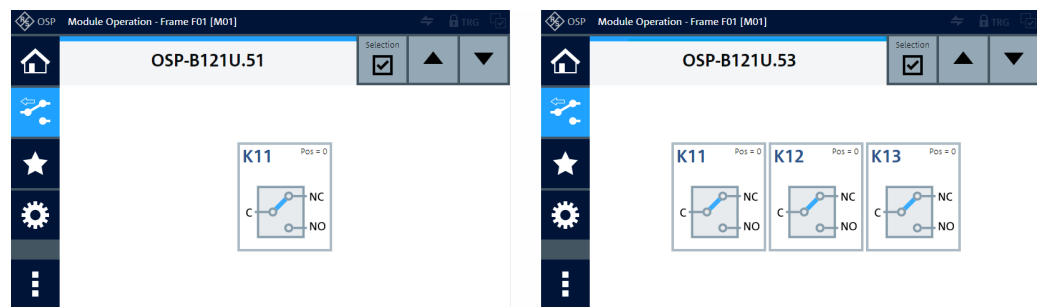

Figure 3-83: Representation of the module on the control screen, with 1 or 3 relays

3.36 R&S OSP-B121VL RF Switch Module



Figure 3-84: R&S OSP-B121VL (here with 3 SPDT relays)

The one-slot [module](#) R&S OSP-B121VL (order no. 1528.1654.61/.62/.63) consists of latching failsafe electromechanical SPDT relays with internal termination.

It is based on the module [B121](#), with the following differences:

- **Latching** relays
- Frequency range from DC to **67 GHz** (instead of 18 GHz)
- PC **1.85** (female) connectors (instead of SMA connectors)
- Availability of three versions:
 - Version 1528.1654.**61** with 1 SPDT relays (K11)
 - Version 1528.1654.**62** with 2 SPDT relays (K11, K12)
 - Version 1528.1654.**63** with 3 SPDT relays (K11 to K13)

Note: Mind the [torque limit recommendation](#) of **90 N·cm** for PC connectors.

The relays operate independently from each other. The terminal port is labeled with C (common), the other relay ports are labeled with numbers "0" (= default port) and "1". Terminal C is connected either with relay port "1" or "0". (In modules manufactured before 2021, the default port was labeled "2" instead of "0".)

Note that the hardware labels "0" and "1" are represented in the software as positions "0" (= default) and "1", respectively. In [RC Commands](#), the corresponding switching states are encoded by the SCPI parameters "00" (= default) and "01".

The relay type is bistable (or "latching"), hence, with no voltage applied, a relay remains in its current position.

To change the connection, the controller must send a voltage pulse to the appropriate switch coil in the relay. After that, no energy is consumed by this relay type.

You can configure two different [Power Up reset conditions](#) to determine, how latching relays behave after booting the switch unit.

The relays are mounted directly into the module's panel and soldered to the module's printed board, to avoid relay cabling and allow a compact module size.

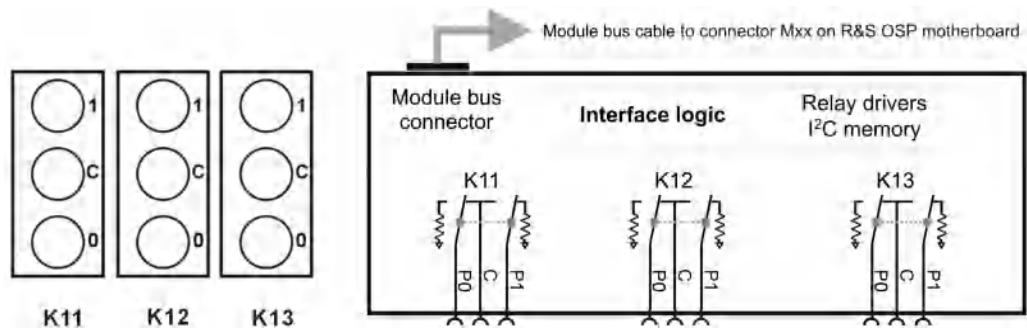

Figure 3-85: Pinout and block diagram of RF switch module R&S OSP-B121VL

In the module versions with less than 3 SPDT relays, the relays with the highest Kxx numbers in the range from K11 to K13 are not available.

The control screen representation of the module R&S OSP-B121VL is similar to [Figure 3-83](#), also with three different versions as listed above.

3.37 R&S OSP-B122 RF Switch Module

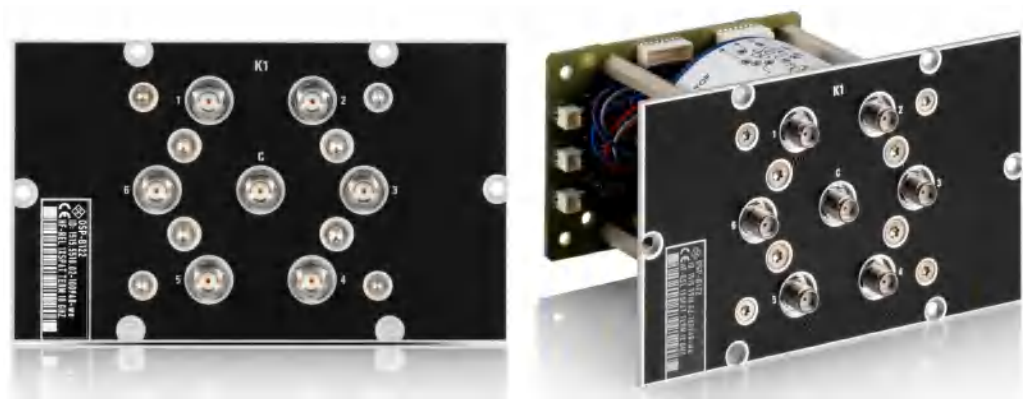

Figure 3-86: R&S OSP-B122

The one-slot [module](#) R&S OSP-B122 (order no. 1515.5510.02) consists of 1 [failsafe \(open\)](#) electromechanical SP6T relay, frequency range DC to 18 GHz, with internally terminated SMA (female) connectors.

Note: Mind the [torque limit recommendation](#) of **56 N·cm** for **SMA** connectors.

The terminal port is labeled with C (common), the other relay ports are labeled with numbers.

The relay type is monostable (or "failsafe open"). Hence, with no voltage applied to the relay, no RF connection is provided from terminal C to any of the numbered ports. To establish an RF connection between C and one of the numbered ports, a continuous voltage must be applied to the corresponding power terminal of the relay.

The relay is mounted directly into the module's panel and soldered to the module's printed board, to avoid relay cabling and allow a compact module size.

The switch unit provides power supply and control via a single module bus cable to a module bus connector on the module's printed board. The module's on-board memory stores its configuration data.

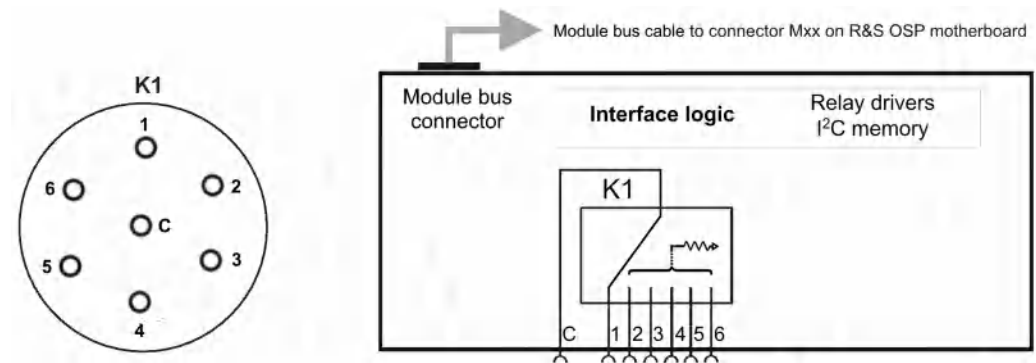

Figure 3-87: Pinout and block diagram of RF switch module R&S OSP-B122 (internal termination of open ports indicated)

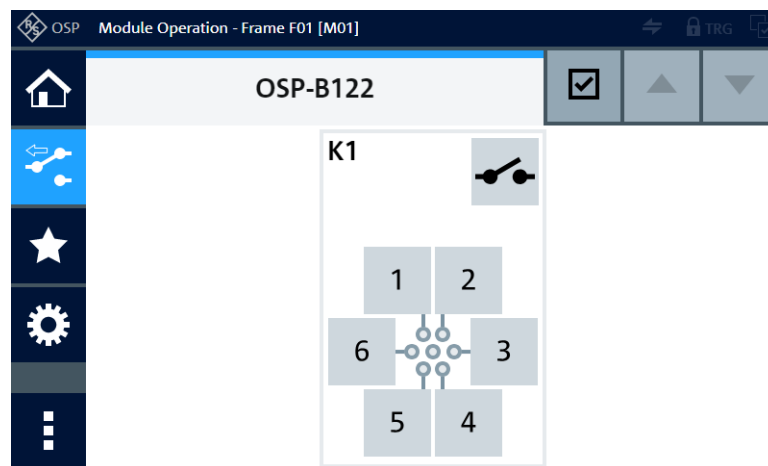

Figure 3-88: Representation of the module on the control screen

For operation, see [Chapter 4, "Operation"](#), on page 147 and [Chapter 5, "Functions"](#), on page 155.

For remote control, refer to the chapters [Remote Operation](#) and [RC Commands](#). For an example, see [ROUTE:CLOSE](#) on page 253.

3.38 R&S OSP-B122E RF Switch Module



Figure 3-89: R&S OSP-B122E

The one-slot module R&S OSP-B122E (order no. 1528.1525.26) has 1 failsafe (open) electromechanical SP6T relay.

It is based on the module B122, with the following differences:

- Frequency range from DC to **26.5 GHz** (instead of 18 GHz)

It also has internally terminated SMA (female) connectors.

Note: Mind the [torque limit recommendation](#) of **56 N·cm** for **SMA** connectors.

The pinout and block diagram of the module R&S OSP-B122E is the same as in [Figure 3-87](#).

The control screen representation of the module R&S OSP-B122E is the same as in [Figure 3-88](#).

3.39 R&S OSP-B122H RF Switch Module



Figure 3-90: R&S OSP-B122H

The one-slot [module](#) R&S OSP-B122H (order no. 1528.1525.02) has 1 [failsafe \(open\)](#) electromechanical SP6T relay.

It is based on the module [B122](#), with the following differences:

- Frequency range from DC to **40 GHz** (instead of 18 GHz)
- **PC 2.92** instead of SMA connectors (also female, internally terminated)

Note: Mind the [torque limit recommendation](#) of **90 N·cm** for **PC** connectors.

The pinout and block diagram of the module R&S OSP-B122H is the same as in [Figure 3-87](#).

The control screen representation of the module R&S OSP-B122H is the same as in [Figure 3-88](#).

3.40 R&S OSP-B122U RF Switch Module



Figure 3-91: R&S OSP-B122U

The one-slot [module](#) R&S OSP-B122U (order no. 1528.1525.51) has 1 [failsafe \(open\)](#) electromechanical SP6T relay.

It is based on the module [B122](#), with the following differences:

- Frequency range from DC to **50 GHz** (instead of 18 GHz)
- **PC 2.4** instead of SMA connectors (also female, internally terminated)

Note: Mind the [torque limit recommendation](#) of **90 N·cm** for **PC** connectors.

The pinout and block diagram of the module R&S OSP-B122U is the same as in [Figure 3-87](#).

The control screen representation of the module R&S OSP-B122U is the same as in [Figure 3-88](#).

3.41 R&S OSP-B123 RF Switch Module



Figure 3-92: R&S OSP-B123

The two-slot (double-width) module R&S OSP-B123 (order no. 1515.5527.02) consists of 6 failsafe SPDT relays and 1 failsafe (open) SP6T relay, all electromechanical, frequency range DC to 18 GHz, with internally terminated SMA (female) connectors.

Note: Mind the torque limit recommendation of 56 N·cm for SMA connectors.

SPDT relays:

The relays operate independently from each other. The terminal port is labeled with C (common), the other relay ports are labeled with NC (normally closed) and NO (normally open). Terminal C is connected either with relay port NC or NO.

The type of relays is monostable (or "failsafe"), hence, with no voltage applied, an RF connection is provided from C to NC, while NO is not connected to C ("Pos = 0"). To disconnect NC and connect C to NO ("Pos = 1"), a continuous voltage must be applied to the relay.

The relays are mounted directly into the module's panel and soldered to the module's printed board, to avoid relay cabling and allow a compact module size.

SP6T relay:

The terminal port is labeled with C (common), the other relay ports are labeled with numbers.

The relay type is monostable (or "failsafe open"). Hence, with no voltage applied to the relay, no RF connection is provided from terminal C to any of the numbered ports. To establish an RF connection between C and one of the numbered ports, a continuous voltage must be applied to the corresponding power terminal of the relay.

The relay is mounted directly into the module's panel and soldered to the module's printed board, to avoid relay cabling and allow a compact module size.

The module's on-board memory stores its configuration data.

The switch unit provides power supply and control via **two** module bus cables to two module bus connectors on the module's printed board. The available module bus connectors ("Mxx") are shown in [Figure 2-26](#).

To find out, which two module bus connectors on the switch unit's motherboard your module uses, refer to the headline of the control screen as in [Figure 3-94](#). In this example, module R&S OSP-B123 uses buses "M01" and "M02". Alternatively, you can query

the module bus connectors by the RC command `DIAG:SERV:HWIN?` (see example there).

To address the relays of the R&S OSP-B123 in the "channel list string" of remote control commands, assign the "Mxx" bus names to the relays as follows:

- The 1st module bus (for example "M01") controls the relays K11, K12 and K13
- The 2nd module bus (for example "M02") controls the relays K14, K15 and K16

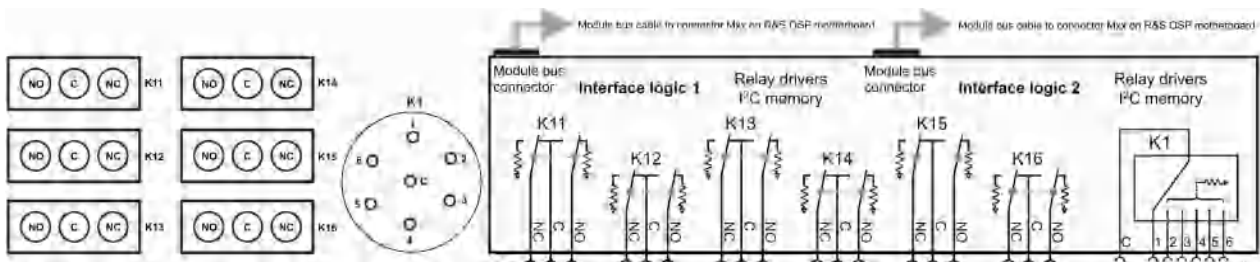

Figure 3-93: Pinout and block diagram of RF switch module R&S OSP-B123 (internal termination of open ports indicated)

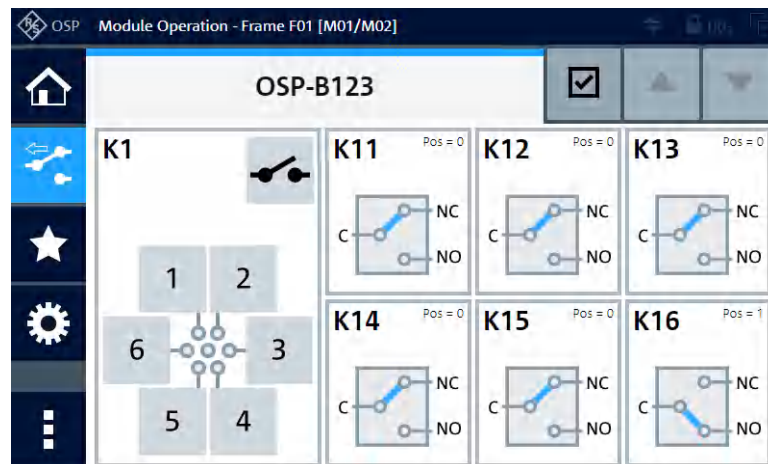

Figure 3-94: Representation of the module on the control screen

For operation, see [Chapter 4, "Operation"](#), on page 147 and [Chapter 5, "Functions"](#), on page 155.

For remote control, refer to the chapters [Remote Operation](#) and [RC Commands](#). For an example, see `ROUTE:CLOSE` on page 253.

3.42 R&S OSP-B124 RF Switch Module



Figure 3-95: R&S OSP-B124

The two-slot (double-width) module R&S OSP-B124 (order no. 1515.5533.02) consists of 3 failsafe SPDT relays and 2 failsafe (open) SP6T relays, all electromechanical, frequency range DC to 18 GHz, with internally terminated SMA (female) connectors.

Note: Mind the torque limit recommendation of **56 N·cm** for **SMA** connectors.

SPDT relays:

The relays operate independently from each other. The terminal port is labeled with C (common), the other relay ports are labeled with NC (normally closed) and NO (normally open). Terminal C is connected either with relay port NC or NO.

The type of relays is monostable (or "failsafe"), hence, with no voltage applied, an RF connection is provided from C to NC, while NO is not connected to C ("Pos = 0"). To disconnect NC and connect C to NO ("Pos = 1"), a continuous voltage must be applied to the relay.

The relays are mounted directly into the module's panel and soldered to the module's printed board, to avoid relay cabling and allow a compact module size.

SP6T relays:

The relays operate independently from each other. The terminal port is labeled with C (common), the other relay ports are labeled with numbers.

The relay type is monostable (or "failsafe open"). Hence, with no voltage applied to a relay, no RF connection is provided from terminal C to any of the numbered ports. To establish an RF connection between C and one of the numbered ports, a continuous voltage must be applied to the corresponding power terminal of the relay.

The relays are mounted directly into the module's panel and soldered to the module's printed board, to avoid relay cabling and allow a compact module size.

The switch unit provides power supply and control via a single module bus cable to a module bus connector on the module's printed board. The module's on-board memory stores its configuration data.

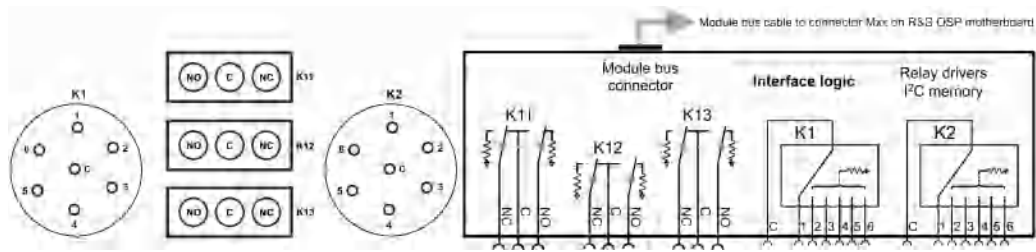

Figure 3-96: Pinout and block diagram of RF switch module R&S OSP-B124 (internal termination of open ports indicated)

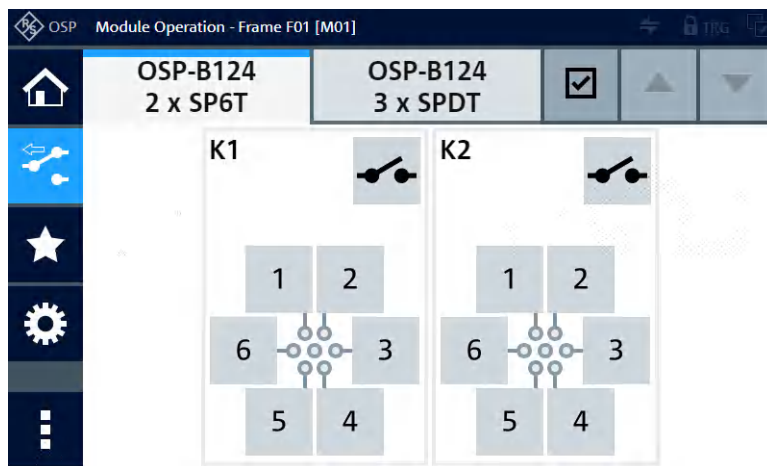

Figure 3-97: Representation of the module's 2 SP6T relays on the control screen

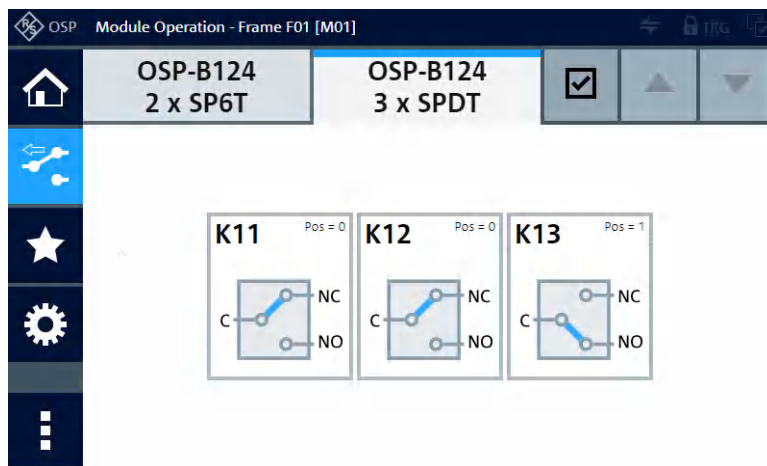

Figure 3-98: Representation of the module's 3 SPDT relays on the control screen

For operation, see [Chapter 4, "Operation"](#), on page 147 and [Chapter 5, "Functions"](#), on page 155.

For remote control, refer to the chapters [Remote Operation](#) and [RC Commands](#). For an example, see [ROUTE:CLOSE](#) on page 253.

3.43 R&S OSP-B125 RF Switch Module



Figure 3-99: R&S OSP-B125

The three-slot (triple-width) module R&S OSP-B125 (order no. 1515.5540.02) consists of 6 failsafe SPDT relays and 3 failsafe (open) SP6T relays, all electromechanical. The frequency range is DC to 18 GHz, with internally terminated SMA (female) connectors. The module requires 2 module bus cables.

Note: Mind the torque limit recommendation of **56 N·cm** for **SMA** connectors.

SPDT relays:

The relays operate independently from each other. The terminal port is labeled with C (common), the other relay ports are labeled with NC (normally closed) and NO (normally open). Terminal C is connected either with relay port NC or NO.

The type of relays is monostable (or "failsafe"), hence, with no voltage applied, an RF connection is provided from C to NC, while NO is not connected to C ("Pos = 0"). To disconnect NC and connect C to NO ("Pos = 1"), a continuous voltage must be applied to the relay.

The relays are mounted directly into the module's panel and soldered to the module's printed board, to avoid relay cabling and allow a compact module size.

SP6T relays:

The relays operate independently from each other. The terminal port is labeled with C (common), the other relay ports are labeled with numbers.

The relay type is monostable (or "failsafe open"). Hence, with no voltage applied to a relay, no RF connection is provided from terminal C to any of the numbered ports. To establish an RF connection between C and one of the numbered ports, a continuous voltage must be applied to the corresponding power terminal of the relay.

The relays are mounted directly into the module's panel and soldered to the module's printed board, to avoid relay cabling and allow a compact module size.

The module's on-board memory stores its configuration data.

The switch unit provides power supply and control via **two** module bus cables to two module bus connectors on the module's printed board. The available module bus connectors ("Mxx") are shown in [Figure 2-26](#).

To find out, which two module bus cables on the switch unit's motherboard your module uses, refer to the headline of the control screen as in [Figure 3-101](#) and [Figure 3-102](#). In this example, module R&S OSP-B125 uses buses "M01" and "M02".

Alternatively, you can query the connectors by the RC command `DIAG:SERV:HWIN?` (see example there).

To address the relays of the R&S OSP-B125 in the "channel list string" of remote control commands, assign the "Mxx" bus names to the relays as follows:

- The 1st module bus (for example "M01") controls the relays K1, K2, K11, K12, K13
- The 2nd module bus (for example "M02") controls the relays K3, K14, K15, K16

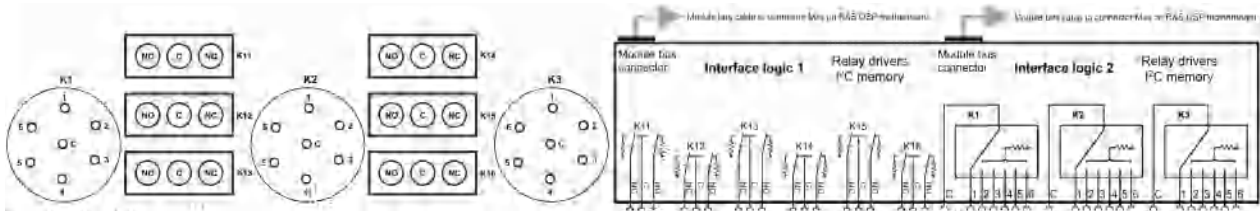

Figure 3-100: Pinout and block diagram of RF switch module R&S OSP-B125 (internal termination of open ports indicated)

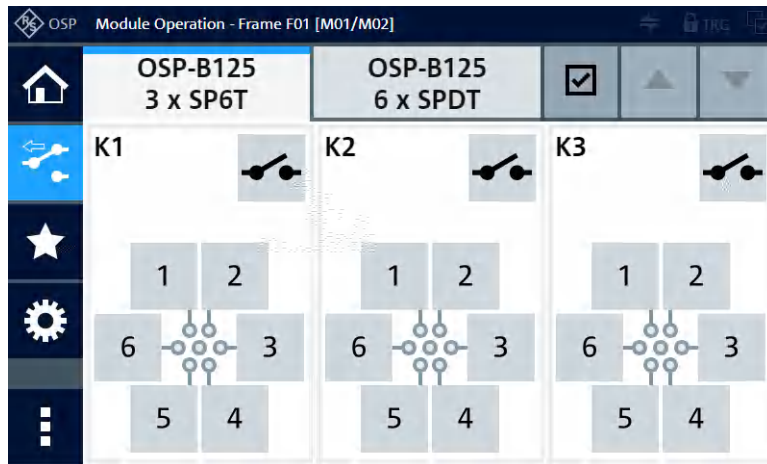

Figure 3-101: Representation of the module's 3 SP6T relays on the control screen

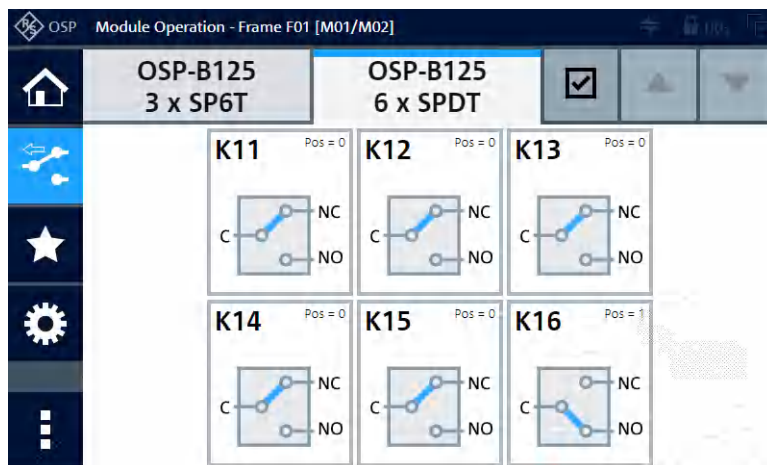

Figure 3-102: Representation of the module's 6 SPDT relays on the control screen

For operation, see [Chapter 4, "Operation"](#), on page 147 and [Chapter 5, "Functions"](#), on page 155.

For remote control, refer to the chapters [Remote Operation](#) and [RC Commands](#). For an example, see [ROUTE:CLOSE](#) on page 253.

3.44 R&S OSP-B125E RF Switch Module



Figure 3-103: R&S OSP-B125E

The failsafe three-slot (triple-width) [module](#) R&S OSP-B125E (order no. 1515.5540.26) is based on the [module B125](#). It also has SMA (female) connectors.

The only difference is the frequency range from DC to **26.5 GHz**.

The module's SMA connectors are geometrically compatible with 3.5 mm and 2.92 mm connectors of RF cables that support 26.5 GHz.

These connectors are geometrically compatible with SMA connectors. The internal termination is limited to 1 W.

Note: Mind the [torque limit recommendation](#) of **90 N·cm** for **PC** connectors.



Backward compatibility

This module was launched in April 2018. When you use it in a legacy switch unit **R&S OSP1xx**, it requires firmware version 2.63 or higher.

The pinout and block diagram of the module R&S OSP-B125E is the same as in [Figure 3-100](#).

The control screen representation of the module R&S OSP-B125E is the same as in [Figure 3-101](#) and [Figure 3-102](#).

3.45 R&S OSP-B125H RF Switch Module



Figure 3-104: R&S OSP-B125H

The failsafe three-slot (triple-width) **module** R&S OSP-B125H (order no. 1515.5540.40) is based on the module [B125](#).

The only difference is the frequency range from DC to **40 GHz**, with terminated **PC 2.92** (female) connectors. The external termination included in the delivery is limited to 1 W. You can increase the power rating of the external termination with other terminal resistors.

Note: Mind the [torque limit recommendation](#) of **90 N·cm** for **PC** connectors.



Backward compatibility

This module was launched in April 2018. When you use it in a legacy switch unit **R&S OSP1xx**, it requires firmware version 2.63 or higher.

The pinout and block diagram of the module R&S OSP-B125H is the same as in [Figure 3-100](#).

The control screen representation of the module R&S OSP-B125H is the same as in [Figure 3-101](#) and [Figure 3-102](#).

3.46 R&S OSP-B126 RF Switch Module

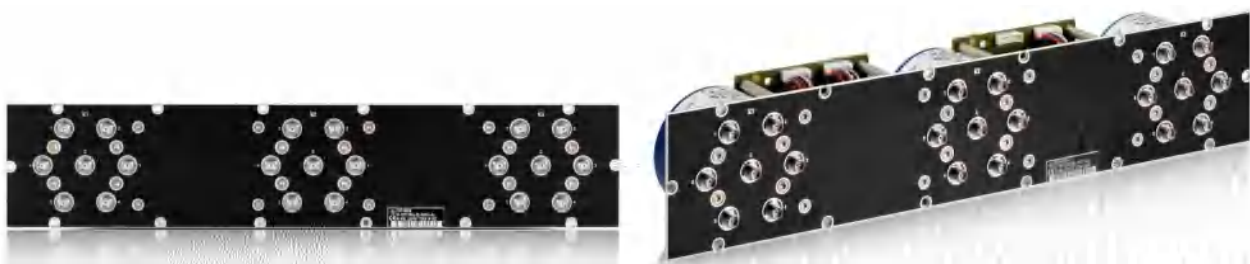

Figure 3-105: R&S OSP-B126

The three-slot (triple-width) **module** R&S OSP-B126 (order no. 1515.5556.02) consists of 3 **failsafe (open)** electromechanical SP6T relays, frequency range DC to 18 GHz, with internally terminated SMA (female) connectors.

Note: Mind the [torque limit recommendation](#) of **56 N·cm** for **SMA** connectors.

The relays operate independently from each other. The terminal port is labeled with C (common), the other relay ports are labeled with numbers.

The relay type is monostable (or "failsafe open"). Hence, with no voltage applied to a relay, no RF connection is provided from terminal C to any of the numbered ports. To establish an RF connection between C and one of the numbered ports, a continuous voltage must be applied to the corresponding power terminal of the relay.

The relays are mounted directly into the module's panel and soldered to the module's printed board, to avoid relay cabling and allow a compact module size.

The module's on-board memory stores its configuration data.

The switch unit provides power supply and control via **two** module bus cables to two module bus connectors on the module's printed board. The available module bus connectors ("Mxx") are shown in [Figure 2-26](#).

To find out, which two module bus cables on the switch unit's motherboard your module uses, refer to the headline of the control screen as in [Figure 3-107](#). In this example, module R&S OSP-B126 uses buses "M01" and "M02". Alternatively, you can query the connectors by the RC command `DIAG:SERV:HWIN?` (see example there).

To address the relays of the R&S OSP-B126 in the "channel list string" of remote control commands, assign the "Mxx" bus names to the relays as follows:

- The 1st module bus (for example "M01") controls the relays K1 and K2
- The 2nd module bus (for example "M02") controls the relays K3

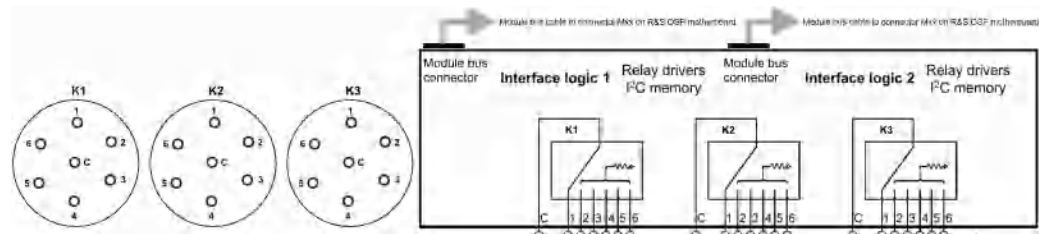

Figure 3-106: Pinout and block diagram of RF switch module R&S OSP-B126 (internal termination of open ports indicated)

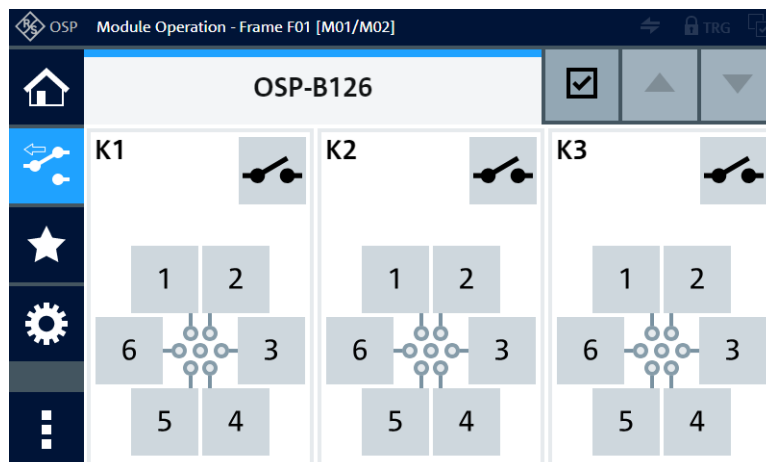

Figure 3-107: Representation of the module on the control screen

For operation, see [Chapter 4, "Operation"](#), on page 147 and [Chapter 5, "Functions"](#), on page 155.

For remote control, refer to the chapters [Remote Operation](#) and [RC Commands](#). For an example, see [ROUTE:CLOSE](#) on page 253.

3.47 R&S OSP-B127 RF SSR Module



Figure 3-108: R&S OSP-B127

The one-slot [module](#) R&S OSP-B127 (order no. 1505.4728.02) consists of 6 solid-state relays (SSRs) of SPDT type, frequency range 9 kHz to 10 GHz, with SMA (female) connectors. Open ports are [reflective](#) with an internal short connection to chassis ground.

Note: Mind the [torque limit recommendation](#) of **56 N·cm** for **SMA** connectors.

The relays operate independently from each other. The terminal port is labeled with C (common), the other relay ports are labeled with NC (normally closed) and NO (normally open). Terminal C is connected either with relay port NC or NO.

After a reset, SSRs automatically go to the default state (control voltage = logical 0) with an RF connection from C to NC, while NO is not connected to C. To disconnect NC and connect C to NO, an SSR must be activated (control voltage = logical 1).

Without power supplied to the relay, it has no defined switching state. Therefore, SSRs are not inherently failsafe, see "[Monostable vs. failsafe](#)" on page 11.

The relays are mounted directly into the module's panel and soldered to the module's printed board, to avoid relay cabling and allow a compact module size.

The switch unit provides power supply and control via a single module bus cable to a module bus connector on the module's printed board. The module's on-board memory stores its configuration data.

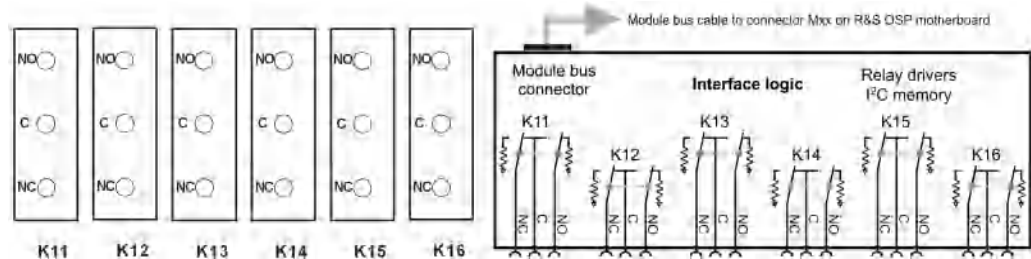

Figure 3-109: Pinout and block diagram of RF switch module R&S OSP-B127

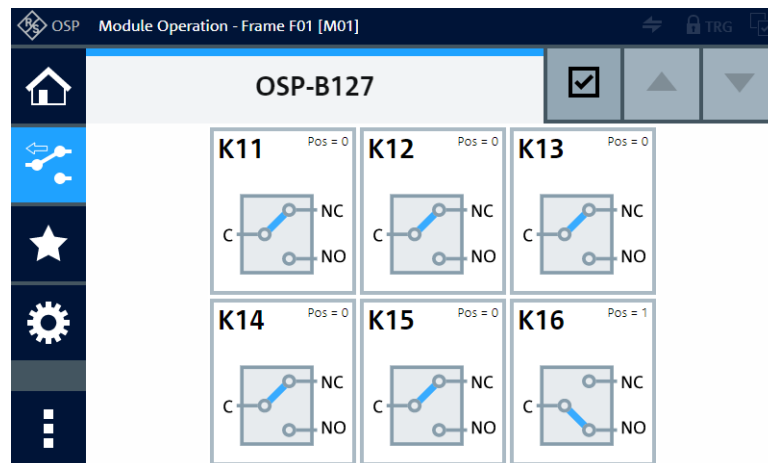

Figure 3-110: Representation of the module on the control screen

For operation, see [Chapter 4, "Operation"](#), on page 147 and [Chapter 5, "Functions"](#), on page 155.

For remote control, refer to the chapters [Remote Operation](#) and [RC Commands](#). For an example, see [ROUTE:CLOSE](#) on page 253.

3.48 R&S OSP-B128 RF SSR Module



Figure 3-111: R&S OSP-B128 with connectors of each relay in a horizontal line (flat relay design)

Left and center = Version 1505.4734.13 with three SP6T relays
 Right = Version 1505.4734.12 with two SP6T relays

The one-slot module R&S OSP-B128 (order no. 1505.4734.11/.12/.13) consists of 1, 2 or 3 solid-state relays (SSRs) of SP6T type, frequency range 9 kHz to 10 GHz, with internally terminated SMA (female) connectors.

Note: Mind the [torque limit recommendation](#) of **56 N·cm** for **SMA** connectors.

The switch module is available in 3 versions:

- With 1 SP6T relay in position K1 (order no. 1505.4734.11)
- With 2 SP6T relays in position K1 and K2 (order no. 1505.4734.12)
- With 3 SP6T relays in position K1 to K3 (order no. 1505.4734.13)

The relays must be configured starting from position K1 onwards. Hence, a configuration with K1 and K3, only, is not permitted. Openings without a relay are covered from the inside by a strip of sheet metal.

The R&S OSP automatically recognizes the installed relays via an EEPROM (factory configuration) and an internal I²C query (current configuration). The user interface displays the actual SP6T relays installed in the R&S OSP-B128.

The relays operate independently from each other. The terminal port is labeled with C (common), the other relay ports are labeled with numbers. In this relay type, the terminal port "C" (common) can be switched to any one of the other ports. The selected connection is coded in the control signal.

After a reset, the relays automatically go to the default state with the port C **not** connected to any of the numbered ports.

Without power supplied to the relay, it has no defined switching state. Therefore, SSRs are not inherently failsafe, see "[Monostable vs. failsafe](#)" on page 11.

The relay is mounted directly into the module's panel and soldered to the module's printed board, to avoid relay cabling and allow a compact module size.

The switch unit provides power supply and control via a single module bus cable to a module bus connector on the module's printed board. The module's on-board memory stores its configuration data.

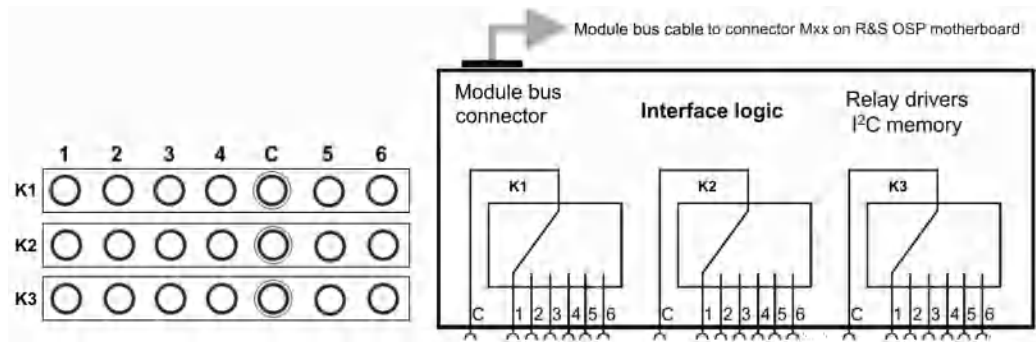

Figure 3-112: Pinout and block diagram of RF switch module R&S OSP-B128 (here: 3 relays)

In the module version with 1 SP6T relay, the relays K2 and K3 are not available.

In the module version with 2 SP6T relays, the relay K3 is not available.

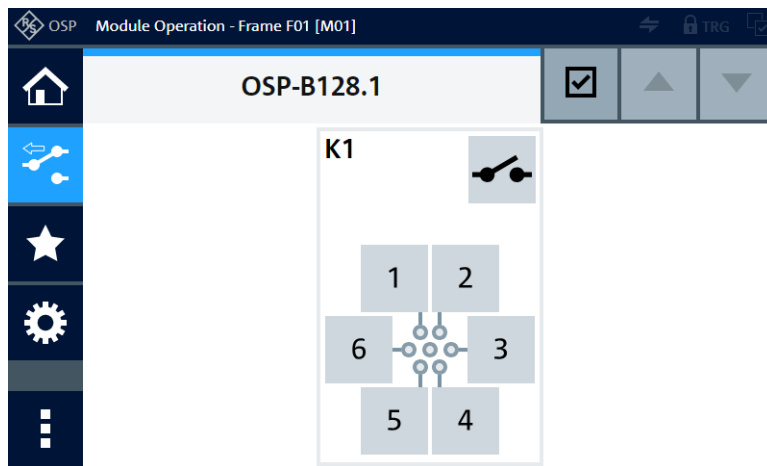

Figure 3-113: Representation of the module with 1 SP6T relay on the control screen

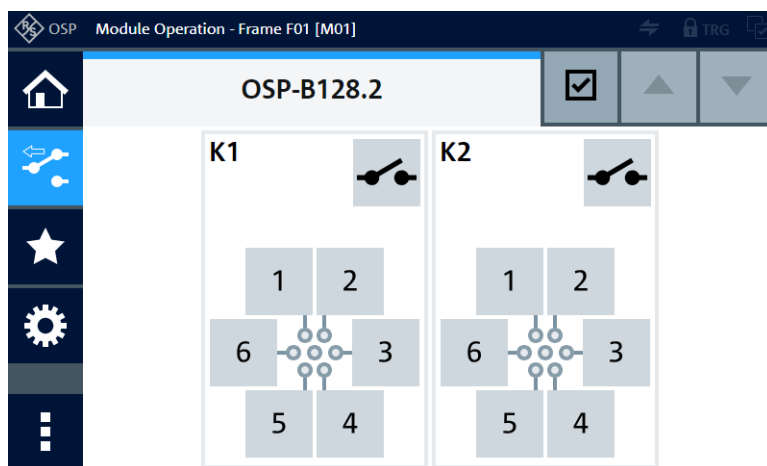

Figure 3-114: Representation of the module with 2 SP6T relays on the control screen

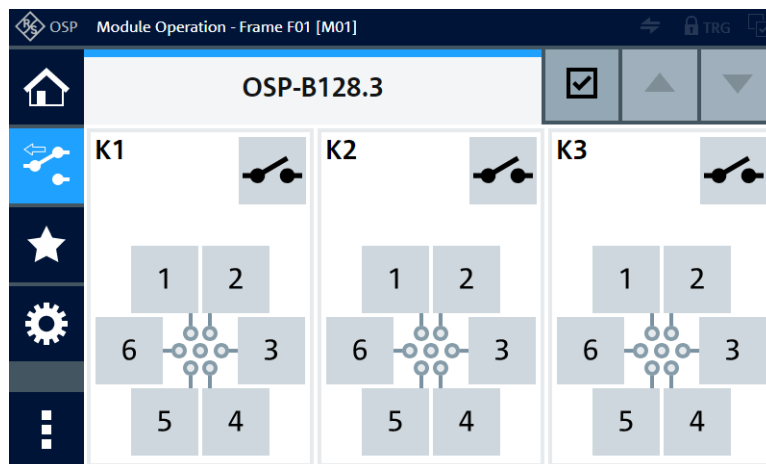

Figure 3-115: Representation of the module with 3 SP6T relays on the control screen

For operation, see [Chapter 4, "Operation"](#), on page 147 and [Chapter 5, "Functions"](#), on page 155.

For remote control, refer to the chapters [Remote Operation](#) and [RC Commands](#). For an example, see [ROUTE:CLOSE](#) on page 253.

3.49 R&S OSP-B129 RF Switch Module



Figure 3-116: R&S OSP-B129

The one-slot [module](#) R&S OSP-B129 (order no. 1517.7004.02) consists of 1 [failsafe \(open\)](#) SP8T relay with internally terminated SMA (female) connectors and 2 failsafe SPDT relays with non-terminated SMA (female) connectors. All relays are electromechanical, frequency range DC to 18 GHz.

Note: Mind the [torque limit recommendation](#) of **56 N·cm** for **SMA** connectors.

SPDT relays:

The relays operate independently from each other. The terminal port is labeled with C (common), the other relay ports are labeled with NC (normally closed) and NO (normally open). Terminal C is connected either with relay port NC or NO.

The type of relays is monostable (or "failsafe"), hence, with no voltage applied, an RF connection is provided from C to NC, while NO is not connected to C ("Pos = 0"). To disconnect NC and connect C to NO ("Pos = 1"), a continuous voltage must be applied to the relay.

The relays are mounted directly into the module's panel and soldered to the module's printed board, to avoid relay cabling and allow a compact module size.

SP8T relay:

The terminal port is labeled with C (common), the other relay ports are labeled with numbers.

The relay type is monostable (or "failsafe open"). Hence, with no voltage applied to the relay, no RF connection is provided from terminal C to any of the numbered ports. To establish an RF connection between C and one of the numbered ports, a continuous voltage must be applied to the corresponding power terminal of the relay.

The relay is mounted directly into the module's panel and soldered to the module's printed board, to avoid relay cabling and allow a compact module size.

The firmware of the switch unit ensures to activate only one out of the eight terminal connections in the SP8T relay at a time.

The switch unit provides power supply and control via a single module bus cable to a module bus connector on the module's printed board. The module's on-board memory stores its configuration data.

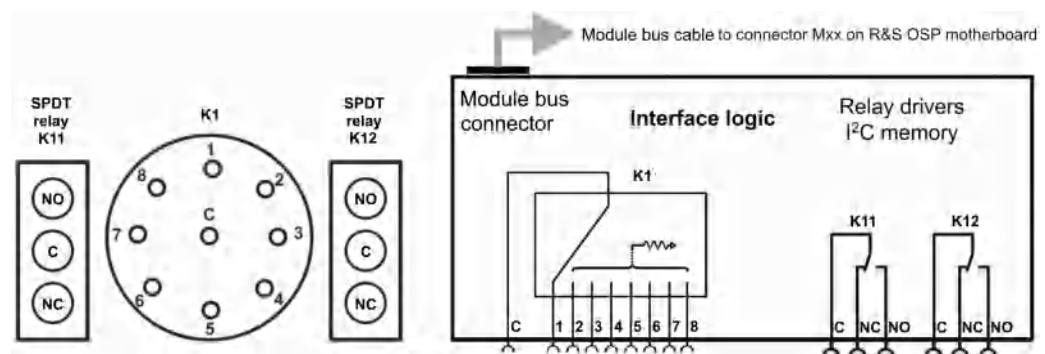

Figure 3-117: Pinout and block diagram of RF switch module R&S OSP-B129 (internal termination of open SP8T ports indicated)

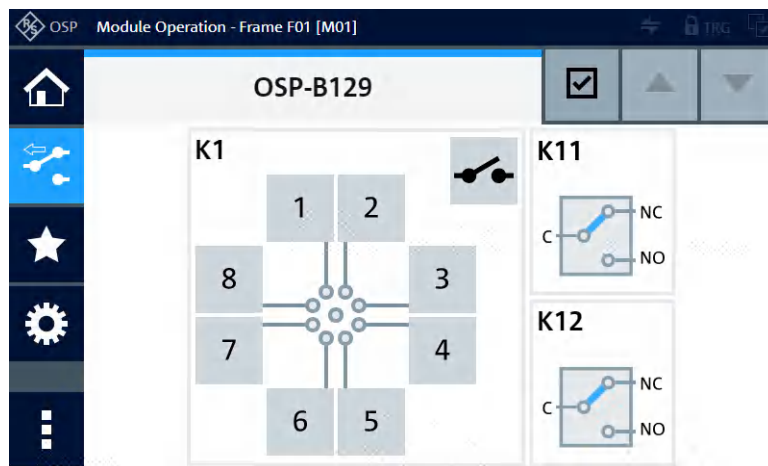

Figure 3-118: Representation of the module on the control screen

For operation, see [Chapter 4, "Operation"](#), on page 147 and [Chapter 5, "Functions"](#), on page 155.

For remote control, refer to the chapters [Remote Operation](#) and [RC Commands](#). For an example, see [ROUTE:CLOSE](#) on page 253.

3.50 R&S OSP-B129E RF Switch Module



Figure 3-119: R&S OSP-B129E

The one-slot module R&S OSP-B129E (order no. 1517.7004.26) is based on the module [B129](#). It consists of 1 failsafe (open) SP8T relay with internally terminated SMA (female) connectors and 2 failsafe SPDT relays with non-terminated SMA (female) connectors.

The only difference is the frequency range from DC to **26.5 GHz** (instead of 18 GHz).

Note: Mind the [torque limit recommendation](#) of **56 N·cm** for **SMA** connectors.

The module's SMA connectors are geometrically compatible with 3.5 mm and 2.92 mm connectors of RF cables that support 26.5 GHz.

Pinout and block diagram of the module R&S OSP-B129E are the same as in [Figure 3-117](#), and the control screen representation is the same as in [Figure 3-118](#).

3.51 R&S OSP-B131 RF Switch Module



Figure 3-120: R&S OSP-B131

The one-slot [module](#) R&S OSP-B131 (order no. 1505.4740.02) consists of 2 failsafe electromechanical SPDT relays, frequency range DC to 12.4 GHz, with non-terminated N (female) connectors.

Note: Mind the [torque limit recommendation](#) of **150 N-cm** for N connectors.

The relays operate independently from each other. The terminal port is labeled with C (common), the other relay ports are labeled with NC (normally closed) and NO (normally open). Terminal C is connected either with relay port NC or NO.

The type of relays is monostable (or "failsafe"), hence, with no voltage applied, an RF connection is provided from C to NC, while NO is not connected to C ("Pos = 0"). To disconnect NC and connect C to NO ("Pos = 1"), a continuous voltage must be applied to the relay.

The relays are mounted directly into the module's panel and soldered to the module's printed board, to avoid relay cabling and allow a compact module size.

The switch unit provides power supply and control via a single module bus cable to a module bus connector on the module's printed board. The module's on-board memory stores its configuration data.

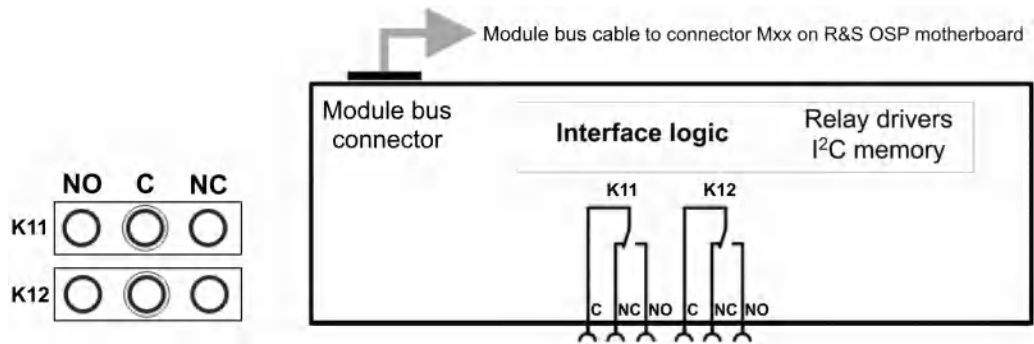

Figure 3-121: Pinout and block diagram of RF switch module R&S OSP-B131

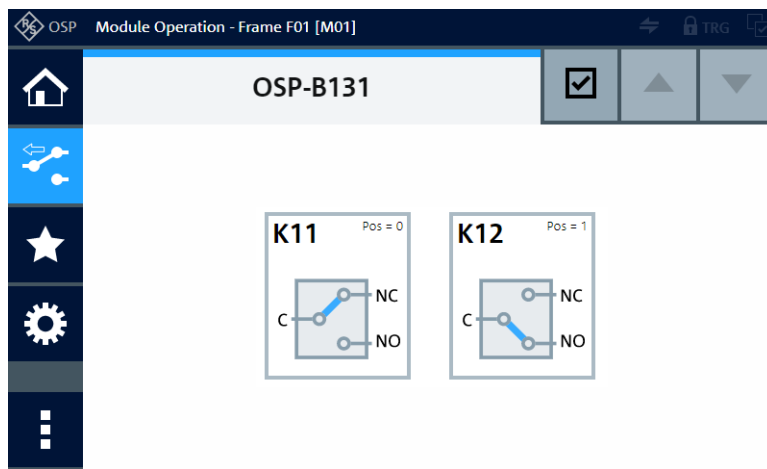

Figure 3-122: Representation of the module on the control screen

For operation, see [Chapter 4, "Operation"](#), on page 147 and [Chapter 5, "Functions"](#), on page 155.

For remote control, refer to the chapters [Remote Operation](#) and [RC Commands](#). For an example, see [ROUTE : CLOSe](#) on page 253.

3.52 R&S OSP-B132 RF Switch Module



Figure 3-123: R&S OSP-B132

The two-slot (double-width) module R&S OSP-B132 (order no. 1505.4757.02) consists of 6 failsafe electromechanical SPDT relays, frequency range DC to 12.4 GHz, with non-terminated N (female) connectors.

Note: Mind the [torque limit recommendation](#) of **150 N-cm** for N connectors.

The relays operate independently from each other. The terminal port is labeled with C (common), the other relay ports are labeled with NC (normally closed) and NO (normally open). Terminal C is connected either with relay port NC or NO.

The type of relays is monostable (or "failsafe"), hence, with no voltage applied, an RF connection is provided from C to NC, while NO is not connected to C ("Pos = 0"). To disconnect NC and connect C to NO ("Pos = 1"), a continuous voltage must be applied to the relay.

The relays are mounted directly into the module's panel and soldered to the module's printed board, to avoid relay cabling and allow a compact module size.

The module's on-board memory stores its configuration data.

The switch unit provides power supply and control via **two** module bus cables to two module bus connectors on the module's printed board. The available module bus connectors ("Mxx") are shown in [Figure 2-26](#).

To find out, which two module bus cables on the switch unit's motherboard your module uses, refer to the headline of the control screen as in [Figure 3-125](#). In this example, module R&S OSP-B132 uses buses "M01" and "M02". Alternatively, you can query the connectors by the RC command `DIAG:SERV:HWIN?` (see example there).

To address the relays of the R&S OSP-B132 in the "channel list string" of remote control commands, assign the "Mxx" bus names to the relays as follows:

- The 1st module bus (for example "M01") controls the relays K11, K12 and K13
- The 2nd module bus (for example "M02") controls the relays K14, K15 and K16

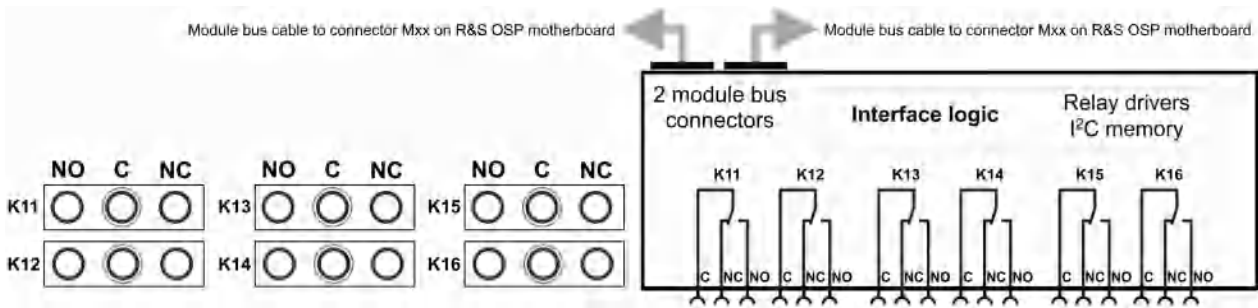

Figure 3-124: Pinout and block diagram of RF switch module R&S OSP-B132

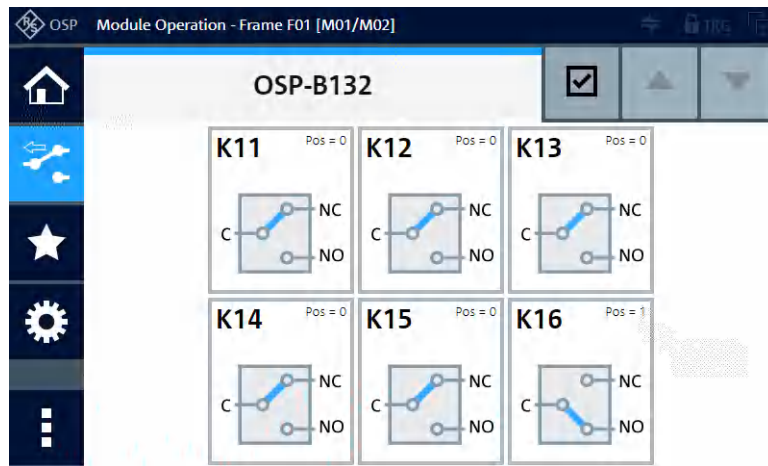

Figure 3-125: Representation of the module on the control screen

For operation, see [Chapter 4, "Operation"](#), on page 147 and [Chapter 5, "Functions"](#), on page 155.

For remote control, refer to the chapters [Remote Operation](#) and [RC Commands](#). For an example, see [ROUTE:CLOSE](#) on page 253.

3.53 R&S OSP-B133 RF Switch Module



Figure 3-126: R&S OSP-B133

The one-slot module R&S OSP-B133 (order no. 1528.3157.02) consists of 1 **failsafe (open)** electromechanical SP6T relay, frequency range DC to 12.4 GHz, with non-terminated N (female) connectors.

Note: Mind the **torque limit recommendation** of **150 N·cm** for N connectors.

The terminal port is labeled with C (common), the other relay ports are labeled with numbers.

The relay type is monostable (or "failsafe open"). Hence, with no voltage applied to the relay, no RF connection is provided from terminal C to any of the numbered ports. To establish an RF connection between C and one of the numbered ports, a continuous voltage must be applied to the corresponding power terminal of the relay.

The relay is mounted directly into the module's panel and soldered to the module's printed board, to avoid relay cabling and allow a compact module size.

The switch unit provides power supply and control via a single module bus cable to a module bus connector on the module's printed board. The module's on-board memory stores its configuration data.

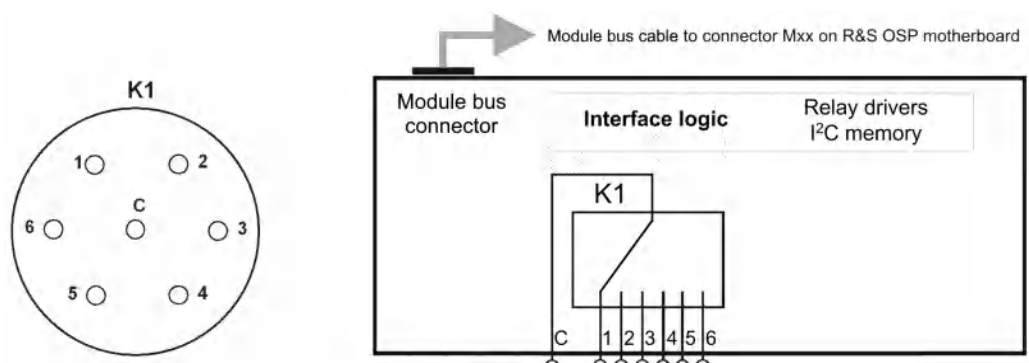

Figure 3-127: Pinout and block diagram of RF switch module R&S OSP-B133

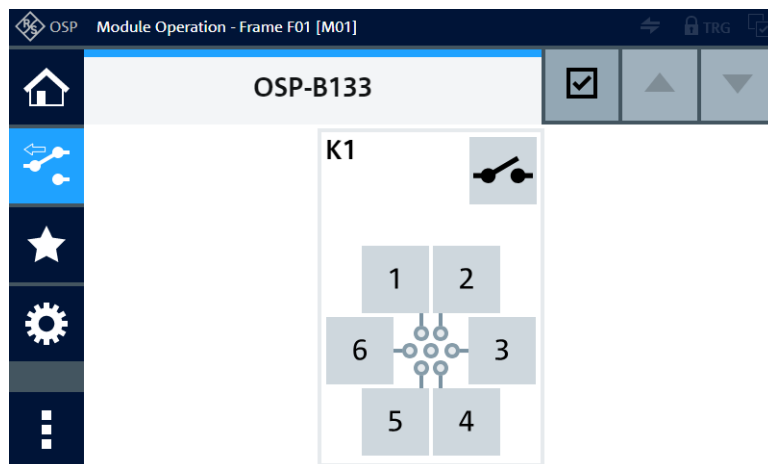

Figure 3-128: Representation of the module on the control screen

For operation, see [Chapter 4, "Operation"](#), on page 147 and [Chapter 5, "Functions"](#), on page 155.

For remote control, refer to the chapters [Remote Operation](#) and [RC Commands](#). For an example, see [ROUTE:CLOSE](#) on page 253.

3.54 R&S OSP-B136 RF Switch Module



Figure 3-129: R&S OSP-B136

The one-slot [module](#) R&S OSP-B136 (order no. 1522.4500.02) consists of 2 failsafe electromechanical DPDT relays, frequency range DC to 12.4 GHz, with non-terminated N (female) connectors.

Note: Mind the [torque limit recommendation](#) of **150 N·cm** for N connectors.

The relays operate independently from each other.

The type of relays is monostable (or "failsafe"), hence, with no voltage applied to a relay, its RF connections automatically go to the "not activated" state, as described below:

- When a DPDT relay is **not activated** (no voltage applied to the relay) and after a reset, the terminals **1 + 2** and **3 + 4** are connected. The user interface (control screen / "WebGUI") labels this state as "Pos = 0".
In the remote control command `ROUTE:CLOSE`, this deactivated state of the relay is represented by "00".
- When the relay is **activated** (continuous voltage applied to the relay), the terminals **1 + 3** and **2 + 4** are connected. The user interface (control screen / "WebGUI") labels this state as "Pos = 1".
In the remote control command `ROUTE:CLOSE`, this activated state of the relay is represented by "01".

The relays are mounted directly into the module's panel and soldered to the module's printed board, to avoid relay cabling and allow a compact module size.

The switch unit provides power supply and control via a single module bus cable to a module bus connector on the module's printed board. The module's on-board memory stores its configuration data.

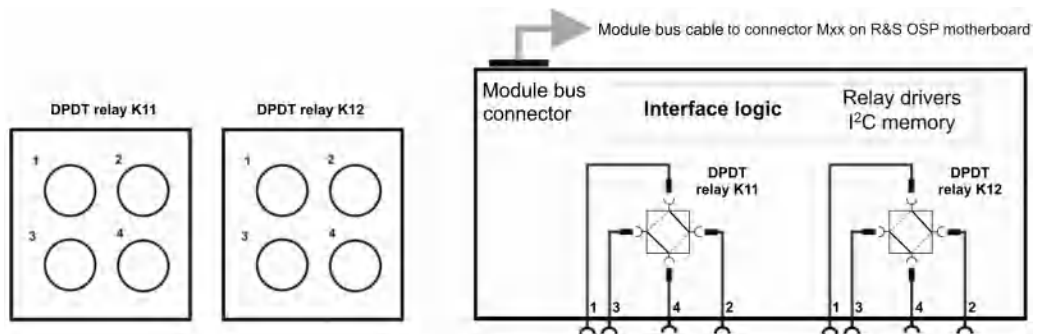

Figure 3-130: Pinout and block diagram of RF switch module R&S OSP-B136

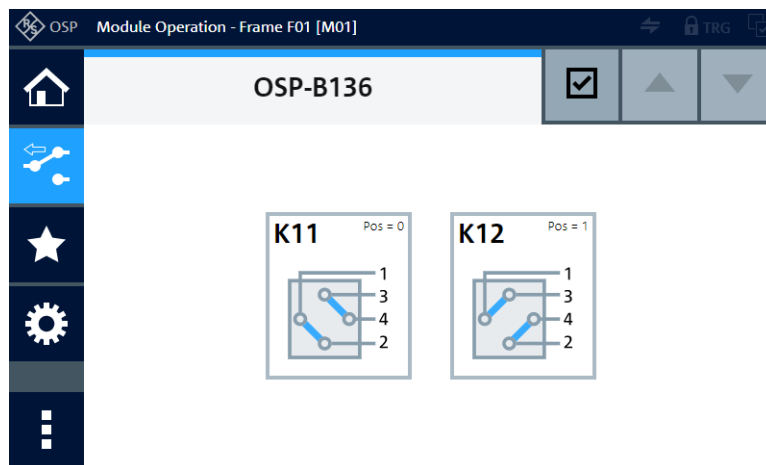

Figure 3-131: Representation of the module on the control screen

For operation, see [Chapter 4, "Operation"](#), on page 147 and [Chapter 5, "Functions"](#), on page 155.

For remote control, refer to the chapters [Remote Operation](#) and [RC Commands](#). For an example, see [ROUTE:CLOSE](#) on page 253.

3.55 R&S OSP-B142 RF SSR Power Module

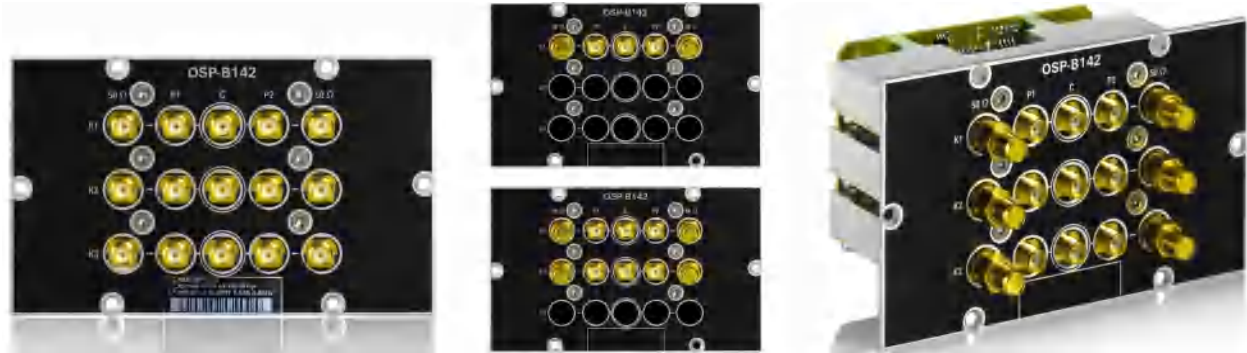

Figure 3-132: R&S OSP-B142, with up to 3 DP3T relays in horizontal lines (flat relay design)

Left	= Version .03 with 3 DP3T relays and no terminations
Center top	= Version .11 with 1 DP3T relay and 2 external 50 Ω terminations, the function is like a terminated SPDT
Center below	= Version .12 with 2 DP3T relays, each with 2 external 50 Ω terminations, the function is like 2 terminated SPDTs
Right	= Version .13 with 3 DP3T relays, each with 2 external 50 Ω terminations, the function is like 3 terminated SPDTs



The port labeled P1 is equivalent with the position NO and the port labeled P2 is equivalent with the position NC in the "WebGUI" ([Figure 3-135](#)) and in the description below.

The one-slot [module](#) R&S OSP-B142 (order no. 1505.4792.03/.11/.12/.13) consists of 1, 2 or 3 solid-state power relays (see below). The relays with SMA (female) connectors can handle up to 10 W (40 dBm) of RF power in the frequency range 9 kHz to 8 GHz.

Note: Mind the [torque limit recommendation](#) of **56 N·cm** for **SMA** connectors.

The switch module is available in 4 versions:

- Order no. 1505.4792.03: 3 DP3T relays without external termination
- Order no. 1505.4792.11: 1 terminated DP3T relay in position K1, equivalent with 1 terminated SPDT relay
- Order no. 1505.4792.12: 2 terminated DP3T relays in position K1 and K2, equivalent with 2 terminated SPDT relays
- Order no. 1505.4792.13: 3 terminated DP3T relays in position K1 to K3, equivalent with 3 terminated SPDT relays

The relays are factory-configured starting from position K1 onwards, hence, there is no configuration with K1 and K3, only. Openings without a relay are covered from the inside by a strip of sheet metal.

The R&S OSP automatically recognizes the relays installed in the R&S OSP-B142. The user interface displays these relays as DP3T (version .03) or SPDTs (versions .11 to .13).

The following diagram explains the difference between the switching schemes of module R&S OSP-B142:

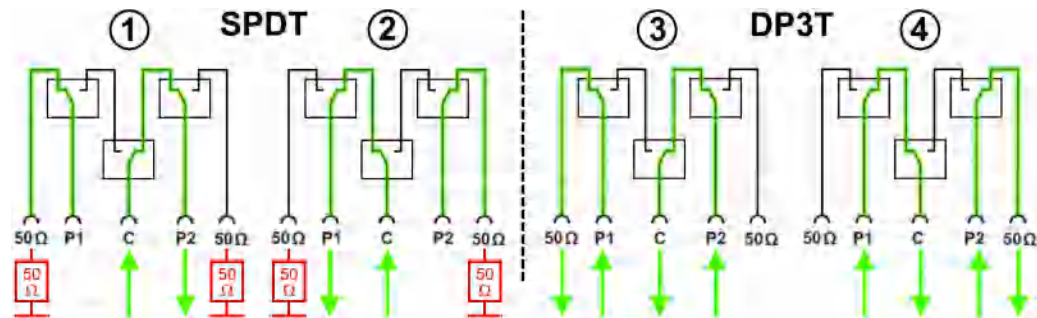

Figure 3-133: SPDT (terminated) and DP3T (non-terminated) switching schemes

- 1 = SPDT, not activated, C switched to P2, P1 is terminated with 50 Ω
- 2 = SPDT, activated, C switched to P1, P2 is terminated with 50 Ω
- 3 = DP3T, not activated, P2 switched to C, P1 switched to the "50 Ω " port (used as output port)
- 4 = DP3T, activated, P1 switched to C, P2 switched to the "50 Ω " port (used as output port)

You can use the output ports as inputs, and vice versa, because signals can travel in a bidirectional way. The ports are labeled with "C", "P1" (equivalent with NO), "P2" (equivalent with NC) and "50 Ω ".

SPDT:

Each of these relays is built-up from three individual solid-state switches as on the left in [Figure 3-133](#).

Here, the common terminal "C" can be switched to one of the ports "P1" or "P2", while the other port is connected to a "50 Ω " port for external termination:

- When the relay is *not activated* (control voltage = logical 0) and after a reset, the relay automatically falls back to its default state. In this state, the ports **C - P2** and **P1 - 50 Ω** (termination) are connected.
- When the relay is *activated* (control voltage = logical 1), the ports **C - P1** and **P2 - 50 Ω** (termination) are connected.

DP3T:

This double-pole triple-throw relay (DP3T or 2P3T) is a switch with 2 input (or output) ports and 3 output (or input) ports. Each relay is built-up by three individual solid-state switches as on the right in [Figure 3-133](#).

Here, the ports "P1" and "P2" serve as **input ports**, while the ports labeled with "C" and "50 Ω " serve as **output ports**. Note that in this module version, the "50 Ω " ports are delivered without external termination. Each input (P1 and P2) can be switched between 2 adjacent outputs, where one output is common to both inputs:

- When the relay is *not activated* (control voltage = logical 0) and after a reset, the relay automatically falls back to its default state. In this state, the ports **P1 - 50 Ω** and **P2 - C** are connected. The 50 Ω port is used as output port.
- When the relay is *activated* (control voltage = logical 1), the ports **P1 - C** and **P2 - 50 Ω** are connected. The 50 Ω port is used as output port.

The (groups of) relays in the module operate independently from each other.

Without power supplied to the relay, it has no defined switching state. Therefore, SSRs are not inherently failsafe, see "[Monostable vs. failsafe](#)" on page 11.

The relays are mounted directly into the module's panel and soldered to the module's printed board, to avoid relay cabling and allow a compact module size.

The switch unit provides power supply and control via a single module bus cable to a module bus connector on the module's printed board. The module's on-board memory stores its configuration data.

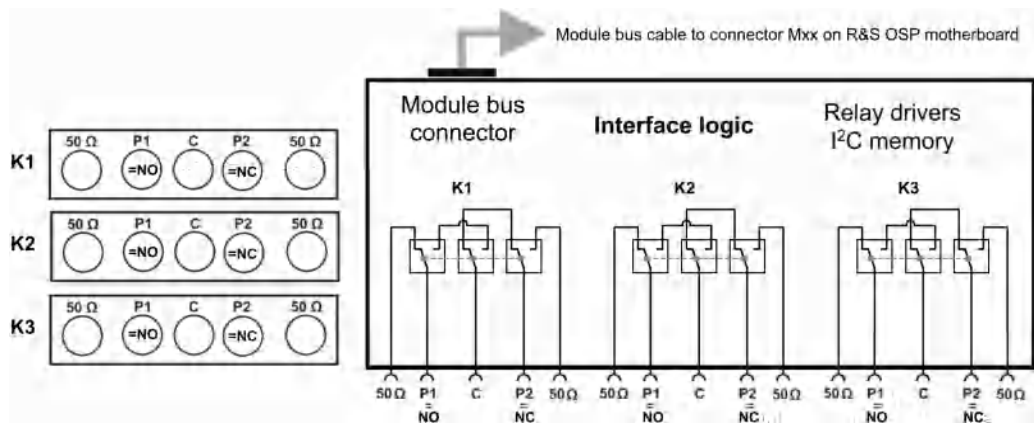

Figure 3-134: Pinout and block diagram of RF switch module R&S OSP-B142 (here: 3 relays)

In the module version .11 with 1 SPDT relay, the relays K2 and K3 are not available.

In the module version .12 with 2 SPDT relays, the relay K3 is not available.

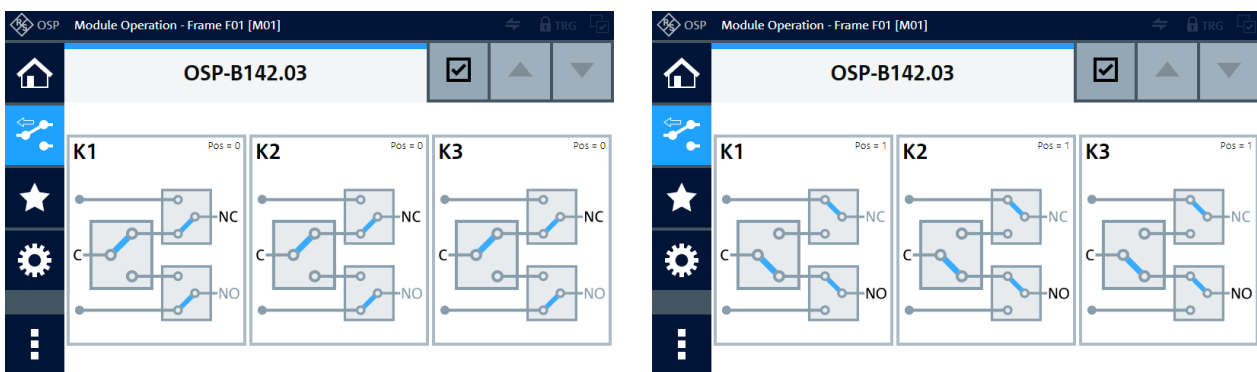

Figure 3-135: Representations of the module version .03 with 3 DP3T relays on the control screen

NC = Normally closed port, labeled as P2 on the module, see "[SCPI parameter for reset state](#)" on page 141

NO = Normally open port, labeled as P1 on the module

Left = In all relays, C is connected to NC, while the NO port is connected to the module's left 50 Ω port

Right = In all relays, C is connected to NO, while the NC port is connected to the module's right 50 Ω port

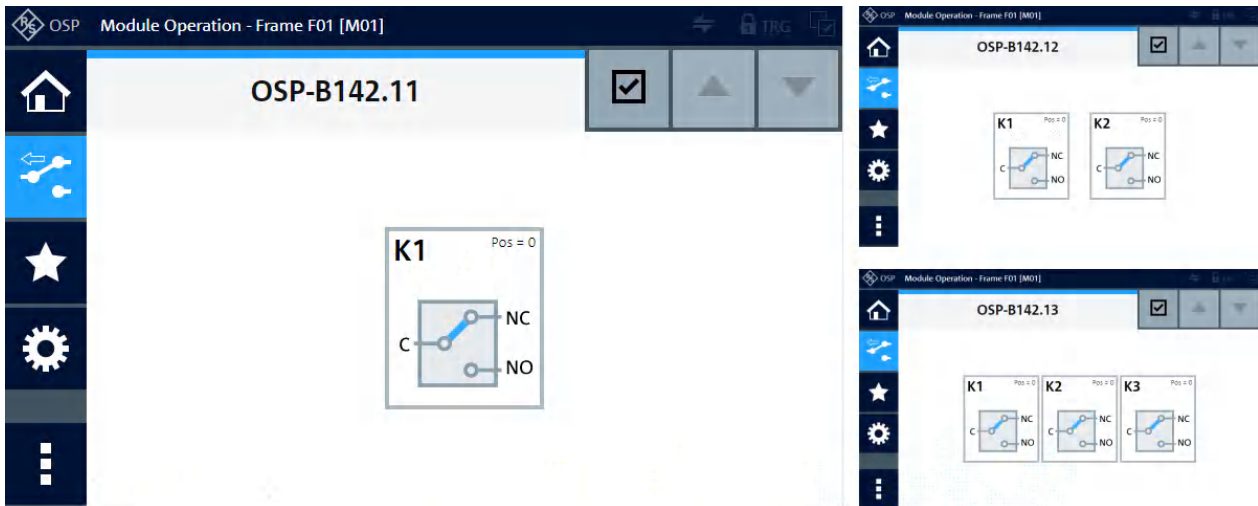

Figure 3-136: Representation of the module relay on the control screen, left: version .11 with 1 SPDT

Top right = Module version .12 with 2 SPDT relays

Lower right = Module version .13 with 3 SPDT relays



SCPI parameter for reset state

[Figure 3-136](#) and the **left** screenshot in [Figure 3-135](#) show the reset state (or default state, deactivated state), where the common terminal C is connected to port NC, labeled as P2 on the module. In the remote control command `ROUTE:CLOSE` on page 253, this reset state is equivalent with the value "00" of the state parameter "ss".

For operation, see [Chapter 4, "Operation"](#), on page 147 and [Chapter 5, "Functions"](#), on page 155.

For remote control, refer to the chapters [Remote Operation](#) and [RC Commands](#). For an example, see `ROUTE:CLOSE` on page 253.

3.56 R&S OSP-B200R Remote Control Module



Figure 3-137: R&S OSP-B200R

The one-slot [module](#) R&S OSP-B200R (order no. 1528.3140.02/.04) serves exclusively for controlling 1 or 2 other modules in a R&S OSP-B200S2 [satellite switch unit](#).

The remote control module is available in 2 versions:

- For control by wired link, only (order no. 1528.3140.02)
- For control by wired link and fiber-optic link (order no. 1528.3140.04)



Figure 3-138: Basic components of a satellite system, linked via fiber-optics

Left = Remote control module
 Center = Fiber-optic link (FOL), available in different lengths with module version 1528.3140.04
 Right = Satellite switch unit (here with two [OSP-B112](#) modules)



[Wired Link] only for satellite system

Use the [Wired Link] connectors **only** for connecting the remote control module R&S OSP-B200R with the satellite unit R&S OSP-B200S2. Connecting a [Wired Link] connector to any other device's connector can damage your equipment.

See [Chapter 2.2.2.4, "Rear Panel of the R&S OSP-B200S2 Satellite Unit"](#), on page 31, and [Chapter 3.56, "R&S OSP-B200R Remote Control Module"](#), on page 142.

The purpose of a satellite system is operating switch modules that are located far away from the switch unit, for example inside an anechoic chamber. In this scenario, the non-conductive fiber-optic link, which can be easily fed through the shielding, avoids electromagnetic interference.

When avoiding interference and long-distance remote operation are not required, you can use a wired link instead of the fiber-optic link. The wired link also supplies power from the R&S OSP base unit to the satellite unit.

The satellite unit has the same link connectors as the remote control module, plus a DC power supply connector and several status LEDs:



Figure 3-139: Connectors and LEDs on the rear panel of the R&S OSP-B200S2

[DC In]	= 4-pin, 28 VDC power supply connector (not required with [Wired Link])
[Power]	= Status LED indicating power supply
[Overheat]	= Status LED indicating excess temperature
[FOL]	= Fiber-optic link for remote communication with R&S OSP-B200R
[Link / Busy]	= Status LED indicating communication on the FOL or wired link
[Wired Link]	= 9-wire copper link for power supply and remote communication with R&S OSP-B200R

The module's on-board memory stores its configuration data.

The switch unit provides power supply and control via **two** module bus cables to two module bus connectors on the module's printed board. The available module bus connectors ("Mxx") are shown in [Figure 2-26](#).

The R&S OSP-B200R must be [mounted](#) in a standard switch unit, not in a satellite unit R&S OSP-B200S2.

The module is not represented in the software's user interface, and you cannot query its presence by SCPI commands like `DIAG:SERV:HWIN?` or `ROUT:MOD:CAT?`.

For the satellite system's description and operating instructions, refer to its user manual, which is available at www.rohde-schwarz.com/manual/osp-n.

3.57 R&S OSP-B171H RF Digital Attenuators Module



Figure 3-140: R&S OSP-B171H (left with 2, center and right with 4 attenuators)

The one-slot module R&S OSP-B171H (order no. 1528.1577.42/.44) consists of 2 or 4 solid-state digital attenuators with PC 2.92 (female) connectors for the frequency range 9 kHz to 40 GHz.

Note: Mind the [torque limit recommendation](#) of **90 N-cm** for PC connectors.

The module is available in 2 versions:

- Order no. 1528.1577.42 with 2 attenuators
- Order no. 1528.1577.44 with 4 attenuators

The attenuators in the module operate independently from each other.

The terminal ports are labeled with IN and OUT, but the attenuators work in either direction. Hence, you can swap input and output.

Without power supplied to the module, the attenuators have no defined state.

The relays are mounted directly into the module's panel and soldered to the module's printed board, to avoid attenuator cabling and allow a compact module size.

The switch unit provides power supply and control via a single module bus cable to a module bus connector on the module's printed board. The module's on-board memory stores its configuration data.

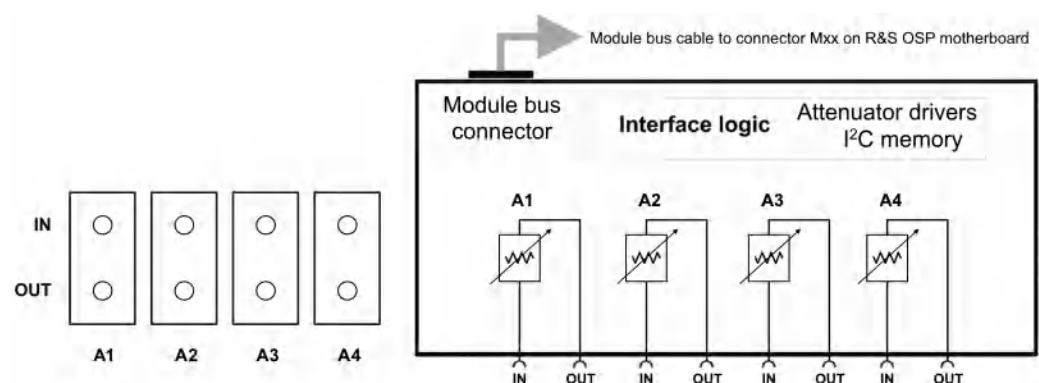

Figure 3-141: Pinout and block diagram of RF attenuator module R&S OSP-B171H (here: version .44)

In the module version .42 with 2 attenuators, the attenuators A3 and A4 are not available.

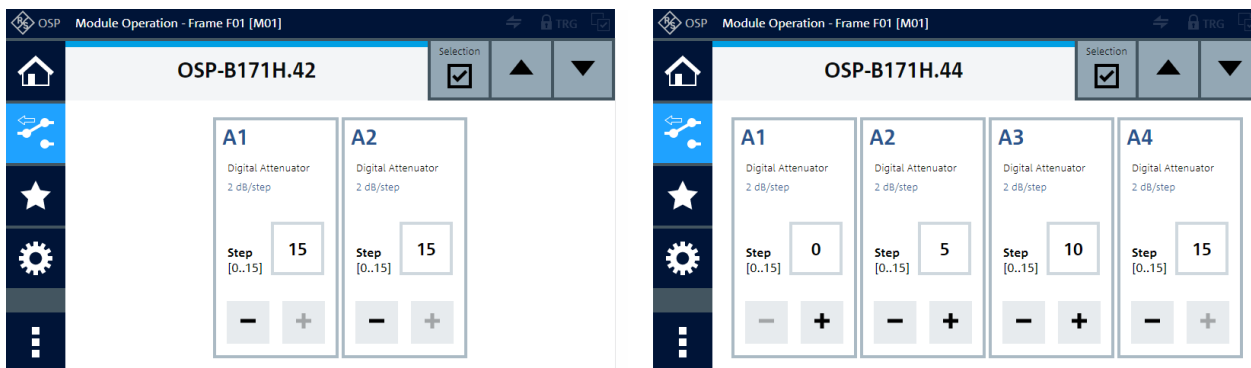

Figure 3-142: Representations of the module on the control screen (left: version .42, right: version .45)



Attenuation levels

The solid-state attenuators are 4-bit digital attenuator devices, allowing to set attenuation levels in 16 steps, from 0 to 15. Roughly, each step increases attenuation by 2 dB, starting from nearly no attenuation at step 0, up to approximately 30 dB attenuation at step 15. However, the actual attenuation levels in dB that correspond to each of the 16 steps are frequency-dependent. Refer to the data sheet for information on the attenuation levels in specific frequency ranges.

For operation, see [Chapter 4, "Operation"](#), on page 147 and [Chapter 5, "Functions"](#), on page 155.

For remote control, refer to the chapters [Remote Operation](#) and [RC Commands](#). For an example, see [ROUTE:CLOSE](#) on page 253.

Note that you can use also the [ROUTE:ATTenuation](#) command for setting and querying the attenuator steps.

3.58 R&S OSP-B300M Touchscreen Module

The R&S OSP-B300M is a touchscreen [module](#) (order no. 1528.3128.02) exclusively for the 3HU base unit [R&S OSP320](#).

The module is factory-mounted by Rohde & Schwarz, only, in the two right-most slots (FS04 and FS05) of the R&S OSP320, see [Figure 2-5](#). It has a special interface connection and does not require a module bus cable.

The touchscreen is a [TFT RGB LCD](#) with capacitive touch function and 800 x 480 pixels ([WVGA](#) resolution).

The module is not represented in the software's user interface, and you cannot query its presence by SCPI commands like `*OPT?`.

3.59 R&S OSP-PM-I Power Sensor Integration

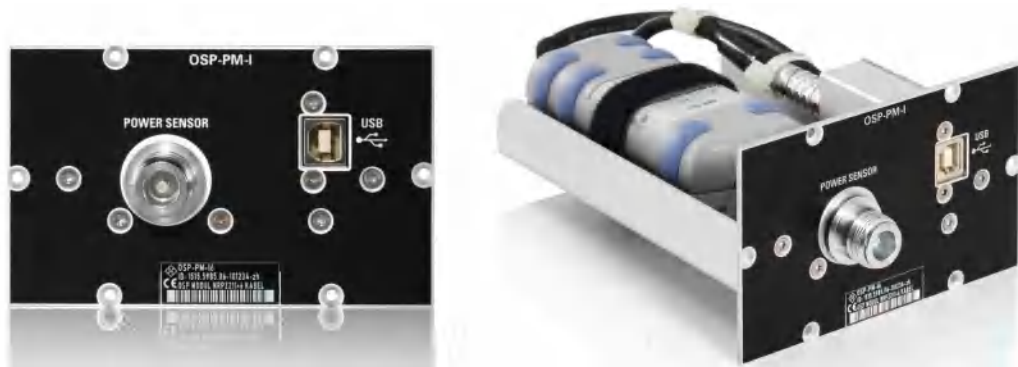

Figure 3-143: R&S OSP-PM-I

The [module](#) R&S OSP-PM-I (order no. 1515.5985.02) allows integrating a power sensor into an R&S OSP switch unit. The module has an N-type feedthrough connector and a USB connector, both mounted in the module's front panel.

Note: Mind the [torque limit recommendation](#) of **150 N·cm** for **N** connectors.

The R&S OSP-PM-I requires a separately ordered power sensor of the Rohde & Schwarz product family [R&S NRP-Zxx](#). Without ordering a sensor, it is not included in the module delivery. We recommend using a power sensor version with a short cable, for example the [R&S NRP-Z211](#) (order no. 1417.0409.04).

The module R&S OSP-PM-I is designed with a base plate that carries and fixes the power sensor and its cable. The sensor's RF input N connector is directly screwed to the feedthrough, while the sensor's control and output connector (Odumac L-series with 6 pins) is connected to a USB adapter. This adapter includes a lowpass filter and provides a USB standard B connector in the module's front panel.

The power sensor is entirely controlled via the USB interface, it has no connection to the switch unit's motherboard or internal connectors. Hence, this module does not require a module bus cable. It only serves for housing the power sensor inside the switch unit.

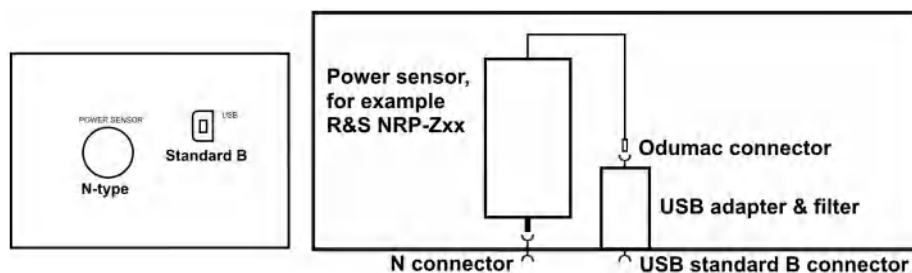

Figure 3-144: Pinout and block diagram of the power sensor integration module R&S OSP-PM-I

For remote control of this module, refer to the [Operating Manual](#) of your power sensor.

4 Operation

Here is an overview of using the R&S OSP and various interaction methods.

• How to Work with a Switch Unit	147
• Instrument Control	148
• LAN Connection	149
• Operation in Interconnection Mode	150
• Virtual Mode	154
• Trigger Mode	154

4.1 How to Work with a Switch Unit

The application-specific switch modules of the R&S OSP facilitate tests by automatically switching the required RF signal paths during measurements. Automatic path switching is a much preferred alternative over having to rearrange coaxial cable connections repeatedly, for example, in RF test systems.

For example, many EMC tests comprise scans across frequency ranges that require using two or more different transducers consecutively. Without a switch unit, you must unscrew the cable connector of the first transducer from your test instrument, once reaching the end of the first part of the frequency range. Then you must connect the cable of the next transducer, which is capable of measuring in the next part of the frequency range. Repeating the scan with the next DUT requires changing the connection again, and so on. This procedure is time-consuming, error-prone, and causes significant wear on all connectors involved.

A switch unit takes care of changing the RF connections by dedicated relays. For an alternating connection of two transceivers, for example, to one test port of a measurement instrument, you can use an SPDT relay module in the switch unit. Connect the first transducer to the relay's NC terminal port, the second transducer to the NO terminal port, and the test instrument to the common terminal port. During a frequency scan, your test control software can let the relay switch from NC to NO in the right instant. Hence, all connectors remain screwed in place, while the relay does the switching.

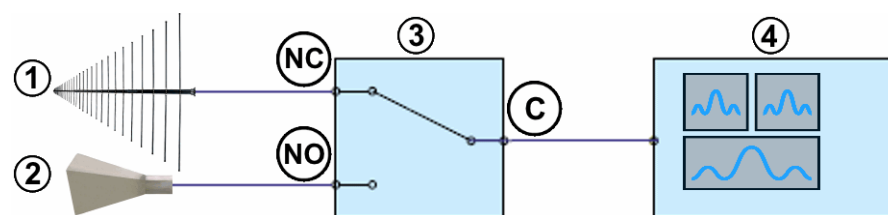

Figure 4-1: Example of a basic setup with one switching function, only

- 1 = Transducer 1, for example, a log-periodic antenna that covers 80 MHz to 6 GHz
- 2 = Transducer 2, for example, a horn antenna that covers 1 GHz to 18 GHz
- 3 = SPDT relay (single-pole double-throw switch)
- 4 = Test instrument, for example, a receiver that covers 10 Hz to 26 GHz

NC = "Normally closed" switch position
NO = "Normally open" switch position
C = Common terminal of the SPDT relay

In this simple example, the two signal paths for the first and second test step are:

- **"Path_A"** (for the first part of the frequency range) =
Transducer 1 to NC terminal to common terminal to test instrument
- **"Path_B"** (for the second part of the frequency range) =
Transducer 2 to NO terminal to common terminal to test instrument

With a comprehensive choice of different [switch module types](#), the R&S OSP supports a wide range of switching applications.

The following basic step-by-step instruction demonstrates how to integrate a switch unit in a typical application:

To configure a measurement:

1. Devise a test plan that specifies the signal paths for all test steps.
2. Evaluate the required switching actions.
3. Determine the required switch modules.
4. Consult with your sales representative for ordering.
5. Equip your switch unit with the required switch modules.
6. Define the relay states for each signal path.
7. Save all required combined relay states as path definitions.
8. Connect the switch unit to your test control system.
9. In your test control software (for example [R&S EMC32](#) or [R&S ELEKTRA](#)), use the path definitions in the specifications of test steps.
10. During tests, let your test control system consecutively activate the required signal paths.

For examples of typical switching scenarios controlled by RC commands, see [Chapter 9, "Programming Examples"](#), on page 298.

4.2 Instrument Control

As indicated in [Chapter 2.3.1, "Manual and Remote Modes of Operation"](#), you can operate the switch unit by any of the following modes:

- **Touchscreen** in the front panel of the switch unit
 - The R&S OSP230 is equipped with a touchscreen display in the [front panel](#)
 - The R&S OSP320 can be equipped with the touchscreen display module [R&S OSP-B300M](#)

- External **keyboard, mouse and monitor** connected to the front panel's USB and HDMI ports as in [Figure 2-13 \(2\)](#)
- "**WebGUI**" (= graphical user interface in a web browser)
- **Remote control** of instrument functions with **RC commands** in SCPI format

Also, the user interface offers a **Virtual Mode** (both via touchscreen and in the "Web-GUI") that allows you configuring modules, which are not present.

Operation via the graphical user interface is described in [Chapter 5, "Functions"](#), on page 155.

Operation via remote control commands is described in [Chapter 7, "Remote Operation"](#), on page 240 and [Chapter 8, "RC Commands"](#), on page 246.



Note that the legacy software R&S OSP Panel is not compatible with the switch units R&S OSP220, R&S OSP230 and R&S OSP320.

4.3 LAN Connection

For the switch unit's network settings, see [Configuration > Network](#).

As a prerequisite, you must have a local area network (LAN, Ethernet) available and supported in your facility.

With switch units in [interconnection](#) mode, as described in [Chapter 4.4, "Operation in Interconnection Mode"](#), on page 150, the user interface lets you control all secondary switch units via the primary switch unit.

To connect your switch units via LAN, proceed as follows:

1. Connect your computer to the LAN.
2. Complete all steps described in [Chapter 2.1, "Preparing for Use"](#), on page 15.
3. Connect the rear [RJ45 connector](#) of all switch units to LAN sockets in the same address space as the computer.
4. If the switch units have touchscreen displays, read the host names of the switch units and proceed with [step 7](#).
Otherwise proceed with [step 5](#).
5. If the switch units have status displays, read the host names from the 1st line of each status display, as described in [Chapter 2.3.2, "User Interface and Functional Elements"](#), on page 34, and proceed with [step 7](#).
Otherwise proceed with [step 6](#).
6. If you know the host names of the switch units from other sources of information, proceed with [step 7](#).
7. Decide, which switch unit you want to use as primary device.

8. Enter the host name of your primary switch unit into the address bar of your browser.
For example, enter osp320-101357 (without additional characters).
Note that you can also enter a switch unit's IP address into the browser's address bar, instead of the host name.
The browser shows the primary device's graphical user interface.
9. Go to the [Configuration](#) > [Interconnection](#) dialog.
10. Click "Add a secondary device".
11. Enter the host name of a secondary switch unit into the "Address" field.
Note that you can also enter a switch unit's IP address into the "Address" field, but we recommend using the host name.
12. Confirm your entry.
13. Repeat [step 10](#) to [step 12](#) for each secondary switch unit.
You can use all connected switch units via the [Module Operation](#) dialog.

If there are problems with this procedure, refer to [Chapter 10, "Troubleshooting"](#), on page 301.

4.4 Operation in Interconnection Mode

Access: [Configuration](#) > [Interconnection](#).

Complex switching scenarios can require several switch units with many modules working together. The R&S OSP allows connecting and jointly controlling even many switch units.

As a precondition, all connected switch units must run the same firmware version.

However, controlling this combination of devices can be a challenging task, if each switch unit must be addressed separately.



Controlling interconnected setups in compatibility mode is limited to 1 primary switch unit with frame ID "F01" and 8 secondary switch units with frame IDs "F02" to "F09".

To facilitate the combination of switch units, the R&S OSP features operation in "Interconnection" mode. To achieve this operating mode, define one of your devices as a primary device and all other as secondary devices:

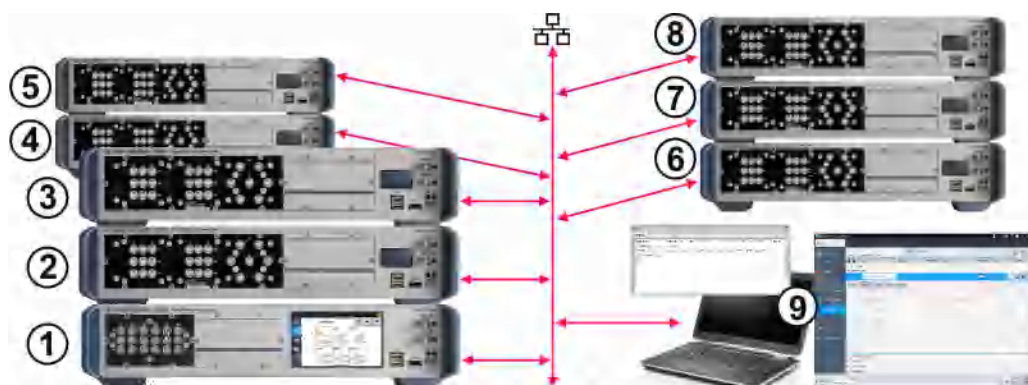

Figure 4-2: Example of a primary switch unit and 3 groups of secondary devices in a LAN setup

- 1 = Frame F01 = Primary switch unit
- 2 = Frame F02 = Secondary device 1
- 3 = Frame F03 = Secondary device 2
- 4 = Frame F04 = Secondary device 3
- 5 = Frame F05 = Secondary device 4
- 6 = Frame F06 = Secondary device 5
- 7 = Frame F07 = Secondary device 6
- 8 = Frame F08 = Secondary device 7
- 9 = Test control system (PC and software)

Connect all switch units to the LAN. In your primary switch unit, configure the other switch units as secondary devices, using the host name (or IP address) of each device.



Using IP addresses instead of host names can lead to address conflicts in the LAN, depending on procedures in your DHCP server. See "[Address Model](#)" on page 211.

Once you have set up your switch units as primary and secondary devices, you can work with the primary device's interface alone. The primary device then controls the behavior of all secondary devices.





The user interface of secondary devices is limited to displaying status and module information. You cannot switch any relays or output channels. The [Path Switching](#) and [Configuration](#) dialogs are absent.

The [Main](#) dialog of each secondary device shows not only its hostname, but also the "Primary Hostname". This information tells you, which R&S OSP is the primary device that controls the secondary device.

The R&S OSP firmware does not permit cascaded secondary devices, hence, no "tertiary devices". Therefore, the [Device Information](#) dialog of a secondary switch unit has no "Secondary Devices" section (as in a primary switch unit).

How to exit from interconnection mode

- The standard method for releasing a secondary switch unit is by removing its entry in the primary switch unit's settings at [Configuration](#) > [Interconnection](#).

- If you want to work with a switch unit that is in secondary state, but you have **no access** to the primary switch unit, you can proceed as follows:
 - In your secondary switch unit, go to the "Main" menu 
 - Click the "Context Menu" button 
The button "Exit Secondary Mode" comes up, which is available only in secondary mode:

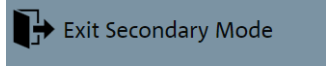
A rectangular button with a dark grey background. On the left, there is a white icon of a square with an arrow pointing to the right. To the right of the icon, the text "Exit Secondary Mode" is written in white.

- Select **"Exit Secondary Mode"**
A message comes up: "This OSP is used as a secondary device in an interconnection with another OSP. Do you really want to exit the secondary mode now?"
- If you want to abort exiting from the secondary mode, click "Cancel".
Otherwise, if you confirm this message with "OK", your switch unit disconnects from the primary device and returns to the "Single" state.
Doing so, the secondary device informs the connected primary device about exiting the interconnection mode. A "User Warning" is shown in the primary device's messages dialog. At the next start-up of the primary device, it tries to connect the secondary device again.



Note that exiting from the interconnection mode interferes with the primary device's operation. Especially, the primary device's paths that include your secondary switch unit become unswitchable.



The primary switch unit dominates

- [Module Operation](#), [Path Switching](#) and [Configuration](#) are locked in the user interfaces of all secondary devices. Instead, all modules and paths are controlled from the primary device's user interface.
- The primary device overrules specific settings in the [Configuration > General](#) dialog of a secondary device, but it does not change any settings in the secondary device. Hence, when a switch unit exits the secondary state, it has the same general settings as before entering the interconnection mode.

The following settings in a secondary device are overruled by the primary device:

- [Switch-On Reset](#): During Power Up, the primary device waits for all secondary devices and then (if configured in the primary device) executes the reset, which is effective for all secondary devices.
- [Switch-On Action](#): During Power Up, the primary device waits for all secondary devices and then (if configured in the primary device) switches an initial path, which can include secondary devices.

The [Path Info](#) is not displayed in secondary devices, because paths are controlled exclusively by the primary device.

The [Compatibility Mode](#) is not relevant in secondary state, because secondary devices cannot receive RC commands.

- Before a switch unit becomes a secondary device, it has the frame ID "F01" and is in "Single" or "Primary" state. When it becomes a secondary device, the primary device overwrites the secondary device's frame ID according to the "Interconnection" configuration in the primary device. For example, this ID can be the next number available in the setup: If one secondary device is already present, the next secondary device gets the frame ID "F03".
- Only switch units that are in single or primary state can be controlled remotely. If a switch unit is in secondary state, its SCPI interface is deactivated. Instead, secondary switch units are controlled by the primary device, and optionally by remote commands to the primary device.
- If a switch unit is in primary state or in [Virtual Mode](#), it refuses becoming a secondary device.
- At shutdown, the primary device remembers its secondary devices to be able to reconnect to them, if available at startup. Also, the secondary devices remember their secondary configuration state at shutdown.
- During startup, the primary switch unit waits for the secondary switch units to complete booting. After completion, before executing any reset commands, the primary device overwrites the reset states of the secondary devices.

If a primary switch unit cannot contact a secondary switch unit to reset it to single mode (no interconnection), use the button "Exit Secondary Mode" in the context menu of the secondary device.

For information on the behavior of locked primary and secondary switch units, see [Lock Mode](#) in [Chapter 5.2.1, "Module Operation Context Functions"](#), on page 173.

4.5 Virtual Mode

Access: [Configuration](#) > [General](#) > [Virtual Mode](#)

The virtual mode allows configuring frames, modules, signal paths and output channel patterns without any modules and secondary switch units being physically present. Or if the modules are present, in virtual mode you can play around without actually switching any relays or channels.

Both user interface commands and remote-control commands like [ROUTE:CLOSE](#) let the switch state being *displayed* in the dialog. Hence a relay can *look* like it is switched, but the hardware is effectively *not switched*.

As in normal operation ("Virtual Mode" disabled), use the following functions in virtual mode for simulated configuration and operation tasks:

- Use [Configuration](#) > [Interconnection](#) to create a virtual setup of primary and secondary switch units
- Use [Module Operation](#) to **select** and **switch** relays and output channels in virtual mode
- Use [Path Switching](#) to **define** and **switch** signal paths in virtual mode



Path definitions are a data set that is common to virtual operation and physical (non-virtual) operation. Hence, paths that you define in virtual mode are identically available for physical operation, and vice versa.



In "Virtual Mode", you can create simulated hardware configurations that greatly differ from your physical hardware configuration.

For example, when you add modules in virtual mode, these modules are numbered by the connector names M01, M02, M03, **M04**, **M05**, M06 etc. On the contrary (at least in the 2HU switch units), module connector names M04 and M05 are skipped (see [Figure 2-26](#)).

We recommend simulating only the same configuration as in your physical setup, along with the correct module connector names.

A virtual setup identical with your physical setup facilitates transferring path definitions from your virtual playground to real-world RC commands.

4.6 Trigger Mode

If you have activated a license for [option R&S OSP-K100](#), your switch unit is enabled for triggering.

For a description of all trigger functions, refer to [Chapter 5.4.2, "Trigger"](#), on page 201.

5 Functions

This chapter explains how to [control](#) the functions of the R&S OSP via the user interface. For access to a function, tap or click its icon on the display or external monitor.



In an [interconnection setup](#), most functions are only available in the primary switch unit. [Module Operation](#), [Path Switching](#) and [Configuration](#) are locked in the user interfaces of all secondary switch units.

5.1 Main	155
5.1.1 Main Context Functions.....	157
5.2 Module Operation	166
5.2.1 Module Operation Context Functions.....	173
5.3 Path Switching	181
5.3.1 Path Switching Context Functions.....	188
5.4 Configuration	195
5.4.1 General.....	196
5.4.2 Trigger.....	201
5.4.3 Network.....	210
5.4.4 Interconnection.....	212
5.4.5 Configuration Context Functions.....	214

5.1 Main



Displays information on the status of your R&S OSP:



Figure 5-1: Main page

Some of this information depends on your settings:

- "Device Type", the model of your switch unit (either R&S OSP220 or R&S OSP230 or R&S OSP320)
- "Hostname" of this device, see [Device Information](#)
- "Address", the IP address of this device, see [Device Information](#)
- "Subnet Mask" for this device, see [Device Information](#)
- "Device State": "Single", "Primary" or "Secondary" (see [Interconnection](#)), either "Connected" or "Disconnected" (see [LAN Connection](#)), or "Remote" (see [Remote Operation](#))
- "Customer Text", see settings at [General > Customer Text](#)
- "Last Switched Path", see settings at [Path Switching](#) and [General > Path Info](#)



Show Device Messages



If the R&S OSP has messages, the "Show Device Messages" button  in the top right of the main page turns into a warning icon :



Figure 5-2: Warning icon on top of the main page

If the R&S OSP has unconfirmed errors, the "Show Device Messages" button in the top right of the main page turns into an error icon:



Figure 5-3: Error icon on top of the main page

This button (with messages, warning or error icon) is a shortcut for displaying errors, warnings and other messages, as described in "Device Messages" on page 161.



Device Information

This button in the "Main" page is a shortcut for displaying detailed device information, as described in "Device Information" on page 159.



Help

Only available in the "Main" page.

The "Help" button brings up [descriptions](#) of the main functions of the user interface:

- = [Main: Status and Device Information](#)
Gives [basic information](#) and offers buttons to view [detailed device information](#) or [device messages](#).
- = [Module Operation](#)
Allows [viewing](#) and [operating](#) the installed hardware modules and offers to [select module switches](#) for saving as path definitions.
- = [Path Switching](#)
Allows [switching](#) or [exporting / importing](#) paths and offers [more options](#).
- = [Device Configuration](#)
Allows configuring the [general settings](#), the [network settings](#) and the [interconnection setup](#).
- = Context Menu with **specific functionality** for each main function, see below

The specific functionality offered in the Context Menu depends on the **main** function that you have **selected together** with the "Context Menu" button:

- + = [Main Context Functions](#)
- + = [Module Operation Context Functions](#)
- + = [Path Switching Context Functions](#)
- + = [Configuration Context Functions](#)

5.1.1 Main Context Functions



Selecting "Main" + "Context Menu" brings up the following dialog:

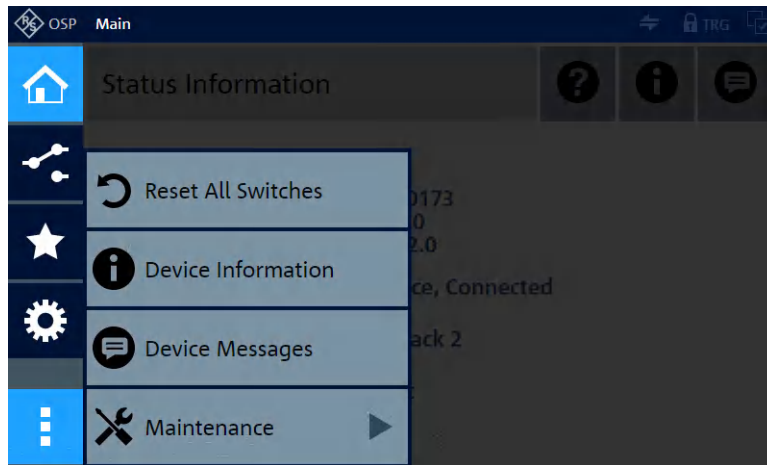

The following context functions are available:

Reset All Switches	158
Device Information	159
L Software Options Overview	160
Device Messages	161
Maintenance	162
L Update Firmware Version	163
L Enter License Key	163
L Device Cleanup	164

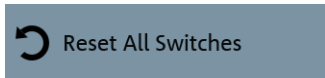

Reset All Switches

Access: "Main" > "Context Menu" > "Reset All Switches"

Confirm the message "Do you really want to reset all switches in all modules" to do so, including all output channels and including all **secondary** switch units.

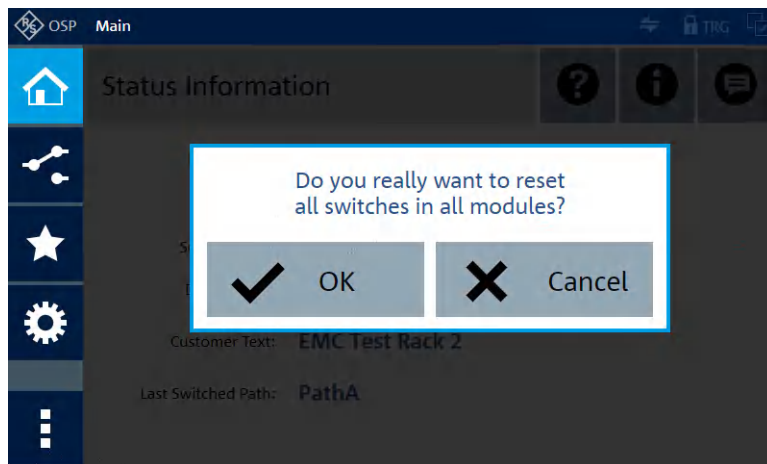

Same function as in the [Module Operation > Context](#) menu and in the [Path Switching > Context](#) menu.

Remote command:

*RST

SYSTEM:PRESet

 Device Information
Device Information

Access: "Main" > "Context Menu" > "Device Information"

Displays more device information than on the [main page](#). Clicking the info button  in the top right corner of the main page opens the same dialog:

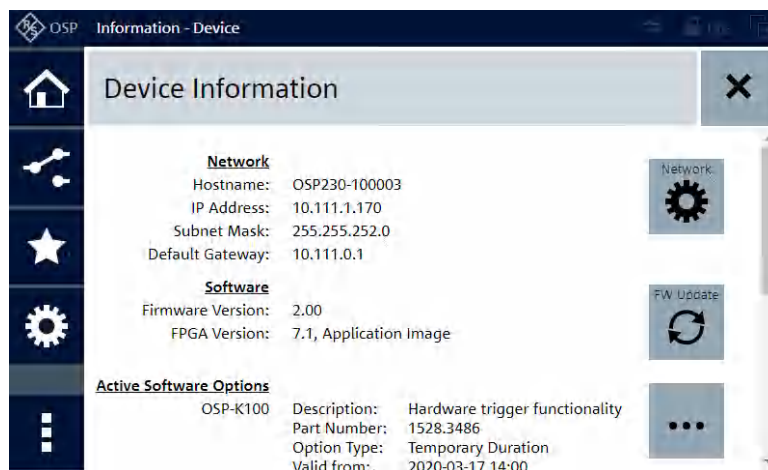

The following information is displayed:

- **"Network"**, see settings at [Configuration > Network](#)
 - "Hostname"
 - "IP Address"
 - "Subnet Mask"
 - "Default Gateway"

For direct access to the network settings at [Configuration > Network](#), click the "Configure Network" button:



- **"Software"**
 - "Firmware Version"
 - "FPGA Version"

For direct access to the firmware update dialog at [Configuration > Context Menu > Update Firmware Version](#), click the "Update Firmware Version" button:



- **"Active Software Options"** (for example "OSP-K100" for triggering), which you can query by the remote-control command `*OPT?`
 - "Description"
 - "Part Number" (= order no.)
 - "Option Type" with validity period, if applicable

For more information, open the [Software Options Overview](#) by clicking the "More" button:



For an example of software option details, refer to [Figure 5-6](#).

- **"Secondary Devices"**, lists interconnected secondary switch units controlled by the primary switch unit
For direct access to the interconnection settings at [Configuration > Interconnection](#), click the "Interconn." button:



- **"Hardware"**
 - "Part Number" (= order no.)
 - "Serial Number"
 - "Product Index" = model iteration of a hardware version
 - "Production Date" in yyyy-mm-dd format

Per default, you can modify only the "Hostname" and the "Secondary Devices" (see links above). If you change the "Address Model" at [Configuration > Network](#) from "Auto DHCP" to "Static", you can modify more network settings.

For more details, see also the description of [DIAGnostic:SERvice:HWInfo?](#) and the example at the end of that section.



Software Options Overview ← Device Information

Access: "Main" > "Context Menu" > "Device Information" > "More"

Displays the following option information:

- **"Active Options"**
The details comprise the following:
 - "OSP-Kxxx": type of the option
 - "Description": name of the option (indication of what it does)
 - "Part Number": first 8 digits of the option's 10-digit order no., which is, for example, "1528.3486.02" for option [OSP-K100](#). The variant ".02" at the end indicates a permanent option.
 - "Option Type": either "Permanent" or "Temporary Duration"
The next two details are available only, if the option is temporary:
 - "Valid from": activation date and time (next full hour after "Creation Date", see below), which determines the start of the option's validity
 - "Valid to": expiration date and time (= "Valid from" plus the license's duration), which determines the end of the option's validity
 - "Creation Date": date and time of entering the option's activation key
 - "Privilege": either "Customer Order" or "Demo"
 - "License Count": 1, unless the same license is installed multiple times on the same device
 - "License Key": displays the 30-digit key that was used for activating this option



"New Option": provides a shortcut to [Configuration > Configuration Context Functions > Enter License Key](#).

NOTICE! Option loss with wrong date. If you use temporary software options, ensure that the correct [System Date](#) is set before activation. Date manipulation can lead to deactivation of options.

- **"Invalid Options"**

Displays a list of all licenses for software options that you have deactivated, that have expired, or that have become invalid due to system date manipulation.

- **"Used Deactivation Keys"**

Displays a list of all deactivated software-option licenses, containing the following deactivation key information: option description, part number, creation date, license key, deactivation response and customer order number.



"Deactivate": provides a shortcut to [Configuration](#) > [Configuration Context Functions](#) > [Enter License Key](#).

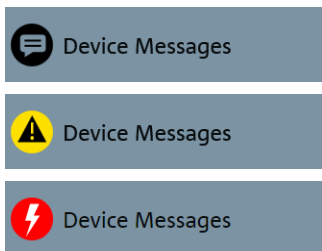

Device Messages

Access: "Main" > "Context Menu" > "Device Messages"

Displays errors, warnings and other messages. The messages button on the [main page](#) opens the same dialog.

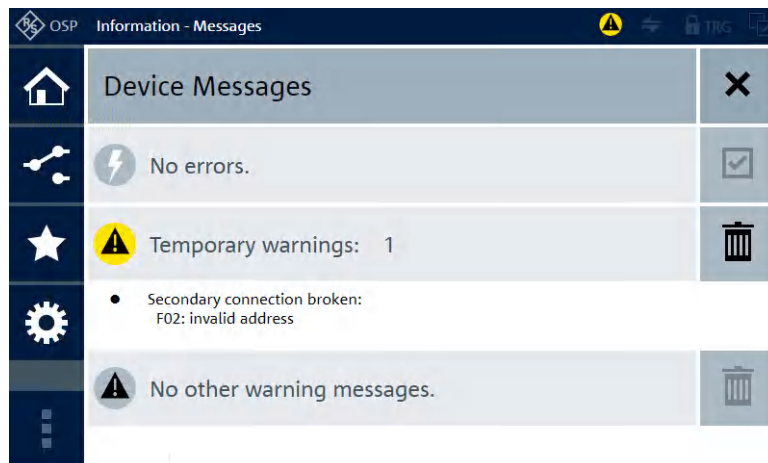

Figure 5-4: Example of messages (here: no error, 1 warning, no other messages)

"Errors" are severe and unexpected problems, for example:

- Unknown modules detected
- The EEPROM of the base unit, of the mainboard, of a connected module or of a satellite unit is empty or cannot be read
- The EEPROM of the base unit, of the mainboard or of a satellite unit has a mismatching part number
- Scanning the I²C addresses has failed
- The module bus connectors of a twin-bus module are crossed-over (erroneously swapped), see [DIAGnostic:SERVice:HWInfo?](#) on page 291
- After the switching of a latching relay, its readback position is not as expected
- A hardware operation does not proceed as expected

"Temporary Warnings" are transitory deviations from normal operation, for example:

- No module was detected when starting the switch unit
- A connected secondary switch unit does not respond
- A path is not switchable, because a secondary switch unit involved in the path is unavailable

- A remote control module R&S OSP-B200R was detected, but without a connected satellite unit R&S OSP-B200S2
- No module was detected in a connected satellite unit

"Other Messages" are notifications of events that typically do not interfere with normal operation, for example:

- The number or location of connected modules has changed (after a restart)
- Instead of a released firmware version, the device runs a service version of the firmware

Check if a device message is relevant for your operation. For information on handling errors and warnings, refer to [Chapter 10, "Troubleshooting"](#), on page 301.

Note: The "Device Messages" dialog does not show SCPI error messages. To query SCPI errors, use the remote control commands `SYST:ERR?` or `SYST:ERR:ALL?`.



If there are **errors**, you can select "Mark All As Confirmed" by clicking the button.

If you have confirmed error messages, you can toggle between the following message display states:



- Click "Show All Errors" to display also the confirmed error messages
- Click "Only Show Unconfirmed Errors" to hide confirmed error messages (= default)



If there are **warnings**, you can select "Delete all temporary warnings" by clicking the  button.

If there are **other messages**, you can select "Delete All Other Messages" by clicking the  button.



To close this dialog and go back, click the "Back"  button.

Remote command:

`DIAGnostic:SERVice:USER:ERRor?`

`DIAGnostic:SERVice:USER:WARNing?`

Maintenance

Access: "Main" > "Context Menu" > "Maintenance"

Provides functions for [updating the firmware](#), [entering a license key](#) and [resetting \(cleaning up\) the device](#).



Maintenance



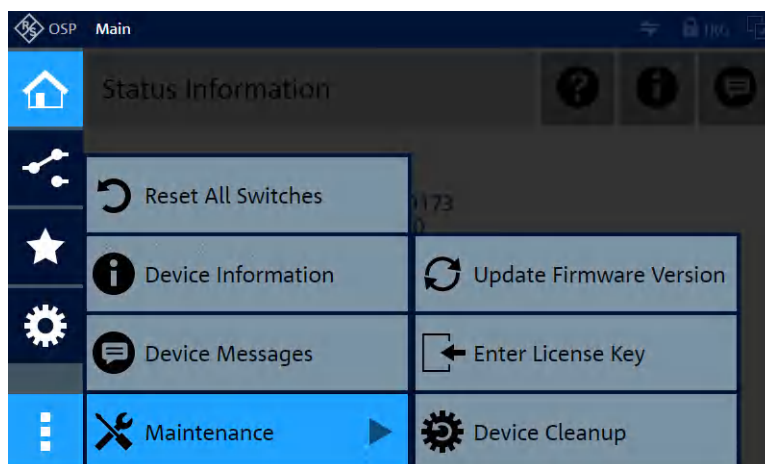

Figure 5-5: Path selection functions in the path switching context menu

These "Maintenance" functions are available also in the [Configuration > Context > Maintenance](#) menu.

Update Firmware Version ← Maintenance

Access: "Main" > "Context Menu" > "Maintenance" > "Update Firmware Version"

Allows updating the firmware to a new version or starting the switch unit with a different firmware version, if available in the internal storage.

You can update the firmware by two means:

- Running an "osp-firmware-x.xx.rsu" file from an external USB storage device, which is connected to one of the switch unit's USB ports
- Running an "osp_firmware_update_x.xx.exe" via LAN, which allows updating several switch units at the same time

Updating the firmware version is described in [Chapter 12.3, "Firmware Update"](#), on page 307.

Enter License Key ← Maintenance

Access: "Main" > "Context Menu" > "Maintenance" > "Enter License Key"

Allows installing a new software option or removing an installed option, for example for transferring it to a different switch unit.

To do so, you must have an activation or deactivation key, which is a 30-digit numerical code. You get *both* keys when you buy an option. Each key fits only for one individual device. The keys are typically transmitted to you by email in `xml` files, or printed in a paper document.

To activate the firmware option, enter the license activation key and confirm with "OK" .

 Update Firmware Version

 Enter License Key

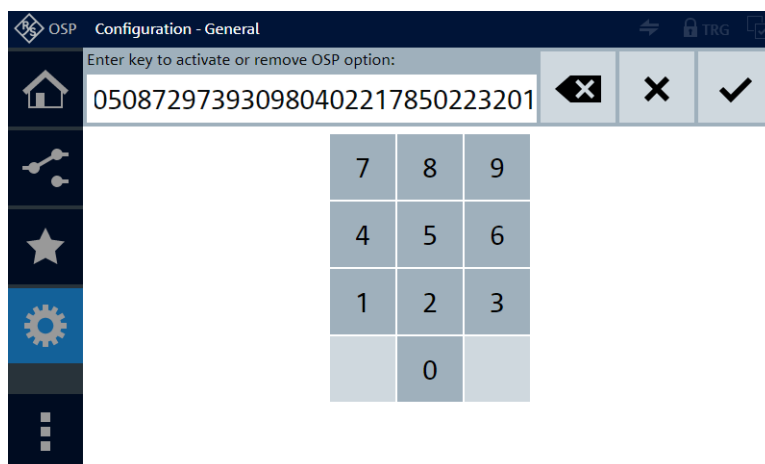

The option is immediately active, without a restart of the switch unit, while the activation key is labeled as used. This key cannot be used anymore.

After clicking "OK", a dialog shows the installed license key and confirms that it is active. Click "Close" **X** to close the dialog.

In the [Main](#) menu, the [Device Information](#) **i** displays the details of all "Active Software Options":

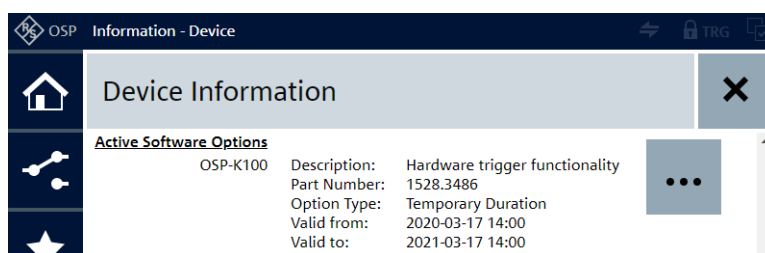

Figure 5-6: Example: option R&S OSP-K100 enables the trigger functionality

For a description of the information details, refer to "[Software Options Overview](#)" on page 160.

NOTICE! Option loss with wrong date. If you use temporary software options, ensure that the correct [System Date](#) is set before activation. Date manipulation can lead to deactivation of options.

If you want to transfer the option to a different switch unit, enter the deactivation key. As a result, the device generates a *deactivation response key* and displays it. Note down this key, or copy it, and send it to Rohde & Schwarz service, to receive a new set of activation and deactivation keys.

Device Cleanup ← Maintenance

Access: "Main" > "Context Menu" > "Maintenance" > "Device Cleanup"

Provides functions for resetting various configurations to a default state. If the cleanup includes a file deletion, you get a warning message.



Device Cleanup

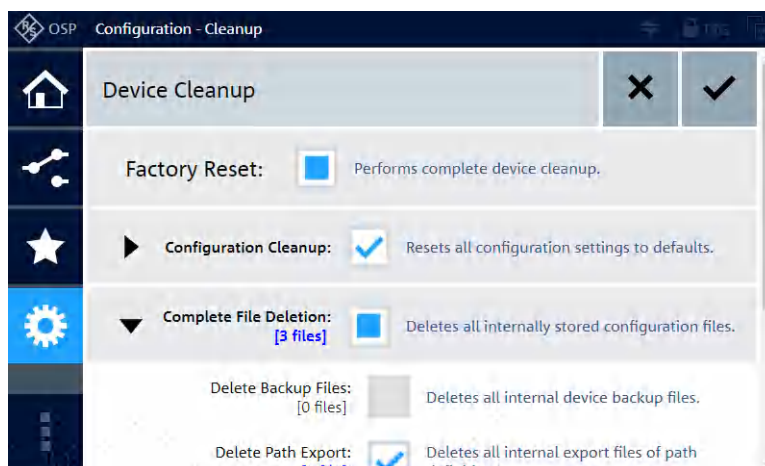

The "Device Cleanup" dialog offers the following functions (some of which require expanding the dialogs and scrolling down the screen):

- **"Factory Reset"**
Performs all operations described below.
- **"Configuration Cleanup"**
Performs all the following operations.
Alternatively, select these operations individually:
 - "Reset General Configuration"
Resets all settings in the [general configuration](#) to factory defaults.
 - "Reset Path Definitions"
Deletes all saved path definitions in the [path switching](#) menu.
 - "Reset Trigger Configuration"
Resets all settings in the [trigger configuration](#) to factory defaults.
 - "Reset Interconnection Setup"
Removes all physically configured secondary switch units as defined in the [Interconnection](#) dialog.
 - "Reset Virtual Configuration"
Deletes all [virtually](#) configured modules and secondary switch units.
- **"Complete File Deletion"**
Removes all internally stored configuration files from the switch unit's flash memory in the SD card slot.
Alternatively, delete these files in individual groups, where the dialog shows the number of existing files per group:
 - "Delete Backup Files"
Deletes all internal [device backup](#) files.
 - "Delete Path Export"
Deletes all internal export files of [path definitions](#).
 - "Delete Interconnection Export"
Deletes all internal export files of [interconnection](#) setups.
 - "Delete Trigger Export"
Deletes all internal export files of [Chapter 5.4.2, "Trigger"](#), on page 201 [trigger](#) configurations.
 - "Delete Virtual Export"
Deletes all internal export files of [virtual configurations](#).

5.2 Module Operation



The module operation dialog serves for **switching** and **selecting** relays and output channels in individual modules.

Note the difference between running the switch unit in physical mode or **virtual mode**:

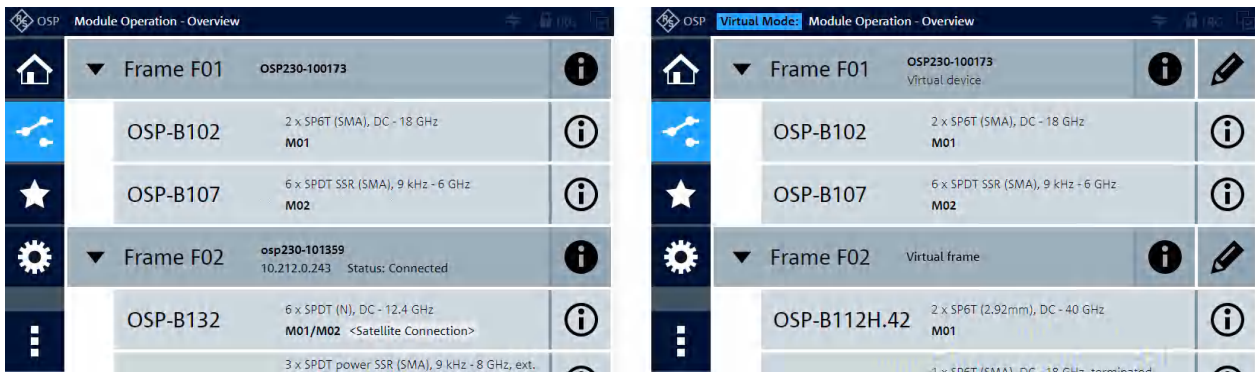

Figure 5-7: The module operation dialog (right: in Virtual Mode, which also allows editing)

In this dialog, you can hide or expand the modules of each frame by clicking the frame entry. The first frame ("F01") is the primary switch unit, all other frames are secondary switch units. In the user interface, the overview of the configured secondary switch units gives you the same information as the RC command `CONFigure:FRAMe:CATalog?`.

The overview also shows the configured modules in each frame, giving you the same information as the RC commands `ROUTE:MODule:CATalog?` and `DIAGnostic:SERvice:HWInfo?`. Among other information, it shows "<Satellite Connection>", if a module is located in a R&S OSP-B200S2 **satellite unit**, or "(Compatibility Mode: A1x)", if modules are operated in **Compatibility Mode** (see [Figure 5-42](#)).

In the "Module Operation" dialog, you can view the list of frames and modules, or you can view the individual dialog of one selected module. To toggle between these views, click as shown below:



Figure 5-8: List of frames and modules (left), individual module interaction dialog (right)



Module views are disabled, when the **Trigger** is activated.

- Individual module **operation** in the right-hand dialog in [Figure 5-8](#) is described in section "[Switching Relays and Channels](#)" on page 170.



- If you see the interaction dialog of one switch module (as on the right in [Figure 5-8](#)), click the "Module Operation" button  to see the list of installed modules (as on the left in [Figure 5-8](#)). In the icon of the "Module Operation" button, the "back" arrow (available with firmware versions from 1.40) indicates that it brings you back to the list. To see the interaction dialog of any module, click its name in the list.
- The list view of the "Module Operation" dialog ([Figure 5-7](#)) provides the following functions:



Frame & Module - Info & Edit

- The buttons with **info** icon open frame and module information dialogs.
- The buttons with **pencil** icon open editing dialogs. These buttons are only available, if the **Virtual Mode** is enabled at [Configuration > General](#).



The "**Frame Information**" button with dark info icon opens the following dialog:



Figure 5-9: Frame information dialog

"Configured Address" = Only available in secondary devices, hence, in switch units with frame numbers > F01, to inform you, under which address the secondary device is configured in the primary switch unit



The "**Get information for ...**" button with bright info icon opens the following **module** information dialog:

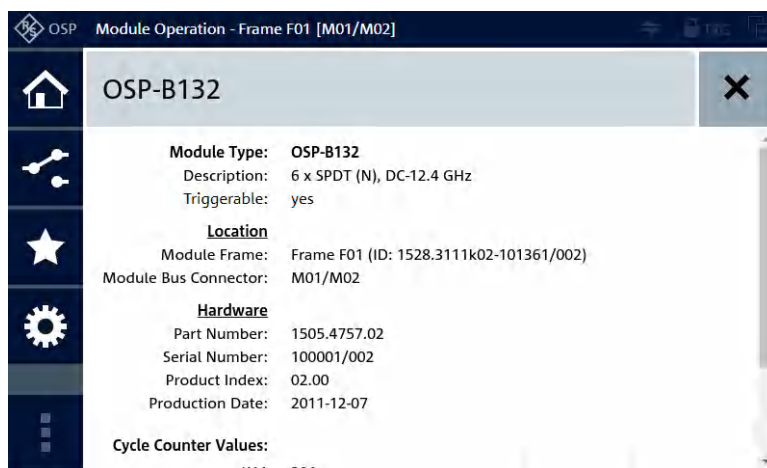

Figure 5-10: Module information dialog including cycle counter values (can be seen by scrolling down)



The "Edit Frames" button with the dark pencil icon is available only in [Virtual Mode](#). It opens the following frame editing dialog:

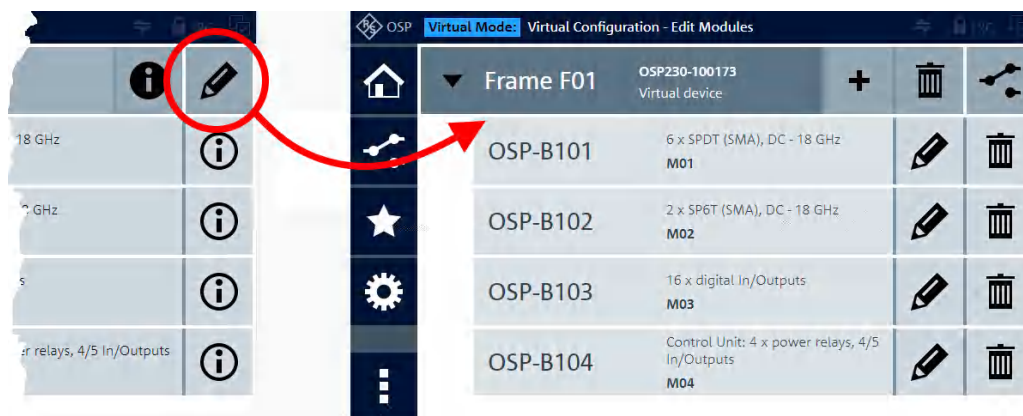

Figure 5-11: The Edit Frames button (dark pencil icon) gives access to editing all virtual modules

In this dialog, you can add modules **+** (see below), delete **🗑️** all or individual modules, or return **🏠** to the previous dialog ("Goto Module Operation").



Import / export virtual configuration

Only in this state, after clicking the dark pencil icon ("Edit Frames") in virtual mode, you can access the [context](#) dialog for [importing or exporting virtual configurations](#).



The "Edit Module" button with the bright pencil icon is available only in [Virtual Mode](#). It opens the following module editing dialog:

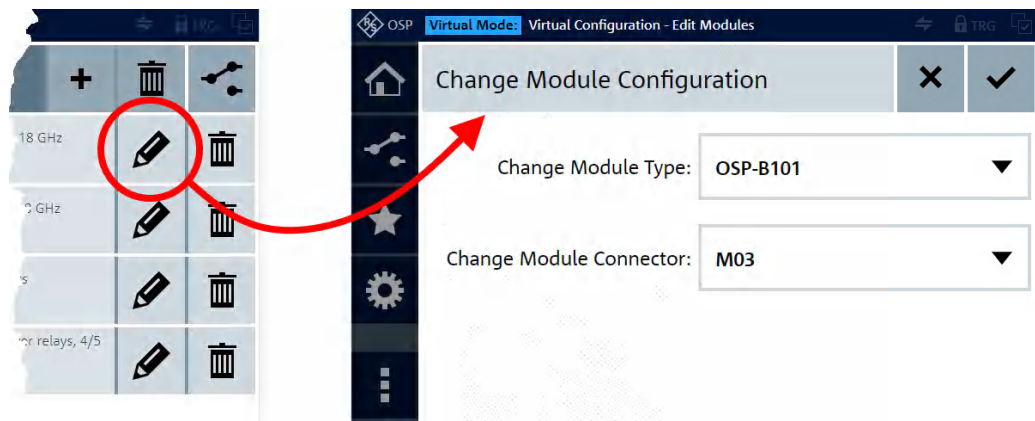

Figure 5-12: The Edit Module button (bright pencil icon) opens a virtual configuration dialog

In this dialog, you can edit the correlation, which module type is virtually assigned to which module connector.



The **"Add"** button with the plus icon opens the following dialog for **adding** a module in the virtual mode:

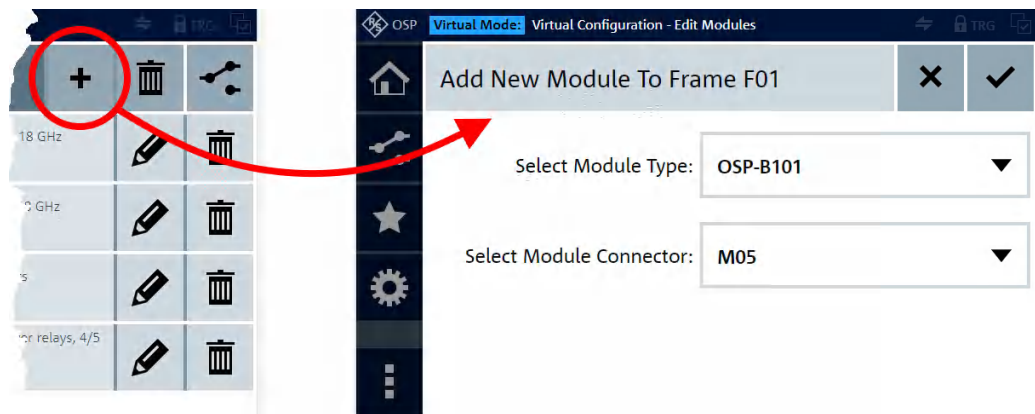

Figure 5-13: The Add button (plus icon) opens a similar virtual configuration dialog

In both the "Edit" and "Add" dialogs, you can select the module type and the module connector:

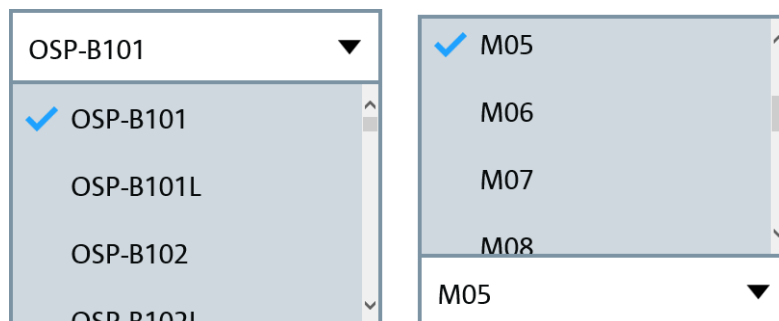

Figure 5-14: Select module type and connector

You can select the module type from the whole list of available [modules](#).

But you can select only a module connector that is not yet occupied by another module. If no more connectors are available in this frame, the selection dialog shows the following message:

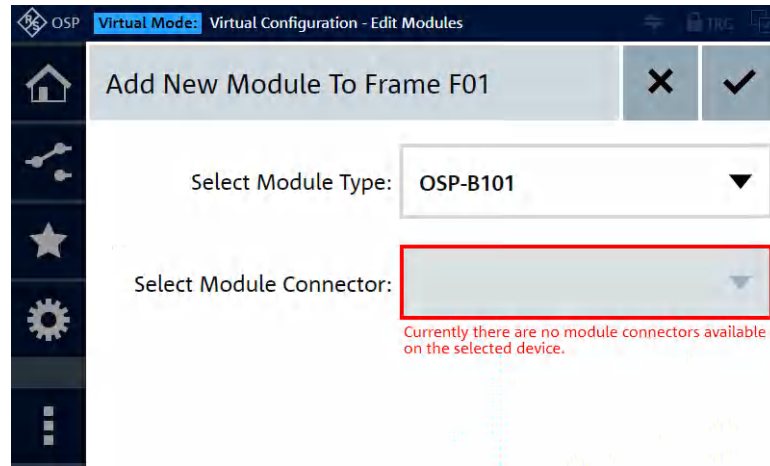

Figure 5-15: No more module connectors available (in virtual mode)



Editing in virtual mode, only

Editing as described above is only possible, if the **Virtual Mode** is enabled. When disabled, the firmware automatically reads from the available hardware, which module type is actually connected to which module connector. See also [Chapter 2.1.13, "Checking the Installed Modules"](#), on page 23.

Also note that there are no [RC \(SCPI\) commands](#) for adding, rearranging and deleting virtual modules.



Switching Relays and Channels

Starting from the "Module Operation" dialog in **list view** as in [Figure 5-7](#), click a module's entry to operate this module in its individual **interaction dialog** (detail view).

To change the state of a relay or channel, tap or click its icon:

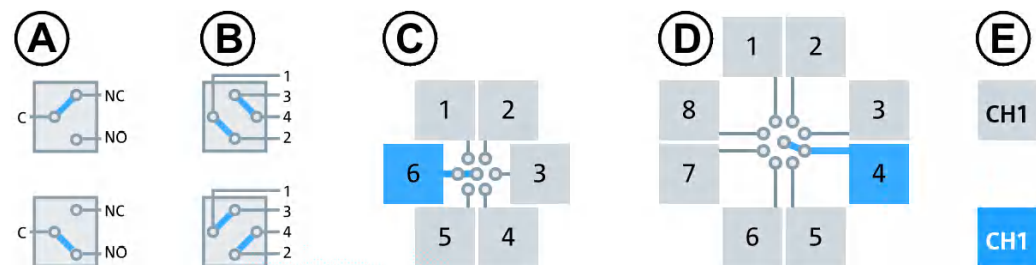

Figure 5-16: Different relays and channels in various switching states

- A = SPDT relay, top icon in deactivated state, lower icon activated
- B = DPDT relay, top icon in deactivated state, lower icon activated
- C = SP6T relay, terminal position 6 is activated
- D = SP8T relay, terminal position 4 is activated
- E = Output channel, top icon in deactivated state, lower icon activated

Generally, items marked in blue color in the user interface are active.

To deactivate an active item, tap or click it again.

If there are multi-pole relays, you can click or tap the "open switch" button to open any previously closed connection:

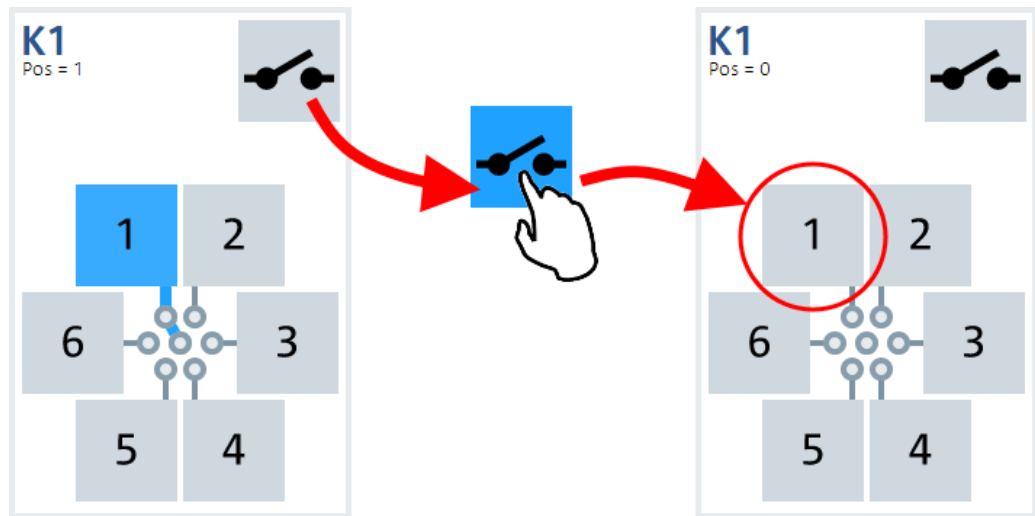

Figure 5-17: The "open switch" button resets a multi-pole relay to its default open state

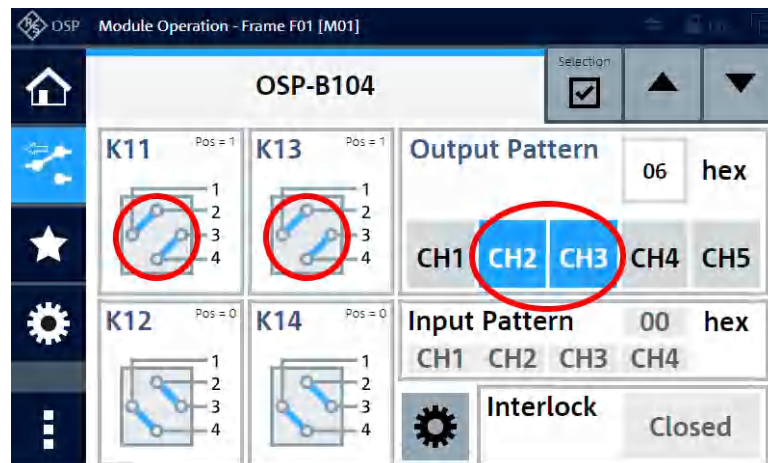

Figure 5-18: Dialog for switching relays and output channels

Red circles = Switched relays (K11, K12) and switched channels (CH2, CH3)

The switched relays and channels in Figure 5-18 are in a state that is different from their deactivated state. In contrast with these bistable components, there are multista-

ble components such as SP6T or SP8T relays. Switching such relays always involves selecting one terminal port to be connected to the common port.



For switching relays and output channels, the "Selection" button (orange, described below) must **not** be active.

Selection Mode



The "**Selection**" button switches the "Selection Mode" on or off. This button (marked by the red circle in [Figure 5-19](#)) is available only in a view that shows at least one module and its details.

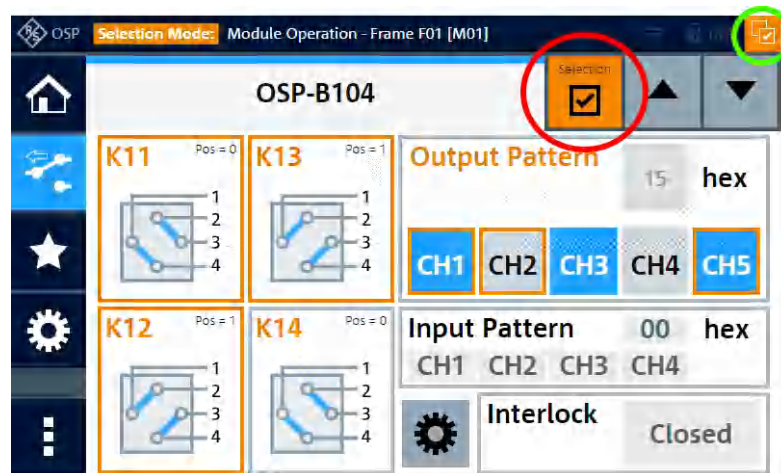

Figure 5-19: Relay and channel selection dialog

Green circle = "Items selected" indicator

Red circle = "Selection" button (mouse-over: "Toggle select mode")

Orange frames = Selected relays and channels are highlighted in the module's interaction dialog



Selection shortcut

If you use the "WebGUI", or if a keyboard is connected to your R&S OSP, press and hold the **key "S"** to activate the selection mode. Releasing the key "S" deactivates the selection mode. This shortcut feature facilitates selecting relays and channels for your path definition.

While the "Selection Mode" is active, tapping or clicking a relay icon or channel icon **does not change** the relay or channel state, but only **selects** the relay or channel. This selection is indicated by the color of the icon's frame changing from gray to orange.

To **define a path**, combine the following two activities *for all modules* that you want to control by a path definition:

- With "Selection Mode" **on**, select the relays and channels that you want to include in a path
- With "Selection Mode" **off**, switch the relays and channels to the state required for this path

If at least one relay or channel is selected, even if it is not part of the currently visible module dialog, the "Items Selected" indicator icon is highlighted in orange. This icon is marked by a green circle in the far right top corner of [Figure 5-19](#). The state of the indicator icon (highlighted or not) is independent of the "Selection" button being active or deactivated.



With "Selection Mode" **on**, you can **switch paths** also in the user interface (touch-screen or "WebGUI") or by remote control commands.

However, we recommend **deactivating** the "Selection Mode" ("Selection" button) before you **switch paths**, to prevent unintentional modification of selected relays and channels during path definition. This precaution is especially relevant for relays that are not currently displayed in the user interface.

When you are done with a path definition and you do not need your current path selection any longer, we recommend using the function [Deselect All](#), immediately.



The buttons "Previous module of frame" and "Next module of frame" (up and down arrows) facilitate navigating to the dialogs of other modules in the same switch unit. If you use a full-screen display as in [Figure 2-21](#), the buttons are labeled "Previous OSP device" and "Next OSP device" and facilitate navigating to the module dialogs of other switch units.

5.2.1 Module Operation Context Functions



Selecting "Module Operation" + "Context Menu" brings up the following dialog:

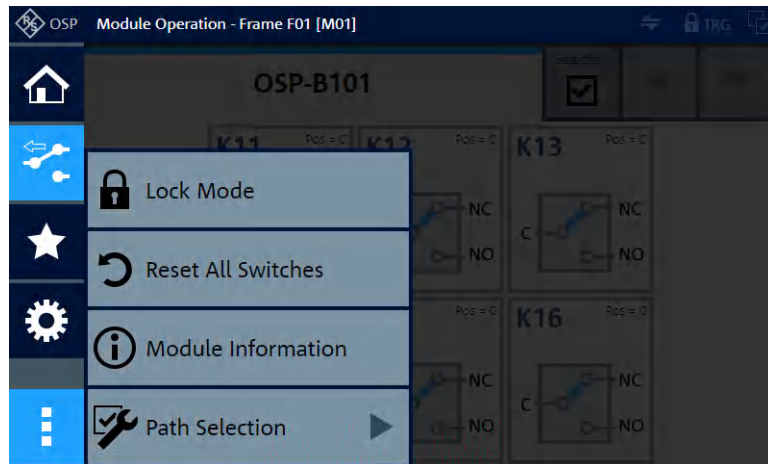

Figure 5-20: Context functions of the module operation dialog

The following "Module Operation" context functions are available:

Lock Mode	174
Reset All Switches	175
Module Information	175

Path Selection.....	175
L Show As List.....	176
L Load From Existing Path.....	176
L Select All.....	176
L Deselect All.....	177
Virtual Configuration.....	178
L Export Virtual Configuration.....	179
L Import Virtual Configuration.....	180
L Delete Virtual Configuration File.....	181

Lock Mode

Lock Mode

Access: "Module Operation" > "Context Menu" > "Lock Mode"

Freezes the state of your setup by locking the switching of relays and output channels and limiting the available settings.

To enable the lock mode, click the "Lock Mode" button in the user interface (touch-screen or [WebGUI](#)) or use the RC command `CONFigure:LOCK:MODE`.

An enabled lock mode has the following effects:

- The lock mode indicator icon is highlighted (see red circles in [Figure 5-21](#))
- You cannot change the state of relays and output channels. If you try to switch one of them, a red rectangle (as in [Figure 5-21](#)) reminds you of the locked state.
- You cannot switch paths. If you try to switch one of them, the [Switch Path](#) button ► is highlighted in red.
- For primary and secondary switch units, the locking applies as follows:
 - In the primary switch unit, the lock mode prevents switching via the user interface and via [remote operation](#)
 - In secondary switch units, where switching via the user interface is locked anyway due to the interconnection mode, the lock mode also prevents switching via remote operation
- The [Reset All Switches](#) function is disabled
- The [Selection Mode](#) is disabled (see [Figure 5-19](#))
- You cannot change the [Virtual Mode](#)
- However, you can change the [Interconnection](#) configuration, and the lock mode does not prevent other commands (see also [Remote Operation](#)).

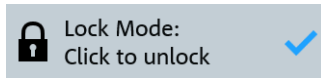

Figure 5-21: Module Operation dialog of a switch unit and of one module in lock mode

Red circles = This icon is the lock mode indicator

Red rectangle = Reminds you of the locked state, when you click a switch

To disable the lock mode, click the "Lock Mode" button again:



Remote command:

[CONFigure:LOCK:MODE](#)

Reset All Switches

Reset All Switches

Access: "Module Operation" > "Context Menu" > "Reset All Switches"

Same function as in the [Main > Context](#) menu and in the [Path Switching > Context](#).

Module Information

Module Information

Access: "Module Operation" > "Context Menu" > "Module Information"

Only available in the context menu, if the [Module Operation](#) dialog shows one individual module (and not a list of modules). Hence, with a dialog as in [Figure 5-7](#), you cannot open the individual module information via the context menu. Instead, select the info icon at the far right end of each module's line.

Otherwise, with a dialog as in [Figure 5-19](#), for example, the context menu offers the "Module Information" button for detailed information for this individual module:

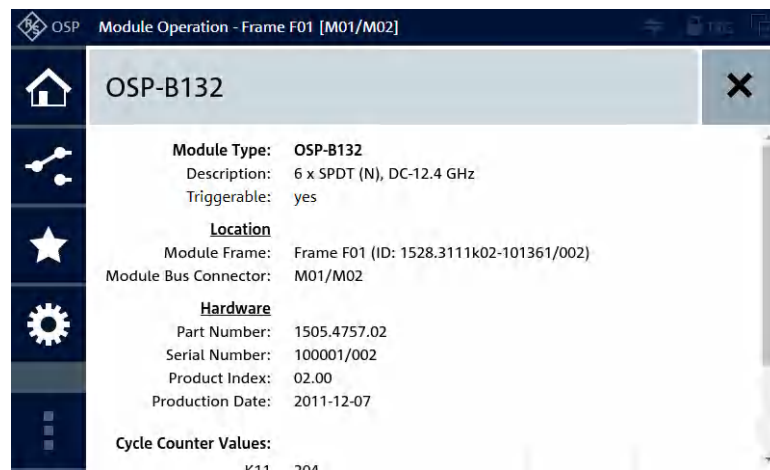

Figure 5-22: Module information dialog (scroll down for cycle counter values that show the number of relay lifetime operations)

If the module is mounted in an R&S OSP-B200S2 satellite unit, this dialog also shows information on the satellite and its R&S OSP-B200R control module, for example:

Satellite Connection: Remote and Satellite Module Info:

- OSP-B200R. 1528.3140.xx,000000/000,00.00,0000-00-00
- OSP-B299S2,1528.3134.02,101417/002,07.00,2017-11-29

Remote command:

[READ:RELAy:OPERations?](#)

Path Selection

Path Selection

Access: "Module Operation" > "Context Menu" > "Path Selection" > ...

Use the following group of functions to manage your selection of relays and I/O channels for defining paths.

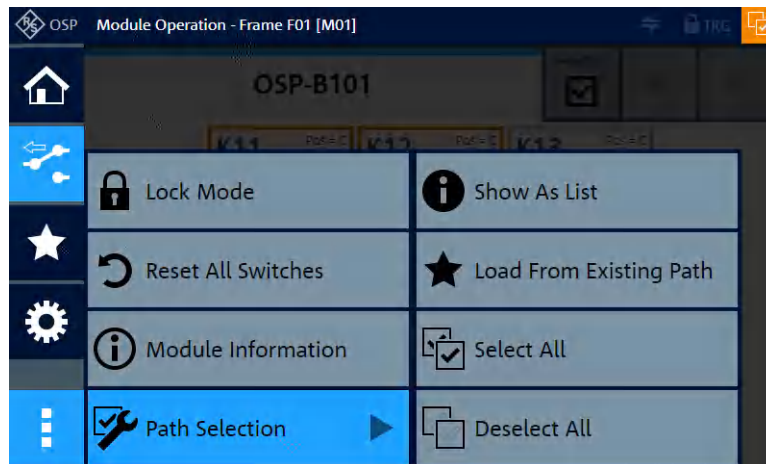



Figure 5-23: Path selection functions in the module operation context menu

Note that the functions available in this context menu depend on your selections in the "Module Operation" menu: "Show As List" and "Deselect All" are available only, if you have selected at least one relay or channel. Therefore, in Figure 5-23, the "Items Selected" indicator is active (highlighted in orange).

 Show As List

Show As List ← Path Selection

Access: "Module Operation" > "Context Menu" > "Path Selection" > "Show As List"

Only available, if at least one relay or channel is selected, as in Figure 5-19, for example.

This function jumps to [Path Switching](#) > [Context Menu](#) > [Path Selection](#) > [Show As List](#).

 Load From Existing Path

Load From Existing Path ← Path Selection

Access: "Module Operation" > "Context Menu" > "Path Selection" > "Load From Existing Path"

Only available, if at least one path is saved in the device.

This function jumps to [Path Switching](#) > [Context Menu](#) > [Path Selection](#) > [Load from Existing Path](#).

 Select All

Select All ← Path Selection

Access: "Module Operation" > "Context Menu" > "Path Selection" > "Select All"

Selects all relays and channels in **all** modules of **all** frames, but does not change any switching states.

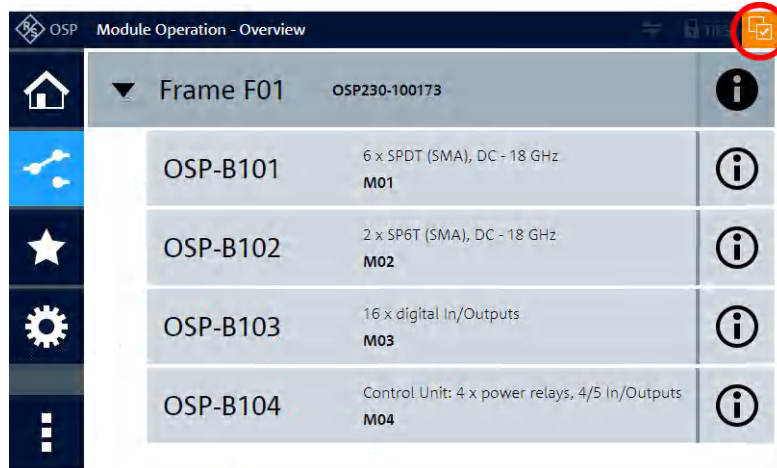

Figure 5-24: When you Select All, the Items Selected indicator is highlighted

In the "Module Operation" dialog of each individual module, all relays and output channels are selected and the "Items Selected" indicator is highlighted:

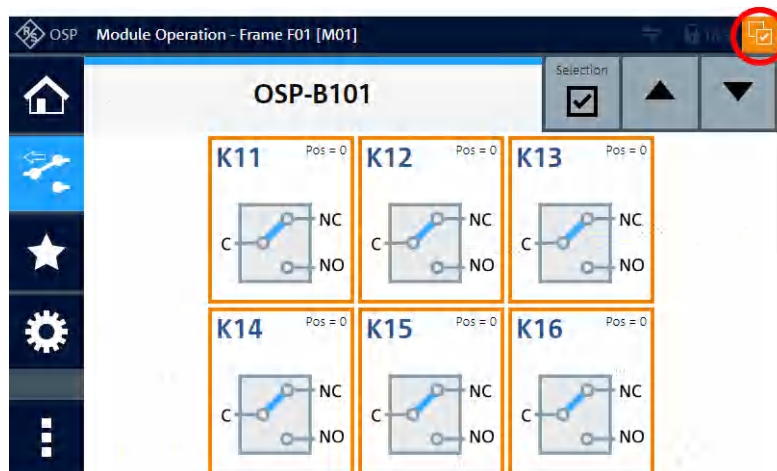

Figure 5-25: All items (here: relays) selected in a module's operation dialog

Note that the state of the "Selection" button is unchanged:

- If this button was disabled when you clicked "Select All", it remains disabled, as in [Figure 5-25](#)
- If this button was enabled when you clicked "Select All", it remains enabled, as in [Figure 5-19](#)

To deselect individual relays or output channels when all items are selected, make sure that the "Selection" button is enabled. Then click the items you want to deselect.

Deselect All ← Path Selection

Access: "Module Operation" > "Context Menu" > "Path Selection" > "Deselect All"

Only available, if at least one relay or channel is selected, as in [Figure 5-19](#), for example.

 Deselect All

Deselects all relays and channels in **all** modules of **all** frames, but does not change any switching states.

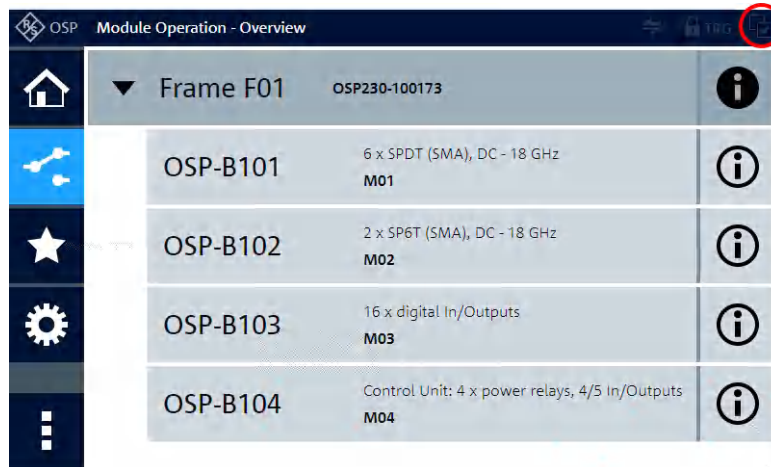

Figure 5-26: When you Deselect All, the Items Selected indicator is not highlighted

As in [Select All](#), clicking "Deselect All" does not change the state of the "Selection" button.

Virtual Configuration

Access: "Module Operation" > List view > **"Edit Frames"** > "Context Menu" > ...

Hence, in [Virtual Mode](#), make sure to display the "List" view of the "Module Operation" dialog and enter the "Edit Frames" mode, before you select the "Context Menu". For details on how to access the dialog in [Figure 5-27](#), see also [Figure 5-11](#) and ["Import / export virtual configuration"](#) on page 168.

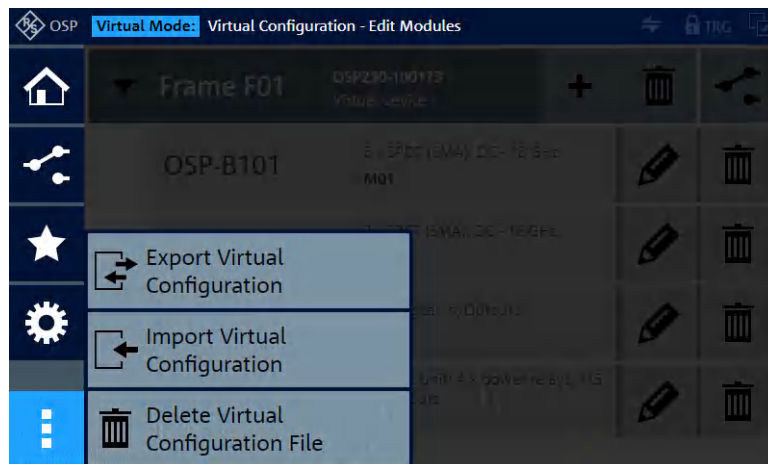

Figure 5-27: Virtual configuration functions in the module operation context menu

Note: [RC \(SCPI\) commands](#) cannot control (import/export) the virtual configuration of *modules*, but only the virtual configuration of *frames* (see [Chapter 5.4.4, "Interconnection"](#), on page 212). However, a full [backup](#), which is controlled remotely by `CONF:ALL:BACK`, also saves the virtual configuration of modules.

 Export Virtual Configuration
Export Virtual Configuration ← **Virtual Configuration**

Access: "Module Operation" > List view > **"Edit Frames"** > "Context Menu" > "Export Virtual Configuration"

Saves the current configuration of virtual frames (primary and secondary switch units) and modules to a non-volatile file on the primary switch unit. This feature helps to avoid losing configuration information.

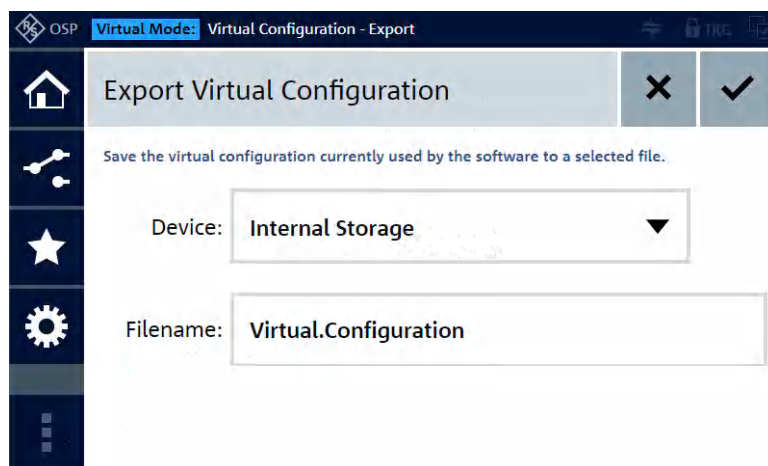

To save the file, click the "OK" button in the top right corner of the dialog.

"Device"

Selects the storage device. Per default, if no external USB storage device is connected, the storage device is the "Internal Storage", which is the primary switch unit's flash memory in the SD card slot. If there is an external USB storage device, it becomes the default storage device.

To save the file on an external USB storage device, connect it to any of the switch unit's USB ports (front or rear), and select it by its <devicename>, for example "MY-USBSTICK".

After saving, before you remove this USB storage device, return to the same "Export Virtual Configuration" dialog. Then once more select the external USB storage device in the "Device" selection field and click the eject button on the right-hand side of it:



The firmware brings up a message to notify you that "The device '<devicename>' can now be safely removed."

Click "Close" to confirm this message, then remove the USB storage device.

On your USB storage device, the folder and filename (with extension .virtual) of this file is

"<Drive>:\ospdata\VirtualConfiguration.virtual".

Here, <Drive> is the drive letter of the removable medium.

"Filename"

Specifies the filename of your virtual configuration file. In the example above, the filename is VirtualConfiguration.

 Import Virtual Configuration
Import Virtual Configuration ← **Virtual Configuration**

Access: "Module Operation" > List view > "**Edit Frames**" > "Context Menu" > "Import Virtual Configuration"

Prerequisite: the data of a previously saved [export](#) must be available.

Loads a configuration of virtual frames (primary and secondary switch units) and modules from a selected file into the switch unit's internal volatile memory. This feature facilitates transferring configurations from one setup to another.

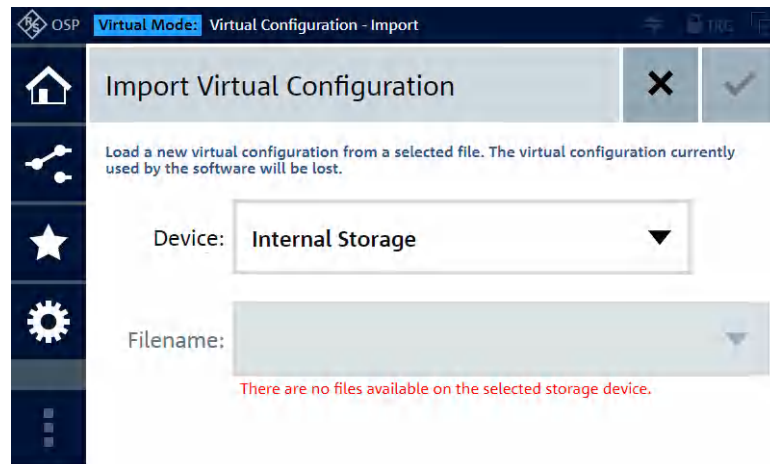

To load the selected file, click the "OK" button in the top right corner of the dialog.

The following message comes up: "You have selected a virtual configuration file to import. The current virtual configuration will be lost! Do you really want to proceed?"

This message warns you of the following loss:

Note: Risk of losing settings. Your import overwrites the current virtual configuration in the switch unit's internal volatile memory with the configuration from the imported file. To avoid losing the current virtual configuration, consider saving it for later reference by [Export Virtual Configuration](#), before you import a different virtual configuration.

If you are sure that you want to proceed, confirm with "OK", otherwise "Cancel" the import.

"Device" Selects the switch unit's "Internal Storage" (= default) or an external USB storage device. An external USB storage device is only available, if it is connected to one of the USB ports on the front or rear panel of the R&S OSP.

To remove an external USB storage device, use the eject button and proceed as described in the section ["Export Virtual Configuration"](#) on page 179.

"Filename" Selects the file you want to import. The firmware offers only suitable configuration files with the extension ".virtual", although this extension is not displayed.

If there is no ".virtual" file in the selected storage device, you cannot select a filename. Instead, the following message is shown as in the screenshot above: "There are no import files available on the selected storage device."

 Delete Virtual Configuration File

Delete Virtual Configuration File ← Virtual Configuration

Access: "Module Operation" > List view > "Edit Frames" > "Context Menu" > "Delete Virtual Configuration File"

Deletes a selected virtual configuration file. Proceed as described in the section "Export Virtual Configuration" on page 179.

5.3 Path Switching



- For information on the concept of paths, see [Chapter 4.1, "How to Work with a Switch Unit"](#), on page 147.
- For information on how to define a path, see "Selection Mode" on page 172, and [Figure 5-39](#).
- You can also [Import Paths](#) or let the firmware help you modifying an existing path by [loading it](#).



The dialog in the "Path Switching" menu shows a list of all available switching paths:



Figure 5-28: Path Switching menu with list of paths



Path switching is disabled, when the [Trigger](#) is activated.

"PathA" in [Figure 5-28](#) is labeled as "Switch-On Path". Hence, when you [switch on](#) the R&S OSP, it tries to set all relays and output channels as specified in this path definition. To specify that a path is switched at startup, go to [Configuration](#) > [General](#) > [Switch-On Action](#).

"PathB" in [Figure 5-28](#) is labeled as "Currently Switched". The switched path is also highlighted in blue.

"Path C" in [Figure 5-28](#) is labeled as **"Not Switchable!"**, which indicates a difference between the target states specified in a path definition and the available hardware for realizing these states. This difference can have the following typical causes:

- If your module configuration has changed between defining a path and viewing the list of paths, the discrepancy can be in the **hardware setup** itself. For example, consider that you have replaced the module R&S OSP-B101 (six SPDT relays) by the module [R&S OSP-B102](#) (two SP6T relays, "K1" and "K2"). If your path definition addresses a third relay "K3", this relay is not available and cannot be switched. However, note that even if there are exchanged modules, a path definition that was not intended for the new module still **can be switchable**. If the path definition specifies, for example, setting the first relay to state "01" and the second relay to state "00", this definition fits for six SPDT relays (R&S OSP-B101) the same as for two SP6T relays (R&S OSP-B102). Hence, if you have replaced module R&S OSP-B101 by R&S OSP-B102 at the same module bus connector of a switch unit, the path intended for two SPDT relays can now switch two SP6T relays. This mistake can go **unnoticed**, if you fail to coordinate your path definitions with your hardware configuration carefully.
- **Path definitions** can easily include a frame, module, relay, channel or state that **does not exist** in your physical setup, if any of the following applies to your path definition:
 - You have [imported paths](#)
 - You have enabled the [Virtual Mode](#)
 - You have used the RC command `ROUte:PATH[:DEFine]`

For example, if the parameters of your RC command specify switching a relay to the state "02", where only states "00" and "01" are available in SPDT relays, this switching action is not possible.

Note that **discrepancies** can occur, if you allow any of the following "risks":

- Importing paths with a configuration that you do not know
- Defining your paths with the virtual mode enabled
- Defining your paths outside of the graphical user interface (GUI), for example on paper, because additional typos can occur
- Modifying your hardware configuration after defining paths

Note also that the order of activation of different paths, which use the same relays, can influence the subsequent switching states. For example, consider a "PathA" that activates relay 1 and 2, "PathB" deactivates relay 2 and 3 and "PathC" activates relay 3. If you switch these paths in the order A-B-C, the result is activated relays 1 and 3. However, if you switch these paths in the order A-C-B, the result is an activated relay 1, only.

For efficient path definition processes, it can be reasonable to accept specific "risks". But consider that without these risks, the GUI supports you by only allowing path definitions that are switchable in a way you can verify easily. Since the GUI cannot prevent path definitions that do not match your application tasks, reasonable path definitions remain in your responsibility.



Switch Path

To switch a path, click the **"Switch Path"** button . The firmware sets all relays and output channels, which are selected in this path's definition, to their defined states.

- If a path is labeled as "Not Switchable!", you cannot switch it. For an explanation, see below [Figure 5-28](#).
- If a path is labeled as "Currently Switched", it is already switched and you cannot switch it again.
- If a path is labeled as "Switch-On Path", this property has no influence on being able to switch this path at any time, too.

The equivalent remote control command is `ROUTE:CLOSE`.



More

To get more options for handling path entries, click the **"More"** button (dots icon) . When you click this button in the line of one path, the following option icons are shown for this path:

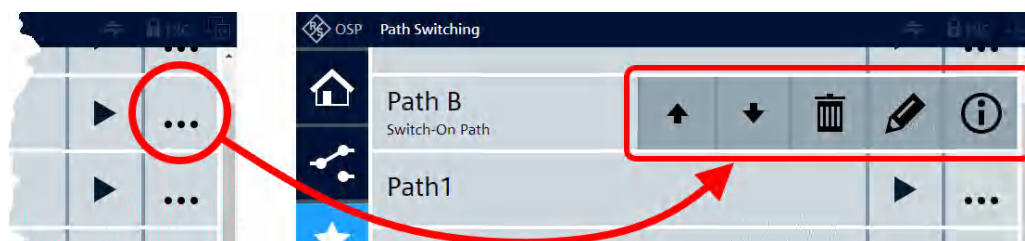

Figure 5-29: The More button (dots icon) gives access to the option buttons of a path



If you see the following option buttons instead of the ones in [Figure 5-29](#), refer to the description in the section ["Manage path selection:"](#) on page 185.



The **"Up"** and **"Down"** buttons move the entry of this path one position up or down. After moving an entry, the option buttons are still available, to facilitate repeated moving actions. To hide the option buttons without further action, click the path entry at its left-hand side, outside of the option buttons.

If an entry is in the top line, you cannot move it further up, and the "Up" button is not available. If an entry is in the lowest line, you cannot move it further down, and the "Down" button is not available.



The **"Delete"** button deletes this path from the switch unit's internal volatile memory.

When you click the button, the firmware brings up the message "Do you really want to delete the path definition '<pathname>'?"

If the path is selected to be switched after startup (see [Switch-On Action](#)), the firmware brings up the message "The path definition '<pathname>' is used as switch-on path. Do you still want to delete the path definition anyway?"

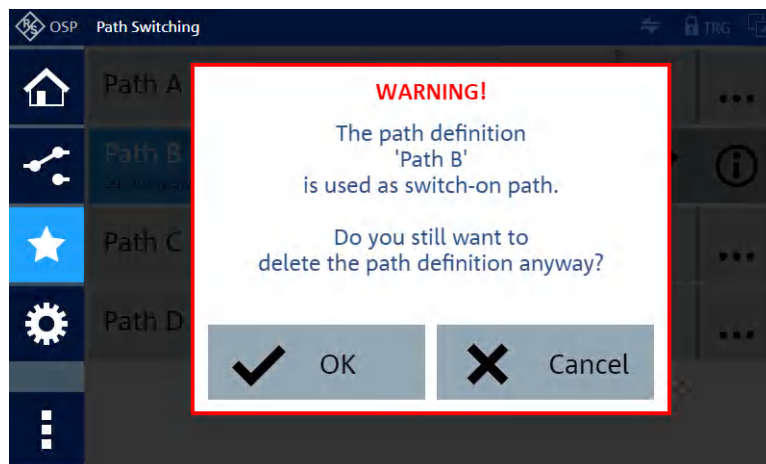

Confirm with "OK" or "Cancel" the deletion.



The **"Rename"** button opens a dialog for editing the name of this path. For editing, you can use the on-screen keyboard, an external keyboard connected to the switch unit, or a keyboard connected to your computer, when you use the R&S OSP in a LAN. The name editor accepts the keyboard shortcuts [Ctrl]+[x] for "cut", [Ctrl]+[c] for "copy" and [Ctrl]+[v] for "paste".

You can quit editing with the cancel button  or confirm the edited name with the OK button .



The **"Info"** button opens a dialog that shows the following information:

- Is the selected path [switchable](#)?
- Is it used as [Switch-On Action](#)?
- Is it [Triggerable](#) and "Used in Trigger Configuration"?
- The "Maximum Trigger Frequency" and the "Minimum Trigger Interval", see [Trigger Activation](#)
- The "Path Definition"
The path-definition syntax in the "channel list string" is described for the RC command [ROUTE:CLOSE](#) on page 253. You can copy this string from the [WebGUI](#) and use it for your remote control commands.
- If you have enabled the [Compatibility Mode](#), the dialog shows also the equivalent remote response for a query of the path definition in legacy switch units, as in [Figure 5-43](#).

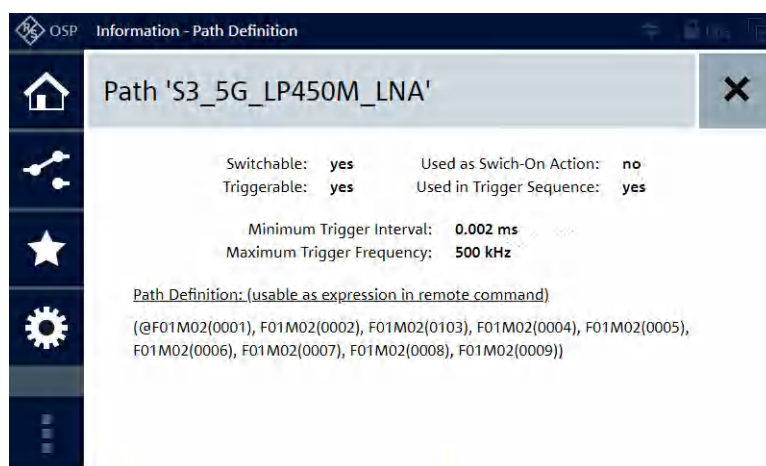

Figure 5-30: Path definition information dialog

To close this dialog, click the "Back" button



Manage path selection:

Only available, if you have selected at least one relay or output channel, as in [Figure 5-19](#), for example.

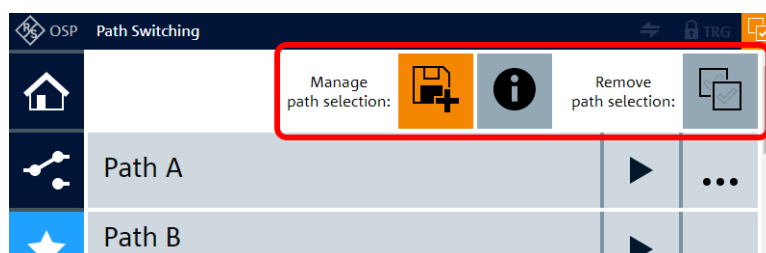

Figure 5-31: Path Switching dialog with existing paths and option for saving a new path



With selected items, the selection indicator is active, see [Selection Mode](#).

Now the list of paths offers a function bar, labeled **"Manage path selection:"**, that provides the following functions:



The button **"Save As New Path"** defines a new path based on the current selection of relays and output channels. The firmware saves the switching state of each selected relay and output channel into a list that represents this new path.





For an example of how to define and save a path, see ["Creating a path configuration"](#) on page 229.

Note that the relays and output channels can be selected in different modules of one switch unit (frame) and in different frames of an [interconnection](#) setup.

For example, if you have selected only relay "K2" in module "M01" in frame "F01", and the state of relay "K2" is "activated" ("01"), the path definition is "(@F01M01(0102))". The syntax in this definition is used as a SCPI parameter for the remote control com-

mand `ROUTE:PATH[:DEFine]`, which is equivalent to the button "Save As New Path".

When you click this button, a dialog opens to let you enter a name for this path. For the path name, only the characters available in the virtual keyboard are permitted. You can quit entering the name with the cancel button  or confirm the entered name with the OK button . When you click OK, the new path entry is added with its name at the top of the list of paths.



To move the entry to a different position in the list, use the "Up" and "Down" buttons shown in [Figure 5-29](#). These buttons are only available, if no relays and channels are selected.

Hence, first complete creating your path definitions. Once you do not need the selection of relays and channels any more, use the button "Remove path selection" (described below, equivalent with "Deselect All").



Then click the [More](#) button to rearrange your new paths in the list of paths.



The button "**Show as List**" displays a path definition in the syntax shown above (see "Save As New Path"). If you have defined a path that consists of one relay, only, the string that represents this path can be as short as "`(@F01M01(0102))`", for example. For each additional relay or output channel used in the definition, a similar string is added, separated by a comma.

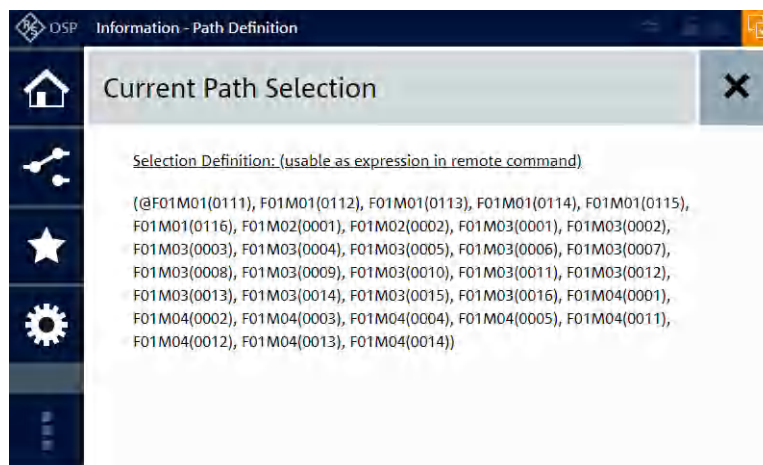

See also "[Show As List](#)" on page 193.

When you close  this dialog, your selection is still available for defining a new path.



The button "**Deselect All**" (also labeled "Remove path selection") disables all selections of relays and output channels. When you click this button, all selected relays and output channels are immediately deselected, but their states remain unchanged. Also, the selection indicator in the top right corner of the dialog is deactivated, and the function bar "Manage path selection:" disappears.

This button is a shortcut for [Path Switching](#) > "Context Menu" > [Path Selection](#) > [Deselect All](#).



The buttons **"Replace This Path"** and **"Add New Path Below"** appear in the line of an individual path, if you click the [More](#) button of this path while a selection is available:

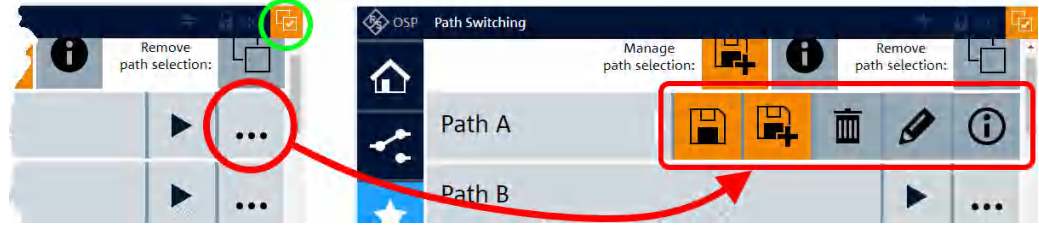

Figure 5-32: When items are selected, the More button gives access to special option buttons

Green circle = "Items selected" indicator

Red circle = "More" button

Red box = Special option buttons appear in the list of paths



The button "Replace This Path" works like the button "Save As New Path", but it overwrites the selected entry with the new path definition.



The button "Add New Path Below" works like the button "Save As New Path", but it inserts the new path definition below the selected entry, and not at the top of the list.



Empty path switching dialog

If no path is defined, the "Path Switching" dialog looks "empty" like in one of the following screenshots:



Figure 5-33: Not path definitions available ...

Left = ... and no relays or output channels selected

Right = ... and at least one relay or output channel selected

- You see the left-hand dialog in [Figure 5-33](#), when you go to the empty "Path Switching" dialog without having selected anything that allows defining a path. However, you can [import](#) path definitions.
- You see the right-hand dialog in [Figure 5-33](#), when you have selected one or more relays or output channels in the "Module Operation" dialog. Optionally, you can also switch some of the selected items. If you now go to the empty "Path Switching" dialog, it allows you saving your selection as a new path definition by using the "Save As New Path" button, as described in ["Manage path selection:"](#) on page 185.

If at least one path is defined in the "Path Switching" dialog, it looks like in [Figure 5-28](#) or [Figure 5-31](#).

5.3.1 Path Switching Context Functions



Selecting "Path Switching" + "Context Menu" brings up the following dialog:

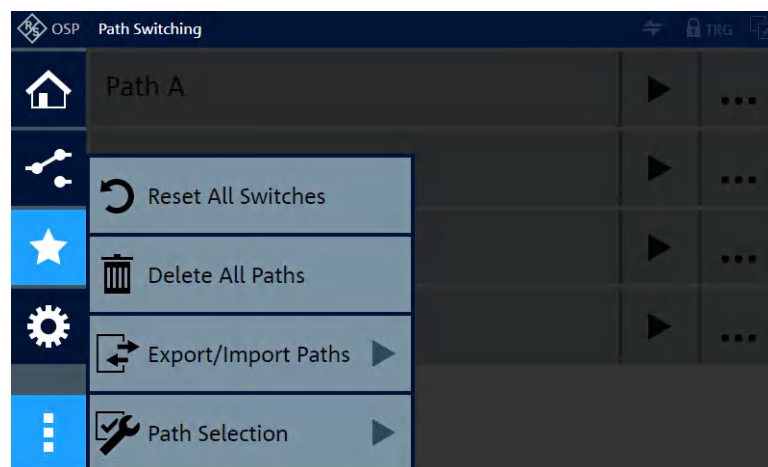



Figure 5-34: Context functions of the path switching menu

The following "Path Switching" context functions are available:

Reset All Switches.....	189
Delete All Paths.....	189
Export/Import Paths.....	189
L Export Paths.....	190
L Import Paths.....	191
L Delete Path Export File.....	192
Path Selection.....	192
L Show As List.....	193
L Load from Existing Path.....	193
L Select All.....	195
L Deselect All.....	195

 Reset All Switches

Reset All Switches

Access: "Path Switching" > "Context Menu" > "Reset All Switches"

Same function as in the [Main > Context](#) menu and in the [Module Operation > Context](#) menu.

 Delete All Paths

Delete All Paths

Access: "Path Switching" > "Context Menu" > "Delete All Paths"

Deletes all previously defined paths from the switch unit's internal volatile memory.

Before you do so, we recommend checking the list of paths ([Figure 5-28](#)) to verify that you want to delete all paths.

When you click the button, the firmware brings up the message "Do you really want to delete all path definitions?"

If one of the paths is selected to be switched after startup (see [Switch-On Action](#)), the firmware brings up the message "The path definition '<pathname>' is used as switch-on path. Do you still want to delete all path definitions anyway?"

Confirm with "OK" or "Cancel" the deletion.

Alternatively, instead of deleting all paths, consider deleting individual paths (see ["More"](#) on page 183).

Remote command:

`ROUTE:PATH:DELeTe:ALL`

 Export/Import Paths

Export/Import Paths

Access: "Path Switching" > "Context Menu" > "Export/Import Paths" > ...

Provides functions for exporting and importing path definitions.

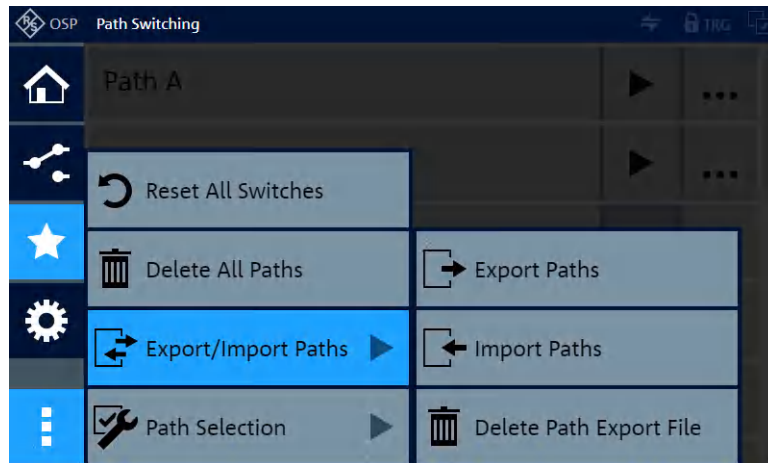

Figure 5-35: Path export / import functions in the path switching context menu

Export Paths

Export Paths ← Export/Import Paths

Access: "Path Switching" > "Context Menu" > "Export/Import Paths" > "Export Paths"

Saves all currently configured path definitions to a file on the primary switch unit's compact flash memory in the SD card slot.

All path definitions are stored in the instrument's internal volatile memory, and all **new** path definitions are stored only there. To avoid losing path definitions, you can export them or shut down the R&S OSP by the front [Pwr] button. Shutting down the switch unit by the rear main power button does not save the path definitions to the flash memory.

Path files are stored with the extension ".path". Do not enter the extension when specifying a filename.

To save the file, click the "OK" button in the top right corner of the dialog.

"Device" Selects the storage device. Per default, if no external USB storage device is connected, the storage device is the "Internal Storage", which is the primary switch unit's flash memory in the SD card slot. If there is an external USB storage device, it becomes the default storage device.

To save the file on an external USB storage device, connect it to any of the switch unit's USB ports (front or rear), and select it by its <devicename>, for example "MY-USBSTICK".

After saving, before you remove this USB storage device, return to the same "Export Paths" dialog. Then once more select the external USB storage device in the "Device" selection field and click the eject button on the right-hand side of it:



The firmware brings up a message to notify you that "The device '<devicename>' can now be safely removed."

Click "Close" to confirm this message, then remove the USB storage device.

On your USB storage device, the folder and filename (with extension .path) of this file is

"<Drive>:\ospdata\MyPathConfigs.path".

Here, <Drive> is the drive letter of the removable medium.

"Filename" Specifies the filename of your path definitions file. In the example above, the filename is MyPathConfigs.

Remote command:

ROUTE:PATH:EXPort

MMEM:STORe:STATe

Import Paths ← Export/Import Paths

Access: "Path Switching" > "Context Menu" > "Export/Import Paths" > "Import Paths"

Prerequisite: the data of a previously saved [export](#) must be available.

Loads a set of path definitions from a selected file into the switch unit's internal volatile memory.

To load the selected file, click the "OK" button in the top right corner of the dialog.

Note: Risk of losing settings. You can lose existing path definitions, if you overwrite these paths in the switch unit's internal volatile memory by importing different path definitions.

To avoid losing current path definitions, consider the following options before you import a different set of paths:

- Use [Export Paths](#) to save the existing path definitions for later reference
- Use the option "Keep existing" (see below)

- "Device" Selects the switch unit's "Internal Storage" (= default) or an external USB storage device. An external USB storage device is only available, if it is connected to one of the USB ports on the front or rear panel of the R&S OSP.
To remove an external USB storage device, use the eject button and proceed as described in the section "Export Paths" on page 190.
- "Filename" Selects the file you want to import. The firmware offers only suitable path definition files with the extension ".path", although this extension is not displayed.
If there is no ".path" file in the selected storage device, you cannot select a filename. Instead, the following message is shown: "There are no files available on the selected storage device."
- "Keep existing" Specifies, if the current path definitions in the switch unit's internal memory are replaced or amended with the imported path definitions. However, if you import paths that have the same name as existing paths in the memory, these existing paths are overwritten.

Remote command:

`ROUTE:PATH:IMPort`

`MMEM:LOAD:STATE`



Delete Path Export File

Delete Path Export File ← Export/Import Paths

Access: "Path Switching" > "Context Menu" > "Export/Import Paths" > "Delete Path Export File"

Deletes a selected path definition file. Proceed as described in the section "Export Paths" on page 190.

Remote command:

`ROUTE:PATH:DELeTe [:NAME]`

`ROUTE:PATH:DELeTe:ALL`



Path Selection ▶

Path Selection

Access: "Path Switching" > "Context Menu" > "Path Selection" > ...

Provides functions for using path definitions, other than switching paths.

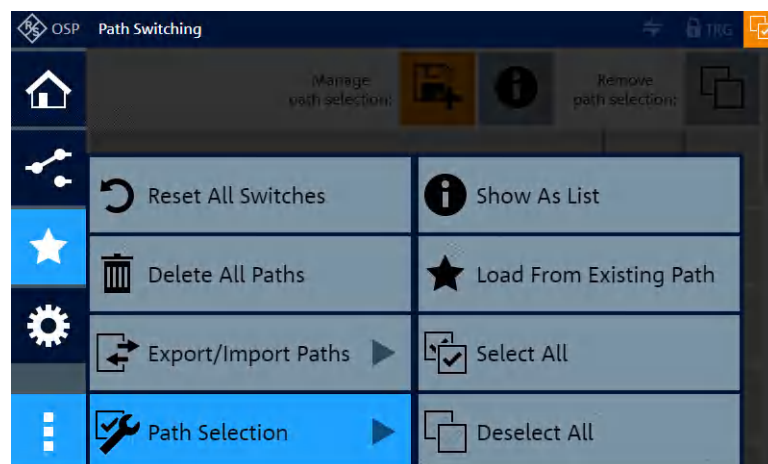



Figure 5-36: Path selection functions in the path switching context menu

 Show As List
Show As List ← Path Selection

Access: "Path Switching" > "Context Menu" > "Path Selection" > "Show As List"

Only available, if at least one relay or channel is selected, as in [Figure 5-19](#), for example.

Displays a comma-separated list of all selected relays or channels and their switching states, together with the number of the module and frame that these relays or channels are in.

For example, if your selection includes relay number 6 in module M03 in frame F01, and the relay is in state "00", the entry in the list is "F01M03(0006)". This entry is embedded in a list of all selected relays and channels. The syntax of this list string is compatible with the [remote control commands](#) for the R&S OSP.

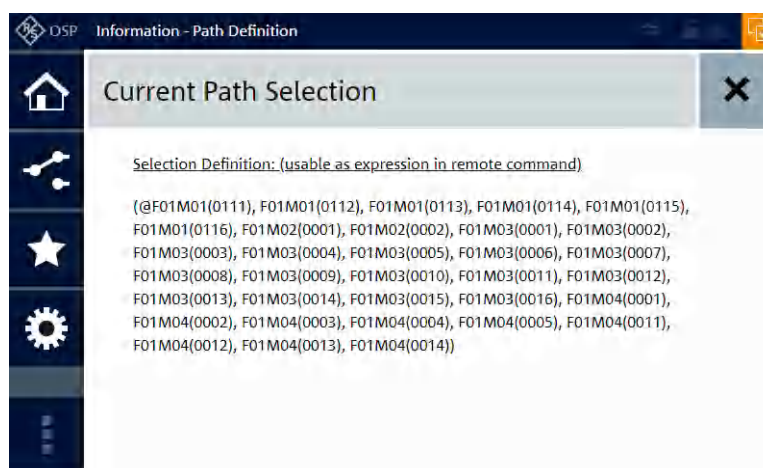

Figure 5-37: Example of a list that represents the selection of 30 relays and channels

To complete the syntax required for RC commands, the list string starts with the characters "(" and ends with an additional ")" .

To copy the list for using it as a "channel list string" in the definition of RC commands, proceed as follows, using a mouse and keyboard:

Either [locally connected](#) or in the [WebGUI](#), use the left mouse button to select and highlight the string. You can also triple-click the string or use the key combination [Ctrl]+[A] to select the whole string. Then press [Ctrl]+[C] to copy the string.

The copied string is now in the clipboard memory of your control device. This clipboard content is especially useful, if your control device is the same computer that you use for defining remote control commands.

Remote command:

[ROUTe](#): CLOSe

 Load From Existing Path
Load from Existing Path ← Path Selection

Access: "Path Switching" > "Context Menu" > "Path Selection" > "Load from Existing Path"

Only available, if at least one path is saved in the device.

Loads one of the existing (previously defined) paths and performs two tasks:

- [Switches](#) this path

- **Selects** (highlights) all relays and output channels that are included in the definition of this path

Hence, do not confuse this function with **switching** a path, which just *sets* the defined relays and channels to the target states.

When you load a path and then go to the **Module Operation** dialog, all modules are displayed in **Selection Mode**. Each relay and output channel specified in the loaded path definition is now selected, hence, highlighted in orange color.

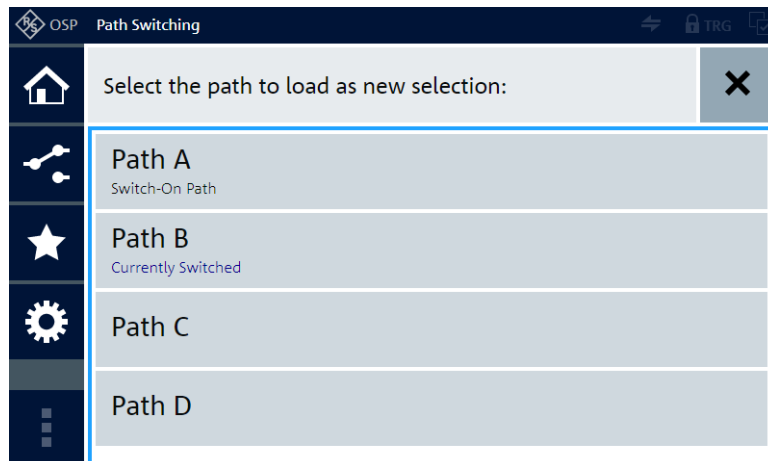

Figure 5-38: Example of a list of paths that are available for loading

To load a path, click its name in the dialog. Otherwise, to quit from this dialog without loading, click the "Back" button **X**.

When you load a path, the firmware brings up a warning, because loading overrides the previous selection of relays and channels. Also, the previous switching states of these relays and channels are lost. If you are sure that you want to load a path as the new selection, confirm the dialog.

As a result, in the "Path Switching" dialog, the loaded path is shown as "Currently Switched", the "Items selected" indicator is highlighted, and the "Manage path selection:" menu is shown.

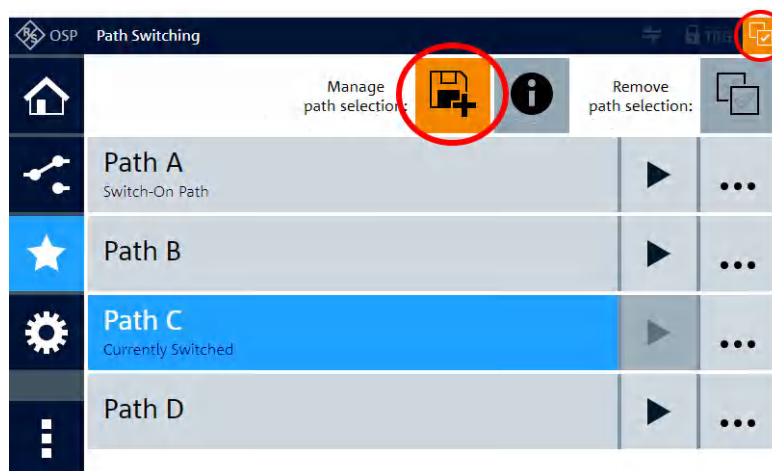
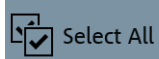

Figure 5-39: Path Switching dialog after loading a path (here: PathC)

Note: The loading function is a useful tool in defining a path similar to an existing path. It allows making dedicated modifications in a path definition, while keeping all other selections and switching states.

After making such modifications, save the new path definition under a new path name.



Select All

Select All ← Path Selection

Access: "Path Switching" > "Context Menu" > "Path Selection" > "Select All"

Selects all relays and channels in all modules of all frames, but does not change any switching states.

Refer to the description at [Module Operation](#) > [Path Selection](#) > [Select All](#).



Deselect All

Deselect All ← Path Selection

Access: "Path Switching" > "Context Menu" > "Path Selection" > "Deselect All"

Only available, if at least one relay or channel is selected, as in [Figure 5-19](#), for example.

Deselects all relays and channels in all modules of all frames, but does not change any switching states.

As a result, in the "Path Switching" dialog, the "Items selected" indicator and the "Manage path selection:" menu are disabled. The previously switched path is still in the state of being "Currently Switched".



Figure 5-40: Path Switching dialog after deselecting all relays and channels

Refer to the description at [Module Operation](#) > [Path Selection](#) > [Deselect All](#).

5.4 Configuration



Specifies device configuration settings:

Table 5-1: Configuration menu, left: with Trigger option (R&S OSP-K100), right: without Trigger option

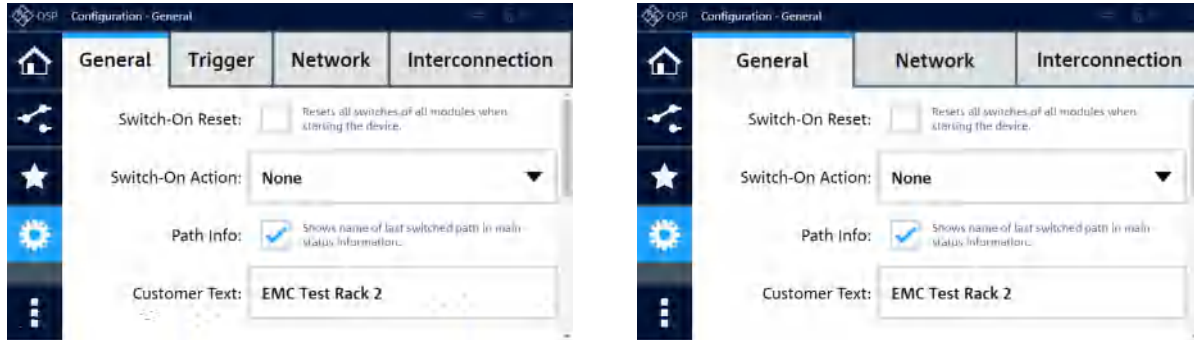

Trigger configuration available with software option

The R&S OSP switch units are equipped with trigger input connectors (BNC, see [Figure 2-16](#)) and prepared for the software trigger option **R&S OSP-K100**. Firmware versions below version 2.00 do not support this trigger option.

The figures above show the "Configuration" menu (here: the "General" tab) in two different versions: The screenshot on the left-hand side is extended with an additional **Trigger** tab, which is enabled after activation of the trigger option, only. Without option R&S OSP-K100, this tab is not available, as shown in the screenshot on the right-hand side.

The remainder of this user manual shows the "Configuration" menu with the "Trigger" tab.

- [General](#)..... 196
- [Trigger](#).....201
- [Network](#).....210
- [Interconnection](#).....212
- [Configuration Context Functions](#).....214

5.4.1 General

Configures basic settings for the switch unit.



Figure 5-41: "General" tab of the "Configuration" menu ("Trigger" option not activated)

The "General" configuration tab has the following functions (some of which require scrolling down the screen):

Switch-On Reset.....	197
Switch-On Action.....	198
└ Path.....	198
Path Info.....	198
Customer Text.....	198
Module Check.....	199
Compatibility Mode.....	199
Status Display Period.....	200
Virtual Mode.....	201
System Date.....	201
System Time.....	201

Switch-On Reset

Enables or disables the Power Up reset condition of switch modules with **latching** relays. This setting determines, how latching relays behave after booting the switch unit.

If enabled, the switch unit handles latching relays at startup as follows:

- It sets all latching **SPDT** relays to the default ports labeled **"2"** , which are represented in the software by position **"0"** .
- It sets all latching **SPxT** relays to the open state.

Note: The module [OSP B104](#), which is designed for controlling *external* latching relays, is *NOT reset* by this command.

If a switch unit is in [secondary mode](#), the setting in the primary switch unit determines, if the secondary device executes a reset at Power Up.

For details, see the description of the remote control command.

Remote command:

`CONFigure:POWerup:RESet`

Switch-On Action

Specifies, if a path is switched after booting the R&S OSP. The following options are available:

- | | |
|---------------|---|
| "None" | The R&S OSP switches no path at instrument startup. |
| "Switch Path" | Upon booting, the R&S OSP switches the path specified in the Path field.
If a switch unit is in secondary mode , the setting in the primary switch unit determines, if the secondary device executes a "Switch-On Action" at Power Up. |

Path ← Switch-On Action

Specifies the path to be switched at startup.

Only available, if the "Switch-On Action" is "Switch Path".

From the path list that opens upon clicking the "Path" field, select one of the existing paths.

Note that the dialog also offers non-switchable paths. In the [Path Switching](#) list, you can check, whether a path is switchable or not.

If you select a non-switchable path, the R&S OSP does not perform any switching action at startup.

Remote command:

```
CONFigure:POWerup:PATH
```

Path Info

Enables or disables in the main page the line "Last Switched Path", showing one of the following pieces of information:

- Path_XY (the name of the previously switched path)
- <Reset State>, if the switch unit is in reset state
See also:
 - ["Reset All Switches"](#) on page 189
 - [*RST](#) on page 249
 - [Switch-On Reset](#)
- <Individual Settings>, if any relays or channels in the switch unit were switched via the web interface or by a remote control command. Such a modification can result in a previously switched path losing its integrity. Therefore, even if actual path integrity is not checked by the firmware, it considers the modules to be in any individual switching state.

Remote command:

```
CONFigure:MAINinfo:PATH  
ROUTE:PATH:LAST?
```

Customer Text

Specifies the string displayed as "Customer Text" in the "Main" page, see [Figure 5-1](#).

Remote command:

```
CONFigure:MAINinfo:TEXT
```

Module Check

Enables or disables checking for any hardware module changes when starting the switch unit.

Note: At startup, the firmware always checks the available hardware modules. But only if the "Module Check" function is enabled, it checks whether the currently available modules differ from the previously available modules.

If a difference is detected, the firmware displays information in the "Other Messages" section of the [Device Messages](#).

Module **added**, for example:

- The modules of this frame changed:
Number of modules changed from 2 to 3
New module on M04: OSP-B128.3, 1505.4734.13, 101057/000

Module **moved**, for example:

- The modules of this frame changed:
Removed module from M05: OSP-B102, 1505.5201.02, 100002/000
New module on M10: OSP-B102, 1505.5201.02, 100002/000

Module **removed**, for example:

- The modules of this frame changed:
Number of modules changed from 3 to 2
Removed module from M04: OSP-B103, 1505.5301.02, 100011/002

Compatibility Mode

Enables or disables backward compatibility of remote-control commands to previous R&S OSP models (OSP1xx). When enabled, the "Status Information" screen displays the words "(Compatibility Mode)" behind the "Device Type".

The switch units R&S OSP220/230/320 are mechanically and electrically fully compatible with all legacy standard hardware modules and new modules. The firmware is also compatible with all these modules. However, the following **limitations in compatibility** apply:

- In an interconnection setup, you cannot mix legacy switch units with new switch units. Differences in communication prevent a combination of the two generations: The legacy switch units were interconnected by a CAN-bus system, while the new switch units are interconnected via Ethernet (LAN).
- Consequently, also the commands for configuring an interconnection setup of new switch units differ from the commands for the legacy units.
- The new firmware addresses the modules in a switch unit via the module bus connectors M01 to M16.
 - In **setting** commands, the firmware alternatively accepts addressing the modules by A11, A12 or A13, according to the 3 module bus connectors in a legacy switch unit.
 - In **query** commands, the firmware per default returns module numbers in Mxx format. However, you can enable the "Compatibility Mode" (by this checkbox or by the remote command) to let the firmware return module numbers in A1x format, according to the legacy syntax.

The legacy units have 3 module bus connectors, only. Therefore, module numbers beyond A11, A12 and A13 make no sense, although the new module bus connectors count up to M16. The equivalence of module buses M01 to M03 with legacy module numbers A11 to A13 is also shown in the "Module Operation" dialog:



Figure 5-42: Module operation overview with information on legacy module numbers

Red frames = Compatibility mode available only for modules on buses M01 to M03

Blue circles = Compatibility mode not available ("n/a") for modules on other buses, e.g. M04

Hence, due to the syntax restrictions of the legacy units, remote control commands in compatibility mode are restricted to module buses M01 to M03. The corresponding legacy module numbers are A11 to A13.

Also, the "Path Definition" > "Information" dialog shows, how the path definition (entries in the channel list) translates into a path definition for legacy switch units R&S OSP1xx:

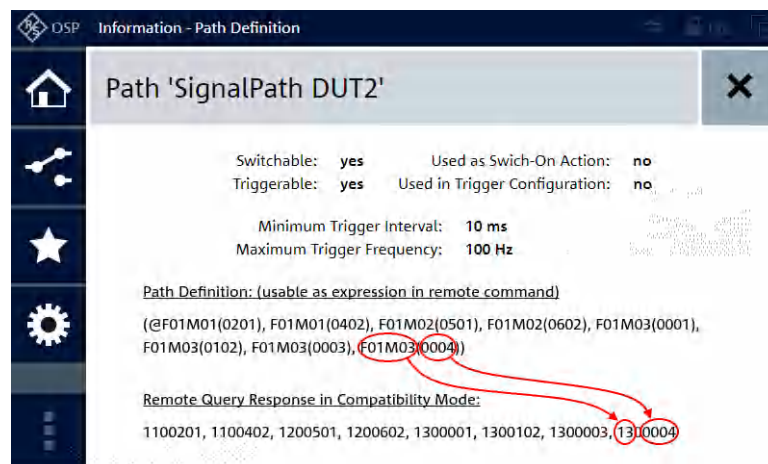

Figure 5-43: Information on a switchable path with a copy of the path definition in legacy format

For more details, refer to the description of the remote control command.

Remote command:

CONFigure:COMPAtible[:MODE]

Status Display Period

Available only in the R&S OSP220 and R&S OSP320, which have a status display (see Chapter 2.3.2, "User Interface and Functional Elements", on page 34).

Select from the following times: 30 minutes (= default), 1 hour, 2 hours, 4 hours or 8 hours. When you change the time setting while the status display is off, it is activated. After setting the time, the display remains active until it switches off after the selected time period. See "[Display timeout](#)" on page 23.

Virtual Mode:**Virtual Mode**

Enables or disables operating the switch unit's user interface in virtual mode, as described in [Chapter 4.5, "Virtual Mode"](#), on page 154.

At startup of the R&S OSP, the virtual mode is always off.

When the switch unit is in virtual mode, it does not control any module hardware. This state is indicated by the tag "<Virtual Mode>" in the headline of the graphical user interface.

Note:

You cannot enable or disable the virtual mode in the following cases:

- When the switch unit is in [Lock Mode](#)
- When the [Trigger](#) is activated

However, you can enable, disable or query the virtual mode remotely (SCPI).

Remote command:

```
CONFigure:VIRTual[:MODE]
```

System Date

Specifies the system date (year:month:day) of the R&S OSP. To edit the value in "YYYY:MM:DD" format, click it.

You cannot edit the system date, when the [Trigger](#) is activated.

NOTICE! Option loss with wrong date. If you use temporary software options, ensure that the correct [System Date](#) is set before activation. Date manipulation can lead to deactivation of options.

Remote command:

```
SYSTEM:DATE
```

System Time

Specifies the system time (hour:minute:second) of the R&S OSP. To edit the value in "hh:mm" or "hh:mm:ss" format, click it.

You cannot edit the system time, when the [Trigger](#) is activated.

Remote command:

```
SYSTEM:TIME
```

5.4.2 Trigger

Configures trigger settings for the switch unit.

Constraints:

- Only available, if you have activated a license for [option R&S OSP-K100](#)
- Only available for supported modules, see overview in the data sheet

- Only available for the [Manual Trigger](#) function and for **input** trigger signals at the following connectors:



Figure 5-44: Trigger connectors

1 = BNC [Trigger A] for input, only

2 = BNC [Trigger B] for reset input (and prepared for future trigger output functions)

3 = D-Sub 9 (only on rear of R&S OSP320) = [TRIGGER] input only for [Addressed](#) trigger

The trigger functionality is especially useful for fast switching of [Modules](#) with solid-state relays (SSR). However, you can use the trigger for all supported modules in all possible [switching path](#) configurations.



Some modules are not triggerable, for example R&S OSP-B102L and R&S OSP-B112UL, due to their multi-position latching relays. For detailed information on compatibility of your modules with the trigger functionality, refer to the [Module Information](#) dialog or to the data sheet.

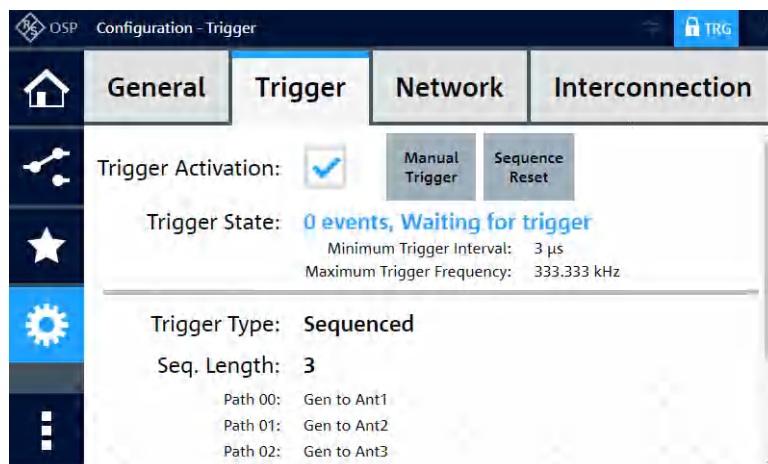

Figure 5-45: Trigger dialog with activated single trigger

"Trigger Activation" and status information = see ["Trigger Activation"](#) on page 203

"Trigger Type" and path information = see ["Trigger Type"](#) on page 205

"Trigger Level" and "Trigger Slope" = see ["Trigger Settings"](#) on page 208

The time sequences in relay triggering can be described according to the following brief overview (for more details, refer to the data sheet):

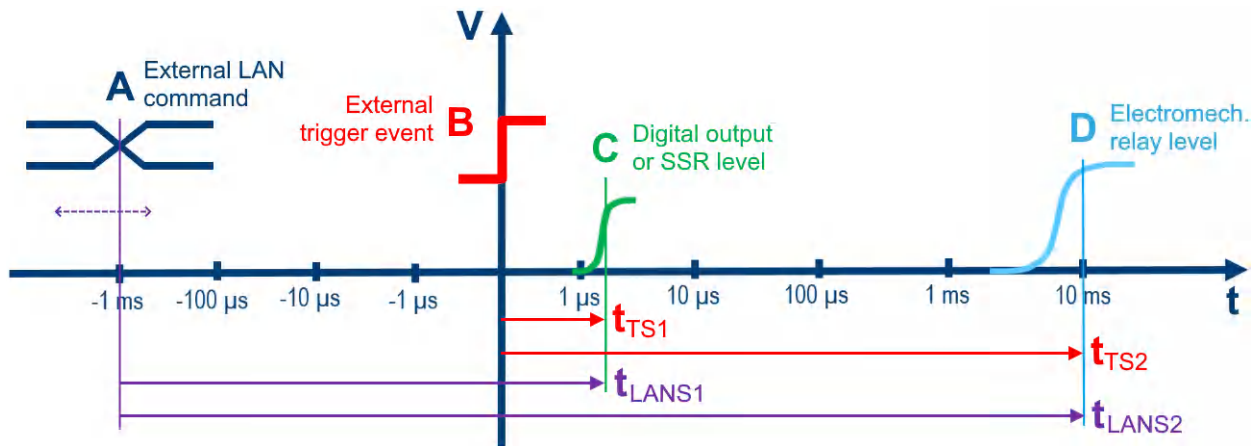

Figure 5-46: Relay trigger timing overview

- t = Time axis (logarithmic)
- V = Voltage level (trigger control signal, output of switched relay)
- A = External **SCPI** trigger command or **Manual Trigger** in the "WebGUI" (in both cases via Ethernet LAN)
- B = **External trigger** or **Manual Trigger** in the touch display (here: **Trigger Slope** = "Positive" or "Any")
- C = Output level of digital outputs and solid-state relays (SSR)
- D = Output level of electromechanical relays
- t_{TS1} = Trigger switching time for SSRs (a few microseconds)
- t_{TS2} = Trigger switching time for electromechanical relays (approximately 10 ms to 15 ms)
- t_{LANS1} = LAN switching time for SSRs (a few milliseconds)
- t_{LANS2} = LAN switching time for electromechanical relays (> 10 ms to 15 ms)

As a **prerequisite** for using a trigger, you must have defined a sufficient number of triggerable **paths**. A path is triggerable, if all involved modules are triggerable (see **Module Information** dialog). Triggerable paths can include (one or combinations of) relays and digital output ports in many modules, especially if you use a **Interconnection** setup. The required number of paths (up to 16) depends on the selected **trigger type**.

In **Interconnection operation**, the trigger functionality requires connecting the trigger signal line also to all secondary switch units, which are involved in the triggered paths, see **Figure 5-49**.

The trigger dialog consists of the following three sections:

Trigger Activation.....	203
Trigger Type.....	205
L Single.....	206
L Toggle A-B.....	206
L Sequenced.....	207
L Addressed.....	207
Trigger Settings.....	208

Trigger Activation
Trigger State

Trigger Activation

Trigger activity is indicated by the status LEDs next to the BNC connectors (labeled 1 and 2 in **Figure 5-44**). The LEDs have the following meanings:

- Trigger deactivated: both LEDs are off

- Triggering system active and ready for events: both LEDs are green
- Triggering system active and incoming trigger event:
[Trigger A]-LED is red during approximately 0.5 s, then it returns to green
- Triggering system active and incoming reset event:
[Trigger B]-LED is red during approximately 1 s, then it returns to green

The **"Trigger Activation"** section (top portion of [Figure 5-45](#)) provides the following:

- You can activate or deactivate the trigger functionality.



When triggering is active, this state is indicated by the following:

- The trigger status LEDs next to the BNC connectors are on (green light).
- The top right corner of the user interface displays the "TRG" flag:



When the trigger is active, also be aware of the following additional effects:

- All module views are hidden
- You cannot switch relays via the [Module Operation](#) dialog
- You cannot switch paths via the [Path Switching](#) dialog, but only by triggering
- [RC Commands](#) (SCPI), which can interfere with the trigger functionality or can prevent correct triggering, are not executed.
Calling forbidden commands creates an error message, which you can query by `SYSTem:ERRor`.

The following commands are forbidden:

- Commands for changing path configurations
- Commands for changing the interconnection configuration
- Switching commands, which change the state of relays or channels, especially `ROUTE:CLOSE`
- Querying the switching state of relays or channels by `ROUTE:CLOSE?` is not supported

However, the commands `*RST` and `SYSTem:PRESet` are permitted and deactivate the trigger mode.

If you cannot activate the trigger, possible reasons are, for example:

- Your trigger [license](#) has just expired, see ["Software Options Overview"](#) on page 160
- A secondary switch unit does not respond, although it is required for a configured path to be triggered
- You can send a **"Manual Trigger"** pulse, if the trigger functionality is enabled and its configuration is complete.



The "Manual Trigger" button is equivalent with sending a remotely controlled trigger pulse by `*TRG` or with receiving the next incoming trigger signal at the BNC connector.

The "Manual Trigger" is not available for the [Addressed](#) trigger type.

- You can send a **"Sequence Reset"** for the [Sequenced](#) trigger, if the trigger functionality is enabled and its configuration is complete.

Sequence
Reset

- In active trigger state, the dialog shows the trigger events counter:
 Trigger State: **9 events (Path: 02)**
 Minimum Trigger Interval: 3 μs
 Maximum Trigger Frequency: 333.333 kHz
- Also, this section displays the **"Minimum Trigger Interval"** in units of seconds, which is derived from the data-sheet specifications of the modules and relays used in the configured paths. The minimum interval comprises only the time that is required to reach 90% of the target level of the switched state. It does not include any operational time to be used while remaining in this state. However, the value also considers a delay of approximately 1μs for modules located in a satellite unit.
- The **"Maximum Trigger Frequency"** in units of Hertz is the inverse value of the "Minimum Trigger Interval".

Remote command:

```
TRIGger:STATe
TRIGger:EXECute
TRIGger:COUNT[:VALue]?
TRIGger:COUNT:OVERflow?
TRIGger:INDEX?
```

Trigger Type
Seq. Length
Path 00

Trigger Type

The "Trigger Type" section (middle portion of [Figure 5-45](#)) is accessible only, if the trigger is **not activated**. It provides different functions and dialogs depending on the trigger type.

Table 5-2: Triggerable paths per trigger type

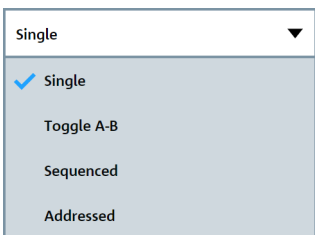
Dialog in the user interface	Trigger type	Number of triggerable paths
	Single	1
	Toggle A-B	2
	Sequenced	3 to 16 ("Seq. Length")
	Addressed	3 to 16 ("Address Count")

The following illustration provides an overview of the different trigger functionalities available with the different trigger types:

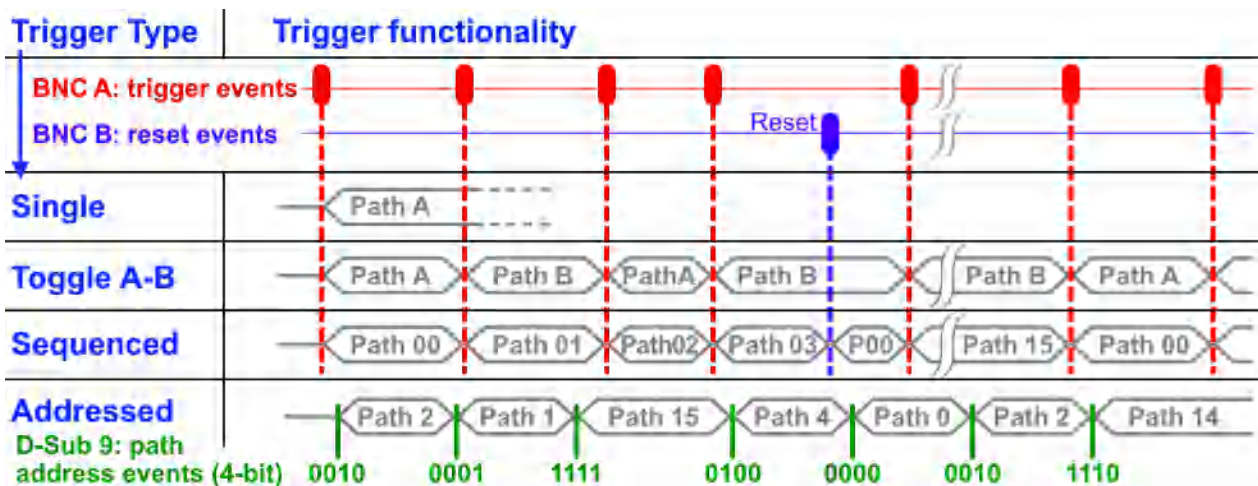

Figure 5-47: Path switching functionalities of the different trigger types

- Single** = The triggered path remains active as described below
- Toggle A-B** = Each trigger event switches from one path to the other
- Sequenced** = Each trigger event switches to the next path in the sequence, unless reaching the last path or sending a "Sequence Reset" makes the sequence recommence from the beginning
- Addressed** = Each 4-bit encoded trigger event at the D-Sub 9 connector of the R&S OSP320 triggers the addressed path
- BNC A, BNC B = Trigger input connectors on the front panel, see (1) and (2) in [Figure 5-44](#)
- D-Sub 9 = **Addressable** trigger input connector on the rear panel of R&S OSP320, see (3) in [Figure 5-44](#)

Single ← Trigger Type

Allows triggering 1 path.

For configuring the toggled trigger, select the single "Path".

Activation:

When you activate the trigger, the next incoming trigger pulse switches the configured path. After switching this path, the switch unit automatically deactivates the trigger functionality.

The switched path remains active, until one of the following events happen:

- You override the path by [Path Switching](#) or a [SCPI command](#)
- You [activate](#) the trigger functionality again and the next trigger event happens
- You [reset](#) all switches
(Note that the switched path does not change, if it happens to be equivalent with all switches being reset.)

Remote command:

`TRIGger:TYPE`

Toggle A-B ← Trigger Type

Allows triggering 2 alternating paths.

For configuring the toggled trigger, select "Path A" and "Path B".

Activation:

When you activate the trigger, the next incoming trigger event switches "Path A". Each following trigger event toggles from the currently switched path to the other path.

Note: After the 2nd trigger event, your relays are not necessarily in the same state as before the 1st trigger event. For example, consider a relay that is originally **deactivated**. If "Path A" activates it, but "Path B" does not include this relay, it is therefore not deactivated. Hence, the relay remains **activated** after the 2nd trigger event, before "Path A" is switched again.

Remote command:

`TRIGger:TYPE`

Sequenced ← Trigger Type

Allows triggering 3 to 16 paths in a given sequence.

For configuring the sequenced trigger, first select a "Seq. Length", where the sequence length $n = 3$ to 16. The dialog displays n path selection boxes, labeled "Path 00" for the 1st path up to "Path (n-1)" for the n^{th} path.

Select a path in each path selection box.

Activation:

When you activate the trigger, the next trigger event ("Manual Trigger" or incoming trigger event at the [TRIGGER A] BNC connector) switches the 1st path ("Path 00"). Each following trigger event switches the next path in the sequential order up to the n^{th} path ("Path (n-1)"). The next trigger event recommences with the 1st path.

At any time, you can reset the trigger sequence to the 1st path. To do so, click "Sequence Reset" or send a reset event to the [TRIGGER B] BNC connector.

Note: If a reset is the first trigger event for the sequenced trigger, the following trigger event has no effect (it does not switch any path), but it is counted.

Note: After the last trigger event in the sequence, your relays are not necessarily in the same state as before the 1st trigger event. For example, consider a relay that is originally **deactivated**. If the 1st path activates it, but all other paths do not include this relay, it is therefore not deactivated. Hence, the relay remains **activated** after the last trigger event, before the 1st path is switched again.

Remote command:

`TRIGger:TYPE`

`TRIGger:SEquence:DEFine:LENGth`

`TRIGger:SEquence:DEFine[:ENTRy]`

`TRIGger:SEquence:DEFine:LENGth`

Addressed ← Trigger Type

Functional **only** in the switch unit **R&S OSP320**, but without any paths that use a [Interconnection](#) configuration. The R&S OSP320 has a rear trigger input D-Sub 9 connector (labeled 3 in [Figure 5-44](#)) with 4 digital input lines on pin 1 to pin 4. With the resulting $2^4 = 16$ addresses, you can use this trigger type to address up to 16 paths directly.

For configuring the addressed trigger, first select an "Address Count", where the address count $n = 3$ to 16. The dialog displays n path selection boxes, labeled "Path 00" for the 1st path up to "Path (n-1)" for the n^{th} path.

Select a path in each path selection box. Note that changing the "Address Count" resets all path selection boxes.

Activation:

When you activate the trigger, the next incoming **valid and stable trigger event** switches the **addressed** path, as described in the following:

- **Address:** the trigger control system reads the states of the lines 1 to 4 of the D-Sub 9 connector (and ignores the lines 5 to 9). It interprets the 4-digit binary states as the address value for the address to be triggered.
Example: If pins 1 and 3 are in high state and pins 2 and 4 are in low state, the binary readout is 0101 (most significant bit first). The decimal equivalent of 0101 is the address 5. Hence, the control system triggers the 5th path, which is "Path 04" (starting with "Path 00" as the 1st path).
- **Trigger event:** a change on any of the 4 lines is interpreted as a trigger event. Hence, the addressed path remains switched, until the address code changes. This rule is true also for the 1st path ("Path 00"). Consider an arbitrary address that differs from 0000: If in this address, the non-zero lines return to the low state, this binary 0000 is interpreted as a new trigger event that switches "Path 00".
- **Validity:** a trigger event is valid, if the encoded address exists. For example, if you have set the "Address Count" to 7, all received addresses from 8 to 16 establish an invalid trigger event, which is ignored.
- **Stability:** for a trigger event to be stable, the following requirements must all be met:
 - Each change of an address value must happen within 15 ns. Address values that do not remain stable for at least 15 ns are interpreted as a glitch or spike and are ignored.
 - Each address must remain unchanged for at least the duration of the minimum trigger interval (typically 2 µs). If the address changes sooner, the control system can process or ignore the change, depending on several parameters. Hence, a premature change can lead to an undefined switching state.

Remote command:

TRIGger:TYPE

Trigger Level
Trigger Slope
Termination

Trigger Settings

The "Trigger Settings" section (lower portion of [Figure 5-45](#)) is accessible only, if the trigger is **not activated**. It provides the following:

- The "Trigger Level" is valid for the front trigger connectors (BNC), only. It is the signal level, at which the switch unit's control system interprets a voltage change as a trigger event. The "Trigger Level" is compatible with values between 0.5 V and 4.5 V.
The "Trigger Level" setting is not available, if the "Trigger Type" is [Addressed](#).
- The "Trigger Slope" is valid for the front trigger connectors (BNC), only. It can be "Positive", "Negative" or "Any".
 - If you select "Positive", a transition of the "Trigger Level" from a lower voltage to a higher voltage is interpreted as a trigger event.
 - On the contrary, if you select "Negative", a transition of the "Trigger Level" from a higher voltage to a lower voltage is interpreted as a trigger event.
 - If you select "Any", both a positive and a negative transition are valid trigger events.

- The "Trigger Slope" setting is not available, if the "Trigger Type" is **Addressed**.
- "Termination" of the trigger signal RF cable
 - Terminate the trigger line with 50 ohms at one switch unit. To do so, terminate it either at the primary switch unit (in the absence of secondary switch units) or typically at the last secondary switch unit (if available). Termination can be **internal** inside a switch unit as in [Figure 5-48](#) or **external** as in [Figure 5-49](#).
 - For the standard case with **internal** termination, consider a setup as follows:

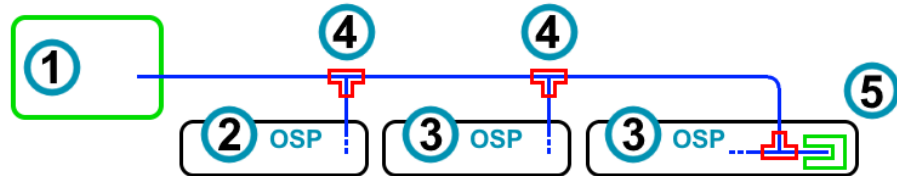

Figure 5-48: Schematic trigger setup with internal 50 ohms termination in the last switch unit (3)

- 1 = Source of the trigger signal, for example a signal generator
- 2 = Primary switch unit
- 3 = Secondary switch units
- 4 = T-junctions in the trigger signal RF cables (blue lines)
- 5 = Internal 50 ohms termination

If the signal cable is not externally terminated (as in [Figure 5-48](#)), use internal termination in **one** switch unit. To do so, set "Termination" to "50 Ohm" in **this** switch unit and to "High Impedance" in **all other** switch units.

- For the alternative case with **external** termination, consider a setup as follows:

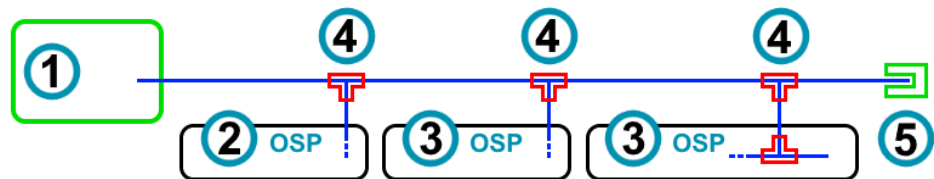

Figure 5-49: Schematic trigger setup with external 50 ohms termination (5) after the last trigger input

- 1 = Source of the trigger signal, for example a signal generator
- 2 = Primary switch unit
- 3 = Secondary switch units
- 4 = T-junctions in the trigger signal RF cables (blue lines)
- 5 = External 50 ohms termination

If the external 50 ohms termination (labeled 5 in [Figure 5-49](#)) is present, set "Termination" to "High Impedance" in **all** switch units.

Make sure to **avoid** simultaneous internal and external termination.

Remote command:

`TRIGger:SIGNal:LEVel`

`TRIGger:SIGNal:SLOPe`

`TRIGger:SIGNal:TERMination`

5.4.3 Network

Configures the network (LAN) parameters and settings of the primary switch unit. See also [Chapter 4.3, "LAN Connection"](#), on page 149.

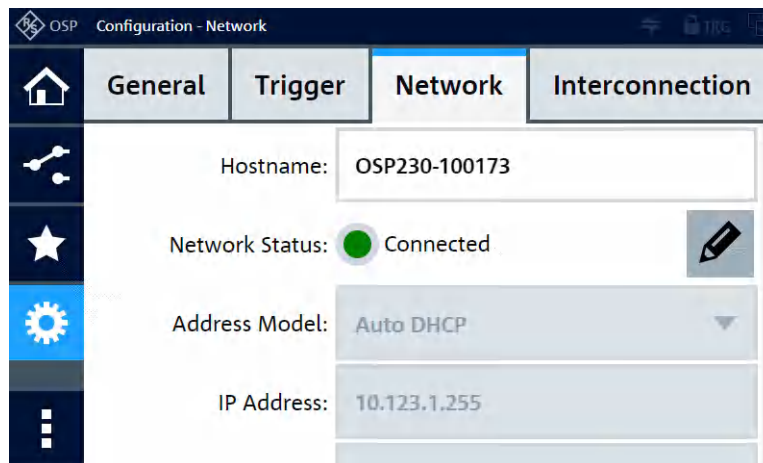

There are no remote control (RC) commands available for modifying the network settings of a switch unit.

The "Network" configuration tab has the following functions (some of which require scrolling down the screen):

Hostname	210
Network Status	210
Edit	211
Address Model	211
IP Address	211
Subnet Mask	211
Default Gateway	211
Automatic DNS	211
DNS Server	212
Alternate DNS Server	212

Hostname

Specifies the hostname for a LAN connection to the primary switch unit.

Network Status

Shows, if the primary switch unit is connected to the LAN.

- Green: "Connected"
- Red: "Disconnected"

You cannot switch the connection on or off. The "Network Status" indicator only informs you of the current connection state. For example, if the LAN cable is disconnected, the "Network Status" indicator turns red.

**Edit**

Enables or disables changing the "Address Model".

If the "Address Model" is "Static", the "Edit" button also enables editing the address details below the "Address Model" field.

Address Model

Selects the network management protocol. Two options are available:

- "Auto DHCP" (dynamic host configuration protocol) lets the server automatically assign the IP address and other network parameters to your switch unit.
- "Static" lets you define a fixed IP address and other parameters for connecting the switch unit via LAN.

Note: To avoid address conflicts in your domain, we **recommend using "Auto DHCP"** with [Automatic DNS](#), where all network settings are automatically configured.

When you change the "Address Model", also click the "Ok" button to confirm your selection.

One of the following warnings comes up:

- "You modified the network settings. The current connection may possibly be lost when changing these settings. Do you really want to proceed?"
- "You modified the address model to 'Auto DHCP'. The current connection typically will be lost when changing this setting. Do you really want to proceed?"

Note: Your server typically assigns a new network address, when you change from "Static" to "Auto DHCP". Hence, if you operate the switch unit by the "WebGUI" via LAN, with the IP address entered in your browser, this LAN connection can be lost. Due to some locally executed java scripts, your browser still shows some features of the interface dialogs. However, these features do **not** reflect the current status of the switch unit. To solve this issue, use the hostname for the LAN connection, or use the changed IP address, which you can read directly from the switch unit's display.

IP Address

Specifies the IP address for a LAN connection to the primary switch unit.

Only available, if [editing](#) is enabled and the [Address Model](#) is "Static".

Note that changing the "Address Model" can change the "IP Address".

Subnet Mask

Specifies the subnetwork parameter for a LAN connection to the primary switch unit.

Only available, if [editing](#) is enabled and the [Address Model](#) is "Static".

Default Gateway

Specifies the network node that can be used for forwarding to other networks.

Only available, if [editing](#) is enabled and the [Address Model](#) is "Static".

Automatic DNS

Enables or disables automatic specification of the domain name system (DNS) by the DHCP server.

Only available, if [editing](#) is enabled and the [Address Model](#) is "Auto DHCP".

- In "Auto DHCP" mode, you can enable "Automatic DNS" to let the DHCP server specify the DNS automatically, or disable "Automatic DNS" to enter the DNS manually.
- In "Static" mode, you must enter the DNS manually.

DNS Server

Specifies the domain name system.

Only available, if [editing](#) is enabled and one of the following selections applies:

- [Address Model](#) = "Static"
- "Address Model" = "Auto DHCP" and [Automatic DNS](#) is disabled.

Alternate DNS Server

Specifies an alternative domain name system server.

Only available, if [editing](#) is enabled and one of the following selections applies:

- [Address Model](#) = "Static"
- "Address Model" = "Auto DHCP" and [Automatic DNS](#) is disabled.

5.4.4 Interconnection

Configures a setup of primary and secondary switch units. See also [Chapter 4.4, "Operation in Interconnection Mode"](#), on page 150.

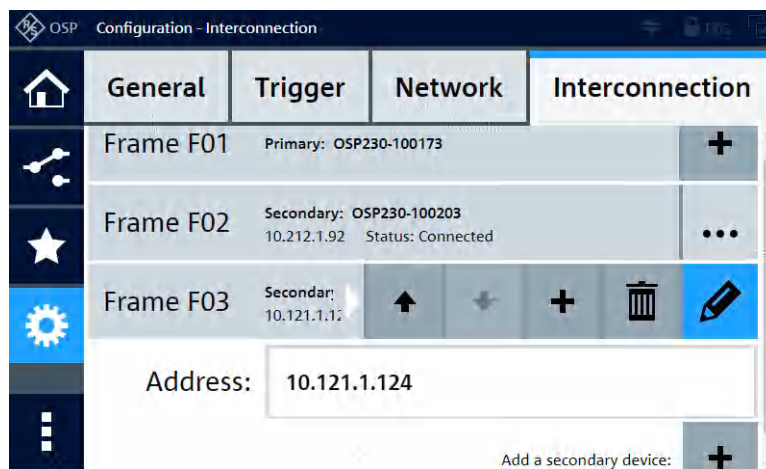

The "Interconnection" configuration tab has the following functions (which are disabled, when the [Trigger](#) is activated):

More	213
Move Up / Move Down	213
Add Secondary	213
Delete	214
Edit Secondary	214
L Address	214



More

To get more options for handling a secondary switch unit, click the "More" button (dots icon) . When you click this button in the line of an existing secondary switch unit, the following option buttons are shown for this switch unit:

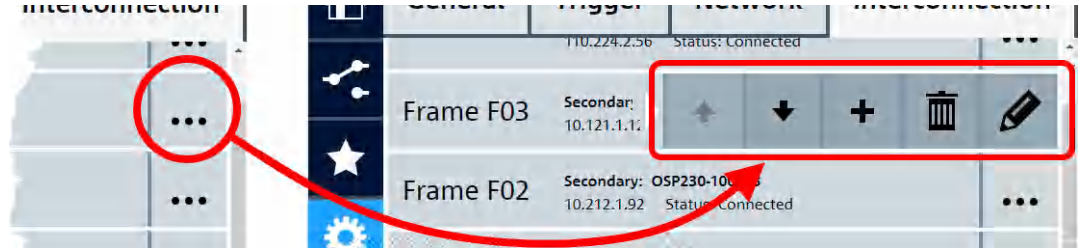

Figure 5-50: The More button (dots icon) gives access to the option buttons of a secondary switch unit

To hide the option buttons without further action, click the secondary switch unit's entry at its left-hand side, outside of the option buttons.

Note: You cannot edit the first frame (with frame ID F01), which is the primary switch unit. Other than in [Figure 5-50](#), the primary switch unit only has the [Add Secondary](#) button:



This button allows adding a secondary switch unit, as described below.



Move Up / Move Down

The "Move Up" and "Move Down" buttons move the entry of this secondary switch unit 1 position up or down in the list. After moving an entry, the option buttons are still available, to facilitate repeated moving actions.

If an entry is in the top line, you cannot move it further up, and the "Move Up" button is not available. If an entry is in the lowest line, you cannot move it further down, and the "Move Down" button is not available.

Note: The frame IDs are locked to the positions in the list. When you move a secondary switch unit to a different position, it exchanges the frame ID with the displaced secondary switch unit. Hence, for example, the second entry in the list (which is the first secondary switch unit) always has frame ID F02.

Before moving secondary switch units, consider that a change of frame IDs disturbs existing path definitions that refer to these secondary switch units.



Add Secondary

The button with the plus icon enters a line for a new secondary switch unit in the list of frames.

- If you click the button "Add a secondary device:" at the end of the list, the new secondary switch unit is added below the existing entries without displacing existing secondary switch units.
- If you click "Add Secondary" in the line of the primary switch unit or any existing secondary switch unit, the new secondary device is added immediately below that line.

Remote command:

```
CONFigure:FRAMe:ADD
CONFigure:FRAMe:INSeRt
CONFigure:FRAMe[:DEFine]
```



Delete

The "Delete" button deletes this secondary switch unit from the list of frames.

When you click the button, the firmware brings up the message "Do you really want to delete the configuration of secondary device Fxx?" (where Fxx is the frame ID).

Confirm with "OK" or "Cancel" the deletion.

Remote command:

```
CONFigure:FRAMe:DELeTe
CONFigure:FRAMe:DELeTe:ALL
```



Edit Secondary

The button with the pencil icon opens and closes a field for defining or modifying this switch unit's "Address".

To edit the address, click in the field. For editing, you can use the on-screen keyboard, an external keyboard connected to the switch unit, or a keyboard connected to your computer, when you use the R&S OSP in a LAN. The name editor accepts the keyboard shortcuts [Ctrl]+[x] for "cut", [Ctrl]+[c] for "copy" and [Ctrl]+[v] for "paste".

You can quit editing with the cancel button  or confirm the edited name with the OK button .

Address: ← Edit Secondary

Not available for the primary switch unit, and not available in [virtual mode](#).

Specifies the IP address, as described in [Chapter 4.3, "LAN Connection"](#), on page 149.

Also, you can enter a hostname in this field, if you adhere to the following rules:

- Letters and numbers are permitted
- Single dots and single or multiple hyphens are permitted. However, you must use at least one letter or number ahead of each dot / each group of hyphens **and** after each dot / each group of hyphens.
- Other (special) characters are not permitted
- You can use a maximum of 63 characters

5.4.5 Configuration Context Functions



The configuration context functions are grouped with the "General", "Trigger", "Network" or "Interconnection" tabs, respectively. You can select either of the following:





- "Configuration" > "**General**" view > "Context Menu"
 - [Backup/Restore](#)
 - [Maintenance](#)
- "Configuration" > "**Trigger**" view > "Context Menu"
 - [Export/Import Trigger](#)

- Maintenance
- "Configuration" > "Network" view > "Context Menu"
 - Maintenance
- "Configuration" > "Interconnection" view > "Context Menu"
 - Delete All Secondary Devices
 - Export/Import Interconnection
 - Maintenance

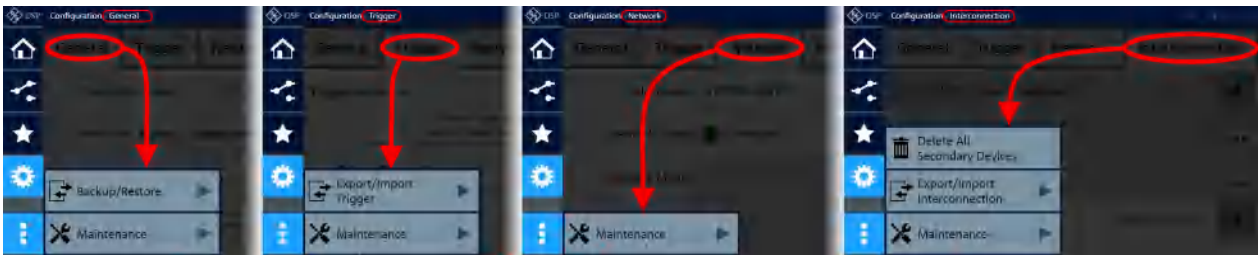
These selections bring up one of the following dialogs:



Note that the functions available in this "Context Menu"  depend on your selection in the "Configuration" menu :

- Backup/Restore is available only, if you have selected the General tab
- Export/Import Trigger is available only, if you have selected the Trigger tab
- Delete All Secondary Devices and Export/Import Interconnection are available only, if you have selected the Interconnection tab
- Maintenance is available with all tabs

The following sections describe all "Configuration" context functions:

Backup/Restore.....	215
L Backup Device.....	216
L Restore Device.....	217
L Delete Backup File.....	218
Maintenance.....	219
Export/Import Trigger.....	220
L Export Trigger Configuration.....	220
L Import Trigger Configuration.....	221
L Delete Trigger Configuration File.....	222
Delete All Secondary Devices.....	223
Export/Import Interconnection.....	223
L Export Interconnection.....	223
L Import Interconnection.....	224
L Delete Interconnection Export File.....	225



Backup/Restore

Access: "Configuration" > "General" tab > "Context Menu" > "Backup/Restore"

Provides functions for saving your configurations and for restoring your setup to the settings of a previously saved backup.

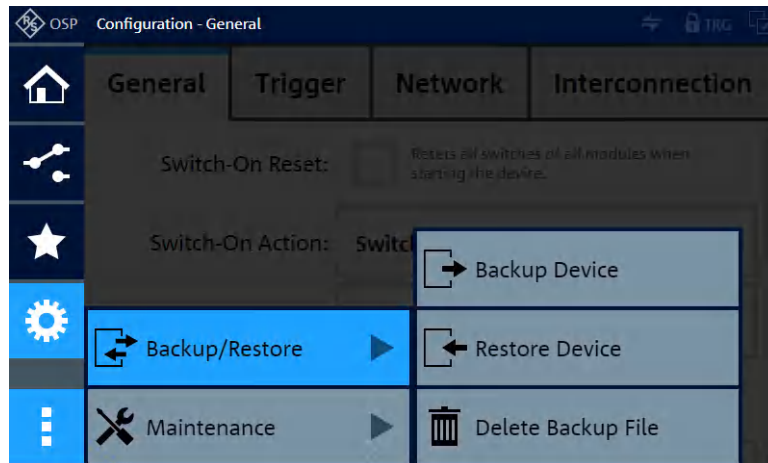

Backup Device ← Backup/Restore

Access: "Configuration" > "General" tab > "Context Menu" > "Backup/Restore" > "Backup Device"

Saves the full set of your configurations to a selected backup file. The backup includes all available device settings, path definitions and secondary switch unit definitions (both in physical and virtual mode) and the virtual module configurations.

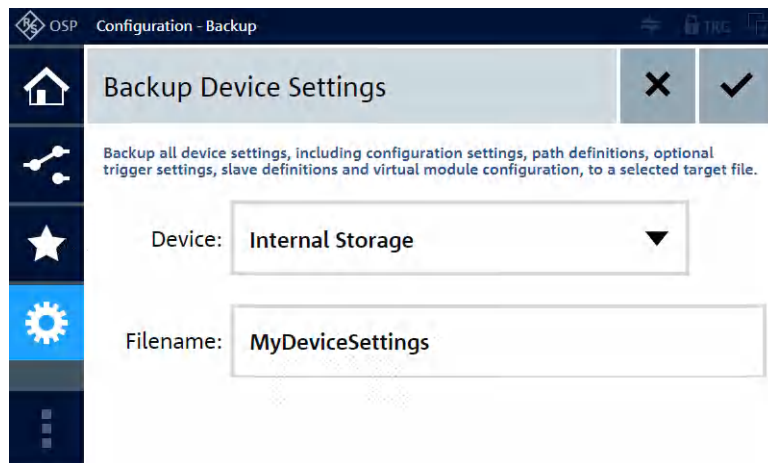

To save the file, click the "OK" button in the top right corner of the dialog.

"Device" Selects the storage device. Per default, if no external USB storage device is connected, the storage device is the "Internal Storage", which is the primary switch unit's flash memory in the SD card slot. If there is an external USB storage device, it becomes the default storage device.

To save the file on an external USB storage device, connect it to any of the switch unit's USB ports (front or rear), and select it by its <devicename>, for example "MY-USBSTICK".

After saving, before you remove this USB storage device, return to the same "Backup Device" dialog. Then once more select the external USB storage device in the "Device" selection field and click the eject button on the right-hand side of it:



The firmware brings up a message to notify you that "The device '<devicename>' can now be safely removed."

Click "Close" to confirm this message, then remove the USB storage device.

On your USB storage device, the folder and filename (with extension .backup) of this file is

"<Drive>:\ospdata\MyDeviceSettings.backup".

Here, <Drive> is the drive letter of the removable medium.

"Filename" Specifies the filename of your backup file. In the example above, the filename is "MyDeviceSettings".

Remote command:

[CONFigure:ALL:BACKup](#)

Restore Device ← Backup/Restore

Access: "Configuration" > "General" tab > "Context Menu" > "Backup/Restore" > "Restore Device"

Prerequisite: the data of a previously saved [backup](#) must be available.

Loads a full set of configurations from a selected backup file into the switch unit's internal volatile memory. The configurations file includes all available device settings, path definitions and secondary switch unit definitions (both in physical and virtual mode) and the virtual module configurations.

 Restore Device

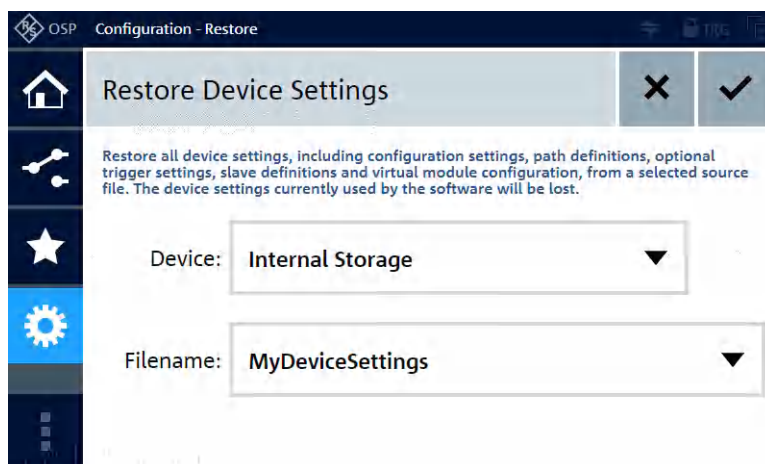

To load the selected file, click the "OK" button  in the top right corner of the dialog.

Note: Risk of losing configurations. Your restoring action overwrites all current configurations in the switch unit's internal volatile memory with the configurations in the imported file.

To avoid losing current configurations, consider saving these configurations for later reference by [Backup Device](#), before you restore a different set of configurations.

"Device" Selects the switch unit's "Internal Storage" (= default) or an external USB storage device. An external USB storage device is only available, if it is connected to one of the USB ports on the front or rear panel of the R&S OSP.

To remove an external USB storage device, use the eject button and proceed as described in the section "[Backup Device](#)" on page 216.

"Filename" Selects the file you want to use for restoring. The firmware offers only suitable configurations files with the extension ".backup", although this extension is not displayed.

If there is no ".backup" file in the selected storage device, you cannot select a filename. Instead, the following message is shown:
"There are no files available on the selected storage device."

Remote command:

`CONFigure:ALL:REStore`

`CONFigure:ALL:REStore:CATalog?`

Delete Backup File ← Backup/Restore

Access: "Configuration" > "General" tab > "Context Menu" > "Backup/Restore" > "Delete Backup File"

Prerequisite: the data of a previously saved [backup](#) must be available.



Delete Backup File

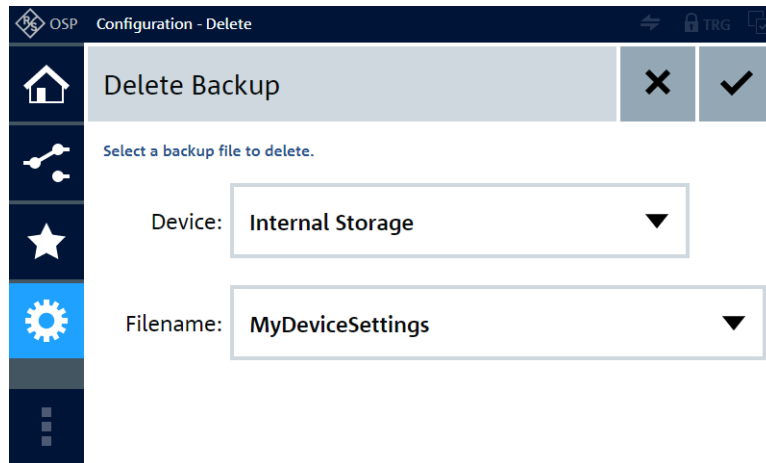

To delete the selected file, click the "OK" button in the top right corner of the dialog. A warning comes up: "You have selected a backup file to delete. Do you really want to proceed?"

Confirm with "OK" or "Cancel" the deletion.

If there is no ".backup" file in the selected storage device, you cannot select a file-name. Instead, the following message is shown: "There are no files available on the selected storage device."

Remote command:

`CONFigure:ALL:REStore:DElete`

`CONFigure:ALL:REStore:DElete:ALL`

Maintenance

Access: "Configuration" > "Context Menu" > "Maintenance"

Provides functions for updating the firmware, entering a license key and resetting (cleaning up) the device.

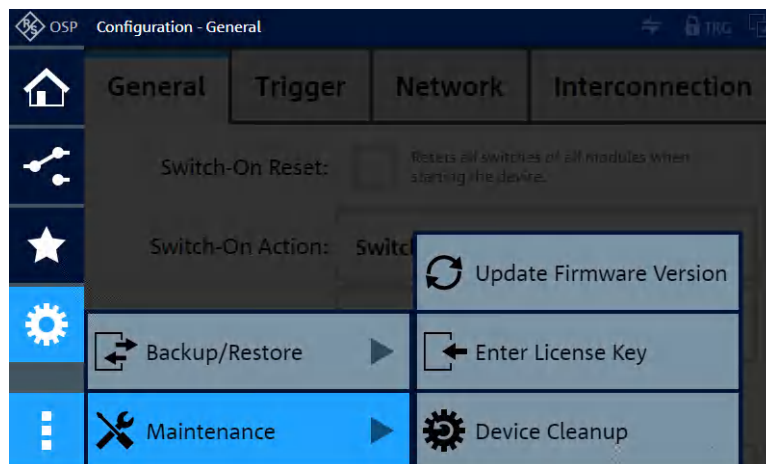
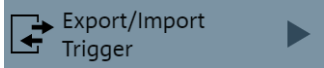

Figure 5-51: Path selection functions in the path switching context menu

These maintenance functions "Update Firmware Version", "Enter License Key" and "Device Cleanup" are available also in the [Main Context Functions](#), described in its section "[Maintenance](#)" on page 162.



Export/Import Trigger

Access: "Configuration" > "Trigger" tab > "Context Menu" > "Export/Import Trigger"

Provides functions for exporting and importing trigger configurations and for deleting previously saved trigger configuration files.

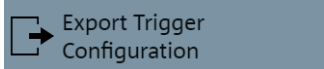
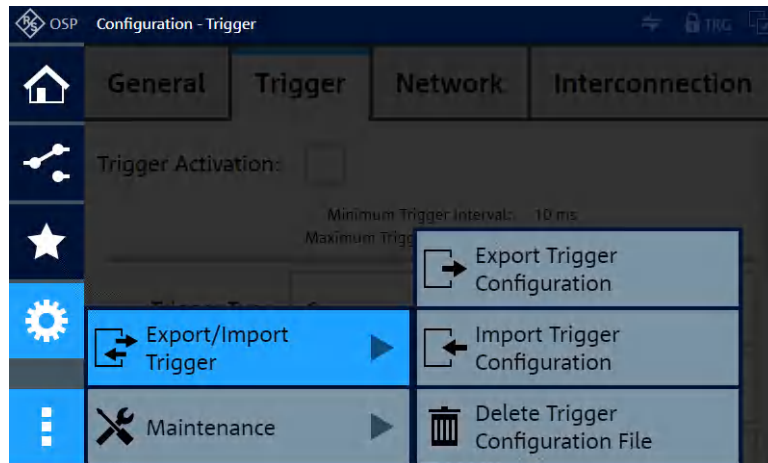

Export Trigger Configuration ← Export/Import Trigger

Access: "Configuration" > "Trigger" tab > "Context Menu" > "Export/Import Trigger" > "Export Trigger Configuration"

Saves all your trigger settings, both in physical and virtual mode, to a selected file.

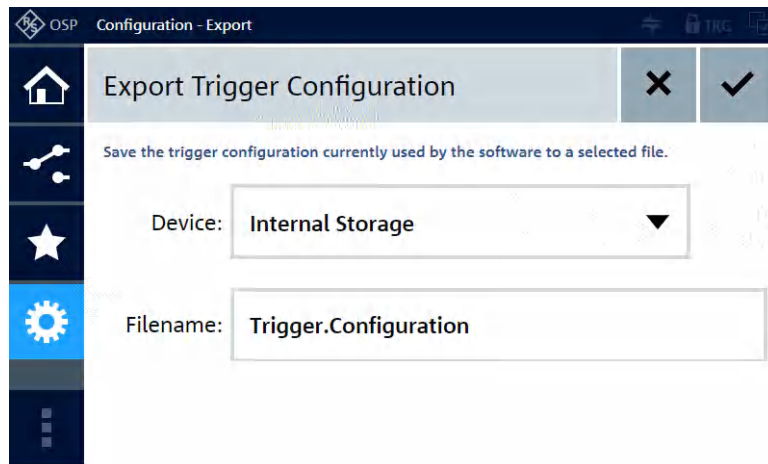

To save the file, click the "OK" button in the top right corner of the dialog.

"Device" Selects the storage device. Per default, if no external USB storage device is connected, the storage device is the "Internal Storage", which is the primary switch unit's flash memory in the SD card slot. If there is an external USB storage device, it becomes the default storage device.

To save the file on an external USB storage device, connect it to any of the switch unit's USB ports (front or rear), and select it by its <devicename>, for example "MY-USBSTICK".

After saving, before you remove this USB storage device, return to the same "Export Trigger Configuration" dialog. Then once more select the external USB storage device in the "Device" selection field and click the eject button on the right-hand side of it:

Device: 

The firmware brings up a message to notify you that "The device '<devicename>' can now be safely removed."

Click "Close" to confirm this message, then remove the USB storage device.

On your USB storage device, the folder and filename (with extension .trigger) of this file is

"<Drive>:\ospdata\Trigger.Configuration".

Here, <Drive> is the drive letter of the removable medium.

"Filename" Specifies the filename of your trigger settings file. In the example above, the filename is "Trigger.Configuration".

Remote command:

TRIGger:EXPort

Import Trigger Configuration ← Export/Import Trigger

Access: "Configuration" > "Trigger" tab > "Context Menu" > "Export/Import Trigger" > "Import Trigger Configuration"

Loads trigger settings from a previously exported file.

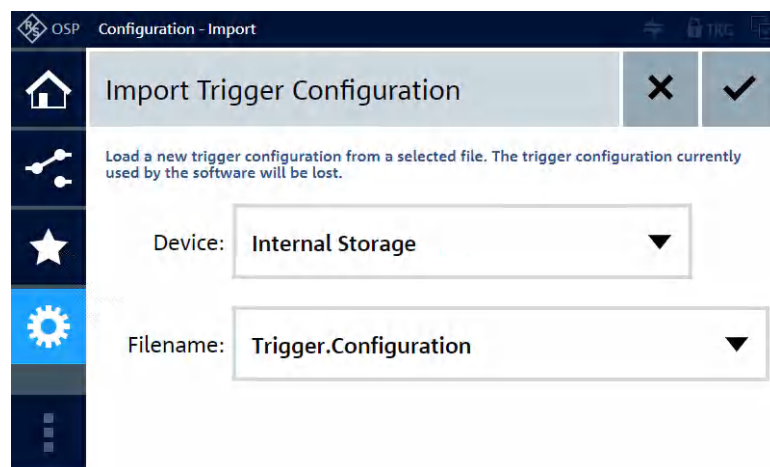

To load the selected file, click the "OK" button  in the top right corner of the dialog.

 Import Trigger Configuration

Note: Risk of losing trigger settings. Your importing action overwrites all current trigger settings in the switch unit's internal volatile memory with the settings in the imported file.

To avoid losing current trigger settings, consider saving these settings for later reference by [Export Trigger Configuration](#), before you import different trigger settings.

"Device" Selects the switch unit's "Internal Storage" (= default) or an external USB storage device. An external USB storage device is only available, if it is connected to one of the USB ports on the front or rear panel of the R&S OSP.
To remove an external USB storage device, use the eject button and proceed as described in the section "[Export Trigger Configuration](#)" on page 220.

"Filename" Selects the trigger settings file you want to import. The firmware offers only suitable settings files with the extension ".trigger", although this extension is not displayed.
If there is no ".trigger" file in the selected storage device, you cannot select a filename. Instead, the following message is shown:
"There are no files available on the selected storage device."

Remote command:

TRIGger:IMPort

TRIGger:IMPort:CATalog?

Delete Trigger Configuration File ← Export/Import Trigger

Access: "Configuration" > "Trigger" tab > "Context Menu" > "Export/Import Trigger" > "Delete Trigger Configuration File"

Prerequisite: a previously exported [trigger settings](#) file must be available.

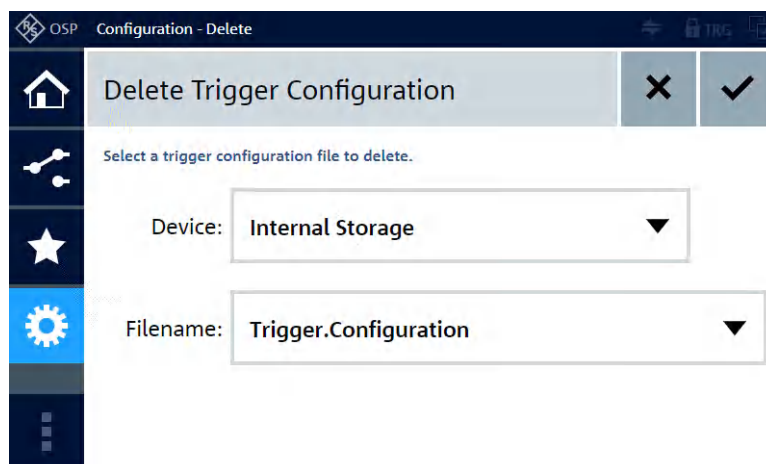

To delete the selected file, click the "OK" button in the top right corner of the dialog.

A warning comes up: "You have selected a trigger configuration file to delete. Do you really want to proceed?"

Confirm with "OK" or "Cancel" the deletion.

If there is no ".trigger" file in the selected storage device, you cannot select a filename. Instead, the following message is shown: "There are no files available on the selected storage device."



Delete Trigger
Configuration File

Remote command:

TRIGger:IMPorT:DELeTe

TRIGger:IMPorT:DELeTe:ALL

 Delete All
Secondary Devices

Delete All Secondary Devices

Access: "Configuration" > "Interconnection" tab > "Context Menu" > "Delete All Secondary Devices"

Only available, if at least 1 secondary switch unit is configured, and if you have selected the [Interconnection](#) tab in the "Configuration" menu.

To delete all configured secondary switch units, click the button "Delete All Secondary Devices".

A warning comes up: "Do you really want delete all configured secondary devices?"

Confirm with "OK" or "Cancel" the deletion.

Remote command:

CONFigure:FRAME:DELeTe:ALL

 Export/Import
Interconnection

Export/Import Interconnection

Access: "Configuration" > "Interconnection" tab > "Context Menu" > "Export/Import Interconnection"

Only available, if you have selected the [Interconnection](#) tab in the "Configuration" menu.

Provides functions for exporting or importing interconnection configurations and for deleting previously saved export files.

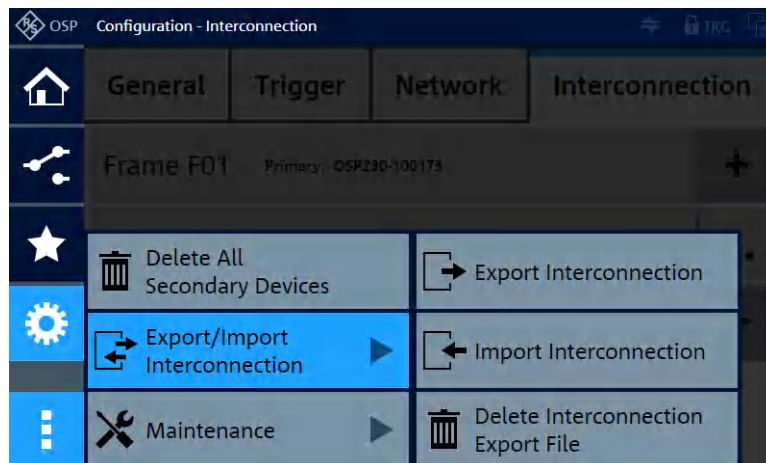

 Export Interconnection

Export Interconnection ← Export/Import Interconnection

Access: "Configuration" > "Interconnection" tab > "Context Menu" > "Export/Import Interconnection" > "Export Interconnection"

Saves your configuration of secondary switch units to a selected export file. The file includes the definitions of all secondary switch units in your interconnection setup (both in physical and virtual mode). If available, it also includes the secondary switch units' virtual module configurations.

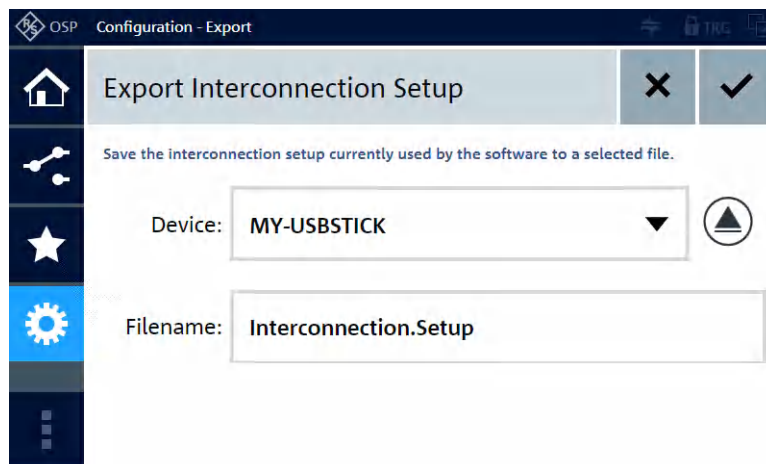

To save the file, click the "OK" button  in the top right corner of the dialog.

"Device"

Selects the storage device. Per default, if no external USB storage device is connected, the storage device is the "Internal Storage", which is the primary switch unit's flash memory in the SD card slot. If there is an external USB storage device, it becomes the default storage device.

To save the file on an external USB storage device, connect it to any of the switch unit's USB ports (front or rear), and select it, for example `<devicename> = "MY-USBSTICK"`.

After saving, before you remove this USB storage device, return to the same "Export Interconnection" dialog. Then once more select the external USB storage device in the "Device" selection field and click the eject button on the right-hand side of it:



The firmware brings up a message to notify you that "The device '`<devicename>`' can now be safely removed."

Click "Close" to confirm this message, then remove the USB storage device.

On your USB storage device, the folder and filename (with extension `.iconn`) of this file is

`"<Drive>:\ospdata\Interconnection.Setup.iconn"`.

Here, `<Drive>` is the drive letter of the removable medium.

"Filename"

Specifies the filename of your export file. In the example above, the filename is "Interconnection.Setup", where the extension `.iconn` is not shown.

Remote command:

`CONFigure:FRAME:EXPort`

Import Interconnection ← Export/Import Interconnection

Access: "Configuration" > "Interconnection" tab > "Context Menu" > "Export/Import Interconnection" > "Import Interconnection"

 Import Interconnection

Prerequisite: the data of a previously [exported](#) interconnection configuration must be available.

Loads an interconnection configuration from a selected export file into the switch unit's internal volatile memory. The file includes the definitions of all secondary switch units in your interconnection setup (both in physical and virtual mode). If available, it also includes the secondary switch units' virtual module configurations.

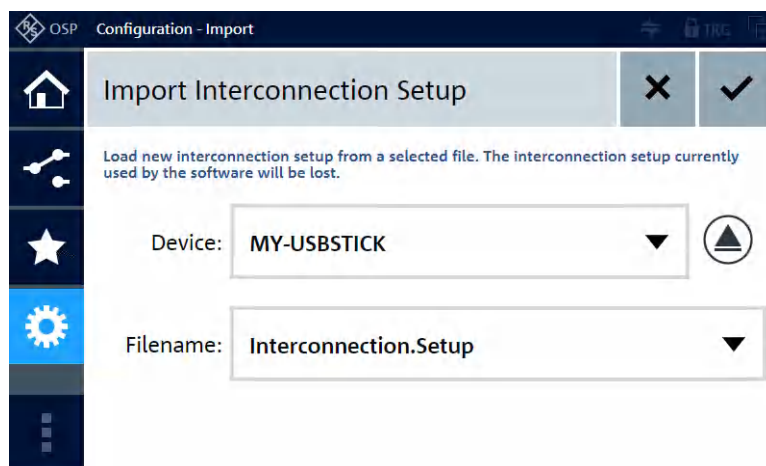

To load the selected file, click the "OK" button in the top right corner of the dialog.

Note: Risk of losing configurations. Your import overwrites all current secondary device configurations in the switch unit's internal volatile memory with the configurations in the imported file.

To avoid losing current configurations, consider saving these configurations for later reference by [Export Interconnection](#), before you import a different set of configurations.

"Device" Selects the switch unit's "Internal Storage" (= default) or an external USB storage device. An external USB storage device is available only, if it is connected to one of the USB ports on the front or rear panel of the R&S OSP.

To remove an external USB storage device, use the eject button and proceed as described in the section "[Backup Device](#)" on page 216.

"Filename" Selects the file you want to import. The firmware offers only suitable secondary device configurations files with the extension ".iconn", although this extension is not displayed. Legacy file extensions are still supported.

If there is no ".iconn" or legacy file in the selected storage device, you cannot select a filename. Instead, the following message is shown: "There are no files available on the selected storage device."

Remote command:

```
CONFigure:FRAMe:IMPort
```

```
CONFigure:FRAMe:IMPort:CATalog?
```

Delete Interconnection Export File ← [Export/Import Interconnection](#)

Access: "Configuration" > "Interconnection" tab > "Context Menu" > "Export/Import Interconnection" > "Delete Interconnection Export File"



Delete Interconnection
Export File

Prerequisite: the data of a previously [exported](#) interconnection configuration must be available.

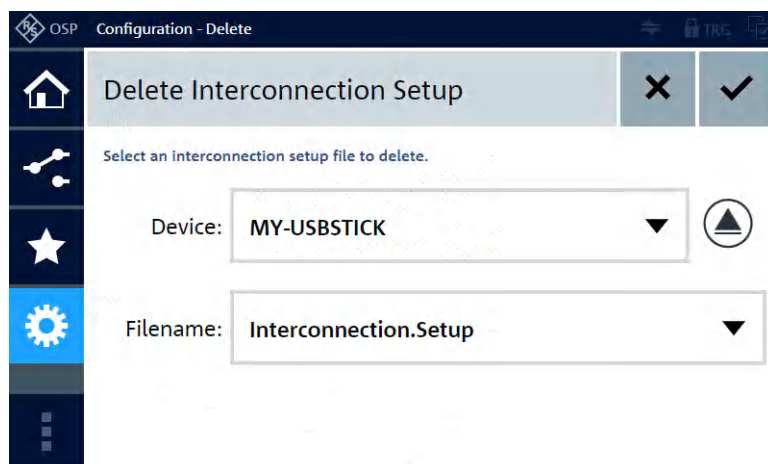

To delete the selected file, click the "OK" button in the top right corner of the dialog.

A warning comes up: "You have selected an interconnection configuration file to delete. Do you really want to proceed?"

Confirm with "OK" or "Cancel" the deletion.

If there is no ".iconn" or legacy file in the selected storage device, you cannot select a filename. Instead, the following message is shown: "There are no files available on the selected storage device."

Remote command:

```
CONFigure:FRAMe:IMPort:DELeTe
```

```
CONFigure:FRAMe:IMPort:DELeTe:ALL
```

6 Application Examples

- [Applications of Module R&S OSP-B103](#)..... 227
- [Applications of Module R&S OSP-B104](#)..... 231
- [Applications of Module R&S OSP-B114](#)..... 235

6.1 Applications of Module R&S OSP-B103



Figure 6-1: R&S OSP-B103

The [R&S OSP-B103 Digital I/O Module](#) with 16 input/output ports can be used to connect additional relays to the R&S OSP.

The following application supports EMI systems in measuring radiated spurious emissions of mobile phones and other equipment. These EMI systems need a series of notch filters to be switched during the measurement. Depending on the system design and due to the size of the notch filters, the relays are mounted close to the notch filters to keep the cable loss low. The module R&S OSP-B103 can be used to control these “remote relays” via the R&S OSP. The following chapter gives an example for such a solution.

The following example is shown for a maximum configuration. Check the R&S OSP-B103 version for maximum output current.

- [Controlling External Relays with R&S OSP-B103](#)..... 227
- [Input Ports of R&S OSP-B103](#)..... 230
- [Output Ports of R&S OSP-B103](#)..... 231

6.1.1 Controlling External Relays with R&S OSP-B103

The module R&S OSP-B103 has 16 output lines and 28 V DC power supply. The output lines are open-drain type and are switched to ground when activated.

The following table gives a short specification and recommendation of the preferred relay type to be used with the R&S OSP-B103.

Table 6-1: Brief specifications of preferred relay models

Switch type	Maximum frequency	Coil voltage / current	Recommended model
SPDT failsafe	18 GHz	24 .. 28 V DC / max 200 mA	Radiall 570 413 000
SP6T failsafe	18 GHz	24 .. 28 V DC / max 200 mA (positive common terminal)	Radiall 583 403 200
SPDT failsafe	40 GHz	24 .. 28 V DC / max 200 mA	Radiall 571 813 200
SP6T failsafe	40 GHz	24 .. 28 V DC / max 200 mA (positive common terminal)	Radiall 573 803 610

You can connect these relays, for example, as shown in Figure 6-2.

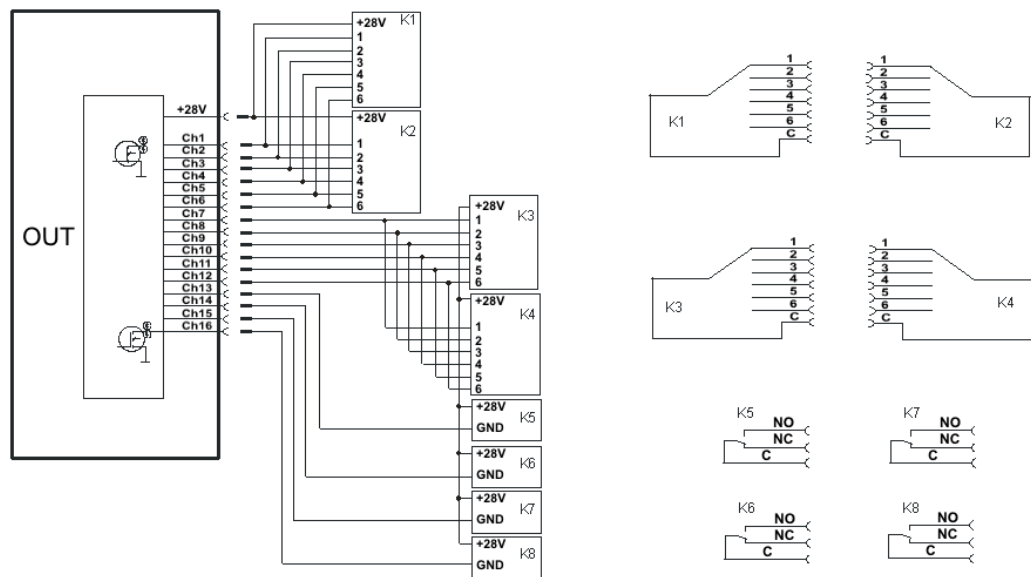

Figure 6-2: Block diagram of an application example with R&S OSP-B103

User interface functions for switching relays and handling paths are described in [Chapter 5.2, "Module Operation"](#), on page 166 and [Chapter 5.3, "Path Switching"](#), on page 181.



Risk of mismatch with SP6T relay

It is in your responsibility to take care that the SP6T switches always are set to one single terminal at the same time.

Not observing this rule causes a mismatch in the RF path, which can lead to erroneous measurements.

For the example in [Figure 6-2](#), set the following relay positions:

Relay No.	Position
K1 / K2	1
K3 / K4	1

Relay No.	Position
K7	NO
K8	NO

Creating a path configuration

1. Start the R&S OSP.

The touchscreen, an external display or your browser shows the user interface.

2. In the [Module Operation](#) dialog, select module R&S OSP-B103.

3. At "Module Operation" > "Context Menu", click "Reset all Switches".

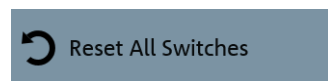

4. At "Module Operation" > "Context Menu" > "Path Selection", click "Deselect All".

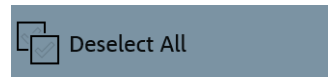

5. Enable the "Selection" button.

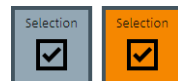

6. *Select* all channels "CH1" to "CH16".

7. Disable the "Selection" button.

8. *Enable* the output channels "CH1", "CH7", "CH15" and "CH16".

In the dialog, the channel states are as follows, with hexadecimal pattern *C041*:

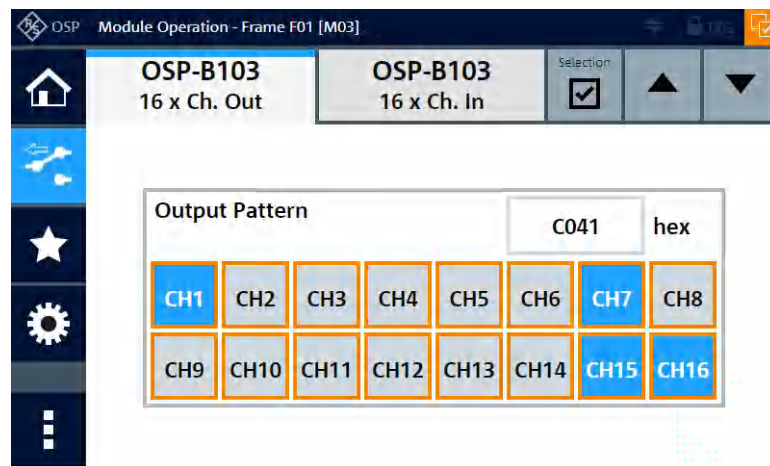

9. In the [Path Switching](#) dialog, select [Save As New Path](#).



10. In the dialog that opens, enter the path name *Path-1*.

The path is stored in the switch unit's volatile memory. It can be switched now via the "Path Switching" dialog in the user interface or via remote control commands, for example, from R&S EMC32 or R&S ELEKTRA, by calling "Path-1".

11. At "Path Switching" > "Context Menu" > "Export/Import Paths", click "Export Paths".

12. Enter a filename for your path configurations export file and click OK.

All currently defined paths are stored in the switch unit's flash memory.

Activating "Path-1" performs the following actions (regarding [Figure 6-2](#)):

- The activated OUT line "CH1" sets relays K1 and K2 to position 1.
- The activated OUT line "CH7" sets relays K3 and K4 to position 1.
- The activated OUT line "CH15" sets relay K7 to position NO.
- The activated OUT line "CH16" sets relay K8 to position NO.

6.1.2 Input Ports of R&S OSP-B103

The input ports of the module R&S OSP-B103 are designed for LVC (Low Voltage CMOS) logic, but can be operated with TTL level up to 5 V, as well.

Control circuits like the interlock loop in typical EMS test systems often use control voltages up to 28 V DC. You can connect the R&S OSP-B103 input to circuits with up to 28 V, if you observe the following point:

Do not **overload** the input: for voltages > 5 V DC up to 28 V DC, insert a **22 kΩ** resistor, see [Chapter 2.1.11, "Connecting Control Cables"](#), on page 22.

[Figure 6-3](#) shows an example for an input connection of the R&S OSP-B103 to external sources:

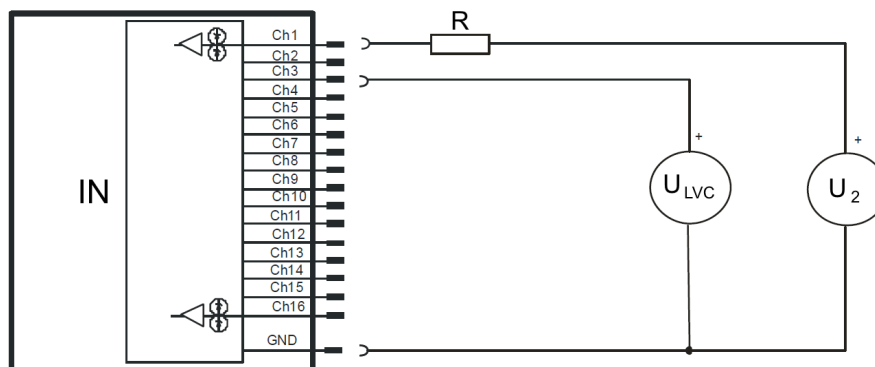

Figure 6-3: Block diagram of R&S OSP-B103 IN connector with external voltage sources (example)

- IN = D-Sub male 25-pin input connector
 R = Resistor in series, minimum 22 kΩ
 U_{LVC} = External source, 3.3 V DC (or maximum 5 V DC)
 U₂ = External source, 28 V DC

6.1.3 Output Ports of R&S OSP-B103

Each output channel is designed as a MOS-FET (open drain) that leaves the channel's pin on high impedance in the inactive state. When activated, the FET switches the pin to internal ground. Each output is protected by two TVS diodes against transient disturbances, which can occur when switching inductive loads such as relay coils.



Output current limits

- The output ports can draw a maximum of 200 mA, each.
- The R&S OSP can supply a maximum current of 600 mA to all OUT ports together.
- The maximum total current for all slots in the switch unit is 10 A.

6.2 Applications of Module R&S OSP-B104



Figure 6-4: R&S OSP-B104 (detail on the right: 3rd-party Spinner relays)

This chapter describes using the [R&S OSP-B104 Digital I/O Module \(EMS\)](#) with its input/output ports for the following applications in EMS systems:

- Controlling up to 4 high-power RF relays
- Monitoring an interlock loop that uses door switches and high-power relays
- Relaying the interlock status to any connected power amplifier
- Ancillary 4 input channels and 5 output channels for arbitrary use
- [Controlling External Power Relays with R&S OSP-B104](#).....231
- [Interlock Monitoring with R&S OSP-B104](#).....233
- [Input Ports of R&S OSP-B104](#).....234
- [Output Ports of R&S OSP-B104](#).....234

6.2.1 Controlling External Power Relays with R&S OSP-B104

The module R&S OSP-B104 has four connectors to control external power relays. The following relay models from Spinner GmbH are supported by this module:

Table 6-2: Brief specifications of preferred relay models

Model	Switch type	Maximum frequency	RF connectors	Operating voltage	Power rating
Spinner BN 640082	DPDT	2 GHz	4 × 1 5/8" EIA (f)	230 V AC	7 kW at 1 GHz
Spinner BN 512690	DPDT	5 GHz	4 × 7/16 (f)	24 V DC	2 kW at 1 GHz
Spinner BN 512698	DPDT	3.5 GHz	4 × 7/8 EIA (f)	230 V AC	1.5 kW at 1 GHz

Model **BN 512690C0002** replaces previous model BN 512670, model **BN 640082** replaces previous model BN 640075.

You can use other switches, if they are compatible with the output specifications of the control lines. Refer to the R&S OSP datasheet for details.



Make sure to define the delay time by `CONFigure:RELAy:DELAy`, as described in "Delay time" on page 72.

The relays mentioned in Table 6-2 are connected as shown in Figure 6-5.

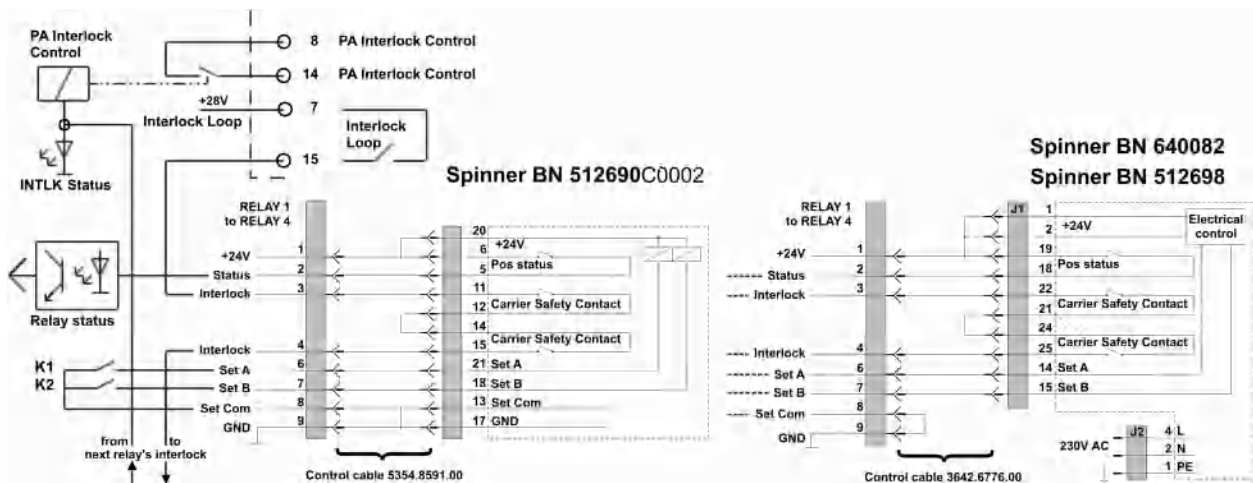

Figure 6-5: Connecting diagram for Spinner relays BN... to R&S OSP-B104

- Left = Overview of basic controls
- Right = Details of the Spinner relay connection plan, with a 9-pin relay port of the R&S OSP-B104 and some pins of the [IN / OUT] connector
- Relay status = Read-in via an optocoupler (isolated, potential-free)
- K1/K2 = Two printed relays in the module R&S OSP-B104, providing isolated potential-free contacts for controlling a Spinner relay (hence, four times K1/K2)



Wire jumpers (bridges) within relay connectors

- The interface connectors for **BN512690C0002** must provide bridges between pins **6 & 20** and **12 & 14** and **13 & 17** on the relay side (also bridging pins **8 & 9** at the R&S OSP-B104). The relay control cable with part no. 5354.8591.00 provides these bridges.
- The interface connectors for **BN640082** or **BN512698** must provide bridges between pins **8 & 9** on the R&S OSP-B104 side and between pins **1, 2 & 19** and **21 & 24** on the relay side. The relay control cable with part no. 3642.6776.00 provides these bridges.

These relay control cables are available via the Rohde & Schwarz [service](#).

6.2.2 Interlock Monitoring with R&S OSP-B104

Interlock monitoring with the module R&S OSP-B104 serves two purposes:

- Detect an open interlock circuit and inform a connected application software
- Relay this information to power amplifiers for deactivating their RF output

Connect pins 7 and 15 of the [IN / OUT] connector your door switch, as indicated in [Figure 6-6](#). Pins 3 and 4 of each [RELAY] port are connected to the external relay's carrier safety contacts. While a relay is turning, the connection between these two pins is interrupted, thus, opening the interlock loop.



If any of the four [RELAY] ports is not connected to an external relay, supply a bridge (in a dummy connector) between pin 3 and 4. Not doing so prevents functional operation of the interlock.

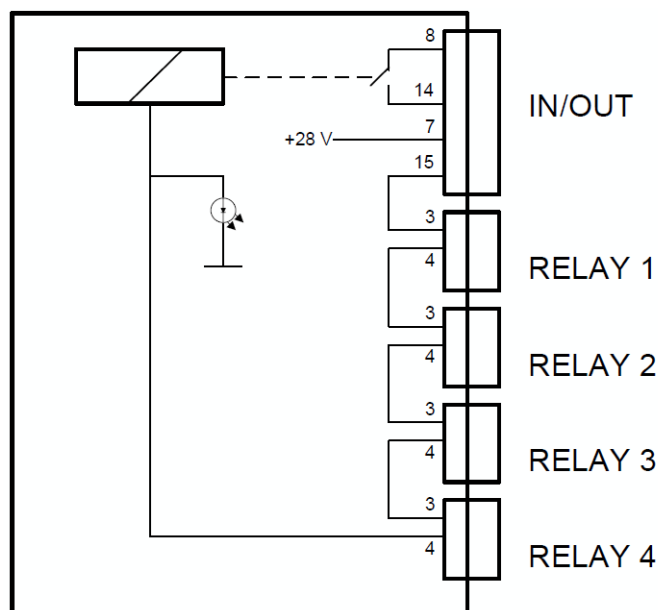

Figure 6-6: Internal wiring for monitoring a full interlock loop with R&S OSP-B104

If the interlock loop is closed, an internal relay bridges the pins 8 and 14 of the [IN / OUT] connector. Connect these pins to your power amplifier's interlock input. If the interlock-monitored door is opened, or if a power relay is turning (hence, not being in a safe position), this circuit shuts down RF power.

Refer to your application software's documentation for details on interlock control.

6.2.3 Input Ports of R&S OSP-B104

The module's dialog in the firmware and the SCPI command `READ:IO:IN?` can display and query the state of the input channels at any time.

The input ports of the module R&S OSP-B104 are designed for LVC (Low Voltage CMOS) logic, but can be operated with TTL level up to 5 V, as well.

Control circuits like the interlock loop in typical EMS test systems often use control voltages up to 28 V DC. You can connect the R&S OSP-B104 inputs to circuits with up to 28 V, if you observe the following point:

Do not **overload** the input: for voltages > 5 V DC up to 28 V DC, insert a **22 k Ω** resistor, see [Chapter 2.1.11, "Connecting Control Cables"](#), on page 22.

Each input channel is protected by a lowpass filter and two TVS diodes against transient disturbances.

6.2.4 Output Ports of R&S OSP-B104

Each output channel is designed as a MOS-FET (open drain) that leaves the channel's pin on high impedance in the inactive state. When activated, the FET switches the pin to internal ground. Each output is protected by two TVS diodes against transient disturbances, which can occur when switching inductive loads such as relay coils.



Output current limits

- The output ports can draw a maximum of 200 mA, each.
- The R&S OSP can supply a maximum current of 600 mA to all OUT ports together.
- The maximum total current for all slots in the switch unit is 10 A.

A typical application of these output ports is switching a lamp to indicate the state of an EMS measurement. For example, the lamp can illuminate a sign "Test in progress". If the lamp uses common 110 V or 230 V mains voltage, you must switch the power supply with an additional relay.

6.3 Applications of Module R&S OSP-B114



Figure 6-7: R&S OSP-B114

The [R&S OSP-B114 EMS Test Control Module](#) is designed for applications in small or medium systems for electromagnetic susceptibility (EMS) tests. The module fulfills the following tasks:

- Switching the output of up to two power amplifiers to one or two transmitting antennas (or other transducers)
- Providing the interlock-loop circuitry with the following functions:
 - Monitoring an interlock loop and reading or displaying its current state
 - Powering down external amplifiers, depending on the interlock's state
 - Disconnecting the signal generator from the power amplifier, if the amplifier cannot be powered down
- Controlling, for example, the position and polarization of transmitting antennas via the module's 4 output lines
- Monitoring application-specific system states via the module's 4 input lines

Together with other switch modules in the R&S OSP family, the module R&S OSP-B114 can perform all switching tasks in an EMS test system, as shown in the following examples.

- [Typical EMS Tests System Setup with R&S OSP-B114](#).....236
- [Switching a Signal Generator with R&S OSP-B114](#).....237
- [Interlock Circuitry with R&S OSP-B114](#).....237
- [I/O Ports of R&S OSP-B114](#).....238

6.3.1 Typical EMS Tests System Setup with R&S OSP-B114

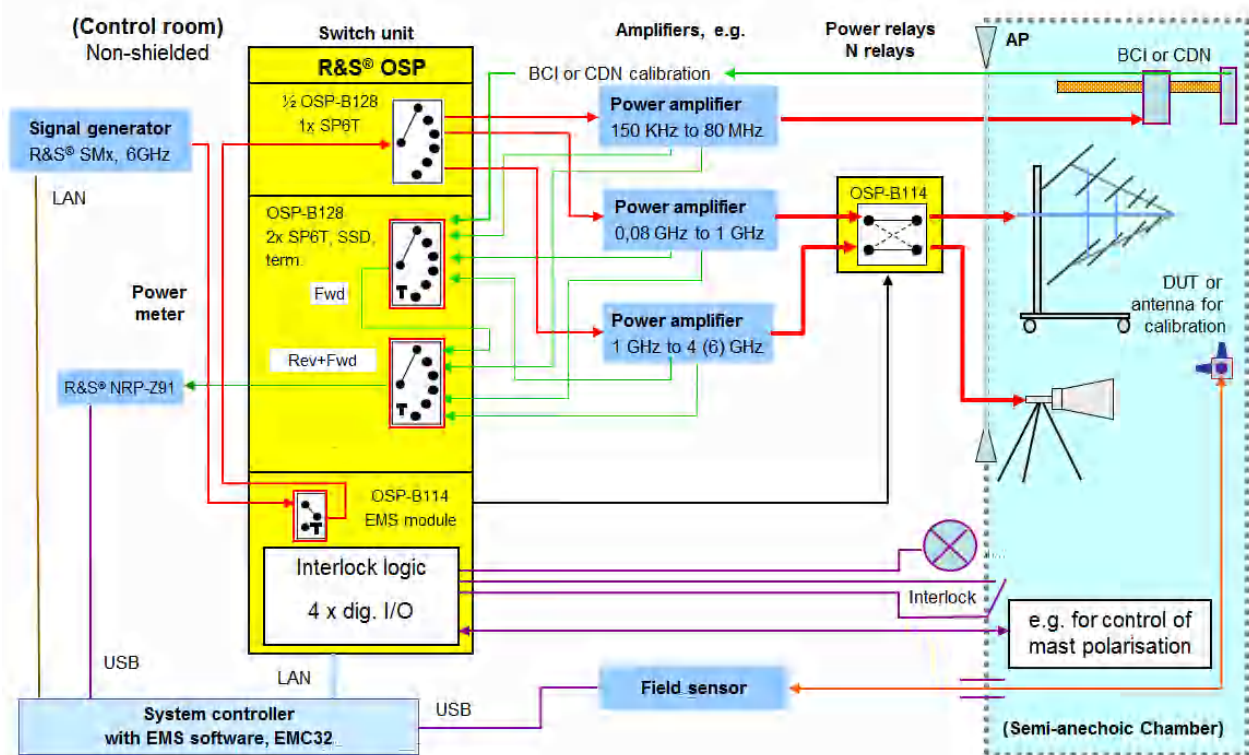

Figure 6-8: Example of an EMS tests system setup with switching functions

Device in the setup	Task of the R&S OSP switch unit
Signal generator	Switching the output of one generator to one out of three power amplifiers, for example: <ul style="list-style-type: none"> • One amplifier for conducted testing with BCI (Bulk Current Injection) clamp or CDN (Coupling / Decoupling Network) • Two amplifiers for radiated testing with log-periodic and horn antennas
Power amplifiers	Switching amplifier outputs to the required transducers in a semi-anechoic chamber
Power meter	<ul style="list-style-type: none"> • Switching of forward or reverse power from each of the three amplifiers to the monitoring power meter • Switching the conducted transducer's output to the power meter for calibration
Interlock	<ul style="list-style-type: none"> • Monitoring the door contact of the semi-anechoic chamber • Switching the power amplifier to standby, if the door is open • Optionally interrupting the signal path from signal generator to power amplifiers, if the amplifiers have no interlock security loop see • Displaying the interlock state in a remote location, for example, at the front side of the test rack
Antenna mast	Remotely controlling antenna position and polarization via the R&S OSP-B114 output ports and a suitable actuator interface

6.3.2 Switching a Signal Generator with R&S OSP-B114

The module R&S OSP-B114 has a terminated solid-state SPDT relay with SMA connectors.

Only if your power amplifiers have no interlock security loop, as described in [Chapter 6.3.3, "Interlock Circuitry with R&S OSP-B114"](#), on page 237, integrate this SPDT relay into the path from the signal generator to the power amplifier, as in [Figure 6-9](#).

The relay is controlled by the interlock loop. If the interlock loop is open, the relay is inactive and the signal generator's output is separated from the power amplifier's input. In this state, the relay can terminate the power amplifier input with 50 Ω .

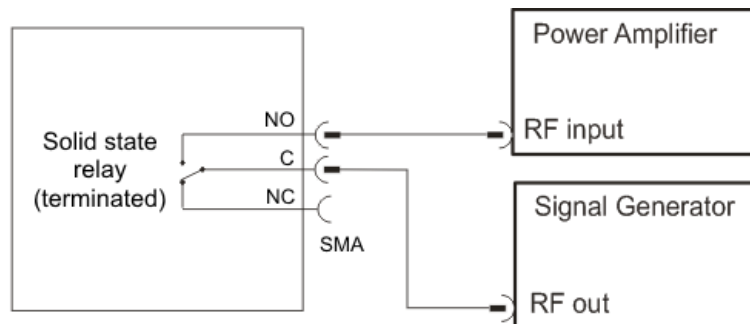

Figure 6-9: R&S OSP-B114 switches the path from signal generator to power amplifier

6.3.3 Interlock Circuitry with R&S OSP-B114

For setting up an EMS test system with interlock functionality, the module R&S OSP-B114 offers the following features:

- Interlock monitoring loop**
 The circuit between pin 6 (+28 V DC) and pin 2 (interlock loop) of the 9-pin D-Sub [IN] port connects to your door contact. If the door is closed, the interlock loop is closed. This logic controls the interlock output.
- Interlock output**
 The [IN] and [OUT] ports each have a relay with two floating "PA interlock control" contacts. If the interlock loop is closed, the relays bridge these contacts, which connect to the "interlock security loop" ports of up to two power amplifiers. Such security ports are a feature available in most power amplifiers. The interlock security loop must be closed to let your power amplifiers switch to operating mode.
- Interlock LED**
 When the interlock loop is closed, the [INTLK] LED on the R&S OSP-B114 front panel is off. When the door contact is opened and interrupts the interlock loop, the LED is turned on and shows red light.
 Also, you can connect an external LED to pin 3 and 9 of the 9-pin D-Sub [OUT] connector according to [Figure 6-10](#). Use a low-power LED that draws a current of up to 10 mA. A resistor for LED current limitation is already integrated in the R&S OSP-B114 module.

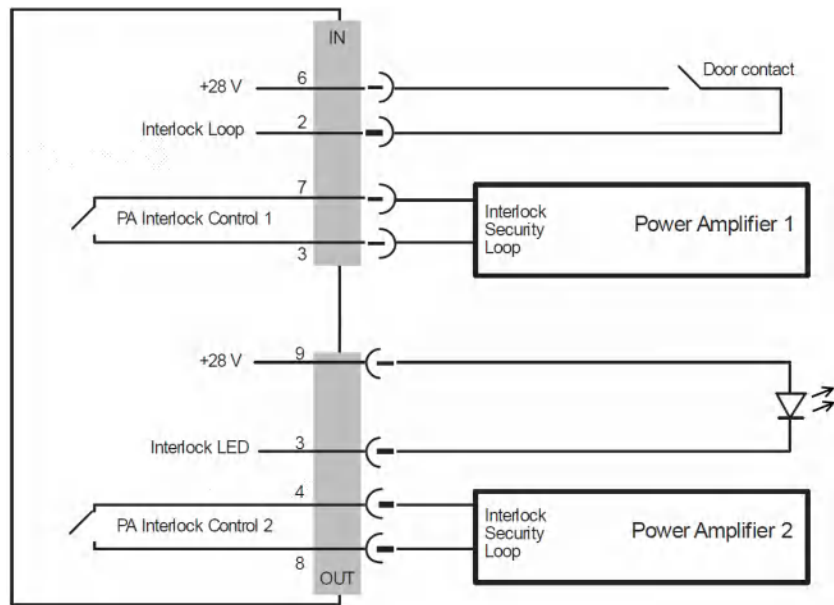

Figure 6-10: Interlock wiring with module R&S OSP-B114

6.3.4 I/O Ports of R&S OSP-B114

The module R&S OSP-B114 offers 4 input channels and 4 output channels. You can use these I/Os for any application-specific purpose, for example for monitoring additional door contacts (IN) and for remote control of antenna position and polarization (OUT).

[IN] port

The input channels of the module R&S OSP-B114 are designed for LVC (Low Voltage CMOS) logic, but can be operated with TTL level up to 5 V, as well.

Control circuits like the interlock loop in typical EMS test systems often use control voltages up to 28 V DC. You can connect the R&S OSP-B104 input to circuits with up to 28 V, if you observe the following point (see [Figure 6-3](#)):

Do not **overload** the input: for voltages > 5 V DC up to 28 V DC, insert a **22 kΩ** resistor, see [Chapter 2.1.11, "Connecting Control Cables"](#), on page 22.

[OUT] port

Each output channel of the module R&S OSP-B114 is designed as a MOS-FET (open drain) that leaves the channel's pin on high impedance in the inactive state. When activated, the FET switches the pin to internal ground. Each output is protected by two TVS diodes against transient disturbances, which can occur when switching inductive loads, such as relay coils.

**Output current limits**

- The output ports can draw a maximum of 200 mA, each.
- The R&S OSP can supply a maximum current of 600 mA to all OUT ports together.
- The maximum total current for all slots in the switch unit is 10 A.

7 Remote Operation

Besides operating the R&S OSP interactively, using the graphical interface on the touchscreen or in a web browser, you can also control the switch unit by SCPI commands from a remote PC. For the available commands, see [Chapter 8, "RC Commands"](#), on page 246. In many applications, test system software like [R&S EMC32](#) or [R&S ELEKTRA](#) sends the required commands for remote control operation. For testing individual SCPI commands, you can use the free scripting tool **R&S Forum**:

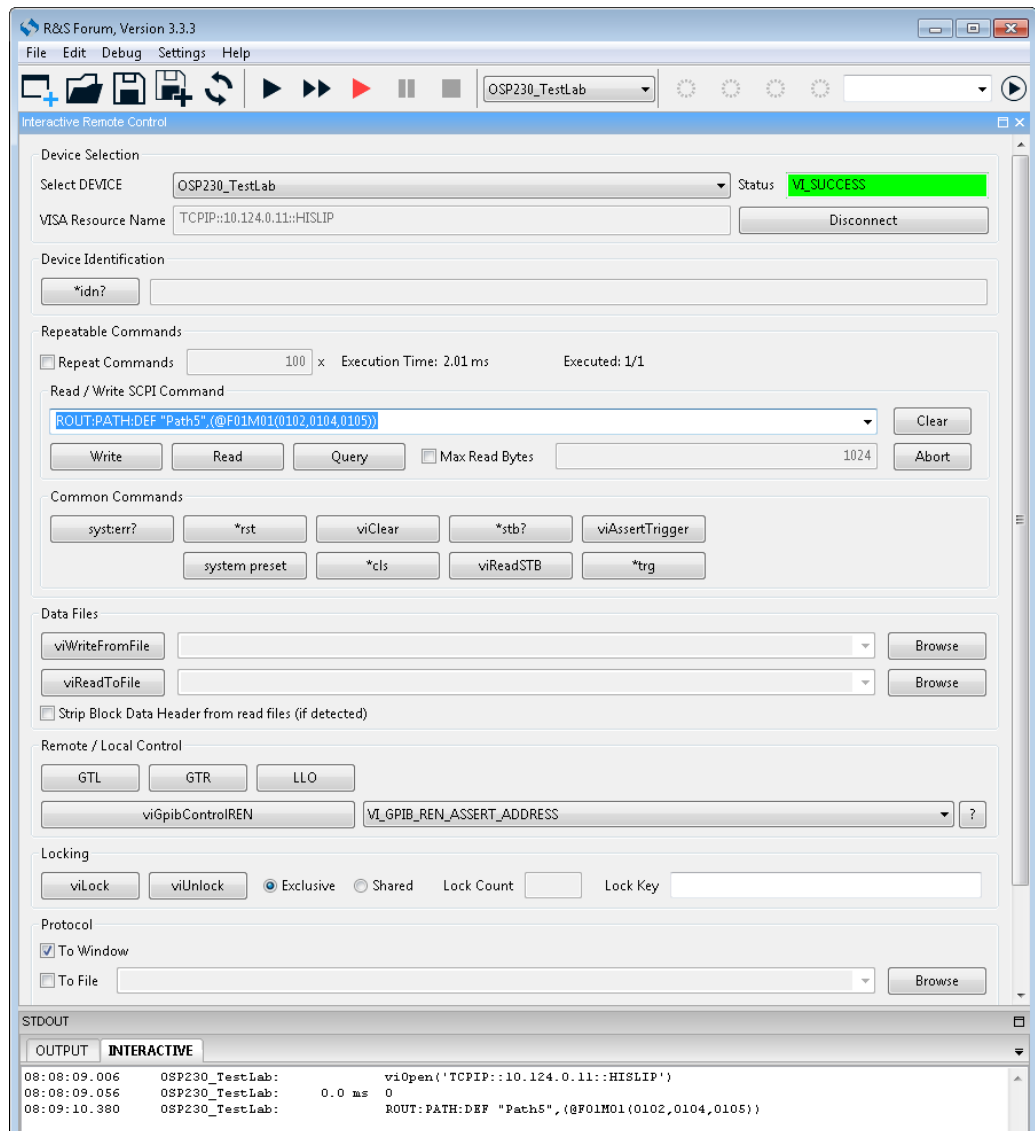

Figure 7-1: Remote control panel, available in R&S Forum by pressing [CTRL]+[Shift]+[I]

Menu > "Settings"	= Select "Instruments" to define the VISA resource address
"Select DEVICE"	= Select your switch unit
"Connect"	= Toggle "Connect" / "Disconnect" your device

"Read / Write" = Enter your SCPI command and send it with "Write", "Read" or "Query"
 "Remote / Local Control" = Select "GTL" (goto local), "GTR" (goto remote) or "LLO" (local lock-out)
 "Protocol" = Select "To Window" to see the protocol at "STDOUT" > "INTERACTIVE"



Only switch units that are in "Single" or "Primary" state can be remotely controlled. If a switch unit is in **Secondary** state, its SCPI interface is deactivated. Instead, secondary switch units are controlled by the primary switch unit, and optionally by remote commands to the primary switch unit.

Refer to the following information available on the internet:

- Resource for installing R&S Forum: www.rohde-schwarz.com/forum
Download and execute the file "RS_Forum_Setup_Win_x_x_x.exe".
- Application note "Using R&S Forum Application for Instrument Remote Control" at www.rohde-schwarz.com/appnote/1MA196
Download and read the file "1MA196_9e_RS_Forum_for_Instr_RC.pdf".
- Overview of [Remote Control and Instrument Drivers](#)
- Webinar training videos [R&S Instruments - Learn About Remote Control](#)
- RC command error codes are specified in the [1999 SCPI Command Reference](#), available for download at www.ivifoundation.org > [Specifications](#)

Remote operation vs. GUI operation

When you establish remote access to the switch unit, it changes into remote operation state. During remote operation, many **functions** in the graphical user interface (GUI) are disabled (similar to the **Lock Mode**).

The touchscreen display shows the remote operation state by the label "REMOTE" in the top left corner and by a double arrow in the top right corner:

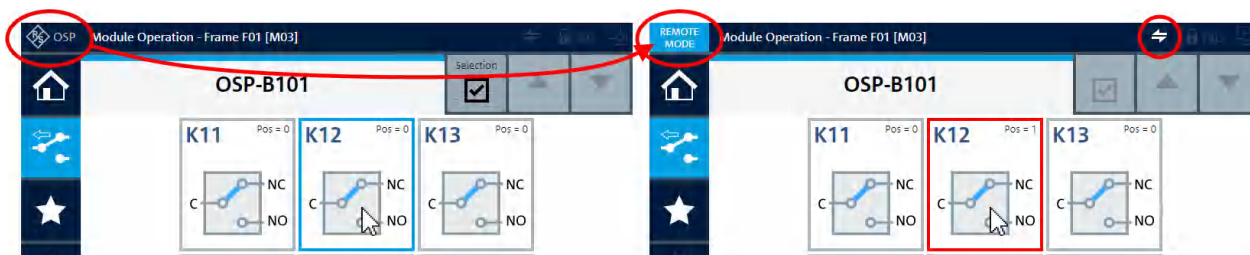

Figure 7-2: User interface operation is disabled during remote operation

Left = Switch unit is in local operation state
 Right = Switch unit is in remote operation state

If you click a relay or channel icon in the user interface (touchscreen or "WebGUI") during remote operation state, this state is indicated by a red instead of blue rectangle. It briefly highlights the relay, as shown on the right in [Figure 7-2](#).

The remote operation state also disables access to most context functions in the user interface:

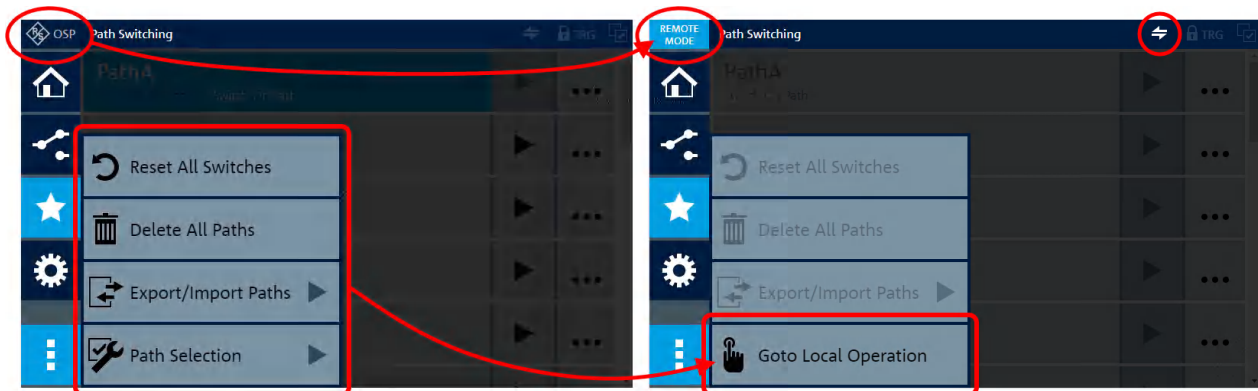

Figure 7-3: Most context functions are disabled during remote operation

Left = Switch unit is in local operation state

Right = Switch unit is in remote operation state

During remote operation, you **cannot execute** the following tasks in the user interface:

- Operate any relays or output channels
- Change any settings
- Save or load any device backups or switching paths

But you **can monitor** the state of the system in the user interface:

- Watch the states of all relays and I/O channels
- Retrieve information on your frames, modules and paths
- Use the functions [Device Information](#) and [Device Messages](#)

To terminate the remote operation mode and enable the user interface again, choose one of the following actions:

- In the remote control program, select "Disconnect" or "GTL" ("goto local") or an equivalent command
- In the local user interface, click "Context Menu" > "Goto Local Operation"



This button is available in the context menu **i** of each [main action button](#), as long as the switch unit is in remote operation state (GUI partly locked).

After returning to local operation, all functions of the switch unit are available locally in its user interface.

When the switch unit receives the next RC command, it automatically returns to remote operation state. Local operation is then locked, again.



LLO

Remote control programs like R&S Forum can set the switch unit to a "**Local Lock-out**" (LLO) state, which disables the "Goto Local Operation" button.

To terminate the LLO state, select GTR (goto remote) or GTL (goto local) in your remote control program. See "Remote / Local Control" in [Figure 7-1](#).

Commands are program messages that a controller (e.g. a PC) sends to an instrument or software. Commands operate an instrument's functions ('setting commands' or 'event commands') and request information ('query commands'). Some commands only work either way (setting only, query only), others work both ways (setting and query).

The syntax of a SCPI command consists of a header and usually one or more parameters. To use a command as a query, append a question mark after the last header element, even if the command contains a parameter.

A header contains one or more keywords, separated by a colon. Header and parameters are separated by a "white space" (ASCII code 0 to 9, 11 to 32 decimal, e.g. blank). If there is more than one parameter for a command, these parameters are separated by a comma from one another.



Remote command examples

Some remote command examples mentioned in this general introduction may not be supported by your particular application. See also [Chapter 9, "Programming Examples"](#), on page 298.

- [Long and Short Form](#)..... 243
- [Optional Keywords](#)..... 243
- [SCPI Parameters](#)..... 244

7.1 Long and Short Form

The keywords have a long and a short form. You can use either the long or the short form, but no other abbreviations of the keywords.

The short form is emphasized in uppercase letters. Note however, that this emphasis only serves the purpose to distinguish the short from the long form in the manual. For the instrument, the case does not matter.

Example:

CONFigure:POWerup:RESet is the same as CONF:POW:RES.

7.2 Optional Keywords

Some keywords are optional and are only part of the syntax because of SCPI compliance. You can include them or not. Optional keywords are emphasized with square brackets.

Example:

ROUTe:PATH[:DEFine] is the same as ROUTe:PATH.

7.3 SCPI Parameters

Many commands feature one or more parameters.

If a command supports more than one parameter, these parameters are separated by a comma.

- [Querying Numeric Values](#)..... 244
- [Boolean](#)..... 244
- [Character Strings](#)..... 244
- [Block Data](#)..... 244

7.3.1 Querying Numeric Values

When you query numeric values, the system returns a number.

Example:

```
CONFIGure:RELAY:DElay? (@F02M11(14))
```

Queries the delay time setting of external relay 14, connected to module M11 in switch unit F02. Return values are in the range of 0 to 255, equivalent with delay times of 0 ms to 12750 ms.

7.3.2 Boolean

Boolean parameters represent two states. The "ON" state (logically true) is represented by "ON" or a numeric value 1. The "OFF" state (logically untrue) is represented by "OFF" or the numeric value 0. When you query Boolean parameters, the system returns either the value 1 ("ON") or the value 0 ("OFF").

Example:

```
Setting: CONFigure:POWerup:RESet ON
```

```
Query: CONF:POW:RES? returns 1.
```

7.3.3 Character Strings

Strings are alphanumeric characters and must be in straight quotation marks. You can use a single quotation mark (') or a double quotation mark (").

Example:

```
ROUTE:PATH:DElete "config_03"
```

7.3.4 Block Data

Block data is a format which is suitable for the transmission of large amounts of data.

The ASCII character # introduces the data block. The next number indicates how many of the following digits describe the length of the data block. For example, in a string that starts with "#45168", the 4 digits after the number 4 indicate the length to be 5168 bytes. The data bytes follow. During the transmission of these data bytes all end or other control signs are ignored until all bytes are transmitted.

Example:

[MMEMory:DATA](#) on page 290

8 RC Commands

The remote control (RC) commands described in this chapter enable operating the R&S OSP in a remote environment. As a prerequisite, have the operative switch unit set up for remote operation in a network, as described in [Chapter 2.3.1.3, "Remote Operation by SCPI Commands"](#), on page 33.

Refer also to the general description in [Chapter 7, "Remote Operation"](#), on page 240.



Conventions used in SCPI command descriptions

Note the following conventions used in the remote command descriptions:

- **Command usage**
If not specified otherwise, commands can be used both for setting and for querying parameters.
If a command can be used for setting or querying only, or if it initiates an event, the usage is stated explicitly.
- **Parameter usage**
If not specified otherwise, a parameter can be used to set a value and it is the result of a query.
Parameters required only for setting are indicated as **Setting parameters**.
Parameters required only to refine a query are indicated as **Query parameters**.
Parameters that are only returned as the result of a query are indicated as **Return values**.
- **Conformity**
Commands that are taken from the SCPI standard are indicated as **SCPI confirmed**. All commands used by the R&S OSP follow the SCPI syntax rules.
- **Asynchronous commands**
A command which does not automatically finish executing before the next command starts executing (overlapping command) is indicated as an **Asynchronous command**.
- **Reset values (*RST)**
Default parameter values that are used directly after resetting the instrument (*RST command) are indicated as ***RST** values, if available.
- **Default unit**
The default unit is used for numeric values if no other unit is provided with the parameter.

The description of available RC commands is grouped in the following sections:

• Common Commands	247
• SYSTem Commands	250
• ROUTe Commands	252
• READ Commands	262
• CONFigure Commands	266
• TRIGger Commands	282
• MMEMory Commands	289

- [DIAGnostic Commands](#).....290
- [Legacy System Commands from R&S OSP1x0](#)..... 293
- [List of Remote Commands](#).....296

8.1 Common Commands

Common commands are described in the IEEE 488.2 (IEC 625-2) standard. These commands have the same effect and are employed in the same way on different devices. The headers of these commands consist of "*" followed by three letters. Many common commands are related to the Status Reporting System.

Available common commands:

*CLS	247
*ESE	247
*ESR?	247
*IDN?	248
*OPC	248
*OPT?	248
*PSC	248
*RST	249
*SRE	249
*STB?	249
*TRG	249
*TST?	249
*WAI	250

*CLS

Clear status

Sets the status byte (STB), the standard event register (ESR) and the `EVENT` part of the `QUESTIONABLE` and the `OPERATION` registers to zero. The command does not alter the mask and transition parts of the registers. It clears the output buffer.

Usage: Setting only

*ESE <Value>

Event status enable

Sets the event status enable register to the specified value. The query returns the contents of the event status enable register in decimal form.

Parameters:

<Value> Range: 0 to 255

*ESR?

Event status read

Returns the contents of the event status register in decimal form and then sets the register to zero.

Return values:

<Contents> Range: 0 to 255

Usage: Query only

***IDN?**

Identification

Returns the instrument identification.

Usage: Query only

***OPC**

Operation complete

Sets bit 0 in the event status register when all preceding commands have been executed. This bit can be used to initiate a service request. The query writes a "1" into the output buffer when all preceding commands have been executed, which is useful for command synchronization.

***OPT?**

Option identification query

Queries the options included in the instrument. For a list of all available options and their description, refer to the data sheet.

Note that this query returns only the software options implemented in your switch unit. To query for hardware options (installed modules), use the command [DIAGnostic:SERVICE:HWInfo?](#) on page 291.

Usage: Query only

Manual operation: See "[Device Information](#)" on page 159

***PSC <Action>**

Power on status clear

Determines whether the contents of the `ENABLE` registers are preserved or reset when the instrument is switched on. Thus a service request can be triggered when the instrument is switched on, if the status registers ESE and SRE are suitably configured. The query reads out the contents of the "power-on-status-clear" flag.

Parameters:

<Action> 0 | 1

0

The contents of the status registers are preserved.

1

Resets the status registers.

***RST**

Reset

Sets the instrument to a defined default status. The default settings are indicated in the description of commands.

Usage: Setting only

Manual operation: See "[Reset All Switches](#)" on page 158
See "[Path Info](#)" on page 198
See "[Trigger Activation](#)" on page 203

***SRE <Contents>**

Service request enable

Sets the service request enable register to the indicated value. This command determines under which conditions a service request is triggered.

Parameters:

<Contents> Contents of the service request enable register in decimal form.
Bit 6 (MSS mask bit) is always 0.
Range: 0 to 255

***STB?**

Status byte query

Reads the contents of the status byte in decimal form.

Usage: Query only

***TRG**

Trigger

Triggers all actions waiting for a trigger event. In particular, *TRG generates a manual trigger signal. This common command complements the commands of the TRIGger subsystem.

Usage: Event

Manual operation: See "[Trigger Activation](#)" on page 203

***TST?**

Self-test query

Initiates self-tests of the instrument and returns an error code.

Currently not implemented.

Return values:

<ErrorCode> **integer > 0 (in decimal format)**
 An error occurred.
0
 No errors occurred.

Usage: Query only

***WAI**

Wait to continue

Prevents servicing of the subsequent commands until all preceding commands have been executed and all signals have settled (see also command synchronization and [*OPC](#)).

Usage: Event

8.2 SYSTem Commands

SYSTem commands relate to setting global configurations, including reading and controlling the error/event queue.

For SCPI errors, see also [Troubleshooting](#) > "[SCPI error messages](#)" on page 302.

SYSTem:ERRor:[NEXT]?	250
SYSTem:ERRor:ALL?	251
SYSTem:PRESet	251
SYSTem:HELP:HEADers?	251
SYSTem:HELP:SYNTax?	251
SYSTem:HELP:SYNTax:ALL?	252
SYSTem:DATE	252
SYSTem:TIME	252
SYSTem:VERSiOn?	252

SYSTem:ERRor:[NEXT]?

Queries the error/event queue for the oldest item and removes it from the queue. The response consists of an error number and a short description of the error.

Positive error numbers are instrument-dependent. Negative error numbers are reserved by the SCPI standard.

Return values:

<Error> Error/event_number,"Error/event_description>[;Device-dependent info]"
 If the queue is empty, the response is 0, "No error"

Usage: Query only
 SCPI confirmed

Manual operation: See ["Device Messages"](#) on page 161
See ["Trigger Activation"](#) on page 203

SYSTem:ERRor:ALL?

Queries the error/event queue for all unread items and removes them from the queue. The response is a comma separated list of error number and a short description of the error in FIFO order.

Positive error numbers are instrument-dependent. Negative error numbers are reserved by the SCPI standard.

Return values:

<Error> List of: Error/event_number,"Error/event_description">[:Device-dependent info]"
If the queue is empty, the response is 0, "No error"

Usage: Query only
SCPI confirmed

Manual operation: See ["Device Messages"](#) on page 161

SYSTem:PRESet

Resets all switches and output channels in all modules (in [primary and secondary](#) switch units) to the deactivated state.

If the [Trigger](#) functionality is active, the system control first deactivates the trigger and then processes the reset.

The command is equivalent to `*RST`.

Usage: Setting only

Manual operation: See ["Reset All Switches"](#) on page 158
See ["Trigger Activation"](#) on page 203

SYSTem:HELP:HEADers?

Returns a string, separated by "\n", with all implemented SCPI commands and their usage. In the return string, "qonly" stands for "query only" usage of a command, while "nquery" means an event with "no query" usage. Commands without usage appendix can be used as setting or query.

Usage: Query only

SYSTem:HELP:SYNTax? <header>

Queries the syntax of a specified command.

Query parameters:

<header> Specifies the command for which you want to query the syntax.

Example: SYST:HELP:SYNT? "ROUT:CLOS"
 Response: "ROUTE:CLoSe[?] <expression>|<string>"

Usage: Query only

SYSTem:HELP:SYNTax:ALL?

Returns a string, separated by "\n", with all implemented SCPI commands and their parameter types. Types are, e.g., block data, boolean, char data, expression, integer, numeric value, string.

Usage: Query only

SYSTem:DATE

Sets or queries the year, month and day of the internal calendar. The date format is the comma-separated string <year>, <month>, <day>, with 4-digit year information.

The date command is not affected by a *RST command.

Take care [not to lose option licences](#) by a manipulation of the system date.

Manual operation: See "[System Date](#)" on page 201

SYSTem:TIME

Sets or queries the hour, minute and second of the internal clock. The time format is the comma-separated string <hour>, <minute>, <second> with integer seconds and 0 to 24 hours.

The time command is not affected by a *RST command.

Manual operation: See "[System Time](#)" on page 201

SYSTem:VERSion?

Queries the implemented SCPI version.

Always returns the value "1999.0", which represents SCPI version 1.0 of 1999.

Usage: Query only

8.3 ROUTe Commands

ROUTE commands provide signal routing capabilities for the R&S OSP and give access to all available relays and I/O channels.

ROUTE:CLoSe	253
ROUTE:PATH[:DEFine]	255
ROUTE:PATH:LAST?	257
ROUTE:PATH:CATalog?	257

ROUTE:PATH:DELeTe[:NAME].....	257
ROUTE:PATH:DELeTe:ALL.....	257
ROUTE:PATH:EXPort.....	258
ROUTE:PATH:IMPort.....	258
ROUTE:PATH:IMPort:CATalog?.....	259
ROUTE:PATH:IMPort:DELeTe.....	260
ROUTE:PATH:IMPort:DELeTe:ALL.....	260
ROUTE:ATTenuation.....	260
ROUTE:PHASe.....	261

ROUTE:CLOSe <channel list or path name>

Sets or queries the state of selected relays or I/O channels.

The query returns a "1" for each physical state of a queried relay or channel that is identical with the state specified in the channel list. If the physical state of a queried relay or channel differs from the state specified in the list, the query returns a "0".

Note that for failsafe (monostable) relays, the query returns the state of the control line, only, while for latched (bistable) relays, the query always reads the true physical switching state.

The parameter <channel list or path name> is also called the "**channel list string**". Its basic syntax is as follows:

(@FxxMyy(sssee))

Defines the channel list for just one relay or I/O channel, with the following parameters:

- **xx** = 01, 02, 03, ..., 99 (frame ID in, e.g., switch unit name F01)
- **yy** = 01, 02, 03, ..., 20 (module ID in, e.g., slot position M02)
 Note that the slot position is labeled with an "M", although in the hardware the actual positions are either FS (front slot) or RS (rear slot). Using "M" instead reflects the fact that the firmware can detect only to the motherboard connector, to which a module is connected. The actual front or rear mounting position is not detected. In a factory configuration, the correlation of slot positions and connectors follows the scheme in [Figure 2-26](#). If you mount modules yourself, we recommend using the same correlation.
 Also note that the modules are addressed by the syntax "M0x", as opposed to the syntax "A1x" that was used for the legacy switch units R&S OSP1x0. Setting commands accept both syntax versions, "M0x" or "A1x". For query commands, to change from one to the other syntax version, use the command `CONFigure:COMPAtible[:MODE]`.
- **sss** = 000 ... n (**s**tate of the element to be controlled in a module)
 The element can be a relay, an output channel or another [Switchable item](#). Some system-specific or customer-specific modules can have different elements.
 In the string "sss", you can omit leading zeros. Hence, "(@FxxMyy(sssee))" for double-digit states or "(@FxxMyy(see))" for single-digit states are permissible.
 The number of available states depends on the module type. Examples are 0 to 1 (for SPDT, DPDT and DP3T relays or I/O channels), 0 to 6 (for SP6T and 4P6T), or 0 to 8 (for SP8T). Some modules, for example the [R&S OSP-B104](#), use `sss` to set

a 3-digit state like the `delay time`. For details, refer to the description of the module.

- `ee` = 01 ... m (number of the element to be controlled in a module)
The number of available elements depends on the module type. Examples are 01 to 06 for the 6 SPDT relays in module [R&S OSP-B101](#) or 01 to 16 for the 16 output channels in module [R&S OSP-B103](#).

Some special modules also allow a different format, for example `eee`, if selecting the element requires 3 digits. For details, refer to the description of the module.

If you want to address a series of relays or channels in the command `ROUTe:CLOSe`, you can use one of the following concatenated syntax formats:

(@FxxMyy(ssee),FxxMyy(ssee),FxxMyy(ssee),...)

Sets selected relays or channels in selected modules of selected switch units to the specified state.

(In each element of the channel list, replace the parameters `xx`, `yy`, `ss` and `ee` with arbitrary numbers according to your needs.)

Or concatenate addressing several relays or channels within a selected module:

(@FxxMyy(sxex,syey,szez,...))

Sets several relays or channels (with numbers `ex`, `ey`, `ez`, ...) in one module to individual states (`sx`, `sy`, `sz`, ...). For example, `ROUT:CLOS (@F01M11 (0102, 0104, 0105))` sets relays 2, 4 & 5 to state 1.

(@FxxMyy(ssee:ssff))

Sets a continuous range of relays or channels in one module to the same state, with `ff` = `ee` + number of continuous relays. For example,
`ROUT:CLOS (@F01M11 (0101:0105))` is equal to `ROUT:CLOS (@F01M11 (0101, 0102, 0103, 0104, 0105))`.

Parameters for setting and query:

<channel list or path name> Channel list string as described above, specifying relays or channels and their states to be set or queried.
Instead of an explicit channel list string, you can use a "**path name**" (in quotation marks), previously defined by `ROUT:PATH`.

Return values:

<arg1> **1**
True, the relay or channel is in the state that is indicated in the channel list.
0
False, the relay or channel is not in the state indicated in the channel list.

Example:

Setting: `ROUT:CLOS (@F01M01 (0301), F01M02 (0602))`
This command has the following two effects in the switch unit with name "F01":
Sets relay 1 of the module in slot M01 to state 3.
Sets relay 2 of the module in slot M02 to state 6.

- Example:** **Query:** ROUT:CLOS? (@F01M01(0301),F01M02(0602))
Response: 1,0
 The return values "1,0" for this query command regarding the switch unit "F01" have the following meaning:
 "1": **Yes**, relay 1 of module M01 **is** in the queried state 3.
 "0": **No**, relay 2 of module M02 **is not** in the queried state 6.
- Example:** **Setting:** ROUT:CLOS "PathA"
 Sets the relays and channels as selected and defined in "PathA", see [ROUTe:PATH\[:DEFine\]](#).
- Example:** **Query:** ROUT:CLOS "PathB"
Response: 1,0,1,1,1,1,1
 If all return values are "1", all relays and channels selected and defined in "PathB" are in their target state.
 Any return value "0" indicates that the corresponding relay or channel is not in the defined target state.
- Manual operation:** See ["Show As List"](#) on page 193
 See ["Trigger Activation"](#) on page 203
 See ["Single"](#) on page 206

ROUTe:PATH[:DEFine] <path name>,<channel list>

ROUTe:PATH[:DEFine]? <path name>

ROUT:PATH:DEF or ROUT:PATH defines a path name and the channel-list string that can be replaced by this path name. A short path name can thus represent a long list of specific states of relays and I/O channels. Use [ROUTe:CLOSe](#) to switch a path.

The query returns the channel list that encodes the defined states for all relays and I/O channels in this path.

Note that in [Compatibility Mode](#), the query returns a string with syntax that differs from the channel list (see query example below).

Setting parameters:

<channel list> <expr>

List of relays and I/O channels and their states to be set, as described in [ROUTe:CLOSe](#) on page 253.

Parameters for setting and query:

<path name> String parameter to specify the name of the path to be defined or queried. Limited to a maximum of 35 characters.
 Write the path name in quotation marks. The firmware observes capitalization of the path name. For example, "path a" in lower case is not the same as "Path A" in upper and lower case.
 A newly defined path name only exists in the instruments internal volatile memory (RAM).
 At shutdown, all path definitions are saved permanently in the instrument's flash memory
 At startup, all saved path definitions are restored automatically.

All new path definitions, which you made since the last startup, are lost, if you switch off the device by the rear on/off switch. The same holds true, if you switch off the device by pushing the front [PWR] key for more than 10 seconds, or if the firmware crashes.

You can trigger immediate storing of all defined path names in the instrument's flash memory by using the command `ROUTE:PATH:EXPort`.

Example:

Setting: `ROUT:PATH:DEF "PathA", (@F01M03(0112))`
 Determines that path name `PathA` is equivalent to the channel list `(@F01M03(0112))`.
 The command `ROUT:CLOS (@F01M03(0112))` now equals the command `ROUT:CLOS "PathA"`. Both commands address the module at position "M03" in the switch unit with frame ID "F01" and set relay K12 to state 1.
 As in `ROUTE:CLOSE`, if you want to address series of relays or channels, you can use concatenated channel lists in path definitions.

Example:

Query: `ROUT:PATH:DEF? "PathA"`
Response (with compatibility disabled):
`(@F01M03(0112))`
 Returns the path definition with a channel list string in the same syntax as described for `ROUTE:CLOSE`.

Example:

Query: `ROUT:PATH:DEF? "PathA"`
Response (with compatibility enabled): `1300112`
 Returns the path definition with a special syntax compatible with the legacy switch units R&S OSP120/130/150. In this example, the 7 digits have the following meanings:
 The 1st digit (1) represents the frame ID, where 1 represents the primary switch unit ("F01"), while 2 represents the first secondary switch unit, hence "F02", and so on. Frame IDs beyond "F09" are represented by a 0.
 The 2nd digit (3) represents the module position in the switch unit, here: "M03". Module numbers beyond "M09" are represented by a 0.
 The 3rd, 4th and 5th digits (001) represent the relay state, here: set relay to state 1. (Note that the state of the delay time requires a 3-digit response.)
 The 6th and 7th digits (12) represent the number of the relay (or channel) to be set, here: relay number "K12". Note that a relay "K2", for example, is represented by 02 in the 6th and 7th digit.
 If the queried path name comprises the states of more than one relay or channel, the returned 7-digit information blocks are separated by a comma, each.

ROUTe:PATH:LAST?

Queries the name of the previously switched path.

If the previous switching action was based on [ROUTe:CLOSe](#) + channel list string (rather than a path name), the response is `<Individual Settings>`. After a `*RST` command, the response is `<Reset State>`.

In the main page of the switch unit's user interface, the line "Last Switched Path" (enabled by the [Path Info](#) setting or by `CONFigure:MAINinfo:PATH`) shows the same information as the response to `ROUT:PATH:LAST?`.

Return values:

`<path name>` See [ROUTe:PATH\[:DEFine\]](#) on page 255

Usage: Query only

Manual operation: See "[Path Info](#)" on page 198

ROUTe:PATH:CATalog?

Returns a list of all currently defined path names in the internal volatile memory of the switch unit.

The query addresses the default directory path `"/home/instrument/ospdata"` in the internal storage of the R&S OSP, unless you specify a different directory path, which is optional.

Return values:

`<list of path names>` Comma-separated list of path names, each in quotation marks.

Example: `ROUT:PATH:CAT?`
Response: `"config_01","config_02","config_03"`

Usage: Query only

ROUTe:PATH:DELeTe[:NAME] <path name>

Deletes the path specified by the `<path name>` parameter from the switch unit's internal volatile memory. If this path does not exist, the command has no effect.

Setting parameters:

`<path name>` See [ROUTe:PATH\[:DEFine\]](#) on page 255.

Example: `ROUT:PATH:DEL:NAME "config_03"`
Deletes the path with the name `config_03`.

Usage: Event

Manual operation: See "[Delete Path Export File](#)" on page 192

ROUTe:PATH:DELeTe:ALL

Deletes all previously defined paths from the switch unit's internal volatile memory.

Before you delete all paths, we recommend using the command `ROUTE:PATH:CATalog?` to query all currently defined path names.

Example: `ROUT:PATH:DEL:ALL`
After sending this command, the query `ROUTE:PATH:CATalog?` returns the response "" (= empty, no paths).

Usage: Event

Manual operation: See "Delete All Paths" on page 189
See "Delete Path Export File" on page 192

ROUTE:PATH:EXPort <export filename>

Stores a nonvolatile file in the compact flash memory of an R&S OSP by transferring it from the instrument's internal volatile memory. The stored file comprises all currently defined path configurations, see `ROUTE:PATH[:DEFine]`.

All path filenames have the extension ".path". Do not enter the extension when specifying a filename. A filename query does not return the extension.

For example, when you save the path file "gen-pa_1", it is saved as "gen-pa_1.path". A query returns this filename as "gen-pa_1", only.

The command `MMEM:STORe:STATe` is equivalent with `ROUT:PATH:EXP`.

Setting parameters:

<export filename> String parameter to specify the name of the file to be stored.

Example: `ROUT:PATH:EXP "mypathconfigs"`
Stores the file `mypathconfigs` in the flash memory.

Usage: Event

Manual operation: See "Export Paths" on page 190

ROUTE:PATH:IMPort <import filename>[,<import mode>]

Loads a set of path configurations from a file on the compact flash memory into the switch unit's internal volatile memory.

All path filenames have the extension ".path". Do not enter the extension when specifying a filename. A filename query does not return the extension.

For example, when you save the path file "gen-pa_1", it is saved as "gen-pa_1.path". A query returns this filename as "gen-pa_1", only.

If the specified file does not exist, a SCPI error is generated. You can query the error with `SYST:ERR?`. The result can be, for example:

```
-200,"Execution error;Restoring device from file /opt/ospn/
exportPath5.path failed,ROUTE:PATH:IMPort ""Path5"""
```

The **legacy** command `MMEM:LOAD:STATe` is equivalent with `ROUT:PATH:IMP`. However, `MMEM:LOAD:STATe` does not support the parameter `<import mode>`, which is used with `ROUT:PATH:IMP` to specify keeping or replacing the path definitions (see below).

Risk of losing settings:

Note that this command overwrites all current path definitions in the switch unit's internal volatile memory with the path definitions in the loaded file.

To avoid losing current path definitions, consider saving these definitions by `ROUTE:PATH:EXPort`, before you send the import command.

Setting parameters:

`<import filename>` String parameter to specify the name of the file to be loaded.

`<import mode>` KEEP | REPLace

Optional parameter that decides about keeping or replacing the currently existing path definitions, see [Keep existing](#). If the parameter is missing, the import is performed in "REPLace" mode.

KEEP

Amends the current path definitions in the switch unit's internal memory with the imported path definitions.

However, if you import paths that have the same names as existing paths in the memory, the imported paths overwrite the existing paths, even if you have specified to "KEEP" them.

REPLace

Discards the current path definitions in the switch unit's internal memory and replaces them with the imported path definitions.

*RST: REPLace

Example:

```
ROUT:PATH:IMP "mypathconfigs",KEEP
```

Loads the file `mypathconfigs.path` from the flash memory into the instrument's internal volatile memory, while keeping all current internal path definitions that have names different from the imported paths.

Usage: Event

Manual operation: See ["Import Paths"](#) on page 191

ROUTE:PATH:IMP:CATalog?

Returns the names of all switching path configuration files that are stored in the switch unit's flash memory.

All path filenames have the extension `".path"`. Do not enter the extension when specifying a filename. A filename query does not return the extension.

For example, when you save the path file `"gen-pa_1"`, it is saved as `"gen-pa_1.path"`. A query returns this filename as `"gen-pa_1"`, only.

The command `MMEMemory:CATalog?` is equivalent with `ROUT:PATH:IMP:CAT?`

Return values:

<list of filenames> Comma-separated list of filenames, each in quotation marks.

Example:

`ROUT:PATH:IMP:CAT?`

Response: "pathsavrcl", "mypathconfigs"

Usage:

Query only

ROUTE:PATH:IMP:DELete <delete filename>

Risk of losing settings: Removes the specified path configuration file from the switch unit's compact flash memory.

All path filenames have the extension ".path". Do not enter the extension when specifying a filename. A filename query does not return the extension.

For example, when you save the path file "gen-pa_1", it is saved as "gen-pa_1.path". A query returns this filename as "gen-pa_1", only.

If the specified file does not exist, a SCPI error is generated. You can query the error with `SYST:ERR?`. The result can be, for example:

```
-200,"Execution error;File does not exist.,ROUTE:PATH:IMP:DELete ""Path5"""
```

The command `MMEMemory:DELete` is equivalent with `ROUT:PATH:IMP:DEL`.

Setting parameters:

<delete filename> String parameter to specify the name of the file to be deleted.

Example:

`ROUT:PATH:IMP:DEL "mypathconfigs"`

Removes the file `mypathconfigs.path` from the flash memory.

Usage:

Event

ROUTE:PATH:IMP:DELete:ALL

Risk of losing settings: Removes all path configuration files from the switch unit's compact flash memory.

Before you delete all path configuration files, we recommend using the command `ROUTE:PATH:IMP:CATalog?` to query all currently defined path configuration files.

Usage:

Event

ROUTE:ATTenuation <channel list>

Sets or queries the level of attenuation, if a step attenuator is available in the module, for example in the [R&S OSP-B171H](#) and in the R&S OSP-B157WN.

Also, you can control attenuators by the standard command `ROUTE:CLOSE`, allowing joint control of attenuators and relays, and saving their target states in joint path definitions.

Similar to `ROUTE:CLOSE`, the parameter `<channel list>` uses the following syntax:

(@FxxMyy(sssee))

- **xx** = 01, 02, 03,...,99 (frame ID in, e.g., switch unit name F01)
- **yy** = 01, 02, 03,...,20 (module ID in, e.g., slot position M02)
- **sss** = 000 ... n (state of the attenuator to be controlled in a module)
- **ee** = 01 ... m (element number of the attenuator to be controlled)

For example, in the [R&S OSP-B171H](#):

- **sss** = 000 ... 015 (attenuator steps)
- **ee** = 01 ... 02 (attenuator number in module version .42)
ee = 01 ... 04 (attenuator number in module version .44)

Note that in the string "sss", you can omit leading zeros.

Parameters for setting and query:

`<channel list>` Channel list string as described above, selecting a module and attenuator and specifying the attenuation level to be set.
The query also requires the element number "ee", but it ignores the state information "sss". You can submit the value of "sss" as 000 (or any arbitrary 3-digit value), or you can omit it, entering only ee.
The range and interpretation of the state value **sss** depends on the specific attenuator used in the module. For details, refer to the module description.

Example: **Setting:** `ROUT:ATT (@F01M01(01102))`
Sets the step attenuator number 2 of the module in slot M01 in the switch unit with name "F01" to an attenuation level, which is encoded by the state 011.

Example: **Query:** `ROUT:ATT? (@F01M01(00001,00002,00003))`
Or shorter: `ROUT:ATT? (@F01M01(01,02,03))`
Response: 010,011,008
Returns the attenuation level states of the step attenuator elements 6, 7 and 8 of the module in slot M01 in the switch unit with name "F01". In this example, these attenuators are in states sss = 010, 127 and 234.

ROUTE:PHASE `<channel list>`

Sets or queries the phase angle, if a phase shifter is available in the module.

Also, you can control phase shifters by the standard command `ROUTE:CLOSE`, allowing joint control of phase shifters and relays, and saving their target states in joint path definitions.

Similar to `ROUTe:CLoSe`, the parameter `<channel list>` uses the following syntax:

(@FxxMyy(sssee))

- **xx** = 01, 02, 03,...,99 (frame ID in, e.g., switch unit name F01)
- **yy** = 01, 02, 03,...,20 (module ID in, e.g., slot position M02)
- **sss** = 000 ... n (state of the phase shifter to be controlled in a module)
- **ee** = 01 ... m (element number of the phase shifter to be controlled)

Note that in the string "sss", you can omit leading zeros.

Parameters for setting and query:

`<channel list>` Channel list string as described above, selecting a module and phase shifter and specifying the phase angle to be set. The query also requires the element number "ee", but it ignores the state information "sss". You can submit the value of "sss" as 000 (or any arbitrary 3-digit value), or you can omit it, entering only ee. The range and interpretation of the state value **sss** depends on the specific phase shifter used in the module. For details, refer to the module description.

Example: **Setting:** `ROUT:PHAS (@F01M01(09007))`
Sets the phase shifter number 7 of the module in slot M01 in the switch unit with name "F01" to a phase angle, which is encoded by the state 090.

Example: **Query:** `ROUT:PHAS? (@F01M01(00001,00002))`
Or shorter: `ROUT:PHAS? (@F01M01(01,02))`
Response: `090,270`
Returns the phase angle states of all phase shifters 1 and 2 of the module in slot M01 in the switch unit with name "F01". In this example, these phase shifters are in states `sss = 090` and `270`.

8.4 READ Commands

READ commands allow acquiring special data from switch units, for example, input channel states in I/O modules, interlock states, or total numbers of relay operation cycles.

<code>READ:IO:IN?</code>	262
<code>READ:MODule:INTerlock?</code>	264
<code>READ:RELAy:OPERations?</code>	265

READ:IO:IN? <module names>

Queries the states of all input channels of one or more selected modules.

The query applies only to modules that have I/O (input / output) channels. For example, the modules listed below have the following number of channels:

- **R&S OSP-B103:** 16 input channels

- [R&S OSP-B104](#): 4 input channels
- [R&S OSP-B114](#): 4 input channels

The return value is a set of single integer **decimal** numbers that represent the state of all queried input channels per module. Each integer is in the range of 0 to 65535:

- **0**: all channels are logical 0 or low
- **65535**: all channels (maximum 16) are logical 1 or high, where $65535 = 2^{16}-1$

When converted to a **binary** number, each 1 or 0 digit shows the state of one channel. This representation starts with the lowest digit for channel one, up to the highest digit for channel 16.

See also [READ:IO:IN4?](#), [READ:IO:IN5?](#) and [READ:IO:IN16?](#).

Query parameters:

<module names> (@FxxMyy,FxxMyy,FxxMyy,...)

Selects the modules that you want to query for their I/O channels.

Identify the modules by their frame IDs Fxx and module numbers Myy. For a description of these parameters, refer to [ROUTE:CLOSE](#).

Write the combined frame/module names FxxMyy, separated by commas, inside an expression of two brackets and the "@" sign. Do not use blank spaces or quotation marks in this expression.

Example: (@F01M01,F01M06,F02M03)

Only for querying *one single* module, you can use syntax without "(@...)", for example: F01M01

If a module that you specify does not exist or does not support READ:IO:IN? (having no input channels), the query returns no result and a SCPI error is generated. You can query the error with [SYST:ERR?](#).

For example, with a query READ:IO:IN? (@F01M06), the result can be:

```
-222,"Data out of range;Invalid index. frame F01:
no module connected to M06,READ:IO:IN? F01M06"
```

Or with a query READ:IO:IN? (@F01M03), the result can be:

```
-170,"Expression error;module on connector M03
does not support input channels,READ:IO:IN?
F01M03"
```

Return values:

<input channel values>

Comma-separated list of integer decimal numbers that represent the queried input channel states as described above.

Example:

```
READ:IO:IN? (@F01M02)
```

Return value: 4

The 16-bit binary equivalent of the value 4 is

0000 0000 0000 0100. Input channel 3 (one-based) of the I/O module at position M02 in the switch unit F01 is in the high state (1). All other channels are in the low state (0).

Example: `READ:IO:IN? (@F01M02,F02M05)`
 Return value: 3, 9
 The 16-bit binary equivalents are 0000 0000 0000 0011 and 0000 0000 0000 1001. Hence, input channels 1 and 2 of module M02 in switch unit F01 and input channels 1 and 4 of module M05 in switch unit F02 are in high state. All other channels are in low state.

Usage: Query only

READ:MODule:INTerlock? <module names>

Queries the interlock state of one or more selected modules.

The query applies only to modules that have an interlock, as in these modules:

- [R&S OSP-B104](#)
- [R&S OSP-B114](#)

Query parameters:

<module names> (@FxxMyy,FxxMyy,FxxMyy,...)

Selects the modules that you want to query for their interlock states.

Identify the modules by their frame IDs Fxx and module numbers Myy. For a description of these parameters, refer to [ROUTE:CLOSE](#).

Write the combined frame/module names FxxMyy, separated by commas, inside an expression of two brackets and the "@" sign. Do not use blank spaces or quotation marks in this expression.

Example: (`@F01M01,F01M06,F02M03`)

Only for querying *one single* module, you can use syntax without "`@...`", for example: `F01M01`

If a module that you specify does not exist or does not support `READ:MOD:INT?` (having no interlock functionality), the query returns no result and a SCPI error is generated. You can query the error with [SYST:ERR?](#).

For example, with a query `READ:MOD:INT? (@F01M06)`, the result can be:

```
-222,"Data out of range;Invalid index. frame F01:
no module connected to M06,READ:MOD:INT?
F01M06"
```

Or with a query `READ:MOD:INT? (@F01M03)`, the result can be:

```
-170,"Expression error;module on connector M03
does not support interlock,READ:MOD:INT?
F01M03"
```

Return values:

<interlock states> 0 | 1

Comma-separated list of "0 | 1" values that represent the interlock states.

0

The interlock of the queried module is in open state, no measurements can be made.

1

The interlock of the queried module is in closed state, measurements can proceed normally.

Example:

```
READ:MOD:INT? (@F01M02)
```

Return value "0": The interlock of module M02 in switch unit F01 is open.

Example:

```
READ:MOD:INT? (@F01M02, F02M05)
```

Return value "0, 1": The interlock of module M02 in switch unit F01 is open and the interlock of module M05 in switch unit F02 is closed.

Usage:

Query only

READ:RElAy:OPERations? <channel list>

Queries the internal switching counter, which acquires the total number of operation cycles of each relay (and even of I/O channels). The number of cycles is stored durable in the flash EEPROM of the module that the relay is part of.

Storing occurs after every hour of R&S OSP operation, but only if the number has changed. Besides this time-controlled storing, also the query command triggers storing the counter's value.

To make sure not to lose any operation cycle counts, we recommend sending the command `READ:REL:OPER?` before terminating a remote control session.

If the module that you specify does not have a switching counter, the query always returns the value "0" as the result.

For example, the following solid-state relay (SSR) modules and digital I/O modules have no switching counter:

- R&S OSP-B103
- R&S OSP-B107
- R&S OSP-B127
- R&S OSP-B128
- R&S OSP-B142

In the R&S OSP-B104 and R&S OSP-B114, only the electromechanical relay has a switching counter.

Query parameters:

<channel list>

<expr>

Specifies the relays and I/O channels to be read. For the channel list syntax, refer to [ROUTe:CLOSe](#) on page 253.

Return values:	
<switch counts>	The query returns a comma-separated string with a number for each relay or channel in the list, in the same order as the channel list is specified.
Example:	<pre>READ:REL:OPER? (@F01M03(0001,0002,0003,0004))</pre> <p>Return value: 100,100,100,100</p> <p>In their life, relays number 1 through 4 in module M03 of switch unit F01 each have closed and opened again a hundred times.</p>
Example:	<pre>READ:REL:OPER? (@F01M02(0001,0002,0003,0004))</pre> <p>Return value: 0</p> <p>In this case, module M02 of switch unit F01 consists of SSRs, which do not support counting of switching cycles.</p>
Usage:	Query only
Manual operation:	See " Module Information " on page 175

8.5 CONFigure Commands

CONFigure commands define LAN-based setups of several switch units in [primary](#) and [secondary](#) mode and configure all relevant instrument settings.

A newly defined setting only exists in the instruments internal volatile memory (RAM).

At shutdown, all settings are saved permanently in the instrument's flash memory.

At startup, all saved settings are restored automatically.

All new settings, which you made since the last startup, are lost, if you switch off the device by the rear on/off switch. The same holds true, if you switch off the device by pushing the front [PWR] key for more than 10 seconds, or if the firmware crashes.

CONFigure:POWERup:RESet.....	267
CONFigure:POWERup:PATH.....	267
CONFigure:MAINinfo:PATH.....	268
CONFigure:MAINinfo:TEXT.....	268
CONFigure:RELAy:DELAy.....	269
CONFigure:ALL:BACKup.....	270
CONFigure:ALL:RESTore.....	271
CONFigure:ALL:RESTore:CATalog?.....	271
CONFigure:ALL:RESTore:DELeTe.....	272
CONFigure:ALL:RESTore:DELeTe:ALL.....	272
CONFigure:COMPAtible[:MODE].....	273
CONFigure:VIRTual[:MODE].....	273
CONFigure:LOCK:MODE.....	274
CONFigure:FRAMe[:DEFine].....	274
CONFigure:FRAMe:ADD.....	275
CONFigure:FRAMe:INSert.....	276
CONFigure:FRAMe:CATalog?.....	277
CONFigure:FRAMe:DELeTe.....	278

CONFigure:FRAMe:DELeTe:ALL.....	279
CONFigure:FRAMe:EXPort.....	279
CONFigure:FRAMe:IMPort.....	280
CONFigure:FRAMe:IMPort:CAteLog?.....	280
CONFigure:FRAMe:IMPort:DELeTe.....	281
CONFigure:FRAMe:IMPort:DELeTe:ALL.....	281

CONFigure:POWerup:RESet <state>

Sets or queries the Power Up reset condition of switch modules with **latching** relays. This setting determines, how latching relays behave after booting the switch unit.

Note that this command does **NOT reset** the module **OSP B104**, which is designed for controlling *external* latching relays.

The following rules apply for identifying positions of **latching SPDT** relays:

- On the relays' front plates, the positions are labeled as **"2"** and **"1"**, with **"2"** being the default position
- In the graphical user interface (GUI), the positions are **"0"** and **"1"**, with **"0"** being the default position
- In a remote control command (SCPI), the positions are **"00"** and **"01"**, with **"00"** being the default value

Hence, if you take the front-plate port labels of a latching SPDT relay, subtract **"1"** to get the position values that the software uses for this relay.

The query returns the current reset condition.

Setting parameters:

<state>

1 | ON

At Power Up, the switch unit handles latching relays as follows:
It sets all latching **SPDT** relays to the default ports labeled **"2"**, which are represented in the software by position **"0"**.
It sets all latching **SPxT** relays to the open state.

0 | OFF

At Power Up, the switch unit leaves all latching relays keep their previous state.

Example:

```
CONF:POW:RES?
```

```
Response: 1
```

Here, the reset condition is **"1"**, equivalent with [Switch-On Reset](#) being enabled.

Manual operation: See ["Switch-On Reset"](#) on page 197

CONFigure:POWerup:PATH <path name>

Sets or queries the switch-on action that determines, which path (if any) is switched after booting the instrument.

This RC command is equivalent to the [Switch-On Action](#) in the [General](#) configuration dialog of the user interface.

The query returns the currently set switch-on action.

Setting parameters:

<path name> String parameter to specify the path name (see [ROUTE:PATH\[:DEFine\]](#)) of the path to be switched at power-up. If you specify a path name that does not exist, the command has no effect. If you specify an empty path name string (""), the "Switch-On Action" is set to "None". The switch unit does not switch any path after being booted.

Example: **Setting:** `CONF:POW:PATH "Path 3"`
Sets the switch unit to switch `Path 3` at power-up, if this path name exists.

Example: **Setting:** `CONF:POW:PATH ""`
Sets the switch unit to switch no path at power-up.

Example: **Query:** `CONF:POW:PATH?`
Return string: "", if [Switch-On Action](#) is "None", or name of the path to be switched at power-up.

Manual operation: See ["Path"](#) on page 198

CONFigure:MAINinfo:PATH <state>

Enables or disables displaying the "Last Switched Path" information in the "Main" page.

This RC command acts equivalent to the "Path Info" checkbox in the [General](#) settings dialog of the user interface.

The query `CONF:MAIN:PATH?` returns the state of this setting.

The query `ROUTE:PATH:LAST?` returns the information on the "Last Switched Path".

Setting parameters:

<state> **1 | ON**
Displaying the "Last Switched Path" is enabled.
0 | OFF
Displaying the "Last Switched Path" is disabled.

Manual operation: See ["Path Info"](#) on page 198

CONFigure:MAINinfo:TEXT <state>

Specifies or queries the text displayed as "Customer Text" in the "Main" page.

This RC command is equivalent to the [Customer Text](#) field in the [General](#) configuration dialog of the user interface.

Setting parameters:

<state> Specifies the content of the "Customer Info" field. Enter the content in parentheses.

- Example:** **Setting:** `CONF:MAIN:TEXT "EMC Test Rack 2"`
Writes the text *EMC Test Rack 2* into the "Customer Information" field.
- Example:** **Setting:** `CONF:MAIN:TEXT ""`
Removes the "Customer Information" field from the "Main" page.
- Example:** **Query:** `CONF:MAIN:TEXT?`
Return string: "EMC Test Rack 2"
Returns the content of the "Customer Info" field.
- Manual operation:** See "[Customer Text](#)" on page 198
-

CONFigure:RELAy:DELAy <channel list>

Sets or queries the command delay times for up to 4 external power-transfer relays connected to the [R&S OSP-B104 Digital I/O Module \(EMS\)](#). The delay determines the period of time, which is reserved for a relay to change its state. Note that these external relays require switching times that are significantly longer than in most other relays.

After receiving a [ROUTE:CLOSE](#) command for changing the state of a connected external relay, the module R&S OSP-B104 behaves as follows:

- It sends the switching pulse during this full period of time
- Then it queries the relay's current position
- If the current position differs from the target position, the module generates a SCPI error, which is available via [SYST:ERR?](#)
- Then it accepts the next command

You can set delay times to ensure that the switching process of external transfer relays is completed, before further commands are executed. If you modify a delay time, the new value is stored durable on the module's EEPROM memory.

Parameters for setting and query:

<channel list>

<expr>

List of external transfer relays (connected to module R&S OSP-B104) and associated delay times to be set or queried.

(@FxxMyy(sssee))

Defines the channel list for one relay with the following parameters:

FxxMyy: as described in [ROUTE:CLoSe](#) on page 253.

sss = 0 to 255. The digits in front of the last 2 digits (hence, the 1, 2 or 3 leading digits in the parenthesis) represent the 8-bit delay value. The adjustable delay time has a resolution of 50 ms and spans from 0 to 12.75 seconds (255 x 50 ms = 12750 ms). The default value 2 is equivalent to a delay time of 100 ms.

ee = 11, 12, 13, 14. The last 2 digits in the parenthesis represent the numbers ("names") of the relays (up to 4) that are connected to the R&S OSP-B104. The numeral offset of 10 distinguishes these relay numbers from the I/O channel numbers 01 to 04 on the same module.

Range: 0 to 255, equivalent with 0 ms to 12750 ms

Increment: 1 = 50 ms

*RST: 2 = 100 ms

For more channel list details, refer to the description of the [ROUTE:CLoSe](#) command.

Example:

Setting: CONF:REL:DEL (@F01M11(611:614))

All four relays (K11, K12, K13, K14) connected to the module at position M11 in the switch unit with ID F01 are configured to a delay time of 6 * 50 ms = 200 ms to change their states.

Example:

Query: CONF:REL:DEL? (@F01M11(11:14))

Return values: 4, 4, 4, 4

In the rear parenthesis of the query's channel list, enter only the two-digit relay names and omit any leading delay-value digits.

The [return values](#) are only the delay time settings of the queried relays. In this example, all delay times are 4 * 50 ms.

CONFigure:ALL:BACKUp <backup filename>

Saves all configuration settings to a backup file. These settings comprise the following:

- General configuration
- Network settings
- Trigger configuration (optional)
- Interconnection configuration
- Virtual configuration

All configuration filenames have the extension ".backup". Do not enter the extension when specifying a filename. A filename query does not return the extension.

For example, when you save the [Interconnection](#) definition file "settings-2018-10-25", it is saved as "settings-2018-10-25.backup". A query returns this filename as "settings-2018-10-25", only.

Setting parameters:

<backup filename> String parameter to specify the filename for the backup.

Usage: Event

Manual operation: See "[Virtual Configuration](#)" on page 178
See "[Backup Device](#)" on page 216

CONFigure:ALL:REStore <file to restore>

Loads a file previously saved as a backup of all settings (see [CONFigure:ALL:BACKup](#)) and uses it to overwrite the current settings.

All configuration filenames have the extension ".backup". Do not enter the extension when specifying a filename. A filename query does not return the extension.

For example, when you save the [Interconnection](#) definition file "settings-2018-10-25", it is saved as "settings-2018-10-25.backup". A query returns this filename as "settings-2018-10-25", only.

Risk of losing settings:

This command overwrites all current settings in the switch unit's internal memory with the settings in the loaded file.

To avoid losing current settings, consider saving these settings by [CONFigure:ALL:BACKup](#), before you send the restore command.

Setting parameters:

<file to restore> String parameter to select the backup file to be restored. The user interface ("WebGUI") shows only files that were saved in the default directory, hence, without specifying an additional file path.

Usage: Event

Manual operation: See "[Restore Device](#)" on page 217

CONFigure:ALL:REStore:CATalog?

Queries the names of all backup files that are stored in the switch unit's internal flash memory. Each of these backup files comprises a full set of switch unit settings.

All configuration filenames have the extension ".backup". Do not enter the extension when specifying a filename. A filename query does not return the extension.

For example, when you save the [Interconnection](#) definition file "settings-2018-10-25", it is saved as "settings-2018-10-25.backup". A query returns this filename as "settings-2018-10-25", only.

Return values:

<list of backup files> Comma-separated list of filenames, each in quotation marks. If no files exist, an empty string "" is returned.

Example:

```
CONF:ALL:REST:CAT?
```

Response:

```
"settings-2018-10-11", "settings-2018-10-25"
```

Usage:

Query only

Manual operation: See ["Restore Device"](#) on page 217

CONFigure:ALL:RESTore:DElete <delete filename>

Deletes a selected settings backup file from the switch unit's internal flash memory.

Use the command [CONFigure:ALL:RESTore:CATalog?](#) to query the list of available backup files.

All configuration filenames have the extension ".backup". Do not enter the extension when specifying a filename. A filename query does not return the extension.

For example, when you save the [Interconnection](#) definition file "settings-2018-10-25", it is saved as "settings-2018-10-25.backup". A query returns this filename as "settings-2018-10-25", only.

Setting parameters:

<delete filename> String parameter to select the backup file to be deleted. If this file does not exist, a SCPI error is generated. You can query the error with [SYST:ERR?](#). The result can be, for example:

```
-200, "Execution error;File does not exist.,CONF:ALL:REST:DElete  
"backup1""
```

Usage:

Event

Manual operation: See ["Delete Backup File"](#) on page 218

CONFigure:ALL:RESTore:DElete:ALL

Risk of losing settings: Removes all settings backup files from the switch unit's internal memory or from a removable flash memory.

Before you delete all settings backup files, we recommend using the command [CONFigure:ALL:RESTore:CATalog?](#) to query the currently defined settings backup files.

All configuration filenames have the extension ".backup". Do not enter the extension when specifying a filename. A filename query does not return the extension.

For example, when you save the [Interconnection](#) definition file "settings-2018-10-25", it is saved as "settings-2018-10-25.backup". A query returns this filename as "settings-2018-10-25", only.

Usage:

Event

Manual operation: See ["Delete Backup File"](#) on page 218

CONFigure:COMPAtible[:MODE] <state>

Enables or disables backward compatibility of some currently available RC commands with the syntax of previous firmware versions, used for the legacy switch units of the **R&S OSP1xx** family: R&S OSP120, R&S OSP130 and R&S OSP150.

The query returns the state of the compatibility mode.

Note that both the current and the deprecated RC commands always are interpreted correctly by the firmware, independent of your compatibility settings. However, a query like "ROUTE:CLOSE?" returns channel setting strings in the format "F01M01" with CONF:COMP = OFF and in the format "F01A11" with CONF:COMP = ON.

If the compatibility mode is enabled, the following commands are also available:

- [MME:LOAD:STATE](#) (new: [ROUTE:PATH:IMPort](#))
- [MME:STORE:STATE](#) (new: [ROUTE:PATH:EXPort](#))
- [ROUTE:MODule:CATalog?](#)

Note that some commands behave differently with or without the compatibility mode enabled. For example, [ROUTE:PATH:DEFine](#) as a setting accepts both syntax versions "F01M01" or "F01A11". But as a query, [ROUTE:PATH:DEFine?](#), sent without the compatibility mode enabled, returns the current syntax. On the contrary, with compatibility mode enabled, it returns the legacy syntax, described in section [ROUTE:PATH\[:DEFine\]](#) on page 255.

Setting parameters:

<state>

1 | ON

The set of RC commands is extended as listed above for backward compatibility with R&S OSP1xx legacy switch units.

0 | OFF

The firmware only accepts the standard set of RC commands. No additional commands are available to provide backward compatibility.

Example:

Setting: CONF:COMP ON

Enables the compatibility mode.

Example:

Query: CONF:COMP:MODE?

Return value: 1

The compatibility mode is enabled.

Manual operation: See ["Compatibility Mode"](#) on page 199

CONFigure:VIRTual[:MODE] <state>

Activates or deactivates the [Virtual Mode](#). The query returns the state of the virtual mode.

Setting parameters:

<state>

1 | ON

Activates the virtual mode.

0 | OFF

Deactivates the virtual mode.

Example: **Setting:** `CONF:VIRT 1`
Activates the virtual mode.

Example: **Query:** `CONF:VIRT?`
Return value: 1
The virtual mode is activated.

Manual operation: See "[Virtual Mode](#)" on page 201

CONFigure:LOCK:MODE <state>Enables or disables the [lock mode](#) or queries this mode.**Setting parameters:**

<state>

1 | ON

The switching of relays and the setting of output channels is locked.

0 | OFF

Relays and output channels are not locked.

Example: **Setting:** `CONF:LOCK:MODE ON`
Enables the lock mode.

Example: **Query:** `CONF:LOCK:MODE?`
Return value: 0
The lock mode is disabled.

Manual operation: See "[Lock Mode](#)" on page 174

CONFigure:FRAME[:DEFine] <frameId>,<configuredAddress>**CONFigure:FRAME[:DEFine]?** <frameId>

Defines how an existing [secondary](#) switch unit is addressed via LAN by the primary switch unit. To do so, the command selects a secondary switch unit by its IP address or hostname and allows you to set the frame ID of this secondary switch unit in the [Inter-connection](#) configuration of the primary switch unit.

Note that this command does not change the network settings or IP address of the primary or secondary device. It only defines the ID, by which a primary device addresses a secondary device.

The query returns the IP address of the secondary switch unit with the specified frame ID.

To query the full list of existing secondary switch units, use the command [CONFigure:FRAME:CATalog?](#).

Note that you can [add](#) or [insert](#) new secondary switch units with separate commands.

The current configuration is always saved automatically to the flash memory during the shutdown procedure and loaded at startup into the volatile memory.

To save a specific configuration of all frames to a separate file on the switch unit's compact flash memory, use the command `CONFigure:FRAMe:EXPort`.

Setting parameters:

`<configuredAddress>` Specifies the IP address or hostname, at which the secondary switch unit (selected by the `<frameId>`) is available via LAN. Use the address or hostname in quotation marks.

Parameters for setting and query:

`<frameId>` `<char_data>`

Selects the frame ID `Fxx` of the secondary switch unit that you wish to modify, starting with `F02` (note that the 1st secondary switch unit is the 2nd frame). Use the frame ID without quotation marks.

In a setting, if you use `F01` or a frame ID, for which no secondary switch unit is defined, a SCPI error is generated.

In a query, if you use `F01`, an empty response is returned. If you use a frame ID, for which no secondary switch unit is defined, a SCPI error is generated.

Example:

Setting: `CONF:FRAM:DEF F03, "100.224.0.203"`

Defines that the secondary switch unit available at the IP address `100.224.0.203` is used as the 2nd secondary switch unit, replacing an existing other connected switch unit that previously had the frame ID `F03`.

Example:

Query: `CONF:FRAM:DEF? F03`

Response: `"100.224.0.203"`

Returns the IP address or hostname of the secondary switch unit with the frame ID `F03`.

Manual operation: See "[Add Secondary](#)" on page 213

CONFigure:FRAMe:ADD `<configuredAddress>`

Adds an entry for a secondary switch unit at the end of the list of frame IDs in the switch unit's internal volatile memory.

The command assigns the next available frame ID to the new secondary switch unit.

Setting parameters:

`<configuredAddress>` Specifies the IP address or the hostname of the secondary switch unit that you want to add.

Example: `CONF:FRAM:ADD "100.224.0.215"`
 Adds the secondary switch unit available at the IP address 100.224.0.215 as a new secondary switch unit, with the next available frame ID. If no secondary switch unit exists, the new secondary switch unit gets the frame ID F02. For example, if three secondary switch units exist (hence, with frame IDs F02, F03 and F04), the newly added secondary switch unit gets frame ID F05.

Usage: Event

Manual operation: See ["Add Secondary"](#) on page 213

CONFigure:FRAME:INSert <frameId>,<configuredAddress>

Inserts an entry for a secondary switch unit ahead of an existing entry in the list of frame IDs in the switch unit's internal volatile memory.

Setting parameters:

<frameId> <char_data>
 Specifies the frame ID Fxx, at which the new secondary switch unit is to be inserted. The lowest accepted frame ID is F02. Existing frame IDs from this frame ID on are automatically **renumbered** (incremented by 1). If the specified frame ID is not yet defined, a SCPI error is generated.

<configuredAddress> Specifies the IP address or the hostname of the secondary switch unit that you want to insert.

Example: `CONF:FRAM:INS F03,"100.224.0.215"`
 Inserts the secondary switch unit available at the IP address 100.224.0.215 as the 2nd secondary switch unit (3rd frame = F03). The frame IDs of existing secondary switch units starting with F03 are incremented by 1. Hence, the previous F03 becomes F04, the previous F04 becomes F05, and so on. In this example, the existing 1st secondary switch unit (F02) remains unchanged.
 Note that the insertion of a secondary switch unit can impact your path definitions. For example, a path that includes modules in secondary switch unit F03 now addresses the *new 2nd secondary switch unit* instead of the *previous 2nd secondary switch unit*. This change can destroy the functionality of your path definitions - or it can be intentional.

Usage: Event

Manual operation: See ["Add Secondary"](#) on page 213

CONFigure:FRAMe:CATalog?

Returns a comma-separated configuration list of all "frames" (switch units in single state or in an interconnection setup) that are stored in the primary switch unit's volatile memory.

Use the command `CONFigure:FRAMe:EXPort` to save the configuration list to the switch unit's compact flash memory.

The configuration is also saved automatically to the flash memory during the shutdown procedure and loaded at startup into the volatile memory.

Return values:

<frame info list>

The information on **each** frame comprises the following information: **Fxx|Address|Status|TransmittedHostname**. In detail:

Fxx

Frame ID, where F01 is the primary switch unit, F02 is the 1st secondary switch unit, F03 is the 2nd secondary switch unit, and so on.

Address

IP address or configured hostname, as specified by `CONF:FRAM:DEF` or in the user interface ("WebGUI") at `Configuration > Interconnection > Edit Secondary > Address`:

No address is defined for the primary switch unit (F01). For the primary switch unit, the query returns an empty field in the response string.

For primary and secondary switch units that are in *Virtual Mode*, the query returns "Not available (virtual frame)" in this field.

Status

For example, "Single", "Primary", or in the secondary switch units: "Connected", "Broken" (secondary switch unit not available), "Refused" (when trying to configure another primary switch unit as a secondary switch unit).

TransmittedHostname

Hostname, if available, or "Not available (virtual frame)".

If no address or hostname is defined for an existing frame, for example due to an incomplete definition in the user interface ("WebGUI"), the query returns an empty field.

For example, the response can be

```
"F02||Invalid address|".
```

Example: `CONF:FRAM:CAT?`

Response string: "F01||Primary|OSP230-100173",
 "F02|100.224.0.203|Connected|OSP320-LAB2",
 "F03|100.224.0.231|Broken|",
 "F04|OSP230-100220|Refused|OSP230-100220"
 "Frame 01" is in "Primary Device" mode with hostname
 "OSP230-100173". It has no configured address within the inter-
 connection setup.
 "Frame 02" is secondary switch unit 1 in connected state with IP
 address 100.224.0.203 and hostname "OSP320-LAB2".
 "Frame 03" is secondary switch unit 2 with broken connection to
 IP address 100.224.0.231 and no transmitted hostname.
 "Frame 04" with hostname "OSP230-100220" refused connec-
 tion as secondary switch unit 3, because this switch unit is con-
 figured as a primary switch unit with its own secondary switch
 units.

Usage: Query only

CONFigure:FRAM:DELeTe <frameld>

Deletes the definition of a selected secondary switch unit from the primary switch unit's internal volatile memory.

Use the command `CONFigure:FRAM:CATalog?` to query the existing secondary switch unit definitions.

When you delete a secondary switch unit from an existing list of secondary devices, all following frame IDs of secondary switch units listed after the deleted device are automatically **renumbered** (decremented by 1). For example, if you delete a secondary switch unit with frame ID `F03`, the next remaining secondary device `F04` becomes secondary device `F03`, the next remaining secondary device `F05` becomes secondary device `F04`, etc.

Note that the deletion of a secondary switch unit can impact your path definitions, even if the deleted frame was not used for any path definitions. For example, consider a setup with 4 secondary devices (`F02` to `F05`). If you delete the 2nd secondary device (`F03`), a path that includes modules in the *previous 3rd secondary device* (`F04`) now addresses the *new 3rd secondary device*, which previously was the 4th secondary device (`F05`). This change can destroy the functionality of your path definitions - or it can be intentional.

Setting parameters:

<frameld> <char_data>

Selects the frame ID `Fxx` of the secondary switch unit you wish to delete, starting with `F02` (note that the 1st secondary switch unit is the 2nd frame). Use the frame ID without quotation marks.

- Example:** `CONF:FRAM:DEL F05`
 Deletes the definition of the 4th secondary switch unit (F05) from the primary switch unit's internal volatile memory. If no secondary switch unit with this frame ID exists, a SCPI error is generated. You can query the error with `SYST:ERR?`. The result can be, for example:
`-222,"Data out of range;invalid index;frame index too big (maximum frame index is F04), CONF:FRAM:DEL F05"`
- Usage:** Event
- Manual operation:** See "[Delete](#)" on page 214

CONFigure:FRAM:DELeTe:ALL

Deletes all currently defined secondary switch units from the primary switch unit's internal volatile memory.

Before you delete all secondary switch unit definitions, we recommend using the command `CONFigure:FRAM:CATalog?` to query all currently defined secondary switch units.

- Example:** `CONF:FRAM:DEL:ALL`
 After sending this command, the query `CONFigure:FRAM:CATalog?` returns only the primary switch unit.
- Usage:** Event
- Manual operation:** See "[Delete](#)" on page 214
 See "[Delete All Secondary Devices](#)" on page 223

CONFigure:FRAM:EXPort <export filename>

Stores the currently defined secondary devices configuration as a nonvolatile file in the compact flash memory of your primary switch unit. For configuring secondary switch units, see `CONFigure:FRAM[:DEFine]`.

All secondary switch unit configuration filenames have the extension ".iconn". Do not enter the extension when specifying a filename. A filename query does not return the extension.

For example, when you save the interconnection configuration file "subunit1", it is saved as "subunit1.iconn". A query returns this filename as "subunit1", only.

Setting parameters:

<export filename> String parameter to specify the name of the file to be stored.

- Example:** `CONF:FRAM:EXP "setup3frameconfigs"`
 Stores the file `setup3frameconfigs` in the flash memory.
- Usage:** Event
- Manual operation:** See "[Export Interconnection](#)" on page 223

CONFigure:FRAMe:IMPort <import filename>

Loads a secondary devices configuration file from the compact flash memory of your primary switch unit into its internal volatile memory. As a prerequisite, you must have exported such a file in advance, see [CONFigure:FRAMe:EXPort](#) on page 279.

All secondary switch unit configuration filenames have the extension ".iconn". Do not enter the extension when specifying a filename. A filename query does not return the extension.

For example, when you save the interconnection configuration file "subunit1", it is saved as "subunit1.iconn". A query returns this filename as "subunit1", only.

Legacy file extensions are still supported.

Risk of losing settings:

Note that this command overwrites the secondary switch units in the current frames configuration in the primary switch unit's internal memory with the secondary switch units configuration in the loaded file.

To avoid losing a current secondary switch units configuration, consider saving this configuration by [CONF:FRAM:EXP](#), before you send the import command.

Setting parameters:

<import filename> String parameter to specify the name of the file to be loaded.

Example: `CONF:FRAM:IMP "setup3frameconfigs"`
Loads the file `setup3frameconfigs` from the flash memory into the volatile memory.

Usage: Event

Manual operation: See "[Import Interconnection](#)" on page 224

CONFigure:FRAMe:IMPort:CATalog?

Returns the names of all secondary device configuration files that are stored in the switch unit's flash memory.

All secondary switch unit configuration filenames have the extension ".iconn". Do not enter the extension when specifying a filename. A filename query does not return the extension.

For example, when you save the interconnection configuration file "subunit1", it is saved as "subunit1.iconn". A query returns this filename as "subunit1", only.

Return values:

<list of filenames> Comma-separated list of filenames, each in quotation marks.

Example: `CONF:FRAM:IMP:CAT?`
Response:
`"setup2frameconfigs", "setup3frameconfigs"`

Usage: Query only

Manual operation: See "[Import Interconnection](#)" on page 224

CONFigure:FRAMe:IMPorT:DELeTe <filename>

Risk of losing settings: Removes the specified interconnection configuration file from the primary switch unit's compact flash memory.

All secondary switch unit configuration filenames have the extension ".iconn". Do not enter the extension when specifying a filename. A filename query does not return the extension.

For example, when you save the interconnection configuration file "subunit1", it is saved as "subunit1.iconn". A query returns this filename as "subunit1", only.

Legacy file extensions are still supported.

Setting parameters:

<filename> String parameter to specify the name of the file to be deleted. If this file does not exist, a SCPI error is generated. You can query the error with `SYST:ERR?`. The result can be, for example:
-200,"Execution error;File does not exist.,CONF:FRAM:IMP:DEL ""setup3frameconfigs"""

Example: CONF:FRAM:IMP:DEL "setup3frameconfigs"
Removes the file "setup3frameconfigs" from the memory.

Usage: Event

Manual operation: See "[Delete Interconnection Export File](#)" on page 225

CONFigure:FRAMe:IMPorT:DELeTe:ALL

Risk of losing settings: Removes all interconnection configuration files from the primary switch unit's compact flash memory.

Before you delete all secondary switch unit configuration files, we recommend using the command `CONF:FRAM:IMP:CAT` to query all currently defined interconnection configuration files.

All secondary switch unit configuration filenames have the extension ".iconn". Do not enter the extension when specifying a filename. A filename query does not return the extension.

For example, when you save the interconnection configuration file "subunit1", it is saved as "subunit1.iconn". A query returns this filename as "subunit1", only.

Legacy file extensions are still supported.

Usage: Event

Manual operation: See "[Delete Interconnection Export File](#)" on page 225

8.6 TRIGger Commands

The following commands provide remote control of your switch unit's trigger functionality, described in [Chapter 5.4.2, "Trigger"](#), on page 201.



Some modules are not triggerable, for example R&S OSP-B102L and R&S OSP-B112UL, due to their multi-position latching relays. For detailed information on compatibility of your modules with the trigger functionality, refer to the [Module Information](#) dialog or to the data sheet.

TRIGger:TYPE.....	282
TRIGger:STATe.....	283
TRIGger:EXECute.....	283
TRIGger:COUNT[:VALue]?.....	283
TRIGger:COUNT:OVERflow?.....	284
TRIGger:EXPort.....	284
TRIGger:IMPort.....	284
TRIGger:IMPort:CATalog?.....	285
TRIGger:IMPort:DELeTe.....	285
TRIGger:IMPort:DELeTe:ALL.....	286
TRIGger:INDex?.....	286
TRIGger:SEQUence:DEFine:LENGth.....	287
TRIGger:SEQUence:DEFine[:ENTRy].....	287
TRIGger:SEQUence:DEFine:ALL.....	287
TRIGger:SIGNal:LEVel.....	287
TRIGger:SIGNal:SLOPe.....	288
TRIGger:SIGNal:TERMination.....	288

TRIGger:TYPE <mode>

Selects or queries the trigger type.

Parameters:

<mode>

SINGLE

Selects the trigger type "Single".

TOGGLE

Selects the trigger type "Toggle A-B".

SEQUENCED

Selects the trigger type "Sequenced".

ADDRESSSED

Selects the trigger type "Addressed".

Example:

Setting: TRIG:TYPE SEQ

Query: TRIG:TYPE?

Reply: SEQ

Manual operation: See ["Single"](#) on page 206
 See ["Toggle A-B"](#) on page 206
 See ["Sequenced"](#) on page 207
 See ["Addressed"](#) on page 207

TRIGger:STATe <state>

Sets or queries the activation state of the trigger functionality.

Parameters:

<state>

OFF

Deactivates the trigger functionality. The command does not accept "0" instead of "OFF".

ON

Activates the trigger functionality. The command does not accept "1" instead of "ON".

*RST: OFF

Example:

Setting: TRIG:STAT OFF

Query: TRIG:STAT?

Reply: OFF

Manual operation: See ["Trigger Activation"](#) on page 203

TRIGger:EXECute <event>

Sends a software trigger event or resets the trigger sequence.

Parameters:

<event>

TRIGger

TRIG:EXEC TRIG sends software trigger event, equivalent with the ["Manual Trigger"](#).

RESet

TRIG:EXEC RES resets the sequence of the [Sequenced](#) trigger.

Usage:

Event

Manual operation: See ["Trigger Activation"](#) on page 203

TRIGger:COUNt[:VALue]?

Queries the trigger count, hence the number of executed trigger events since the last activation of the trigger functionality.

Example:

Query: TRIG:COUN?

Reply: 0

*TRG

*TRG

*TRG

Query: TRIG:COUN?

Reply: 3

Usage: Query only

Manual operation: See "[Trigger Activation](#)" on page 203

TRIGger:COUNT:OVERflow? <true>

Queries, if a trigger overflow has happened since the last activation of the trigger functionality.

If the trigger input connectors of the switch unit receive input signals faster than the firmware can process, it cannot count all trigger events, and it cannot update the trigger counter correctly.

You can use the command to check, if this case has occurred since the last trigger activation.

Example: Query: TRIG:COUN:OVER?
 Reply 0 means: No overflow since the last trigger activation.
 Reply 1 means: At least one overflow since the last trigger activation.

Usage: Query only

Manual operation: See "[Trigger Activation](#)" on page 203

TRIGger:EXPort <export filename>

Stores the currently defined trigger configuration as a nonvolatile file in the compact flash memory of your primary switch unit.

Setting parameters:

<export filename> String parameter to specify the name of the file to be stored.

Example: TRIG:EXP "sequencedtrig2"
 Stores the file `sequencedtrig2` in the flash memory.

Usage: Event

Manual operation: See "[Export Trigger Configuration](#)" on page 220

TRIGger:IMPort <import filename>

Loads a trigger configuration file from the compact flash memory of your primary switch unit into its internal volatile memory. As a prerequisite, you must have exported such a file in advance, see [TRIGger:EXPort](#) on page 284.

All trigger configuration filenames have the extension ".trigger". Do not enter the extension when specifying a filename. A filename query does not return the extension.

For example, when you save the trigger configuration file "trg42", it is saved as "trg42.trigger". A query returns this filename as "trg42", only.

Risk of losing settings:

Note that this command overwrites the current trigger configuration in the primary switch unit's internal memory with the trigger configuration in the loaded file.

To avoid losing a current trigger configuration, consider saving this configuration by [TRIG:EXP](#), before you send the import command.

Setting parameters:

<import filename> String parameter to specify the name of the file to be stored.

Example: `TRIG:IMP "sequencedtrig2"`
Loads the file `sequencedtrig2` from the flash memory into the volatile memory.

Usage: Event

Manual operation: See "[Import Trigger Configuration](#)" on page 221

TRIGger:IMPort:CATalog?

Returns a list of trigger configurations that are stored in the primary switch unit's volatile memory.

Return values:

<path information> The reply is a comma-separated list of the exported trigger configuration filenames.

Example: `TRIG:IMP:CAT?`
Response string: `"TriggerConfig1", "TriggerConfig2"`

Usage: Query only

Manual operation: See "[Import Trigger Configuration](#)" on page 221

TRIGger:IMPort:DELeTe <filename>

Risk of losing settings: Removes the specified trigger configuration file from the primary switch unit's compact flash memory.

All trigger configuration filenames have the extension `".trigger"`. Do not enter the extension when specifying a filename. A filename query does not return the extension.

For example, when you save the trigger configuration file `"trg42"`, it is saved as `"trg42.trigger"`. A query returns this filename as `"trg42"`, only.

Setting parameters:

<filename> String parameter to specify the name of the file to be deleted. If this file does not exist, a SCPI error is generated. You can query the error with [SYST:ERR?](#). The result can be, for example:
`-200,"Execution error;File does not exist.,TRIG:IMP:DEL ""sequencedtrig2"""`

Example: `TRIG:IMP:DEL "sequencedtrig2"`
Removes the file `"sequencedtrig2"` from the memory.

Usage: Event

Manual operation: See ["Delete Trigger Configuration File"](#) on page 222

TRIGger:IMPort:DELeTe:ALL

Risk of losing settings: Removes all trigger configuration files from the primary switch unit's compact flash memory.

Before you delete all trigger configuration files, we recommend using the command [TRIG:IMP:CAT](#) to query all currently stored trigger configuration files.

All trigger configuration filenames have the extension ".trigger". Do not enter the extension when specifying a filename. A filename query does not return the extension.

For example, when you save the trigger configuration file "trg42", it is saved as "trg42.trigger". A query returns this filename as "trg42", only.

Usage: Event

Manual operation: See ["Delete Trigger Configuration File"](#) on page 222

TRIGger:INDex?

Queries the trigger index, which is the number of the currently triggered path in the trigger types described below.

- [Toggle A-B](#), the index has the following meaning:
 - -1 = no trigger event yet, [TRIGger:COUNT](#) = 0
 - 0 = "Path A "
 - 1 = "Path B"
- [Sequenced](#), the index has the following meaning:
 - -1 = no trigger event yet, [TRIGger:COUNT](#) = 0
 - 0 = "Path 0"
 - 1 = "Path 1"
 - 2 = "Path 2"
 - ...
 - 15 = "Path 15"

Example:

```

Settings:
TRIG:TYPE SEQ
TRIG:STAT ON
Query: TRIG:IND?
Reply: -1
*TRG
*TRG
*TRG
Query: TRIG:IND?
Reply: 2
  
```

Usage: Query only

Manual operation: See ["Trigger Activation"](#) on page 203

TRIGger:SEquence:DEFine:LENGth <integer>

Sets or queries the length of the sequence for the "Sequenced" trigger.

Parameters:

<integer> Range: 3 to 16

Example:

Setting: TRIG:SEQ:DEF:LENG 5

Query: TRIG:SEQ:DEF:LENG?

Reply: 5

Manual operation: See ["Sequenced"](#) on page 207

TRIGger:SEquence:DEFine[:ENTRy] <integer>,<string>

Sets or queries the path, which is defined for the selected number in the sequence.

Parameters:

<integer> Selects a number in the trigger sequence.

Range: 0 to (LENGth - 1), see "TRIG-
ger:SEquence:DEFine:LENGth"

<string> Specifies the path name to be set for the selected number in the
trigger sequence. Write the path name in quotation marks.

Example:

Setting: TRIG:SEQ:DEF 1, "PathB"

Query: TRIG:SEQ:DEF:ENTR? 1

Reply: "PathB"

Manual operation: See ["Sequenced"](#) on page 207

TRIGger:SEquence:DEFine:ALL <string>

Sets several or all paths for the sequenced trigger. The query returns all path names.

Parameters:

<string> Specifies all path names for the trigger sequence. Separate the
path names by commas and write each path name in quotation
marks.

Example:

Setting: TRIG:SEQ:DEF:ALL "PathA", "PathB", "PathC",
"PathD", "PathE"

Query: TRIG:SEQ:DEF:ALL?

Reply: "PathA", "PathB", "PathC", "PathD", "PathE"

TRIGger:SIGNal:LEVel <numeric_value>

Sets or queries the voltage level, which defines the threshold for a trigger event. The level setting is not influenced by reset commands.

Parameters:

<numeric_value> Specifies the voltage level. Factory default is 2.5 V.
 Range: 0.5 to 4.5
 Increment: 0.01
 Default unit: V|mV

Example:

Setting: TRIG:SIGN:LEV 0.5V
 Query: TRIG:SIGN:LEV?
 Reply: 5.000000E-01
 Setting: TRIG:SIGN:LEV 4.5V
 Query: TRIG:SIGN:LEV?
 Reply: 4.500000E+00

Manual operation: See ["Trigger Settings"](#) on page 208

TRIGger:SIGNal:SLOPe <slope>

Sets or queries, which kind of threshold transition is interpreted as a trigger event. For the threshold level, see [TRIGger:SIGNal:LEVel](#).

Parameters:

<slope>

POSitive

Defines interpreting a positive (low-to-high) transition of the threshold as a trigger event.

NEGative

Defines interpreting a negative (high-to-low) transition of the threshold as a trigger event.

BOTH

Defines interpreting a positive or a negative transition of the threshold as a trigger event.

Equivalent with "Any" in the user interface ("WebGUI").

Example:

Setting: TRIG:SIGN:SLOP POS
 Query: TRIG:SIGN:SLOP?
 Reply: POS

Manual operation: See ["Trigger Settings"](#) on page 208

TRIGger:SIGNal:TERMination <term>

Sets or queries the type of termination of the trigger signal cable.

Parameters:

<term>

50OHM

Sets the termination to "50 Ohm".

Also accepted parameter syntax: "50" or "50 ohm" (a blank and all capital/small letters are ignored).

HIGH

Sets the termination to "High", equivalent with "High Impedance" in the user interface ("WebGUI").

Also accepted parameter syntax: "high" (capital/small letters are ignored).

Example: Setting: TRIG:SIGN:TERM High
 Query: TRIG:SIGN:TERM?
 Reply: HIGH

Manual operation: See "[Trigger Settings](#)" on page 208

8.7 MMEMory Commands

The following mass memory (MMEMory) commands relate to the flash memory card inserted into the rear of your switch unit.

See also the commands [MMEM:LOAD:STATe](#) on page 294 and [MMEM:STORe:STATe](#) on page 294. These commands were intended originally for saving and loading path definitions in the legacy switch units R&S OSP120, R&S OSP130 and R&S OSP150. Now the commands are still available to ensure backward compatibility.

MMEMory:CATalog?	289
MMEMory:DATA	290
MMEMory:DELeTe	290

MMEMory:CATalog?

Returns the size and contents of a selected directory in the mass storage media.

Per default, this directory is `"/home/instrument/ospdata"`. You can change the target directory for reading and writing data by the command `MMEMory:CDIRectory`. However, we recommend not to change the default.

The first parameter in the response indicates the number of bytes of storage currently used. The second parameter indicates the total amount of storage available in the flash memory, also in bytes. The following string is a list of file and directory names together with their size in bytes, separated by commas.

Example: MMEM:CAT?
 Response: 23204, 3448745984, ".", DIR, 4096", ".", DIR, 4096", "settings-2018-10-25.backup, BIN, 15007", "Cheers.txt, ASC, 5"
 According to this response, 23204 bytes are used, while 3448745984 bytes (approximately 3.2 GB) are available. The empty `"ospdata"` directory and its parent directory each use 4096 bytes. The binary file `"settings-2018-10-25.backup"` uses 15007 bytes, the ASCII file `"Cheers.txt"` uses 5 bytes.

Usage: Query only

MMEMory:DATA <FileName>,<data>

MMEMory:DATA? <FileName>

Saves <data> in a file that is specified by the filename.

The query returns the data from this file in block format.

Setting parameters:

<data>

Specifies the data block in 488.2 block format. The header of the data block has the format "#nm" with the following meaning:

After the # character, one digit "n" (1 to 9) encodes the number of the following characters "m". The 1 to 9 digits of "m" (or "mm" or

"mmm" up to "mmmmmmmmmm") encode the length of the data block.

For example, in the header "#233", the "2" specifies, that "m" is a 2-digit number. Hence, the next 2 characters (here: "33")

specify that the following data block has a length of 33 characters. The data can be, for example,

"example information block number1", that is 33 characters, blanks included.

Parameters for setting and query:

<FileName>

Specifies the filename.

Example:

Setting: MMEM:DATA "Cheers.txt", #15Hello

Writes the 5-byte word "Hello" into the file "Cheers.txt".

Example:

Query: MMEM:DATA? "Cheers.txt"

Response: #15Hello

Hence, the length information is 1 character, which is a 5. These 5 characters are the 5-byte word "Hello".

MMEMory:DELeTe <FileName>

Deletes the file that is specified by the parameter.

Setting parameters:

<FileName>

Specifies the filename.

Example:

MMEM:DEL "Cheers.txt"

Usage:

Event

8.8 DIAGnostic Commands

DIAGnostic:SERVice:HWINfo?	291
DIAGnostic:SERVice:MODUle:HWINfo	292
DIAGnostic:SERVice:MODUle:TEMPerature?	292
DIAGnostic:SERVice:USER:ERRor?	293
DIAGnostic:SERVice:USER:WARNIing?	293

DIAGnostic:SERVice:HWInfo?

Returns information about all hardware components (motherboards and modules) that are part of the complete system of one or several R&S OSP instruments.

The returned component information consists of:

- Location ID (= switch unit and module number, for example, frame "F01" is the primary device, frame "F02" is the first secondary device, "M00" is the primary device's motherboard, "M01" is the module connected to the connector "M01")
- Name (for example, "OSPMMAINBOARD", "OSP220", "OSP230", "OSP320", "OSP-B101")
- Serial number (for example, "100173")
- Part number (= order number, for example, "1528.3105.03")
- Hardware code:
 - Modules that are controlled via 1 module bus typically return the code "0"
 - Modules that are controlled via 2 module buses return the codes "1" for the first control board and "2" for the second control board
- Product index (model iteration of a hardware version, for example, "01.00")

Return values:

<hw info list>

The response is a string in following format:

```
<location>|<name>|<sn_nbr>|<part_nbr>|
<hardware_code>|<product_index>
```

Example:

DIAG:SERV:HWIN?

Response:

```
"F01|OSP230|100173/003|1528.3105k03|0|01.00",
"F01M00|OSPMMAINBOARD|100916/000|1528.4053.00|0|03.00",
"F01M01|OSP-B101|100301/002|1505.3250.02|0|01.00",
"F01M02|OSP-B123|100212|1515.5527.02|1|01.00",
"F01M03|OSP-B123|100212|1515.5527.02|2|01.00",
"F02|OSP220|100185/003|1528.3105k02|0|01.00",
"F02M00|OSPMMAINBOARD|100827/000|1528.4053.00|0|03.00",
"F02M01|OSP-B101|100297/002|1505.3250.02|0|01.00"
```

The hardware information query detected two R&S OSP switch units with ID F01 and F02.

The device F01 has a motherboard and 2 modules:

OSP-B101 at connector M01.

OSP-B123 at connectors M02 and M03.

The device F02 has a motherboard and 1 module:

OSP-B101 at connector M01.

In this example, at OSP-B123 (2 entries with serial number 100212), note the **increasing** values of both the <location> (F01M02 -> F01M03) and the <hardware_code> (1 -> 2). Otherwise, for the entries of a module with two bus connectors, if one of these values does not increase, the module bus cables are **crossed over**. See [step 11](#) in the [mounting procedure](#).

Usage:

Query only

Manual operation: See "Device Information" on page 159
See "Device Messages" on page 161

DIAGnostic:SERVice:MODule:HWInfo <module names>

The **setting** command can make modules update their hardware configuration. The command is implemented for all modules, but it was developed especially for system modules that can have submodules attached. The command allows updating such submodules in the firmware during operation. For modules that cannot update any hardware configuration, the command has no effect.

The **query** command returns the most recently updated hardware configuration. Modules, which support this query, reply with an individual, module-specific return string. All other modules reply with an empty string "".

Parameters:

<module names> (@FxxMyy,FxxMyy,FxxMyy,...)

The command addresses the modules by the following syntax, like the <module names> string in [READ:IO:IN?](#):

xx = 01, 02, 03,...,99 (frame ID in, e.g., switch unit name F01)

yy = 01, 02, 03,...,20 (module ID in, e.g., slot position M02)

Example:

Setting: DIAG:SERV:MOD:HWIN (@F01M03)

Query: DIAG:SERV:MOD:HWIN? (@F01M03)

Reply "" means: The module at bus F01M03 does not support the command.

Example:

Setting: DIAG:SERV:MOD:HWIN (@F01M03,F01M05)

Query: DIAG:SERV:MOD:HWIN? (@F01M03,F01M05)

Reply "", "<returnstring>" means: The module at bus F01M03 does not support the command. The module at bus F01M05 replies with a <returnstring>.

DIAGnostic:SERVice:MODule:TEMPerature? <module names>

Queries the temperature of selected modules in degrees centigrade.

Parameters:

<module names> (@FxxMyy,FxxMyy,FxxMyy,...)

The command addresses the modules by the following syntax, like the <module names> string in [READ:IO:IN?](#):

xx = 01, 02, 03,...,99 (frame ID in, e.g., switch unit name F01)

yy = 01, 02, 03,...,20 (module ID in, e.g., slot position M02)

Example:

DIAG:SERV:MOD:TEMP? (@F01M03)

Reply: 2.487500E+01

This reply shows a temperature reading of 24.875 °C for module 03 in switch unit 01.

Example: `DIAG:SERV:MOD:TEMP? (@F01M03,F01M05)`
 Reply `2.485000E+01,2.507000E+01`
 This reply shows a temperature reading of 24.85 °C for module 03 and 25.07 °C for module 05, both in switch unit 01.

Usage: Query only

DIAGnostic:SERVice:USER:ERRor?

Queries for device errors that were not necessarily evoked by a remote control command. Typically, use this query for errors that may have come up during booting.

Example: `DIAG:SERV:USER:ERR?`
 Reply: `0,"No error"`

Usage: Query only

Manual operation: See "[Device Messages](#)" on page 161

DIAGnostic:SERVice:USER:WARNing?

Queries for device warnings that were not necessarily evoked by a remote control command. Typically, use this query for warnings that may have come up during booting.

Example: `DIAG:SERV:USER:WARN?`
 Reply: `-1000,"Options invalid:|K0 not yet in activation phase"`

Example: `DIAG:SERV:USER:WARN?`
 Reply: `1,"Service firmware.|This firmware provides elevated access rights needed by the R&S service.|However this means a certain security vulnerability of the device.|Please reboot into an official customer firmware."`

Usage: Query only

Manual operation: See "[Device Messages](#)" on page 161

8.9 Legacy System Commands from R&S OSP1x0

The following commands are implemented only for providing compatibility with [Inter-connection](#) setups of the legacy switch units R&S OSP120, R&S OSP130 and R&S OSP150. Refer to the operating manual of these switch units for more information.

DIAGnostic:SERVice:STESt:RESult?	294
MMEM:LOAD:STATe	294
MMEM:STORe:STATe	294
ROUte:MODule:CATalog?	295

READ:IO:IN4?.....	295
READ:IO:IN5?.....	295
READ:IO:IN16?.....	295

DIAGnostic:SERVice:STES:RESult?

Provides compatibility of remote control commands with legacy switch units R&S OSP120/130/150.

The command does **not** execute any self-test. It is implemented only to prevent errors in existing remote control programs, when these programs cannot address the command.

Return values:

<result> The result is always "Passed", because the command does not execute any self-test.

Example: `DIAG:SERV:STES:RES?`
Return string: "Passed"

Usage: Query only

MMEM:LOAD:STATe <dummy>,<filename>

Provides compatibility of remote control commands with legacy switch units R&S OSP120/130/150.

Equivalent to `ROUTE:PATH:IMPort`.

All path filenames have the extension ".path". Do not enter the extension when specifying a filename. A filename query does not return the extension.

For example, when you save the path file "gen-pa_1", it is saved as "gen-pa_1.path". A query returns this filename as "gen-pa_1", only.

Setting parameters:

<dummy> This parameter is required but not evaluated. It can have any integer numerical value (no decimal places).

<filename> String parameter to specify the name of the file to be loaded.

Example: `MMEM:LOAD:STAT "1", "mypathconfigs"`
Loads the file "mypathconfigs" from the flash memory into the instrument's internal volatile memory.

Usage: Event

Manual operation: See "[Import Paths](#)" on page 191

MMEM:STORe:STATe <dummy>,<filename>

Provides compatibility of remote control commands with legacy switch units R&S OSP120/130/150.

Equivalent to `ROUTE:PATH:EXPort`.

All path filenames have the extension ".path". Do not enter the extension when specifying a filename. A filename query does not return the extension.

For example, when you save the path file "gen-pa_1", it is saved as "gen-pa_1.path". A query returns this filename as "gen-pa_1", only.

Setting parameters:

<dummy> This parameter is required but not evaluated. It can have any integer numerical value (no decimal places).

<filename> String parameter to specify the name of the file to be stored.

Usage: Event

Manual operation: See ["Export Paths"](#) on page 190

ROUTE:MODule:CATalog?

Provides compatibility of remote control commands with legacy switch units R&S OSP120/130/150.

Returns a list of all hardware-detected modules installed in all legacy switch units in an interconnection setup.

Example:

ROUT:MOD:CAT?

Return string: "OSP-B101|F01M01", "OSP-B123|F01M02", "OSP-B123|F01M03"

The response contains the module type (e.g. R&S OSP-B101) and the internal module name (e.g. F01M01).

In the comma-separated string, each module's information is in quotation marks.

If you enable the [compatibility mode](#), the module index is returned as "A11" rather than "M01". Also, a hyphen is used instead of the vertical line character. Hence, an example for a segment in the return string is "OSP-B101-F01A01".

If no installed module is detected, the following SCPI error is generated (which you can query by [SYST:ERR?](#)):

-200, "Execution error;ROUTE:MODule:CATalog?"

Usage: Query only

READ:IO:IN4?

READ:IO:IN5?

READ:IO:IN16?

Provides compatibility of remote control commands with legacy switch units R&S OSP120/130/150.

Like [READ:IO:IN?](#), these commands query the states of all 4, 5 or 16 input channels of a selected I/O module.

Usage: Query only

8.10 List of Remote Commands

*CLS.....	247
*ESE.....	247
*ESR?.....	247
*IDN?.....	248
*OPC.....	248
*OPT?.....	248
*PSC.....	248
*RST.....	249
*SRE.....	249
*STB?.....	249
*TRG.....	249
*TST?.....	249
*WAI.....	250
CONFigure:ALL:BACKUp.....	270
CONFigure:ALL:REStore.....	271
CONFigure:ALL:REStore:CATalog?.....	271
CONFigure:ALL:REStore:DELeTe.....	272
CONFigure:ALL:REStore:DELeTe:ALL.....	272
CONFigure:COMPATible[:MODE].....	273
CONFigure:FRAMe:ADD.....	275
CONFigure:FRAMe:CATalog?.....	277
CONFigure:FRAMe:DELeTe.....	278
CONFigure:FRAMe:DELeTe:ALL.....	279
CONFigure:FRAMe:EXPort.....	279
CONFigure:FRAMe:IMPort.....	280
CONFigure:FRAMe:IMPort:CATalog?.....	280
CONFigure:FRAMe:IMPort:DELeTe.....	281
CONFigure:FRAMe:IMPort:DELeTe:ALL.....	281
CONFigure:FRAMe:INSert.....	276
CONFigure:FRAMe[:DEFine].....	274
CONFigure:LOCK:MODE.....	274
CONFigure:MAINinfo:PATH.....	268
CONFigure:MAINinfo:TEXT.....	268
CONFigure:POWerup:PATH.....	267
CONFigure:POWerup:RESet.....	267
CONFigure:RELay:DELay.....	269
CONFigure:VIRTual[:MODE].....	273
DIAGnostic:SERVice:HWINfo?.....	291
DIAGnostic:SERVice:MODule:HWINfo.....	292
DIAGnostic:SERVice:MODule:TEMPerature?.....	292
DIAGnostic:SERVice:STESt:RESult?.....	294
DIAGnostic:SERVice:USER:ERRor?.....	293
DIAGnostic:SERVice:USER:WARning?.....	293
MMEM:LOAD:STATe.....	294
MMEM:StORe:STATe.....	294
MMEMory:CATalog?.....	289
MMEMory:DATA.....	290

List of Remote Commands

MMEMory:DELeTe.....	290
READ:IO:IN?.....	262
READ:IO:IN4?.....	295
READ:IO:IN5?.....	295
READ:IO:IN16?.....	295
READ:MODUle:INTerlock?.....	264
READ:RELay:OPERations?.....	265
ROUTe:ATTenuation.....	260
ROUTe:CLOSe.....	253
ROUTe:MODUle:CATalog?.....	295
ROUTe:PATH:CATalog?.....	257
ROUTe:PATH:DELeTe:ALL.....	257
ROUTe:PATH:DELeTe[:NAME].....	257
ROUTe:PATH:EXPort.....	258
ROUTe:PATH:IMPort.....	258
ROUTe:PATH:IMPort:CATalog?.....	259
ROUTe:PATH:IMPort:DELeTe.....	260
ROUTe:PATH:IMPort:DELeTe:ALL.....	260
ROUTe:PATH:LAST?.....	257
ROUTe:PATH[:DEFine].....	255
ROUTe:PHASe.....	261
SYSTem:DATE.....	252
SYSTem:ERRor:[NEXT]?.....	250
SYSTem:ERRor:ALL?.....	251
SYSTem:HELP:HEADers?.....	251
SYSTem:HELP:SYNTax:ALL?.....	252
SYSTem:HELP:SYNTax?.....	251
SYSTem:PRESet.....	251
SYSTem:TIME.....	252
SYSTem:VERSion?.....	252
TRIGger:COUNT:OVERflow?.....	284
TRIGger:COUNT[:VALue]?.....	283
TRIGger:EXECute.....	283
TRIGger:EXPort.....	284
TRIGger:IMPort.....	284
TRIGger:IMPort:CATalog?.....	285
TRIGger:IMPort:DELeTe.....	285
TRIGger:IMPort:DELeTe:ALL.....	286
TRIGger:INDex?.....	286
TRIGger:SEQuence:DEFine:ALL.....	287
TRIGger:SEQuence:DEFine:LENGth.....	287
TRIGger:SEQuence:DEFine[:ENTRY].....	287
TRIGger:SIGNal:LEVel.....	287
TRIGger:SIGNal:SLOPe.....	288
TRIGger:SIGNal:TERMination.....	288
TRIGger:STATe.....	283
TRIGger:TYPE.....	282

9 Programming Examples

The following examples demonstrate how to switch relays and channel paths remotely in the R&S OSP.

9.1 Switching Relays by SCPI Commands

In this example, direct SCPI commands are sent to control SPDT relays in the module R&S OSP-B101. [Figure 9-1](#) shows the dialog window of module R&S OSP-B101 in the user interface ("WebGUI"). All 6 relays are in their default position (C-NC closed), and the dialog is still in local operation mode: the flag "REMOTE" as in the top left corner of [Figure 9-3](#) is not displayed.

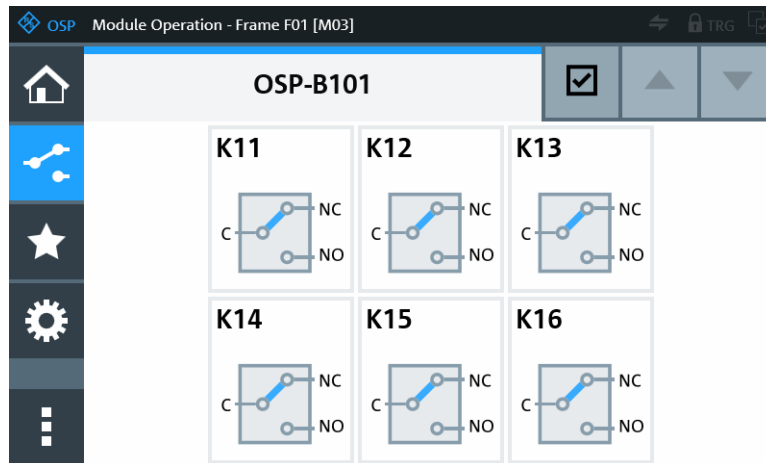

Figure 9-1: Default state: all connections C-NC are closed

For remote operation, we recommend using the scripting tool **R&S Forum**, as described in [Chapter 7, "Remote Operation"](#), on page 240. Use this tool to send the commands in the following examples to the switch unit.

As soon as you send the first command, the switch unit is in remote operation mode. For terminating this mode from the "WebGUI", click the button "Goto Local Operation", which is available in the "Context" menu of each main function (see [Figure 7-3](#)).

The lines that start with a double slash (//) are comments, only.

Resetting all modules

```
*RST
//Resets all switches and output channels in the switch unit.
//The relay states as shown above are not changed.
//The WebGUI control interface shows the remote state by the
//flag "REMOTE" in the top left corner of the display.
```



Overview of syntax

The commands in the following examples require parameters in a specific syntax:

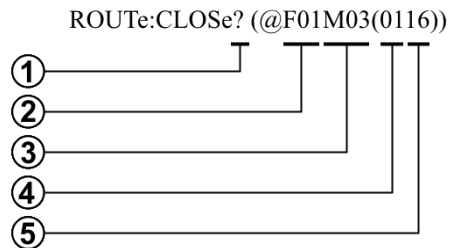

Figure 9-2: Command syntax and example of parameters

- 1 = The question mark defines a query command
- 2 = Frame ID, for example, "F01" for the primary switch unit, "F02" for the 1st secondary switch unit
- 3 = Module number, see [Figure 2-26](#)
- 4 = State data, for example, "00" = C-NC closed, "01" = C-NO closed
- 5 = Relay or channel number, for example, "16" can stand for relay "K16" or channel "CH16"

Note that there are two opening brackets and two closing brackets at the end of the parameters string. If any bracket is missing, the command is not executed.

Commands for closing relays

```
ROUTe:CLOSe (@F01M03(0112))
//Setting relay K12 in unit F01, module M03, to state 01 (= C-NO closed)
ROUTe:CLOSe (@F01M03(0116))
//Setting relay K16 in unit F01, module M03, to state 01 (= C-NO closed)
ROUT:CLOS (@F01M03(0112,0116))
//Alternative syntax for closing C-NO in both relays K12 and K16
```

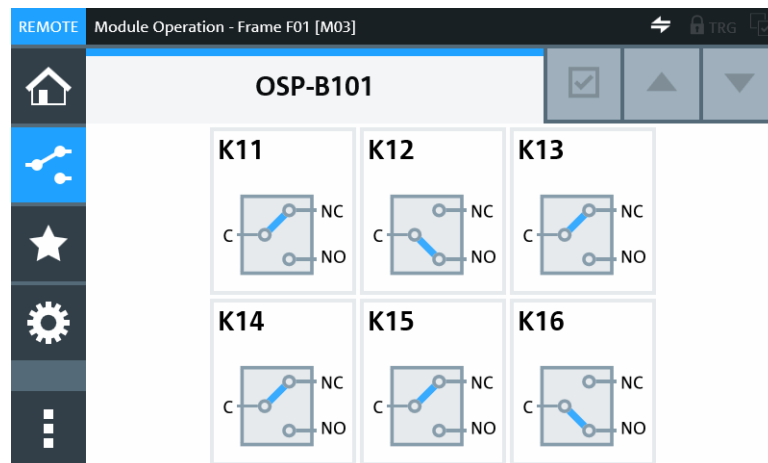

Figure 9-3: Relays K12 and K16 are closed, connecting C-NO (note the "REMOTE" flag)

Commands for querying relay states

```
ROUTe:CLOSe? (@F01M03(0112))
//Response: 1 (yes, in unit F01, module M03, relay K12 is in state 01 = closed)
ROUTe:CLOSe? (@F01M03(0116))
```

```
//Response: 1 (yes, in unit F01, module M03, relay K16 is in state 01 = closed)
ROUT:CLOS (@F01M03(0112,0116))
//Alternative syntax for querying both relays K12 and K16
//Response: 1,1 (in unit F01, module M03, both relays K12 & K16 are in state 01)
```

9.2 Switching Output Channel Paths by SCPI Commands

This example uses the same path definition as in procedure ["Creating a path configuration"](#) on page 229 for a path that includes all 16 output channels of the module R&S OSP-B103.

Commands for defining a path

```
*RST
//Resets all switches and output channels in the switch unit
ROUTE:PATH:DEFine "Path-1", (@F01M03(0101,0002,0003,0004,0005,0006,0107,0008,
0009,0010,0011,0012,0013,0014,0115,0116))
//Defines a path with name "Path-1", which sets output channels 1, 7, 15 and 16
//in module "M03" of switch unit "F01" to "ON" and all other channels in the
//same module to the "OFF" state. In this example, M03 is R&S OSP-B103.
ROUTE:PATH:EXPort "All-Paths"
//Stores all currently defined paths in a nonvolatile file called "All-Paths".
```

Commands for reading a path definition

```
ROUTE:PATH:DEFine? "Path-1"
//Queries the definition of "Path-1". The return string is: "@F01M03(0101,
//0002,0003,0004,0005,0006,0107,0008,0009,0010,0011,0012,0013,0014,0115,0116)"
CONFigure:COMPatible 1
//Sets te switch unit to compatibility mode.
ROUTE:PATH:DEFine? "Path-1"
//Queries the definition of "Path-1", again. Now in compatibility mode, the
//return string is: "0300101,0300002,0300003,0300004,0300005,0300006,0300107,
//0300008,0300009,0300010,0300011,0300012,0300013,0300014,0300115,0300116"
```

For more details, refer to the description of [ROUTE:PATH\[:DEFine\]](#).

Command for switching a path

```
ROUTE:CLOSe "Path-1"
//Sets the output channels as defined in "Path-1".
```

Command for reading channel states

```
ROUTE:CLOSe? (@F01M03(0101,0107,0115,0116))
//Queries, if the output channels 1, 7, 15 and 16 are all in state "ON".
//If the return string is 1,1,1,1 (equivalent with 4x "yes"), all four
//are in the queried state. A return string like 1,1,1,0 means that
//channel 16 fails being in the queried "ON" state.
```

10 Troubleshooting

If the performance of your switch units does not meet your expectations, try the following approaches for optimization:

Firmware version

Make sure that all your switch units in an [interconnection](#) configuration use the same firmware version. Otherwise, flawless communication between the switch unit is not ensured. See [Chapter 12.3, "Firmware Update"](#), on page 307.

Device messages (user interface)

If your switch unit shows error messages, temporary warnings or other messages in the graphical user interface (GUI), as described in ["Device Messages"](#) on page 161, follow the instructions or hints provided.

Examples:

- A bad connection after mounting a module results in an error message. For example, to find out if the module bus connectors of a twin-bus module are crossed-over (erroneously swapped), see [DIAGnostic:SERvice:HWInfo?](#) on page 291. To solve the problem, you can try to repeat the [mounting procedure](#).
- If the firmware does not detect any module, check your hardware configuration. This event can be relevant especially, if you start a switch unit that holds a remote control module R&S OSP-B200R: As long as the corresponding satellite unit R&S OSP-B200S2 is not connected or not powered up, the firmware cannot detect modules in the satellite. In this case, if the base switch unit holds only that remote control module, the firmware cannot find any switch module.
- There are many possible reasons for a path not being switchable. Refer to the description of "Path C" in [Figure 5-28](#) in the section on [Path Switching](#).
- If there is a device or mainboard EEPROM error (data missing or corrupted), you can try a restart of the switch unit.
- If the scanning of SPI addresses on module bus M20 failed, you can try a restart.

If you cannot solve an operating problem, collect all [relevant information](#) and contact the Rohde & Schwarz customer support.

Touchscreen display

If the RGB-LED touchscreen display does not function properly, for example after starting up the switch unit, restart it by pressing the [Pwr] button on the front panel.

Network connection issues

If you cannot connect to your R&S OSP via the LAN to use the graphic user interface ("[WebGUI](#)") or RC commands, try the following:

- Enter the primary switch unit's hostname rather than its IP address into your browser or scripting program

- Configure the network connection locally in the switch unit's user interface (touch-screen or connected external display) rather than via LAN
- Verify that no other instrument uses static access to the same IP address that your switch unit uses (typically via DHCP). See "[Address Model](#)" on page 211 for details. Your LAN administrator can help you solving address conflicts.

SCPI error messages

When you query a switch unit for error messages by `SYSTem:ERRor:[NEXT]?` or `SYSTem:ERRor:ALL?`, the response includes error codes. To find information on the details of an error message, refer to the specification of these error codes in the [1999 SCPI Command Reference](#). This document is available for download at www.ivifoundation.org > [Specifications](#).

- Error codes `-100` to `-184`: see chapter 21.8.9 **Command Error**
- Error codes `-200` to `-294`: see chapter 21.8.10 **Execution Error**
- Error codes `-300` to `-365`: see chapter 21.8.11 **Device-Specific Error**
- Error codes `-400` to `-440`: see chapter 21.8.12 **Query Error**

Example:

The Command Error `-148`, "Character data not allowed", indicates that a character data element was encountered, which is prohibited by the command interpreter. For example, if you use typographical quotation marks (") or (") instead of straight quotation marks (") around a command's parameters, two things can happen: 1) Your command tool ignores the command due to its improper syntax. 2) The tool sends the command, but the device software interprets the content between the quotation marks as character data type instead of string data type. In the second case, the unexpected data type leads to the error message, which is the same as for missing quotation marks.

[Chapter 8, RC Commands](#), provides more descriptions and examples of SCPI errors. You can find these descriptions and examples by their index entries at the end of the user manual, under the keyword "SCPI error".

High current consumption

The legacy switch units R&S OSP120/130/150 executed switching commands for multiple relays consecutively, relay per relay. In contrast, the switch units of the new generation R&S OSP220/230/320 are switching all relays at nearly the same time. Note that this simultaneity can lead to a situation where a switch unit draws a high peak current. The worst case scenario is the maximum of 10 switch modules in an R&S OSP320, with relays that all draw a maximum switching current of 800 mA per module. If all relays are switched at the same time, the modules jointly can come close to the limit of 10 A per switch unit. However, the R&S OSP can handle this load.

Hardware damage due to open cable ends

If the open ends of a 26-pin flat-ribbon cable (module bus cable, up to 28 V DC) come into contact with conductive parts, it can cause device damage or malfunction. This short connection can happen during [Mounting a Module](#), see "[Avoid bad contact with open cable ends](#)" on page 44. In this case, call Rohde & Schwarz service.

10.1 Collecting Information for Technical Support

If you encounter problems that you cannot solve yourself, after having checked the hints above, contact your Rohde & Schwarz support center, see [Chapter 10.2](#). The support center staff is trained to assist you in solving problems.

The support center finds solutions more quickly and efficiently, if you provide them with information on your hardware and software and an error description:

- Type and serial number of a defective R&S OSP switch unit or R&S OSP module
- Firmware version
- Detailed description of the error conditions and its effects
- Optionally a description of your system or application
- Rohde & Schwarz order number (6 digits), if you can refer to a warranty contract

Note that you can copy text directly from the "WebGUI" dialogs [Device Information](#), [Frame Information](#) and [Module Information](#).

Collect the error information and attach it to an email in which you describe the problem. Send the email to the customer support address for your region.

If you need to transport or ship the product, see [Chapter 11, "Transporting"](#), on page 304.

10.2 Contacting Customer Support

Technical support – where and when you need it

For quick, expert help with any Rohde & Schwarz product, contact our customer support center. A team of highly qualified engineers provides support and works with you to find a solution to your query on any aspect of the operation, programming or applications of Rohde & Schwarz products.

Contact information

Contact our customer support center at www.rohde-schwarz.com/support, or follow this QR code:



Figure 10-1: QR code to the Rohde & Schwarz support page

11 Transporting

See also:

- ["Lifting and carrying the product"](#) on page 8
- [Chapter 2.1.1, "Lifting and Carrying"](#), on page 15

Packing

Use the original packaging material. It consists of antistatic wrap for electrostatic protection and packing material designed for the product.

If you do not have the original packaging, use similar materials that provide the same level of protection.

Especially, cover and protect the front and rear panels.

Securing

When moving the product in a vehicle or using transporting equipment, make sure that the product is properly secured. Only use items intended for securing objects.

Transport altitude

Unless otherwise specified in the data sheet, the maximum transport altitude without pressure compensation is 4500 m above sea level.

12 Maintenance

The product does not require regular maintenance. It only requires occasional cleaning. It is however advisable to check the nominal data from time to time.

- [Replacing Fuses](#)..... 305
- [Cleaning](#).....306
- [Firmware Update](#).....307

12.1 Replacing Fuses

See also "[Connecting to power](#)" on page 9.



If the R&S OSP does not start, it is possible that a blown fuse is the cause. The product is protected against excess AC supply voltage or voltage peaks by two fuses, labeled F1 and F2. The fuses are located in the fuse holder next to the power switch on the [rear panel](#).



Fuse type IEC60127 T5.0H / 250 V

Using the wrong fuse type can cause severe instrument damage or even personal injury.

To avoid this risk, replace the fuses only with the same type, IEC60127 T5.0H / 250 V. These time-lag fuses are specified for 5.0 A and comply with all nominal AC supply voltages specified in the data sheet.

You can order these fuses from Rohde & Schwarz, order number 0099.6735.00.

To change the fuses

1. **WARNING!** The fuse is part of the main power supply. Handling the fuse while the power is on can lead to electric shock.

Before changing the fuse:

- a) Shut down the switch unit, see "[To shut down the R&S OSP](#)" on page 22.
- b) Set the power switch to position [0] ([Figure 12-1](#)).
- c) Disconnect the power cable.

2. Insert a small screwdriver (or similar sharp tool) into one of the holes that are marked red in [Figure 12-1](#).



Figure 12-1: Removing the fuse holder (holes to unlock marked red)

3. Press the tool tip towards the fuse holder to unlock the first flat plastic spring that fixes the fuse holder in its housing.
4. Unlock the flat plastic spring on the opposite side of the fuse holder in the same way.
When both plastic springs are released, the fuse holder is partly ejected by the load of two metal springs.
5. Pull the fuse holder out of its housing, as on the right in [Figure 12-1](#).

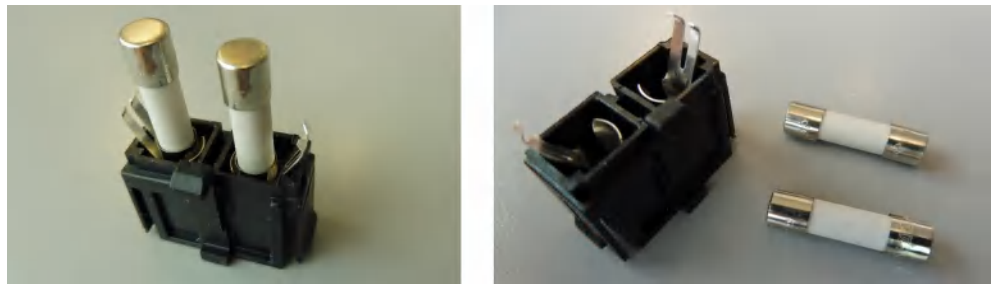

Figure 12-2: Replacing the fuses

6. Remove the fuses from the fuse holder as in [Figure 12-2](#).
7. Check the condition of the fuses.
8. Replace any blown fuse.
Only use fuses of the specified type, as indicated next to the fuse holder.
9. Insert the assembled fuse holder into the housing, while observing the correct orientation.
Due to the fuse holder's shape, inserting it in the wrong orientation is not possible.
10. Push the fuse holder into its housing, until it is level with the surface.
A clicking sound indicates that the flat plastic springs have snapped in.

12.2 Cleaning

For safe cleaning, see "[Cleaning the product](#)" on page 9.

To clean the switch unit

1. Before cleaning:
 - a) Shut down the switch unit, see ["To shut down the R&S OSP"](#) on page 22.
 - b) Set the power switch to position [0] ([Figure 12-1](#)).
 - c) Disconnect the power cable.
 - d) Optionally, remove all RF cables, I/O cables, HDMI, USB and LAN cables.
2. Clean the outside of the switch unit using a soft, dry, lint-free dust cloth.

Note: Do not use any liquids for cleaning. Cleaning agents, solvents (thinners, acetone), acids and bases can damage the front panel labeling, plastic parts and display.
3. Check and clean the fan openings regularly to ensure that the fans always operate properly.
4. Clean the touchscreen as follows:
 - a) Apply a small amount of standard screen cleaner to a soft cloth.
 - b) Wipe the screen gently with the moist, but not wet, cloth.
 - c) If necessary, remove any excess moisture with a dry, soft cloth.

12.3 Firmware Update

For best performance, keep the firmware of your switch units up-to-date. Especially, to ensure flawless communication between switch units in an [interconnection](#) configuration, install the same firmware version on all your switch units.

You have two options for installing an update:

- [Update by USB Storage Device](#).....307
- [Update by R&S Software Distributor](#).....310

12.3.1 Update by USB Storage Device

For installing new firmware on a single R&S OSP via an external USB storage device, perform the following steps:

1. Download the setup file of the latest firmware ("`osp-firmware-x.xx.rsu`", where x.xx is the version) from www.rohde-schwarz.com/firmware/osp-n to your PC.
2. Copy the `osp-firmware-x.xx.rsu` file to an external USB storage device connected to your computer.
3. Remove the external USB storage device from your computer.
4. Connect the external USB storage device to a front or rear USB port of the R&S OSP.

- In the GUI, select "Configuration" > "General" > "Context Menu" > "Update Firmware Version".



The following dialog opens:

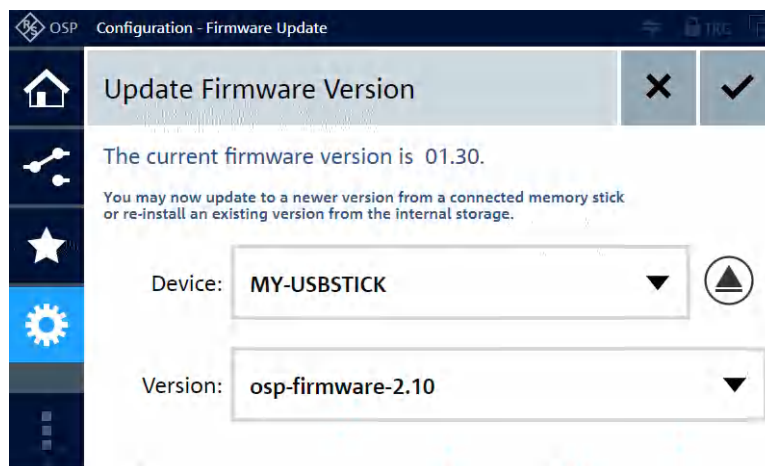

Figure 12-3: Installing firmware from USB

In this example, the external USB storage device with name `MY-USBSTICK` contains the firmware update file `osp-firmware-2.10.rsu`.



Note that the dialog also informs you on the currently installed firmware version.

Note: The device "Internal Storage" can contain up to 4 firmware versions, which have been installed previously via external USB storage device or LAN. Hence, via the internal memory you can always return to any of the 4 most recent firmware installations.

- If the external USB storage device contains several firmware `.rsu` files, select the firmware version that you want to install.

Note:

- If you select the "Device" = "Internal Storage" and then select a firmware version that is available there, the switch unit reboots with this firmware version.
- If you select the same firmware version that is running, updating the firmware is aborted automatically. A [device message](#) informs you that this firmware version cannot be installed.

- If you do not want to install any firmware, you can click the "Cancel" button  to return to the "Configuration" dialog.
- Otherwise, to install the selected firmware from the external USB storage device, click the "OK" button  in the top right corner of the dialog.

The following message comes up: "You have selected a firmware version for installation. The firmware currently running will be terminated and the selected version will be started now. Do you really want to proceed?"

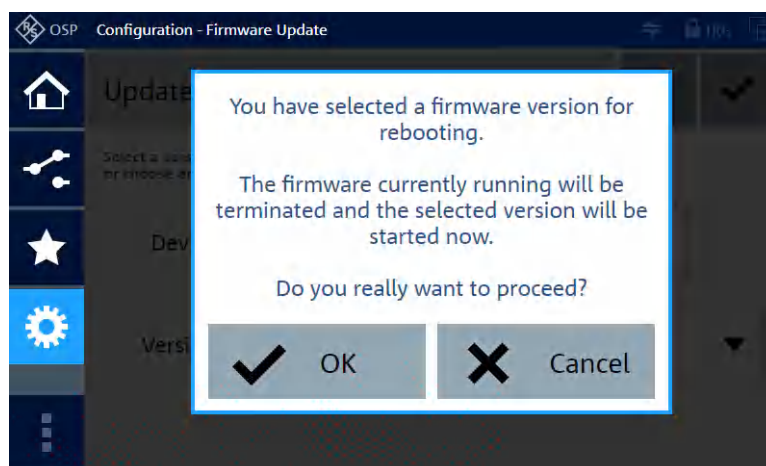

9. Confirm with "OK" or "Cancel" the updating procedure.
10. Wait during the updating procedure is running.
Make sure to keep the switch unit powered on.
If you observe this procedure in the "WebGUI" on your remote PC, ignore the following screens:

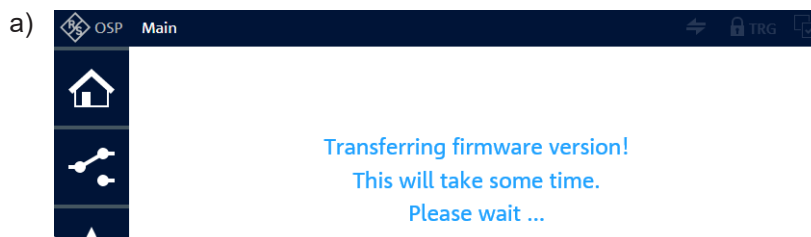

Figure 12-4: Update file transfer

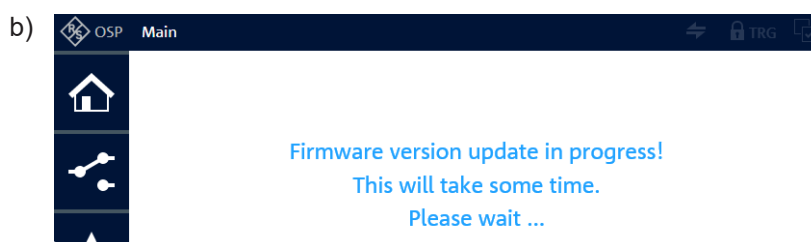



Figure 12-5: Firmware update running

When the installation is completed, the device connection typically recovers automatically. If the "WebGUI" indicates a temporary loss of device connection, hit the function key [F5] to reload the page.

Note: The touchscreen shows different displays during the installation procedure.

11. After a successful installation, the switch unit displays the [Main](#) dialog.
12. The newly installed firmware version is active.
13. Optionally click the [Device Information](#) button  to check the currently installed firmware version.

14. Before removing the USB storage device, return to the "Update Firmware Version" dialog.
15. Click the eject button on the right-hand side of the "Device" selection field:



The following message comes up: "**Safe To Remove Hardware**". "The device '<devicename>' can now be safely removed."

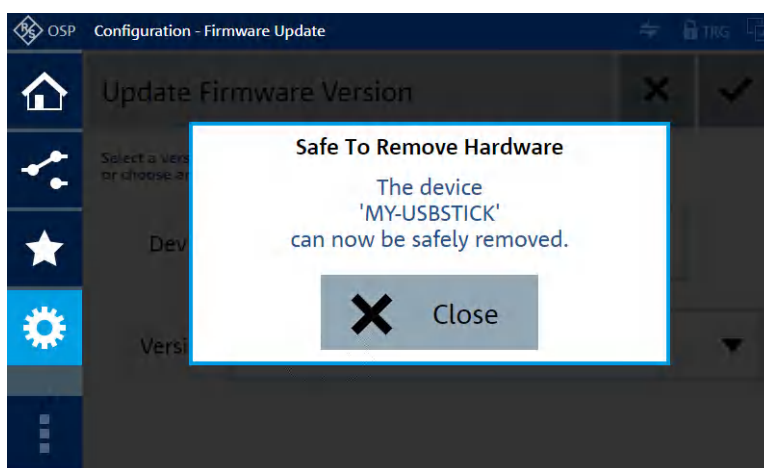

16. Remove the external USB storage device from the front or rear USB port.
17. Click "Close" to confirm this message.

12.3.2 Update by R&S Software Distributor

To install new firmware on **several** R&S OSP switch units simultaneously, you can use the "**R&S Software Distributor**".

For installation, proceed as follows:

1. Download the setup file of the latest firmware ("osp_firmware_update_x.xx.exe", where x.xx is the version) from www.rohde-schwarz.com/firmware/osp-n to your PC.
2. Connect both the PC and your switch units to the LAN.
3. Open the "Windows Explorer".
4. Go to the folder with the download of "osp_firmware_update_x.xx.exe".
5. Start this setup file.

The "R&S Software Distributor" opens up.

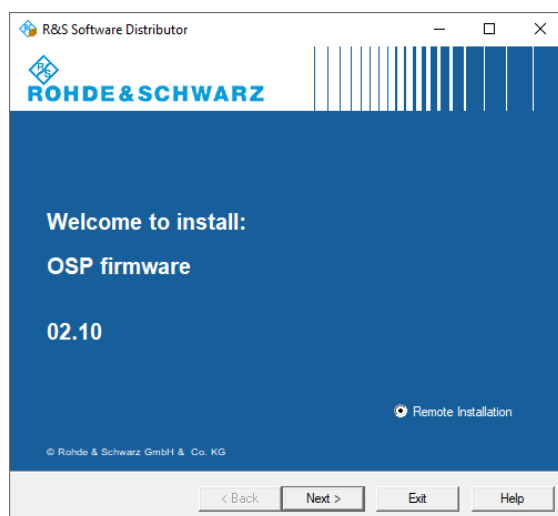

Figure 12-6: R&S Software Distributor for R&S OSP

In this example, the firmware version is "2.10". Note that you cannot deselect "Remote Installation".

6. Click "Next >".

The "Packages" dialog shows all firmware packages available for setup.

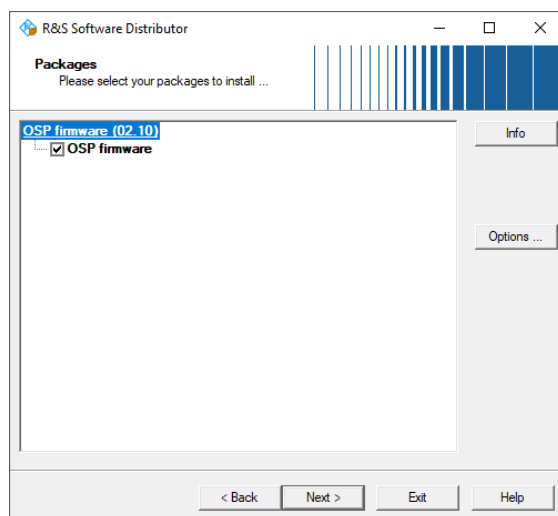

Figure 12-7: Available firmware packages

The `osp_firmware_update_x.xx.exe` files only contain "OSP firmware".

7. Click "Next >" to confirm without changes.
8. Wait for an update of the "Device List" dialog.

The dialog shows all R&S OSP devices available in the network:

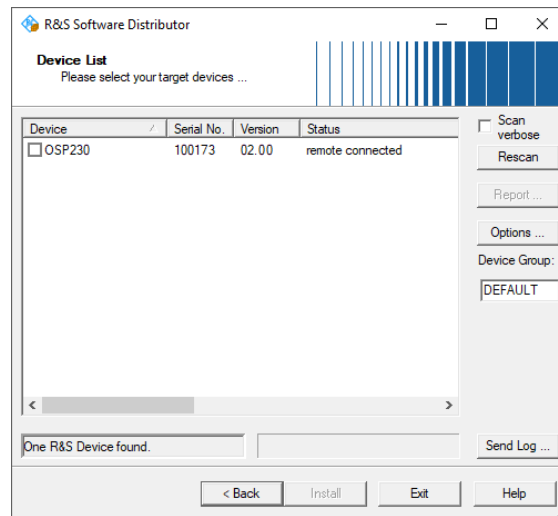

Figure 12-8: Available R&S OSP devices

In the example in [Figure 12-8](#), only one R&S OSP230 is remotely connected and available for firmware update. The device has the serial number 100173, and the currently installed firmware version is "2.00".

- In the list, tick the checkboxes of all devices that you want to update.

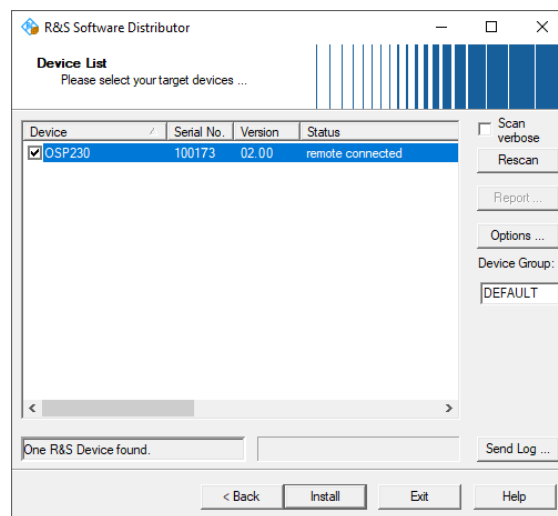

Figure 12-9: Select devices

- Click "Install>"

The "R&S Software Distributor" starts the setup.

Make sure to keep the switch units powered on.

During the installation, the switch unit's user interface shows this information:

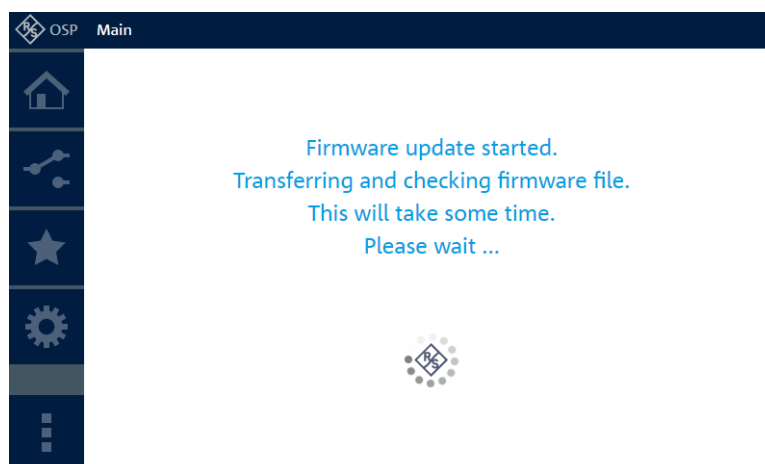

11. In the installer's interface, you can monitor the progress (percentage of installation) in the dialog's "Status" column (see red arrow).

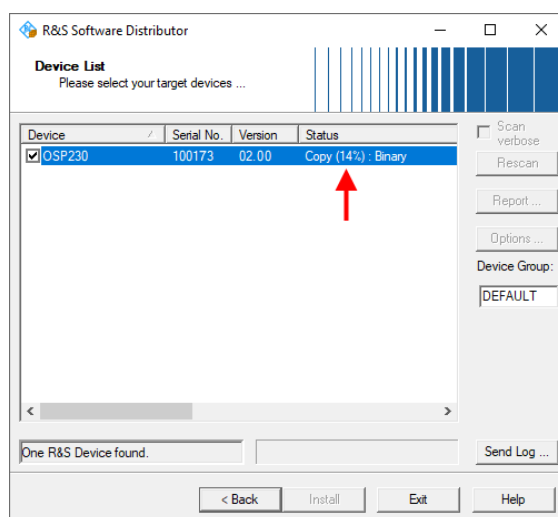

The setup has finished, when the status changes to "Ready: ...".

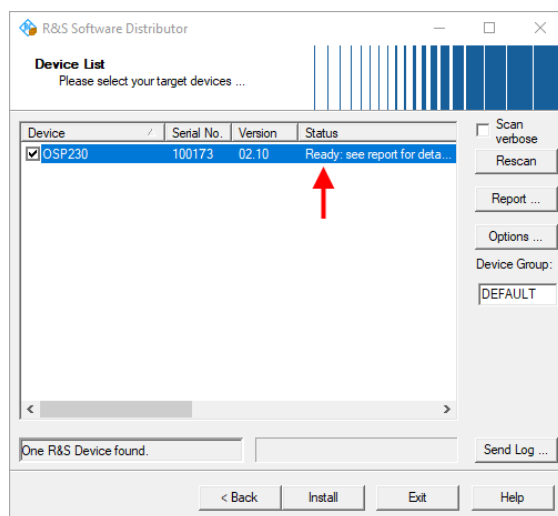

12. Optionally, click "Report ..." to see installation details:

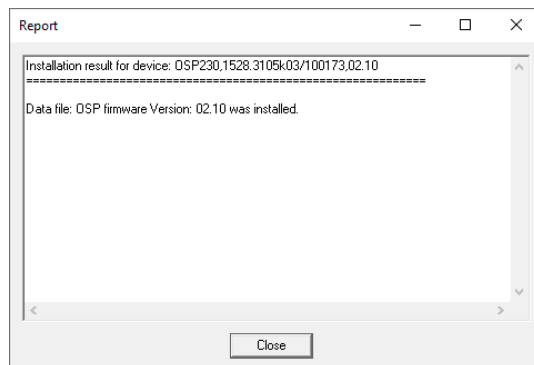

13. Close the "Report" dialog.
14. Click "Exit" to close the "R&S Software Distributor" on your PC.
Each updated device reboots automatically.
Do not power off the R&S OSP before having restarted.
15. If the firmware update includes an FPGA update (which is not necessarily obvious), the device does not restart automatically. Instead of rebooting, the device shuts down to standby mode.
In this case, push the [Pwr] button to restart the device manually.
The updated devices now operate with the new firmware version.

13 Storage and Disposal

13.1 Storage

Protect the product against dust. Ensure that the environmental conditions, e.g. temperature range and climatic load, meet the values specified in the data sheet.

13.2 Disposal

Rohde & Schwarz is committed to making careful, ecologically sound use of natural resources and minimizing the environmental footprint of our products. Help us by disposing of waste in a way that causes minimum environmental impact.

Disposing electrical and electronic equipment

A product that is labeled as follows cannot be disposed of in normal household waste after it has come to the end of its service life. Even disposal via the municipal collection points for waste electrical and electronic equipment is not permitted.



Figure 13-1: Labeling in line with EU directive WEEE

Rohde & Schwarz has developed a disposal concept for the eco-friendly disposal or recycling of waste material. As a manufacturer, Rohde & Schwarz completely fulfills its obligation to take back and dispose of electrical and electronic waste. Contact your local service representative to dispose of the product.

Annex

A Technical Drawings of Device Geometry

The following technical drawings show the mechanical geometry of the front and rear panels of the switch units R&S OSP220, R&S OSP230 and R&S OSP320.

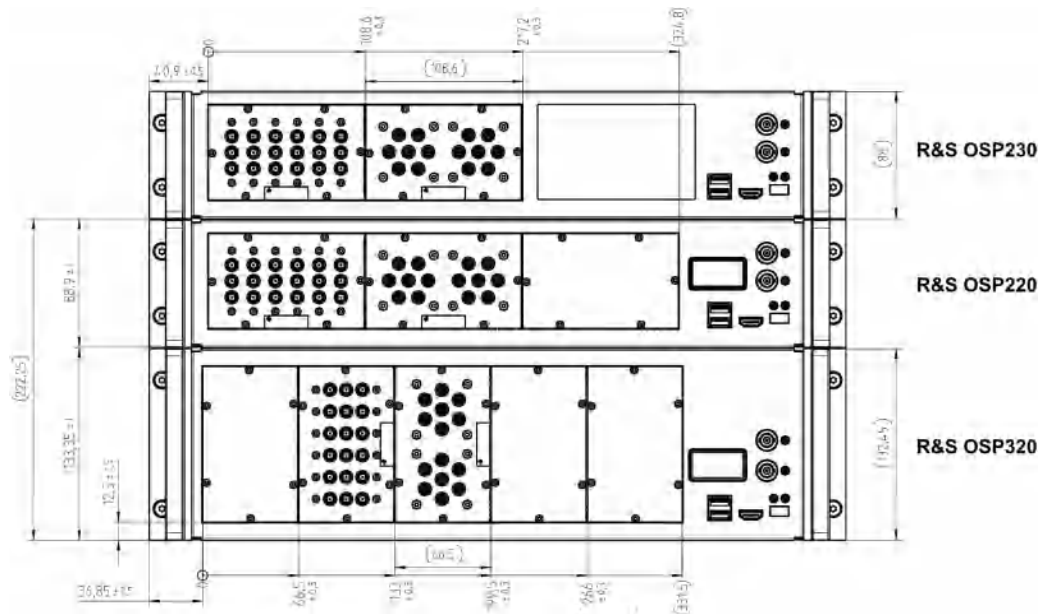

Figure A-1: Front panels of the units as mounted in a 19" rack

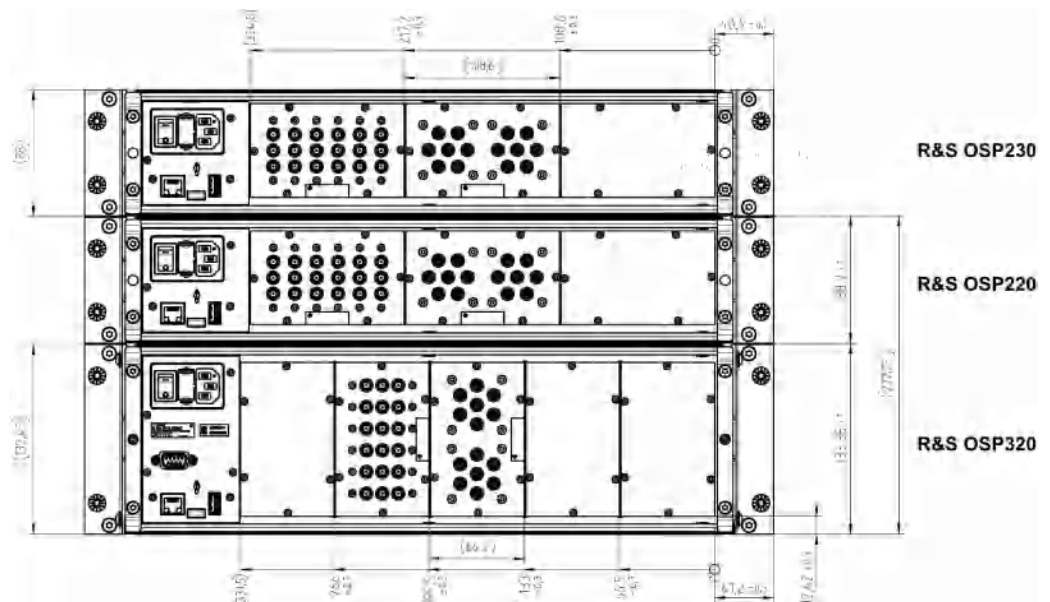

Figure A-2: Rear panels of the units as mounted in a 19" rack

- Figure A-1 and Figure A-2 show the units as mounted in a 19" rack
- Figure A-3 and Figure A-4 show the geometry in a stack of stand-alone units

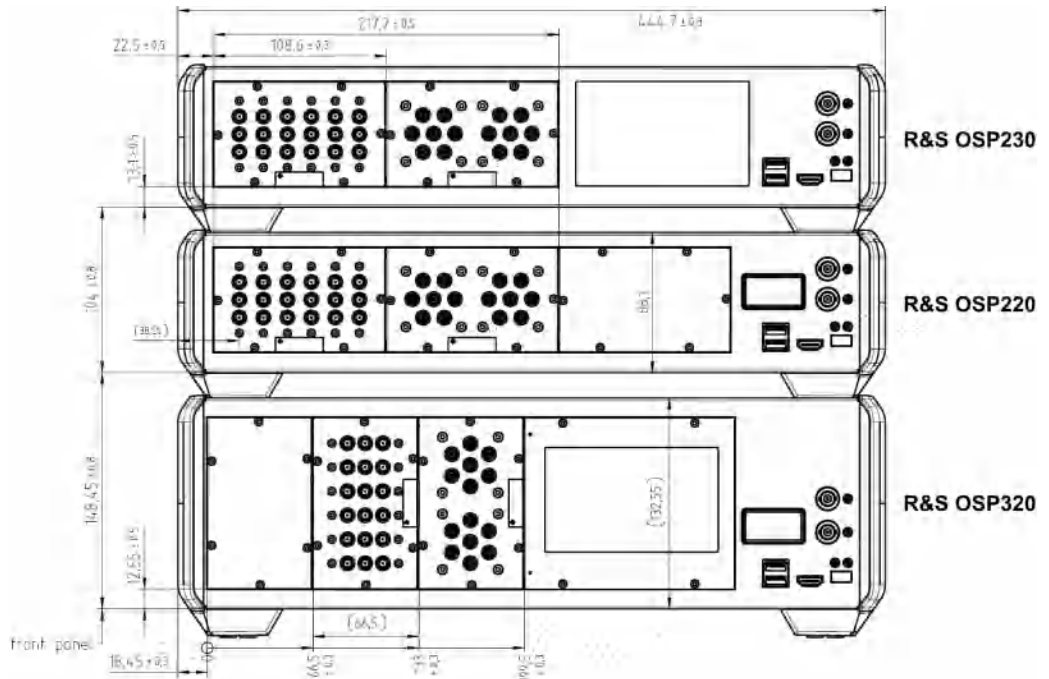

Figure A-3: Front panels of the stacked stand-alone units

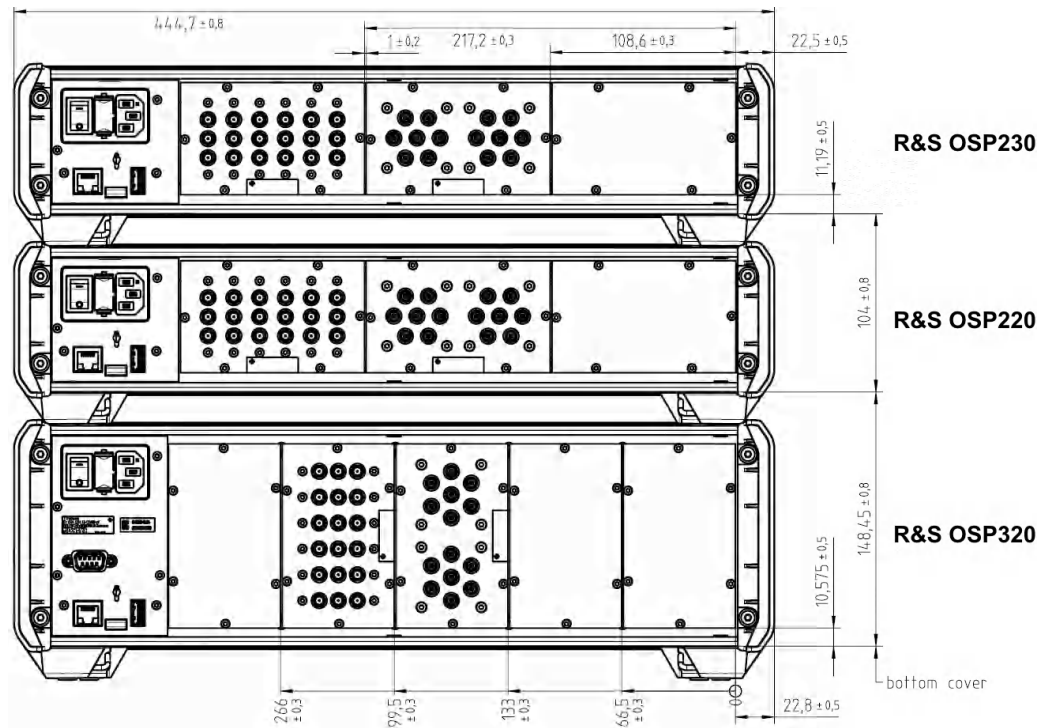

Figure A-4: Rear panels of the stacked stand-alone units

B Motherboard Interfaces

The R&S OSP motherboard has the following external interface connectors (labeled 2 and 3 in [Figure B-1](#)) and internal interface connectors (4 to 6, S, P and M):

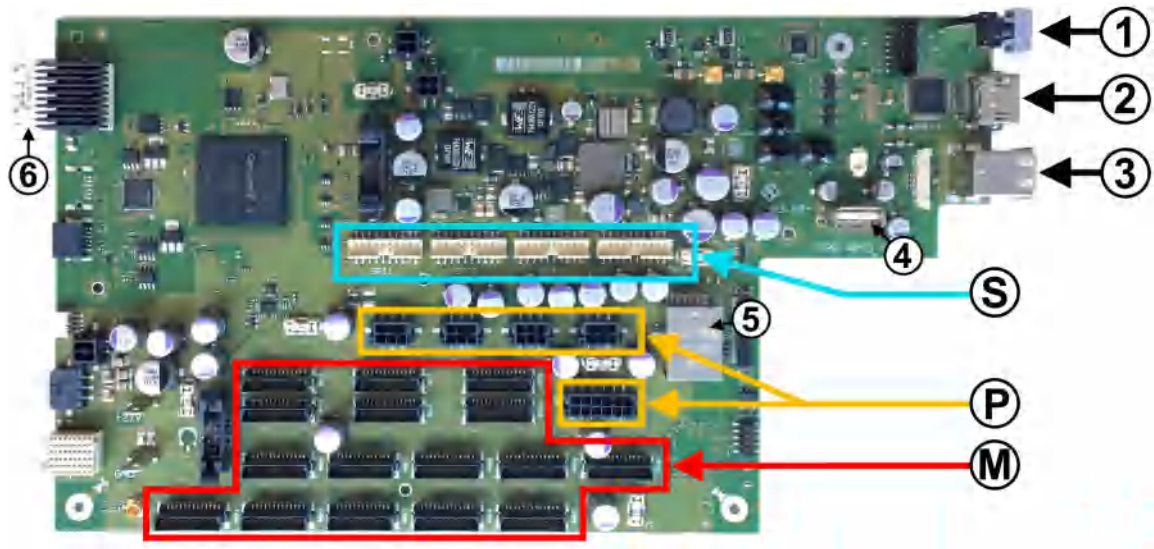

Figure B-1: Interfaces and bus connectors on R&S OSP motherboard

- 1 = Front power switch
- 2 = Front HDMI connector (for external monitor)
- 3 = Two front USB 2.0 connectors (for external mouse and keyboard)
- 4 = Internal USB connector
- 5 = Internal Ethernet connector (RJ45)
- 6 = Internal connector to controller board
- S = SPI module bus connectors [M17] to [M20], see [Table B-1](#)
- P = Power connectors with 6 pins (4x, see [Table B-2](#)) and with 12 pins (1x, see [Table B-3](#))
- M = Module bus connectors [M01] to [M16], see [Table B-4](#)

Table B-1: 20-pin SPI module bus connectors M17 to M20

Contact	Description	Direction	Contact	Description	Direction
1	+3V3_SPI_x_y (1 A el. fused)	Power	2	DGND	Power
3	I2C_Sx_SCL ¹	Output	4	I2C_Sx_SDA ¹	Bidirectional
5	SDI_SPIx_P ²	Output	6	SDI_SPIx_N ²	Output
7	SCLK_SPIx_P ²	Output	8	SCLK_SPIx_N ²	Output
9	CS_SPIx_P ²	Output	10	CS_SPIx_N ²	Output
11	SDO_SPIx_P ²	Input	12	SDO_SPIx_N ²	Input
13	DGND	Power	14	+5V_SPI_x_y (1 A el. fused)	Power
15, 17, 19	AGND	Power	16, 18, 20	+27V / 1.1A Polyfuse	Power

- 1: I²C signals with on-board pullup resistors
- 2: Low-voltage differential signaling with 350 mV typical output voltages into a 100 Ω load

Table B-2: 6-pin module power supply

Contact	Description	Direction	Contact	Description	Direction
1	+5V (max. 10 A)	Power	2	+5V	Power
3	+3V3 (1 A electronic fuse)	Power	4	DGND	Power
5	DGND	Power	6	DGND	Power

Table B-3: 12-pin module power supply

Contact	Description	Direction	Contact	Description	Direction
1	+5V (max. 10 A)	Power	2	+5V	Power
3	+5V	Power	4	+3V3 (1 A electronic fuse)	Power
5	Not connected (former -12 V PXI)	Power	6	Not connected (former +12 V PXI)	Power
7	DGND	Power	8	DGND	Power
9	DGND	Power	10	DGND	Power
11	DGND	Power	12	DGND	Power

Table B-4: 26-pin module bus connectors M01 to M16 (with module bus number M##, power supply el. fuse path F#)

Contact	Description	Direction	Contact	Description	Direction
A1	DGND	Power	B1	+3V3_F# (1 A el. fused)	Power
A2	I2C_M##_SDA	Output	B2	I2C_M##_SCL	Bidirectional
A3	M##_O00	Input	B3	M##_O01	Input
A4	M##_O02	Output	B4	M##_O03	Output
A5	M##_O04	Output	B5	M##_O05	Output
A6	M##_O06	Output	B6	M##_O07	Output
A7	M##_O08	Power	B7	M##_O09	Power
A8	M##_O10	Power	B8	M##_O11	Power
A9	M##_O12	Power	B9	M##_O13	Power
A10	M##_O14	Power	B10	M##_O15	Power
A11, A12, A13	+27V / 1.1A Polyfuse (0.9 A recommended)	Power	B11, B12, B13	AGND	Power

C Off/On Switching States of Various Relays

This section describes the behavior of the various relay types, when you switch the R&S OSP switch unit OFF and ON again (without or with reset). A loss of power at the relays due to some malfunction has the same effect as switching the R&S OSP OFF.

The following types of relays are discerned:

- [Table C-1](#): **Monostable** electromechanical relays (SPDT, DPDT and SPxT, fail-safe)
- [Table C-2](#): **Bistable** electromechanical relays (SPDT, DPDT and SPxT, latching)
- [Table C-3](#): Solid-state relays (SPDT and SPxT, not failsafe)

Table C-1: Monostable electromechanical relays

Icon (deactivated relay)	Relay type	R&S OSP: OFF	R&S OSP: ON without reset	R&S OSP: ON with reset
	General description	Relay falls back to (or remains in) default position Equivalent SCPI command, e.g.: <code>ROUT:CLOS (@F01M01 (0001))</code>	Relay remains in default position	
	SPDT (failsafe)	Switching state: ports C-NC are connected (port NO is open)		
	DPDT (failsafe)	Switching state: ports 1 to 2 and ports 3 to 4 are connected		
	SPxT (failsafe open)	Switching state: all ports are open		

Table C-2: Bistable and multistable electromechanical relays



Icon (arbitrarily activated relay, examples)	Relay type	R&S OSP : OFF	R&S OSP: ON without reset	R&S OSP: ON with reset	
	General description	Relay position remains unchanged	Relay position remains unchanged	Relay falls back to (or remains in) default position, equiv. SCPI: <code>...00...</code>	
	SPDT (latching)	Switching state remains activated or deactivated		Switching state: C-NC (port NO is open)	
	DPDT (latching)			Switching state: 1-2 and 3-4 are connected, R&S OSP-B104 is different	
	SPxT (latching)				

Table C-3: Solid-state relays (SSRs, not failsafe)

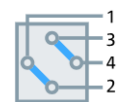
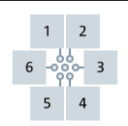

Relay type	R&S OSP: OFF	R&S OSP: ON without reset	R&S OSP: ON with reset
General description	Relay is not operative	Relay goes to default position Equivalent SCPI command: ...00...	
SPDT	Switching state: undefined, ports have high impedance	 NC C NO	Switching state: C-NC (port NO is open)
SPxT			Switching state: all ports are open

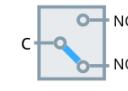
Table C-2: On the module panel of a bistable (latching) electromechanical SPDT relay, terminal NC is sometimes labeled as P2 (or "0"), according to SCPI 00. And terminal NO is sometimes labeled as P1 (or "1"), according to SCPI 01.

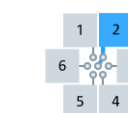
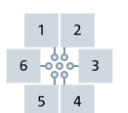
Relays in special modules, for example in system modules R&S OSP-B15x, can deviate from the states shown in this section.

Glossary: Frequently used Terms and Abbreviations

C

CMOS: Complementary metal-oxide semiconductor, a basic integrated circuit technology

CW: Continuous wave, an RF signal with constant amplitude and frequency

D

D-Sub: Electrical D-subminiature connector, surrounded by a D-shaped metal support

DHCP: Dynamic host configuration protocol, provides a framework for passing configuration information to hosts on a TCP/IP network. DHCP is based on the Bootstrap protocol (BOOTP), adding automatic allocation of reusable network addresses and additional configuration options. It allows simple TCP/IP network configuration in a safe and reliable way, preventing address conflicts and helping to conserve the use of client IP addresses. DHCP-supporting clients can request and obtain lease of an IP address from a DHCP server as part of their network boot process.

DPDT: Double pole double throw: a crossover switch, transfer switch or four change-over switches (SPDT) controlled by a common mechanism

E

EMS: Electromagnetic susceptibility

F

FET: Field-effect transistor

G

GUI: [WebGUI](#)

H

HDMI: High-definition multimedia interface for transmitting digital audio and video data

Hostname: A unique name by which a network-attached device is known on a network. The hostname is used to identify a particular host in various forms of electronic communication.

HU: Height unit or rack unit, a single HU of 44.5 mm (1.752 in) is the smallest height of equipment that fits into a standard 19" rack. The height of larger equipment is typically expressed as multiples of 1 HU. For example, the R&S OSP is available in heights of 2 HU = 89 mm and 3 HU = 133.5 mm.

I

Interlock: An installation that prevents operating certain equipment as long as a given mechanism is not in a desired state. For example, while the door of an anechoic chamber is open, the door's interlock can disable a signal generator or amplifier and a connected antenna from emitting RF radiation. Hence, this interlock prevents emitting RF power into the chamber, while an operator may still be inside.

L

LAN: Local area network within a limited space, such as an office building. A LAN connects computers or electronic equipment that has processing capability. It uses network media technologies such as Ethernet (over electric or fiber-optic cables, according to the IEEE 802.3 standards) or wireless LAN (Wi-Fi, according to IEEE 802.11).

LCD: Liquid-crystal display

LVC: Low voltage CMOS, referring to standardized power supply voltage levels of 3.3, 3.0, 2.5, 1.5, 1.2 and 1.0 volts.

M

MOS-FET: Metal-oxide-semiconductor field-effect transistor

N

N: A ruggedized coaxial RF connector, originally developed for navy (N) applications. N can also stand for the inventor Paul Neill.

O

ODU connector: A type of push-pull circular connector from manufacturer ODU GmbH, Mühlendorf, Germany

OLED: Organic light-emitting diode

OTA: Over-the-air, referring to wireless RF tests and applications

P

PC: Precision coaxial RF connector

R

RF: Radio frequency, electromagnetic oscillation in the range of 3 kHz to 300 GHz

RGB: Red, green and blue colors (for example of the pixels in a display)

S

SCPI: Standard commands for programmable instruments (see www.ivifoundation.org/scpi), based on Standard Codes and Formats, IEEE-488.2, allows controlling programmable devices in test and measurement systems

SMA: Subminiature coaxial RF connector, version A (standard)

SPDT: Single pole double throw: a changeover switch with the common line (C) connected to the NC (normally closed) port in the deactivated state, and to the NO (normally open) port in the activated state

SPxT: Single pole x-fold throw, a multi-terminal switch (typically a drum switch): Its common line (C) is not connected to any terminal port in the deactivated state, and to one of the x terminal ports in an activated state.

Switchable item: R&S OSP modules can contain a broad range of "switchable items": Most standard modules have relays and output channels as their switchable items. Special modules for system applications also can have step attenuators, phase shifters, amplifiers and modulators. Switchable items can also be read. On the contrary, non-switchable but "readable items" are input channels, interlocks and sensors.

T

TCP/IP: Transmission control protocol / Internet protocol, a set of widely used networking protocols that provides communications across interconnected networks of computers with diverse hardware architectures and various operating systems. TCP/IP includes standards for computer communication and conventions for connecting networks and routing traffic.

TFT: Thin-foil transistor (used for displays)

TVS: Transient-voltage suppression, typically achieved with unidirectional or bidirectional diodes that can handle large peak currents.

U

USB: Universal serial bus, industrial connector standard

W

WebGUI: Web-based graphical user interface, the instrument's dialogs in a browser window

WVGA: Wide video graphics array, a standard display resolution of 800 x 480 pixels

Index

A

Absorptive ports 54
 AC supply fuses 35, 305
 Application notes, application cards 14

B

Backup 215
 Backward compatibility 199
 Bench-top positioning 17
 Bistable, multistable 53, 55, 320
 BNC connectors 35
 Brochures 13
 Browser 36
 Bus connectors 318

C

Changing fuses 305
 Cleaning 306
 Cleanup (device reset) 162
 Clear status
 Remote 247
 Command sequence
 Remote 250
 Commands
 Common 246
 see Remote commands 246
 Common commands 246
 Compatibility mode 199
 Configuration 38
 CONFIGure commands 266
 Configured address 167
 Connectors 35
 Context menu 38
 Conventions
 SCPI commands 246
 Counting relay operation cycles 265
 Current peak 302
 Customer support 303

D

Data sheets 13
 Default values
 Remote 249
 Device cleanup (reset) 162
 Device messages 161
 DIAGnostic commands 290
 Display
 External (HDMI) 32
 Status display 34, 200
 Touchscreen 34
 Display (touchscreen) 148
 Disposal 315
 Drawings of device geometry 316
 DVI 36

E

Electromagnetic interference 19
 Electromechanical relay 53, 320
 Electrostatic discharge 19

EMI 19
 Enable registers
 Remote 248
 Errors
 GUI 161, 301
 Non-switchable paths 182
 SCPI 250, 302
 ESD 19
 Ethernet 149
 Event status enable register (ESE)
 Remote 247
 Event status register (ESR)
 Remote 247

F

Failsafe 11, 53, 320
 Failsafe (open) 53, 320
 Firmware 301
 Update 162, 307
 Front panel
 Overview 25
 R&S OSP-B200S2 27
 R&S OSP220 25
 R&S OSP230 25
 R&S OSP320 26
 Front slots 49
 Fuses 35, 305

G

Geometry of the switch units 316
 Getting started 13

H

HDMI 32, 36

I

I2C 161
 Identification
 Remote 248
 Input connectors 22
 Interconnection 150
 Interface cables, see: Module bus cables 49
 Interface panels 35

K

Key features 12
 Keyboard
 External (USB) 32
 On-screen 28

L

LAN 33, 35, 149
 Environment 20
 Latching 55, 320
 License key 162, 163

M

Main	37
Maintenance	162, 305
Mechanical geometry of the switch units	316
Messages	161
MMEMoRY commands	289
Module	
All available options	51
Bus cables	49
Bus connectors	49
Detection	161
Operation	37
Overview	51
Monitor (external, HDMI)	32
Monostable	11, 53, 320
Motherboard	49
Motherboard interfaces	318
Mouse (USB)	32

N

NC (normally closed)	53
Network	
Configuring	240
Environment	20
Network connection issues	301
NO (normally open)	53

O

On-screen keyboard	28
Open-source acknowledgment (OSA)	14
Operation	
Manual, direct	32
Manual, remote	33
Remote (SCPI)	33
Operation complete	
Remote	248
Option key	
See: license key	163
Options	
Identification (remote)	248
Overview	51
Overloading terminated ports	20

P

Parameters	
Remote commands	244
Path switching	38
Peak current	302
Positioning	
Bench-top	17
Rack-mounted	18
Power switch	35, 305
Primary / secondary	150
Exit interconnection mode	151
Programming examples	298

R

R&S OSP-B200S2	
Front panel	27
Rear panel	31

R&S OSP220	
Front panel	25
Rear panel	29
R&S OSP230	
Front panel	25
Rear panel	29
R&S OSP320	
Front panel	26
Rear panel	30
Rack mounting	18
READ commands	262
Rear panel	
Overview	29
R&S OSP-B200S2	31
R&S OSP220	29
R&S OSP230	29
R&S OSP320	30
Rear slots	49
Reboot	308
Reflective ports	54
Release notes	14
Remote commands	
Basics on syntax	243
Boolean values	244
Capitalization	243
CONFIgure	266
Conventions	246
Data blocks	244
DIAGnostic	290
MMEMory	289
Numeric values	244
Optional keywords	243
Parameters	244
Programming examples	298
READ	262
ROUTe	252
Strings	244
Syntax	299
SYSTem	250, 293
TRIGger	282
Remote operation	
Configuring	240
see also Remote commands	246
Replacing fuses	305
Reset	23, 267
Device	162
Switches	158
Reset values	
Remote	249
RF connectors	21
ROUTe commands	252

S

Safety instructions	13
SCPI commands	
see Remote commands	246
SCPI error	
-170 (READ:IO:IN)	262
-170 (READ:MOD:INT)	264
-200 (CONF:ALL:REST:DEL)	272
-200 (CONF:FRAM:IMP:DEL)	281
-200 (ROUT:MOD:CAT)	295
-200 (ROUT:PATH:IMP:DEL)	260
-200 (ROUT:PATH:IMP)	258
-222 (CONF:FRAM:DEL)	278

-222 (READ:IO:IN)	262
-222 (READ:MOD:INT)	264
Scrolling	32
SD card	35
Secondary / primary	150
Exit interconnection mode	151
Self-test	
Remote	249
Service manual	13
Service request enable register (SRE)	
Remote	249
Shut down	23
Slots	49
Software option	163
Solid-state relay	320
SSR	321
Status byte	
Remote	247, 249
Status display period	200
Status reporting system	
Common commands	247
Storage	315
Syntax of remote commands	299
SYSTem commands	250, 293

T

Technical drawings of device geometry	316
Terminated ports	20, 54
Torque limits	21
Touchscreen	148
Module details	145
Overview	28
Transporting	304
Trigger	196, 201
Event (remote)	249
Export / import	220
Functionality	206
Timing	203
Type	206
TRIGger commands	282
Trigger input	35
Troubleshooting	301
Trying out	32
Tutorials	14

U

Update the firmware	307
USB	32, 35
User interface	34, 36
User manual	13

V

Virtual mode	154, 201
--------------------	----------

W

Wait	
Remote	250
Warnings	161
WebGUI	33, 36
White papers	14
Wired link	22