

# R&S® ESRP

## EMI Test Receiver

### User Manual



1175744502

This manual covers the following products:

- R&S ESRP3 (1316.4500.03)
- R&S ESRP7 (1316.4500.07)
- R&S FSV-B9 (1310.9545.02)
- R&S ESRP-K53 (1316.4639.02)
- R&S ESRP-K56 (1316.4897.02)

The contents of this manual correspond to firmware version 3.46 or higher.

© 2018 Rohde & Schwarz GmbH & Co. KG

Mühlhofstr. 15, 81671 München, Germany

Phone: +49 89 41 29 - 0

Fax: +49 89 41 29 12 164

Email: [info@rohde-schwarz.com](mailto:info@rohde-schwarz.com)

Internet: [www.rohde-schwarz.com](http://www.rohde-schwarz.com)

Subject to change – Data without tolerance limits is not binding.

R&S® is a registered trademark of Rohde & Schwarz GmbH & Co. KG.

Trade names are trademarks of the owners.

1175.7445.02 | Version 08 | R&S®ESRP

Throughout this manual, products from Rohde & Schwarz are indicated without the ® symbol , e.g. R&S®ESRP is indicated as R&S ESRP.

# Safety Instructions

## Instrucciones de seguridad

## Sicherheitshinweise

## Consignes de sécurité

---

### **WARNING**

#### **Risk of injury and instrument damage**

The instrument must be used in an appropriate manner to prevent personal injury or instrument damage.

- Do not open the instrument casing.
  - Read and observe the "Basic Safety Instructions" delivered as printed brochure with the instrument.
  - Read and observe the safety instructions in the following sections. Note that the data sheet may specify additional operating conditions.
  - Keep the "Basic Safety Instructions" and the product documentation in a safe place and pass them on to the subsequent users.
- 

### **ADVERTENCIA**

#### **Riesgo de lesiones y daños en el instrumento**

El instrumento se debe usar de manera adecuada para prevenir descargas eléctricas, incendios, lesiones o daños materiales.

- No abrir la carcasa del instrumento.
  - Lea y cumpla las "Instrucciones de seguridad elementales" suministradas con el instrumento como folleto impreso.
  - Lea y cumpla las instrucciones de seguridad incluidas en las siguientes secciones. Se debe tener en cuenta que las especificaciones técnicas pueden contener condiciones adicionales para su uso.
  - Guarde bien las instrucciones de seguridad elementales, así como la documentación del producto, y entréguelas a usuarios posteriores.
-

---

**⚠️ WARNUNG****Gefahr von Verletzungen und Schäden am Gerät**

Betreiben Sie das Gerät immer ordnungsgemäß, um elektrischen Schlag, Brand, Verletzungen von Personen oder Geräteschäden zu verhindern.

- Öffnen Sie das Gerätegehäuse nicht.
  - Lesen und beachten Sie die "Grundlegenden Sicherheitshinweise", die als gedruckte Broschüre dem Gerät beiliegen.
  - Lesen und beachten Sie die Sicherheitshinweise in den folgenden Abschnitten; möglicherweise enthält das Datenblatt weitere Hinweise zu speziellen Betriebsbedingungen.
  - Bewahren Sie die "Grundlegenden Sicherheitshinweise" und die Produktdokumentation gut auf und geben Sie diese an weitere Benutzer des Produkts weiter.
- 

---

**⚠️ AVERTISSEMENT****Risque de blessures et d'endommagement de l'appareil**

L'appareil doit être utilisé conformément aux prescriptions afin d'éviter les électrocutions, incendies, dommages corporels et matériels.

- N'ouvrez pas le boîtier de l'appareil.
  - Lisez et respectez les "consignes de sécurité fondamentales" fournies avec l'appareil sous forme de brochure imprimée.
  - Lisez et respectez les instructions de sécurité dans les sections suivantes. Il ne faut pas oublier que la fiche technique peut indiquer des conditions d'exploitation supplémentaires.
  - Gardez les consignes de sécurité fondamentales et la documentation produit dans un lieu sûr et transmettez ces documents aux autres utilisateurs.
-

# Customer Support

## Technical support – where and when you need it

For quick, expert help with any Rohde & Schwarz equipment, contact one of our Customer Support Centers. A team of highly qualified engineers provides telephone support and will work with you to find a solution to your query on any aspect of the operation, programming or applications of Rohde & Schwarz equipment.

## Up-to-date information and upgrades

To keep your instrument up-to-date and to be informed about new application notes related to your instrument, please send an e-mail to the Customer Support Center stating your instrument and your wish. We will take care that you will get the right information.

### Europe, Africa, Middle East

Phone +49 89 4129 12345  
[customersupport@rohde-schwarz.com](mailto:customersupport@rohde-schwarz.com)

### North America

Phone 1-888-TEST-RSA (1-888-837-8772)  
[customer.support@rsa.rohde-schwarz.com](mailto:customer.support@rsa.rohde-schwarz.com)

### Latin America

Phone +1-410-910-7988  
[customersupport.la@rohde-schwarz.com](mailto:customersupport.la@rohde-schwarz.com)

### Asia/Pacific

Phone +65 65 13 04 88  
[customersupport.asia@rohde-schwarz.com](mailto:customersupport.asia@rohde-schwarz.com)

### China

Phone +86-800-810-8228 /  
+86-400-650-5896  
[customersupport.china@rohde-schwarz.com](mailto:customersupport.china@rohde-schwarz.com)



# Contents

<b>1</b>	<b>Preface</b> .....	<b>19</b>
1.1	<b>For Your Safety</b> .....	<b>19</b>
1.2	<b>Conventions Used in the Documentation</b> .....	<b>19</b>
1.2.1	Typographical Conventions.....	19
1.2.2	Conventions for Procedure Descriptions.....	20
1.2.3	Notes on Screenshots.....	20
1.3	<b>How to Use the Help System</b> .....	<b>20</b>
<b>2</b>	<b>Documentation Overview</b> .....	<b>23</b>
2.1	<b>Getting Started Manual</b> .....	<b>23</b>
2.2	<b>User Manuals and Help</b> .....	<b>23</b>
2.3	<b>Service Manual</b> .....	<b>23</b>
2.4	<b>Instrument Security Procedures</b> .....	<b>24</b>
2.5	<b>Basic Safety Instructions</b> .....	<b>24</b>
2.6	<b>Data Sheets and Brochures</b> .....	<b>24</b>
2.7	<b>Release Notes and Open Source Acknowledgment (OSA)</b> .....	<b>24</b>
2.8	<b>Application Notes, Application Cards, White Papers, etc</b> .....	<b>24</b>
<b>3</b>	<b>Quick Start</b> .....	<b>25</b>
3.1	<b>Front and Rear Panel View</b> .....	<b>25</b>
3.1.1	Front Panel View.....	25
3.1.1.1	Function Keys on the Front Panel.....	26
3.1.1.2	Touchscreen Display.....	29
3.1.1.3	Connectors on the Front Panel.....	30
3.1.1.4	Optional Front Panel Connectors.....	32
3.1.2	Rear Panel View.....	33
3.1.2.1	Standard Rear Panel Connectors.....	33
3.1.2.2	Optional Rear Panel Connectors.....	36
3.2	<b>Preparing for Use</b> .....	<b>36</b>
3.2.1	Putting into Operation.....	36
3.2.1.1	Unpacking and Checking the Instrument.....	37
3.2.1.2	Accessory List.....	38
3.2.1.3	Placing or Mounting the Instrument.....	38

3.2.1.4	Connecting the AC Power.....	40
3.2.1.5	Changing the AC Supply Fuse.....	40
3.2.1.6	Using an Optional DC Power Supply.....	40
3.2.1.7	Switching the Instrument On and Off.....	41
3.2.1.8	Maintenance.....	42
3.2.1.9	Performing a Self Alignment and a Self Test.....	43
3.2.1.10	Checking the Supplied Options.....	43
3.2.2	Connecting USB Devices.....	44
3.2.3	Connecting an External Monitor.....	45
3.2.4	R&S ESRP Setup.....	45
3.2.4.1	Selecting the Frequency Reference Signal.....	46
3.2.4.2	Setting the Date and Time.....	46
3.2.4.3	Aligning the Touchscreen.....	47
3.2.4.4	Setting the Screen Colors.....	48
3.2.4.5	Setting the Display Power Save Function.....	50
3.2.4.6	Selecting and Configuring Printers.....	51
3.2.5	Windows Operating System.....	53
3.2.5.1	Virus Protection.....	54
3.2.5.2	Service Packs and Updates.....	54
3.2.5.3	Login.....	54
3.2.5.4	Accessing the Start Menu.....	56
3.2.5.5	Accessing the Windows Taskbar.....	57
3.2.6	Configuring the GPIB Interface.....	57
<b>3.3</b>	<b>Firmware Update and Installation of Firmware Options.....</b>	<b>58</b>
3.3.1	Firmware Update.....	58
3.3.2	Activating Firmware Options.....	59
<b>3.4</b>	<b>Basic Operations.....</b>	<b>60</b>
3.4.1	Information in the Diagram Area.....	60
3.4.1.1	Channel Display.....	61
3.4.1.2	Display of Hardware Settings.....	62
3.4.1.3	Measurement Settings Information.....	63
3.4.1.4	Diagram-specific and Trace Information.....	64
3.4.1.5	Instrument and Status Information.....	66

3.4.2	Means of User Interaction.....	68
3.4.2.1	Toolbar.....	68
3.4.2.2	Touchscreen.....	69
3.4.2.3	On-screen Keyboard.....	70
3.4.2.4	Keypad.....	71
3.4.2.5	Rotary Knob.....	72
3.4.2.6	Arrow Keys, UNDO/REDO Keys.....	72
3.4.2.7	Softkeys.....	73
3.4.2.8	Context-sensitive Menus.....	74
3.4.2.9	Dialog Boxes.....	75
3.4.3	Setting Parameters.....	76
3.4.3.1	Entering Numeric Parameters.....	76
3.4.3.2	Entering Alphanumeric Parameters.....	76
3.4.3.3	Navigating in Dialog Boxes.....	78
3.4.4	Changing the Display.....	81
3.4.4.1	Changing the Focus.....	81
3.4.4.2	Switching between Split and Maximized Display.....	81
3.4.4.3	Soft and Mini Soft Front Panel Display.....	81
3.4.4.4	Enlarging the Display Area.....	84
3.4.4.5	Displaying the Toolbar.....	84
3.4.4.6	Zooming into the Diagram.....	84
3.4.4.7	Adding a Title to the Diagram Header.....	86
3.4.4.8	Removing the Diagram Footer.....	87
3.4.4.9	Selecting a Theme.....	87
3.4.4.10	Displaying and Setting the Date and Time.....	87
3.4.4.11	Changing the Display Update Rate.....	88
<b>3.5</b>	<b>Basic Measurement Examples.....</b>	<b>88</b>
3.5.1	Measuring a Sinusoidal Signal.....	89
3.5.1.1	Measuring the Level and Frequency Using Markers.....	89
3.5.1.2	Measuring the Signal Frequency Using the Frequency Counter.....	91
3.5.2	Measuring Harmonics of Sinusoidal Signals.....	93
3.5.3	Measuring Signal Spectra with Multiple Signals.....	96
3.5.3.1	Separating Signals by Selecting the Resolution Bandwidth.....	96



3.5.3.2	Measuring the Modulation Depth of an AM-Modulated Carrier (Span > 0).....	100
3.5.3.3	Measuring AM-Modulated Signals.....	101
3.5.4	Measurements in Zero Span.....	103
3.5.4.1	Measuring the Power Characteristic of Burst Signals.....	103
3.5.4.2	Measuring the Signal-to-Noise Ratio of Burst Signals.....	107
3.5.4.3	Measuring FM-Modulated Signals.....	110
3.5.5	Storing and Loading Instrument Settings.....	113
3.5.5.1	Storing an Instrument Configuration (without Traces).....	114
3.5.5.2	Storing Traces.....	115
3.5.5.3	Loading an Instrument Configuration (with Traces).....	115
3.5.5.4	Configuring Automatic Loading.....	115
<b>4</b>	<b>Measurement Modes.....</b>	<b>117</b>
<b>4.1</b>	<b>Receiver Mode.....</b>	<b>117</b>
<b>4.2</b>	<b>Spectrum Mode.....</b>	<b>117</b>
<b>4.3</b>	<b>I/Q Analyzer Mode.....</b>	<b>118</b>
<b>4.4</b>	<b>Measurement Mode Root Menus (HOME Key).....</b>	<b>118</b>
<b>5</b>	<b>Receiver Mode.....</b>	<b>119</b>
<b>5.1</b>	<b>Measurements and Result Displays.....</b>	<b>119</b>
5.1.1	Bargraph Measurement.....	119
5.1.2	IF Spectrum Analysis.....	120
5.1.3	Scans.....	121
5.1.3.1	Stepped Scans in the Frequency Domain.....	122
5.1.3.2	Time Domain Scans in the Frequency Domain.....	123
5.1.3.3	The Scan Table.....	123
5.1.4	Peak List and Data Reduction.....	124
5.1.5	Final Measurement.....	126
5.1.6	Spectrogram.....	127
5.1.6.1	How a Spectrogram Works.....	127
5.1.6.2	Color Map.....	128
5.1.7	Measurement Control.....	132
5.1.7.1	Running Scans and Measurements.....	132
5.1.7.2	Selecting the Result Display.....	132
5.1.7.3	Bargraph Control.....	133

5.1.7.4	Scan Control.....	134
5.1.7.5	Final Measurement Control.....	136
5.1.7.6	Measurement Settings.....	138
5.1.7.7	Spectrogram Configuration.....	140
<b>5.2</b>	<b>Measurement Basics.....</b>	<b>141</b>
5.2.1	Measurement Bandwidth.....	142
5.2.2	Detectors.....	143
5.2.3	Trace Modes.....	147
5.2.4	AF Demodulation.....	148
5.2.5	V-Networks Control (LISN).....	149
5.2.6	Transducers.....	150
5.2.7	Preamplifier.....	151
5.2.8	Exported Peak List.....	152
5.2.9	Formats for Returned Values: ASCII Format and Binary Format.....	153
<b>5.3</b>	<b>Common Measurement Settings.....</b>	<b>154</b>
5.3.1	Defining the Frequency and Span.....	155
5.3.2	Configuring the Level Display and the RF Input.....	157
5.3.3	Selecting the Bandwidth.....	160
5.3.4	Configuring the Scan.....	161
5.3.5	Configuring the Trigger .....	162
5.3.6	Controlling Inputs and Outputs.....	163
5.3.7	Test Automation.....	163
5.3.7.1	Overview .....	164
5.3.7.2	Scan Table.....	165
5.3.7.3	Peak Search.....	167
5.3.7.4	Peak Lists.....	169
5.3.7.5	Trace / Final Meas.....	171
5.3.7.6	LISN Settings.....	172
<b>5.4</b>	<b>Common Analysis Functions.....</b>	<b>174</b>
5.4.1	Trace Configuration.....	174
5.4.2	Markers.....	176
5.4.2.1	Controlling Markers.....	176
5.4.2.2	Positioning Markers.....	180

5.4.2.3	Markers in Spectrograms.....	183
5.4.3	(Limit) Lines.....	184
5.4.3.1	Softkeys of the Lines Menu.....	185
5.4.3.2	Display Lines.....	189
5.4.3.3	Limit Lines (Frequency/Time Lines).....	190
5.4.3.4	Working with Lines.....	191
5.4.3.5	Selecting a Limit Line.....	191
5.4.3.6	Creating a New Limit Line.....	192
5.4.3.7	Editing an Existing Limit Line.....	195
5.4.3.8	Creating a New Limit Line Based upon an Existing Limit Line.....	195
5.4.3.9	Activating/Deactivating a Limit Line.....	196
<b>6</b>	<b>Spectrum Measurements.....</b>	<b>197</b>
<b>6.1</b>	<b>Measurements.....</b>	<b>197</b>
6.1.1	Power Measurements – MEAS Key.....	197
6.1.1.1	Softkeys of the Power Measurement Menu.....	198
6.1.1.2	Measuring Channel Power and Adjacent-Channel Power.....	201
6.1.1.3	Measuring the Carrier-to-Noise Ratio.....	225
6.1.1.4	Measuring the Occupied Bandwidth.....	228
6.1.1.5	Measuring with Spectrum Emission Masks.....	232
6.1.1.6	Measuring Spurious Emissions.....	259
6.1.1.7	Measuring the Power in Zero Span.....	270
6.1.1.8	Performing EMI Measurements.....	273
6.1.1.9	Calculating Signal Amplitude Statistics.....	282
6.1.1.10	Measuring the Third Order Intercept Point (TOI).....	301
6.1.1.11	Measuring the AM Modulation Depth.....	307
6.1.1.12	Measuring Harmonic Distortion.....	308
6.1.2	Measurement Configuration – MEAS CONFIG Key.....	312
6.1.3	Performing Measurements – RUN SINGLE/RUN CONT Keys.....	312
<b>6.2</b>	<b>Configuration.....</b>	<b>313</b>
6.2.1	Initializing the Configuration – PRESET Key.....	313
6.2.1.1	Presetting the Instrument.....	313
6.2.1.2	Initial Configuration.....	314
6.2.2	Selecting the Frequency and Span – FREQ Key.....	315

6.2.2.1	Softkeys of the Frequency Menu.....	315
6.2.2.2	Specifying the Frequency Axis by the Start and Stop Frequency.....	319
6.2.2.3	Specifying the Frequency Axis by the Center Frequency and the Span.....	319
6.2.2.4	Specifying the Step Size for the Arrow Keys and the Rotary Knob.....	319
6.2.2.5	Modifying the Frequency Axis by an Offset.....	320
6.2.2.6	Tracking Signals (Span > 0).....	320
6.2.3	Setting the Frequency Span – SPAN Key.....	320
6.2.3.1	Softkeys of the Span Menu.....	321
6.2.3.2	Specifying the Span (Alternatives).....	321
6.2.4	Setting the Level Display and Configuring the RF Input – AMPT Key.....	322
6.2.4.1	Softkeys of the Amplitude Menu.....	322
6.2.4.2	Specifying the Amplitude.....	327
6.2.5	Defining Automatic Settings – AUTO SET Key.....	327
6.2.5.1	Softkeys of the Auto Set Menu.....	327
6.2.6	Setting the Bandwidths and Sweep Time – BW Key.....	331
6.2.6.1	Softkeys of the Bandwidth Menu.....	331
6.2.6.2	Specifying the Bandwidth.....	337
6.2.6.3	Selecting the Appropriate Filter Type.....	337
6.2.6.4	List of Available RRC and Channel Filters.....	338
6.2.7	Configuring the Sweep Mode – SWEEP Key.....	340
6.2.7.1	Softkeys of the Sweep Menu.....	340
6.2.7.2	Specifying the Sweep Settings.....	345
6.2.8	Triggering the Sweep – TRIG Key.....	345
6.2.8.1	Softkeys of the Trigger Menu.....	345
6.2.8.2	Specifying the Trigger Settings.....	352
6.2.8.3	Using Gated Sweep Operation.....	352
6.2.9	Input/Output Configuration – INPUT/OUTPUT Key.....	354
6.2.9.1	Softkeys of the Input/Output Menu.....	354
6.2.9.2	Using Active Probes for Input.....	356
<b>6.3</b>	<b>Analysis.....</b>	<b>358</b>
6.3.1	Trace Configuration.....	358
6.3.1.1	Softkeys of the Trace Menu.....	359
6.3.1.2	Configuring Traces.....	366

6.3.1.3	Specifying the Trace Settings.....	368
6.3.1.4	Description of the Averaging Method.....	368
6.3.1.5	Detector Overview.....	370
6.3.1.6	ASCII File Export Format.....	370
6.3.2	Spectrogram.....	373
6.3.2.1	Working with Spectrograms.....	373
6.3.2.2	Softkeys of the Spectrogram Menu.....	376
6.3.3	Markers.....	377
6.3.3.1	Controlling Markers.....	377
6.3.3.2	Positioning Markers (MKR→ Key).....	382
6.3.3.3	Performing Peak Searches with Markers – PEAK SEARCH Key.....	386
6.3.3.4	Measuring with Markers (MKR FUNC Key).....	387
6.3.4	Lines.....	400
<b>6.4</b>	<b>Advanced Measurement Examples.....</b>	<b>401</b>
6.4.1	Test Setup.....	401
6.4.2	Measurement of Harmonics.....	402
6.4.3	Measuring the Spectra of Complex Signals.....	404
6.4.3.1	Separating Signals by Selecting an Appropriate Resolution Bandwidth.....	404
6.4.3.2	Intermodulation Measurements.....	405
6.4.4	Measuring Signals in the Vicinity of Noise.....	407
6.4.4.1	Measurement Example – Measuring Level at Low S/N Ratios.....	408
6.4.5	Noise Measurements.....	412
6.4.5.1	Measuring Noise Power Density.....	413
6.4.5.2	Measurement of Noise Power within a Transmission Channel.....	415
6.4.5.3	Measuring Phase Noise.....	417
6.4.6	Measurements on Modulated Signals.....	419
6.4.6.1	Measuring Channel Power and Adjacent Channel Power.....	419
6.4.6.2	Amplitude Distribution Measurements.....	426
<b>7</b>	<b>I/Q Analyzer.....</b>	<b>429</b>
7.1	Softkeys and Parameters of the I/Q Analyzer Menu.....	430
7.2	Softkeys of the Amplitude Menu in I/Q Analyzer Mode.....	435
7.3	Softkeys of the Marker To Menu in I/Q Analyzer Mode.....	440
7.4	Softkeys of the Trigger Menu in I/Q Analyzer Mode.....	440

7.5	<b>Working with I/Q Data.....</b>	<b>444</b>
7.5.1	Sample Rate and Maximum Usable Bandwidth (RF Input).....	445
<b>8</b>	<b>Tracking Generator.....</b>	<b>447</b>
<b>8.1</b>	<b>Softkeys of the Tracking Generator Menu.....</b>	<b>447</b>
<b>8.2</b>	<b>Connecting External Tracking Generators.....</b>	<b>452</b>
8.2.1	Overview of Generators Supported by the R&S ESRP.....	453
<b>8.3</b>	<b>Configuring Tracking Generators.....</b>	<b>456</b>
8.3.1	Internal Tracking Generator.....	456
8.3.2	External Tracking Generator.....	458
<b>8.4</b>	<b>Tracking Generator Functions.....</b>	<b>463</b>
8.4.1	Calibration mechanism.....	463
8.4.2	Calibrating for transmission and reflection measurement.....	464
8.4.3	Transmission measurement.....	465
8.4.4	Reflection measurement.....	465
8.4.5	Normalization.....	465
8.4.6	Modulation (internal Tracking Generator only).....	469
<b>8.5</b>	<b>Displayed Information and Errors.....</b>	<b>471</b>
<b>9</b>	<b>System Configuration.....</b>	<b>473</b>
<b>9.1</b>	<b>Manual Operation – Local Menu.....</b>	<b>473</b>
<b>9.2</b>	<b>User-Defined Menu – USER key.....</b>	<b>474</b>
<b>9.3</b>	<b>Instrument Setup and Interface Configuration – SETUP Key.....</b>	<b>475</b>
9.3.1	Softkeys of the Setup Menu.....	476
<b>10</b>	<b>Data Management and Documentation.....</b>	<b>500</b>
<b>10.1</b>	<b>Saving and Recalling Settings Files – SAVE/RCL Key.....</b>	<b>500</b>
10.1.1	Softkeys of the SAVE/RCL Menu.....	501
10.1.2	File Selection Dialog Boxes.....	507
10.1.3	Importing and Exporting I/Q Data.....	509
10.1.3.1	iq-tar File Format Specification.....	509
<b>10.2</b>	<b>Measurement Documentation – PRINT Key.....</b>	<b>514</b>
<b>10.3</b>	<b>Working with Test Reports.....</b>	<b>517</b>
10.3.1	Designing a Test Report Template.....	517
10.3.2	Creating a Test Report.....	520

<b>11 Remote Control.....</b>	<b>524</b>
<b>11.1 Remote Control - Basics.....</b>	<b>524</b>
11.1.1 Remote Control Interfaces and Protocols.....	524
11.1.1.1 VISA Libraries.....	526
11.1.1.2 Messages.....	526
11.1.1.3 LAN Interface.....	527
11.1.1.4 GPIB Interface (IEC 625/IEEE 418 Bus Interface).....	530
11.1.2 Starting a Remote Control Session.....	534
11.1.3 Returning to Manual Operation.....	535
11.1.4 SCPI Command Structure.....	535
11.1.4.1 Syntax for Common Commands.....	535
11.1.4.2 Syntax for Device-Specific Commands.....	536
11.1.4.3 SCPI Parameters.....	537
11.1.4.4 Overview of Syntax Elements.....	540
11.1.4.5 Structure of a Command Line.....	541
11.1.4.6 Responses to Queries.....	542
11.1.5 Command Sequence and Synchronization.....	543
11.1.5.1 Preventing Overlapping Execution.....	544
11.1.6 Status Reporting System.....	545
11.1.6.1 Hierarchy of Status Registers.....	545
11.1.6.2 Structure of a SCPI Status Register.....	546
11.1.6.3 Contents of the Status Register.....	548
11.1.6.4 Application of the Status Reporting System.....	560
11.1.6.5 Reset Values of the Status Reporting System.....	562
11.1.7 General Programming Recommendations.....	563
11.1.8 The IECWIN Tool.....	563
<b>11.2 Controlling the R&amp;S ESRP Remotely.....</b>	<b>565</b>
11.2.1 Operation with Windows Remote Desktop .....	565
11.2.1.1 Configuring the R&S ESRP for Remote Operation.....	566
11.2.1.2 Configuring the Controller.....	567
11.2.1.3 Starting and Terminating Remote Operation.....	569
11.2.1.4 Deactivating the R&S ESRP via Remote Operation.....	571
11.2.2 Operation with a VNC Client.....	571

11.2.3	Brief Introduction to Remote Control.....	572
11.2.3.1	Basic Steps in Remote Control Programming.....	572
11.2.3.2	Detailed Programming Examples.....	579
11.2.4	Configuring the GPIB Interface.....	592
11.2.5	Setting Up a Network (LAN) Connection.....	592
11.2.5.1	Connecting the Instrument to the Network.....	593
11.2.5.2	Assigning the IP Address.....	594
11.2.5.3	Using Computer Names.....	597
11.2.5.4	Changing the Windows Firewall Settings.....	598
11.2.6	How to Configure the LAN Using the LXI Web Browser Interface.....	598
11.2.6.1	LAN Configuration.....	599
11.2.7	Configuring the Network.....	600
11.2.7.1	Operating the Instrument Without a Network.....	601
11.2.7.2	Creating Users.....	601
11.2.7.3	Changing the User Password.....	602
11.2.7.4	Mapping Network Drives.....	602
11.2.7.5	Sharing Directories (only with Microsoft Networks).....	604
<b>11.3</b>	<b>Selecting the Operating Mode.....</b>	<b>604</b>
<b>11.4</b>	<b>Remote Commands in Receiver Mode.....</b>	<b>605</b>
11.4.1	Measurements and Result Displays.....	606
11.4.1.1	Display Configuration.....	606
11.4.1.2	Bargraph Control.....	606
11.4.1.3	Scan Control.....	608
11.4.1.4	Final Measurements and Automated Test Sequence Control.....	610
11.4.1.5	Trace Data and Result Query.....	612
11.4.1.6	Demodulating Analog Signals.....	616
11.4.1.7	Spectrogram Control.....	617
11.4.2	Defining the Frequency.....	633
11.4.3	Configuring the Vertical Axis.....	636
11.4.4	Selecting the Bandwidth.....	639
11.4.5	Controlling Inputs and Outputs.....	641
11.4.6	Test Automation.....	641
11.4.6.1	General Scan Configuration.....	642



11.4.6.2	Scan Table.....	643
11.4.6.3	Peak Search.....	647
11.4.6.4	Peak Lists.....	650
11.4.6.5	Trace Configuration.....	651
11.4.6.6	LISN Settings.....	653
11.4.7	Working with Markers.....	656
11.4.7.1	Configuring Marker Functionality.....	656
11.4.7.2	Using Markers.....	659
11.4.7.3	Using Delta Markers.....	665
11.4.8	Limit Lines.....	672
11.4.8.1	Using Display Lines.....	672
11.4.8.2	Using Frequency Lines.....	673
11.4.8.3	Using Limit Lines.....	674
<b>11.5</b>	<b>Remote Commands in Spectrum Analyzer Mode.....</b>	<b>687</b>
11.5.1	Measurements and Result Displays.....	687
11.5.1.1	Controlling Power Measurements.....	688
11.5.1.2	Measuring Channel Power.....	695
11.5.1.3	Measuring the Occupied Bandwidth.....	716
11.5.1.4	Measuring Spurious Emissions.....	717
11.5.1.5	Testing Against a Spectrum Emission Mask.....	727
11.5.1.6	Performing EMI Measurements.....	746
11.5.1.7	Measuring the Modulation Depth.....	752
11.5.1.8	Measuring the Harmonic Distortion.....	754
11.5.1.9	Measuring the Carrier-to-Noise Ratio.....	758
11.5.1.10	Measuring the Third Order Intercept Point.....	758
11.5.1.11	Measuring Statistics.....	759
11.5.1.12	Measuring in the Time Domain.....	767
11.5.1.13	Measuring the Pulse Power.....	779
11.5.1.14	Performing List Evaluations.....	783
11.5.1.15	Probe Configuration.....	788
11.5.2	Configuring Spectrum Measurements.....	790
11.5.2.1	Frequency Settings.....	790
11.5.2.2	Automatic Measurement Configuration.....	795

11.5.2.3	Bandwidth Settings.....	798
11.5.2.4	Sweep Configuration.....	801
11.5.2.5	Trigger Configuration.....	804
11.5.2.6	Vertical Axis Configuration.....	811
11.5.3	Analyzing Spectrum Measurements.....	815
11.5.3.1	Trace Configuration.....	815
11.5.3.2	Spectrogram.....	824
11.5.3.3	Limit Lines.....	828
11.5.3.4	Markers.....	829
<b>11.6</b>	<b>Remote Commands in I/Q Analyzer Mode.....</b>	<b>855</b>
11.6.1	Using the I/Q Analyzer.....	855
11.6.2	I/Q Gating.....	867
<b>11.7</b>	<b>Remote Commands to Control the Tracking Generator.....</b>	<b>868</b>
11.7.1	Controlling the Internal Tracking Generator.....	868
11.7.2	Controlling the External Tracking Generator.....	875
<b>11.8</b>	<b>Common Commands.....</b>	<b>883</b>
<b>11.9</b>	<b>System Configuration.....</b>	<b>887</b>
11.9.1	General System Configuration.....	887
11.9.2	Checking the System Configuration.....	893
11.9.3	Coupling Parameters.....	895
11.9.4	Controlling In- and Outputs.....	899
11.9.5	Configuring the Reference Frequency.....	902
11.9.6	Calibrating the R&S ESRP.....	903
11.9.7	Using Service Functions.....	906
<b>11.10</b>	<b>Data Management.....</b>	<b>908</b>
11.10.1	Managing Data Files.....	908
11.10.2	Saving and Restoring Customized Data.....	913
<b>11.11</b>	<b>Using Transducers.....</b>	<b>917</b>
<b>11.12</b>	<b>Documentation.....</b>	<b>925</b>
<b>11.13</b>	<b>Working with Test Reports.....</b>	<b>934</b>
11.13.1	Designing a Test Report Template.....	934
11.13.1.1	Selecting the Test Report Contents.....	934
11.13.1.2	Designing the Header of the Test Report.....	936

11.13.1.3	Defining the Contents of the Title Page.....	939
11.13.1.4	Managing Templates.....	939
11.13.2	Creating a Test Report.....	941
11.13.2.1	Configuring and Printing the Test Report.....	941
11.13.2.2	Adding and Removing Datasets.....	941
11.13.2.3	Selecting Datasets for the Report.....	943
11.13.3	Deprecated Commands (Test Report).....	944
<b>11.14</b>	<b>Display Configuration.....</b>	<b>944</b>
11.14.1	Controlling Display Elements.....	945
11.14.2	Selecting Items to Store and Restore.....	952
<b>11.15</b>	<b>Network Connection.....</b>	<b>955</b>
11.15.1	Configuring Network Connections.....	955
11.15.2	Emulating HP Instruments.....	958
<b>11.16</b>	<b>Status Register.....</b>	<b>962</b>
11.16.1	General Status Register Commands.....	962
11.16.2	Reading out the EVENT Part.....	963
11.16.3	Reading Out the CONDition Part.....	963
11.16.4	Controlling the ENABLE Part.....	964
11.16.5	Controlling the Negative Transition Part.....	964
11.16.6	Controlling the Positive Transition Part.....	965
<b>11.17</b>	<b>Remote Control – Programming Examples.....</b>	<b>965</b>
11.17.1	Service Request.....	967
11.17.1.1	Initiate Service Request.....	967
11.17.1.2	Waiting for the Arrival of a Service Request.....	968
11.17.1.3	Waiting Without Blocking the Keyboard and Mouse.....	969
11.17.1.4	Service Request Routine.....	970
11.17.1.5	Reading Out the Output Buffer.....	971
11.17.1.6	Reading Error Messages.....	971
11.17.1.7	Evaluation of SCPI Status Registers.....	972
11.17.1.8	Evaluation of Event Status Register.....	973
11.17.2	Using Marker and Delta Marker.....	974
11.17.2.1	Shape Factor Measurement (using n dB down).....	974
11.17.2.2	Measuring the Third Order Intercept Point.....	975

11.17.2.3	Measuring the AM Modulation Depth.....	976
11.17.3	Limit Lines and Limit Test.....	976
11.17.4	Measuring the Channel and Adjacent Channel Power.....	978
11.17.5	Occupied Bandwidth Measurement.....	981
11.17.6	Time Domain Power Measurement.....	982
11.17.7	Fast Power Measurement on Power Ramps.....	983
11.17.7.1	Power Measurement with Multi-Summary Marker.....	983
11.17.7.2	Multi-Burst Power Measurement.....	985
11.17.8	Fast Level Measurement Using Frequency Lists.....	986
11.17.9	Level Correction of Transducers.....	988
11.17.10	Measuring the Magnitude and Phase of a Signal.....	989
11.17.11	Reading and Writing Files.....	991
11.17.11.1	Reading a File from the Instrument.....	991
11.17.11.2	Creating a File on the Instrument.....	992
11.17.12	Spectrum Emission Mask Measurement.....	992
11.17.12.1	Using Predefined Standard Wibro.....	993
11.17.12.2	Defining 5 Ranges with all Parameters.....	993
11.17.13	Spurious Emissions Measurement.....	996
11.17.14	Averaging I/Q Data.....	999
11.17.15	Using IQ Gating.....	1000
11.17.16	Usage of Four Spectrum Instances.....	1005
<b>11.18</b>	<b>GPIB Commands of HP Models 856xE, 8566A/B, 8568A/B and 8594E.....</b>	<b>1007</b>
11.18.1	GPIB Languages.....	1008
11.18.2	Command Set of Models 8560E, 8561E, 8562E, 8563E, 8564E, 8565E, 8566A/B, 8568A/B, 8591E, 8594E, 71100C, 71200C, and 71209A.....	1009
11.18.3	Special Features of the Syntax Parsing Algorithms for 8566A and 8568A Models..	1033
11.18.4	Special Behavior of Commands.....	1034
11.18.5	Model-Dependent Default Settings.....	1035
11.18.6	Data Output Formats.....	1036
11.18.7	Trace Data Output Formats.....	1036
11.18.8	Trace Data Input Formats.....	1036
11.18.9	GPIB Status Reporting.....	1036
<b>12</b>	<b>Maintenance.....</b>	<b>1038</b>

<b>12.1</b>	<b>Cleaning.....</b>	<b>1038</b>
<b>12.2</b>	<b>Storing and Packing.....</b>	<b>1039</b>
<b>12.3</b>	<b>List of Available Power Cables.....</b>	<b>1039</b>
<b>13</b>	<b>Error Messages.....</b>	<b>1040</b>
<b>14</b>	<b>Appendix: LAN Interface.....</b>	<b>1042</b>
<b>14.1</b>	<b>Configuring the Network.....</b>	<b>1042</b>
14.1.1	Changing the Computer Name.....	1043
14.1.2	Changing the Domain or Workgroup.....	1043
14.1.3	Operating the Instrument Without a Network.....	1044
14.1.4	Creating Users.....	1045
14.1.5	Changing the User Password.....	1045
14.1.6	Logging on to the Network.....	1045
14.1.7	Automatic Login Function.....	1046
14.1.8	Mapping Network Drives.....	1047
14.1.9	Sharing Directories (only with Microsoft Networks).....	1048
<b>14.2</b>	<b>Operation with Windows Remote Desktop .....</b>	<b>1049</b>
14.2.1	Configuring the R&S ESRP for Remote Operation.....	1049
14.2.2	Configuring the Controller.....	1050
<b>14.3</b>	<b>Operation with a VNC Client.....</b>	<b>1053</b>
<b>14.4</b>	<b>Starting and Terminating Remote Operation.....</b>	<b>1054</b>
<b>14.5</b>	<b>Deactivating the R&amp;S ESRP via Remote Operation.....</b>	<b>1055</b>
	<b>List of Commands.....</b>	<b>1057</b>
	<b>Index.....</b>	<b>1074</b>

# 1 Preface

This chapter provides safety-related information, an overview of the user documentation and the conventions used in the documentation.

## 1.1 For Your Safety

The R&S ESRP is designated for use in industrial, administrative, and laboratory environments. Use the R&S ESRP only for its designated purpose. Observe the safety and usage instructions documented in the user manual, as well as operating conditions and performance limits stated in the data sheet.

The product documentation helps you use the R&S ESRP safely and efficiently. Keep the product documentation in a safe place and pass it on to subsequent users.

Safety information is part of the product documentation. It warns you about potential dangers and gives instructions how to prevent personal injury or damage caused by dangerous situations. Safety information is provided as follows:

- In the "Basic Safety Instructions", safety issues are grouped according to subjects. For example, one subject is electrical safety. The "Basic Safety Instructions" are delivered with the R&S ESRP in different languages in print.
- Throughout the documentation, safety instructions are provided when you need to take care during setup or operation. Always read the safety instructions carefully. Make sure to comply fully with them. Do not take risks and do not underestimate the potential danger of small details such as a damaged power cable.

## 1.2 Conventions Used in the Documentation

### 1.2.1 Typographical Conventions

The following text markers are used throughout this documentation:

Convention	Description
"Graphical user interface elements"	All names of graphical user interface elements on the screen, such as dialog boxes, menus, options, buttons, and softkeys are enclosed by quotation marks.
[Keys]	Key and knob names are enclosed by square brackets.
File names, commands, program code	File names, commands, coding samples and screen output are distinguished by their font.
<i>Input</i>	Input to be entered by the user is displayed in italics.

Convention	Description
Links	Links that you can click are displayed in blue font.
"References"	References to other parts of the documentation are enclosed by quotation marks.

## 1.2.2 Conventions for Procedure Descriptions

When operating the instrument, several alternative methods may be available to perform the same task. In this case, the procedure using the touchscreen is described. Any elements that can be activated by touching can also be clicked using an additionally connected mouse. The alternative procedure using the keys on the instrument or the on-screen keyboard is only described if it deviates from the standard operating procedures.

The term "select" may refer to any of the described methods, i.e. using a finger on the touchscreen, a mouse pointer in the display, or a key on the instrument or on a keyboard.

## 1.2.3 Notes on Screenshots

When describing the functions of the product, we use sample screenshots. These screenshots are meant to illustrate as many as possible of the provided functions and possible interdependencies between parameters. The shown values may not represent realistic usage scenarios.

The screenshots usually show a fully equipped product, that is: with all options installed. Thus, some functions shown in the screenshots may not be available in your particular product configuration.

# 1.3 How to Use the Help System

## Calling context-sensitive and general help

- ▶ To display the general help dialog box, press the [HELP] key on the front panel. The help dialog box "View" tab is displayed. A topic containing information about the current menu or the currently opened dialog box and its function is displayed.



For standard Windows dialog boxes (e.g. File Properties, Print dialog etc.), no context-sensitive help is available.

- ▶ If the help is already displayed, press the softkey for which you want to display help. A topic containing information about the softkey and its function is displayed.



If a softkey opens a submenu and you press the softkey a second time, the submenu of the softkey is displayed.

### Contents of the help dialog box

The help dialog box contains four tabs:

- "Contents" - contains a table of help contents
- "View" - contains a specific help topic
- "Index" - contains index entries to search for help topics
- "Zoom" - contains zoom functions for the help display

To change between these tabs, press the tab on the touchscreen.

### Navigating in the table of contents

- To move through the displayed contents entries, use the [UP ARROW] and [DOWN ARROW] keys. Entries that contain further entries are marked with a plus sign.
- To display a help topic, press the [ENTER] key. The "View" tab with the corresponding help topic is displayed.
- To change to the next tab, press the tab on the touchscreen.

### Navigating in the help topics

- To scroll through a page, use the rotary knob or the [UP ARROW] and [DOWN ARROW] keys.
- To jump to the linked topic, press the link text on the touchscreen.

### Searching for a topic

1. Change to the "Index" tab.
2. Enter the first characters of the topic you are interested in. The entries starting with these characters are displayed.
3. Change the focus by pressing the [ENTER] key.
4. Select the suitable keyword by using the [UP ARROW] or [DOWN ARROW] keys or the rotary knob.
5. Press the [ENTER] key to display the help topic.

The "View" tab with the corresponding help topic is displayed.

### Changing the zoom

1. Change to the "Zoom" tab.
2. Set the zoom using the rotary knob. Four settings are available: 1-4. The smallest size is selected by number 1, the largest size is selected by number 4.



**Closing the help window**

- ▶ Press the [ESC] key or a function key on the front panel.

## 2 Documentation Overview

This section provides an overview of the R&S ESRP user documentation. Unless specified otherwise, you find the documents on the R&S ESRP product page at:

[www.rohde-schwarz.com/manual/esrp](http://www.rohde-schwarz.com/manual/esrp)

### 2.1 Getting Started Manual

Introduces the R&S ESRP and describes how to set up and start working with the product. Includes basic operations, typical measurement examples, and general information, e.g. safety instructions, etc.

A printed version is delivered with the instrument. A PDF version is available for download on the Internet.

### 2.2 User Manuals and Help

Contains the description of all instrument modes and functions. It also provides an introduction to remote control, a complete description of the remote control commands with programming examples, and information on maintenance, instrument interfaces and error messages. Includes the contents of the getting started manual.

The contents of the user manuals are available as help in the R&S ESRP. The help offers quick, context-sensitive access to the complete information.

All user manuals are also available for download or for immediate display on the Internet.

### 2.3 Service Manual

Describes the performance test for checking the rated specifications, module replacement and repair, firmware update, troubleshooting and fault elimination, and contains mechanical drawings and spare part lists.

The service manual is available for download for registered users on the global Rohde & Schwarz information system (GLORIS):

<https://gloris.rohde-schwarz.com>).

## 2.4 Instrument Security Procedures

Deals with security issues when working with the R&S ESRP in secure areas. It is available for download on the Internet.

## 2.5 Basic Safety Instructions

Contains safety instructions, operating conditions and further important information. The printed document is delivered with the instrument.

## 2.6 Data Sheets and Brochures

The data sheet contains the technical specifications of the R&S ESRP. It also lists the options and their order numbers as well as optional accessories.

The brochure provides an overview of the instrument and deals with the specific characteristics.

[www.rohde-schwarz.com/brochure-datasheet/esrp](http://www.rohde-schwarz.com/brochure-datasheet/esrp)

## 2.7 Release Notes and Open Source Acknowledgment (OSA)

The release notes list new features, improvements and known issues of the current firmware version, and describe the firmware installation.

The open source acknowledgment document provides verbatim license texts of the used open source software.

[www.rohde-schwarz.com/firmware/esrp](http://www.rohde-schwarz.com/firmware/esrp)

## 2.8 Application Notes, Application Cards, White Papers, etc.

These documents deal with special applications or background information on particular topics.

[www.rohde-schwarz.com/application/esrp](http://www.rohde-schwarz.com/application/esrp)

### 3 Quick Start

**Note:** the following chapters are identical to those in the printed R&S ESRP Quick Start Guide.

- [Front and Rear Panel View](#).....25
- [Preparing for Use](#).....36
- [Firmware Update and Installation of Firmware Options](#).....58
- [Basic Operations](#).....60
- [Basic Measurement Examples](#).....88

## 3.1 Front and Rear Panel View

### 3.1.1 Front Panel View

The front panel of the R&S ESRP is shown in [Figure 3-1](#). Each element (function keys and connectors) is described in more detail in the subsequent sections.



Figure 3-1: Front panel of the R&S ESRP













No.	Description	See
1	General device functions e.g. Change mode, Setup, Default Settings, Help.	<a href="#">Chapter 3.1.1.1, "Function Keys on the Front Panel"</a> , on page 26
2	USB connector for external devices, e.g. keyboard, mouse	<a href="#">Chapter 3.1.1.3, "Connectors on the Front Panel"</a> , on page 30
3	ON/OFF switch	<a href="#">Chapter 3.2.1.7, "Switching the Instrument On and Off"</a> , on page 41
4	Touchscreen; display area for measurement results	<a href="#">Chapter 3.1.1.2, "Touchscreen Display"</a> , on page 29



No.	Description	See
5	Auxiliary functions to display Windows Start menu or on-screen keyboard	<a href="#">Chapter 3.1.1.1, "Function Keys on the Front Panel"</a> , on page 26
6	Display options for screen	<a href="#">Chapter 3.4.4, "Changing the Display"</a> , on page 81
7	Navigation options for screen menu	<a href="#">Chapter 3.4.2.6, "Arrow Keys, UNDO/REDO Keys"</a> , on page 72
8	Measurement control settings, e.g. frequency, levels	<a href="#">Chapter 3.1.1.1, "Function Keys on the Front Panel"</a> , on page 26
9	Marker functions	<a href="#">Chapter 3.1.1.1, "Function Keys on the Front Panel"</a> , on page 26
10	Measurement configuration	<a href="#">Chapter 3.1.1.1, "Function Keys on the Front Panel"</a> , on page 26
11	Measurement start	<a href="#">Chapter 3.1.1.1, "Function Keys on the Front Panel"</a> , on page 26
12	Numeric keyboard, units and data entry keys	<a href="#">Chapter 3.4.2.4, "Keypad"</a> , on page 71
13	Rotary knob	<a href="#">Chapter 3.4.2.5, "Rotary Knob"</a> , on page 72
14	Arrow keys	<a href="#">Chapter 3.4.2.6, "Arrow Keys, UNDO/REDO Keys"</a> , on page 72
15	Undo/redo functions	<a href="#">Chapter 3.4.2.6, "Arrow Keys, UNDO/REDO Keys"</a> , on page 72
16	AF output with volume control	<a href="#">Chapter 3.1.1.4, "Optional Front Panel Connectors"</a> , on page 32
17	Noise source control	<a href="#">Chapter 3.1.1.3, "Connectors on the Front Panel"</a> , on page 30
18	Supply voltage for measurement accessories	<a href="#">Chapter 3.1.1.4, "Optional Front Panel Connectors"</a> , on page 32
19	Probe power connector (supply voltage for measurement accessories)	<a href="#">Chapter 3.1.1.3, "Connectors on the Front Panel"</a> , on page 30
20	Tracking generator output, optional	<a href="#">Chapter 3.1.1.4, "Optional Front Panel Connectors"</a> , on page 32
21	RF input	<a href="#">Chapter 3.1.1.3, "Connectors on the Front Panel"</a> , on page 30

### 3.1.1.1 Function Keys on the Front Panel

A detailed description of the corresponding menus and the other function keys is provided in chapter 6 "Instrument Functions" of the Operating Manual.

Table 3-1: Function keys

	Turns the instrument on and off.
	Restores the default configuration of the R&S ESRP.
	Provides functionality to save, restore and manage instrument settings and other files.
	Provides functionality for general instrument configuration, for example: <ul style="list-style-type: none"> <li>to configure the display</li> <li>to set the date and time</li> <li>to establish a LAN connection</li> </ul>
	Provides functionality to configure printers and hardcopies.
	Displays the online help.
	Selects the operating mode or firmware application.
	Opens the Windows "Start" menu
	Turns the on-screen keyboard on and off. Repeatedly pressing the key changes the position of the keyboard (top or bottom of the display).
	Selects alphanumeric characters.
	Opens a dialog box to turn screen elements on or off.
	Switches between maximized and split display of focus area.
	Switches focus area between table and diagram.

	Allows you to define and use softkeys to load custom configurations.
	Opens the root menu of the current application.
FREQ (CHANNEL)	Provides functionality to define frequency parameters, for example: <ul style="list-style-type: none"> <li>• the center or receiver frequency</li> <li>• the frequency offset</li> </ul> (CHANNEL is for special applications)
SPAN	Provides functionality to configure the frequency span.
AMPT (SCALE)	Provides functionality to configure amplitude or level characteristics, for example: <ul style="list-style-type: none"> <li>• the reference level</li> <li>• the attenuation</li> <li>• the input impedance</li> <li>• the scale of the level axis</li> <li>• the preamplifier</li> </ul>
AUTO SET	Provides functionality to automatically define various parameters like the level or frequency.
BW	Provides functionality to define the resolution and video bandwidth.
SWEEP	Provides functionality to configure the sweep, for example: <ul style="list-style-type: none"> <li>• the measurement time</li> <li>• the number of measurement points</li> <li>• the measurement mode (single or continuous measurements)</li> </ul>
TRACE	Provides functionality to configure data acquisition and analyze measured data, for example: <ul style="list-style-type: none"> <li>• the trace mode</li> <li>• the detector</li> </ul>
TRIG	Provides functionality to configure triggered and gated measurements, for example:
MKR	Provides functionality to activate and position absolute and relative markers (markers and delta markers).
PEAK SEARCH	Performs a peak search for active markers. If no marker is active, Marker 1 is activated and the peak search is performed for it.
MKR FUNC	Provides additional analysis functions of the measurement markers, for example: <ul style="list-style-type: none"> <li>• the frequency counter</li> <li>• the noise measurement</li> <li>• the phase noise measurement</li> <li>• the AM/FM audio demodulator</li> </ul>
MKR→	Provides functionality to position and control markers, for example: <ul style="list-style-type: none"> <li>• to position the marker on the center frequency</li> <li>• to define the marker search area</li> <li>• to configure the peak excursion</li> </ul>

MEAS	Provides the measurement functions, for example: <ul style="list-style-type: none"> <li>• the bargraph measurement (in Receiver mode)</li> <li>• the scan and final measurement (in Receiver mode)</li> <li>• the AF demodulation (in Receiver mode)</li> <li>• IF analysis (in Receiver mode with option R&amp;S ESRP-K56)</li> <li>• the channel power and ACLR measurement (in Spectrum mode)</li> <li>• the occupied bandwidth measurement (in Spectrum mode)</li> <li>• the Spectrum Emission Mask (SEM) measurement (in spectrum mode)</li> <li>• the spurious emission measurement (in spectrum mode)</li> <li>• the signal statistics (in spectrum mode)</li> </ul>
MEAS CONFIG	Provides functionality to configure the measurement.
LINES	Provides functionality to control display and limit lines.
INPUT/OUTPUT	Provides functionality to configure inputs and outputs.
RUN SINGLE	Starts a single measurement.
RUN CONT	Starts a continuous measurement.
UNDO	Reverts the last operation.
REDO	Repeats previously reverted operation.

### 3.1.1.2 Touchscreen Display

All measurement results are displayed in the screen on the front panel. Additionally, the screen display provides status and setting information and allows you to switch between various measurement tasks. The screen is touch-sensitive, offering an alternative means of user interaction for quick and easy handling of the device.

#### **NOTICE**

##### **Risk of touchscreen damage**

Inappropriate tools or excessive force can damage the touchscreen.

Observe the following instructions when operating the touchscreen:

- Never touch the screen with ball point pens or other sharp objects, use your fingers instead.  
As an alternative, you can use a stylus pen with a smooth soft tip.
- Never apply excessive force to the screen. Touch it gently.
- Never scratch the screen surface, for example with a finger nail.
- Never rub the screen surface strongly, for example with a dust cloth.  
For instructions on cleaning the screen, see [Chapter 12.1, "Cleaning"](#), on page 1038.

The [Figure 3-2](#) shows the touchscreen display of the R&S ESRP. The individual elements are described in more detail in [Chapter 3.4, "Basic Operations"](#), on page 60.



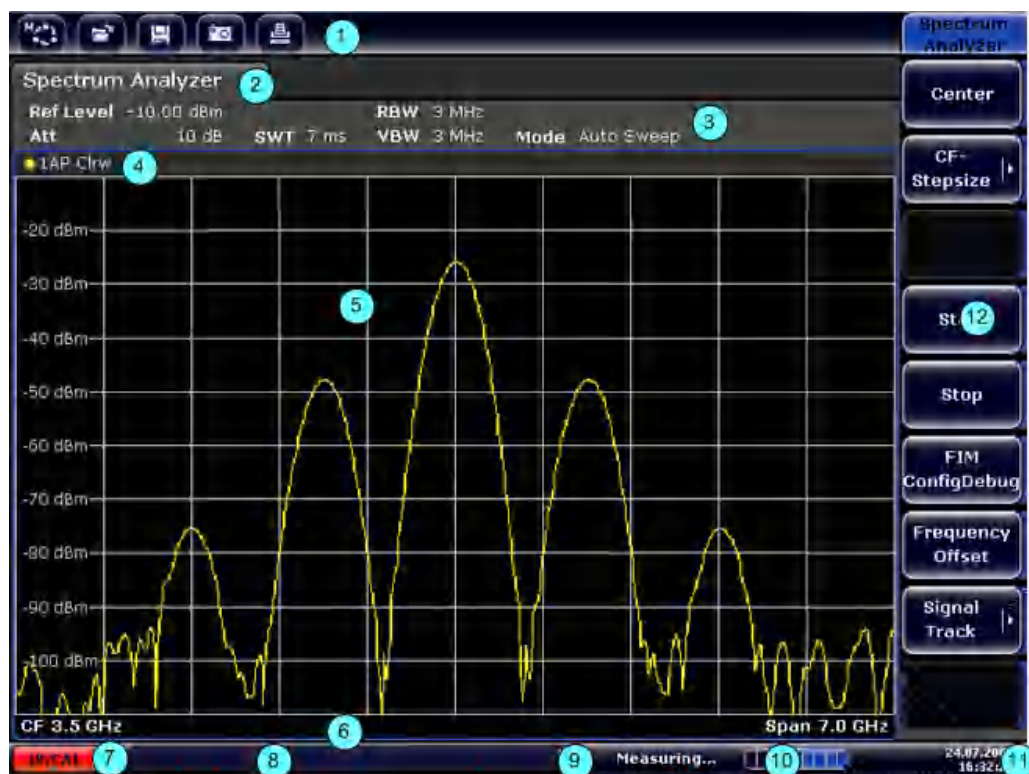

**Figure 3-2: Touchscreen elements**

- 1 = Toolbar with standard application functions, e.g. print, save/open file etc.
- 2 = Tabs for individual measurement tasks
- 3 = Channel information bar for current measurement settings
- 4 = Diagram header with diagram-specific (trace) information
- 5 = Measurement results area
- 6 = Diagram footer with diagram-specific information, depending on measurement mode
- 7 = Error indicator
- 8 = Error message, if available
- 9 = Device status
- 10 = Progress bar for measurement
- 11 = Date and time display
- 12 = Softkeys for menu access

### 3.1.1.3 Connectors on the Front Panel

This section describes the front connectors and interfaces of the R&S ESRP. Optional connectors and interfaces are indicated by the option name in brackets. Most connectors on the front panel (except for USB) are located at the bottom right-hand side.



### EMI impact on measurement results

Electromagnetic interference (EMI) may affect the measurement results.

To suppress generated electromagnetic interference (EMI):

- Use suitable shielded cables of high quality. For example, use double-shielded RF and LAN cables.
- Always terminate open cable ends.
- Note the EMC classification in the data sheet.

### USB

The front panel provides two female USB connectors to connect devices like an external keyboard or mouse. You can also connect a memory stick to save and restore instrument settings and measurement data.

### NOISE SOURCE CONTROL

The noise source control female connector is used to provide the supply voltage for an external noise source, for example to measure the noise figure and gain of amplifiers and frequency converting DUTs.

Conventional noise sources require a voltage of +28 V in order to be switched on and 0 V to be switched off. The output supports a maximum load of 100 mA.

### RF INPUT 50Ω

The R&S ESRP provides an RF input for connection of a device under test (DUT) to the R&S ESRP. The DUT is connected to the RF Input via cable and an appropriate connector (for example a male N connector).

The RF Input supports a frequency range from 9 kHz to  $f_{\max}$  and an attenuation range from 0 dB to 70 dB.

With option R&S R&S ESRP-B29, the minimum frequency is extended to 10 Hz.

## NOTICE

### Risk of instrument damage

Do not overload the input. For maximum allowed values, see the data sheet.

For AC-coupling, a DC input voltage of 50 V must never be exceeded. For DC-coupling, DC voltage must not be applied at the input. In both cases, noncompliance will destroy the input mixers.

When measuring unknown signals, do not use a 0 dB attenuation level. Otherwise, the input mixer may be damaged or destroyed.

### PROBE POWER

The R&S ESRP provides two connectors to supply accessories like transducers or probes with power.

The probe power connector on the left supports supply voltages of  $\pm 10$  V and ground. The maximum permissible current is 200 mA. This probe power connector is suitable, for example, for transducers from Rohde & Schwarz.

The probe power connector on the right supports supply voltages from +15 V to -12.6 V and ground. The maximum permissible current is 150 mA. This probe power connector is suitable, for example, for high-impedance probes from Agilent.

### AF OUTPUT

Headphones equipped with a miniature jack plug can be connected to the AF output female connector. The internal impedance is 10  $\Omega$ . The output voltage can be set by using the volume control to the right of the female connector. If a plug is connected, the internal loudspeaker is automatically switched off.

---

#### CAUTION

##### Risk of hearing damage

Before putting on the headphones, make sure that the volume setting is not too high to protect your hearing.

---

#### 3.1.1.4 Optional Front Panel Connectors

##### Tracking Generator Output (GEN OUTPUT 50 $\Omega$ , Option R&S FSV-B9)

The R&S ESRP is equipped with an optional tracking generator and therefore provides a tracking generator output connector.

The output of the tracking generator is connected to the DUT via a cable equipped with a male N connector. The female connector is available only with the tracking generator option (R&S FSV-B9).

---

#### NOTICE

##### Risk of damaging the tracking generator

To avoid damaging the tracking generator, make sure that the reverse power (i.e. input power caused, for example, by reflections in the test setup) never exceeds 1 W RF power. Do not apply a DC voltage at the output.

For details, refer to the data sheet.

---



##### Sensitive DUTs concerning matching

For DUTs with sensitive RF characteristics with regard to matching (VSWR) at the input, insert a 10 dB attenuator between the DUT and the tracking generator.

---

### 3.1.2 Rear Panel View

The rear panel of the R&S ESRP is shown in [Figure 3-3](#). Each element is described in more detail in the subsequent sections.



**Figure 3-3: R&S ESRP rear panel**

- 1 = LAN
- 2 = TRIGGER OUTPUT
- 3 = IF/VIDEO
- 4 = USB
- 5 = AUX PORT
- 6 = EXT TRIGGER / GATE IN
- 7 = MONITOR (VGA)
- 8 = REF IN
- 9 = REF OUT
- 10 = GPIB interface
- 11 = AC Power Supply Connection and Main Power Switch with fuse

#### 3.1.2.1 Standard Rear Panel Connectors



##### EMI impact on measurement results

Electromagnetic interference (EMI) may affect the measurement results.

To suppress generated electromagnetic interference (EMI):

- Use suitable shielded cables of high quality. For example, use double-shielded RF and LAN cables.
- Always terminate open cable ends.
- Note the EMC classification in the data sheet.

##### AC Power Supply Connection and Main Power Switch

The AC power supply connector and main power switch are located in a unit on the rear panel of the instrument.

The main power switch works as follows.

- Position "O": The instrument is disconnected from the AC power supply.
- Position "1": The instrument is supplied with power and in operation.

For more information see [Chapter 3.2.1.7, "Switching the Instrument On and Off"](#), on page 41.



#### Warm-up time for OCXO

When the instrument is switched on, the OCXO requires an extended warm-up time (see data sheet).

#### LAN

The LAN interface can be used to connect the R&S ESRP to a local network for remote control, printouts and data transfer. The assignment of the RJ-45 connector supports twisted-pair category 5 UTP/STP cables in a star configuration (UTP stands for *unshielded twisted pair*, and STP for *shielded twisted pair*).

#### MONITOR (VGA)

The female VGA connector is used to connect an external monitor. Instructions on how to connect an external monitor are provided in [Chapter 3.2.3, "Connecting an External Monitor"](#), on page 45.

#### EXT TRIGGER / GATE IN

The female connector for external trigger/gate input is used to control the measurement by means of an external signal. The voltage levels can range from 0.5 to 3.5 V. The default value is 1.4 V. The typical input impedance is 10 k $\Omega$ .

#### REF IN

As a reference signal, you can either use the internal reference, or connect an external one. The setup menu is used to switch between the internal and an external reference. The REF IN female connector is used as an input for a 1-20 MHz reference signal. The required input level is 0-10 dBm.

#### REF OUT

This connector can be used to provide an external reference signal (e.g. the OCXO) to other devices that are connected to this instrument. The REF OUT female connector can output a 10 MHz reference signal with an output level of 0 dBm.

#### GPIO Interface

The GPIO interface is in compliance with IEEE488 and SCPI. A computer for remote control can be connected via this interface. To set up the connection, a shielded cable is recommended.

For more information refer to the User Manual, chapter 7 "Remote Control Basics".

### TRIGGER OUTPUT

The female BNC connector can be used to provide a signal to another device. The signal is TTL compatible (0 V / 5 V).

You can control the trigger output with the functionality provided in the "In-/Output" menu ([INPUT/OUTPUT] key).

### IF/VIDEO

The female BNC connector can be used for various outputs:

- Intermediate frequency (IF) output of 32 MHz
- Video output (1 V)

You can select between IF and video output with the functionality provided in the "In-/Output" menu ([INPUT/OUTPUT] key).

### USB

The rear panel provides two female USB connectors to connect devices like an external keyboard or mouse. You can also connect a memory stick to save and restore instrument settings and measurement data.

### AUX PORT

The 9 pole SUB-D male connector provides control signals for controlling external devices. The voltage levels are of the TTL type (5 V).



Pin	Signal	Description
1	+5 V / max. 250 mA	Supply voltage for external circuits
2	I/O	Control Phase N
3	I/O	Controls the 150 kHz highpass filter
4	I/O	Controls Phase L3
5	I/O	not used
6	I/O	Controls Phase L1
7	I/O	Controls Phase L2
8	GND	Ground
9	READY FOR TRIGGER	Signal indicating that the instrument is ready to receive a trigger signal (Low active = 0 V)

### NOTICE

#### Short-circuit hazard

Always observe the designated pin assignment. A short-circuit can damage the port.

### 3.1.2.2 Optional Rear Panel Connectors

#### OCXO option (R&S FSV-B4)

This option generates a very precise 10 MHz reference signal. If installed, this signal is used as an internal reference. It can also be used to synchronize other connected devices via the REF OUT connector.



#### Warm-up time for OCXO

When the instrument is switched on, the OCXO requires an extended warm-up time (see data sheet).

---

## 3.2 Preparing for Use

### 3.2.1 Putting into Operation

This section describes the basic steps to be taken when setting up the R&S ESRP for the first time.



#### **WARNING**

##### **Risk of injury due to disregarding safety information**

Observe the information on appropriate operating conditions provided in the data sheet to prevent personal injury or damage to the instrument. Read and observe the basic safety instructions provided with the instrument, in addition to the safety instructions in the following sections. In particular:

- Do not open the instrument casing.
- 

#### **NOTICE**

##### **Risk of instrument damage due to inappropriate operating conditions**

Specific operating conditions are required to ensure accurate measurements and to avoid damage to the instrument. Observe the information on appropriate operating conditions provided in the basic safety instructions and the instrument's data sheet.

---

**NOTICE****Risk of instrument damage due to inappropriate operating conditions**

An unsuitable operating site or test setup can damage the instrument and connected devices. Before switching on the instrument, observe the information on appropriate operating conditions provided in the data sheet. In particular, ensure the following:

- All fan openings are unobstructed and the airflow perforations are unimpeded. The minimum distance from the wall is 10 cm.
- The instrument is dry and shows no sign of condensation.
- The instrument is positioned as described in the following sections.
- The ambient temperature does not exceed the range specified in the data sheet.
- Signal levels at the input connectors are all within the specified ranges.
- Signal outputs are connected correctly and are not overloaded.

**NOTICE****Instrument damage caused by electrostatic discharge**

Electrostatic discharge (ESD) can damage the electronic components of the instrument and the device under test (DUT). Electrostatic discharge is most likely to occur when you connect or disconnect a DUT or test fixture to the instrument's test ports. To prevent electrostatic discharge, use a wrist strap and cord and connect yourself to the ground, or use a conductive floor mat and heel strap combination.

**EMI impact on measurement results**

Electromagnetic interference (EMI) may affect the measurement results.

To suppress generated electromagnetic interference (EMI):

- Use suitable shielded cables of high quality. For example, use double-shielded RF and LAN cables.
- Always terminate open cable ends.
- Note the EMC classification in the data sheet.

**3.2.1.1 Unpacking and Checking the Instrument**

To remove the instrument from its packaging and check the equipment for completeness, proceed as follows:

1. Pull off the polyethylene protection pads from the instrument's rear feet.
2. Carefully remove the pads from the instrument handles at the front.
3. Pull off the corrugated cardboard cover that protects the rear of the instrument.



4. Carefully unthread the corrugated cardboard cover at the front that protects the instrument handles and remove it.
5. Check the equipment for completeness using the delivery note and the accessory lists for the various items.
6. Check the instrument for any damage. If there is damage, immediately contact the carrier who delivered the instrument. Make sure not to discard the box and packing material.



#### **Packing material**

Retain the original packing material. If the instrument needs to be transported or shipped later, you can use the material to protect the control elements and connectors.

#### **3.2.1.2 Accessory List**

The instrument comes with the following accessories:

- Power cable
- Quick Start Guide

#### **3.2.1.3 Placing or Mounting the Instrument**

The R&S ESRP is designed for use under laboratory conditions, either on a bench top or in a rack.

##### **Bench Top Operation**

If the R&S ESRP is operated on a bench top, the surface should be flat. The instrument can be used in horizontal position, standing on its feet, or with the support feet on the bottom extended.

**⚠ WARNING****Risk of injury if feet are folded out**

The feet can fold in if they are not folded out completely or if the instrument is shifted. Collapsing feet can cause injury or damage the instrument.

- Fold the feet completely in or out to ensure stability of the instrument. Never shift the instrument when the feet are folded out.
- When the feet are folded out, do not work under the instrument or place anything underneath.
- The feet can break if they are overloaded. The overall load on the folded-out feet must not exceed 500 N.

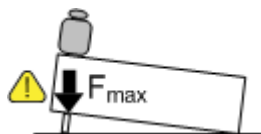
**⚠ WARNING****Risk of injury when stacking instruments**

A stack of instruments can tilt over and cause injury if not stacked correctly. Furthermore, the instruments at the bottom of the stack can be damaged due to the load imposed by the instruments on top.

Observe the following instructions when stacking instruments:

- Never stack more than three instruments. If you need to stack more than three instruments, install them in a rack.
- The overall load imposed on the lowest instrument must not exceed 500 N.
- It is best if all instruments have the same dimensions (width and length). If you need to stack smaller instruments on the top, the overall load imposed on the lowest instrument must not exceed 250 N.
- If the instruments have foldable feet, fold them in completely.

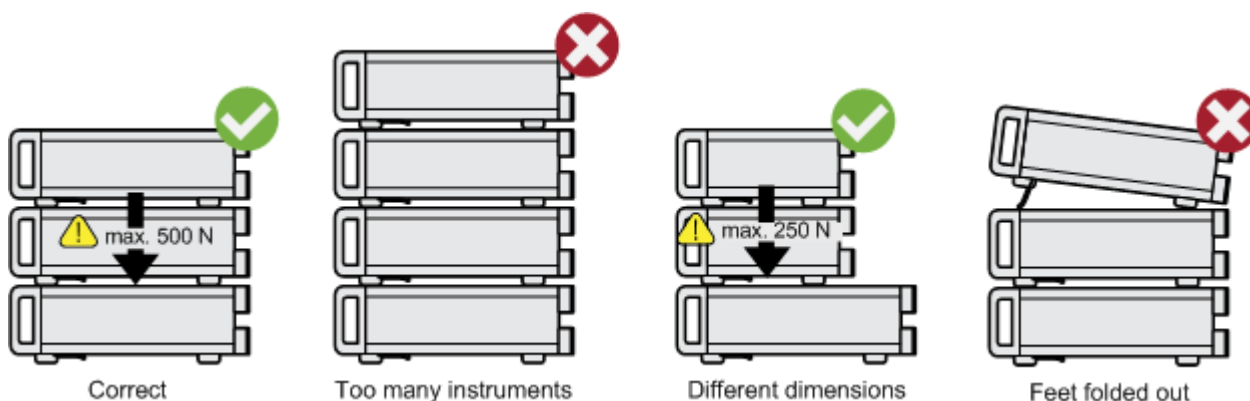

### Rackmounting

The R&S ESRP can be installed in a rack using a rack adapter kit (for the order no., see data sheet). The installation instructions are part of the adapter kit.

#### **NOTICE**

##### **Risk of instrument damage due to insufficient airflow in a rack**

If the instrument is run with insufficient airflow for a longer period, the instrument overheats, which can disturb the operation and even cause damage.

Make sure that all fan openings are unobstructed, that the airflow perforations are unimpeded, and that the minimum distance from the wall is 10 cm.

#### 3.2.1.4 Connecting the AC Power

The R&S ESRP is equipped with an AC power supply connector. The R&S ESRP can be used with different AC power voltages and adapts itself automatically to it. Refer to the datasheet for the requirements of voltage and frequency. The AC power connector is located on the rear panel of the instrument.



- ▶ Connect the R&S ESRP to the AC power supply using the supplied power cable. Since the instrument is assembled in line with the specifications for safety class EN61010, it may only be connected to an outlet that has a ground contact.

#### 3.2.1.5 Changing the AC Supply Fuse

Only fuses of the type IEC 60 127-T3.15H/250 V should be used. Those fuses are used for all of the specified nominal AC supply voltages.

Changing the AC supply fuses:

1. Disconnect the power cable.
2. Open the flap covering the voltage selector using a small screwdriver (or similar).
3. Remove the fuseholder. Remove both fuses and install the new ones. Reinsert the fuseholder.
4. Close the flap.

#### 3.2.1.6 Using an Optional DC Power Supply

When only DC power is available, for example from a battery or in a vehicle, an optional DC power supply adapter (R&S FSV-B30) can be connected to the R&S ESRP to operate the instrument with a DC voltage of 10 V to 28 V.

For installation instructions see the option's installation guide.

---

**⚠ WARNING****Shock hazard due to power supply**

If you use external power supplies to supply the equipment with DC safety extra low voltage (SELV), make sure the requirements for reinforced or double insulation are met, according to DIN/EN/IEC 61010 (UL61010, CAN CSA C22.2 No. 61010) or DIN/EN/IEC 60950 (UL60950, CAN CSA C22.2 No. 60950). Otherwise you may be injured due to electrical shock.

---

Before switching on the R&S ESRP, switch on the DC power supply:

**Switching the DC power supply on**

1. Connect the R&S ESRP DC power supply device to the DC power source (e.g. battery pack or vehicle) as described in the option's installation guide.
2. Set the switch on the DC power supply to "I". A green LED indicates that the DC power supply is ready for operation.
3. In case of overvoltage or undervoltage, the DC power supply switches off automatically. This state is indicated by means of a red LED.
4. Set the power switch on the rear panel to "I".
5. Press the [ON/OFF] key on the front panel. A green LED above the [ON/OFF] key indicates that the instrument is ready for operation.

**Switching the DC power supply off**

1. Press the [ON/OFF] key on the front panel of the R&S ESRP and wait until the instrument has shut down.
2. Switch off the power switch on the rear panel of the R&S ESRP.
3. Switch off the DC power supply.

### 3.2.1.7 Switching the Instrument On and Off

**Switching the instrument on**

If an optional DC power supply (R&S FSV-B30) is used, you must switch on these devices first; see [Chapter 3.2.1.6, "Using an Optional DC Power Supply"](#), on page 40.

1. Press the AC power switch on the rear panel to position "I".  
The instrument is supplied with AC power.
2. Press the [ON/OFF] key on the front panel.

After booting, the instrument is ready for operation. A green LED above the [ON/OFF] key indicates this.



#### Warm-up time for OCXO

When the instrument is switched on, the OCXO requires an extended warm-up time (see data sheet).

#### Switching the instrument off

1. Press the [ON/OFF] key on the front panel.
2. Change the AC power switch on the rear panel to position "O", or disconnect the instrument from the AC power supply.

The R&S ESRP changes into off mode.

### NOTICE

#### Risk of losing data

If you switch off the running instrument using the rear panel switch or by disconnecting the power cord, the instrument loses its current settings. Furthermore, program data can be lost.

Press the ON/STANDBY key first to shut down the application properly.

#### 3.2.1.8 Maintenance

The R&S ESRP does not require regular maintenance. Maintenance is essentially restricted to cleaning the R&S ESRP. It is however advisable to check the nominal data from time to time.

### NOTICE

#### Instrument damage caused by cleaning agents

Cleaning agents contain substances such as solvents (thinners, acetone, etc.), acids, bases, or other substances. Solvents can damage the front panel labeling, plastic parts, or screens, for example.

Never use cleaning agents to clean the outside of the instrument. Use a soft, dry, lint-free dust cloth instead.

The storage temperature range for the R&S ESRP is specified in the data sheet. The instrument must be protected against dust if it is to be stored for a long period.

When transporting or shipping the instrument, it is advisable to use the original packing material (especially the two protective covers for the front and rear panel).

### 3.2.1.9 Performing a Self Alignment and a Self Test



#### Operating temperature

Before performing this functional test, make sure that the instrument has reached its operating temperature (for details, refer to the data sheet).

#### Performing a self alignment

1. Press the [SETUP] key.
2. Press the "Alignment" softkey.
3. Press the "Self Alignment" softkey.

Once the system correction values have been calculated successfully, a message is displayed.



#### To display the alignment results again later

- Press the [SETUP] key.
- Press the "Alignment" softkey.
- Press the "Show Align Results" softkey.

#### Performing a self test

The self test does not need to be repeated every time the instrument is switched on. It is only necessary when instrument malfunction is suspected.

1. Press the [SETUP] key.
2. Press the "More" softkey.
3. Press the "Service" softkey.
4. Press the "Selftest" softkey.

Once the instrument modules have been checked successfully, a message is displayed.

### 3.2.1.10 Checking the Supplied Options

The instrument may be equipped with both hardware and firmware options. In order to check whether the installed options correspond to the options indicated on the delivery note, proceed as follows.

1. Press the [SETUP] key.
2. Press the "System Info" softkey.
3. Press the "Versions + Options" softkey.

A list with hardware and firmware information is displayed.

4. Check the availability of the hardware options as indicated in the delivery note.  
For an overview of the available options, refer to the datasheet.

### 3.2.2 Connecting USB Devices

The USB interfaces of the R&S ESRP allow you to connect USB devices directly to the instrument. Increase the number of possible connections using USB hubs. Due to the large number of available USB devices, there is almost no limit to the expansions that are possible with the R&S ESRP.

The following list shows various USB devices that can be useful:

- Memory stick for easy transfer of data to/from a computer (e.g. firmware updates)
- CD-ROM drives for easy installation of firmware applications
- Keyboard or mouse to simplify the entry of data, comments, filenames, etc.
- Printer for printing measurement results
- Power sensors, e.g. of the NRP Zxy family

Installing USB devices is easy under Windows, because all USB devices are plug&play. After a device is connected to the USB interface, the operating system automatically searches for a suitable device driver.

If Windows does not find a suitable driver, it prompts you to specify a directory that contains the driver software. If the driver software is on a CD, connect a USB CD-ROM drive to the instrument before proceeding.

When a USB device is then disconnected from the R&S ESRP, Windows immediately detects the change in hardware configuration and deactivates the corresponding driver.

All USB devices can be connected to or disconnected from the instrument during operation.

#### Connecting a memory stick or CD-ROM drive

If installation of a memory stick or CD-ROM drive is successful, Windows informs you that the device is ready to use. The device is made available as a new drive and is displayed in Windows Explorer. The name of the drive depends on the manufacturer.

#### Connecting a keyboard

The keyboard is detected automatically when it is connected. The default input language is English – US.

Select "Start > Settings > Time & language > Region & language > Add a language" to configure the keyboard language. To access the Windows operating system, press the Windows key on the external keyboard.

#### Connecting a mouse

The mouse is detected automatically when it is connected.

Select "Start > Settings > Devices > Mouse & touchpad" to configure the mouse properties. To access the Windows operating system, press the Windows key on the external keyboard.

### Connecting a printer

When printing a file, the instrument checks whether a printer is connected and turned on and whether the appropriate printer driver is installed. If necessary, printer driver installation is initiated. You only have to install a printer driver once.

To install a printer, select "Start > Settings > Devices > Add a printer or scanner". To access the Windows operating system, press the Windows key on the external keyboard.

You can load updated and improved driver versions or new drivers from an installation disk, USB memory stick or another external storage medium. If the instrument is integrated in a network, you can also install driver data stored in a network directory.

Select "Start > Settings > Devices > Device Manager > Update Device drivers" to install the driver.

## 3.2.3 Connecting an External Monitor

You can connect an external monitor to the "MONITOR" connector on the instrument's rear panel.

For details on the connector refer to "[MONITOR \(VGA\)](#)" on page 34.

1. Connect the external monitor to the R&S ESRP.
2. Press the [SETUP] key.
3. Press the "General Setup" softkey.
4. Press the "More" softkey.
5. Press the "Configure Monitor" softkey.

The configuration of the connected monitor is determined and displayed in the standard Windows configuration dialog box.

6. In the configuration dialog box, you can switch from the internal monitor (laptop icon) to the external monitor (monitor icon), or both (double monitor icon).

If the external monitor is selected, the R&S ESRP display is disabled. The screen content (measurement screen) formerly displayed on the R&S ESRP is displayed on the external screen. If you select both monitors, the R&S ESRP screen and the external screen are both active.

## 3.2.4 R&S ESRP Setup

This section describes how to setup the instrument. It includes the following topics:



- [Selecting the Frequency Reference Signal](#).....46
- [Setting the Date and Time](#)..... 46
- [Aligning the Touchscreen](#).....47
- [Setting the Screen Colors](#)..... 48
- [Setting the Display Power Save Function](#).....50
- [Selecting and Configuring Printers](#).....51

### 3.2.4.1 Selecting the Frequency Reference Signal

You can switch the reference signal for frequency processing of the R&S ESRP between the internal reference and an external reference signal at 10 MHz as follows:

1. Press the [SETUP] key.
2. Press the "Reference Int/Ext" softkey until it is in the desired state.



#### External reference signal

It is important that the external reference signal is deactivated when switching from external to internal reference to avoid interactions with the internal reference signal.

Remote commands:

```
ROSC:SOUR EXT
```

```
ROSC:EXT:FREQ 20
```

### 3.2.4.2 Setting the Date and Time

You can set the date and time for the internal real time clock as follows:

#### Opening the Date and Time Properties dialog box

1. Press the [SETUP] key.
2. Press the "General Setup" softkey.
3. Press the "Time + Date" softkey to open the "Date and Time Properties" dialog box.  
The "Date & Time" tab is displayed.

#### Changing the date

1. Press the arrow on the "Month" field to display the list.
2. Select the month from the list.
3. Select the year by clicking on the up and down arrow buttons next to the "Year" field.
4. Select the day in the calendar display or enter the date via the keyboard.

5. Click "OK".

Remote command  
SYST:DATE 2008,10,1

### Changing the time

You can change hours, minutes and seconds independently of each other.

1. Select the hour, minute or seconds area of the "Time" field.
2. Enter the required setting via the keyboard or rotary knob.
3. Repeat these steps until the hour, minute and second settings are correct.
4. Click "OK".

Remote command  
SYST:TIME 12,30,30

### Changing the time zone

1. Select the "Time Zone" tab.
2. Press the arrow on the "Time Zone" field to display the list.
3. Select the required time zone from the list.
4. Optionally, select the "Automatically adjust clock for daylight saving changes" check box.
5. Click "OK".

#### 3.2.4.3 Aligning the Touchscreen

When the device is delivered, the touchscreen is initially aligned. However, it may become necessary to adjust the alignment later, e.g. after an image update or after exchanging a hard disk. If you notice that touching a specific point on the screen does not achieve the correct response, try adjusting the alignment.



If the touchscreen is so out of order that you cannot navigate properly, connect an external mouse to the R&S ESRP and follow the steps described below to start re-alignment.

1. Press the [SETUP] key.
2. Press the "Alignment" softkey.
3. Press the "Touchscreen Alignment" softkey.
4. Using a finger or any other pointing device, press the 4 markers on the screen.

The touchscreen is aligned according to the executed pointing operations.

### 3.2.4.4 Setting the Screen Colors

To change the colors of the displayed objects, two default color settings are provided. Alternatively, you can change the color of objects individually using predefined colors or using colors of your own definition.



Some color settings are defined by the selected theme, see [Chapter 3.4.4.9, "Selecting a Theme"](#), on page 87, and cannot be changed individually.

#### Displaying the Screen Colors Submenu

1. Press the [SETUP] key.
2. Press the "Display Setup" softkey.
3. Press the "More" softkey.
4. Press the "Screen Colors" softkey.

The "Screen Colors" submenu is displayed.

#### Using the Default Color Settings

To select the default setting for brightness, tint and color saturation of all screen objects:

1. In the "Screen Colors" submenu (see ["Displaying the Screen Colors Submenu"](#) on page 48), press the "Set to Default" softkey.  
The "Set User Colors to Default" dialog box is displayed.
2. Select one of the default color sets. The color schemes are selected in such a manner that all screen elements are visible optimally regardless whether viewed from above or below. In the instrument's default setting, "Default Colors 1" is active.

Remote commands:

```
DISP:CMAP:DEF1
```

```
DISP:CMAP:DEF2
```

#### Using the Predefined Color Set

1. In the screen colors submenu (see ["Displaying the Screen Colors Submenu"](#) on page 48), press the "Select Screen Color Set" softkey.  
The "Select Screen Color Set" dialog box is displayed.
2. Select the "User Defined Colors" option.
3. In the screen colors submenu, press the "Select Object" softkey.  
The "Screen Color Setup" dialog box is displayed.



4. Press the arrow on the "Selected Object" list and select the object for which you want to change the color setting.
5. Select the color you want to use for the object. The defined color is displayed in the "Preview" box.
6. Repeat the steps for all objects that you want to change in color.
7. To change to user-defined colors, press the "Userdefined Colors" softkey. For details refer to ["Defining and Using a User-Defined Color Set"](#) on page 49.
8. Click "OK" to accept the new settings and to close the dialog box.

Remote command:

```
DISP:CMAP1 ... 41:PDEF <color>
```

### Defining and Using a User-Defined Color Set

1. In the screen colors submenu (see ["Displaying the Screen Colors Submenu"](#) on page 48), press the "Select Screen Color Set" softkey.  
The "Select Screen Color Set" dialog box is displayed.
2. Select the "User Defined Colors" option.
3. In the "Screen Colors" submenu, press the "Select Object" softkey.  
The "Screen Color Setup" dialog box is displayed.



4. Press the arrow on the "Selected Object" list and select the object for which you want to change the color setting.
5. In the color palette, select the color you want to use for the object, or enter values for tint, saturation and brightness.

The defined color is displayed in the "Preview" box.

**Note:** In the continuous color spectrum ("Tint") red is represented by 0% and blue by 100%.

6. Repeat the steps for all objects for which you want to change the color.
7. To change to predefined colors, press the "Predefined Colors" softkey. For details refer to ["Using the Predefined Color Set"](#) on page 48.
8. Click "OK" to accept the new settings and to close the dialog box.

Remote command:

```
DISP:CMAP1 ... 41:HSL <hue>,<sat>,<lum>
```

#### 3.2.4.5 Setting the Display Power Save Function

The R&S ESRP provides a feature for automatically switching off its screen after a user-defined period of time. The background lighting is disabled if no entries are made from the front panel after the selected response time (key, softkey and rotary knob).

**Activating display power save**

1. Press the [SETUP] key.
2. Press the "Display Setup" softkey.
3. Press the "More" softkey.
4. Press the "Display Pwr Save On/Off" softkey.

The power save mode is activated ("On" is highlighted), and the dialog box to enter the response time is displayed.

5. Enter the desired response time in minutes and confirm the entry with the [ENTER] key.

The screen is disabled (turns dark) after the selected period of time.

**Deactivating Display Power Save**

- ▶ In the "Display Setup" submenu, press the "Display Pwr Save On/Off" softkey again.

"Off" is highlighted and the power save mode is switched off.

**3.2.4.6 Selecting and Configuring Printers**

You can printout your measurement results using a local printer or a network printer. The instrument supports two independent printout settings. This allows you to quickly switch between output to a file and a printer.

**Configuring the Printer and the Printout**

1. Press the [PRINT] key.
2. Press the "Device Setup" softkey.

The "Hardcopy Setup" dialog box is displayed.

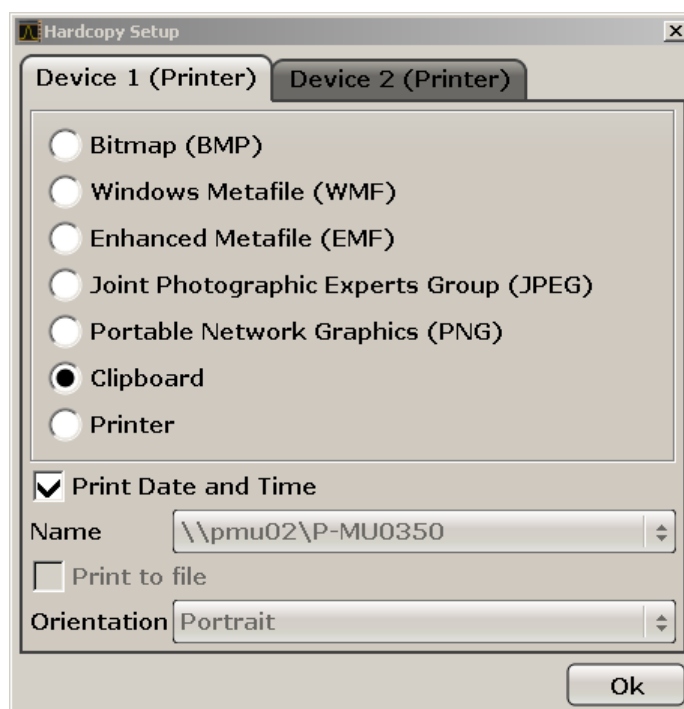

3. To change the tab in order to define the second print setting, press the tab on the screen.
4. Define the output by selecting the required options.
  - To save the hardcopy in an image file, select one of the image types. Depending on the image type, the color depth varies (e.g. 4-bit for BMP, 24-bit for PNG and JPEG).
  - To copy the image to the clipboard, select the "Clipboard" option.
  - To use a preconfigured network printer, select the "Printer" option.

**Note:** The "Name", "Print to File" and "Orientation" fields are only available if the "Printer" option is selected. You can perform the following steps only with the "Printer" option selected.
5. In the "Name" field, select the desired printer type.
6. To redirect the output to a postscript file rather than a printer, select the "Print to file" option.
7. In the "Orientation" field, select the desired orientation.
8. Optionally, activate the "Print Date and Time" option to add this information to the printout.
9. Click "OK" to accept the settings and to close the dialog box.

### Selecting the Printout Colors

1. Press the [PRINT] key.

2. Press the "Colors" softkey.
3. To print in color, press the "Select Print Color Set" softkey to select the color set. The "Select Print Color Set" dialog box is displayed.
4. Select the color set by using the arrow keys and confirm your selection by pressing the [ENTER] key.
  - "Screen Colors (Print)" option: The current screen colors are used for the printout. Independently of the current screen colors, the background is printed in white and the grid in black.  
Remote command: `HCOP:CMAP:DEF1`
  - "Optimized Colors" option: This setting improves the color clarity of the printout. Trace 1 is printed in blue, trace 2 in black, trace 3 in bright green, trace 4 in pink, trace 5 in sea green, trace 6 in dark red, and the markers in sky blue. The background is printed in white and the grid in black. The other colors correspond to the screen colors of the default color setting of the "Setup" menu.  
Remote command: `HCOP:CMAP:DEF2`
  - "User Defined Colors" option: You define and use your own color set for the printout. For details how to proceed refer to ["Defining and Using a User-Defined Color Set"](#) on page 49.  
Remote command: `HCOP:CMAP:DEF3`
  - "Screen Colors (Hardcopy)" option: The current screen colors without any changes for a hardcopy. For details on the output format see ["Configuring the Printer and the Printout"](#) on page 51 .  
Remote command: `HCOP:CMAP:DEF4`
5. If you want a black-and-white printout, press the "Color On/Off" softkey to switch off the color. In the black-and-white printout, all background colors are printed out in white and all color lines in black. This allows you to improve contrast on the printout.  
Remote command: `HCOP:DEV:COL ON`

### 3.2.5 Windows Operating System

The instrument contains the Windows 7 operating system which has been configured according to the instrument's features and needs. Changes in the system setup are only required when peripherals like keyboard or a printer are installed or if the network configuration does not comply with the default settings. After the R&S ESRP is started, the operating system boots and the instrument firmware is started automatically.

To ensure that the instrument software functions properly, certain rules must be adhered to concerning the operating system.



**NOTICE****Risk of rendering instrument unusable**

The instrument is equipped with the Windows 7 operating system. You can install additional software on the instrument, however, additional software can impair instrument function. Thus, run only programs that Rohde & Schwarz has tested for compatibility with the instrument software.

The drivers and programs used on the instrument under Windows 7 are adapted to the instrument. Only install update software released by Rohde & Schwarz to modify existing instrument software.

The following program packages have been tested:

- Symantec Endpoint Security – virus-protection software
- FileShredder - for reliable deletion of files on the hard disk

**3.2.5.1 Virus Protection**

Take appropriate steps to protect your instruments from infection. Use strong firewall settings and scan any removable storage device used with a Rohde & Schwarz instrument regularly. It is also recommended that you install anti-virus software on the instrument. Rohde & Schwarz does NOT recommend running anti-virus software in the background ("on-access" mode) on Windows-based instruments, due to potentially degrading instrument performance. However, Rohde & Schwarz does recommend running it during non-critical hours.

For details and recommendations, see the following Rohde & Schwarz white paper:

- [1EF96: Malware Protection Windows 10](#)

**3.2.5.2 Service Packs and Updates**

Microsoft regularly creates security updates and other patches to protect Windows-based operating systems. These are released through the Microsoft Update website and associated update server. Instruments using Windows, especially those that connect to a network, should be updated regularly.

For details and recommendations, see the Rohde & Schwarz White Paper [1EF96: Malware Protection Windows 10](#).

**3.2.5.3 Login**

Windows 7 requires that users identify themselves by entering a user name and password in a login window. By default, the R&S ESRP provides two user accounts:

- **"Instrument"**: an administrator account with unrestricted access to the computer/domain
- **"NormalUser"**: a standard user account with limited access

### Automatic login

For the administrator account, an automatic login function is active by default. If activated, login is carried out automatically for the administrator (with full access) in the background when the R&S ESRP is started, without having to enter a password. This function is active until you explicitly deactivate it or change the password.

For information on how to deactivate or reactivate the automatic login, refer to "[Automatic Login Function](#)" on page 55.

### Passwords

For all default user accounts, the initial password is 894129. Note that this password is very weak, and it is recommended that you change the password for both users after initial login.

You can change the password in Windows 7 for any user at any time via "Start > Settings > Account > SignIn Options > Password > Change".



### Changing the password and use of auto-login function

Note that when you change the default passwords, the default auto-login function no longer works! Reactivate it manually as described in "[Reactivating the automatic login function](#)" on page 56.

### Automatic Login Function

When shipped, the instrument automatically logs on the default "Instrument" user to Windows 7 using the default password.

### Switching users when using the automatic login function

Which user account is used is defined during login. If automatic login is active, the login window is not displayed. However, you can also switch the user account to be used when the automatic login function is active.



1. Press the "Windows" key or the [CTRL + ESC] key combination on your keyboard to access the operating system of the R&S ESRP (see also [Chapter 3.2.5.4, "Accessing the Start Menu"](#), on page 56).
2. Press [CTRL + ALT + DEL], then select "Sign out".

The "Login" dialog box is displayed, in which you can enter the different user account name and password.

### Deactivating the automatic login function

To deactivate the automatic login function, perform the following steps:



1. Press the "Windows" key or the [CTRL + ESC] key combination on your keyboard to access the operating system of the R&S ESRP (see also [Chapter 3.2.5.4, "Accessing the Start Menu"](#), on page 56).
2. In the "Start" menu, select "All applications > Windows System > Run".  
The "Run" dialog box is displayed.

3. Enter the command `C:\R_S\INSTR\USER\NO_AUTOLOGIN.REG`.
4. Press the [ENTER] key to confirm.  
This command deactivates the automatic login function. The next time you switch on the instrument, the operating system prompts you to enter your user name and password before it starts the firmware.

### Adapting the automatic login function to a new password

If you change the "Instrument" user's password, which is used during automatic login, this function no longer works. Adapt the settings for the command that activates the auto login function first.

1. Open the `C:\R_S\INSTR\USER\NO_AUTOLOGIN.REG` file in any text editor (e.g. Notepad).
2. In the line `"DefaultPassword"="894129"`, replace the default password (894129) by the new password for automatic login.
3. Save the changes to the file.

### Reactivating the automatic login function



1. Press the "Windows" key or the [CTRL + ESC] key combination on your keyboard to access the operating system of the R&S ESRP (see also [Chapter 3.2.5.4, "Accessing the Start Menu"](#), on page 56).
2. In the "Start" menu, select "All applications > Windows System > Run".  
The "Run" dialog box is displayed.
3. Enter the command `C:\R_S\INSTR\USER\AUTOLOGIN.REG`.
4. Press the [ENTER] key to confirm.  
This command reactivates automatic login function. It is active the next time the instrument reboots.

#### 3.2.5.4 Accessing the Start Menu

The Windows "Start" menu provides access to the Windows 7 functionality and installed programs.

To open the "Start" menu:



- ▶ In Windows 10:  
Press the "Windows" key or the [CTRL + ESC] key combination on your (external) keyboard.

The Windows "Start Menu" provides access to the Windows 7 functionality and other installed programs.

- ▶ Select the "Windows"  icon in the toolbar.  
The R&S ESRP opens the "Start Menu".

In addition, the taskbar becomes visible.

When you connect an external keyboard, you can access the "Start Menu" using the "Windows" key or the [Ctrl] + [Esc] key combination.

All necessary system settings can be defined in the "Start > Settings" menu (for required settings refer to the Windows 7 documentation and to the hardware description).

### 3.2.5.5 Accessing the Windows Taskbar

The Windows taskbar also provides quick access to commonly used programs, for example Paint or WordPad. IECWIN, the auxiliary remote control tool provided free of charge and installed by Rohde & Schwarz, is also available from the taskbar.



For details on the IECWIN tool, see the "Network and Remote Control" chapter of the R&S ESRP user manual.



To open the taskbar, press the "Windows" key or the [CTRL + ESC] key combination on your keyboard.

## 3.2.6 Configuring the GPIB Interface

A GPIB interface is integrated on the rear panel of the instrument. You can set the GPIB address and the ID response string. The GPIB language is set as SCPI by default and cannot be changed for the R&S ESRP.

For details on the GPIB interface see "[GPIB Interface](#)" on page 34).

### Displaying the GPIB submenu

1. Press the [SETUP] key.
2. Press the "General Setup" softkey.
3. Press the "GPIB" softkey.

The submenu for setting the parameters of the remote control interface is displayed.

### Setting the GPIB address

- ▶ In the "GPIB" menu, press the "GPIB Address" softkey.

The edit dialog box for the GPIB address is displayed. The setting range is from 0 to 30. If SCPI is selected as the GPIB language, the default address is 20.

Remote command:

```
SYST:COMM:GPIB:ADDR 20
```

#### Setting the default ID response string

- ▶ In the "GPIB" menu, press the "ID String Factory" softkey to select the default response to the \*IDN? command.

#### Setting a user-defined ID response string

- ▶ In the "GPIB" menu, press the "ID String User" softkey to enter a user-defined response to the \*IDN? command. The maximum length of the output string is 36 characters.

## 3.3 Firmware Update and Installation of Firmware Options

This chapter describes how to update the firmware and how to activate optional firmware packages.



Updating the firmware or installing optional firmware requires administrator rights (see [Chapter 3.2.5.3, "Login"](#), on page 54).

### 3.3.1 Firmware Update

You can install a new firmware version using one of the following methods:

- Copying the files to the instrument using USB devices (e.g. a memory stick), GPIB, or LAN
- Using the "Remote Installation" feature in a LAN network

Copying the files to the instrument

1. Press the [SETUP] key.
2. Press the "More" softkey.
3. Press the "Firmware Update" softkey.  
The "Firmware Update" dialog box is displayed.
4. Enter the drive name and directory via the keypad.  
**Example:** The installation files are stored on a memory stick in the `Update` directory. After you insert the memory stick, it will be detected as drive `D:`. Therefore, the required path specification is `D:\UPDATE`.
5. If you install via LAN using the Remote Desktop application, enter the drive name and directory or press the "Browse" button to locate the directory:
  - a) In the displayed dialog box, select the drive.
  - b) On the selected drive, select the folder that contains the installation file (\*.exe).

- c) Press the "Select" button to confirm your selection and go back to the "Firmware Update" dialog box.
6. Press "Execute"  
The installation program will guide you through the installation.
7. After the firmware update, the "UNCAL" status display indicates the necessity of a self alignment. Perform a self alignment (for details refer to [Chapter 3.2.1.9, "Performing a Self Alignment and a Self Test"](#), on page 43).  
Remote command: `SYST:FIRM:UPD 'D:\FW_UPDATE'`

### Performing a remote installation from a Windows PC

This method requires a LAN connection from the instrument to a Windows PC (see [Chapter 11.2.5.1, "Connecting the Instrument to the Network"](#), on page 593).

1. Run the `Setup.exe` file on your PC.
2. Select "Remote Installation" and click the "Next" button.
3. Select the packages you want to install and click the "Next" button.
4. Your LAN subnet is scanned and all found instruments are listed.  
**Note:** The setup procedure communicates with the instrument via LAN, which means the file must pass the firewall. Therefore, add the `Setup.exe` file to your firewall rules, then restart the scan by clicking "Rescan".
5. Select the instruments you want to update. You can select up to 5 instruments to update at the same time.  
**Note:** All instruments in your LAN structure are included in the list. Make sure you select the correct instruments!  
To display further options, click the "Options" button.
6. Start installation by clicking "Install".
7. Confirm that you want to reboot the instrument in order to activate the firmware update. The instrument restarts automatically.

### 3.3.2 Activating Firmware Options

Firmware options are enabled by entering license keys as described here.

To activate firmware options

1. Press the [SETUP] key.
2. Press the "More" softkey.
3. Press the "Option Licenses" softkey.
4. Press the "Install Option" softkey.  
An edit dialog box is displayed.
5. Enter the option key number using the keypad.

6. Press the [ENTER] key.  
If validation is successful, the message "option key valid" is displayed. If the validation fails, the option software is not installed.
7. Reboot the instrument.



With time-limited licenses, a message box appears if an option is about to expire. Press the "OK" button to resume using the R&S ESRP. If an option has already expired, a message box appears for you to confirm. In this case, all instrument functions are unavailable (including remote control) until the R&S ESRP is rebooted.

Alternatively, you can activate options using an XML file.

#### To activate firmware options using an XML file

1. Press the [SETUP] key.
2. Press the "More" softkey.
3. Press the "Option Licenses" softkey.
4. Press the "Install Option by XML" softkey.  
An edit dialog box is displayed.
5. Enter or browse for the name of an XML file on the instrument that contains the option key.
6. Press "Select."  
If validation is successful, the message "option key valid" is displayed. If the validation fails, the option software is not installed.
7. Reboot the instrument.

## 3.4 Basic Operations

This chapter gives an overview on how to work with the R&S ESRP. It describes what kind of information is displayed in the diagram area, how to operate the R&S ESRP via the front panel keys and other interaction methods, and how to use the Online Help.



Note the [Conventions Used in the Documentation](#) concerning procedure descriptions and terminology described at the beginning of this manual.

### 3.4.1 Information in the Diagram Area

The following figure shows a measurement diagram during analyzer operation. All different information areas are labeled. They are explained in more detail in the following sections.

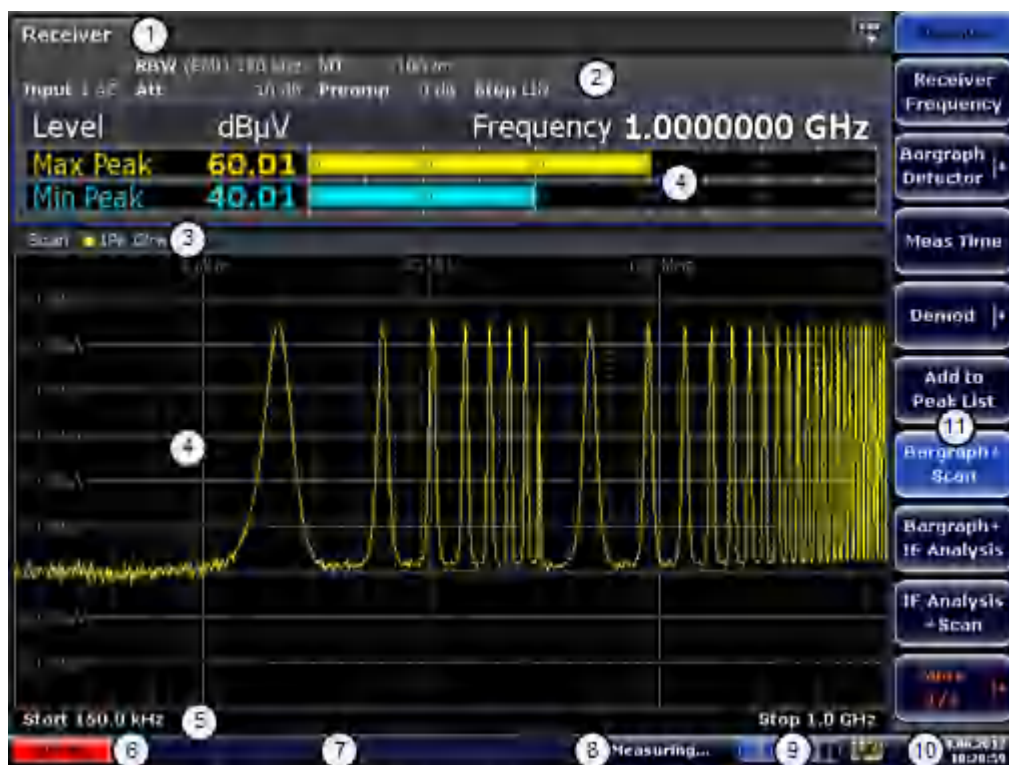

- 1 = Operation mode tabs
- 2 = Hardware information
- 3 = Header of the result display containing trace information
- 4 = Result display
- 5 = Footer of the result display containing general measurement settings
- 6 = Calibration status
- 7 = Error messages
- 8 = Measurement status information
- 9 = Measurement progress bar
- 10 = Date and time
- 11 = Softkeys

### 3.4.1.1 Channel Display

Using the R&S ESRP you can handle several different measurement tasks (channels) at the same time (although they can only be performed asynchronously). For each channel, a separate tab is displayed on the screen. In order to switch from one channel display to another, simply press the corresponding tab.



The  icon on the tab label indicates that the displayed trace no longer matches the current instrument settings. This may be the case, for example, if a trace is frozen and the instrument settings are changed. As soon as a new measurement is performed, the icon disappears.



### To start a new channel

1. Click the icon in the toolbar at the top of the screen (see also [Chapter 3.4.2.1, "Toolbar"](#), on page 68 on how to display the toolbar).
2. Select the softkey for the required measurement mode.  
A new tab is displayed for the new channel.

#### 3.4.1.2 Display of Hardware Settings

Information on hardware settings are displayed in the channel bar above the diagram.

Receiver		Spectrum							
Demod	AM	RBW (EMI)	100 kHz	MT	100 ms	SGL	10/10	Generic Probe	
Input	1 AC	Att	10 dB	Preamp	20 dB	Step	LIN	ENV4200 L1	



#### Invalid settings

A bullet next to the hardware setting indicates that user-defined settings are used, not automatic settings. A green bullet indicates this setting is valid and the measurement is correct. A red bullet indicates an invalid setting that does not provide useful results. It is the user's responsibility to remedy such a situation.



#### Editing settings in the channel bar

All settings that are displayed in the channel bar can easily be edited by touching the setting in the display (with a finger or mouse pointer). The corresponding (edit) dialog box is displayed where you can edit the setting.

In receiver mode, the R&S ESRP shows the following settings:

Demod	Active AF demodulation.
Input	Type of coupling currently used.
RBW	Resolution bandwidth currently used.
Att	Current (RF) attenuation level.
MT	Measurement time currently used.
Preamp	Current preamplification level.
SGL	Current scan count.
Step	Current frequency step mode.
no label	Active transducer factor.
no label	Active LISN.

In spectrum mode, the R&S ESRP shows the following settings:

<b>Ref Level</b>	Reference level
<b>Att</b>	RF attenuation level.
<b>Ref Offset</b>	Reference level offset
<b>SWT</b>	Sweep time that has been set. If the sweep time does not correspond to the value for automatic coupling, a bullet is displayed in front of the field. The color of the bullet turns red if the sweep time is set below the value for automatic coupling. In addition, the UNCAL flag is shown. In this case, the sweep time must be increased.
<b>RBW</b>	Resolution bandwidth that has been set. If the bandwidth does not correspond to the value for automatic coupling, a green bullet appears in front of the field.
<b>VBW</b>	Video bandwidth that has been set. If the bandwidth does not correspond to the value for automatic coupling, a green bullet is displayed in front of the field.
<b>Compatible</b>	Compatible device mode (FSP, FSU, default; default not displayed)
<b>Mode</b>	Indicates which sweep mode type is selected: <ul style="list-style-type: none"> <li>• "Auto FFT": automatically selected FFT sweep mode</li> <li>• "Auto sweep": automatically selected swept sweep mode</li> <li>• "FFT": manually selected FFT sweep mode</li> <li>• "Sweep": manually selected swept sweep mode</li> </ul>

### 3.4.1.3 Measurement Settings Information

In addition to the common hardware settings, the channel bar above the diagram also displays information on instrument settings that affect the measurement results even though this is not immediately apparent from the display of the measured values. This information is displayed in gray font and only when applicable for the current measurement, as opposed to the common hardware settings that are always displayed.

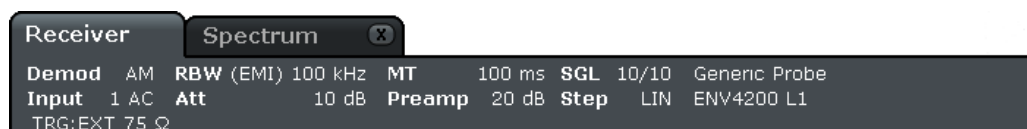

In Receiver mode, the R&S ESRP shows the following information.

<b>TRG</b>	Trigger source (for details see trigger settings in the "TRIG" menu in the Operating manual) <ul style="list-style-type: none"> <li>• <b>EXT</b>: External</li> <li>• <b>VID</b>: Video</li> </ul>
<b>75 Ω</b>	The input impedance of the instrument is set to 75 Ω.

In Spectrum mode, the following types of information may be displayed, if applicable.

Label	Description
<b>SGL</b>	The sweep is set to single sweep mode.
<b>Sweep Count</b>	The current signal count for measurement tasks that involve a specific number of subsequent sweeps (see "Sweep Count" setting in "Sweep" menu in the Operating manual)
<b>TRG</b>	Trigger source (for details see trigger settings in the "TRIG" menu in the Operating manual) <ul style="list-style-type: none"> <li>• <b>EXT</b>: External</li> <li>• <b>VID</b>: Video</li> <li>• <b>RFP</b>: RF power</li> <li>• <b>IFP</b>: IF power</li> <li>• <b>TIM</b>: Time</li> <li>• <b>SQL</b>: Squelch</li> </ul>
<b>6dB/RRC/CHN</b>	Filter type for sweep bandwidth (see BW menu in the Operating manual)
<b>PA</b>	The preamplifier is activated.
<b>GAT</b>	The frequency sweep is controlled via the [EXT TRIG/GATE IN] connector.
<b>TDF</b>	A transducer factor is activated.
<b>75 Ω</b>	The input impedance of the instrument is set to 75 Ω.
<b>FRQ</b>	A frequency offset ≠ 0 Hz is set.
<b>DC/AC</b>	An external DC or AC calibration signal is in use.
<b>Inp</b>	Input source: digital I/Q (option R&S FSV-B17 only)

#### 3.4.1.4 Diagram-specific and Trace Information

Diagram-specific information, e.g. concerning traces, is indicated in the diagram header and footer.

##### Trace information in diagram header

The diagram header (above the diagram) contains the following trace information:



The header may contain a user-defined introductory title, see [Chapter 3.4.4.7, "Adding a Title to the Diagram Header"](#), on page 86.



##### Editing settings in the diagram header

All settings that are displayed in the diagram header can easily be edited by selecting the setting in the display (by tapping or clicking). The corresponding (edit) dialog box is displayed in which you can edit the setting.

##### Norm/NCor

Correction data is not used.

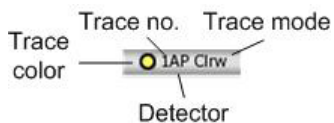

<b>Trace color</b>		Color of trace display in diagram
<b>Trace no.</b>		Trace number (1 to 6)
<b>Detector</b>		Selected detector:
	AP	AUTOPEAK detector
	Pk	MAX PEAK detector
	Mi	MIN PEAK detector
	Sa	SAMPLE detector
	Av	AVERAGE detector
	Rm	RMS detector
	QP	QUASIPeAK detector
	CA	CISPR Average detector
	RA	RMS Average detector
<b>Trace Mode</b>		Sweep mode:
	Clrw	CLEAR/WRITE
	Max	MAX HOLD
	Min	MIN HOLD
	Avg	AVERAGE (Lin/Log/Pwr)
	View	VIEW

**Marker information in Diagram Grid**

The x and y axis positions of the last 2 markers or delta markers that were set, as well as their index, are displayed within the diagram grid, if available. The value in the square brackets after the index indicates the trace to which the marker is assigned. (Example: M1[1] defines marker 1 on trace 1.) For more than 2 markers, a separate marker table is displayed beneath the diagram.

If applicable, the active measurement function for the marker and its main results are indicated, as well. The functions are indicated with the following abbreviations:

<b>FXD</b>	Reference fixed marker active
<b>PHNoise</b>	Phase noise measurement active
<b>CNT</b>	Frequency counter active
<b>TRK</b>	Signal track active

<b>NOIse</b>	Noise measurement active
<b>MDepth</b>	Measurement of the AM modulation depth active
<b>TOI</b>	TOI measurement active

### Marker Information in Marker Table

In addition to the marker information displayed within the diagram grid, a separate marker table may be displayed beneath the diagram. This table provides the following information for all active markers:

<b>Type</b>	Marker type: N (normal), D (delta), T (temporary, internal), PWR (power sensor)
<b>Dgr</b>	Diagram number
<b>Trc</b>	Trace to which the marker is assigned
<b>Stimulus</b>	x-value of the marker
<b>Response</b>	y-value of the marker
<b>Func</b>	Activated marker or measurement function
<b>Func .Result</b>	Result of the active marker or measurement function

### Mode-dependant Information in Diagram Footer

The diagram footer (beneath the diagram) contains the following information, depending on the current mode:

Mode	Label	Information
FREQ	CF	Center frequency (between start and stop)
	Span	Frequency span
SPAN	CF (1.0 ms/)	Zero span

For most modes, the number of sweep points shown in the display are indicated in the diagram footer. In zoom mode, the (rounded) number of currently displayed points are indicated.

The diagram footer can be removed from the display temporarily, see [Chapter 3.4.4.8, "Removing the Diagram Footer"](#), on page 87.

#### 3.4.1.5 Instrument and Status Information

Global instrument settings, the instrument status and any irregularities are indicated in the status bar beneath the diagram.





### Hiding the status bar

You can hide the status bar display, e.g. in order to enlarge the display area for the measurement results.

1. Press the [DISPLAY] key.
2. In the "Display Settings" dialog box, select "Status Bar State: Off".  
The status bar is no longer displayed.

- To display the status bar again, select "Status Bar State: On".

SCPI command:

```
DISP:SBAR:STAT OFF
```

The following information is displayed:

#### Instrument status

	The instrument is configured for operation with an external reference.
--	------------------------------------------------------------------------

#### Error information

If errors or irregularities are detected, a keyword and an error message, if available, are displayed in the status bar.



The following keywords are used:

<b>UNCAL</b>	One of the following conditions applies: <ul style="list-style-type: none"> <li>• Correction data has been switched off.</li> <li>• No correction values are available. This occurs, for example, if a firmware update is performed followed by a cold start of the instrument.</li> <li>• Record the correction data by performing a self alignment</li> </ul>
<b>OVL</b>	Overload of the input mixer. <ul style="list-style-type: none"> <li>• Increase the RF attenuation (for RF input).</li> <li>• Reduce the input level (for digital input)</li> </ul>
<b>IFOVL</b>	Overload of the IF signal path after the input mixer. <ul style="list-style-type: none"> <li>• Increase the reference level.</li> </ul>
<b>LOUNL</b>	Error in the instrument's frequency processing hardware was detected.
<b>NO REF</b>	Instrument was set to an external reference but no signal was detected on the reference input.
<b>OVEN</b>	OCXO reference frequency (option R&S FSV-B4) has not yet reached its operating temperature. The message usually disappears a few minutes after power has been switched on.

#### Progress

The progress of the current operation is displayed in the status bar.



### Date and time

The date and time settings of the instrument are displayed in the status bar.



## 3.4.2 Means of User Interaction

The instrument provides a user interface for operation that does not require an external keyboard, using the following means of interaction:

- [Chapter 3.4.2.1, "Toolbar"](#), on page 68
- [Chapter 3.4.2.2, "Touchscreen"](#), on page 69
- [Chapter 3.4.2.3, "On-screen Keyboard"](#), on page 70
- [Chapter 3.4.2.5, "Rotary Knob"](#), on page 72
- [Chapter 3.4.2.6, "Arrow Keys, UNDO/REDO Keys"](#), on page 72
- [Chapter 3.4.2.7, "Softkeys"](#), on page 73
- [Chapter 3.4.2.9, "Dialog Boxes"](#), on page 75

All tasks necessary to operate the instrument can be performed using this user interface. Apart from instrument specific keys, all other keys that correspond to an external keyboard (e.g. arrow keys, ENTER key) operate conform to Microsoft.

For most tasks, there are at least 2 alternative methods to perform them:

- Using the touchscreen
- Using other elements provided by the front panel, e.g. the keypad, rotary knob, or arrow and position keys

### 3.4.2.1 Toolbar

Standard functions can be performed via the icons in the toolbar at the top of the screen, if available (see [Chapter 3.4, "Basic Operations"](#), on page 60). By default, this toolbar is not displayed.

#### Displaying the toolbar

- ▶ Press the "Toolbar" icon to the right of the tabs in the display to toggle the toolbar on or off.



Alternatively:











1. Press the [SETUP] key.
2. Press the "Display Setup" softkey.
3. Press the "Tool Bar State On/Off" softkey.  
Or:
4. Press the [DISPLAY] key.
5. In the "Display Settings" dialog box, select "Tool Bar State: On".  
The toolbar is displayed at the top of the screen.

Remote:

DISP:TBAR:STAT ON

The following functions are available:

**Table 3-2: Standard Application Functions in the Toolbar**

Icon	Description
	Opens the "Select Mode" menu (see <a href="#">Chapter 3.4.1.1, "Channel Display"</a> , on page 61)
	Opens an existing measurement (settings) file
	Stores the current measurement file
	Prints the current measurement screen
	Saves the current measurement screen as a file (screenshot)
	Reverts last operation.
	Repeats previously reverted operation.
	Selection mode: the cursor can be used to select (and move) markers in a zoomed display
	Zoom mode: displays a dotted rectangle in the diagram that can be expanded to define the zoom area. Can be repeated several times.
	Zoom off: the diagram is displayed in its original size

### 3.4.2.2 Touchscreen

A touchscreen is a screen that is touch-sensitive, i.e. it reacts in a specified way when a particular element on the screen is tapped by a finger or a pointing device, for example. Any user interface elements that can be clicked on by a mouse pointer can also be tapped on the screen to trigger the same behavior, and vice versa. Using the touchscreen, the following tasks (among others) can be performed by the tap of your finger:

- Changing a setting
- Changing the display
- Moving a marker
- Zooming into a diagram
- Saving or printing results and settings



To imitate a right-click by mouse using the touchscreen, for example to open a context-sensitive menu for a specific item, press the screen for about 1 second.

### Deactivating and Activating the Touchscreen Function

The touchscreen function can be deactivated, e.g. when the instrument is being used for demonstration purposes and tapping the screen should not provoke an action.

1. Press the [DISPLAY] key.
2. In the dialog box, select one of the following options:
  - "Touchscreen ON": touchscreen function is active for the entire screen
  - "Touchscreen OFF": touchscreen is deactivated for the entire screen
  - "DIAGRAM TOUCH OFF": touchscreen is deactivated for the diagram area of the screen, but active for the surrounding softkeys, toolbars and menus.

SCPI command:

```
DISP:TOUCH:STAT OFF
```

#### 3.4.2.3 On-screen Keyboard

The on-screen keyboard is an additional means of interacting with the instrument without having to connect an external keyboard.



The on-screen keyboard display can be switched on and off as desired using the "On-Screen Keyboard" function key beneath the screen.



When you press this key, the display switches between the following options:

- Keyboard displayed at the top of the screen
- Keyboard displayed at the bottom of the screen
- No keyboard displayed



You can use the TAB key on the on-screen keyboard to move the focus from one field to another in dialog boxes.

### 3.4.2.4 Keypad

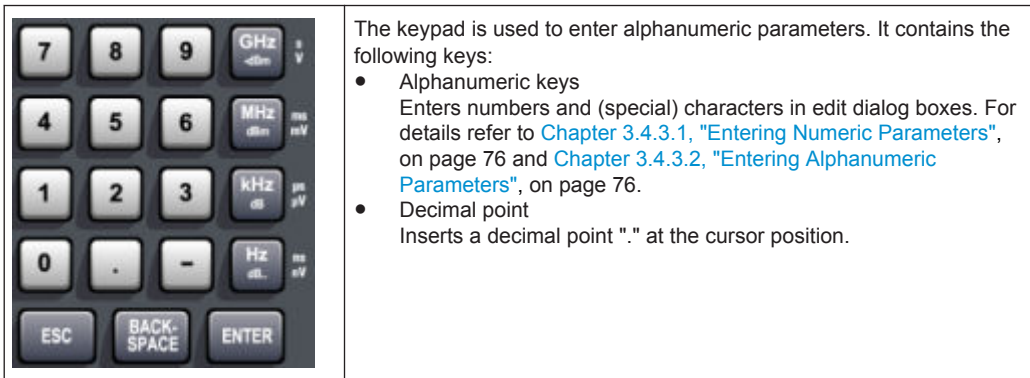

- Sign key  
Changes the sign of a numeric parameter. In the case of an alphanumeric parameter, inserts a "-" at the cursor position.
- Unit keys (GHz/dBm MHz/dBm, kHz/dB and Hz/dB)  
These keys add the selected unit to the entered numeric value and complete the entry.  
In the case of level entries (e.g. in dB) or dimensionless values, all units have the value "1" as multiplying factor. Thus, they have the same function as an ENTER key. The same is true for an alphanumeric entry.
- ESC key  
Closes all kinds of dialog boxes, if the edit mode is not active. Quits the edit mode, if the edit mode is active. In dialog boxes that contain a "Cancel" button it activates that button.  
For "Edit" dialog boxes the following mechanism is used:
  - If data entry has been started, it retains the original value and closes the dialog box.
  - If data entry has not been started or has been completed, it closes the dialog box.
- BACKSPACE key
  - If an alphanumeric entry has already been started, this key deletes the character to the left of the cursor.
  - If no input field is currently active, the most recently entered value is undone, i.e. the previous value is retrieved. Thus, you can toggle between two values (e.g. spans).
- ENTER key
  - Concludes the entry of dimensionless entries. The new value is accepted.
  - With other entries, this key can be used instead of the "Hz/dB" unit key.
  - In a dialog box, presses the default or focused button.
  - In a dialog box, activates the edit mode for the focused area, if available. For details on the edit mode refer to [Chapter 3.4.3.3, "Navigating in Dialog Boxes"](#), on page 78.

- In a dialog box, activates or deactivates the selected option of the focused area, if the edit mode is active.

### 3.4.2.5 Rotary Knob



The rotary knob has several functions:

- Increments (clockwise direction) or decrements (counter-clockwise direction) the instrument parameter at a defined step width in the case of a numeric entry.
- Shifts the selection bar within focused areas (e.g. lists), if the edit mode is activated.
- Shifts markers, limit lines, etc on the screen.
- Acts like the ENTER key, when it is pressed. For details refer to [Chapter 3.4.3.3, "Navigating in Dialog Boxes"](#), on page 78.
- Moves the scroll bar vertically, if the scroll bar is focused and the edit mode is activated.

For details on the edit mode refer to [Chapter 3.4.3.3, "Navigating in Dialog Boxes"](#), on page 78.

### 3.4.2.6 Arrow Keys, UNDO/REDO Keys

The arrow keys are used for navigation. The [UNDO]/[REDO] keys support you during input.



#### UPARROW/DNARROW keys

The [UPARROW] or [DNARROW] keys do the following:

- In a numeric edit dialog box, increase or decrease the instrument parameter.
- In a list, scroll forward and backward through the list entries.
- In a table, move the selection bar vertically.
- In windows or dialog boxes with vertical scroll bar, move the scroll bar.

#### LEFTARROW/RIGHTARROW keys

The [LEFTARROW] or [RIGHTARROW] keys do the following:

- In an alphanumeric edit dialog box, move the cursor.
- In a list, scroll forward and backward through the list entries.
- In a table, move the selection bar horizontally.
- In windows or dialog boxes with horizontal scroll bar, move the scroll bar.

### UNDO/REDO keys

- The [UNDO] key reverts the previously performed action, i.e. the status before the previous action is retrieved.  
The undo function is useful, for example, if you are performing a zero span measurement with several markers and a limit line defined and accidentally click the "ACP" softkey. In this case, very many settings would be lost. However, if you press [UNDO] immediately afterwards, the previous status is retrieved, i.e. the zero span measurement and all settings.
- The [REDO] key repeats the previously reverted action, i.e. the most recently performed action is repeated.



The [UNDO] function is not available after a [PRESET] or "RECALL" operation. When these functions are used, the history of previous actions is deleted.

#### 3.4.2.7 Softkeys

Softkeys are virtual keys provided by the software. Thus, more functions can be provided than those that can be accessed directly via the function keys on the device. Softkeys are dynamic, i.e. depending on the selected function key, a different list of softkeys is displayed on the right side of the screen

A list of softkeys for a certain function key is also called a menu. Each softkey can either represent a specific function, or a submenu that in turn represents several softkeys.

#### Selecting softkeys

- ▶ A particular softkey is selected by pressing the key on the screen with a finger, mouse pointer or other pointing device.



Softkeys can only be operated via the screen, there are (usually) no corresponding function keys.

#### Navigating in softkey menus

- The "More" softkey indicates that the menu contains more softkeys than can be displayed at once on the screen. When pressed, it displays the next set of softkeys.
- If the softkey label contains a ">" symbol, it represents a submenu of further softkeys. When you press it, the submenu is displayed.
- The "Up" key switches to the next higher level of the menu.
- The start menu of the current measurement mode is accessed directly by pressing the [HOME] key on the front panel.

#### Softkey actions

A softkey performs one of the following actions when pressed:

- Opens a dialog box to enter data.
- Switches a function on or off.
- Opens a submenu (only softkeys with a ">" symbol).

### Recognizing the softkey status by color

In the factory configuration, a softkey is highlighted orange when a corresponding dialog box is open. If it is a toggle softkey, the current state is highlighted blue. If an instrument function is not available temporarily due to a specific setting, the associated softkey is deactivated and its text is colored gray.

Some softkeys belong to a certain (firmware) option. If this option is not implemented in your device, the associated softkeys are not displayed.

### Hiding softkeys

You can hide the softkey display, e.g. when using remote control, in order to enlarge the display area for the measurement results. When you press a function key on the front panel, the softkeys are displayed temporarily, enabling you to perform a certain task with the softkeys. They are then automatically hidden again when they have not been used for a specified time. Any edit dialog boxes required for entry remain in the display.

1. Press the [DISPLAY] key.
2. In the "Display Settings" dialog box, select "Softkey Bar State: Off".  
The softkeys are no longer displayed.

► To display the softkeys again, select "Softkey Bar State: On".

Remote:

```
DISP:SKEY:STAT OFF
```

#### 3.4.2.8 Context-sensitive Menus

Markers and traces in the display, as well as the information in the channel bar, have context-sensitive menus. If you right-click on a marker or trace in the display, or information in the channel bar (or touch it for about 1 second), a menu is displayed which contains the same functions as the corresponding softkey. This is useful, for example, when the softkey display is hidden (see [Chapter 3.4.2.7, "Softkeys"](#), on page 73).

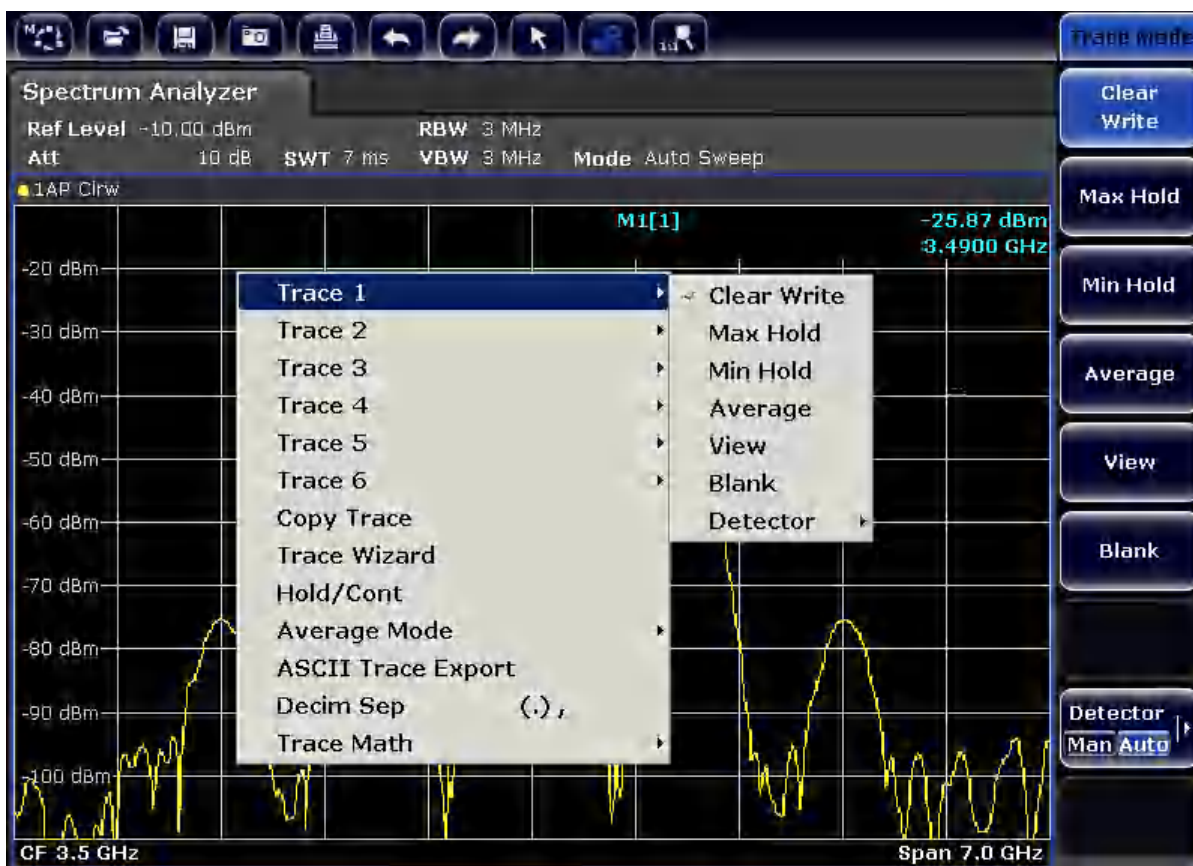

If a menu entry contains an arrow to the right of it, a submenu is available for that entry.

- ▶ To close the menu, press the ESC key or click in the display outside of the menu.

### 3.4.2.9 Dialog Boxes

In most cases, the R&S ESRP dialog boxes are designed to enter a numeric value. In the documentation, these dialog boxes are called "edit dialog boxes". Dialog boxes that are not only designed for parameter entry have a more complex structure and, in the documentation, are called "dialog boxes". The navigation in Windows dialog boxes differs in some aspects from the navigation in R&S ESRP dialog boxes. For details, see [Chapter 3.4.3.3, "Navigating in Dialog Boxes"](#), on page 78.

The following figure shows an example of a edit dialog box:

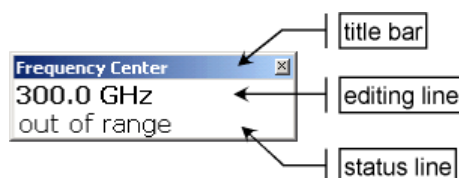

Figure 3-4: Edit dialog box for parameter entry

The title bar shows the name of the parameter that was selected. The entry is performed in the editing line. When the dialog box is displayed, the focus is on the editing line and it contains the currently used parameter value and its unit. The optional third line shows status and error messages which always refer to the current entry.

### 3.4.3 Setting Parameters

This section describes how to perform the following basic tasks in the R&S ESRP:

- [Chapter 3.4.3.1, "Entering Numeric Parameters"](#), on page 76
- [Chapter 3.4.3.2, "Entering Alphanumeric Parameters"](#), on page 76
- [Chapter 3.4.3.3, "Navigating in Dialog Boxes"](#), on page 78

#### 3.4.3.1 Entering Numeric Parameters

If a field requires numeric input, the keypad provides only numbers.

1. Enter the parameter value using the keypad, or change the currently used parameter value by using the rotary knob (small steps) or the UPARROW or DNARROW keys (large steps).
2. After entering the numeric value via keypad, press the corresponding unit key. The unit is added to the entry.
3. If the parameter does not require a unit, confirm the entered value by pressing the ENTER key or one of the unit keys. The editing line is highlighted in order to confirm the entry.

#### 3.4.3.2 Entering Alphanumeric Parameters

If a field requires alphanumeric input, you can use the on-screen keyboard to enter numbers and (special) characters (see also [Chapter 3.4.2.3, "On-screen Keyboard"](#), on page 70).



Figure 3-5: On-screen keyboard

Alternatively, you can use the keypad. Every alphanumeric key provides several characters and one number. The decimal point key (.) provides special characters, and the

sign key (-) toggles between capital and small letters. For the assignment refer to [Table 3-3](#).

### Entering numbers and (special) characters via the keypad

1. Press the key once to enter the first possible value.
2. All characters available via this key are displayed.
3. To choose another value provided by this key, press the key again, until your desired value is displayed.
4. With every key stroke the next possible value of this key is displayed. If all possible values have been displayed, the series starts with the first value again. For information on the series refer to [Table 3-3](#).
5. To change from capital to small letters and vice versa, press the sign key (-).
6. When you have chosen the desired value, wait for 2 seconds (to use the same key again), or start the next entry by pressing another key.

### Entering a blank

- ▶ Press the "Space" bar, or press the "0" key and wait 2 seconds.

### Correcting an entry:

1. Using the arrow keys, move the cursor to the right of the entry you want to delete.
2. Press the [BACKSPACE] key.
3. The entry to the left of the cursor is deleted.
4. Enter your correction.

### Completing the entry

- ▶ Press the [ENTER] key or the rotary knob.

### Aborting the entry

- ▶ Press the [ESC] key.  
The dialog box is closed without changing the settings.

*Table 3-3: Keys for alphanumeric parameters*

Key name (upper inscription)	Series of (special) characters and number provided
7	7 μ Ω ° € ¥ \$ ¢
8	A B C 8 Ä Æ Å Ç
9	D E F 9 É



Key name (upper inscription)	Series of (special) characters and number provided
4	G H I 4
5	J K L 5
6	M N O 6 Ñ Ö
1	P Q R S 1
2	T U V 2 Ü
3	W X Y Z 3
0	<blank> 0 – @ + / \ < > = % &
.	. * : _ , ; ' ' ? ( ) #
–	<toggles between capital and small letters>

### 3.4.3.3 Navigating in Dialog Boxes

Some of the dialog boxes are not only for parameter entry, and therefore have a more complex structure. The following figure shows an example.

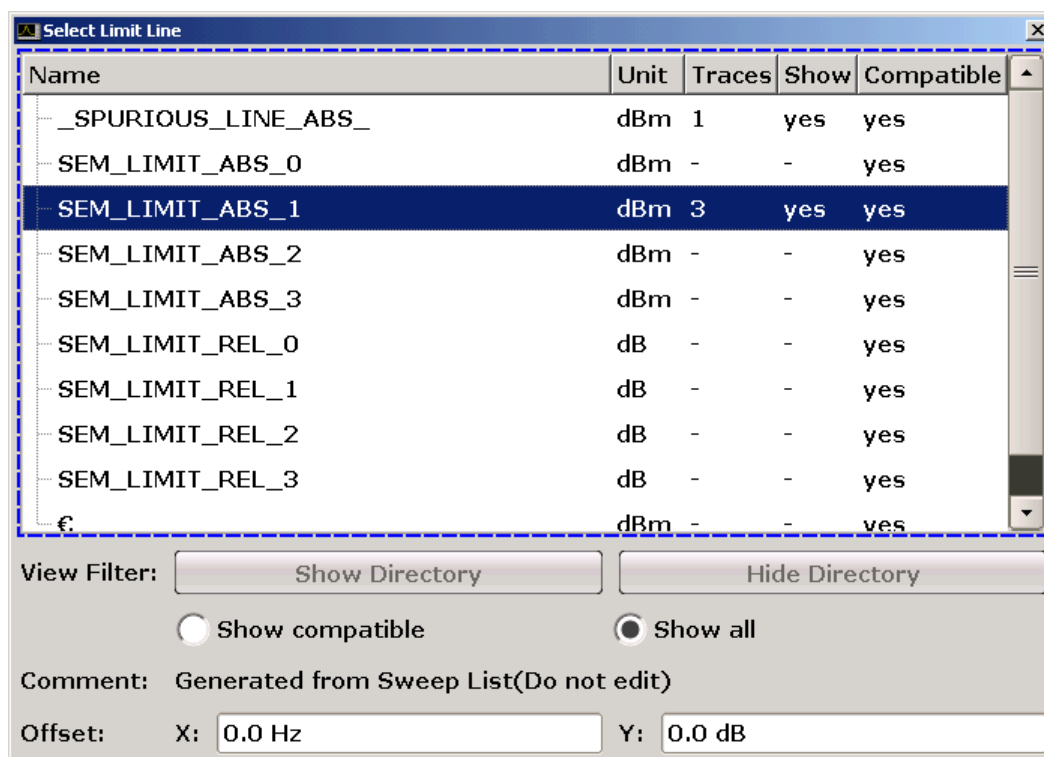

#### Changing the focus

The focus on the graphical user interface is moved by pressing an element on the screen, or via the rotary knob. The focused area is marked with a blue frame (see [Figure 3-6](#)). If this area consists of more than one element, e.g. lists of options or tables,

you must first switch to the edit mode in order to make changes. A focused area in the edit mode is marked with a dashed blue frame (see [Figure 3-7](#)).

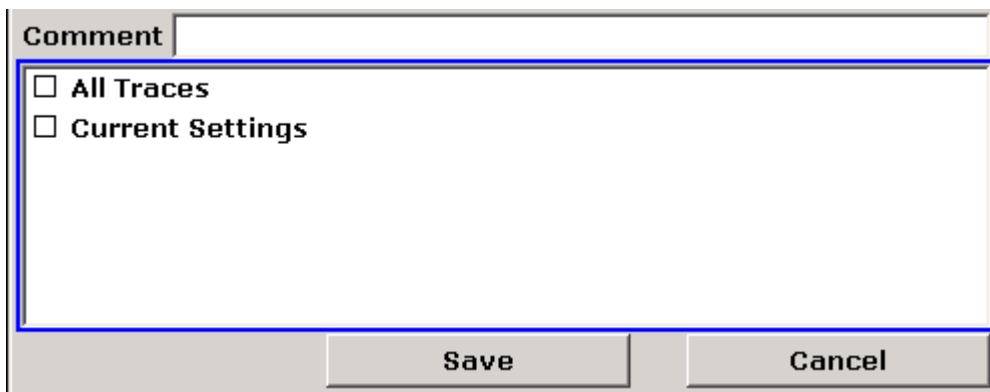

Figure 3-6: Focused area

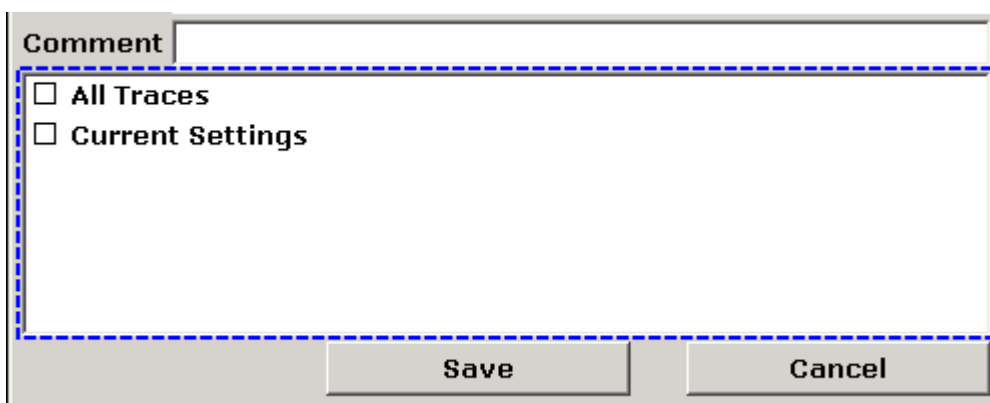

Figure 3-7: Focused area in edit mode



### Edit mode

When using the touchscreen for focus changes, all focused areas are in the edit mode automatically, if available. Otherwise, you must switch to edit mode manually.

### Switching to edit mode

1. Press the [ENTER] key.
2. To quit the edit mode, press the [ESC] key.

### Working in dialog boxes

- To edit alphanumeric parameters, use the keypad or the on-screen keyboard. For details see [Chapter 3.4.3.1, "Entering Numeric Parameters"](#), on page 76 and [Chapter 3.4.3.2, "Entering Alphanumeric Parameters"](#), on page 76. If you edit fields, the edit mode is activated automatically when you start typing.
- To move the focus to the next interface element (e.g. field, option, list), press it on the screen, or turn the rotary knob.

- To select or deselect an option, press the option on the screen.  
Alternatively:
  - If the focused area consists of more than one option and the edit mode is not active, change into the edit mode.
  - Scroll through the list of options using the arrow keys or the rotary knob (only for vertical direction) until the option you want to activate or deactivate is highlighted.
  - Press the rotary knob or the [ENTER] key to confirm your selection.  
The option is activated or deactivated, depending on its previous setting.
  - To leave the edit mode, press the [ESC] key.
- To open a drop-down list, press the arrow next to the list. Alternatively, press the [ENTER] key or the rotary knob. When opened, the list is in edit mode.
- To select an entry without opening a drop-down list, use the arrow keys to browse through the list entries.
- To select a list entry, press the entry on the screen.  
Alternatively:
  - If the edit mode is not active, change into the edit mode.
  - Scroll through the list using the arrow keys or the rotary knob until the list entry you want to select is highlighted.
  - Confirm your choice by pressing the rotary knob or the [ENTER] key.  
If a drop-down list was opened, it is closed.
- To change from one tab to the next, press the tab on the screen.
- To press a button in a dialog box, press the button on the screen.  
Alternatively:
  - Place the focus on the desired button using the rotary knob.
  - Confirm your choice by pressing the rotary knob or the [ENTER] key.
- To close the dialog box and accept the changes, press the "OK" button.
- To close the dialog box without accepting the changes, press the [ESC] key or the "Cancel" button.

### Particularities in Windows dialog boxes

In some cases, e.g. if you want to install a printer, original Windows dialog boxes are used. In these dialog boxes, the navigation behavior is different to the one you are used to from R&S ESRP applications. In the following, the important differences and useful tips are listed:

- The rotary knob and function keys do not work. Do not use them. Use the touch-screen instead.

### 3.4.4 Changing the Display

#### 3.4.4.1 Changing the Focus

Any selected function is always performed on the currently focussed element in the display, e.g. a dialog field, diagram, or table row. Which element is focussed is indicated by a blue frame (diagram, window, table) or is otherwise highlighted (softkey, marker etc.). Moving the focus is most easily done by tapping on the element on the touchscreen. Alternatively, use the "Tab" key on the on-screen keyboard or the rotary knob to move the focus from one element to the next on the display.



To move the focus on the screen between any displayed diagrams or tables, press the "Change focus" function key on the front panel. The focus moves from the diagram to the first table to the next table etc. and then back to the diagram.

#### 3.4.4.2 Switching between Split and Maximized Display



In some measurement modes, a table with markers or measurement results is displayed beneath the diagram. In this case, you may wish to maximize the diagram or table display in order to see more details.

Press the [SPLIT/MAXIMIZE] key on the front panel to switch between a split screen and a full screen (maximized display). In maximized display, the table or diagram currently focused is maximized. In split display, both the diagram and any available tables are displayed in one screen.

#### SCPI command:

`DISPlay[:WINDow<n>][:SUBWindow<m>]:SIZE` on page 949

#### 3.4.4.3 Soft and Mini Soft Front Panel Display

When working with an external monitor or operating via remote control on a computer, it is useful to be able to interact with the R&S ESRP without requiring the keypad and keys located on the front panel of the instrument. Therefore, a "Soft Front Panel" display is available, which simulates the entire front panel of the instrument (except for the external connectors) on the screen. You can switch between "normal" screen display and extended display. In the extended display, the keys and other hardware controls of the instrument are simulated on the screen.

If you require a Soft Front Panel but do not want to lose too much space for results in the display area, a mini soft Front Panel is available. The mini version displays only the hardkeys in a separate window in the display area. This window can be closed automatically after pressing a key, or remain open, as desired. Using the Mini Front Panel, the R&S ESRP interface is fully operable from a monitor with a resolution of 1024x768 pixels.

### Switching to soft Front Panel display

1. Press the SETUP key.
2. Press the "General Setup" softkey.
3. Press the "More" softkey.
4. Press the "Soft Front Panel" softkey.  
Alternatively:
5. Press the [DISPLAY] key.
6. In the "Display Settings" dialog box, select "Front Panel State: On".  
The extended display appears on the screen.

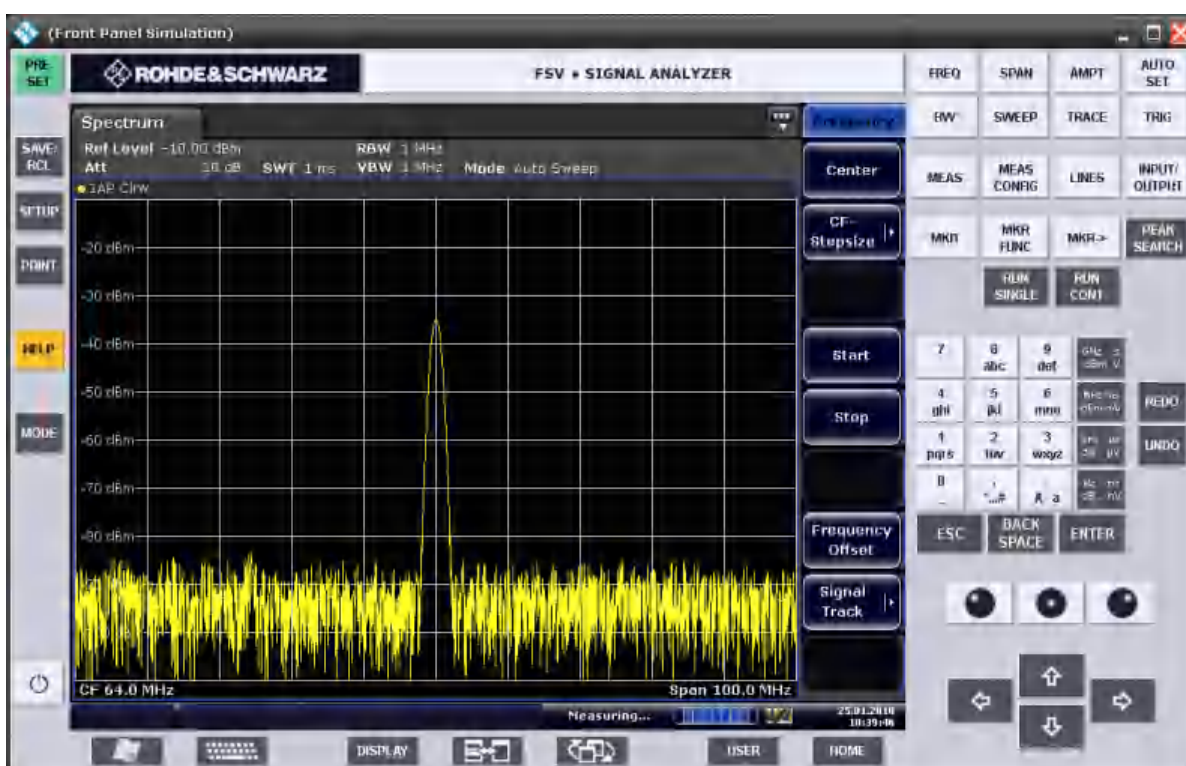



Using the F6 key you can toggle the Front Panel display on and off.

Remote: `SYST:DISP:FPAN:STAT ON`

### Working with the Soft Front Panel

Basic operation with the soft Front Panel is identical to normal operation. To activate a key, either press the key on the touchscreen, or click on it with the mouse pointer. To simulate the use of the rotary knob, use the additional keys displayed between the keypad and the arrow keys:

Icon	Function
	Turn left
	Enter
	Turn right

### Switching to Mini Front Panel display

1. Press the [DISPLAY] key.
2. In the "Display Settings" dialog box, select "Mini Front Panel State: On".  
The "Mini Front Panel" window appears on the screen. It can be moved anywhere on the screen where it does not interfere with your current task.



Using the key combination [ALT + M] you can toggle the Mini Front Panel display on and off.

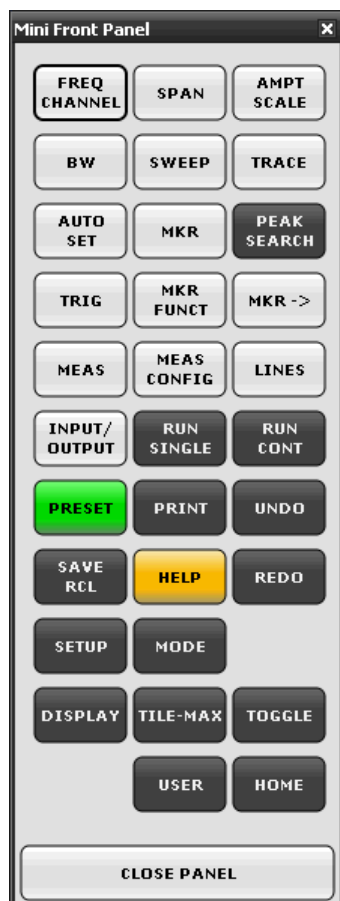

### Auto close option

By default, the "Auto close" option is activated and the Mini Front Panel window closes automatically after you select a key. This is useful if you only require the Front Panel display to press a single function key.

If you want the window to remain open, deactivate the "Auto close" option. You can close the window manually by clicking "Close Panel" or the key combination [ALT + M].

#### 3.4.4.4 Enlarging the Display Area

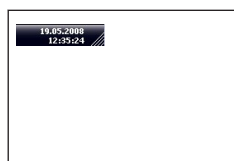

You can enlarge the screen display area if you are using an external monitor or the Soft and Mini Soft Frontpanel display (see [Chapter 3.4.4.3, "Soft and Mini Soft Front Panel Display"](#), on page 81). To do so, drag the lower right corner of the window to the required size. In standard display, a small icon is displayed in the lower right corner of the screen.

#### 3.4.4.5 Displaying the Toolbar

Standard file functions can be performed via the icons in the toolbar at the top of the screen (see the [Chapter 3.4.2.1, "Toolbar"](#), on page 68). By default, this toolbar is not displayed.

##### To display the toolbar:

1. Press the DISPLAY key.
2. Under "Select Tool Bar State", select "On".

Alternatively:

1. Press the SETUP key.
2. Press the "Display Setup" softkey.
3. Press the "Tool Bar State On/Off" softkey.

The toolbar is displayed at the top of the screen.

#### 3.4.4.6 Zooming into the Diagram

You can zoom into the diagram to visualize the measurement results in greater detail. Using the touchscreen or a mouse pointer you can easily define the area to be enlarged.



### Zoom and the number of sweep points

Note that zooming is merely a visual tool, it does not change any measurement settings, such as the number of sweep points!

You should increase the number of sweep points before zooming, as otherwise the function has no real effect (see the "Sweep Points" softkey, described in the Operating Manual and online help).

### To zoom into the diagram

1. Display the toolbar as described in [Chapter 3.4.4.5, "Displaying the Toolbar"](#), on page 84.
2.  Click on the "Zoom On" icon in the toolbar.  
A dotted rectangle is displayed in the diagram.

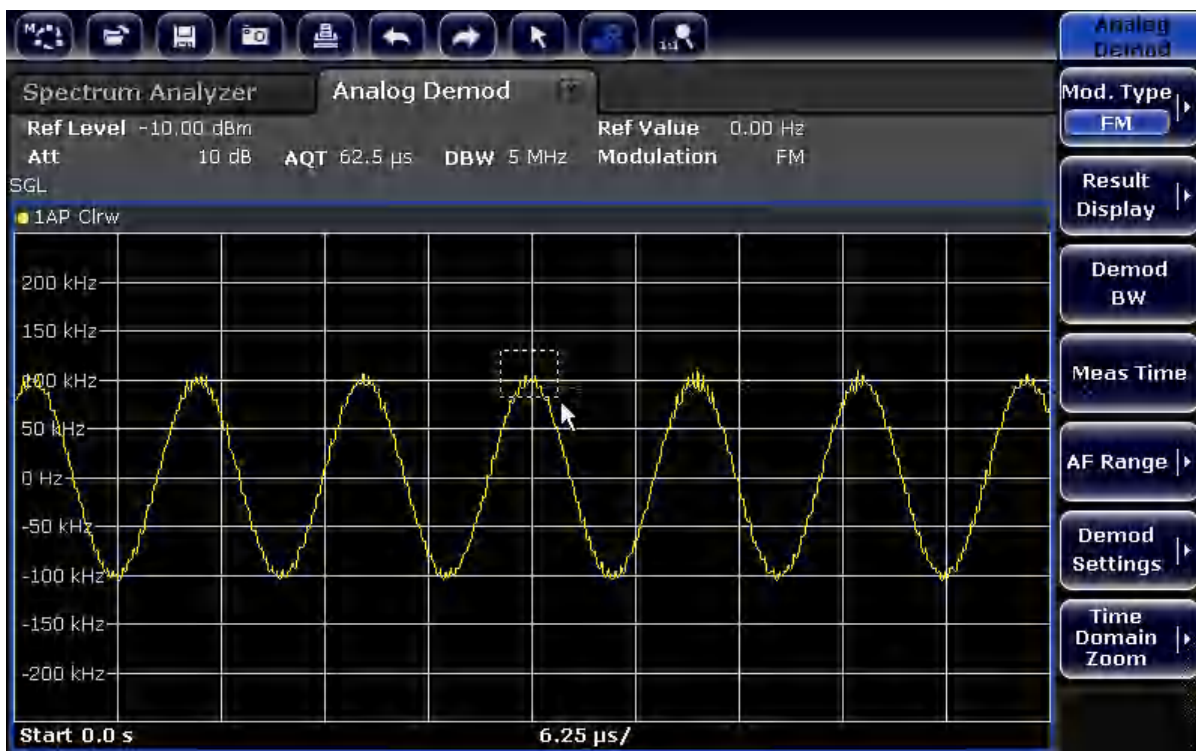

3. Drag the lower right corner of the rectangle (either via touchscreen or a mouse pointer) to define the area in the diagram to be enlarged.
4. Repeat these steps, if necessary, to enlarge the diagram further.



### Scrolling in the zoomed display

You can scroll the diagram area to display the entire diagram using the scrollbars at the right and at the bottom of the diagram.



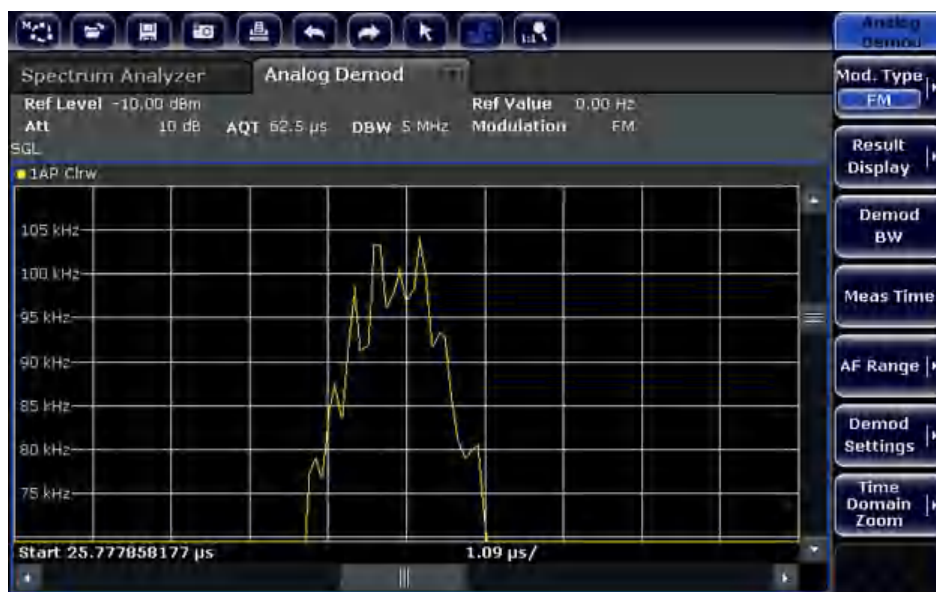

#### To return to selection mode in the diagram

While you are in zoom mode, touching the screen changes the zoom area. In order to select or move a trace or marker, you must switch back to selection mode:



- ▶ Click on the "Selection mode" icon in the toolbar.

#### To return to original display



- ▶ Click on the "Zoom Off" icon in the toolbar.  
A dotted rectangle is displayed in the diagram.

#### Remote commands:

1. Activate the zoom mode:  
`DISP:ZOOM ON`
2. Define the zoom area:  
`DISP:ZOOM:AREA 5, 30, 20, 100`
3. Hide the overview window:  
`DISP:ZOOM:OVER OFF`

#### 3.4.4.7 Adding a Title to the Diagram Header

You can add an introductory title to the trace information in the diagram header.

1. Press the SETUP key.

2. Press the "Display Setup" softkey.
3. Press the "Screen Title On/Off" softkey.  
An edit dialog box is displayed.
4. Enter the title and press "ENTER".  
The title is displayed at the beginning of the diagram header.

#### 3.4.4.8 Removing the Diagram Footer

Some additional diagram-specific information is displayed in the diagram footer (see [Chapter 3.4.1.4, "Diagram-specific and Trace Information"](#), on page 64). This footer can be removed from display if necessary.

1. Press the SETUP key.
2. Press the "Display Setup" softkey.
3. Press the "Annotation On/Off" softkey.  
The footer is displayed beneath the diagram or removed from display.

#### 3.4.4.9 Selecting a Theme

You can select a theme for the screen display. The theme defines the colors used for keys and screen elements, for example. The default theme is "BlueOcean".

##### Selecting a theme

1. Press the SETUP key.
2. Press the "Display Setup" softkey.
3. Press the "More" softkey.
4. Press the "Theme Selection" softkey. A list of available themes is displayed.
5. Select the desired theme from the list.  
The screen display changes according to the selected theme.

SCPI command:

```
DISPlay:THEMe:SElect
```

#### 3.4.4.10 Displaying and Setting the Date and Time

You can switch the date and time display in the diagram footer on or off. By default, it is displayed. You can also switch between German and US format.

##### Switching the date and time display off

1. Press the SETUP key.

2. Press the "Display Setup" softkey.
3. Press the "Time+Date" softkey to "Off".

#### Changing the format

1. Press the SETUP key.
2. Press the "Display Setup" softkey.
3. Press the "Time+Date Format" softkey until the required format is selected.

#### Setting the date and time

To set the date and time, click on the date and time display in the diagram footer. The standard Windows "Date and Time Properties" dialog is displayed and you can set the correct date and time.

#### 3.4.4.11 Changing the Display Update Rate

When performance is poor due to slow data transfer (for example during remote control), it may be helpful to decrease the frequency with which the screen display is updated.

##### To decrease the display update rate

1. Press the [DISPLAY] key.  
The "Display Settings" dialog box is opened.
2. Under "Display Update Rate", select "Slow".  
The display is updated less frequently, and performance for measurements should improve. When data transfer is no longer a problem, you can set the update rate back to "Fast" in the same way.

## 3.5 Basic Measurement Examples

The following measurement examples are intended as an introduction to operating the R&S ESRP. The User Manual contains additional and more advanced examples. Refer to chapter "Advanced Measurement Examples" to find the following topics:

- High-Sensitivity Harmonics Measurements
- Separating Signals by Selecting an Appropriate Resolution Bandwidth
- Intermodulation Measurements
- Measuring Signals in the Vicinity of Noise
- Measuring Noise Power Density
- Measurement of Noise Power within a Transmission Channel
- Measuring Phase Noise
- Measuring Channel Power and Adjacent Channel Power

For a more detailed description of the basic operating steps, e.g. selecting menus and setting parameters, refer to [Chapter 3.4, "Basic Operations"](#), on page 60.

### 3.5.1 Measuring a Sinusoidal Signal

One of the most common measurement tasks that can be handled by using a signal analyzer is determining the level and frequency of a signal. When measuring an unknown signal, you can usually start with the presets.

#### WARNING

##### High input values

If levels higher than +30 dBm (=1 W) are expected or are possible, a power attenuator must be inserted before the RF input of the analyzer. If this is not done, signal levels exceeding 30 dBm can damage the RF attenuator or the input mixer. The total power of all occurring signals must be taken into account.

Test setup

- Connect the RF output of the signal generator to the RF input of R&S ESRP.

*Table 3-4: Signal generator settings (e.g. R&S SMU)*

Frequency	128 MHz
Level	-30 dBm

#### 3.5.1.1 Measuring the Level and Frequency Using Markers

The level and frequency of a sinusoidal signal can be measured easily by using the marker function. The R&S ESRP always displays its amplitude and frequency at the marker position. The frequency measurement uncertainty is determined by the frequency reference of the R&S ESRP, the resolution of the marker frequency display and the number of sweep points.

1. Reset the instrument by pressing the [PRESET] key.
2. Select "Spectrum" mode.
3. Connect the signal to be measured to the *RF INPUT* analyzer input on the instrument front panel.
4. Set the center frequency to *128 MHz*.
  - a) Press the [FREQ] key.  
The dialog box for the center frequency is displayed.
  - b) In the dialog box, enter *128* using the numeric keypad and confirm the entry with the MHz key.
5. Reduce the frequency span to *1 MHz*.
  - a) Press the [SPAN] key.

- b) In the dialog box, enter *1* using the numeric keypad and confirm the entry by pressing the [MHz] key.

**Note:** Coupled settings. When the frequency span is defined, the resolution bandwidth, the video bandwidth and the sweep time are automatically adjusted, because these functions are defined as coupled functions in the presets.

6. Measure the level and frequency using the marker by pressing the [MKR] key. The marker is activated and automatically set on the maximum of the trace. The level and frequency values measured by the marker are displayed in the marker field at the top edge of the screen. They can be taken as the measurement result.

M1[1]	-30.00 dBm
	128.00000 MHz

The field header indicates the number of the marker (Marker 1) and the trace on which the marker is located ([1] = Trace 1).

**Note:** Performing a peak search. When a marker is initially activated, it automatically performs the peak search function (as shown in the example).

If a marker was already active, you have to press the [Peak Search] key on the front panel or the "Peak" softkey in the [MKR >] menu in order to set the currently active marker to the maximum of the displayed signal.

### Increasing the Frequency Resolution

The frequency resolution of the marker is predefined by the pixel resolution of the trace. A trace uses 691 pixels, i.e. if the frequency span is 1 MHz, each pixel corresponds to a span of approx. 1.4 kHz. This corresponds to a maximum uncertainty of +/- 0.7 kHz.

You can increase the pixel resolution of the trace by reducing the frequency span.

### Reducing the frequency span to 10 kHz

1. Press the [SPAN] key.
2. Using the numeric keypad, enter *10* in the dialog box and confirm the entry with the [kHz] key.

The generator signal is measured using a span of 10 kHz. The pixel resolution of the trace is now approx. 14 Hz (10 kHz span / 691 pixels), i.e. the precision of the marker frequency display increases to approx.  $\pm 7$  Hz.

### Setting the Reference Level

With signal analyzers, the reference level is the level at the upper limit of the diagram. To achieve the widest dynamic range possible for a spectrum measurement, use the entire level span of the signal analyzer. In other words, the highest level that occurs in the signal should be located at the top edge of the diagram (=reference level) or immediately below it.



### Low Reference Levels

If the selected reference level is lower than the highest signal that occurs in the spectrum, the signal path in the R&S ESRP is overloaded.

In this case, the message "IFOVL" is displayed in the error message field.

In the presettings, the value of the reference level is -10 dBm. If the input signal is -30 dBm, the reference level can be reduced by 20 dB without causing the signal path to be overloaded.

#### Reducing the reference level by 20 dB

1. Press the [AMPT] key.  
The amplitude menu is displayed. The "Ref Level" softkey is highlighted in red to indicate that it is activated for data entry. The dialog box for the reference level is also opened.
2. Using the numeric keypad, enter 30 and confirm the entry with the [- dBm] key.  
The reference level is set to -30 dBm. The maximum of the trace is near the maximum of the measurement diagram. However, the increase in the displayed noise is not substantial. Thus, the distance between the signal maximum and the noise display (=dynamic range) has increased.

Setting the marker level equal to the reference level

The marker can also be used to shift the maximum value of the trace directly to the top edge of the diagram. If the marker is located at the maximum level of the trace (as in this example), the reference level can be moved to the marker level as follows:

1. Press the [MKR] key.
2. Press the "Ref Lvl = Mkr Lvl" softkey.

The reference level is set equal to the measured level where the marker is located.

Thus, setting the reference level is reduced to two keystrokes.

### 3.5.1.2 Measuring the Signal Frequency Using the Frequency Counter

The built-in frequency counter allows you to measure the frequency more accurately than measuring it with the marker. The frequency sweep is stopped at the marker, and the R&S ESRP measures the frequency of the signal at the marker position.

In the following example, the frequency of the generator at 128 MHz is shown by using the marker.

#### Prerequisite

In this example, a precise frequency measurement is to be performed. Therefore, connect the signal generator's "Ref OUT" connector to the analyzer's "Ref IN" connector.

1. Set the signal analyzer to the default state by pressing the [PRESET] key.

- The R&S ESRP is set to its default state.
2. Select "Spectrum" mode.
  3. Set the center frequency and the span.
    - a) Press the [FREQ] key and enter 128 MHz.  
The center frequency of the R&S ESRP is set to 128 MHz.
    - b) Press the [SPAN] key and enter 1 MHz.  
The frequency span of the R&S ESRP is set to 1 MHz.
  4. In the "Setup" menu, select "Reference Ext".
  5. Activate the marker by pressing the [MKR] key.  
The marker is activated and set to the signal maximum. The level and the frequency of the marker are displayed in the marker field (diagram header or marker table).
  6. Activate the frequency counter by pressing the "Sig Count On/Off" softkey in the "MKR FUNC" menu.  
The result of frequency counting is displayed in the selected resolution in the marker field.

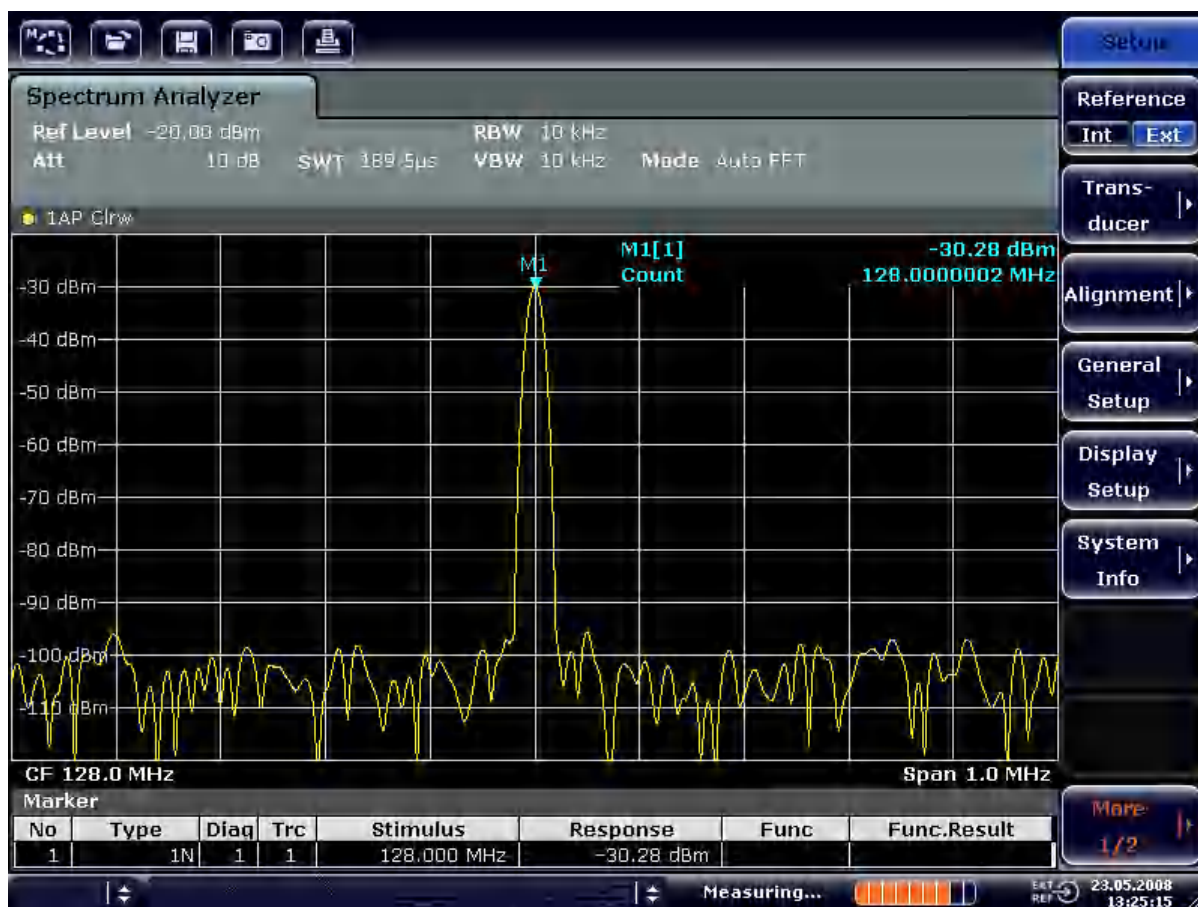

Figure 3-8: Measurement of the frequency with the frequency counter



### Prerequisites for using the internal frequency counter

In order to obtain a correct result when measuring the frequency with the internal frequency counter, an RF sinusoidal signal or a spectral line must be available. The marker must be located more than 25 dB above the noise level to ensure that the specified measurement accuracy is adhered to.

## 3.5.2 Measuring Harmonics of Sinusoidal Signals

Measuring the harmonics of a signal is a very common task that can be performed optimally by using a Signal and Spectrum Analyzer.

In the following example, the generator signal with 128 MHz and -20 dBm is used again.

Measuring the Suppression of the First and Second Harmonic of an Input Signal

1. Set the signal analyzer to the default state by pressing the [PRESET] key.  
The R&S ESRP is in the default state.
2. Select "Spectrum" mode.
3. Set the start frequency to 100 MHz and the stop frequency to 400 MHz.
  - a) Press the [FREQ] key.
  - b) Press the "Start" softkey and enter *100 MHz*.
  - c) Press the "Stop" softkey and enter *400 MHz*.  
The R&S ESRP displays the fundamental and the first and second harmonics of the input signal.
4. To average (smooth) the noise, reduce the video bandwidth.
  - a) Press the [BW] key.
  - b) Press the "Video BW Manual" softkey and enter *100 kHz*.
5. Set the attenuation to 0 dB.
  - a) Press the [AMPT] key.
  - b) Press the "RF Atten Manual" softkey.
  - c) Enter *0 dB* in the edit dialog box.
6. Activate the marker by pressing the [MKR] key.  
"Marker 1" is activated and positioned to the signal maximum (fundamental at 128 MHz). The level and frequency of the marker is displayed in the marker field.
7. Activate the delta marker and measure the harmonic suppression.
  - a) In the "MKR" menu, press the "Marker 2" softkey.  
"Marker 2" is activated as a delta marker ("D2 [1]"). It is automatically set on the largest harmonic of the signal. The frequency offset and level offset from marker 1 are displayed in the channel information bar.



- b) In the "MKR" menu, press the "Marker 3" softkey. "Marker 3" is activated as a delta marker ("D3 [1]"). It is automatically set on the next largest harmonic of the signal. The frequency offset and level offset from marker 1 on the fundamental are displayed in the channel information bar (see Figure 3-9).

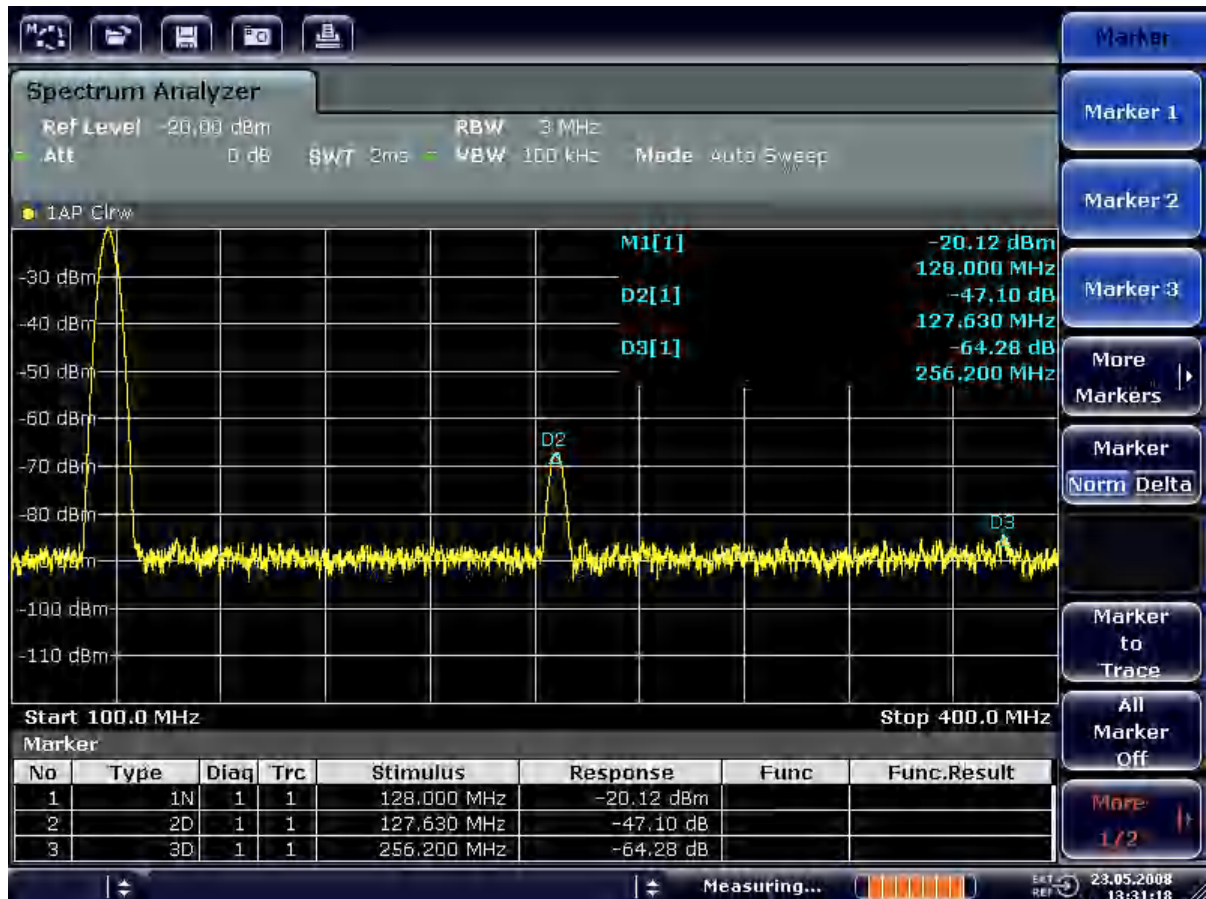

Figure 3-9: Measuring the harmonic suppression of the internal reference generator.

Delta markers D2 [1] and D3 [1] show the offset of the first and second harmonics from the fundamental.

### Reducing Noise

The signal analyzer offers three methods to differentiate the harmonics of a signal from the noise effectively:

- Reducing the video bandwidth
- Averaging the trace
- Reducing the resolution bandwidth

Reducing the video bandwidth and averaging the traces cause the noise from the analyzer or the DUT to be reduced, depending on which component is larger. Both averaging methods reduce the measurement uncertainty, particularly in the case of small signal-to-noise ratios, because the measurement signal is also separated from the noise.

Reducing the noise by reducing the video bandwidth

1. Press the [BW] key.
2. Press the "Video BW Manual" softkey.
3. Reduce the video bandwidth to 1 kHz (for example), by entering *1 kHz*.  
This smoothes the noise significantly, and the sweep time is increased to 200 ms. In other words, the measurement will take significantly more time. The video bandwidth that is displayed is marked with a bullet to indicate that it is no longer coupled to the resolution bandwidth (see [Figure 3-10](#)).



Figure 3-10: Suppression of noise during harmonics measurement by reducing video bandwidth

4. Recouple the video bandwidth to the resolution bandwidth.
  - a) Press the [BW] key.
  - b) Press the "Video BW Auto" softkey.

Reducing the noise by averaging the trace

1. Press the [TRACE] key.
2. Press the "Trace Wizard" softkey.

3. For "Trace 1", press the button in the "Trace Mode" column and select "Average" from the list.  
The noise component of the trace is smoothed by averaging 10 successive traces.
4. Switch off trace averaging by pressing the button in the "Trace Mode" column and selecting "Clear Write" from the list.

### Reducing the noise by reducing the measurement bandwidth

The noise is reduced in proportion to the bandwidth by reducing the resolution bandwidth, i.e. reducing the resolution bandwidth by a factor of 10 also reduces the noise by a factor of 10 (which corresponds to 10 dB). The amplitude of sinusoidal signals is not affected by reducing the resolution bandwidth.

1. Set the resolution bandwidth to 10 kHz.
  - a) Press the [BW] key.
  - b) Press the "Res BW Manual" softkey and enter *10 kHz*.  
The noise decreases by approx. 25 dB compared to the previous setting. Since the video bandwidth is coupled to the resolution bandwidth, it is reduced to 30 kHz in proportion to the resolution bandwidth. This causes the sweep time to increase to 3.0 seconds.
2. Reset the resolution bandwidth (couple it to the span) by pressing the "Res BW Auto" softkey in the "BW" menu.

## 3.5.3 Measuring Signal Spectra with Multiple Signals

### 3.5.3.1 Separating Signals by Selecting the Resolution Bandwidth

A basic feature of a Signal and Spectrum Analyzer is the ability to separate the spectral components of a mixture of signals. The resolution at which the individual components can be separated is determined by the resolution bandwidth. Selecting a resolution bandwidth that is too large may make it impossible to distinguish between spectral components, i.e. they are displayed as a single component.

An RF sinusoidal signal is displayed using the passband characteristic of the defined resolution filter (RBW). Its specified bandwidth is the 3 dB bandwidth of the filter.

Two signals with the same amplitude can be resolved if the resolution bandwidth is smaller than or equal to the frequency spacing of the signal. If the resolution bandwidth is equal to the frequency spacing, the spectrum display shows a level drop of 3 dB precisely in the center of the two signals. Decreasing the resolution bandwidth makes the level drop larger, which thus makes the individual signals clearer.

Higher spectral resolution at a narrower bandwidth is accomplished through longer sweep times at the same span. Reducing the resolution bandwidth by a factor of 3 increases the sweep time by a factor of 9.

**Example:**

## Separating Two Signals

The two signals have a level of -30 dBm each at a frequency spacing of 30 kHz

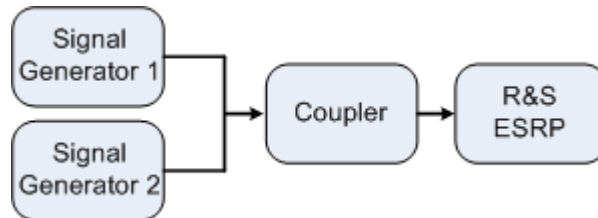

**Table 3-5: Signal generator settings (e.g. R&S SMU)**

	Level	Frequency
Signal generator 1	-30 dBm	128,00 MHz
Signal generator 2	-30 dBm	128,03 MHz

1. Set the signal analyzer to the default state by pressing the [PRESET] key. The R&S ESRP is set to its default state.
2. Select "Spectrum" mode.
3. Set the center frequency to 128.015 MHz and the frequency span to 300 kHz.
  - a) Press the [FREQ] key and enter 128.015 MHz.
  - b) Press the [SPAN] key and enter 300 kHz.
4. Set the resolution bandwidth to 30 kHz and the video bandwidth to 1 kHz.
  - a) Press the [BW] key
  - b) Press the "Res BW Manual" softkey and enter 30 kHz.
  - c) Press the "Video BW Manual" softkey and enter 1 kHz.

**Note:** Larger video bandwidths. The video bandwidth is set to 1 kHz in order to make the level drop in the center of the two signals clearly visible. At larger video bandwidths, the video voltage that results from envelope detection is not sufficiently suppressed. This produces additional voltages, which are visible in the trace, in the transition area between the two signals.



*Figure 3-11: Measurement of two equally-leveled RF sinusoidal signals with the resolution bandwidth which corresponds to the frequency spacing of the signals*

### Matching generator and R&S ESRP frequencies

The level drop is located exactly in the center of the screen only if the generator frequencies match the frequency display of the R&S ESRP exactly. To achieve exact matching, the frequencies of the generators and the R&S ESRP must be synchronized.

- Set the resolution bandwidth to 100 kHz. To do so, in the bandwidth menu, press the "Res BW Manual" softkey and enter 100 kHz.

It is no longer possible to clearly distinguish the two generator signals.



*Figure 3-12: Measurement of two equally-leveled RF sinusoidal signals with a resolution bandwidth which is larger than their frequency spacing*

**Note:** Reducing the resolution bandwidth. The resolution bandwidth (RBW) can be reduced again by turning the rotary knob counterclockwise, thus yielding a higher frequency resolution.

6. Set the resolution bandwidth to 1 kHz. To do so, in the bandwidth menu, press the "Res BW Manual" softkey and enter 1 kHz.  
The two generator signals are shown with high resolution. However, the sweep time becomes longer. At smaller bandwidths, the noise display decreases simultaneously (10 dB decrease in noise floor for a decrease in bandwidth by a factor of 10).

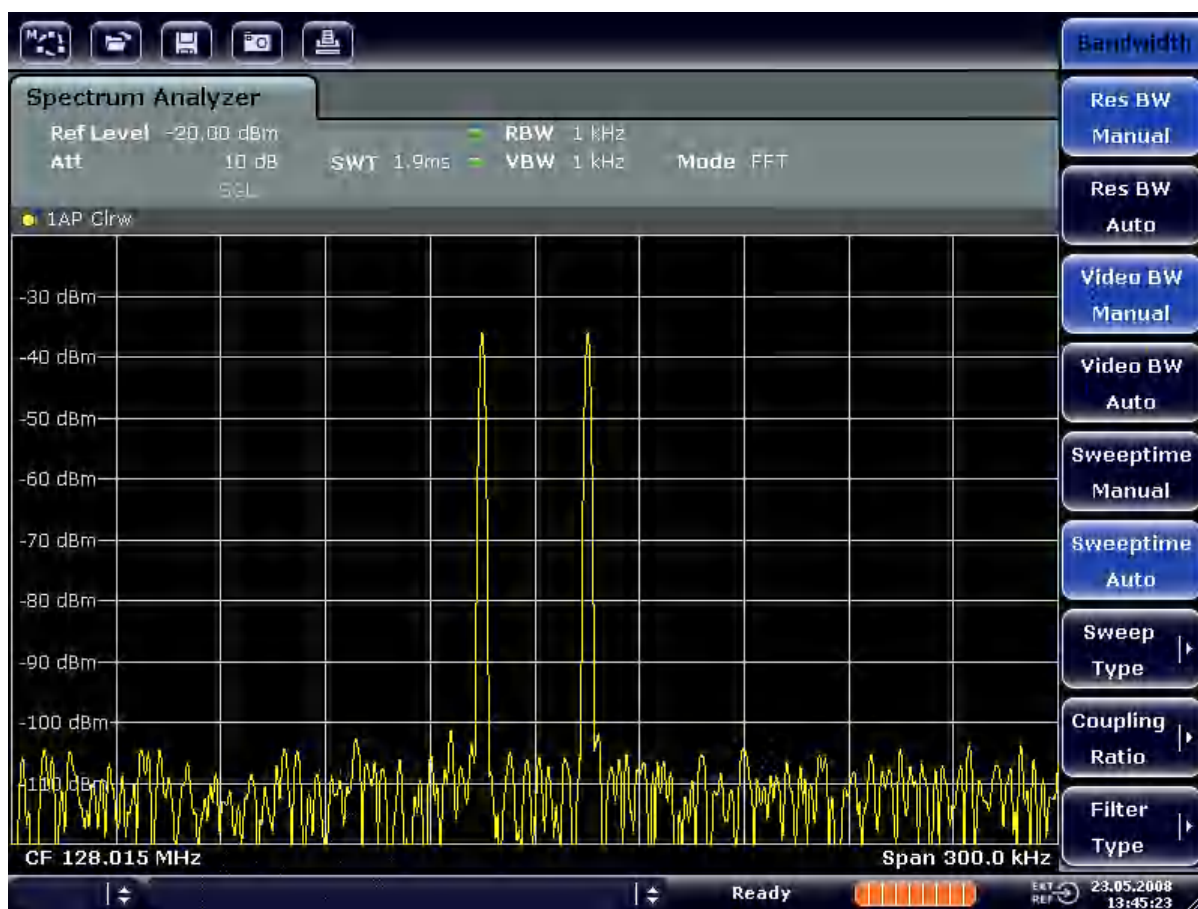

Figure 3-13: Measurement of two equally-leveled RF sinusoidal signals with a resolution bandwidth (1 kHz) which is significantly smaller than their frequency spacing

### 3.5.3.2 Measuring the Modulation Depth of an AM-Modulated Carrier (Span > 0)

In the frequency range display, the AM side bands can be resolved with a narrow bandwidth and measured separately. The modulation depth of a carrier modulated with a sinusoidal signal can then be measured. Since the dynamic range of a signal analyzer is very large, extremely small modulation depths can also be measured precisely. For this purpose, the R&S ESRP provides measurement routines that output the modulation depth numerically in % directly.

#### Test setup

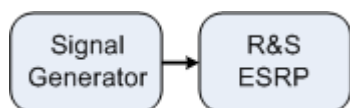

Table 3-6: Signal generator settings (e.g. R&amp;S SMU)

Frequency	128 MHz
Level	-30 dBm
Modulation	50 % AM, 10 kHz AF

1. Set the signal analyzer to the default state by pressing the [PRESET] key.  
The R&S ESRP is set to its default state.
2. Select "Spectrum" mode.
3. Set the center frequency to 128 MHz and span to 50 kHz.
  - a) Press the [FREQ] key and enter *128 MHz*.
  - b) Press the [SPAN] key and enter *50 kHz*.
4. Activate the marker function for measuring the AM modulation depth.
  - a) Press the [MEAS] key.
  - b) Press the "More" key.
  - c) Press the "AM Mod Depth" softkey.  
The R&S ESRP automatically sets a marker to the carrier signal in the center of the diagram and one delta marker each to the upper and lower AM sidebands. The R&S ESRP calculates the AM modulation depth from the level differences of the delta markers to the main marker and outputs the numeric value in the marker field.

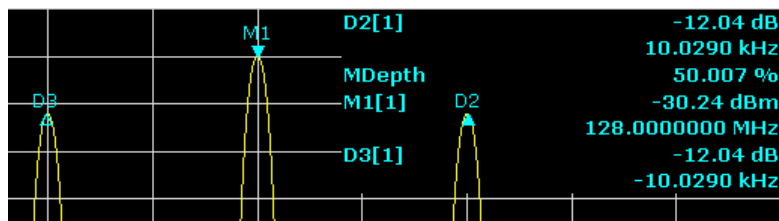

Figure 3-14: Measurement of the AM modulation depth

The modulation depth is displayed as "MDepth". The frequency of the AF signal can be obtained from the frequency display of the delta marker.

### 3.5.3.3 Measuring AM-Modulated Signals

The signal analyzer rectifies the RF input signal and displays it as a magnitude spectrum. The rectification also demodulates AM-modulated signals. The AF voltage can be displayed in zero span if the modulation sidebands fall within the resolution bandwidth.

#### Displaying the AF of an AM-modulated signal (Zero Span)

##### Test setup



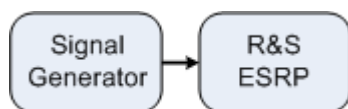

**Table 3-7: Signal generator settings (e.g. R&S SMU)**

Frequency	128 MHz
Level	-30 dBm
Modulation	50 % AM, 1 kHz AF

1. Set the signal analyzer to the default state by pressing the [PRESET] key. The R&S ESRP is set to its default state.
2. Select "Spectrum" mode.
3. Set the center frequency to 128 MHz and the span to 0 Hz.
  - a) Press the [FREQ] key and enter *128 MHz*.
  - b) Press the [SPAN] key and enter *0 Hz* or press the "Zero Span" softkey.
4. Set the sweep time to 2.5 ms.
  - a) Press the [SWEEP] key.
  - b) Press the "Sweeptime Manual" softkey.
  - c) Enter *2.5 ms*.
5. Set the reference level to +6 dBm and the display range to linear.
  - a) Press the [AMPT] key and enter *6 dBm*.
  - b) Press the "Range" softkey.
  - c) Press the "Range Linear %" softkey.
6. Set triggering in response to the AF signal by using the video trigger to produce a static image.
  - a) Press the [TRIG] key.
  - b) Press the "Trg/Gate Source" softkey and select "Video" using the arrow keys.
  - c) Press the "Trg/Gate Level" softkey and enter *50%*.  
The trigger level is displayed as a horizontal line across the entire measurement diagram. The R&S ESRP displays the 1 kHz AF signal as a static image in zero span. Use a headset to listen to the AF.
7. Activate the internal AM demodulator.
  - a) Press the [MKR FUNC] key.
  - b) Press the "Marker Demod" softkey.  
The R&S ESRP automatically switches on the AM audio demodulator. A 1 kHz tone can be heard over headset. If necessary, use the volume control knob for AF OUTPUT on the front panel to turn up the volume.

### 3.5.4 Measurements in Zero Span

For radio transmission systems that use the TDMA method (e.g. GSM or IS136), transmission quality is determined not only by spectral characteristics but also by characteristics in zero span. A timeslot is assigned to each user since several users share the same frequency. Smooth operation is ensured only if all users adhere exactly to their assigned timeslots.

Both the power during the send phase as well as the timing and duration of the TDMA burst, and rise and fall times of the burst, are important.

#### 3.5.4.1 Measuring the Power Characteristic of Burst Signals

To measure power in zero span, the R&S ESRP offers easy-to-use functions that measure the power over a predefined time.

##### Measuring the Power of a GSM Burst During the Activation Phase

###### Test setup

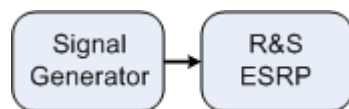

**Table 3-8: Signal generator settings (e.g. R&S SMU)**

Frequency	890 MHz
Level	0 dBm
Modulation	GSM, one timeslot activated

1. Set the signal analyzer to the default state by pressing the [PRESET] key.  
The R&S ESRP is set to its default state.
2. Select "Spectrum" mode.
3. Set the center frequency to 890 MHz, the span to 0 Hz and the resolution bandwidth to 1 MHz.
  - a) Press the [FREQ] key and enter *890 MHz*.
  - b) Press the [SPAN] key and enter *0 Hz*, or press the "Zero Span" softkey.
4. Set the reference level of the R&S ESRP to 10 dBm (= level of the signal generator +10 dB) and set the attenuation to 20 dB.
  - a) Press the [AMPT] key.
  - b) Enter *10 dBm*.
  - c) Press the "Rf Atten Manual" softkey.
  - d) Enter *20 dB*.
5. Set the sweep time to 1 ms.
  - a) Press the [SWEEP] key.

- b) Press the "Sweptime Manual" softkey and enter *1 ms*.  
The R&S ESRP shows the GSM burst continuously across the display.
6. By using the video trigger, set triggering on the rising edge of the burst.
  - a) Press the [TRIG] key.
  - b) Press the "Trg/Gate Source" softkey and select "Video" using the arrow keys.
  - c) Press the "Trg/Gate Level" softkey and enter *70%*.  
The R&S ESRP shows a static image with the GSM burst at the start of the trace. The trigger level is displayed as a horizontal line labeled with the absolute level for the trigger threshold in the measurement diagram.
7. Configure power measurement in zero span.
  - a) Press the [MEAS] key.
  - b) Press the "Time Domain Power" softkey to open the submenu.
  - c) Switch the "Limits" softkey to "On."
  - d) Press the "Left Limit" softkey.
  - e) By turning the rotary knob clockwise, move the vertical line to the start of the burst.
  - f) Press the "Right Limit" softkey.
  - g) By turning the rotary knob counterclockwise, set the second vertical line to the end of the burst.

The R&S ESRP displays the average (mean) power during the activation phase of the burst.

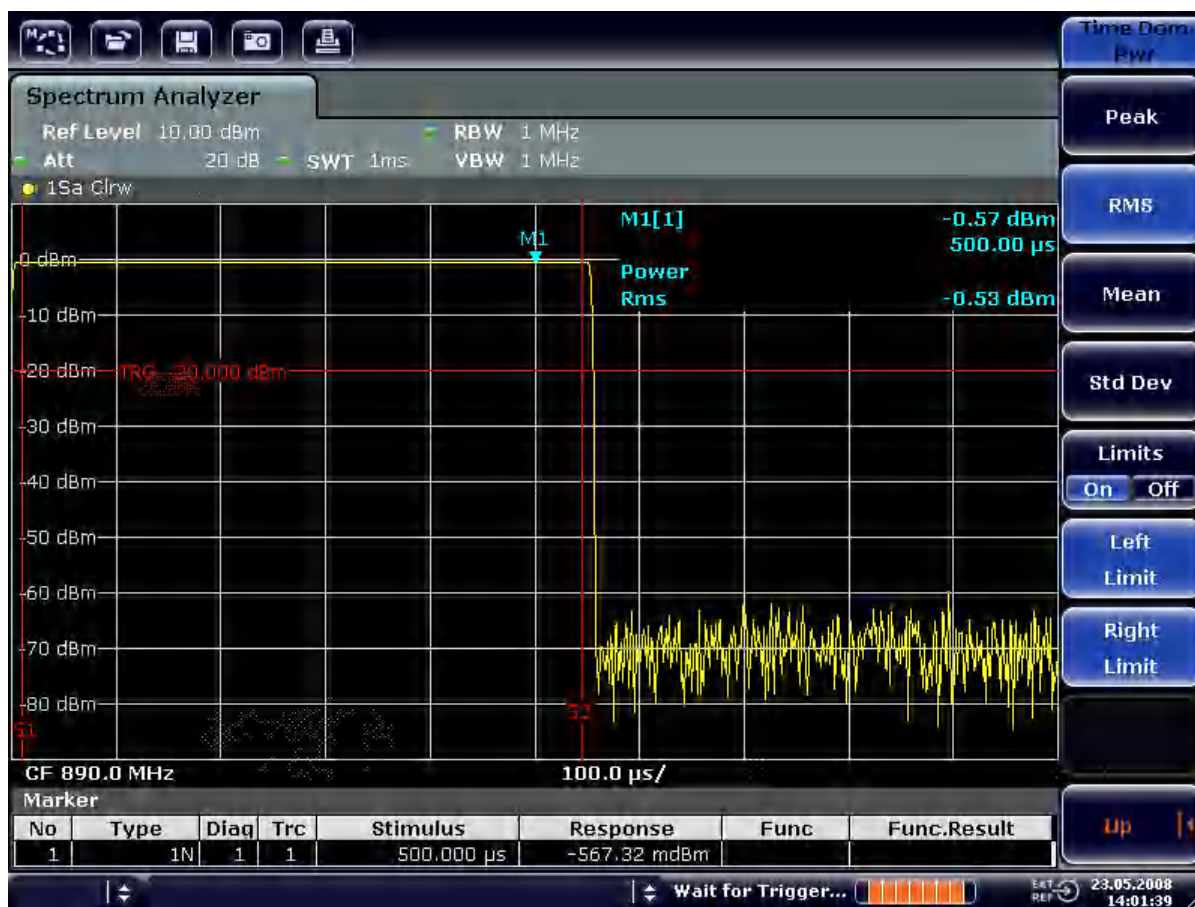

Figure 3-15: Measurement of the average power during the burst of a GSM signal

### Measuring the Edges of a GSM Burst with High Time Resolution

Because of the high time resolution of the R&S ESRP at the 0 Hz display range, the edges of TDMA bursts can be measured precisely. The edges can be shifted to the screen area by using the trigger offset.

#### Test setup

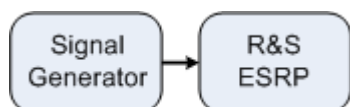

Table 3-9: Signal generator settings (e.g. R&S SMU)

Frequency	890 MHz
Level	0 dBm
Modulation	GSM, one timeslot activated

The measurement is based on the setting in the example above for measuring the power of the GSM during the activation phase.

1. Switch off the power measurement.

- a) Press the [MEAS] key.
  - b) Press the "All Functions Off" softkey.
2. Increase the time resolution to 100  $\mu$ s.
    - a) Press the [SWEEP] key.
    - b) Press the "Sweeptime Manual" softkey and enter 100  $\mu$ s.
  3. Using the trigger softkey, shift the rising edge of the GSM burst to the center of the screen.
    - a) Press the [TRIG] key.
    - b) Press the "Trigger Offset" softkey.
    - c) By turning the rotary knob counterclockwise, move the trigger offset until the burst edge can be seen in the center of the screen, or enter -50  $\mu$ s.  
The R&S ESRP displays the rising edge of the GSM burst.

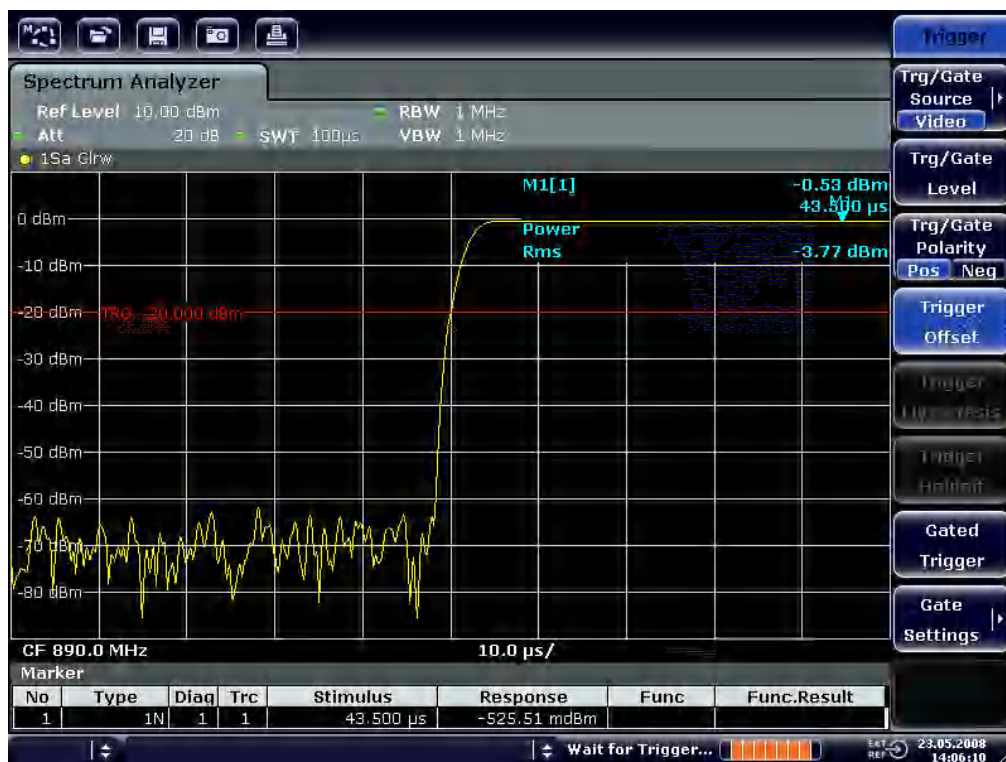

Figure 3-16: Rising edge of the GSM burst displayed with high time resolution

4. Using the trigger offset, move the falling edge of the burst to the center of the screen. To do so, switch the "Trg/Gate Polarity" softkey to "Neg".  
The R&S ESRP displays the falling edge of the GSM burst.

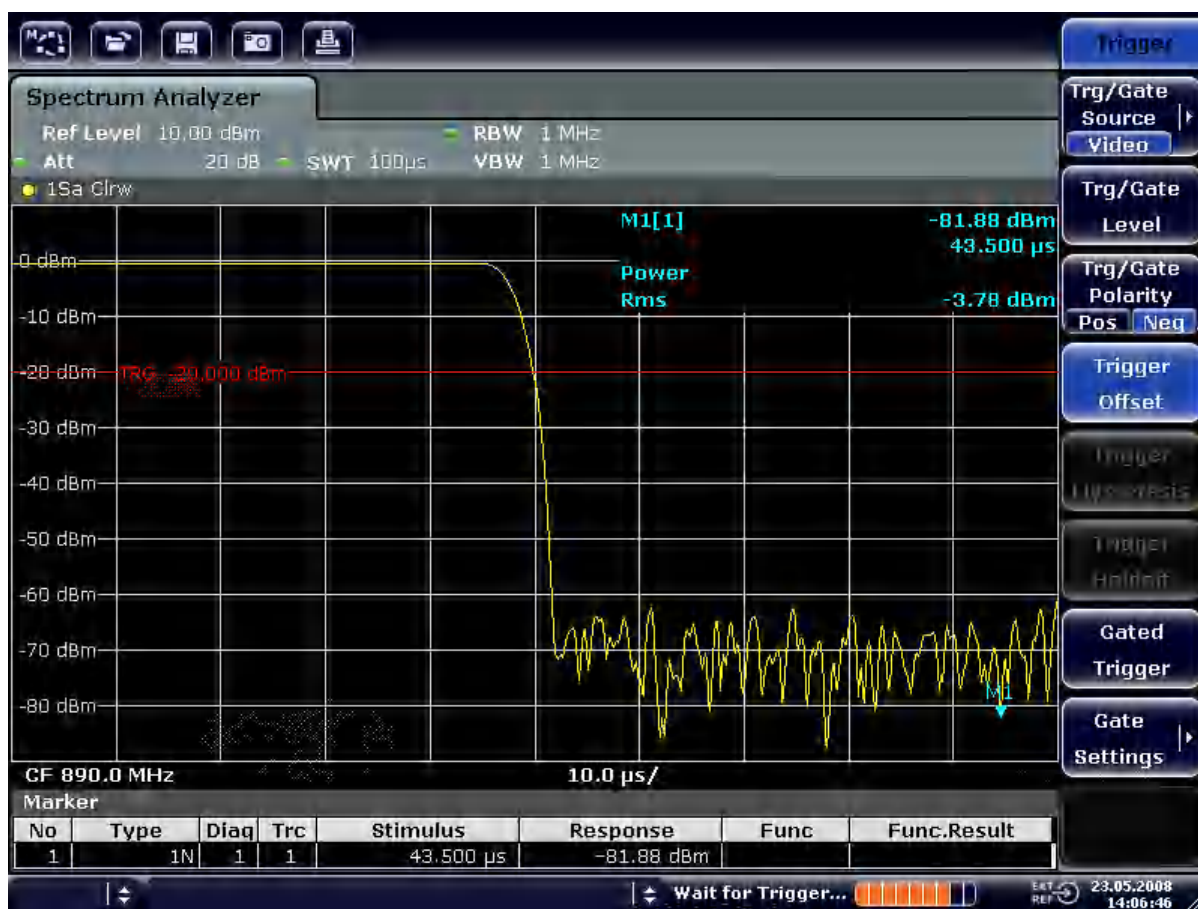

Figure 3-17: Falling edge of the GSM burst displayed with high time resolution

### 3.5.4.2 Measuring the Signal-to-Noise Ratio of Burst Signals

When TDMA transmission methods are used, the signal-to-noise ratio or the deactivation dynamic range can be measured by comparing the power values during the activation phase and the deactivation phase of the transmission burst. For this purpose, the R&S ESRP provides the function for measuring absolute and relative power in zero span. In the following example, the measurement is performed using a GSM burst.

#### Signal-to-Noise Ratio of a GSM Signal

##### Test setup

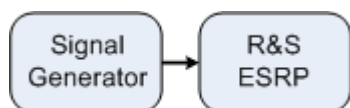

Table 3-10: Signal generator settings (e.g. R&S SMU)

Frequency	890 MHz
Level	0 dBm
Modulation	GSM, one time slot is switched on

1. Set the signal analyzer to the default state by pressing the [PRESET] key.  
The R&S ESRP is set to its default state.
2. Select "Spectrum" mode.
3. Set the center frequency to 890 MHz, the span to 0 Hz and the resolution bandwidth to 1 MHz.
  - a) Press the [FREQ] key and enter *890 MHz*.
  - b) Press the [SPAN] key and enter 0 Hz or press the "Zero Span" softkey.
  - c) Press the [BW] key.
  - d) Press the "Res BW Manual" softkey and enter *1 MHz*.
4. Set the reference level of the R&S ESRP to 0 dBm (= level of the signal generator) by pressing the [AMPT] key and entering *0 dBm*.
5. Set the sweep time to 2 ms.
  - a) Press the [SWEEP] key.
  - b) Press the "Sweeptime Manual" softkey and enter *2 ms*.  
The R&S ESRP shows the GSM burst continuously across the display.
6. Use the trigger source "Video" and the trigger polarity "Pos" to trigger on the rising edge of the burst and shift the start of burst to the center of the screen.
  - a) Press the [TRIG] key.
  - b) Press the "Trg/Gate Source" softkey and select "Video" using the arrow keys.
  - c) Press the "Trg/Gate Level" softkey and enter *70%*.  
The R&S ESRP shows a static image with the GSM burst at the start of the trace.
  - d) Press the "Trigger Offset" softkey and enter *-1 ms*.  
The R&S ESRP shows the GSM burst in the right half of the measurement diagram.
7. Configure the power measurement in zero span.
  - a) Press the [MEAS] key.
  - b) Press the "Time Domain Power" softkey to open the submenu.
  - c) Switch the "Limits" softkey to "On."
  - d) Press the "Left Limit" softkey.
  - e) Using the rotary knob, move the vertical line to the start of the burst.
  - f) Press the "Right Limit" softkey.

- g) Using the rotary knob, move the second vertical line to the end of the burst.  
The R&S ESRP displays the power during the activation phase of the burst.

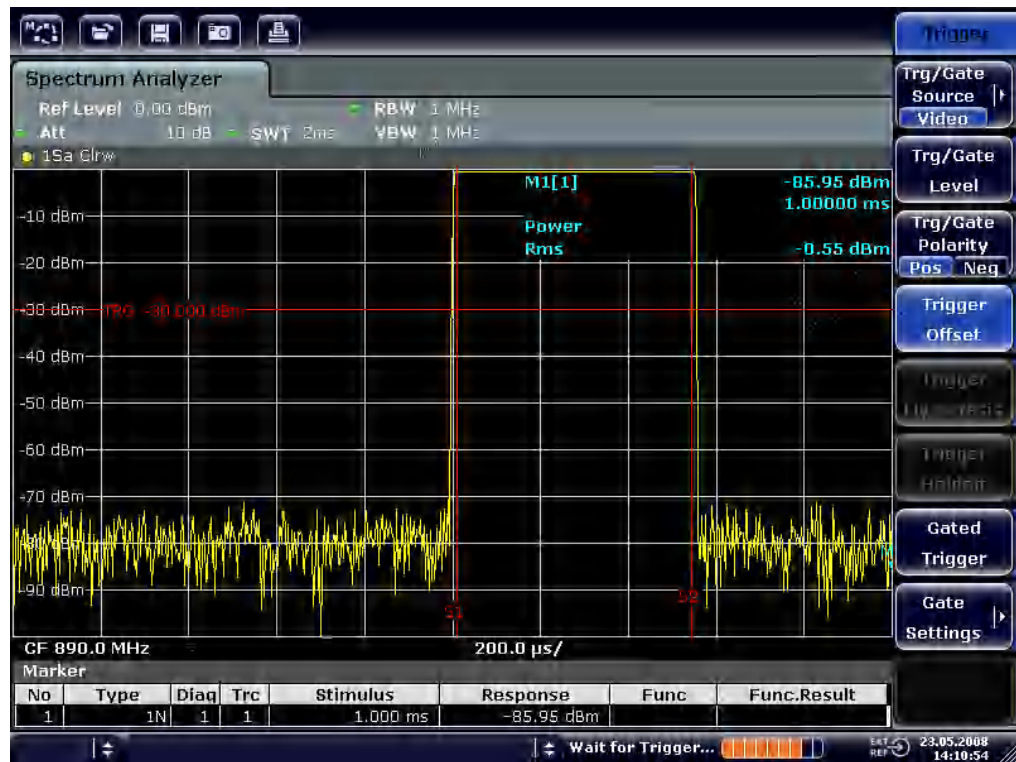

Figure 3-18: Power measurement during the activation phase of the burst

8. Measure the power during the deactivation phase of the burst.  
a) Press the [TRIG] key.



- b) Switch the "Trg/Gate Polarity" softkey to "Neg."

The R&S ESRP initiates triggering in response to the falling edge of the burst. This shifts the burst to the left-hand half of the measurement diagram. The power is measured in the deactivation phase. The start of the burst is shifted to the center of the screen and the power during the deactivation phase is measured.

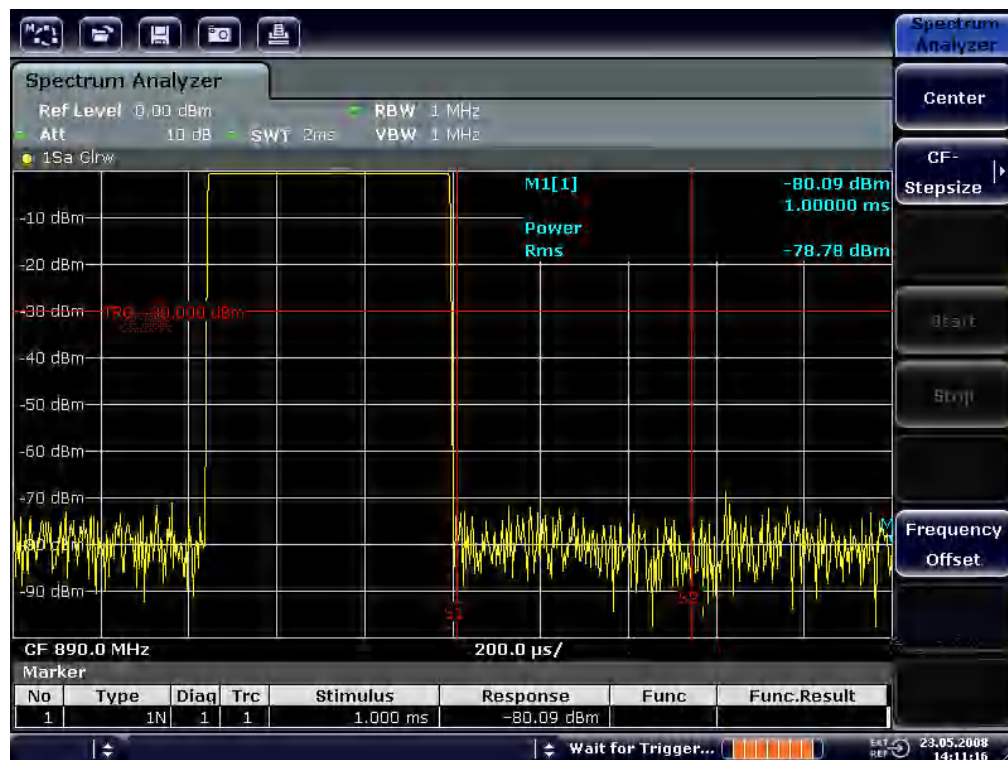

Figure 3-19: Measurement of the signal-to-noise ratio of a GSM burst signal in zero span.

### 3.5.4.3 Measuring FM-Modulated Signals

Since signal analyzers can display only the magnitude of the measurement signal by using the envelope detector, the modulation of FM-modulated signals cannot be measured directly as in the case of AM-modulated signals. The voltage at the output of the envelope detector remains constant for FM-modulated signals as long as the frequency deviation of the signal is located within the flat part of the passband characteristic of the employed resolution filter. Amplitude variation occurs only if the instantaneous frequency extends into a falling edge of the filter curve. This behavior can be used to demodulate FM-modulated signals. The center frequency of the analyzer is set in such a manner that the nominal frequency of the measurement signal is located on a filter edge (below or above the center frequency). The resolution bandwidth and the frequency offset must be selected in such a manner that the instantaneous frequency is located in the linear part of the filter edge. As a result, the frequency variation of the FM-modulated signal is transformed into an amplitude variation that can be displayed on screen in zero span.

## Displaying the AF of an FM-Modulated Carrier

### Test setup

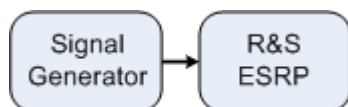

**Table 3-11: Signal generator settings (e.g. R&S SMU)**

<b>Frequency</b>	128 MHz
<b>Level</b>	-20 dBm
<b>Modulation</b>	FM 0 kHz deviation (i.e. FM modulation is deactivated), 1 kHz AF

1. Set the signal analyzer to the default state by pressing the [PRESET] key. The R&S ESRP is set to its default state.
2. Select "Spectrum" mode.
3. Set the center frequency to 127.50 MHz and the span to 300 kHz.
  - a) Press the [FREQ] key and enter *127.50 MHz*.
  - b) Press the [SPAN] key and enter *300 kHz*.
4. Set the resolution bandwidth to 300 kHz.
  - a) Press the [BW] key.
  - b) Press the "Res BW Manual" softkey and enter *300 kHz*.
  - c) Press the "Video BW Manual" softkey and enter *30 kHz*.
5. Set the display range to 20 dB and shift the filter trace to the center of the screen.
  - a) Press the [AMPT] key.
  - b) Press the "Range" softkey
  - c) Press the "Range Log Manual" softkey and enter *20 dB*.
  - d) Press the "Up ↑" softkey.
  - e) Press the "More" softkey.
  - f) Switch the "Grid" softkey to "Rel".
  - g) Press the "Up ↑" softkey.
  - h) Press the "Ref Level" softkey.

- i) Using the rotary knob, set the reference level such that the filter edge at the center frequency intersects the -10 dB level line.  
The filter edge of the 300 kHz filter is displayed. This corresponds to the demodulator characteristic for FM signals with a steepness of approx. 18 dB/140 kHz. This can be verified using the marker and delta marker.

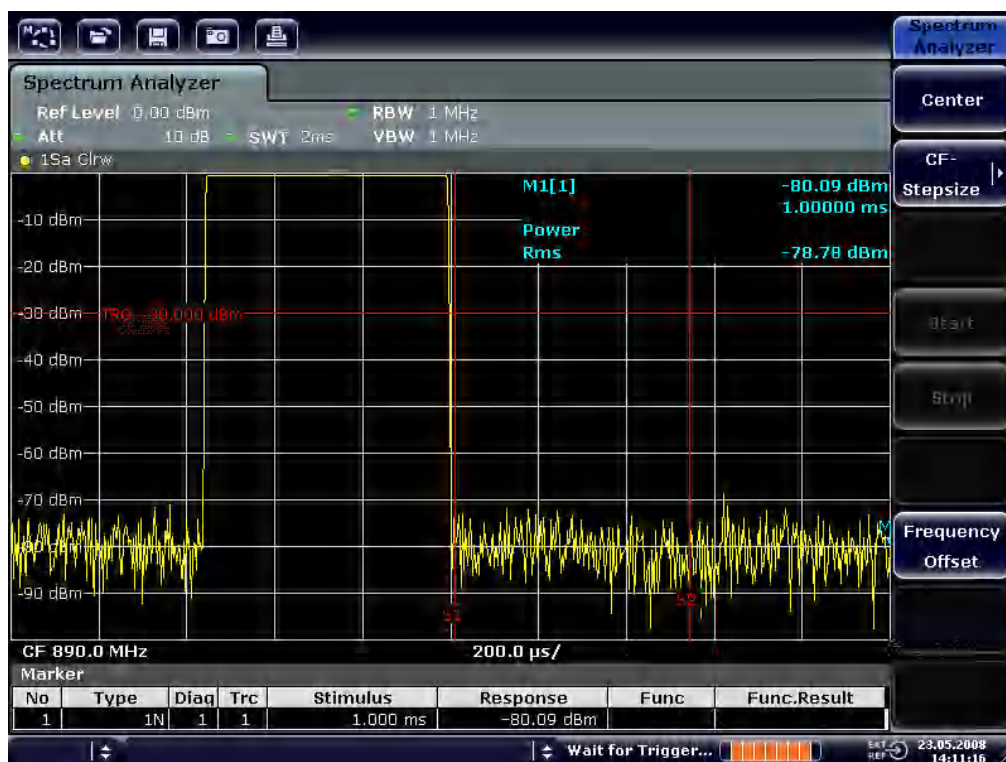

Figure 3-20: Display of the filter edge of the 300 kHz filter as an FM discriminator characteristic

6. Set the FM deviation to 50 kHz on the signal generator.
7. Set the span to 0 Hz on the R&S ESRP.
  - a) Press the [SPAN] key.
  - b) Press the "Zero Span" softkey.  
The demodulated FM signal is displayed. The signal crosses the screen continuously.
8. Establish a stable display using video triggering.
  - a) Press the [TRIG] key.
  - b) Press the "Trg/Gate Source" softkey and select "Video" using the arrow keys.

- c) Press the "Trg/Gate Level" softkey and enter 50%.  
 A static image for the FM AF signal is produced.  
 Result: (-10 ( 5) dB; this yields a deviation of 100 kHz when the steepness of the demodulator characteristic is 5 dB/100 kHz.

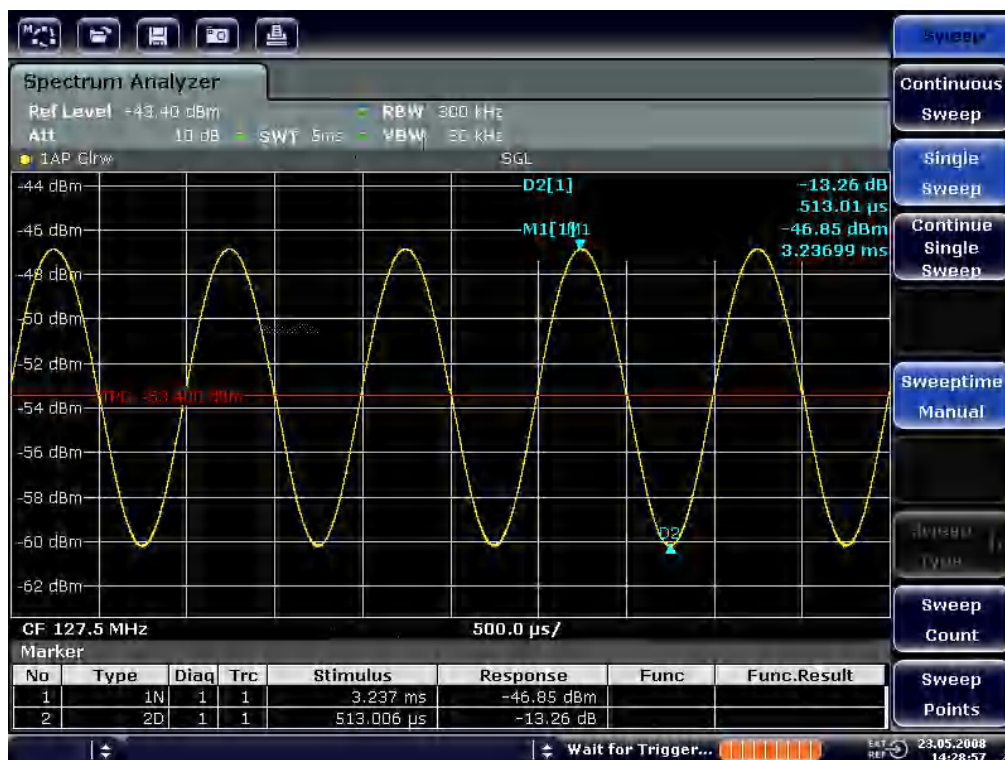

Figure 3-21: Demodulated FM signal

9. Determine the deviation.
- Press the [MKR] key.  
Marker 1 is activated and placed on the peak of the curve.
  - Press the "Marker 2" softkey.
  - Press the [MKR] key.
  - Press the "More" softkey.
  - Press the "Min" softkey.  
Marker 2 (delta marker) is placed on the minimum of the curve. The level difference is 13.3 dB, which corresponds to the peak-to-peak deviation. With the filter slope of 18 dB/140 kHz, the deviation can be calculated as follows:

$$\text{deviation} = \frac{1}{2} \times \frac{13.3 \times 140}{18} \text{ kHz} = \frac{1}{2} 103 \text{ kHz} = 51.7 \text{ kHz}$$

### 3.5.5 Storing and Loading Instrument Settings

The R&S ESRP can store complete instrument settings together with instrument configurations and measurement data in a settings file. The data is stored on the built-in

hard disk or - if selected - on a USB device (e.g. memory stick) or on a network drive. The hard disk has the drive letter C : .

In the default state, the current settings are stored. This includes the settings of the measurement functions, the activated limit lines and the active transducer factor.

### 3.5.5.1 Storing an Instrument Configuration (without Traces)

1. Press the [SAVE/RCL] key.
2. Press the "Save" softkey.  
The dialog box for instrument configurations is displayed. The File Name field is in edit mode and contains a suggestion for a new name.

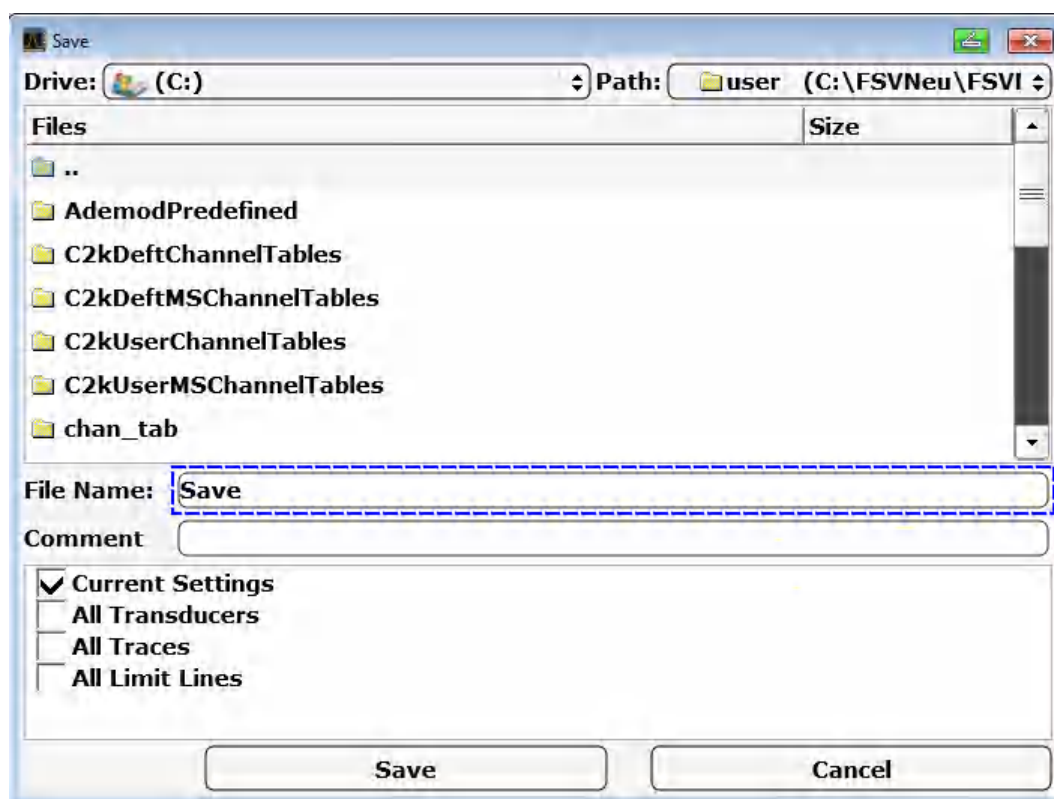

3. To change the suggested name, enter a name for the settings file to be stored. The name may contain letters and digits. For details on alphanumeric entries see [Chapter 3.4.3.2, "Entering Alphanumeric Parameters"](#), on page 76.
4. To store the file in a directory different to the default directory, select the required path in the Files area.  
If the path is not changed, the default path for the instrument configurations (C:\R\_S\Instr\user) is used.

**Note:** The selected directory is automatically used for any further save and recall operations.

5. Press the "Save File" softkey.  
The settings file is stored and the dialog box is closed.

### 3.5.5.2 Storing Traces

Before you can store traces, you must first select the corresponding item entry. To do so, proceed as follows:

1. Press the [SAVE/RCL] key.
2. Press the "Save" softkey.
3. To change the suggested name, enter a file name.
4. Select the "All Traces" option.
5. Press the "SAVE" button.

### 3.5.5.3 Loading an Instrument Configuration (with Traces)

1. Press the [SAVE/RCL] key.
2. Press the "Recall" softkey.
3. If necessary, select the path under which the file to be loaded is stored.
4. Define the settings file to be loaded. One of the following ways is possible:
  - Click in the File Name field and enter the file name via the keyboard or keypad.
  - Select the file from the selection list using the touchscreen or mouse.

Alternatively:

- a) Press the "Select File" softkey.  
The focus is set on the files list.
  - b) Using the rotary knob or arrow keys, focus the settings file to be loaded and confirm by pressing the rotary knob or the [ENTER] key.
5. To load traces, select the "All Traces" option.  
**Note:** The "All Traces" option is only available if the selected file contains traces.
  6. Press the "Recall" button in the dialog box, or the "Recall File" softkey.  
The settings file is loaded. During loading, the R&S ESRP detects which items the selected settings file contains and, if applicable, ignores any items that were selected but are not available.

### 3.5.5.4 Configuring Automatic Loading

If the R&S ESRP is switched on in the factory default state, it loads the instrument settings that it had when switched off (provided that it was switched off using the [ON /

OFF] key on the front panel; see [Chapter 3.2.1.7, "Switching the Instrument On and Off"](#), on page 41. If the instrument is preset, it loads the presets.

You can alter these settings and define a settings file to be loaded. This requires performing the following procedure. Be aware that the chosen settings file is loaded both while booting and presetting.

1. Press the [SAVE/RCL] key.
2. Press the "Startup Recall" softkey.
3. Press the "Startup Recall (On/Off)" softkey to activate the recall function.
4. Press the "Select Dataset" softkey.  
The "Startup Recall" dialog box is displayed.
5. If necessary, select the path under which the file to be loaded is stored.
6. Select the settings file to be loaded (DFL file).
7. Press the "Select" button in the dialog box.

## 4 Measurement Modes

The R&S ESRP provides several measurement modes for different analysis tasks. When you activate a measurement mode, a new measurement channel is created. The channel determines the settings for that measurement mode. Each channel is displayed in a separate tab on the screen.

SCPI command:

`INSTRument[:SElect]` on page 605

### To change the measurement mode

1. Press the MODE key.  
A menu with the currently available measurement modes is displayed.
2. To activate a different mode, press the corresponding softkey.

### 4.1 Receiver Mode

In Receiver mode, the R&S ESRP measures the signal level at a particular frequency. It also provides tools (e.g. detectors or bandwidths) necessary to measure the signal according to EMC standards. The Receiver mode is the default mode of the R&S ESRP.

The R&S ESRP also provides function for IF analysis if you have equipped your R&S ESRP with firmware application R&S ESRP-K56. IF analysis is not a separate measurement mode but is integrated into the Receiver mode.

For more information on functionality available for the Receiver mode see [Chapter 5, "Receiver Mode"](#), on page 119.

SCPI command:

`INST REC`

### 4.2 Spectrum Mode

In Spectrum mode the provided functions correspond to those of a conventional spectrum analyzer. The analyzer measures the frequency spectrum of the RF input signal over the selected frequency range with the selected resolution and sweep time, or, for a fixed frequency, displays the waveform of the video signal.

The Spectrum mode also provides spectrogram measurements. The spectrogram is not a separate measurement mode, but rather a trace evaluation mode. Note also that the Spectrogram available in Spectrum mode is independent of that available in real time mode. It provides similar functionality but uses different data acquisition methods.



For more information on functionality available for the Spectrum mode see [Chapter 6, "Spectrum Measurements"](#), on page 197.

SCPI command:

```
INST SAN
```

### 4.3 I/Q Analyzer Mode

The I/Q Analyzer mode provides measurement and display functions for digital I/Q signals.

For more information on functionality available for the I/Q Analyzer see [Chapter 7, "I/Q Analyzer"](#), on page 429.

SCPI command:

```
TRACe<n>: IQ[:STATe] on page 866
```

### 4.4 Measurement Mode Root Menu (HOME Key)

The HOME key provides a quick access to the root menu of the current measurement mode.

## 5 Receiver Mode

In receiver mode, the R&S ESRP measures the level at the set frequency with a selected bandwidth and measurement time. Signal weighting is by means of detectors.

A frequency scan can be performed after setting the start and stop frequency and the step width. Scan subranges are defined in a table.

Functions for data reduction and the control of line impedance simulating network are available.

Preselection is always switched on in receiver mode.

### 5.1 Measurements and Result Displays

The R&S ESRP provides several types of measurements.

- The bargraph result display shows the signal level on a single frequency.
- Fast prescans together with several data reduction methods are used to reduce the amount of data in the final measurements. The final measurement is then performed only on frequencies that have a high interferer level.
- The final measurement may be either automatic or in interactive mode. Automatic control functions for line impedance stabilization networks (LISN) are available.
- Time domain scans (option R&S ESRP-K53) reduce the required overall measurement times enormously by using fast fourier transform (FFT) of frequency sections. Time domain scan may even eliminate the need for preliminary measurements.
- IF spectrum analysis mode for manual tuning.
- The spectrogram result display provides an additional data evaluation method by showing the signals over time.

• <a href="#">Bargraph Measurement</a> .....	119
• <a href="#">IF Spectrum Analysis</a> .....	120
• <a href="#">Scans</a> .....	121
• <a href="#">Peak List and Data Reduction</a> .....	124
• <a href="#">Final Measurement</a> .....	126
• <a href="#">Spectrogram</a> .....	127
• <a href="#">Measurement Control</a> .....	132

#### 5.1.1 Bargraph Measurement

The bargraph result display shows the signal level on a single frequency. It is a basic result display that indicates the signal level numerically and graphically.

The length of the bar represents the signal level at the current receiver frequency evaluated with the currently selected detector.

Up to four bargraphs with different detector weighting can be displayed simultaneously. The R&S ESRP assigns a different color to each detector. This provides an easy way to compare the signal level with different weighting factors.



- 1 = current level unit
- 2 = current receiver frequency
- 3 = detectors
- 4 = measured levels (numerically)
- 5 = measured levels (graphically)

The results in the bargraph are shown upon entering the receiver mode. Either single or continuous measurement can be selected. The level range is always 100 dB, the unit of the displayed signal level can be selected.

An enabled maxhold function shows the maximum level that has been measured for each active detector in addition to the live results. If a new maximum has been found, the result indication is updated accordingly. The display keeps the overall maximum level even after changing the frequency until a reset of the maxhold function.

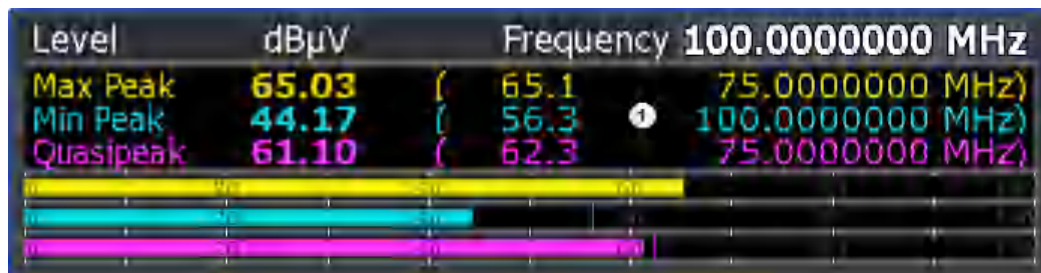

- 1 = maximum levels; note that the maximum and quasipeak peaks have been measured at frequency different to the current receiver frequency

### 5.1.2 IF Spectrum Analysis

The IF spectrum analysis is a very comfortable means for exact frequency tuning of the receiver and for identification of signals and of their bandwidth.

In IF spectrum analysis, the spectrum of the RF input signal is displayed in the vicinity of the receiver frequency. The center frequency of the displayed spectrum is always the current receive frequency.

The IF analysis provides a fast overview of the assignment of the spectrum adjacent to the measuring channel proper, or, with a large resolution bandwidth, the spectral distribution of a modulated signal in the channel. Interference of the received useful signal can also be detected quickly, whether it is CW interference appearing as unmodulated

carrier or pulse-like interference which is represented in the form of narrow horizontal lines on the screen.

The accuracy of the frequency axis corresponds to the reference used (internal or external). The frequency display range (span) can be selected between 1 kHz and 10 MHz in steps of 1, 2 and 5. With the bandwidths 10 Hz to 100 kHz in steps of 1, 3, 10 the frequency resolution can be matched to the span.

In contrast to normal spectrum analyzer operation, the measured values are determined using FFT from samples recorded from the A/D-converter. Thus the receiver stays tuned to the center frequency. It may continue to measure with the selected measurement time and display the signal level with the bargraph. For example, the quasi-peak level measured with one second measurement time may be displayed in the upper half of the display while in the lower half the spectrum may be refreshed every few milliseconds.

The measurement time of the bargraph may be longer than the measurement time of the IF analysis. If the measurement time of the bargraph is set to a smaller value than the measurement time of the IF analysis, the bargraph will as often be refreshed as the display of the IF analysis.

The level display of the IF analysis is unweighted. It is independent of the selected detector for the bargraph measurement, e.g. average or quasi peak. A maximum of three traces can be displayed in parallel. The display mode "Clear / Write", "Max Hold", "Min Hold", "Average", "View" or "Blank" may be selected independent for each trace.



The displayed level values do have the full accuracy of the instrument only at the center frequency. At all other frequencies, the level is typically lower due to the frequency response of the IF filter and the preselector.

The IF display does switch on the 6 dB EMI resolution bandwidth filters for the bargraph measurement. 3 dB or channel filters are not possible in the IF analysis mode. The maximum span for the IF analysis is limited to ten times the selected resolution bandwidth for the bar graph measurement. This is due to the dynamic range of the bar graph measurement.

### 5.1.3 Scans

In scan mode, the R&S ESRP measures in a predefined frequency range with selectable step width and measurement time for each frequency.

A scan is either based on the current receiver settings or on the settings defined in the "Scan Table" (see [Chapter 5.1.3.3, "The Scan Table"](#), on page 123).

Transducer factors or transducer sets and limit lines can be defined and displayed separately and are not part of the scan data record.

The scanned frequency range is defined by the start and stop frequency set independently of the scan table. A scan table can thus be defined for each measurement task.

The scan can be performed as a single scan or continuously. In the case of single scan it is stopped when the stop frequency is reached. The continuous scan can be interrupted or terminated any time.

The maximal number of measured frequencies is limited to 4.000.000 per detector. The data can be stored for postprocessing. If the scan subranges are defined so that more than the possible values would be measured, a respective message is output upon the scan start. Afterwards the scan is performed up to the maximum value.

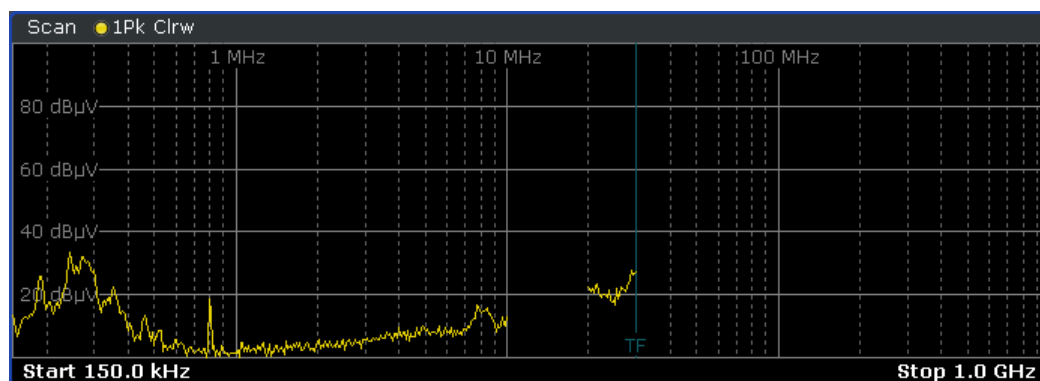

Figure 5-1: Scan on selected frequencies showing gaps in the trace

The R&S ESRP offers three types of scans:

- **Stepped scan in the frequency domain**  
In stepped scan mode, step width and frequency spacing (step mode) can be selected.
- **Time domain scan in the frequency domain**  
In time domain measurement systems, up to 30 MHz of the spectrum at the receiver input are measured in parallel by using fast fourier transform (FFT) of frequency sections. Time Domain scans require option R&S ESRP-K53.
- [Stepped Scans in the Frequency Domain](#).....122
- [Time Domain Scans in the Frequency Domain](#).....123
- [The Scan Table](#).....123

### 5.1.3.1 Stepped Scans in the Frequency Domain

In stepped scan mode, the step width and the frequency spacing (step mode) can be selected. Linear, logarithmic or automatic frequency spacing is available. In automatic mode, the step width is selected so that it is always smaller than the bandwidth.

EMI measurements may involve much time. Time saving procedures are explained in [Chapter 5.1.4, "Peak List and Data Reduction"](#), on page 124. They reduced the total measurement time by reducing the number of quasipeak measurements to a minimum.

Nevertheless, this time is still very long, often in the order of hours, especially for the CISPR radiated emissions tests. A way out of this situation can be time-domain measurements, see [Chapter 5.1.3.2, "Time Domain Scans in the Frequency Domain"](#), on page 123.

### 5.1.3.2 Time Domain Scans in the Frequency Domain

Time Domain scan are available with firmware application R&S ESRP-K53. Measurement results fully comply with CISPR 16-1-1 standards.

Time domain scan reduce the overall measurement time enormously. For applications like voltage tests, no preliminary measurement for data reduction is required, because the final measurement with the quasipeak detector is already fast enough. For more time consuming tests like field strength test with mast and turn table, prescans are still recommended. However, due to the increased measurement speed both in prescan and final scan, the overall measurement still is considerably reduced.

Whereas in conventional EMI measurement systems, only the spectrum within the measurement bandwidth can be measured during a certain measurement time of e.g. 100 ms, in this measurement systems, large parts of the spectrum at the receiver input can be measured in parallel using fast fourier transform (FFT) of frequency sections.

For measurements with prescan, the prescan is used to get a detailed overview of the emission spectrum. The prescan result is then analyzed and the critical frequencies can be determined. On the critical frequencies, if further maximization with antenna mast and turntable movement is needed, the R&S ESRP can be used in its conventional measurement function with quasipeak and/or average detection.

### 5.1.3.3 The Scan Table

Either the current receiver settings or the settings defined in the Scan table are used for stepped or time domain scans.

In the scan table, up to 10 subranges can be defined within one scan. They need not be next to each other. The subranges are then scanned by R&S ESRP one after the other. Measurement ranges should not overlap. The parameters to be measured in each subrange can be selected independently. For more information on the available range parameters see [Chapter 5.3.7.2, "Scan Table"](#), on page 165.

#### Example:

The graph below shows a scan performed in four subranges. The scan start at the start frequency of subrange 1. Between subrange 2 and 3 is a frequency gap, where no measurement is performed. In subrange 4, the part of the frequency range that is outside the overall scan range is also not considered for the scan results.

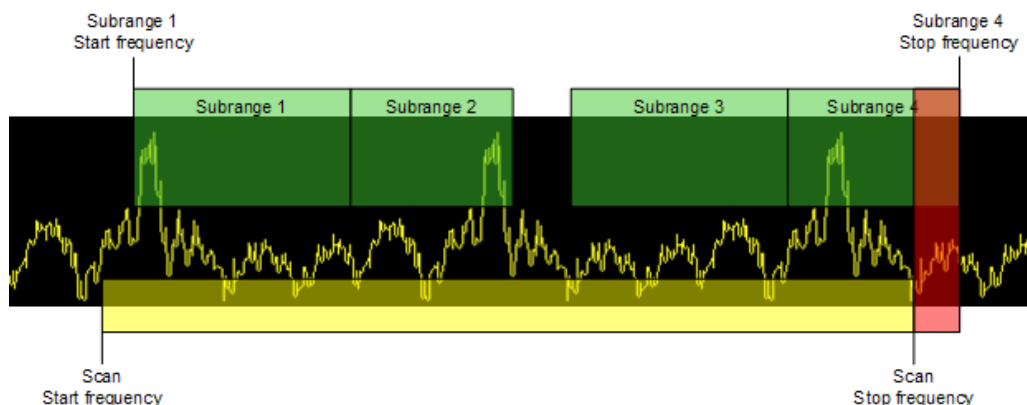

	Range 1	Range 2	Range 3
Scan Start	100.0 kHz		
Scan Stop	101.0 kHz		
Step Mode	AUTO		
Time Domain Scan	OFF	ON	
Adjust Axis			
Delete Range			
Insert Range Before			
Insert Range After			
Range Start	9.0 kHz	150.0 kHz	30.0 MHz
Range Stop	150.0 kHz	30.0 MHz	1.0 GHz
Step Size	50.0 Hz	2.25 kHz	30.0 kHz
Res BW	200.0 Hz	9.0 kHz	120.0 kHz
Meas Time	1 s	1 s	1 s
Auto Ranging	OFF	OFF	OFF
RF Attenuation	50 dB	10 dB	10 dB
Preamp	OFF	OFF	OFF
Prev Range			
Next Range			

Range Start = Start frequency of the scan range. To avoid overlapping scan ranges, the stop frequency of the previous scan range is adjusted if necessary.

Range Stop = Stop frequency of the scan range. To avoid overlapping scan ranges, the start range of the next scan range is adjusted if necessary.

Stepsize = Frequency stepsize within the scan range. If you define a stepsize that is larger than the range itself, the R&S ESRP only measures the start and stop frequencies of the scan range. The step size is available if the [Step Mode](#) is either linear or logarithmic. If the step mode is linear, the step size is a value in Hz. If the step mode is logarithmic, the step size is a percentage.

Res BW = Measurement bandwidth used within the scan range, see [Chapter 5.2.1, "Measurement Bandwidth"](#), on page 142. The R&S ESRP displays an exclamation mark if the selected measurement bandwidth is not compatible to the bandwidth required by CISPR for the corresponding frequency range.

Meas Time = Measurement time applied to the scan range, also see ["Final Measurement Time"](#) on page 171

Auto Ranging = Turns automatic selection of the input attenuation on and off, see [Auto Range \(On Off\)](#)

RF Attenuation = Attenuation level at the RF input.

Preamp = Turns the preamplifier on and off. If you select "Auto", the preamplifier is also considered in the auto ranging process.

RF Input = Selects the RF input.

## 5.1.4 Peak List and Data Reduction

### Peak List

The Peak Search function of the R&S ESRP can be used to create a peak list containing only the measurement values of high interferers. In a fast prescan the signal is measured against a limit line, and the level values above the set margin are written into the peak list. The resulting peak list then is used for the final measurement where only the frequencies in the peak list are measured with the required detector.

If the scan uses the detector stipulated by the specifications, the peak list already provides the final measurement data.

### Data Reduction using the Peak List

EMI measurements may involve much time because the time constants of up to 160 ms prescribed by the standard for the quasipeak weighting lead to long measurement times per each value. In addition, some standards stipulate procedures for finding local EMI maxima such as shifting the absorbing clamp, variation of the test antenna height and rotating the DUT. Measuring with quasipeak weighting at each frequency and for each setting of the test configuration would lead to unacceptably long measurement times. For this reason, a method is used which reduces the time-consuming measurements to a minimum with an optimum reliability of detection.

The interference spectrum is first pre-analyzed in a fast prescan to optimize the duration of the measurement. Data reduction follows so that the time-consuming final measurement is performed only at critical frequencies.

Several data reduction methods are used:

- Generating subrange maxima (search method "Subranges").  
The whole frequency range is divided into equidistant frequency subranges. A selectable number of subrange maxima are determined for each subrange. In the final measurement, the interference spectrum is further analyzed at frequencies with the highest interference level of a frequency subrange.

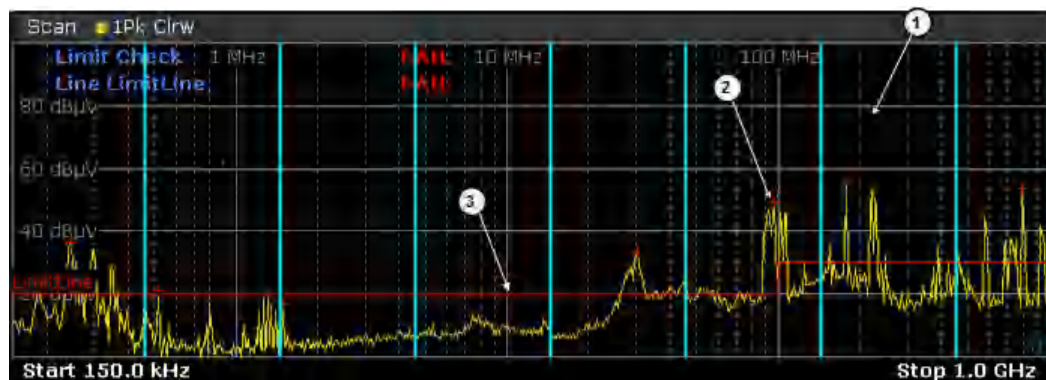

- 1 = Subrange
- 2 = Subrange maximum
- 3 = Limit line

- Determination of a specific number of peak values relative to the limit lines with the level values being independent of their frequency spectral distribution (search method "Peaks").  
Determining the level maxima irrespective of their distribution in the frequency spectrum is suitable for measurement regulations that demand determination of the relatively highest level irrespective of the distribution in the measured frequency range, e.g. FCC.

If the prescan is performed in parallel with several detectors, typically Peak and Average, the maxima are determined separately for the two detectors so that the distribution of narrowband and wideband sources of interference can be taken into account. For example, the frequency of the maximum determined with the average detector can



be used for the final measurement performed with the CISPR Avg detector and the frequency found in the prescan carried out with the peak detector is taken for the final measurement using the quasipeak detector.

Consideration of the limit lines ensures that the final measurement is not performed at frequencies at which the inference level is far below the limit value. A margin below the limit line can be defined (in dB). Peak values measured in the margin area are also considered in the final measurement. The margin is valid for all limit lines. Each limit line is allocated to a trace, i.e. different limit lines are taken for the different detectors.

If no limit lines are activated, the measurement procedure is as if all measured values would exceed the limit line.

#### **Data Reduction by Editing the Peak List**

As an alternative method, it is possible to preset a list of frequencies at which the final measurements are performed. A typical application is, for example, the statistical analysis of several units.

The peak list can be either edited manually or can be filled with desired values by adopting the marker values.

### **5.1.5 Final Measurement**

A final measurement is performed after data reduction, thus reducing the overall measurement time.

The final measurement analyzes only the data that still remains after the preliminary measurement stages, in other words those frequencies that have been collected in the peak list. Detectors defined for the final measurement replace those that have been used during preliminary measurements.

Because the peak list contains a manageable set of frequencies only, the final measurement is also usable in combination with a configuration that requires long measurement times. It is then still possible to perform the measurement in a reasonable time frame.

During the final measurement, the R&S ESRP performs a measurement on each frequency in the peak list. When done, it updates the preliminary results in the peak list with those found during the final measurement.

#### **Automatic vs interactive final measurements**

The R&S ESRP provides two methods to perform a final measurement: an automatic and interactive final measurement.

An automatic final measurement measures all frequencies in the peak list automatically. The measurement can be interrupted or aborted, or the measurement mode can be switched to interactive. Measurement settings can not be changed. The advantage is that the measurement runs on its own.

Control of the final measurement is possible in interactive final measurement mode.

In interactive final measurement mode, the R&S ESRP stops on each frequency of the peak list. If required, the frequency can be fine tuned, e.g. if the interferer has shifted. For fine tuning, the bargraph display can be used to find the new peak value. The level measurement is performed only after initialization by the user.

It is possible to start with an automatic measurement and later change into interactive mode. Likewise, it is possible to start measuring in interactive mode and later change into automatic mode.

## 5.1.6 Spectrogram

In receiver mode, the R&S ESRP provides a spectrogram result display for scans and for IF analysis. For both result displays, the spectrogram allows you to view and evaluate the signal characteristics over time.

### 5.1.6.1 How a Spectrogram Works

A spectrogram shows the spectral density of a signal in the frequency domain and over time simultaneously. It provides an overview of the spectrum over time and so allows for an easy detection of anomalies and interfering signals.

The horizontal axis represents the frequency span. The vertical axis represents time. Time in the spectrogram runs chronologically from top to bottom. Therefore, the top of the diagram is the most recently recorded data. A spectrogram also shows the power levels that have been measured. To display the level information, the R&S ESRP maps different colors to each power level that has been measured.

Creating a spectrogram consists of several stages.

- Data acquisition based on the scan or the IF analysis
- Result coloring
- Data processing

The stages occur simultaneously.

#### Data acquisition

The spectrogram uses the traces of the scan or the IF analysis as its data basis. The data capture process is therefore the same as that of these two measurements.

Note that if you use the Scan or IF Analysis result displays, the R&S ESRP saves spectrogram data even if the spectrogram result display is off.

After the data has been captured, the R&S ESRP transforms the data of the traces into the spectrogram result display.

#### Result coloring

To get the final looks of the spectrogram, the R&S ESRP applies colors to visualize the power levels in a two dimensional diagram.

Each color in the spectrogram corresponds to a particular power level that is shown in the color map in the title bar of the result display. The color the R&S ESRP assigns to each power level depends on:

- the color scheme you have selected
- the (customized) color mapping settings

In the default configuration, the R&S ESRP displays low power levels in 'cold' colors (blue, green etc.) and higher power levels in 'warm' colors (red, yellow etc.).

For more information, see [Chapter 5.1.6.2, "Color Map"](#), on page 128.

### Data processing

Now that the data is available, the R&S ESRP processes the data to display it in the spectrogram result display.

To understand the structure and contents of the spectrogram, it is best to look at it in combination with the scan or IF analysis result display. The data that is shown in the spectrogram is always based on the data of the scan or IF analysis trace.

The spectrogram is made up out of a number of horizontal lines, each one a pixel high, that are called (time) frames.

- When you use a spectrogram in combination with a scan, each frame corresponds to a single sweep of the frequency range you are scanning.
- When you use a spectrogram in combination with IF analysis, a single sweep may consist of several frames. The exact number of frames depends on the measurement time of the bargraph.

In the default state, a frame is added to the spectrogram after a sweep is done. As the spectrogram in the R&S ESRP runs from top to bottom, the outdated frame(s) move down one position, so that the most recently recorded frame is always on top of the diagram.

The number of frames the R&S ESRP can display simultaneously is only limited by the vertical screen size. The number of frames the R&S ESRP stores in its memory is bigger. The maximum number of frames you can record is 100.000. The actual number, however, depends on the measurement configuration. With markers, you can navigate to any frame that has been saved.

Note that the contents of the spectrograms for scan and IF analysis are independent from one another: the R&S ESRP saves the data you have already recorded and the current configuration when you switch to another result display. It keeps the data until you start a new measurement or the capture buffer is full.

#### 5.1.6.2 Color Map

Colors are an important part of the spectrogram. Therefore, the R&S ESRP provides various ways to customize the display for best viewing results.

You can access the Color Mapping dialog via the "Color Mapping" softkey or by tapping on the color map. For the spectrogram the R&S ESRP maps power levels (dBm).

### Selecting the color scheme

Before adjusting the details of the color map, you should select the color scheme you are most comfortable with. You can select from four different color schemes:

- 

The "Hot" color scheme shows the results in colors ranging from blue to red. Blue colors indicate low probabilities or levels respectively. Red colors indicate high ones.

- 

The "Cold" color scheme shows the results in colors ranging from red to blue. Red colors indicate low probabilities or levels respectively. Blue colors indicate high ones.

The "Cold" color scheme is the inverse "Hot" color scheme.

- 

The "Radar" color scheme shows the colors ranging from black over green to light turquoise with shades of green in between. Dark colors indicate low probabilities or levels respectively. Light colors indicate high ones.

- 

The "Grayscale" color scheme shows the results in shades of gray. Dark grays indicate low probabilities or levels respectively. Light grays indicate high ones.

If a result lies outside the defined range of the color map, it is colored in black at the lower end of the color range. On the upper end of the color range it is always the lightest color possible, regardless of differences in amplitude (e.g. black and blue in case of the "Cold" scheme).

### Defining the Range of the Color Map

The current configuration could be a color map that you can optimize for better visualization of the measured signal, for example if the results cover only a small part of the color map. In the resulting trace, it would be hard to distinguish between values that are close together.

There are several ways to optimize the distribution of the colors over the results and then get the best viewing results.

Note that the following examples are based on the "Hot" color scheme.

The easiest way to adjust the colors is to use the color range sliders in the "Color Mapping" dialog.

In the histogram that is in the background of the color curve pane (grey bars), you can observe the distribution of measurement results. If no significant shifts in result distribution occur after evaluating this for a time, you can adjust the color map to the overall shape of the measurement results. To do so and still cover the whole signal, move the sliders in a way that the first and last bar of the histogram are still inside the range. You can optimize the display further, if you suppress the noise by excluding the lower 10 to

20 dB of the distribution. Note that the color map has to cover at least 10% of the range of the horizontal axis.

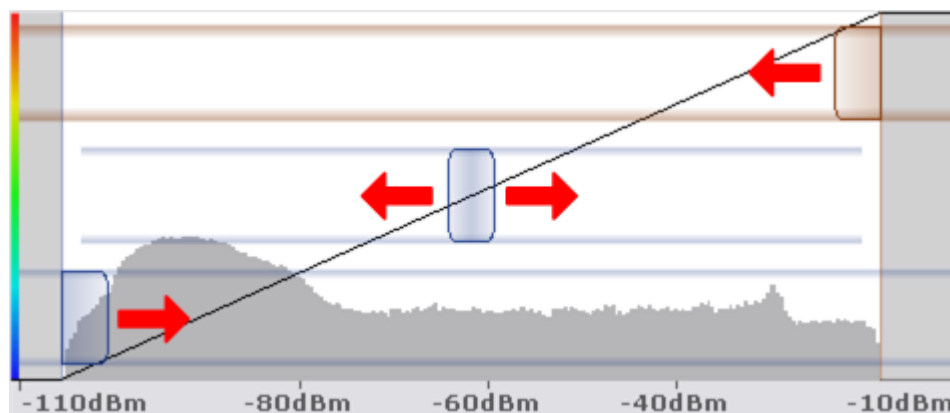

Alternatively, you can set the range in the numeric input field. In that field, you have to enter the distance from the right and left border as a percentage.

#### Example:

The color map starts at -100 dBm and ends at 0 dBm (i.e. a range of 100 dB). You, however, want the color map to start at -90 dBm. To do so, you have to enter 10% in the Start field. The R&S ESRP shifts the start point 10% to the right, to -90 dBm.

In the spectrogram, cutting the range as far as possible is also a good way if you want to observe and put the focus on signals with a certain amplitude only. Then, only those signal amplitudes that you really want see are displayed. The rest of the display remains dark (or light, depending on the color scheme). It is also a good way to eliminate noise from the display. In the spectrogram you can do this easily by excluding the corresponding power levels at the low end of the power level distribution.

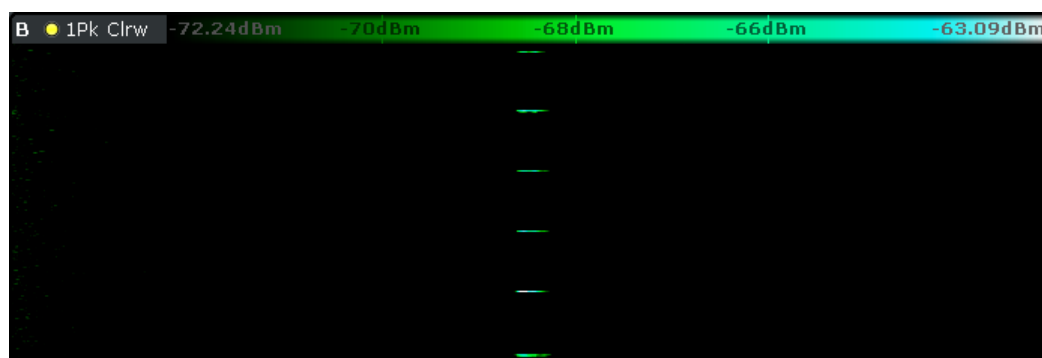

Figure 5-2: Spectrogram that shows the peaks of a pulsed signal only



#### Adjusting the reference level and level range

Changing the reference level and level range also affects the color scheme in the spectrogram.

Make sure, however, that you never adjust in a way that could overload the R&S ESRP.

### Defining the shape of the color curve

Now that the color scheme and range of the color map suit your needs, you can improve the color map even more by changing the shape of the color curve.

The color curve is a tool to shift the focus of the color distribution on the color map. By default, the color curve is linear. The color curve is linear, i.e. the colors on the color map are distributed evenly. If you shift the curve to the left or right, the distribution becomes non-linear. The slope of the color curve increases or decreases. One end of the color palette then covers a large amount results while the the other end distributes a lot of colors on relatively small result range.

You can use this feature to put the focus on a particular region in the diagram and to be able to detect small variations of the signal.

#### Example:



Figure 5-3: Linear color curve shape = 0

The color map above is based on a linear color curve. Colors are distributed evenly over the complete result range.



Figure 5-4: Non-linear color curve shape = -0.5

After shifting the color curve to the left (negative value), more colors cover the range from -105.5 dBm to -60 dBm (blue, green and yellow). In the color map based on the linear color curve, the same range is covered by blue and a few shades of green only. The range from -60 dBm to -20 dBm on the other hand is dominated by various shades of red, but no other colors. In the linear color map, the same range is covered by red, yellow and a few shades of green.

The result of shifting the color curve is that results in a particular result range (power levels in case of the spectrogram and densities in the case of the spectral histogram) become more differentiated.

You can adjust the color curve by moving the middle slider in the color curve pane to a place you want it to be. Moving the slider to the left shifts the focus in the direction of low values. Most of the colors in the color map are then concentrated on the low power levels (spectrogram) or densities (histogram), while only a few colors cover the upper end of the color map or high power levels or densities. Moving the slider to the right shifts the focus to the higher amplitudes or densities.

Alternatively, you can enter the shape of the color curve in the corresponding input field below the color curve pane. A value of 0 corresponds to a linear shape, negative values up to -1 shift the curve to the left, positive values up to 1 shift the curve to the right.

## 5.1.7 Measurement Control

Measurements in receiver mode allow you to control the course of the measurement. This way, you can make use of the automated test sequences but still be able to change the setup once the test sequence is already running.

- [Running Scans and Measurements](#)..... 132
- [Selecting the Result Display](#)..... 132
- [Bargraph Control](#)..... 133
- [Scan Control](#)..... 134
- [Final Measurement Control](#)..... 136
- [Measurement Settings](#)..... 138
- [Spectrogram Configuration](#)..... 140

### 5.1.7.1 Running Scans and Measurements

The [RUN SINGLE] and [RUN CONT] hardkeys initiate scans and measurements.

- RUN SINGLE starts a single scan or measurement. A single measurement lasts until the defined frequency range has been measured once under the configured conditions. When it has finished, the measurement stops.  
In case of measurements in the time domain, a single measurement lasts until the defined measurement time has passed.
- RUN CONT starts a continuous scan or measurement. A continuous measurement lasts until it is interrupted or stopped.

SCPI command:

`INITiate<n>:CONTinuous` on page 609

`INITiate<n>[:IMMediate]` on page 610

### 5.1.7.2 Selecting the Result Display

The R&S ESRP allows you to display the results in various combinations.

You can display up to three results simultaneously, for example the Bargraph, the Scan diagram and the Spectrogram.

The "Meas" menu contains the basic measurement settings and the selection of result displays.

- ▶ Press the [MEAS] key.  
The R&S ESRP opens the "Meas" menu.
- ▶ Press the "More Display Options" softkey.  
The submenu contains more result displays.

Note that the Spectrogram is available for the Scan display and the IF Analysis. To add the Spectrogram, either Scan or IF Analysis have to be turned on already. If you are using the Scan and IF Analysis simultaneously, the Spectrogram is unavailable.

The Spectrogram of the Scan is independent of the Spectrogram available for IF Analysis and vice versa. Therefore you should regard the two Spectrograms as separate result displays. For more information see [Chapter 5.1.6, "Spectrogram"](#), on page 127.

Remote command:

`CALCulate<n>:FEED` on page 606

### **Bargraph + Scan**

Shows the Bargraph and Scan result displays.

### **Bargraph + IF Analysis**

Shows the Bargraph and IF Analysis result displays.

### **Bargraph**

Turns the Bargraph result display on and off.

### **IF Analysis**

Turns the IF Analysis result display on and off.

### **Scan**

Turns the Scan result display on and off.

### **Spectrogram**

Turns the Spectrogram result display on and off.

## **5.1.7.3 Bargraph Control**

The "Measurement Configuration" menu contains functionality to configure the bargraph.

SCPI commands:

Querying the signal level:

["Querying bargraph results"](#) on page 613

Querying the upper and lower value of the bargraph scale:

`DISPlay:BARGraph:LEVel:LOWer?` on page 607

`DISPlay:BARGraph:LEVel:UPPer?` on page 607

<a href="#">Continuous Bargraph / Single Bargraph</a> .....	133
<a href="#">Bargraph Maxhold</a> .....	134
<a href="#">Maxhold Reset</a> .....	134

### **Continuous Bargraph / Single Bargraph**

Selects single or continuous bargraph measurements.

Continuous bargraph measurements continuously evaluate the signal level at the receiver frequency.



A single bargraph measurement evaluates the signal level at the receiver frequency once and then stops.

Remote command:

`INITiate<n>:CONTinuous` on page 609

### **Bargraph Maxhold**

Turns the maxhold bargraph on and off. The maxhold bargraph shows the highest level that has been measured.

Remote command:

`DISPlay:BARGraph:PHOLd[:STATe]` on page 607

### **Maxhold Reset**

Resets the maxhold bargraph.

After reset, collection of maximum values starts again.

Remote command:

`DISPlay:BARGraph:PHOLd:RESet` on page 607

## **5.1.7.4 Scan Control**

At the start of a scan, the R&S ESRP opens a softkey menu to control the measurement.

### **Interrupting a scan**

The R&S ESRP allows to interrupt a scan any time. If you interrupt it, the scan stops immediately. The scan stops at the frequency at which it was interrupted until it is continued. While the scan is stopped, the receiver settings can be changed, e.g. for a detailed analysis of the recorded trace. You have two options to continue the scan or you can abort it.

- Continue at a set receiver frequency - "Continue at Rec Frequency".  
The receiver frequency can be set to a frequency that was already measured. As soon as the "Continue at Rec Frequency" softkey is pressed, the scan restarts at this frequency. This function can be used repeat part of the measurement.
- Continue at the hold frequency - "Continue at Hold"  
Resumes the scan at the frequency it has been interrupted.
- Continue at a spectrogram frame - "Continue at Frame"  
Resumes the scan at a spectrogram frame that was already recorded.
- Stop the scan - "Abort Scan"  
Aborts the scan.

Hold Scan.....	135
Continue at Rec Frequency.....	135
Continue at Hold.....	135
Continue at Frame.....	135
Stop Scan.....	135

**Hold Scan**

Interrupts the scan and opens a submenu that contains functionality to control the scan.

Data that has already been collected is kept in the memory.

Remote command:

`HOLD` on page 609

**Continue at Rec Frequency**

Resumes the scan at a set receiver frequency.

After "Hold", the receiver frequency can be set to a frequency that was already measured, i.e. which is lower than the frequency at which the scan was interrupted. As soon as the "Continue at Rec Frequency" softkey is pressed, the scan restarts at this frequency. This function can be used repeat part of the measurement.

If a frequency is set that is higher than the frequency at which the scan was interrupted the scan continues at the frequency at which it was interrupted.

The scan is continued with the settings in the scan table.

Remote command:

`HOLD` on page 609

`[SENSe:]FREQuency:CENTer` on page 634

`INITiate<n>[:IMMediate]` on page 610

**Continue at Hold**

Resumes the scan at the frequency it was interrupted.

The scan is continued with the settings in the scan table.

Remote command:

`INITiate<n>:CONMeas` on page 609

**Continue at Frame**

Resumes the scan at a previously recorded spectrogram frame.

The data recorded between the selected frame and the current frame is recorded again, including minimum and maximum hold information.

Available for scans that are combined with a spectrogram measurement and the minimum or maximum hold trace mode.

Remote command:

not supported

**Stop Scan**

Aborts the scan.

Data that has already been collected is lost.

Remote command:

`ABORt` on page 609

### 5.1.7.5 Final Measurement Control

The final measurement is started in the "Test Automation" menu . The R&S ESRP provides two methods to perform a final measurement: an automatic and interactive final measurement.

At the start of a final measurement, the R&S ESRP opens a softkey menu to control the measurement.

The measurement configuration is as defined in the scan table.

#### Sequence for automatic final measurements

Generally, the automatic final measurements requires no interactions. however, the measurement can be interrupted, e.g. to change the mode or to analyze the signal in detail.

- ▶ Press the "Hold Final Measurement" softkey.

The R&S ESRP interrupts the measurement. While the measurement is interrupted, the receiver settings can be changed in order to examine the signal in detail.

The interruption also changes the contents of the "Measurement" menu. Several actions are available:

- Switch the mode of the final measurement ("Automatic" or "Interactive").
- Resume the final measurement ("Measure").  
The final measurement starts or continues at the next entry of the peak list.
- Abort the final measurement ("Stop Final Measurement").  
The collected data is lost.

After all frequencies in the peak list have been measured, the R&S ESRP opens the "Final Peak List" with the results for the final measurement.

#### Sequence for interactive final measurements

For an interactive final measurement, the R&S ESRP initiates the following sequence.

1. The R&S ESRP tunes to the first frequency in the peak list (or the next frequency).
2. The R&S ESRP stops the measurement and positions a marker on the frequency.
3. If required, the frequency can be fine tuned, e.g. if the interferer has shifted. For fine tuning, the bargraph display can be used to find the new peak value.

In addition, you have several options:

- Skip the current frequency ("Skip Frequency")  
Positions the marker on the next frequency in the peak list without performing a final measurement on the current frequency.
- Get maxhold result for the current frequency ("Get Maxhold")  
Writes the maximum level that has been measured on this frequency during the prescan to the final peak list without performing a final measurement.
- Stop the final measurement ("Stop Final Meas")

4. The level measurement on the current frequency is initiated after you press the "Measure" softkey.
5. After the final measurement on the current frequency is done, the R&S ESRP replaces the scan result in the peak list with the result of the final measurement. If the frequency has drifted compared to the one of the prescan, it also updates the frequency in the peak list.
6. The R&S ESRP moves to the next frequency in the peak list, positions the marker on that frequency etc.
7. After all frequencies in the peak list are finished, the R&S ESRP opens the "Final Peak List" with the results for the final measurement.



Note that it is possible to start with an automatic measurement and later change into interactive mode. Likewise, it is possible to start measuring in interactive mode and later change into automatic mode.

Hold Final Measurement.....	137
Automatic Final.....	137
Interactive Final.....	137
Skip Frequency.....	137
Get Maxhold.....	138
Measure.....	138
Stop Final Measurement.....	138

#### Hold Final Measurement

Interrupts the final measurement and opens a submenu that contains functionality to control the final measurement.

Data that has already been collected is kept in the memory.

Remote command:

`HOLD` on page 609

#### Automatic Final

Selects an automatic final measurement.

See also [Chapter 5.1.5, "Final Measurement"](#), on page 126.

Remote command:

`[SENSe:] FMEasurement:AUTO` on page 612

#### Interactive Final

Selects interactive final measurements.

See also [Chapter 5.1.5, "Final Measurement"](#), on page 126.

Remote command:

`[SENSe:] FMEasurement:AUTO` on page 612

#### Skip Frequency

Skips the peak list entry the final measurement is due to measure next and proceeds with the next peak.

Available for interactive final measurements.

Remote command:

-

#### Get Maxhold

Uses the highest level that was measured during the scan for the final results instead of the signal level measured during the final measurement.

Remote command:

-

#### Measure

Initiates a final measurement on the current peak.

Available for interactive final measurements.

Remote command:

-

#### Stop Final Measurement

Aborts the final measurement.

Data that has already been collected is lost.

Remote command:

[ABORT](#) on page 609

### 5.1.7.6 Measurement Settings

The "Meas" menu contains the basic measurement settings and the selection of result displays ([Chapter 5.1.7.2, "Selecting the Result Display"](#), on page 132).

- ▶ Press the [MEAS] key.

The R&S ESRP opens the "Measurement" menu.

Receiver Frequency.....	138
Bargraph Detector.....	139
L Couple to Scan Trace.....	139
Measurement Time.....	139
Demod.....	139
L Demod (On Off).....	139
L AM / FM.....	139
L Squelch.....	139
Add To Peak List.....	140
Test Automation.....	140

#### Receiver Frequency

Defines the receiver frequency.

The tuning frequency has to be set to at least twice the IF bandwidth.

When the tuning frequency is lower than twice the IF bandwidth, the IF bandwidth is automatically reduced so that this condition is met again.

Remote command:

[\[SENSe:\] FREQuency:CENTer](#) on page 634

### **Bargraph Detector**

Opens a submenu to select the detector for the bargraph result display.

Each detector you select adds another bargraph to the result display. Up to four bargraphs at the same time are possible.

For more information see [Chapter 5.2.2, "Detectors"](#), on page 143.

Remote command:

[\[SENSe:\] DETector:RECeiver\[:FUNction\]](#) on page 608

### **Couple to Scan Trace ← Bargraph Detector**

Couples or decouples the bargraph detector and scan detectors.

If on, the R&S ESRP does as follows.

- Turns on a scan detector for every active bargraph.  
If you add a new bargraph detector, the corresponding scan trace is automatically turned on.
- Matches the scan trace number to the number of the bargraph.
- Matches the color of the scan trace to a particular bargraph detector.

If you couple bargraph and scan trace, the R&S ESRP replaces the detectors of all other active scan traces with the new detector type.

Remote command:

[DISPlay:BARGraph:TCoupling\[:STATe\]](#) on page 607

### **Measurement Time**

Defines the measurement time for a scan and the bargraph.

Remote command:

[\[SENSe:\] SWEEp:TIME](#) on page 608

### **Demod**

Opens a submenu to configure AM or FM demodulation.

### **Demod (On Off) ← Demod**

Turns demodulation at the receiver frequency on and off.

Remote command:

[\[SENSe:\] DEMod](#) on page 616

### **AM / FM ← Demod**

Selects AM or FM demodulation.

Remote command:

[\[SENSe:\] DEMod](#) on page 616

### **Squelch ← Demod**

Defines the minimum level for the signal to be demodulated.

For more information see [Chapter 5.2.4, "AF Demodulation"](#), on page 148.

Remote command:

Turning on the squelch:

[SENSe:] DEMod: SQUelch[:STATe] on page 617

Defining a squelch level:

[SENSe:] DEMod: SQUelch:LEVel on page 617

#### Add To Peak List

Adds the current receiver frequency to the peak list.

Remote command:

-

#### Test Automation

Opens a dialog box to configure automated test sequences.

For more information see [Chapter 5.3.7, "Test Automation"](#), on page 163.

Remote command:

-

### 5.1.7.7 Spectrogram Configuration

The "MeasConfig" menu contains functionality to configure the spectrogram.

The R&S ESRP provides two spectrograms in receiver mode: one for scans and one for IF analysis. You can configure the spectrograms independently from one another. The R&S ESRP saves the settings accordingly.

- ▶ Press the [MEAS CONFIG] key.

The R&S ESRP opens the "MeasConfig" menu.

<a href="#">Clear Spectrogram</a> .....	140
<a href="#">History Depth</a> .....	140
<a href="#">Color Mapping</a> .....	140
<a href="#">Trace to Spectrogram</a> .....	141

#### Clear Spectrogram

Clears the contents of the spectrogram.

If you clear the spectrogram of either scan or IF analysis, the other one remains in the internal memory of the R&S ESRP.

#### History Depth

Defines the amount of frames that the R&S ESRP is able to store in its memory.

The R&S ESRP can store a maximum of 100.000 frames. However, the actual size of the history buffer depends on the measurement configuration.

Using markers, you can recall the traces to any of the frames in the history buffer. The R&S ESRP shows the trace to the frame the marker is currently on.

#### Color Mapping

Opens a dialog box to define the color map of the spectrogram.

For more information see [Chapter 5.1.6.2, "Color Map"](#), on page 128.

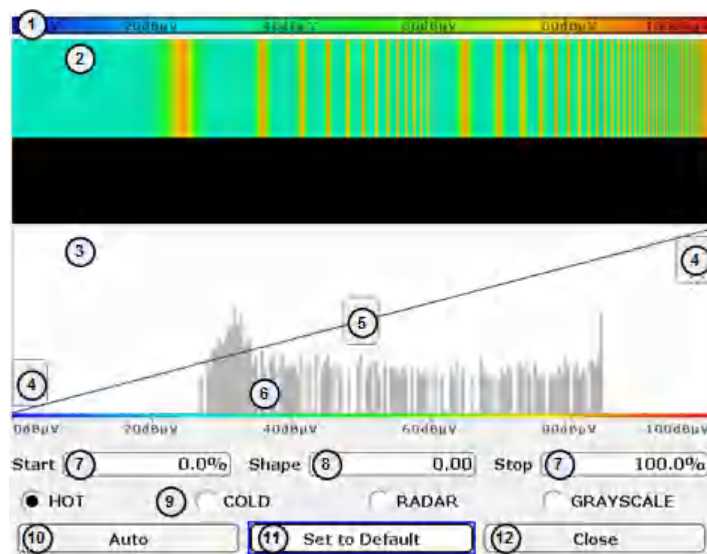

- 1 = Color map: shows the current color distribution
- 2 = Preview pane: shows a preview of the spectrogram with any changes that you make to the color scheme
- 3 = Color curve pane: graphic representation of all settings available to customize the color scheme
- 4 = Color range start and stop sliders: define the range of the color map (amplitudes for the spectrogram)
- 5 = Color curve slider: adjusts the focus of the color curve
- 6 = Histogram: shows the distribution of measured values
- 7 = Color range start and stop: numerical input to define the range of the color map
- 8 = Color curve: numerical input to define the shape of the color curve
- 9 = Color scheme selection
- 10 = Auto button: automatically sets the value range of the color map
- 11 = Default button: resets the color settings
- 12 = Close button: closes the dialog box

Remote command:

See ["Configuring Spectrograms"](#) on page 618

### Trace to Spectrogram

Selects the trace the spectrogram is coupled to.

The availability depends on how many traces you are have turned on in the scan or IF analysis. You cannot assign a spectrogram to a "Blank" trace.

Remote command:

[CALCulate:SGRam:TRACe](#) on page 620

## 5.2 Measurement Basics

Measurement basics explain various terms and principles used in the context of EMI measurements. They also assist you in finding the right configuration for your measurement tasks.



• Measurement Bandwidth.....	142
• Detectors.....	143
• Trace Modes.....	147
• AF Demodulation.....	148
• V-Networks Control (LISN).....	149
• Transducers.....	150
• Preamplifier.....	151
• Exported Peak List.....	152
• Formats for Returned Values: ASCII Format and Binary Format.....	153

## 5.2.1 Measurement Bandwidth

The measurement bandwidth ("RES BW") defines the bandwidth of the resolution filter. The RF signal is evaluated and displayed according to the bandpass characteristics of the resolution filter.

The receiver mode supports the following types of resolution filter.

- Filters with a 3 dB bandwidth (*normal filters*).
- Filters with a 6 dB bandwidth (*EMI filters*).  
The 6 dB bandwidths are designed and required for EMI tests and measurements.

Note that the available bandwidth is limited by the current receiver frequency. The measurement bandwidth must be less than or equal to half of the current receiver frequency:

$$BW \leq f_{in} / 2$$



### Additional 6 dB bandwidths

Installing option R&S ESRP-B29 adds additional 6 dB bandwidths that are specified for and comply to MIL, DO and automotive standards.

The resolution filters are implemented as digital Gaussian bandpass filters. Concerning the attenuation characteristic, the filters behave like analog filters, but their measurement speed is much higher than the measurement speed of comparable analog filters. This is due to the fact that the transient response can be compensated because the filters have an accurately defined behavior.

The highest sensitivity is obtained at the smallest bandwidth (10 Hz). If the bandwidth is increased, the reduction in sensitivity is proportional to the change in bandwidth. Increasing the bandwidth by a factor of 3 increases the displayed noise by approx. 5 dB (4.77 dB precisely). If the bandwidth is increased by a factor of 10, the displayed noise increases by a factor of 10, i.e. 10 dB.

The higher spectral resolution with smaller bandwidths leads to longer measurement times at each frequency, because the measurement time has to allow the resolution filters to settle during a sweep at all signal levels and frequencies to be displayed.

For large measurement bandwidths, signal parts that are very far away (e.g. from a different signal) are considered in the measurement and distort the results. The displayed noise increases.

For small measurement bandwidths, the measurement time increases.



#### **Bandwidths and detectors**

If you use the Quasipeak, CISPR Average or RMS Average detector, the R&S ESRP by default couples the resolution bandwidth to the receiver frequency.

If you need a different bandwidth, you can decouple the bandwidth from the frequency. When decoupled, you can select any of the supported CISPR bandwidths.

### **5.2.2 Detectors**

The task of the detector is to determine which of the samples that have been recorded are displayed for each sweep point. The result obtained from the selected detector for a sweep point is displayed as the signal level at this frequency point in the trace.

The detectors of the R&S ESRP are implemented as digital devices. All detectors work in parallel in the background, which means that the measurement speed is independent of the detector combination used for different traces.

The receiver mode of the R&S ESRP provides several detectors, including detectors that are especially designed for and required by EMI applications.

You can use several detectors at the same time. The combined use of several detectors (multiple detection) is important for EMI measurements. This is due to specifications in the standards, for example commercial standards specify limits for quasipeak and average values. In that case, multiple detection requires only one measurement.



The R&S ESRP allows you to use different detectors for the bargraph, scan and final measurement.

#### **Maximum and Minimum peak detector**

The max/min detector yields the maximum/minimum level occurred during the set measurement time. The peak detector is reset at the beginning of each measurement.

Regarding measurement time,

- unmodulated signals can be measured with the shortest possible measurement time.
- for pulses, the selected measurement time must be long enough for at least one pulse to occur during the measurement time.

The peak detectors are digital detectors. Therefore, discharging is irrelevant even with long measurement times.

#### **Average detector**

The average detector yields the average level of the samples of the samples measured during the set measurement time.

With average detection selected, the video voltage (envelope of IF signal) is averaged during the measurement time. Averaging is digital, i.e. the digitized values of the video

voltage are summed up and divided by the number of samples at the end of the measurement time. This corresponds to a filtering with a rectangular window in the time domain and a filtering with  $\sin x/x$  characteristic in the frequency domain.

With modulated signals the measurement time is determined by the lowest modulation frequency to be averaged. With pulse signals, the selected measurement time should be long enough for sufficient number of pulses ( $>10$ ) to occur in the measurement window for averaging.

Regarding measurement time,

- with unmodulated signals the shortest possible measurement time can be selected.
- with modulated signals the measurement time is determined by the lowest modulation frequency to be averaged.
- with pulse signals, the selected measurement time should be long enough for sufficient number of pulses ( $>10$ ) to occur in the measurement window for averaging.



### Average and RMS detector in Time Domain Scan

Note that it is not possible to use the Average detector and the RMS detector at the same time when performing a Time Domain Scan.

### RMS detector

The RMS detector evaluates the root mean square (RMS) value over the specified measurement time and displays the resulting value. The integration time is the specified measurement time.

Regarding measurement time,

- with unmodulated signals the shortest possible measurement time can be selected.
- with modulated signals the measurement time is determined by the lowest modulation frequency to be averaged.
- with pulse signals, the selected measurement time should be long enough for sufficient number of pulses ( $>10$ ) to occur in the measurement window for averaging.



### RMS detector and VBW

If the RMS detector is selected, the video bandwidth in the hardware is bypassed. Thus, duplicate trace averaging with small VBWs and RMS detector no longer occurs. However, the VBW is still considered when calculating the measurement time. This leads to a longer sweep time for small VBW values. Thus, you can reduce the VBW value to achieve more stable trace curves even when using an RMS detector. Normally, if the RMS detector is used the measurement time should be increased to get more stable traces.

### Sample detector

The sample detector displays the instantaneous value of the level at a pixel. It routes through the sampled data without any further evaluation.

The sample detector is used for IF analysis and for noise or phase noise marker calculation in analyzer mode. However, it is unreliable if the displayed span is much wider than the resolution bandwidth or if the tuning steps of the local oscillator are too large.

### Quasipeak detector

The quasipeak detector yields the maximum detected value weighted to CISPR 16-1-1 that was detected during the measurement time.

Depending on the set frequency, the R&S ESRP automatically selects the detectors and IF bandwidths defined for bands A, B and C/D listed in the following table:

	Band A	Band B	Band C/D
Frequency range	< 150 kHz	150 kHz to 30 MHz	> 30 MHz
Resolution bandwidth	200 Hz	9 kHz	120 kHz
Charge time constant	45 ms	1 ms	1 ms
Discharge time constant	500 ms	160 ms	550 ms
Time constant of the mechanical device	160 ms	160 ms	100 ms

The coupling of the resolution bandwidth to the frequency range with activated quasipeak detector can be cancelled using the "CISPR RBW uncoupled" softkey.

Regarding measurement time, the relatively long time constants used with quasipeak detectors entail long measurement times to obtain correct results.

- With unknown signals the measurement time should be at least 1 s. This ensures correct weighting of pulses down to a pulse frequency of 5 Hz.
- With known signals much shorter measurement times can be used. After internal switching, the R&S ESRP waits until the measurement result has stabilized before it starts the actual measurement. Since the level does not change during a frequency scan, known signals (e.g. broadband RFI) can be correctly measured with a much shorter measurement time.

### CISPR Average detector

The CISPR Average detector yields a weighted average signal level according to CISPR 16-1-1. The average value according to CISPR 16-1-1 is the maximum value of the linear average during the set measurement time.

The detector is used, for example, to measure pulsed sinusoidal signals with a low pulse frequency. It is calibrated with the rms value of an unmodulated sinusoidal signal. Averaging is with lowpass filters of the 2nd order (simulation of a mechanical instrument).

The lowpass time constants and the IF bandwidths are fixed depending on the frequency. The main parameters are listed in the following table:

	Band A	Band B	Band C/D	Band E
Frequency range	< 150 kHz	150 kHz to 30 MHz	30 MHz to 1 GHz	> 1 GHz
Resolution bandwidth	200 Hz	9 kHz	120 kHz	1 MHz
Time constant of the mechanical device	160 ms	160 ms	100 ms	100 ms

The coupling of the resolution bandwidth to the frequency range with activated CISPR average detector can be cancelled using the "CISPR RBW uncoupled" softkey.

Regarding measurement time, the relatively long time constants used with CISPR average and RMS average detector result in long measurement times in order to obtain a correct measurement result.

- With unknown signals the measurement time should be at least 1 s. This ensures correct weighting of pulses down to a pulse frequency of 5 Hz.
- With unmodulated sinusoidal signals as well as signals with high modulation frequency much shorter measurement times can be used.
- Slowly fluctuating signals or pulse signals require longer measurement times.



#### Measurement times shorter than 20 ms

With measurement times shorter than 20 ms the detector weighting changes to plain average weighting.

When you change the receiver frequency or the attenuation, the R&S ESRP waits until the the lowpass filter has settled before starting the measurement. The measurement time in that case depends on the resolution bandwidth and the characteristics of the signal.

#### RMS Average detector

The RMS Average detector is a combination of the RMS detector (for pulse repetition frequencies above a corner frequency) and the Average detector (for pulse repetition frequencies below the corner frequency). It thus achieves a pulse response curve with the following characteristics: 10 dB/decade above the corner frequency and 20 dB/decade below the corner frequency. The average value is determined by lowpass filters of the 2nd order (simulation of a mechanical instrument).

The detector is used, for example, to measure broadband emissions and may replace the quasipeak detector in the future.

The filter bandwidth and time constants of the detector are coupled to the receiver frequency.

**Table 5-1: RMS Average detector**

	Band A	Band B	Band C/D	Band E
Frequency range	< 150 kHz	150 kHz to 30 MHz	30 MHz to 1 GHz	> 1 GHz
Resolution band-width	200 Hz	9 kHz	120 kHz	1 MHz
Time constant of the mechanical device	160 ms	160 ms	100 ms	100 ms
Corner frequency	10 Hz	100 Hz	100 Hz	1 kHz

Regarding measurement time, see CISPR Average detector.



#### Measurement times shorter than 20 ms

With measurement times shorter than 20 ms the detector weighting changes to plain RMS weighting.

### 5.2.3 Trace Modes

The traces can be activated individually for a measurement or frozen after a measurement has been performed. Traces that are not active are not visible. Each time the trace mode is changed, the selected trace memory is cleared.

Note that in Spectrum mode, the Max Hold and Min Hold modes are unavailable for statistics measurements.

#### Clear Write

Overwrite mode: the trace is overwritten by each sweep. This is the default setting.

All available detectors can be selected.

Remote command:

`DISP:TRAC:MODE WRIT`, see `DISPlay[:WINDow<n>]:TRACe<t>:MODE`  
on page 652

#### Max Hold

The maximum value is determined over several sweeps and displayed. The R&S ESRP saves the sweep result in the trace memory only if the new value is greater than the previous one.

This mode is especially useful with modulated or pulsed signals. The signal spectrum is filled up upon each sweep until all signal components are detected in a kind of envelope.

Remote command:

`DISP:TRAC:MODE MAXH`, see `DISPlay[:WINDow<n>]:TRACe<t>:MODE`  
on page 652

**Min Hold**

The minimum value is determined from several measurements and displayed. The R&S ESRP saves the smallest of the previously stored/currently measured values in the trace memory.

This mode is useful e.g. for making an unmodulated carrier in a composite signal visible. Noise, interference signals or modulated signals are suppressed whereas a CW signal is recognized by its constant level.

Remote command:

DISP:TRAC:MODE MINH, see [DISPlay\[:WINDow<n>\]:TRACe<t>:MODE](#) on page 652

**View**

The current contents of the trace memory are frozen and displayed.

**Note:** If a trace is frozen, the instrument settings, apart from level range and reference level (see below), can be changed without impact on the displayed trace. The fact that the displayed trace no longer matches the current instrument setting is indicated by the  icon on the tab label.

If the level range or reference level is changed, the R&S ESRP automatically adapts the measured data to the changed display range. This allows an amplitude zoom to be made after the measurement in order to show details of the trace.

Remote command:

DISP:TRAC:MODE VIEW, see [DISPlay\[:WINDow<n>\]:TRACe<t>:MODE](#) on page 652

**Blank**

Hides the selected trace.

Remote command:

DISP:TRAC OFF, see [DISPlay\[:WINDow<n>\]:TRACe<t>\[:STATe\]](#) on page 817

**5.2.4 AF Demodulation**** CAUTION****Risk of hearing damage when using headphones**

To protect your hearing, make sure that the volume setting is not too high before putting on the headphones.

The volume for the headphones is controlled using the rotary knob next to the "AF Output" interface on the front panel of the instrument or with the [SYSTEM:SPEaker:VOLume](#) command.

The R&S ESRP provides demodulators for AM and FM signals. With these demodulators, a displayed signal can be identified and monitor acoustically through the use of the internal loudspeaker or with headphones.

The R&S ESRP demodulates the signal on the receiver frequency in a bandwidth corresponding to the resolution bandwidth to the audio output.

A squelch function that is linked to the video trigger defines the level that the signal must at least have to be demodulated. If you turn the squelch on, the R&S ESRP automatically turns on the video trigger. The squelch level and trigger level are the same.

### 5.2.5 V-Networks Control (LISN)

For measurements with power lines, the R&S ESRP provides functionality to directly control a line impedance stabilization network (LISN). The configuration is then taken into account in the scan and final measurement.

You can connect the LISN with an adapter (R&S EZ-27, order no. 1142.8271.02) to the userport that controls the phases during the scan and the final measurement. The R&S ESRP supports several V-networks.

- Four-line V-networks
  - R&S ESH2-Z5
  - R&S ENV4200
  - R&S ENV432
- Two-line V-networks
  - R&S ESH3-Z5
  - R&S ENV216

For the R&S ENV216 network, a 150 kHz high pass filter is available for protection of the input.

After selecting the type of network, you can define the phase you want to test for interferences. Phase N and L1 are available for two-line networks. Four-line networks in addition have access to phase L2 and L3.

- During scans, you can control several phases simultaneously.
- During final measurements the R&S ESRP supports the control of several phases. When you select more than one phase, the R&S ESRP measures all phase combinations and determines the maximum value.

For an automatic phase selection with the networks, a connection between the R&S ESRP and network has to be established with a control line. To connect the control line to the R&S ESRP, adapter R&S EZ-27 is required. The following illustrations show the right PIN assignment.

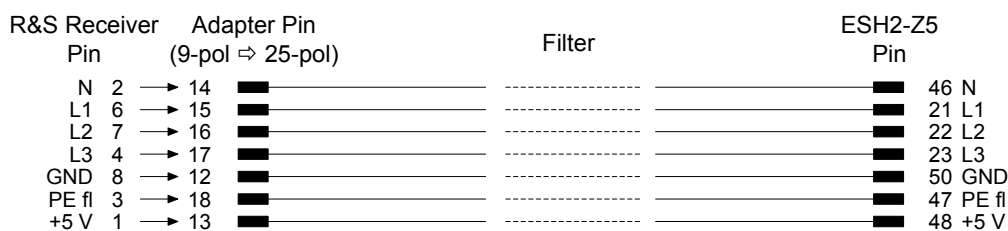

Figure 5-5: Connection from R&S ESRP to R&S ESH2-Z5



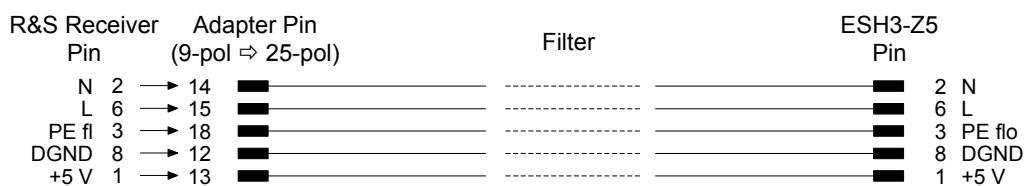

Figure 5-6: Connection from R&S ESRP to R&S ESH3-Z5

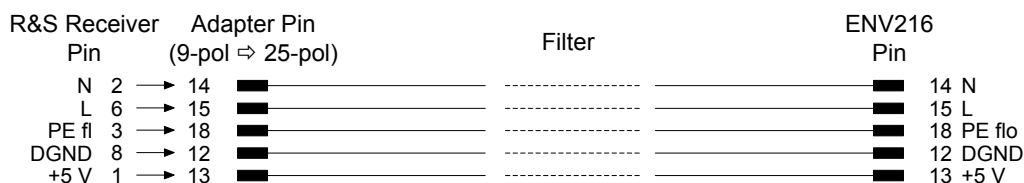

Figure 5-7: Connection from R&S ESRP to R&S ESH216

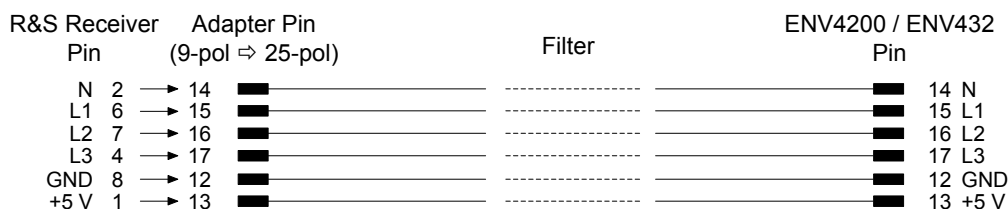

Figure 5-8: Connection from R&S ESRP to R&S ENV4200 or R&S ENV432

To control the phase selection and PE simulating network of the V-Networks R&S ESH2-Z5, R&S ESH3-Z5, R&S ENV4200 and R&S ENV432, the +5 V supply voltage and some control lines have to be routed through the wall of the shielded room.

You can also use a direct connection without a filter, e.g. when you use the R&S ESRP in a shielded room. In that case, you can use the following cables.

- R&S ESH2-Z5: EZ-5, EZ-13, EZ14
- R&S ESH3-Z5: EZ-6, EZ-14
- R&S ENV216: EZ14
- R&S ENV4200 and R&S ENV432: EZ-14, EZ-21

## 5.2.6 Transducers

A transducer is often connected ahead of the R&S ESRP both during the measurement of useful signals and EMI and converts the useful or interference variable such as field strength, current or RFI voltage into a voltage across 50 Ω. Because most transducers such as antennas, probes or current probes have a characteristic frequency response, it is necessary to correct the measurement results by the frequency characteristics of the transducer. These characteristics are defined in a transducer factor or transducer sets. The transducer factor can be stored in the R&S ESRP and automatically has the correct unit during level measurement.

If a transducer is switched on it is considered as part of the unit during the measurement, i.e. the measured values are displayed in the correct unit and magnitude. When working with two measurement windows, the transducer is always assigned to two windows.

The R&S ESRP distinguishes between transducer factor and transducer set.

A transducer factor takes the frequency response of a single transfer element, e.g. an antenna into consideration. A transducer set can summarize different transducer factors in several subranges (several transducer factors at the same time), e.g. an antenna, a cable and a diplexer.

### Transducer factors

A transducer factor takes the frequency response of a single transfer element into account. It consists of a series of reference values defined with frequency, transducer factor and the unit. For the measurement between frequency values linear or logarithmic interpolation of the transducer factor can be chosen. The transducer factor may consist of up to 625 reference values.

### Transducer sets

Several transducer factors can be compiled in a transducer set provided that all factors have the same unit or unit "dB". The frequency range covered by a set can be subdivided into max. 10 subranges (each with up to 4 transducer factors) which follow each other without a gap, i.e. the stop frequency of a subrange is the start frequency of the next subrange.

The transducer factors used in a subrange have to fully cover the subrange.

The definition of a transducer set is recommended if different transducers are used in the frequency range to be measured or if a cable attenuation or an amplifier has to be taken into consideration.

If a transducer set is defined during a frequency sweep, the latter can be stopped at the interface between two transducer ranges and the user is asked to exchange the transducer.

A message informs that the limit has been reached. It is possible either to continue the sweep by confirming the message or to switch off the transducer. With the automatic switchover of the transducer used, the frequency sweep is not interrupted.

### Transducer management

The R&S ESRP provides functionality to store and use the transducer factors during a measurement.

For more information on creating and managing transducer factors see "[Transducer](#)" on page 478.

## 5.2.7 Preamplifier

Switching on the preamplifier reduces the noise figure of the R&S ESRP, thus increasing the sensitivity. The preamplifier follows the preselection filters so that the risk of an

overload by strong out-of-band signals is reduced to a minimum. For frequencies between 100 Hz to 7 GHz, the signal level of the subsequent mixer is 20 dB higher so that the maximum input level is reduced by the gain of the preamplifier. For frequencies above 7 GHz, the gain is 30 dB.

The use of the preamplifier is recommended when measurements with a maximum sensitivity are to be performed. If the measurement should be performed at maximum dynamic range, the preamplifier should be switched off.

The gain of the preamplifier is automatically considered in the level display. The disadvantage of a poorer large-signal immunity (intermodulation) is reduced by the connected preselector.

### 5.2.8 Exported Peak List

When you export the (final) peak list, the results are saved in an ASCII file. The contents of the file are split into several sections.

- The header contains general information about the measurement and instrument settings and characteristics.  
It consists of three columns, separated by a semicolon: parameter name; numeric value; unit
- The data section contains information about the evaluation of the data and the contents of the peak list.  
The data section always starts with `Trace <n> [Final]:.`

**Table 5-2: Example of an exported peak list with a description of the contents**

Type;ESR-7;	instrument model and type
Version;1.76;	Firmware version
Date;07.May 12;	Date of the export
Mode;Receiver;	Operating mode
Start;150000.000000;Hz	Start frequency
Stop;1000000000.000000;Hz	Stop frequency
x-axis;log;	X-axis scaling
Scan count;1;	Number of scans in a single measurement
Transducer;Antenna;;;;;	Active transducer(s)
Scan <x>:	Results for scan range <x>
Start;150000.000000;Hz	Start frequency of scan range <x>
Stop;30000000.000000;Hz	Stop frequency of scan range <x>
Step;4000.000000;Hz	Frequency stepsize in scan range <x>
RBW;9000.000000;Hz	Resolution bandwidth in scan range <x>
Meas time;0.001000;s	Measurement time in scan range <x>
Auto ranging;OFF;	Autoranging state for scan range <x>

RF Att;10.000000;dB	RF attenuation level in scan range <x>
Auto Preamp;OFF;	Auto preamplification state for scan range <x>
Preamp;0.000000;dB	Preamplification state for scan range <x>
TRACE <x> FINAL	Peak list contents for trace <x> after scan [or final measurement]
Trace Mode;CLR/WRITE;	Trace mode for trace <x>
Detector;QUASI PEAK;	Detector for trace <x>
x-Unit;Hz;	Unit of the x-axis
y-Unit;dBμV;	Unit of the y-axis
Final Meas Time;1.000000;s	Final measurement time
Margin;6.000000;dB	Margin of the peaks
Value;26;	Number of result values
1;2150000.000000;84.210000;;;	Peak list entries:
1;6150000.000000;84.210000;;;	<Trace>;<Frequency>;<Level>;<DeltaLimit>;<Phase>;<Unused>
etc.	

## 5.2.9 Formats for Returned Values: ASCII Format and Binary Format

### ASCII Format (FORMat ASCII)

The command reads out a list of comma separated values (CSV) of the measured values in floating point format.



Reading out data in binary format is quicker than in ASCII format. Thus, binary format is recommended for large amounts of data.

### Binary Format (FORMat REAL,32)

The command reads out binary data (Definite Length Block Data according to IEEE 488.2), each measurement value being formatted in 32 Bit IEEE 754 Floating-Point-Format.

Depending on the number of samples to be transferred, 2 different kinds of syntax are used:

#### For <math>10^{10}</math> samples:

The schema of the result string is as follows:

#<NoOfDigits><NoOfDataBytes><value1><value2>...<value n>, with

#	Header prefix, 1 byte
<NoOfDigits>	Number of digits of the following number of data bytes (= 4 in the example), 1 byte
<NoOfDataBytes>	Number of following data bytes in decimal form (= 1024 in the example), 1...9 bytes
<Value>	Data values, each one is a 4-byte floating point value

Example:

#41024<value1><value2>...<value 256>

4: the following number of data bytes has 4 digits

1024: 1024 Bytes of following data; float: 4 Bytes / value => 1024 / 4 = 256 values (128 I and 128 Q values)

<value x>: 4 Byte values, must be interpreted as float

**For  $\geq 10^{10}$  samples:**

The schema of the result string is as follows:

# (<NoOfDataBytes>) <value1><value2>...<value n>, with

#	Header prefix, 1 byte
(	1 byte
<NoOfDataBytes>	number of following data bytes (= 1024 in the example), 10 bytes
)	1 byte
<Value>	Data values, each one is a 4-byte floating point value

Example:

#(1677721600)<value 1><value 2> ... <value 419430400>

(1677721600): 1677721600 Bytes of following data; float: 4 Bytes / value ==> 1677721600 / 4 = 419430400 values (200Ms I and 200Ms Q values)

<value x>: 4 Byte values, must be interpreted as float

### 5.3 Common Measurement Settings

- [Defining the Frequency and Span](#).....155
- [Configuring the Level Display and the RF Input](#).....157
- [Selecting the Bandwidth](#).....160
- [Configuring the Scan](#).....161
- [Configuring the Trigger](#) ..... 162
- [Controlling Inputs and Outputs](#).....163
- [Test Automation](#)..... 163

### 5.3.1 Defining the Frequency and Span

The frequency and span settings define the scope of the signal to be analyzed. The settings are available in the [FREQ] and [SPAN] menus.

Span settings and signal tracking are only available for IF Analysis (firmware application R&S ESRP-K56).

Receiver Frequency.....	155
Stepsize.....	155
Start / Stop Frequency.....	156
IF Span Manual.....	156
Full Span.....	156
Last Span.....	156
Signal Track.....	156

#### Receiver Frequency

Defines the receiver frequency.

The tuning frequency has to be set to at least twice the IF bandwidth.

When the tuning frequency is lower than twice the IF bandwidth, the IF bandwidth is automatically reduced so that this condition is met again.

Remote command:

[SENSe:] FREQuency:CENTer on page 634

#### Stepsize

Opens a submenu to define the receiver frequency step size.

By default, the frequency step size is coupled to the receiver frequency. Alternatively, you can define a custom step size.

"Auto Coarse"	The step size is coupled to the receiver frequency. When you change the frequency with the rotary knob, the R&S ESRP increases or decreases the 4th digit of the receiver frequency. When you change the frequency with the cursor keys, the R&S ESRP increases or decreases the 2nd digit of the receiver frequency.
"Auto Fine"	The step size is coupled to the receiver frequency. When you change the frequency with the rotary knob, the R&S ESRP increases or decreases the 7th digit of the receiver frequency. When you change the frequency with the cursor keys, the R&S ESRP increases or decreases the 5th digit of the receiver frequency.
"Stepsize Manual"	The step size is a fixed custom value. When you change the frequency with the rotary knob, the R&S ESRP increases or decreases the frequency by 1 % of the manual step size. When you change the frequency with the cursor keys, the R&S ESRP increases or decreases the frequency by the manual step size.
"Stepsize = Freq"	The step size is equal to the current receiver frequency. Defining a step size equal to the receiver frequency is useful during measurements of the harmonic content of a signal. Each change of the receiver frequency with the cursor key or the rotary knob selects the next harmonic.

Remote command:

[SENSe:] FREQuency: CENTer: STEP on page 634

### Start / Stop Frequency

Defines the start and stop frequency for the scan.

The range for the start frequency is  $f_{\min}$  to  $(f_{\max} - 10 \text{ Hz})$ .

The range for the stop frequency is  $(f_{\min} + 10 \text{ Hz})$  to  $f_{\max}$ .

$f_{\min}$  and  $f_{\max}$  are defined in the datasheet.

Remote command:

Start frequency:

[SENSe:] FREQuency: START on page 635

Stop frequency:

[SENSe:] FREQuency: STOP on page 635

### IF Span Manual

Defines the span for IF spectrum analysis.

The receiver (center) frequency is kept constant. Possible span values are in the range from 10 kHz to 10 MHz.

Available for IF Analysis (firmware application R&S ESRP-K56).

Remote command:

[SENSe:] FREQuency: SPAN on page 793

### Full Span

Restores the span to the full available frequency range.

The full span is specified in the data sheet.

In receiver mode, full span is available for IF Analysis and is limited to 10 MHz.

Remote command:

[SENSe:] FREQuency: SPAN: FULL on page 793

### Last Span

Sets the span to the previous value. With this function e.g. a fast change between overview measurement and detailed measurement is possible.

Remote command:

-

### Signal Track

Opens a submenu to define and enable the signal tracking:

- search bandwidth
- threshold value
- trace

Signal tracking is available for IF analysis and is defined in the [FREQ] menu. After each sweep the center frequency is set to the maximum signal found within the searched bandwidth. If no maximum signal above the set threshold value is found in the searched bandwidth, the track mechanism stops.

For a description of the softkeys of the submenu, see "[Signal Track \(span > 0\)](#)" on page 318.

### 5.3.2 Configuring the Level Display and the RF Input

The settings to define the level display range for the scan and to configure the RF input are available in the [AMPT] menu.

<a href="#">RF Atten Manual</a> .....	157
<a href="#">Preamp On/Off</a> .....	157
<a href="#">10 dB Min</a> .....	157
<a href="#">Auto Range (On Off)</a> .....	158
<a href="#">Auto Preamp (On Off)</a> .....	158
<a href="#">Unit</a> .....	158
$\text{L dBx/MHz}$ .....	158
<a href="#">Grid Range / Grid Min Level</a> .....	159
<a href="#">Input 50 <math>\Omega</math>/75 <math>\Omega</math></a> .....	160

#### RF Atten Manual

Opens an edit dialog box to enter the attenuation.

The RF attenuation defines the level at the input mixer according to the formula:

$$\text{level}_{\text{mixer}} = \text{level}_{\text{input}} - \text{RF attenuation} + \text{RF preamplifier gain}$$

You can attenuate the signal in 5 dB steps. The range is specified in the data sheet.

Note that receiver mode, an attenuation of 10 dB or less is possible only if you turn [10 dB Min](#) off.

**Note:** The maximum mixer level allowed is **0 dBm**. Mixer levels above this value may lead to incorrect measurement results, which are indicated by the "OVLD" status display. The increased mixer level allows for an improved signal, but also increases the risk of overloading the instrument.

When measuring spurious emissions in spectrum mode, this softkey automatically opens the "Sweep List" dialog box, see "[Sweep List dialog box](#)" on page 265.

Remote command:

[INPut:ATTenuation](#) on page 637

#### Preamp On/Off

Switches the preamplifier on and off.

Remote command:

[INPut:GAIN:STATe](#) on page 638

#### 10 dB Min

Determines whether the 10 dB setting of the attenuator may be used in the manual or automatic setting of the attenuator.

If on, the attenuation level is always at least 10 dB to protect the input mixer and avoid accidental setting of 0 dB, especially if you measure DUTs with high RFI voltage.

"10dB Min" ON is the default value, i.e. an RF attenuation of at least 10 dB is always set on the R&S ESRP to protect the input mixer.



An attenuation of 0 dB cannot be set manually either. This avoids 0 dB being switched on inadvertently, particularly when DUTs with high RFI voltage are measured.

Remote command:

`INPut:ATTenuation:PROTection[:STATe]` on page 638

#### **Auto Range (On Off)**

Turns automatic configuration of the attenuation level on and off.

If off, the R&S ESRP uses the manual RF attenuation that you have defined.

If on, the R&S ESRP defines an attenuation level that results in a good S/N ration without overloading the receiver stages. Note that it is possible that the R&S ESRP does not utilize the maximum possible dynamic range. However, measurement results are still valid in that case, because it is ensured that performing scans does not result in an overload.

**NOTICE!** Risk of damage to the input mixer. If you apply a 0 dB RF attenuation in combination with auto ranging, make sure that the signal level at the RF input does not exceed the allowed limits.

Exceeding the limit might damage the input mixer.

Do not use a 0 dB attenuation under any circumstances when you measure RFI voltage (or unknown signals) in combination with an artificial network, because such a test setup generates very high pulses during phase switching.

Remote command:

`INPut:ATTenuation:AUTO` on page 637

#### **Auto Preamp (On Off)**

Turns automatic selection of the preamplifier state on and off.

If on, the R&S ESRP considers the preamplifier in the autorange process. The preamplifier is cut in when the RF attenuation is reduced to the minimum settable value.

If off, the preamplifier is not considered in the autorange procedure.

Remote command:

`INPut:GAIN:AUTO` on page 638

#### **Unit**

Selects the unit displayed on the vertical axis.

The unit on the vertical axis represents the unit the results are evaluated in. You can select one of the following units: dBm, dB $\mu$ V, dBpW, dB $\mu$ A, dBmV, dBpT.

Remote command:

`CALCulate<n>:UNIT:POWer` on page 636

#### **dBx/MHz ← Unit**

Turns the display of results in units relative to a 1 MHz bandwidth on and off.

You can normalize the following units to 1 MHz.

Unit	Relative unit
dB $\mu$ V	dB $\mu$ V/MHz
dB $\mu$ V/m	dB $\mu$ V/mMHz (Available for active transducers only.)
dBmV	dBmV/MHz
dB $\mu$ A	dB $\mu$ A/MHz
dB $\mu$ A/m	dB $\mu$ A/mMHz (Available for active transducers only.)
dBpW	dBpW/MHz
dBpT	dBpT/MHz

The conversion to 1 MHz bandwidth is realized via the pulse bandwidth of the selected resolution bandwidth.

**Example:**

Conversion example for dB $\mu$ V:

$$P[\text{dB}\mu\text{V}/\text{MHz}] = P[\text{dB}\mu\text{V}] - 20 \cdot \log\left(\frac{B_{\text{imp}}[\text{MHz}]}{1\text{MHz}}\right)$$

P = Displayed level

B<sub>imp</sub> = Pulse bandwidth of the selected RBW

If you are using another unit, replace "dB $\mu$ V" with the corresponding unit.

The conversion is also possible when a transducer defines the used unit.

Remote command:

[CALCulate<n>:UNIT:POWer](#) on page 636

**Grid Range / Grid Min Level**

Defines the scale of the vertical diagram axis.

The display ranges go from 10 to 200 dB in 10-dB steps. Invalid entries are rounded off to the nearest valid value.

"Grid Range" Defines the level display range for the scan diagram.

"Grid Min Level" Defines the minimum level of the display range.

Remote command:

Defining the range of the grid:

[DISPlay\[:WINDow<n>\]:TRACe<t>:Y\[:SCALe\]](#) on page 812

Defining the minimum level displayed on the axis:

[DISPlay\[:WINDow<n>\]:TRACe<t>:Y\[:SCALe\]:BOTTom](#) on page 636

**Input 50 Ω/75 Ω**

Uses 50 Ω or 75 Ω as reference impedance for the measured levels. Default setting is 50 Ω.

The setting 75 Ω should be selected if the 50 Ω input impedance is transformed to a higher impedance using a 75 Ω adapter of the RAZ type (= 25 Ω in series to the input impedance of the instrument). The correction value in this case is 1.76 dB = 10 log (75 Ω/50 Ω).

All levels specified in this Operating Manual refer to the default setting of the instrument (50 Ω).

Remote command:

`INPut:IMPedance` on page 638

**5.3.3 Selecting the Bandwidth**

The bandwidth settings are available in the [BW] menu.

<code>Res BW Manual</code> .....	160
<code>CISPR RBW Uncoupled</code> .....	160
<code>Filter Type</code> .....	160
<code>IF Analysis RBW</code> .....	161

**Res BW Manual**

Opens an input field to define the measurement or resolution bandwidth.

The R&S ESRP supports a selected set of resolution bandwidths. If you enter a number that is not supported, the R&S ESRP rounds the value up to next available bandwidth.

You can also select some bandwidths directly with the corresponding softkeys in the "Bandwidth" menu.

For more information see [Chapter 5.2.1, "Measurement Bandwidth"](#), on page 142.

Remote command:

`[SENSe:]BANDwidth|BWIDth[:RESolution]` on page 639

**CISPR RBW Uncoupled**

Cancels the coupling of the IF bandwidth to the frequency range with the activated quasipeak detector, CISPR Average or RMS average detector.

See also [Chapter 5.2.2, "Detectors"](#), on page 143.

Remote command:

`[SENSe:]BANDwidth|BWIDth[:RESolution]:AUTO` on page 640

**Filter Type**

Selects the filter type.

The available resolution bandwidths depend on the filter selection.

The R&S ESRP provides the following filter types:

- **EMI CISPR / MIL**

Gaussian filter with a 6 bandwidth. 6 dB bandwidths that comply with CISPR and MIL standards are available.

- **CISPR only**  
Gaussian filter with a 6 bandwidth. 6 dB bandwidths that comply with CISPR standards are available.
- **MIL Std only**  
Gaussian filter with a 6 bandwidth. 6 dB bandwidths that comply with military standards are available.
- **3 dB Bandwidth**  
Gaussian filter with a 3 dB bandwidth.

6 dB bandwidths correspond approximately to the pulse bandwidth..

3 dB bandwidths correspond approximately to the noise bandwidth.

Remote command:

`[SENSe:]BANDwidth|BWIDth[:RESolution]:TYPE` on page 640

#### IF Analysis RBW

Selects the resolution bandwidth for IF spectrum analysis

Available for IF Analysis (firmware application R&S ESRP-K56).

Remote command:

`[SENSe:]BANDwidth:IF` on page 639

### 5.3.4 Configuring the Scan

The following settings for configuring the scan are available in the [Sweep] menu.

Run Continuous / Run Single.....	161
Edit Scan Table.....	161
Freq Axis (Lin Log).....	161

#### Run Continuous / Run Single

Initiates a continuous or single measurement.

See also [Chapter 5.1.7.1, "Running Scans and Measurements"](#), on page 132.

Remote command:

Selecting single and continuous measurements:

`INITiate<n>:CONTinuous` on page 609

Initiating a measurement:

`INITiate<n>[:IMMediate]` on page 610

#### Edit Scan Table

Opens a dialog box to create or edit a scan table.

For more information see [Chapter 5.1.3.3, "The Scan Table"](#), on page 123

#### Freq Axis (Lin Log)

Switches between linear and logarithmic frequency axis.

Remote command:

[DISPlay\[:WINDow<n>\]:TRACe<t>:X:SPACing](#) on page 634

### 5.3.5 Configuring the Trigger

The trigger settings are available in the [TRIG] menu.

<a href="#">External</a> .....	162
<a href="#">Free Run</a> .....	162
<a href="#">Video</a> .....	162
<a href="#">Trigger Polarity</a> .....	162

#### External

Selects an external trigger source.

The external trigger source is a TTL signal fed in at the EXT TRIG/GATE IN interface on the rear panel.

Remote command:

[TRIGger<n>\[:SEQuence\]:SOURce](#) on page 807

#### Free Run

Selects free run mode. In free run mode, a measurement is not triggered. Once a measurement is completed, another is started immediately.

Remote command:

[TRIGger<n>\[:SEQuence\]:SOURce](#) on page 807

#### Video

Selects the video trigger. The trigger event is a certain voltage level.

For the video triggering mode, a level line showing the trigger threshold is displayed. Using the level line, the threshold can be adjusted between 0% and 100% of the diagram height.

Video mode is only available in the time domain.

Remote command:

[TRIGger<n>\[:SEQuence\]:SOURce](#) on page 807

[TRIGger<n>\[:SEQuence\]:LEVel:VIDeo](#) on page 806

#### Trigger Polarity

Selects the polarity of the trigger source.

The scan starts after a positive or negative edge of the trigger signal. The default setting is "Pos".

The trigger polarity is unavailable for the free run trigger source.

Remote command:

[TRIGger<n>\[:SEQuence\]:SLOPe](#) on page 807

### 5.3.6 Controlling Inputs and Outputs

The input/output settings are available in the [Input/Output ] menu.

For information on the LISN control see [Chapter 5.3.7.6, "LISN Settings"](#), on page 172.

<a href="#">Input (AC/DC)</a> .....	163
<a href="#">User Port</a> .....	163

#### Input (AC/DC)

Toggles the RF input of the R&S ESRP between AC and DC coupling.

Remote command:

[INPut:COUPling](#) on page 641

#### User Port

The user port (AUX port) can transmit bit patterns in two directions, depending on the actual selected signal direction. The user port is available on the rear panel when you equip the R&S ESRP with option R&S ESRP-B5.

- "Direction" = "In" (read only)  
Opens a dialog box. Select the "Read" button to read out the user port configuration. The value is displayed in the dialog box.
- "Direction" = "Out"  
Select the required bit pattern by changing the state of the individual ports ("Port <x>").  
See ["AUX PORT"](#) on page 35 for information about the pin assignment of the connector.  
See [OUTPut:UPORt\[:VALue\]](#) on page 901 for information about the pin to bit assignment.

Remote command:

State: [INPut<ip>:UPORt:STATe](#) on page 900

State: [OUTPut:UPORt:STATe](#) on page 901

Bit pattern (query): [INPut<ip>:UPORt\[:VALue\]](#) on page 900

Bit pattern (setting): [OUTPut:UPORt\[:VALue\]](#) on page 901

### 5.3.7 Test Automation

The test automation settings are available in the [MEAS] and [MEAS Config] menu.

The Test Automation dialog box contains functionality to configure automated test sequences.

It is made up of several tabs, each of which contains the settings for one of the stages in an automated test sequence (see also [Chapter 5.1, "Measurements and Result Displays"](#), on page 119).

The "Peak Search" and "Run Final Test" buttons at the bottom of each of the tabs initiate the corresponding measurement function.

SCPI command:

[CALCulate<n>:PEAKsearch|PSEarch\[:IMMEDIATE\]](#) on page 648

[INITiate<n>:FMEasurement](#) on page 611

### Peak Search





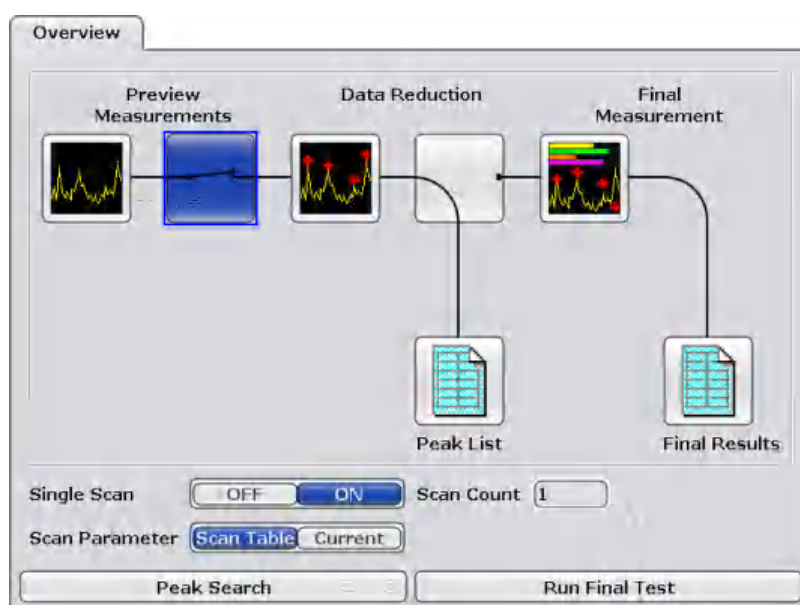

In addition to the "Peak Search" button, you can initiate a peak search with the [PEAK SEARCH] key on the R&S ESRP front panel.

#### 5.3.7.1 Overview

The "Overview" tab in the "Test Automation" dialog box contains general functions to configure automated test sequences.



The main part of the "Overview" tab represents a complete test sequence (scan, peak search and final measurement).

- The  item opens the [Scan Table](#) tab.
- The  item includes (blue state) or excludes (grey state) the peak search and later stages from the test sequence.
- The  item opens the [Peak Search](#) tab.
- The  item includes (blue state) or excludes (grey state) the final measurement from the test sequence. Note that if you include the final measurement, the R&S ESRP automatically includes the peak search in the test sequence.
- The  item opens the [Trace / Final Meas](#) tab.
- The  item opens the peak list after the scan or the final measurement.

Below the diagram, the source for the scan parameter settings is determined, and the number of scans set.

**Scan Count**

Defines the number of scans performed in a single scan or the number of scans included in calculating the moving average in a continuous scan.

Remote command:

Defining the scan count:

[SENSe:] SWEep:COUNT on page 642

Querying the number of started scans:

[SENSe:] SWEep:COUNT:CURRent on page 642

**Scan Parameter**

Selects the configuration the scan is based on.

"Scan Table" The scan is performed based on the settings defined of the scan table.

"Current" The scan is performed based on the current setting of the R&S ESRP.

Remote command:

not supported

**5.3.7.2 Scan Table**

The "Scan Table" tab in the "Test Automation" dialog box contains the scan table where parameters for the individual subranges can be set.

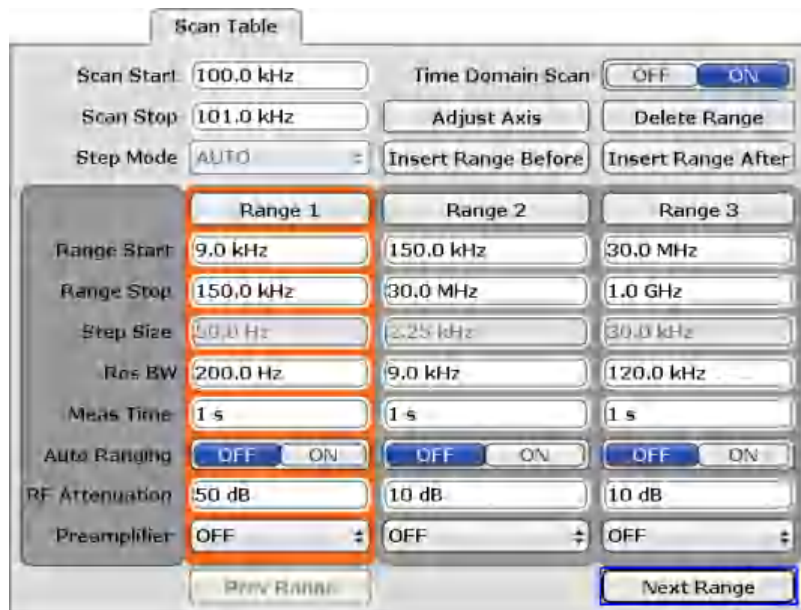

Start / Stop Frequency..... 166

Step Mode..... 166

Time Domain Scan (On Off)..... 166

Adjust Axis..... 166

Insert Range Before / After..... 166

Delete Range..... 167

Range 1 to 10..... 167

Prev / Next Range..... 167



**Start / Stop Frequency**

Defines the start and stop frequency for the scan.

The range for the start frequency is  $f_{\min}$  to  $(f_{\max} - 10 \text{ Hz})$ .

The range for the stop frequency is  $(f_{\min} + 10 \text{ Hz})$  to  $f_{\max}$ .

$f_{\min}$  and  $f_{\max}$  are defined in the datasheet.

Remote command:

Start frequency:

[SENSe:] FREQuency: START on page 635

Stop frequency:

[SENSe:] FREQuency: STOP on page 635

**Step Mode**

Selects the mode for frequency steps.

Note that the frequency stepsize for time domain scans (R&S ESRP-K53) is always selected automatically.

"AUTO"	Linear frequency steps. The stepsize is coupled to the current resolution bandwidth and is about a third of the resolution bandwidth. In this way, the probability to detect all signals in the scan range is very good.
"LIN"	Linear frequency steps. The stepsize is fix and depends on the <a href="#">Stepsize</a> .
"LOG"	Logarithmic frequency steps. The stepsize is a percentage of the current frequency.

Remote command:

[ [SENSe:] SWEep: SPACing on page 647

**Time Domain Scan (On Off)**

Turns the time domain scan on and off.

For more information see [Chapter 5.1.3.2, "Time Domain Scans in the Frequency Domain"](#), on page 123.

Note that time domain scans are available with option R&S ESRP-K53.

Remote command:

[SENSe:] FREQuency: MODE on page 635

**Adjust Axis**

Adjusts the scale of the horizontal axis if the overall scan range is different than the scan range defined by the scan subranges.

Remote command:

not supported

**Insert Range Before / After**

Inserts a new scan range before or after the currently selected range.

Except for the start and stop frequencies, the configuration of the new scan range is the same as the one that has been selected previously. The selected range is highlighted in orange.

Remote command:

The suffix at `SCAN<range>` of the commands listed in [Chapter 11.4.6.2, "Scan Table"](#), on page 643 defines the ranges.

#### **Delete Range**

Deletes the currently selected scan range.

Remote command:

not supported

#### **Range 1 to 10**

Configures the currently selected scan range.

You can use and configure up to 10 individual scan ranges. For each range you can customize the following parameters.

- Range Start / Range Stop
- Frequency Stepsize
- Resolution Bandwidth
- Meas Time
- Auto Ranging
- RF Attenuation
- Preamplifier

For more information see [Chapter 5.1.3.3, "The Scan Table"](#), on page 123.

Remote command:

See [Chapter 11.4.6.2, "Scan Table"](#), on page 643

#### **Prev / Next Range**

Selects the scan range to the left or right of the currently selected scan range.

Remote command:

not supported

### **5.3.7.3 Peak Search**

The "Peak Search" tab in the "Test Automation" dialog box contains functionality to control the peak search.

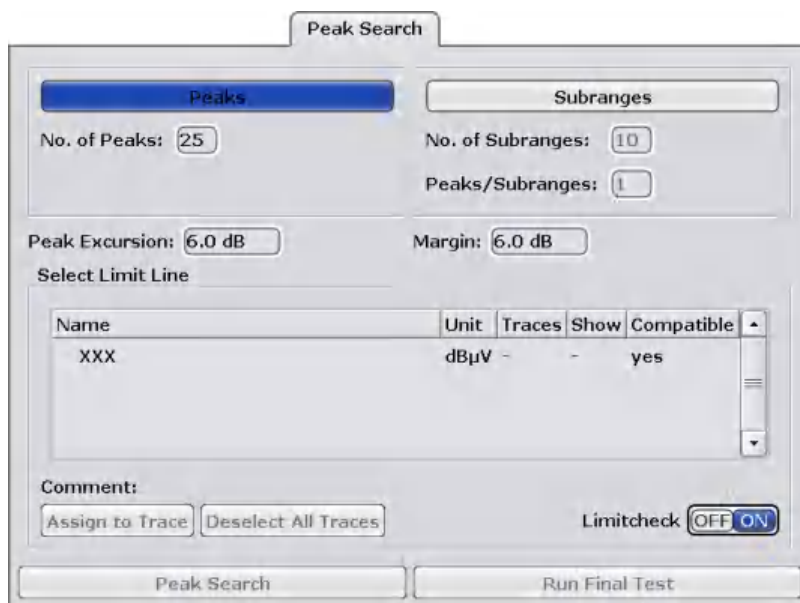

Peak Search Mode (Peaks Subranges)..... 168

No Of Peaks..... 168

No of Subranges / Peaks per Subrange..... 168

Peak Excursion..... 169

Margin..... 169

Select Limit Line..... 169

**Peak Search Mode (Peaks Subranges)**

Selects the peak search mode.

- "Peaks" Looks for a particular number of peaks over the complete scan range.
- "Subranges" Divides the scan range into smaller subranges and looks for a particular number of peaks in each subrange.

Remote command:

[CALCulate<n>:PEAKsearch|PSEarch:METHOD](#) on page 649

**No Of Peaks**

Defines the number of peaks the R&S ESRP looks for during a peak search.

The range is from 1 to 500 peaks.

The number of peaks only takes effect if the peak search mode is "Peaks".

Remote command:

[CALCulate<n>:PEAKsearch|PSEarch:SUBRanges](#) on page 649

**No of Subranges / Peaks per Subrange**

Defines the number of subranges for a subrange peak search and the number of peaks that the R&S ESRP looks for in each subrange.

Note that the maximum number of peaks is 500. Thus, the maximum number of peaks per subrange depends on the number of subranges you have defined.

These parameters only take effect if the peak search mode is "Subranges".

Remote command:

Number of subranges:

[CALCulate<n>:PEAKsearch|PSEarch:SUBRanges](#) on page 649

Peaks per subrange:

[CALCulate<n>:PEAKsearch|PSEarch:SUBRanges:PCount](#) on page 650

### Peak Excursion

Defines the relative signal level to determine a peak during a peak search.

For more information see [Chapter 5.1.4, "Peak List and Data Reduction"](#), on page 124.

Remote command:

[CALCulate<n>:MARKer<m>:PEXCursion](#) on page 647

### Margin

Defines an additional level margin relative to a limit line that is considered during a peak search.

For more information see [Chapter 5.1.4, "Peak List and Data Reduction"](#), on page 124.

Remote command:

[CALCulate<n>:PEAKsearch|PSEarch:MARGIN](#) on page 648

### Select Limit Line

Applies one or more limit lines for the peak search.

For more information on limit lines see [Chapter 5.4.3, "\(Limit\) Lines"](#), on page 184.

"Assign to Trace" Assigns the limit line to one or more traces.

"Deselect all Traces"

"Limitcheck (On Off)" Turns the limit check on and off.

#### 5.3.7.4 Peak Lists

The peak list dialog box is available for the prescan results and the final measurement results. Both dialog boxes contain the same elements.

Trace1: LimitLine not assigned

Trace/Detector	Frequency	Level dB $\mu$ V	DeltaLimit
1 Max Peak	2.1500 MHz	84.21	
1 Max Peak	6.1500 MHz	84.21	
1 Max Peak	10.1500 MHz	84.21	
1 Max Peak	14.1500 MHz	84.21	
1 Max Peak	18.1500 MHz	84.21	
1 Max Peak	22.1500 MHz	84.21	
1 Max Peak	26.1500 MHz	84.21	

Symbols  OFF  ON
 
 Decim Sep

Peak List.....	170
Insert Frequency.....	170
Delete Frequency.....	170
Sort by Delta Limit.....	170
Symbols (On Off).....	171
Peak List Export.....	171

### Peak List

Contains information about the peaks that were found during the peak search.

- **Trace / Detector**  
Shows the number of trace that the peak is on and the detector with which the peak has been measured.
- **Frequency**  
Shows the frequency of the peak level.
- **Level**  
Shows the signal level of the peak. The unit depends on the one you have selected.
- **Delta Limit**  
Shows the distance of the peak to a limit line. The delta limit is only calculated if you have activated a limit line and have assigned it to one more traces.

### Insert Frequency

Adds a new frequency to the peak list that is considered in the next scan.

Remote command:

[CALCulate<n>:PEAKsearch|PSEarch:ADD](#) on page 648

### Delete Frequency

Deletes the currently selected peak list table row (grey highlighting).

Remote command:

not supported

### Sort by Delta Limit

Sort the entries of the peak list according to the delta limit results.

The delta limit is the distance of a peak to a limit line, if one has been assigned.

Remote command:  
not supported

### Symbols (On Off)

Turns the labels on the peak position in the diagram on and off.

The peak labels have a different color and shape depending on the trace they are on. Trace 1, for example, has red crosses as the peak label. By default they are on.

Remote command:

`DISPlay[:WINDow<n>]:TRACe<t>:SYMBOL` on page 650

### Peak List Export

Opens a dialog box to export and save the contents of the peak list in ASCII format to a \*.dat file.

The file consists of a header and the results of the scan or the final measurement.

- The header is a list of general instrument settings and characteristics. It consists of three columns, each column separated by a semicolon: <parameter>;<value>;<unit>.
- The results are split into several data sections, one for each active trace. The data section begins with the entry `Trace <x> [Final] :`, followed by the trace characteristics and the peak list data itself.

For a description of the data see [Chapter 6.3.1.6, "ASCII File Export Format"](#), on page 370 .

By default, decimal places are separated by a point in the exported list. If required, you can use a comma instead of a point as the decimal separator.

Remote command:

Export the peak list of the scan results:

`MMEMemory:STORe:PEAKlist` on page 651

Export the peak list of the final measurement:

`MMEMemory:STORe:FINAl` on page 651

Select the decimal separator:

`FORMat:DEXPort:DSEParator` on page 818

### 5.3.7.5 Trace / Final Meas

The Trace / Final Meas tab in the Test Automation dialog box contains functionality to configure the traces for the scan and the final measurement.

<a href="#">Final Measurement Time</a> .....	171
<a href="#">Interactive Mode</a> .....	172
<a href="#">Trace 1 to 6</a> .....	172

### Final Measurement Time

Defines the measurement time for the final measurement.

The measurement time is the time during which the R&S ESRP measures the input signal and forms a measurement result weighted by the selected detector. The measurement time does not include settling times of the synthesizer and the IF filter. The R&S ESRP automatically waits until transients are over.

#### Interactive Mode

Turns interactive final measurements on and off.

Remote command:

`[SENSe:] FMEasurement:AUTO` on page 612

#### Trace 1 to 6

Selects the characteristics of each trace.

In addition to the trace mode, you can select a detector for the scan and the final measurement. For more information see

- [Chapter 5.1.3, "Scans"](#), on page 121
- [Chapter 5.1.5, "Final Measurement"](#), on page 126
- [Chapter 5.2.3, "Trace Modes"](#), on page 147
- [Chapter 5.2.2, "Detectors"](#), on page 143

**Note:** When you select detector type "None" for the final measurement, the R&S ESRP ignores peaks found on the corresponding trace during the final measurement.

Remote command:

Trace mode:

`DISPlay[:WINDow<n>]:TRACe<t>:MODE` on page 652

Scan detector:

`[SENSe:] [WINDow:] DETector<trace>[:FUNCTION]` on page 651

Final measurement detector:

`[SENSe:] DETector<t>:FMEasurement` on page 611

#### 5.3.7.6 LISN Settings

The "LISN Settings" tab in the "Test Automation" dialog box contains functionality to control line impedance networks.



LISN Type..... 173  
 Prescan Phase..... 173  
 Final Test Phase..... 173  
 150 kHz Highpass Filter..... 174

**LISN Type**

Selects the V-network to be controlled via the user port.

For more information see [Chapter 5.2.5, "V-Networks Control \(LISN\)"](#), on page 149.

Remote command:

For the scan:

`INPut:LISN[:TYPE]` on page 655

For the final measurement:

`[SENSe:]FMEasurement:LISN[:TYPE]` on page 654

**Prescan Phase**

Selects the phase of the network you want to control during the scan.

During the scan, you can control more than one phase at a time.

For more information see [Chapter 5.2.5, "V-Networks Control \(LISN\)"](#), on page 149.

Remote command:

`INPut:LISN:PHASe` on page 655

**Final Test Phase**

Selects the phase of the network you want to control during the final measurement.

During the final measurement you can control more than one phase.

For more information see [Chapter 5.2.5, "V-Networks Control \(LISN\)"](#), on page 149.

Remote command:

`[SENSe:]FMEasurement:LISN:PHASe` on page 653



**150 kHz Highpass Filter**

Turns the highpass filter available with the R&S ENV216 network on and off.

For more information see [Chapter 5.2.5, "V-Networks Control \(LISN\)"](#), on page 149.

Remote command:

Highpass filter for the scan:

`INPut:LISN:FILTer:HPAS[:STATe]` on page 654

Highpass filter for the final measurement:

`[SENSe:]FMEasurement:LISN:FILTer:HPAS[:STATe]` on page 653

## 5.4 Common Analysis Functions

### 5.4.1 Trace Configuration

The TRACE key is used to configure the data acquisition for measurement and the analysis of the measurement data.

The R&S ESRP is capable of displaying up to six different traces at a time in a diagram. A trace consists of a maximum of 691 displayed measurement points on the horizontal axis (frequency or time). If more measured values than measurement points are available, several measured values are combined in one displayed measurement point.

The trace functions include the following:

- Display mode of the trace  
For details on trace modes see [Chapter 5.2.3, "Trace Modes"](#), on page 147.
- Evaluation of individual measurement points of a trace. For details on detectors see [Chapter 5.2.2, "Detectors"](#), on page 143.

**To open the Trace menu**

- Press the TRACE key.  
The "Trace" menu is displayed.

**Further information**

- [Chapter 5.2.3, "Trace Modes"](#), on page 147
- [Chapter 5.2.2, "Detectors"](#), on page 143
- [Chapter 6.3.1.6, "ASCII File Export Format"](#), on page 370

**Tasks**

- [Chapter 6.3.1.2, "Configuring Traces"](#), on page 366
- [Chapter 6.3.1.3, "Specifying the Trace Settings"](#), on page 368

The following table shows all softkeys available in the "Trace" menu. It is possible that your instrument configuration does not provide all softkeys. If a softkey is only available

with a special option, model or (measurement) mode, this information is provided in the corresponding softkey description.

Trace 1 - 6.....	175
More Traces.....	175
Copy Trace.....	175
Trace Wizard.....	175
ASCII Trace Export.....	175
Decim Sep.....	176

### Trace 1 - 6

Opens a submenu to select the trace mode and detector (for both scan and final measurement).

For more information see [Chapter 5.2.2, "Detectors"](#), on page 143 and [Chapter 5.2.3, "Trace Modes"](#), on page 147.

**Note:** When you select detector type "None" for the final measurement, the R&S ESRP ignores peaks found on the corresponding trace during the final measurement.

Remote command:

Selecting the trace mode:

`DISPlay[:WINDow<n>]:TRACe<t>:MODE` on page 652

Selecting the detector for the scan:

`[SENSe:] [WINDow:] DETector<trace>[:FUNction]` on page 821

Selecting the detector for the final measurement:

`[SENSe:] DETector<t>:FMEasurement` on page 611

### More Traces

Opens a submenu to select one of the traces not currently displayed in the main menu.

### Copy Trace

Opens an edit dialog box to enter the number of the trace memory in which the currently selected trace will be copied.

Remote command:

`TRACe<n>:COPY` on page 822

### Trace Wizard

Opens the "Trace Wizard" dialog box.

For more information see [Chapter 5.3.7.5, "Trace / Final Meas"](#), on page 171.

### ASCII Trace Export

Opens the "ASCII Trace Export Name" dialog box and saves the active trace in ASCII format to the specified file and directory.

**Tip:** You can export a single trace ("ASCII Trace Export Trace (x)" softkey) or all traces at the same time ("ASCII Trace Export All Traces"). When you use single trace export, the R&S ESRP exports the currently selected trace (indicated by the softkey label).

Note that the exported ASCII file has a slightly different structure compared to a single trace export.

The file consists of the header containing important scaling parameters and a data section containing the trace data. For details on an ASCII file see [Chapter 6.3.1.6, "ASCII File Export Format"](#), on page 370.

This format can be processed by spreadsheet calculation programs, e.g. MS-Excel. It is necessary to define ';' as a separator for the data import. Different language versions of evaluation programs may require a different handling of the decimal point. It is therefore possible to select between separators '.' (decimal point) and ',' (comma) using the "Decim Sep" softkey (see ["Decim Sep"](#) on page 176).

If the spectrogram display is selected when you perform this function, the entire histogram buffer with all frames is exported to a file. The data corresponding to a particular frame begins with information about the frame number and the time that frame was recorded. For large history buffers the export operation may take some time.

Remote command:

[FORMat:DEXPort:TRACes](#) on page 615

[FORMat:DEXPort:DSEParator](#) on page 818

[MMEMory:STORe<n>:TRACe](#) on page 819

[MMEMory:STORe:SGRam](#) on page 621

### Decim Sep

Selects the decimal separator with floating-point numerals for the ASCII Trace export to support evaluation programs (e.g. MS-Excel) in different languages. The values '.' (decimal point) and ',' (comma) can be set.

Remote command:

[FORMat:DEXPort:DSEParator](#) on page 818

## 5.4.2 Markers

### 5.4.2.1 Controlling Markers

The markers are used for marking points on traces, reading out measurement results and for selecting a display section quickly. The R&S ESRP provides 16 markers per trace.

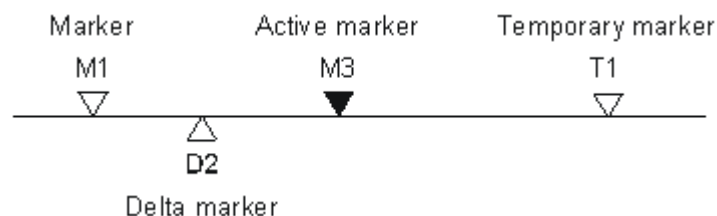

**Figure 5-9: Marker types**

All markers can be used either as markers or delta markers. The marker that can be moved by the user is defined in the following as the active marker. Temporary markers are used in addition to the markers and delta markers to evaluate the measurement results. They disappear when the associated function is deactivated.

The measurement results of the active marker (also called marker values) are displayed in the marker field, which is located at the upper right corner of the diagram, or in a separate table beneath the diagram. The marker information includes the following:

- marker type (M1 in the example)
- trace in square brackets ([1] in the example)
- level (-33.09 dBm in the example)
- marker location (3 GHz in the example)

```
M1[1]           -33.09 dBm
                3.000000000 GHz
```

*Figure 5-10: Marker values*

The MKR key is used to select and position the absolute and relative measurement markers (markers and delta markers). In addition, the functions for the frequency counter, a fixed reference point for relative measurement markers, and for enlargement of the measurement area are assigned to this key.

#### To open the Marker menu

- Press the MKR key.  
The "Marker" menu is displayed. If no marker is active, marker 1 is activated and a peak search on the trace is carried out. Otherwise, the edit dialog box for the last activated marker is opened and the current frequency/time value is displayed.

#### Further information

- ["Displayed Marker Information"](#) on page 381
- [Chapter 5.4.2.2, "Positioning Markers"](#), on page 180.

#### Tasks

- ["Basic Marker Functions"](#) on page 379

#### Marker 1 / Marker 2 / Marker 3 / ... Marker 16,/ Marker Norm/Delta

The "Marker X" softkey activates the corresponding marker and opens an edit dialog box to enter a value for the marker to be set to. Pressing the softkey again deactivates the selected marker.

If a marker value is changed using the rotary knob, the step size is defined via the [Stepsize Standard](#) or [Stepsize Sweep Points](#) softkeys.

Marker 1 is always the reference marker for relative measurements. If activated, markers 2 to 16 are delta markers that refer to marker 1. These markers can be converted into markers with absolute value display using the "Marker Norm/Delta" softkey. If marker 1 is the active marker, pressing the "Marker Norm/Delta" softkey switches on an additional delta marker.

Remote command:

[CALCulate<n>:MARKer<m>\[:STATe\]](#) on page 663

[CALCulate<n>:MARKer<m>:X](#) on page 664

- [CALCulate<n>:MARKer<m>:Y on page 664](#)
- [CALCulate<n>:DELTAmarker<m>\[:STATe\] on page 669](#)
- [CALCulate<n>:DELTAmarker<m>:X on page 670](#)
- [CALCulate<n>:DELTAmarker<m>:X:RELative? on page 671](#)
- [CALCulate<n>:DELTAmarker<m>:Y on page 671](#)

**More Markers**

Opens a sub-menu to select one of up to 16 available markers. See "[Marker 1 / Marker 2 / Marker 3 / ... Marker 16,/ Marker Norm/Delta](#)" on page 177.

**Marker to Trace**

Opens an edit dialog box to enter the number of the trace on which the marker is to be placed.

Remote command:

- [CALCulate<n>:MARKer<m>:TRACe on page 664](#)
- [CALCulate<n>:DELTAmarker<m>:TRACe on page 670](#)

**Marker Wizard**

Opens a configuration dialog for markers. The marker wizard allows you to configure and activate up to 16 different markers in one dialog. The first 8 markers are displayed on one tab, the last 8 markers on a second tab. For each marker, the following settings are available:



- "Selected/ State" When you press the "Selected" or "State" field the corresponding marker is activated and the marker row is highlighted.
- "Normal/Delta" Defines whether it is a normal marker or delta marker. For delta markers you can define a reference marker.

- "Ref. Marker" Reference marker for delta markers. The marker values for the delta marker are indicated relative to the specified reference marker. The reference marker can either be another active marker, or a fixed reference marker ("FXD", see ["Ref Fixed"](#) on page 390).
- "Trace" Trace for which the marker is to be set.

Remote command:

[CALCulate<n>:MARKer<m>\[:STATe\]](#) on page 663

[CALCulate<n>:DELTAmarker<m>\[:STATe\]](#) on page 669

[CALCulate<n>:MARKer<m>:TRACe](#) on page 664

[CALCulate<n>:DELTAmarker<m>:TRACe](#) on page 670

[CALCulate<n>:DELTAmarker<m>:MREF](#) on page 835

#### All Marker Off ← Marker Wizard

Switches all markers off. It also switches off all functions and displays that are associated with the markers/delta markers.

Remote command:

[CALCulate<n>:MARKer<m>:AOFF](#) on page 660

#### All Marker Off

Switches all markers off. It also switches off all functions and displays that are associated with the markers/delta markers.

Remote command:

[CALCulate<n>:MARKer<m>:AOFF](#) on page 660

#### Marker Table

Defines how the marker information is displayed.

For more information, see [Displayed Marker Information](#).

- "On" Displays the marker information in a table in a separate area beneath the diagram.
- "Off" Displays the marker information within the diagram area.
- "Aut" (Default) The marker table is displayed automatically if more than 2 markers are active, and removed if only 1 or 2 markers are active. This helps keep the information in the display clear.

Remote command:

[DISPlay:MTABLE](#) on page 834

#### Marker Info (On Off)

Turns the numerical marker information in the diagram area on and off.

Remote command:

[DISPlay\[:WINDow<n>\]:MINFo:STATe](#) on page 659

#### Tune to Marker

Defines the marker frequency as the new center frequency.

Remote command:

[CALCulate<n>:MARKer<m>:FUNCTion:CENTer](#) on page 656

**Marker Track**

Turns marker frequency tracking on and off.

If on, the R&S ESRP changes the center frequency to the marker frequency when you change the marker position.

Remote command:

`CALCulate<n>:MARKer<m>:COUPled[:STATe]` on page 656

**Marker to Stepsize**

Matches the [frequency stepsize](#) to the marker frequency.

**Example:**

If the marker is positioned on a frequency of 1.25 MHz, the frequency stepsize is 1.25 MHz.

Remote command:

`CALCulate<n>:MARKer<m>:FUNction:CSTep` on page 657

**Settings Coupled**

Couples or decouples the receiver settings to the scan range settings when you use "Marker Tracking".

If on, the R&S ESRP changes the receiver settings according to the scan range the marker frequency is currently in.

Remote command:

`CALCulate<n>:MARKer<m>:SCOupled[:STATe]` on page 657

### 5.4.2.2 Positioning Markers

The MKR → key is used for search functions of measurement markers, assignment of the marker frequency as center frequency, restriction of the search area and characterization of maxima and minima. For details on markers in general, see [Chapter 5.4.2.1, "Controlling Markers"](#), on page 176.

**To open the Marker To menu**

- Press the MKR -> key.  
The "Marker To" menu is displayed. If no marker is active, marker 1 will be activated and a peak search on the trace carried out. Otherwise, the edit dialog box for the last activated marker is opened and the current frequency/time value is displayed.

**Further information**

- ["Effect of Different Peak Excursion Settings \(Example\)"](#) on page 385

**Tasks**

- ["Searching for a Maximum"](#) on page 384
- ["Searching for a Minimum"](#) on page 384

- ["Specifying the Search Limits"](#) on page 384
- ["Specifying the Search Range"](#) on page 384
- ["Examining a Signal at the Center in Detail"](#) on page 384
- ["Specifying the Suitable Peak Excursion"](#) on page 385

### Select Marker (No)

Opens a submenu to select one of 16 markers and define whether the marker is a normal or a delta marker (see ["Marker 1 / Marker 2 / Marker 3 / ... Marker 16, / Marker Norm/Delta"](#) on page 177). "(No)" indicates the number of the currently active marker.

### Peak

Sets the active marker/delta marker to the highest maximum of the trace.

Remote command:

[CALCulate<n>:MARKer<m>:MAXimum\[:PEAK\]](#) on page 661

[CALCulate<n>:DELTamarker<m>:MAXimum\[:PEAK\]](#) on page 667

### Next Peak

Sets the active marker/delta marker to the next maximum of the selected trace.

Remote command:

[CALCulate<n>:MARKer<m>:MAXimum:NEXT](#) on page 660

[CALCulate<n>:DELTamarker<m>:MAXimum:NEXT](#) on page 667

### Min

Sets the active marker/delta marker to the minimum of the selected trace.

Remote command:

[CALCulate<n>:MARKer<m>:MINimum\[:PEAK\]](#) on page 662

[CALCulate<n>:DELTamarker<m>:MINimum\[:PEAK\]](#) on page 668

### Next Min

Sets the active marker/delta marker to the next minimum of the selected trace.

Remote command:

[CALCulate<n>:MARKer<m>:MINimum:NEXT](#) on page 662

[CALCulate<n>:DELTamarker<m>:MINimum:NEXT](#) on page 668

### Next Mode

Selects the mode of the [Next Peak](#) or [Next Min](#) softkey.

Three settings are available:

- |                                                                                                                     |                                                                                                            |
|---------------------------------------------------------------------------------------------------------------------|------------------------------------------------------------------------------------------------------------|
| "<"                                                                                                                 | Sets the active marker/delta marker to the next maximum/minimum left to the marker of the selected trace.  |
| "abs"                                                                                                               | Sets the active marker/delta marker to the next lower maximum/higher minimum of the selected trace.        |
| <td>Sets the active marker/delta marker to the next maximum/minimum right to the marker of the selected trace.</td> | Sets the active marker/delta marker to the next maximum/minimum right to the marker of the selected trace. |



Remote command:

**Next Peak:**

CALC:MARK:MAX:LEFT (<): CALCulate<n>:MARKer<m>:MAXimum:LEFT  
on page 660

CALCulate<n>:DELTamarker<m>:MAXimum:LEFT on page 666

CALC:MARK:MAX:RIGH (>): CALCulate<n>:MARKer<m>:MAXimum:RIGHT  
on page 661

CALCulate<n>:DELTamarker<m>:MAXimum:RIGHT on page 667

CALC:DELT:MAX:NEXT (abs): CALCulate<n>:MARKer<m>:MAXimum:NEXT  
on page 660

CALCulate<n>:DELTamarker<m>:MAXimum:NEXT on page 667

**Next Min:**

CALC:MARK:MIN:LEFT (>): CALCulate<n>:MARKer<m>:MINimum:LEFT  
on page 662

CALCulate<n>:DELTamarker<m>:MINimum:LEFT on page 668

CALC:MARK:MIN:RIGH (>): CALCulate<n>:MARKer<m>:MINimum:RIGHT  
on page 663

CALCulate<n>:DELTamarker<m>:MINimum:RIGHT on page 669

CALC:MARK:MIN:NEXT (abs): CALCulate<n>:MARKer<m>:MINimum:NEXT  
on page 662

CALCulate<n>:DELTamarker<m>:MINimum:NEXT on page 668

**Search Limits**

Opens a submenu to set the limits for maximum or minimum search in the x and y direction.

Remote command:

CALCulate<n>:MARKer<m>:X:SLIMits[:STATE] on page 659

**Left Limit ← Search Limits**

Opens an edit dialog box to enter a value for the lower limit (left vertical line: S1 for span > 0; T1 for zero span). The search is performed between the lines of the left and right limit (see also [Right Limit](#) softkey).

Remote command:

CALCulate<n>:MARKer<m>:X:SLIMits:LEFT on page 658

**Right Limit ← Search Limits**

Opens an edit dialog box to enter a value for the upper limit (left vertical line: S2 for span > 0; T2 for zero span). The search is performed between the lines of the left and right limit (see also [Left Limit](#) softkey). If no value is set, the upper limit corresponds to the stop frequency.

Remote command:

CALCulate<n>:MARKer<m>:X:SLIMits:RIGHT on page 658

**Threshold ← Search Limits**

Opens an edit dialog box to define the threshold line. The threshold line represents the lower level limit for a "Peak" search and the upper level limit for a "Min" search.

Remote command:

`CALCulate<n>:THReshold:STAtE` on page 833

`CALCulate<n>:THReshold` on page 833

#### Use Zoom Limits ← Search Limits

Restricts the marker search to the zoomed area.

Note that the marker zoom is only available in Spectrum mode.

Remote command:

`CALCulate<n>:MARKer<m>:X:SLIMits:ZOOM` on page 832

#### Search Lim Off ← Search Limits

Deactivates all limits of the search range.

Remote command:

`CALCulate<n>:MARKer<m>:X:SLIMits[:STAtE]` on page 659

`CALCulate<n>:THReshold:STAtE` on page 833

#### Peak Excursion

Opens an edit dialog box for level measurements to enter the minimum level value by which a signal must rise or fall so that it will be identified as a maximum or a minimum by the search functions. Entries from 0 dB to 80 dB are allowed; the resolution is 0.1 dB. The default setting for the peak excursion is 6 dB.

Remote command:

`CALCulate<n>:MARKer<m>:PEXCursion` on page 647

### 5.4.2.3 Markers in Spectrograms

In addition to the marker functionality described above, spectrograms support the following marker positioning functionality.

Search Mode.....	183
L Next Mode X.....	183
L Next Mode Y.....	184
L Marker Search Type.....	184
L Select Search Area.....	184

#### Search Mode

Opens a submenu to select the marker search mode.

#### Next Mode X ← Search Mode

Sets the search mode for the marker peak search if a search in the x-direction is active. Three modes are available:

"<"	Sets the active marker/delta marker to the next maximum/minimum left of the marker of the selected trace.
"abs"	Sets the active marker/delta marker to the next lower maximum/higher minimum of the selected trace.
">"	Sets the active marker/delta marker to the next maximum/minimum right of the marker of the selected trace.

Remote command:

See [Chapter 11.4.1.7, "Spectrogram Control"](#), on page 617

#### Next Mode Y ← Search Mode

Sets the search mode for the marker peak search if a search in the y direction is active. Three modes are available:

"up"	Places the active marker or deltamarker to the next peak value above the current marker position.
"abs"	Places the active marker or deltamarker to the next peak either to the left or to the right of the current position.
"dn"	Places the active marker or deltamarker to the next peak value below the current marker position.

Remote command:

See [Chapter 11.4.1.7, "Spectrogram Control"](#), on page 617

#### Marker Search Type ← Search Mode

Opens a dialog box to select the marker search direction.

- **X Search**  
Performs a search in the currently selected frame.
- **Y Search**  
Performs a search on the marker frequency (span > 0) or time (span = 0) over all captured frames.
- **XY Search**  
Performs a search in the frequency domain (span >0) or time domain (span=0) and over all captured frames at the same time.  
An XY Search is possible for searches that are independent on direction (< and >)

#### Select Search Area ← Search Mode

Opens a dialog box to specify the search area.

- **Visible**  
Performs a search in the visible Spectrogram area only.  
Note that if the Spectrogram is not visible for any reason (e.g. if the Spectrum Analyzer is in full screen mode), the search area is the data stored in the memory.
- **Memory**  
Performs a search over all captured frames that are stored in the memory of the R&S ESRP

Remote command:

[CALCulate<n>:MARKer<m>:SGRam:SARea](#) on page 622

### 5.4.3 (Limit) Lines

The [LINES] key is used to configure limit and display lines.

#### To open the Lines menu

- Press the [LINES] key.

The "Lines" menu and the "Select Limit Line" dialog box are displayed. For details on the "Select Limit Line" dialog box refer to [Chapter 5.4.3.5, "Selecting a Limit Line"](#), on page 191.

#### Menu and softkey description

- [Chapter 5.4.3.1, "Softkeys of the Lines Menu"](#), on page 185

#### Further information

- [Chapter 5.4.3.2, "Display Lines"](#), on page 189
- [Chapter 5.4.3.3, "Limit Lines \(Frequency/Time Lines\)"](#), on page 190

#### Tasks

- [Chapter 5.4.3.4, "Working with Lines"](#), on page 191
- [Chapter 5.4.3.5, "Selecting a Limit Line"](#), on page 191
- [Chapter 5.4.3.6, "Creating a New Limit Line"](#), on page 192
- [Chapter 5.4.3.7, "Editing an Existing Limit Line"](#), on page 195
- [Chapter 5.4.3.8, "Creating a New Limit Line Based upon an Existing Limit Line"](#), on page 195
- [Chapter 5.4.3.9, "Activating/Deactivating a Limit Line"](#), on page 196

### 5.4.3.1 Softkeys of the Lines Menu

The following table shows all softkeys available in the "Lines" menu.

(Lines are only available for RF measurements.)

#### Further information

- [Chapter 5.4.3.2, "Display Lines"](#), on page 189
- [Chapter 5.4.3.3, "Limit Lines \(Frequency/Time Lines\)"](#), on page 190

#### Tasks

- [Chapter 5.4.3.4, "Working with Lines"](#), on page 191
- [Chapter 5.4.3.5, "Selecting a Limit Line"](#), on page 191
- [Chapter 5.4.3.6, "Creating a New Limit Line"](#), on page 192
- [Chapter 5.4.3.7, "Editing an Existing Limit Line"](#), on page 195
- [Chapter 5.4.3.8, "Creating a New Limit Line Based upon an Existing Limit Line"](#), on page 195
- [Chapter 5.4.3.9, "Activating/Deactivating a Limit Line"](#), on page 196

Select Traces to check.....	186
Deselect All.....	186
New.....	186
L Edit Name.....	186
L Edit Comment.....	186

L Edit Margin.....	187
L Edit Value.....	187
L Insert Value.....	187
L Delete Value.....	187
L Save Limit Line.....	187
Edit.....	187
Copy to.....	187
Delete.....	188
X Offset.....	188
Y Offset.....	188
Display Lines.....	188
L Display Line 1 / Display Line 2.....	188
L Frequency Line 1 / Frequency Line 2.....	189
L Time Line 1 / Time Line 2.....	189
L Tuned Frequency (On Off).....	189

### Select Traces to check

Opens a dialog box to activate the selected limit line for a trace. One limit line can be activated for several traces simultaneously. For details see also [Chapter 5.4.3.9, "Activating/Deactivating a Limit Line"](#), on page 196.

Remote command:

`CALCulate<n>:LIMit<k>:TRACe` on page 676

`CALCulate<n>:LIMit<k>:STATe` on page 687

### Deselect All

Deactivates the selected limit line for all assigned traces. For details see also [Chapter 5.4.3.9, "Activating/Deactivating a Limit Line"](#), on page 196.

Remote command:

`CALCulate<n>:LIMit<k>:STATe` on page 687

### New

Opens the "Edit Limit Line" dialog box and a submenu to define a new limit line. For details see also [Chapter 5.4.3.3, "Limit Lines \(Frequency/Time Lines\)"](#), on page 190 and [Chapter 5.4.3.5, "Selecting a Limit Line"](#), on page 191.

### Edit Name ← New

Sets the focus on the "Name" field to enter or change the limit line name. All names must be compatible with the Windows conventions for file names. The limit line data are stored under this name. The instrument stores all limit lines with LIM as extension.

Remote command:

`CALCulate<n>:LIMit<k>:LOWer:MODE` on page 680

### Edit Comment ← New

Sets the focus on the "Comment" field to enter or change a comment for the limit line. The text must not exceed 40 characters.

Remote command:

`CALCulate<n>:LIMit<k>:COMMeNt` on page 674

**Edit Margin ← New**

Sets the focus on the "Margin" field to enter or change a margin for the limit line. The default setting is 0 dB (i.e. no margin).

**Edit Value ← New**

Opens an edit dialog box to change an existing x or y value, depending on the selected column. The softkey is only available if an existing value is selected.

The desired data points are entered in ascending order (two repeated frequencies/time values are permitted).

Remote command:

[CALCulate<n>:LIMit<k>:CONTrol\[:DATA\]](#) on page 677

[CALCulate<n>:LIMit<k>:UPPer\[:DATA\]](#) on page 683

[CALCulate<n>:LIMit<k>:LOWer\[:DATA\]](#) on page 679

**Insert Value ← New**

Creates an empty line above the selected data point to enter a new data point.

It is also possible to add a data point at the end of the list, if the focus is set below the last entry line of the list.

The data points are entered in ascending order (two repeated frequencies/time values are permitted). If the entered values are not in accordance with the ascending order rule, an error message is displayed and the values are discarded.

**Delete Value ← New**

Deletes the selected data point (x and y value). All succeeding data points are shifted up accordingly. This softkey is only available if an existing value is selected.

**Save Limit Line ← New**

Saves the currently edited limit line under the name defined in the "Name" field.

**Edit**

Opens a submenu to edit limit lines. For details see also [Chapter 5.4.3.3, "Limit Lines \(Frequency/Time Lines\)"](#), on page 190 and [Chapter 5.4.3.7, "Editing an Existing Limit Line"](#), on page 195.

The submenu contains the same commands as the "New" menu, see ["New"](#) on page 186.

Remote command:

see ["Using Display Lines"](#) on page 828

**Copy to**

Copies the data of the selected limit line and displays it in the "Edit Limit Line" dialog box. If the limit line is edited and saved under a new name, a new limit line can be easily generated by parallel translation or editing of an existing limit line.

For details see also [Chapter 5.4.3.3, "Limit Lines \(Frequency/Time Lines\)"](#), on page 190 and [Chapter 5.4.3.8, "Creating a New Limit Line Based upon an Existing Limit Line"](#), on page 195.

The submenu contains the same commands as the "New" menu, see ["New"](#) on page 186.

Remote command:

[CALCulate<n>:LIMit<k>:COPY](#) on page 675

### Delete

Deletes the selected limit line.

Remote command:

[CALCulate<n>:LIMit<k>:DELete](#) on page 675

### X Offset

Horizontally shifts a limit line that has been specified for relative frequencies or times (x-axis). The softkey opens an edit dialog box in which the value for shifting can be entered numerically or via the rotary knob.

**Note:** This softkey does not have any effect on limit lines that represent absolute values for the x-axis.

Remote command:

[CALCulate<n>:LIMit<k>:CONTRol:OFFSet](#) on page 678

### Y Offset

Vertically shifts a limit line that has relative values for the y-axis (levels or linear units such as volt). The softkey opens an edit dialog box in which the value for shifting can be entered numerically or via the rotary knob.

**Note:** This softkey does not have any effect on limit lines that represent absolute values for the y-axis.

Remote command:

[CALCulate<n>:LIMit<k>:LOWer:OFFSet](#) on page 681

[CALCulate<n>:LIMit<k>:UPPer:OFFSet](#) on page 684

### Display Lines

Opens a submenu to enable, disable and set display lines. Which softkeys are available depends on the display mode (frequency or time range).

For details see also [Chapter 5.4.3.2, "Display Lines"](#), on page 189 and [Chapter 5.4.3.4, "Working with Lines"](#), on page 191.

The submenu contains the following functions:

- ["Display Line 1 / Display Line 2"](#) on page 188
- ["Display Line 1 / Display Line 2"](#) on page 188
- ["Frequency Line 1 / Frequency Line 2 "](#) on page 189
- ["Frequency Line 1 / Frequency Line 2 "](#) on page 189
- ["Time Line 1 / Time Line 2"](#) on page 189
- ["Time Line 1 / Time Line 2"](#) on page 189
- ["Tuned Frequency \(On Off\)"](#) on page 189

### Display Line 1 / Display Line 2 ← Display Lines

Enables or disables the level lines 1/2 and opens an edit dialog box to enter the position of the lines.

For details see also [Chapter 5.4.3.2, "Display Lines"](#), on page 189 and [Chapter 5.4.3.4, "Working with Lines"](#), on page 191.

Remote command:

`CALCulate<n>:DLINe<k>` on page 672

`CALCulate<n>:DLINe<k>:STATe` on page 672

### Frequency Line 1 / Frequency Line 2 ← Display Lines

Enables or disables the frequency lines 1/2 (span > 0) and opens an edit dialog box to enter the position of the lines.

For details see also [Chapter 5.4.3.2, "Display Lines"](#), on page 189 and [Chapter 5.4.3.4, "Working with Lines"](#), on page 191.

Remote command:

`CALCulate<n>:FLINe<k>` on page 673

`CALCulate<n>:FLINe<k>:STATe` on page 673

### Time Line 1 / Time Line 2 ← Display Lines

Enables or disables the time lines 1/2 (zero span) and opens an edit dialog box to enter the position of the lines.

For details see also [Chapter 5.4.3.2, "Display Lines"](#), on page 189 and [Chapter 5.4.3.4, "Working with Lines"](#), on page 191.

Note that time lines are only available in Spectrum mode.

Remote command:

`CALCulate<n>:TLINe<Line>` on page 829

`CALCulate<n>:TLINe<Line>:STATe` on page 829

### Tuned Frequency (On Off) ← Display Lines

Turns a frequency line coupled to the receiver frequency on and off.

The line that marks the receiver frequency is a green line labeled "TF".

Available for the Scan result display.

Remote command:

`CALCulate:TFLine:STATe` on page 673

## 5.4.3.2 Display Lines

Display lines help to evaluate a trace – as do markers. The function of a display line is comparable to that of a ruler that can be shifted on the trace in order to mark absolute values. They are used exclusively to visually mark relevant frequencies or points in time (span = 0), as well as constant level values. It is not possible to check automatically whether the points are below or above the marked level values.

For details on setting and switching the display lines on/off see [Chapter 5.4.3.4, "Working with Lines"](#), on page 191.

Two different types of display lines are provided:

- Two horizontal level lines for marking levels – Display Line 1 and 2  
The level lines are continuous horizontal lines across the entire width of a diagram and can be shifted in y direction.
- Two vertical frequency or time lines for marking frequencies or points in time – Frequency/Time Line 1 and 2



The frequency or time lines are continuous vertical lines across the entire height of the diagram and can be shifted in x direction.

### Lables

Each line is identified by one of the following abbreviations in the display:

- D1: Display Line 1
- D2: Display Line 2
- F1: Frequency Line 1
- F2: Frequency Line 2
- T1: Time Line 1
- T2: Time Line 2

#### 5.4.3.3 Limit Lines (Frequency/Time Lines)

Limit lines are used to define amplitude curves or spectral distribution boundaries on the display screen which are not to be exceeded. They indicate, for example, the upper limits for interference radiation or spurious waves which are allowed from a device under test (DUT). For transmission of information in TDMA systems (e.g. GSM), the amplitude of the bursts in a timeslot must adhere to a curve that falls within a specified tolerance band. The lower and upper limits may each be specified by a limit line. Then, the amplitude curve can be controlled either visually or automatically for any violations of the upper or lower limits (GO/NOGO test).

The instrument supports limit lines with a maximum of 50 data points. 8 of the limit lines stored in the instrument can be activated simultaneously. The number of limit lines stored in the instrument is only limited by the capacity of the flash disk used. Which softkeys are available depends on the display mode (frequency or time range). For details see also [Chapter 5.4.3.5, "Selecting a Limit Line"](#), on page 191.

Limit lines are compatible with the current measurement settings, if the following applies:

- The x unit of the limit line has to be identical to the current setting.
- The y unit of the limit line has to be identical to the current setting with the exception of dB based units; all dB based units are compatible with each other.

At the time of entry, the R&S ESRP immediately checks that all limit lines are in accordance with the following guidelines:

- The frequencies/times for each data point must be entered in ascending order, however, for any single frequency/time, two data points may be entered (vertical segment of a limit line).
- The data points are allocated in order of ascending frequency/time. Gaps are not allowed. If gaps are desired, two separate limit lines must be defined and then both enabled.
- The entered frequencies/times need not necessarily be selectable in R&S ESRP. A limit line may also exceed the specified frequency or time range. The minimum frequency for a data point is -200 GHz, the maximum frequency is 200 GHz. For the

time range representation, negative times may also be entered. The allowed range is -1000 s to +1000 s.

#### 5.4.3.4 Working with Lines

If a line is switched on, the softkey is highlighted.

##### Switching a line on or off

1. Press the **Display Lines** softkey.
2. Press the softkey for the required line, e.g. **Display Line 1 / Display Line 2**.  
An edit dialog box is opened to enter the position of the line. If the line was switched off, it is switched on. If it was switched on, it remains switched on.
3. If another softkey is pressed, the edit dialog box for the line is closed, but the line remains switched on (softkey with highlighted background).
4. When you press the **Display Line 1 / Display Line 2** softkey for the second time, the edit dialog box for the line is opened again.
5. When you press the **Display Line 1 / Display Line 2** softkey the third time, the line is switched off (softkey without highlighted background).

#### 5.4.3.5 Selecting a Limit Line

- To display the "Select Limit Line" dialog box, press the LINES key.

All limit lines saved in the default directory and all subdirectories are displayed. For each limit line, the following information is given:

"Unit"	unit of the y-axis
"Traces"	selected traces to check
"Show"	limit line displayed in the measurement diagram or hidden
"Compatible"	compatibility of the limit line to the current measurement settings
"Offset"	user-definable X- and Y-offset for the limit line

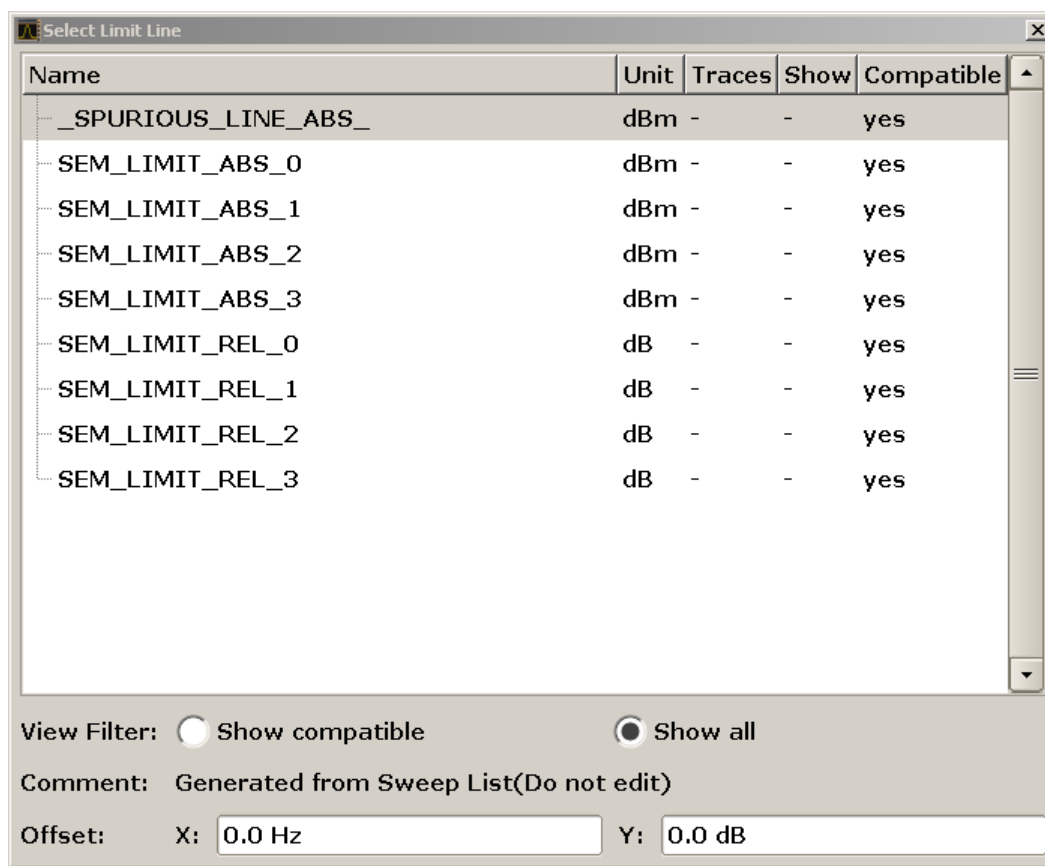

- To display only the limit lines that are compatible, activate the "Show compatible" option. For details on compatibility refer to [Chapter 5.4.3.3, "Limit Lines \(Frequency/Time Lines\)"](#), on page 190.

#### 5.4.3.6 Creating a New Limit Line

Press the **New** softkey to define a new limit line.

The "Edit Limit Line" dialog box is displayed. For more details on limit lines refer also to [Chapter 5.4.3.3, "Limit Lines \(Frequency/Time Lines\)"](#), on page 190. The following settings can be defined:

Setting	Description
Name	The name under which the limit line is to be stored in the main directory. To save the limit line in an existing subdirectory, enter the relative path. A new subdirectory can only be created using the [FILE] key (for details refer to <a href="#">"Save File / Recall File"</a> on page 502).
Comment	Optional description
Threshold	Absolute threshold value that works as a lower limit for the relative limit values (only for relative scaling of the y-axis).

Setting	Description
Margin	A fixed distance to the limit line. Margins are not as strict as limits and belong to the valid value range, but violation is also indicated in the display.
Position	Position of data point
Value	Value of data point
<b>X-Axis:</b>	
Span setting	<ul style="list-style-type: none"> <li>• "Hz" for span &gt; 0 Hz</li> <li>• "s" for zero span</li> </ul>
Scale mode	<ul style="list-style-type: none"> <li>• Absolute: The frequencies or times are interpreted as absolute physical units.</li> <li>• Relative: In the data point table, the frequencies are referred to the currently set center frequency. In the zero span mode, the left boundary of the diagram constitutes the reference.</li> </ul> <p>Relative scaling is always suitable if masks for bursts are to be defined in zero span or if masks for modulated signals are required for span &gt; 0 Hz.</p>
Scale	<ul style="list-style-type: none"> <li>• Linear</li> <li>• Logarithmic</li> </ul>
<b>Y-Axis:</b>	
Scale unit	Unit of the y-axis
Scale mode	<ul style="list-style-type: none"> <li>• Absolute: The limit values refer to absolute levels or voltages.</li> <li>• Relative: The limit values refer to the reference level (Ref Level). Limit values with the unit dB are always relative values.</li> </ul>
Limit type	<ul style="list-style-type: none"> <li>• Upper limit</li> <li>• Lower limit</li> </ul>

In addition, the following functions are available for the limit line:

### Defining a threshold

If the scaling of the y-axis is relative, you can define an absolute threshold value that works as a lower limit for the relative limit values (see figure below).

- ▶ Enter a value in the "Threshold" field of the "Edit Limit Line" dialog box.

The function is especially useful for mobile radio applications provided the limit values are defined in relation to the carrier power as long as they are above an absolute limit value.

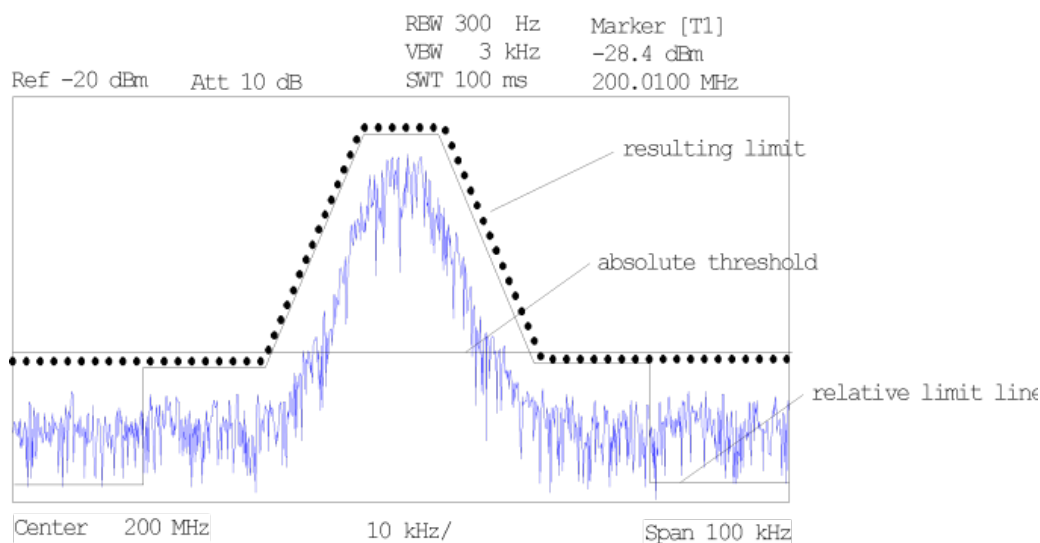

### Defining a margin

A margin is similar to a limit, but less strict and it still belongs to the valid data range. It can be used as a warning that the limit is almost reached. The margin is not indicated by a separate line in the display.

- ▶ Enter a value in the "Margin" field of the "Edit limit Line" dialog box.  
 If the limit line is defined as an upper limit, the margin is below the limit line. If the limit line is defined as a lower limit, the margin is above the limit line.

### Entering a new data point

1. Press the "Insert value" button in the dialog, or select an existing data point in the table and press the [Insert Value](#) softkey.
2. Enter the new position (x) and value (y) in the edit dialog box.

### Changing a data point

1. Press on the data point to be changed in the table.
2. Enter the new position (x) and value (y) in the edit dialog box.

### Deleting a data point

1. Press on the data point to be deleted in the table.
2. Press the "Delete" button in the dialog.

### Shifting a limit line horizontally

- ▶ Select the "Shift x" button and enter a shift width for the x value in the edit dialog box.

### Shifting a limit line vertically

- ▶ Select the "Shift y" button and enter a shift width for the y value in the edit dialog box.

### Saving the limit line settings

- ▶ Press the "Save" button in the dialog.  
If an existing name is used, a message box is displayed. You have to confirm before the limit line is overwritten.

#### 5.4.3.7 Editing an Existing Limit Line

In the "Select Limit Line" dialog box, select the limit line you want to change. For details see also [Chapter 5.4.3.5, "Selecting a Limit Line"](#), on page 191.



Note that any changes to the special limit lines for spurious and SEM measurements are automatically overwritten when the sweep list settings are changed.

1. Press the "Edit" on page 187 softkey.
2. Edit the data as described in [Chapter 5.4.3.6, "Creating a New Limit Line"](#), on page 192.
3. Save the limit line ( "Save Limit Line" on page 187 softkey).

#### 5.4.3.8 Creating a New Limit Line Based upon an Existing Limit Line

1. In the "Select Limit Line" dialog box, select the limit line you want to use as a basis for a new limit line. For details see also [Chapter 5.4.3.5, "Selecting a Limit Line"](#), on page 191.
2. Press the [Copy to](#) softkey to transfer the data of the limit line into the "Edit Limit Line" dialog box.
3. Press the [Edit Name](#) softkey and enter a new name.
4. To shift the complete limit line parallel in the horizontal direction, select the "Shift x" button and enter an x shift value. In this manner, a new limit line can be easily generated based upon an existing limit line which has been shifted horizontally.
5. To shift the complete limit line parallel in the vertical direction, select the "Shift y" button and enter a y shift value. In this manner, a new limit line can be easily generated based upon an existing limit line which has been shifted vertically.
6. If required, edit the data as described in [Chapter 5.4.3.5, "Selecting a Limit Line"](#), on page 191.
7. Save the limit line ( [Save Limit Line](#) softkey).

### 5.4.3.9 Activating/Deactivating a Limit Line

**Prerequisites:**

The x- and y-units of limit line and current measurement setting have to be compatible. For details refer to [Chapter 5.4.3.3, "Limit Lines \(Frequency/Time Lines\)"](#), on page 190.

The limit line has to consist of 2 or more data points.

1. In the "Select Limit Line" dialog box, select the limit line you want to activate/deactivate. For details see also [Chapter 5.4.3.5, "Selecting a Limit Line"](#), on page 191.
2. To activate or deactivate a limit line for a trace, press the ["Select Traces to check"](#) on page 186 softkey and select or deselect the trace(s) to which this limit line applies.
3. To deactivate the limit line for all traces, press the ["Deselect All"](#) on page 186 softkey.

## 6 Spectrum Measurements

You can also perform conventional spectrum analysis with the R&S ESRP.

When you start the R&S ESRP for the first time or after a preset, it starts in receiver mode. If it is inactive, press the [MODE] key and select the "Spectrum" softkey in the corresponding menu to enter the spectrum mode.

This chapter of the manual describes all functionality that is available in spectrum mode.

- [Chapter 6.1, "Measurements"](#), on page 197  
This section describes how to configure and perform specific measurements that are available in Spectrum mode.  
Measurement examples are provided in the Quick Start Guide, chapter 5 "Basic Measurement Examples" and the Operating Manual, chapter "Advanced Measurement Examples".
- [Chapter 6.3, "Analysis"](#), on page 358  
This section describes the tools that are available to analyze measurement results.
- [Chapter 6.2, "Configuration"](#), on page 313  
This section describes general measurement parameters. The general measurement parameters apply to all measurements performed in Spectrum mode.

### 6.1 Measurements

In the Spectrum mode, the R&S ESRP provides a variety of different measurement functions.

The individual functions are described in detail in the following sections.

#### 6.1.1 Power Measurements – MEAS Key

With its power measurement functions, the R&S ESRP is able to measure all the necessary parameters with high accuracy in a wide dynamic range.

A modulated carrier is almost always used (except e.g. SSB-AM) for high-frequency transmission of information. Due to the information modulated upon the carrier, the latter covers a spectrum which is defined by the modulation, the transmission data rate and the signal filtering. Within a transmission band each carrier is assigned a channel taking into account these parameters. In order to ensure error-free transmission, each transmitter must be conforming to the specified parameters. These include among others:

- the output power
- the occupied bandwidth, i.e. the bandwidth which must contain a defined percentage of the power
- the power dissipation allowed in the adjacent channels



The MEAS key is used for complex measurement functions as power measurements, occupied bandwidth, signal statistic, carrier to noise spacing, AM modulation depth, third-order intercept point, harmonics and spurious emissions. For measurement examples refer to the Quick Start Guide, "Basic Measurement Examples".

**The following measurements can be performed:**

- Channel power and adjacent-channel power with span > 0 and with a single or several carriers ("CH Power ACLR" softkey, for details see [Chapter 6.1.1.2, "Measuring Channel Power and Adjacent-Channel Power"](#), on page 201)
- Carrier-to-noise ratio ("C/N C/NO" softkey, for details see [Chapter 6.1.1.3, "Measuring the Carrier-to-Noise Ratio"](#), on page 225)
- Occupied bandwidth ("OBW" softkey, for details see [Chapter 6.1.1.4, "Measuring the Occupied Bandwidth"](#), on page 228)
- Spectrum Emission Mask measurements ("Spectrum Emission Mask" softkey, for details see [Chapter 6.1.1.5, "Measuring with Spectrum Emission Masks"](#), on page 232)
- Spurious Emissions measurements ("Spurious Emissions" softkey, for details see [Chapter 6.1.1.6, "Measuring Spurious Emissions"](#), on page 259)
- Power in zero span ("Time Domain Power" softkey, for details see [Chapter 6.1.1.7, "Measuring the Power in Zero Span"](#), on page 270).
- EMI Measurement softkey, for details see [Chapter 6.1.1.8, "Performing EMI Measurements"](#), on page 273
- Amplitude probability distribution ("APD" and "CCDF" softkeys, for details see [Chapter 6.1.1.9, "Calculating Signal Amplitude Statistics"](#), on page 282)
- 3rd order intercept ("TOI" softkey, for details see [Chapter 6.1.1.10, "Measuring the Third Order Intercept Point \(TOI\)"](#), on page 301)
- Modulation depth ("AM Mod Depth" softkey, for details see [Chapter 6.1.1.11, "Measuring the AM Modulation Depth"](#), on page 307)
- Harmonic Distortion measurements ("Harmonic Distortion" softkey, for details see [Chapter 6.1.1.12, "Measuring Harmonic Distortion"](#), on page 308)

**To open the power measurement menu**

- Press the [MEAS] key.  
The measurement menu for spectrum analysis is displayed (see [Chapter 6.1.1.1, "Softkeys of the Power Measurement Menu"](#), on page 198).

### 6.1.1.1 Softkeys of the Power Measurement Menu

The following table shows all softkeys available in the power measurement menu. It is possible that your instrument configuration does not provide all softkeys. If a softkey is only available with a special option, model or (measurement) mode, this information is provided in the corresponding softkey description.

Ch Power ACLR.....	199
C/N, C/No (span > 0).....	199
OBW (span > 0).....	199

Spectrum Emission Mask.....	199
Spurious Emissions.....	199
Time Domain Power (zero span).....	200
All Functions Off.....	200
APD.....	200
CCDF.....	200
TOI.....	200
AM Mod Depth.....	200
Harmonic Distortion.....	201
All Functions Off.....	201

### Ch Power ACLR

Activates the active channel or adjacent-channel power measurement either for a single carrier signal or for several carrier signals, depending on the current measurement configuration, and opens a submenu to configure the channel power measurement.

For details see [Chapter 6.1.1.2, "Measuring Channel Power and Adjacent-Channel Power"](#), on page 201.

Remote command:

`CALCulate<n>:MARKer<m>:FUNCTION:POWER:SElect` on page 688

`CALCulate<n>:MARKer<m>:FUNCTION:POWER:RESult?` on page 689

`CALCulate<n>:MARKer<m>:FUNCTION:POWER[:STATe]` on page 692

### C/N, C/No (span > 0)

Opens a submenu to configure the carrier/noise ratio measurement. Measurements without (C/N) and measurements with reference to the bandwidth (C/No) are possible.

For details see [Chapter 6.1.1.3, "Measuring the Carrier-to-Noise Ratio"](#), on page 225.

### OBW (span > 0)

Activates measurement of the occupied bandwidth according to the current configuration and opens a submenu to configure the measurement. For details see [Chapter 6.1.1.4, "Measuring the Occupied Bandwidth"](#), on page 228.

Remote command:

`CALCulate<n>:MARKer<m>:FUNCTION:POWER:SElect` on page 688

`CALCulate<n>:MARKer<m>:FUNCTION:POWER:RESult?` on page 689

`CALCulate<n>:MARKer<m>:FUNCTION:POWER[:STATe]` on page 692

### Spectrum Emission Mask

Opens a submenu to configure the Spectrum Emission Mask measurement.

The Spectrum Emission Mask (SEM) measurement defines a measurement that monitors compliance with a spectral mask.

For details see [Chapter 6.1.1.5, "Measuring with Spectrum Emission Masks"](#), on page 232.

Remote command:

`SENS:SWE:MODE ESP`, see `[SENSe:]SWEep:MODE` on page 729

### Spurious Emissions

Opens a submenu to configure the Spurious Emissions measurement.

The Spurious Emissions measurement defines a measurement that monitors unwanted RF products outside the assigned frequency band generated by an amplifier.

For details see [Chapter 6.1.1.6, "Measuring Spurious Emissions"](#), on page 259.

Remote command:

`SENS:SWE:MODE LIST`, see `[SENSe:]SWEep:MODE` on page 729

#### **Time Domain Power (zero span)**

Activates the power measurement in zero span and opens a submenu to configure the power measurement. For details see [Chapter 6.1.1.7, "Measuring the Power in Zero Span"](#), on page 270.

Remote command:

`CALCulate<n>:MARKer<m>:FUNction:SUMMary[:STATe]` on page 769

#### **All Functions Off**

Switches off all power measurement functions.

#### **APD**

Activates the function to measure the amplitude probability density (APD) and opens a submenu.

For details see [Chapter 6.1.1.9, "Calculating Signal Amplitude Statistics"](#), on page 282.

Remote command:

`CALCulate<n>:STATistics:APD[:STATe]` on page 760

#### **CCDF**

Activates the function to measure the complementary cumulative distribution function (CCDF) and opens a submenu.

For details see [Chapter 6.1.1.9, "Calculating Signal Amplitude Statistics"](#), on page 282.

Remote command:

`CALCulate<n>:STATistics:CCDF[:STATe]` on page 760

#### **TOI**

Opens a submenu and activates the measurement of the 3rd order intercept point.

For details see [Chapter 6.1.1.10, "Measuring the Third Order Intercept Point \(TOI\)"](#), on page 301.

Remote command:

`CALCulate<n>:MARKer<m>:FUNction:TOI[:STATe]` on page 758

`CALCulate<n>:MARKer<m>:FUNction:TOI:RESult?` on page 759

#### **AM Mod Depth**

Opens a submenu and activates the measurement of the AM modulation depth. An AM-modulated carrier is required on the screen to ensure correct operation.

For details see [Chapter 6.1.1.11, "Measuring the AM Modulation Depth"](#), on page 307.

Remote command:

`CALCulate<n>:MARKer<m>:FUNCTION:MDEPth[:STATe]` on page 753

`CALCulate<n>:MARKer<m>:FUNCTION:MDEPth:RESult?` on page 752

### Harmonic Distortion

Opens a submenu to determine the settings for harmonics measurement and activates the harmonic distortion measurement.

For details see [Chapter 6.1.1.12, "Measuring Harmonic Distortion"](#), on page 308.

Remote command:

`CALCulate<n>:MARKer<m>:FUNCTION:HARMonics[:STATe]` on page 757

`CALCulate<n>:MARKer<m>:FUNCTION:HARMonics:DISToRtion?` on page 755

`CALCulate<n>:MARKer<m>:FUNCTION:HARMonics:LIST?` on page 755

### All Functions Off

Switches off all power measurement functions.

## 6.1.1.2 Measuring Channel Power and Adjacent-Channel Power

Measuring the power in channels adjacent to the carrier or transmission channel is useful to detect interference. The results are displayed as a bar chart for the individual channels.

- [About Channel Power Measurements](#)..... 201
- [Channel Power Measurement Results](#).....205
- [Configuring and Performing Channel Power Measurements](#).....207
- [Softkeys for Channel and Adjacent-Channel Power Measurements](#)..... 211
- [Predefined CP/ACLR Standards](#).....222
- [Optimized Settings for CP/ACLR Test Parameters](#).....223

### About Channel Power Measurements

Measuring channel power and adjacent channel power is one of the most important tasks in the field of digital transmission for a signal analyzer with the necessary test routines. While, theoretically, channel power could be measured at highest accuracy with a power meter, its low selectivity means that it is not suitable for measuring adjacent channel power as an absolute value or relative to the transmit channel power. The power in the adjacent channels can only be measured with a selective power meter.

A signal analyzer cannot be classified as a true power meter, because it displays the IF envelope voltage. However, it is calibrated such as to correctly display the power of a pure sine wave signal irrespective of the selected detector. This calibration cannot be applied for non-sinusoidal signals. Assuming that the digitally modulated signal has a Gaussian amplitude distribution, the signal power within the selected resolution bandwidth can be obtained using correction factors. These correction factors are normally used by the signal analyzer's internal power measurement routines in order to determine the signal power from IF envelope measurements. These factors apply if and only if the assumption of a Gaussian amplitude distribution is correct.

Apart from this common method, the R&S ESRP also has a true power detector, i.e. an RMS detector. It correctly displays the power of the test signal within the selected reso-

lution bandwidth irrespective of the amplitude distribution, without additional correction factors being required. The absolute measurement uncertainty of the R&S ESRP is < 1.5 dB and a relative measurement uncertainty of < 0.5 dB (each with a confidence level of 95 %).

**Measurement Methods**

The channel power is defined as the integration of the power across the channel bandwidth.

The **Adjacent Channel Power Ratio (ACPR)**, also known as the **Adjacent Channel Leakage Power Ratio (ACLR)**, is defined as the ratio between the total power of the adjacent channel to the carrier channel's power. An ACLR measurement with several carrier (transmission) channels (TX channels) is also possible and is referred to as a "multi-carrier ACLR measurement".

There are two possible methods for measuring channel and adjacent channel power with a signal analyzer:

- IBW method (Integration **B**andwidth **M**ethod)
- Zero-span method (Fast ACLR), i.e. using a channel filter
- [IBW method](#)..... 202
- [Fast ACLR](#).....203

**IBW method**

When measuring the channel power, the R&S ESRP integrates the linear power which corresponds to the levels of the pixels within the selected channel. The signal analyzer uses a resolution bandwidth which is far smaller than the channel bandwidth. When sweeping over the channel, the channel filter is formed by the passband characteristics of the resolution bandwidth (see [Figure 6-1](#)).

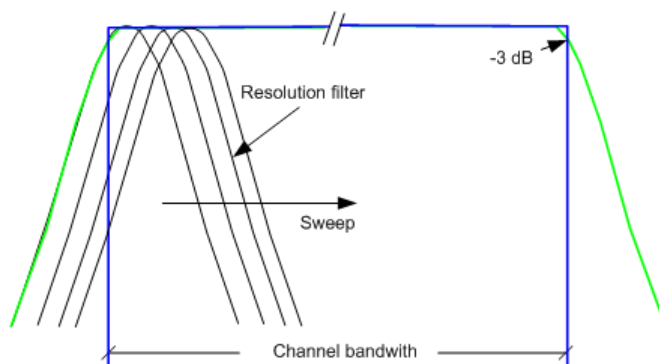

*Figure 6-1: Approximating the channel filter by sweeping with a small resolution bandwidth*

The following steps are performed:

1. The linear power of all the trace pixels within the channel is calculated.  
 $P_i = 10^{(L_i/10)}$   
 where  $P_i$  = power of the trace pixel  $i$   
 $L_i$  = displayed level of trace point  $i$

2. The powers of all trace pixels within the channel are summed up and the sum is divided by the number of trace pixels in the channel.
3. The result is multiplied by the quotient of the selected channel bandwidth and the noise bandwidth of the resolution filter (RBW).

Since the power calculation is performed by integrating the trace within the channel bandwidth, this method is called the IBW method (**I**ntegration **B**andwidth method).

### Fast ACLR

Using Fast ACLR, the R&S ESRP sets the center frequency to the different channel center frequencies consecutively and measures the power with the selected measurement time (= sweep time/number of channels).

The RBW filters suitable for the selected standard and frequency offset are automatically used (e.g. root raised cos with IS 136).

The RMS detector is used for obtaining correct power measurement results. Therefore no software correction factors are required.

### Measurement Repeatability

The repeatability of the results, especially in the narrow adjacent channels, strongly depends on the measurement time for a given resolution bandwidth. A longer sweep time may increase the probability that the measured value converges to the true value of the adjacent channel power, but obviously increases measurement time.

The integrated bandwidth method (IBW) calculates channel power and ACLR from the trace data obtained during a continuous sweep over the selected span. Most parts of this sweep are neither part of the channel itself nor the defined adjacent channels. Therefore, most of the samples taken during the sweeptime cannot be used for channel power or ACLR calculation.

To obtain a high repeatability with short measurement times, the R&S ESRP offers a "Fast ACLR" mode. In the Fast ACLR mode, the R&S ESRP measures the power of each channel at the defined channel bandwidth, while being tuned to the center frequency of the channel in question. The digital implementation of the resolution bandwidths makes it possible to select filter characteristics that are precisely tailored to the signal. In case of CDMA2000, the power in the useful channel is measured with a bandwidth of 1.23 MHz and that of the adjacent channels with a bandwidth of 30 kHz. Therefore the R&S ESRP changes from one channel to the other and measures the power at a bandwidth of 1.23 MHz or 30 kHz using the RMS detector. The power of the frequency range between the channels of interest is not measured in Fast ACLR mode, because it is not required for channel power or ACLR calculation. The measurement time per channel is set with the sweep time. It is equal to the selected measurement time divided by the selected number of channels.

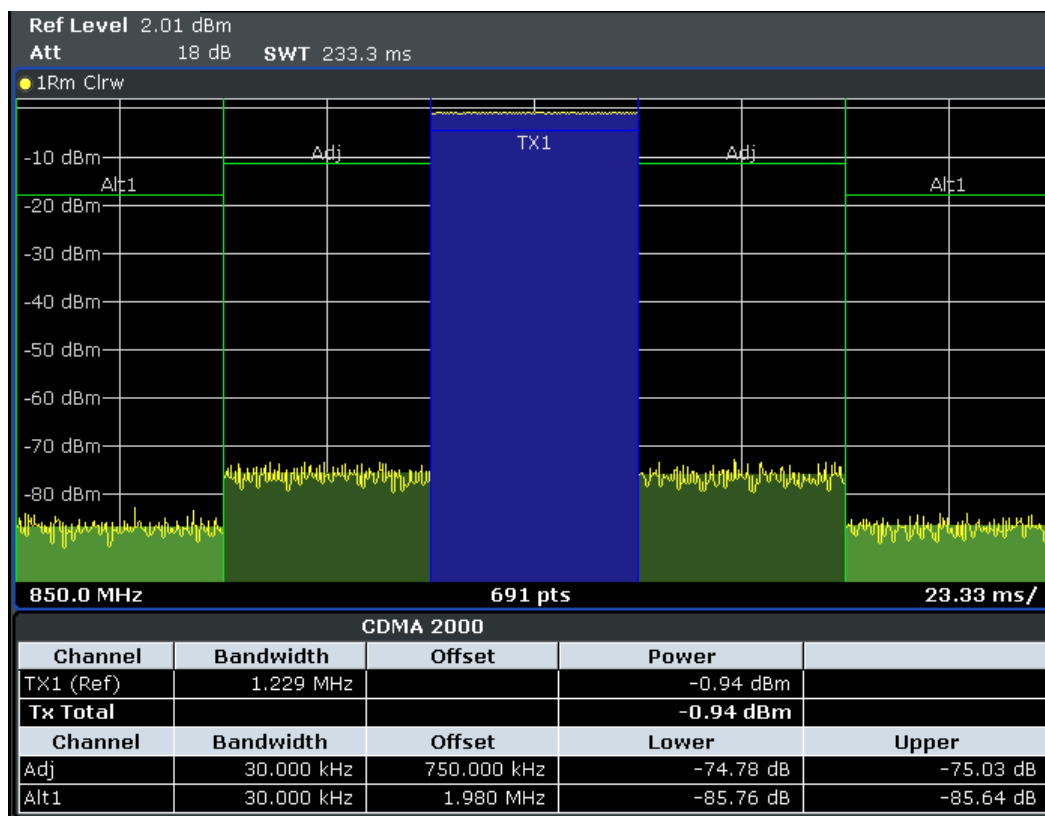

Figure 6-2: Measuring the channel power and adjacent channel power ratio for CDMA2000 1X signals with zero span (Fast ACP)

Assuming a measurement with five channels (1 channel plus 2 lower and 2 upper adjacent channels) and a sweep time of 100 ms, a measurement time per channel of 20 ms is required. The number of effective samples taken into account for power calculation in one channel is the product of sweeptime in channel times the selected resolution bandwidth.

Assuming a sweeptime of 100 ms, there are  $(30 \text{ kHz} / 4.19 \text{ MHz}) * 100 \text{ ms} * 10 \text{ kHz} \approx 7$  samples. Whereas in Fast ACLR mode, there are  $(100 \text{ ms} / 5) * 30 \text{ kHz} \approx 600$  samples. Comparing these numbers explains the increase of repeatability with a 95% confidence level ( $2\sigma$ ) from  $\pm 2.8 \text{ dB}$  to  $\pm 0.34 \text{ dB}$  for a sweeptime of 100 ms (as shown in Figure 6-3 and ).

For the same repeatability, the sweep time would have to be set to 8.5 s with the integration method. The Figure 6-4 shows the standard deviation of the results as a function of the sweep time.

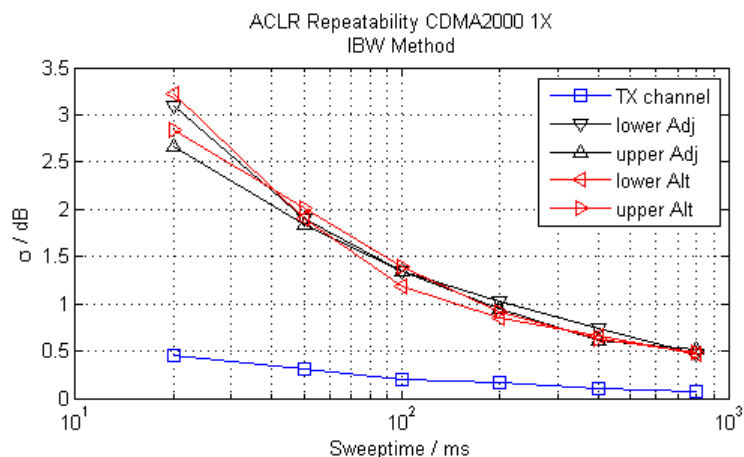

Figure 6-3: Repeatability of adjacent channel power measurement on CDMA2000 standard signals if the integration bandwidth method is used

The Figure 6-4 shows the repeatability of power measurements in the transmit channel and of relative power measurements in the adjacent channels as a function of sweep time. The standard deviation of measurement results is calculated from 100 consecutive measurements. Take scaling into account if comparing power values.

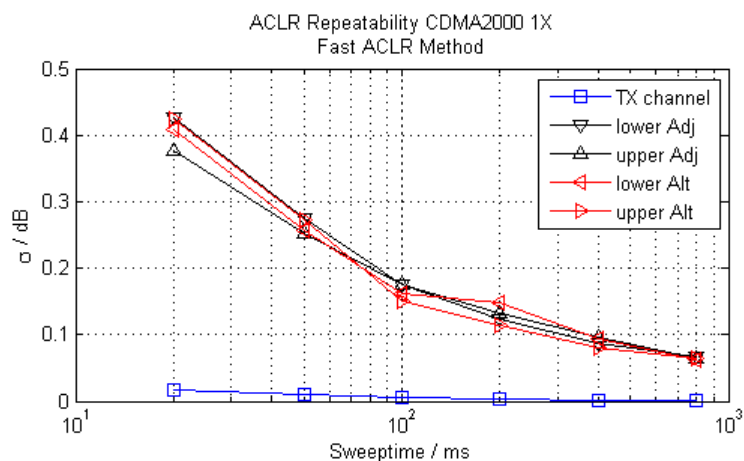
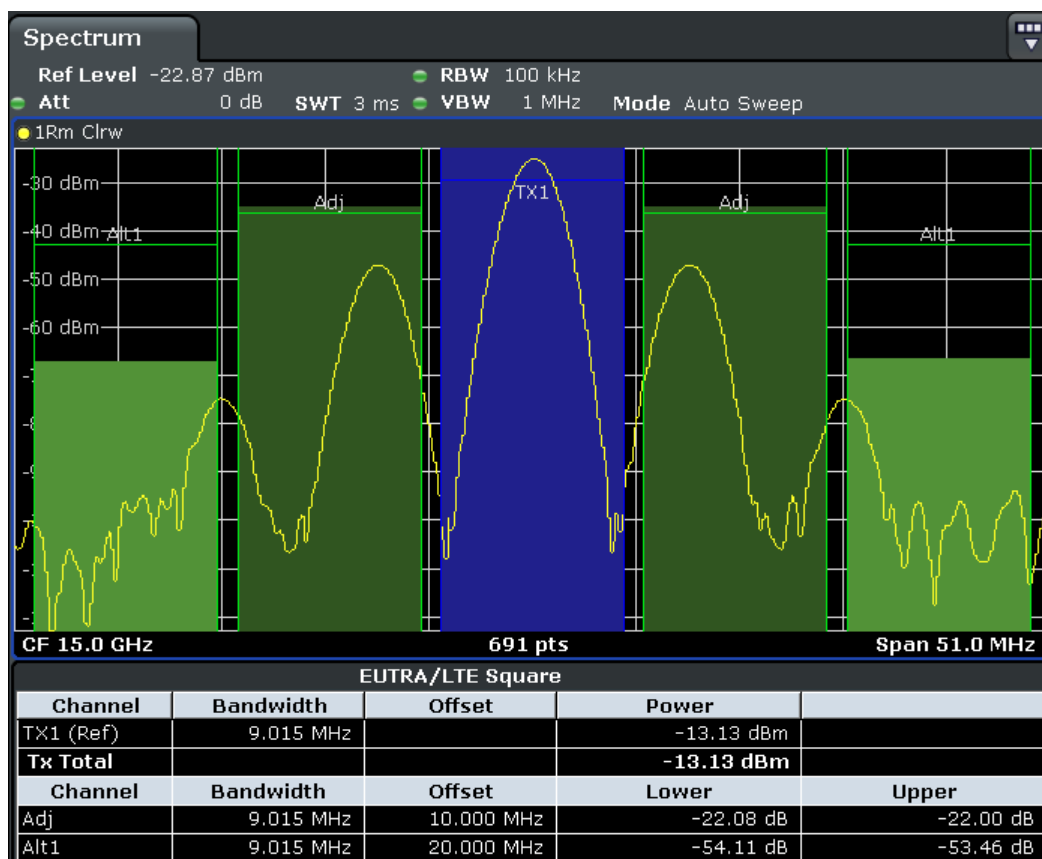

Figure 6-4: Repeatability of adjacent channel power measurements on CDMA2000 signals in the fast ACP mode

### Channel Power Measurement Results

For channel or adjacent-channel power measurements, the individual channels are indicated by different colored bars in the diagram. The height of each bar corresponds to the measured power of that channel. In addition, the name of the channel ("Adj", "Alt1", "TX1", etc. or a user-defined name) is indicated above the bar (separated by a line which has no further meaning).





Results are provided for the TX channel and the number of defined adjacent channels *above and below* the TX channel. If more than one TX channel is defined, the carrier channel to which the relative adjacent-channel power values should be referenced must be defined.

The measured power values for the TX and adjacent channels are also output as a table in the second screen. Which powers are measured depends on the number of configured channels, see "[# of Adj Chan](#)" on page 213.

For each channel, the following values are displayed:

Label	Description
Channel	Channel name as specified in the "Channel Settings" (see " <a href="#">Names</a> " on page 216).
Bandwidth	Configured channel bandwidth (see " <a href="#">Bandwidth</a> " on page 214)
Offset	Offset of the channel to the TX channel (Configured channel spacing, see " <a href="#">Spacing</a> " on page 215)
Power (Lower/Upper)	The measured power values for the TX and lower and upper adjacent channels. The powers of the transmission channels are output in dBm or dBm/Hz, or in dBc, relative to the specified reference TX channel.

### Retrieving Results via Remote Control

All or specific channel power measurement results can be retrieved using the `CALCulate<n>:MARKer<m>:FUNCTION:POWer:RESult?` command from a remote computer.

Alternatively, the results can be output as channel power density, i.e. in reference to the measurement bandwidth (see `CALCulate<n>:MARKer<m>:FUNCTION:POWer:RESult:PHZ` on page 714).

In addition, the `TRACe<n>:DATA` command queries the trace data. In case of channel power measurements, the trace data is the power levels that have been measured for each sweep point (max. 691).

### Configuring and Performing Channel Power Measurements

Predefined standards contain the main measurement settings for standard measurements. When such a standard is loaded, the required channel settings are automatically set on the R&S ESRP. However, the settings can be changed, and measurements with user-defined configurations are also possible.

Once the channels have been set up, other instrument settings such as the used filter bandwidths, frequency span and detector and trace settings can be optimized automatically (see "Adjust Settings" on page 219).

For an overview of the softkeys and menus see "Softkeys for Channel and Adjacent-Channel Power Measurements" on page 211.

### Selecting a Predefined Standard

Predefined standards contain the main measurement settings for standard measurements. When such a standard is loaded, the required channel settings are automatically set on the R&S ESRP.

The selected standard defines the following settings:

- "Bandwidth" on page 214
- "Spacing" on page 215
- Detector, see "Optimized Settings for CP/ACLR Test Parameters" on page 223
- Trace averaging, see "Average Mode" on page 364
- RBW, see "Optimized Settings for CP/ACLR Test Parameters" on page 223
- "Weighting Filter" on page 216

► Select a predefined standard via the `CP/ACLR Standard` softkey.

### Setting up the Channels

Channel definition is the basis for measuring power levels in certain frequency ranges. Usually, the power levels in one or more carrier (TX) channels and possibly the adjacent channels are of interest. Up to 18 carrier channels and up to 12 adjacent channels can be defined.



In the R&S ESRP's display, only the first neighboring channel of the carrier (TX) channel is labelled "Adj" (adjacent) channel; all others are labelled "Alt" (alternate) channels. In this manual, "adjacent" refers to both adjacent and alternate channels.

When an ACLR measurement is started by pressing the "Ch Power ACLR" softkey, all settings including the channel bandwidths and channel spacings are set according to the selected standard and can be adjusted afterwards.

Channel setup consists of the following settings:

- The number of transmission (TX) and adjacent channels
- The bandwidth of each channel
- For multi-carrier ACLR measurements: which TX channel is used as a reference ("ACLR Reference")
- The spacing between the individual channels
- Optionally: the names of the channels displayed in the diagram and result table
- Optionally: the influence of individual channels on the total measurement result ("Weighting Filter")
- Optionally: limits for a limit check on the measured power levels



Changes to an existing standard can be stored as a user-defined standard, see "[User-Defined Configurations](#)" on page 210.

- ▶ In the "Ch Power" menu, press [Channel Setup](#), then press the [Channel Setup](#) softkey to configure the channels in the "Channel Setup" dialog box.



In the "Channel Setup" dialog box you define the channel settings for all channels, independent of the defined number of *used* TX or adjacent channels.

- [Defining Channel Bandwidths](#).....208
- [Defining Channel Spacings](#).....209
- [Configuring a Limit Check](#).....210

### Defining Channel Bandwidths

The transmission-channel bandwidth is normally defined by the transmission standard. The correct bandwidth is set automatically for the selected standard (see "[Optimized Settings for CP/ACLR Test Parameters](#)" on page 223).

For measurements that require channel bandwidths which deviate from those defined in the selected standard, use the IBW method (see [Fast ACLR \(On/Off\)](#) softkey). With the IBW method, the channel bandwidth borders are right and left of the channel center frequency. Thus, you can visually check whether the entire power of the signal under test is within the selected channel bandwidth.

- ▶ In the "Channel Setup" dialog box, select the "Bandwidth" tab to define the channel bandwidths.

The value entered for any TX channel is automatically also defined for all subsequent TX channels. Thus, only one value needs to be entered if all TX channels have the same bandwidth.

The value entered for any ADJ or ALT channel is automatically also defined for all alternate (ALT) channels. Thus, only one value needs to be entered if all adjacent channels have the same bandwidth.

### Defining Channel Spacings

Channel spacings are normally defined by the selected standard but can be changed.

If the spacings are not equal, the channel distribution according to the center frequency is as follows:

Odd number of TX channels	The middle TX channel is centered to center frequency.
Even number of TX channels	The two TX channels in the middle are used to calculate the frequency between those two channels. This frequency is aligned to the center frequency.

- ▶ In the "Channel Setup" dialog box, select the "Spacing" tab to define the channel spacings.
  - The value entered for any TX channel is automatically also defined for all subsequent TX channels. Thus, only one value needs to be entered if all TX channels have the same spacing.
  - If the channel spacing for the adjacent or an alternate channel is changed, all higher alternate channel spacings are multiplied by the same factor (new spacing value/old spacing value). The lower adjacent-channel spacings remain unchanged.
  - Only one value needs to be entered for equal channel spacing.

### Example: Defining channel spacing

In the default setting, the adjacent channels have the following spacing: 20 kHz ("ADJ"), 40 kHz ("ALT1"), 60 kHz ("ALT2"), 80 kHz ("ALT3"), 100 kHz ("ALT4"), ...

If the spacing of the first adjacent channel ("ADJ") is set to 40 kHz, the spacing of all other adjacent channels is multiplied by factor 2 to result in 80 kHz ("ALT1"), 120 kHz ("ALT2"), 160 kHz ("ALT3"), ...

If, starting from the default setting, the spacing of the 5th adjacent channel ("ALT4") is set to 150 kHz, the spacing of all higher adjacent channels is multiplied by factor 1.5 to result in 180 kHz ("ALT5"), 210 kHz ("ALT6"), 240 kHz ("ALT7"), ...



For the R&S ESRP, the channel spacing is defined as the distance between the center frequency of the adjacent channel and the center frequency of the transmission channel. The definition of the adjacent-channel spacing in standards IS95C and CDMA 2000 is different. These standards define the adjacent-channel spacing from the center of the transmission channel to the closest border of the adjacent channel. This definition is also used for the R&S ESRP if the standards marked with an asterisk \*) are selected.

### Configuring a Limit Check

During an ACLR measurement, the power values can be checked whether they exceed user-defined limits. A relative or absolute limit can be defined, or both. Both limit types are considered, regardless whether the measured levels are absolute or relative values. The check of both limit values can be activated independently. If any active limit value is exceeded, the measured value is displayed in red and marked by a preceding asterisk in the result table.

W-CDMA 3GPP FWD				
Channel	Bandwidth	Offset	Power	
TX1 (Ref)	3.840 MHz		-124.39 dBm	
<b>Tx Total</b>			<b>-124.39 dBm</b>	
Channel	Bandwidth	Offset	Lower	Upper
Adj*	3.840 MHz	5.000 MHz	81.17 dB*	81.17 dB*
Alt1*	3.840 MHz	10.000 MHz	0.00 dB*	0.00 dB*

### To configure a limit check

1. In the "Channel Setup" dialog box, select the "Limits" tab to define a limit check.
2. For each channel, define a relative or absolute value that should not be exceeded.
3. Select the channels to be included in the limit check by activating the "Check" option.
4. Activate limit checking for the selected channels by setting "Limit Checking" to *On*.

### Performing a Channel Power Measurement

A channel power measurement is started automatically according to the currently selected standard when you press the "Ch Power ACLR" softkey in the [MEAS] menu.

- ▶ To start a new measurement after changing the settings, press the [RUN Single] or [RUN CONT] hardkeys.  
Alternatively, you can save your settings as a user standard (see ["User-Defined Configurations"](#) on page 210), then select that standard and start the measurement as usual by pressing the "Ch Power ACLR" softkey.

The configured measurement is performed (depending on the number of defined channels, see ["# of Adj Chan"](#) on page 213) and the results are displayed in the graphic and the result table.

### User-Defined Configurations

You can define measurement configurations independently of a predefined standard and save the current ACLR configuration as a "user standard" in an xml file. You can then load the file and thus the settings again at a later time.

User-defined standards are not supported for "Fast ACLR" and Multi-Carrier ACLR measurements.



### Compatibility to R&S FSP

User standards created on an analyzer of the R&S FSP family are compatible to the R&S ESRP. User standards created on an R&S ESRP, however, are not necessarily compatible to the analyzers of the R&S FSP family and may not work there.

#### To store a user-defined configuration

1. Select the "User Standard" softkey in the "Ch Power" menu.
2. Press "Save".
3. Define a file name for the user standard and select its storage location.  
By default, the xml file is stored in C:\R\_S\Instr\acp\_std\. However, you can define any other storage location.
4. Press "Save".

The following parameter definitions are saved:

- "# of Adj Chan" on page 213
- Channel spacing and adjacent-channel spacing, see "Spacing" on page 215
- Channel bandwidth of transmission (Tx), adjacent (Adj) and alternate (Alt) channels, see "Bandwidth" on page 214
- Resolution bandwidth, see "Res BW Auto" on page 332
- Video bandwidth, see "Video BW Auto" on page 333
- Detector, see "Detector" on page 362
- ACLR limits and their state, see "Limits" on page 217
- Sweep time and sweep time coupling, see "Sweep Time" on page 219
- Trace and power mode, see "Select Trace" on page 219 and "Power Mode" on page 218

#### To load a user-defined configuration

- ▶ Press "User Standard > Load" and select the user standard file.

#### Softkeys for Channel and Adjacent-Channel Power Measurements

Ch Power ACLR.....	212
L CP/ACLR Standard.....	212
L CP/ACLR Settings.....	213
L # of TX Chan.....	213
L # of Adj Chan.....	213
L Channel Setup.....	213
L Bandwidth.....	214
L ACLR Reference.....	215
L Spacing.....	215
L Names.....	216
L Weighting Filter.....	216
L Limits.....	217
L Limit Checking.....	217
L Relative Limit.....	218
L Absolute Limit.....	218
L Check.....	218

L Chan Pwr/Hz.....	218
L Power Mode.....	218
L Clear/Write.....	218
L Max Hold.....	219
L Select Trace.....	219
L ACLR (Abs/Rel).....	219
L Adjust Settings.....	219
L Sweep Time.....	219
L Fast ACLR (On/Off).....	220
L Set CP Reference.....	220
L User Standard.....	220
L Load.....	221
L Save.....	221
L Delete.....	221
L Noise Correction.....	221
L Adjust Ref Lvl.....	222

### Ch Power ACLR

Activates the active channel or adjacent-channel power measurement either for a single carrier signal or for several carrier signals, depending on the current measurement configuration, and opens a submenu to configure the channel power measurement. With default settings the measurement is performed by integrating the powers at the display points within the specified channels (IBW method).

If several TX channels (carriers) are activated, the number of measured values is increased to ensure that adjacent-channel powers are measured with adequate accuracy.

For general information on performing channel or adjacent-channel power measurements, see [Chapter 6.1.1.2, "Measuring Channel Power and Adjacent-Channel Power"](#), on page 201.

Remote command:

`CALCulate<n>:MARKer<m>:FUNCTION:POWER:SElect` on page 688

`CALCulate<n>:MARKer<m>:FUNCTION:POWER:RESult?` on page 689

`CALCulate<n>:MARKer<m>:FUNCTION:POWER[:STATe]` on page 692

### CP/ACLR Standard ← Ch Power ACLR

Opens an edit dialog box to select the settings according to predefined standards. For details on the available standards see ["Predefined CP/ACLR Standards"](#) on page 222. By default no standard is set.

The selection of the standard influences the following parameters (see ["Optimized Settings for CP/ACLR Test Parameters"](#) on page 223):

- channel spacing and adjacent-channel spacing
- channel bandwidth, adjacent-channel bandwidth, and type of filtering
- resolution bandwidth
- video bandwidth
- detector
- # of adjacent channels
- trace averaging (switched off)

Remote command:

`CALCulate<n>:MARKer<m>:FUNCTION:POWER:PRESet` on page 696

### CP/ACLR Settings ← Ch Power ACLR

Opens a submenu to configure the channel power and adjacent channel power measurement independently of the predefined standards (for details see also "[Predefined CP/ACLR Standards](#)" on page 222 and "[Optimized Settings for CP/ACLR Test Parameters](#)" on page 223).

### # of TX Chan ← CP/ACLR Settings ← Ch Power ACLR

Opens an edit dialog box to enter the number of carrier signals to be taken into account in channel and adjacent-channel power measurements. Values from 1 to 18 are allowed.

Remote command:

`[SENSe:]POWER:ACHannel:TXChannel:COUNT` on page 701

### # of Adj Chan ← CP/ACLR Settings ← Ch Power ACLR

Opens an edit dialog box to enter the number of adjacent channels to be considered in the adjacent-channel power measurement. Values from 0 to 12 are allowed.

The following measurements are performed depending on the number of the channels:

0	Only the channel powers are measured.
1	The channel powers and the power of the upper and lower adjacent channel are measured.
2	The channel powers, the power of the upper and lower adjacent channel, and of the next higher and lower channel (alternate channel 1) are measured.
3	The channel power, the power of the upper and lower adjacent channel, the power of the next higher and lower channel (alternate channel 1), and of the next but one higher and lower adjacent channel (alternate channel 2) are measured.
...	...
12	The channel power, the power of the upper and lower adjacent channel, and the power of the all higher and lower channels (alternate channel 1 to 11) are measured.

Remote command:

`[SENSe:]POWER:ACHannel:ACPairs` on page 698

### Channel Setup ← CP/ACLR Settings ← Ch Power ACLR

Opens a dialog to define the channel settings for all channels, independent of the defined number of *used* TX or adjacent channels.



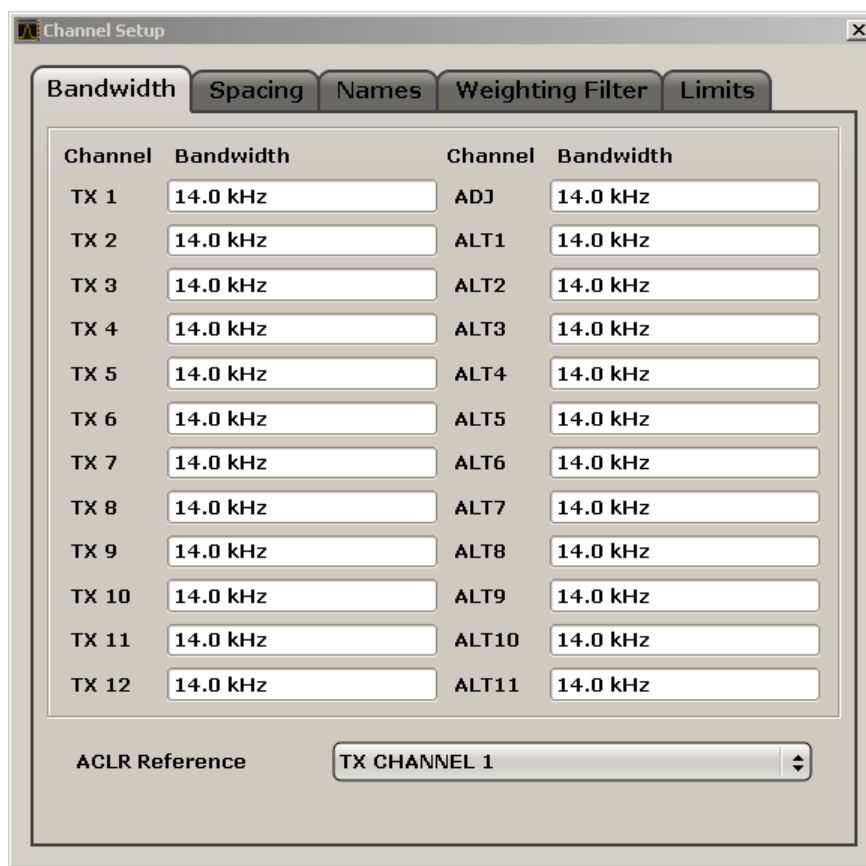

The dialog contains the following tabs:

- "Bandwidth" on page 214
- "Spacing" on page 215
- "Names" on page 216
- "Weighting Filter" on page 216
- "Limits" on page 217

#### Bandwidth ← Channel Setup ← CP/ACLR Settings ← Ch Power ACLR

Define the channel bandwidths for the transmission channels and the adjacent channels. "TX" is only available for the multi-carrier ACLR measurement. When you change the bandwidth for one channel, the value is automatically also defined for all subsequent channels of the same type.

The transmission-channel bandwidth is normally defined by the transmission standard. The correct bandwidth is set automatically for the selected standard (see "Optimized Settings for CP/ACLR Test Parameters" on page 223).

- Measurements in zero span (see [Fast ACLR \(On/Off\)](#) softkey) are performed in the zero span mode. The channel limits are indicated by vertical lines. For measurements requiring channel bandwidths deviating from those defined in the selected standard the IBW method is to be used.
- With the IBW method (see [Fast ACLR \(On/Off\)](#) softkey), the channel bandwidth limits are marked by two vertical lines right and left of the channel center frequency. Thus you can visually check whether the entire power of the signal under test is within the selected channel bandwidth.

If measuring according to the IBW method ("Fast ACLR Off"), the bandwidths of the different adjacent channels are to be entered numerically. Since all adjacent channels often have the same bandwidth, the other alternate channels are set to the bandwidth of the adjacent channel when it is changed. Thus, only one value needs to be entered in case of equal adjacent channel bandwidths.

For details on available channel filters see [Chapter 6.2.6.3, "Selecting the Appropriate Filter Type"](#), on page 337.

Remote command:

`[SENSe:] POWer:ACHannel:BANDwidth|BWIDth[:CHANnel<channel>]`

on page 699

`[SENSe:] POWer:ACHannel:BANDwidth|BWIDth:ACHannel` on page 698

`[SENSe:] POWer:ACHannel:BANDwidth|BWIDth:ALternate<channel>`

on page 698

### ACLR Reference ← Bandwidth ← Channel Setup ← CP/ACLR Settings ← Ch Power ACLR

Select the transmission channel to which the relative adjacent-channel power values should be referenced.

TX Channel 1	Transmission channel 1 is used.
Min Power TX Channel	The transmission channel with the lowest power is used as a reference channel.
Max Power TX Channel	The transmission channel with the highest power is used as a reference channel.
Lowest & Highest Channel	The outer left-hand transmission channel is the reference channel for the lower adjacent channels, the outer right-hand transmission channel that for the upper adjacent channels.

Remote command:

`[SENSe:] POWer:ACHannel:REference:TXCHannel:MANual` on page 705

`[SENSe:] POWer:ACHannel:REference:TXCHannel:AUTO` on page 704

### Spacing ← Channel Setup ← CP/ACLR Settings ← Ch Power ACLR

Define the channel spacings for the TX channels and for the adjacent channels.

- TX channels (left column)

TX1-2	spacing between the first and the second carrier
TX2-3	spacing between the second and the third carrier
...	...

The spacings between all adjacent TX channels can be defined separately. When you change the spacing for one channel, the value is automatically also defined for all subsequent TX channels in order to set up a system with equal TX channel spacing quickly. For different spacings, a setup from top to bottom is necessary.

If the spacings are not equal, the channel distribution according to the center frequency is as follows:

Odd number of TX channels	The middle TX channel is centered to center frequency.
Even number of TX channels	The two TX channels in the middle are used to calculate the frequency between those two channels. This frequency is aligned to the center frequency.

- **Adjacent channels (right column)**

Since all the adjacent channels often have the same distance to each other, the modification of the adjacent-channel spacing (ADJ) causes a change in all higher adjacent-channel spacings (ALT1, ALT2, ...): they are all multiplied by the same factor (new spacing value/old spacing value). Thus only one value needs to be entered in case of equal channel spacing. A modification of a higher adjacent-channel spacing (ALT1, ALT2, ...) causes a change by the same factor in all higher adjacent-channel spacings, while the lower adjacent-channel spacings remain unchanged.

**Example:**

In the default setting, the adjacent channels have the following spacing: 20 kHz ("ADJ"), 40 kHz ("ALT1"), 60 kHz ("ALT2"), 80 kHz ("ALT3"), 100 kHz ("ALT4"), ...  
If the spacing of the first adjacent channel ("ADJ") is set to 40 kHz, the spacing of all other adjacent channels is multiplied by factor 2 to result in 80 kHz ("ALT1"), 120 kHz ("ALT2"), 160 kHz ("ALT3"), ...

If, starting from the default setting, the spacing of the 5th adjacent channel ("ALT4") is set to 150 kHz, the spacing of all higher adjacent channels is multiplied by factor 1.5 to result in 180 kHz ("ALT5"), 210 kHz ("ALT6"), 240 kHz ("ALT7"), ...

If a ACLR or MC-ACLR measurement is started, all settings according to the standard including the channel bandwidths and channel spacings are set and can be adjusted afterwards.

Remote command:

[SENSe:] POWer:ACHannel:SPACing:CHANnel<channel> on page 701

[SENSe:] POWer:ACHannel:SPACing[:ACHannel] on page 700

[SENSe:] POWer:ACHannel:SPACing:ALternate<channel> on page 701

**Names ← Channel Setup ← CP/ACLR Settings ← Ch Power ACLR**

Define user-specific channel names for each channel. The names defined here are displayed in the result diagram and result table.

Remote command:

[SENSe:] POWer:ACHannel:NAME:ACHannel on page 699

[SENSe:] POWer:ACHannel:NAME:ALternate<channel> on page 700

[SENSe:] POWer:ACHannel:NAME:CHANnel<channel> on page 700

**Weighting Filter ← Channel Setup ← CP/ACLR Settings ← Ch Power ACLR**

Define weighting filters for all channels. Weighting filters are not available for all supported standards and cannot always be defined manually where they are available.

The dialog contains the following fields:

Field	Description
Channel	<ul style="list-style-type: none"> <li>• TX 1-18: TX channels</li> <li>• ADJ: Adjacent channel</li> <li>• ALT1-11: Alternate channels</li> </ul>
Active	Activates/Deactivates the weighting filter for the selected and any subsequent channels of the same type
Alpha	Defines the alpha value for the weighting filter for the selected and any subsequent channels of the same type

Remote command:

POW:ACH:FILT:CHAN1 ON, see [SENSe:]POW:ACHannel:FILTer[:STATe]:CHANnel<channel> on page 703

Activates the weighting filter for TX channel 1.

POW:ACH:FILT:ALPH:CHAN1 0,35 see [SENSe:]POW:ACHannel:FILTer:ALPHa:CHANnel<channel> on page 703

Sets the alpha value for the weighting filter for TX channel 1 to 0,35.

POW:ACH:FILT:ACH ON see [SENSe:]POW:ACHannel:FILTer[:STATe]:ACHannel on page 703

Activates the weighting filter for the adjacent channel.

POW:ACH:FILT:ALPH:ACH 0,35 see [SENSe:]POW:ACHannel:FILTer:ALPHa:ACHannel on page 702

Sets the alpha value for the weighting filter for the adjacent channel to 0,35.

POW:ACH:FILT:ALT1 ON see [SENSe:]POW:ACHannel:FILTer[:STATe]:ALTernate<channel> on page 703

Activates the alpha value for the weighting filter for the alternate channel 1.

POW:ACH:FILT:ALPH:ALT1 0,35 see [SENSe:]POW:ACHannel:FILTer:ALPHa:ALTernate<channel> on page 702

Sets the alpha value for the weighting filter for the alternate channel 1 to 0,35.

#### Limits ← Channel Setup ← CP/ACLR Settings ← Ch Power ACLR

Activate and define the limits for the ACLR measurement.

#### Limit Checking ← Limits ← Channel Setup ← CP/ACLR Settings ← Ch Power ACLR

Activate or deactivate limit checking for the ACLR measurement.

The following rules apply for the limits:

- A separate limit can be defined for each adjacent channel. The limit applies to both the upper and the lower adjacent channel.
- A relative and/or absolute limit can be defined. The check of both limit values can be activated independently.
- The R&S ESRP checks adherence to the limits irrespective of whether the limits are absolute or relative or whether the measurement is carried out with absolute or relative levels. If both limits are active and if the higher of both limit values is exceeded, the measured value is marked by a preceding asterisk.

Remote command:

[CALCulate<n>:LIMit<k>:ACPowEr\[:STATe\]](#) on page 713

[CALCulate<n>:LIMit<k>:ACPowEr:ACHannel:RESult](#) on page 708

[CALCulate<n>:LIMit<k>:ACPowEr:ALternate<channel>\[:RELative\]](#)  
on page 711

#### **Relative Limit** ← Limits ← Channel Setup ← CP/ACLR Settings ← Ch Power ACLR

Defines a limit relative to the carrier signal.

Remote command:

CALC:LIM:ACP ON, see [CALCulate<n>:LIMit<k>:ACPowEr\[:STATe\]](#)  
on page 713

CALC:LIM:ACP:<adjacent-channel> 0dBc,0dBc

CALC:LIM:ACP:<adjacent-channel>:STAT ON

#### **Absolute Limit** ← Limits ← Channel Setup ← CP/ACLR Settings ← Ch Power ACLR

Defines an absolute limit.

Remote command:

CALC:LIM:ACP ON, see [CALCulate<n>:LIMit<k>:ACPowEr\[:STATe\]](#)  
on page 713

CALC:LIM:ACP:<adjacent-channel>:ABS -10dBm,-10dBm

CALC:LIM:ACP:<adjacent-channel>:ABS:STAT ON, see [CALCulate<n>:LIMit<k>:ACPowEr:ACHannel:ABSolute:STATe](#) on page 706

#### **Check** ← Limits ← Channel Setup ← CP/ACLR Settings ← Ch Power ACLR

Activate or deactivate the limit to be considered during a limit check. The check of both limit values can be activated independently.

#### **Chan Pwr/Hz** ← CP/ACLR Settings ← Ch Power ACLR

If deactivated, the channel power is displayed in dBm. If activated, the channel power density is displayed instead. Thus, the absolute unit of the channel power is switched from dBm to dBm/Hz. The channel power density in dBm/Hz corresponds to the power inside a bandwidth of 1 Hz and is calculated as follows:

"channel power density = channel power – log<sub>10</sub>(channel bandwidth)"

By means of this function it is possible e.g. to measure the signal/noise power density or use the additional functions "[ACLR \(Abs/Rel\)](#)" on page 219 and "[ACLR Reference](#)" on page 215 to obtain the signal to noise ratio.

Remote command:

[CALCulate<n>:MARKer<m>:FUNCTion:POWer:RESult:PHZ](#) on page 714

#### **Power Mode** ← CP/ACLR Settings ← Ch Power ACLR

Opens a submenu to select the power mode.

#### **Clear/Write** ← Power Mode ← CP/ACLR Settings ← Ch Power ACLR

If this mode is activated, the channel power and the adjacent channel powers are calculated directly from the current trace (default mode).

Remote command:

CALC:MARK:FUNC:POW:MODE WRIT, see [CALCulate<n>:MARKer<m>:FUNCTION:POWer:MODE](#) on page 692

#### **Max Hold ← Power Mode ← CP/ACLR Settings ← Ch Power ACLR**

If this mode is activated, the power values are calculated from the current trace and compared with the previous power value using a maximum algorithm. The higher value is retained. If activated, the enhancement label "Pwr Max" is displayed.

Remote command:

CALC:MARK:FUNC:POW:MODE MAXH, see [CALCulate<n>:MARKer<m>:FUNCTION:POWer:MODE](#) on page 692

#### **Select Trace ← CP/ACLR Settings ← Ch Power ACLR**

Opens an edit dialog box to enter the trace number on which the CP/ACLR measurement is to be performed. Only activated traces can be selected.

For details on trace modes see [Chapter 5.2.3, "Trace Modes"](#), on page 147.

Remote command:

[SENSe:]POWer:TRACe on page 693

#### **ACLR (Abs/Rel) ← CP/ACLR Settings ← Ch Power ACLR**

Switches between absolute and relative power measurement in the adjacent channels.

Abs	The absolute power in the adjacent channels is displayed in the unit of the y-axis, e.g. in dBm, dBμV.
Rel	The level of the adjacent channels is displayed relative to the level of the transmission channel in dBc.

Remote command:

[SENSe:]POWer:ACHannel:MODE on page 714

#### **Adjust Settings ← CP/ACLR Settings ← Ch Power ACLR**

Automatically optimizes all instrument settings for the selected channel configuration (channel bandwidth, channel spacing) within a specific frequency range (channel bandwidth). The adjustment is carried out only once. If necessary, the instrument settings can be changed later.

For details on the settings of span, resolution bandwidth, video bandwidth, detector and trace averaging see ["Optimized Settings for CP/ACLR Test Parameters"](#) on page 223.

Remote command:

[SENSe:]POWer:ACHannel:PRESet on page 693

#### **Sweep Time ← Ch Power ACLR**

Opens an edit dialog box to enter the sweep time. With the RMS detector, a longer sweep time increases the stability of the measurement results.

The function of this softkey is identical to the [Sweep Time Manual](#) softkey in the "Bandwidth" menu.

Remote command:

[SENSe:] SWEep:TIME on page 803

#### **Fast ACLR (On/Off) ← Ch Power ACLR**

Switches between the IBW method ("Fast ACLR Off") and the zero span method ("Fast ACLR On").

When switched on, the R&S ESRP sets the center frequency consecutively to the different channel center frequencies and measures the power with the selected measurement time (= sweep time/number of channels). The RBW filters suitable for the selected standard and frequency offset are automatically used (e.g. root raised cos with IS 136). For details on available channel filters see [Chapter 6.2.6.3, "Selecting the Appropriate Filter Type"](#), on page 337.

The RMS detector is used for obtaining correct power measurement results. Therefore this requires no software correction factors.

Measured values are output as a list. The powers of the transmission channels are output in dBm, the powers of the adjacent channels in dBm.

The sweep time is selected depending on the desired reproducibility of results. Reproducibility increases with sweep time since power measurement is then performed over a longer time period. As a general approach, it can be assumed that approx. 500 non-correlated measured values are required for a reproducibility of 0.5 dB (99 % of the measurements are within 0.5 dB of the true measured value). This holds true for white noise. The measured values are considered as non-correlated if their time interval corresponds to the reciprocal of the measured bandwidth.

With IS 136 the measurement bandwidth is approx. 25 kHz, i.e. measured values at an interval of 40  $\mu$ s are considered as non-correlated. A measurement time of 40 ms is thus required per channel for 1000 measured values. This is the default sweep time which the R&S ESRP sets in coupled mode. Approx. 5000 measured values are required for a reproducibility of 0.1 dB (99 %), i.e. the measurement time is to be increased to 200 ms.

Remote command:

[SENSe:] PWEr:HSPEED on page 715

#### **Set CP Reference ← Ch Power ACLR**

Defines the currently measured channel power as the reference value if channel power measurement is activated. The reference value is displayed in the "Tx1 (Ref) Power" field; the default value is 0 dBm.

The softkey is available only for multi carrier ACLR measurements.

In adjacent-channel power measurement with one or several carrier signals, the power is always referenced to a transmission channel, i.e. no value is displayed for "Tx1 (Ref) Power".

Remote command:

[SENSe:] PWEr:ACHannel:REFERENCE:AUTO ONCE on page 704

#### **User Standard ← Ch Power ACLR**

Opens a submenu to configure customized standards.

**Load ← User Standard ← Ch Power ACLR**

Opens a dialog to select and load a user defined ACLR standard.

Remote command:

Querying available standards:

`CALCulate<n>:MARKer<m>:FUNCTION:POWER:STANDARD:CATALOG?`  
on page 697

Loading a standard:

`CALCulate<n>:MARKer<m>:FUNCTION:POWER:PRESet` on page 696

**Save ← User Standard ← Ch Power ACLR**

Saves the current ACLR configuration in an xml file in order for you to use it again at a later time. You can define the drive, path and file name in the corresponding dialog.

The default location is `C:\R_S\Instr\acp_std\`.

Note that the ACLR user standard is not supported by Fast ACLR and Multi Carrier ACLR measurements.

If you create your own standard, you can customize the following parameters:

- number of adjacent channels
- channel bandwidth of transmission (Tx), adjacent (Adj) and alternate (Alt) channels
- channel spacings
- resolution and video bandwidth
- ACLR limits and their state
- sweep time and sweep time coupling
- detector
- trace mode

Remote command:

Configuring channels:

see "[Configuring ACLR Channels](#)" on page 697 and "[Defining Weighting Filters](#)" on page 702

Saving custom channel configurations:

`CALCulate<n>:MARKer<m>:FUNCTION:POWER:STANDARD:SAVE` on page 697

**Delete ← User Standard ← Ch Power ACLR**

Deletes the user standard that you select in the corresponding dialog box. Note that the R&S ESRP deletes the file without further notice.

Remote command:

`CALCulate<n>:MARKer<m>:FUNCTION:POWER:STANDARD:DELETE` on page 697

**Noise Correction ← Ch Power ACLR**

If activated, the results are corrected by the instrument's inherent noise, which increases the dynamic range.



"ON"	A reference measurement of the instrument's inherent noise is carried out. The noise power measured is then subtracted from the power in the channel that is being examined. The inherent noise of the instrument depends on the selected center frequency, resolution bandwidth and level setting. Therefore, the correction function is disabled whenever one of these parameters is changed. A disable message is displayed on the screen. Noise correction must be switched on again manually after the change.
"OFF"	No noise correction is performed.
"AUTO"	Noise correction is performed. After a parameter change, noise correction is restarted automatically and a new correction measurement is performed.

Remote command:

`[SENSe:]POWer:NCORrection` on page 715

### Adjust Ref Lvl ← Ch Power ACLR

Adjusts the reference level to the measured channel power. This ensures that the settings of the RF attenuation and the reference level are optimally adjusted to the signal level without overloading the R&S ESRP or limiting the dynamic range by a too small S/N ratio.

For details on manual settings see "[Optimized Settings for CP/ACLR Test Parameters](#)" on page 223.

The reference level is not influenced by the selection of a standard. To achieve an optimum dynamic range, the reference level has to be set in a way that places the signal maximum close to the reference level without forcing an overload message. Since the measurement bandwidth for channel power measurements is significantly lower than the signal bandwidth, the signal path may be overloaded although the trace is still significantly below the reference level.

Remote command:

`[SENSe:]POWer:ACHannel:PRESet:RLEVel` on page 694

### Predefined CP/ACLR Standards

When using predefined standards for ACLR measurement, the test parameters for the channel and adjacent-channel measurements are configured automatically. The available standards are listed below.



Predefined standards are selected using the "CP/ACLR Standard" softkey or the `CALC:MARK:FUNC:POW:PRES` command.

Standard	GUI-Parameter	SCPI-Parameter
EUTRA/LTE Square	EUTRA/LTE Square	EUTRa
EUTRA/LTE Square/RRC	EUTRA/LTE Square/RRC	REUTRa
W-CDMA 3.84 MHz forward	W-CDMA 3GPP FWD	FW3G
W-CDMA 3.84 MHz reverse	W-CDMA 3GPP REV	RW3G

Standard	GUI-Parameter	SCPI-Parameter
CDMA IS95A forward	CDMA IS95A FWD	F8CD   FIS95a
CDMA IS95A reverse	CDMA IS95A REV	R8CD   RIS95a
CDMA IS95C Class 0 forward*)	CDMA IS95C Class 0 FWD	FIS95c0
CDMA IS95C Class 0 reverse*)	CDMA IS95C Class 0 REV	RIS95c0
CDMA J-STD008 forward	CDMA J-STD008 FWD	F19C   FJ008
CDMA J-STD008 reverse	CDMA J-STD008 REV	R19C   RJ008
CDMA IS95C Class 1 forward*)	CDMA IS95C Class 1 FWD	FIS95c1
CDMA IS95C Class 1 reverse*)	CDMA IS95C Class 1 REV	RIS95c1
CDMA 2000	CDMA 2000	S2CD
TD-SCDMA forward	TD SCDMA FWD	FTCD   TCDMa
TD-SCDMA reverse	TD SCDMA REV	RTCD
WLAN 802.11A	WLAN 802.11A	AWLan
WLAN 802.11B	WLAN 802.11B	BWLan
WiMAX	WiMAX	WiMAX
WIBRO	WIBRO	WIBRO
GSM	GSM	GSM
RFID 14443	RFID 14443	RFID14443
TETRA	TETRA	TETRA
PDC	PDC	PDC
PHS	PHS	PHS
CDPD	CDPD	CDPD
APCO-25 Phase 2	APCO-25 P2	PAPCo25



For the R&S ESRP, the channel spacing is defined as the distance between the center frequency of the adjacent channel and the center frequency of the transmission channel. The definition of the adjacent-channel spacing in standards IS95C and CDMA 2000 is different. These standards define the adjacent-channel spacing from the center of the transmission channel to the closest border of the adjacent channel. This definition is also used for the R&S ESRP if the standards marked with an asterisk \*) are selected.

### Optimized Settings for CP/ACLR Test Parameters

The "Adjust Settings" softkey (see ["Adjust Settings"](#) on page 219) automatically optimizes all instrument settings for the selected channel configuration, as described in the following:

- **Frequency span**

The frequency span must at least cover the channels to be measured plus a measurement margin of approx. 10 %.

If the frequency span is large in comparison to the channel bandwidth (or the adjacent-channel bandwidths) being examined, only a few points on the trace are available per channel. This reduces the accuracy of the waveform calculation for the channel filter used, which has a negative effect on the measurement accuracy. It is therefore strongly recommended that the formulas mentioned be taken into consideration when selecting the frequency span.

For channel power measurements the [Adjust Settings](#) softkey sets the frequency span as follows:

"(No. of transmission channels – 1) x transmission channel spacing + 2 x transmission channel bandwidth + measurement margin"

For adjacent-channel power measurements, the [Adjust Settings](#) softkey sets the frequency span as a function of the number of transmission channels, the transmission channel spacing, the adjacent-channel spacing, and the bandwidth of one of adjacent-channels ADJ, ALT1 or ALT2, whichever is furthest away from the transmission channels:

"(No. of transmission channels – 1) x transmission channel spacing + 2 x (adjacent-channel spacing + adjacent-channel bandwidth) + measurement margin"

The measurement margin is approx. 10 % of the value obtained by adding the channel spacing and the channel bandwidth.

- **Resolution bandwidth (RBW)**

To ensure both, acceptable measurement speed and required selection (to suppress spectral components outside the channel to be measured, especially of the adjacent channels), the resolution bandwidth must not be selected too small or too large. As a general approach, the resolution bandwidth is to be set to values between 1% and 4% of the channel bandwidth.

A larger resolution bandwidth can be selected if the spectrum within the channel to be measured and around it has a flat characteristic. In the standard setting, e.g. for standard IS95A REV at an adjacent channel bandwidth of 30 kHz, a resolution bandwidth of 30 kHz is used. This yields correct results since the spectrum in the neighborhood of the adjacent channels normally has a constant level.

With the exception of the IS95 CDMA standards, the [Adjust Settings](#) softkey sets the resolution bandwidth (RBW) as a function of the channel bandwidth:

" $RBW \leq 1/40$  of channel bandwidth"

The maximum possible resolution bandwidth (with respect to the requirement  $RBW \leq 1/40$ ) resulting from the available RBW steps (1, 3) is selected.

- **Video bandwidth (VBW)**

For a correct power measurement, the video signal must not be limited in bandwidth. A restricted bandwidth of the logarithmic video signal would cause signal averaging and thus result in a too low indication of the power (-2.51 dB at very low video bandwidths). The video bandwidth should therefore be selected at least three times the resolution bandwidth:

" $VBW \geq 3 \times RBW$ "

The [Adjust Settings](#) softkey sets the video bandwidth (VBW) as a function of the channel bandwidth (see formula above) and the smallest possible VBW with regard to the available step size will be selected.

- **Detector**

The [Adjust Settings](#) softkey selects the RMS detector. This detector is selected since it correctly indicates the power irrespective of the characteristics of the signal to be measured. The whole IF envelope is used to calculate the power for each measurement point. The IF envelope is digitized using a sampling frequency which is at least five times the resolution bandwidth which has been selected. Based on the sample values, the power is calculated for each measurement point using the following formula:

$$P_{\text{RMS}} = \sqrt{\frac{1}{N} \cdot \sum_{i=1}^N s_i^2}$$

where:

" $s_i$  = linear digitized video voltage at the output of the A/D converter"

"N = number of A/D converter values per measurement point"

" $P_{\text{RMS}}$  = power represented by a measurement point"

When the power has been calculated, the power units are converted into decibels and the value is displayed as a measurement point.

In principle, the sample detector would be possible as well. Due to the limited number of measurement points used to calculate the power in the channel, the sample detector would yield less stable results.

- **Trace averaging**

The [Adjust Settings](#) softkey switches off this function. Averaging, which is often performed to stabilize the measurement results, leads to a too low level indication and should therefore be avoided. The reduction in the displayed power depends on the number of averages and the signal characteristics in the channel to be measured.

- **Reference level**

The [Adjust Settings](#) softkey does not influence the reference level. It can be adjusted separately using the "Adjust Ref Lvl" softkey (see "[Adjust Ref Lvl](#)" on page 222).

### 6.1.1.3 Measuring the Carrier-to-Noise Ratio

The R&S ESRP can easily determine the carrier-to-noise ratio, also normalized to a 1 Hz bandwidth.

The largest signal in the frequency span is the carrier. It is searched when the C/N or C/NO function is activated (see "[C/N, C/No](#)" on page 227) and is marked using a fixed reference marker ("FXD").

To determine the noise power, a channel at the defined center frequency is examined. The bandwidth of the channel is defined by the "Channel Bandwidth" setting. The power within this channel is integrated to obtain the noise power level. (If the carrier is within this channel, an extra step is required to determine the correct noise power level, see below.)

The noise power of the channel is subtracted from the maximum carrier signal level, and in the case of a C/NO measurement, it is referred to a 1 Hz bandwidth.



For this measurement, the RMS detector is activated.

The carrier-to-noise measurements are only available in the frequency domain (span >0).

There are two methods to measure the carrier-to-noise ratio:

- The carrier is outside the examined channel: In this case, it is sufficient to switch on the desired measurement function and to set the channel bandwidth. The carrier/noise ratio is displayed on the screen.
- The carrier is inside the examined channel: In this case, the measurement must be performed in two steps:
  - First, perform the reference measurement by switching on either the C/N or the C/NO measurement and waiting for the end of the next measurement run. The fixed reference marker is set to the maximum of the measured carrier signal.
  - Then, switch off the carrier so that only the noise of the test setup is active in the channel. The carrier-to-noise ratio is displayed after the subsequent measurement has been completed.



The frequency span should be set to approximately 4 times the channel bandwidth in order to measure the carrier-to-noise ratio correctly. This setting is defined automatically by the "Adjust Settings" function.

#### To determine the carrier-to-noise ratio

1. Press the "C/N, C/NO" softkey to configure the carrier-to-noise ratio measurement.
2. To change the channel bandwidth to be examined, press the "Channel Bandwidth" softkey.
3. To optimize the settings for the selected channel configuration, press the "Adjust Settings" softkey.
4. To activate the measurements without reference to the bandwidth, press the "C/N" softkey.  
To activate the measurements with reference to the bandwidth, press the "C/NO" softkey .
5. If the carrier signal is located within the examined channel bandwidth, switch off the carrier signal so that only the noise is displayed in the channel and perform a second measurement.

The carrier-to-noise ratio is displayed after the measurement has been completed.

#### Measurement results

As a result of the carrier-to-noise measurement the evaluated bandwidth and the calculated C/N ratio are indicated beneath the diagram.

You can also query the determined carrier-to-noise ratio via the remote command `CALC:MARK:FUNC:POW:RES? CN` or `CALC:MARK:FUNC:POW:RES? CNO`, see [CALCulate<n>:MARKer<m>:FUNction:POWer:RESult?](#) on page 689.

### Softkeys for Carrier-to-Noise Ratio Measurements

<a href="#">C/N, C/No</a> .....	227
L <a href="#">C/N</a> .....	227
L <a href="#">C/No</a> .....	227
L <a href="#">Channel Bandwidth</a> .....	227
L <a href="#">Adjust Settings</a> .....	228

### C/N, C/No

Opens a submenu to configure the carrier/noise ratio measurement. Measurements without (C/N) and measurements with reference to the bandwidth (C/No) are possible.

Carrier-to-noise measurements are not available in zero span mode.

**Note:** Carrier-to-noise measurements are also available in the I/Q Analyzer, but only for **Spectrum** displays (see ["Display Config"](#) on page 431).

For general information on performing carrier-to-noise ratio measurements see [Chapter 6.1.1.3, "Measuring the Carrier-to-Noise Ratio"](#), on page 225.

### C/N ← C/N, C/No

Switches the measurement of the carrier/noise ratio on or off. If no marker is active, marker 1 is activated.

The measurement is performed on the trace that marker 1 is assigned to. To shift marker 1 and measure another trace, use the [Marker to Trace](#) softkey in the "Marker To" menu.

Remote command:

[CALCulate<n>:MARKer<m>:FUNction:POWer:SElect](#) on page 688

[CALCulate<n>:MARKer<m>:FUNction:POWer:RESult?](#) on page 689

[CALCulate<n>:MARKer<m>:FUNction:POWer\[:STATe\]](#) on page 692

### C/No ← C/N, C/No

Switches the measurement of the carrier/noise ratio with reference to a 1 Hz bandwidth on or off. If no marker is active, marker 1 is activated.

The measurement is performed on the trace that marker 1 is assigned to. To shift marker 1 and measure another trace, use the [Marker to Trace](#) softkey in the "Marker To" menu.

Remote command:

[CALCulate<n>:MARKer<m>:FUNction:POWer:SElect](#) on page 688

[CALCulate<n>:MARKer<m>:FUNction:POWer:RESult?](#) on page 689

[CALCulate<n>:MARKer<m>:FUNction:POWer\[:STATe\]](#) on page 692

### Channel Bandwidth ← C/N, C/No

Opens an edit dialog box to enter the measurement channel bandwidth for each channel.

The default setting is 14 kHz.

Note that in the I/Q Analyzer the channel bandwidth does not change the measurement span or sampling rate; it merely defines the range for the carrier-to-noise analysis.

Remote command:

[SENSe:]POWER:ACHannel:ACPairs on page 698

#### **Adjust Settings ← C/N, C/No**

Enables the RMS detector (see also [Chapter 6.3.1.5, "Detector Overview"](#), on page 370) and adjusts the span to the selected channel bandwidth according to:

"4 x channel bandwidth + measurement margin"

The adjustment is performed once; if necessary, the setting can be changed later on.

**Note:** in the I/Q Analyzer, this function is not available. The channel bandwidth defines the range for the carrier-to-noise analysis.

Remote command:

[SENSe:]POWER:ACHannel:PRESet on page 693

#### **6.1.1.4 Measuring the Occupied Bandwidth**

An important characteristic of a modulated signal is its occupied bandwidth. In a radio communications system for instance the occupied bandwidth must be limited to enable distortion-free transmission in adjacent channels. The occupied bandwidth is defined as the bandwidth containing a defined percentage of the total transmitted power. A percentage between 10 % and 99.9 % can be set.

The measurement principle is the following: The bandwidth containing 99% of the signal power is to be determined, for example. The routine first calculates the total power of all displayed points of the trace. In the next step, the points from the right edge of the trace are summed up until 0.5 % of the total power is reached. Auxiliary marker 1 is positioned at the corresponding frequency. Then the points from the left edge of the trace are summed up until 0.5 % of the power is reached. Auxiliary marker 2 is positioned at this point. 99 % of the power is now between the two markers. The distance between the two frequency markers is the occupied bandwidth which is displayed in the marker field.



### New: OBW now also possible within defined search limits - multi-carrier OBW measurement in one sweep

The occupied bandwidth of the signal can be determined within defined search limits instead of for the entire signal. Thus, only a single sweep is required to determine the OBW for a multi-carrier signal. To do so, search limits are defined for an individual carrier and the OBW measurement is restricted to the frequency range contained within those limits. Then the search limits are adapted for the next carrier and the OBW is automatically re-calculated for the new range.

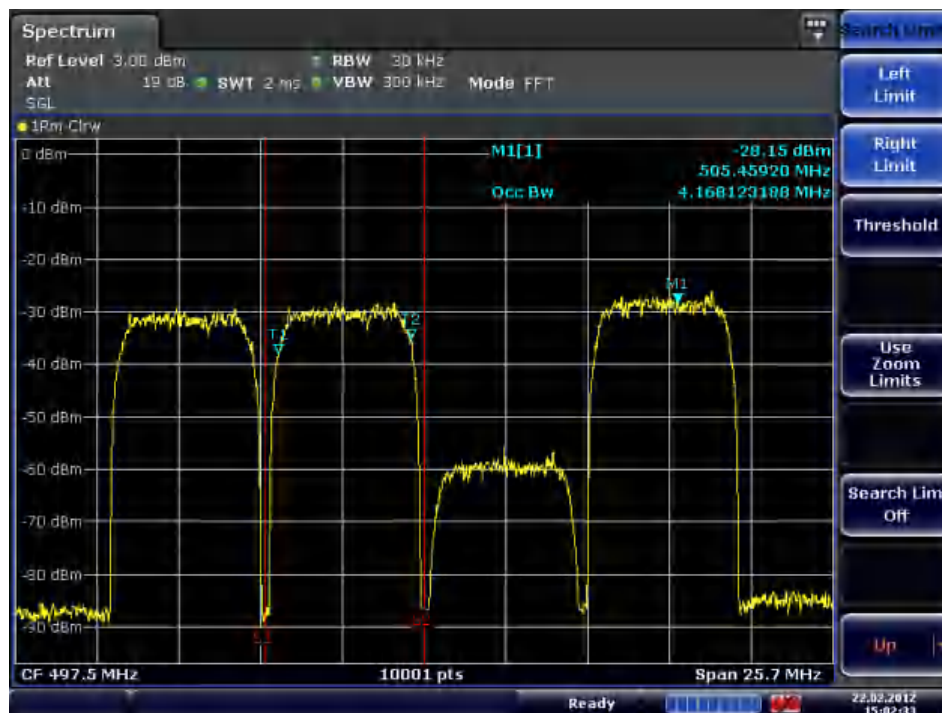

The OBW measurement uses the same search limits as defined for marker search (see "Search Limits" on page 182). However, only the left and right limits are considered.

To ensure correct power measurement, especially for noise signals, and to obtain the correct occupied bandwidth, the following prerequisites and settings are necessary:

- Only the signal to be measured is displayed on the screen. An additional signal would falsify the measurement.
- $RBW \ll$  occupied bandwidth (approx. 1/20 of occupied bandwidth, for voice communication type 300 Hz or 1 kHz)
- $VBW \geq 3 \times RBW$
- RMS detector
- $Span \geq 2$  to  $3 \times$  occupied bandwidth

Some of the measurement specifications (e.g. PDC, RCR STD-27B) require measurement of the occupied bandwidth using a peak detector. The detector setting of the R&S ESRP has to be changed accordingly then.





A remote control programming example is described in [Chapter 11.17.5, "Occupied Bandwidth Measurement"](#), on page 981.

### To determine the occupied bandwidth

1. Press the **OBW** softkey to activate the measurement of the occupied bandwidth. The corresponding submenu is displayed.
2. Press the "% Power Bandwidth" softkey to enter the percentage of power (see "[% Power Bandwidth \(span > 0\)](#)" on page 231).
3. To change the channel bandwidth for the transmission channel, press the "Channel Bandwidth" softkey (see "[Channel Bandwidth \(span > 0\)](#)" on page 231).
4. To optimize the settings for the selected channel configuration, press the **Adjust Settings** softkey. For details see also "[Optimized Settings for CP/ACLR Test Parameters](#)" on page 223.
5. To adjust the reference level to the measured total power after the first sweep, press the **Adjust Ref Lvl** softkey.

### Measurement results

As a result of the OBW measurement the occupied bandwidth ("Occ BW") is indicated in the marker results. Furthermore, the marker at the center frequency and the temporary markers are indicated.



The OBW calculation is repeated if the [Search Limits](#) are changed, without performing a new sweep. Thus, the OBW for a multi-carrier signal can be determined using only one sweep.

The determined occupied bandwidth can also be queried using the remote command `CALC:MARK:FUNC:POW:RES? OBW` or `CALC:MARK:FUNC:POW:RES? AOBW`. While the `OBW` parameter returns only the occupied bandwidth, the `AOBW` parameter also returns the position and level of the temporary markers T1 and T2 used to calculate the occupied bandwidth.

### Softkeys for Occupied Bandwidth (OBW) Measurements

<b>OBW</b> .....	230
L % Power Bandwidth (span > 0).....	231
L Channel Bandwidth (span > 0).....	231
L Adjust Ref Lvl (span > 0).....	231
L Adjust Settings.....	231

### OBW

Activates measurement of the occupied bandwidth according to the current configuration and opens a submenu to configure the measurement. The occupied bandwidth is displayed in the marker display field and marked on the trace by temporary markers. For details see [Chapter 6.1.1.4, "Measuring the Occupied Bandwidth"](#), on page 228.

This measurement is not available in zero span.

The measurement is performed on the trace with marker 1. In order to evaluate another trace, marker 1 must be placed on another trace (see the [Marker to Trace](#) soft-key in the "Marker" menu).

Remote command:

[CALCulate<n>:MARKer<m>:FUNCTION:POWER:SElect](#) on page 688

[CALCulate<n>:MARKer<m>:FUNCTION:POWER:RESult?](#) on page 689

[CALCulate<n>:MARKer<m>:FUNCTION:POWER\[:STATe\]](#) on page 692

#### **% Power Bandwidth (span > 0) ← OBW**

Opens an edit dialog box to enter the percentage of total power in the displayed frequency range which defines the occupied bandwidth. Values from 10% to 99.9% are allowed.

Remote command:

[\[SENSe:\] POWER: BANDwidth| BWIDth](#) on page 717

#### **Channel Bandwidth (span > 0) ← OBW**

Opens an edit dialog box to enter the channel bandwidth for the transmission channel. The specified channel bandwidth is used for optimization of the test parameters (for details see "[Optimized Settings for CP/ACLR Test Parameters](#)" on page 223). The default setting is 14 kHz.

For measurements in line with a specific transmission standard, the bandwidth specified by the standard for the transmission channel must be entered.

Remote command:

[\[SENSe:\] POWER: ACHannel: BANDwidth| BWIDth\[:CHANnel<channel>\]](#)  
on page 699

#### **Adjust Ref Lvl (span > 0) ← OBW**

Adjusts the reference level to the measured total power of the signal. the softkey is activated after the first sweep with active measurement of the occupied bandwidth has been completed and the total power of the signal is thus known.

Adjusting the reference level ensures that the signal path will not be overloaded and the dynamic range not limited by too low a reference level. Since the measurement bandwidth for channel power measurements is significantly lower than the signal bandwidth, the signal path may be overloaded although the trace is distinctly below the reference level. If the measured channel power is equal to the reference level, the signal path cannot be overloaded.

Remote command:

[\[SENSe:\] POWER: ACHannel: PRESet: RLEVel](#) on page 694

#### **Adjust Settings ← OBW**

Automatically optimizes all instrument settings for the selected channel configuration (channel bandwidth, channel spacing) within a specific frequency range (channel bandwidth). The adjustment is carried out only once. If necessary, the instrument settings can be changed later.

For details on the settings of span, resolution bandwidth, video bandwidth, detector and trace averaging see ["Optimized Settings for CP/ACLR Test Parameters"](#) on page 223.

Remote command:

[SENSe:] POWER:ACHannel:PRESet on page 693

### 6.1.1.5 Measuring with Spectrum Emission Masks

The Spectrum Emission Mask (SEM) measurement defines a measurement that monitors compliance with a spectral mask. The SEM measurement is used to measure the excess emissions of a TX channel that would interfere to other channels or to other systems.

The SEM measurement of the base unit allows a flexible definition of all parameters in the SEM measurement. It is performed using the [Spectrum Emission Mask](#) softkey in the "Measurement" menu. Most parameters are defined in the "Sweep List" dialog box (see ["Sweep List dialog box"](#) on page 234). After a preset, the sweep list contains a set of default ranges and parameters. For each range, you can change the parameters. For information on other SEM settings, see the description of the corresponding softkeys (["Spectrum Emission Mask"](#) on page 234).

If you want a parameter set to be available permanently, you can create an XML file for this configuration and, if necessary, export this file to another application (for details refer to ["Format Description of Spectrum Emission Mask XML Files"](#) on page 251 and ["ASCII File Export Format \(Spectrum Emission Mask\)"](#) on page 256).

Some predefined XML files are provided that contain ranges and parameters according to the selected standard (see ["Provided XML Files for the Spectrum Emission Mask Measurement"](#) on page 248).

In order to improve the performance of the R&S ESRP for spectrum emission mask measurements, a "Fast SEM" mode is available. For details see ["Fast Spectrum Emission Mask Measurements"](#) on page 257.

Monitoring compliance of the spectrum is supported by a special limit check for SEM measurements, see ["Working with Limit Lines in SEM Measurements"](#) on page 247.



A remote control programming example is described in [Chapter 11.17.12, "Spectrum Emission Mask Measurement"](#), on page 992.

Softkeys for Spectrum Emission Mask (SEM) Measurements.....	233
Result Evaluation.....	244
Ranges and Range Settings.....	245
Working with Limit Lines in SEM Measurements.....	247
Provided XML Files for the Spectrum Emission Mask Measurement.....	248

Format Description of Spectrum Emission Mask XML Files.....	251
ASCII File Export Format (Spectrum Emission Mask).....	256
Fast Spectrum Emission Mask Measurements.....	257

### Softkeys for Spectrum Emission Mask (SEM) Measurements

Spectrum Emission Mask.....	234
L Sweep List.....	234
L Sweep List dialog box.....	234
L Range Start / Range Stop.....	235
L Fast SEM.....	235
L Filter Type.....	235
L RBW.....	235
L VBW.....	236
L Sweep Time Mode.....	236
L Sweep Time.....	236
L Ref. Level.....	236
L RF Att. Mode.....	236
L RF Attenuator.....	236
L Preamp.....	236
L Transd. Factor.....	236
L Limit Check 1-4.....	237
L Abs Limit Start.....	237
L Abs Limit Stop.....	237
L Rel Limit Start.....	237
L Rel Limit Stop.....	237
L Close Sweep List.....	238
L Insert before Range.....	238
L Insert after Range.....	238
L Delete Range.....	238
L Symmetric Setup.....	238
L Edit Reference Range.....	239
L List Evaluation.....	239
L List Evaluation (On/Off).....	240
L Margin.....	240
L Show Peaks.....	240
L Save Evaluation List.....	240
L ASCII File Export.....	240
L Decim Sep.....	241
L Edit Reference Range.....	241
L Edit Power Classes.....	242
L Used Power Classes.....	242
L PMin/PMax.....	242
L Sweep List.....	243
L Add/Remove.....	243
L Load Standard.....	243
L Save As Standard.....	243
L Meas Start/Stop.....	243
L Restore Standard Files.....	243

### Spectrum Emission Mask

Opens a submenu to configure the Spectrum Emission Mask measurement.

The Spectrum Emission Mask (SEM) measurement defines a measurement that monitors compliance with a spectral mask. The SEM measurement of the base unit allows a flexible definition of all parameters in the SEM measurement.

For general information on performing SEM measurements, see [Chapter 6.1.1.5, "Measuring with Spectrum Emission Masks"](#), on page 232.



Remote command:

SENS:SWE:MODE ESP, see [SENSe:]SWEep:MODE on page 729

### Sweep List ← Spectrum Emission Mask

Opens a submenu to edit the sweep list and displays the "Sweep List" dialog box.

### Sweep List dialog box ← Sweep List ← Spectrum Emission Mask

After a preset, the sweep list contains a set of default ranges and parameters. For each range, you can change the parameters listed below. To insert or delete ranges, use the "Insert Before Range", "Insert After Range", "Delete Range" softkeys. The measurement results are not updated during editing but on closing the dialog box ("Edit Sweep List/ Close Sweep List" softkey, see ["Close Sweep List"](#) on page 238).

The changes of the sweep list are only kept until you load another parameter set (by pressing PRESET or by loading an XML file). If you want a parameter set to be available permanently, create an XML file for this configuration (for details refer to "[Format Description of Spectrum Emission Mask XML Files](#)" on page 251).

If you load one of the provided XML files ("Load Standard" softkey, see "[Load Standard](#)" on page 243), the sweep list contains ranges and parameters according to the selected standard. For further details refer also to "[Provided XML Files for the Spectrum Emission Mask Measurement](#)" on page 248.

**Note:** If you edit the sweep list, always follow the rules and consider the limitations described in "[Ranges and Range Settings](#)" on page 245.

#### **Range Start / Range Stop** ← Sweep List dialog box ← Sweep List ← Spectrum Emission Mask

Sets the start frequency/stop frequency of the selected range. Follow the rules described in "[Ranges and Range Settings](#)" on page 245.

In order to change the start/stop frequency of the first/last range, select the appropriate span with the SPAN key. If you set a span that is smaller than the overall span of the ranges, the measurement includes only the ranges that lie within the defined span and have a minimum span of 20 Hz. The first and last ranges are adapted to the given span as long as the minimum span of 20 Hz is not violated.

Frequency values for each range have to be defined relative to the center frequency. The reference range has to be centered on the center frequency. The minimum span of the reference range is given by the current TX Bandwidth.

Remote command:

[\[SENSe:\]ESpectrum:RANGe<range>\[:FREQUENCY\]:START](#) on page 733

[\[SENSe:\]ESpectrum:RANGe<range>\[:FREQUENCY\]:STOP](#) on page 733

#### **Fast SEM** ← Sweep List dialog box ← Sweep List ← Spectrum Emission Mask

Activates "Fast SEM" mode for all ranges in the sweep list. For details see "[Fast Spectrum Emission Mask Measurements](#)" on page 257.

**Note:** If "Fast SEM" mode is deactivated while [Symmetric Setup](#) mode is on, "Symmetrical Setup" mode is automatically also deactivated.

If "Fast SEM" mode is activated while "Symmetrical Setup" mode is on, not all range settings can be set automatically.

Remote command:

[\[SENSe:\]ESpectrum:HighSPeed](#) on page 730

#### **Filter Type** ← Sweep List dialog box ← Sweep List ← Spectrum Emission Mask

Sets the filter type for this range. For details on filters see also [Chapter 6.2.6.3, "Selecting the Appropriate Filter Type"](#), on page 337.

Remote command:

[\[SENSe:\]ESpectrum:RANGe<range>:FILTer:TYPE](#) on page 732

#### **RBW** ← Sweep List dialog box ← Sweep List ← Spectrum Emission Mask

Sets the RBW value for this range.

Remote command:

[\[SENSe:\]ESpectrum:RANGe<range>:BANDwidth\[:RESolution\]](#) on page 731

**VBW ← Sweep List dialog box ← Sweep List ← Spectrum Emission Mask**

Sets the VBW value for this range.

Remote command:

[\[SENSe:\]ESpectrum:RANGe<range>:BANDwidth:VIDeo](#) on page 731

**Sweep Time Mode ← Sweep List dialog box ← Sweep List ← Spectrum Emission Mask**

Activates or deactivates the auto mode for the sweep time.

Remote command:

[\[SENSe:\]ESpectrum:RANGe<range>:SWEep:TIME:AUTO](#) on page 738

**Sweep Time ← Sweep List dialog box ← Sweep List ← Spectrum Emission Mask**

Sets the sweep time value for the range.

Remote command:

[\[SENSe:\]ESpectrum:RANGe<range>:SWEep:TIME](#) on page 737

**Ref. Level ← Sweep List dialog box ← Sweep List ← Spectrum Emission Mask**

Sets the reference level for the range.

Remote command:

[\[SENSe:\]ESpectrum:RANGe<range>:RLEVel](#) on page 737

**RF Att. Mode ← Sweep List dialog box ← Sweep List ← Spectrum Emission Mask**

Activates or deactivates the auto mode for RF attenuation.

Remote command:

[\[SENSe:\]ESpectrum:RANGe<range>:INPut:ATTenuation:AUTO](#) on page 734

**RF Attenuator ← Sweep List dialog box ← Sweep List ← Spectrum Emission Mask**

Sets the attenuation value for that range.

Remote command:

[\[SENSe:\]ESpectrum:RANGe<range>:INPut:ATTenuation](#) on page 734

**Preamp ← Sweep List dialog box ← Sweep List ← Spectrum Emission Mask**

Switches the preamplifier on or off.

Remote command:

[\[SENSe:\]ESpectrum:RANGe<range>:INPut:GAIN:STATe](#) on page 734

**Transd. Factor ← Sweep List dialog box ← Sweep List ← Spectrum Emission Mask**

Sets a transducer for the specified range. You can only choose a transducer that fulfills the following conditions:

- The transducer overlaps or equals the span of the range.
- The x-axis is linear.
- The unit is dB.

Remote command:

[\[SENSe:\]ESpectrum:RANGe<range>:TRANsducer](#) on page 738

**Limit Check 1-4 ← Sweep List dialog box ← Sweep List ← Spectrum Emission Mask**

Sets the type of limit check for all ranges.

For details on limit checks see ["Working with Limit Lines in SEM Measurements"](#) on page 247.

For details on limit checks see the base unit description ["Working with Lines in SEM"](#).

The limit state affects the availability of all limit settings (["Abs Limit Start"](#) on page 237, ["Abs Limit Stop"](#) on page 237, ["Rel Limit Start"](#) on page 237, ["Rel Limit Stop"](#) on page 237).

Depending on the number of active power classes (see ["Power Class"](#) dialog box), the number of limits that can be set varies. Up to four limits are possible. The sweep list is extended accordingly.

Remote command:

[\[SENSe:\]ESpectrum:RANGe<range>:LIMit<source>:STATe](#) on page 737  
[CALCulate<n>:LIMit<k>:FAIL?](#) on page 686

**Abs Limit Start ← Sweep List dialog box ← Sweep List ← Spectrum Emission Mask**

Sets an absolute limit value at the start frequency of the range [dBm].

This parameter is only available if the limit check is set accordingly (see ["Limit Check 1-4"](#) on page 237).

Remote command:

[\[SENSe:\]ESpectrum:RANGe<range>:LIMit<source>:ABSolute:START](#)  
on page 735

**Abs Limit Stop ← Sweep List dialog box ← Sweep List ← Spectrum Emission Mask**

Sets an absolute limit value at the stop frequency of the range [dBm].

This parameter is only available if the limit check is set accordingly (see ["Limit Check 1-4"](#) on page 237).

Remote command:

[\[SENSe:\]ESpectrum:RANGe<range>:LIMit<source>:ABSolute:STOP](#)  
on page 735

**Rel Limit Start ← Sweep List dialog box ← Sweep List ← Spectrum Emission Mask**

Sets a relative limit value at the start frequency of the range [dBc].

This parameter is only available if the limit check is set accordingly (see ["Limit Check 1-4"](#) on page 237).

Remote command:

[\[SENSe:\]ESpectrum:RANGe<range>:LIMit<source>:RELative:START](#)  
on page 736

**Rel Limit Stop ← Sweep List dialog box ← Sweep List ← Spectrum Emission Mask**

Sets a relative limit value at the stop frequency of the range [dBc].



This parameter is only available if the limit check is set accordingly (see ["Sweep List dialog box"](#) on page 234).

Remote command:

`[SENSe:]ESpectrum:RANGe<range>:LIMit<source>:RELative:STOP`  
on page 736

#### **Close Sweep List ← Sweep List ← Spectrum Emission Mask**

Closes the "Sweep List" dialog box and updates the measurement results.

#### **Insert before Range ← Sweep List ← Spectrum Emission Mask**

Inserts a new range to the left of the currently focused range. The range numbers of the currently focused range and all higher ranges are increased accordingly. The maximum number of ranges is 20.

For further details refer to ["Ranges and Range Settings"](#) on page 245.

Remote command:

`ESP:RANG3:INS BEF`, see `[SENSe:]ESpectrum:RANGe<range>:INSert`  
on page 735

#### **Insert after Range ← Sweep List ← Spectrum Emission Mask**

Inserts a new range to the right of the currently focused range. The range numbers of all higher ranges are increased accordingly. The maximum number of ranges is 20.

For further details refer to ["Ranges and Range Settings"](#) on page 245.

Remote command:

`ESP:RANG1:INS AFT`, see `[SENSe:]ESpectrum:RANGe<range>:INSert`  
on page 735

#### **Delete Range ← Sweep List ← Spectrum Emission Mask**

Deletes the currently focused range, if possible. The range numbers are updated accordingly. For further details refer to ["Ranges and Range Settings"](#) on page 245.

Remote command:

`[SENSe:]ESpectrum:RANGe<range>:DELete` on page 732

#### **Symmetric Setup ← Sweep List ← Spectrum Emission Mask**

If activated, the current sweep list configuration is changed to define a symmetrical setup regarding the reference range. The number of ranges to the left of the reference range is reflected to the right, i.e. any missing ranges on the right are inserted, while superfluous ranges are removed. The values in the ranges to the right of the reference range are adapted symmetrically to those in the left ranges.

Any changes to the range settings in active "Symmetric Setup" mode lead to symmetrical changes in the other ranges (where possible). In particular, this means:

- Inserting ranges: a symmetrical range is inserted on the other side of the reference range
- Deleting ranges: the symmetrical range on the other side of the reference range is also deleted
- Editing range settings: the settings in the symmetrical range are adapted accordingly

**Note:** If "Fast SEM" mode is deactivated while "Symmetric Setup" mode is on, "Sym Setup" mode is automatically also deactivated.  
If "Fast SEM" mode is activated while "Symmetric Setup" mode is on, not all range settings can be set automatically.

### Edit Reference Range ← Sweep List ← Spectrum Emission Mask

Opens the "Reference Range" dialog box to edit the additional settings used for SEM measurements.

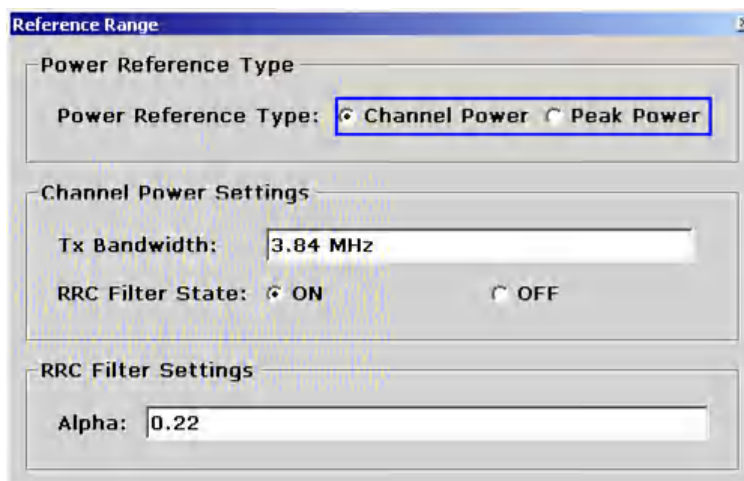

Two different power reference types are supported:

- "Peak Power"  
Measures the highest peak within the reference range.
- "Channel Power"  
Measures the channel power within the reference range (integral bandwidth method).  
If the "Channel Power" reference power type is activated, the dialog box is extended to define additional settings:
- "Tx Bandwidth"  
Defines the bandwidth used for measuring the channel power:  
minimum span ≤ value ≤ span of reference range
- "RRC Filter State"  
Activates or deactivates the use of an RRC filter.
- "RRC Filter Settings"  
Sets the alpha value of the RRC filter. This window is only available if the RRC filter is activated.

For further details refer to "[Ranges and Range Settings](#)" on page 245.

Remote command:

[SENSe:]ESpectrum:RTYPE on page 740

[SENSe:]ESpectrum:BWID on page 739

[SENSe:]ESpectrum:FILTer[:RRC][:STATE] on page 740

[SENSe:]ESpectrum:FILTer[:RRC]:ALPHA on page 739

### List Evaluation ← Spectrum Emission Mask

Opens a submenu to edit the list evaluation settings.

**List Evaluation (On/Off) ← List Evaluation ← Spectrum Emission Mask**

Activates or deactivates the list evaluation.

Remote command:

Turning list evaluation on and off:

[CALCulate<n>:PEAKsearch|PSEarch:AUTO](#) on page 726

Querying list evaluation results:

[TRACe<n>:DATA](#) on page 694

**Margin ← List Evaluation ← Spectrum Emission Mask**

Opens an edit dialog box to enter the margin used for the limit check/peak search.

Remote command:

[CALCulate<n>:PEAKsearch|PSEarch:MARGin](#) on page 648

**Show Peaks ← List Evaluation ← Spectrum Emission Mask**

In the diagram, marks all peaks with blue squares that have been listed during an active list evaluation.

Remote command:

[CALCulate<n>:ESpectrum:PSEarch|:PEAKsearch:PSHow](#) on page 746

**Save Evaluation List ← List Evaluation ← Spectrum Emission Mask**

Opens the "ASCII File Export Name" dialog box to save the result in ASCII format to a specified file and directory. For further details refer also to the "ASCII File Export" soft-key ("[ASCII File Export](#)" on page 240).

Remote command:

[MMEMory:STORE<n>:LIST](#) on page 745

**ASCII File Export ← Save Evaluation List ← List Evaluation ← Spectrum Emission Mask**

Opens the "ASCII File Export Name" dialog box and saves the active peak list in ASCII format to the specified file and directory.

The file consists of the header containing important scaling parameters and a data section containing the marker data. For details on an ASCII file see [Chapter 6.3.1.6, "ASCII File Export Format"](#), on page 370.

This format can be processed by spreadsheet calculation programs, e.g. MS-Excel. It is necessary to define ';' as a separator for the data import. Different language versions of evaluation programs may require a different handling of the decimal point. It is therefore possible to select between separators '.' (decimal point) and ',' (comma) using the "Decim Sep" softkey (see "[Decim Sep](#)" on page 176).

An example of an output file for Spectrum Emission Mask measurements is given in "[ASCII File Export Format \(Spectrum Emission Mask\)](#)" on page 256.

Remote command:

[FORMat:DEXPort:DSEParator](#) on page 818

[MMEMory:STORE<n>:LIST](#) on page 745

### Decim Sep ← Save Evaluation List ← List Evaluation ← Spectrum Emission Mask

Selects the decimal separator with floating-point numerals for the ASCII Trace export to support evaluation programs (e.g. MS-Excel) in different languages. The values '.' (decimal point) and ',' (comma) can be set.

Remote command:

`FORMat:DEXPort:DSEParator` on page 818

### Edit Reference Range ← Spectrum Emission Mask

Opens the "Reference Range" dialog box to edit the additional settings used for SEM measurements.

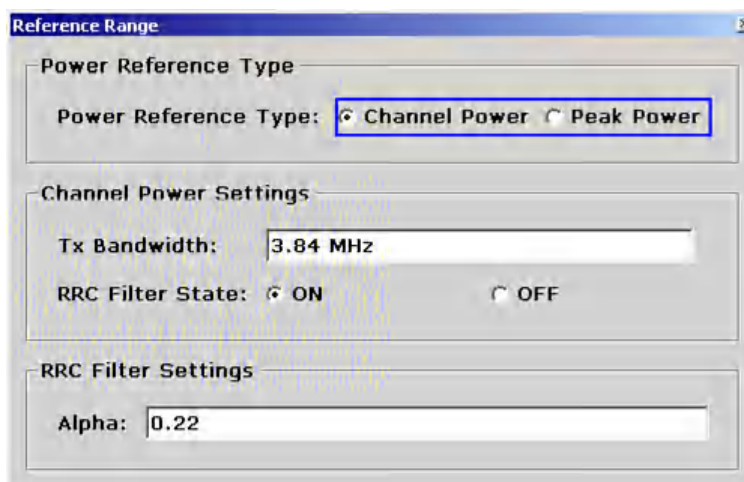

Two different power reference types are supported:

- "Peak Power"  
Measures the highest peak within the reference range.
- "Channel Power"  
Measures the channel power within the reference range (integral bandwidth method).  
If the "Channel Power" reference power type is activated, the dialog box is extended to define additional settings:
- "Tx Bandwidth"  
Defines the bandwidth used for measuring the channel power:  
minimum span ≤ value ≤ span of reference range
- "RRC Filter State"  
Activates or deactivates the use of an RRC filter.
- "RRC Filter Settings"  
Sets the alpha value of the RRC filter. This window is only available if the RRC filter is activated.

For further details refer to "[Ranges and Range Settings](#)" on page 245.

Remote command:

`[SENSe:]ESpectrum:RTYPE` on page 740

`[SENSe:]ESpectrum:BWID` on page 739

`[SENSe:]ESpectrum:FILTer[:RRC][:STATe]` on page 740

`[SENSe:]ESpectrum:FILTer[:RRC]:ALPHa` on page 739

**Edit Power Classes ← Spectrum Emission Mask**

Opens a dialog box to modify the power class settings.

Power Class	PMin	<=P<	PMax	
Power Class 1	-INF	-63.5 dBm	-63.5 dBm	Sweep List
Power Class 2	-63.5 dBm	-40.0 dBm	-40.0 dBm	Sweep List
Power Class 3	-40.0 dBm	+INF	+INF	Sweep List

Buttons: Add, Remove

**Used Power Classes ← Edit Power Classes ← Spectrum Emission Mask**

Choose the power classes to be used from this dropdown menu. It is only possible to select either one of the defined power classes or all of the defined power classes together.

Only power classes for which limits are defined are available for selection.

If "All" is selected, the power class that corresponds to the currently measured power in the reference range is used. The limits assigned to that power class are applied (see "PMin/PMax" on page 242).

Remote command:

```
CALCulate<n>:LIMit<k>:ESpectrum:PClass<Class>[:EXCLUSIVE]
```

on page 742

To define all limits in one step:

```
CALCulate<n>:LIMit<k>:ESpectrum:PClass<Class>:LIMit[:STATE]
```

on page 742

**PMin/PMax ← Edit Power Classes ← Spectrum Emission Mask**

Defines the level limits for each power class. The range always starts at -200 dBm (-INF) and always stops at 200 dBm (+INF). These fields cannot be modified. If more than one Power Class is defined, the value of "PMin" must be equal to the value of "PMax" of the last Power Class and vice versa.

Note that the power level may be equal to the lower limit, but must be lower than the upper limit:

$$P_{\min} \leq P < P_{\max}$$

Remote command:

`CALCulate<n>:LIMit<k>:ESpectrum:PCLass<Class>:MINimum` on page 743

`CALCulate<n>:LIMit<k>:ESpectrum:PCLass<Class>:MAXimum` on page 743

### **Sweep List ← Edit Power Classes ← Spectrum Emission Mask**

See "Sweep List" on page 234

### **Add/Remove ← Edit Power Classes ← Spectrum Emission Mask**

Activates or deactivates power classes to be defined. Up to four power classes can be defined. The number of active power classes affects the availability of the items of the Used Power Classes dropdown menu.

Remote command:

`CALCulate<n>:LIMit<k>:ESpectrum:PCLass<Class>[:EXCLusive]`  
on page 742

### **Load Standard ← Spectrum Emission Mask**

Opens a dialog box to select an XML file which includes the desired standard specification. For details on the provided XML files refer to "Provided XML Files for the Spectrum Emission Mask Measurement" on page 248.

Remote command:

`[SENSe:]ESpectrum:PRESet[:STANdard]` on page 728

### **Save As Standard ← Spectrum Emission Mask**

Opens the "Save As Standard" dialog box, in which the currently used SEM settings and parameters can be saved and exported into an \*.xml file. Enter the name of the file in the "File name" field. For details on the structure and contents of the XML file refer to "Format Description of Spectrum Emission Mask XML Files" on page 251.

Remote command:

`[SENSe:]ESpectrum:PRESet:STORe` on page 728

### **Meas Start/Stop ← Spectrum Emission Mask**

Aborts/restarts the current measurement and displays the status:

"Start"                    The measurement is currently running.

"Stop"                    The measurement has been stopped, or, in single sweep mode, the end of the sweep has been reached.

Remote command:

`ABORt` on page 609

`INITiate<n>:ESpectrum` on page 729

### **Restore Standard Files ← Spectrum Emission Mask**

Copies the XML files from the C:\R\_S\instr\sem\_backup folder to the C:\R\_S\instr\sem\_std folder. Files of the same name are overwritten.

Remote command:

`[SENSe:]ESpectrum:PRESet:REStore` on page 728

### Result Evaluation

As a result of the Spectrum Emission Mask measurement, the measured signal levels, the result of the limit check (mask monitoring) and the defined limit line are displayed in a diagram (see also ["Working with Limit Lines in SEM Measurements"](#) on page 247). Furthermore, the TX channel power "P" is indicated in relation to the defined power class ranges.

### Example:

For example, "P<31" is indicated if the lowest power class is defined from infinity to 31 and the power is currently 17 dBm.

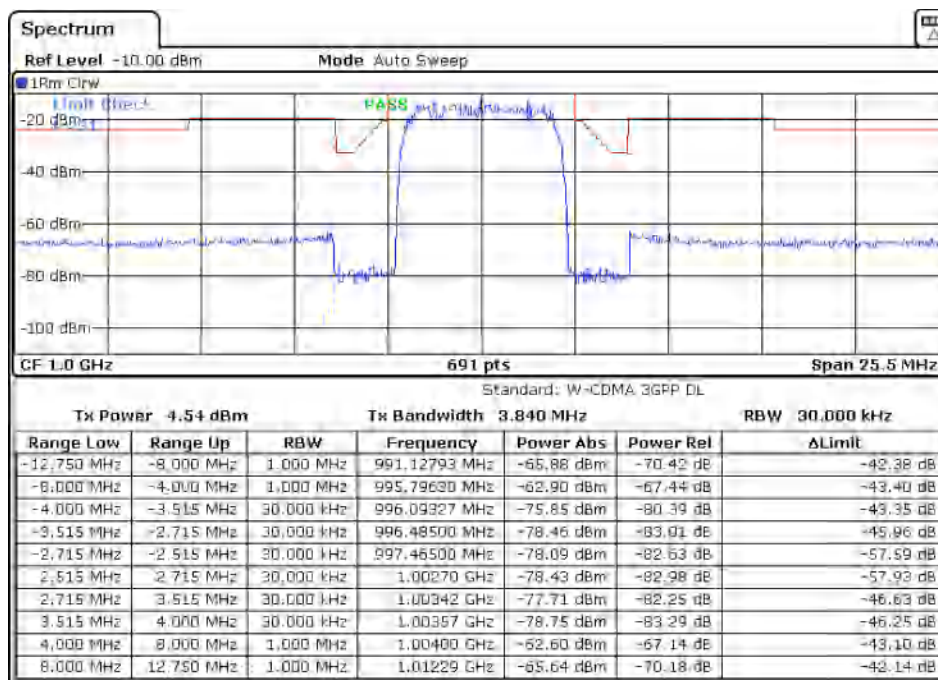

In addition to the graphical results of the SEM measurement displayed in the diagram, a result table is displayed to evaluate the limit check results (see also ["Working with Limit Lines in SEM Measurements"](#) on page 247).

The following information is provided in the result table:

Label	Description
<b>General Information</b>	
Standard	Loaded standard settings
Tx Power	Tx channel power
Tx Bandwidth	Tx channel bandwidth
RBW	RBW for the Tx channel
<b>Range results</b>	
Range Low	Frequency range start for range the peak value belongs to

Label	Description
Range Up	Frequency range stop for range the peak value belongs to
RBW	RBW of the range
Frequency	Frequency
Power Abs	Absolute power level
Power Rel	Power level relative to the TX channel power
$\Delta$ Limit	Deviation of the power level from the defined limit

In which detail the data is displayed in the result table can be defined in the [List Evaluation](#) menu. By default, one peak per range is displayed. However, you can change the settings to display only peaks that exceed a threshold ("Margin").

In addition to listing the peaks in the list evaluation, detected peaks can be indicated by blue squares in the diagram ("Show Peaks").

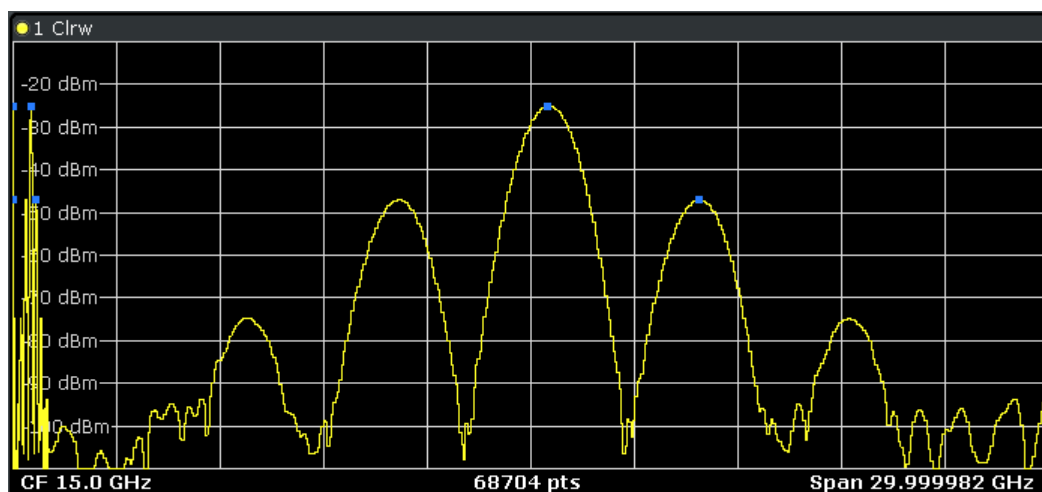

Furthermore, you can save the evaluation list to a file ("Save Evaluation List").

### Retrieving Results via Remote Control

The measurement results of the spectrum emission mask test can be retrieved using the `CALCulate<n>:LIMit<k>:FAIL?` command from a remote computer.

The power result for the reference range can be queried using `CALC:MARK:FUNC:POW:RES? CPOW`, the peak power for the reference range using `CALC:MARK:FUNC:POW:RES? PPOW`.

For details see `CALCulate<n>:MARKer<m>:FUNction:POWer:RESult?` on page 689.

### Ranges and Range Settings

In the Spectrum Emission Mask measurements, a range defines a segment for which you can define the following parameters separately:

- Start and stop frequency



- RBW
- VBW
- Sweep time
- Sweep points
- Reference level
- Attenuator settings
- Limit values

Via the sweep list, you define the ranges and their settings. For details on settings refer to "[Sweep List dialog box](#)" on page 234.

For details on defining the limits (masks) see "[Working with Limit Lines in SEM Measurements](#)" on page 247.

For details on defining the limits (masks) see the base unit description "Working with Lines in SEM".

The following rules apply to ranges:

- The minimum span of a range is 20 Hz.
- The individual ranges must not overlap (but need not directly follow one another).
- The maximum number of ranges is 20.
- A minimum of three ranges is mandatory.
- The reference range cannot be deleted (it is marked in blue color).
- The reference range has to be centered on the center frequency.
- The minimum span of the reference range is given by the current TX Bandwidth.
- Frequency values for each range have to be defined relative to the center frequency.

In order to change the start frequency of the first range or the stop frequency of the last range, select the appropriate span with the [SPAN] key. If you set a span that is smaller than the overall span of the ranges, the measurement includes only the ranges that lie within the defined span and have a minimum span of 20 Hz. The first and last ranges are adapted to the given span as long as the minimum span of 20 Hz is not violated.



### Symmetrical ranges

You can easily define a sweep list with symmetrical range settings, i.e. the ranges to the left and right of the center range are defined symmetrically. In the "Sweep List" menu, select the "Symmetrical Setup" softkey to activate symmetrical setup mode. The current sweep list configuration is changed to define a symmetrical setup regarding the reference range. The number of ranges to the left of the reference range is reflected to the right, i.e. any missing ranges on the right are inserted, while superfluous ranges are removed. The values in the ranges to the right of the reference range are adapted symmetrically to those in the left ranges.

For details see "[Symmetric Setup](#)" on page 238.

Symmetrical ranges fulfill the conditions required for "Fast SEM" mode (see "[Fast Spectrum Emission Mask Measurements](#)" on page 257).

### Working with Limit Lines in SEM Measurements

Using the R&S ESRP, the spectrum emission mask is defined using limit lines. Limit lines allow you to check the measured data against specified limit values. Generally, it is possible to define limit lines for any measurement in Spectrum mode using the [Lines] key. For SEM measurements, however, special limit lines are available via the "Sweep List", and it is strongly recommended that you use only these limit line definitions.

In the "Sweep List" you can define a limit line for each power class that varies its level according to the specified frequency ranges. Distinguished limit lines ("\_SEM\_LINE\_ABS<0...3>"/ "\_SEM\_LINE\_REL<0...3>") are automatically defined for each power class according to the current "Sweep List" settings every time the settings change.

The limit line defined for the current power class is indicated by a red line in the display, and the result of the limit check is indicated at the top of the diagram. Note that only "Pass" or "Fail" is indicated; a "margin" function as for general limit lines is not available.

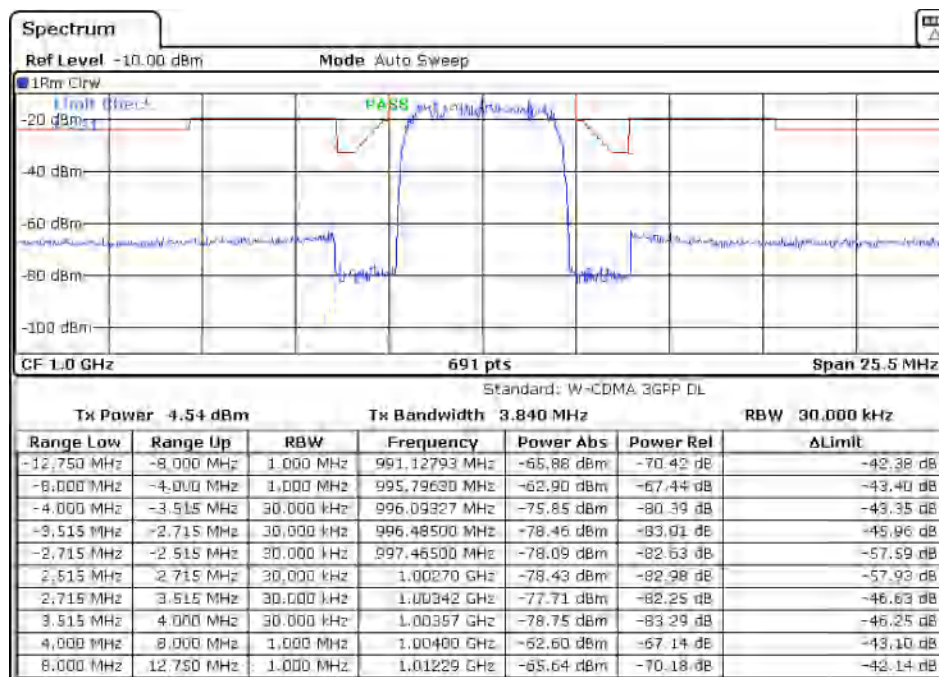

The indicated limit line depends on the settings in the "Sweep List". Several types of limit checks are possible:

Limit check type	Pass/fail criteria	Indicated limit line
Absolute	Absolute power levels may not exceed limit line	Defined by the "Abs Limit Start"/ "Abs Limit Stop" values for each range
Relative	Power deviations relative to the TX channel power may not exceed limit line	Defined by the "Rel Limit Start"/ "Rel Limit Stop" values (relative to the center frequency) for each range

Limit check type	Pass/fail criteria	Indicated limit line
Abs and Rel	Only if the power exceeds <b>both</b> the absolute <b>and</b> the relative limits, the check fails.	The less strict (higher) limit line is displayed for each range.
Abs or Rel	If the power exceeds <b>either</b> the absolute <b>or</b> the relative limits, the check fails.	The stricter (lower) limit line is displayed for each range.

The largest deviations of the power from the limit line for each range are displayed in the evaluation list. Furthermore, the absolute powers for those values, as well as the relative deviation from the TX channel power are displayed. Values that exceed the limit are indicated in red and by an asterisk (\*).

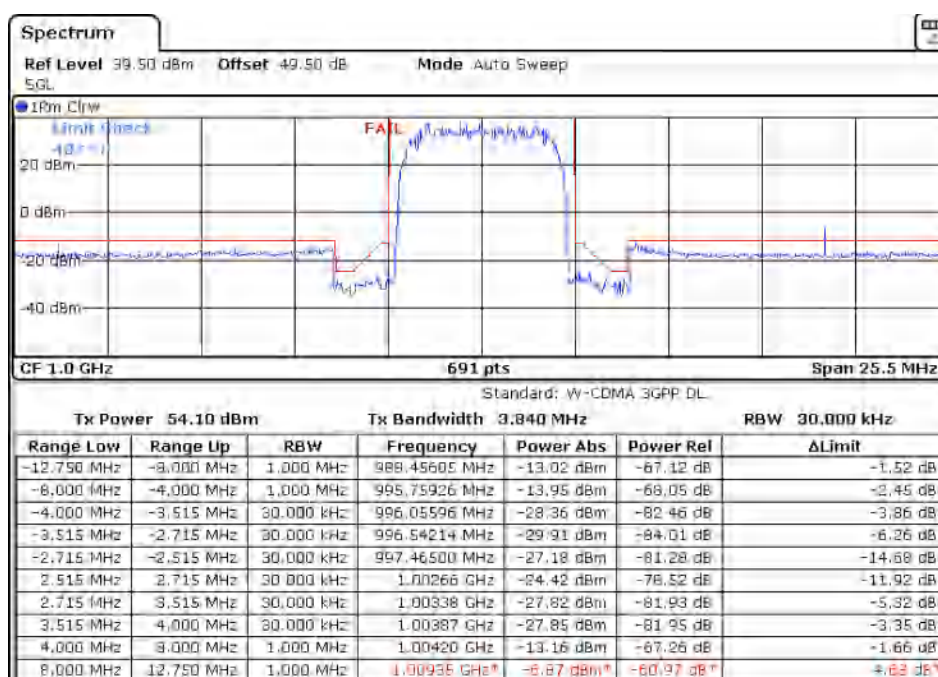

Although a margin functionality is not available for the limit check, a margin (threshold) for the peak values to be displayed in the evaluation list can be defined in the list evaluation settings. For details see ["Result Evaluation"](#) on page 244.

### Provided XML Files for the Spectrum Emission Mask Measurement

You can change the settings manually or via XML files. The XML files offer a quick way to change the configuration. A set of ready-made XML files for different standards is already provided. For details see [Table 6-1](#). You can also create and use your own XML files (for details see ["Format Description of Spectrum Emission Mask XML Files"](#) on page 251). All XML files are stored under "C:\r\_s\instr\sem\_std". Use the "Load Standard" softkey for quick access to the available XML files (see ["Load Standard"](#) on page 243).

Table 6-1: Provided XML files

Path	XML file name	Displayed standard characteristics*
cdma2000\DL	default0.xml	CDMA2000 BC0 DL
	default1.xml	CDMA2000 BC1 DL
cdma2000\UL	default0.xml	CDMA2000 BC0 UL
	default1.xml	CDMA2000 BC1 UL
WCDMA\3GPP\DL	PowerClass_31_39.xml	W-CDMA 3GPP (31,39)dBm DL
	PowerClass_39_43.xml	W-CDMA 3GPP (39,43)dBm DL
	PowerClass_43_INF.xml	W-CDMA 3GPP (43,INF)dBm DL
	PowerClass_negINF_31.xml	W-CDMA 3GPP (-INF,31)dBm DL
WIBRO\DL	PowerClass_29_40.xml	WiBro TTA (29,40)dBm DL
	PowerClass_40_INF.xml	WiBro TTA (40,INF)dBm DL
	PowerClass_negINF_29.xml	WiBro TTA (-INF,29)dBm DL
WIBRO\UL	PowerClass_23_INF.xml	WiBro TTA (23,INF)dBm UL
	PowerClass_negINF_23.xml	WiBro TTA (23,INF)dBm UL
WIMAX\DL\ETSI...MHz (1.75 MHz, 2.00 MHz, 3.5 MHz, 7.00 MHz, 14.00 MHz, 28 MHz)	System_Type_E.xml	WIMAX System Type E DL
	System_Type_F.xml	WIMAX System Type F DL
	System_Type_G.xml	WIMAX System Type G DL
WIMAX\DL\IEEE	10MHz.xml	WIMAX 10MHz DL
	20MHz.xml	WIMAX 20MHz DL
WIMAX\UL\ETSI...MHz (1.75 MHz, 2.00 MHz, 3.5 MHz, 7.00 MHz, 14.00 MHz, 28 MHz)	System_Type_E.xml	WIMAX System Type E UL
	System_Type_F.xml	WIMAX System Type F UL
	System_Type_G.xml	WIMAX System Type G UL
WIMAX\UL\IEEE	10MHz.xml	WIMAX 10MHz UL
	20MHz.xml	WIMAX 20MHz UL
WLAN\802_11_TURBO	ETSI.xml	IEEE 802.11
	IEEE.xml	IEEE 802.11
WLAN\802_11a	ETSI.xml	IEEE 802.11a
	IEEE.xml	IEEE 802.11a
WLAN\802_11b	IEEE.xml	IEEE 802.11b
WLAN\802_11j_10MHz	ETSI.xml	IEEE.802.11j

Path	XML file name	Displayed standard characteristics*
	IEEE.xml	IEEE.802.11j
WLAN\802_11j_20MHz	ETSI.xml	IEEE 802.11j
	IEEE.xml	IEEE 802.11j
EUTRA-LTE\DL\CategoryA\	BW_01_4_MHz__CFhigher1GHz.xml	LTE Cat. A >1GHz DL
EUTRA-LTE\DL\CategoryA\	BW_01_4_MHz__CFlower1GHz.xml	LTE Cat. A <1GHz DL
EUTRA-LTE\DL\CategoryA\	BW_03_0_MHz__CFhigher1GHz.xml	LTE Cat. A >1GHz DL
EUTRA-LTE\DL\CategoryA\	BW_03_0_MHz__CFlower1GHz.xml	LTE Cat. A <1GHz DL
EUTRA-LTE\DL\CategoryA\	BW_05_0_MHz__CFhigher1GHz.xml	LTE Cat. A >1GHz DL
EUTRA-LTE\DL\CategoryA\	BW_05_0_MHz__CFlower1GHz.xml	LTE Cat. A <1GHz DL
EUTRA-LTE\DL\CategoryA\	BW_10_0_MHz__CFhigher1GHz.xml	LTE Cat. A >1GHz DL
EUTRA-LTE\DL\CategoryA\	BW_10_0_MHz__CFlower1GHz.xml	LTE Cat. A >1GHz DL
EUTRA-LTE\DL\CategoryA\	BW_15_0_MHz__CFhigher1GHz.xml	LTE Cat. A >1GHz DL
EUTRA-LTE\DL\CategoryA\	BW_15_0_MHz__CFlower1GHz.xml	LTE Cat. A <1GHz DL
EUTRA-LTE\DL\CategoryA\	BW_20_0_MHz__CFhigher1GHz.xml	LTE Cat. A >1GHz DL
EUTRA-LTE\DL\CategoryA\	BW_20_0_MHz__CFlower1GHz.xml	LTE Cat. A <1GHz DL
EUTRA-LTE\DL\CategoryB\	BW_01_4_MHz__CFhigher1GHz.xml	LTE Cat. B >1GHz DL
EUTRA-LTE\DL\CategoryB\	BW_01_4_MHz__CFlower1GHz.xml	LTE Cat. B <1GHz DL
EUTRA-LTE\DL\CategoryB\	BW_03_0_MHz__CFhigher1GHz.xml	LTE Cat. B >1GHz DL
EUTRA-LTE\DL\CategoryB\	BW_03_0_MHz__CFlower1GHz.xml	LTE Cat. B <1GHz DL
EUTRA-LTE\DL\CategoryB\	BW_05_0_MHz__CFhigher1GHz.xml	LTE Cat. B >1GHz DL
EUTRA-LTE\DL\CategoryB\	BW_05_0_MHz__CFlower1GHz.xml	LTE Cat. B <1GHz DL
EUTRA-LTE\DL\CategoryB\	BW_10_0_MHz__CFhigher1GHz.xml	LTE Cat. B >1GHz DL
EUTRA-LTE\DL\CategoryB\	BW_10_0_MHz__CFlower1GHz.xml	LTE Cat. B >1GHz DL
EUTRA-LTE\DL\CategoryB\	BW_15_0_MHz__CFhigher1GHz.xml	LTE Cat. B >1GHz DL
EUTRA-LTE\DL\CategoryB\	BW_15_0_MHz__CFlower1GHz.xml	LTE Cat. B <1GHz DL
EUTRA-LTE\DL\CategoryB\	BW_20_0_MHz__CFhigher1GHz.xml	LTE Cat. B >1GHz DL
EUTRA-LTE\DL\CategoryB\	BW_20_0_MHz__CFlower1GHz.xml	LTE Cat. B <1GHz DL

Path	XML file name	Displayed standard characteristics*
EUTRA-LTE\UL\Standard\	BW_05_0_MHz.xml	LTE UL
EUTRA-LTE\UL\Standard\	BW_10_0_MHz.xml	LTE UL
EUTRA-LTE\UL\Standard\	BW_15_0_MHz.xml	LTE UL
EUTRA-LTE\UL\Standard\	BW_20_0_MHz.xml	LTE UL

\*Used abbreviations:

BC: band class

UL: uplink

DL: downlink

TTA: Telecommunications Technology Association

### Format Description of Spectrum Emission Mask XML Files

The files for importing range settings are in XML format and therefore obey the rules of the XML standard. Below, the child nodes, attributes, and structure defined for the data import is described. Build your own XML files according to these conventions because the R&S ESRP can only interpret XML files of a known structure. For example files look in the C:\r\_s\instr\sem\_std directory.

Spectrum Emission Mask							Standard: W-CDMA 3GPP (39,43)dBm DL	
Tx Power		Tx Bandwidth		RBW				
-47.93 dBm		3.840 MHz		30.000 kHz				
Range Low	Range Up	RBW	Frequency	Power Abs	Power Rel	ΔLimit		
-12.750 MHz	-8.000 MHz	1.000 MHz	14.99094 GHz*	-74.76 dBm*	-26.83 dB*	27.67 dB*		
-8.000 MHz	-4.000 MHz	1.000 MHz	14.99598 GHz	-36.79 dBm	11.14 dB	-25.29 dB		
-4.000 MHz	-3.515 MHz	30.000 kHz	14.99628 GHz	-100.18 dBm	-52.25 dB	-75.68 dB		
-3.515 MHz	-2.715 MHz	30.000 kHz	14.99648 GHz	-103.55 dBm	-55.63 dB	-79.05 dB		
-2.715 MHz	-2.515 MHz	30.000 kHz	14.99747 GHz	-108.91 dBm	-60.98 dB	-96.41 dB		
2.515 MHz	2.715 MHz	30.000 kHz	15.00251 GHz	-48.25 dBm	-0.32 dB	-35.75 dB		
2.715 MHz	3.515 MHz	30.000 kHz	15.00272 GHz	-52.48 dBm	-4.56 dB	-39.98 dB		
3.515 MHz	4.000 MHz	30.000 kHz	15.00398 GHz	-74.53 dBm	-26.60 dB	-50.03 dB		
4.000 MHz	8.000 MHz	1.000 MHz	15.00769 GHz	-74.76 dBm	-26.83 dB	-63.26 dB		
8.000 MHz	12.750 MHz	1.000 MHz	15.01273 GHz*	-36.79 dBm*	11.14 dB*	65.64 dB*		

Figure 6-5: Example Spectrum emission mask standard file (PowerClass\_39\_43.xml)



Be sure to follow the structure exactly as shown below or else the R&S ESRP is not able to interpret the XML file and error messages are shown on the screen. Therefore, we recommend you make a copy of an existing file (see [Save As Standard](#) softkey) and edit the copy of the file.

Alternatively, edit the settings using the "Spectrum Emission Mask" softkey and the [Sweep List dialog box](#) and save the XML file with the [Save As Standard](#) softkey afterwards. This way, no modifications have to be done in the XML file itself.

Basically, the file consists of three elements that can be defined:

- The "BaseFormat" element
- The "PowerClass" element

- The "Range" element

### The "BaseFormat" element

It carries information about basic settings. In this element only the "ReferencePower" child node has any effects on the measurement itself. The other attributes and child nodes are used to display information about the Spectrum Emission Mask Standard on the measurement screen. The child nodes and attributes of this element are shown in [Table 6-2](#).

In the example above (`PowerClass_39_43.xml` under `C:\r_s\instr\sem_std\WCDMA\3GPP`, see [Figure 6-5](#)), these attributes are defined as follows:

- `Standard="W-CDMA 3GPP"`
- `LinkDirection="DL"`
- `PowerClass="(39,43)dBm"`

### The "PowerClass" element

It is embedded in the "BaseFormat" element and contains settings information about the power classes. Up to four different power classes can be defined. For details refer to the "Sweep List" softkey ("[Sweep List](#)" on page 234) and the corresponding parameter description. The child nodes and attributes of this element are shown in [Table 6-3](#).

### The "Range" element

This element is embedded in the "PowerClass" element. It contains the settings information of the range. There have to be at least three defined ranges: one reference range and at least one range to either side of the reference range. The maximum number of ranges is 20. Note that the R&S ESRP uses the same ranges in each power class. Therefore, the contents of the ranges of each defined power class have to be identical to the first power class. An exception are the Start and Stop values of the two Limit nodes that are used to determine the power class. Note also, that there are two Limit nodes to be defined: one that gives the limit in absolute values and one in relative values. Make sure units for the Start and Stop nodes are identical for each Limit node.

For details refer to the "Sweep List" softkey ("[Sweep List](#)" on page 234) and the corresponding parameter description. The child nodes and attributes of this element are shown in [Table 6-4](#).

The following tables show the child nodes and attributes of each element and show if a child node or attribute is mandatory for the R&S ESRP to interpret the file or not. Since the hierarchy of the XML can not be seen in the tables, either view one of the default files already stored on the R&S ESRP in the `C:\r_s\instr\sem_std` directory or check the structure as shown below.

Below, a basic example of the structure of the file is shown, containing all mandatory attributes and child nodes. Note that the "PowerClass" element and the range element are themselves elements of the "BaseFormat" element and are to be inserted where noted. The separation is done here simply for reasons of a better overview. Also, no example values are given here to allow a quick reference to the tables above. *Italic font* shows the placeholders for the values.

- The "BaseFormat" element is structured as follows:
  - ```
<RS_SEM_ACP_FileFormat Version=""1.0.0.0">
  <Name>"Standard"</Name>
  <Instrument>
  <Type>"Instrument Type"</Type>
  <Application>"Application"</Application>
  </Instrument>
  <LinkDirection Name=""Name"">
  <ReferencePower>
  <Method>"Method"</Method>
  </ReferencePower>
  <PowerClass Index=""n"">
  <!-- For contents of the PowerClass node see
  Table 6-3 -->
  <!-- Define up to four PowerClass nodes -->
  </PowerClass>
  </LinkDirection>
  </RS_SEM_ACP_File>
```
- The "PowerClass" element is structured as follows:
  - ```
<PowerClass Index=""n">
  <StartPower Unit=""dBm"" InclusiveFlag=""true"" Value=""StartPowerValue""/>
  <StopPower Unit=""dBm"" InclusiveFlag=""false"" Value=""StopPowerValue""/>
  <DefaultLimitFailMode>"Limit Fail Mode"</DefaultLimitFailMode>
  <Range Index=""n"">
  <!-- For contents of the Range node see Table 6-4 -->
  <!-- Define up to twenty Range nodes -->
  </Range>
  ...
  </PowerClass>
```
- The "Range" element is structured as follows:
  - ```
<Range Index=""n">
  <Name=""Name"">
  <ChannelType>"Channel Type"</Channel Type>
  <WeightingFilter>
  <Type>"FilterType"</Type>
  <RollOffFactor>"Factor"</RollOffFactor>
  <Bandwidth>"Bandwidth"</Bandwidth>
  </WeightingFilter>
  <FrequencyRange>
  <Start>"RangeStart"</Start>
  <Stop>"RangeStop"</Stop>
  </FrequencyRange>
  <Limit>
  <Start Unit=""Unit"" Value=""Value""/>
  <Stop Unit=""Unit"" Value=""Value""/>
  </Limit>
  <Limit>
  <Start Unit=""Unit"" Value=""Value""/>
  <Stop Unit=""Unit"" Value=""Value""/>
```



```

</Limit>
<RBW Bandwidth=""Bandwidth"" Type=""FilterType""/>
<VBW Bandwidth=""Bandwidth""/>
<Detector>"Detector"</Detector>
<Sweep Mode=""SweepMode"" Time=""SweepTime""/>
<Amplitude>
<ReferenceLevel Unit=""dBm"" Value=""Value""/>
<RFAttenuation Mode=""Auto"" Unit=""dB"" Value=""Value""/>
<Preamplifier State=""State""/>
</Amplitude>
</Range>

```

**Table 6-2: Attributes and child nodes of the BaseFormat element**

Child Node	Attribute	Value	Parameter Description	Mand.
	FileFormatVersion	1.0.0.0		Yes
	Date	YYYY-MM-DD HH:MM:SS	Date in ISO 8601 format	No
Name		<string>	Name of the standard	Yes
Instrument	Type	FSL	Name of the instrument	No
	Application	SA   K72   K82	Name of the application	No
LinkDirection	Name	Downlink   Uplink   None		Yes
	ShortName	DL   UL		No
Reference- Power				Yes
Method	TX Channel Power   TX Channel Peak Power			Yes
Reference- Channel	<string>			No

**Table 6-3: Attributes and child nodes of the PowerClass element**

Child Node	Attribute	Value	Parameter Description	Mand.
StartPower	Value	<power in dBm>	The start power must be equal to the stop power of the previous power class. The StartPower value of the first range is -200	Yes
	Unit	dBm		Yes
	InclusiveFlag	true		Yes
StopPower	Value	<power in dBm>	The stop power must be equal to the start power of the next power class. The StopPower value of the last range is 200	Yes
	Unit	dBm		

Child Node	Attribute	Value	Parameter Description	Mand.
	InclusiveFlag	false		Yes
DefaultLimitFailMode		Absolute   Relative   Absolute and Relative   Absolute or Relative		Yes

**Table 6-4: Attributes and child nodes of the Range element (normal ranges)**

Child Node	Attribute	Value	Parameter Description	Mand.
	Index	0...19	Indices are continuous and have to start with 0	Yes
	Name	<string>	Name of the range	Only if ReferenceChannel contains a name and the range is the reference range
	Short-Name	<string>	Short name of the range	No
ChannelType		TX   Adjacent		Yes
WeightingFilter				Only if ReferencePower method is TX Channel Power and the range is the reference range
Type		RRC   CFilter	Type of the weighting filter	Yes
Roll Off Factor		0...1	Excess bandwidth of the filter	Only if the filter type is RRC
Bandwidth		<bandwidth in Hz>	Filter bandwidth	Only if the filter type is RRC
FrequencyRange				Yes
Start		<frequency in Hz>	Start value of the range	Yes
Stop		<frequency in Hz>	Stop value of the range	Yes
Limit		dBm/Hz   dBm   dBc   dBr   dB	A Range must contain exactly two limit nodes; one of the limit nodes has to have a relative unit (e.g. dBc), the other one must have an absolute unit (e.g. dBm)	Yes
Start	Value	<numeric_value>	Power limit at start frequency	Yes
	Unit	dBm/Hz   dBm   dBc   dBr   dB	Sets the unit of the start value	
Stop	Value	<numeric_value>	Power limit at stop frequency	

Child Node	Attribute	Value	Parameter Description	Mand.
	Unit	dBm/Hz   dBm   dBc   dBr   dB	Sets the unit of the stop value	
LimitFailMode		Absolute   Relative   Absolute and Relative   Absolute or Relative	If used, it has to be identical to DefaultLimitFailMode	No
RBW	Bandwidth	<bandwidth in Hz>	"RBW" on page 235	Yes
	Type	NORM   PULS   CFIL   RRC		No
VBW	Bandwidth	<bandwidth in Hz>	"VBW" on page 236	Yes
Detector		NEG   POS   SAMP   RMS   AVER   QUAS	If used, it has to be identical in all ranges.	No
Sweep	Mode	Manual   Auto	"Sweep Time Mode" on page 236	Yes
	Time	<time in sec>	"Sweep Time" on page 236	No
Amplitude				No
ReferenceLevel	Value	<power in dBm>	"Ref. Level" on page 236	Yes, if the ReferenceLevel child node is used
	Unit	dBm	Defines dBm as unit	Yes, if the ReferenceLevel node is used
RFAttenuation	Mode	Manual   Auto	"RF Att. Mode" on page 236	Yes, if the ReferenceLevel child node is used
Preamplifier		ON   OFF	"Preamp" on page 236	Yes

### ASCII File Export Format (Spectrum Emission Mask)

The first part of the file lists information about the signal analyzer and the general setup. For a detailed description refer to [Chapter 6.3.1.6, "ASCII File Export Format"](#), on page 370.

File contents	Description
RefType; CPOWER; TxBandwidth;9540000;Hz Filter State; ON; Alpha;0.22;	reference range setup, for details see <a href="#">"Edit Reference Range"</a> on page 239
PeaksPerRange;1; Values;4;	evaluation list information
0;-22500000;-9270000;1000000;2986455000;-74.762840270996094; -10.576210021972656;-45.762840270996094;PASS; 1;-9270000;-4770000;1000000;2991405000;-100.17695617675781; -35.990325927734375;-1.490325927734375;PASS 3;4770000;9270000;1000000;3005445000;-100.17695617675781; -35.990325927734375;-1.490325927734375;PASS; 4;9270000;22500000;1000000;3018225000;-74.762840270996094; -10.576210021972656;-45.762840270996094;PASS;	information about each peak: <range number>; <start frequency>; <stop frequency>; <resolution bandwidth of range>; <frequency of peak>; <absolute power in dBm of peak>; <relative power in dBc of peak (related to the channel power)>; <distance to the limit line in dB (positive value means above the limit)>; <limit fail (pass = 0, fail =1)>;

### Fast Spectrum Emission Mask Measurements

In order to improve the performance of the R&S ESRP for spectrum emission mask measurements, a "Fast SEM" mode is available. If this mode is activated, several consecutive ranges with identical sweep settings are combined to one sweep internally, which makes the measurement considerably more efficient. The displayed results remain unchanged and still consist of several ranges. Thus, measurement settings that apply only to the results, such as limits or transducer factors, can nevertheless be defined individually for each range.

#### Prerequisites

"Fast SEM" mode is available if the following criteria apply:

- The frequency ranges are consecutive, without frequency gaps
- The following sweep settings are identical:
  - "Filter Type", see ["Filter Type"](#) on page 235
  - "RBW", see ["RBW"](#) on page 235
  - "VBW", see ["VBW"](#) on page 236
  - "Sweep Time Mode", see ["Sweep Time Mode"](#) on page 236
  - "Ref Level", see ["Ref. Level"](#) on page 236
  - "Rf Att. Mode", see ["RF Att. Mode"](#) on page 236
  - "RF Attenuator", see ["RF Att. Mode"](#) on page 236
  - "Preamp", see ["Preamp"](#) on page 236

### Activating Fast SEM mode

"Fast SEM" mode is activated in the sweep list (see ["Fast SEM"](#) on page 235) or using a remote command. Activating the mode for one range automatically activates it for all ranges in the sweep list.

In the provided XML files for the Spectrum Emission Mask measurement, "Fast SEM" mode is activated by default.

SCPI command:

`[SENSe:]ESpectrum:HighSPeed` on page 730

### Consequences

When the "Fast SEM" mode is activated, the ranges for which these criteria apply are displayed as one single range. The sweep time is defined as the sum of the individual sweep times, initially, but can be changed. When the "Fast SEM" mode is deactivated, the originally defined individual sweep times are reset.



If "Symmetrical Setup" mode is active when "Fast SEM" mode is activated, not all sweep list settings can be configured symmetrically automatically (see also ["Symmetric Setup"](#) on page 238).

---

Any other changes to the sweep settings of the combined range are applied to each included range and remain changed even after deactivating "Fast SEM" mode.

### Example

	Range 1	Range 2	Range 3	Range 4	Range 5
Range Start	-12.75 MHz	-8 MHz	-4 MHz	-3.515 MHz	-2.715 MHz
Range Stop	-8 MHz	-4 MHz	-3.515 MHz	-2.715 MHz	-2.515 MHz
Fast SEM	On	On	On	On	On
Filter Type	Channel	---	Gaussian	---	---
RBW	1 MHz	---	30 kHz	---	---
VBW	10 MHz	---	10 MHz	---	---
Sweep Time Mode	---	---	---	---	---
Sweep Time	10 ms	---	30 ms	---	---
Ref. Level	-10 dBm	---	-10 dBm	---	---
RF Att. Mode	Auto	---	Auto	---	---
RF Attenuator	10 dB	---	10 dB	---	---
Preamp	Off	---	Off	---	---
Transd. Factor	None	None	None	None	None
Limit Check 1	Absolute	Absolute	Absolute	Absolute	Absolute
Abs Limit Start 1	-23.5 dBm	-19.5 dBm	-32.5 dBm	-32.5 dBm	-20.5 dBm
Abs Limit Stop 1	-23.5 dBm	-19.5 dBm	-32.5 dBm	-20.5 dBm	-20.5 dBm
Rel Limit Start 1	-50 dBc	-50 dBc	-50 dBc	-50 dBc	-50 dBc
Rel Limit Stop 1	-50 dBc	-50 dBc	-50 dBc	-50 dBc	-50 dBc
Limit Check 2	Relative	Relative	Relative	Relative	Relative

Figure 6-6: Sweep list using Fast SEM mode

In [Figure 6-6](#), a sweep list is shown for which Fast SEM is activated. The formerly 5 separately defined ranges are combined to 2 sweep ranges internally.

#### 6.1.1.6 Measuring Spurious Emissions

The Spurious Emissions measurement defines a measurement that monitors unwanted RF products outside the assigned frequency band generated by an amplifier. The spurious emissions are usually measured across a wide frequency range. The Spurious Emissions measurement allows a flexible definition of all parameters. A result table indicates the largest deviations of the absolute power from the limit line for each range, and the results can be checked against defined limits automatically.

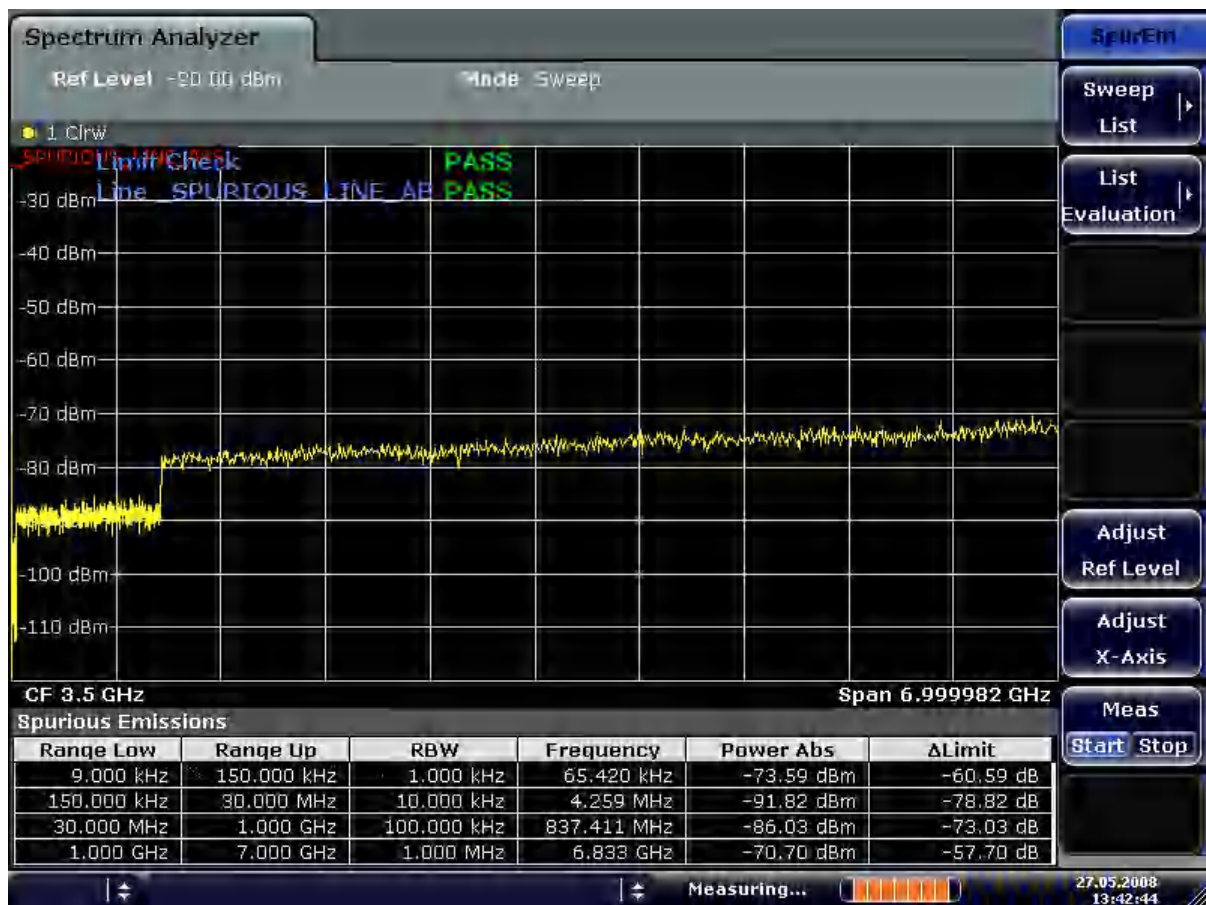

Spurious Emissions measurements are performed using the "Spurious Emissions" softkey in the "Measurement" menu (see ["Spurious Emissions"](#) on page 265).

Most parameters are defined in the "Sweep List" dialog box (see ["Sweep List dialog box"](#) on page 265). For information on other parameters, see the corresponding softkeys (["Spurious Emissions"](#) on page 265).

### Conditions for ranges

The following rules apply to ranges:

- The minimum span of a range is 20 Hz.
- The individual ranges must not overlap (but need not directly follow one another).
- The maximum number of ranges is 20.
- The maximum number of sweep points in all ranges is limited to 100001.

In order to change the start/stop frequency of the first/last range, select the appropriate span with the [SPAN] key. If you set a span that is smaller than the overall span of the ranges, the measurement includes only the ranges that lie within the defined span and have a minimum span of 20 Hz. The first and last ranges are adapted to the given span as long as the minimum span of 20 Hz is not violated.



### Defining ranges by remote control

In Spurious Emissions measurements, there are no remote commands to insert new ranges between existing ranges directly. However, you can delete or re-define the existing ranges to create the required order.

A remote command example for defining parameters and ranges in spurious emissions measurements can be found in chapter 7 "Remote Control – Programming Examples" of the Operating manual.

### Result Evaluation

In addition to the graphical results of the spurious measurement displayed in the diagram, a result table can be displayed to evaluate the limit check results (see also "[Working with Limit Lines in Spurious Measurements](#)" on page 262). Which data is displayed in the evaluation list can be defined in the "List Evaluation" menu (see "[List Evaluation](#)" on page 268).

The following information is provided in the evaluation list:

Column	Description
Range Low	Frequency range start for range the peak value belongs to
Range Up	Frequency range stop for range the peak value belongs to
RBW	RBW of the range
Frequency	Frequency at the peak value
Power Abs	Absolute power level at the peak value
$\Delta$ Limit	Deviation of the absolute power level from the defined limit for the peak value

By default, one peak per range is displayed. However, you can change the settings to:

- Display all peaks ("Details ON")
- Display a certain number of peaks per range ("Details ON" + "Peaks per Range")
- Display only peaks that exceed a threshold ("Margin")

In addition to listing the peaks in the list evaluation, detected peaks can be indicated by blue squares in the diagram ("Show Peaks").



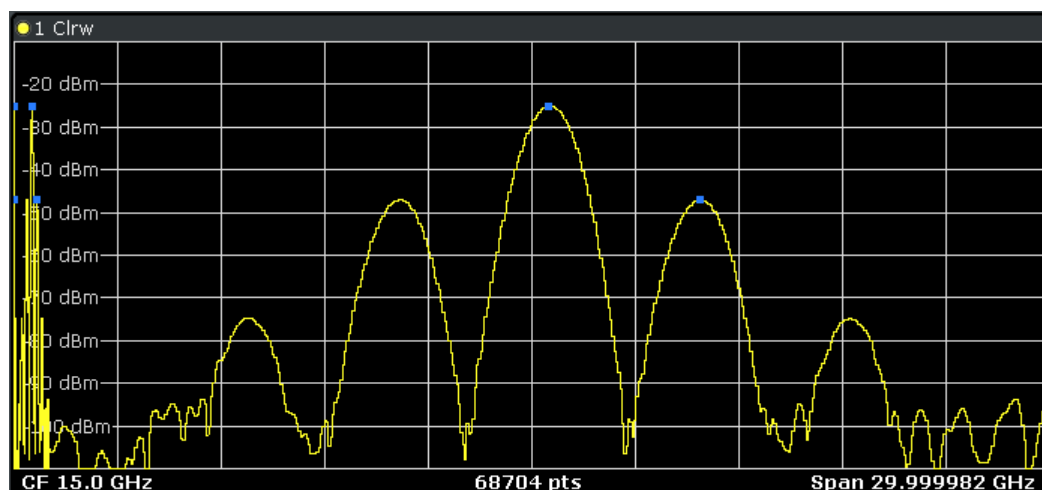

Furthermore, you can save the evaluation list to a file ("Save Evaluation List").

### Retrieving Results via Remote Control

The spurious measurement results can be retrieved using the `CALC:PSE?` command from a remote computer (see `CALCulate<n>:PEAKsearch|PSEarch[:IMMediate]` for a detailed description).

In addition, the `TRACe<n>:DATA` command queries the trace data. In case of spurious emission measurements, the trace data is the power levels that have been measured for each sweep point (max. 691).

### Working with Limit Lines in Spurious Measurements

Limit lines allow you to check the measured data against specified limit values. Generally, it is possible to define limit lines for any measurement in Spectrum mode using the `[Lines]` key. For Spurious measurements, however, a special limit line is available via the "Sweep List", and it is strongly recommended that you use only this limit line definition.

In the "Sweep List" you can define a limit line that varies its level according to the specified frequency ranges. A distinguished limit line ("`_SPURIOUS_LINE_ABS`") is automatically defined according to the current "Sweep List" settings every time the settings change.

If a limit check is activated in the "Sweep List", the "`_SPURIOUS_LINE_ABS`" limit line is indicated by a red line in the display, and the result of the limit check is indicated at the top of the diagram. Note that only "Pass" or "Fail" is indicated; a "margin" function as for general limit lines is not available. Also, only absolute limits can be checked, not relative ones.

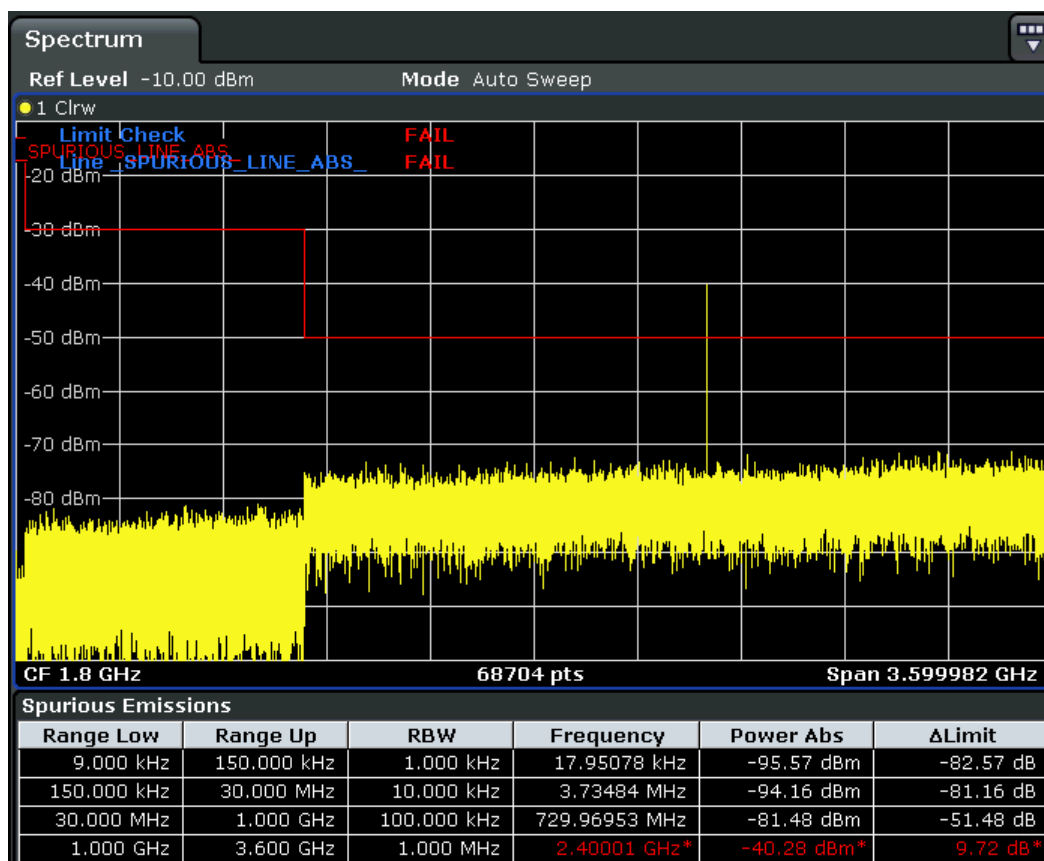

As for general limit lines, the results of each limit line check are displayed (here: "\_SPURIOUS\_LINE\_ABS"), as well as the combined result for all defined limit lines ("Limit Check").

In addition to the limit line itself, the largest deviations of the absolute power from the limit line for each range are displayed in the evaluation list if the limit check is activated. Values that exceed the limit are indicated in red and by an asterisk (\*).



Although a margin functionality is not available for the limit check, a margin (threshold) for the peak values to be displayed in the evaluation list can be defined in the list evaluation settings. Furthermore, you can define how many peaks per range are listed. For details see ["Result Evaluation"](#) on page 261.

### To define a limit check for spurious measurements

The limit check is defined in the "Sweep List" dialog box, see ["Sweep List dialog box"](#) on page 265 for details.

1. Press the [Meas Config] key to open the main "Spurious" menu.
2. Press the "Sweep List" softkey to open the "Sweep List" dialog box.

3. In the "Sweep List" dialog box, define the limit line for each range using the "Abs Limit Start" and "Abs Limit Stop" settings.  
The limit values are absolute values for the absolute power level.
4. Set the "Limit Check" setting to "Absolute" to activate the limit check.
5. Close the "Sweep List" dialog box.  
The limit line and the result of the limit check are displayed in the diagram and the result table displays the largest deviations from the limit for each range.
6. To reduce the number of displayed delta values, change the margin (threshold) for peak detection in the list evaluation. By default, this value is very high (200 dB), so that initially all peaks are detected.  
In the "Spurious" menu, press "List Evaluation > Margin" and enter a value in dB.  
Only delta values that exceed this margin are displayed in the result table.

### Softkeys for Spurious Emissions Measurement

Spurious Emissions.....	265
L Sweep List.....	265
L Sweep List dialog box.....	265
L Range Start / Range Stop.....	265
L Filter Type.....	265
L RBW.....	266
L VBW.....	266
L Sweep Time Mode.....	266
L Sweep Time.....	266
L Detector.....	266
L Ref. Level.....	266
L RF Att. Mode.....	266
L RF Attenuator.....	266
L Preamp.....	266
L Sweep Points.....	267
L Stop After Sweep.....	267
L Transd. Factor.....	267
L Limit Check 1-4.....	267
L Abs Limit Start.....	267
L Abs Limit Stop.....	267
L Close Sweep List.....	268
L Insert before Range.....	268
L Insert after Range.....	268
L Delete Range.....	268
L Adjust Ref Lvl (span > 0).....	268
L Adjust X-Axis.....	268
L List Evaluation.....	268
L List Evaluation (On/Off).....	269
L Details On/Off.....	269
L Margin.....	269
L Peaks per Range.....	269
L Show Peaks.....	269
L Save Evaluation List.....	269

L ASCII File Export.....	269
L Decim Sep.....	270
L Adjust Ref Lvl (span > 0).....	270
L Adjust X-Axis.....	270
L Meas Start/Stop.....	270

### Spurious Emissions

Opens a submenu to configure the Spurious Emissions measurement and immediately starts a measurement.

For general information on performing Spurious Emissions measurements see [Chapter 6.1.1.6, "Measuring Spurious Emissions"](#), on page 259.

Remote command:

[SENSe:] SWEep:MODE on page 729

### Sweep List ← Spurious Emissions

Opens a submenu to edit the sweep list and displays the "Sweep List" dialog box.

**Note:** If you edit the sweep list, always follow the rules described in [Chapter 6.1.1.6, "Measuring Spurious Emissions"](#), on page 259.

### Sweep List dialog box ← Sweep List ← Spurious Emissions

After a preset, the sweep list contains a set of default ranges and parameters. For each range, you can change the parameters listed below. To insert or delete ranges, use the "Insert Before Range", "Insert After Range", "Delete Range" softkeys. The measurement results are not updated during editing but on closing the dialog box.

For details and limitations regarding spurious emissions configuration, see [Chapter 6.1.1.6, "Measuring Spurious Emissions"](#), on page 259.

### Range Start / Range Stop ← Sweep List dialog box ← Sweep List ← Spurious Emissions

Sets the start frequency/stop frequency of the selected range. Follow the rules described in [Chapter 6.1.1.6, "Measuring Spurious Emissions"](#), on page 259.

In order to change the start/stop frequency of the first/last range, select the appropriate span with the SPAN key. If you set a span that is smaller than the overall span of the ranges, the measurement includes only the ranges that lie within the defined span and have a minimum span of 20 Hz. The first and last ranges are adapted to the given span as long as the minimum span of 20 Hz is not violated.

Frequency values for each range have to be defined relative to the center frequency. The reference range has to be centered on the center frequency. The minimum span of the reference range is given by the current TX Bandwidth.

Remote command:

[SENSe:] LIST:RANGe<range>[:FREQuency]:START on page 721

[SENSe:] LIST:RANGe<range>[:FREQuency]:STOP on page 721

### Filter Type ← Sweep List dialog box ← Sweep List ← Spurious Emissions

Sets the filter type for this range. For details on filters see also [Chapter 6.2.6.3, "Selecting the Appropriate Filter Type"](#), on page 337.

Remote command:

[\[SENSe:\]LIST:RANGe<range>:FILTer:TYPE](#) on page 720

**RBW** ← Sweep List dialog box ← Sweep List ← Spurious Emissions

Sets the RBW value for this range.

Remote command:

[\[SENSe:\]LIST:RANGe<range>:BANDwidth\[:RESolution\]](#) on page 718

**VBW** ← Sweep List dialog box ← Sweep List ← Spurious Emissions

Sets the VBW value for this range.

Remote command:

[\[SENSe:\]LIST:RANGe<range>:BANDwidth:VIDeo](#) on page 719

**Sweep Time Mode** ← Sweep List dialog box ← Sweep List ← Spurious Emissions

Activates or deactivates the auto mode for the sweep time.

Remote command:

[\[SENSe:\]LIST:RANGe<range>:SWEep:TIME:AUTO](#) on page 725

**Sweep Time** ← Sweep List dialog box ← Sweep List ← Spurious Emissions

Sets the sweep time value for the range.

Remote command:

[\[SENSe:\]LIST:RANGe<range>:SWEep:TIME](#) on page 725

**Detector** ← Sweep List dialog box ← Sweep List ← Spurious Emissions

Sets the detector for the range. For details refer to [Chapter 6.3.1.5, "Detector Overview"](#), on page 370.

Remote command:

[\[SENSe:\]LIST:RANGe<range>:DETector](#) on page 720

**Ref. Level** ← Sweep List dialog box ← Sweep List ← Spurious Emissions

Sets the reference level for the range.

Remote command:

[\[SENSe:\]LIST:RANGe<range>:RLEVel](#) on page 724

**RF Att. Mode** ← Sweep List dialog box ← Sweep List ← Spurious Emissions

Activates or deactivates the auto mode for RF attenuation.

Remote command:

[\[SENSe:\]LIST:RANGe<range>:INPut:ATTenuation:AUTO](#) on page 722

**RF Attenuator** ← Sweep List dialog box ← Sweep List ← Spurious Emissions

Sets the attenuation value for that range.

Remote command:

[\[SENSe:\]LIST:RANGe<range>:INPut:ATTenuation](#) on page 722

**Preamp** ← Sweep List dialog box ← Sweep List ← Spurious Emissions

Switches the preamplifier on or off.

Remote command:

[\[SENSe:\]LIST:RANGe<range>:INPut:GAIN:STATe](#) on page 722

#### **Sweep Points** ← Sweep List dialog box ← Sweep List ← Spurious Emissions

Sets the number of sweep points for the specified range.

Remote command:

[\[SENSe:\]LIST:RANGe<range>:POINTs](#) on page 724

#### **Stop After Sweep** ← Sweep List dialog box ← Sweep List ← Spurious Emissions

This command configures the sweep behavior.

"ON"                    The R&S ESRP stops after one range is swept and continues only if you confirm (a message box is displayed).

"OFF"                   The R&S ESRP sweeps all ranges in one go.

Remote command:

[\[SENSe:\]LIST:RANGe<range>:BREak](#) on page 719

#### **Transd. Factor** ← Sweep List dialog box ← Sweep List ← Spurious Emissions

Sets a transducer for the specified range. You can only choose a transducer that fulfills the following conditions:

- The transducer overlaps or equals the span of the range.
- The x-axis is linear.
- The unit is dB.

Remote command:

[\[SENSe:\]LIST:RANGe<range>:TRANsducer](#) on page 725

#### **Limit Check 1-4** ← Sweep List dialog box ← Sweep List ← Spurious Emissions

Sets the type of limit check for all ranges. Possible states are:

Absolute	Checks the absolute limits defined.
None	No limit check performed.

The limit settings are only available if limit check is activated ("Absolute"). If activated, the limit line and the results of the check are indicated in the diagram.

Remote command:

[\[SENSe:\]LIST:RANGe<range>:LIMit:STATe](#) on page 723

[CALCulate<n>:LIMit<k>:FAIL?](#) on page 686

#### **Abs Limit Start** ← Sweep List dialog box ← Sweep List ← Spurious Emissions

Sets an absolute limit value at the start frequency of the range [dBm].

This parameter is only available if the limit check is set to "Absolute" (see "[Limit Check 1-4](#)" on page 267).

Remote command:

[\[SENSe:\]LIST:RANGe<range>:LIMit:START](#) on page 723

#### **Abs Limit Stop** ← Sweep List dialog box ← Sweep List ← Spurious Emissions

Sets an absolute limit value at the stop frequency of the range [dBm].

This parameter is only available if the limit check is set to "Absolute" (see ["Limit Check 1-4"](#) on page 267).

Remote command:

`[SENSe:]LIST:RANGe<range>:LIMit:STOP` on page 724

#### **Close Sweep List ← Sweep List ← Spurious Emissions**

Closes the "Sweep List" dialog box and updates the measurement results.

#### **Insert before Range ← Sweep List ← Spurious Emissions**

Inserts a new range to the left of the currently focused range. The range numbers of the currently focused range and all higher ranges are increased accordingly. The maximum number of ranges is 20.

For further details refer to ["Ranges and Range Settings"](#) on page 245.

#### **Insert after Range ← Sweep List ← Spurious Emissions**

Inserts a new range to the right of the currently focused range. The range numbers of all higher ranges are increased accordingly. The maximum number of ranges is 20.

For further details refer to ["Ranges and Range Settings"](#) on page 245.

#### **Delete Range ← Sweep List ← Spurious Emissions**

Deletes the currently focused range, if possible. The range numbers are updated accordingly. For further details refer to ["Ranges and Range Settings"](#) on page 245.

Remote command:

`[SENSe:]LIST:RANGe<range>:DELete` on page 720

#### **Adjust Ref Lvl (span > 0) ← Sweep List ← Spurious Emissions**

Adjusts the reference level to the measured total power of the signal. The softkey is activated after the first sweep with active measurement of the occupied bandwidth has been completed and the total power of the signal is thus known.

Adjusting the reference level ensures that the signal path will not be overloaded and the dynamic range not limited by too low a reference level. Since the measurement bandwidth for channel power measurements is significantly lower than the signal bandwidth, the signal path may be overloaded although the trace is distinctly below the reference level. If the measured channel power is equal to the reference level, the signal path cannot be overloaded.

Remote command:

`[SENSe:]ADJust:LEVel` on page 798

#### **Adjust X-Axis ← Sweep List ← Spurious Emissions**

Adjusts the frequency axis of measurement diagram automatically so that the start frequency matches the start frequency of the first sweep range, and the stop frequency of the last sweep range.

#### **List Evaluation ← Spurious Emissions**

Opens a submenu to edit the list evaluation settings.

For more information on list evaluation see ["Result Evaluation"](#) on page 261.

**List Evaluation (On/Off) ← List Evaluation ← Spurious Emissions**

Activates or deactivates the list evaluation.

Remote command:

[CALCulate<n>:PEAKsearch|PSEarch:AUTO](#) on page 726

[TRACe<n>:DATA](#) on page 694

**Details On/Off ← List Evaluation ← Spurious Emissions**

Configures the list contents.

On	Displays the whole list contents.
Off	Displays only the highest peaks (one peak per range).

**Margin ← List Evaluation ← Spurious Emissions**

Opens an edit dialog box to enter the margin used for the limit check/peak search.

Only peaks that exceed the limit and are larger than the specified margin are indicated in the evaluation list.

Remote command:

[CALCulate<n>:PEAKsearch|PSEarch:MARGIN](#) on page 648

**Peaks per Range ← List Evaluation ← Spurious Emissions**

Opens an edit dialog box to enter the number of peaks per range that are stored in the list. Once the selected number of peaks has been reached, the peak search is stopped in the current range and continued in the next range. The maximum value is 50.

Remote command:

[CALCulate<n>:PEAKsearch|PSEarch:SUBRanges](#) on page 727

**Show Peaks ← List Evaluation ← Spurious Emissions**

In the diagram, marks all peaks with blue squares that have been listed during an active list evaluation.

Remote command:

[CALCulate<n>:PEAKsearch|PSEarch:PSHOW](#) on page 726

**Save Evaluation List ← List Evaluation ← Spurious Emissions**

Opens the "ASCII File Export Name" dialog box and a submenu to save the result in ASCII format to a specified file and directory.

Remote command:

[MMEMory:STORe<n>:LIST](#) on page 745

**ASCII File Export ← Save Evaluation List ← List Evaluation ← Spurious Emissions**

Saves the evaluation list in ASCII format to a specified file and directory.

Remote command:

[MMEMory:STORe<n>:LIST](#) on page 745



**Decim Sep ← Save Evaluation List ← List Evaluation ← Spurious Emissions**

Selects the decimal separator with floating-point numerals for the ASCII Trace export to support evaluation programs (e.g. MS-Excel) in different languages. The values '.' (decimal point) and ',' (comma) can be set.

Remote command:

`FORMat:DEXPort:DSEParator` on page 818

**Adjust Ref Lvl (span > 0) ← Spurious Emissions**

Adjusts the reference level to the measured total power of the signal. The softkey is activated after the first sweep with active measurement of the occupied bandwidth has been completed and the total power of the signal is thus known.

Adjusting the reference level ensures that the signal path will not be overloaded and the dynamic range not limited by too low a reference level. Since the measurement bandwidth for channel power measurements is significantly lower than the signal bandwidth, the signal path may be overloaded although the trace is distinctly below the reference level. If the measured channel power is equal to the reference level, the signal path cannot be overloaded.

Remote command:

`[SENSe:]ADJust:LEVel` on page 798

**Adjust X-Axis ← Spurious Emissions**

Adjusts the frequency axis of measurement diagram automatically so that the start frequency matches the start frequency of the first sweep range, and the stop frequency of the last sweep range.

**Meas Start/Stop ← Spurious Emissions**

Aborts/restarts the current measurement and displays the status:

"Start"	The measurement is currently running.
"Stop"	The measurement has been stopped, or, in single sweep mode, the end of the sweep has been reached.

**6.1.1.7 Measuring the Power in Zero Span**

Using the power measurement function, the R&S ESRP determines the power of the signal in zero span by summing up the power at the individual measurement points and dividing the result by the number of measurement points. Thus it is possible to measure the power of TDMA signals during transmission, for example, or during the muting phase. Both the mean power and the RMS power can be measured.

For this measurement, the sample detector is activated.

**Measurement results**

Several different power results can be determined simultaneously:

Mode	Description
Peak	Peak value from the points of the displayed trace or a segment thereof.
RMS	RMS value from the points of the displayed trace or a segment thereof.
Mean	Mean value from the points of the displayed trace or a segment thereof. The linear mean value of the equivalent voltages is calculated.  For example to measure the mean power during a GSM burst
Std Dev	The standard deviation of the measurement points from the mean value.

The result is displayed in the marker results, indicated by "Power" and the selected power mode, e.g. "RMS". The measured values are updated after each sweep or averaged over a user-defined number of sweeps (trace averaging).

You can query the measurement results with the commands described in ["Retrieving Measurement Results"](#) on page 770.

### Restricting the measurement range using limit lines

The range of the measured signal to be evaluated for the power measurement can be restricted using limit lines. The left and right limit lines (S1, S2) define the evaluation range and are indicated by vertical red lines in the diagram. If activated, the power results are only calculated from the levels within the limit lines.

For example, if both the on and off phase of a burst signal are displayed, the measurement range can be limited to the transmission or to the muting phase. The ratio between signal and noise power of a TDMA signal for instance can be measured using a measurement as a reference value and then varying the measurement range.

### To measure the power in the time domain

1. Press the "Time Domain Power" softkey to activate the power measurement.
2. Select the type of power measurement using the "Peak", "Mean", "RMS" or "Std Dev" softkeys.
3. To limit the power evaluation range, switch on the limits ("Limits (On/Off)" softkey) and enter the limits using the "Left Limit" and "Right Limit" softkeys.

### Softkeys for Time Domain Power Measurements

Time Domain Power.....	272
L Peak.....	272
L RMS.....	272
L Mean.....	272
L Std Dev.....	272
L Limits (On/Off).....	272
L Left Limit.....	273
L Right Limit.....	273

**Time Domain Power**

Activates the power measurement in zero span and opens a submenu to configure the power measurement. For more details see also [Chapter 6.1.1.7, "Measuring the Power in Zero Span"](#), on page 270.

Remote command:

`CALCulate<n>:MARKer<m>:FUNCTION:SUMMARY[:STATE]` on page 769

**Peak ← Time Domain Power**

Activates the calculation of the peak value from the points of the displayed trace or a segment thereof.

Remote command:

`CALCulate<n>:MARKer<m>:FUNCTION:SUMMARY:PPEAK[:STATE]` on page 774

`CALCulate<n>:MARKer<m>:FUNCTION:SUMMARY:PPEAK:RESULT?` on page 773

**RMS ← Time Domain Power**

Activates the calculation of the RMS value from the points of the displayed trace or a segment thereof.

Remote command:

`CALCulate<n>:MARKer<m>:FUNCTION:SUMMARY:RMS[:STATE]` on page 776

`CALCulate<n>:MARKer<m>:FUNCTION:SUMMARY:RMS:RESULT?` on page 776

**Mean ← Time Domain Power**

Activates the calculation of the mean value from the points of the displayed trace or a segment thereof. The linear mean value of the equivalent voltages is calculated.

This can be used for instance to measure the mean power during a GSM burst.

Remote command:

`CALCulate<n>:MARKer<m>:FUNCTION:SUMMARY:MEAN[:STATE]` on page 772

`CALCulate<n>:MARKer<m>:FUNCTION:SUMMARY:MEAN:RESULT?` on page 771

**Std Dev ← Time Domain Power**

Activates the calculation of the standard deviation of measurement points from the mean value and displays them as measured value. The measurement of the mean power is automatically switched on at the same time.

Remote command:

`CALCulate<n>:MARKer<m>:FUNCTION:SUMMARY:SDEViation[:STATE]`

on page 778

`CALCulate<n>:MARKer<m>:FUNCTION:SUMMARY:SDEViation:RESULT?`

on page 778

**Limits (On/Off) ← Time Domain Power**

Switches the limitation of the evaluation range on or off. Default setting is off.

If switched off, the evaluation range is not limited. If switched on, the evaluation range is defined by the left and right limit. If only one limit is set, it corresponds to the left limit and the right limit is defined by the stop frequency. If the second limit is also set, it defines the right limit.

Remote command:

`CALCulate<n>:MARKer<m>:X:SLIMITS[:STATE]` on page 659

**Left Limit ← Time Domain Power**

Opens an edit dialog box to enter a value for line 1.

Remote command:

[CALCulate<n>:MARKer<m>:X:SLIMits:LEFT](#) on page 658

**Right Limit ← Time Domain Power**

Opens an edit dialog box to enter a value for line 2.

Remote command:

[CALCulate<n>:MARKer<m>:X:SLIMits:RIGHT](#) on page 658

### 6.1.1.8 Performing EMI Measurements

The R&S ESRP features EMI measurement functionality in Spectrum mode. This functionality is suitable for measurements according to EMS standards.

The EMI functionality is integrated into the measurement and marker functions that are available in Spectrum mode.

**Measurement Background**

EMI measurements can be very time-consuming, especially if weighting detectors are required by the standard. In addition, EMC standards specify various procedures to locate local EMI maxima. Such procedures include movements of an absorbing clamp, variations in the height of the test antenna or the rotation of the DUT.

Covering all test setups with one of the (slow) EMI weighting detectors over the required frequency range would lead to unacceptable measurement times.

Splitting the measurement procedure into several stages eliminates this problem.

The first stage, or peak search, is used to get a rough idea about the location of peak powers that may indicate interference over the required frequency range. You can use a detector that allows for a fast sweep time, e.g. the peak detector.

During the second stage, or final evaluation, the analyzer performs the actual EMC test, with detectors designed for and required by EMC standards. To keep measurement times brief, the analyzer measures only those frequencies you have marked with markers or delta markers. You can assign a different detector to every marker and thus test a particular frequency easily for compliance.

**Selecting a Detector**

For more information on EMI detectors see [Chapter 5.2.2, "Detectors"](#), on page 143.

**Selecting the Measurement Bandwidth**

For more information on the measurement bandwidth in EMI test setups see [Chapter 5.2.1, "Measurement Bandwidth"](#), on page 142.

### Setting the Number of Sweep Points

The number of sweep points defines the number of measurement values collected during one sweep. Thus, increasing the sweep points also increases the accuracy of the results regarding the frequency resolution.

Because EMI measurements often cover a large frequency range you should define an adequate number of sweep points, especially when performing the measurement on a logarithmic axis. Like on a linear axis, the distance from one sweep point to the next is calculated graphically on a logarithmic axis, and is not based on the frequency itself. Thus, the frequency resolution between two sweep points deteriorates with higher frequencies.

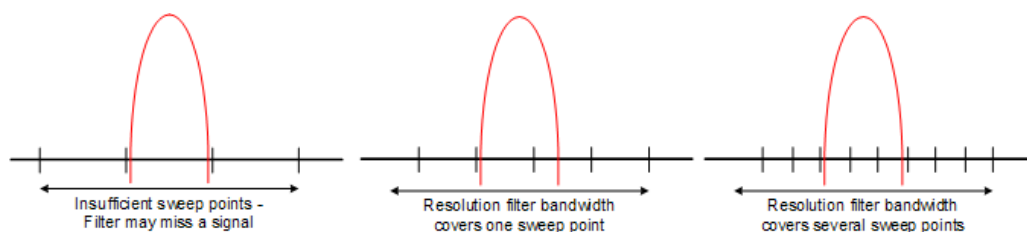

The resolution bandwidth should cover at least one sweep point (more is better). If this condition is not met, signals or interferences could be missed during final evaluation of narrowband interferers.

#### Example:

Linear axis:

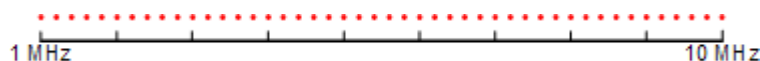

In case of a linear axis, the distance between the sweep points is equal, e.g. 200 kHz.

Logarithmic axis:

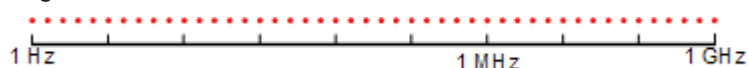

In case of a logarithmic axis, the distance between sweep points is variable. In the spectrum from 10 Hz to 100 Hz, the distance is a few Hz. Between 100 MHz and 1 GHz, the distance is several MHz.

The R&S ESRP supports a maximum of 200000 sweep points. This number is based on typical bands measured with a single resolution bandwidth. There are sufficient sweep points to make sure that a signal is found when doing the final evaluation. Even when covering 30 MHz to 1 GHz with logarithmic scaling and 120 kHz RBW.

### Controlling V-Networks

For more information on Line Impedance Stability Networks see [Chapter 5.2.5, "V-Networks Control \(LISN\)"](#), on page 149.

### Using Transducer Factors

For more information on transducer factors see [Chapter 5.2.6, "Transducers"](#), on page 150.

### Performing a Peak Search

The purpose of a peak search is to find signals with a high interference level quickly. Usually the peak search is done with a fast detector like the peak or average detector. The marker peak search is the basis for a possible final evaluation of interferences with the detectors specific to EMI measurements.

You can control markers in the [Marker Configuration](#) dialog box or turn them on with the "Marker <x>" softkey. The results of the peak search are summarized in the [Marker Table](#).

There are two ways to perform a peak search, automatic and manual.

#### Automatic peak search

By default, the automatic peak search starts as soon as you turn on the EMI measurement marker. During the peak search, the application looks for the strongest peaks in the frequency range you are measuring and positions a marker on those peaks. When a limit line is assigned to the trace, the level difference between the trace and the limit line determines the peak search. The number of peaks it will find during the search depends on the number of markers you have turned on. You can use up to 16 markers simultaneously.

The first marker is always on the most powerful peak while the last marker is always on the least powerful peak. If the application finds a more powerful peak, it will move one of the markers to that position and adjust the order of the other markers.

The application allows you to distribute markers among several traces. If you do so, the marker with the lowest number assigned to a particular trace will be positioned on the most powerful peak of the corresponding trace.

#### Manual peak search

If you turn the automatic peak search off, you can put the markers manually to any frequency you need more information about. You can change the marker position with the rotary knob, the cursor keys or position it to a particular frequency with the number keys.

Setting markers is the same as setting markers in normal spectrum mode. For more information see the manual of the base unit.

#### Searching for peaks over several traces

You can measure on six traces with a different weighting detector simultaneously.

In that case, the application searches for peaks on all traces separately, given that you have assigned at least one marker to that trace.

A typical selection for EMI measurement is to use the peak and the average detector. If the premeasurement is done, the application would look for peaks on the peak trace

and the average trace separately so that the distribution of narrowband and wideband sources of interference can be taken into account.

For example, the frequency of the maximum determined with the average detector can be used for the final measurement performed with this detector and the frequency found in the premeasurement carried out with the peak detector is taken for the final measurement using the quasipeak detector.

### Measuring at the Marker Position

Finding peaks with the help of a peak search reduces data to be evaluated and thus measurement time.

The measurement at the marker frequency may have a different detector during the peak search. This way, the measurement consumes much less time because detectors with a long measurement time are needed only at the critical frequency.

The application also allows you to use multiple detectors for the final evaluation. The advantage of multiple detection is that you will only need one test run to see if the results comply with the limits specified in a standard. You can select and assign detectors for EMI markers in the "[Marker Configuration](#)" on page 279 dialog box.

As EMC tests often require special measurement times, you can also specify a dwell time for the measurement with the EMI markers.

The application shows the results in the [Marker Table](#).

### Defining a Dwell Time for the Final Measurement

The dwell time defines for how long the R&S ESRP measures the signal at the frequencies of the marker positions. Thus the dwell time defines the amount of data that is included in the detection of the displayed results. As each detector needs a different period of time to fully charge and discharge, the minimum dwell time should not be shorter than the slowest detector in use.

### Evaluating the Results

For more information on functionality to evaluate measurement results see [Chapter 5.2.4, "AF Demodulation"](#), on page 148 and [Chapter 5.4.3, "\(Limit\) Lines"](#), on page 184.

### Configuration and Analysis

#### Measurement Configuration

The reference section contains an overview of all functions that are part of the chapter and lists the associated elements of the user interface.

For a list and description of supported detectors see [Chapter 5.2.2, "Detectors"](#), on page 143.

#### Filter Type

Opens a submenu to select the filter type.

When measuring Spurious Emissions, using this softkey automatically opens the "Sweep List" dialog (see ["Sweep List dialog box"](#) on page 265).

The submenu contains the following softkeys:

- Normal (3 dB)
- CISPR (6 dB)
- MIL Std (6 dB)  
Note that the 6 dB bandwidths are available only with option R&S FSV-K54.
- Channel
- RRC
- 5-Pole (not available for sweep type "FFT")

For detailed information on filters see [Chapter 6.2.6.3, "Selecting the Appropriate Filter Type"](#), on page 337 and [Chapter 6.2.6.4, "List of Available RRC and Channel Filters"](#), on page 338.

Remote command:

`[SENSe:]BANDwidth|BWIDth[:RESolution]:TYPE` on page 640

#### **Res BW CISPR / CISPR (6 dB)**

Selects the measurement bandwidth for commercial EMC standards according to CISPR.

If you select the bandwidth with the "Res BW CISPR" softkey, the R&S ESRP automatically changes the filter type to a 6 dB bandwidth.

Remote command:

Filter type:

`[SENSe:]BANDwidth|BWIDth[:RESolution]:TYPE` on page 640

Filter bandwidth:

`[SENSe:]BANDwidth|BWIDth[:RESolution]` on page 639

#### **Res BW Mil Std/ MIL Std (6 dB)**

Selects the measurement bandwidths for military EMC standards.

If you select the bandwidth with the "Res BW Mil Std" softkey, the R&S ESRP automatically changes the filter type to a 6 dB bandwidth.

Remote command:

Filter type:

`[SENSe:]BANDwidth|BWIDth[:RESolution]:TYPE` on page 640

Filter bandwidth:

`[SENSe:]BANDwidth|BWIDth[:RESolution]` on page 639

#### **Sweep Points**

Opens an edit dialog box to enter the number of measured values collected during a single measurement.

For more information see ["Setting the Number of Sweep Points"](#) on page 274.

Remote command:

`[SENSe:]SWEep:POINTs` on page 802

#### **Freq (Lin Log)**

Turns logarithmic scaling of the frequency axis on and off.



By default, the frequency axis has linear scaling. Logarithmic scaling of the frequency axis, however, is common for EMI measurements over large frequency ranges as it enhances the resolution of the lower frequencies. On the other hand, high frequencies get more crowded and become harder to distinguish.

Because it shows the lower frequencies more clearly, logarithmic scaling is used for tests that focus on those frequencies, for example acoustic tests and measurements.

Remote command:

`DISPlay[:WINDow<n>]:TRACe<t>:X:SPACing` on page 634

### LISN Control

Opens a dialog box to control a LISN.

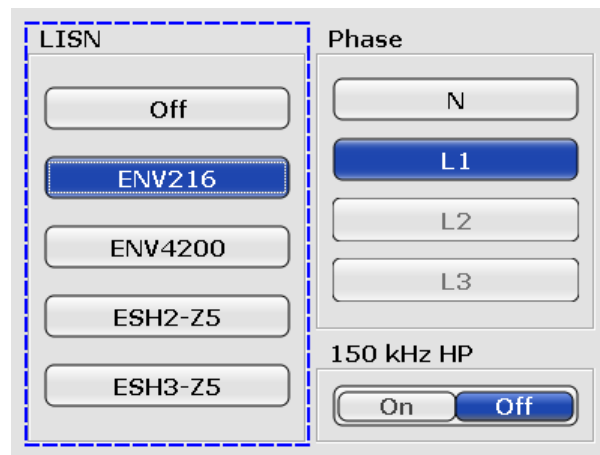

The dialog box contains the following elements.

- LISN  
Selects the V-network that you have in use. The R&S FSV-K54 supports the following networks:
  - R&S ESH3-Z5 and R&S ENV216 (two-line networks)
  - R&S ESH-Z5, R&S ENV432 and R&S ENV4200 (four-line networks)
- Phase  
Selects the phase to be measured. Phase N and L1 are included in all four LISN. Phase L2 and L3 are only included in four-line networks. You can select one phase for a measurement only.
- 150 kHz HP  
Turns on a 150 kHz highpass filter. The filter is available for the ENV 216 network only.

Remote command:

LISN type:

Phase:

Highpass filter:

### Peak Search

The reference section contains an overview of all functions that are part of the chapter and lists the associated elements of the user interface.

### Auto Peak Search

Turns the automatic marker peak search on and off.

For more information see ["Performing a Peak Search"](#) on page 275.

Remote command:

`CALCulate<n>:MARKer<m>:FUNCTion:FMEasurement:PSearch:AUTO`  
on page 749

### Marker Configuration

To make the process of configuring markers as easy as possible, the R&S FSV-K54 features a "Marker Configuration" dialog box that contains all marker characteristics necessary to perform successful EMI measurements.

The dialog box is made up out of two tabs. The first tab controls markers 1 to 8, the second tab controls markers 9 to 16.



- **Selected**  
Selects one of the markers. The currently selected marker is highlighted in orange color. The label indicates the marker type and its number.
- **State**  
Turns the marker on and off.
- **Type**  
Selects the marker type.  
The first marker always is a normal marker (abbreviated 'N'). Normal markers determine absolute signal levels. In the diagram area, they are drawn as a triangle pointing up (▲).

If you add more markers, these will be delta markers by default (abbreviated 'D'). Delta markers show signal levels in relation to another (normal) marker, by default in relation to the first marker. If necessary, you can still change the reference marker in the "Ref" column. In the diagram area, delta markers are drawn as a triangle pointing down (▲).

When performing EMI measurements however, you usually want to have absolute marker readouts for all markers that you are using.

- Ref  
Selects the reference marker for delta markers.  
By default, the reference marker for all delta markers is the first marker.  
This is active only for delta markers.
- Trace  
Selects the trace number the marker is positioned on.  
You can place markers on any of the active traces. The R&S FSV-K54 supports the use of up to four traces.
- Detector  
Selects the detector for the final measurement.
- Auto Peak  
Turns automatic peak search for all markers on and off.  
For more information see ["Performing a Peak Search"](#) on page 275.
- Dwell Time  
Sets the dwell time for all markers.  
For more information see ["Measuring at the Marker Position"](#) on page 276.
- All Markers Off  
Turns all markers off.

Remote command:

Reference marker:

`CALCulate<n>:DELTaMarker<m>:MREF`

Trace:

`CALCulate<n>:DELTaMarker<m>:TRACe` on page 670

`CALCulate<n>:MARKer<m>:TRACe` on page 664

Detector:

`CALCulate<n>:MARKer<m>:FUNCTion:FMEasurement:DETECTOR` on page 748

`CALCulate<n>:DELTaMarker<m>:FUNCTion:FMEasurement:DETECTOR`  
on page 747

Auto peak:

`CALCulate<n>:MARKer<m>:FUNCTion:FMEasurement:PSEarch:AUTO`

on page 749

Dwell time:

`CALCulate<n>:MARKer<m>:FUNCTion:FMEasurement:DWELL` on page 748

All marker off:

`CALCulate<n>:MARKer<m>:AOFF` on page 660

`CALCulate<n>:DELTaMarker<m>:AOFF` on page 666

See also the documentation of the base unit for information on how to remotely work with markers in general.

### Final Evaluation

The reference section contains an overview of all functions that are part of the chapter and lists the associated elements of the user interface.

**Dwell Time**

Sets the dwell time for the EMI marker measurement.

For more information see ["Measuring at the Marker Position"](#) on page 276.

Remote command:

`CALCulate<n>:MARKer<m>:FUNCTion:FMEasurement:DWELL` on page 748

**Marker Table**

If more than two markers have been activated, the application adds a marker table to the display below the diagram area. The size of the table depends on the number of markers that are active. It contains the following information for every marker.

EMI Measurement Marker							
Type	Ref	Trace	Frequency	Level	Detector	ΔLimit	Result
N1		1	999.28 MHz	-25.87 dBm	Peak	14.13 dB	-25.87 dBm*
N2		1	925.47 MHz	-47.77 dBm	Peak	-7.77 dB	-47.77 dBm
N3		1	1.07525 GHz	-47.77 dBm	Quasi Peak	-7.77 dB	-47.77 dBm
N4		1	849.493 MHz	-75.28 dBm	Quasi Peak	---	-75.28 dBm
N5		1	1.017366 GHz	-40.45 dBm	Quasi Peak	-0.45 dB	-40.45 dBm

- **Type**  
Shows the marker type. The marker type is either a normal marker (N) or delta marker (D).
- **Ref**  
Shows the reference marker. Applicable only for delta markers.
- **Trace**  
Trace number the marker is positioned on. You can turn on a maximum of six traces at the same time. Each trace has a different color.
- **Frequency**  
Frequency of a peak that was detected during the peak search. For normal markers this is an absolute value, for delta markers this is a relative value. The corresponding reference marker for delta markers is indicated in the "Ref" column.
- **Level**  
Signal level at the marker position according to the trace detector. For normal markers this is an absolute value, for delta markers this is a relative value. The corresponding reference marker for delta markers is indicated in the "Ref" column. The unit for absolute markers depends on the selected unit. The unit for relative markers is dB.
- **Detector**  
Detector that has been assigned to the EMI measurement marker.
- **ΔLimit**  
Shows the distance of the marker level to all active limit lines. The order of results depends on the order in that you have loaded the limit lines and is the same as the order in the status register. The result is either a relative value in dB or three dashes (- - -). In case of three dashes the marker is either
  - on a different trace than the limit line or
  - on a horizontal position that is not covered by the limit line.
 The delta limit is shown only if you have assigned a detector to the measurement marker.
- **Result**

Shows the signal level at the marker position according to the detector assigned to the corresponding marker. The result is only displayed after the final measurement is done. The overall measurement time depends on the dwell time.

If a limit line is active, the result can have three colors.

- green indicates that the marker has passed the limit check.
- yellow indicates that the marker is in the margins of the limit line.
- red and a star (\*) indicate that the marker has failed the limit check.

For more information on limit lines see the documentation of the base unit.

The result is shown only if you have assigned a detector to the measurement marker.

Remote command:

Detector:

$\Delta$ Limit:

`CALCulate<n>:MARKer<m>:FUNction:FMEasurement:LIMit<k>:DELta?`

on page 751

`CALCulate<n>:MARKer<m>:FUNction:FMEasurement:LIMit<k>:`

`CONDition ?` on page 750

`CALCulate<n>:DELTAmarker<m>:FUNction:FMEasurement:LIMit<k>:`

`DELta?` on page 750

`CALCulate<n>:DELTAmarker<m>:FUNction:FMEasurement:LIMit<k>:`

`CONDition ?` on page 749

Result:

`CALCulate<n>:MARKer<m>:FUNction:FMEasurement:RESult?` on page 751

`CALCulate<n>:DELTAmarker<m>:FUNction:FMEasurement:RESult?`

on page 750

### 6.1.1.9 Calculating Signal Amplitude Statistics

To measure the amplitude distribution, the R&S ESRP has simple measurement functions to determine both the APD = Amplitude Probability Distribution and CCDF = Complementary Cumulative Distribution Function.

#### To determine the amplitude distribution

- To activate and configure the measurement of the amplitude probability distribution (APD), press the "APD" softkey (see "APD" on page 200).

To activate and configure the measurement of the complementary cumulative distribution (CCDF), press the "CCDF" softkey (see "CCDF" on page 200).

Only one of the signal statistic functions can be switched on at a time. When a statistic function is switched on, the R&S ESRP is set into zero span mode automatically. The R&S ESRP measures the statistics of the signal applied to the RF input with the defined resolution bandwidth. To avoid affecting the peak amplitudes the video bandwidth is automatically set to 10 times the resolution bandwidth. The sample detector is used for detecting the video voltage.

About the Statistical Measurements.....	283
Result Evaluation.....	284
Softkeys for APD Measurements.....	287
Softkeys for CCDF Measurements.....	292
Defining Gated Triggering for APD and CCDF.....	298

### About the Statistical Measurements

Digital modulated signals are similar to white noise within the transmit channel, but are different in their amplitude distribution. In order to transmit the modulated signal without distortion all amplitudes of the signal have to be transmitted linearly, e.g. from the output power amplifier. Most critical are the peak amplitude values. Degradation in transmit quality caused by a transmitter two port network is dependent on the amplitude of the peak values as well as on their probability.

If modulation types are used that do not have a constant zero span envelope, the transmitter has to handle peak amplitudes that are greater than the average power. This includes all modulation types that involve amplitude modulation, QPSK for example. CDMA transmission modes in particular may have power peaks that are large compared to the average power.

For signals of this kind, the transmitter must provide large reserves for the peak power to prevent signal compression and thus an increase of the bit error rate at the receiver. The peak power or the crest factor of a signal is therefore an important transmitter design criterion. The crest factor is defined as the peak power/mean power ratio or, logarithmically, as the peak level minus the average level of the signal. To reduce power consumption and cut costs, transmitters are not designed for the largest power that could ever occur, but for a power that has a specified probability of being exceeded (e.g. 0.01 %).

The probability of amplitude values can be measured with the APD function (Amplitude Probability Distribution). During a selectable measurement time all occurring amplitude values are assigned to an amplitude range. The number of amplitude values in the specific ranges is counted and the result is displayed as a histogram.

Alternatively, the Complementary Cumulative Distribution Function (CCDF) can be displayed. It shows the probability that the mean signal power amplitude will be exceeded in percent.

### Bandwidth selection

When the amplitude distribution is measured, the resolution bandwidth must be set so that the complete spectrum of the signal to be measured falls within the bandwidth. This is the only way of ensuring that all the amplitudes will pass through the IF filter without being distorted. If the selected resolution bandwidth is too small for a digitally modulated signal, the amplitude distribution at the output of the IF filter becomes a Gaussian distribution according to the central limit theorem and thus corresponds to a white noise signal. The true amplitude distribution of the signal therefore cannot be determined.

### Selecting the number of samples

For statistics measurements with the R&S ESRP, the number of samples to be measured is defined instead of the sweep time. Since only statistically independent samples contribute to statistics, the acquisition or sweep time is calculated automatically and displayed in the channel bar (AQT). The samples are statistically independent if the time difference is at least  $1/\text{RBW}$ . The acquisition time AQT is, therefore, expressed as follows:

$$\text{AQT} = N_{\text{Samples}}/\text{RBW}$$

### Statistic measurements on pulsed signals

Statistic measurements on pulsed signals can be performed using a gated trigger. An external frame trigger is required as a time (frame) reference. For details see ["Defining Gated Triggering for APD and CCDF"](#) on page 298.

### Result Evaluation

#### Amplitude Probability Distribution (APD)

As a result of the APD function (Amplitude Probability Distribution), the probability of measured amplitude values is displayed. During a selectable measurement time all occurring amplitude values are assigned to an amplitude range. The number of amplitude values in the specific ranges is counted and the result is displayed as a histogram. Each bar of the histogram represents the percentage of measured amplitudes within the specific amplitude range. The x-axis is scaled in absolute values in dBm.

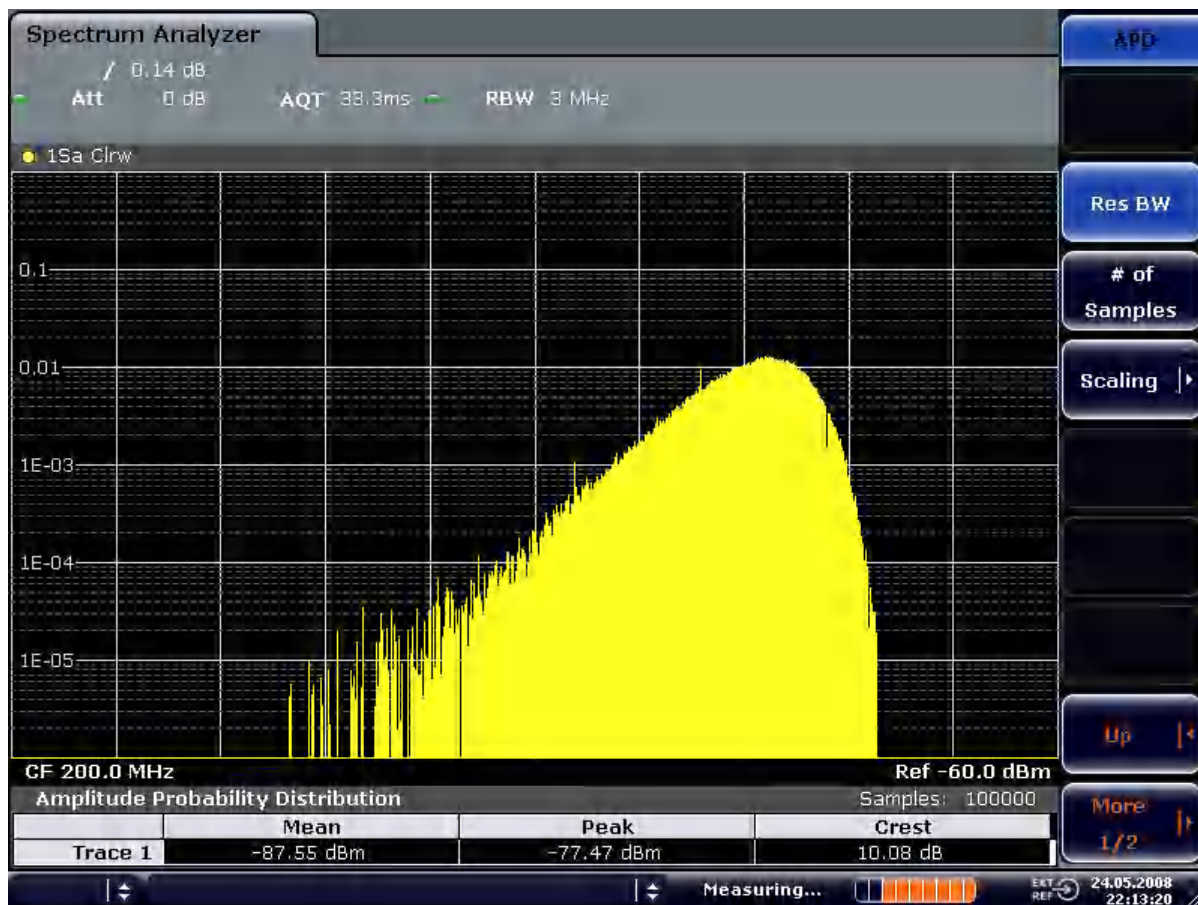

Figure 6-7: Amplitude probability distribution of white noise

In addition to the histogram, a result table is displayed containing the following information:

- Number of samples used for calculation
- For each displayed trace:
  - Mean amplitude
  - Peak amplitude
  - Crest factor

### Complementary Cumulative Distribution Function (CCDF)

The Complementary Cumulative Distribution Function (CCDF) shows the probability that the mean signal power amplitude will be exceeded in percent. The level above the mean power is plotted along the x-axis of the graph. The origin of the axis corresponds to the mean power level. The probability that a level will be exceeded is plotted along the y-axis.



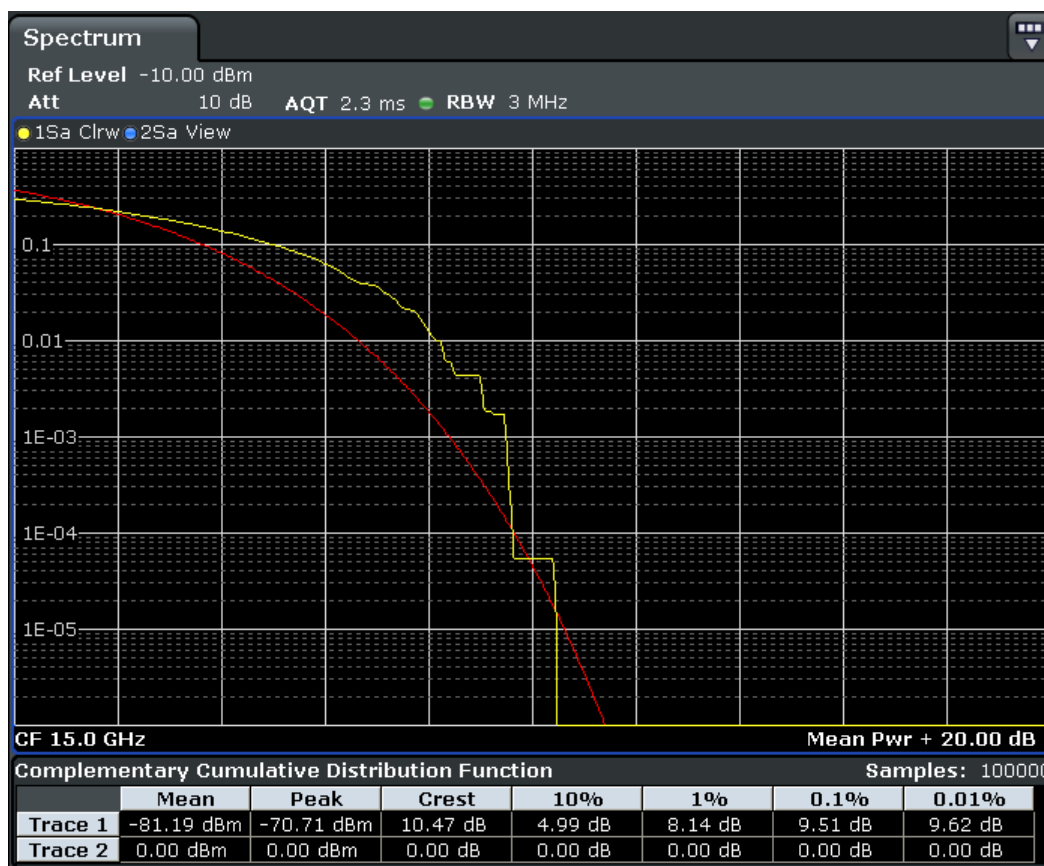

Figure 6-8: CCDF of white noise



A red line indicates the ideal Gaussian distribution for the measured amplitude range (white noise).

The displayed amplitude range is indicated as "Mean Pwr + <x dB>"

In addition to the histogram, a result table is displayed containing the following information:

- Number of samples used for calculation
- For each displayed trace:

<b>Mean</b>	Mean power
<b>Peak</b>	Peak power
<b>Crest</b>	Crest factor (peak power – mean power)
<b>0,01 %</b>	Level values over 0,01 % above mean power
<b>0,1 %</b>	Level values over 0,1 % above mean power

1 %	Level values over 1 % above mean power
10 %	Level values over 10 % above mean power

### Softkeys for APD Measurements

APD.....	287
L Res BW.....	287
L # of Samples.....	288
L Scaling.....	288
L x-Axis Ref Level.....	288
L x-Axis Range.....	288
L Range Log 100 dB.....	288
L Range Log 50 dB.....	288
L Range Log 10 dB.....	289
L Range Log 5 dB.....	289
L Range Log 1 dB.....	289
L Range Log Manual.....	289
L Range Linear %.....	289
L Range Lin. Unit.....	290
L y-Axis Max Value.....	290
L y-Axis Min Value.....	290
L y-Unit % / Abs.....	290
L Default Settings.....	290
L Adjust Settings.....	291
L Gated Trigger (On/Off).....	291
L Gate Ranges.....	291
L Adjust Settings.....	292

### APD

Activates the function to measure the amplitude probability density (APD) and opens a submenu.

For general information on calculating signal statistics see [Chapter 6.1.1.9, "Calculating Signal Amplitude Statistics"](#), on page 282.

Remote command:

`CALCulate<n>:STATistics:APD[:STATe]` on page 760

### Res BW ← APD

Opens an edit dialog box to set the resolution bandwidth directly.

For correct measurement of the signal statistics the resolution bandwidth has to be wider than the signal bandwidth in order to measure the actual peaks of the signal amplitude correctly. In order not to influence the peak amplitudes the video bandwidth is automatically set to 10 MHz. The sample detector is used for detecting the video voltage.

Remote command:

`[SENSe:]BANDwidth|BWIDth[:RESolution]` on page 639

**# of Samples ← APD**

Opens an edit dialog box to set the number of power measurements that are taken into account for the statistics.

Apart from the number of measurements the overall measurement time depends also on the set resolution bandwidth as the resolution bandwidth directly influences the sampling rate.

For details see ["Selecting the number of samples"](#) on page 284.

Remote command:

`CALCulate<n>:STATistics:NSAMples` on page 761

**Scaling ← APD**

Opens a submenu to change the scaling parameters of x- and y-axis.

**x-Axis Ref Level ← Scaling ← APD**

Opens an edit dialog box to enter the reference level in the currently active unit (dBm, dBμV, etc). The function of this softkey is identical to the "Ref Level" softkey in the "Amplitude" menu (see ["Ref Level"](#) on page 323).

For the APD function this value is mapped to the right diagram border. For the CCDF function there is no direct representation of this value on the diagram as the x-axis is scaled relatively to the measured mean power.

Remote command:

`CALCulate<n>:STATistics:SCALE:X:RLEVEL` on page 766

**x-Axis Range ← Scaling ← APD**

Opens the "Range" submenu to select a value for the level range to be covered by the statistics measurement selected.

Remote command:

`CALCulate<n>:STATistics:SCALE:X:RANGE` on page 765

**Range Log 100 dB ← x-Axis Range ← Scaling ← APD**

Sets the level display range to 100 dB.

Remote command:

Logarithmic scaling:

`DISP:WIND:TRAC:Y:SPAC LOG`, see `DISPlay[:WINDow<n>]:TRACe<t>:Y:SPACing` on page 636

Display range:

`DISP:WIND:TRAC:Y 100DB`, see `DISPlay[:WINDow<n>]:TRACe<t>:Y[:SCALE]` on page 812

**Range Log 50 dB ← x-Axis Range ← Scaling ← APD**

Sets the level display range to 50 dB.

Remote command:

Logarithmic scaling:

`DISP:WIND:TRAC:Y:SPAC LOG`, see `DISPlay[:WINDow<n>]:TRACe<t>:Y:SPACing` on page 636

Display range:

DISP:WIND:TRAC:Y 50DB, see [DISPlay\[:WINDow<n>\]:TRACe<t>:Y\[:SCALe\]](#) on page 812

#### **Range Log 10 dB ← x-Axis Range ← Scaling ← APD**

Sets the level display range to 10 dB.

Remote command:

Logarithmic scaling:

DISP:WIND:TRAC:Y:SPAC LOG, see [DISPlay\[:WINDow<n>\]:TRACe<t>:Y:SPACing](#) on page 636

Display range:

DISP:WIND:TRAC:Y 10DB, see [DISPlay\[:WINDow<n>\]:TRACe<t>:Y\[:SCALe\]](#) on page 812

#### **Range Log 5 dB ← x-Axis Range ← Scaling ← APD**

Sets the level display range to 5 dB.

Remote command:

Logarithmic scaling:

DISP:WIND:TRAC:Y:SPAC LOG, see [DISPlay\[:WINDow<n>\]:TRACe<t>:Y:SPACing](#) on page 636

Display range:

DISP:WIND:TRAC:Y 5DB, see [DISPlay\[:WINDow<n>\]:TRACe<t>:Y\[:SCALe\]](#) on page 812

#### **Range Log 1 dB ← x-Axis Range ← Scaling ← APD**

Sets the level display range to 1 dB.

Remote command:

Logarithmic scaling:

DISP:WIND:TRAC:Y:SPAC LOG, see [DISPlay\[:WINDow<n>\]:TRACe<t>:Y:SPACing](#) on page 636

Display range:

DISP:WIND:TRAC:Y 1DB, see [DISPlay\[:WINDow<n>\]:TRACe<t>:Y\[:SCALe\]](#) on page 812

#### **Range Log Manual ← x-Axis Range ← Scaling ← APD**

Opens an edit dialog box to define the display range of a logarithmic level axis manually.

Remote command:

Logarithmic scaling:

DISP:WIND:TRAC:Y:SPAC LOG, see [DISPlay\[:WINDow<n>\]:TRACe<t>:Y:SPACing](#) on page 636

Display range:

[DISPlay\[:WINDow<n>\]:TRACe<t>:Y\[:SCALe\]](#) on page 812

#### **Range Linear % ← x-Axis Range ← Scaling ← APD**

Selects linear scaling for the level axis in %.

The grid is divided into decadal sections.

Markers are displayed in the selected unit ("Unit" softkey). Delta markers are displayed in % referenced to the voltage value at the position of marker 1. This is the default setting for linear scaling.

Remote command:

DISP:TRAC:Y:SPAC LIN, see [DISPlay\[:WINDow<n>\]:TRACe<t>:Y:SPACing](#) on page 636

#### **Range Lin. Unit ← x-Axis Range ← Scaling ← APD**

Selects linear scaling in dB for the level display range, i.e. the horizontal lines are labeled in dB.

Markers are displayed in the selected unit ("Unit" softkey). Delta markers are displayed in dB referenced to the power value at the position of marker 1.

Remote command:

DISP:TRAC:Y:SPAC LDB, see [DISPlay\[:WINDow<n>\]:TRACe<t>:Y:SPACing](#) on page 636

#### **y-Axis Max Value ← Scaling ← APD**

Opens an edit dialog box to define the upper limit of the displayed probability range.

Values on the y-axis are normalized which means that the maximum value is 1.0. The y-axis scaling is defined via the [y-Unit % / Abs](#) softkey. The distance between max and min value must be at least one decade.

Remote command:

[CALCulate<n>:STATistics:SCALE:Y:UPPer](#) on page 767

#### **y-Axis Min Value ← Scaling ← APD**

Opens an edit dialog box to define the lower limit of the displayed probability range.

Values in the range  $1e^{-9} < value < 0.1$  are allowed. The y-axis scaling is defined via the [y-Unit % / Abs](#) softkey. The distance between max and min value must be at least one decade.

Remote command:

[CALCulate<n>:STATistics:SCALE:Y:LOWer](#) on page 766

#### **y-Unit % / Abs ← Scaling ← APD**

Defines the scaling type of the y-axis. The default value is absolute scaling.

Remote command:

[CALCulate<n>:STATistics:SCALE:Y:UNIT](#) on page 766

#### **Default Settings ← Scaling ← APD**

Resets the x- and y-axis scalings to their preset values.

x-axis ref level:	-10 dBm
x-axis range APD:	100 dB
x-axis range CISPR APD:	100 dB
x-axis range CCDF:	20 dB

y-axis upper limit:	1.0
y-axis lower limit:	1E-6

Remote command:

[CALCulate<n>:STATistics:PRESet](#) on page 764

### Adjust Settings ← Scaling ← APD

Adjusts the level settings according to the measured difference between peak and minimum power for APD measurement or peak and mean power for CCDF measurement in order to obtain maximum power resolution. Adjusts the reference level to the current input signal. For details see also the [Adjust Ref Lvl](#) softkey.

Remote command:

[CALCulate<n>:STATistics:SCALE:AUTO ONCE](#) on page 765

### Gated Trigger (On/Off) ← APD

Activates and deactivates the gating for statistics functions for the ACP and the CCDF channel. The trigger source is changed to "EXTERN" if this function is switched on. The gate ranges are defined using the ["Gate Ranges"](#) on page 291 softkey.

Remote command:

[\[SENSe:\]SWEep:EGATe](#) on page 809

[\[SENSe:\]SWEep:EGATe:SOURce](#) on page 810

### Gate Ranges ← APD

Opens a dialog to configure up to 3 gate ranges for each trace.

For details on configuration, see ["Defining Gated Triggering for APD and CCDF"](#) on page 298.

Gate Ranges						
	Trace 1	Trace 2	Trace 3	Trace 4	Trace 5	Trace 6
Comment	SlotA					
Period	8 ms	8 ms	8 ms	8 ms	8 ms	8 ms
Range 1 Start	1 ms	1 $\mu$ s	1 $\mu$ s	1 $\mu$ s	1 $\mu$ s	1 $\mu$ s
Range 1 Stop	3 ms	1 $\mu$ s	1 $\mu$ s	1 $\mu$ s	1 $\mu$ s	1 $\mu$ s
Range 1 Use	On	Off	Off	Off	Off	Off
Range 2 Start	1 $\mu$ s	1 $\mu$ s	1 $\mu$ s	1 $\mu$ s	1 $\mu$ s	1 $\mu$ s
Range 2 Stop	1 $\mu$ s	1 $\mu$ s	1 $\mu$ s	1 $\mu$ s	1 $\mu$ s	1 $\mu$ s
Range 2 Use	Off	Off	Off	Off	Off	Off
Range 3 Start	1 $\mu$ s	1 $\mu$ s	1 $\mu$ s	1 $\mu$ s	1 $\mu$ s	1 $\mu$ s
Range 3 Stop	1 $\mu$ s	1 $\mu$ s	1 $\mu$ s	1 $\mu$ s	1 $\mu$ s	1 $\mu$ s
Range 3 Use	Off	Off	Off	Off	Off	Off

Remote command:

[SWE:EGAT ON](#) (see [\[SENSe:\]SWEep:EGATe](#) on page 809)

Switches on the external gate mode.

[SWE:EGAT:TRAC1:COMM "SlotA"](#) (see [\[SENSe:\]SWEep:EGATe:TRACe<k>:COMMENT](#) on page 762)

Adds a comment to trace 1.

SWE:EGAT:TRAC1:STAT1 ON (see [SENSe:]SWEep:EGATe:TRACe<k>[:STATe<range>] on page 763)

Activates tracing for range 1 of trace 1.

SWE:EGAT:TRAC1:STAR1 3ms (see [SENSe:]SWEep:EGATe:TRACe<k>:STARt<range> on page 763)

Sets the starting point for range 1 on trace 1 at 3 ms.

SWE:EGAT:TRAC1:STOp1 5ms (see [SENSe:]SWEep:EGATe:TRACe<k>:STOP<range> on page 764)

Sets the stopping point for range 1 on trace 1 at 5 ms.

SWE:EGAT:TRAC1:PER 5ms (see [SENSe:]SWEep:EGATe:TRACe<k>:PERiod on page 763)

Defines the period for gated triggering to 5 ms.

### Adjust Settings ← APD

Adjusts the level settings according to the measured difference between peak and minimum power for APD measurement or peak and mean power for CCDF measurement in order to obtain maximum power resolution. Adjusts the reference level to the current input signal. For details see also the [Adjust Ref Lvl](#) softkey.

Remote command:

CALCulate<n>:STATistics:SCALE:AUTO ONCE on page 765

### Softkeys for CCDF Measurements

CCDF.....	292
L Percent Marker.....	293
L Res BW.....	293
L # of Samples.....	293
L Scaling.....	294
L x-Axis Ref Level.....	294
L x-Axis Range.....	294
L Range Log 100 dB.....	294
L Range Log 50 dB.....	294
L Range Log 10 dB.....	294
L Range Log 5 dB.....	295
L Range Log 1 dB.....	295
L Range Log Manual.....	295
L Range Linear %.....	295
L Range Lin. Unit.....	296
L y-Axis Max Value.....	296
L y-Axis Min Value.....	296
L y-Unit % / Abs.....	296
L Default Settings.....	296
L Adjust Settings.....	297
L Gated Trigger (On/Off).....	297
L Gate Ranges.....	297
L Adjust Settings.....	298

### CCDF

Activates the function to measure the complementary cumulative distribution function (CCDF) and opens a submenu.

After a CCDF measurement, the results are displayed in a table beneath the diagram.

<b>Mean</b>	Mean power
<b>Peak</b>	Peak power
<b>Crest</b>	Crest factor (peak power – mean power)
<b>0,01 %</b>	Level values over 0,01 % above mean power
<b>0,1 %</b>	Level values over 0,1 % above mean power
<b>1 %</b>	Level values over 1 % above mean power
<b>10 %</b>	Level values over 10 % above mean power

In addition, a red reference line indicating the calculated Gauss distribution is displayed.

Remote command:

[CALCulate<n>:STATistics:CCDF\[:STATe\]](#) on page 760

Activates the CCDF measurement.

[CALCulate<n>:STATistics:CCDF:X<Trace>](#) on page 761

Reads out the level values for 1 % probability.

#### **Percent Marker ← CCDF**

Opens an edit dialog box to enter a probability value and to position marker 1. Thus, the power which is exceeded with a given probability can be determined very easily. If marker 1 is deactivated, it will be switched on automatically.

As all markers, the percent marker can be moved simply by touching it with a finger or mouse cursor and dragging it to the desired position.

Remote command:

[CALCulate<n>:MARKer<m>:Y:PERCent](#) on page 833

#### **Res BW ← CCDF**

Opens an edit dialog box to set the resolution bandwidth directly.

For correct measurement of the signal statistics the resolution bandwidth has to be wider than the signal bandwidth in order to measure the actual peaks of the signal amplitude correctly. In order not to influence the peak amplitudes the video bandwidth is automatically set to 10 MHz. The sample detector is used for detecting the video voltage.

Remote command:

[\[SENSe:\]BANDwidth|BWIDth\[:RESolution\]](#) on page 639

#### **# of Samples ← CCDF**

Opens an edit dialog box to set the number of power measurements that are taken into account for the statistics.

Apart from the number of measurements the overall measurement time depends also on the set resolution bandwidth as the resolution bandwidth directly influences the sampling rate.

For details see "[Selecting the number of samples](#)" on page 284.



Remote command:

`CALCulate<n>:STATistics:NSAMples` on page 761

### **Scaling ← CCDF**

Opens a submenu to change the scaling parameters of x- and y-axis.

#### **x-Axis Ref Level ← Scaling ← CCDF**

Opens an edit dialog box to enter the reference level in the currently active unit (dBm, dBμV, etc). The function of this softkey is identical to the "Ref Level" softkey in the "Amplitude" menu (see "Ref Level" on page 323).

For the APD function this value is mapped to the right diagram border. For the CCDF function there is no direct representation of this value on the diagram as the x-axis is scaled relatively to the measured mean power.

Remote command:

`CALCulate<n>:STATistics:SCALE:X:RLEVEL` on page 766

#### **x-Axis Range ← Scaling ← CCDF**

Opens the "Range" submenu to select a value for the level range to be covered by the statistics measurement selected.

Remote command:

`CALCulate<n>:STATistics:SCALE:X:RANGE` on page 765

#### **Range Log 100 dB ← x-Axis Range ← Scaling ← CCDF**

Sets the level display range to 100 dB.

Remote command:

Logarithmic scaling:

`DISP:WIND:TRAC:Y:SPAC LOG`, see `DISPlay[:WINDow<n>]:TRACe<t>:Y:SPACing` on page 636

Display range:

`DISP:WIND:TRAC:Y 100DB`, see `DISPlay[:WINDow<n>]:TRACe<t>:Y[:SCALE]` on page 812

#### **Range Log 50 dB ← x-Axis Range ← Scaling ← CCDF**

Sets the level display range to 50 dB.

Remote command:

Logarithmic scaling:

`DISP:WIND:TRAC:Y:SPAC LOG`, see `DISPlay[:WINDow<n>]:TRACe<t>:Y:SPACing` on page 636

Display range:

`DISP:WIND:TRAC:Y 50DB`, see `DISPlay[:WINDow<n>]:TRACe<t>:Y[:SCALE]` on page 812

#### **Range Log 10 dB ← x-Axis Range ← Scaling ← CCDF**

Sets the level display range to 10 dB.

Remote command:

Logarithmic scaling:

DISP:WIND:TRAC:Y:SPAC LOG, see [DISPlay\[:WINDow<n>\]:TRACe<t>:Y:SPACing](#) on page 636

Display range:

DISP:WIND:TRAC:Y 10DB, see [DISPlay\[:WINDow<n>\]:TRACe<t>:Y\[:SCALE\]](#) on page 812

#### **Range Log 5 dB ← x-Axis Range ← Scaling ← CCDF**

Sets the level display range to 5 dB.

Remote command:

Logarithmic scaling:

DISP:WIND:TRAC:Y:SPAC LOG, see [DISPlay\[:WINDow<n>\]:TRACe<t>:Y:SPACing](#) on page 636

Display range:

DISP:WIND:TRAC:Y 5DB, see [DISPlay\[:WINDow<n>\]:TRACe<t>:Y\[:SCALE\]](#) on page 812

#### **Range Log 1 dB ← x-Axis Range ← Scaling ← CCDF**

Sets the level display range to 1 dB.

Remote command:

Logarithmic scaling:

DISP:WIND:TRAC:Y:SPAC LOG, see [DISPlay\[:WINDow<n>\]:TRACe<t>:Y:SPACing](#) on page 636

Display range:

DISP:WIND:TRAC:Y 1DB, see [DISPlay\[:WINDow<n>\]:TRACe<t>:Y\[:SCALE\]](#) on page 812

#### **Range Log Manual ← x-Axis Range ← Scaling ← CCDF**

Opens an edit dialog box to define the display range of a logarithmic level axis manually.

Remote command:

Logarithmic scaling:

DISP:WIND:TRAC:Y:SPAC LOG, see [DISPlay\[:WINDow<n>\]:TRACe<t>:Y:SPACing](#) on page 636

Display range:

[DISPlay\[:WINDow<n>\]:TRACe<t>:Y\[:SCALE\]](#) on page 812

#### **Range Linear % ← x-Axis Range ← Scaling ← CCDF**

Selects linear scaling for the level axis in %.

The grid is divided into decadal sections.

Markers are displayed in the selected unit ("Unit" softkey). Delta markers are displayed in % referenced to the voltage value at the position of marker 1. This is the default setting for linear scaling.

Remote command:

DISP:TRAC:Y:SPAC LIN, see [DISPlay\[:WINDow<n>\]:TRACe<t>:Y:SPACing](#) on page 636

**Range Lin. Unit ← x-Axis Range ← Scaling ← CCDF**

Selects linear scaling in dB for the level display range, i.e. the horizontal lines are labeled in dB.

Markers are displayed in the selected unit ("Unit" softkey). Delta markers are displayed in dB referenced to the power value at the position of marker 1.

Remote command:

DISP:TRAC:Y:SPAC LDB, see [DISPlay\[:WINDow<n>\]:TRACe<t>:Y:SPACing](#) on page 636

**y-Axis Max Value ← Scaling ← CCDF**

Opens an edit dialog box to define the upper limit of the displayed probability range. Values on the y-axis are normalized which means that the maximum value is 1.0. The y-axis scaling is defined via the [y-Unit % / Abs](#) softkey. The distance between max and min value must be at least one decade.

Remote command:

[CALCulate<n>:STATistics:SCALE:Y:UPPer](#) on page 767

**y-Axis Min Value ← Scaling ← CCDF**

Opens an edit dialog box to define the lower limit of the displayed probability range. Values in the range  $1e^{-9} < value < 0.1$  are allowed. The y-axis scaling is defined via the [y-Unit % / Abs](#) softkey. The distance between max and min value must be at least one decade.

Remote command:

[CALCulate<n>:STATistics:SCALE:Y:LOWer](#) on page 766

**y-Unit % / Abs ← Scaling ← CCDF**

Defines the scaling type of the y-axis. The default value is absolute scaling.

Remote command:

[CALCulate<n>:STATistics:SCALE:Y:UNIT](#) on page 766

**Default Settings ← Scaling ← CCDF**

Resets the x- and y-axis scalings to their preset values.

x-axis ref level:	-10 dBm
x-axis range APD:	100 dB
x-axis range CISPR APD:	100 dB
x-axis range CCDF:	20 dB
y-axis upper limit:	1.0
y-axis lower limit:	1E-6

Remote command:

[CALCulate<n>:STATistics:PRESet](#) on page 764

**Adjust Settings ← Scaling ← CCDF**

Adjusts the level settings according to the measured difference between peak and minimum power for APD measurement or peak and mean power for CCDF measurement in order to obtain maximum power resolution. Adjusts the reference level to the current input signal. For details see also the [Adjust Ref Lvl](#) softkey.

Remote command:

`CALCulate<n>:STATistics:SCALE:AUTO ONCE` on page 765

**Gated Trigger (On/Off) ← CCDF**

Activates and deactivates the gating for statistics functions for the ACP and the CCDF channel. The trigger source is changed to "EXTERN" if this function is switched on. The gate ranges are defined using the ["Gate Ranges"](#) on page 291 softkey.

Remote command:

`[SENSe:]SWEep:EGATe` on page 809

`[SENSe:]SWEep:EGATe:SOURce` on page 810

**Gate Ranges ← CCDF**

Opens a dialog to configure up to 3 gate ranges for each trace.

For details on configuration, see ["Defining Gated Triggering for APD and CCDF"](#) on page 298.

Gate Ranges						
	Trace 1	Trace 2	Trace 3	Trace 4	Trace 5	Trace 6
Comment	SlotA					
Period	8 ms	8 ms	8 ms	8 ms	8 ms	8 ms
Range 1 Start	1 ms	1 μs	1 μs	1 μs	1 μs	1 μs
Range 1 Stop	3 ms	1 μs	1 μs	1 μs	1 μs	1 μs
Range 1 Use	On	Off	Off	Off	Off	Off
Range 2 Start	1 μs	1 μs	1 μs	1 μs	1 μs	1 μs
Range 2 Stop	1 μs	1 μs	1 μs	1 μs	1 μs	1 μs
Range 2 Use	Off	Off	Off	Off	Off	Off
Range 3 Start	1 μs	1 μs	1 μs	1 μs	1 μs	1 μs
Range 3 Stop	1 μs	1 μs	1 μs	1 μs	1 μs	1 μs
Range 3 Use	Off	Off	Off	Off	Off	Off

Remote command:

`SWE:EGAT ON` (see [\[SENSe:\]SWEep:EGATe](#) on page 809)

Switches on the external gate mode.

`SWE:EGAT:TRAC1:COMM "SlotA"` (see [\[SENSe:\]SWEep:EGATe:TRACe<k>:COMMENT](#) on page 762)

Adds a comment to trace 1.

`SWE:EGAT:TRAC1:STAT1 ON` (see [\[SENSe:\]SWEep:EGATe:TRACe<k>\[:STATE<range>\]](#) on page 763)

Activates tracing for range 1 of trace 1.

`SWE:EGAT:TRAC1:STAR1 3ms` (see [\[SENSe:\]SWEep:EGATe:TRACe<k>:START<range>](#) on page 763)

Sets the starting point for range 1 on trace 1 at 3 ms.

`SWE:EGAT:TRAC1:STOp1 5ms` (see [\[SENSe:\]SWEep:EGATe:TRACe<k>:STOP<range>](#) on page 764)

Sets the stopping point for range 1 on trace 1 at 5 ms.

`SWE:EGAT:TRAC1:PER 5ms` (see [`SENSe:]SWEp:EGATe:TRACe<k>:PERiod` on page 763)

Defines the period for gated triggering to 5 ms.

#### **Adjust Settings ← CCDF**

Adjusts the level settings according to the measured difference between peak and minimum power for APD measurement or peak and mean power for CCDF measurement in order to obtain maximum power resolution. Adjusts the reference level to the current input signal. For details see also the [Adjust Ref Lvl](#) softkey.

Remote command:

`CALCulate<n>:STATistics:SCALE:AUTO ONCE` on page 765

#### **Defining Gated Triggering for APD and CCDF**

Statistic measurements on pulsed signals can be performed using GATED TRIGGER. An external frame trigger is required as a time (frame) reference.

The gate ranges define the part of the I/Q capture data taken into account for the statistics calculation. These ranges are defined relative to a reference point T=0. The gate interval is repeated for each period until the end of the I/Q capture buffer.

The reference point T=0 is defined by the external trigger event and the instrument's trigger offset.

For each trace you can define up to 3 separate ranges of a single period to be traced.

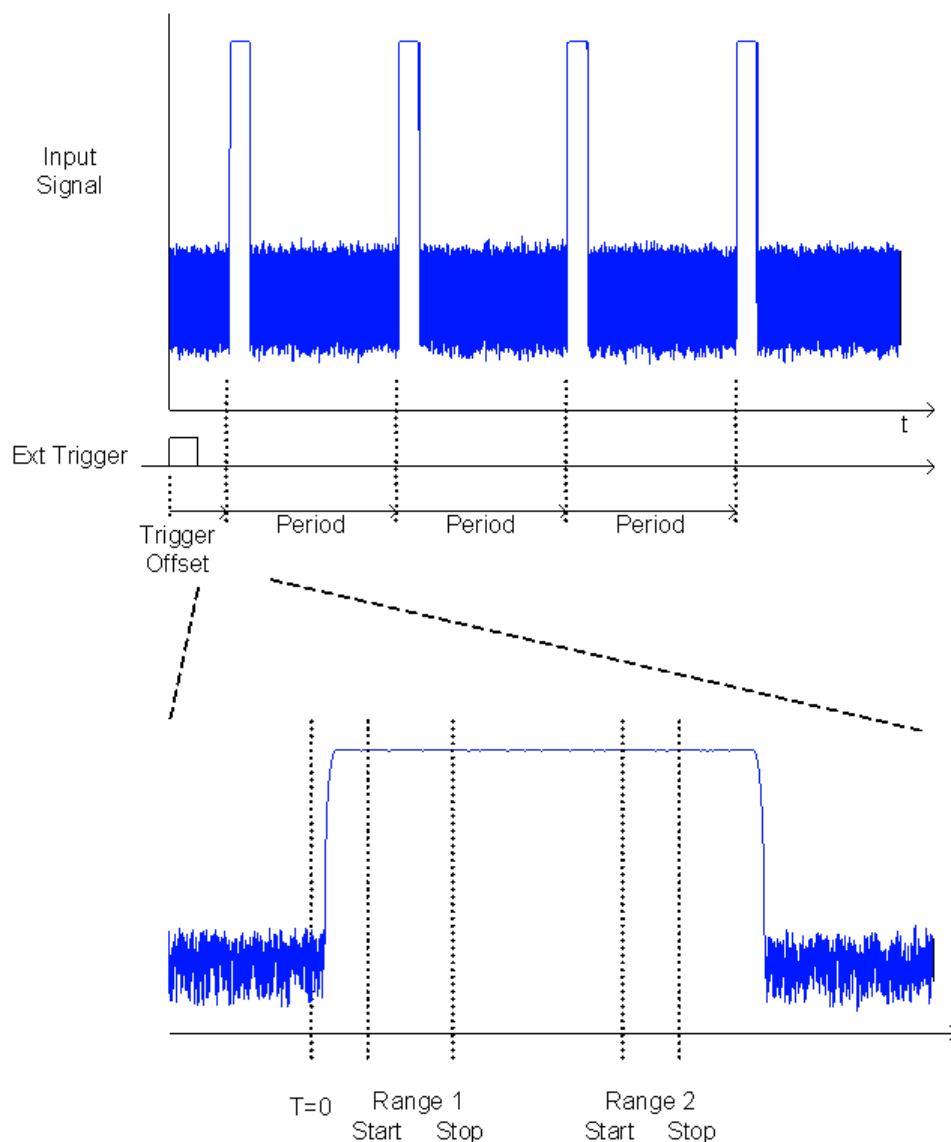

### Defining gated triggering

1. Press the "Gated Trigger" softkey to activate gated triggering (see ["Gated Trigger \(On/Off\)"](#) on page 291).
2. Press the "Gate Ranges" softkey to open the "Gate Ranges" dialog (see ["Gate Ranges"](#) on page 291).
3. Define the length of the period to be analyzed in the "Period" field.

**Note:** The period is the same for all traces. If you change the period for one trace, it is automatically changed for all traces.

Make sure the defined period is not longer than the acquisition time of the current measurement. Keep in mind that the acquisition time depends on the bandwidth and the number of samples settings (see ["Selecting the number of samples"](#) on page 284). The current acquisition time is indicated as "AQT" in the channel bar.

4. Optionally, define a description of the trace in the "Comment" field.
5. Activate tracing for the range by selecting "On" in the "Range <number> Use" field for the corresponding range and trace.

The start and stop time edit fields are ready for input.

**Note:** The time values have full numerical resolution and are only rounded for display.

6. Define the starting point of the range within the period.
7. Define the stopping point for the range within the period. Make sure the value for the stopping time is smaller than the length of the period.
8. To define further ranges for the same period in the same trace, repeat steps 5- 7 for the same trace.  
To define further ranges for the same period in a different trace, repeat steps 4- 7 for a different trace.
9. If necessary, activate the configured traces in the "Trace" menu.

#### Gated statistics configuration example

A statistics evaluation has to be done over the useful part of the signal between t3 and t4. The period of the GSM signal is 4.61536 ms

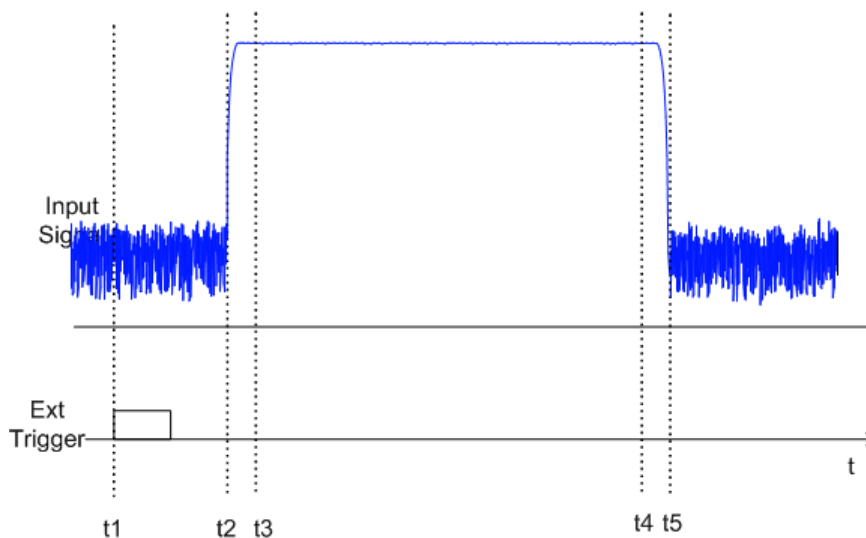

- t1: External positive trigger slope
- t2: Begin of burst (after 25  $\mu$ s)
- t3: Begin of useful part, to be used for statistics (after 40  $\mu$ s)
- t4: End of useful part, to be used for statistics (after 578  $\mu$ s)
- t5: End of burst (after 602  $\mu$ s)

The instrument has to be configured as follows:

Trigger Offset	$t_2 - t_1 = 25 \mu\text{s}$	now the gate ranges are relative to $t_2$
Range1 Start	$t_3 - t_2 = 15 \mu\text{s}$	start of range 1 relative to $t_2$
Range1 End	$t_4 - t_2 = 553 \mu\text{s}$	end of range 1 relative to $t_2$

#### 6.1.1.10 Measuring the Third Order Intercept Point (TOI)

In order to measure the third order intercept point (TOI), a two-tone signal with equal carrier levels is expected at the R&S ESRP input. Marker 1 and marker 2 (both normal markers) are set to the maximum of the two signals. Marker 3 and marker 4 are placed on the intermodulation products.

The R&S ESRP calculates the third order intercept point from the level difference between the first 2 markers and the markers 3 and 4 and displays it in the marker field.

The third order intercept point is measured using the "TOI" softkey, see "TOI" on page 200.

##### About TOI Measurement

If several signals are applied to a transmission two-port device with nonlinear characteristic, intermodulation products appear at its output at the sums and differences of the signals. The nonlinear characteristic produces harmonics of the useful signals which intermodulate at the characteristic. The intermodulation products of lower order have a special effect since their level is largest and they are near the useful signals. The intermodulation product of third order causes the highest interference. It is the intermodulation product generated from one of the useful signals and the 2nd harmonic of the second useful signal in case of two-tone modulation.

The frequencies of the intermodulation products are above and below the useful signals. The [Figure 6-9](#) shows intermodulation products  $P_{I1}$  and  $P_{I2}$  generated by the two useful signals  $P_{U1}$  and  $P_{U2}$ .



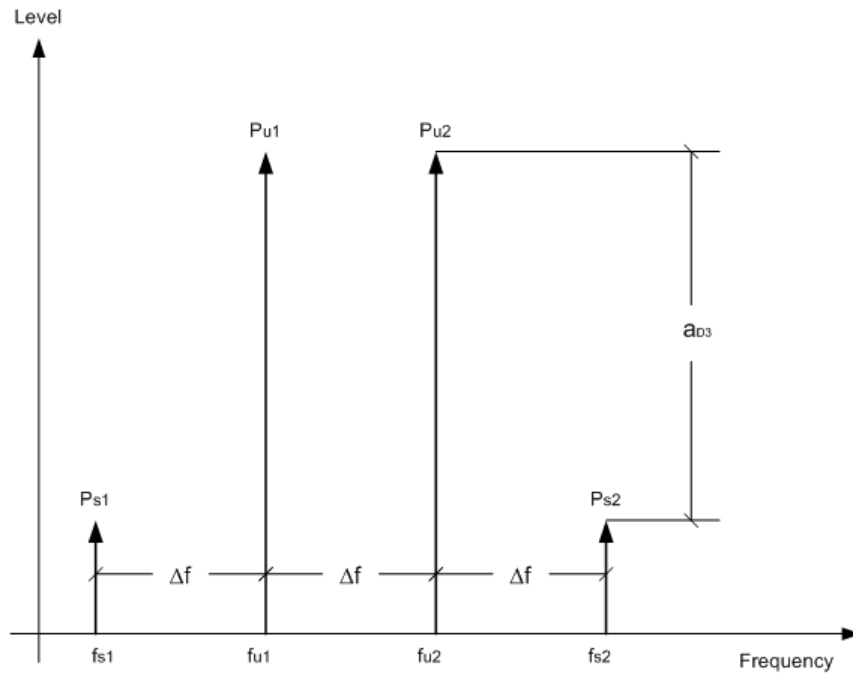

**Figure 6-9: Intermodulation products  $P_{U1}$  and  $P_{U2}$**

The intermodulation product at  $f_{i2}$  is generated by mixing the 2nd harmonic of useful signal  $P_{U2}$  and signal  $P_{U1}$ , the intermodulation product at  $f_{i1}$  by mixing the 2nd harmonic of useful signal  $P_{U1}$  and signal  $P_{U2}$ .

$$f_{i1} = 2 \times f_{u1} - f_{u2} \quad (6)$$

$$f_{i2} = 2 \times f_{u2} - f_{u1} \quad (7)$$

#### Dependency on level of useful signals

The level of the intermodulation products depends on the level of the useful signals. If the two useful signals are increased by 1 dB, the level of the intermodulation products increases by 3 dB, which means that spacing  $a_{D3}$  between intermodulation signals and useful signals are reduced by 2 dB. This is illustrated in [Figure 6-10](#).

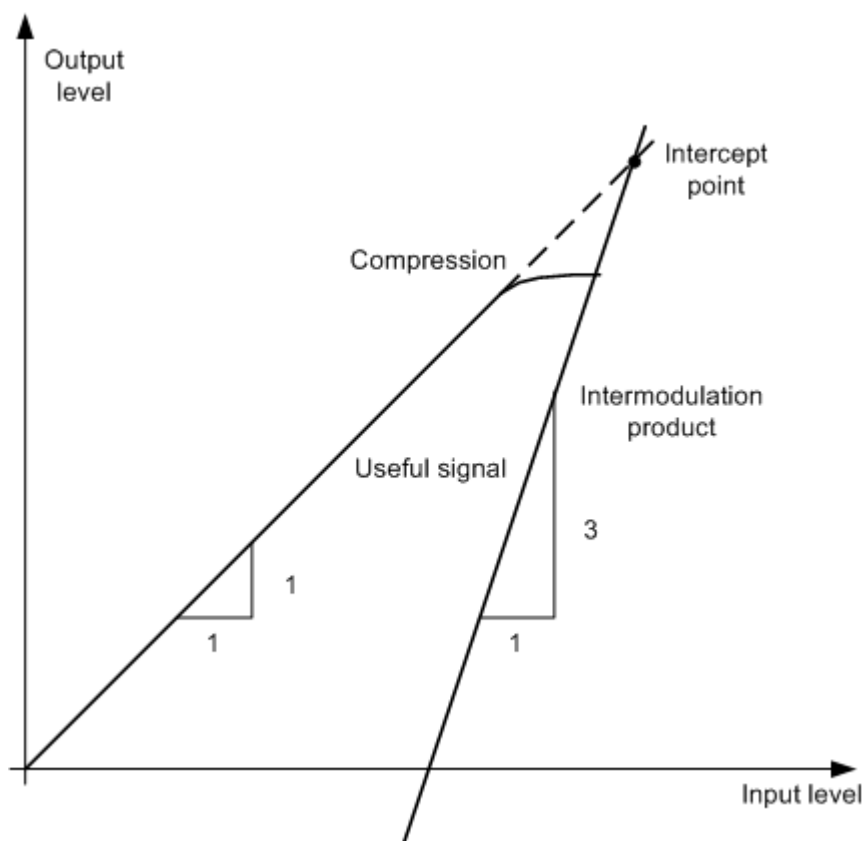

Figure 6-10: Dependency of intermodulation level on useful signal level

The useful signals at the two-port output increase proportionally with the input level as long as the two-port is in the linear range. A level change of 1 dB at the input causes a level change of 1 dB at the output. Beyond a certain input level, the two-port goes into compression and the output level stops increasing. The intermodulation products of the third order increase three times as much as the useful signals. The intercept point is the fictitious level where the two lines intersect. It cannot be measured directly since the useful level is previously limited by the maximum two-port output power.

#### Calculation method

It can be calculated from the known line slopes and the measured spacing  $a_{D3}$  at a given level according to the following formula:

$$IP3 = \frac{a_{D3}}{2} + P_N$$

The 3<sup>rd</sup> order intercept point (TOI), for example, is calculated for an intermodulation of 60 dB and an input level  $P_U$  of -20 dBm according to the following formula:

$$IP3 = \frac{60}{2} + (-20dBm) = 10dBm$$

### Intermodulation-free dynamic range

The "Intermodulation-free dynamic range", i.e. the level range in which no internal intermodulation products are generated if two-tone signals are measured, is determined by the 3<sup>rd</sup> order intercept point, the phase noise and the thermal noise of the signal analyzer. At high signal levels, the range is determined by intermodulation products. At low signal levels, intermodulation products disappear below the noise floor, i.e. the noise floor and the phase noise of the signal analyzer determine the range. The noise floor and the phase noise depend on the resolution bandwidth that has been selected. At the smallest resolution bandwidth, the noise floor and phase noise are at a minimum and so the maximum range is obtained. However, a large increase in sweep time is required for small resolution bandwidths. It is, therefore, best to select the largest resolution bandwidth possible to obtain the range that is required. Since phase noise decreases as the carrier-offset increases, its influence decreases with increasing frequency offset from the useful signals.

The following diagrams illustrate the intermodulation-free dynamic range as a function of the selected bandwidth and of the level at the input mixer (= signal level – set RF attenuation) at different useful signal offsets.

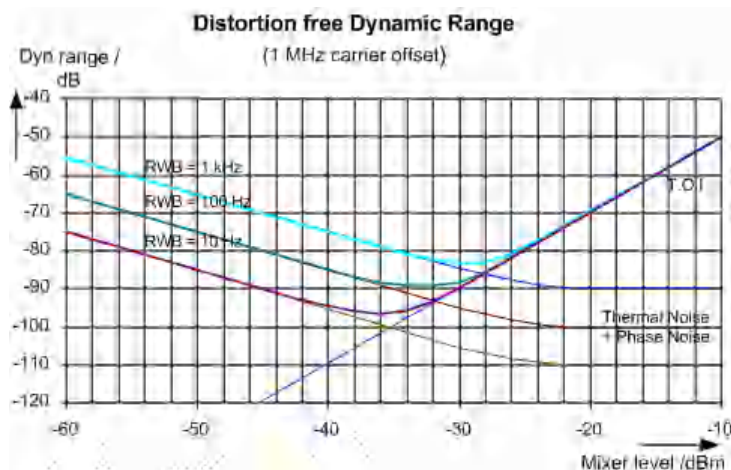

**Figure 6-11: Intermodulation-free range of the R&S ESRP as a function of level at the input mixer and the set resolution bandwidth**

(Useful signal offset = 1 MHz, DANL = -145 dBm/Hz, TOI = 15 dBm; typical values at 2 GHz)

The optimum mixer level, i.e. the level at which the intermodulation distance is at its maximum, depends on the bandwidth. At a resolution bandwidth of 10 Hz, it is approx. -35 dBm and at 1 kHz increases to approx. -30 dBm.

Phase noise has a considerable influence on the intermodulation-free range at carrier offsets between 10 and 100 kHz ( Figure 6-11). At greater bandwidths, the influence of the phase noise is greater than it would be with small bandwidths. The optimum mixer level at the bandwidths under consideration becomes almost independent of bandwidth and is approx. -40 dBm.

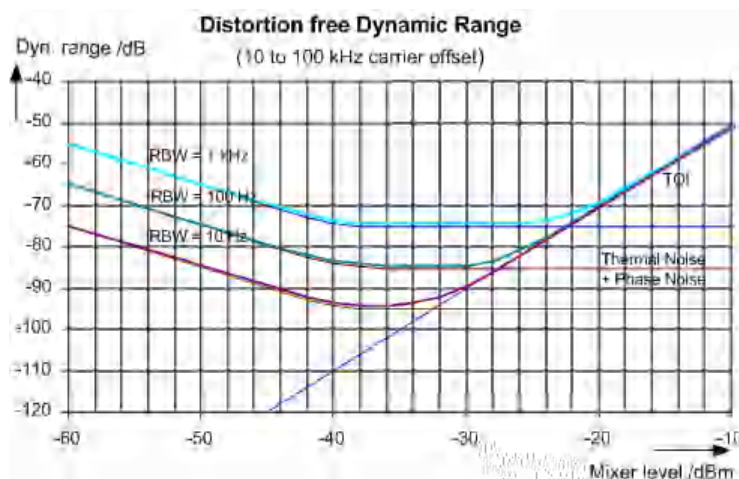

Figure 6-12: Intermodulation-free dynamic range of the R&S ESRP as a function of level at the input mixer and of the selected resolution bandwidth

(Useful signal offset = 10 to 100 kHz, DANL = -145 dBm/Hz, TOI = 15 dBm; typical values at 2 GHz).



If the intermodulation products of a DUT with a very high dynamic range are to be measured and the resolution bandwidth to be used is therefore very small, it is best to measure the levels of the useful signals and those of the intermodulation products separately using a small span. The measurement time will be reduced- in particular if the offset of the useful signals is large. To find signals reliably when frequency span is small, it is best to synchronize the signal sources and the R&S ESRP.

**Measurement Results**

As a result of the TOI measurement, the following values are displayed in the marker area of the diagram:

Label	Description
TOI	Third-order intercept point
M1	Maximum of first useful signal
M2	Maximum of second useful signal
M3	First intermodulation product
M4	Second intermodulation product

**Remote command**

The TOI can also be queried using the remote command `CALCulate<n>:MARKer<m>:FUNction:TOI:RESult?` on page 759.

**Softkeys for TOI Measurements**

TOI.....	306
L Marker 1 / Marker 2 / Marker 3 / ... Marker 16,/ Marker Norm/Delta.....	306
L Search Signals.....	306

**TOI**

Opens a submenu and activates the measurement of the 3rd order intercept point.

A two-tone signal with equal carrier levels is expected at the R&S ESRP input. Marker 1 and marker 2 (both normal markers) are set to the maximum of the two signals. Marker 3 and marker 4 are placed on the intermodulation products.

The R&S ESRP calculates the third order intercept point from the level difference between the first 2 markers and the markers 3 and 4 and displays it in the marker field.

For general information on measuring the TOI see [Chapter 6.1.1.10, "Measuring the Third Order Intercept Point \(TOI\)"](#), on page 301.

Remote command:

`CALCulate<n>:MARKer<m>:FUNCTion:TOI[:STATe]` on page 758

`CALCulate<n>:MARKer<m>:FUNCTion:TOI:RESult?` on page 759

**Marker 1 / Marker 2 / Marker 3 / ... Marker 16,/ Marker Norm/Delta ← TOI**

The "Marker X" softkey activates the corresponding marker and opens an edit dialog box to enter a value for the marker to be set to. Pressing the softkey again deactivates the selected marker.

If a marker value is changed using the rotary knob, the step size is defined via the [Stepsize Standard](#) or [Stepsize Sweep Points](#) softkeys.

Marker 1 is always the reference marker for relative measurements. If activated, markers 2 to 16 are delta markers that refer to marker 1. These markers can be converted into markers with absolute value display using the "Marker Norm/Delta" softkey. If marker 1 is the active marker, pressing the "Marker Norm/Delta" softkey switches on an additional delta marker.

Remote command:

`CALCulate<n>:MARKer<m>[:STATe]` on page 663

`CALCulate<n>:MARKer<m>:X` on page 664

`CALCulate<n>:MARKer<m>:Y` on page 664

`CALCulate<n>:DELTamarker<m>[:STATe]` on page 669

`CALCulate<n>:DELTamarker<m>:X` on page 670

`CALCulate<n>:DELTamarker<m>:X:RELative?` on page 671

`CALCulate<n>:DELTamarker<m>:Y` on page 671

**Search Signals ← TOI**

Activates all markers.

Remote command:

`CALCulate<n>:MARKer<m>:FUNCTion:TOI:SEARChsignal ONCE` on page 758

### 6.1.1.11 Measuring the AM Modulation Depth

The AM modulation depth, also known as a modulation index, indicates by how much the modulated signal varies around the carrier amplitude. It is defined as:

$$\text{MDepth} = \text{peak signal amplitude} / \text{unmodulated carrier amplitude}$$

So for MDepth = 0.5, for example, the carrier amplitude varies by 50% above and below its unmodulated level, and for h = 1.0 it varies by 100%.

You can measure the modulation depth of a modulated signal using the [AM Mod Depth](#) function.

When this function is activated, marker 1 is set to the peak level, which is considered to be the carrier level. Deltamarkers 2 and 3 are automatically set symmetrically to the carrier on the adjacent peak values of the trace. The markers can be adjusted manually, if necessary.

The R&S ESRP calculates the power at the marker positions from the measured levels. The AM modulation depth is calculated as the ratio between the power values at the reference marker and at the delta markers. If the powers of the two AM side bands are unequal, the mean value of the two power values is used for AM modulation depth calculation.



A remote control programming example is described in [Chapter 11.17.2.3, "Measuring the AM Modulation Depth"](#), on page 976 and an example of how to perform the measurement manually in [Chapter 3.5.3.2, "Measuring the Modulation Depth of an AM-Modulated Carrier \(Span > 0\)"](#), on page 100.

#### Measurement results

The AM modulation depth in percent is displayed as a result of the measurement, indicated in the marker results as "MDepth".

It can also be queried using the remote command `CALCulate<n>:MARKer<m>:FUNction:MDEPth:RESult?` on page 752.

#### Softkeys for AM Modulation Depth Measurements

AM Mod Depth.....	307
L Marker 1 / Marker 2 / Marker 3 / ... Marker 16,/ Marker Norm/Delta.....	308
L Search Signals.....	308

#### AM Mod Depth

Activates the measurement of the AM modulation depth. An AM-modulated carrier is required on the screen to ensure correct operation.

When this function is activated, marker 1 is set to the peak level, which is considered to be the carrier level. Deltamarkers 2 and 3 are automatically set symmetrically to the carrier on the adjacent peak values of the trace. An edit dialog box is displayed for deltamarker 2 in order to adjust the position manually.

When the position of deltamarker 2 is changed, deltamarker 3 is moved symmetrically with respect to the reference marker 1.

Deltamarker 3, on the other hand, can be moved for fine adjustment irrespective of marker 2.

Marker 1 can also be moved manually for re-adjustment without affecting the position of the deltamarkers.

For general information on measuring the AM modulation depth see [Chapter 6.1.1.11, "Measuring the AM Modulation Depth"](#), on page 307.

Remote command:

`CALCulate<n>:MARKer<m>:FUNction:MDEPth[:STATe]` on page 753

`CALCulate<n>:MARKer<m>:FUNction:MDEPth:RESult?` on page 752

### **Marker 1 / Marker 2 / Marker 3 / ... Marker 16,/ Marker Norm/Delta ← AM Mod Depth**

The "Marker X" softkey activates the corresponding marker and opens an edit dialog box to enter a value for the marker to be set to. Pressing the softkey again deactivates the selected marker.

If a marker value is changed using the rotary knob, the step size is defined via the [Stepsize Standard](#) or [Stepsize Sweep Points](#) softkeys.

Marker 1 is always the reference marker for relative measurements. If activated, markers 2 to 16 are delta markers that refer to marker 1. These markers can be converted into markers with absolute value display using the "Marker Norm/Delta" softkey. If marker 1 is the active marker, pressing the "Marker Norm/Delta" softkey switches on an additional delta marker.

Remote command:

`CALCulate<n>:MARKer<m>[:STATe]` on page 663

`CALCulate<n>:MARKer<m>:X` on page 664

`CALCulate<n>:MARKer<m>:Y` on page 664

`CALCulate<n>:DELTamarker<m>[:STATe]` on page 669

`CALCulate<n>:DELTamarker<m>:X` on page 670

`CALCulate<n>:DELTamarker<m>:X:RELative?` on page 671

`CALCulate<n>:DELTamarker<m>:Y` on page 671

### **Search Signals ← AM Mod Depth**

Activates all markers.

Remote command:

`CALCulate<n>:MARKer<m>:FUNction:MDEPth:SEARChsignal ONCE`  
on page 752

#### **6.1.1.12 Measuring Harmonic Distortion**

The harmonics and their distortion can be measured using the ["Harmonic Distortion"](#) on page 201 function.

With this measurement it is possible to measure the harmonics e.g. from a VCO easily. In addition the THD (total harmonic distortion) is calculated in % and dB.

With span > 0 Hz, an automatic search for the first harmonic is carried out within the set frequency range. Also the level is adjusted. In zero span, the center frequency is unchanged.

As a result, the zero span sweeps on all harmonics are shown, as well as the RMS values and the THD (total harmonic distortion).

### About Harmonics Distortion Measurement

Measuring the harmonics of a signal is a frequent problem which can be solved best using a signal analyzer. In general, every signal contains harmonics which are larger than others. Harmonics are particularly critical regarding high-power transmitters such as transceivers because large harmonics can interfere with other radio services.

Harmonics are generated by nonlinear characteristics. They can often be reduced by low pass filters. Since the signal analyzer has a nonlinear characteristic, e.g. in its first mixer, measures must be taken to ensure that harmonics produced in the signal analyzer do not cause spurious results. If necessary, the fundamental wave must be selectively attenuated with respect to the other harmonics with a high pass filter.

### Obtainable dynamic range

When harmonics are being measured, the obtainable dynamic range depends on the second harmonic intercept of the signal analyzer. The second harmonic intercept is the virtual input level at the RF input mixer at which the level of the 2nd harmonic becomes equal to the level of the fundamental wave. In practice, however, applying a level of this magnitude would damage the mixer. Nevertheless, the available dynamic range for measuring the harmonic distance of a DUT can be calculated relatively easily using the second harmonic intercept.

As shown in [Figure 6-13](#), the level of the 2<sup>nd</sup> harmonic drops by 20 dB if the level of the fundamental wave is reduced by 10 dB.

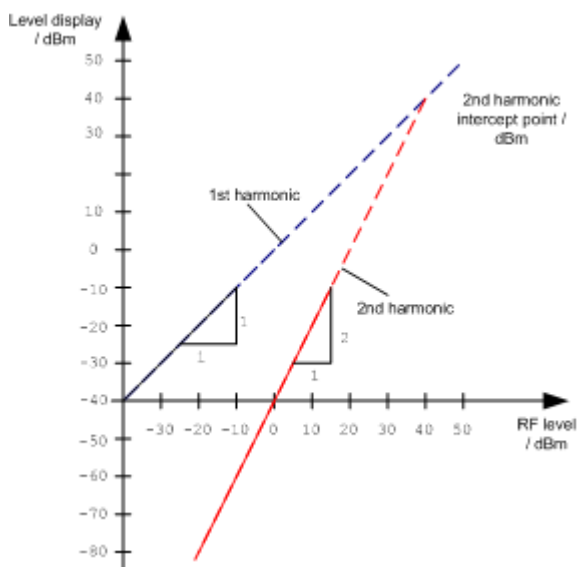

*Figure 6-13: Extrapolation of the 1st and 2nd harmonics to the 2nd harmonic intercept at 40 dBm*

The following formula for the obtainable harmonic distortion  $d_2$  in dB is derived from the straight-line equations and the given intercept point:

$$d_2 = \text{S.H.I} - P_1 \quad (1)$$



where:

d2	=	harmonic distortion
P <sub>1</sub>	=	mixer level/dBm
S.H.I.	=	second harmonic intercept



The mixer level is the RF level applied to the RF input minus the set RF attenuation.

The formula for the internally generated level P<sub>1</sub> at the 2<sup>nd</sup> harmonic in dBm is:

$$P_1 = 2 * P_1 - \text{S.H.I.} \quad (2)$$

The lower measurement limit for the harmonic is the noise floor of the signal analyzer. The harmonic of the measured DUT should – if sufficiently averaged by means of a video filter – be at least 4 dB above the noise floor so that the measurement error due to the input noise is less than 1 dB.

The following rules for measuring high harmonic ratios can be derived:

- Select the smallest possible IF bandwidth for a minimal noise floor.
- Select an RF attenuation which is high enough to just measure the harmonic ratio.

The maximum harmonic distortion is obtained if the level of the harmonic equals the intrinsic noise level of the receiver. The level applied to the mixer, according to (2), is:

$$P_1 = \frac{P_{\text{noise}} / \text{dBm} + \text{IP2}}{2}$$

At a resolution bandwidth of 10 Hz (noise level -143 dBm, S.H.I. = 40 dBm), the optimum mixer level is – 51.5 dBm. According to (1) a maximum measurable harmonic distortion of 91.5 dB minus a minimum S/N ratio of 4 dB is obtained.



If the harmonic emerges from noise sufficiently (approx. >15 dB), it is easy to check (by changing the RF attenuation) whether the harmonics originate from the DUT or are generated internally by the signal analyzer. If a harmonic originates from the DUT, its level remains constant if the RF attenuation is increased by 10 dB. Only the displayed noise is increased by 10 dB due to the additional attenuation. If the harmonic is exclusively generated by the signal analyzer, the level of the harmonic is reduced by 20 dB or is lost in noise. If both – the DUT and the signal analyzer – contribute to the harmonic, the reduction in the harmonic level is correspondingly smaller.

### High-Sensitivity Harmonics Measurements

If harmonics have very small levels, the resolution bandwidth required to measure them must be reduced considerably. The sweep time is, therefore, also increased considerably. In this case, the measurement of individual harmonics is carried out with the

R&S ESRP set to a small span. Only the frequency range around the harmonics will then be measured with a small resolution bandwidth.

### Measurement Results

As a result of the harmonics distortion measurement, the zero span sweeps on all detected harmonics are shown in the diagram, separated by red display lines. This provides a very good overview of the measurement.

In addition, a result table is displayed providing the following information:

- 1st harmonic frequency
- THD (total harmonic distortion), relative and absolute values
- For each detected harmonic:
  - Frequency
  - RBW
  - Power

The results can also be queried using the remote commands:

THD: `CALCulate<n>:MARKer<m>:FUNCTION:HARMonics:DISTortion?`  
on page 755

List of harmonics: `CALCulate<n>:MARKer<m>:FUNCTION:HARMonics:LIST?`  
on page 755

### Softkeys for Harmonic Distortion Measurements

Harmonic Distortion.....	311
L No. of Harmonics.....	312
L Harmonic Sweep Time.....	312
L Harmonic RBW Auto.....	312
L Adjust Settings.....	312

### Harmonic Distortion

Opens a submenu to determine the settings for harmonics measurement and activates the harmonic distortion measurement.

With this measurement you can measure the harmonics of a signal. In addition the THD (total harmonic distortion) is calculated in % and dB.

With span > 0 Hz, an automatic search for the first harmonic is carried out within the set frequency range. Also the level is adjusted. In zero span, the center frequency is unchanged.

In the upper window, the zero span sweeps on all harmonics are shown, separated by display lines. In the lower window, the mean RMS results are displayed in numerical values. The THD values are displayed in the marker field.

For details see [Chapter 6.1.1.12, "Measuring Harmonic Distortion"](#), on page 308.

Remote command:

`CALCulate<n>:MARKer<m>:FUNCTION:HARMonics[:STATe]` on page 757

`CALCulate<n>:MARKer<m>:FUNCTION:HARMonics:DISTortion?` on page 755

`CALCulate<n>:MARKer<m>:FUNCTION:HARMonics:LIST?` on page 755

**No. of Harmonics ← Harmonic Distortion**

Sets the number of harmonics that shall be measured. The range is from 1 to 26.

Remote command:

`CALCulate<n>:MARKer<m>:FUNction:HARMonics:NHARmonics` on page 756

**Harmonic Sweep Time ← Harmonic Distortion**

For details refer to the [SweepTime Manual](#) softkey in the "Bandwidth" menu.

**Harmonic RBW Auto ← Harmonic Distortion**

Enables/disables the automatic adjustment of the resolution bandwidth for filter types Normal (3dB) (Gaussian) and 5-Pole filters. The automatic adjustment is carried out according to:

$$"RBW_n = RBW_1 * n"$$

If  $RBW_n$  is not available, the next higher value is used.

Remote command:

`CALCulate<n>:MARKer<m>:FUNction:HARMonics:BANDwidth:AUTO`  
on page 754

**Adjust Settings ← Harmonic Distortion**

Activates the frequency search in the frequency range that was set before starting the harmonic measurement (if harmonic measurement was with span > 0) and adjusts the level.

Remote command:

`CALCulate<n>:MARKer<m>:FUNction:HARMonics:PRESet` on page 756

**6.1.2 Measurement Configuration – MEAS CONFIG Key**

The MEAS CONFIG key displays the submenu of the currently activated and running measurement function, e.g. the submenu of "TOI" or "Harmonic Distortion" (see [Chapter 6.1.1, "Power Measurements – MEAS Key"](#), on page 197, for quick access to the measurement configuration. If no measurement function is activated, this key has no effect.

**6.1.3 Performing Measurements – RUN SINGLE/RUN CONT Keys**

The [RUN SINGLE] and [RUN CONT] keys are used to start measurement tasks.

- [RUN SINGLE] switches to single sweep mode and performs a single sweep, just as the [Single Sweep](#) softkey in the "Sweep" menu does.
- [RUN CONT] switches to continuous sweep mode and starts sweeping, just as the [Continuous Sweep](#) softkey in the "Sweep" menu does.

## 6.2 Configuration

Basic measurement settings that are common to many measurement tasks are described here. If you are performing a specific measurement task or using an operating mode other than Spectrum mode, be sure to check the specific measurement or mode description for settings that may deviate from these common settings.

### 6.2.1 Initializing the Configuration – PRESET Key

The PRESET key resets the instrument to the default setting and therefore provides a defined initial state as a known starting point for measurements.



If the "local lockout" function is active in the remote control mode, the PRESET key is disabled.

#### Further information

- [Chapter 6.2.1.2, "Initial Configuration"](#), on page 314

#### Task

- [Chapter 6.2.1.1, "Presetting the Instrument"](#), on page 313

#### 6.2.1.1 Presetting the Instrument

1. Define the data set for the presetting:
  - a) To retrieve the originally provided settings file (see [Chapter 6.2.1.2, "Initial Configuration"](#), on page 314), deactivate the "Startup Recall" softkey in the "SAVE/RCL" menu.
  - b) To retrieve a customized settings file, in the "File" menu, activate the "Startup Recall" softkey, press the "Startup Recall Setup" softkey, and select the corresponding file.  
For details refer to [Chapter 10.1, "Saving and Recalling Settings Files – SAVE/RCL Key"](#), on page 500.
2. Press the PRESET key to perform a preset.

Remote: \*RST or SYSTem:PRESet



After you use the PRESET function, the history of previous actions is deleted, i.e. any actions performed previously cannot be undone or redone using the UNDO/REDO keys.

### 6.2.1.2 Initial Configuration

The initial configuration is selected such that the RF input is always protected against overload, provided that the applied signal levels are in the allowed range for the instrument.

The parameter set of the initial configuration can be customized using the "Startup Recall" softkey in the "Save/Rcl" menu. For further information refer to [Chapter 10.1, "Saving and Recalling Settings Files – SAVE/RCL Key"](#), on page 500.

**Table 6-5: Initial configuration**

Parameter	Setting
mode	Spectrum
sweep mode	auto
center frequency	$f_{\max}/2$
center frequency step size	0.1 * span
span	maximum possible (depends on instrument model)
RF attenuation	0 dB
reference level	-10 dBm
level range	100 dB log
level unit	dBm
sweep time	auto
resolution bandwidth	auto (3 MHz)
video bandwidth	auto (3 MHz)
FFT filters	off
span/RBW	100
RBW/VBW	1
sweep	cont
trigger	free run
trace 1	clr write
trace 2/3/4/5/6	blank
detector	auto peak
frequency offset	0 Hz
reference level offset	0 dB
reference level position	100 %
grid	abs
cal correction	on

Parameter	Setting
noise source	off
input	RF

## 6.2.2 Selecting the Frequency and Span – FREQ Key

The FREQ key is used to configure the frequency axis, to set the frequency offset and the signal track function. You can configure the frequency axis either by the start and stop frequency or the center frequency and the span.

### To open the Frequency menu

- Press the [FREQ] key.  
The "Frequency" menu is displayed. The "Frequency Center" edit dialog box is displayed.

### Menu and softkey description

- [Chapter 6.2.2.1, "Softkeys of the Frequency Menu"](#), on page 315

### Tasks

- [Chapter 6.2.2.2, "Specifying the Frequency Axis by the Start and Stop Frequency"](#), on page 319
- [Chapter 6.2.2.3, "Specifying the Frequency Axis by the Center Frequency and the Span"](#), on page 319
- [Chapter 6.2.2.4, "Specifying the Step Size for the Arrow Keys and the Rotary Knob"](#), on page 319
- [Chapter 6.2.2.5, "Modifying the Frequency Axis by an Offset"](#), on page 320
- [Chapter 6.2.2.6, "Tracking Signals \(Span > 0\)"](#), on page 320

### 6.2.2.1 Softkeys of the Frequency Menu

The following chapter describes all softkeys available in the "Frequency" menu. It is possible that your instrument configuration does not provide all softkeys. If a softkey is only available with a special option, model or (measurement) mode, this information is provided in the corresponding softkey description.

Center.....	316
CF Stepsize.....	316
L 0.1*Span (span > 0).....	316
L 0.1*RBW (span > 0).....	316
L 0.5*Span (span > 0).....	317
L 0.5*RBW (span > 0).....	317
L x*Span (span > 0).....	317
L x*RBW (span > 0).....	317
L =Center.....	317
L =Marker.....	317

L Manual.....	318
Start.....	318
Stop.....	318
Frequency Offset.....	318
Signal Track (span > 0).....	318
L Track On/Off (span > 0).....	319
L Track BW (span > 0).....	319
L Track Threshold (span > 0).....	319
L Select Trace (span > 0).....	319

### Center

Opens an edit dialog box to enter the center frequency. The allowed range of values for the center frequency depends on the frequency span.

span > 0:  $\text{span}_{\min}/2 \leq f_{\text{center}} \leq f_{\text{max}} - \text{span}_{\min}/2$

span = 0:  $0 \text{ Hz} \leq f_{\text{center}} \leq f_{\text{max}}$

$f_{\text{max}}$  and  $\text{span}_{\min}$  are specified in the data sheet.

Remote command:

[SENSe:]FREQuency:CENTer on page 790

### CF Stepsize

Opens a submenu to set the step size of the center frequency.

The step size defines the value by which the center frequency is increased or decreased when the arrow keys are pressed. When you use the rotary knob the center frequency changes in steps of 10% of the "Center Frequency Stepsize".

The step size can be set to a fraction of the span (span > 0) or a fraction of the resolution bandwidth (span = 0) or it can be set to a fixed value manually.

Apart from the =Center, =Marker and Manual softkeys, the other softkeys are displayed depending on the selected frequency span.

#### 0.1\*Span (span > 0) ← CF Stepsize

Sets the step size for the center frequency to 10 % of the span.

Remote command:

FREQ:CENT:STEP:LINK SPAN, see [SENSe:]FREQuency:CENTer:STEP:LINK on page 791

FREQ:CENT:STEP:LINK:FACT 10PCT, see [SENSe:]FREQuency:CENTer:STEP:LINK:FACTor on page 792

#### 0.1\*RBW (span > 0) ← CF Stepsize

Sets the step size for the center frequency to 10 % of the resolution bandwidth.

This is the default setting.

Remote command:

FREQ:CENT:STEP:LINK RBW, see [SENSe:]FREQuency:CENTer:STEP:LINK on page 791

FREQ:CENT:STEP:LINK:FACT 10PCT, see [SENSe:]FREQuency:CENTer:STEP:LINK:FACTor on page 792

**0.5\*Span (span > 0) ← CF Stepsize**

Sets the step size for the center frequency to 50 % of the span.

Remote command:

FREQ:CENT:STEP:LINK SPAN, see [\[SENSe:\]FREQuency:CENTer:STEP:LINK](#) on page 791

FREQ:CENT:STEP:LINK:FACT 50PCT, see [\[SENSe:\]FREQuency:CENTer:STEP:LINK:FACTor](#) on page 792

**0.5\*RBW (span > 0) ← CF Stepsize**

Sets the step size for the center frequency to 50 % of the resolution bandwidth.

Remote command:

FREQ:CENT:STEP:LINK RBW, see [\[SENSe:\]FREQuency:CENTer:STEP:LINK](#) on page 791

FREQ:CENT:STEP:LINK:FACT 50PCT, see [\[SENSe:\]FREQuency:CENTer:STEP:LINK:FACTor](#) on page 792

**x\*Span (span > 0) ← CF Stepsize**

Opens an edit dialog box to set the step size for the center frequency as a percentage (%) of the span.

Remote command:

FREQ:CENT:STEP:LINK SPAN, see [\[SENSe:\]FREQuency:CENTer:STEP:LINK](#) on page 791

FREQ:CENT:STEP:LINK:FACT 20PCT, see [\[SENSe:\]FREQuency:CENTer:STEP:LINK](#) on page 791

**x\*RBW (span > 0) ← CF Stepsize**

Opens an edit dialog box to set the step size for the center frequency as a percentage (%) of the resolution bandwidth. Values between 1 % and 100 % in steps of 1 % are allowed. The default setting is 10 %.

Remote command:

FREQ:CENT:STEP:LINK RBW, see [\[SENSe:\]FREQuency:CENTer:STEP:LINK](#) on page 791

FREQ:CENT:STEP:LINK:FACT 20PCT, see [\[SENSe:\]FREQuency:CENTer:STEP:LINK](#) on page 791

**=Center ← CF Stepsize**

Sets the step size to the value of the center frequency and removes the coupling of the step size to span or resolution bandwidth.

This function is especially useful for measurements of the signal harmonics. In this case, each stroke of the arrow key selects the center frequency of another harmonic.

**=Marker ← CF Stepsize**

Sets the step size to the value of the current marker and removes the coupling of the step size to span or resolution bandwidth.

This function is especially useful for measurements of the signal harmonics. In this case, each stroke of the arrow key selects the center frequency of another harmonic.



**Manual ← CF Step Size**

Opens an edit dialog box to enter a fixed step size for the center frequency.

Remote command:

[\[SENSe:\] FREQuency:CENTer:STEP](#) on page 634

**Start**

Opens an edit dialog box to define the start frequency. The following range of values is allowed:

$$f_{\min} \leq f_{\text{start}} \leq f_{\max} - \text{span}_{\min}$$

$f_{\min}$ ,  $f_{\max}$  and  $\text{span}_{\min}$  are specified in the data sheet.

Remote command:

[\[SENSe:\] FREQuency:START](#) on page 793

**Stop**

Opens an edit dialog box to define the stop frequency. The following range of values for the stop frequency is allowed:

$$f_{\min} + \text{span}_{\min} \leq f_{\text{stop}} \leq f_{\max}$$

$f_{\min}$ ,  $f_{\max}$  and  $\text{span}_{\min}$  are specified in the data sheet.

Remote command:

[\[SENSe:\] FREQuency:STOP](#) on page 793

**Frequency Offset**

Opens an edit dialog box to enter a frequency offset that shifts the displayed frequency range by the specified offset.

The softkey indicates the current frequency offset. The allowed values range from -100 GHz to 100 GHz. The default setting is 0 Hz.

Remote command:

[\[SENSe:\] FREQuency:OFFSet](#) on page 792

**Signal Track (span > 0)**

Opens a submenu to define the signal tracking characteristics:

- search bandwidth
- threshold value
- trace

The search bandwidth and the threshold value are shown in the diagram by two vertical lines and one horizontal line, which are labeled as "TRK". After each sweep the center frequency is set to the maximum signal found within the searched bandwidth. If no maximum signal above the set threshold value is found in the searched bandwidth, the track mechanism stops.

The submenu contains the following softkeys:

- ["Track On/Off \(span > 0\)"](#) on page 319
- ["Track BW \(span > 0\)"](#) on page 319
- ["Track Threshold \(span > 0\)"](#) on page 319
- ["Select Trace \(span > 0\)"](#) on page 319

**Track On/Off (span > 0) ← Signal Track (span > 0)**

Switches the signal tracking on and off.

Remote command:

`CALCulate<n>:MARKer<m>:FUNCTION:STRack[:STATe]` on page 794

**Track BW (span > 0) ← Signal Track (span > 0)**

Opens an edit dialog box to set the search bandwidth for signal tracking. The frequency range is calculated as a function of the center frequency.

Remote command:

`CALCulate<n>:MARKer<m>:FUNCTION:STRack:BANDwidth|BWIDth` on page 794

**Track Threshold (span > 0) ← Signal Track (span > 0)**

Opens an edit dialog box to set the threshold value for signal tracking.

Remote command:

`CALCulate<n>:MARKer<m>:FUNCTION:STRack:THReshold` on page 795

**Select Trace (span > 0) ← Signal Track (span > 0)**

Opens an edit dialog box to select the trace on which the signal is tracked.

Remote command:

`CALCulate<n>:MARKer<m>:FUNCTION:STRack:TRACe` on page 795

**6.2.2.2 Specifying the Frequency Axis by the Start and Stop Frequency**

1. Press the **Start** softkey and enter a start frequency.
2. Press the **Stop** softkey and enter a stop frequency.

**6.2.2.3 Specifying the Frequency Axis by the Center Frequency and the Span**

1. Press the **FREQ** key and enter a center frequency in the "Frequency Center" edit dialog box.
2. Press the **SPAN** key and enter the bandwidth you want to analyze.



Entering a value of 0 Hz causes a change to the zero span analysis mode.

**6.2.2.4 Specifying the Step Size for the Arrow Keys and the Rotary Knob**

1. Press the **CF Stepsize** softkey.  
The available softkeys depend on the selected frequency span (zero span or span > 0).

2. To define the step size of the center frequency:
  - a) If span > 0:  
Press "0.1\*Span", "0.5\*Span" or "x\*Span" to define the step size for the center frequency as percentage of the span (see [CF Stepsize](#)).
  - b) If span = 0:  
Press "0.1\*RBW", "0.5\*RBW", or "x\*RBW" to define the step size for the center frequency as percentage of the resolution bandwidth (see [CF Stepsize](#)).
  - c) Press the **=Center** softkey to set the step size to the value of the center frequency and remove the dependency of the step size to span or resolution bandwidth.
  - d) Press the **=Marker** softkey to set the step size to the value of the marker and remove the dependency of the step size to span or resolution bandwidth.
  - e) Press the **Manual** softkey and enter a fixed step size for the center frequency.



The step size assigned to arrow keys corresponds to the selected value.  
The step size of the rotary knob is always 10 % of it.

#### 6.2.2.5 Modifying the Frequency Axis by an Offset

- Press the **Frequency Offset** softkey and enter the offset to shift the displayed frequency span.

#### 6.2.2.6 Tracking Signals (Span > 0)

Note that signal tracking is available for frequency spans > 0.

- Press the **Signal Track (span > 0)** softkey to open the submenu and start and stop signal tracking with specified parameters.
- Press the **Track On/Off (span > 0)** softkey to switch signal tracking on or off.
- Press the **Track BW (span > 0)** softkey and enter a bandwidth for signal tracking.
- Press the **Track Threshold (span > 0)** softkey and enter the threshold for signal tracking.
- Press the **Select Trace (span > 0)** softkey and select the trace for signal tracking.

### 6.2.3 Setting the Frequency Span – SPAN Key

The SPAN key is used to set the frequency span to be analyzed.

#### To open the Span menu

- Press the SPAN key.  
The "Span" menu is displayed. For span > 0 an edit dialog box to enter the frequency is displayed. For zero span, an edit dialog box to enter the sweep time is displayed.

**Menu and softkey description**

- [Chapter 6.2.3.1, "Softkeys of the Span Menu"](#), on page 321

**Task**

- [Chapter 6.2.3.2, "Specifying the Span \(Alternatives\)"](#), on page 321

**6.2.3.1 Softkeys of the Span Menu**

The following chapter describes all softkeys available in the "Span" menu. It is possible that your instrument configuration does not provide all softkeys. If a softkey is only available with a special option, model or (measurement) mode, this information is provided in the corresponding softkey description.

Functions to configure the span described elsewhere:

- ["Last Span"](#) on page 156
- ["Full Span"](#) on page 156

<a href="#">Span Manual</a> .....	321
<a href="#">Zero Span</a> .....	321

**Span Manual**

Opens an edit dialog box to enter the frequency span. The center frequency remains the same when you change the span.

The following range is allowed:

span = 0: 0 Hz

span >0:  $\text{span}_{\min} \leq f_{\text{span}} \leq f_{\max}$

$f_{\max}$  and  $\text{span}_{\min}$  are specified in the data sheet.

Remote command:

[\[SENSe:\] FREQuency: SPAN](#) on page 793

**Zero Span**

Sets the span to 0 Hz (zero span). The x-axis becomes the time axis with the grid lines corresponding to 1/10 of the current sweep time ("SWT").

Remote command:

[FREQ:SPAN 0Hz](#), see [\[SENSe:\] FREQuency: SPAN](#) on page 793

**6.2.3.2 Specifying the Span (Alternatives)**

1. To set the span, use the [Span Manual](#), [Full Span](#), [Zero Span](#) and [Last Span](#) softkeys.
2. To define a frequency range, use the [Start](#) and [Stop](#) softkeys of the "Frequency" menu.

3. In zero span, the span corresponds to the sweep time. In that case, press the [SweepTime Manual](#) softkey and enter a sweep time.

## 6.2.4 Setting the Level Display and Configuring the RF Input – AMPT Key

The AMPT key is used to set the reference level, the level range and unit, the scaling and the RF attenuation.

### To open the amplitude menu

- Press the AMPT key.  
The "Amplitude" menu is displayed. The "Reference Level" dialog box is displayed.

### Menu and softkey description

- [Chapter 6.2.4.1, "Softkeys of the Amplitude Menu"](#), on page 322

### Tasks

- [Chapter 6.2.4.2, "Specifying the Amplitude"](#), on page 327

### 6.2.4.1 Softkeys of the Amplitude Menu

The following table shows all softkeys available in the "Amplitude" menu. It is possible that your instrument configuration does not provide all softkeys. If a softkey is only available with a special option, model or (measurement) mode, this information is provided in the corresponding softkey description.

Functions to configure the amplitude described elsewhere:

- ["RF Atten Manual"](#) on page 157
- ["10 dB Min"](#) on page 157
- ["dBx/MHz"](#) on page 158

Ref Level.....	323
Range.....	323
L Range Log 100 dB.....	323
L Range Log 50 dB.....	323
L Range Log 10 dB.....	323
L Range Log 5 dB.....	324
L Range Log 1 dB.....	324
L Range Log Manual.....	324
L Range Linear %.....	324
L Range Lin. Unit.....	325
Unit.....	325
Preamp On/Off.....	325
RF Atten Auto.....	325
Ref Level Offset.....	325
Ref Level Position.....	326
Grid Abs/Rel .....	326

Noise Correction.....	326
Input (AC/DC).....	326
Input 50 $\Omega$ /75 $\Omega$ .....	326

### Ref Level

Opens an edit dialog box to enter the reference level in the current unit (dBm, dB $\mu$ V, etc).

The reference level is the maximum value the AD converter can handle without distortion of the measured value. Signal levels above this value will not be measured correctly, which is indicated by the "IFOVL" status display.

Remote command:

`DISPlay[:WINDow<n>]:TRACe<t>:Y[:SCALe]:RLEVEL` on page 813

### Range

Opens a submenu to define the display range of the level axis.

- [Range Log 100 dB](#)
- [Range Log 50 dB](#)
- [Range Log 10 dB](#)
- [Range Log 5 dB](#)
- [Range Log 1 dB](#)
- [Range Log Manual](#)
- [Range Linear %](#)
- [Range Lin. Unit](#)

#### Range Log 100 dB ← Range

Sets the level display range to 100 dB.

Remote command:

Logarithmic scaling:

`DISP:WIND:TRAC:Y:SPAC LOG`, see `DISPlay[:WINDow<n>]:TRACe<t>:Y:SPACing` on page 636

Display range:

`DISP:WIND:TRAC:Y 100DB`, see `DISPlay[:WINDow<n>]:TRACe<t>:Y[:SCALe]` on page 812

#### Range Log 50 dB ← Range

Sets the level display range to 50 dB.

Remote command:

Logarithmic scaling:

`DISP:WIND:TRAC:Y:SPAC LOG`, see `DISPlay[:WINDow<n>]:TRACe<t>:Y:SPACing` on page 636

Display range:

`DISP:WIND:TRAC:Y 50DB`, see `DISPlay[:WINDow<n>]:TRACe<t>:Y[:SCALe]` on page 812

#### Range Log 10 dB ← Range

Sets the level display range to 10 dB.

Remote command:

Logarithmic scaling:

DISP:WIND:TRAC:Y:SPAC LOG, see [DISPlay\[:WINDow<n>\]:TRACe<t>:Y:SPACing](#) on page 636

Display range:

DISP:WIND:TRAC:Y 10DB, see [DISPlay\[:WINDow<n>\]:TRACe<t>:Y\[:SCALe\]](#) on page 812

#### **Range Log 5 dB ← Range**

Sets the level display range to 5 dB.

Remote command:

Logarithmic scaling:

DISP:WIND:TRAC:Y:SPAC LOG, see [DISPlay\[:WINDow<n>\]:TRACe<t>:Y:SPACing](#) on page 636

Display range:

DISP:WIND:TRAC:Y 5DB, see [DISPlay\[:WINDow<n>\]:TRACe<t>:Y\[:SCALe\]](#) on page 812

#### **Range Log 1 dB ← Range**

Sets the level display range to 1 dB.

Remote command:

Logarithmic scaling:

DISP:WIND:TRAC:Y:SPAC LOG, see [DISPlay\[:WINDow<n>\]:TRACe<t>:Y:SPACing](#) on page 636

Display range:

DISP:WIND:TRAC:Y 1DB, see [DISPlay\[:WINDow<n>\]:TRACe<t>:Y\[:SCALe\]](#) on page 812

#### **Range Log Manual ← Range**

Opens an edit dialog box to define the display range of a logarithmic level axis manually.

Remote command:

Logarithmic scaling:

DISP:WIND:TRAC:Y:SPAC LOG, see [DISPlay\[:WINDow<n>\]:TRACe<t>:Y:SPACing](#) on page 636

Display range:

[DISPlay\[:WINDow<n>\]:TRACe<t>:Y\[:SCALe\]](#) on page 812

#### **Range Linear % ← Range**

Selects linear scaling for the level axis in %.

The grid is divided into decadal sections.

Markers are displayed in the selected unit ("Unit" softkey). Delta markers are displayed in % referenced to the voltage value at the position of marker 1. This is the default setting for linear scaling.

Remote command:

DISP:TRAC:Y:SPAC LIN, see [DISPlay\[:WINDow<n>\]:TRACe<t>:Y:SPACing](#) on page 636

**Range Lin. Unit ← Range**

Selects linear scaling in dB for the level display range, i.e. the horizontal lines are labeled in dB.

Markers are displayed in the selected unit ("Unit" softkey). Delta markers are displayed in dB referenced to the power value at the position of marker 1.

Remote command:

`DISP:TRAC:Y:SPAC LDB`, see `DISPlay[:WINDow<n>]:TRACe<t>:Y:SPACing` on page 636

**Unit**

Opens the "Unit" submenu to select the unit for the level axis.

The default setting in spectrum mode is dBm.

If a transducer is switched on, the softkey is not available.

In general, the signal analyzer measures the signal voltage at the RF input. The level display is calibrated in RMS values of an unmodulated sine wave signal. In the default state, the level is displayed at a power of 1 mW (= dBm). Via the known input impedance (50 Ω or 75 Ω), conversion to other units is possible. The following units are available and directly convertible:

- dBm
- dBmV
- dBμV
- dBμA
- dBpW
- Volt
- Ampere
- Watt

Remote command:

`CALCulate<n>:UNIT:POWer` on page 812

**Preamp On/Off**

Switches the preamplifier on and off.

Remote command:

`INPut:GAIN:STATe` on page 638

**RF Atten Auto**

Sets the RF attenuation automatically as a function of the selected reference level. This ensures that the optimum RF attenuation is always used. It is the default setting.

When measuring spurious emissions, using this softkey automatically opens the "Sweep List" dialog, see "[Sweep List dialog box](#)" on page 265.

Remote command:

`INPut:ATTenuation:AUTO` on page 814

**Ref Level Offset**

Opens an edit dialog box to enter the arithmetic level offset. This offset is added to the measured level irrespective of the selected unit. The scaling of the y-axis is changed accordingly. The setting range is ±200 dB in 0.1 dB steps.



Remote command:

`DISPlay[:WINDow<n>]:TRACe<t>:Y[:SCALe]:RLEVel:OFFSet` on page 813

### Ref Level Position

Opens an edit dialog box to enter the reference level position, i.e. the position of the maximum AD converter value on the level axis. The setting range is from -200 to +200 %, 0 % corresponding to the lower and 100 % to the upper limit of the diagram.

Remote command:

`DISPlay[:WINDow<n>]:TRACe<t>:Y[:SCALe]:RPOSition` on page 814

### Grid Abs/Rel

Switches between absolute and relative scaling of the level axis (not available with "Linear" range).

- |       |                                                                                                                                                                                                   |
|-------|---------------------------------------------------------------------------------------------------------------------------------------------------------------------------------------------------|
| "Abs" | Absolute scaling: The labeling of the level lines refers to the absolute value of the reference level. Absolute scaling is the default setting.                                                   |
| "Rel" | Relative scaling: The upper line of the grid is always at 0 dB. The scaling is in dB whereas the reference level is always in the set unit (for details on unit settings see the "Unit" softkey). |

Remote command:

`DISPlay[:WINDow<n>]:TRACe<t>:Y[:SCALe]:MODE` on page 812

### Noise Correction

If activated, the results are corrected by the instrument's inherent noise, which increases the dynamic range.

- |        |                                                                                                                                                                                                                                                                                                                                                                                                                                                                                                                        |
|--------|------------------------------------------------------------------------------------------------------------------------------------------------------------------------------------------------------------------------------------------------------------------------------------------------------------------------------------------------------------------------------------------------------------------------------------------------------------------------------------------------------------------------|
| "ON"   | A reference measurement of the instrument's inherent noise is carried out. The noise power measured is then subtracted from the power in the channel that is being examined.<br>The inherent noise of the instrument depends on the selected center frequency, resolution bandwidth and level setting. Therefore, the correction function is disabled whenever one of these parameters is changed. A disable message is displayed on the screen. Noise correction must be switched on again manually after the change. |
| "OFF"  | No noise correction is performed.                                                                                                                                                                                                                                                                                                                                                                                                                                                                                      |
| "AUTO" | Noise correction is performed. After a parameter change, noise correction is restarted automatically and a new correction measurement is performed.                                                                                                                                                                                                                                                                                                                                                                    |

Remote command:

`[SENSe:]POWer:NCORrection` on page 715

### Input (AC/DC)

Toggles the RF input of the R&S ESRP between AC and DC coupling.

Remote command:

`INPut:COUPling` on page 641

### Input 50 Ω/75 Ω

Uses 50 Ω or 75 Ω as reference impedance for the measured levels. Default setting is 50 Ω.

The setting 75  $\Omega$  should be selected if the 50  $\Omega$  input impedance is transformed to a higher impedance using a 75  $\Omega$  adapter of the RAZ type (= 25  $\Omega$  in series to the input impedance of the instrument). The correction value in this case is 1.76 dB = 10 log (75  $\Omega$ /50  $\Omega$ ).

All levels specified in this Operating Manual refer to the default setting of the instrument (50  $\Omega$ ).

Remote command:

[INPut : IMPedance](#) on page 638

#### 6.2.4.2 Specifying the Amplitude

1. Set the reference level, offset and position using the "Ref Level", "Ref Level Offset" and "Ref Level Position" softkeys (see ["Ref Level"](#) on page 323, ["Ref Level Offset"](#) on page 325 and ["Ref Level Position"](#) on page 326).
2. Select the level range and the unit for the level axis using the "Range" and "Unit" softkeys (see ["Range"](#) on page 323 and ["Unit"](#) on page 325).
3. Set the scaling using the "Ref Level Position" and/or "Grid Abs/Rel" softkeys (see ["Ref Level Position"](#) on page 326 and ["Grid Abs/Rel "](#) on page 326).
4. Set the attenuation using the "RF Atten Manual" or "RF Atten Auto" (see ["RF Atten Manual"](#) on page 157 and ["RF Atten Auto"](#) on page 325).
5. Define the RF input coupling using the "Input (AC/DC)" softkey, or a reference impedance using the "Input (50 $\Omega$ /75 $\Omega$ )" softkey (see ["Input \(AC/DC\)"](#) on page 163, ["Input 50  \$\Omega\$ /75  \$\Omega\$  "](#) on page 160).
6. Activate or deactivate the RF Preamplifier using the "Preamp" softkey (see ["Pre-amp On/Off"](#) on page 157).

#### 6.2.5 Defining Automatic Settings – AUTO SET Key

The "Auto Set" menu allows you define automatic settings for measurements quickly.

##### To open the Auto Set menu

- Press the [AUTO SET] key.  
The "Auto Set" menu is displayed.

##### Menu and softkey description

- [Chapter 6.2.5.1, "Softkeys of the Auto Set Menu"](#), on page 327

#### 6.2.5.1 Softkeys of the Auto Set Menu

The following table shows all softkeys available in the "Auto Set" menu. It is possible that your instrument configuration does not provide all softkeys. If a softkey is only

available with a special option, model or (measurement) mode, this information is provided in the corresponding softkey description.



### Adjusting settings automatically during triggered measurements

When you select an auto adjust function a measurement is performed to determine the optimal settings. If you select an auto adjust function for a triggered measurement, you can select how the R&S ESRP should behave:

- (default:) The measurement for adjustment waits for the next trigger
- The measurement for adjustment is performed without waiting for a trigger. The trigger source is temporarily set to "Free Run". After the measurement is completed, the original trigger source is restored. The trigger level is adjusted as follows:
  - For IF Power and RF Power triggers:  
Trigger Level = Reference Level - 15 dB
  - For Video trigger:  
Trigger Level = 85 %

#### SCPI command:

[SENSe:]ADJust:CONFigure:TRIG on page 797

Auto All.....	328
Auto Freq.....	328
Auto Level.....	329
Settings.....	329
L Meas Time Manual.....	329
L Meas Time Auto.....	329
L Upper Level Hysteresis.....	329
L Lower Level Hysteresis.....	329
Sweep Type.....	329
L Sweep.....	330
L FFT.....	330
L Auto.....	330
L FFT Filter Mode.....	330
L Auto.....	330
L Narrow.....	330

#### Auto All

Performs all automatic settings.

- "Auto Freq" on page 328
- "Auto Level" on page 329

Remote command:

[SENSe:]ADJust:ALL on page 796

#### Auto Freq

Defines the center frequency and the reference level automatically by determining the highest frequency level in the frequency span. This function uses the signal counter; thus it is intended for use with sinusoidal signals.

Remote command:

[SENSe:]ADJust:FREQuency on page 797

### Auto Level

Defines the optimal reference level for the current measurement automatically.

The measurement time for automatic leveling can be defined using the [Settings](#) softkey.

You can define a threshold that the signal must exceed before the reference level is adjusted, see "[Upper Level Hysteresis](#)" on page 329 and "[Lower Level Hysteresis](#)" on page 329.

Remote command:

[SENSe:]ADJust:LEVel on page 798

### Settings

Opens a submenu to define settings for automatic leveling.

Possible settings are:

- "[Meas Time Manual](#)" on page 329
- "[Meas Time Auto](#)" on page 329

### Meas Time Manual ← Settings

Opens an edit dialog box to enter the duration of the level measurement in seconds. The level measurement is used to determine the optimal reference level automatically (see the "Auto Level" softkey, "[Auto Level](#)" on page 329). The default value is 1 ms.

Remote command:

[SENSe:]ADJust:CONFIgure:LEVel:DURation on page 796

### Meas Time Auto ← Settings

The level measurement is used to determine the optimal reference level automatically (see the [Auto Level](#) softkey).

### Upper Level Hysteresis ← Settings

Defines an upper threshold the signal must exceed before the reference level is automatically adjusted when the "Auto Level" function is performed.

Remote command:

[SENSe:]ADJust:CONFIguration:HYSTeresis:UPPer on page 796

### Lower Level Hysteresis ← Settings

Defines a lower threshold the signal must exceed before the reference level is automatically adjusted when the "Auto Level" function is performed.

Remote command:

[SENSe:]ADJust:CONFIguration:HYSTeresis:LOWer on page 796

### Sweep Type

Opens a submenu to define the sweep type.

Selecting the sweep type is not available for the I/Q analyzer.

In frequency sweep mode, the analyzer provides several possible methods of sweeping:

- "Sweep" on page 330
- "FFT" on page 330 (not available with 5-Pole filters, channel filters or RRC filters, see [Chapter 6.2.6.3, "Selecting the Appropriate Filter Type"](#), on page 337)
- "Auto" on page 330

#### **Sweep ← Sweep Type**

Sets the [Sweep Type](#) to standard analog frequency sweep.

In the standard sweep mode, the local oscillator is set to provide the spectrum quasi analog from the start to the stop frequency.

Remote command:

SWE:TYPE SWE, see [\[SENSe:\]SWEep:TYPE](#) on page 803

#### **FFT ← Sweep Type**

Sets the [Sweep Type](#) to FFT mode.

The FFT sweep mode samples on a defined frequency value and transforms it to the spectrum by fast Fourier transformation (FFT).

FFT is not available when using 5-Pole filters, Channel filters or RRC filters. In this case, sweep mode is used.

Remote command:

SWE:TYPE FFT, see [\[SENSe:\]SWEep:TYPE](#) on page 803

#### **Auto ← Sweep Type**

Automatically sets the fastest available [Sweep Type](#) for the current measurement. Auto mode is set by default.

Remote command:

SWE:TYPE AUTO, see [\[SENSe:\]SWEep:TYPE](#) on page 803

#### **FFT Filter Mode ← Sweep Type**

Defines the filter mode to be used for FFT filters by defining the partial span size. The partial span is the span which is covered by one FFT analysis.

#### **Auto ← FFT Filter Mode ← Sweep Type**

The firmware determines whether to use wide or narrow filters to obtain the best measurement results.

Remote command:

[\[SENSe:\]BANDwidth|BWIDth\[:RESolution\]:FFT](#) on page 799

#### **Narrow ← FFT Filter Mode ← Sweep Type**

For an RBW  $\leq$  10kHz, the FFT filters with the smaller partial span are used. This allows you to perform measurements near a carrier with a reduced reference level due to a narrower analog prefilter.

Remote command:

[\[SENSe:\]BANDwidth|BWIDth\[:RESolution\]:FFT](#) on page 799

## 6.2.6 Setting the Bandwidths and Sweep Time – BW Key

The BW key is used to set the resolution bandwidth, video bandwidth (VBW) and sweep time (SWT). The values available for resolution bandwidth and video bandwidth depend on the selected filter type. For details on channel filters see also [Chapter 6.2.6.4, "List of Available RRC and Channel Filters"](#), on page 338.

### To open the bandwidth menu

- Press the BW key.  
The "Bandwidth" menu is displayed.

### Menu and softkey description

- [Chapter 6.2.6.1, "Softkeys of the Bandwidth Menu"](#), on page 331

### Further information

- [Chapter 6.2.6.4, "List of Available RRC and Channel Filters"](#), on page 338
- [Table 6-6](#)

### Tasks

- [Chapter 6.2.6.2, "Specifying the Bandwidth"](#), on page 337
- [Chapter 6.2.6.3, "Selecting the Appropriate Filter Type"](#), on page 337

### 6.2.6.1 Softkeys of the Bandwidth Menu

The following table shows all softkeys available in the "Bandwidth" menu. It is possible that your instrument configuration does not provide all softkeys. If a softkey is only available with a special option, model or (measurement) mode, this information is provided in the corresponding softkey description.



For Spurious Emission Measurements, the settings are defined in the "Sweep List" dialog, see ["Sweep List dialog box"](#) on page 265.

Bandwidth settings are only available for RF measurements.

Res BW Manual.....	332
Res BW Auto.....	332
Video BW Manual.....	332
Video BW Auto.....	333
Sweeptime Manual.....	333
Sweeptime Auto.....	334
Sweep Type.....	334
L Sweep.....	334
L FFT.....	334
L Auto.....	334
L FFT Filter Mode.....	335
L Auto.....	335

L Narrow.....	335
Coupling Ratio.....	335
L RBW/VBW Sine [1/1].....	335
L RBW/VBW Pulse [.1].....	335
L RBW/VBW Noise [10].....	335
L RBW/VBW Manual.....	336
L Span/RBW Auto [100].....	336
L Span/RBW Manual.....	336
L Default Coupling.....	336
Filter Type.....	337

### Res BW Manual

Opens an edit dialog box to enter a value for the resolution bandwidth. The available resolution bandwidths are specified in the data sheet.

For details on the correlation between resolution bandwidth and filter type refer to [Chapter 6.2.6.3, "Selecting the Appropriate Filter Type"](#), on page 337.

Numeric input is always rounded to the nearest possible bandwidth. For rotary knob or UP/DNARROW key inputs, the bandwidth is adjusted in steps either upwards or downwards.

The manual input mode of the resolution bandwidth is indicated by a green bullet next to the "RBW" display in the channel bar.

When measuring Spurious Emissions, using this softkey automatically opens the "Sweep List" dialog (see ["Sweep List dialog box"](#) on page 265).

Remote command:

`[SENSe:]BANDwidth|BWIDth[:RESolution]:AUTO` on page 798

`[SENSe:]BANDwidth|BWIDth[:RESolution]` on page 639

### Res BW Auto

Couples the resolution bandwidth to the selected span (for span > 0). If you change the span, the resolution bandwidth is automatically adjusted.

This setting is recommended if you need the ideal resolution bandwidth in relation to a particular span.

Remote command:

`[SENSe:]BANDwidth|BWIDth[:RESolution]:AUTO` on page 798

### Video BW Manual

Opens an edit dialog box to enter the video bandwidth. The available video bandwidths are specified in the data sheet.

Numeric input is always rounded to the nearest possible bandwidth. For rotary knob or UP/DOWN key inputs, the bandwidth is adjusted in steps either upwards or downwards.

The manual input mode of the video bandwidth is indicated by a green bullet next to the "VBW" display in the channel bar.

**Note:** RMS detector and VBW.

If an RMS detector is used, the video bandwidth in the hardware is bypassed. Thus, duplicate trace averaging with small VBWs and RMS detector no longer occurs. However, the VBW is still considered when calculating the sweep time. This leads to a longer sweep time for small VBW values. Thus, you can reduce the VBW value to achieve more stable trace curves even when using an RMS detector. Normally, if the RMS detector is used the sweep time should be increased to get more stable trace curves. For details on detectors see [Chapter 6.3.1.5, "Detector Overview"](#), on page 370.

When measuring Spurious Emissions, using this softkey automatically opens the "Sweep List" dialog (see ["Sweep List dialog box"](#) on page 265).

Remote command:

[\[SENSe:\]BANDwidth|BWIDth:VIDeo:AUTO](#) on page 800

[\[SENSe:\]BANDwidth|BWIDth:VIDeo](#) on page 799

### Video BW Auto

Couples the video bandwidth to the resolution bandwidth. If you change the resolution bandwidth, the video bandwidth is automatically adjusted.

This setting is recommended if a minimum sweep time is required for a selected resolution bandwidth. Narrow video bandwidths result in longer sweep times due to the longer settling time. Wide bandwidths reduce the signal/noise ratio.

Remote command:

[\[SENSe:\]BANDwidth|BWIDth:VIDeo:AUTO](#) on page 800

### Sweeptime Manual

Opens an edit dialog box to enter the sweep time.

Sweep time	
absolute max. sweep time value:	16000 s
absolute min. sweep time value:	zero span: 1 $\mu$ s
	span > 0: depends on device model (refer to data sheet)

Allowed values depend on the ratio of span to RBW and RBW to VBW. For details refer to the data sheet.

Numeric input is always rounded to the nearest possible sweep time. For rotary knob or UPARROW/DNARROW key inputs, the sweep time is adjusted in steps either downwards or upwards.

The manual input mode of the sweep time is indicated by a green bullet next to the "SWT" display in the channel bar. If the selected sweep time is too short for the selected bandwidth and span, level measurement errors will occur due to a too short settling time for the resolution or video filters. In this case, the R&S ESRP displays the error message "UNCAL" and marks the indicated sweep time with a red bullet.

When measuring Spurious Emissions, using this softkey automatically opens the "Sweep List" dialog, see ["Sweep List dialog box"](#) on page 265.

Remote command:

[SWE:TIME:AUTO OFF](#), see [\[SENSe:\]SWEep:TIME:AUTO](#) on page 803

[\[SENSe:\]SWEep:TIME](#) on page 803



**Sweeptime Auto**

Couples the sweep time to the span, video bandwidth (VBW) and resolution bandwidth (RBW) (not available for zero span). If you change the span, resolution bandwidth or video bandwidth, the sweep time is automatically adjusted.

The R&S ESRP always selects the shortest sweep time that is possible without falsifying the signal. The maximum level error is < 0.1 dB, compared to using a longer sweep time.

When measuring Spurious Emissions, using this softkey automatically opens the "Sweep List" dialog, see "[Sweep List dialog box](#)" on page 265.

Remote command:

[SENSe:] SWEep:TIME:AUTO on page 803

**Sweep Type**

Opens a submenu to define the sweep type.

Selecting the sweep type is not available for the I/Q analyzer.

In frequency sweep mode, the analyzer provides several possible methods of sweeping:

- "[Sweep](#)" on page 330
- "[FFT](#)" on page 330 (not available with 5-Pole filters, channel filters or RRC filters, see [Chapter 6.2.6.3, "Selecting the Appropriate Filter Type"](#), on page 337)
- "[Auto](#)" on page 330

**Sweep ← Sweep Type**

Sets the [Sweep Type](#) to standard analog frequency sweep.

In the standard sweep mode, the local oscillator is set to provide the spectrum quasi analog from the start to the stop frequency.

Remote command:

SWE:TYPE SWE, see [SENSe:] SWEep:TYPE on page 803

**FFT ← Sweep Type**

Sets the [Sweep Type](#) to FFT mode.

The FFT sweep mode samples on a defined frequency value and transforms it to the spectrum by fast Fourier transformation (FFT).

FFT is not available when using 5-Pole filters, Channel filters or RRC filters. In this case, sweep mode is used.

Remote command:

SWE:TYPE FFT, see [SENSe:] SWEep:TYPE on page 803

**Auto ← Sweep Type**

Automatically sets the fastest available [Sweep Type](#) for the current measurement. Auto mode is set by default.

Remote command:

SWE:TYPE AUTO, see [SENSe:] SWEep:TYPE on page 803

**FFT Filter Mode ← Sweep Type**

Defines the filter mode to be used for FFT filters by defining the partial span size. The partial span is the span which is covered by one FFT analysis.

**Auto ← FFT Filter Mode ← Sweep Type**

The firmware determines whether to use wide or narrow filters to obtain the best measurement results.

Remote command:

`[SENSe:]BANDwidth|BWIDth[:RESolution]:FFT` on page 799

**Narrow ← FFT Filter Mode ← Sweep Type**

For an  $RBW \leq 10\text{kHz}$ , the FFT filters with the smaller partial span are used. This allows you to perform measurements near a carrier with a reduced reference level due to a narrower analog prefilter.

Remote command:

`[SENSe:]BANDwidth|BWIDth[:RESolution]:FFT` on page 799

**Coupling Ratio**

Opens a submenu to select the coupling ratios for functions coupled to the bandwidth.

**RBW/VBW Sine [1/1] ← Coupling Ratio**

Sets the following coupling ratio:

"video bandwidth = resolution bandwidth"

This is the default setting for the coupling ratio resolution bandwidth/video bandwidth.

This is the coupling ratio recommended if sinusoidal signals are to be measured.

This setting takes effect if you define the video bandwidth automatically ([Video BW Auto](#)).

Remote command:

`BAND:VID:RAT 1`, see `[SENSe:]BANDwidth|BWIDth:VIDeo:RATio` on page 800

**RBW/VBW Pulse [.1] ← Coupling Ratio**

Sets the following coupling ratio:

"video bandwidth =  $10 \times$  resolution bandwidth or"

"video bandwidth = 10 MHz (= max. VBW)."

This coupling ratio is recommended whenever the amplitudes of pulsed signals are to be measured correctly. The IF filter is exclusively responsible for pulse shaping. No additional evaluation is performed by the video filter.

This setting takes effect if you define the video bandwidth automatically ([Video BW Auto](#)).

Remote command:

`BAND:VID:RAT 10`, see `[SENSe:]BANDwidth|BWIDth:VIDeo:RATio` on page 800

**RBW/VBW Noise [10] ← Coupling Ratio**

Sets the following coupling ratio:

"video bandwidth = resolution bandwidth/10"

At this coupling ratio, noise and pulsed signals are suppressed in the video domain. For noise signals, the average value is displayed.

This setting takes effect if you define the video bandwidth automatically ([Video BW Auto](#)).

Remote command:

BAND:VID:RAT 0.1, see [\[SENSe:\]BANDwidth|BWIDth:VIDeo:RATio](#) on page 800

#### **RBW/VBW Manual ← Coupling Ratio**

Activates the manual input of the coupling ratio.

The resolution bandwidth/video bandwidth ratio can be set in the range 0.001 to 1000.

This setting takes effect if you define the video bandwidth automatically ([Video BW Auto](#)).

Remote command:

BAND:VID:RAT 10, see [\[SENSe:\]BANDwidth|BWIDth:VIDeo:RATio](#) on page 800

#### **Span/RBW Auto [100] ← Coupling Ratio**

Sets the following coupling ratio:

"resolution bandwidth = span/100"

This coupling ratio is the default setting of the R&S ESRP.

This setting takes effect if you define the resolution bandwidth automatically ([Res BW Auto](#)).

Remote command:

BAND:VID:RAT 0.001, see [\[SENSe:\]BANDwidth|BWIDth:VIDeo:RATio](#) on page 800

#### **Span/RBW Manual ← Coupling Ratio**

Activates the manual input of the coupling ratio.

This setting takes effect if you define the resolution bandwidth automatically ([Res BW Auto](#)).

The span/resolution bandwidth ratio can be set in the range 1 to 10000.

Remote command:

BAND:RAT 0.1, see [\[SENSe:\]BANDwidth|BWIDth\[:RESolution\]:RATio](#) on page 799

#### **Default Coupling ← Coupling Ratio**

Sets all coupled functions to the default state ("AUTO").

In addition, the ratio "RBW/VBW" is set to "SINE [1/1]" and the ratio "SPAN/RBW" to 100.

Remote command:

[\[SENSe:\]BANDwidth|BWIDth\[:RESolution\]:AUTO](#) on page 798

[\[SENSe:\]BANDwidth|BWIDth:VIDeo:AUTO](#) on page 800

[\[SENSe:\]SWEep:TIME:AUTO](#) on page 803

### Filter Type

Opens a submenu to select the filter type.

When measuring Spurious Emissions, using this softkey automatically opens the "Sweep List" dialog (see ["Sweep List dialog box"](#) on page 265).

The submenu contains the following softkeys:

- Normal (3 dB)
- CISPR (6 dB)
- MIL Std (6 dB)  
Note that the 6 dB bandwidths are available only with option R&S FSV-K54.
- Channel
- RRC
- 5-Pole (not available for sweep type "FFT")

For detailed information on filters see [Chapter 6.2.6.3, "Selecting the Appropriate Filter Type"](#), on page 337 and [Chapter 6.2.6.4, "List of Available RRC and Channel Filters"](#), on page 338.

Remote command:

`[SENSe:]BANDwidth|BWIDth[:RESolution]:TYPE` on page 640

### 6.2.6.2 Specifying the Bandwidth

1. Set the resolution bandwidth using the [Res BW Manual](#) or [Res BW Auto](#) softkey.
2. Set the video bandwidth using the [Video BW Manual](#) or [Video BW Auto](#) softkey.
3. Set the sweep time using the [Sweptime Manual](#) or [Sweptime Auto](#) softkey.
4. Press the [Filter Type](#) softkey and select the appropriate filters.

### 6.2.6.3 Selecting the Appropriate Filter Type

All resolution bandwidths are realized with digital filters.

The video filters are responsible for smoothing the displayed trace. Using video bandwidths that are small compared to the resolution bandwidth, only the signal average is displayed and noise peaks and pulsed signals are repressed. If pulsed signals are to be measured, it is advisable to use a video bandwidth that is large compared to the resolution bandwidth ( $VBW * 10 \times RBW$ ) for the amplitudes of pulses to be measured correctly.

The following filter types are available:

- Normal (3dB) (Gaussian) filters  
The Gaussian filters are set by default. The available bandwidths are specified in the data sheet.
- CISPR (6 dB) filters  
For more information see [Chapter 5.2.1, "Measurement Bandwidth"](#), on page 142.
- MIL Std (6 dB) filters  
For more information see [Chapter 5.2.1, "Measurement Bandwidth"](#), on page 142.

- Channel filters  
For details see [Chapter 6.2.6.4, "List of Available RRC and Channel Filters"](#), on page 338 .  
Channel filters do not support FFT mode.
- RRC filters  
For details see [Chapter 6.2.6.4, "List of Available RRC and Channel Filters"](#), on page 338 .  
RRC filters do not support FFT mode.
- 5-Pole filters  
The available bandwidths are specified in the data sheet.  
5-Pole filters do not support FFT mode.

#### 6.2.6.4 List of Available RRC and Channel Filters

For power measurement a number of especially steep-edged channel filters are available (see the following table). The indicated filter bandwidth is the 3 dB bandwidth. For RRC filters, the fixed roll-off factor ( $\alpha$ ) is also indicated.

**Table 6-6: Filter types**

Filter Bandwidth	Filter Type	Application
100 Hz	CFILter	
200 Hz	CFILter	
300 Hz	CFILter	
500 Hz	CFILter	
1 kHz	CFILter	
1.5 kHz	CFILter	
2 kHz	CFILter	
2.4 kHz	CFILter	SSB
2.7 kHz	CFILter	
3 kHz	CFILter	
3.4 kHz	CFILter	
4 kHz	CFILter	DAB, Satellite
4.5 kHz	CFILter	
5 kHz	CFILter	
6 kHz	CFILter	
6 kHz, $\alpha=0.2$	RRC	APCO
7.5 kHz	CFILter	
8.5 kHz	CFILter	ETS300 113 (12.5 kHz channels)
9 kHz	CFILter	AM Radio

Filter Bandwidth	Filter Type	Application
10 kHz	CFILter	
12.5 kHz	CFILter	CDMAone
14 kHz	CFILter	ETS300 113 (20 kHz channels)
15 kHz	CFILter	
16 kHz	CFILter	ETS300 113 (25 kHz channels)
18 kHz, a=0.35	RRC	TETRA
20 kHz	CFILter	
21 kHz	CFILter	PDC
24.3 kHz, a=0.35	RRC	IS 136
25 kHz	CFILter	APCO 25-P2
30 kHz	CFILter	CDPD, CDMAone
50 kHz	CFILter	
100 kHz	CFILter	
150 kHz	CFILter	FM Radio
192 kHz	CFILter	PHS
200 kHz	CFILter	GSM
300 kHz	CFILter	
500 kHz	CFILter	J.83 (8-VSB DVB, USA); RF ID 14333
1 MHz	CFILter	CDMAone
1.228 MHz	CFILter	CDMAone
1.28 MHz, a=0.22	RRC	TD-SCDMA
1.5 MHz	CFILter	DAB
2 MHz	CFILter	
3 MHz	CFILter	
3.75 MHz	CFILter	
3.84 MHz, a=0.22	RRC	W-CDMA 3GPP
4.096 MHz, a=0.22	RRC	W-CDMA NTT DOCoMo
5 MHz	CFILter	
20 MHz	CFILter	

Filter Bandwidth	Filter Type	Application
28 MHz	CFILter	
40 MHz	CFILter	

## 6.2.7 Configuring the Sweep Mode – SWEEP Key

The SWEEP key is used to configure the sweep mode. Continuous sweep or single sweep is possible. The sweep time and the number of measured values are set.

### To open the Sweep menu

- Press the SWEEP key.  
The "Sweep" menu is displayed.

### Menu and softkey description

- [Chapter 6.2.7.1, "Softkeys of the Sweep Menu"](#), on page 340

### Task

- [Chapter 6.2.7.2, "Specifying the Sweep Settings"](#), on page 345

### 6.2.7.1 Softkeys of the Sweep Menu

The following table shows all softkeys available in the "Sweep" menu. It is possible that your instrument configuration does not provide all softkeys. If a softkey is only available with a special option, model or (measurement) mode, this information is provided in the corresponding softkey description.

Continuous Sweep.....	341
Single Sweep.....	341
Continue Single Sweep.....	341
Sweeptime Manual.....	341
Sweeptime Auto.....	342
Sweep Type.....	342
L Sweep.....	342
L FFT.....	342
L Auto.....	342
L FFT Filter Mode.....	343
L Auto.....	343
L Narrow.....	343
Sweep Count.....	343
Sweep Points.....	343
Select Frame.....	344
Continue Frame (On Off).....	344
Frame Count.....	344
Spectrogram Clear.....	345

**Continuous Sweep**

Sets the continuous sweep mode: the sweep takes place continuously according to the trigger settings. This is the default setting.

The trace averaging is determined by the sweep count value (see the "Sweep Count" softkey, "[Sweep Count](#)" on page 343).

Remote command:

[INITiate<n>:CONTInuous](#) on page 609

**Single Sweep**

Sets the single sweep mode: after triggering, starts the number of sweeps that are defined by using the [Sweep Count](#) softkey. The measurement stops after the defined number of sweeps has been performed.

Remote command:

[INITiate<n>:CONTInuous](#) on page 609

**Continue Single Sweep**

Repeats the number of sweeps set by using the [Sweep Count](#) softkey, without deleting the trace of the last measurement.

This is particularly of interest when using the trace configurations "Average" or "Max Hold" to take previously recorded measurements into account for averaging/maximum search.

For details on trace configuration refer to [Chapter 6.3.1, "Trace Configuration"](#), on page 358.

Remote command:

[INITiate<n>:CONMeas](#) on page 801

**Sweeptime Manual**

Opens an edit dialog box to enter the sweep time.

Sweep time	
absolute max. sweep time value:	16000 s
absolute min. sweep time value:	zero span: 1 $\mu$ s
	span > 0: depends on device model (refer to data sheet)

Allowed values depend on the ratio of span to RBW and RBW to VBW. For details refer to the data sheet.

Numeric input is always rounded to the nearest possible sweep time. For rotary knob or UPARROW/DNARROW key inputs, the sweep time is adjusted in steps either downwards or upwards.

The manual input mode of the sweep time is indicated by a green bullet next to the "SWT" display in the channel bar. If the selected sweep time is too short for the selected bandwidth and span, level measurement errors will occur due to a too short settling time for the resolution or video filters. In this case, the R&S ESRP displays the error message "UNCAL" and marks the indicated sweep time with a red bullet.

When measuring Spurious Emissions, using this softkey automatically opens the "Sweep List" dialog, see "[Sweep List dialog box](#)" on page 265.



Remote command:

SWE:TIME:AUTO OFF, see [SENSe:]SWEep:TIME:AUTO on page 803

[SENSe:]SWEep:TIME on page 803

### Sweeptime Auto

Couples the sweep time to the span, video bandwidth (VBW) and resolution bandwidth (RBW) (not available for zero span). If you change the span, resolution bandwidth or video bandwidth, the sweep time is automatically adjusted.

The R&S ESRP always selects the shortest sweep time that is possible without falsifying the signal. The maximum level error is < 0.1 dB, compared to using a longer sweep time.

When measuring Spurious Emissions, using this softkey automatically opens the "Sweep List" dialog, see "Sweep List dialog box" on page 265.

Remote command:

[SENSe:]SWEep:TIME:AUTO on page 803

### Sweep Type

Opens a submenu to define the sweep type.

Selecting the sweep type is not available for the I/Q analyzer.

In frequency sweep mode, the analyzer provides several possible methods of sweeping:

- "Sweep" on page 330
- "FFT" on page 330 (not available with 5-Pole filters, channel filters or RRC filters, see Chapter 6.2.6.3, "Selecting the Appropriate Filter Type", on page 337)
- "Auto" on page 330

### Sweep ← Sweep Type

Sets the [Sweep Type](#) to standard analog frequency sweep.

In the standard sweep mode, the local oscillator is set to provide the spectrum quasi analog from the start to the stop frequency.

Remote command:

SWE:TYPE SWE, see [SENSe:]SWEep:TYPE on page 803

### FFT ← Sweep Type

Sets the [Sweep Type](#) to FFT mode.

The FFT sweep mode samples on a defined frequency value and transforms it to the spectrum by fast Fourier transformation (FFT).

FFT is not available when using 5-Pole filters, Channel filters or RRC filters. In this case, sweep mode is used.

Remote command:

SWE:TYPE FFT, see [SENSe:]SWEep:TYPE on page 803

### Auto ← Sweep Type

Automatically sets the fastest available [Sweep Type](#) for the current measurement. Auto mode is set by default.

Remote command:

SWE:TYPE AUTO, see [SENSe:]SWEep:TYPE on page 803

### FFT Filter Mode ← Sweep Type

Defines the filter mode to be used for FFT filters by defining the partial span size. The partial span is the span which is covered by one FFT analysis.

#### Auto ← FFT Filter Mode ← Sweep Type

The firmware determines whether to use wide or narrow filters to obtain the best measurement results.

Remote command:

[SENSe:]BANDwidth|BWIDth[:RESolution]:FFT on page 799

#### Narrow ← FFT Filter Mode ← Sweep Type

For an RBW  $\leq$  10kHz, the FFT filters with the smaller partial span are used. This allows you to perform measurements near a carrier with a reduced reference level due to a narrower analog prefilter.

Remote command:

[SENSe:]BANDwidth|BWIDth[:RESolution]:FFT on page 799

### Sweep Count

Opens an edit dialog box to enter the number of sweeps to be performed in the single sweep mode. Values from 0 to 32767 are allowed. If the values 0 or 1 are set, one sweep is performed. The sweep count is applied to all the traces in a diagram.

If the trace configurations "Average", "Max Hold" or "Min Hold" are set, the sweep count value also determines the number of averaging or maximum search procedures.

In continuous sweep mode, if sweep count = 0 (default), averaging is performed over 10 sweeps. For sweep count = 1, no averaging, maxhold or minhold operations are performed.

For details on trace configuration see [Chapter 6.3.1, "Trace Configuration"](#), on page 358.

Example:

- Press the [TRACE] key > [Trace 1/Trace 2/Trace 3/Trace 4/Trace 5/Trace 6](#) softkey > ["Max Hold"](#) on page 147 softkey.
- Press the [SWEEP] key > "Sweep Count" softkey.
- In the "Average Sweep Count" dialog box, enter 10.
- Press the ["Single Sweep"](#) on page 341 softkey:  
R&S ESRP performs the "Max Hold" function over 10 sweeps.

Remote command:

[SENSe:]SWEep:COUNT on page 802

### Sweep Points

Opens an edit dialog box to enter the number of measured values to be collected during one sweep.

- Entry via rotary knob:
  - In the range from 101 to 1001, the sweep points are increased or decreased in steps of 100 points.

- In the range from 1001 to 32001, the sweep points are increased or decreased in steps of 1000 points.
- Entry via keypad:  
All values in the defined range can be set.

The default value is 691 sweep points.

When measuring spurious emissions, using this softkey automatically opens the "Sweep List" dialog, see "[Sweep List dialog box](#)" on page 265.

Remote command:

[\[SENSe:\] SWEep: POINTs](#) on page 802

### Select Frame

For spectrogram measurements only.

Opens a dialog box to select a specific frame and loads the corresponding trace from the memory.

Note that activating a marker or changing the position of the active marker automatically selects the frame that belongs to that marker.

This softkey is available in single sweep mode or if the sweep is stopped.

Remote command:

[CALCulate<n>:SGRam:FRAMe:SElect](#) on page 826

### Continue Frame (On Off)

For spectrogram measurements only.

Determines whether the results of the last measurement are deleted before starting a new measurement.

- **On**  
Repeats the single sweep measurement without deleting the spectrogram results of the last measurement. One of the following trace modes is to be used: Max Hold, Min Hold, Average.
- **Off**  
Deletes the last measurement results before performing a single sweep measurement.

This softkey is available in single sweep mode.

Remote command:

[CALCulate<n>:SGRam:CONT](#) on page 825

### Frame Count

For spectrogram measurements only.

Opens a dialog box to set the number of frames to be captured in a single sweep.

Therefore, the frame count defines the number of traces the R&S ESRP plots in the Spectrogram result display in a single sweep. The maximum number of possible frames depends on the history depth (see [CALCulate<n>:SGRam:HDEPth](#) on page 620).

The sweep count, on the other hand, determines how many sweeps are combined in one frame in the Spectrogram, i.e. how many sweeps the R&S ESRP performs to plot one trace in the Spectrogram result display (see "[Sweep Count](#)" on page 343).

This softkey is available in single sweep mode.

Remote command:

[CALCulate<n>:SGRam:FRAMe:COUNT](#) on page 825

### **Spectrogram Clear**

For spectrogram measurements only.

Resets the Spectrogram result display and clears its history buffer.

Remote command:

[CALCulate<n>:SGRam:CLEAr\[:IMMEDIATE\]](#) on page 618

## **6.2.7.2 Specifying the Sweep Settings**

1. Press the [Sweep Count](#) softkey and enter the sweep count.
2. Press the [Sweeptime Manual](#) or [Sweeptime Auto](#) softkey to set the sweep time.
3. Press the [Sweep Type](#) softkey to select the sweep type.
4. Press the [Sweep Points](#) softkey and enter the number of sweep points.
5. Press the [Continuous Sweep](#) or [Single Sweep](#) softkey to select the sweep mode.
6. Press the [Continue Single Sweep](#) softkey to repeat the single sweep.

## **6.2.8 Triggering the Sweep – TRIG Key**

The [TRIG] key is used to select trigger mode, trigger threshold, trigger delay, trigger polarity and for gated sweep the gate configuration.

### **To open the Trigger menu**

- Press the [TRIG] key.  
The "Trigger" menu is displayed.

### **Menu and softkey description**

- [Chapter 6.2.8.1, "Softkeys of the Trigger Menu"](#), on page 345

### **Tasks**

- [Chapter 6.2.8.2, "Specifying the Trigger Settings"](#), on page 352
- [Chapter 6.2.8.3, "Using Gated Sweep Operation"](#), on page 352

### **6.2.8.1 Softkeys of the Trigger Menu**

The following table shows all softkeys available in the "Trigger" menu. It is possible that your instrument configuration does not provide all softkeys. If a softkey is only available

with a special option, model or (measurement) mode, this information is provided in the corresponding softkey description.

Trg/Gate Source.....	346
L Free Run.....	346
L External.....	346
L Video.....	347
L RF Power.....	347
L IF Power/BB Power.....	347
L Time.....	348
Trg/Gate Level.....	348
Trg/Gate Polarity.....	348
Trigger Offset.....	349
Repetition Interval.....	349
Trigger Hysteresis.....	349
Trigger Holdoff.....	349
Gated Trigger.....	349
Gate Settings.....	350
L Gate Mode (Lvl/Edge).....	350
L Gate Delay.....	350
L Gate Length (Gate Mode Edge).....	351
L Trg/Gate Source.....	351
L Trg/Gate Level.....	351
L Trg/Gate Polarity.....	351
L Sweep Time.....	351
L Res BW Manual.....	351

### Trg/Gate Source

Opens the "Trigger/Gate Source" dialog box to select the trigger/gate mode.

As gate modes, all modes except "Power Sensor" are available. For details see also [Chapter 6.2.8.3, "Using Gated Sweep Operation"](#), on page 352.

The default setting is "Free Run". If a trigger mode other than "Free Run" has been set, the enhancement label "TRG" is displayed and the trigger source is indicated.

**Note:** When triggering or gating is activated, the squelch function is automatically disabled (see ["Squelch"](#) on page 392).

Remote command:

TRIGger<n> [ : SEQuence ] : SOURce on page 807

[ SENSE: ] SWEEP: EGATE: SOURce on page 810

### Free Run ← Trg/Gate Source

The start of a sweep is not triggered. Once a measurement is completed, another is started immediately.

Remote command:

TRIG: SOUR IMM, see TRIGger<n> [ : SEQuence ] : SOURce on page 807

### External ← Trg/Gate Source

Defines triggering via a TTL signal at the "EXT TRIG/GATE IN" input connector on the rear panel.

Remote command:

TRIG:SOUR EXT, see [TRIGger<n>\[:SEQuence\]:SOURce](#) on page 807

SWE:EGAT:SOUR EXT for gated triggering, see [\[SENSe:\]SWEep:EGATe:SOURce](#) on page 810

#### Video ← Trg/Gate Source

Defines triggering by the displayed voltage.

A horizontal trigger line is shown in the diagram. It is used to set the trigger threshold from 0 % to 100 % of the diagram height.

Video mode is only available in the time domain.

Remote command:

TRIG:SOUR VID, see [TRIGger<n>\[:SEQuence\]:SOURce](#) on page 807

SWE:EGAT:SOUR VID for gated triggering, see [\[SENSe:\]SWEep:EGATe:SOURce](#) on page 810

#### RF Power ← Trg/Gate Source

Defines triggering of the measurement via signals which are outside the measurement channel.

In RF Power trigger mode the instrument uses a level detector at the first intermediate frequency. The detector threshold can be selected in a range between - 50 dBm and -10 dBm at the input mixer. The resulting trigger level at the RF input lies within the following range:

$(-24\text{dBm} + \text{RF Att}) \leq \text{Triggerlevel} \leq (+5\text{dBm} + \text{RF Att})$ , max. 30 dBm, for Preamp = OFF

$(-40\text{dBm} + \text{RF Att}) \leq \text{Triggerlevel} \leq (-11\text{dBm} + \text{RF Att})$ , max. 30 dBm, for Preamp = ON with

$500 \text{ MHz} \leq \text{InputSignal} \leq 7 \text{ GHz}$

**Note:** If input values outside of this range occur (e.g. for fullspan measurements), the sweep may be aborted and a message indicating the allowed input values is displayed in the status bar.

A [Trigger Offset](#), [Trg/Gate Polarity](#) and [Trigger Holdoff](#) can be defined for the RF trigger to improve the trigger stability, but no hysteresis.

Remote command:

TRIG:SOUR RFP, see [TRIGger<n>\[:SEQuence\]:SOURce](#) on page 807

SWE:EGAT:SOUR RFP for gated triggering, see [\[SENSe:\]SWEep:EGATe:SOURce](#) on page 810

#### IF Power/BB Power ← Trg/Gate Source

Defines triggering of the measurement using the second intermediate frequency.

For this purpose, the R&S ESRP uses a level detector at the second intermediate frequency.

The available trigger levels depend on the RF attenuation and preamplification. A reference level offset, if defined, is also considered.

For details on available trigger levels and trigger bandwidths see the data sheet.

The bandwidth at the intermediate frequency depends on the RBW and sweep type:

Sweep mode:

- RBW > 500 kHz: 40 MHz, nominal
- RBW ≤ 500 kHz: 6 MHz, nominal

FFT mode:

- RBW > 20 kHz: 40 MHz, nominal
- RBW ≤ 20 kHz: 6 MHz, nominal

**Note:** Be aware that in auto sweep type mode, due to a possible change in sweep types, the bandwidth may vary considerably for the same RBW setting.

The R&S ESRP is triggered as soon as the trigger level is exceeded around the selected frequency (= start frequency in the frequency sweep).

Thus, the measurement of spurious emissions, e.g. for pulsed carriers, is possible even if the carrier lies outside the selected frequency span.

Remote command:

TRIG:SOUR IFP, see [TRIGger<n>\[:SEQuence\]:SOURce](#) on page 807

SWE:EGAT:SOUR IFP for gated triggering, see [\[SENSe:\]SWEep:EGATe:SOURce](#) on page 810

#### Time ← Trg/Gate Source

Opens an edit dialog box to define a repetition interval in which the measurement is triggered. The shortest interval is 2 ms.

Remote command:

TRIG:SOUR TIMETRIGger<n>[:SEQuence]:SOURce on page 807

#### Trg/Gate Level

Opens an edit dialog box to enter the trigger/gate level.

For details see also [Chapter 6.2.8.3, "Using Gated Sweep Operation"](#), on page 352.

In the trigger modes "Time" and "Power Sensor", this softkey is not available.

Remote command:

[TRIGger<n>\[:SEQuence\]:LEVel:IFPower](#) on page 806

[TRIGger<n>\[:SEQuence\]:LEVel:VIDeo](#) on page 806

#### Trg/Gate Polarity

Sets the polarity of the trigger/gate source.

The sweep starts after a positive or negative edge of the trigger signal. The default setting is "Pos". The setting applies to all trigger modes with the exception of the "Free Run", "Power Sensor" and "Time" mode.

For details also see [Chapter 6.2.8.3, "Using Gated Sweep Operation"](#), on page 352.

"Pos"                    Level triggering: the sweep is stopped by the logic "0" signal and restarted by the logical "1" signal after the gate delay time has elapsed.

"Neg"                    Edge triggering: the sweep is continued on a "0" to "1" transition for the gate length duration after the gate delay time has elapsed.

Remote command:

[TRIGger<n>\[:SEQuence\]:SLOPe](#) on page 807

[\[SENSe:\]SWEep:EGATe:POLarity](#) on page 810

**Trigger Offset**

Opens an edit dialog box to enter the time offset between the trigger signal and the start of the sweep.

offset > 0:	Start of the sweep is delayed
offset < 0:	Sweep starts earlier (pre-trigger) Only possible for span = 0 (e.g. I/Q Analyzer mode) and gated trigger switched off Maximum allowed range limited by the sweep time: $\text{pretrigger}_{\text{max}} = \text{sweep time}$

In the "External" or "IF Power" trigger mode, a common input signal is used for both trigger and gate. Therefore, changes to the gate delay will affect the trigger delay (trigger offset) as well.

**Tip:** To determine the trigger point in the sample (for "External" or "IF Power" trigger mode), use the `TRACe<n>:IQ:TPISample?` command.

In the "Time" trigger mode, this softkey is not available.

Remote command:

`TRIGger<n>[:SEquence]:HOLDoff[:TIME]` on page 804

**Repetition Interval**

Opens an edit dialog box to define a repetition interval in which the measurement is triggered. The shortest interval is 2 ms. This softkey is only available if the trigger source "Time" is selected (see "Time" on page 348).

Remote command:

`TRIGger<n>[:SEquence]:TIME:RINTerval` on page 808

**Trigger Hysteresis**

Defines the value for the trigger hysteresis for "IF power" or "RF Power" trigger sources. The hysteresis in dB is the value the input signal must stay below the power trigger level in order to allow a trigger to start the measurement. The range of the value is between 3 dB and 50 dB with a step width of 1 dB.

Remote command:

`TRIGger<n>[:SEquence]:IFPower:HYSteresis` on page 805

**Trigger Holdoff**

Defines the value for the trigger holdoff. The holdoff value in s is the time which must pass before triggering, in case another trigger event happens.

This softkey is only available if "IFPower", "RF Power" or "BBPower" is the selected trigger source.

Remote command:

`TRIGger<n>[:SEquence]:IFPower:HOLDoff` on page 805

**Gated Trigger**

Switches the sweep mode with gate on or off.



This softkey requires the following "Trigger Mode" (see ["Trg/Gate Source"](#) on page 346):

span > 0	External or IF Power/BB Power/IF Power
span = 0	External or IF Power/BB Power/IF Power or Video

If a different mode is active, the [IF Power/BB Power](#) trigger mode is automatically selected.

**Note:** When triggering or gating is activated, the squelch function is automatically disabled (see ["Squelch"](#) on page 392).

If the gate is switched on, a gate signal applied to the rear panel connector "EXT TRIGGER/GATE" or the internal IF power detector controls the sweep of the analyzer.

In the trigger mode [Time](#), this softkey is not available.

For details also see [Chapter 6.2.8.3, "Using Gated Sweep Operation"](#), on page 352.

Remote command:

[\[SENSe:\] SWEep:EGATe](#) on page 809

[\[SENSe:\] SWEep:EGATe:SOURce](#) on page 810

### Gate Settings

Opens a submenu to make all the settings required for gated sweep operation.

In the "Time" trigger mode, this softkey is not available.

For details also see [Chapter 6.2.8.3, "Using Gated Sweep Operation"](#), on page 352.

### Gate Mode (Lvl/Edge) ← Gate Settings

Sets the gate mode. As settings level-triggered or edge-triggered gate mode can be selected.

For details also see [Chapter 6.2.8.3, "Using Gated Sweep Operation"](#), on page 352.

"Edge"            Edge-triggered gate mode

"Lvl"            Level-triggered gate mode

This mode is not supported when using R&S Power Sensors as power triggers ("Trg/Gate Source" = *Power Sensor* or *External*).

Remote command:

[\[SENSe:\] SWEep:EGATe:TYPE](#) on page 811

### Gate Delay ← Gate Settings

Opens an edit dialog box to enter the gate delay time between the gate signal and the continuation of the sweep. The delay position on the time axis in relation to the sweep is indicated by a line labeled "GD".

This is useful for e.g. taking into account a delay between the gate signal and the stabilization of an RF carrier.

As a common input signal is used for both trigger and gate when selecting the "External" or "IF Power" trigger mode, changes to the gate delay will affect the trigger delay (trigger offset) as well.

For details also see [Chapter 6.2.8.3, "Using Gated Sweep Operation"](#), on page 352.

Remote command:

[SENSe:] SWEep:EGATe:HOLDoFF on page 809

#### **Gate Length (Gate Mode Edge) ← Gate Settings**

Opens an edit dialog box to enter the gate length. The gate length in relation to the sweep is indicated by a line labeled "GL".

The length of the gate signal defines if the sweep is to be interrupted. Only in the edge-triggered mode the gate length can be set, while in the level-triggered the gate length depends on the length of the gate signal.

For details also see [Chapter 6.2.8.3, "Using Gated Sweep Operation"](#), on page 352.

Remote command:

[SENSe:] SWEep:EGATe:LENGth on page 810

#### **Trg/Gate Source ← Gate Settings**

See ["Trg/Gate Source"](#) on page 346.

#### **Trg/Gate Level ← Gate Settings**

See ["Trg/Gate Level"](#) on page 348.

#### **Trg/Gate Polarity ← Gate Settings**

See ["Trg/Gate Polarity"](#) on page 348.

#### **Sweep Time ← Gate Settings**

Opens an edit dialog box to change the sweep time in order to obtain a higher resolution for positioning gate delay and gate length. When leaving the "Gate Settings" sub-menu, the original sweep time is retrieved.

For details also see [Chapter 6.2.8.3, "Using Gated Sweep Operation"](#), on page 352.

#### **Res BW Manual ← Gate Settings**

Opens an edit dialog box to enter a value for the resolution bandwidth. The available resolution bandwidths are specified in the data sheet.

For details on the correlation between resolution bandwidth and filter type refer to [Chapter 6.2.6.3, "Selecting the Appropriate Filter Type"](#), on page 337.

Numeric input is always rounded to the nearest possible bandwidth. For rotary knob or UP/DNARROW key inputs, the bandwidth is adjusted in steps either upwards or downwards.

The manual input mode of the resolution bandwidth is indicated by a green bullet next to the "RBW" display in the channel bar.

When measuring Spurious Emissions, using this softkey automatically opens the "Sweep List" dialog (see ["Sweep List dialog box"](#) on page 265).

Remote command:

[SENSe:] BANDwidth|BWIDth[:RESolution]:AUTO on page 798

[SENSe:] BANDwidth|BWIDth[:RESolution] on page 639

### 6.2.8.2 Specifying the Trigger Settings

1. Press the "Trg/Gate Source" softkey to select the trigger mode (for details see "[Trg/Gate Source](#)" on page 346).
2. Press the [Trg/Gate Level](#) softkey to set the trigger level.
3. Press the [Trigger Offset](#) softkey to set the trigger offset. In addition, a [Trigger Hysteresis](#) and [Trigger Holdoff](#) can be defined via the corresponding softkeys.

For details on gated sweep operation, see [Chapter 6.2.8.3, "Using Gated Sweep Operation"](#), on page 352.

### 6.2.8.3 Using Gated Sweep Operation

By using a gate in sweep mode and stopping the measurement while the gate signal is inactive, the spectrum for pulsed RF carriers can be displayed without the superposition of frequency components generated during switching. Similarly, the spectrum can also be examined for an inactive carrier. The sweep can be controlled by an external gate or by the internal power trigger.

Gated sweep operation is also possible for span = 0. This enables – e.g. in burst signals – level variations of individual slots to be displayed versus time.

1. Press the [Gate Settings](#) softkey to define the settings of the gate mode.  
At the center frequency a transition to zero span is made and the time parameters gate delay and gate length are displayed as vertical lines to adjust them easily.  
When quitting the [Gate Settings](#) submenu, the original span is retrieved so the desired measurement can be performed with the accurately set gate.
2. Setting the parameters gate delay and gate length highly accurate, press the [Sweep Time](#) softkey to alter the x-axis in a way that the signal range concerned (e.g. one full burst) is displayed.
3. Press the [Gate Delay](#) softkey to set the sampling time in a way that the desired portion of the signal is shown.
4. Press the [Gate Mode \(Lvl/Edge\)](#) softkey to set the gate mode.
5. If the "Edge" gate mode has been selected, press the [Gate Length \(Gate Mode Edge\)](#) softkey to set the sampling duration in a way that the desired portion of the signal is shown.
6. Press the [Trg/Gate Polarity](#) softkey to set the polarity of the trigger source.
7. Press the [Gated Trigger](#) softkey to activate the gated sweep mode.  
To indicate that a gate is used for the sweep, the enhancement label "GAT" is displayed on the screen. This label appears to the right of the window for which the gate is configured.

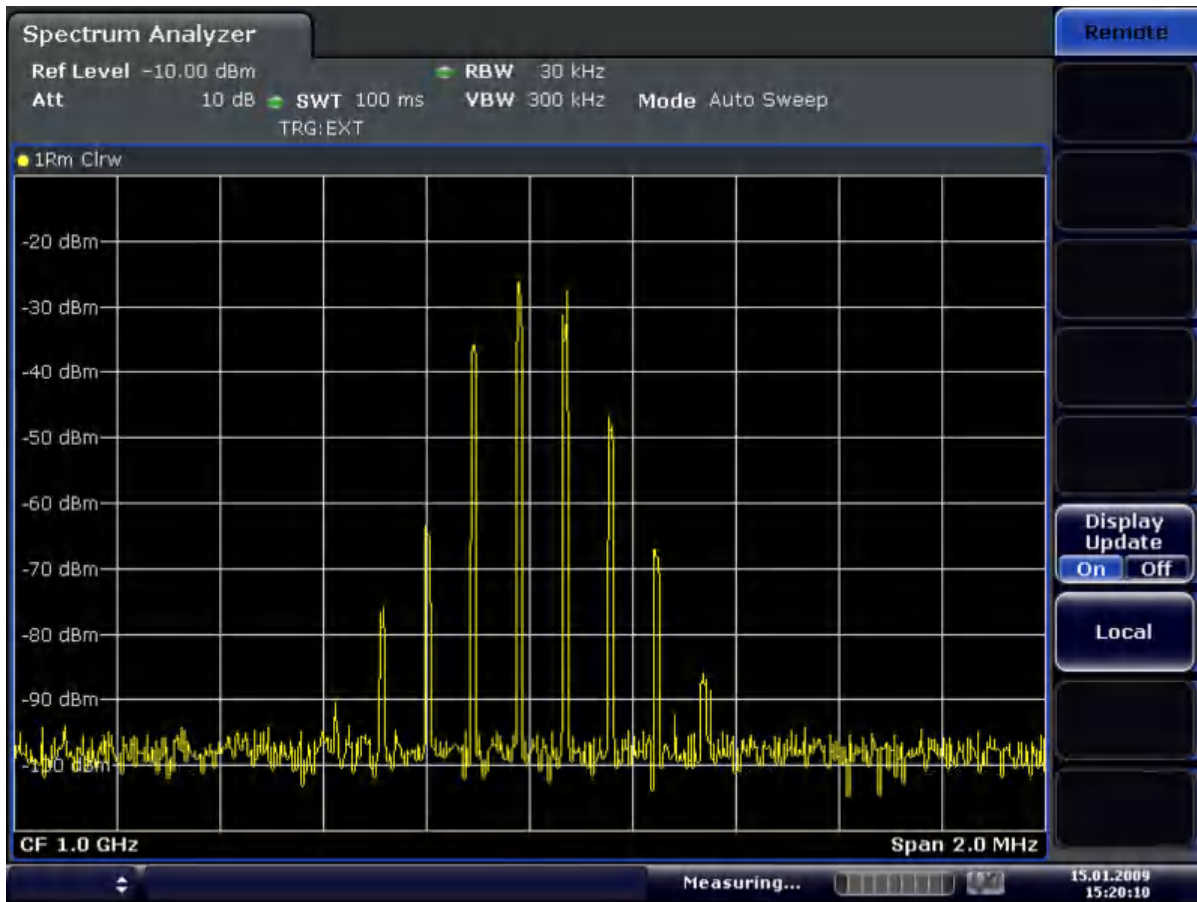

Figure 6-14: TDMA signal with GATE OFF

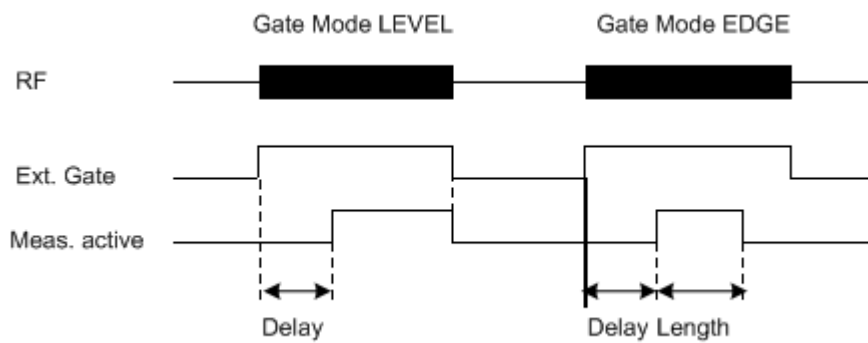

Figure 6-15: Timing diagram for GATE, GATE DELAY and GATE LENGTH

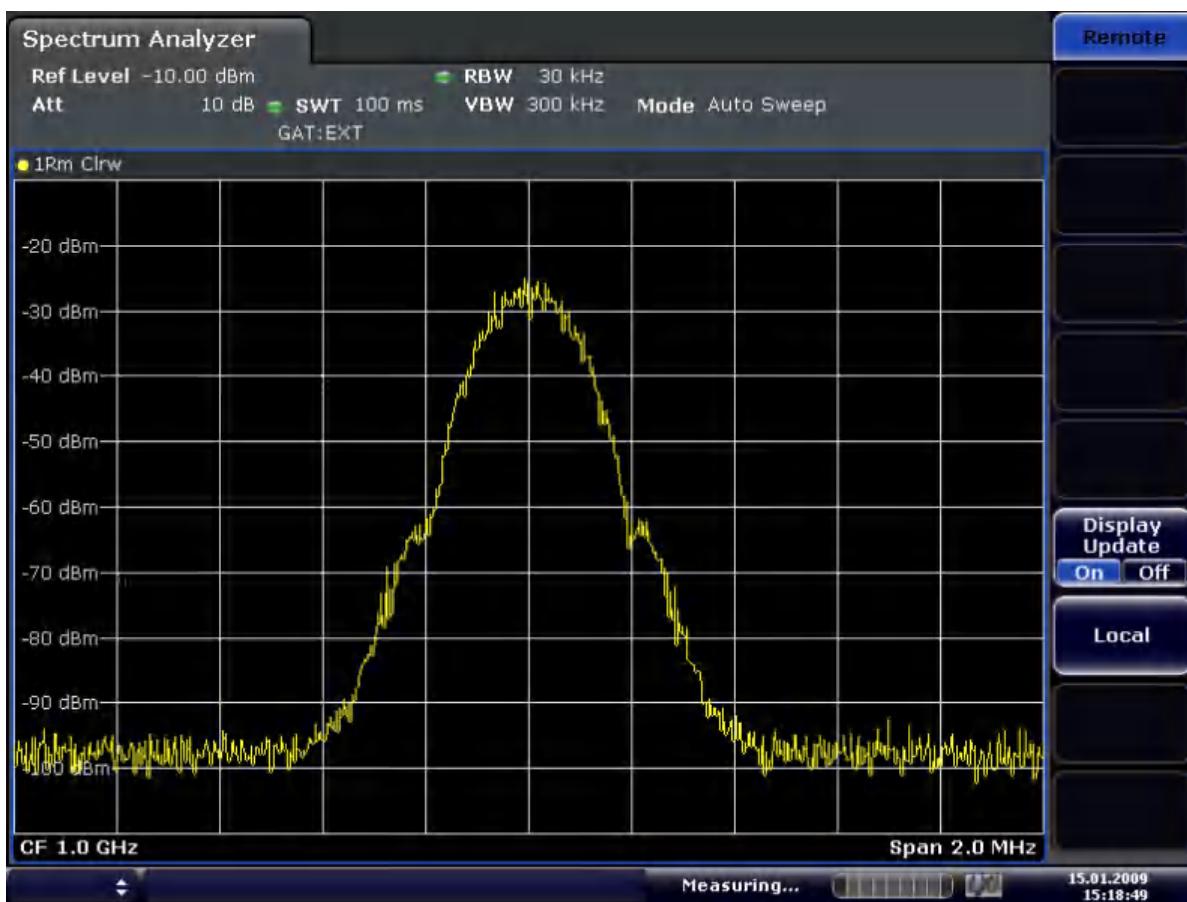

Figure 6-16: TDMA signal with GATE ON

## 6.2.9 Input/Output Configuration – INPUT/OUTPUT Key

The [INPUT/OUTPUT] key is used to configure input and output sources for measurement functions.

### 6.2.9.1 Softkeys of the Input/Output Menu

The following table shows all softkeys available in the "Input/Output" menu. It is possible that your instrument configuration does not provide all softkeys. If a softkey is only available with a special option, model or (measurement) mode, this information is provided in the corresponding softkey description.

Functions in the "Input / Output" menu described elsewhere:

- "User Port" on page 163

Input (AC/DC).....	355
Preselector (On Off).....	355
Noise Source.....	355

Video Output.....	355
Trigger Out.....	355
Probe Config.....	355

**Input (AC/DC)**

Toggles the RF input of the R&S ESRP between AC and DC coupling.

Remote command:

`INPut:COUPling` on page 641

**Preselector (On Off)**

Turns the preselector on and off.

The preselector is available with option R&S ESRP-B2.

Remote command:

`INPut:PRESelection:STATe` on page 899

**Noise Source**

Switches the supply voltage for an external noise source on or off.

For details on connectors refer to "[NOISE SOURCE CONTROL](#)" on page 31.

Remote command:

`DIAGnostic<n>:SERVice:NSource` on page 899

**Video Output**

Selects the type of output for the optional IF / Video output.

When you turn on the output, you can select to output either the intermediate frequency or the video signal.

**Note:** Video output does not return valid values in IQ or FFT mode.

Remote command:

`OUTPut:IF VID`, see `OUTPut:IF[:SOURce]` on page 900

**Trigger Out**

Sets the Trigger Out port to low or high. Thus, you can trigger an additional device via the external trigger port, for example.

Remote command:

`OUTPut:TRIGger` on page 901

**Probe Config**

Opens an edit dialog box to activate and configure a connected probe which is to provide an input signal. It is only available if a probe is connected to the instrument's [RF Input] and USB connectors.

For details see [Chapter 6.2.9.2, "Using Active Probes for Input"](#), on page 356.

Remote command:

`PROBe[:STATe]` on page 790

`PROBe:SETup:MODE` on page 789

### 6.2.9.2 Using Active Probes for Input

When the input from the device under test requires high impedance, an active probe can be connected between the device and the R&S ESRP.

The R&S ESRP supports active probes from the R&S RT-ZS series when using the new probe adapter RT-ZA9.

When the probe has been connected to and recognized by the R&S ESRP, a pre-defined "Generic Probe" transducer factor with 20 dB is automatically activated and the unit of the spectrum analyzer is changed to dB $\mu$ V. (The same applies after presetting the instrument.) Then the system is ready to analyze circuit points that cannot be loaded with the 50  $\Omega$  of the analyzer input, but require a higher impedance.

Optionally, the probe can be deactivated while remaining connected to the R&S ESRP, for instance to analyze the digital input from the probe without considering the transducer factor.

All RT probes (except for ZS10E) have a micro button. The action for the micro button can be defined. Currently, either a single sweep or no action can be performed when the button is pressed. By default, when you press the probe's micro button, the R&S ESRP is set to single sweep mode and a single sweep is performed. This allows you to start a measurement whilst applying the probe to a certain pin on the board under test.

When using RT probes, consider the following:

- Active probes require operating power from the instrument and have a proprietary interface to the instrument.
- The probe is automatically recognized by the instrument, no adjustment is required.
- Connections should be as short as possible to keep the usable bandwidth high.
- Observe the operating voltage range.

For more information on RT probes, refer to the probe's documentation.

#### Connecting Active Probes

In order to use active probes with an R&S ESRP, an RT-ZA9 adapter is required. The RT-ZA9 provides an interface between the probe's BNC socket and the analyzer's N-socket and provides the necessary supply voltages for the probe via the USB connection. Using this adapter, the following probes are currently supported:

- R&S RT-ZS10
- RT-ZS10E
- RT-ZS20
- RT-ZS30

To connect an active probe, proceed as follows:

1. Connect the adapter to the RF Input connector on the R&S ESRP.
2. Connect the adapter's USB cable to a USB connector on the R&S ESRP.

3. Connect the probe to the adapter.

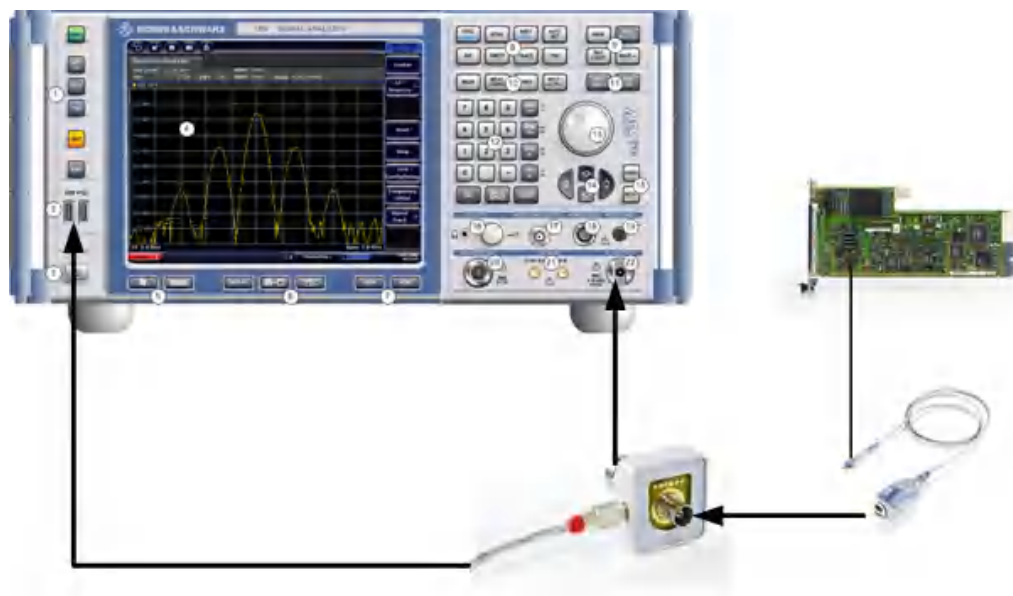

Once the probe and adapter have been connected to the R&S ESRP correctly and the analyzer has recognized the probe, the "Generic Probe" transducer is activated and you can start a measurement.



To determine whether the probe has been connected properly and recognized by the R&S ESRP, use the remote control command `PROB:SET:STAT?` (see `PROBe:SETup:STATe?` on page 789).

**To perform a measurement with the probe**

- ▶ Place the probe on the required position on the test equipment, then press the micro button on the probe to perform a single sweep measurement.

**Probe Configuration**

Principally, the probe is automatically recognized by the instrument and no further adjustment is required. However, you can switch off the probe while leaving it connected, and you can configure which action is to be performed when the probe's micro button is pressed.

To display the "Probe Configuration" dialog box, select the [INPUT/OUTPUT] key and then the "Probe Config" softkey.

The following settings are available:

<a href="#">State</a> .....	358
<a href="#">Name</a> .....	358
<a href="#">Serial Number</a> .....	358
<a href="#">Part number</a> .....	358
<a href="#">Micro Button Action</a> .....	358



**State**

Activates a connected probe. Use this command to switch off the probe and measure the digital input without considering the transducer factor of the probe.

Remote command:

[PROBe\[:STATe\]](#) on page 790

**Name**

Indicates the name of the connected probe.

Remote command:

[PROBe:SETup:NAME?](#) on page 789

**Serial Number**

Indicates the serial number of the connected probe.

Remote command:

[PROBe:ID:SRNumber?](#) on page 789

**Part number**

Indicates the material part number of the connected probe.

Remote command:

[PROBe:ID:PARTnumber?](#) on page 789

**Micro Button Action**

Defines which action is taken when the probe's micro button is pressed.

"RunSingle"      A single sweep is performed.

"No Action"      No action is taken.

Remote command:

[PROBe:SETup:MODE](#) on page 789

## 6.3 Analysis

General methods and basic settings to display and analyze measurements. If you are performing a specific measurement task or using an operating mode other than Spectrum mode, be sure to check the specific measurement or mode description for settings and functions that may deviate from these general ones.

- [Trace Configuration](#).....358
- [Spectrogram](#).....373
- [Markers](#).....377
- [Lines](#).....400

### 6.3.1 Trace Configuration

The TRACE key is used to configure the data acquisition for measurement and the analysis of the measurement data.

The R&S ESRP is capable of displaying up to six different traces at a time in a diagram. A trace consists of a maximum of 691 displayed measurement points on the horizontal axis (frequency or time). If more measured values than measurement points are available, several measured values are combined in one displayed measurement point.

The trace functions include the following:

- Display mode of the trace  
For details on trace modes see [Chapter 5.2.3, "Trace Modes"](#), on page 147.
- Evaluation of the trace as a whole  
For details on averaging see [Chapter 6.3.1.4, "Description of the Averaging Method"](#), on page 368.
- Evaluation of individual measurement points of a trace. For details on detectors see [Chapter 6.3.1.5, "Detector Overview"](#), on page 370.

#### To open the Trace menu

- Press the TRACE key.  
The "Trace" menu is displayed. The "Trace Configuration" dialog box is displayed.

#### Menu and softkey description

- [Chapter 6.3.1.1, "Softkeys of the Trace Menu"](#), on page 359

#### Further information

- [Chapter 5.2.3, "Trace Modes"](#), on page 147
- [Chapter 6.3.1.5, "Detector Overview"](#), on page 370
- [Chapter 6.3.1.6, "ASCII File Export Format"](#), on page 370

#### Tasks

- [Chapter 6.3.1.2, "Configuring Traces"](#), on page 366
- [Chapter 6.3.1.3, "Specifying the Trace Settings"](#), on page 368

### 6.3.1.1 Softkeys of the Trace Menu

The following table shows all softkeys available in the "Trace" menu. It is possible that your instrument configuration does not provide all softkeys. If a softkey is only available with a special option, model or (measurement) mode, this information is provided in the corresponding softkey description.

Functions to configure traces described elsewhere:

- ["More Traces"](#) on page 175
- ["Copy Trace"](#) on page 175
- ["Trace Wizard"](#) on page 175
- ["ASCII Trace Export"](#) on page 175
- ["Decim Sep"](#) on page 176

**Functions to configure traces exclusive in Spectrum mode**

Trace 1/Trace 2/Trace 3/Trace 4/Trace 5/Trace 6	360
L Clear Write	360
L Max Hold	361
L Min Hold	361
L Average	361
L View	361
L Blank	361
L Hold/Cont	362
L Detector	362
L Auto Select	362
L Auto Peak	363
L Positive Peak	363
L Negative Peak	363
L Sample	363
L RMS	363
L Average	363
L Quasipeak	363
L CISPR Average	363
L RMS Average	364
Average Mode	364
L Lin	364
L Log	364
L Power	365
Trace Math	365
Trace Math Mode	365
L Lin	365
L Log	366
L Power	366
Trace Math Position	366
Trace Math Off	366

**Trace 1/Trace 2/Trace 3/Trace 4/Trace 5/Trace 6**

Selects the active trace (1, 2, 3, 4, 5, 6) and opens the "Trace Mode" submenu for the selected trace.

In the default state, trace 1 is in [Clear Write](#) mode. The other traces are turned off. For details see [Chapter 5.2.3, "Trace Modes"](#), on page 147.

**Tip:** To configure several traces in one step, use the functionality of the Trace Configuration dialog box. To access the dialog box, press the [Trace Wizard](#) softkey.

Remote command:

Selected via numeric suffix of: TRACe<1 . . . 6> commands

**Clear Write ← Trace 1/Trace 2/Trace 3/Trace 4/Trace 5/Trace 6**

Overwrite mode: the trace is overwritten by each sweep. This is the default setting.

All available detectors can be selected.

Remote command:

DISP:TRAC:MODE WRIT, see [DISPlay\[:WINDow<n>\]:TRACe<t>:MODE](#)  
on page 652

**Max Hold ← Trace 1/Trace 2/Trace 3/Trace 4/Trace 5/Trace 6**

The maximum value is determined over several sweeps and displayed. The R&S ESRP saves the sweep result in the trace memory only if the new value is greater than the previous one.

This mode is especially useful with modulated or pulsed signals. The signal spectrum is filled up upon each sweep until all signal components are detected in a kind of envelope.

Remote command:

DISP:TRAC:MODE MAXH, see [DISPlay\[:WINDow<n>\]:TRACe<t>:MODE](#) on page 652

**Min Hold ← Trace 1/Trace 2/Trace 3/Trace 4/Trace 5/Trace 6**

The minimum value is determined from several measurements and displayed. The R&S ESRP saves the smallest of the previously stored/currently measured values in the trace memory.

This mode is useful e.g. for making an unmodulated carrier in a composite signal visible. Noise, interference signals or modulated signals are suppressed whereas a CW signal is recognized by its constant level.

Remote command:

DISP:TRAC:MODE MINH, see [DISPlay\[:WINDow<n>\]:TRACe<t>:MODE](#) on page 652

**Average ← Trace 1/Trace 2/Trace 3/Trace 4/Trace 5/Trace 6**

The average is formed over several sweeps. The [Sweep Count](#) determines the number of averaging procedures.

All available detectors can be selected. If the detector is automatically selected, the sample detector is used (see [Chapter 6.3.1.5, "Detector Overview"](#), on page 370).

This mode is not available for statistics measurements.

Remote command:

DISP:TRAC:MODE AVER, see [DISPlay\[:WINDow<n>\]:TRACe<t>:MODE](#) on page 652

**View ← Trace 1/Trace 2/Trace 3/Trace 4/Trace 5/Trace 6**

The current contents of the trace memory are frozen and displayed.

**Note:** If a trace is frozen, the instrument settings, apart from level range and reference level (see below), can be changed without impact on the displayed trace. The fact that the displayed trace no longer matches the current instrument setting is indicated by the  icon on the tab label.

If the level range or reference level is changed, the R&S ESRP automatically adapts the measured data to the changed display range. This allows an amplitude zoom to be made after the measurement in order to show details of the trace.

Remote command:

DISP:TRAC:MODE VIEW, see [DISPlay\[:WINDow<n>\]:TRACe<t>:MODE](#) on page 652

**Blank ← Trace 1/Trace 2/Trace 3/Trace 4/Trace 5/Trace 6**

Hides the selected trace.

Remote command:

DISP:TRAC OFF, see [DISPlay\[:WINDow<n>\]:TRACe<t>\[:STATe\]](#) on page 817

#### Hold/Cont ← Trace 1/Trace 2/Trace 3/Trace 4/Trace 5/Trace 6

Switches the reset of the traces in Min Hold, Max Hold and Average mode after some specific parameter changes have been made on and off. The default setting is off.

Normally, the measurement is started anew after parameter changes, before the measurement results are evaluated (e.g. using a marker). In all cases that require a new measurement after parameter changes, the trace is reset automatically to avoid false results (e.g. with span changes). For applications that require no reset after parameter changes, the automatic reset can be switched off.

Remote command:

[DISPlay\[:WINDow<n>\]:TRACe<t>:MODE:HCONtinuous](#) on page 817

#### Detector ← Trace 1/Trace 2/Trace 3/Trace 4/Trace 5/Trace 6

Opens a submenu to select the detector manually, or activate automatic selection.

**Note:** When measuring spurious emissions, using this softkey automatically opens the Sweep List dialog, see "[Sweep List dialog box](#)" on page 265.

If a detector was selected manually, the "MAN" indicator is highlighted.

If "AUTO" is selected, the detector is defined automatically, depending on the selected trace mode:

Trace mode	Detector
Clear Write	Auto Peak
Max Hold	Positive Peak
Min Hold	Negative Peak
Average	Sample Peak
View	–
Blank	–

#### Auto Select ← Detector ← Trace 1/Trace 2/Trace 3/Trace 4/Trace 5/Trace 6

Selects the best detector for the selected trace and filter mode. This is the default setting.

Trace mode	Detector
Clear/Write	Auto Peak
Average	Sample
Max Hold	Max Peak
Min Hold	Min Peak

Remote command:

[\[SENSe:\] \[WINDow:\] DETector<trace>\[:FUNction\]:AUTO](#) on page 821

**Auto Peak ← Detector ← Trace 1/Trace 2/Trace 3/Trace 4/Trace 5/Trace 6**

Selects the "Auto Peak" detector.

The "Auto Peak" detector determines the maximum and minimum value within a measurement point. The Auto Peak detector is not available for SEM measurements.

Remote command:

DET APE, see [SENSe:] [WINDow:] DETector<trace>[:FUNCTION]  
on page 821

**Positive Peak ← Detector ← Trace 1/Trace 2/Trace 3/Trace 4/Trace 5/Trace 6**

Selects the "Positive Peak" detector.

Remote command:

DET POS, see [SENSe:] [WINDow:] DETector<trace>[:FUNCTION]  
on page 821

**Negative Peak ← Detector ← Trace 1/Trace 2/Trace 3/Trace 4/Trace 5/Trace 6**

Selects the "Negative Peak" detector.

Remote command:

DET NEG, see [SENSe:] [WINDow:] DETector<trace>[:FUNCTION]  
on page 821

**Sample ← Detector ← Trace 1/Trace 2/Trace 3/Trace 4/Trace 5/Trace 6**

Selects the "Sample" detector.

Remote command:

DET SAMP, see [SENSe:] [WINDow:] DETector<trace>[:FUNCTION]  
on page 821

**RMS ← Detector ← Trace 1/Trace 2/Trace 3/Trace 4/Trace 5/Trace 6**

Selects the "RMS" detector.

Remote command:

DET RMS, see [SENSe:] [WINDow:] DETector<trace>[:FUNCTION]  
on page 821

**Average ← Detector ← Trace 1/Trace 2/Trace 3/Trace 4/Trace 5/Trace 6**

Selects the "Average" detector.

Remote command:

DET AVER, see [SENSe:] [WINDow:] DETector<trace>[:FUNCTION]  
on page 821

**Quasipeak ← Detector ← Trace 1/Trace 2/Trace 3/Trace 4/Trace 5/Trace 6**

Selects the "Quasipeak" detector.

Remote command:

DET QPE, see [SENSe:] [WINDow:] DETector<trace>[:FUNCTION]  
on page 821

**CISPR Average ← Detector ← Trace 1/Trace 2/Trace 3/Trace 4/Trace 5/Trace 6**

Selects the "CISPR Average" detector.

Remote command:

DET CAV, see [SENSe:] [WINDow:] DETector<trace>[:FUNCTION]  
on page 821

### **RMS Average ← Detector ← Trace 1/Trace 2/Trace 3/Trace 4/Trace 5/Trace 6**

Selects the "RMS Average" detector.

Remote command:

DET CRMS, see [SENSe:] [WINDow:] DETector<trace>[:FUNCTION]  
on page 821

### **Average Mode**

Opens a submenu to select the averaging method for the average trace mode. The following methods are available:

- [Lin](#)
- [Log](#)
- [Power](#)

Logarithmic averaging is recommended to display signals with a low signal to noise ratio. While positive peak values are decreased in logarithmic averaging due to the characteristics involved, it is also true that negative peaks are increased relative to the average value. If the distorted amplitude distribution is averaged, a value is obtained that is smaller than the actual average value. The difference is -2.5 dB.

This low average value is usually corrected in noise power measurements by a 2.5 dB factor. Therefore the R&S ESRP offers the selection of linear averaging. The trace data is converted to linear values prior to averaging, then averaged and reconverted to logarithmic values. After these conversions the data is displayed on the screen. The average value is always correctly displayed irrespective of the signal characteristic.

In case of stationary sinusoidal signals both logarithmic and linear averaging has the same results.

### **Lin ← Average Mode**

Activates linear averaging. Linear averaging means that the power level values are converted into linear units prior to averaging. After the averaging, the data is converted back into its original unit.

This softkey takes effect if the grid is set to a linear scale (see "Range Linear" softkey, "[Range Linear %](#)" on page 289). In this case, the averaging is done in two ways (depending on the set unit – see "Unit" softkey):

- The unit is set to either W or dBm: the data is converted into W prior to averaging, i.e. averaging is done in W.
- The unit is set to either V, A, dBmV, dBμV, dBμA or dBpW: the data is converted into V prior to averaging, i.e. averaging is done in V.

Remote command:

SENS: AVER1: TYPE LIN, see [SENSe:] AVERage<n>: TYPE on page 820

### **Log ← Average Mode**

Activates logarithmic averaging.

This averaging method only takes effect if the grid is set to a logarithmic scale ("Range" softkey), i.e. the unit of the data is dBm. In this case the values are averaged in dBm. Otherwise (i.e. with linear scaling), the behavior is the same as with linear averaging (see [Lin](#) softkey). For further information on logarithmic scaling refer to the "Average Mode" softkey.

Remote command:

SENS: AVER1: TYPE VID, see [\[SENSe:\] AVERage<n>: TYPE](#) on page 820

### Power ← Average Mode

Activates linear power averaging.

The power level values are converted into unit Watt prior to averaging. After the averaging, the data is converted back into its original unit.

Unlike the linear mode, the averaging is always done in W.

Remote command:

SENS: AVER1: TYPE POW, see [\[SENSe:\] AVERage<n>: TYPE](#) on page 820

### Trace Math

Opens the "Trace Mathematics" dialog box to define which trace is subtracted from trace 1. The result is displayed in trace 1 and refers to the zero point defined with the [Trace Math Position](#) softkey. The following subtractions can be performed:

"T1"->"T1"-T2"	Subtracts trace 2 from trace 1.
"T1"->"T1"-T3"	Subtracts trace 3 from trace 1
"T1"->"T1"-T4"	Subtracts trace 4 from trace 1
"T1"->"T1"-T5"	Subtracts trace 5 from trace 1
"T1"->"T1"-T6"	Subtracts trace 6 from trace 1

To switch off the trace math, use the [Trace Math Off](#) softkey.

Remote command:

[CALCulate<n>: MATH\[:EXpression\] \[:DEFine\]](#) on page 815

[CALCulate<n>: MATH: STATE](#) on page 816

### Trace Math Mode

Opens a submenu to select the mode for the trace math calculations.

### Lin ← Trace Math Mode

Activates linear subtraction, which means that the power level values are converted into linear units prior to subtraction. After the subtraction, the data is converted back into its original unit.

This softkey takes effect if the grid is set to a linear scale (see [Range](#) softkey). In this case, subtraction is done in two ways (depending on the set unit – see [Unit](#) softkey):

- The unit is set to either W or dBm: the data is converted into W prior to subtraction, i.e. averaging is done in W.
- The unit is set to either V, A, dBmV, dBμV, dBμA or dBpW: the data is converted into V prior to subtraction, i.e. subtraction is done in V.



Remote command:

CALC:MATH:MODE LIN, see [CALCulate<n>:MATH:MODE](#) on page 816

#### **Log ← Trace Math Mode**

Activates logarithmic subtraction.

This subtraction method only takes effect if the grid is set to a logarithmic scale (see [Range](#) softkey), i.e. the unit of the data is dBm. In this case the values are subtracted in dBm. Otherwise (i.e. with linear scaling) the behavior is the same as with linear subtraction (see [Lin](#) softkey). For further information on logarithmic scaling refer to the [Average Mode](#) softkey.

Remote command:

CALC:MATH:MODE LOG, see [CALCulate<n>:MATH:MODE](#) on page 816

#### **Power ← Trace Math Mode**

Activates linear power subtraction.

The power level values are converted into unit Watt prior to subtraction. After the subtraction, the data is converted back into its original unit.

Unlike the linear mode, the subtraction is always done in W.

Remote command:

CALC:MATH:MODE POW, see [CALCulate<n>:MATH:MODE](#) on page 816

#### **Trace Math Position**

Opens an edit dialog box to define the zero point in % of the diagram height. The range of values extends from -100 % to +200 %.

Remote command:

[CALCulate<n>:MATH:POSition](#) on page 816

#### **Trace Math Off**

Deactivates any previously selected trace math functions.

Remote command:

CALC:MATH:STAT OFF, see [CALCulate<n>:MATH:STATe](#) on page 816

### **6.3.1.2 Configuring Traces**

1. To open the trace wizard, press the TRACE key and then the "Trace Wizard" softkey (see ["Trace Wizard"](#) on page 175).

**Tip:** Context-sensitive menus for traces. Traces have context-sensitive menus. If you right-click on a trace in the display or a trace setting in the information channel bar (or touch it for about 1 second), a menu is displayed which corresponds to the softkey functions available for traces. This is useful, for example, when the softkey display is hidden.

If a menu entry contains an arrow to the right of it, a submenu is available for that entry.

To close the menu, press the ESC key or click in the display outside of the menu.

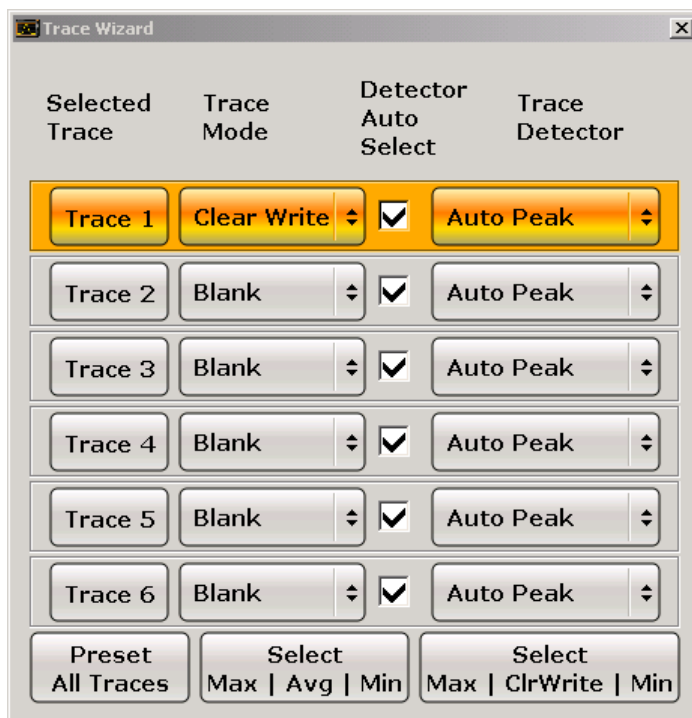

2. For each trace you can define the following settings:

Display Mode	<ul style="list-style-type: none"> <li>• Clear Write</li> <li>• Max Hold</li> <li>• Min Hold</li> <li>• Average</li> <li>• View</li> <li>• Blank</li> </ul> <p>For details see <a href="#">Chapter 5.2.3, "Trace Modes"</a>, on page 147.</p>
Detector Auto Select	Activates automatic detector selection (see <a href="#">Auto Select</a> softkey). If activated, the "Trace Detector" setting is ignored.
Trace Detector	<p>Defines a specific trace detector. If one of the following settings is defined, the "Detector Auto Select" option is deactivated.</p> <ul style="list-style-type: none"> <li>• <a href="#">"Auto Select"</a> on page 362</li> <li>• <a href="#">"Auto Peak"</a> on page 363</li> <li>• <a href="#">"Positive Peak"</a> on page 363</li> <li>• <a href="#">"Negative Peak"</a> on page 363</li> <li>• <a href="#">"Sample"</a> on page 363</li> <li>• <a href="#">"RMS"</a> on page 363</li> <li>• <a href="#">"Average"</a> on page 363</li> </ul>

3. To configure several traces to predefined display modes in one step, press the button for the required function:

Preset All Traces	Trace 1: <a href="#">Clear Write</a> Trace 2-6: <a href="#">Blank</a>
Select Max   Avg   Min	Trace 1: <a href="#">Max Hold</a> Trace 2: <a href="#">Average</a> Trace 3: <a href="#">Min Hold</a> Trace 4-6: <a href="#">Blank</a>
Select Max   ClrWrite   Min	Trace 1: <a href="#">Max Hold</a> Trace 2: <a href="#">Clear Write</a> Trace 3: <a href="#">Min Hold</a> Trace 4-6: <a href="#">Blank</a>

For details see [Chapter 5.2.3, "Trace Modes"](#), on page 147.

### 6.3.1.3 Specifying the Trace Settings

1. To configure one or more traces, see [Chapter 6.3.1.2, "Configuring Traces"](#), on page 366.
2. To select the trace mode for the selected trace, press the softkey for the corresponding trace (for details see [Chapter 5.2.3, "Trace Modes"](#), on page 147).
3. To select a detector, press the [Auto Select](#) softkey for automatic detector selection, or press the [Detector](#) softkey (for details see [Chapter 6.3.1.5, "Detector Overview"](#), on page 370).
4. To change the sweep count setting, which also determines trace averaging, press the [Sweep Count](#) softkey.
5. To deactivate the reset of the traces in "Min Hold" and "Max Hold" mode after some specific parameter changes, press the [Trace Math](#) softkey.
6. To copy a trace into another trace memory, press the [Copy Trace](#) softkey. Upon copying, the contents of the selected memory are overwritten and the new contents are displayed in the View mode.
7. To export the active trace in ASCII format:
  - a) Press the "More" softkey.
  - b) If necessary, press the [Decim Sep](#) softkey to change the decimal separator with floating-point numerals.
  - c) Press the [ASCII File Export](#) softkey to enter the ASCII file export name. The active trace is saved in ASCII format on the harddisk on or an external storage device.

### 6.3.1.4 Description of the Averaging Method

Averaging is carried out over the measurement points derived from the measurement samples. Several measured values may be combined in a measurement point. This

means that with linear level display the average is formed over linear amplitude values. The sweep mode (continuous or single sweep, for details see [Chapter 6.2.7, "Configuring the Sweep Mode – SWEEP Key"](#), on page 340) and running averaging apply to the average display analogously. In principle, two methods for calculating the average are used: continuous averaging and averaging over the selected number of sweeps.

- sweep count > 1  
Depending on the relation of the following two parameters, two different situations exist:

$n$  = number of sweeps performed since measurement start

$c$  = sweep count (number of sweeps forming one statistics cycle)

- $n \leq c$

In single sweep or continuous sweep mode during the first statistics cycle, averaging over the selected number of sweeps is performed. The average trace " $n$ " is calculated at each measurement point according to:

$$Avg(n) = \frac{n-1}{n} Avg(n-1) + \frac{1}{n} Curr(n)$$

**Figure 6-17: Equation 1**

with Avg = average trace; Curr = current trace

Until the first statistics cycle is completed ( $n < c$ ), a preliminary average is displayed which represents the arithmetic mean value over all measured sweeps. With  $n$  increasing, the displayed trace is increasingly smoothed since there are more single sweeps for averaging.

When the first statistics cycle is completed ( $n = c$ ), the average trace is saved in the trace memory.

- $n > c$

In continuous sweep mode after the first statistics cycle, continuous averaging is performed. The average trace " $n$ " is calculated at each measurement point according to:

$$Avg(n) = \frac{c-1}{c} Avg(n-1) + \frac{1}{c} Curr(n)$$

**Figure 6-18: Equation 2**

with Avg = average trace; Curr = current trace

In single sweep mode, the same formula is valid if the [Continue Single Sweep](#) softkey is pressed.

- sweep count = 0  
In continuous sweep mode, a continuous average is calculated according to [Figure 6-18](#) with  $c = 10$ :

$$Avg(n) = \frac{9}{10} Avg(n-1) + \frac{1}{10} Curr(n)$$

**Figure 6-19: Equation 3**

with Avg = average trace; Curr = current trace

Due to the weighting between the current trace and the average trace, past values have practically no influence on the displayed trace after about ten sweeps. With this setting, signal noise is effectively reduced without need for restarting the averaging process after a change of the signal.

- sweep count = 1  
The current trace is displayed. No averaging is performed. This is a special case of [Figure 6-17](#) with  $n = 0$ .

### 6.3.1.5 Detector Overview

The measurement detector for the individual display modes can be selected directly by the user or set automatically by the R&S ESRP. The detector activated for the specific trace is indicated in the corresponding trace display field by an abbreviation.

For more information on available detectors see [Chapter 5.2.2, "Detectors"](#), on page 143.

All detectors work in parallel in the background, which means that the measurement speed is independent of the detector combination used for different traces.



#### Number of measured values

During a frequency sweep, the R&S ESRP increments the first local oscillator in steps that are smaller than approximately 1/10 of the bandwidth. This ensures that the oscillator step speed is conform to the hardware settling times and does not affect the precision of the measured power.

The number of measured values taken during a sweep is independent of the number of oscillator steps. It is always selected as a multiple or a fraction of 691 (= default number of trace points displayed on the screen). Choosing less than 691 measured values (e.g. 125 or 251) will lead to an interpolated measurement curve, choosing more than 691 points (e.g. 1001, 2001 ...) will result in several measured values being overlaid at the same frequency position.



#### RMS detector and VBW

If the RMS detector is selected, the video bandwidth in the hardware is bypassed. Thus, duplicate trace averaging with small VBWs and RMS detector no longer occurs. However, the VBW is still considered when calculating the sweep time. This leads to a longer sweep time for small VBW values. Thus, you can reduce the VBW value to achieve more stable trace curves even when using an RMS detector. Normally, if the RMS detector is used the sweep time should be increased to get more stable trace curves.

### 6.3.1.6 ASCII File Export Format

The data of the file header consist of three columns, each separated by a semicolon: parameter name; numeric value; basic unit. The data section starts with the keyword "Trace <n>" (<n> = number of stored trace), followed by the measured data in one or

several columns (depending on measurement) which are also separated by a semicolon.



**Exporting a single trace vs exporting all traces**

Note that the file containing the trace data has a slightly different structure when you export all traces compared to exporting a single trace only. The differences are indicated in the tables below.

<p><b>Blue font:</b> Information provided when you export a single trace  <b>Green font:</b> Information provided when you export all traces  <b>Black font:</b> Information provided regardless of the export mode</p>	
<b>Header</b>	
Type;<instrument_model>;	Instrument model
Version;1.00;	Firmware version
Date;01. Jan 3000;	Date of data set storage
Mode;Receiver;	Application
Start;150000.000000;Hz	Start frequency of the scan
Stop;100000000.000000;Hz;	Stop frequency of the scan
X-Axis;LIN;	Scale of the x-axis
Detector;Average;	Detector type
X-Unit;Hz;	Unit of the x-axis
Y-Unit;dBµV;	Unit of the y-axis
Scan Count;1;	Scan count
Transducer;;;;;;;;;	Transducer information

<b>Data section (scan ranges)</b>	
Scan 1:	
Start;150000.000000;Hz;	Start frequency of the scan range
Stop;29998500.000000;Hz;	Stop frequency of the scan range
Step;4500.000000;Hz;	Frequency stepsize applied in the scan range
RBW;9000.000000;Hz;	Measurement bandwidth applied in the scan range
Meas Time;0.001000;s;	Measurement time in the scan range
Auto Ranging;OFF;	State of the auto ranging feature
RF Att;10.000000;dB;	Attenuation applied in the scan range
Auto Preamp;OFF; Preamp;0.000000;dB;	Preamplifier information for the scan range
RF Input;1;	RF input used in the scan range
Scan 2:	
(...)	

Data section (traces)	
Trace 1:	
Trace Mode;CLR/WRITE;	Trace mode
Detector;MAX PEAK;	Detector type
X-Unit;Hz;	Unit of the x-axis
Y-Unit;Hz;	Unit of the y-axis
Values;1343;	Number of measurement points
150000.000000;3.541122; 154500.000000;5.776306;[...]	String of results
Trace 2:	
(...)	

<b>Blue font:</b> Information provided when you export a single trace	
<b>Green font:</b> Information provided when you export all traces	
<b>Black font:</b> Information provided regardless of the export mode	
Header	
Type; <instrument_model>;	Instrument model
Version;1.00;	Firmware version
Date;01. Jan 3000;	Date of data set storage
Mode;Analyzer;	Application
Center Freq;100000000.000000;	Center frequency
Freq Offset;0.000000;Hz;	Frequency offset
Span;1000000000.000000;Hz;	Frequency span
X-Axis;LIN;	Scale of the x-axis
Start;150000.000000;Hz;	Start frequency
Stop;2500000.000000;Hz;	Stop frequency
Ref Level;97.000000;dB $\mu$ V;	Reference level
Level Offset;0.000000;Hz;	Reference level offset
Ref Position;100.000000;%;	Reference position
Y-Axis;LOG;	Scale of the y-axis
Level Range;100.000000;dB;	Range of the y-axis
Rf Att;10.000000;dB;	RF attenuation
RBW;3000000.000000;Hz;	Resolution bandwidth
VBW;300000.000000;Hz;	Video bandwidth
SWT;0.002000;s;	Sweep time
Trace mode;CLR/WRITE;	Trace mode
Detector;AUTOPEAK;	Detector type
X-Unit;Hz;	Unit of the x-axis
Y-Unit;Hz;	Unit of the y-axis
Preamplifier;OFF;	State of the preamplifier
Transducer;OFF;	Transducer information
Sweep Count;0;	Sweep / average count

Data section (traces)	
Trace 1:	
Trace Mode;CLR/WRITE;	Trace mode
Detector;MAX PEAK;	Detector type
X-Unit;Hz;	Unit of the x-axis
Y-Unit;Hz;	Unit of the y-axis
Preamplifier;OFF;	State of the preamplifier
Transducer;OFF;	Transducer information
Values;691;	Number of measurement points
150000.000000;3.541122; 154500.000000;5.776306;[...]	String of results
Trace 2:	
(...)	

## 6.3.2 Spectrogram

The spectrogram is a graphical overview of changes in the frequency and amplitude over time.

The spectrogram uses the configuration of the Spectrum mode and vice versa.

Note that not all measurements of the Spectrum mode support a spectrogram result display.

### Menus and softkeys

The main menu of the Spectrogram result display is part of the "Trace" menu in Spectrum mode. For more information see .

Some special functions supported by the spectrogram are available in the "Sweep" menu in Spectrum mode. For more information see [Chapter 6.2.7.1, "Softkeys of the Sweep Menu"](#), on page 340.

### 6.3.2.1 Working with Spectrograms

Functions of the spectrogram described elsewhere:

- [Chapter 5.1.6, "Spectrogram"](#), on page 127

### General Information

This section provides some basic information about using the firmware application and about performing measurements with the firmware application.

### Screen Layout

The Spectrogram view is divided into two screens: the spectrum analyzer result display (upper screen) and the spectrogram result display (lower screen).



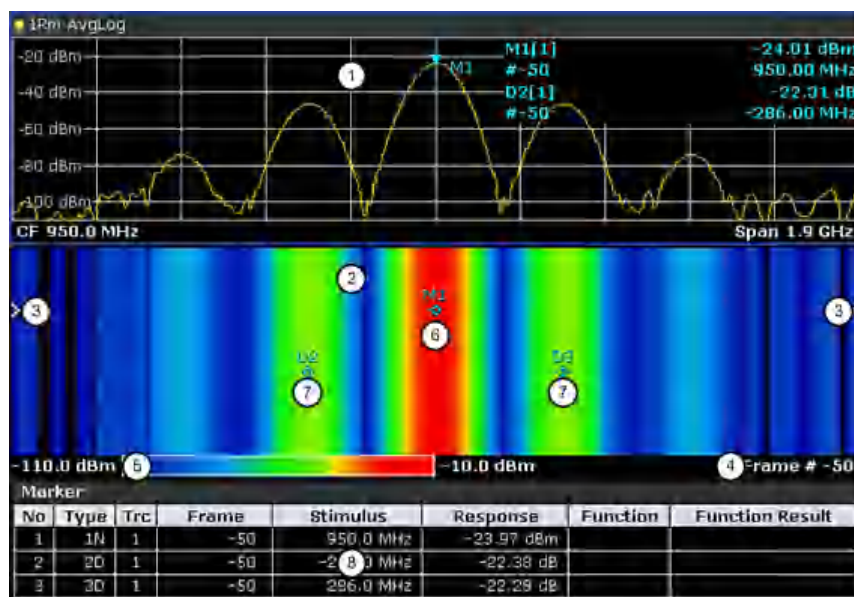

Figure 6-20: Screen layout of the spectrogram result display

- 1 = Spectrum result display
- 2 = Spectrogram result display
- 3 = Frame indicator
- 4 = Time stamp / frame number
- 5 = Color map
- 6 = Marker
- 7 = Deltamarker
- 8 = Marker list

- **Spectrum Analyzer result display (1 in Figure 6-20)**  
This result display is the same as the Spectrum Analyzer with the x-axis representing the frequency span or time (span = 0) and the y-axis the power level. Configure and use this display in the same way as you would in Spectrum Analyzer mode. All traces are available and you can view those traces just like in the base unit (see Chapter 5.2.3, "Trace Modes", on page 147). The trace modes View and Blank are not available for trace 1.  
While performing a measurement the trace is updated continuously. You can also restore the trace to a point that has already been recorded by selecting a specific frame (see "Select Frame" on page 344). This is possible in Single Sweep mode or if the sweep has been stopped.
- **Spectrogram result display (2)**  
The data displayed in the Spectrogram is always based on the data of trace 1 in the Spectrum Analyzer result display. The Spectrogram can handle measurements in the frequency domain (span > 0) as well as measurements in the time domain (span = 0)  
The Spectrogram is a cartesian diagram. The x-axis shows the power distribution of a measured signal over a specified frequency or time range. Different power levels are displayed in different colors. The y-axis represents the time with the top of the diagram being the current timeframe (the measurement runs from top to bottom). Each line (or trace) of the y-axis represents one captured frame. The frames are sorted in chronological order. One frame is equal to a certain number of sweep

points, depending on the dimension of the x-axis. If there are more measurement values than measurement points, several measured values are combined in one measurement point using the selected detector (see [Chapter 6.3.1.5, "Detector Overview"](#), on page 370). Frames are sorted in chronological order, beginning with the most recently recorded frame or frame number 0 at the top of the diagram. After that and below frame 0 is the frame recorded before the current frame (frame -1) and so on until the maximum number of captured frames is reached. The maximum number of frames that you can capture is summarized in the table below (see [Table 6-7](#)). A marker in the form of an arrow (3) on the left and right border of the Spectrogram indicates the currently selected frame.

The actual number of the currently selected frame is shown below the diagram (4). If the time stamp is active, the R&S ESRP shows the time stamp instead of the frame number (see [Time Stamp \(On Off\)](#)).

Below the diagram there is also a color map (5) that shows the power levels corresponding to the displayed colors. The minimum value of the y-axis is on the left of the color map. The maximum value is on the right of the map. You can also change the color scheme in use (see [Color Mapping](#)). The colors corresponding to the power levels, however, are always assigned automatically.

Markers and deltamarkers (6) (7) take the form of diamonds in the Spectrogram. They are only displayed in the Spectrogram, if the marker position is inside the visible area of the spectrogram. If more than two markers are active, it is possible to display a [Marker Table](#) at the bottom of the display (8).

**Table 6-7: Correlation between number of sweep points and number of frames stored in the history buffer**

Sweep Points	Max. History Depth
≤1250	20000
2001	12488
4001	6247
8.001	3124
16.001	1562
32.001	781

### Markers and Marker Values

In the Spectrum Analyzer result display, the markers and their frequency and level values (1) are displayed in the marker field just like in the base unit (see [Chapter 5.4.2, "Markers"](#), on page 176). In addition to the base unit functionality, the frame number is displayed to indicate the position of the marker in time (2).

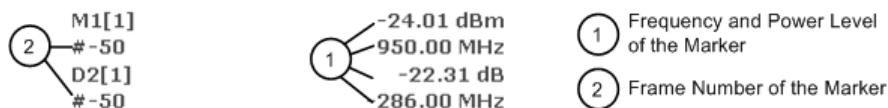

In the Spectrogram result display, you can activate up to 16 markers or deltamarkers at the same time. Any marker can be assigned to a different frame. Therefore, in addition to the frequency (1) you can set the frame number (2) when activating a new marker. If no frame number is specified, the marker is positioned on the currently selected frame.

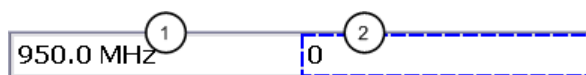

- ① Input Field for Marker Frequency
- ② Input Field for Marker Frame Number

In the Spectrogram result display all markers are visible that are positioned on a visible frame.

In the Spectrum Analyzer result display, only the markers positioned on the currently selected frame are visible. In Continuous Sweep mode this means that only markers positioned on frame 0 are visible. To view markers that are positioned on a frame other than frame 0 in the Spectrum Analyzer result display, it is necessary to stop the measurement and select the corresponding frame.

### 6.3.2.2 Softkeys of the Spectrogram Menu

#### Softkeys of the Spectrogram Menu

The following chapter describes all softkeys available in the "Spectrogram" menu. It is possible that your instrument configuration does not provide all softkeys. If a softkey is only available with a special option, model or (measurement) mode, this information is delivered in the corresponding softkey description.

To display the "Spectrogram" menu, press the [TRACE] key and then select the "Spectrogram" softkey.

Spectrogram.....	376
L Spectrogram (On Off).....	376
L History Depth.....	376
L Color Mapping.....	377
L Time Stamp (On Off).....	377
L Clear Spectrogram.....	377

#### Spectrogram

Opens the submenu for the spectrogram view.

#### Spectrogram (On Off) ← Spectrogram

Activates and deactivates the Spectrogram result display

Remote command:

`CALCulate<n>:SGRam[:STATe]` on page 826

#### History Depth ← Spectrogram

Sets the number of frames that the R&S ESRP stores in its memory. The maximum number of frames depends on the Sweep Points (see "General Information" on page 373).

If the memory is full, the R&S ESRP deletes the oldest frames stored in the memory and replaces them with the new data.

Remote command:

[CALCulate<n>:SGRam:HDEPth](#) on page 620

### **Color Mapping ← Spectrogram**

Displays the "Color Mapping" dialog box to configure the display of the spectrogram (assignment of colors to power levels).

For more information see [Chapter 5.1.6.2, "Color Map"](#), on page 128.

Remote command:

[CALCulate<n>:SGRam:COLor](#) on page 824

[DISPlay:WINDow:SGRam:COLor:LOWer](#) on page 618

[DISPlay:WINDow:SGRam:COLor:UPPer](#) on page 619

### **Time Stamp (On Off) ← Spectrogram**

Activates and deactivates the time stamp. The time stamp shows the system time while the measurement is running. In single sweep mode or if the sweep is stopped, the time stamp shows the time and date of the end of the sweep.

When active, the time stamp replaces the display of the frame number.

Remote command:

[CALCulate<n>:SGRam:TSTamp\[:STATe\]](#) on page 826

### **Clear Spectrogram ← Spectrogram**

Resets the Spectrogram result display and clears the history buffer.

Remote command:

[CALCulate<n>:SGRam:CLEar\[:IMMediate\]](#) on page 618

## **6.3.3 Markers**

### **6.3.3.1 Controlling Markers**

The markers are used for marking points on traces, reading out measurement results and for selecting a display section quickly. The R&S ESRP provides 16 markers per trace.

#### **To open the Marker menu**

- Press the MKR key.  
The "Marker" menu is displayed. If no marker is active, marker 1 is activated and a peak search on the trace is carried out. Otherwise, the edit dialog box for the last activated marker is opened and the current frequency/time value is displayed.

#### **Further information**

- ["Displayed Marker Information"](#) on page 381
- [Chapter 5.4.2.2, "Positioning Markers"](#), on page 180.

## Tasks

- ["Basic Marker Functions"](#) on page 379

## Softkeys of the Marker Menu

Functions to control markers described elsewhere:

- ["Marker 1 / Marker 2 / Marker 3 / ... Marker 16,/ Marker Norm/Delta"](#) on page 177
- ["Marker to Trace"](#) on page 178
- ["Marker Wizard"](#) on page 178
- ["All Marker Off"](#) on page 179
- ["Marker Table"](#) on page 179
- ["Marker Info \(On Off\)"](#) on page 179

## Functions to control markers exclusive in Spectrum mode

<a href="#">Marker Stepsize</a> .....	378
L <a href="#">Stepsize Standard</a> .....	378
L <a href="#">Stepsize Sweep Points</a> .....	378
<a href="#">Marker Zoom (span &gt; 0)</a> .....	379
<a href="#">Link Mkr1 and Delta1</a> .....	379

## Marker Stepsize

Opens a submenu to set the step size of all markers and delta markers.

Default value for the marker step size is [Stepsize Sweep Points](#).

### Stepsize Standard ← Marker Stepsize

Moves the marker or delta marker from one measurement point to the next, if the marker or delta marker value is changed via the rotary knob ( "Marker 1 / Marker 2 / Marker 3 / ... Marker 16,/ Marker Norm/Delta" softkeys, see ["Marker 1 / Marker 2 / Marker 3 / ... Marker 16,/ Marker Norm/Delta"](#) on page 177). If more measured values than measurement points exist, it is not possible to read out all measured values. In this case, use the [Stepsize Sweep Points](#) softkey.

Remote command:

CALC:MARK:X:SSIZ STAN (see [CALCulate<n>:MARKer<m>:X:SSIZe](#) on page 832)

### Stepsize Sweep Points ← Marker Stepsize

Moves the marker or delta marker from one measured value to the next, if the marker or delta marker value is changed via the rotary knob ( "Marker 1 / Marker 2 / Marker 3 / ... Marker 16,/ Marker Norm/Delta" softkeys, see ["Marker 1 / Marker 2 / Marker 3 / ... Marker 16,/ Marker Norm/Delta"](#) on page 177). If more measured values than measurement points exist, every single measured value is accessible and its value is displayed in the marker field.

The number of measured values is defined in the ""Sweep"" menu via the [Sweep Points](#) softkey.

This functionality is not available for statistical measurements (APD and CCDF).

Remote command:

CALC:MARK:X:SSIZ POIN (see [CALCulate<n>:MARKer<m>:X:SSIZe](#) on page 832)

### Marker Zoom (span > 0)

Opens an edit dialog box to enter a display range for the zoom. The area around marker 1 is expanded accordingly and more details of the result can be seen. If no marker is activated, marker 1 is switched on and set on the largest signal.

The following sweep is stopped at the position of the reference marker. The frequency of the signal is counted and the measured frequency becomes the new center frequency. The zoomed display range is then configured and the new settings are used by the R&S ESRP for further measurements.

If the display has not yet been switched to the new frequency display range and you press the softkey, the procedure is aborted. If an instrument setting is changed during this operation, the procedure is also aborted.

This function is not available in I/Q Analyzer mode.

Remote command:

[CALCulate<n>:MARKer<m>:FUNction:ZOOM](#) on page 657

### Link Mkr1 and Delta1

The delta marker 1 is linked to marker 1, so if the x-axis value of the marker 1 is changed, the delta marker 1 will follow on the same x-position. The link is off by default.

You can set the two markers on different traces to measure the difference (e.g. between a max hold trace and a min hold trace or between a measurement and a reference trace).

Remote command:

[CALCulate<n>:DELTAmarker<m>:LINK](#) on page 666

### Basic Marker Functions

- To open the "Marker" menu, press the [MKR] key.  
Marker 1 is activated and positioned on the maximum value of the trace as a normal marker. If several traces are displayed, the marker is set to the maximum value (peak) of the trace which has the lowest number (1 to 3) and is not frozen (View mode). In case a marker is already located there, the new marker is set to the frequency of the next lowest level (next peak).
- To change marker settings quickly, right-click on the marker in the display (or touch it for about 1 second). A context-sensitive menu is displayed which corresponds to the softkey functions available for markers.
- To configure and activate several markers at once, select the "Marker Wizard" to open a configuration dialog for all markers.
- To change to another trace, press the "Marker to Trace" softkey ("[Marker to Trace](#)" on page 178) and enter the number of the trace on which the marker is to be placed.  
The marker changes to the selected trace, but remains on the previous frequency or time. If a trace is turned off, the corresponding markers and marker functions are also deactivated.

- To switch to another marker, click on the marker label in the diagram. Alternatively, select the corresponding softkey. If necessary, select the [More Markers](#) softkey first to open a submenu that contains all marker numbers.
- To move the marker to a different position, click the marker label in the diagram and then drag it to the new position. When a marker label is selected, a vertical line is displayed which indicates the marker's current x-value.

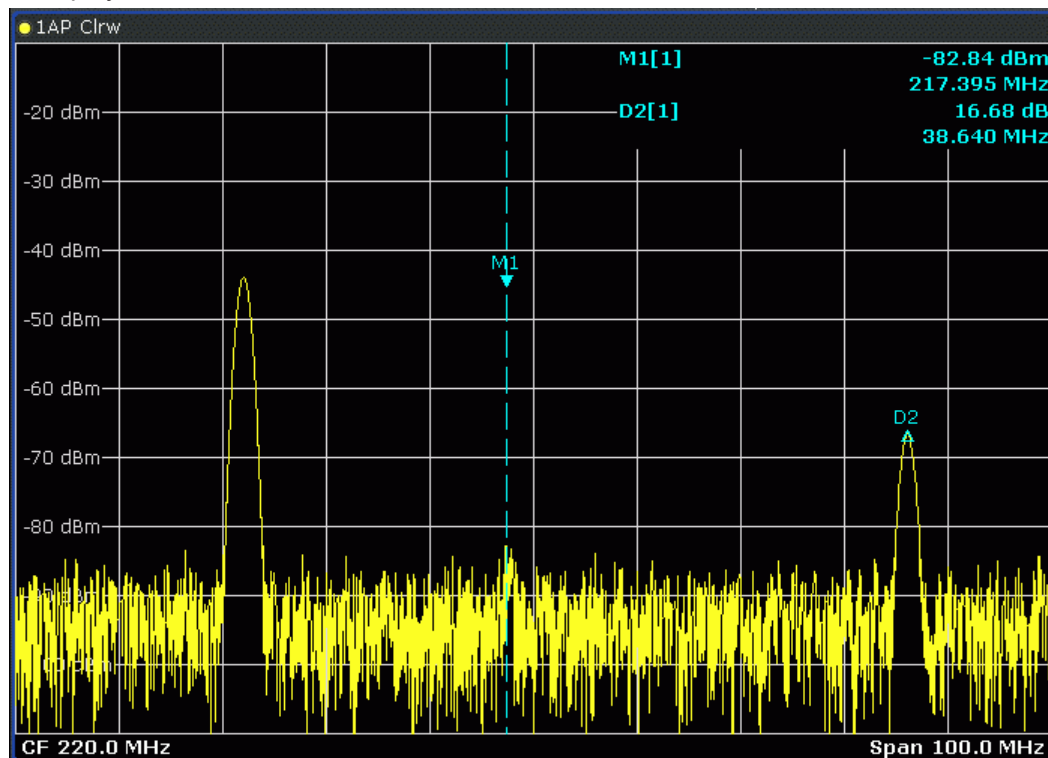

- To switch on a delta marker, select the softkey for the corresponding marker, then press the "Marker 1 / Marker 2 / Marker 3 / ... Marker 16, / Marker Norm/Delta" ("[Marker 1 / Marker 2 / Marker 3 / ... Marker 16, / Marker Norm/Delta](#)" on page 177) until "Delta" is highlighted. The selected marker is switched on as a delta marker. The frequency and level of the marker are displayed in relation to marker 1 in the marker field.
- To change the marker type of a marker, select the softkey for the corresponding marker, then press the "Marker 1 / Marker 2 / Marker 3 / ... Marker 16, / Marker Norm/Delta" softkey ("[Marker 1 / Marker 2 / Marker 3 / ... Marker 16, / Marker Norm/Delta](#)" on page 177). For a normal marker, the frequency and level are displayed as absolute values in the marker field. For a delta marker, the frequency and level of the marker are displayed in relation to marker 1 in the marker field.
- To switch off a marker, press the corresponding softkey again. The marker is deactivated. Marker 1 becomes the active marker for entry. The frequency and level of marker 1 are displayed in the marker field.
- To switch off all markers, press the [All Marker Off](#) softkey.
- To change the stepsize between one measured value and the next when the marker or delta marker value is changed via the rotary knob, press either the [Stepsize Standard](#) softkey or the [Stepsize Sweep Points](#) softkey.

- To zoom into the display around a marker, press the "[Marker Zoom \(span > 0\)](#)" on page 379 softkey and enter a span.
- To link the delta marker1 to marker1, so if the x-axis value of the marker 1 is changed, the delta marker 1 follows on the same x-position, press the [Link Mkr1 and Delta1](#) softkey.

### Displayed Marker Information

The following additional information is displayed within the diagram grid or in a marker table beneath the diagram. The marker table is displayed automatically if more than 2 markers are active. You can hide or show the table using the [Marker Table](#) softkey.

### Marker information in Diagram Grid

The x and y axis positions of the last 2 markers or delta markers that were set, as well as their index, are displayed within the diagram grid, if available. The value in the square brackets after the index indicates the trace to which the marker is assigned. (Example: M1[1] defines marker 1 on trace 1.) For more than 2 markers, a separate marker table is displayed beneath the diagram.

If applicable, the active measurement function for the marker and its main results are indicated, as well. The functions are indicated with the following abbreviations:

<b>FXD</b>	Reference fixed marker active
<b>PHNoise</b>	Phase noise measurement active
<b>CNT</b>	Frequency counter active
<b>TRK</b>	Signal track active
<b>NOIse</b>	Noise measurement active
<b>MDepth</b>	Measurement of the AM modulation depth active
<b>TOI</b>	TOI measurement active
<b>Occ BW</b>	Occupied bandwidth

### Marker Information in Marker Table

In addition to the marker information displayed within the diagram grid, a separate marker table may be displayed beneath the diagram. This table provides the following information for all active markers:

<b>No.</b>	Serial number
<b>Type</b>	Marker type: N (normal), D (delta), T (temporary, internal)
<b>Dgr</b>	Diagram number
<b>Trc</b>	Trace to which the marker is assigned
<b>Stimulus</b>	x-value of the marker
<b>Response</b>	y-value of the marker



<b>Func</b>	Activated marker or measurement function
<b>Func.Result</b>	Result of the active marker or measurement function

### 6.3.3.2 Positioning Markers (MKR→ Key)

The MKR→ key is used for search functions of measurement markers, assignment of the marker frequency as center frequency, restriction of the search area and characterization of maxima and minima. For details on markers in general, see [Chapter 6.3.3.1, "Controlling Markers"](#), on page 377.

#### To open the Marker To menu

- Press the MKR→ key.  
The "Marker To" menu is displayed. If no marker is active, marker 1 will be activated and a peak search on the trace carried out. Otherwise, the edit dialog box for the last activated marker is opened and the current frequency/time value is displayed.

#### Menu and softkey description

- ["Softkeys of the Marker To Menu"](#) on page 382

#### Further information

- ["Effect of Different Peak Excursion Settings \(Example\)"](#) on page 385

#### Tasks

- ["Searching for a Maximum"](#) on page 384
- ["Searching for a Minimum"](#) on page 384
- ["Specifying the Search Limits"](#) on page 384
- ["Specifying the Search Range"](#) on page 384
- ["Examining a Signal at the Center in Detail"](#) on page 384
- ["Specifying the Suitable Peak Excursion"](#) on page 385

#### Softkeys of the Marker To Menu

The following table shows all softkeys available in the "Marker To" menu. It is possible that your instrument configuration does not provide all softkeys. If a softkey is only available with a special option, model or (measurement) mode, this information is provided in the corresponding softkey description.

Functions to position markers described elsewhere:

- ["Select Marker \(No\)"](#) on page 181
- ["Peak"](#) on page 181
- ["Next Peak"](#) on page 181
- ["Marker to Trace"](#) on page 178
- ["Min"](#) on page 181

- "Next Min" on page 181
- "Next Mode" on page 181
- "Search Limits" on page 182
- "Peak Excursion" on page 183
- Spectrogram: [Chapter 5.4.2.3, "Markers in Spectrograms"](#), on page 183

#### Functions to position markers exclusive in Spectrum mode

<a href="#">Center =Mkr Freq (span &gt; 0)</a> .....	383
<a href="#">Ref Lvl =Mkr Lvl</a> .....	383
<a href="#">Auto Max Peak/Auto Min Peak</a> .....	383
<a href="#">Exclude LO</a> .....	383

#### Center =Mkr Freq (span > 0)

Sets the center frequency to the current marker or delta marker frequency. A signal can thus be set to as center frequency, for example to examine it in detail with a smaller span.

Remote command:

[CALCulate<n>:MARKer<m>:FUNCTION:CENTer](#) on page 656

#### Ref Lvl =Mkr Lvl

Sets the reference level to the current marker level.

Remote command:

[CALCulate<n>:MARKer<m>:FUNCTION:REFerence](#) on page 830

#### Auto Max Peak/Auto Min Peak

Adds an automatic peak search action for marker 1 at the end of each particular sweep. This function may be used during adjustments of a device under test to keep track of the current peak marker position and level.

The current marker search limit settings ([Left Limit](#), [Right Limit](#), [Threshold](#) softkeys) are taken into account.

Remote command:

[CALCulate<n>:MARKer<m>:MAXimum:AUTO](#) on page 831

[CALCulate<n>:MARKer<m>:MINimum:AUTO](#) on page 831

#### Exclude LO

Switches the frequency range limit for the marker search functions on or off.

"ON"                    The minimum frequency included in the peak search range is  $\geq 5 \times$  resolution bandwidth (RBW).  
Due to the interference by the first local oscillator to the first intermediate frequency at the input mixer, the LO is represented as a signal at 0 Hz. To avoid the peak marker jumping to the LO signal at 0 Hz, this frequency is excluded from the peak search.

"OFF"                    No restriction to the search range. The frequency 0 Hz is included in the marker search functions.

Remote command:

[CALCulate<n>:MARKer<m>:LOEXclude](#) on page 831

### Searching for a Maximum

- To search for the highest maximum, press the **Peak** softkey.
- To define the search mode for the next maximum, use the **Next Mode** softkey.
- To start the search, press the **Next Peak** softkey.



You can define an automatic peak search action for marker 1 at the end of each particular sweep using the **Auto Max Peak/Auto Min Peak** softkey.

### Searching for a Minimum

- To search for the minimum, press the **Min** softkey.
- To define the search mode for the next minimum, use the **Next Mode** softkey.
- To start the search, press the **Next Min** softkey.



You can define an automatic peak search action for marker 1 at the end of each particular sweep using the **Auto Max Peak/Auto Min Peak** softkey.

### Specifying the Search Limits

- To define the lower limit, press the **Left Limit** softkey.
- To define the upper limit, press the **Right Limit** softkey.
- To define the threshold, press the **Threshold** softkey.
- To switch the search limits off, press the **Search Lim Off** softkey.

### Specifying the Search Range

- Press the **Exclude LO** softkey to deactivate the "Exclude LO" mode in order to include the frequency down to 0 Hz in the marker search functions.

### Examining a Signal at the Center in Detail

1. Press the [PRESET] key to set the R&S ESRP to the default setting.
2. Press the [MKR ->] key to open the "Marker To" menu.
3. Marker 1 is activated and set to the largest signal of the trace.
4. Press the **Center =Mkr Freq (span > 0)** softkey to set to the marker frequency.
5. The span is adapted in such a way that the minimum frequency (= 0 Hz) or the maximum frequency is not exceeded.
6. Press the **Ref Lvl =Mkr Lvl** softkey to set the reference level to the measured marker level.
7. Press the SPAN key.
8. The edit dialog box to enter a frequency span is displayed.

9. Reduce the span, e.g. using the rotary knob.

**Specifying the Suitable Peak Excursion**

1. If the **Peak Excursion** softkey is used, the default value is sufficient, since, in this mode, the next lower maximum or next higher minimum will always be detected.
2. If the < or > of the softkey **Next Mode** is used, the 6 dB level change set as a default value may already be attained by the inherent noise of the instrument. To avoid identifying noise peaks as maxima or minima, enter a peak excursion value that is higher than the difference between the highest and the lowest value measured for the displayed inherent noise.

**Effect of Different Peak Excursion Settings (Example)**

The following figure shows a trace to be examined.

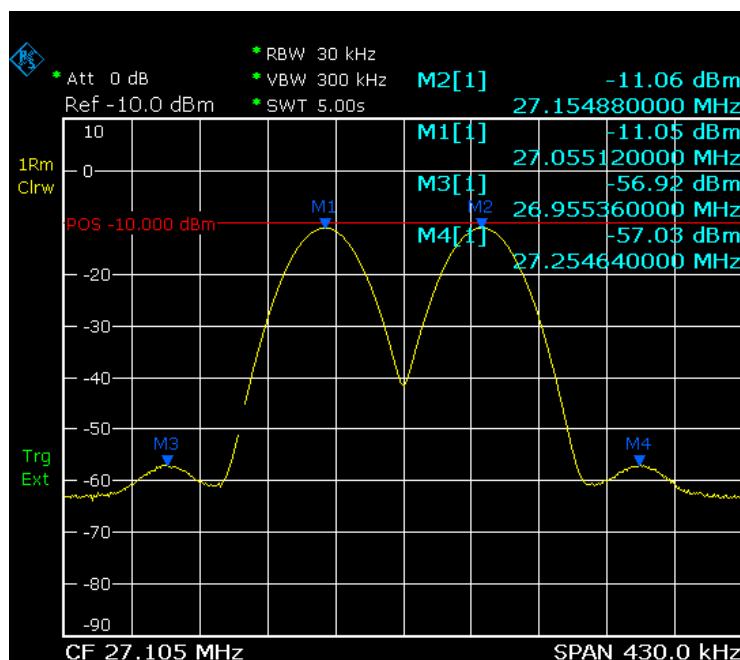

Figure 6-21: Trace example

The following table lists the signals as indicated by the marker numbers in the diagram above, as well as the minimum of the amplitude decrease to both sides of the signal:

Signal #	Min. amplitude decrease to both sides of the signal
1	30 dB
2	29.85 dB
3	7 dB
4	7 dB

The detected signals and their order are different depending on the peak excursion setting and the peak search method (whether the next lower maximum or the next relative maximum is searched). The following results are obtained. All tests start with the marker set to signal 1 by pressing the **Peak** softkey.

- 40 dB peak excursion  
Result: With both methods apart from signal 1 no signal is detected, as the signal level does not decrease by more than 30 dB to either side of any signal.

Next lower maximum	Next relative maximum
Next Mode abs: signal 1 (no further signal detected)	Next Mode <: signal 1 (no further signal detected)
	Next Mode >: signal 1 (no further signal detected)

- 20 dB peak excursion  
Result: With both methods apart from signal 1 signal 2 is detected, as the signal level decreases at least by 29.85 dB to either side of this signal, which is now greater than the peak excursion.

Next lower maximum	Next relative maximum
Next Mode abs: signal 2	Next Mode <: signal 1 (no further signal detected)
Next Mode abs: signal 2 (no further signal detected)	Next Mode >: signal 2
	Next Mode >: signal 2 (no further signal detected)

- 6 dB peak excursion  
Result: With both methods all signals are detected.

Next lower maximum	Next relative maximum
Next Mode abs: signal 2	Next Mode <: signal 3
Next Mode abs: signal 3	Next Mode >: signal 1
Next Mode abs: signal 4	Next Mode >: signal 2
	Next Mode >: signal 4

### 6.3.3.3 Performing Peak Searches with Markers – PEAK SEARCH Key

The PEAK SEARCH key is used to perform a peak search with the currently active marker. If no marker is active, marker 1 is activated in normal mode and set as the peak.

If the selected diagram does not support markers, this key is ignored.

### 6.3.3.4 Measuring with Markers (MKR FUNC Key)

The [MKR FUNC] key provides various functions for markers, e.g.

- Phase Noise measurements
- Setting reference points
- Marker demodulation
- Defining Marker peak lists
- Signal counts
- Measuring the power for a band around the marker

#### To open the marker function menu

- Press the [MKR FUNC] key.  
The "Mkr Func" (marker function) menu is displayed.

#### Menu and softkey description

- ["Softkeys of the Marker Function Menu"](#) on page 387

#### Further information

- ["AF Demodulation"](#) on page 396
- ["Frequency Measurement with the Frequency Counter"](#) on page 397
- ["Measurement of Noise Density"](#) on page 397
- ["Measurement example for Phase Noise Auto Peak Search"](#) on page 399

#### Tasks

- ["Setting a Fixed Reference Point \(Phase Noise Measurement\)"](#) on page 396
- ["Setting the Demodulation Mode and Duration"](#) on page 396
- ["Performing Band Power Measurements"](#) on page 399

#### Softkeys of the Marker Function Menu

The following table shows all softkeys available in the marker function menu. It is possible that your instrument configuration does not provide all softkeys. If a softkey is only available with a special option, model or (measurement) mode, this information is provided in the corresponding softkey description.

Select Marker (No).....	388
Signal Count.....	388
Noise Meas On/Off.....	389
Phase Noise.....	389
L Phase Noise On/Off.....	389
L Ref Point Level.....	389
L Ref Point Frequency (span > 0)/Ref Point Time (zero span).....	389
L Peak Search.....	389
L Ph. Noise Auto Peak Search.....	390
L Select Marker (No).....	390
Ref Fixed.....	390

L Ref. Fixed On/Off.....	390
L Ref Point Level.....	390
L Ref Point Frequency (span > 0)/Ref Point Time (zero span).....	390
L Peak Search.....	391
Marker Demod.....	391
L Mkr Demod On/Off.....	391
L AM.....	391
L FM.....	391
L Mkr Stop Time.....	391
L Continuous Demod (span > 0).....	391
L Squelch.....	392
L Squelch Level.....	392
n dB down.....	392
Marker Peak List.....	393
L Peak List On/Off.....	393
L Sort Mode Freq/Lvl.....	393
L Max Peak Count.....	393
L Peak Excursion.....	394
L Left Limit.....	394
L Right Limit.....	394
L Threshold.....	394
L ASCII File Export.....	394
L Decim Sep.....	395
L Marker Number.....	395
Band Power.....	395
L Select Marker (No).....	395
L Band Power On/Off.....	395
L Span.....	395
L Power.....	395
L Density.....	396

### Select Marker (No)

Opens a submenu to select one of 16 markers and define whether the marker is a normal or a delta marker (see "[Marker 1 / Marker 2 / Marker 3 / ... Marker 16, / Marker Norm/Delta](#)" on page 177). "(No)" indicates the number of the currently active marker.

See "[Marker 1 / Marker 2 / Marker 3 / ... Marker 16, / Marker Norm/Delta](#)" on page 177.

### Signal Count

Switches the frequency counter on or off, and opens an edit dialog box to define the resolution of the frequency counter, if enabled. The frequency is counted at the position of the reference marker (marker 1). If no marker is activate, marker 1 is switched on and positioned on the largest signal.

The sweep stops at the reference marker until the frequency counter has delivered a result. The result is displayed in the marker field (see [Figure 5-9](#)), labeled with [Tx CNT].

For more information see "[Frequency Measurement with the Frequency Counter](#)" on page 397.

Remote command:

`CALCulate<n>:MARKer<m>:COUNT` on page 838

`CALCulate<n>:MARKer<m>:COUNT:FREQuency?` on page 838

### Noise Meas On/Off

Switches the noise measurement for the active marker on or off. The corresponding marker becomes the normal marker.

For more information on noise measurement see "[Measurement of Noise Density](#)" on page 397.

Remote command:

`CALCulate<n>:MARKer<m>:FUNCTion:NOISe[:STATe]` on page 840

`CALCulate<n>:MARKer<m>:FUNCTion:NOISe:RESult` on page 839

### Phase Noise

This softkey opens a submenu that contains functionality to configure and perform phase noise measurements.

#### Phase Noise On/Off ← Phase Noise

Switches the phase noise measurement with all active delta markers on and off. The correction values for the bandwidth and the log amplifier are taken into account in the measurement.

Marker 1 is activated, if necessary, and a peak search is performed. If marker 1 is activated, its position becomes the reference point for the measurement.

Deltamarker 2 is activated and can be used to read out the phase noise value at a given frequency offset.

Remote command:

`CALCulate<n>:DELTamarker<m>:FUNCTion:PNOise[:STATe]` on page 841

`CALCulate<n>:DELTamarker<m>:FUNCTion:PNOise:RESult?` on page 841

#### Ref Point Level ← Phase Noise

Opens an edit dialog box to enter a reference level value. All relative level values of the delta markers refer to this reference level.

Remote command:

`CALCulate<n>:DELTamarker<m>:FUNCTion:FIXed:RPOINT:Y` on page 836

#### Ref Point Frequency (span > 0)/Ref Point Time (zero span) ← Phase Noise

Opens an edit dialog box to enter a frequency reference or time value. All relative frequency or time values of the delta markers refer to this frequency reference. For phase noise measurement, input of reference time is not possible.

Remote command:

`CALCulate<n>:DELTamarker<m>:FUNCTion:FIXed:RPOINT:X` on page 836

#### Peak Search ← Phase Noise

Sets the maximum value of the selected trace as the reference point.

Remote command:

`CALCulate<n>:DELTamarker<m>:FUNCTion:FIXed:RPOINT:MAXimum[:PEAK]`  
on page 835



**Ph. Noise Auto Peak Search ← Phase Noise**

Activates an automatic peak search for the reference fixed marker 1 at the end of each particular sweep.

This function can be used to track a drifting source during a phase noise measurement. The delta marker 2, which shows the phase noise measurement result, keeps the delta frequency value. Therefore the phase noise measurement leads to reliable results in a certain offset although the source is drifting. Only if the marker 2 reaches the border of the span, the delta marker value is adjusted to be within the span. In these cases, select a larger span.

Remote command:

`CALCulate<n>:DELTAmarker<m>:FUNCTION:PNOise:AUTO` on page 840

**Select Marker (No) ← Phase Noise**

Opens a submenu to select one of 16 markers and define whether the marker is a normal or a delta marker (see "[Marker 1 / Marker 2 / Marker 3 / ... Marker 16 / Marker Norm/Delta](#)" on page 177). "(No)" indicates the number of the currently active marker.

See "[Marker 1 / Marker 2 / Marker 3 / ... Marker 16 / Marker Norm/Delta](#)" on page 177.

**Ref Fixed**

Opens a submenu to set all values of a reference point. Instead of using the current values of the reference marker (marker 1) as reference point for the delta markers, level and frequency or time are set to fixed values and used as reference point.

**Ref. Fixed On/Off ← Ref Fixed**

Switches the relative measurement to a fixed reference value on or off. The level and frequency or time values of marker 1 immediately become the reference point, but can be altered using the corresponding softkeys ("[Ref Point Level](#)" on page 389, "[Ref Point Frequency \(span > 0\)/Ref Point Time \(zero span\)](#)" on page 389 and "[Peak Search](#)" on page 389).

When set to ON, all delta markers which previously referenced marker 1 are automatically set to reference the fixed marker.

The reference marker assignment can be changed using the "Marker Wizard" (see "[Marker Wizard](#)" on page 178).

Remote command:

`CALCulate<n>:DELTAmarker<m>:FUNCTION:FIXed[:STATe]` on page 837

**Ref Point Level ← Ref Fixed**

Opens an edit dialog box to enter a reference level value. All relative level values of the delta markers refer to this reference level.

Remote command:

`CALCulate<n>:DELTAmarker<m>:FUNCTION:FIXed:RPoint:Y` on page 836

**Ref Point Frequency (span > 0)/Ref Point Time (zero span) ← Ref Fixed**

Opens an edit dialog box to enter a frequency reference or time value. All relative frequency or time values of the delta markers refer to this frequency reference. For phase noise measurement, input of reference time is not possible.

Remote command:

`CALCulate<n>:DELTaMarker<m>:FUNction:FIXed:RPOint:X` on page 836

#### **Peak Search ← Ref Fixed**

Sets the maximum value of the selected trace as the reference point.

Remote command:

`CALCulate<n>:DELTaMarker<m>:FUNction:FIXed:RPOint:MAXimum[:PEAK]`  
on page 835

#### **Marker Demod**

The marker demodulation function sends the AM data at the current marker frequency (in a bandwidth corresponding to the RBW) to the audio output. The "Marker Demod" softkey opens a submenu to set the demodulation output settings.

For more information see "[AF Demodulation](#)" on page 396.

Marker demodulation is not available for Spectrum Emission Mask measurements.

#### **Mkr Demod On/Off ← Marker Demod**

Switches the demodulation output on or off.

For more information see "[AF Demodulation](#)" on page 396.

Remote command:

`CALCulate<n>:MARKer<m>:FUNction:DEModulation[:STATe]` on page 843

#### **AM ← Marker Demod**

Sets AM as the output demodulation mode. This is the default setting.

For more information see "[AF Demodulation](#)" on page 396.

Remote command:

`CALC:MARK1:FUNC:DEM:SEL AM`, see `CALCulate<n>:MARKer<m>:FUNction:DEModulation:SElect` on page 843

#### **FM ← Marker Demod**

Sets FM as the output demodulation mode. Default setting is AM.

For more information see "[AF Demodulation](#)" on page 396.

Remote command:

`CALC:MARK1:FUNC:DEM:SEL FM`, see `CALCulate<n>:MARKer<m>:FUNction:DEModulation:SElect` on page 843

#### **Mkr Stop Time ← Marker Demod**

Opens an edit dialog box to define how long demodulation should be output for span > 0.

For more information see "[AF Demodulation](#)" on page 396.

Remote command:

`CALCulate<n>:MARKer<m>:FUNction:DEModulation:HOLDoFF` on page 842

#### **Continuous Demod (span > 0) ← Marker Demod**

Switches the continuous demodulation on or off. If the sweep time is long enough, the set frequency range can be monitored acoustically.

For more information see "AF Demodulation" on page 396.

Remote command:

`CALCulate<n>:MARKer<m>:FUNCTION:DEModulation:CONTinuous`  
on page 842

#### Squelch ← Marker Demod

Activates the squelch function, i.e. the audible AF is cut off below a defined threshold level. Thus, you avoid hearing noise at the audio output when no signal is available.

The squelch function activates the video trigger function (see "Video" on page 347) and deactivates any other trigger or gating settings. The squelch level and trigger level are set to the same value.

The trigger source in the channel information bar is indicated as "SQL" for squelch. The squelch level is indicated by a red line in the diagram.

Remote command:

`[SENSe:]DEMod:SQUelch[:STATe]` on page 617

#### Squelch Level ← Marker Demod

Defines the level threshold below which the audible AF is cut off if squelching is enabled. The video trigger level is set to the same value.

The squelch level is indicated by a red line in the diagram.

Remote command:

`[SENSe:]DEMod:SQUelch:LEVel` on page 617

#### n dB down

Opens an edit dialog box to enter a value to define the level spacing of the two temporary markers to the right and left of marker 1 (default setting: 3 dB). Activates the temporary markers T1 and T2. The values of the temporary markers (T1, T2) and the entered value (ndB) are displayed in the marker field.

If a positive value is entered, the markers T1 and T2 are placed below the active reference marker. If a negative value (e.g. for notch filter measurements) is entered, the markers T1 and T2 are placed above the active reference marker. Marker T1 is placed to the left and marker T2 to the right of the reference marker.

In the marker table, the following results are displayed:

Span setting	Parameter name	Description
span > 0	Bw	frequency spacing of the two temporary markers
	Q factor	quality of the displayed bandwidth value (Bw)
span = 0	PWid	pulse width between the two temporary markers

If it is not possible to form the frequency spacing for the n dB value (e.g. because of noise display), dashes instead of a measured value are displayed.

**Remote command:**

CALC:MARK1:FUNC:NDBD:STAT ON, see [CALCulate<n>:MARKer<m>:FUNCTION:NDBDown:STATe](#) on page 846

CALC:MARK1:FUNC:NDBD 3dB, see [CALCulate<n>:MARKer<m>:FUNCTION:NDBDown](#) on page 844

CALC:MARK1:FUNC:NDBD:RES? , see [CALCulate<n>:MARKer<m>:FUNCTION:NDBDown:RESult?](#) on page 845

CALC:MARK:FUNC:NDBD:QFAC?, see [CALCulate<n>:MARKer<m>:FUNCTION:NDBDown:QFACTOR](#) on page 845

CALC:MARK1:FUNC:NDBD:FREQ? (span > 0), see [CALCulate<n>:MARKer<m>:FUNCTION:NDBDown:FREQuency?](#) on page 844

CALC:MARK1:FUNC:NDBD:TIME? (span = 0), see [CALCulate<n>:MARKer<m>:FUNCTION:NDBDown:TIME?](#) on page 846

**Marker Peak List**

Opens the "Peak List" submenu to define criteria for the sort order and the contents of the peak list. For each listed peak the frequency ("Stimulus") and level ("Response") values are given. In addition, the peaks are indicated in the trace display. A maximum of 50 entries are listed.

**Remote command:**

[CALCulate<n>:MARKer<m>:FUNCTION:FPEaks:COUNT?](#) on page 848

[CALCulate<n>:MARKer<m>:FUNCTION:FPEaks:X](#) on page 850

[CALCulate<n>:MARKer<m>:FUNCTION:FPEaks:Y?](#) on page 851

**Peak List On/Off ← Marker Peak List**

Activates/deactivates the marker peak list. If activated, the peak list is displayed and the peaks are indicated in the trace display.

**Remote command:**

[CALCulate<n>:MARKer<m>:FUNCTION:FPEaks:STAT](#) on page 850

**Sort Mode Freq/Lvl ← Marker Peak List**

Defines the criteria for sorting:

"Freq"                    sorting in ascending order of frequency values (span > 0) or time values (span = 0)

"Lvl"                     sorting in ascending order of the level

**Remote command:**

[CALCulate<n>:MARKer<m>:FUNCTION:FPEaks:SORT](#) on page 850

**Max Peak Count ← Marker Peak List**

Defines the maximum number of peaks to be determined and displayed.

**Remote command:**

[CALCulate<n>:MARKer<m>:FUNCTION:FPEaks:LIST:SIZE](#) on page 849

**Peak Excursion ← Marker Peak List**

Opens an edit dialog box for level measurements to enter the minimum level value by which a signal must rise or fall so that it will be identified as a maximum or a minimum by the search functions. Entries from 0 dB to 80 dB are allowed; the resolution is 0.1 dB. The default setting for the peak excursion is 6 dB.

Remote command:

[CALCulate<n>:MARKer<m>:PEXCursion](#) on page 647

**Left Limit ← Marker Peak List**

Opens an edit dialog box to enter a value for the lower limit (left vertical line: S1 for span > 0; T1 for zero span). The search is performed between the lines of the left and right limit (see also [Right Limit](#) softkey).

Remote command:

[CALCulate<n>:MARKer<m>:X:SLIMits:LEFT](#) on page 658

**Right Limit ← Marker Peak List**

Opens an edit dialog box to enter a value for the upper limit (left vertical line: S2 for span > 0; T2 for zero span). The search is performed between the lines of the left and right limit (see also [Left Limit](#) softkey). If no value is set, the upper limit corresponds to the stop frequency.

Remote command:

[CALCulate<n>:MARKer<m>:X:SLIMits:RIGHT](#) on page 658

**Threshold ← Marker Peak List**

Opens an edit dialog box to define the threshold line. The threshold line represents the lower level limit for a "Peak" search and the upper level limit for a "Min" search.

Remote command:

[CALCulate<n>:THReshold:STATe](#) on page 833

[CALCulate<n>:THReshold](#) on page 833

**ASCII File Export ← Marker Peak List**

Opens the "ASCII File Export Name" dialog box and saves the active peak list in ASCII format to the specified file and directory.

The file consists of the header containing important scaling parameters and a data section containing the marker data. For details on an ASCII file see [Chapter 6.3.1.6, "ASCII File Export Format"](#), on page 370.

This format can be processed by spreadsheet calculation programs, e.g. MS-Excel. It is necessary to define ';' as a separator for the data import. Different language versions of evaluation programs may require a different handling of the decimal point. It is therefore possible to select between separators '.' (decimal point) and ',' (comma) using the "Decim Sep" softkey (see ["Decim Sep"](#) on page 176).

An example of an output file for Spectrum Emission Mask measurements is given in ["ASCII File Export Format \(Spectrum Emission Mask\)"](#) on page 256.

Remote command:

[FORMat:DEXPort:DSEPARATOR](#) on page 818

[MMEMory:STORe<n>:LIST](#) on page 745

**Decim Sep ← Marker Peak List**

Selects the decimal separator with floating-point numerals for the ASCII Trace export to support evaluation programs (e.g. MS-Excel) in different languages. The values '.' (decimal point) and ',' (comma) can be set.

Remote command:

`FORMat:DEXPort:DSEParator` on page 818

**Marker Number ← Marker Peak List**

If enabled, the determined peaks are indicated by their corresponding marker number in the trace display.

Remote command:

`CALCulate<n>:MARKer<m>:FUNCTion:FPEaks:ANNotation:LABEL:STATE` on page 847

**Band Power**

Opens a submenu to activate and configure a band power marker. Band power markers allow you to measure the integrated power for a defined span (band) around a marker. The result can be displayed either as a power (dBm) or density (dBm/Hz). The span is indicated by lines in the diagram.

Band power markers are only available for standard frequency measurements in Spectrum mode.

**Note:** Band Power markers are also available in the I/Q Analyzer, but only for **Spectrum** displays (see "[Display Config](#)" on page 431).

For more information see "[Performing Band Power Measurements](#)" on page 399.

**Select Marker (No) ← Band Power**

Opens a submenu to select one of 16 markers and define whether the marker is a normal or a delta marker (see "[Marker 1 / Marker 2 / Marker 3 / ... Marker 16, / Marker Norm/Delta](#)" on page 177). "(No)" indicates the number of the currently active marker.

See "[Marker 1 / Marker 2 / Marker 3 / ... Marker 16, / Marker Norm/Delta](#)" on page 177.

**Band Power On/Off ← Band Power**

Activates or deactivates the band power marker. When switched to on, if no marker is active yet, marker 1 is activated. Otherwise, the currently active marker is used as a band power marker (all other marker functions for this marker are deactivated). All markers can be defined as band power markers, each with a different span.

Remote command:

`CALCulate<n>:MARKer<m>:FUNCTion:BPOWer[:STATE]` on page 853

**Span ← Band Power**

Defines the span (band) around the marker for which the power is measured. The span is indicated by lines in the diagram.

Remote command:

`CALCulate<n>:MARKer<m>:FUNCTion:BPOWer:SPAN` on page 853

**Power ← Band Power**

Selects the power mode for the band power marker, i.e. the result is displayed in dBm.

Remote command:

`CALCulate<n>:MARKer<m>:FUNCTION:BPOWer:MODE` on page 852

`CALCulate<n>:MARKer<m>:FUNCTION:BPOWer:RESult?` on page 852

### Density ← Band Power

Selects the density mode for the band power marker, i.e. the result is displayed in dBm/Hz.

Remote command:

`CALCulate<n>:MARKer<m>:FUNCTION:BPOWer:MODE` on page 852

`CALCulate<n>:MARKer<m>:FUNCTION:BPOWer:RESult?` on page 852

### Setting a Fixed Reference Point (Phase Noise Measurement)

1. Press the **Phase Noise** softkey.

The submenu with the **Phase Noise On/Off** softkey switched on is displayed. The level and frequency or time values of marker 1 immediately become the reference point.

2. Setting the maximum of the selected trace as reference point, press the **Peak Search** softkey.
3. To define the values for the reference point, proceed as follows:
  - a) Press the **Ref Fixed** softkey.
  - b) Press the **Ref Point Level** softkey and enter a reference level value.
  - c) If span > 0, press the **Ref Point Frequency (span > 0)/Ref Point Time (zero span)** softkey and enter a frequency reference value.
  - d) If span = 0, press the "Ref Point Time" softkey and enter a reference time value (see "**Ref Point Frequency (span > 0)/Ref Point Time (zero span)**" on page 389).

### Setting the Demodulation Mode and Duration

1. Press the **Marker Demod** softkey.  
The submenu with the **Mkr Demod On/Off** softkey switched on is displayed.
2. To change the demodulation mode, press the **AM** or **FM** softkey.
3. For details see "**AF Demodulation**" on page 396.
4. To modify the demodulation time for span > 0, press the **Mkr Stop Time** softkey.
5. To change to continuous demodulation for span > 0, press the **Continuous Demod (span > 0)** softkey.

### AF Demodulation

The R&S ESRP provides demodulators for AM and FM signals. With these demodulators, a displayed signal can be identified acoustically by using headphones.

**⚠ CAUTION****Risk of hearing damage**

To protect your hearing, make sure that the volume setting is not too high before putting on the headphones.

The volume for the headphones is controlled using the rotary knob next to the "AF Output" interface on the front panel of the instrument.

For span > 0, the demodulation is not continuous. The frequency at which the demodulation takes place is determined by the active marker. The demodulation bandwidth corresponds to the RBW. If the level of the selected frequency is above the threshold line, the sweep stops for the selected time (stop time) and the RF signal is demodulated. For span = 0, the demodulation is continuously active irrespective of the stop time set.

**Frequency Measurement with the Frequency Counter**

In order to accurately determine the frequency of a signal, the R&S ESRP is equipped with a frequency counter which measures the frequency of the RF signal at the intermediate frequency. Using the measured IF, the R&S ESRP calculates the frequency of the RF input signal by applying the known frequency conversion factors.

The frequency measurement uncertainty depends only upon the accuracy of the frequency reference used (external or internal reference). Although the R&S ESRP always operates synchronously irrespective of the set span, the frequency counter delivers a more exact result than a measurement performed with a marker. This is due to the following:

- The marker measures only the position of the point on the trace and infers from this value the signal frequency. The trace, however, contains only a limited number of points. Depending upon the selected span, each point may contain many measurement values, which therefore limits the frequency resolution.
- The resolution with which the frequency can be measured with a marker is dependent on the selected resolution bandwidth, which in return affects the necessary measurement time. For this reason, the bandwidth is normally defined as wide as possible and the sweep time as short as possible. This results in a loss of frequency resolution. For the measurement with the frequency counter, the sweep is stopped at the reference marker, the frequency is counted with the desired resolution and then the sweep is allowed to continue.  
In I/Q Analyzer mode (see [Chapter 7, "I/Q Analyzer"](#), on page 429), the resolution with which the frequency can be measured with a marker is always the filter bandwidth, which is derived from the defined sample rate.

**Measurement of Noise Density**

During noise measurement, the noise power density is measured at the position of the marker. For span = 0, all points of the trace are used to determine the noise power density. For span > 0, two points to the right and left of the marker are used for the measurement to obtain a stable result.



The noise power density is indicated in the marker field. With logarithmic amplitude units (dBm, dBmV, dBm $\mu$ V, dB $\mu$ A), the noise power density is output in dBm/Hz, i.e. as level in 1 Hz bandwidth with reference to 1 mW. With linear amplitude units (V, A, W), the noise voltage density is evaluated in  $\mu$ V/Hz, the noise current density in  $\mu$ A/Hz or the noise power density in  $\mu$ W/Hz.

In the default setting, the R&S ESRP uses the sample detector for the noise function.

With the sample detector, the trace can additionally be set to AVERAGE to stabilize the measured values. With RMS detector used, trace averaging must not be used since in this case it produces too low noise levels which cannot be corrected. Instead, the sweep time can be increased to obtain stable measurement results.

### Prerequisite settings

The following settings have to be made to ensure that the power density measurement yields correct values:

- Detector: Sample or RMS
- Video bandwidth:
  - $\leq 0.1$  resolution bandwidth with sample detector
  - $\geq 3 \times$  resolution bandwidth with RMS detector
- Trace averaging:

With the sample detector, the trace can additionally be set to average to stabilize the measured values. With RMS detector used, trace averaging must not be used since in this case it produces too low noise levels which cannot be corrected. Instead, the sweep time can be increased to obtain stable measurement results.

### Correction factors

The R&S ESRP uses the following correction factors to evaluate the noise density from the marker level:

- Since the noise power is indicated with reference to 1 Hz bandwidth, the bandwidth correction value is deducted from the marker level. It is  $10 \times \lg(1 \text{ Hz}/\text{BWNoise})$ , where BWNoise is the noise or power bandwidth of the set resolution filter (RBW).
- RMS detector: With the exception of bandwidth correction, no further corrections are required since this detector already indicates the power with every point of the trace.
- Sample detector: As a result of video filter averaging and trace averaging, 1.05 dB is added to the marker level. This is the difference between the average value and the RMS value of white noise. With a logarithmic level axis, 1.45 dB is added additionally. Logarithmic averaging is thus fully taken into account which yields a value that is 1.45 dB lower than that of linear averaging.
- To allow a more stable noise display the adjacent (symmetric to the measurement frequency) points of the trace are averaged.
- For span  $> 0$ , the measured values are averaged versus time (after a sweep).



The R&S ESRP noise figure can be calculated from the measured power density level. It is calculated by deducting the set RF attenuation (RF Att) from the displayed noise level and adding 174 to the result.

### Measurement example for Phase Noise Auto Peak Search

The phase noise of a CW signal at 100 MHz with 0 dBm level is to be measured at 800 kHz from the carrier.

1. [PRESET]  
The R&S FSP is set to the default setting.
2. [FREQ] > "CENTER": 100 MHz  
The center frequency is set to 100 MHz.
3. [SPAN]: 2 MHz  
The span is set to 2 MHz.
4. [AMPT]: 0 dBm  
The reference level is set to 0 dBm.
5. [MKR FCTN] > "MARKER 1"  
Marker 1 is switched on and positioned at the maximum of the displayed trace.
6. "PHASE NOISE": 800 kHz  
The phase noise measurement is switched on. The delta marker is positioned on the main marker and the measured phase noise value is displayed in the marker info field. The sample detector is used and the video bandwidth is set to  $3 \times \text{RBW}$ . When the phase noise measurement function is enabled, the entry of the delta marker frequency is activated. It can be entered directly.

### Performing Band Power Measurements

Band power markers allow you to measure the integrated power (similar to ACP measurements) for a defined span (band) around a marker. By default, 5 % of the current span is used. The span is indicated by colored lines in the diagram. The result can be displayed either as a power (dBm) or density (dBm/Hz).



Band power markers are only available for standard frequency measurements in Spectrum mode (not zero span, I/Q Analyzer etc.).

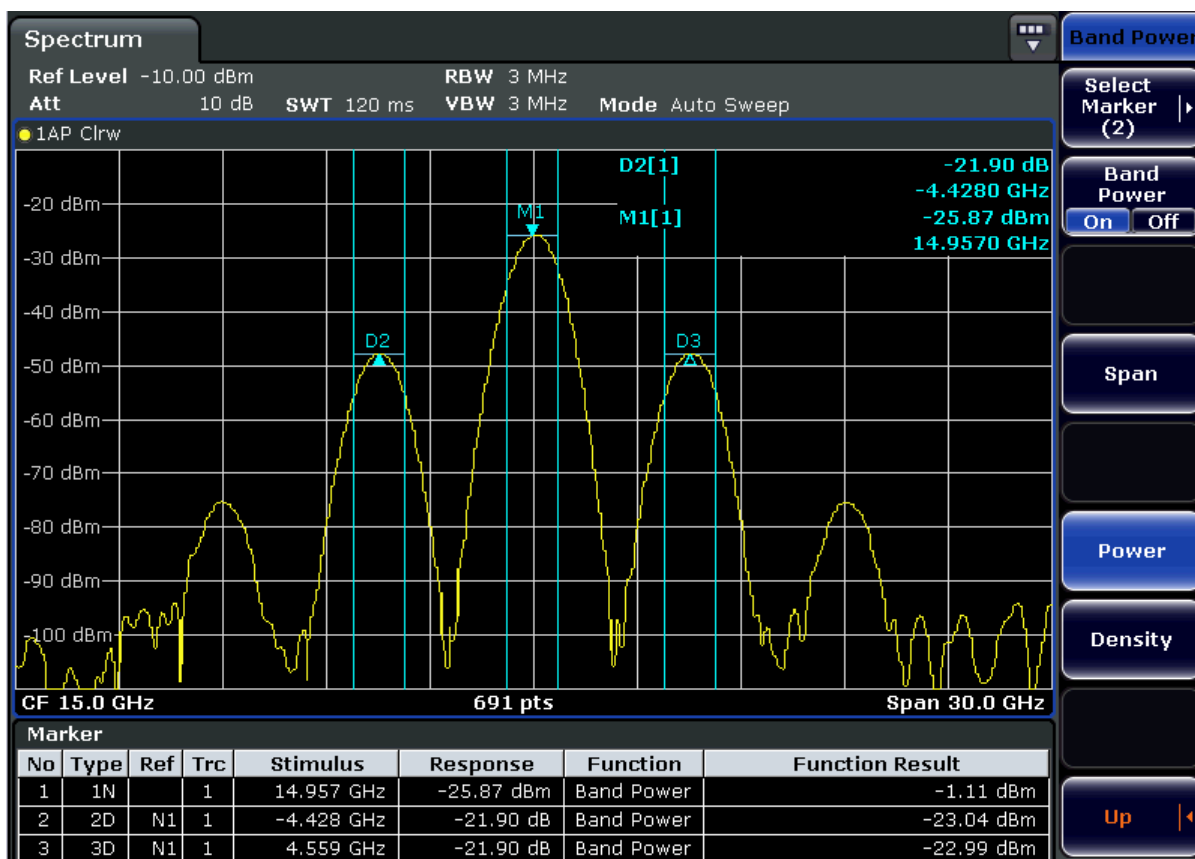

All markers can be defined as band power markers, each with a different span. When a band power marker is activated, if no marker is active yet, marker 1 is activated. Otherwise, the currently active marker is used as a band power marker (all other marker functions for this marker are deactivated).

If the detector mode for the marker trace is set to "AutoSelect", the RMS detector is used.

1. In the [MKR FUNC] menu, press "Band Power".
2. In the "Band Power" menu, press "Span" and enter the width of the band around the marker for which the power is to be measured.
3. To display the measurement result in dBm/Hz, press "Density". By default, the result is displayed as a power in dBm.
4. Press "Band Power On" to activate the band power marker.

The measurement results are displayed as usual in the marker table or in the diagram.

### 6.3.4 Lines

The [LINES] key is used to configure limit and display lines.

**To open the Lines menu**

- Press the [LINES] key.

The "Lines" menu and the "Select Limit Line" dialog box are displayed. For details on the "Select Limit Line" dialog box refer to [Chapter 5.4.3.5, "Selecting a Limit Line"](#), on page 191.

**Menu and softkey description**

- [Chapter 5.4.3.1, "Softkeys of the Lines Menu"](#), on page 185

**Further information**

- [Chapter 5.4.3.2, "Display Lines"](#), on page 189
- [Chapter 5.4.3.3, "Limit Lines \(Frequency/Time Lines\)"](#), on page 190

**Tasks**

- [Chapter 5.4.3.4, "Working with Lines"](#), on page 191
- [Chapter 5.4.3.5, "Selecting a Limit Line"](#), on page 191
- [Chapter 5.4.3.6, "Creating a New Limit Line"](#), on page 192
- [Chapter 5.4.3.7, "Editing an Existing Limit Line"](#), on page 195
- [Chapter 5.4.3.8, "Creating a New Limit Line Based upon an Existing Limit Line"](#), on page 195
- [Chapter 5.4.3.9, "Activating/Deactivating a Limit Line"](#), on page 196

## 6.4 Advanced Measurement Examples

This chapter explains how to operate the R&S ESRP in spectrum mode using typical measurements as examples. Additional background information on the settings is given. For more detailed information on all available softkeys and the corresponding instrument functions, see [Chapter 6, "Spectrum Measurements"](#), on page 197.

- [Test Setup](#)..... 401
- [Measurement of Harmonics](#)..... 402
- [Measuring the Spectra of Complex Signals](#)..... 404
- [Measuring Signals in the Vicinity of Noise](#)..... 407
- [Noise Measurements](#)..... 412
- [Measurements on Modulated Signals](#)..... 419

### 6.4.1 Test Setup

All of the following examples are based on the standard settings of the R&S ESRP. These are set with the PRESET key. A complete listing of the standard settings can be found in chapter "Instrument Functions", section "Initializing the Configuration – PRE-SET Key".

In the following examples, a signal generator is used as a signal source. The RF output of the signal generator is connected to the RF input of R&S ESRP.

If a 64 MHz signal is required for the test setup, as an alternative to the signal generator, the internal 64 MHz reference generator can be used:

1. Switch on the internal reference generator.
  - a) Press the SETUP key.
  - b) Press the "More" key.
  - c) Press the "Service" softkey.
  - d) Press the "Input RF/Cal" softkey, until "Cal" is highlighted.  
The internal 64 MHz reference generator is now on. The R&S ESRP's RF input is switched off.
  
2. Switch on the RF input again for normal operation of the R&S ESRP. Two ways are possible:
  - a) Press the PRESET key.  
or:
  - b) Press the SETUP key.
  - c) Press the "Service" softkey.
  - d) Press the "Input RF/Cal" softkey, until "RF" is highlighted.  
The internal signal path of the R&S ESRP is switched back to the RF input in order to resume normal operation.

## 6.4.2 Measurement of Harmonics

### Signal generator settings (e.g. R&S SMW):

Frequency:	128 MHz
Level:	- 25 dBm

### Procedure on the R&S ESRP:

1. Set the R&S ESRP to its default state by pressing the [PRESET] key.
2. Set the center frequency to *128 MHz* and the span to *100 kHz*.
3. Switch on the marker by pressing the [MKR] key.  
The marker is positioned on the trace maximum.
4. Set the measured signal frequency and the measured level as reference values.
  - a) Press the [MKR FUNC] key
  - b) Press the "Ref Fixed" softkey.  
The position of the marker becomes the reference point. The reference point level is indicated by a horizontal line, the reference point frequency with a vertical line. At the same time, the delta marker 2 is switched on.

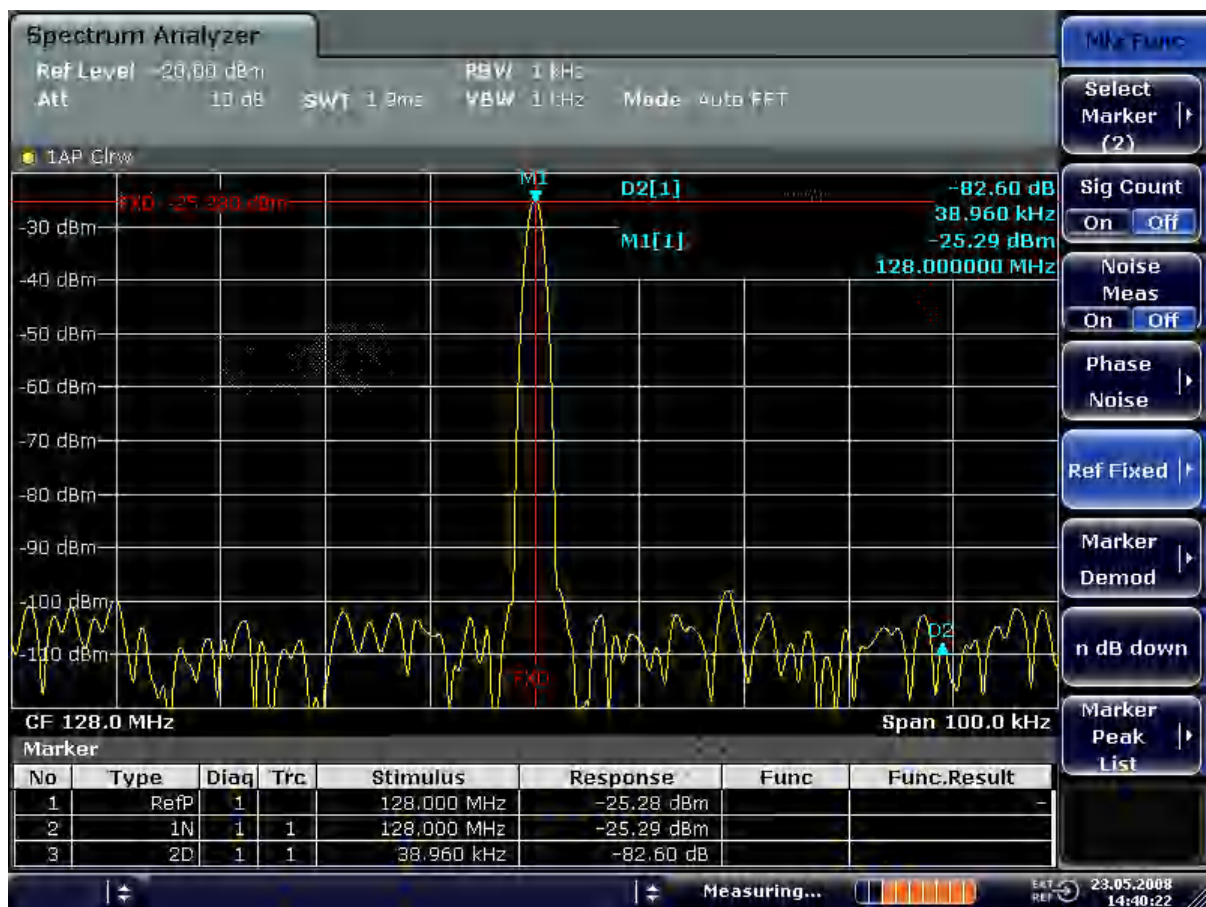

Figure 6-22: Fundamental wave and the frequency and level reference point

5. Make the step size for the center frequency equal to the signal frequency
  - a) Press the [FREQ] key.
  - b) Press the "CF-Stepsize" softkey and press the "= Marker" softkey in the sub-menu.

The step size for the center frequency is now equal to the marker frequency.

6. Set the center frequency to the second harmonic of the signal.
  - a) Press the [FREQ] key.
  - b) Press the [UPARROW] key once.

The center frequency is set to the second harmonic.

7. Place the delta marker on the second harmonic.

- a) Press the [MKR ->] key.
- b) Press the "Peak" softkey.

The delta marker moves to the maximum of the second harmonic. The displayed level result is relative to the reference point level (= fundamental wave level).

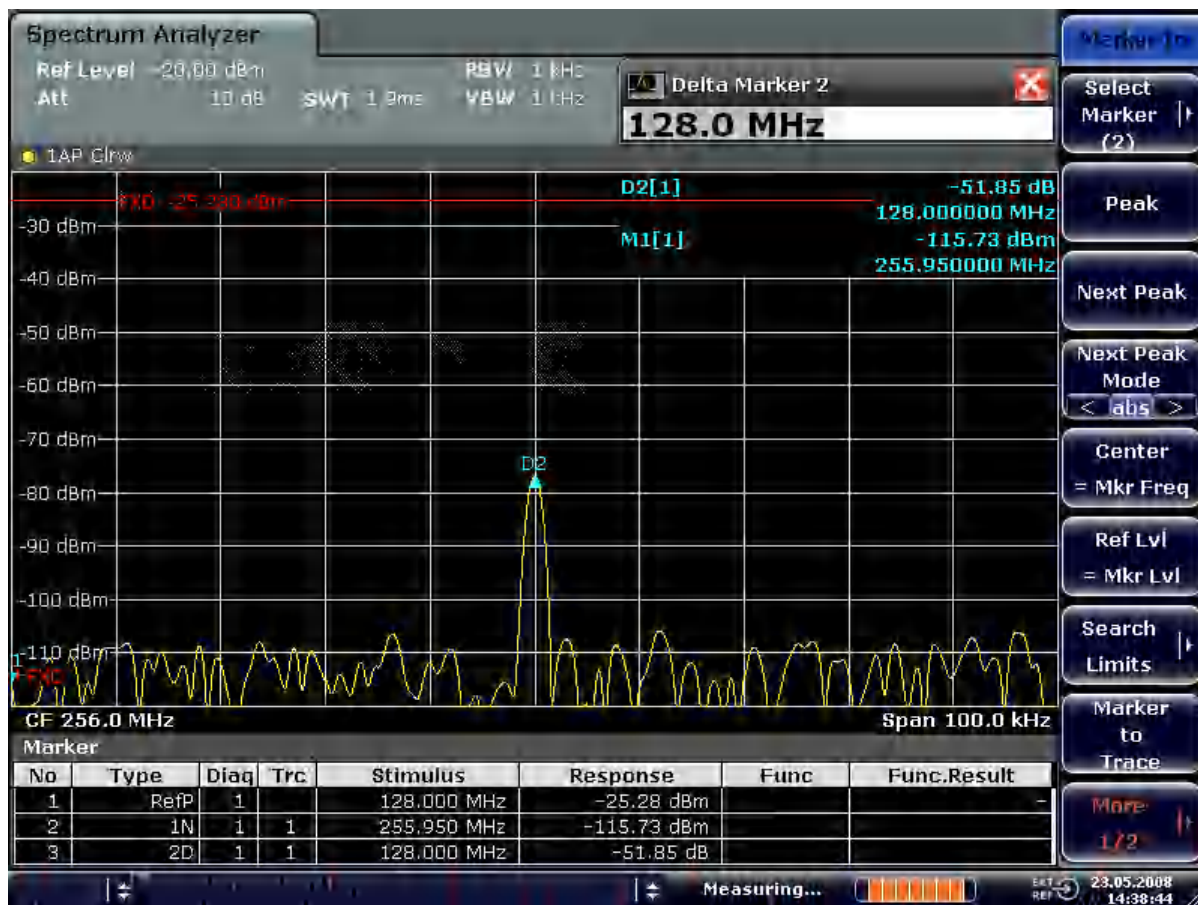

Figure 6-23: Measuring the level difference between the fundamental wave (= reference point level) and the 2nd harmonic

The other harmonics are measured with steps 5 and 6, the center frequency being incremented or decremented in steps of 128 MHz using the [UPARROW] or [DNARROW] key.

### 6.4.3 Measuring the Spectra of Complex Signals

#### 6.4.3.1 Separating Signals by Selecting an Appropriate Resolution Bandwidth

A basic feature of a signal analyzer is being able to separate the spectral components of a mixture of signals. The resolution at which the individual components can be separated is determined by the resolution bandwidth. Selecting a resolution bandwidth that is too large may make it impossible to distinguish between spectral components, i.e. they are displayed as a single component.

An RF sinusoidal signal is displayed by means of the passband characteristic of the resolution filter (RBW) that has been set. Its specified bandwidth is the 3 dB bandwidth of the filter.

Two signals with the same amplitude can be resolved if the resolution bandwidth is smaller than or equal to the frequency spacing of the signal. If the resolution bandwidth is equal to the frequency spacing, the spectrum display screen shows a level drop of 3 dB precisely in the center of the two signals. Decreasing the resolution bandwidth makes the level drop larger, which thus makes the individual signals clearer.

If there are large level differences between signals, the resolution is determined by selectivity as well as by the resolution bandwidth that has been selected. The measure of selectivity used for signal analyzers is the ratio of the 60 dB bandwidth to the 3 dB bandwidth (= shape factor).

For the R&S ESRP, the shape factor for bandwidths is  $< 5$ , i.e. the 60 dB bandwidth of the 30 kHz filter is  $< 150$  kHz.

The higher spectral resolution with smaller bandwidths is won by longer sweep times for the same span. The sweep time has to allow the resolution filters to settle during a sweep at all signal levels and frequencies to be displayed.

### 6.4.3.2 Intermodulation Measurements

If several signals are applied to a transmission two-port device with nonlinear characteristic, intermodulation products appear at its output at the sums and differences of the signals. The nonlinear characteristic produces harmonics of the useful signals which intermodulate at the characteristic. The intermodulation products of lower order have a special effect since their level is largest and they are near the useful signals. The intermodulation product of third order causes the highest interference. It is the intermodulation product generated from one of the useful signals and the 2nd harmonic of the second useful signal in case of two-tone modulation.

#### Measurement Example – Measuring the R&S ESRP's Intrinsic Intermodulation

##### Test setup:

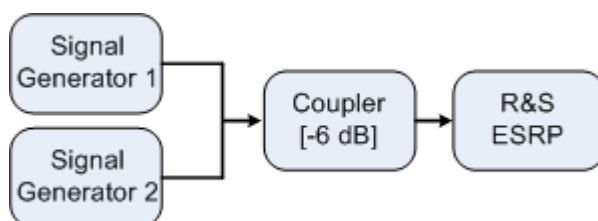

##### Signal generator settings (e.g. R&S SMW):

	Level	Frequency
Signal generator 1	-4 dBm	999.7 MHz
Signal generator 2	-4 dBm	1000.3 MHz

##### Setting up the measurement

1. Set the R&S ESRP to its default settings by pressing the [PRESET] key.



The R&S ESRP is in its default state.

2. Set center frequency to 1 GHz and the frequency span to 3 MHz.
3. Set the reference level to -10 dBm and RF attenuation to 0 dB.
4. Set the resolution bandwidth to 10 kHz.  
The noise is reduced, the trace is smoothed further and the intermodulation products can be clearly seen.
5. Set the VBW to "1 kHz".

### Measuring intermodulation using the 3<sup>rd</sup> order intercept (TOI) measurement function

1. Press the [MEAS] key and then the "TOI" softkey.

The R&S ESRP activates four markers to measure the intermodulation distance. Two markers are positioned on the useful signals and two on the intermodulation products. The 3<sup>rd</sup> order intercept is calculated from the level difference between the useful signals and the intermodulation products. It is then displayed on the screen:

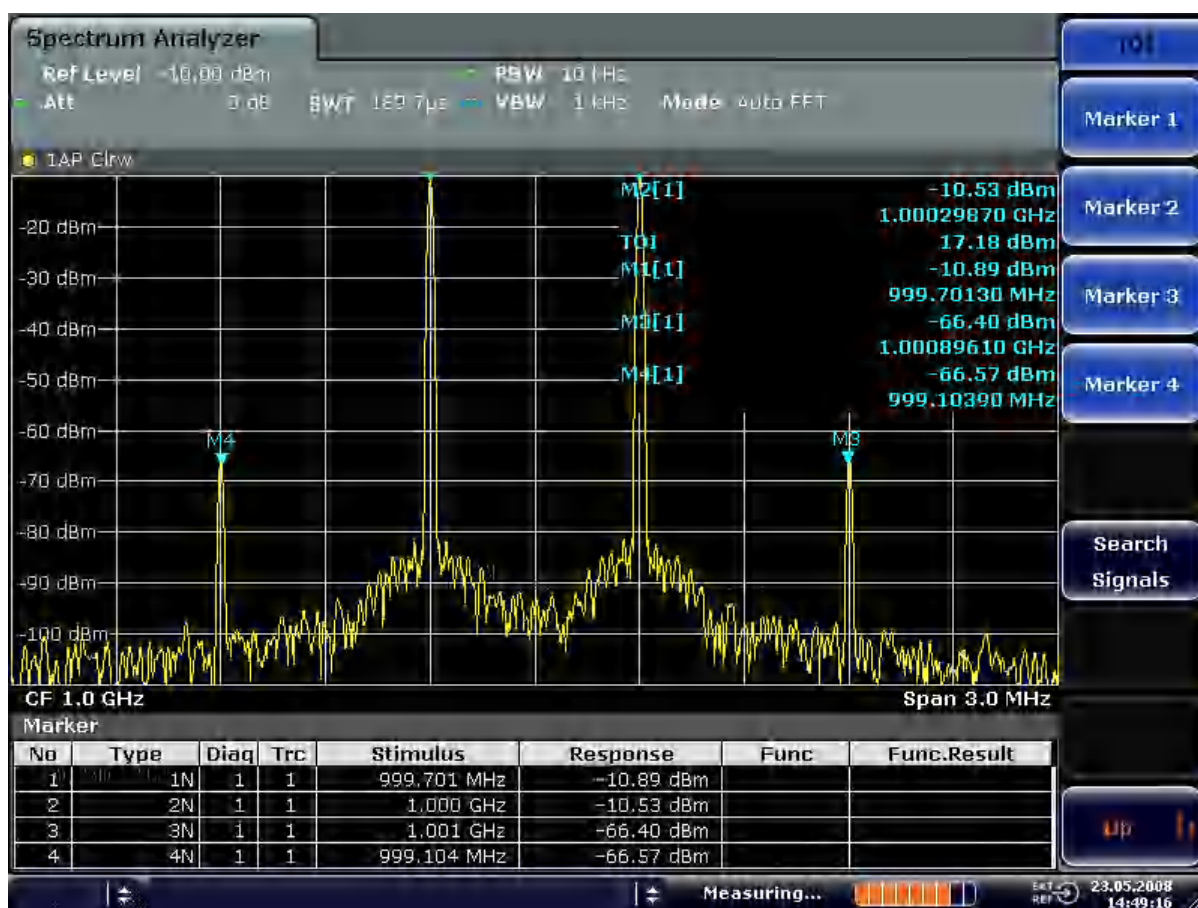
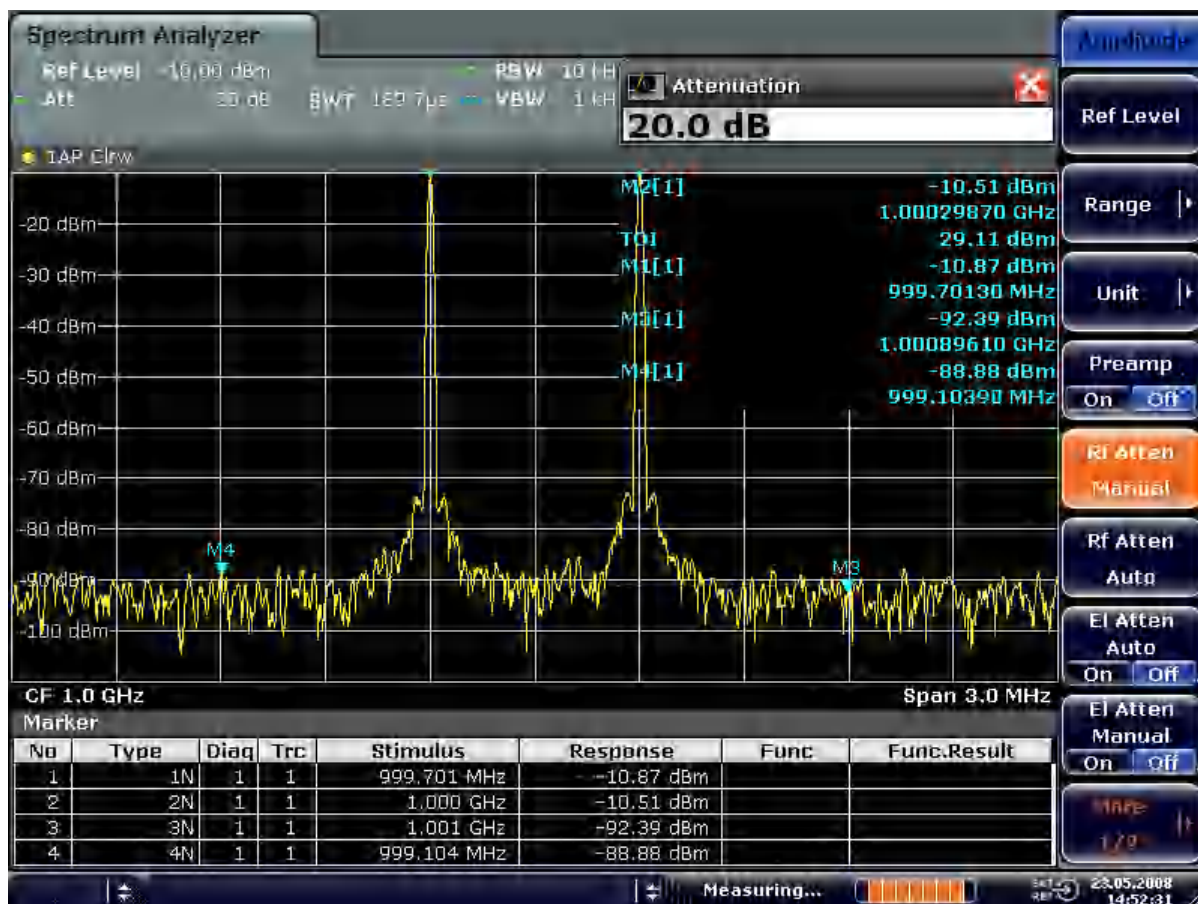

Figure 6-24: Result of intrinsic intermodulation measurement on the R&S ESRP.

The 3<sup>rd</sup> order intercept (TOI) is displayed at the top right corner of the grid.

- The level of a signal analyzer's intrinsic intermodulation products depends on the RF level of the useful signals at the input mixer. When the RF attenuation is added, the mixer level is reduced and the intermodulation distance is increased. With an additional RF attenuation of 10 dB, the levels of the intermodulation products are reduced by 20 dB. The noise level is, however, increased by 10 dB. Increase the RF attenuation to 20 dB to reduce intermodulation products.

The R&S ESRP's intrinsic intermodulation products disappear below the noise floor.



#### 6.4.4 Measuring Signals in the Vicinity of Noise

The minimum signal level a signal analyzer can measure is limited by its intrinsic noise. Small signals can be swamped by noise and therefore cannot be measured. For signals that are just above the intrinsic noise, the accuracy of the level measurement is influenced by the intrinsic noise of the signal analyzer.

The displayed noise level of a signal analyzer depends on its noise figure, the selected RF attenuation, the selected reference level, the selected resolution and video bandwidth and the detector. The effect of the different parameters is explained in the following.

### Impact of the RF attenuation setting

The sensitivity of a signal analyzer is directly influenced by the selected RF attenuation. The highest sensitivity is obtained at a RF attenuation of 0 dB. The attenuation can be set in 10 dB steps up to 70 dB. Each additional 10 dB step reduces the sensitivity by 10 dB, i.e. the displayed noise is increased by 10 dB.

### Impact of the resolution bandwidth

The sensitivity of a signal analyzer also directly depends on the selected bandwidth. The highest sensitivity is obtained at the smallest bandwidth (1 Hz). If the bandwidth is increased, the reduction in sensitivity is proportional to the change in bandwidth. The R&S ESRP has bandwidth settings in 1, 2, 3, 5 sequence. Increasing the bandwidth by a factor of 3 increases the displayed noise by approx. 5 dB (4.77 dB precisely). If the bandwidth is increased by a factor of 10, the displayed noise increases by a factor of 10, i.e. 10 dB.

### Impact of the video bandwidth

The displayed noise of a signal analyzer is also influenced by the selected video bandwidth. If the video bandwidth is considerably smaller than the resolution bandwidth, noise spikes are suppressed, i.e. the trace becomes much smoother. The level of a sine wave signal is not influenced by the video bandwidth. A sine wave signal can therefore be freed from noise by using a video bandwidth that is small compared with the resolution bandwidth, and thus be measured more accurately.

### Impact of the detector

Noise is evaluated differently by the different detectors. The noise display is therefore influenced by the choice of detector. Sine wave signals are weighted in the same way by all detectors, i.e. the level display for a sine wave RF signal does not depend on the selected detector, provided that the signal-to-noise ratio is high enough. The measurement accuracy for signals in the vicinity of intrinsic signal analyzer noise is also influenced by the detector which has been selected. For details on the detectors of the R&S ESRP refer to chapter "Instrument Functions", section "Detector overview" or the Online Help.

#### 6.4.4.1 Measurement Example – Measuring Level at Low S/N Ratios

The example shows the different factors influencing the S/N ratio.

#### Signal generator settings (e.g. R&S SMW):

Frequency:	128 MHz
Level:	- 90 dBm

#### Procedure:

1. Set the R&S ESRP to its default state by pressing the PRESET key.  
The R&S ESRP is in its default state.

2. Set the center frequency to 128 MHz and the frequency span to 100 MHz:
  - a) Press the FREQ key and enter "128 MHz".
  - b) Press the SPAN key and enter "100 MHz".

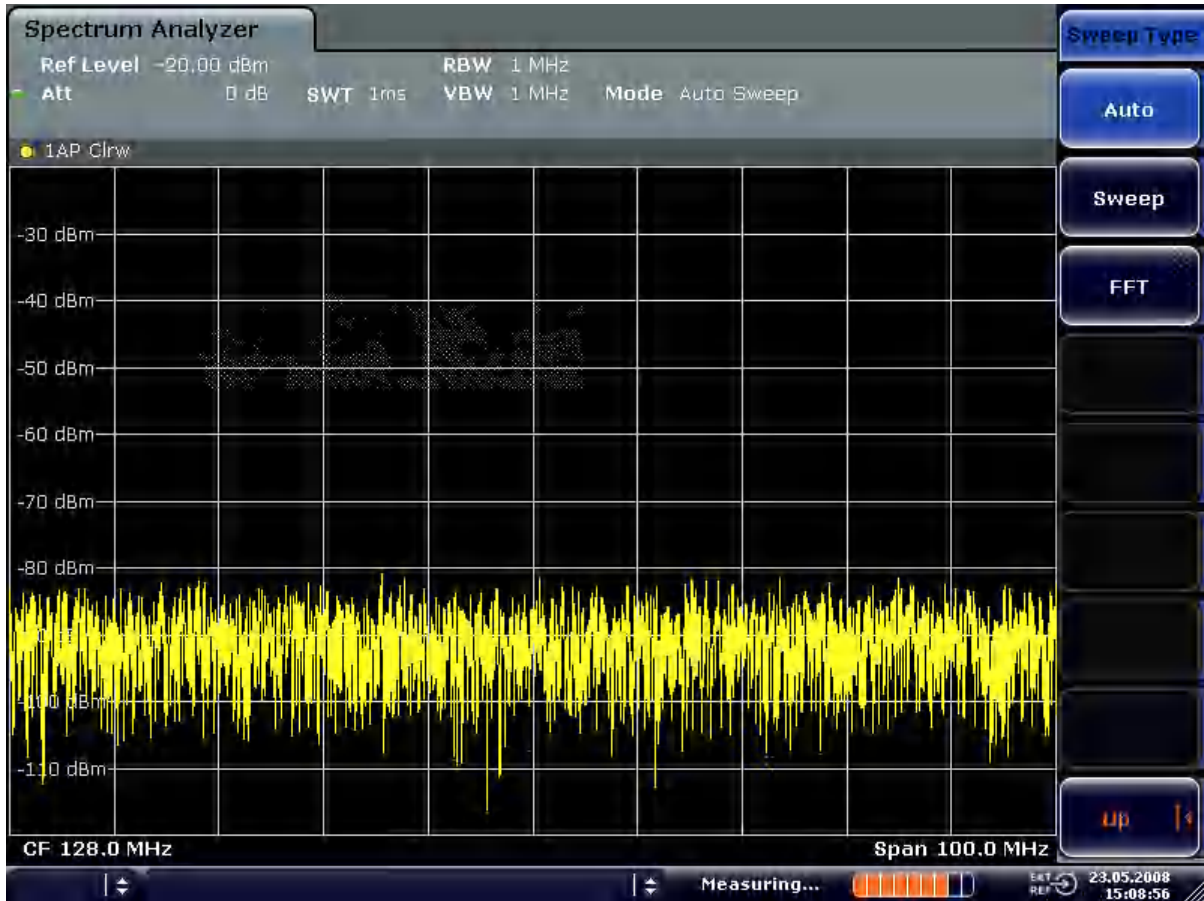

*Figure 6-25: Sine wave signal with low S/N ratio. The signal is measured with the auto peak detector and is completely hidden in the intrinsic noise of the R&S ESRP.*

3. To suppress noise spikes the trace can be averaged.
  - a) Press the TRACE key.
  - b) Press the "Trace Wizard" softkey.  
The Trace Wizard dialog box opens.

- c) Select "Average" in the "Trace Mode" drop-down menu of the selected trace. The traces of consecutive sweeps are averaged. To perform averaging, the R&S ESRP automatically switches on the sample detector. The RF signal, therefore, can be more clearly distinguished from noise.

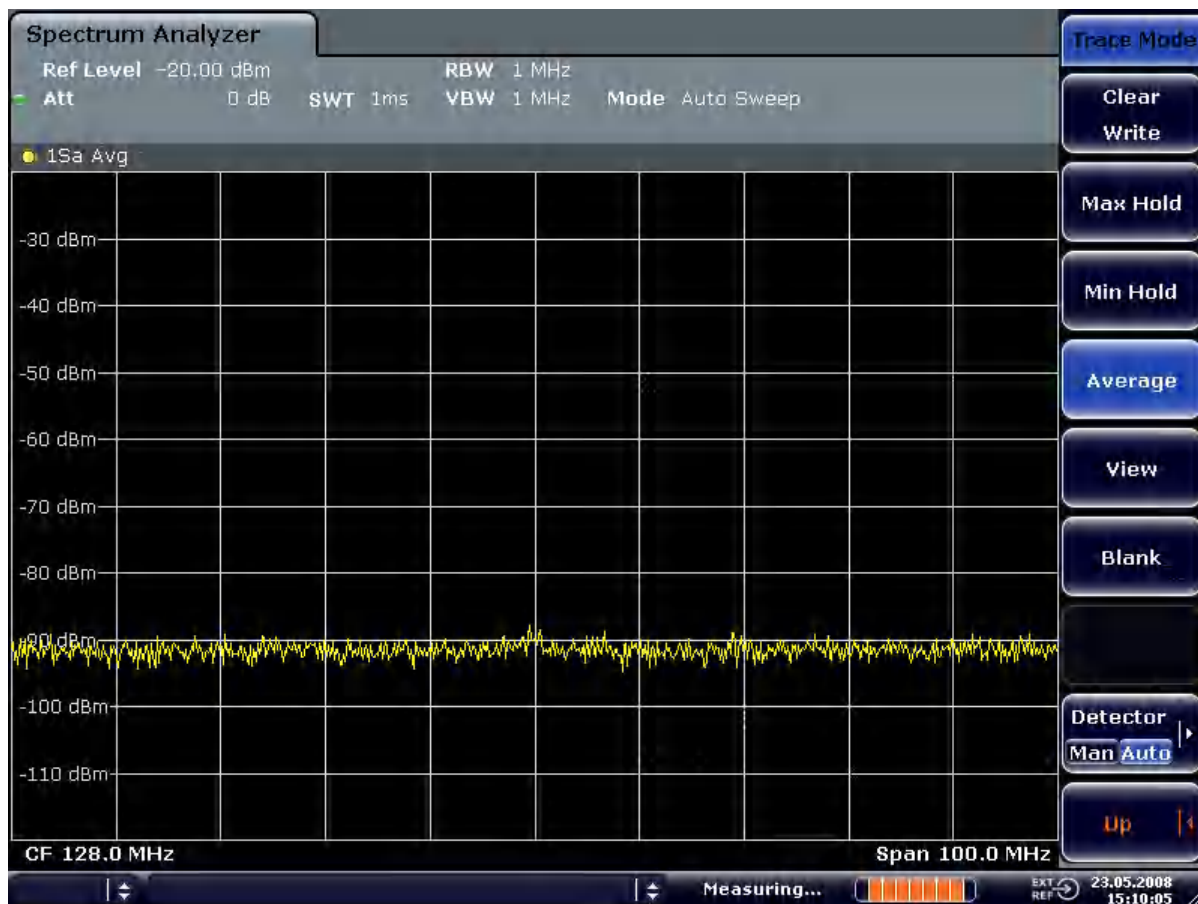

Figure 6-26: RF sine wave signal with low S/N ratio if the trace is averaged.

4. Instead of trace averaging, a video filter that is narrower than the resolution bandwidth can be selected:
  - a) Press the TRACE key.
  - b) Press the "Trace Wizard" softkey.  
The Trace Wizard dialog box opens.
  - c) Select "Clear Write" in the "Trace Mode" drop-down menu of the selected trace.
  - d) Press the BW key.

- e) Press the "Video BW Manual" softkey and enter "10 kHz".  
The RF signal can be more clearly distinguished from noise.



Figure 6-27: RF sine wave signal with low S/N ratio if a smaller video bandwidth is selected.

5. By reducing the resolution bandwidth by a factor of 10, the noise is reduced by 10 dB:

- a) In the "Bandwidth" menu press the "Res BW Manual" softkey and enter "100 kHz".

The displayed noise is reduced by approx. 10 dB. The signal, therefore, emerges from noise by about 10 dB. Compared to the previous setting, the video bandwidth has remained the same, i.e. it has increased relative to the smaller resolution bandwidth. The averaging effect of the video bandwidth is therefore reduced. The trace will be noisier.

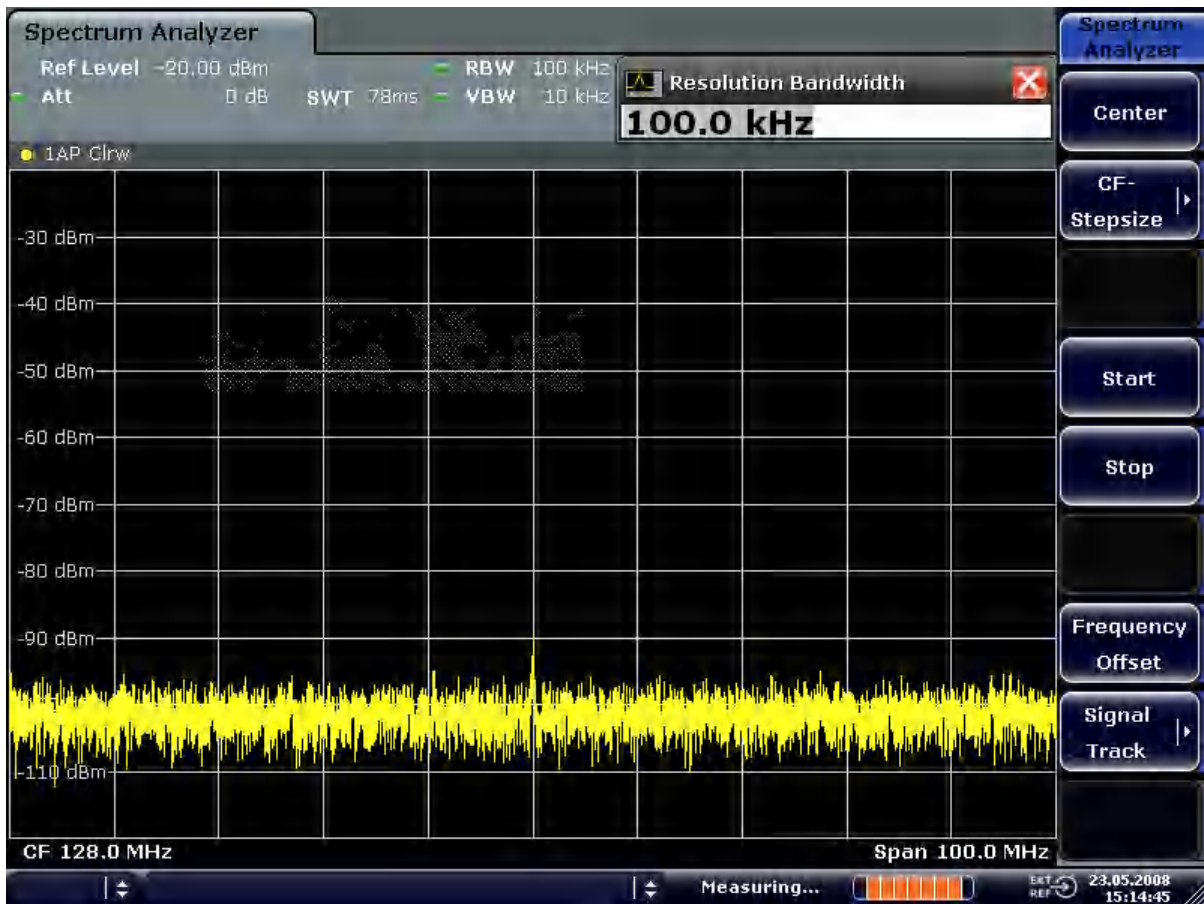

Figure 6-28: Reference signal at a smaller resolution bandwidth

### 6.4.5 Noise Measurements

Noise measurements play an important role in signal analysis. Noise e.g. affects the sensitivity of radio communication systems and their components.

Noise power is specified either as the total power in the transmission channel or as the power referred to a bandwidth of 1 Hz. The sources of noise are, for example, amplifier noise or noise generated by oscillators used for the frequency conversion of useful signals in receivers or transmitters. The noise at the output of an amplifier is determined by its noise figure and gain.

The noise of an oscillator is determined by phase noise near the oscillator frequency and by thermal noise of the active elements far from the oscillator frequency. Phase noise can mask weak signals near the oscillator frequency and make them impossible to detect.

#### 6.4.5.1 Measuring Noise Power Density

To measure noise power referred to a bandwidth of 1 Hz at a certain frequency, the R&S ESRP provides marker function. This marker function calculates the noise power density from the measured marker level.

##### Measurement Example – Measuring the Intrinsic Noise Power Density of the R&S ESRP at 1 GHz and Calculating the R&S ESRP's Noise Figure

###### Test setup:

- ▶ Connect no signal to the RF input; terminate RF input with 50 Ω.

###### Procedure:

1. Set the R&S ESRP to its default state by pressing the PRESET key.  
The R&S ESRP is in its default state.
2. Set the center frequency to 1.234 GHz and the span to 1 MHz.
  - a) Press the FREQ key and enter "1.234 GHz".
  - b) Press the SPAN key and enter "1 MHz".
3. Switch on the marker and set the marker frequency to 1.234 GHz by pressing the MKR key and entering "1.234 GHz".
4. Switch on the noise marker function by switching on the "Noise Meas" softkey.
  - a) Press the MKR FUNC key.
  - b) Switch the "Noise Meas" softkey to "On"  
The R&S ESRP displays the noise power at 1.234 GHz in dBm (1Hz).

**Note:** Since noise is random, a sufficiently long measurement time has to be selected to obtain stable measurement results. This can be achieved by averaging the trace or by selecting a very small video bandwidth relative to the resolution bandwidth.

5. The measurement result is stabilized by averaging the trace.
  - a) Press the TRACE key.
  - b) Press the "Trace Wizard" softkey.  
The Trace Wizard dialog box opens.
  - c) Select "Average" in the "Trace Mode" drop-down menu of the selected trace.  
The R&S ESRP performs sliding averaging over 10 traces from consecutive sweeps. The measurement result becomes more stable.



### Conversion to other reference bandwidths

The result of the noise measurement can be referred to other bandwidths by simple conversion. This is done by adding  $10 \times \log(\text{BW})$  to the measurement result, BW being the new reference bandwidth.

#### Example:

A noise power of -150 dBm (1 Hz) is to be referred to a bandwidth of 1 kHz.

$$P_{[1\text{kHz}]} = -150 + 10 \times \log(1000) = -150 + 30 = -120 \text{ dBm (1 kHz)}$$

### Calculation method for noise power

If the noise marker is switched on, the R&S ESRP automatically activates the sample detector. The video bandwidth is set to 1/10 of the selected resolution bandwidth (RBW).

To calculate the noise, the R&S ESRP takes an average over 17 adjacent pixels (the pixel on which the marker is positioned and 8 pixels to the left, 8 pixels to the right of the marker). The measurement result is stabilized by video filtering and averaging over 17 pixels.

Since both video filtering and averaging over 17 trace points is performed in the log display mode, the result would be 2.51 dB too low (difference between logarithmic noise average and noise power). The R&S ESRP, therefore, corrects the noise figure by 2.51 dB.

To standardize the measurement result to a bandwidth of 1 Hz, the result is also corrected by  $-10 \times \log(\text{RBW}_{\text{noise}})$ , with  $\text{RBW}_{\text{noise}}$  being the power bandwidth of the selected resolution filter (RBW).

### Detector selection

The noise power density is measured in the default setting with the sample detector and using averaging. Other detectors that can be used to perform a measurement giving true results are the average detector or the RMS detector. If the average detector is used, the linear video voltage is averaged and displayed as a pixel. If the RMS detector is used, the squared video voltage is averaged and displayed as a pixel. The averaging time depends on the selected sweep time ( $=\text{SWT}/501$ ). An increase in the sweep time gives a longer averaging time per pixel and thus stabilizes the measurement result. The R&S ESRP automatically corrects the measurement result of the noise marker display depending on the selected detector (+1.05 dB for the average detector, 0 dB for the RMS detector). It is assumed that the video bandwidth is set to at least three times the resolution bandwidth. While the average or RMS detector is being switched on, the R&S ESRP sets the video bandwidth to a suitable value.

The Pos Peak, Neg Peak, Auto Peak and Quasi Peak detectors are not suitable for measuring noise power density.

### Determining the noise figure

The noise figure of amplifiers or of the R&S ESRP alone can be obtained from the noise power display. Based on the known thermal noise power of a 50  $\Omega$  resistor at

room temperature (-174 dBm (1Hz)) and the measured noise power  $P_{\text{noise}}$  the noise figure (NF) is obtained as follows:

$$NF = P_{\text{noise}} + 174 - g,$$

where  $g$  = gain of DUT in dB

**Example:**

The measured internal noise power of the R&S ESRP at an attenuation of 0 dB is found to be -143 dBm/1 Hz. The noise figure of the R&S ESRP is obtained as follows

$$NF = -143 + 174 = 31 \text{ dB}$$



If noise power is measured at the output of an amplifier, for example, the sum of the internal noise power and the noise power at the output of the DUT is measured. The noise power of the DUT can be obtained by subtracting the internal noise power from the total power (subtraction of linear noise powers). By means of the following diagram, the noise level of the DUT can be estimated from the level difference between the total and the internal noise level.

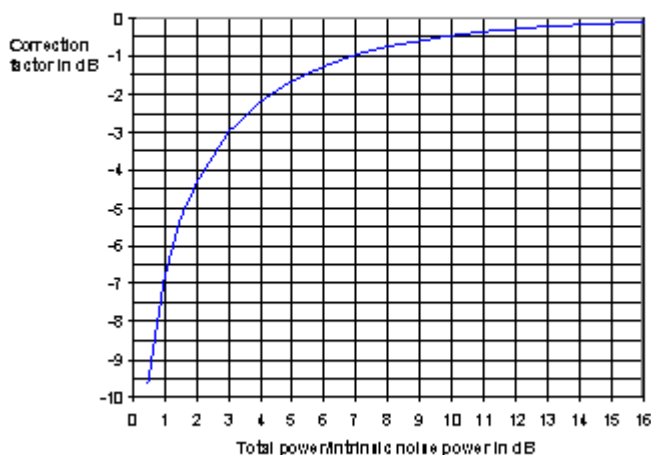

*Figure 6-29: Correction factor for measured noise power as a function of the ratio of total power to the intrinsic noise power of the signal analyzer*

#### 6.4.5.2 Measurement of Noise Power within a Transmission Channel

Noise in any bandwidth can be measured with the channel power measurement functions. Thus the noise power in a communication channel can be determined, for example. If the noise spectrum within the channel bandwidth is flat, the noise marker from the previous example can be used to determine the noise power in the channel by considering the channel bandwidth. If, however, phase noise and noise that normally increases towards the carrier is dominant in the channel to be measured, or if there are

discrete spurious signals in the channel, the channel power measurement method must be used to obtain correct measurement results.

### **Measurement Example – Measuring the Intrinsic Noise of the R&S ESRP at 1 GHz in a 1.23 MHz Channel Bandwidth with the Channel Power Function**

#### **Test setup:**

- ▶ Leave the RF input of the R&S ESRP open-circuited or terminate it with 50  $\Omega$ .

#### **Procedure:**

1. Set the R&S ESRP to its default state by pressing the [PRESET] key.  
The R&S ESRP is in its default state.
2. Set the center frequency to 1 GHz and the span to 1 MHz.
3. To obtain maximum sensitivity, set RF attenuation on the R&S ESRP to 0 dB.
4. Set the "Sweep Type" to "Sweep".
5. Switch on and configure the channel power measurement.
  - a) Press the [MEAS] key.
  - b) Press the "Ch Power/ACLR" softkey.  
The R&S ESRP activates the channel or adjacent channel power measurement according to the currently set configuration.
  - c) Press the "CP/ACLR Settings" softkey.
  - d) Press the "Channel Settings" softkey.
  - e) Press the "Channel Bandwidth" softkey and enter 1.23 MHz.  
The R&S ESRP displays the 1.23 MHz channel as two vertical lines which are symmetrical to the center frequency.

- f) Press the "Adjust Settings" softkey.  
The settings for the frequency span, the bandwidth (RBW and VBW) and the detector are automatically set to the optimum values required for the measurement.

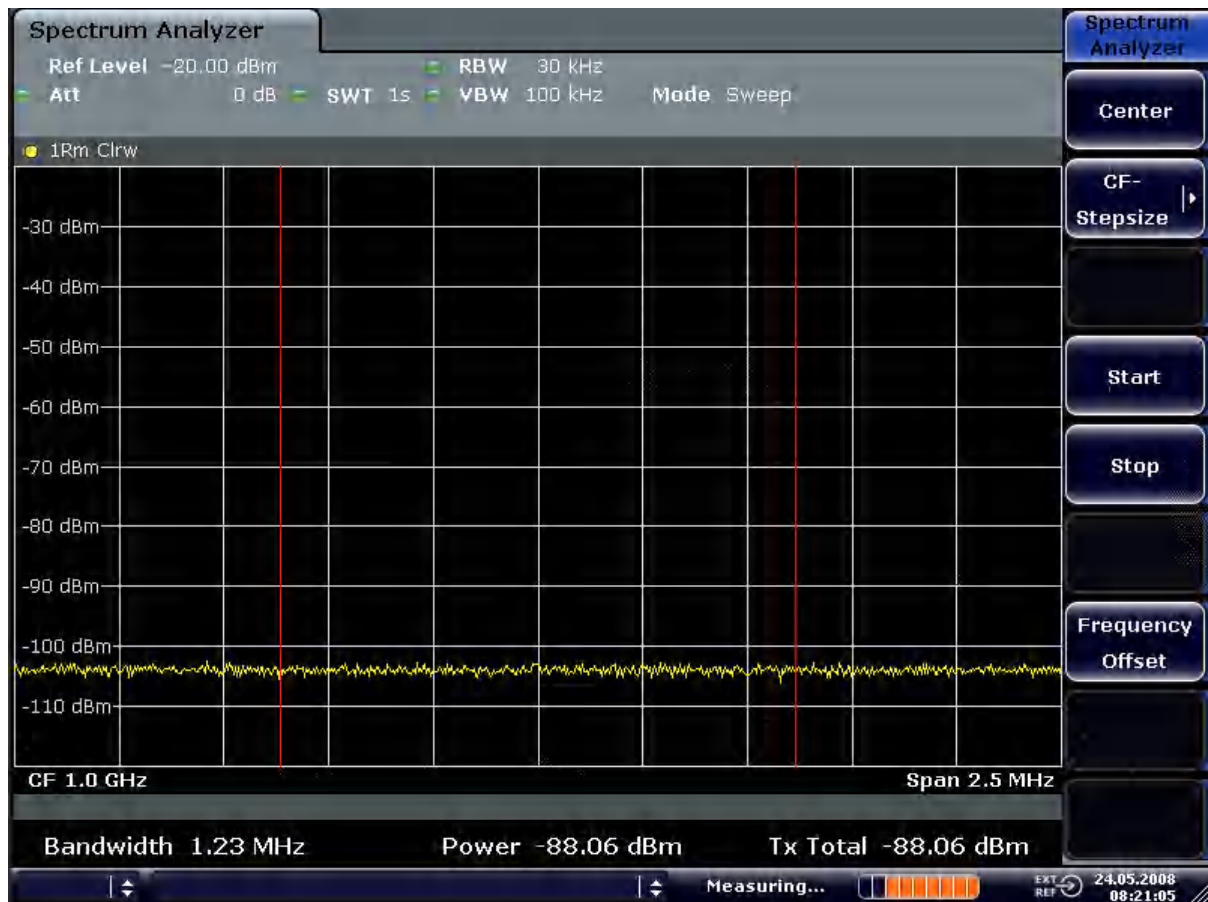

Figure 6-30: Measurement of the R&S ESRP's intrinsic noise power in a 1.23 MHz channel bandwidth.

6. Stabilize the measurement result by increasing the sweep time.  
In the "Ch Power ACLR" menu, press the "Sweep Time" softkey and enter 1 s.  
The trace becomes much smoother because of the RMS detector and the channel power measurement display is much more stable.

#### 6.4.5.3 Measuring Phase Noise

The R&S ESRP has an easy-to-use marker function for phase noise measurements. This marker function indicates the phase noise of an RF oscillator at any carrier in dBc in a bandwidth of 1 Hz.

### Measurement Example – Measuring the Phase Noise of a Signal Generator at a Carrier Offset of 10 kHz

#### Test setup:

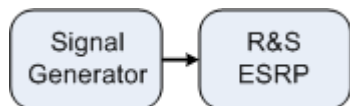

#### Signal generator settings (e.g. R&S SMW):

Frequency:	100 MHz
Level:	0 dBm

#### Procedure:

1. Set the R&S ESRP to its default state by pressing the PRESET key.  
R&S ESRP is in its default state.
2. Set the center frequency to 100 MHz and the span to 50 kHz.
  - a) Press the FREQ key and enter "100 MHz".
  - b) Press the SPAN key and enter "50 kHz".
3. Set the R&S ESRP's reference level to 0 dBm (=signal generator level) by pressing the AMPT key and enter "0 dBm".
4. Enable phase noise measurement.
  - a) Press the MKR FUNC key.
  - b) Press the "Phase Noise" softkey.  
The R&S ESRP activates phase noise measurement. Marker 1 (=main marker) and marker 2 (= delta marker) are positioned on the signal maximum. The position of the marker is the reference (level and frequency) for the phase noise measurement. A horizontal line represents the level of the reference point and a vertical line the frequency of the reference point. The dialog box for the delta marker is displayed so that the frequency offset at which the phase noise is to be measured can be entered directly.
5. Set the frequency offset to 10 kHz for determining phase noise by entering "10 kHz".  
The R&S ESRP displays the phase noise at a frequency offset of 10 kHz. The magnitude of the phase noise in dBc/Hz is displayed in the delta marker output field at the top right of the screen (Phn2).
6. Stabilize the measurement result by activating trace averaging.

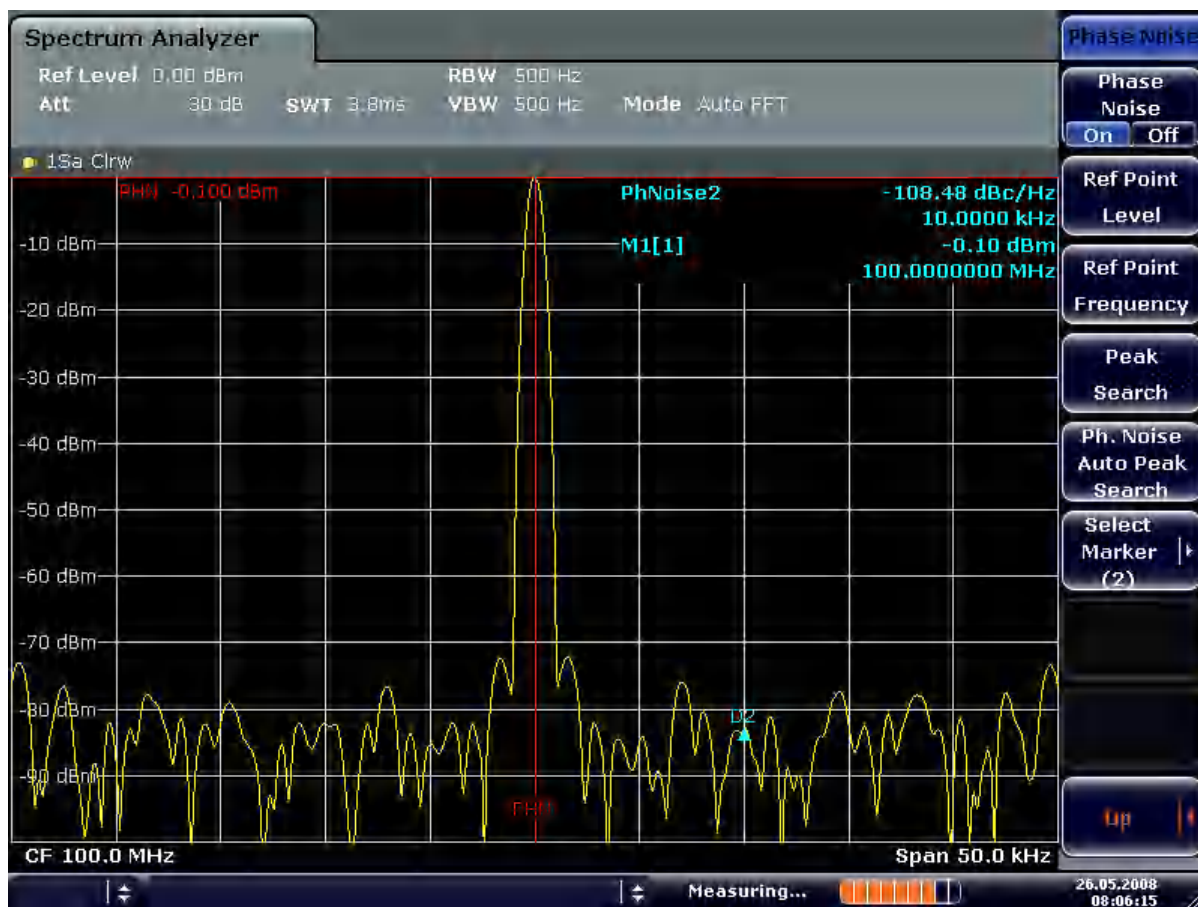

Figure 6-31: Measuring phase noise with the phase-noise marker function

The frequency offset can be varied by moving the marker with the rotary knob or by entering a new frequency offset as a number.

## 6.4.6 Measurements on Modulated Signals

### 6.4.6.1 Measuring Channel Power and Adjacent Channel Power

Measuring channel power and adjacent channel power is one of the most important tasks in the field of digital transmission for a signal analyzer with the necessary test routines. While, theoretically, channel power could be measured at highest accuracy with a power meter, its low selectivity means that it is not suitable for measuring adjacent channel power as an absolute value or relative to the transmit channel power. The power in the adjacent channels can only be measured with a selective power meter.

A signal analyzer cannot be classified as a true power meter, because it displays the IF envelope voltage. However, it is calibrated such as to correctly display the power of a pure sine wave signal irrespective of the selected detector. This calibration cannot be applied for non-sinusoidal signals. Assuming that the digitally modulated signal has a Gaussian amplitude distribution, the signal power within the selected resolution band-

width can be obtained using correction factors. These correction factors are normally used by the signal analyzer's internal power measurement routines in order to determine the signal power from IF envelope measurements. These factors apply if and only if the assumption of a Gaussian amplitude distribution is correct.

Apart from this common method, the R&S ESRP also has a true power detector, i.e. an RMS detector. It correctly displays the power of the test signal within the selected resolution bandwidth irrespective of the amplitude distribution, without additional correction factors being required. The absolute measurement uncertainty of the FSV is < 1.5 dB and a relative measurement uncertainty of < 0.5 dB (each with a confidence level of 95 %).

There are two possible methods for measuring channel and adjacent channel power with a signal analyzer:

1. IBW method (**I**ntegration **B**andwidth **M**ethod)

The signal analyzer measures with a resolution bandwidth that is less than the channel bandwidth and integrates the level values of the trace versus the channel bandwidth. This method is described in "[Measurement Example – Measuring the Intrinsic Noise of the R&S ESRP at 1 GHz in a 1.23 MHz Channel Bandwidth with the Channel Power Function](#)" on page 416.

2. Using a channel filter

For a detailed description, refer to the following section.

### Measurements using a channel filter

In this case, the signal analyzer makes zero span measurements using an IF filter that corresponds to the channel bandwidth. The power is measured at the output of the IF filter. Until now, this method has not been used for signal analyzers, because channel filters were not available and the resolution bandwidths, optimized for the sweep, did not have a sufficient selectivity. The method was reserved for special receivers optimized for a particular transmission method.

The R&S ESRP has test routines for simple channel and adjacent channel power measurements. These routines give quick results without any complex or tedious setting procedures.

### Measurement Example 1 – ACPR Measurement on an CDMA2000 Signal

#### Test setup:

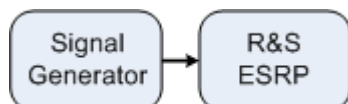

**Signal generator settings (e.g. R&S SMW):**

Frequency:	850 MHz
Level:	0 dBm
Modulation:	CDMA2000

**Procedure:**

1. Set the R&S ESRP to its default state by pressing the [PRESET] key.  
The R&S ESRP is in its default state.
2. Press the [FREQ] key and enter "850 MHz" as the center frequency.
3. Press the [SPAN] key and enter "4 MHz".
4. Set the reference level to +10 dBm by pressing the [AMPT] key and enter "10 dBm".
5. Configure the adjacent channel power for the CDMA2000 standard (more precisely: CDMA2000 1X).
  - a) Press the [MEAS] key.
  - b) Press the "Ch Power ACLR" softkey.
  - c) Press the "CP/ACLR Standard" softkey.
  - d) In the standards list, mark *CDMA2000*.

The R&S ESRP sets the channel configuration according to the 2000 standard with 2 adjacent channels above and 2 below the transmit channel. The spectrum is displayed in the upper part of the screen, the numeric values of the results and the channel configuration in the lower part of the screen. The various channels are represented by vertical lines on the graph.

The frequency span, resolution bandwidth, video bandwidth and detector are selected automatically to give correct results. To obtain stable results – especially in the adjacent channels (30 kHz bandwidth) which are narrow in comparison with the transmission channel bandwidth (1.23 MHz) – the RMS detector is used.

6. Set the optimal reference level and RF attenuation for the applied signal level by pressing the "Adjust Ref Level" softkey.
7. Activate "Fast ACP" mode to increase the repeatability of results by pressing the "Fast ACP" softkey (for details see below).

The R&S ESRP sets the optimal RF attenuation and the reference level based on the transmission channel power to obtain the maximum dynamic range. The [Figure 6-32](#) shows the result of the measurement.



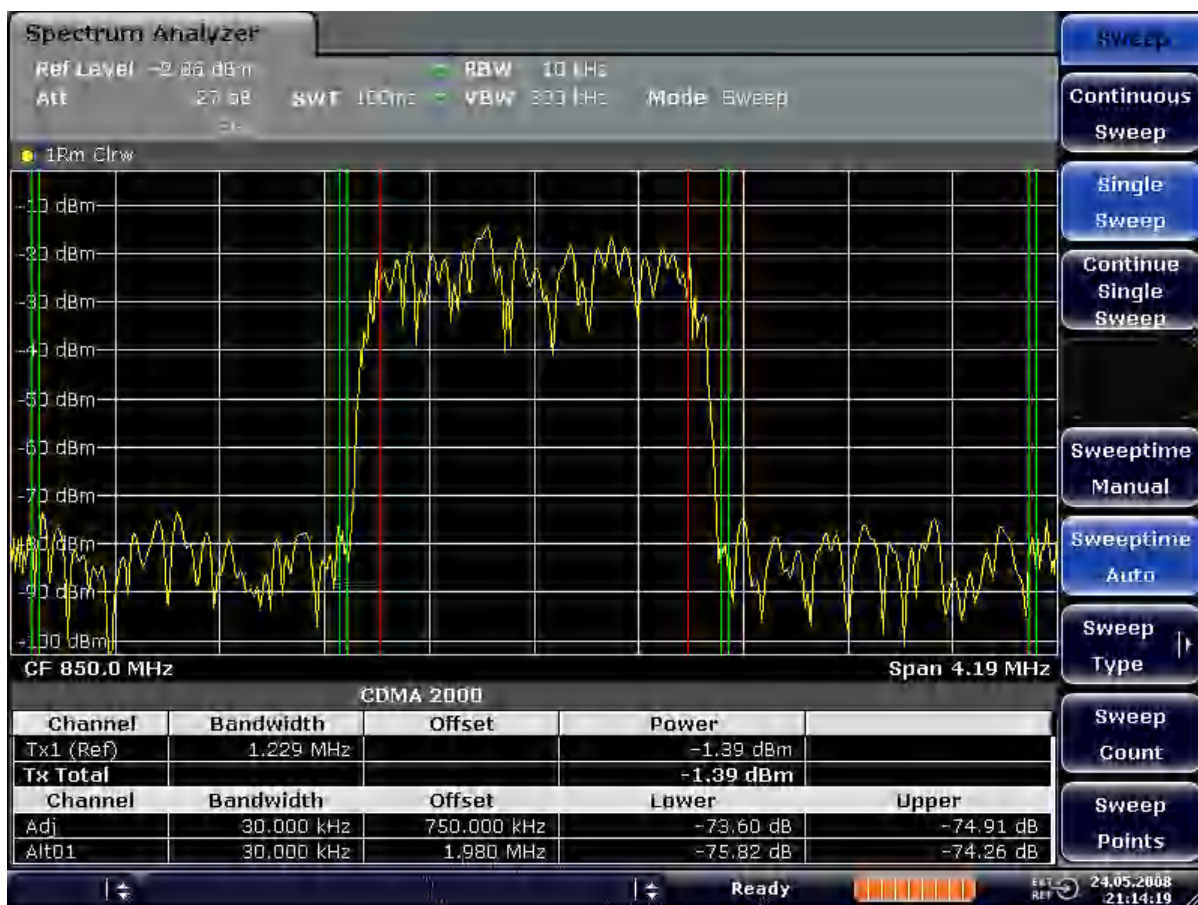
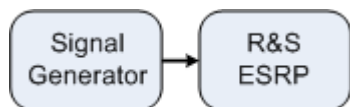

Figure 6-32: Adjacent channel power measurement on a CDMA2000 1x signal

### Measurement Example 2 – Measuring Adjacent Channel Power of a W-CDMA Uplink Signal

Test setup:



Signal generator settings (e.g. R&S SMW):

Frequency:	1950 MHz
Level:	4 dBm
Modulation:	3 GPP W-CDMA Reverse Link

Procedure:

1. Set the R&S ESRP to its default state by pressing the [PRESET] key.

The R&S ESRP is in its default state.

2. Set the center frequency to 1950 MHz by pressing the [FREQ] key and entering "1950 MHz".
3. Switch on the ACLR measurement for W-CDMA.
  - a) Press the [MEAS] key.
  - b) Press the "Ch Power ACLR" softkey.
  - c) Press the "CP/ACLR Standard" softkey.
  - d) In the standards list, select *W-CDMA 3GPP REV.*

The R&S ESRP sets the channel configuration to the 3GPP W-CDMA standard for mobiles with two adjacent channels above and below the transmit channel. The frequency span, the resolution and video bandwidth and the detector are automatically set to the correct values. The spectrum is displayed in the upper part of the screen and the channel power, the level ratios of the adjacent channel powers and the channel configuration in the lower part of the screen. The individual channels are displayed as vertical lines on the graph.

4. Set the optimum reference level and the RF attenuation for the applied signal level.
  - a) Press the "Adjust Ref Level" softkey.

The R&S ESRP sets the optimum RF attenuation and the reference level for the power in the transmission channel to obtain the maximum dynamic range. The following figure shows the result of the measurement.



Figure 6-33: Measuring the relative adjacent channel power on a W-CDMA uplink signal

5. Set up the adjacent channel power measurement with the fast ACLR mode.

- a) Set "Fast ACLR" softkey to "On".
- b) Press the "Adjust Ref Level" softkey.

The R&S ESRP measures the power of the individual channels with zero span. A root raised cosine filter with the parameters  $\alpha = 0.22$  and chip rate 3.84 Mcps (= receive filter for 3GPP W-CDMA) is used as channel filter.

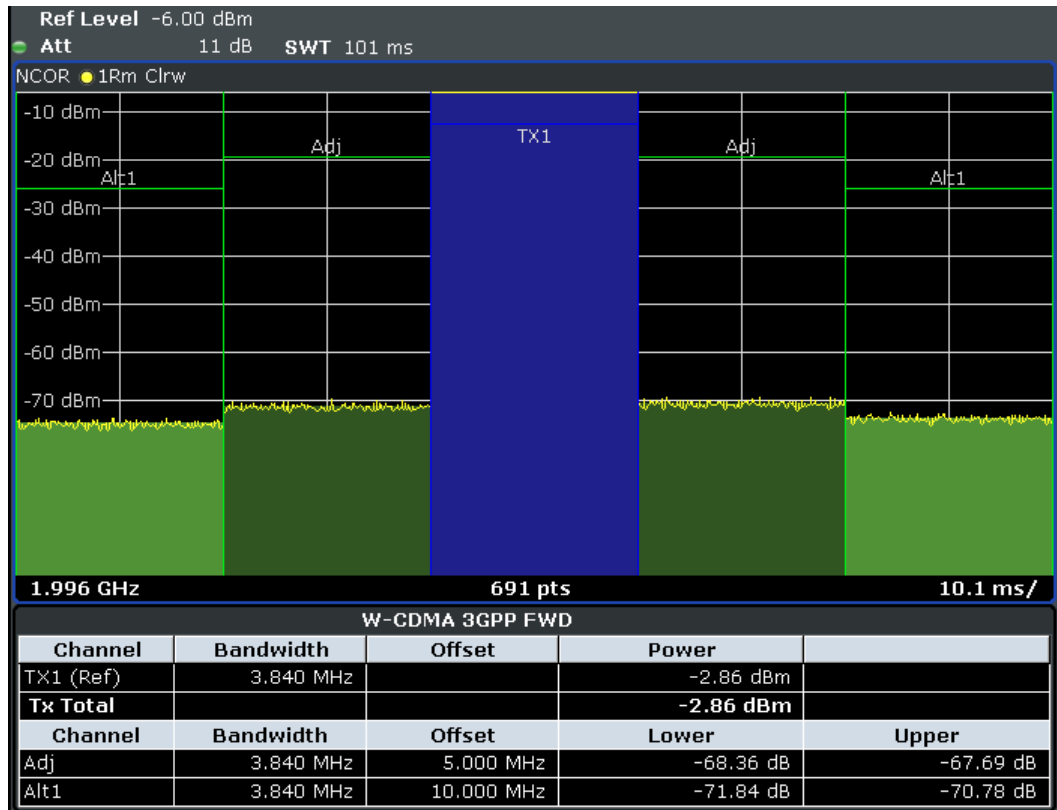
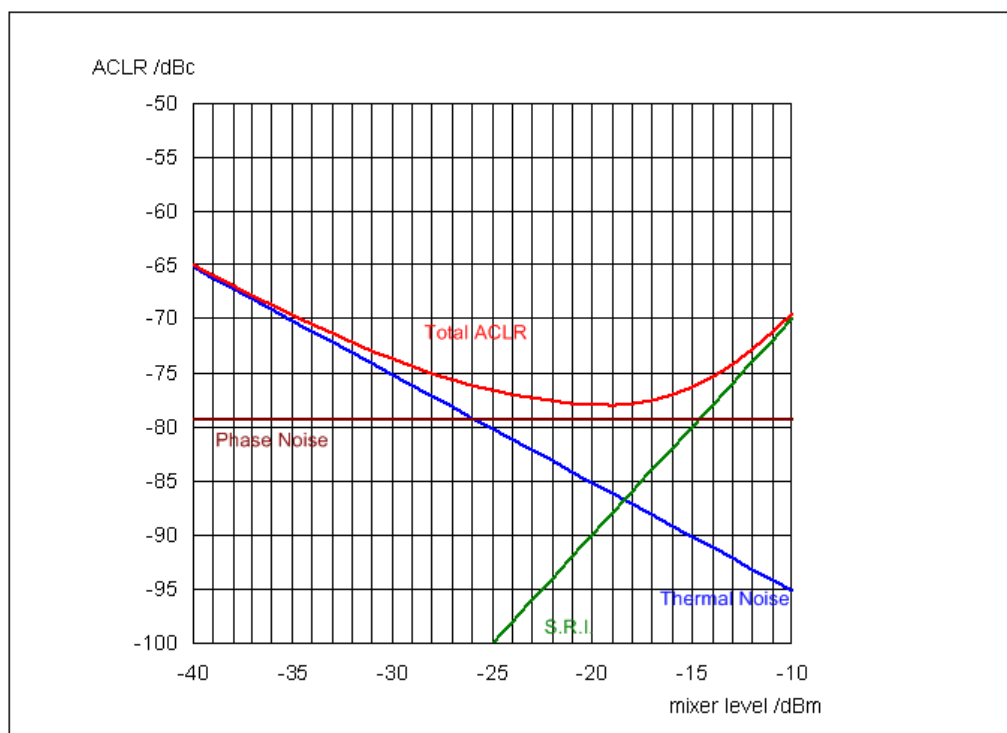

Figure 6-34: Measuring the adjacent channel power of a W-CDMA signal with the fast ACLR mode

**Optimum Level Setting for ACP Measurements on W-CDMA Signals**

The dynamic range for ACPR measurements is limited by the thermal noise floor, the phase noise and the intermodulation (spectral regrowth) of the signal analyzer. The power values produced by the R&S ESRP due to these factors accumulate linearly. They depend on the applied level at the input mixer. The three factors are shown in the figure below for the adjacent channel (5 MHz carrier offset).



**Figure 6-35:** The R&S ESRP's dynamic range for adjacent channel power measurements on W-CDMA uplink signals is a function of the mixer level.

The level of the W-CDMA signal at the input mixer is shown on the horizontal axis, i.e. the measured signal level minus the selected RF attenuation. The individual components which contribute to the power in the adjacent channel and the resulting relative level (total ACPR) in the adjacent channel are displayed on the vertical axis. The optimum mixer level is -18 dBm. The relative adjacent channel power (ACPR) at an optimum mixer level is -77 dBc. Since, at a given signal level, the mixer level is set in 5 dB steps with the 5 dB RF attenuator, the optimum 10 dB range spreads from -17 dBm to -22 dBm. In this range, the obtainable dynamic range with noise correction is 77 dB.

To set the attenuation parameter manually, the following method is recommended:

- ▶ Set the RF attenuation so that the mixer level (= measured channel power – RF attenuation) is between -16 dBm and -22 dBm.

This method is automated with the "Adjust Ref Level" function. Especially in remote control mode, e.g. in production environments, it is best to correctly set the attenuation parameters prior to the measurement, as the time required for automatic setting can be saved.



To measure the R&S ESRP's intrinsic dynamic range for W-CDMA adjacent channel power measurements, a filter which suppresses the adjacent channel power is required at the output of the transmitter. A SAW filter with a bandwidth of 4 MHz, for example, can be used.

### 6.4.6.2 Amplitude Distribution Measurements

If modulation types are used that do not have a constant zero span envelope, the transmitter has to handle peak amplitudes that are greater than the average power. This includes all modulation types that involve amplitude modulation –QPSK for example. CDMA transmission modes in particular may have power peaks that are large compared to the average power.

For signals of this kind, the transmitter must provide large reserves for the peak power to prevent signal compression and thus an increase of the bit error rate at the receiver.

The peak power or the crest factor of a signal is therefore an important transmitter design criterion. The crest factor is defined as the peak power/mean power ratio or, logarithmically, as the peak level minus the average level of the signal.

To reduce power consumption and cut costs, transmitters are not designed for the largest power that could ever occur, but for a power that has a specified probability of being exceeded (e.g. 0.01 %).

To measure the amplitude distribution, the R&S ESRP has simple measurement functions to determine both the APD = Amplitude Probability Distribution and CCDF = Complementary Cumulative Distribution Function.

In the APD display mode, the probability of occurrence of a certain level is plotted against the level.

In the CCDF display mode, the probability that the mean signal power will be exceeded is shown in percent.

#### Measurement Example – Measuring the APD and CCDF of White Noise Generated by the R&S ESRP

1. Set the R&S ESRP to its default state by pressing the PRESET key.  
The R&S ESRP is in its default state.
2. Configure the R&S ESRP for APD measurement
  - a) Press the AMPT key and enter "-60 dBm".  
The R&S ESRP's intrinsic noise is displayed at the top of the screen.
  - b) Press the MEAS key.
  - c) Press the "More" softkey.
  - d) Press the "APD" softkey.  
The R&S ESRP sets the frequency span to 0 Hz and measures the amplitude probability distribution (APD). The number of uncorrelated level measurements used for the measurement is 100000. The mean power and the peak power are displayed in dBm. The crest factor (peak power – mean power) is output as well.

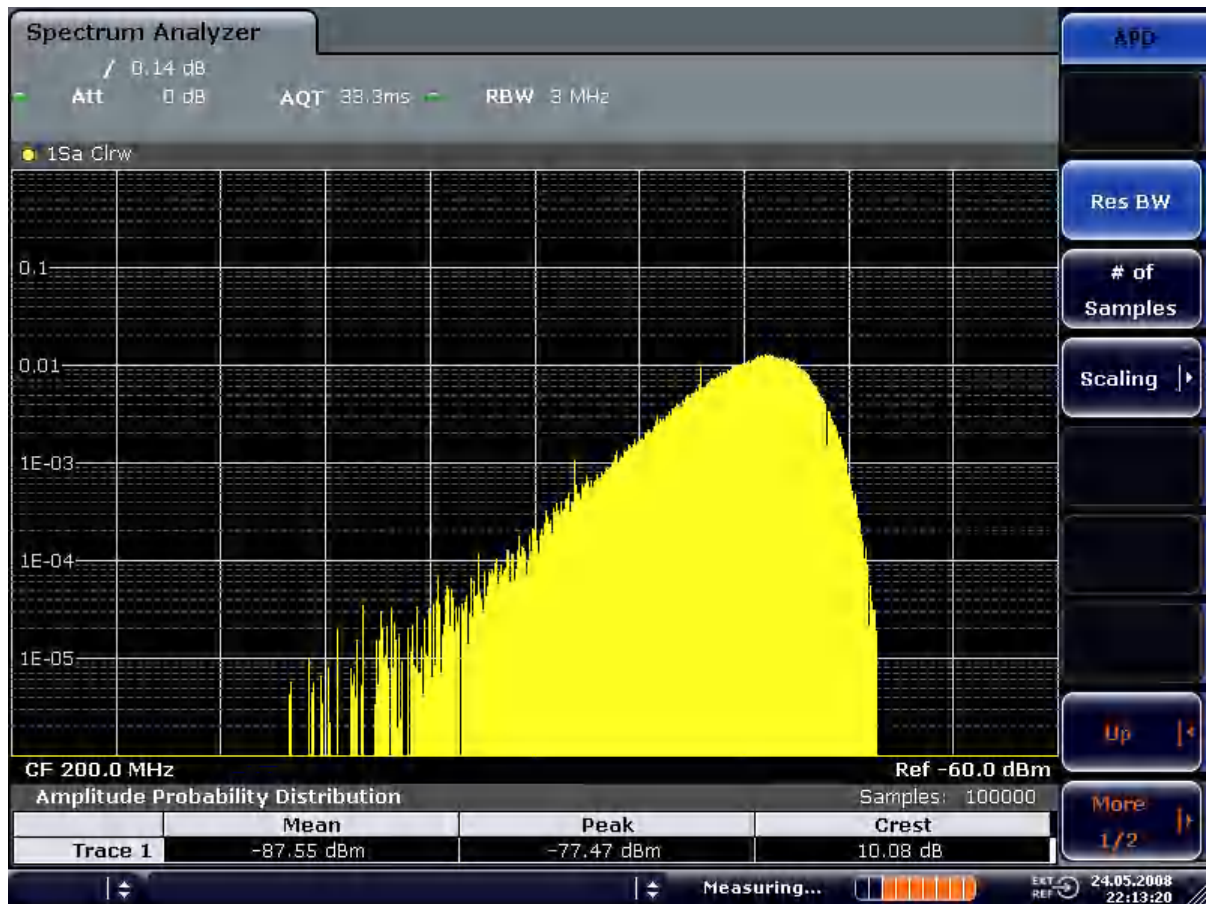

Figure 6-36: Amplitude probability distribution of white noise

3. Switch to the CCDF display mode.
  - a) Press the "UP" key.
  - b) Press the "CCDF" softkey.  
The CCDF display mode is switched on.



Figure 6-37: CCDF of white noise

The CCDF trace indicates the probability that a level will exceed the mean power. The level above the mean power is plotted along the x-axis of the graph. The origin of the axis corresponds to the mean power level. The probability that a level will be exceeded is plotted along the y-axis.

## 7 I/Q Analyzer

The I/Q Analyzer provides functions to capture, visualize and evaluate I/Q data. These functions include:

- capturing data from the RF input
- displaying I/Q data in various result types, e.g. separate Real/Imag diagrams or as an I/Q-vector

### Menu and softkey description

The "I/Q Analyzer" menu is displayed when you select the "I/Q Analyzer" softkey in the [Mode] menu. The same menu is displayed when you press the [MEAS] or [MEAS Config] keys in "I/Q Analyzer" mode. For details see [Chapter 7.1, "Softkeys and Parameters of the I/Q Analyzer Menu"](#), on page 430.

The "Amplitude" menu, which is displayed when you select the [AMPT] key, is described in see [Chapter 7.2, "Softkeys of the Amplitude Menu in I/Q Analyzer Mode"](#), on page 435.

The "Input/Output" menu, which is displayed when you select the [INPUT/OUTPUT] key, as well as the "Save/Recall" menu ([Save/Rcl] key) contain the same functions in I/Q Analyzer mode as in "Spectrum" mode (see [Chapter 6.2.9, "Input/Output Configuration – INPUT/OUTPUT Key"](#), on page 354).

The "Marker" menu is identical to the one in Spectrum mode for display modes "Magnitude", "Real/Imag" and "Spectrum" (except for "Marker Zoom"), see ["Display Config"](#) on page 431. For the other display modes this menu is not available.

The "Marker To" menu is identical to the one in Spectrum mode. For the "I/Q" display mode, an additional function is available, see [Chapter 7.3, "Softkeys of the Marker To Menu in I/Q Analyzer Mode"](#), on page 440.

The "Trace" menu is identical to the one in Spectrum mode, except in "I/Q Vector" display mode. In this case, only 1 trace is available and no detector can be selected (see [Chapter 6.3.1.1, "Softkeys of the Trace Menu"](#), on page 359).

The "Trigger" menu, which is displayed when you select the [TRIG] key, is described in see [Chapter 7.4, "Softkeys of the Trigger Menu in I/Q Analyzer Mode"](#), on page 440.

The "Span", "BW", and "Lines" menus are not available in this mode. All other menus are identical to those described for "Spectrum" mode (see [Chapter 6.2, "Configuration"](#), on page 313 and [Chapter 6.3, "Analysis"](#), on page 358).

### Remote Control

Measurements with the I/Q Analyzer can also be performed via remote control.

For more information see [Chapter 11.6, "Remote Commands in I/Q Analyzer Mode"](#), on page 855.



**Further information**

- Some general information on working with I/Q data can be found in [Chapter 7.5, "Working with I/Q Data"](#), on page 444.

**7.1 Softkeys and Parameters of the I/Q Analyzer Menu**

This section describes the softkeys and parameters of the "I/Q Analyzer" submenu which is displayed when you select the "I/Q Analyzer" softkey in the [MODE] menu. The same menu is displayed when you press the [MEAS] or [MEAS Config] keys in "I/Q Analyzer" mode.

I/Q Analyzer.....	430
L Signal Source.....	430
L Input Path.....	430
L Level.....	431
L Reference Level.....	431
L Preamp On/Off.....	431
L Data Acquisition.....	431
L Sample Rate.....	431
L Filter BW.....	431
L Meas Time.....	431
L Record Length.....	431
L Display Config.....	431
L C/N, C/No.....	433
L C/N.....	434
L C/No.....	434
L Channel Bandwidth .....	434
L Adjust Settings .....	434

**I/Q Analyzer**

Starts the I/Q Analyzer evaluation mode and opens the submenu for the I/Q analyzer, which allows you to configure and display measurements of I/Q data, e.g. digital base-band signals.

Remote command:

Starting I/Q Analyzer:

`TRACe<n>:IQ[:STATe]` on page 866

Selecting evaluation mode:

`TRACe<n>:IQ:EVAL` on page 866

Selecting the I/Q Analyzer display configuration

`CALCulate<n>:FORMat` on page 856

**Signal Source ← I/Q Analyzer**

Opens a dialog box to select the signal source.

**Input Path ← Signal Source ← I/Q Analyzer**

The input path is always "RF Radio Frequency".

**Level ← I/Q Analyzer**

Opens a dialog box to define the level settings.

**Reference Level ← Level ← I/Q Analyzer**

Specifies the reference level for the I/Q measurement.

Remote command:

[DISPlay\[:WINDow<n>\]:TRACe<t>:Y\[:SCALe\]:RVALue](#) on page 857

**Preamp On/Off ← Level ← I/Q Analyzer**

Switches the preamplifier on and off.

Remote command:

[INPut:GAIN:STATe](#) on page 638

**Data Acquisition ← I/Q Analyzer**

Opens a dialog box to configure data acquisition in I/Q Analyzer mode.

**Sample Rate ← Data Acquisition ← I/Q Analyzer**

Defines the I/Q data sample rate of the R&S ESRP.

Remote command:

[TRACe<n>:IQ:SRATe](#) on page 859

**Filter BW ← Data Acquisition ← I/Q Analyzer**

Displays the flat, usable bandwidth of the final I/Q data.

Remote command:

[TRACe<n>:IQ:BWIDth](#) on page 857

**Meas Time ← Data Acquisition ← I/Q Analyzer**

Defines the I/Q acquisition time. By default, the measurement time is calculated as the number of I/Q samples ("Record Length") divided by the sample rate. If you change the measurement time, the [Record Length](#) is automatically changed, as well.

For details on the maximum number of samples see also [Chapter 7.5, "Working with I/Q Data"](#), on page 444.

Remote command:

[\[SENSe:\]SWEep:TIME](#) on page 803

**Record Length ← Data Acquisition ← I/Q Analyzer**

Defines the number of I/Q samples to record. By default, the number of sweep points is used. The record length is calculated as the measurement time multiplied by the sample rate. If you change the record length, the [Meas Time](#) is automatically changed, as well.

Remote command:

[TRACe<n>:IQ:RLENgth](#) on page 858

[TRACe<n>:IQ:SET](#) on page 858

**Display Config ← I/Q Analyzer**

Opens a selection list to specify the result display configuration. The following displays are available:

"Magnitude" Shows the values in time domain

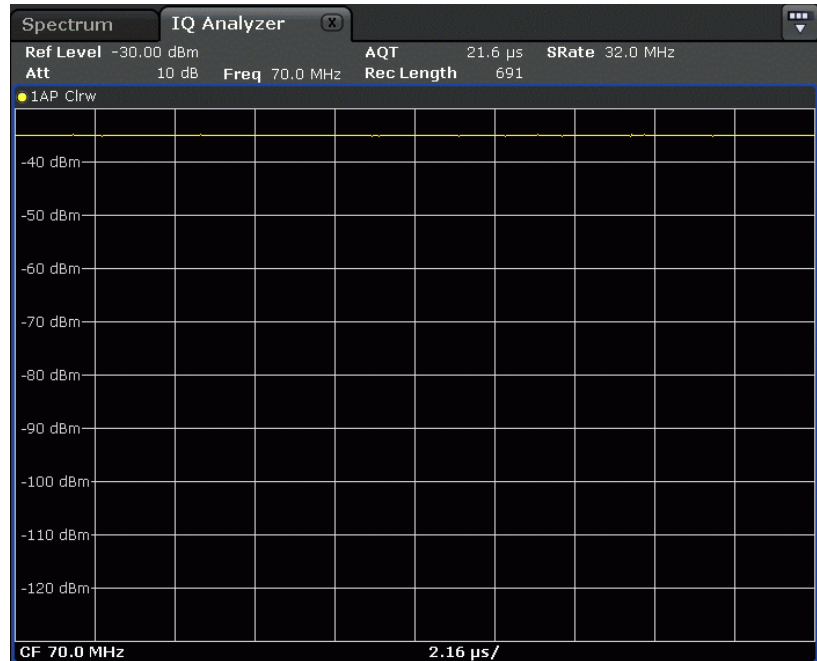

"Spectrum" Displays the frequency spectrum of the captured I/Q samples.

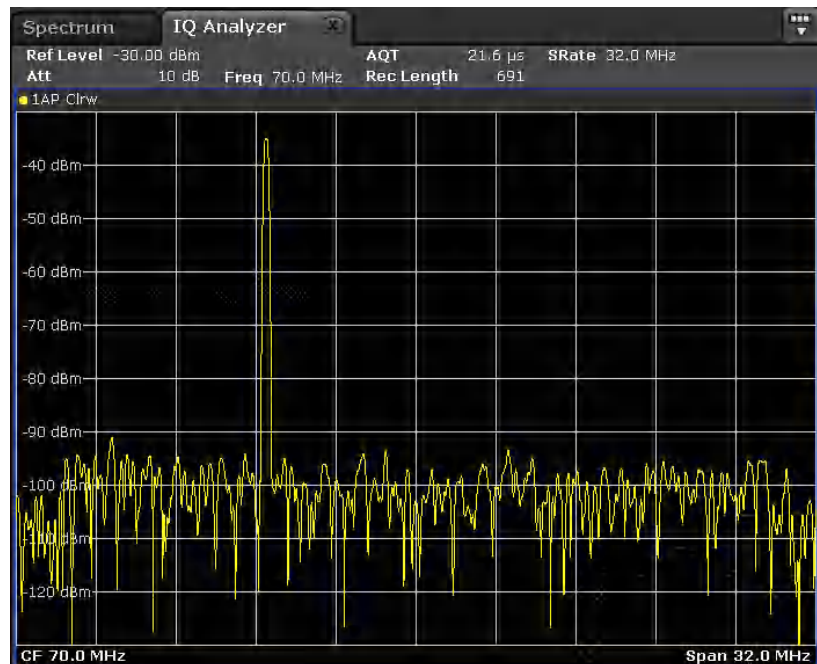

"I/Q-Vector" Displays the captured samples in an I/Q-plot. The samples are connected by a line.

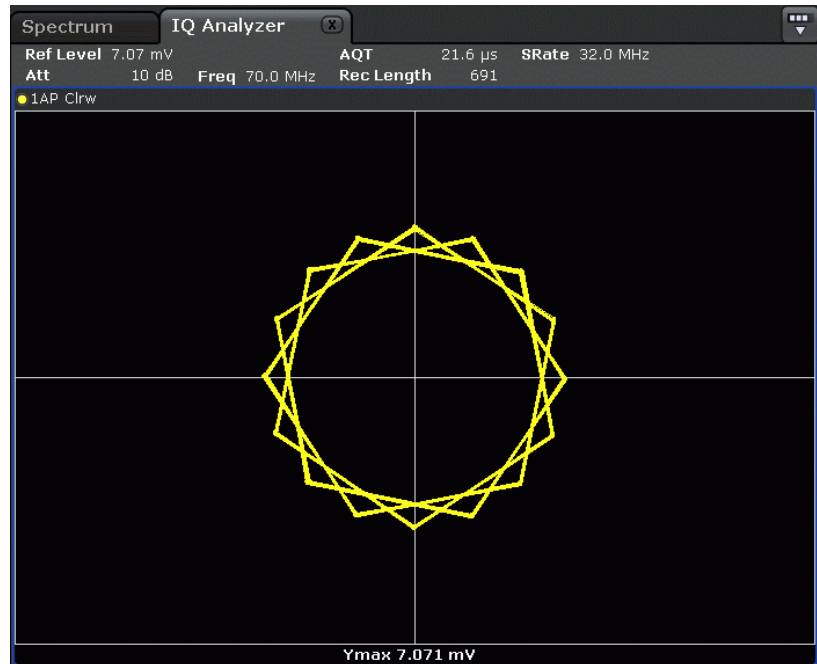

"Real/Imag (I/Q)"

Displays the I and Q values in separate diagrams.

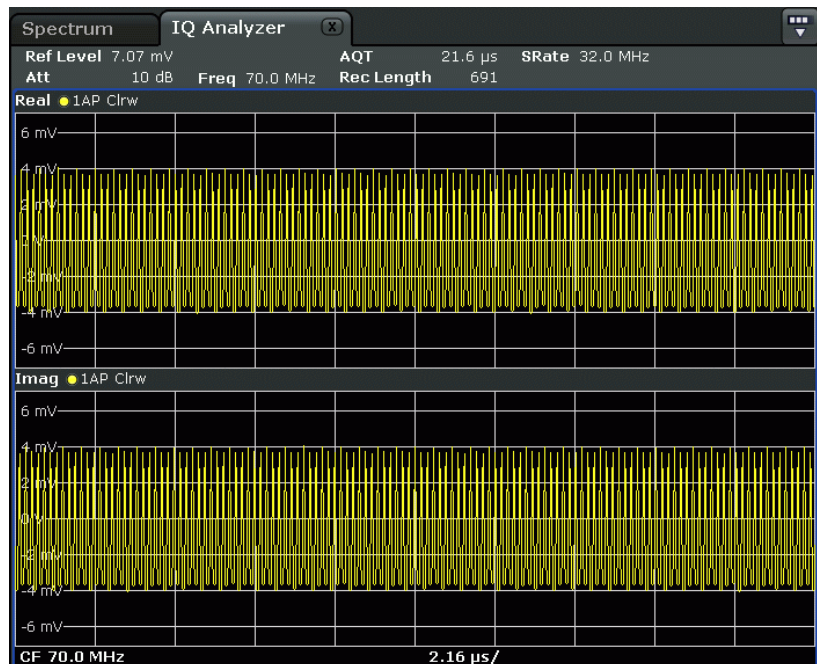

Remote command:

`CALCulate<n>:FORMat` on page 856

**C/N, C/No** ← I/Q Analyzer

Opens a submenu to configure the carrier/noise ratio measurement. Measurements without (C/N) and measurements with reference to the bandwidth (C/No) are possible.

Carrier-to-noise measurements are not available in zero span mode.

**Note:** Carrier-to-noise measurements are also available in the I/Q Analyzer, but only for **Spectrum** displays (see "Display Config" on page 431).

For general information on performing carrier-to-noise ratio measurements see [Chapter 6.1.1.3, "Measuring the Carrier-to-Noise Ratio"](#), on page 225.

#### **C/N ← C/N, C/No ← I/Q Analyzer**

Switches the measurement of the carrier/noise ratio on or off. If no marker is active, marker 1 is activated.

The measurement is performed on the trace that marker 1 is assigned to. To shift marker 1 and measure another trace, use the [Marker to Trace](#) softkey in the "Marker To" menu.

Remote command:

[CALCulate<n>:MARKer<m>:FUNCTION:POWER:SElect](#) on page 688

[CALCulate<n>:MARKer<m>:FUNCTION:POWER:RESult?](#) on page 689

[CALCulate<n>:MARKer<m>:FUNCTION:POWER\[:STATe\]](#) on page 692

#### **C/No ← C/N, C/No ← I/Q Analyzer**

Switches the measurement of the carrier/noise ratio with reference to a 1 Hz bandwidth on or off. If no marker is active, marker 1 is activated.

The measurement is performed on the trace that marker 1 is assigned to. To shift marker 1 and measure another trace, use the [Marker to Trace](#) softkey in the "Marker To" menu.

Remote command:

[CALCulate<n>:MARKer<m>:FUNCTION:POWER:SElect](#) on page 688

[CALCulate<n>:MARKer<m>:FUNCTION:POWER:RESult?](#) on page 689

[CALCulate<n>:MARKer<m>:FUNCTION:POWER\[:STATe\]](#) on page 692

#### **Channel Bandwidth ← C/N, C/No ← I/Q Analyzer**

Opens an edit dialog box to enter the measurement channel bandwidth for each channel.

The default setting is 14 kHz.

Note that in the I/Q Analyzer the channel bandwidth does not change the measurement span or sampling rate; it merely defines the range for the carrier-to-noise analysis.

Remote command:

[\[SENSe:\]POWER:ACHannel:ACPairs](#) on page 698

#### **Adjust Settings ← C/N, C/No ← I/Q Analyzer**

Enables the RMS detector (see also [Chapter 6.3.1.5, "Detector Overview"](#), on page 370) and adjusts the span to the selected channel bandwidth according to:

"4 x channel bandwidth + measurement margin"

The adjustment is performed once; if necessary, the setting can be changed later on.

**Note:** in the I/Q Analyzer, this function is not available. The channel bandwidth defines the range for the carrier-to-noise analysis.

Remote command:

[SENSe:] POWER:ACHannel:PRESet on page 693

## 7.2 Softkeys of the Amplitude Menu in I/Q Analyzer Mode

In I/Q Analyzer mode, the "Amplitude" menu, which is displayed when you select the [AMPT] key, contains the following functions.



If the display configuration for the I/Q Analyzer is set to "I/Q Vector" or "Real/Imag (I/Q)", the [Range](#) and [Unit](#) functions are not available.

Functions to configure the amplitude described elsewhere:

- "10 dB Min" on page 157

Ref Level.....	435
Y-Axis Max.....	436
Range.....	436
L Range Log 100 dB.....	436
L Range Log 50 dB.....	436
L Range Log 10 dB.....	436
L Range Log 5 dB.....	437
L Range Log 1 dB.....	437
L Range Log Manual.....	437
L Range Linear %.....	437
L Range Lin. Unit.....	437
Unit.....	438
Preamp On/Off.....	438
RF Atten Auto.....	438
Ref Level Offset.....	438
Ref Level Position.....	439
Grid Abs/Rel .....	439
Noise Correction.....	439
Input (AC/DC).....	439
Input 50 Ω/75 Ω .....	439

### Ref Level

Opens an edit dialog box to enter the reference level in the current unit (dBm, dBμV, etc).

The reference level is the maximum value the AD converter can handle without distortion of the measured value. Signal levels above this value will not be measured correctly, which is indicated by the "IFOVL" status display.

Remote command:

DISPlay[:WINDow<n>]:TRACe<t>:Y[:SCALE]:RLEVel on page 813

**Y-Axis Max**

Opens an edit dialog box to specify the maximum value of the y-axis in either direction (in Volts). Thus, the y-axis scale starts at  $-<Y\text{-AxisMax}>$  and ends at  $+<Y\text{-AxisMax}>$ .

This command is only available if the display configuration for the I/Q Analyzer is set to "I/Q Vector" or "Real/Imag (I/Q)", see ["Display Config"](#) on page 431.

**Range**

Opens a submenu to define the display range of the level axis.

- [Range Log 100 dB](#)
- [Range Log 50 dB](#)
- [Range Log 10 dB](#)
- [Range Log 5 dB](#)
- [Range Log 1 dB](#)
- [Range Log Manual](#)
- [Range Linear %](#)
- [Range Lin. Unit](#)

**Range Log 100 dB ← Range**

Sets the level display range to 100 dB.

Remote command:

Logarithmic scaling:

DISP:WIND:TRAC:Y:SPAC LOG, see [DISPlay\[:WINDow<n>\]:TRACe<t>:Y:SPACing](#) on page 636

Display range:

DISP:WIND:TRAC:Y 100DB, see [DISPlay\[:WINDow<n>\]:TRACe<t>:Y\[:SCALe\]](#) on page 812

**Range Log 50 dB ← Range**

Sets the level display range to 50 dB.

Remote command:

Logarithmic scaling:

DISP:WIND:TRAC:Y:SPAC LOG, see [DISPlay\[:WINDow<n>\]:TRACe<t>:Y:SPACing](#) on page 636

Display range:

DISP:WIND:TRAC:Y 50DB, see [DISPlay\[:WINDow<n>\]:TRACe<t>:Y\[:SCALe\]](#) on page 812

**Range Log 10 dB ← Range**

Sets the level display range to 10 dB.

Remote command:

Logarithmic scaling:

DISP:WIND:TRAC:Y:SPAC LOG, see [DISPlay\[:WINDow<n>\]:TRACe<t>:Y:SPACing](#) on page 636

Display range:

DISP:WIND:TRAC:Y 10DB, see [DISPlay\[:WINDow<n>\]:TRACe<t>:Y\[:SCALe\]](#) on page 812

**Range Log 5 dB ← Range**

Sets the level display range to 5 dB.

Remote command:

Logarithmic scaling:

DISP:WIND:TRAC:Y:SPAC LOG, see [DISPlay\[:WINDow<n>\]:TRACe<t>:Y:SPACing](#) on page 636

Display range:

DISP:WIND:TRAC:Y 5DB, see [DISPlay\[:WINDow<n>\]:TRACe<t>:Y\[:SCALe\]](#) on page 812

**Range Log 1 dB ← Range**

Sets the level display range to 1 dB.

Remote command:

Logarithmic scaling:

DISP:WIND:TRAC:Y:SPAC LOG, see [DISPlay\[:WINDow<n>\]:TRACe<t>:Y:SPACing](#) on page 636

Display range:

DISP:WIND:TRAC:Y 1DB, see [DISPlay\[:WINDow<n>\]:TRACe<t>:Y\[:SCALe\]](#) on page 812

**Range Log Manual ← Range**

Opens an edit dialog box to define the display range of a logarithmic level axis manually.

Remote command:

Logarithmic scaling:

DISP:WIND:TRAC:Y:SPAC LOG, see [DISPlay\[:WINDow<n>\]:TRACe<t>:Y:SPACing](#) on page 636

Display range:

[DISPlay\[:WINDow<n>\]:TRACe<t>:Y\[:SCALe\]](#) on page 812

**Range Linear % ← Range**

Selects linear scaling for the level axis in %.

The grid is divided into decadal sections.

Markers are displayed in the selected unit ("Unit" softkey). Delta markers are displayed in % referenced to the voltage value at the position of marker 1. This is the default setting for linear scaling.

Remote command:

DISP:TRAC:Y:SPAC LIN, see [DISPlay\[:WINDow<n>\]:TRACe<t>:Y:SPACing](#) on page 636

**Range Lin. Unit ← Range**

Selects linear scaling in dB for the level display range, i.e. the horizontal lines are labeled in dB.

Markers are displayed in the selected unit ("Unit" softkey). Delta markers are displayed in dB referenced to the power value at the position of marker 1.



Remote command:

DISP:TRAC:Y:SPAC LDB, see [DISPlay\[:WINDow<n>\]:TRACe<t>:Y:SPACing](#) on page 636

### Unit

Opens the "Unit" submenu to select the unit for the level axis.

The default setting in spectrum mode is dBm.

If a transducer is switched on, the softkey is not available.

In general, the signal analyzer measures the signal voltage at the RF input. The level display is calibrated in RMS values of an unmodulated sine wave signal. In the default state, the level is displayed at a power of 1 mW (= dBm). Via the known input impedance (50  $\Omega$  or 75  $\Omega$ ), conversion to other units is possible. The following units are available and directly convertible:

- dBm
- dBmV
- dB $\mu$ V
- dB $\mu$ A
- dBpW
- Volt
- Ampere
- Watt

Remote command:

[CALCulate<n>:UNIT:POWer](#) on page 812

### Preamp On/Off

Switches the preamplifier on and off.

Remote command:

[INPut:GAIN:STATe](#) on page 638

### RF Atten Auto

Sets the RF attenuation automatically as a function of the selected reference level. This ensures that the optimum RF attenuation is always used. It is the default setting.

When measuring spurious emissions, using this softkey automatically opens the "Sweep List" dialog, see ["Sweep List dialog box"](#) on page 265.

Remote command:

[INPut:ATTenuation:AUTO](#) on page 814

### Ref Level Offset

Opens an edit dialog box to enter the arithmetic level offset. This offset is added to the measured level irrespective of the selected unit. The scaling of the y-axis is changed accordingly. The setting range is  $\pm 200$  dB in 0.1 dB steps.

Remote command:

[DISPlay\[:WINDow<n>\]:TRACe<t>:Y\[:SCALE\]:RLEVel:OFFSet](#) on page 813

**Ref Level Position**

Opens an edit dialog box to enter the reference level position, i.e. the position of the maximum AD converter value on the level axis. The setting range is from -200 to +200 %, 0 % corresponding to the lower and 100 % to the upper limit of the diagram.

Remote command:

`DISPlay[:WINDow<n>]:TRACe<t>:Y[:SCALe]:RPOSition` on page 814

**Grid Abs/Rel**

Switches between absolute and relative scaling of the level axis (not available with "Linear" range).

"Abs" Absolute scaling: The labeling of the level lines refers to the absolute value of the reference level. Absolute scaling is the default setting.

"Rel" Relative scaling: The upper line of the grid is always at 0 dB. The scaling is in dB whereas the reference level is always in the set unit (for details on unit settings see the "Unit" softkey).

Remote command:

`DISPlay[:WINDow<n>]:TRACe<t>:Y[:SCALe]:MODE` on page 812

**Noise Correction**

If activated, the results are corrected by the instrument's inherent noise, which increases the dynamic range.

"ON" A reference measurement of the instrument's inherent noise is carried out. The noise power measured is then subtracted from the power in the channel that is being examined.

The inherent noise of the instrument depends on the selected center frequency, resolution bandwidth and level setting. Therefore, the correction function is disabled whenever one of these parameters is changed. A disable message is displayed on the screen. Noise correction must be switched on again manually after the change.

"OFF" No noise correction is performed.

"AUTO" Noise correction is performed. After a parameter change, noise correction is restarted automatically and a new correction measurement is performed.

Remote command:

`[SENSe:]POWer:NCORrection` on page 715

**Input (AC/DC)**

Toggles the RF input of the R&S ESRP between AC and DC coupling.

Remote command:

`INPut:COUPling` on page 641

**Input 50 Ω/75 Ω**

Uses 50 Ω or 75 Ω as reference impedance for the measured levels. Default setting is 50 Ω.

The setting 75  $\Omega$  should be selected if the 50  $\Omega$  input impedance is transformed to a higher impedance using a 75  $\Omega$  adapter of the RAZ type (= 25  $\Omega$  in series to the input impedance of the instrument). The correction value in this case is 1.76 dB = 10 log (75  $\Omega$ /50  $\Omega$ ).

All levels specified in this Operating Manual refer to the default setting of the instrument (50  $\Omega$ ).

Remote command:

[INPut : IMPedance](#) on page 638

## 7.3 Softkeys of the Marker To Menu in I/Q Analyzer Mode

In I/Q Analyzer mode, The "Marker To" menu is identical to the one in Spectrum mode (see ["Softkeys of the Marker To Menu"](#) on page 382). For the "Real/Imag (I/Q)" display mode, however, an additional function is available.

### Search Settings

Opens a dialog box to define which data is used for marker search functions.

**Note:** The search settings apply to all markers, not only the currently selected one.

"Search Real" Marker search functions are performed on the real trace of the I/Q measurement.

"Search Imag" Marker search functions are performed on the imaginary trace of the I/Q measurement.

"Search Magnitude" Marker search functions are performed on the magnitude of the I and Q data.

Remote command:

[CALCulate<n>:MARKer<m>:SEARch](#) on page 856

## 7.4 Softkeys of the Trigger Menu in I/Q Analyzer Mode

In I/Q Analyzer mode, the "Trigger" menu, which is displayed when you select the [TRIG] key, contains the following functions:

Trg/Gate Source.....	441
L Free Run.....	441
L External.....	441
L Video.....	441
L RF Power.....	441
L IF Power/BB Power.....	442
L Time.....	443
Trigger Level.....	443
Trigger Polarity.....	443
Trigger Offset.....	443

Repetition Interval.....	444
Trigger Hysteresis.....	444
Trigger Holdoff.....	444

### Trg/Gate Source

Opens the "Trigger/Gate Source" dialog box to select the trigger/gate mode.

As gate modes, all modes except "Power Sensor" are available. For details see also [Chapter 6.2.8.3, "Using Gated Sweep Operation"](#), on page 352.

The default setting is "Free Run". If a trigger mode other than "Free Run" has been set, the enhancement label "TRG" is displayed and the trigger source is indicated.

**Note:** When triggering or gating is activated, the squelch function is automatically disabled (see ["Squelch"](#) on page 392).

Remote command:

TRIGger<n>[:SEQuence]:SOURce on page 807

[SENSe:]SWEep:EGATe:SOURce on page 810

### Free Run ← Trg/Gate Source

The start of a sweep is not triggered. Once a measurement is completed, another is started immediately.

Remote command:

TRIG:SOUR IMM, see [TRIGger<n>\[:SEQuence\]:SOURce](#) on page 807

### External ← Trg/Gate Source

Defines triggering via a TTL signal at the "EXT TRIG/GATE IN" input connector on the rear panel.

Remote command:

TRIG:SOUR EXT, see [TRIGger<n>\[:SEQuence\]:SOURce](#) on page 807

SWE:EGAT:SOUR EXT for gated triggering, see [\[SENSe:\]SWEep:EGATe:SOURce](#) on page 810

### Video ← Trg/Gate Source

Defines triggering by the displayed voltage.

A horizontal trigger line is shown in the diagram. It is used to set the trigger threshold from 0 % to 100 % of the diagram height.

Video mode is only available in the time domain.

Remote command:

TRIG:SOUR VID, see [TRIGger<n>\[:SEQuence\]:SOURce](#) on page 807

SWE:EGAT:SOUR VID for gated triggering, see [\[SENSe:\]SWEep:EGATe:SOURce](#) on page 810

### RF Power ← Trg/Gate Source

Defines triggering of the measurement via signals which are outside the measurement channel.

In RF Power trigger mode the instrument uses a level detector at the first intermediate frequency. The detector threshold can be selected in a range between - 50 dBm and -10 dBm at the input mixer. The resulting trigger level at the RF input lies within the following range:

$(-24\text{dBm} + \text{RF Att}) \leq \text{Triggerlevel} \leq (+5\text{dBm} + \text{RF Att})$ , max. 30 dBm, for Preamp = OFF

$(-40\text{dBm} + \text{RF Att}) \leq \text{Triggerlevel} \leq (-11\text{dBm} + \text{RF Att})$ , max. 30 dBm, for Preamp = ON with

$500 \text{ MHz} \leq \text{InputSignal} \leq 7 \text{ GHz}$

**Note:** If input values outside of this range occur (e.g. for fullspan measurements), the sweep may be aborted and a message indicating the allowed input values is displayed in the status bar.

A **Trigger Offset**, **Trg/Gate Polarity** and **Trigger Holdoff** can be defined for the RF trigger to improve the trigger stability, but no hysteresis.

Remote command:

TRIG:SOUR RFP, see TRIGger<n>[:SEquence]:SOURce on page 807

SWE:EGAT:SOUR RFP for gated triggering, see [SENSe:]SWEep:EGATe:SOURce on page 810

#### IF Power/BB Power ← Trg/Gate Source

Defines triggering of the measurement using the second intermediate frequency.

For this purpose, the R&S ESRP uses a level detector at the second intermediate frequency.

The available trigger levels depend on the RF attenuation and preamplification. A reference level offset, if defined, is also considered.

For details on available trigger levels and trigger bandwidths see the data sheet.

The bandwidth at the intermediate frequency depends on the RBW and sweep type:

Sweep mode:

- RBW > 500 kHz: 40 MHz, nominal
- RBW ≤ 500 kHz: 6 MHz, nominal

FFT mode:

- RBW > 20 kHz: 40 MHz, nominal
- RBW ≤ 20 kHz: 6 MHz, nominal

**Note:** Be aware that in auto sweep type mode, due to a possible change in sweep types, the bandwidth may vary considerably for the same RBW setting.

The R&S ESRP is triggered as soon as the trigger level is exceeded around the selected frequency (= start frequency in the frequency sweep).

Thus, the measurement of spurious emissions, e.g. for pulsed carriers, is possible even if the carrier lies outside the selected frequency span.

Remote command:

TRIG:SOUR IFP, see TRIGger<n>[:SEquence]:SOURce on page 807

SWE:EGAT:SOUR IFP for gated triggering, see [SENSe:]SWEep:EGATe:SOURce on page 810

**Time ← Trg/Gate Source**

Opens an edit dialog box to define a repetition interval in which the measurement is triggered. The shortest interval is 2 ms.

Remote command:

TRIG:SOUR TIME:TRIGger<n>[:SEquence]:SOURce on page 807

**Trigger Level**

Defines the trigger level as a numeric value.

In the trigger mode "Time", this softkey is not available.

Remote command:

TRIGger<n>[:SEquence]:LEVel:IFPower on page 806

TRIGger<n>[:SEquence]:LEVel:VIDeo on page 806

**Trigger Polarity**

Sets the polarity of the trigger source.

The sweep starts after a positive or negative edge of the trigger signal. The default setting is "Pos". The setting applies to all modes with the exception of the "Free Run" and "Time" mode.

"Pos" Level triggering: the sweep is stopped by the logic "0" signal and restarted by the logical "1" signal after the gate delay time has elapsed.

"Neg" Edge triggering: the sweep is continued on a "0" to "1" transition for the gate length duration after the gate delay time has elapsed.

Remote command:

TRIGger<n>[:SEquence]:SLOPe on page 807

[SENSe:]SWEep:EGATE:POLarity on page 810

**Trigger Offset**

Opens an edit dialog box to enter the time offset between the trigger signal and the start of the sweep.

offset > 0:	Start of the sweep is delayed
offset < 0:	Sweep starts earlier (pre-trigger) Only possible for span = 0 (e.g. I/Q Analyzer mode) and gated trigger switched off Maximum allowed range limited by the sweep time: $\text{pretrigger}_{\text{max}} = \text{sweep time}$

In the "External" or "IF Power" trigger mode, a common input signal is used for both trigger and gate. Therefore, changes to the gate delay will affect the trigger delay (trigger offset) as well.

**Tip:** To determine the trigger point in the sample (for "External" or "IF Power" trigger mode), use the TRACe<n>:IQ:TPISample? command.

In the "Time" trigger mode, this softkey is not available.

Remote command:

TRIGger<n>[:SEquence]:HOLDoff[:TIME] on page 804

**Repetition Interval**

Opens an edit dialog box to define a repetition interval in which the measurement is triggered. The shortest interval is 2 ms. This softkey is only available if the trigger source "Time" is selected (see "Time" on page 348).

Remote command:

`TRIGger<n>[:SEquence]:TIME:RINTerval` on page 808

**Trigger Hysteresis**

Defines the value for the trigger hysteresis for "IF power" or "RF Power" trigger sources. The hysteresis in dB is the value the input signal must stay below the power trigger level in order to allow a trigger to start the measurement. The range of the value is between 3 dB and 50 dB with a step width of 1 dB.

Remote command:

`TRIGger<n>[:SEquence]:IFPower:HYSteresis` on page 805

**Trigger Holdoff**

Defines the value for the trigger holdoff. The holdoff value in s is the time which must pass before triggering, in case another trigger event happens.

This softkey is only available if "IFPower", "RF Power" or "BBPower" is the selected trigger source.

Remote command:

`TRIGger<n>[:SEquence]:IFPower:HOLDoff` on page 805

## 7.5 Working with I/Q Data

This section describes I/Q data processing of RF input, e.g. in the I/Q Analyzer.

The block diagram in [Figure 7-1](#) shows the analyzer hardware for active RF input from the IF section to the processor.

The A/D converter samples the IF signal at a rate of 128 MHz. The digital signal is down-converted to the complex baseband, lowpass-filtered, and the sample rate is reduced. The continuously adjustable sample rates are realized using an optimal decimation filter and subsequent resampling on the set sample rate.

The I/Q data is written to a single memory, the data acquisition is hardware-triggered.

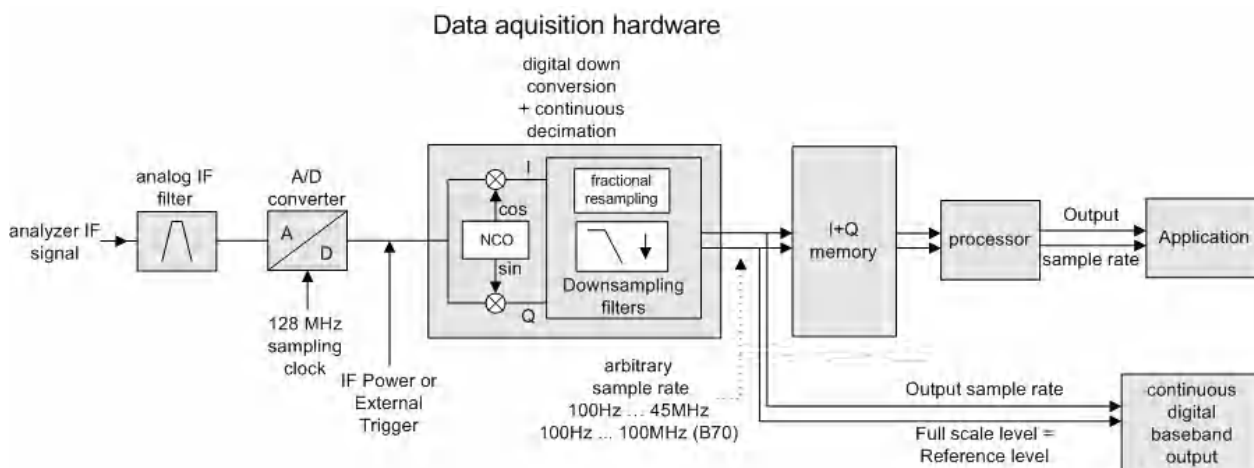

Figure 7-1: Block diagram illustrating the R&S ESRP signal processing

### Maximum number of samples

The maximum number of samples for RF input is 200 MS.

## 7.5.1 Sample Rate and Maximum Usable Bandwidth (RF Input)

### Definitions

- **Input sample rate (ISR):** the sample rate of the useful data provided by the connected instrument to the R&S ESRP input
- (User, Output) **Sample rate (SR):** the sample rate that is defined by the user (e.g. in the "Data Acquisition" dialog box in the "I/Q Analyzer" application) and which is used as the basis for analysis or output
- **Usable I/Q (Analysis) bandwidth:** the bandwidth range in which the signal remains undistorted in regard to amplitude characteristic and group delay; this range can be used for accurate analysis by the R&S ESRP

For the I/Q data acquisition, digital decimation filters are used internally. The passband of these digital filters determines the *maximum usable I/Q bandwidth*. In consequence, signals within the usable I/Q bandwidth (passband) remain unchanged, while signals outside the usable I/Q bandwidth (passband) are suppressed. Usually, the suppressed signals are noise, artifacts, and the second IF side band. If frequencies of interest to you are also suppressed, you should try to increase the output sample rate, since this increases the maximum usable I/Q bandwidth.

### Relationship between sample rate and usable bandwidth

The diagram [Figure 7-2](#) shows the maximum usable I/Q bandwidths depending on the user sample rates.

As a rule, the usable bandwidth is proportional to the output sample. Yet, when the I/Q bandwidth reaches the bandwidth of the analog IF filter (at very high sample rates), the curve breaks.



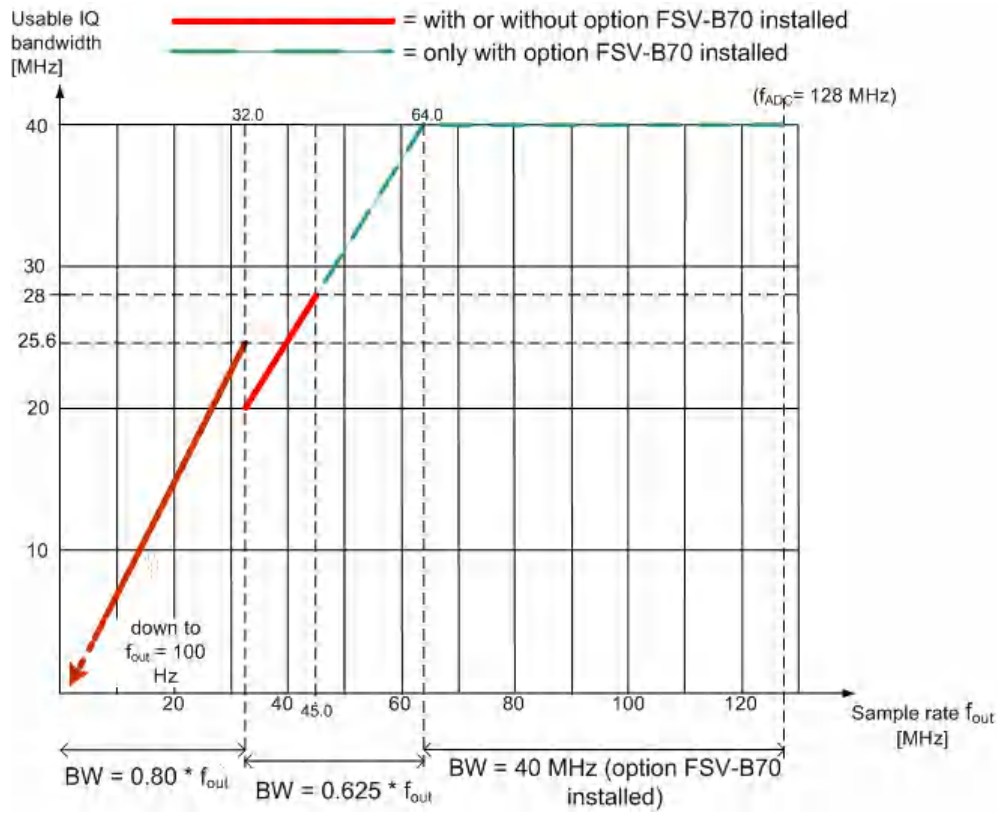

Figure 7-2: Relation between maximum usable bandwidth and sample rate (RF input)

## 8 Tracking Generator

Equipped with option R&S FSV-B9, an internal tracking generator emits a signal at the exact input frequency of the analyzer during operation. The generated signal is sent to the DUT, thus allowing the analyzer to control the input frequency of the device directly.

When you equip the R&S ESRP with option R&S FSV-B10, you are also able to control various commercially available generators as a tracking generator.

Tracking generator control is available in "Spectrum" and "I/Q Analyzer" mode for frequency, time or I/Q measurements. Special measurement functions are not available with tracking generator control. The corresponding softkeys in the "Measurement" menu are deactivated in this case.

### Menu and softkey description

- [Chapter 8.1, "Softkeys of the Tracking Generator Menu"](#), on page 447

### Further information

## 8.1 Softkeys of the Tracking Generator Menu

The "Tracking Generator" menu is displayed when you press the INPUT/OUTPUT key and then "Tracking Generator".

This softkey is only available if the R&S FSV option Tracking Generator (B9) or External Tracking Generator (B10) or both are installed. The following table shows all softkeys available in the "Tracking Generator" menu.



As long as a tracking generator is active, the HOME key also displays the "Tracking Generator" menu.

Source RF Internal (On/ Off).....	448
Source Power.....	448
Source Cal.....	448
L Calibrate Transmission.....	448
L Calibrate Reflection Short.....	448
L Calibrate Reflection Open.....	448
L Normalize.....	449
L Reference Value Position.....	449
L Reference Value.....	449
L Recall.....	449
L Save As Trd Factor.....	450
Modulation.....	450
L External AM.....	450
L External FM.....	450
L External I/Q.....	450
L Modulation OFF.....	450

Power Sweep.....	451
L Power Sweep (On /Off).....	451
L Power Sweep Start.....	451
L Power Sweep Stop.....	451
Source Config.....	452

### Source RF Internal (On/ Off)

Switches the selected tracking generator on or off. Default setting is off. The currently selected generator is indicated on the softkey.

Remote command:

`OUTPut [:STATe]` on page 869

Activates the internal tracking generator (B9).

`SOURce<n>:EXTernal<generator> [:STATe]` on page 880

Activates the external tracking generator 1 (B10).

### Source Power

Opens an edit dialog box to quickly change the output power of the currently selected tracking generator, alternatively to the "Tracking Generator configuration" dialog box (see "Source Config" on page 452 softkey).

The default output power is -20 dBm. The range is specified in the data sheet.

Remote command:

`SOURce<n>:POWER [:LEVel] [:IMMediate] [:AMPLitude]` on page 873

### Source Cal

Opens a submenu to configure calibration for transmission and reflection measurement for tracking generators. For details on the test setups see [Chapter 8.4.2, "Calibrating for transmission and reflection measurement"](#), on page 464.

### Calibrate Transmission ← Source Cal

Starts a sweep that records a reference trace. This trace is used to calculate the difference for the normalized values.

Remote command:

`[SENSe:]CORRection:METhod` on page 870

Selects the transmission method and starts the sweep to record a reference trace.

### Calibrate Reflection Short ← Source Cal

Starts a sweep as a reference trace for short-circuit calibration.

If both calibrations (open circuit, short circuit) are carried out, the calibration curve is calculated by averaging the two measurements and stored in the memory. The order of the two calibration measurements is irrelevant.

Remote command:

`[SENSe:]CORRection:METhod` on page 870

Selects the reflection method.

`[SENSe:]CORRection:COLLect [:ACQuire]` on page 869

Starts the sweep for short-circuit calibration.

### Calibrate Reflection Open ← Source Cal

Starts a sweep as a reference trace for the open-circuit calibration.

If both calibrations (open circuit, short circuit) are carried out, the calibration curve is calculated by averaging the two measurements and stored in the memory. The order of the two calibration measurements is irrelevant.

Remote command:

`[SENSe:]CORRection:MEtHod` on page 870

Selects the reflection method.

`[SENSe:]CORRection:COLLect[:ACQuire]` on page 869

Starts the sweep for open-circuit calibration.

#### **Normalize ← Source Cal**

Switches the normalization on or off. The softkey is only available if the memory contains a reference trace. For details on normalization see [Chapter 8.4.5, "Normalization"](#), on page 465.

Remote command:

`[SENSe:]CORRection[:STATe]` on page 870

#### **Reference Value Position ← Source Cal**

Switches the reference line on or off. The reference line marks the reference position at which the normalization result (calculated difference to a reference trace) is displayed. For details on the reference line see [Chapter 8.4.5, "Normalization"](#), on page 465.

Remote command:

`DISPlay[:WINDow<n>]:TRACe<t>:Y[:SCALe]:RPOSition` on page 814

#### **Reference Value ← Source Cal**

Opens an edit dialog box to enter a position value that shifts the reference line vertically. By default, the reference line corresponds to a difference of 0 dB between the currently measured trace and the reference trace.

If a 10 dB attenuation is inserted into the signal path between DUT and R&S ESRP input, for example after a source calibration, the measurement trace is moved down by 10 dB. Entering a reference value of -10 dB will also shift the reference line down by 10 dB and place the measurement trace on the reference line. The deviation from the nominal power level can be displayed with higher resolution (e.g. 1 dB/div). The power is still displayed in absolute values.

Remote command:

`DISPlay[:WINDow<n>]:TRACe<t>:Y[:SCALe]:RVALue` on page 857

#### **Recall ← Source Cal**

Restores the settings that were used during source calibration. This can be useful if instrument settings were changed after calibration (e.g. center frequency, frequency deviation, reference level, etc).

Remote command:

`[SENSe:]CORRection:RECall` on page 870

**Save As Trd Factor ← Source Cal**

Uses the normalized measurement data to generate a transducer factor with up to 625 points. The trace data is converted to a transducer with unit dB and stored in a file with the specified name and the suffix.trd under "c:\r\_s\instr\trd". The frequency points are allocated in equidistant steps between start and stop frequency. The generated transducer factor can be further adapted using the "Transducer" softkey in the "SETUP" menu.

The "Save As Trd Factor" softkey is only available if normalization is switched on.

Remote command:

[\[SENSe:\]CORRection:TRANsducer:GENerator](#) on page 875

**Modulation**

Opens a submenu to define modulation settings. This submenu contains the following commands:

- ["External AM"](#) on page 450
- ["External FM"](#) on page 450
- ["External I/Q"](#) on page 450
- ["Modulation OFF"](#) on page 450

**External AM ← Modulation**

Activates an AM modulation of the tracking generator output signal.

The modulation signal is applied to the TG IN I/AM connector. An input voltage of 1 V corresponds to 100 % amplitude modulation.

Switching on an external AM disables the active I/Q modulation.

Remote command:

[SOURce<n>:AM:STATe](#) on page 871

**External FM ← Modulation**

Activates the FM modulation of the tracking generator output signal. The modulation signal is applied to the TG IN Q/FM connector. Switching on an external FM disables the active I/Q modulation.

Remote command:

[SOURce<n>:FM:STATe](#) on page 872

[SOURce<n>:FM:DEVIation](#) on page 872

**External I/Q ← Modulation**

Activates the external I/Q modulation of the tracking generator output signal. The signals for modulation are applied to the two input connectors TG IN I and TG IN Q at the rear panel of the unit. The input voltage range is  $\pm 1$  V into 50  $\Omega$ . Switching on an external I/Q modulation disables the active AM or FM modulation.

Remote command:

[SOURce<n>:DM:STATe](#) on page 871

**Modulation OFF ← Modulation**

Deactivates external modulation of the tracking generator output signal.

Remote command:

[SOURce<n>:AM:STATe](#) on page 871

[SOURce<n>:DM:STATe](#) on page 871

[SOURce<n>:FM:STATe](#) on page 872

### Power Sweep

Opens a submenu to define power sweep settings.

This softkey is only available if the (internal) Tracking Generator option (B9) is installed.

This submenu contains the following commands:

- ["Power Sweep \(On /Off\)"](#) on page 451
- ["Power Sweep Start"](#) on page 451
- ["Power Sweep Stop"](#) on page 451

### Power Sweep (On /Off) ← Power Sweep

Activates or deactivates the power sweep. If the power sweep is on, the analyzer is set to zero span mode (span = 0Hz). During the sweep time of the zero span, the power at the internal tracking generator is changed linearly from start power to stop power. The start and stop power for the power sweep are displayed in the diagram header ("INT TG <start power>... <stop power>", see also [Chapter 8.5, "Displayed Information and Errors"](#), on page 471.

The start power can be set between -30 dBm and +0 dBm.

The stop value can also be set between -30 dBm and +0 dBm and may be smaller than the start value.

The difference between the start and stop values may not exceed 10 dB.

This softkey is only available if the (internal) Tracking Generator option (B9) is installed.

Remote command:

[SOURce<n>:POWer:MODE](#) on page 874

### Power Sweep Start ← Power Sweep

Defines the start power of the power sweep.

The start power can be set between -30 dBm and +0 dBm.

The difference between the start and stop values may not exceed 10 dB.

This softkey is only available if the (internal) Tracking Generator option (B9) is installed.

Remote command:

[SOURce<n>:POWer:START](#) on page 874

### Power Sweep Stop ← Power Sweep

Defines the stop power of the power sweep.

The stop power can be set between -30 dBm and +0 dBm.

The difference between the start and stop values may not exceed 10 dB.

This softkey is only available if the (internal) Tracking Generator option (B9) is installed.

Remote command:

`SOURce<n>:POWer:STOP` on page 875

### Source Config

Opens the "Tracking Generator Configuration" dialog, see [Chapter 8.3, "Configuring Tracking Generators"](#), on page 456.

## 8.2 Connecting External Tracking Generators

The external tracking generator is controlled either via a LAN connection or via the – optional – second GPIB interface of the R&S ESRP (= IEC2, supplied with the option).

Using GPIB, with some Rohde & Schwarz generators, additionally the TTL synchronization interface included in the AUX interface of the R&S ESRP can be used.



Using the TTL interface allows for considerably higher measurement rates than pure GPIB control, because the frequency stepping of the R&S ESRP is directly coupled with the frequency stepping of the generator.

Therefore, the frequency sweep differs according to the capabilities of the employed generator:

- For generators without a TTL interface, the generator frequency is set for each frequency point via GPIB first, then the setting procedure has to be completed before recording of measured values is possible.
- For generators with a TTL interface, a list of the frequencies to be set is entered into the generator before the beginning of the first sweep. Then the sweep is started and the next frequency point is selected using the TTL handshake line TRIGGER. Recording measured values is only enabled when the generator signals the end of the setting procedure via the BLANK signal. This method is considerably faster than pure GPIB control.

The "Tracking Generator Configuration" dialog provides a list of the supported generators with the frequency and level range, as well as the capabilities used. The interface settings are defined using the "Source Config" on page 452 softkey. For details see [Chapter 8.3.2, "External Tracking Generator"](#), on page 458.

In order to use the functions of the external tracking generator, an appropriate generator must be connected and configured correctly. If no external generator is selected, if the GPIB or TCP/IP address is not correct, or the generator is not ready for operation, an error message is displayed ("Ext. Generator GPIB Handshake Error!" or "Ext. Generator TCPIP Handshake Error!").

[Figure 8-1](#) illustrates the TTL connection using an SMU generator, for example.

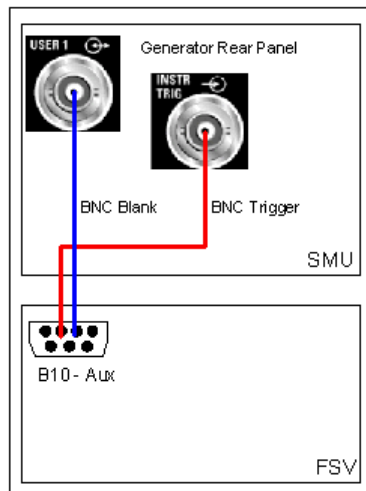

Figure 8-1: TTL connection for an SMU generator



In order to enhance measurement accuracy, a common reference frequency should be used for both the R&S ESRP and the generator. If no independent 10 MHz reference frequency is available, it is recommended that you connect the reference output of the generator with the reference input of the R&S ESRP and that you enable usage of the external reference on the R&S ESRP via "SETUP" >"Reference EXT".

### 8.2.1 Overview of Generators Supported by the R&S ESRP



The R&S SMA and R&S SMU require the following firmware versions:

R&S SMA: V2.10.x or higher

R&S SMU: V1.10 or higher

Generator	Interface Type	Generator Min Freq	Generator Max Freq	Generator Min Power dBm	Generator Max Power dBm
SMA01A	TTL	9 kHz	3.0 GHz	-145	+30
SMBV100A3	TTL	9 kHz	3.2 GHz	-145	+30
SMBV100A6	TTL	9 kHz	6.0 GHz	-145	+30
SMC100A1	TTL	9 kHz	1.1 GHz	-120	+30

- 1) Requires the option SMR-B11 to be fitted.
- 2) Maximum/minimum power depends on presence of Option SMR-B15/-B17 and set frequency range. For more details see SMR data sheet.
- 3) Maximum/minimum power depends on presence of Option SMP-B15/-B17 and set frequency range. For more details see SMP data sheet.
- 4) Requires firmware version V3.20.200 or higher on the signal generator



## Connecting External Tracking Generators

Generator	Interface Type	Generator Min Freq	Generator Max Freq	Generator Min Power dBm	Generator Max Power dBm
SMC100A3	TTL	9 kHz	3.2 GHz	-145	+30
SME02	TTL	5 kHz	1.5 GHz	-144	+16
SME03	TTL	5 kHz	3.0 GHz	-144	+16
SME06	TTL	5 kHz	6.0 GHz	-144	+16
SMG	GPIB	100 kHz	1.0 GHz	-137	+13
SMGL	GPIB	9 kHz	1.0 GHz	-118	+30
SMGU	GPIB	100 kHz	2.16 GHz	-140	+13
SMH	GPIB	100 kHz	2.0 GHz	-140	+13
SMHU	GPIB	100 kHz	4.32 GHz	-140	+13
SMIQ02B	TTL	300 kHz	2.2 GHz	-144	+13
SMIQ02E	GPIB	300 kHz	2.2 GHz	-144	+13
SMIQ03B	TTL	300 kHz	3.3 GHz	-144	+13
SMIQ03E	GPIB	300 kHz	3.3 GHz	-144	+13
SMIQ04B	TTL	300 kHz	4.4 GHz	-144	+10
SMIQ06B	TTL	300 kHz	6.4 GHz	-144	+10
SML01	GPIB	9 kHz	1.1 GHz	-140	+13
SML02	GPIB	9 kHz	2.2 GHz	-140	+13
SML03	GPIB	9 kHz	3.3 GHz	-140	+13
SMR20	TTL	1 GHz	20 GHz	-130 <sup>2)</sup>	+11 <sup>2)</sup>
SMR20B11 <sup>1)</sup>	TTL	10 MHz	20 GHz	-130 <sup>2)</sup>	+13 <sup>2)</sup>
SMR27	TTL	1 GHz	27 GHz	-130 <sup>2)</sup>	+11 <sup>2)</sup>
SMR27B11 <sup>1)</sup>	TTL	10 MHz	27 GHz	-130 <sup>2)</sup>	+12 <sup>2)</sup>
SMR30	TTL	1 GHz	30 GHz	-130 <sup>2)</sup>	+11 <sup>2)</sup>
SMR30B11 <sup>1)</sup>	TTL	10 MHz	30 GHz	-130 <sup>2)</sup>	+12 <sup>2)</sup>
SMR40	TTL	1 GHz	40 GHz	-130 <sup>2)</sup>	+9 <sup>2)</sup>
SMR40B11 <sup>1)</sup>	TTL	10 MHz	40 GHz	-130 <sup>2)</sup>	+12 <sup>2)</sup>
SMR50	TTL	1 GHz	50 GHz	-130 <sup>2)</sup>	+9 <sup>2)</sup>

1) Requires the option SMR-B11 to be fitted.

2) Maximum/minimum power depends on presence of Option SMR-B15/-B17 and set frequency range. For more details see SMR data sheet.

3) Maximum/minimum power depends on presence of Option SMP-B15/-B17 and set frequency range. For more details see SMP data sheet.

4) Requires firmware version V3.20.200 or higher on the signal generator

## Connecting External Tracking Generators

Generator	Interface Type	Generator Min Freq	Generator Max Freq	Generator Min Power dBm	Generator Max Power dBm
SMR50B11 <sup>1)</sup>	TTL	10 MHz	50 GHz	-130 <sup>2)</sup>	+12 <sup>2)</sup>
SMR60	TTL	1 GHz	60 GHz	-130 <sup>2)</sup>	+9 <sup>2)</sup>
SMR60B11 <sup>1)</sup>	TTL	10 MHz	60 GHz	-130 <sup>2)</sup>	+12 <sup>2)</sup>
SMP02	TTL	10 MHz	20 GHz	-130 <sup>3)</sup>	+17 <sup>3)</sup>
SMP03	TTL	10 MHz	27 GHz	-130 <sup>3)</sup>	+13 <sup>3)</sup>
SMP04	TTL	10 MHz	40 GHz	-130 <sup>3)</sup>	+12 <sup>3)</sup>
SMP22	TTL	10 MHz	20 GHz	-130 <sup>3)</sup>	+20 <sup>3)</sup>
SMT02	GPIB	5.0 kHz	1.5 GHz	-144	+13
SMT03	GPIB	5.0 kHz	3.0 GHz	-144	+13
SMT06	GPIB	5.0 kHz	6.0 GHz	-144	+13
SMV03	GPIB	9 kHz	3.3 GHz	-140	+13
SMU200A	TTL	100 kHz	2.2 GHz	-145	+13
SMU02B31	TTL	100 kHz	2.2 GHz	-145	+19
SMU03	TTL	100 kHz	3 GHz	-145	+13
SMU03B31	TTL	100 kHz	3 GHz	-145	+19
SMU04	TTL	100 kHz	4 GHz	-145	+13
SMU04B31	TTL	100 kHz	4 GHz	-145	+19
SMU06	TTL	100 kHz	6 GHz	-145	+13
SMU06B31	TTL	100 kHz	6 GHz	-145	+19
SMW20	TTL <sup>4)</sup>	100 kHz	20 GHz	-145	+30
SMW40	TTL <sup>4)</sup>	100 kHz	40 GHz	-145	+30
SMX	GPIB	100 kHz	1.0 GHz	-137	+13
SMY01	GPIB	9 kHz	1.04 GHz	-140	+13
SMY02	GPIB	9 kHz	2.08 GHz	-140	+13
HP8340A	GPIB	10 MHz	26.5 GHz	-110	10
HP8648	GPIB	9 kHz	4 GHz	-136	10

1) Requires the option SMR-B11 to be fitted.

2) Maximum/minimum power depends on presence of Option SMR-B15/-B17 and set frequency range. For more details see SMR data sheet.

3) Maximum/minimum power depends on presence of Option SMP-B15/-B17 and set frequency range. For more details see SMP data sheet.

4) Requires firmware version V3.20.200 or higher on the signal generator

Generator	Interface Type	Generator Min Freq	Generator Max Freq	Generator Min Power dBm	Generator Max Power dBm
HP ESG-A Series 1000A, 2000A, 3000A, 4000A	GPIB	250 kHz	4 GHz	-136	20
HP ESG-D SERIES E4432B	GPIB	250 kHz	3 GHz	-136	+10

- 1) Requires the option SMR-B11 to be fitted.
- 2) Maximum/minimum power depends on presence of Option SMR-B15/-B17 and set frequency range. For more details see SMR data sheet.
- 3) Maximum/minimum power depends on presence of Option SMP-B15/-B17 and set frequency range. For more details see SMP data sheet.
- 4) Requires firmware version V3.20.200 or higher on the signal generator

## 8.3 Configuring Tracking Generators

The "Tracking Generator Configuration" dialog box is opened via the "Source Config" softkey in the "Tracking Generator" menu.

This dialox box allows you to define measurement settings, as well as connection settings for the optional external generators (option B10 only). Depending on which options are installed, the corresponding tabs for internal or external generators, or both, are displayed.

- [Chapter 8.3.1, "Internal Tracking Generator"](#), on page 456
- [Chapter 8.3.2, "External Tracking Generator"](#), on page 458

### 8.3.1 Internal Tracking Generator

The internal tracking generator is configured in the "Internal" tab of the "tracking Generator Configuration" dialog box.

In the top half of the dialog box, the measurement configurations can be defined. In the lower half of the dialog box, the capabilities of the internal tracking generator are displayed for reference only.

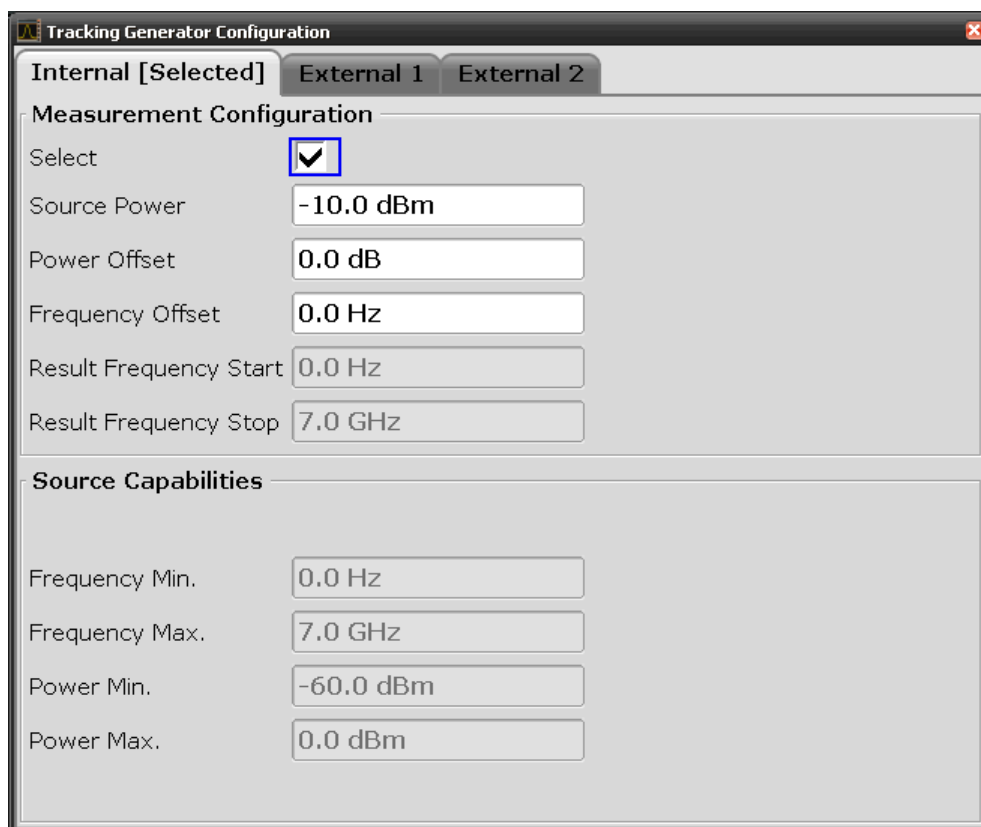

The configuration dialog box contains the following fields:

### Select

Selects the internal tracking generator as the current tracking generator source. "Internal" is displayed as the source on the "Source RF" softkey. All tracking generator functions are performed with the currently selected source.

**Note:** Note that the generator is not automatically activated when it is selected. To activate the currently selected generator, click the "Source RF On" softkey.

### Source Power

The tracking generator output power. The default output power is -20 dBm. The range is specified in the data sheet.

Remote command:

`SOURCE<n>:POWER[:LEVEL][:IMMEDIATE][:AMPLITUDE]` on page 873

### Power Offset

Constant level offset for the tracking generator. Values from -200 dB to +200 dB in 1 dB steps are allowed. The default setting is 0 dB. Offsets are indicated by the enhancement label "LVL" in the diagram header (see also [Chapter 8.5, "Displayed Information and Errors"](#), on page 471).

With this offset, attenuators or amplifiers at the output connector of the tracking generator can be taken into account for the displayed output power values on screen or during data entry, for example. Positive offsets apply to an amplifier and negative offsets to an attenuator subsequent to the tracking generator.

Remote command:

`SOURce<n>:POWER[:LEVel][:IMMediate]:OFFSet` on page 873

### Frequency Offset

Constant frequency offset between the output signal of the tracking generator and the input frequency of the R&S ESRP. Possible offsets are in a range of  $\pm 1$  GHz in 0.1 Hz steps.

The default setting is 0 Hz. Offsets  $\neq 0$  Hz are marked with the enhancement label "FRQ" in the diagram header (see also [Chapter 8.5, "Displayed Information and Errors"](#), on page 471).

If a positive frequency offset is entered, the tracking generator generates an output signal above the receive frequency of the R&S ESRP. In case of a negative frequency offset it generates a signal below the receive frequency of the R&S ESRP. The output frequency of the tracking generator is calculated as follows:

Tracking generator frequency = receive frequency + frequency offset.

Remote command:

`SOURce<n>:FREQuency:OFFSet` on page 873

### Result Frequency Start

For reference only: The start frequency for the generator, calculated from the configured generator frequency and the start value defined for the analyzer.

### Result Frequency Stop

For reference only: The stop frequency for the generator, calculated from the configured generator frequency and the stop value defined for the analyzer.

### Frequency Min.

For reference only: Lower frequency limit for the generator.

### Frequency Max.

For reference only: Upper frequency limit for the generator.

### Power Min.

For reference only: Lower power limit for the generator.

### Power Max.

For reference only: Upper power limit for the generator.

## 8.3.2 External Tracking Generator

The external tracking generators are configured in the "External" tabs of the "Tracking Generator Configuration" dialog box.

In the top section of the dialog box, the measurement configurations can be defined. In the middle section, interface settings for the connection to the external generator are defined. In the lower section of the dialog box, the capabilities of the external tracking generator are displayed for reference only.

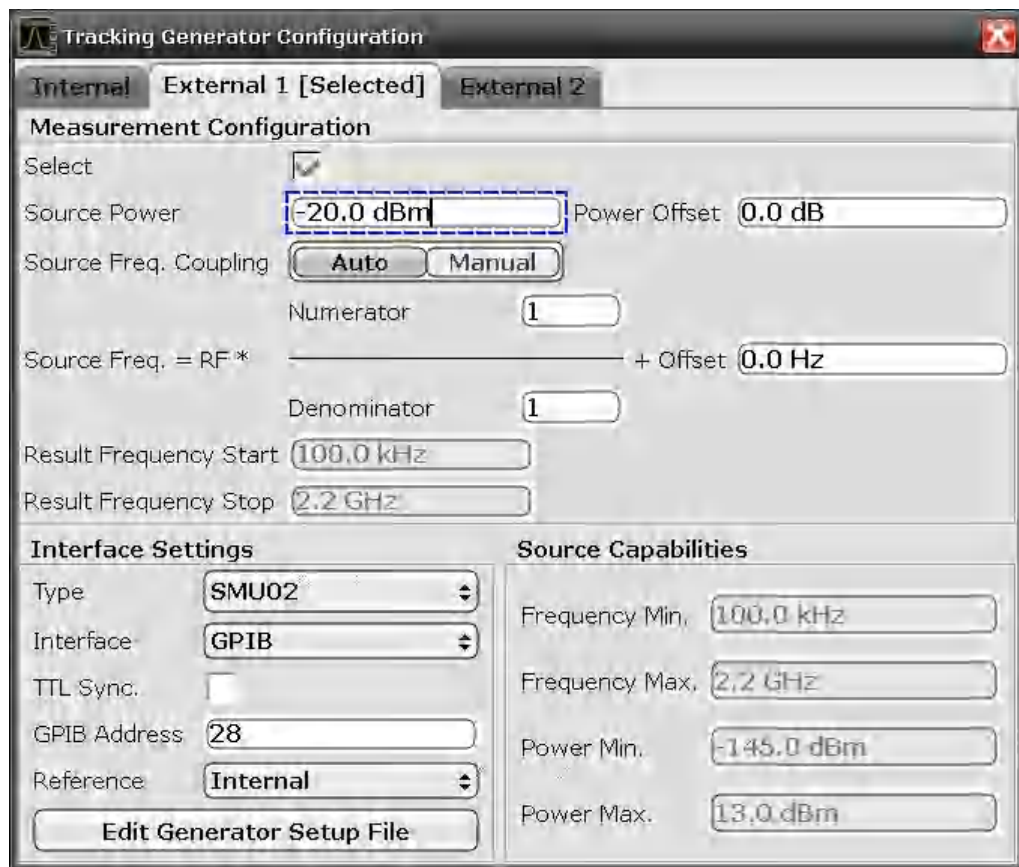

The configuration dialog box contains the following fields:

#### Select

Selects the specified external tracking generator as the current tracking generator source. "External 1" or "External 2" is displayed as the source on the "Source RF" softkey. All tracking generator functions are performed with the currently selected source.

**Note:** Note that the generator is not automatically activated when it is selected. To activate the currently selected generator, click the "Source RF On" softkey.

#### Source Frequency Coupling

Enables or disables frequency coupling between the analyzer and the generator.

- "Auto" Default setting: the frequencies are coupled (see "[Generator Frequency \(Numerator/Denominator/Offset\)](#)" on page 460).
- "Manual" The generator uses a fixed frequency, defined in the [\(Fixed\) Generator Frequency](#) field which is displayed when you select "Manual" coupling.

Remote command:

`SOURce<n>:EXternal<generator>:FREQuency:COUPling[:STATe]`  
on page 876

#### (Fixed) Generator Frequency

Defines the fixed frequency to be used by the generator.

Remote command:

`SOURce<n>:EXTernal<generator>:FREQuency` on page 876

### Source Power

The output power of the external tracking generator. The default output power is -20 dBm. The range is specified in the data sheet.

Remote command:

`SOURce<n>:EXTernal<generator>:POWer[:LEVel]` on page 879

### Power Offset

Constant level offset for the tracking generator. Values from -200 dB to +200 dB in 1 dB steps are allowed. The default setting is 0 dB. Offsets are indicated by the enhancement label "LVL" in the diagram header (see also [Chapter 8.5, "Displayed Information and Errors"](#), on page 471).

With this offset, attenuators or amplifiers at the output connector of the tracking generator can be taken into account for the displayed output power values on screen or during data entry, for example. Positive offsets apply to an amplifier and negative offsets to an attenuator subsequent to the tracking generator.

Remote command:

`SOURce<n>:POWer[:LEVel][:IMMediate]:OFFSet` on page 873

### Generator Frequency (Numerator/Denominator/Offset)

The frequency used by the generator may differ from the input from the analyzer. The RF frequency may be multiplied by a specified factor, or a frequency offset can be added, or both.

**Note:** The input for the generator frequency is not validated, i.e. you can enter any values. However, if the allowed frequency ranges of the generator are exceeded, an error message is displayed on the analyzer screen and the values for [Start](#) and [Stop](#) are corrected to comply with the range limits.

The value range for the offset depends on the selected generator. The default setting is 0 Hz. Offsets  $\neq$  0 Hz are marked with the enhancement label "FRQ" in the diagram header (see also [Chapter 8.5, "Displayed Information and Errors"](#), on page 471).

If a positive frequency offset is entered, the tracking generator generates an output signal above the receive frequency of the analyzer. For a negative frequency offset it generates a signal below the receive frequency of the analyzer.

The output frequency of the generator is calculated as follows:

$$F_{\text{Generator}} = \left| F_{\text{Analyzer}} * \frac{\text{Numerator}}{\text{Denominator}} + F_{\text{Offset}} \right|$$

**Figure 8-2: Output frequency of the generator**

**Note:** Make sure that the frequencies resulting from the start and stop frequency of the R&S ESRP do not exceed the allowed generator range:

- If the start frequency lies below F MIN, the generator is only switched on when F MIN is reached.

- If the stop frequency lies above F MAX, the generator is switched off. When the generator is subsequently switched on using the "Source RF Internal (On/ Off)" on page 448 softkey, the stop frequency is limited to F MAX.
- If the stop frequency lies below F MIN, the generator is switched off and an error message is displayed.

Remote command:

`SOURce<n>:EXTernal<generator>:FREQuency[:FACTor]:NUMerator`  
on page 877

`SOURce<n>:EXTernal<generator>:FREQuency[:FACTor]:DENominator`  
on page 877

`SOURce<n>:EXTernal<generator>:FREQuency:OFFSet<m>` on page 878

### Reverse sweep

The "Offset" setting can be used to sweep in the reverse direction. You can do this by setting a "negative" offset in the tracking generator configuration.

Example for reverse sweep:

$F_{\text{AnalyzerStart}} = 100 \text{ MHz}$

$F_{\text{AnalyzerStop}} = 200 \text{ MHz}$

$F_{\text{Offset}} = -300 \text{ MHz}$

Numerator = Denominator = 1

$\rightarrow F_{\text{GeneratorStart}} = 200 \text{ MHz}$

$\rightarrow F_{\text{GeneratorStop}} = 100 \text{ MHz}$

If the offset is adjusted so that the sweep of the generator crosses the minimum generator frequency, a message is displayed in the status bar ("Reverse Sweep via min. Ext. Generator Frequency!").

Example for reverse sweep via minimum frequency:

$F_{\text{AnalyzerStart}} = 100 \text{ MHz}$

$F_{\text{AnalyzerStop}} = 200 \text{ MHz}$

$F_{\text{Offset}} = -150 \text{ MHz}$

$F_{\text{min}} = 20 \text{ MHz}$

Numerator = Denominator = 1

$\rightarrow F_{\text{GeneratorStart}} = 50 \text{ MHz}$

$\rightarrow F_{\text{GeneratorStop}} = 50 \text{ MHz via } F_{\text{min}}$

### Result Frequency Start

For reference only: The start frequency for the generator, calculated from the configured generator frequency and the start value defined for the analyzer.

### Result Frequency Stop

For reference only: The stop frequency for the generator, calculated from the configured generator frequency and the stop value defined for the analyzer.

### Type

Generator type. See also [Chapter 8.2.1, "Overview of Generators Supported by the R&S ESRP"](#), on page 453.

Remote command:

`SYSTem:COMMunicate:RDEvice:GENerator<generator>:TYPE` on page 882



**Interface**

Type of interface connection used. The following interfaces are currently supported:

- TCP/IP
- GPIB

For details on interfaces see "[LAN](#)" on page 34 and "[GPIB Interface](#)" on page 34.

Remote command:

`SYSTem:COMMunicate:RDEvice:GENerator<generator>:INTerface`  
on page 881

**TTL Synchronization**

If available for the specified generator type, this option activates TTL synchronization for GPIB connections.

See also [Chapter 8.2, "Connecting External Tracking Generators"](#), on page 452.

For Noise Figure measurements (K30) this setting currently has no effect.

Remote command:

`SYSTem:COMMunicate:RDEvice:GENerator<generator>:LINK` on page 881

**Address**

For LAN connections: TCP/IP address.

For GPIB connections: GPIB address.

Remote command:

`SYSTem:COMMunicate:RDEvice:GENerator<generator>:LINK` on page 881

**Reference**

Selects internal or external reference for the generator (default: internal).

**Note:** Using the TTL interface allows for considerably higher measurement rates than pure GPIB control, because the frequency stepping of the R&S ESRP is directly coupled with the frequency stepping of the generator.

Remote command:

`SOURce<n>:EXTernal<generator>:ROSCillator[:SOURce]` on page 879

**Edit Generator Setup File**

Displays the setup file for the currently selected generator (see [Type](#) field) in read-only mode in an editor.

**Adding new generator types**

Although the existing setup files are displayed in read-only mode in the editor, they can be saved under a different name (using "File > SaveAs"). To add a new generator type to the selection list in the [Type](#) field, edit the setup file for an existing generator as required, then save the file with the extension ".gen" (select "Save as type: All Files (\*.\*)"). After you close the configuration dialog and re-open it, a new generator is available in the [Type](#) list with the name of the saved setup file.

Be careful, however, to adhere to the required syntax and commands. Errors will only be detected and displayed when you try to use the new generator (see also [Chapter 8.5, "Displayed Information and Errors"](#), on page 471).

**Frequency Min.**

For reference only: Lower frequency limit for the generator.

**Frequency Max.**

For reference only: Upper frequency limit for the generator.

**Power Min.**

For reference only: Lower power limit for the generator.

**Power Max.**

For reference only: Upper power limit for the generator.

## 8.4 Tracking Generator Functions

The following functions are available if the optional Tracking Generator or the optional External Tracking Generator is installed.

- [Calibration mechanism](#).....463
- [Calibrating for transmission and reflection measurement](#).....464
- [Transmission measurement](#).....465
- [Reflection measurement](#).....465
- [Normalization](#).....465
- [Modulation \(internal Tracking Generator only\)](#).....469

### 8.4.1 Calibration mechanism

Calibration means calculating the difference between the currently measured power and a reference curve, independent of the selected type of measurement (transmission/reflection). The hardware settings used for measuring the reference curve are included in the reference dataset.

Even with normalization switched on, the instrument settings can be changed in a wide area without stopping the normalization. This reduces the necessity to carry out a new normalization to a minimum.

Therefore, the reference dataset (trace with  $n$  measured values, where  $n$  is the number of [Sweep Points](#)) is stored internally as a table of  $n$  points (frequency/level).

Differences in level settings between the reference curve and the current instrument settings are taken into account automatically. If the span is reduced, a linear interpolation of the intermediate values is applied. If the span increases, the values at the left or right border of the reference dataset are extrapolated to the current start or stop frequency, i.e. the reference dataset is extended by constant values.

An enhancement label is used to mark the different levels of measurement accuracy. This enhancement label is displayed at the right diagram border if normalization is switched on and a deviation from the reference setting occurs. Three accuracy levels are defined:

Table 8-1: Measurement accuracy levels

Accuracy	Enhancement label	Reason/Limitation
high	NOR	No difference between reference setting and measurement
medium	APX (approximation)	Change of the following settings: <ul style="list-style-type: none"> <li>• coupling (RBW, VBW, SWT)</li> <li>• reference level, RF attenuation</li> <li>• start or stop frequency</li> <li>• output level of tracking generator</li> <li>• detector (max. peak, min. peak, sample, etc.)</li> <li>• change of frequency:</li> </ul> max. 691 points within the set sweep limits (corresponds to a doubling of the span)
–	Aborted normalization	More than 500 extrapolated points within the current sweep limits (in case of span doubling)



At a reference level of -10 dBm and at a tracking generator output level of the same value, the R&S ESRP operates without overrange reserve. That means the R&S ESRP is in danger of being overloaded if a signal is applied whose amplitude is higher than the reference line. In this case, either the message "OVLD" for overload or "IFOVL" for exceeded display range (clipping of the trace at the upper diagram border = overrange) is displayed in the status line.

Overloading can be avoided as follows:

- Reducing the output level of the tracking generator ( "Source Config" on page 452 softkey in the Tracking Generator menu)
- Increasing the reference level (Ref Level softkey in the "Amplitude" menu)

## 8.4.2 Calibrating for transmission and reflection measurement

Prerequisite: The instrument is in tracking generator measurement mode.

1. To enter the generator output level, press the "Source Power" on page 448 softkey.
2. To enter a constant level offset for the tracking generator, press the "Source Config" on page 452 softkey and enter a "Power Offset".
3. To open the submenu for calibration, press the "Source Cal" on page 448 softkey.
4. To record a reference trace for transmission measurement, press the "Calibrate Transmission" on page 448 softkey.  
The recording of the reference trace and the completion of the calibration sweep are indicated by message bo XE s.
5. To record a reference trace for reflection measurement, press the "Calibrate Reflection Short" on page 448 or "Calibrate Reflection Open" on page 448 softkey.  
The recording of the reference trace and the completion of the calibration sweep are indicated by message bo XE s.
6. To switch on the normalization, press the "Normalize" on page 449 softkey.

7. To display the reference line, press the ["Reference Value Position"](#) on page 449 softkey.
8. To enter a value to shift the reference line, press the ["Reference Value"](#) on page 449 softkey.
9. To restore the settings used for source calibration, press the ["Recall"](#) on page 449 softkey.

### 8.4.3 Transmission measurement

This measurement yields the transmission characteristics of a two-port network. The internal or external tracking generator serves as a signal source. It is connected to the input connector of the DUT. The input of the R&S ESRP is fed from the output of the DUT. A calibration can be carried out to compensate for the effects of the test setup (e.g. frequency response of connecting cables).

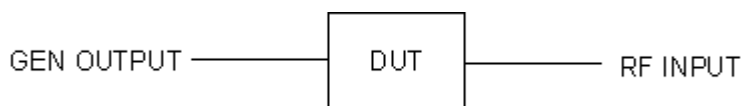

*Figure 8-3: Test setup for transmission measurement*

### 8.4.4 Reflection measurement

Scalar reflection measurements can be carried out by means of a reflection-coefficient measurement bridge.

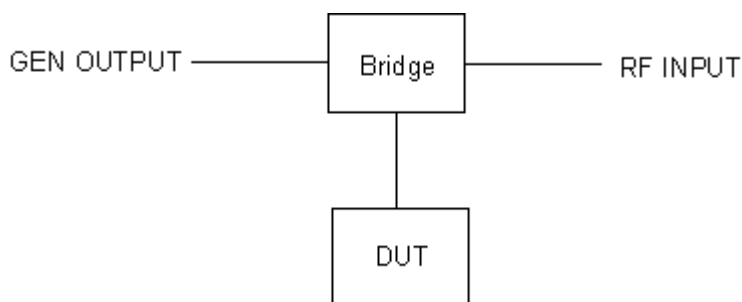

*Figure 8-4: Test setup for reflection measurement*

### 8.4.5 Normalization

The ["NORMALIZE"](#) softkey switches normalization on or off. The softkey is only available if the memory contains a correction trace.

You can shift the relative reference point within the grid using the ["Reference Value Position"](#) on page 449 softkey. Thus, the trace can be shifted from the top grid margin to the middle of the grid:



Figure 8-5: Normalized display

CORR ON, see [SENSe:]CORRection[:STATe] on page 870

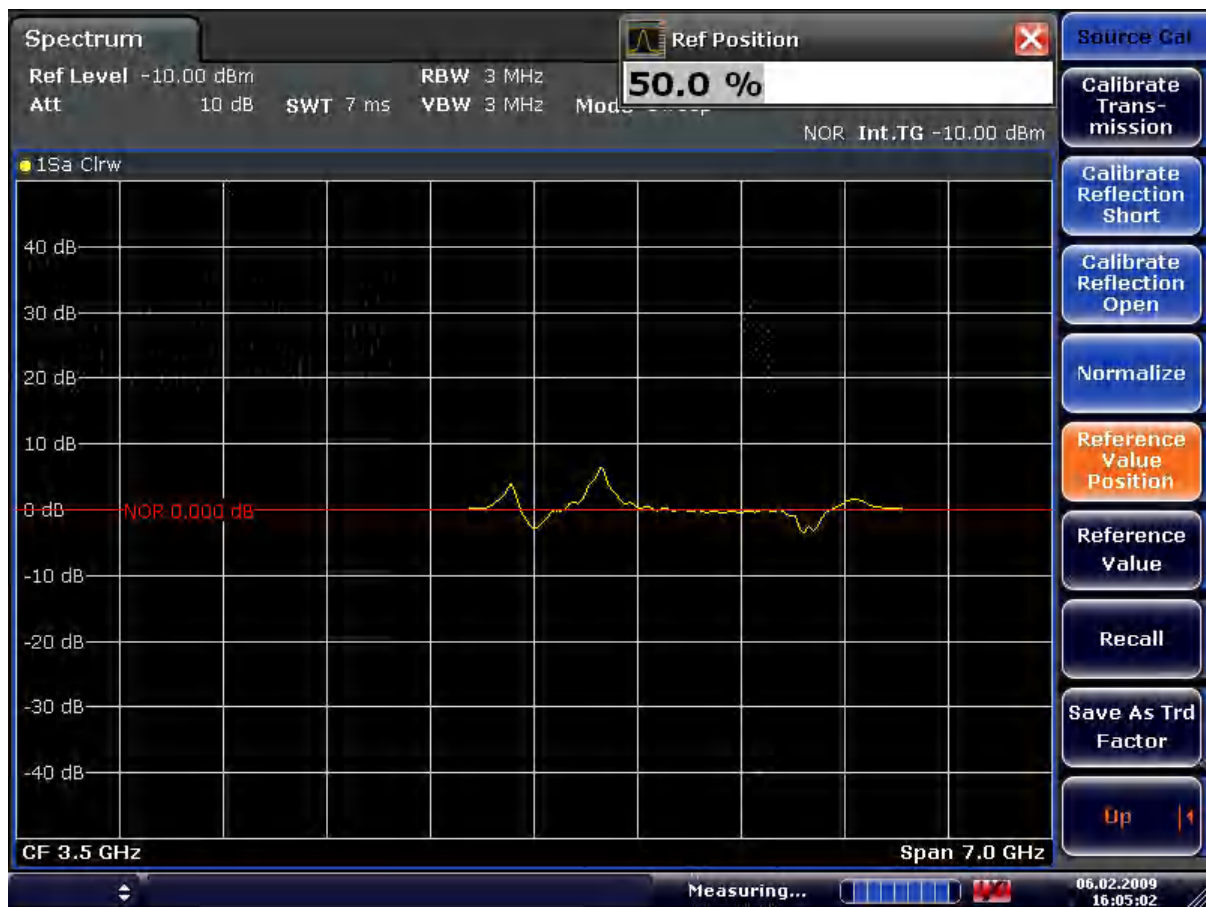

Figure 8-6: Normalized measurement, shifted with Reference Value Position= 50%

DISP:WIND:TRAC:Y:RPOS 10PCT, see [DISPlay\[:WINDow<n>\]:TRACe<t>:Y\[:SCALE\]:RPOSition](#) on page 814



**Figure 8-7: Measurement with Reference Value: +10dB and Reference Value Position = 50%**

After the reference line has been shifted by entering +10 dB as the "Reference Value" on page 449, deviations from the nominal value can be displayed with high resolution (e.g. 2 dB/Div.). The absolute measured values are still displayed; in the above example, 2 dB below nominal value (reference line) = 8 dB attenuation.



Figure 8-8: Measurement of a 10-dB attenuator pad with 2dB/Div

DISP:WIND:TRAC:Y:RVAL +10dB, see [DISPlay\[:WINDow<n>\]:TRACe<t>:Y\[:SCALE\]:RVALue](#) on page 857

#### 8.4.6 Modulation (internal Tracking Generator only)

The time characteristics of the tracking generator output signal can be influenced by means of external signals (input voltage range -1 V to +1 V).

Two BNC connectors at the rear panel are available as signal inputs. Their function changes depending on the selected modulation:

- TG IN I/AMand
- TG IN Q/FM

The modulation modes can be combined with each other and with the frequency offset function up to a certain degree. The following table shows which modulation modes are possible at the same time and which ones can be combined with the frequency offset function.



**Table 8-2: Simultaneous modes of modulation (tracking generator)**

Modulation	Frequency offset	EXT AM	EXT FM	EXT I/Q
Frequency offset		•	•	•
EXT AM	•		•	
EXT FM	•	•		
EXT I/Q	•			

• = can be combined

#### External AM

The "External AM" on page 450 softkey activates an AM modulation of the tracking generator output signal.

The modulation signal is applied to the TG IN I/AM connector. An input voltage of 1 V corresponds to 100% amplitude modulation.

Switching on an external AM disables the active I/Q modulation.

#### External FM

The "External FM" on page 450 softkey activates the FM modulation of the tracking generator output signal.

The modulation frequency range is 1 kHz to 100 kHz, the deviation can be set in 1-decade steps in the range of 100 Hz to 10 MHz at an input voltage of 1 V. The phase deviation  $h$  should not exceed the value 100.

Phase deviation  $h = \text{deviation/modulation frequency}$

The modulation signal is applied to the TG IN Q/FM connector.

Switching on an external FM disables the active I/Q modulation.

#### External IQ

The "External I/Q" on page 450 softkey activates the external I/Q modulation of the tracking generator.

The signals for modulation are applied to the two input connectors TG IN I and TG IN Q at the rear panel of the unit. The input voltage range is  $\pm 1$  V into 50  $\Omega$ .

Switching on an external I/Q modulation disables the active external AM or FM.

Functional description of the quadrature modulator:

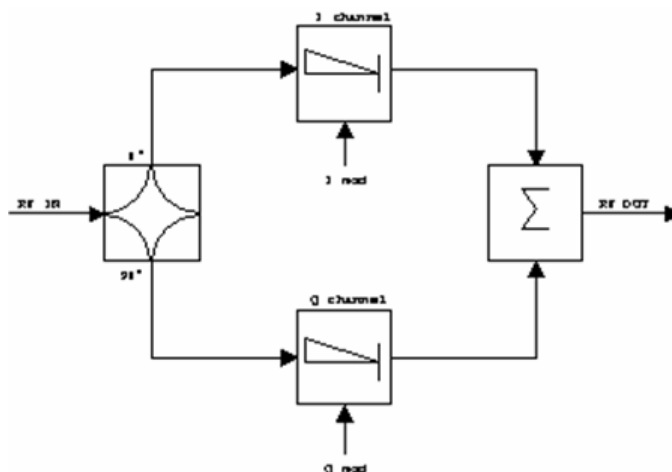

Figure 8-9: I/Q modulation

I/Q modulation is performed by means of the built-in quadrature modulator. The RF signal is divided into two orthogonal I and Q components (in phase and quadrature phase). Amplitude and phase are controlled in each path by the I and Q modulation signal. By adding the two components an RF output signal is generated that can be controlled in amplitude and phase.

Remote command:

`SOURce<n>:DM:STATe` on page 871

## 8.5 Displayed Information and Errors

### Diagram header

In Tracking Generator measurement mode, some additional information is displayed in the diagram header.

Label	Description
INT TG: <source power>	Internal tracking generator active
INT TG: <start power>... <stop power>	Internal tracking generator with power sweep active
EXT TG <1 2>: <source power>	External tracking generator (1 or 2) active
LVL	Power Offset (see <a href="#">Chapter 8.3, "Configuring Tracking Generators"</a> , on page 456)
FRQ	Frequency Offset (see <a href="#">Chapter 8.3, "Configuring Tracking Generators"</a> , on page 456)
<b>Measurement accuracy levels</b>	
NOR	Normalization on; No difference between reference setting and measurement

Label	Description
APX (approximation)	Normalization on; Deviation from the reference setting occurs
-	Aborted normalization

For details on measurement accuracy levels, see [Chapter 8.4.5, "Normalization"](#), on page 465.

### Error and status messages

Message	Description
"Ext. Generator GPIB Handshake Error!" / "Ext. Generator TCPIP Handshake Error!" / "Ext. Generator TTL Handshake Error!"	Connection to the generator is not possible, e.g. due to a cable damage or loose connection or wrong address.
"Ext. Generator Limits Exceeded!"	The allowed frequency or power ranges for the generator were exceeded.
"Reverse Sweep via min. Ext. Generator Frequency!"	Reverse sweep is performed; frequencies are reduced to the minimum frequency, then increased again; see <a href="#">Figure 8-2</a>
"Ext. Generator File Syntax Error!"	Syntax error in the generator setup file (see <a href="#">"Edit Generator Setup File"</a> on page 462)
"Ext. Generator Command Error!"	Missing or wrong command in the generator setup file (see <a href="#">"Edit Generator Setup File"</a> on page 462)
"Ext. Generator Visa Error!!"	Error with Visa driver provided with installation (very unlikely)

## 9 System Configuration

### 9.1 Manual Operation – Local Menu

When switched on, the instrument is always in the manual measurement mode and can be operated via the front panel. As soon as the instrument receives a remote command, it is switched to the remote control mode.

In remote control mode, all keys of the instrument except the PRESET key are disabled, see [Chapter 9.3, "Instrument Setup and Interface Configuration – SETUP Key"](#), on page 475. The "LOCAL" softkey and the [Display Update \(On/Off\)](#) softkey are displayed. Depending on the setting of the [Display Update \(On/Off\)](#) softkey, the diagrams, traces and display fields are displayed or hidden. For further details on the [Display Update \(On/Off\)](#) softkey refer to [Chapter 9.3, "Instrument Setup and Interface Configuration – SETUP Key"](#), on page 475.

For details on remote control refer to [Chapter 11.1, "Remote Control - Basics"](#), on page 524.



If you select the "Local" softkey while a self-alignment or a self-test is still running (which was started remotely), the instrument only returns to the manual operation state when the alignment or test is completed.

#### The change to manual operation consists of:

- Enabling the Front Panel Keys  
Returning to manual mode enables all inactive keys. The main softkey menu of the current mode is displayed.
- Displaying the measurement diagrams again.  
The diagrams, traces and display fields are displayed again.
- Generating the "OPERATION COMPLETE" message  
If, at the time of pressing the "LOCAL" softkey, the synchronization mechanism via \*OPC, \*OPC? or \*WAI is active, the currently running measurement procedure is aborted and synchronization is achieved by setting the corresponding bits in the registers of the status reporting system.
- Setting Bit 6 (User Request) of the Event Status Register  
With a corresponding configuration of the status reporting system, this bit immediately causes the generation of a service request (SRQ) to inform the control software that the user wishes to return to front panel control. For example this can be used to interrupt the control program and to correct instrument settings manually. This bit is set each time the "LOCAL" softkey is pressed.

#### To return to manual operation

- ▶ Press the "LOCAL" softkey.

The instrument switches from remote to manual operation, but only if the local lock-out function has not been activated in the remote control mode.

## 9.2 User-Defined Menu – USER key

The USER key displays a user-defined menu. The softkeys displayed here can be labelled and assigned to user-defined settings files as required.

### To open the user-defined menu

- ▶ Press the USER key.  
The "User" menu is displayed.

### Softkeys of the "User" menu

The "User" menu contains 8 user-definable softkeys as well as a "[User Preference Setup](#)" softkey that allows you to define them. Pressing one of the user-definable softkeys has the same effect as the [Save File / Recall File](#) function for a pre-defined settings file. The definitions for these softkeys remain unchanged even after a reset function and after updating the firmware.



As opposed to recalling a settings file via the "Save/Recall" menu, when a saved settings file is loaded using one of the user-definable softkeys, the only item to be loaded is the current (measurement) settings - no trace settings, transducer or limit line configurations etc.

### "User Preference Setup" softkey

Opens an "ApplicationManager" dialog to set up the user-defined softkeys.

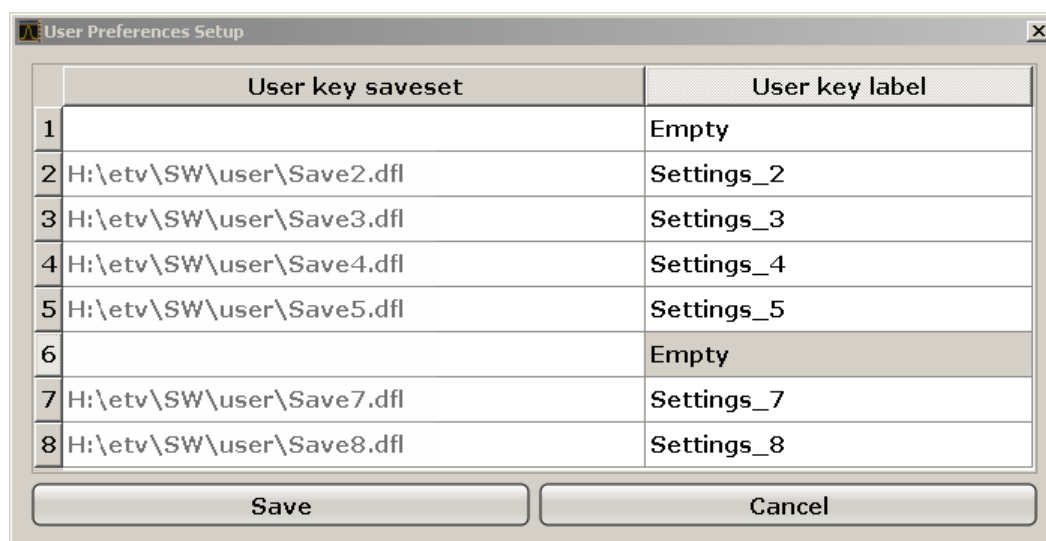

For each user-definable softkey (1–8), you can define a key label and assign a settings file that is to be loaded when the softkey is selected.

**SCPI command:**

[MMEMory:USER<Softkey>](#) on page 954

**To define the key label**

1. Click into the table entry for the corresponding softkey.
2. Enter a label for the softkey.
3. Press ENTER.

**To assign a settings file**

1. Click into the table entry for the corresponding softkey.
2. In the file selection dialog, select a stored settings file to be recalled when the softkey is selected.
3. Click "Select".  
The selected file is displayed in the "ApplicationManager" dialog.

**To store the softkey settings**

- ▶ Click "Save" to store the user-defined softkey definitions.

## 9.3 Instrument Setup and Interface Configuration – SETUP Key

The SETUP key is used to set or display the default settings of the instrument: reference frequency, noise source, level correction values, date, time, LAN interface, firmware update and enabling of options, information about instrument configuration and service support functions. For further details refer also to the Quick Start Guide, chapter 2 "Preparing for Use".

**To open the Setup menu**

- ▶ Press the SETUP key.  
The "Setup" menu is displayed.

**Menu and softkey description**

- [Chapter 9.3.1, "Softkeys of the Setup Menu"](#), on page 476

### 9.3.1 Softkeys of the Setup Menu

The following table shows all softkeys available in the "Setup" menu. It is possible that your instrument configuration does not provide all softkeys. If a softkey is only available with a special option, model or (measurement) mode, this information is delivered in the corresponding softkey description.

Reference Int/Ext.....	478
Handle missing Ext. Ref.....	478
L Show Error Flag.....	478
L Auto select Reference.....	478
Transducer.....	478
L Using transducer factors or transducer sets.....	479
L Defining characteristics of a transducer factor.....	479
L Managing transducer sets.....	481
Alignment.....	482
L Self Alignment.....	482
L Show Align Results.....	483
L Touch Screen Alignment.....	483
General Setup.....	483
L Configure Network.....	483
L Network Address.....	483
L Computer Name.....	483
L IP Address.....	484
L Subnet Mask.....	484
L DHCP (On/Off).....	484
L LXI.....	484
L Info.....	484
L Password.....	484
L Description.....	485
L LAN Reset.....	485
L GPIB.....	485
L GPIB Address.....	485
L ID String Factory.....	485
L ID String User.....	485
L Compatibility Mode.....	485
L Mode Default.....	486
L Mode R&S FSP.....	486
L Mode R&S FSU.....	486
L GPIB Language.....	486
L IF Gain (Norm/Puls).....	487
L Sweep Repeat (On/Off).....	487
L Coupling (FSx/HP).....	488
L REV String Factory.....	488
L REV String User.....	488
L Tree Walking.....	488
L Display Update (On/Off).....	488
L GPIB Terminator LFEOI/EOI.....	489
L *IDN Format Leg./New.....	489
L I/O Logging (On/Off).....	489

L Time+Date.....	489
L Configure Monitor.....	489
L Soft Frontpanel.....	490
Display Setup.....	490
L Tool Bar State (On/Off).....	491
L Status Bar.....	491
L Screen Title (On/Off).....	491
L Time+Date (On/Off).....	491
L Time+Date Format (US/DE).....	491
L Print Logo (On/Off).....	491
L Annotation (On/Off).....	492
L Theme Selection.....	492
L Screen Colors.....	492
L Select Screen Color Set.....	492
L Color (On/Off).....	492
L Select Object.....	492
L Predefined Colors.....	493
L User Defined Colors.....	493
L Set to Default.....	493
L Print Colors.....	493
L Select Print Color Set.....	494
L Color (On/Off).....	494
L Display Pwr Save (On/Off).....	494
System Info.....	494
L Hardware Info.....	495
L Versions+Options.....	495
L System Messages.....	495
L Clear All Messages.....	496
Parameter Coupling.....	496
Firmware Update.....	496
Option Licenses.....	496
L Install Option.....	497
L Install Option by XML.....	497
Application Setup Recovery.....	497
Preset Receiver.....	497
Preset Spectrum.....	497
Service.....	498
L Input Source.....	498
L RF.....	498
L Calibration Frequency RF.....	498
L Reset Password.....	498
L Selftest.....	498
L Selftest Results.....	498
L Password.....	499
L Service Function.....	499



### Reference Int/Ext

Switches between the internal and external reference signal source. The default setting is internal reference. It is important that the external reference signal is deactivated when switching from external to internal reference to avoid interactions. When an external reference is used, "EXT REF" is displayed in the status bar.

If the reference signal is missing after switching to an external reference, the message "NO REF" is displayed to indicate that no synchronization is performed.

The R&S ESRP can use the internal reference source or an external reference source as frequency standard from which all internal oscillators are derived. A 10 MHz crystal oscillator is used as internal reference source. In the external reference setting, all internal oscillators of the R&S ESRP are synchronized to the external reference frequency. The external frequency can be set from 1 Hz to 20 MHz in 100 kHz steps.

For details on connectors, refer to [Chapter 3.1.2, "Rear Panel View"](#), on page 33.

Remote command:

`[SENSe:]ROSCillator:SOURce` on page 902

### Handle missing Ext. Ref

If an external reference is selected but none is available, there are different ways the instrument can react. This command opens a submenu to select the preferred method of handling a missing external reference. By default, an error flag is displayed in the status bar of the display.

The submenu contains the following commands:

- ["Show Error Flag"](#) on page 478
- ["Auto select Reference"](#) on page 478

### Show Error Flag ← Handle missing Ext. Ref

If this option is selected, an error flag is displayed in the status bar of the display when an external reference is selected but none is available.

Remote command:

`[SENSe:]ROSCillator:SOURce` on page 902

### Auto select Reference ← Handle missing Ext. Ref

If this option is selected, the instrument automatically switches back to the internal reference if no external reference is available. Note that you must re-activate the external reference if it becomes available again later.

Remote command:

`[SENSe:]ROSCillator:SOURce` on page 902

### Transducer

Opens a dialog box that contains functionality to work with transducer factors or transducer sets.

Name	Unit	State	
Generic Probe	dB	-	▲
Transducer 1	dB	-	☰
Transducer 2	dB	-	▼

View Filter:  Show compatible  Show all

Comment:

Basically, the dialog box contains three elements.

- A list of available transducer factors or transducer sets.  
The list shows the name of the transducer factor or set, its unit and its state.
- A button to filter the transducer factors that are displayed in the list.  
The filter is available for transducer **factor** selection.
- A line that shows the comment of a transducer factor or set.  
A comment is displayed only if one has been defined.

For more information on using transducer factors and sets, see [Chapter 5.2.6, "Transducers"](#), on page 150.

For more information on designing transducer factors and sets, see:

- ["Defining characteristics of a transducer factor"](#) on page 479
- ["Managing transducer sets"](#) on page 481

### Using transducer factors or transducer sets ← Transducer

The "(Factor Set)" softkey selects if you want to use a transducer factor or set.

The label of the currently selected type of transducer is highlighted.

To actually include the transducer in the measurement, you first have to select one and turn it on with the "Active (On Off)" softkey. When the transducer factor is active, all amplitude settings and outputs take on the unit of the transducer factor. You can no longer select another unit. An exception is in case the transducer has the unit dB.

The name of the active transducer is displayed in the channel bar. To indicate the progress of the measurement, the diagram area also contains a green vertical line with the label "TF".

Note that you can turn on up to eight transducer factors at the same time. If you want to use more transducer factors in the same measurement, you have to combine them in a transducer set.

Remote command:

[\[SENSe:\]CORRection:TRANsdUcer:SElect](#) on page 921

[\[SENSe:\]CORRection:TRANsdUcer\[:STATe\]](#) on page 921

[\[SENSe:\]CORRection:TSET:SElect](#) on page 924

[\[SENSe:\]CORRection:TSET\[:STATe\]](#) on page 924

### Defining characteristics of a transducer factor ← Transducer

Before you can define the characteristics of a transducer factor, make sure that you are actually using a transducer factor (→"(Factor Set)" softkey).

You can define the characteristics in several ways:

- Edit a transducer factor that already exists (→"Edit" softkey).
- Create a new transducer factor (→"New" softkey).
- Create a new transducer factor based on an existing one (→"Copy To" softkey).

Each of the three options opens a dialog box that contains the functionality to characterize a transducer factor.

Position	Value
0.00 Hz	5.00 dB
1.0000000 MHz	5.00 dB

- 1 = Name and comment of the transducer factor (→"Edit Name" softkey)
- 2 = Unit of the transducer factor (→"Edit Unit" softkey)
- 3 = Linear or logarithmic scaling of the frequency axis (→"Edit Name" softkey)
- 4 = Table of data points and graphical preview of the transducer factor (→"Edit Value" softkey)
- 5 = Button to insert a data point in the table (→"Insert Value" softkey)
- 6 = Button to delete a data point from the table (→"Delete Value" softkey)
- 7 = Button to shift all data points of the transducer factor horizontally by a certain amount
- 8 = Button to shift all data points of the transducer factor vertically by a certain amount
- 9 = Button to save and store the transducer factor on the internal hard disk of the R&S ESRP (→"Save Factor" softkey)

Note that there are softkeys for several elements of the dialog box as mentioned in the legend above.

A transducer factor can consist of up to 625 data points. Each data point is a pair of values: the first value describes the frequency, the second value describes the level for that frequency.

Enter the frequencies in ascending order and without overlapping.

When you save the transducer factor, the R&S ESRP uses the name of the transducer factor as the filename. The file type is \*.tdf. If a transducer factor of the same name already exists, the R&S ESRP asks you to confirm before it overwrites the existing file.

The transducer factors and sets are stored in separate but fix directories on the internal memory of the R&S ESRP. You can create subdirectories for a more concise file structure and display their contents with the "Show Directories" softkey (you have to select the directory first, though).

It is possible to delete a transducer factor at any time, if you do not need it anymore (→"Delete" softkey).

### Dynamic range with active transducers

The shift of the trace caused by the transducer factor by a certain amount deteriorates the dynamic range of the measurement results.

To restore the original dynamic range, you have to compensate for the transducer factor. You can do this by adjusting the reference level accordingly. If you turn on the automatic adjustment of the reference level (using the "Ref Level Adjust (Man Auto)" softkey), the R&S ESRP restores the original dynamic range as best as possible. It does so by changing the reference level by the maximum level shift defined in the active transducer factor.

Remote command:

[SENSe:]CORRection:TRANsdUcer:SElect on page 921

[SENSe:]CORRection:TRANsdUcer:COMMeNt on page 919

[SENSe:]CORRection:TRANsdUcer:UNIT on page 921

[SENSe:]CORRection:TRANsdUcer:SCALing on page 920

[SENSe:]CORRection:TRANsdUcer:DATA on page 920

[SENSe:]CORRection:TRANsdUcer:DELeTe on page 920

[SENSe:]CORRection:TRANsdUcer:ADJust:RLEVel[:STATe] on page 918

### Managing transducer sets ← Transducer

Before you can define the contents of a transducer set, make sure that you are actually using a transducer set (→"Factor Set") softkey).

You can define the contents in several ways:

- Edit a transducer set that already exists (→"Edit" softkey).
- Create a new transducer set (→"New" softkey).
- Create a new transducer set based on an existing one (→"Copy To" softkey).

Each of the three options opens a dialog box that contains the functionality to define a transducer set.

Range	Frequency	Factors
1	0.000 Hz 50.000 kHz	Transducer 3
2	50.000 kHz 500.000 kHz	
3	500.000 kHz 1.000 MHz	Transducer 1 Transducer 5
4	1.000 MHz 10.000 MHz	Transducer 2 Transducer 4

Start Frequency 50.0 kHz Stop Frequency 500.0 kHz

1 2 3 4 5 6 7 8 9 10

- 1 = Name and comment of the transducer set
- 2 = Unit of the transducer set
- 3 = Button to turn the transducer break on and off
- 4 = Table of transducer set ranges and corresponding frequencies and transducer factors
- 5 = Start and stop frequency of the currently selected range
- 6 = List of transducer ranges

For more information on using and designing transducer sets, see ["Transducer sets"](#) on page 151.

Opening the dialog box also opens an additional softkey menu that contains functionality that you need to design a transducer set.

This softkey menu provides the function to

- Insert ranges up to a maximum of 10 (→"Insert Range" softkey)
- Delete ranges that already exist (→"Delete Range" softkey)
- Add up to eight transducer factors to a range (→"Add Factor" softkey)
- Replace a transducer factor that has been assigned with another one (→"Change Factor)" softkey)
- Remove a transducer factor from the transducer set (→"Remove Factor" softkey)
- Save the contents of the transducer set (→"Save Set" softkey)

Remote command:

[\[SENSe:\]CORRection:TSET:SELEct](#) on page 924

[\[SENSe:\]CORRection:TSET:COMMeNt](#) on page 923

[\[SENSe:\]CORRection:TSET:UNIT](#) on page 924

[\[SENSe:\]CORRection:TSET:BReAk](#) on page 922

[\[SENSe:\]CORRection:TSET:RANGe<range>](#) on page 923

[\[SENSe:\]CORRection:TSET:DELEte](#) on page 923

### Alignment

Opens a submenu with the available functions for recording, displaying and activating the data for self-alignment.

The R&S ESRP determines the correction data and characteristics required for the alignment automatically. It compares the results at different settings with the known characteristics of the high-precision calibration signal source at 65.83 MHz. The correction data is stored as a file on the instrument. You can display it using the ["Show Align Results"](#) on page 483 softkey.

The submenu contains the following commands:

- ["Self Alignment"](#) on page 482
- ["Show Align Results"](#) on page 483
- ["Touch Screen Alignment"](#) on page 483

### Self Alignment ← Alignment

Starts the recording of correction data of the instrument. If the correction data acquisition has failed or if the correction values are deactivated, a corresponding message is displayed in the status field.

As long as the self-alignment data is being collected, you can cancel the procedure using the "Abort" button.

Remote command:  
[\\*CAL?](#) on page 883

### Show Align Results ← Alignment

Opens a dialog box that displays the correction data of the alignment:

- Date and time of last correction data record
- Overall results of correction data record
- List of found correction values according to function/module

The results are classified as follows:

<b>PASSED</b>	calibration successful without any restrictions
<b>CHECK</b>	deviation of correction value larger than expected, correction could however be performed
<b>FAILED</b>	deviations of correction value too large, no correction was possible. The found correction data are not applicable.

Remote command:  
[CALibration:RESult?](#) on page 904

### Touch Screen Alignment ← Alignment

Displays a touchscreen alignment dialog.

When the device is delivered, the touchscreen is initially aligned. However, it may become necessary to adjust the alignment later, e.g. after an image update or after exchanging a hard disk. If you notice that touching a specific point on the screen does not achieve the correct response, you may try adjusting the alignment, as well.

Using a finger or any other pointing device, press the 4 markers on the screen.

The touchscreen is aligned according to the executed pointing operations.

### General Setup

Opens a submenu for all general settings such as IP address and LAN settings, date and time, remote control (optional) and measurement display.

### Configure Network ← General Setup

Opens the "Network Connections" dialog box to change the LAN settings.

For details, refer to [Chapter 11.2.5, "Setting Up a Network \(LAN\) Connection"](#), on page 592.

### Network Address ← General Setup

Opens a submenu to configure the Internet protocol properties and the computer name.

### Computer Name ← Network Address ← General Setup

Opens an edit dialog box to enter the computer name via the keypad. The naming conventions of Windows apply. If too many characters and/or numbers are entered, a message is displayed in the status line. For step-by-step instructions, refer to [Chapter 11.2.5.3, "Using Computer Names"](#), on page 597.

**IP Address ← Network Address ← General Setup**

Opens an edit dialog box to enter the IP address via the keypad. The TCP/IP protocol is preinstalled with the IP address 10.0.0.10. If the DHCP server is available ("DHCP On"), the dialog box entry is read-only.

The IP address consists of four number blocks separated by dots. Each block contains 3 numbers in maximum (e.g. 100.100.100.100), but also one or two numbers are allowed in a block (as an example see the pre-installed address). For step-by-step instructions, refer to [Chapter 11.2.5.2, "Assigning the IP Address"](#), on page 594.

**Subnet Mask ← Network Address ← General Setup**

Opens an edit dialog box to enter the subnet mask via the keypad. The TCP/IP protocol is preinstalled with the subnet mask 255.255.255.0. If the DHCP server is available ("DHCP On"), the dialog box entry is read-only.

The subnet mask consists of four number blocks separated by dots. Each block contains 3 numbers in maximum (e.g. 100.100.100.100), but also one or two numbers are allowed in a block (as an example see the preinstalled address). For step-by-step instructions, refer to [Chapter 11.2.5, "Setting Up a Network \(LAN\) Connection"](#), on page 592.

**DHCP (On/Off) ← Network Address ← General Setup**

Switches between DHCP server available ("On") or not available ("Off"). If a DHCP server is available in the network, the IP address and subnet mask of the instrument are obtained automatically from the DHCP server. For further details, refer to [Chapter 11.2.5, "Setting Up a Network \(LAN\) Connection"](#), on page 592.

**LXI ← General Setup**

Opens the LXI submenu containing the following softkeys:

- "Info" on page 484
- "Password" on page 484
- "Description" on page 485
- "LAN Reset" on page 485

LXI functionality is available only for user accounts with administrator rights.

**Info ← LXI ← General Setup**

Shows the current LXI parameters, including the current version, class and various computer parameters like the computer name or IP address.

While active, the dialog is not updated.

LXI functionality is available only for user accounts with administrator rights.

Remote command:

`SYSTem:LXI:INFo?` on page 957

**Password ← LXI ← General Setup**

Shows the currently set password. You can also change the current password using this softkey.

The password is required to change settings via the web browser (e.g. IP parameter). An empty password is not valid, i.e. you must enter a password.

By default, the password is *LxiWebIfc*.

LXI functionality is available only for user accounts with administrator rights.

Remote command:

`SYSTem:LXI:PASSword` on page 958

#### **Description ← LXI ← General Setup**

Opens a dialog box to view or change the LXI instrument description. This description is used on some of the LXI web sites.

By default, the description is "Signal Analyzer".

LXI functionality is available only for user accounts with administrator rights.

Remote command:

`SYSTem:LXI:MDEscription` on page 958

#### **LAN Reset ← LXI ← General Setup**

Resets the LAN configuration to a state required by the LXI standard. For example, the TCP/IP mode is set to "DHCP" and "Dynamic DNS" and "ICMP Ping" are enabled. In addition, the R&S ESRP sets the password and the instrument description to their initial states (see "[Password](#)" on page 484 and "[Description](#)" on page 485 softkeys).

Only user accounts with administrator rights can reset the LAN configuration.

Remote command:

`SYSTem:LXI:LANReset` on page 958

#### **GPIB ← General Setup**

Opens a submenu to set the parameters of the remote control interface.

#### **GPIB Address ← GPIB ← General Setup**

Opens an edit dialog box to enter the GPIB address. Values from 0 to 30 are allowed. The default address is 20.

Remote command:

`SYSTem:COMMunicate:GPIB[:SELF]:ADDRess` on page 957

#### **ID String Factory ← GPIB ← General Setup**

Selects the default response to the \*IDN? query.

Remote command:

`SYSTem:IDENtify:FACTory` on page 894

#### **ID String User ← GPIB ← General Setup**

Opens an edit dialog box to enter a user-defined response to the \*IDN? query. Max. 36 characters are allowed.

Remote command:

`SYSTem:IDENtify[:STRing]` on page 894

#### **Compatibility Mode ← GPIB ← General Setup**

Sets the R&S ESRP in a state compatible to previous R&S devices, enabling the usage of existing external control applications. In particular, the number of measurement points and available bandwidths are adjusted to the settings of other devices.



Furthermore, some special GPIB settings are available to emulate HP models (see [Chapter 11.18, "GPIB Commands of HP Models 856xE, 8566A/B, 8568A/B and 8594E"](#), on page 1007):

- "GPIB Language" on page 486
- "IF Gain (Norm/Puls)" on page 487
- "Sweep Repeat (On/Off)" on page 487
- "Coupling (FSx/HP)" on page 488

"Default" Standard R&S ESRP operation, see ["Mode Default"](#) on page 486

"R&S FSP" Compatible to R&S FSP, see ["Mode R&S FSP"](#) on page 486

"R&S FSU" Compatible to R&S FSU, see ["Mode R&S FSU"](#) on page 486

Remote command:

[SYSTem:COMPAtible](#) on page 888

#### **Mode Default ← Compatibility Mode ← GPIB ← General Setup**

Resets the number of measurement points and available bandwidths to default R&S ESRP values.

Remote command:

SYST:COMP DEF, see [SYSTem:COMPAtible](#) on page 888

#### **Mode R&S FSP ← Compatibility Mode ← GPIB ← General Setup**

Sets the number of measurement points and available bandwidths as in R&S FSP devices.

Remote command:

SYST:COMP FSP, see [SYSTem:COMPAtible](#) on page 888

#### **Mode R&S FSU ← Compatibility Mode ← GPIB ← General Setup**

Sets the number of measurement points and available bandwidths as in R&S FSU devices.

Remote command:

SYST:COMP FSU, see [SYSTem:COMPAtible](#) on page 888

#### **GPIB Language ← Compatibility Mode ← GPIB ← General Setup**

Opens a list of selectable remote-control languages:

Language	Comment
SCPI	
71100C	Compatible to 8566A/B
71200C	Compatible to 8566A/B
71209A	Compatible to 8566A/B
8560E	
8561E	
8562E	
8563E	

Language	Comment
8564E	
8565E	
8566A	Command sets A and B are available. Command sets A and B differ in the rules regarding the command structure.
8566B	
8568A	Command sets A and B are available. Command sets A and B differ in the rules regarding the command structure.
8568A_DC	Uses DC input coupling by default if supported by the instrument
8568B	Command sets A and B are available. Command sets A and B differ in the rules regarding the command structure.
8568B_DC	Uses DC input coupling by default if supported by the instrument
8591E	Compatible to 8594E
8594E	Command sets A and B are available. Command sets A and B differ in the rules regarding the command structure.

For details on the GPIB languages, see [Chapter 11.18, "GPIB Commands of HP Models 856xE, 8566A/B, 8568A/B and 8594E"](#), on page 1007.

Remote command:

[SYSTem:LANGuage](#) on page 960

#### **IF Gain (Norm/Puls) ← Compatibility Mode ← GPIB ← General Setup**

Configures the internal IF gain settings in HP emulation mode due to the application needs. This setting is only taken into account for resolution bandwidth < 300 kHz.

NORM	Optimized for high dynamic range, overload limit is close to reference level.
PULS	Optimized for pulsed signals, overload limit up to 10 dB above reference level.

This softkey is only available if an HP language is selected via the "GPIB Language" softkey (see ["GPIB Language"](#) on page 486).

Remote command:

[SYSTem:IFGain:MODE](#) on page 961

#### **Sweep Repeat (On/Off) ← Compatibility Mode ← GPIB ← General Setup**

Controls a repeated sweep of the E1 and MKPK HI/HL HP model commands (for details on the commands refer to ["GPIB Language"](#) on page 486). If the repeated sweep is "OFF", the marker is set without sweeping before.

**Note:** In single sweep mode, switch off this softkey before you set the marker via the E1 and MKPK HI/HL commands to avoid sweeping again.

This softkey is only available if an HP language is selected via the "GPIB Language" softkey (see ["GPIB Language"](#) on page 486).

Remote command:

[SYSTem:RSW](#) on page 959

**Coupling (FSx/HP) ← Compatibility Mode ← GPIB ← General Setup**

Controls the default coupling ratios in the HP emulation mode for:

- Span and resolution bandwidth (Span/RBW) and
- Resolution bandwidth and video bandwidth (RBW/VBW)

For FSP(=FSV), the standard parameter coupling of the instrument is used. As a result, usually a shorter sweeptime is used than for HP.

This softkey is only available if an HP language is selected via the "GPIB Language" softkey (see ["GPIB Language"](#) on page 486).

Remote command:

`SYSTem:HPCoupling` on page 960

**REV String Factory ← Compatibility Mode ← GPIB ← General Setup**

Selects the default response to the `REV?` query for the revision number (HP emulation only, see [Chapter 11.18, "GPIB Commands of HP Models 856xE, 8566A/B, 8568A/B and 8594E"](#), on page 1007).

Remote command:

`SYSTem:REVision:FACTory` on page 959

**REV String User ← Compatibility Mode ← GPIB ← General Setup**

Opens an edit dialog box to enter a user-defined revision number in response to the `REV?` query (HP emulation only, see [Chapter 11.18, "GPIB Commands of HP Models 856xE, 8566A/B, 8568A/B and 8594E"](#), on page 1007). Max. 36 characters are allowed.

Remote command:

`SYSTem:REVision[:STRing]` on page 959

**Tree Walking ← Compatibility Mode ← GPIB ← General Setup**

Defines how remote control programs are evaluated, in particular multiple commands in one command line.

Note that this setting is retained after a [preset] or recall operation.

See the SCPI command for an example.

"Normal"	(Initial default:) SCPI-conform behavior The first command is always referenced to the root node. Subsequent commands, however, are referenced to the same tree level as the previous command in a message unit.
"Enhanced"	If subsequent commands are not found on the same tree level as the previous command, the SCPI parser searches "backwards up the tree" of defined SCPI commands. If the command is found at a higher node, that command is used. Only if the command is not found anywhere, an error message is returned.

Remote command:

`SYSTem:TWALking` on page 961

**Display Update (On/Off) ← GPIB ← General Setup**

Defines whether the instrument display is switched off when changing from manual operation to remote control. In remote control mode, this softkey is displayed in the local menu.

Remote command:

[SYSTem:DISPlay:UPDate](#) on page 889

#### **GPIO Terminator LFEOI/EOI ← GPIO ← General Setup**

Changes the GPIO receive terminator.

According to the standard, the terminator in ASCII is <LF> and/or <EOI>. For binary data transfers (e.g. trace data) from the control computer to the instrument, the binary code used for <LF> might be included in the binary data block. Therefore, it should not be interpreted as a terminator in this particular case. This can be avoided by changing the receive terminator to EOI.

Remote command:

[SYSTem:COMMunicate:GPIO\[:SELF\]:RTERminator](#) on page 957

#### **\*IDN Format Leg./New ← GPIO ← General Setup**

Defines the response format to the \*IDN? remote command (see [\\*IDN?](#) on page 884). This function is intended for re-use of existing control programs together with the R&S ESRP.

"Leg"	Legacy format, compatible to the R&S FSP/FSU/FSQ family e.g. Rohde&Schwarz, FSV-7, 100005/007, 1.61
"New"	R&S ESRP format e.g. Rohde&Schwarz, FSV-7, 1307.9002K07/100005, 1.61

Remote command:

[SYSTem:FORMat:IDENt](#) on page 889

#### **I/O Logging (On/Off) ← GPIO ← General Setup**

Activates or deactivates the SCPI log function. All remote control commands received by the R&S ESRP are recorded in the following log file:

C:\R\_S\Instr\scpi\logging\ScpiLog.txt

Logging the commands can be extremely useful for debug purposes, e.g. to find misspelled keywords in control programs.

Remote command:

[SYSTem:CLOGging](#) on page 888

#### **Time+Date ← General Setup**

Opens an edit dialog box to enter time and date for the internal real-time clock.

For details, refer to [Chapter 3.2.4.2, "Setting the Date and Time"](#), on page 46.

Remote command:

[SYSTem:TIME](#) on page 891

[SYSTem:DATE](#) on page 892

#### **Configure Monitor ← General Setup**

Determines and displays the configuration of a connected external monitor, if available. In the configuration dialog box, you can switch from the internal monitor (laptop icon) to the external monitor (monitor icon), or both (double monitor icon). For external, the R&S ESRP display is disabled (turns dark). The screen content formerly displayed on the R&S ESRP is displayed on the external screen.

For further details, refer to [Chapter 3.2.3, "Connecting an External Monitor"](#), on page 45.

### Soft Frontpanel ← General Setup

Activates or deactivates the display of the instrument emulation.

deactivated	Only the measurement screen is displayed. This is the setting for working at the R&S ESRP.
activated	In addition to the measurement screen, the whole front panel is displayed, i.e. the hardkeys and other hardware controls of the device are simulated on the screen. This is the setting for working at a computer with Remote Desktop or at an external monitor.

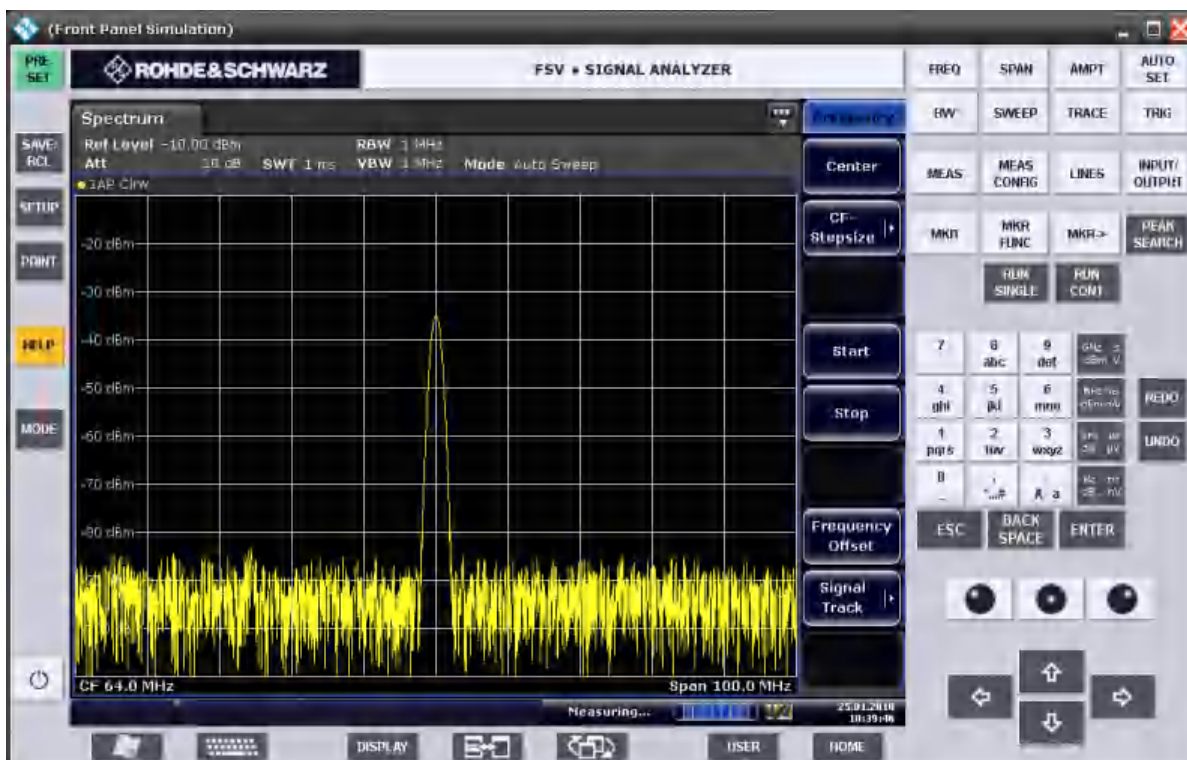

**Figure 9-1: Soft frontpanel**

Alternatively to this softkey, you can use the F6 key.

Remote command:

`SYSTEM:DISPlay:FPANel` on page 892

### Display Setup

Opens a submenu to define the display settings.

The following display settings are available:

- ["Tool Bar State \(On/Off\)"](#) on page 491
- ["Screen Title \(On/Off\)"](#) on page 491
- ["Time+Date \(On/Off\)"](#) on page 491
- ["Time+Date Format \(US/DE\)"](#) on page 491
- ["Print Logo \(On/Off\)"](#) on page 491

- "Annotation (On/Off)" on page 492
- "Theme Selection" on page 492
- "Screen Colors" on page 492
- "Print Colors" on page 493
- "Display Pwr Save (On/Off)" on page 494

**Tool Bar State (On/Off) ← Display Setup**

Displays or removes the toolbar above the diagram.

This setting is stored in instrument settings files.

Remote command:

`DISPlay:TBAR[STATe]` on page 948

**Status Bar ← Display Setup**

Displays or removes the status bar beneath the diagram.

The status bar indicates the global instrument settings, the instrument status and any irregularities during measurement or display.

This setting is stored in instrument settings files.

Remote command:

`DISPlay:SBAR[:STATe]` on page 948

**Screen Title (On/Off) ← Display Setup**

Activates/deactivates the display of a diagram title (if available) and opens an edit dialog box to enter a new title for the active diagram. Max. 20 characters are allowed.

Remote command:

`DISPlay[:WINDow<n>]:TEXT[:DATA]` on page 951

`DISPlay[:WINDow<n>]:TIME` on page 951

**Time+Date (On/Off) ← Display Setup**

Activates/deactivates the display of date and time beneath the diagram.

This setting is stored in instrument settings files.

Remote command:

`DISPlay[:WINDow<n>]:TIME` on page 951

**Time+Date Format (US/DE) ← Display Setup**

Switches the time and date display on the screen between US and German (DE).

This setting is stored in instrument settings files.

Remote command:

`DISPlay[:WINDow<n>]:TIME:FORMat` on page 951

**Print Logo (On/Off) ← Display Setup**

Activates/deactivates the display of the Rohde & Schwarz company logo in the upper left corner.

Remote command:

`DISPlay:LOGO` on page 947

**Annotation (On/Off) ← Display Setup**

Activates/deactivates the display of the frequency information in the diagram footer. For example, to protect confidential data it can be useful to hide the frequency information.

Remote command:

`DISPlay:ANNOtation:FREQuency` on page 945

**Theme Selection ← Display Setup**

Opens a selection list of available themes for the screen display. The theme defines the colors used for keys and screen elements, for example. The default theme is "Blue-Ocean".

Remote command:

`DISPlay:THEME:SELEct` on page 949

**Screen Colors ← Display Setup**

Opens a submenu to configure the screen colors.

For details on screen colors, refer to [Chapter 3.2.4.4, "Setting the Screen Colors"](#), on page 48.

The submenu contains the following commands:

- ["Select Screen Color Set"](#) on page 492
- ["Color \(On/Off\)"](#) on page 492
- ["Select Object"](#) on page 492
- ["Predefined Colors"](#) on page 493
- ["User Defined Colors"](#) on page 493
- ["Set to Default"](#) on page 493

Remote command:

`DISPlay:CMAP<item>:HSL` on page 946

**Select Screen Color Set ← Screen Colors ← Display Setup**

Opens the "Select Screen Color Set" dialog box to select default or user-defined color settings.

If one of the default settings is selected ("Default Colors 1"/"2"), the default settings for brightness, color tint and color saturation for all display screen elements are restored. The default color schemes provide optimum visibility of all picture elements at an angle of vision from above or below. Default setting is "Default Colors 1".

If "User Defined Colors" is selected, a user-defined color set can be defined.

For details on screen colors, refer to [Chapter 3.2.4.4, "Setting the Screen Colors"](#), on page 48.

Remote command:

`DISPlay:CMAP<item>:DEFault` on page 945

**Color (On/Off) ← Screen Colors ← Display Setup**

Switches from color display to black-and-white display and back. The default setting is color display.

**Select Object ← Screen Colors ← Display Setup**

Opens the "Color Setup" dialog box to select the color settings for a selected object.

The "Selected Object" list is displayed to select the object. To set the color, the predefined colors are displayed.

Remote command:

[DISPlay:CMAP<item>:HSL](#) on page 946

[HCOPY:CMAP<item>:HSL](#) on page 927

#### **Predefined Colors ← Screen Colors ← Display Setup**

In the "Color Setup" dialog box, displays the "Predefined Colors" (alternatively to the "Predefined Colors" button). This softkey is only available if, in the "Select Color Set" dialog box, the "User Defined Colors" option is selected or the "Color Setup" dialog box is displayed.

For details on screen colors, refer to [Chapter 3.2.4.4, "Setting the Screen Colors"](#), on page 48.

Remote command:

[DISPlay:CMAP<item>:PDEFined](#) on page 946

[HCOPY:CMAP<item>:PDEFined](#) on page 928

#### **User Defined Colors ← Screen Colors ← Display Setup**

In the "Color Setup" dialog box, displays the "User Defined Colors" (alternatively to the "User Defined Colors" button). This softkey is only available if, in the "Select Color Set" dialog box, the "User Defined Colors" option is selected or the "Color Setup" dialog box is displayed.

For details on screen colors, refer to [Chapter 3.2.4.4, "Setting the Screen Colors"](#), on page 48.

Remote command:

[DISPlay:CMAP<item>:HSL](#) on page 946

[HCOPY:CMAP<item>:HSL](#) on page 927

#### **Set to Default ← Screen Colors ← Display Setup**

Opens the "Set to Default" dialog box to select one of the factory default color settings.

Remote command:

[DISPlay:CMAP<item>:DEFault](#) on page 945

[HCOPY:CMAP<item>:DEFault](#) on page 927

#### **Print Colors ← Display Setup**

Opens a submenu to select the colors for the printout. To facilitate color selection, the selected color combination is displayed when the menu is entered. The previous colors are restored when the menu is exited.

For details on screen colors, refer to [Chapter 3.2.4.4, "Setting the Screen Colors"](#), on page 48.

The submenu contains the following commands:

- ["Select Print Color Set"](#) on page 494
- ["Color \(On/Off\)"](#) on page 494
- ["Select Object"](#) on page 516
- ["Predefined Colors"](#) on page 516
- ["User Defined Colors"](#) on page 516
- ["Set to Default"](#) on page 516



Remote command:

[HCOPY:CMAP<item>:HSL](#) on page 927

### Select Print Color Set ← Print Colors ← Display Setup

Opens the "Select Print Color Set" dialog box to select the color settings for printout.

Screen colors (Print)	Selects the current screen colors for the printout. The background is always printed in white and the grid in black.
Screen colors (Hardcopy)	Selects the current screen colors without any changes for a hard-copy. The output format is set via the "Device Setup" on page 515 softkey in the "Print" menu.
Optimized colors	Selects an optimized color setting for the printout to improve the visibility of the colors (default setting). Trace 1 is blue, trace 2 black, trace 3 green, and the markers are turquoise. The background is always printed in white and the grid in black.
User-Defined colors	Enables the softkeys to define colors for the printout.

Remote command:

[HCOPY:CMAP<item>:DEFault](#) on page 927

### Color (On/Off) ← Print Colors ← Display Setup

Switches from color printout to black-and-white printout and back. All colored areas are printed in white and all colored lines in black. This improves the contrast. The default setting is color printout, provided that the selected printer can produce color printouts.

Remote command:

[HCOPY:DEVICE:COLor](#) on page 929

### Display Pwr Save (On/Off) ← Display Setup

Switches the power-save mode for the display (On/Off) and opens an edit dialog box to enter the time for the power-save function to respond. After this time, the display is switched off completely, i.e. including backlighting. This mode is recommended when the instrument is exclusively operated in remote control.

For details on the power-save mode for the display, refer to [Chapter 3.2.4.5, "Setting the Display Power Save Function"](#), on page 50.

Remote command:

[DISPlay:PSAVe\[:STATe\]](#) on page 947

[DISPlay:PSAVe:HOLDoff](#) on page 947

### System Info

Opens a submenu to display detailed information on module data, device statistics and system messages.

The submenu contains the following commands:

- ["Hardware Info"](#) on page 495
- ["Versions+Options"](#) on page 495
- ["System Messages"](#) on page 495
- ["Clear All Messages"](#) on page 496

**Hardware Info ← System Info**

Opens a dialog box that displays hardware information, e.g. on the frontend and motherboard. Every listed component is described by its serial number, order number, model information, hardware code, and hardware revision.

Remote command:

[DIAGnostic<n>:SERVice:HWINfo?](#) on page 893

**Versions+Options ← System Info**

Opens a dialog box that displays a list of hardware and firmware information, including:

Label	Description
Device ID	Unique ID of the device
Instrument firmware	Installed firmware version
BIOS	Installed BIOS version
CPLD	CPLD version
MB-FPGA	Motherboard FPGA version
Data Sheet version	Data sheet version of the basic device
<option>	Installed hardware and firmware options
"Open Source Acknowledgment: Open"	Displays a PDF file containing information on open source code used by the R&S ESRP firmware.

For details on options, refer to [Chapter 3.2.1.10, "Checking the Supplied Options"](#), on page 43.

Remote command:

[\\*IDN?](#) on page 884

[\\*OPT?](#) on page 885

[SYSTem:DEVice:ID?](#) on page 892

**System Messages ← System Info**

Opens the "System Messages" dialog box that displays the generated system messages in the order of their occurrence. The most recent messages are placed at the top of the list. Messages that have occurred since the last display of system messages menu are marked with an asterisk '\*'. The following information is available:

No	device-specific error code
Message	brief description of the message
Component	hardware messages: name of the affected module
	software messages: name of the affected software
Date/Time	date and time of the occurrence of the message

If the number of error messages exceeds the capacity of the error buffer, "Message buffer overflow" is displayed. To delete messages, see ["Clear All Messages"](#) on page 496 softkey.

Remote command:

[SYSTem:ERRor:LIST?](#) on page 895

### Clear All Messages ← System Info

Deletes all system messages. The softkey is only available if the "System Messages" dialog box is displayed.

Remote command:

[SYSTem:ERRor:CLEar:ALL](#) on page 894

### Parameter Coupling

Opens a dialog box to couple or decouple various parameters.

If the coupling of a parameter is on, its value is transferred when you switch from receiver into another operating mode and vice versa. Coupling of the following parameters is supported.

- Frequency
- Span (start and stop frequencies)
- Marker frequency
- RF attenuation and unit
- 10 dB Minimum Attenuation
- Preamplifier state
- Preselector state
- Audio demodulation settings
- Bandwidth settings (including filter type)
- Limit lines

Note that the preselector is always on in receiver mode.

Limit lines are only transferred if they are compatible to the current diagram configuration.

Remote command:

See [Chapter 11.9.3, "Coupling Parameters"](#), on page 895

### Firmware Update

Opens the "Firmware Update" dialog box.

Enter the name of or browse for the firmware installation file and press the "Execute" button. For details on installation, refer to [Chapter 3.3, "Firmware Update and Installation of Firmware Options"](#), on page 58.

Only user accounts with administrator rights can perform a firmware update.

Remote command:

[SYSTem:FIRMware:UPDate](#) on page 889

### Option Licenses

Opens a submenu to install options. For details on options, refer to [Chapter 3.3, "Firmware Update and Installation of Firmware Options"](#), on page 58.

The submenu contains the following commands:

- ["Install Option"](#) on page 497
- ["Install Option by XML"](#) on page 497

Only user accounts with administrator rights are able to install options.

**Install Option ← Option Licenses**

Opens an edit dialog box to enter the license key for the option that you want to install.

If an option is about to expire, a message box is displayed to inform you. You can then use this softkey to enter a new license key.

If an option has already expired, a message box appears for you to confirm. In this case, all instrument functions are unavailable (including remote control) until you reboot the R&S ESRP. Then use the "Install Option" softkey to enter the new license key.

For more information about the option in question, refer to the [System Info](#) softkey in the "Setup" menu.

Only user accounts with administrator rights are able to install options.

**Install Option by XML ← Option Licenses**

Opens an edit dialog to install an additional option to the R&S ESRP using an XML file. Enter or browse for the name of an XML file on the instrument that contains the option key and press "Select".

Only user accounts with administrator rights are able to install options.

**Application Setup Recovery**

Controls instrument behavior when switching between measurement applications, e.g. from "Spectrum" to "Analog Demod" and back.

If this softkey is activated, the current instrument settings are stored when you switch to a different application. When you switch back to the previous application, the corresponding instrument settings are restored. Thus, the settings of the individual applications are independent of each other.

If the softkey is deactivated (default), only a few parameters of the current instrument setting are passed between applications (e.g. center frequency, level settings).

Note that this setting is not deactivated during a preset operation, i.e. you must deactivate it manually, if necessary.

Remote command:

[SYSTem:APPLication:SREcovery\[:STATe\]](#) on page 888

**Preset Receiver**

Selects the default settings defined for the Receiver mode to be restored when you perform an instrument preset.

Remote command:

[SYSTem:PRESet:COMPatible](#) on page 890

**Preset Spectrum**

Selects the default settings defined for the Spectrum mode to be restored when you perform an instrument preset.

Remote command:

[SYSTem:PRESet:COMPatible](#) on page 890

**Service**

Opens a submenu that contains additional functions for maintenance and/or troubleshooting.

**NOTICE!** Risk of incorrect operation due to service functions. The service functions are not necessary for normal measurement operation. However, incorrect use can affect correct operation and/or data integrity of the R&S ESRP.

Therefore, many of the functions can only be used after entering a password. They are described in the instrument service manual.

Only user accounts with administrator rights are able to use service functions.

**Input Source ← Service**

Opens a submenu to select the input source for measurement.

The submenu contains the following options:

- "RF" on page 498
- "Calibration Frequency RF" on page 498

**RF ← Input Source ← Service**

Switches the input of the R&S ESRP to the RF input connector (normal position). This is the default setting.

Remote command:

[DIAGnostic<n>:SERvice:INPut\[:SElect\]](#) on page 905

**Calibration Frequency RF ← Input Source ← Service**

Opens an edit dialog box to set the generator frequency for the internal calibration.

Remote command:

[DIAGnostic<n>:SERvice:INPut:PULSed:CFrequency](#) on page 904

**Reset Password ← Service**

Deactivates all set passwords.

Remote command:

[SYSTem:PASSword:RESet](#) on page 907

**Selftest ← Service**

Initiates the self-test of the instrument modules to identify a defective module if there was a failure. All modules are checked consecutively and the test result is displayed.

Remote command:

[\\*TST?](#) on page 886

**Selftest Results ← Service**

Opens the "Selftest Result" dialog box that contains the test results. In case of failure a short description of the failed test, the defective module, the associated value range and the corresponding test results are indicated.

Remote command:

[DIAGnostic<n>:SERvice:STESSt:RESult?](#) on page 905

**Password ← Service**

Opens an edit dialog box to enter the password. This ensures that the service functions are only used by authorized personnel.

Remote command:

[SYSTem:PASSword\[:CENable\]](#) on page 907

**Service Function ← Service**

Opens the "Service Function" dialog box to start special service functions. For further information, refer to the service manual.

Remote command:

[DIAGnostic<n>:SERvice:SFUNction](#) on page 906

## 10 Data Management and Documentation

### 10.1 Saving and Recalling Settings Files – SAVE/RCL Key

The [SAVE/RCL] key is used to store and recall an instrument configuration.

The "Save/Recall" menu enables the user to save or recall the configuration file from the instrument's internal storage, a memory stick or a network drive. The file can also include various settings used by the options installed on the instrument. Measurement results can also be stored; however, it is strongly recommended that you use the "Print Screen" or "Trace Export" functions instead.



When recalling a saved configuration file, the following restrictions apply:

- Configuration files cannot be transferred from an R&S ESRP with a larger frequency range to one with a smaller frequency range
- Configuration files created on a R&S ESRP with certain options in use will not work on an R&S ESRP without these options
- Files created with newer firmware versions may not work with a previous version

#### Saving and recalling transducer and limit line settings

If a transducer file was in use when the save set was stored (with the save item "Current Settings" only) it is anticipated that these transducer values should remain valid after every recall of that save set. Thus, even if the transducer file is changed and the original save set file is recalled later, the *originally stored* transducer values are recalled and applied to the measurement. In the "Transducer" dialog box, however, the *changed* transducer file values are displayed as no updated transducer file was loaded.

The same applies to limit line settings.



If you want to apply the changed transducer values after recalling the save set you must force the application to reload the transducer file. To do so, simply open the "Edit Transducer" dialog box and toggle the "X-Axis" option from "lin" to "log" and back. Due to that change, the transducer file is automatically reloaded, and the changed transducer values are applied to the current measurement. Now you can create a new save set with the updated transducer values.

Similarly, if you want to apply the changed limit values after recalling the save set you must force the application to reload the limit file. To do so, simply open the "Edit Limit Line" dialog box (see "Edit" on page 187) and toggle the "Y-Axis" unit. Due to that change, the limit line file is automatically reloaded, and the changed limit values are applied to the current measurement. Now a new save set with the updated limit values can be created.

**To open the Save/Recall menu**

- ▶ Press the [SAVE/RCL] key.  
The "Save/Recall" menu is displayed.

**Menu and softkey description**

- [Chapter 10.1.1, "Softkeys of the SAVE/RCL Menu"](#), on page 501

**Further information**

- [Chapter 10.1.2, "File Selection Dialog Boxes"](#), on page 507
- [Chapter 10.1.3, "Importing and Exporting I/Q Data"](#), on page 509

**10.1.1 Softkeys of the SAVE/RCL Menu**

The following table shows all softkeys available in the "Save/Recall" menu.

Save.....	502
L Save File / Recall File.....	502
L Select Path.....	502
L Select File.....	502
L Edit File Name.....	502
L Edit Comment.....	502
L Select Items.....	502
L Select Items.....	502
L Enable all Items.....	503
L Disable all Items.....	503
L Delete File.....	503
Recall.....	503
Startup Recall.....	503
L Startup Recall (On/Off).....	504
L Select Dataset.....	504
ScreenShot.....	504
Export.....	504
L ASCII Trace Export.....	504
L Decim Sep.....	505
L IQ Export.....	505
Import.....	505
L IQ Import.....	505
File Manager.....	505
L Edit Path.....	505
L New Folder.....	505
L Copy.....	506
L Rename.....	506
L Cut.....	506
L Paste.....	506
L Delete.....	506
L Sort Mode.....	506
L Name.....	506



L Date.....	506
L Extension.....	506
L Size.....	506
L File Lists (1/2).....	506
L Current File List (1/2).....	506
L Network Drive.....	507
L Map Network Drive.....	507
L Disconnect Network Drive.....	507

**Save**

Opens the "Save" dialog box to define which measurement settings and results to store. To navigate in the dialog box and define/enter data, use the corresponding soft-keys.

For details see also [Chapter 10.1.2, "File Selection Dialog Boxes"](#), on page 507.

**Save File / Recall File ← Save**

Saves the settings file with the defined file name ("Save" dialog box), or recalls the selected settings file ("Recall" dialog box).

You can assign stored settings files to user-definable softkeys in the "User" menu for easy access, see [Chapter 9.2, "User-Defined Menu – USER key"](#), on page 474 .

Remote command:

[MMEMory:STORe<n>:STATe](#) on page 916

[MMEMory:STORe<n>:STATe:NEXT](#) on page 917

[MMEMory:LOAD:STATe](#) on page 915

**Select Path ← Save**

Opens the directory list to select the drive and folder for the settings file to be stored or loaded. The default path is C:\r\_s\instr\user.

**Select File ← Save**

Sets the focus on the "Files" list.

Remote command:

[MMEMory:CATaLog?](#) on page 908

**Edit File Name ← Save**

Sets the focus on the "File Name" field.

**Edit Comment ← Save**

Sets the focus on the "Comment" field to enter a comment for the settings file. Max. 60 characters are allowed.

**Select Items ← Save**

Displays the submenu for selecting the items to be stored or loaded.

**Select Items ← Select Items ← Save**

Sets the focus on the items list. Which items are available depends on the installed options.

In the "Save" dialog box, all items that can be saved are displayed.

In the "Recall" dialog box, the items saved in the selected file are displayed.

Remote command:

`MMEMemory:SELEct[:ITEM]:HWSettings` on page 953

`MMEMemory:SELEct[:ITEM]:LINes:ALL` on page 953

`MMEMemory:SELEct[:ITEM]:TRACe[:ACTive]` on page 954

`MMEMemory:SELEct[:ITEM]:TRANsducer:ALL` on page 954

#### **Enable all Items ← Select Items ← Save**

Selects all items for saving or loading.

Remote command:

`MMEMemory:SELEct[:ITEM]:ALL` on page 952

#### **Disable all Items ← Select Items ← Save**

Selects none of the items for saving or loading.

Remote command:

`MMEMemory:SELEct[:ITEM]:NONE` on page 953

#### **Delete File ← Save**

Deletes the selected settings file.

Remote command:

`MMEMemory:CLEar:STATe 1`, on page 914

#### **Recall**

Opens the "Recall" dialog box to load a settings file. To navigate in the dialog box, use the corresponding softkeys.

For details see also [Chapter 10.1.2, "File Selection Dialog Boxes"](#), on page 507.

Path	Directory from which the settings file is loaded. The default path for user settings files is C:\r_s\instr\user
Files	List of stored settings files
File Name	Name of settings file
Comment	Comment of the settings file
[Items]	Items saved in the settings file

**Note:** After you use the "Recall" function, the history of previous actions is deleted, i.e. any actions performed previously cannot be undone or redone using the [UNDO/REDO] keys.

Remote command:

`MMEMemory:LOAD:STATe` on page 915

#### **Startup Recall**

Opens a submenu to activate or deactivate and set up the startup recall function.

**Startup Recall (On/Off) ← Startup Recall**

Activates or deactivates the startup recall function. If activated, the settings stored in the file selected via the [Select Dataset](#) softkey are loaded when booting or for preset. If deactivated, the default settings are loaded.

Remote command:

[MMEMory:LOAD:AUTO](#) on page 914

**Select Dataset ← Startup Recall**

Opens the "Startup Recall" dialog box to select the settings file for the startup recall function.

**ScreenShot**

Saves the current measurement screen as a file (screenshot). This function can also be performed via the "Screenshot" icon in the toolbar, if available.

Remote command:

[HCOPY\[:IMMEDIATE<1|2>\]](#) on page 931

**Export**

Opens a submenu to configure data export.

**ASCII Trace Export ← Export**

Opens the "ASCII Trace Export Name" dialog box and saves the active trace in ASCII format to the specified file and directory.

**Tip:** You can export a single trace ("ASCII Trace Export Trace (x)" softkey) or all traces at the same time ("ASCII Trace Export All Traces"). When you use single trace export, the R&S ESRP exports the currently selected trace (indicated by the softkey label). Note that the exported ASCII file has a slightly different structure compared to a single trace export.

The file consists of the header containing important scaling parameters and a data section containing the trace data. For details on an ASCII file see [Chapter 6.3.1.6, "ASCII File Export Format"](#), on page 370.

This format can be processed by spreadsheet calculation programs, e.g. MS-Excel. It is necessary to define ';' as a separator for the data import. Different language versions of evaluation programs may require a different handling of the decimal point. It is therefore possible to select between separators '.' (decimal point) and ',' (comma) using the "Decim Sep" softkey (see ["Decim Sep"](#) on page 176).

If the spectrogram display is selected when you perform this function, the entire histogram buffer with all frames is exported to a file. The data corresponding to a particular frame begins with information about the frame number and the time that frame was recorded. For large history buffers the export operation may take some time.

Remote command:

[FORMat:DEXPort:TRACes](#) on page 615

[FORMat:DEXPort:DSEParator](#) on page 818

[MMEMory:STORe<n>:TRACe](#) on page 819

[MMEMory:STORe:SGRam](#) on page 621

**Decim Sep ← Export**

Selects the decimal separator with floating-point numerals for the ASCII Trace export to support evaluation programs (e.g. MS-Excel) in different languages. The values '.' (decimal point) and ',' (comma) can be set.

Remote command:

`FORMat:DEXPort:DSEParator` on page 818

**IQ Export ← Export**

Opens a file selection dialog box to select an export file to which the IQ data will be stored. This function is only available in single sweep mode.

For details see [Chapter 10.1.3, "Importing and Exporting I/Q Data"](#), on page 509.

Remote command:

`MMEMorY:STORe:IQ:STATe` on page 916

`MMEMorY:STORe:IQ:COMM` on page 916

**Import**

Provides functions to import data.

**IQ Import ← Import**

Opens a file selection dialog box to select an import file that contains IQ data. This function is only available in single sweep mode.

For details see [Chapter 10.1.3, "Importing and Exporting I/Q Data"](#), on page 509.

Remote command:

`MMEMorY:LOAD:IQ:STATe` on page 857

**File Manager**

Opens the "File Manager" dialog box and a submenu to manage mass storage media and files. In the upper left corner, the current drive is displayed. Below the folders and subfolders of the current directory are displayed.

For details on navigation see also [Chapter 10.1.2, "File Selection Dialog Boxes"](#), on page 507.

The following tasks can be performed:

- copying files from flash disk to other media
- copying files into another directory
- renaming and deleting files

**Edit Path ← File Manager**

Opens the directory list to select the drive and folder for the file to be stored or loaded. The default path is `C:\r_s\instr\user`.

Remote command:

`MMEMorY:MSIS` on page 912

`MMEMorY:CDIRectory` on page 910

**New Folder ← File Manager**

Creates a new folder and opens an edit dialog box to enter name and path (absolute or relative to the current directory) of the new folder.

Remote command:

[MMEMoRY:MDIRectory](#) on page 912

#### **Copy ← File Manager**

Copies the selected item to the clipboard. The item can be copied later using the [Paste](#) softkey.

Remote command:

[MMEMoRY:CoPY](#) on page 910

#### **Rename ← File Manager**

Opens an edit dialog box to enter a new file or folder name.

Remote command:

[MMEMoRY:MoVE](#) on page 912

#### **Cut ← File Manager**

Copies the selected file to the clipboard. If the file is later copied to a different directory using the [Paste](#) softkey, it is deleted in the current directory.

#### **Paste ← File Manager**

Copies a file from the clipboard to the currently selected directory.

#### **Delete ← File Manager**

Deletes the selected item after confirmation.

Remote command:

[MMEMoRY:DELeTe](#) on page 911

[MMEMoRY:RDIRectory](#) on page 913

#### **Sort Mode ← File Manager**

Opens a submenu to select the sorting mode for the displayed files. The entry for the next higher directory level ("..") and the folders are always located at the top of the list.

#### **Name ← Sort Mode ← File Manager**

Sorts the displayed files in alphabetical order of the file names.

#### **Date ← Sort Mode ← File Manager**

Sorts the displayed files in respect to the date.

#### **Extension ← Sort Mode ← File Manager**

Sorts the displayed files in respect to the extension.

#### **Size ← Sort Mode ← File Manager**

Sorts the displayed files in respect to the size.

#### **File Lists (1/2) ← File Manager**

Splits the screen to copy files from one directory to the other. The focus between the two panes is switched using the [FIELD RIGHT] and [FIELD LEFT] keys.

#### **Current File List (1/2) ← File Manager**

Changes the focus to the selected file list.

**Network Drive ← File Manager**

Opens the "Map Network Drive" dialog box and submenu.

**Map Network Drive ← Network Drive ← File Manager**

Sets the focus on the "Drive" list.

Remote command:

[MMEemory:NETWork:MAP](#) on page 955

[MMEemory:NETWork:USEDdrives?](#) on page 956

[MMEemory:NETWork:UNUSeddrives?](#) on page 956

**Disconnect Network Drive ← Network Drive ← File Manager**

Opens the "Disconnect Network Drive" dialog box. In the "Drive" list, select the drive you want to disconnect and confirm with "OK".

Remote command:

[MMEemory:NETWork:DISConnect](#) on page 955

## 10.1.2 File Selection Dialog Boxes

The "Save" and "Recall" dialog boxes are used to save and recall settings and data files. The "File Manager" allows you to copy, delete or rename data files on the R&S ESRP. These and other file selection dialog boxes are very similar.

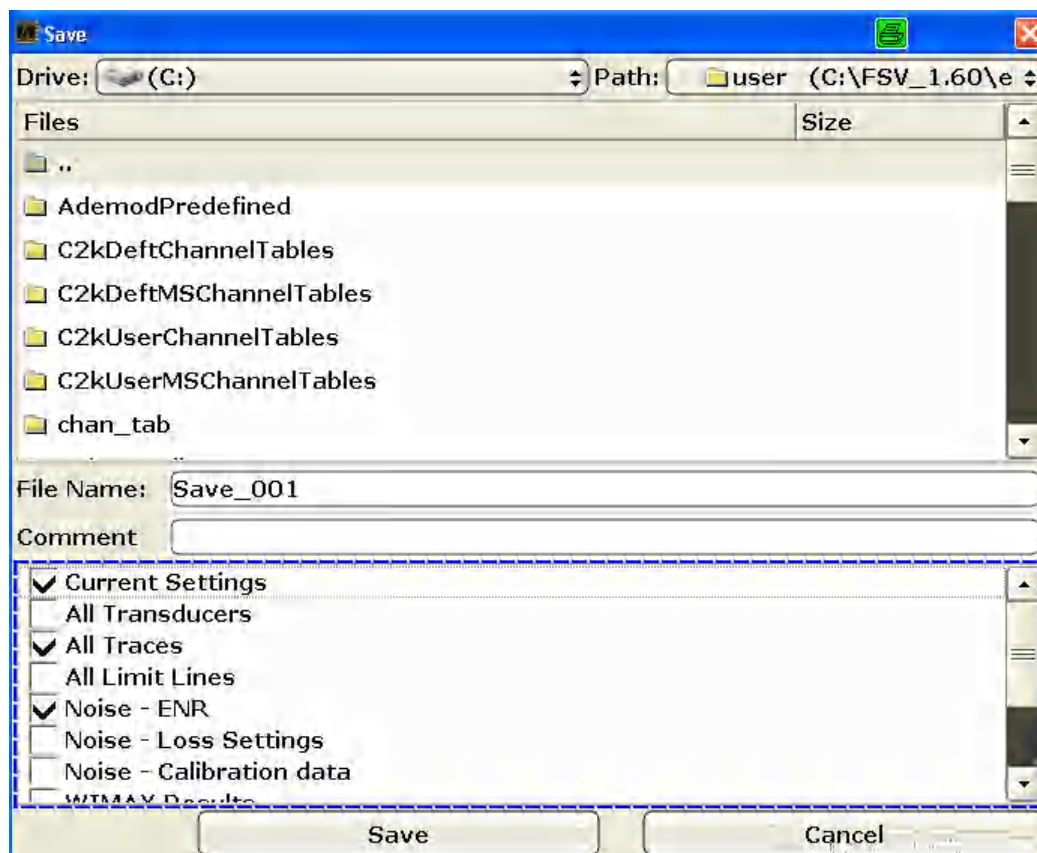

### Drive

The data is stored on the internal flash disk or, if selected, on a memory stick or network drive. The mass media are assigned to the volume names as follows:

Drive	Designation	Comment
C	operating system, firmware and stored instrument settings	for customer data
A	USB floppy drive	if connected
D	USB memory stick or USB CD-ROM	if connected
E ...Z	additional USB mass storage devices or mounted LAN volumes	if connected

### Path

The current path contains the drive and the complete file path to the currently selected folder.

To set the focus on the "Path" list, press the [Select Path/ Edit Path](#) softkey.

### Files

This list contains the files and folders contained in the currently selected path.

To set the focus on the "Files" list, press the [Select File](#) softkey.

### File Name

The "File Name" field contains the name of the data file without the path or extension.

To set the focus on "File Name" field, press the [Edit File Name](#) softkey.

In the "Save" dialog box, the field already contains a suggestion for a new name: the file name used in the last saving process is used, extended by an index. For example, if the name last used was `test_004`, the new name `test_005` is suggested, but only if this name is not in use. You can change the suggested name as you like.

By default, the name of a settings file consists of a base name followed by an underscore and three numbers, e.g. `limit_lines_005`. In the example, the base name is `limit_lines`. The base name can contain characters, numbers and underscores. The file extension `df1` is added automatically.

### Comment

The comment is optional and may contain a description for the data file.

To set the focus on the "Comment" field, press the [Edit Comment](#) softkey.

### Items

When saving data files you can select which data and settings are stored; when recalling such files, this field indicates which items were included during storage. In the "File Manager", this field is not available.

Which items are available depends on the installed options. The following items may be included:

Item	Description
Current Settings	Current measurement settings.
All Transducers	All transducer factor <i>files</i> . (Note: Restoring a saveset overwrites transducer factor files on the hard disk that have the same name as those in the saveset. For more information, read " <a href="#">Saving and recalling transducer and limit line settings</a> " on page 500.)
All Traces	All active traces.
All Limit Lines	All limit line <i>files</i> . (Note: information on which limit lines are active is stored with the "Current Settings").
Spectrograms	Spectrogram trace data.
Peak List	Information of the peak list.

### 10.1.3 Importing and Exporting I/Q Data

In addition to instrument settings and displayed traces, also captured I/Q data can be exported to a file on the R&S ESRP. The stored data can then be imported again at a later time, also by different applications, for further processing.

As opposed to storing trace data, which may be averaged or restricted to peak values, I/Q data is stored as it was captured, without further processing. The data is stored as complex values in 32-bit floating-point format. The I/Q data is stored in a packed format with the file extension `.iq.tar`.

The [IQ Import](#) and [IQ Export](#) functions are available from the "Save/Recall" menu, which is displayed when you press the [Save/Rcl] key on the front panel.

They can also be performed remotely using the following commands:

`MMEMoRY:STORe:IQ:STATe` on page 916

`MMEMoRY:LOAD:IQ:STATe` on page 857

#### 10.1.3.1 iq-tar File Format Specification

I/Q data is stored in a compressed format with the file extension `.iq.tar`.

An `.iq.tar` file contains I/Q data in binary format together with meta information that describes the nature and the source of data, e.g. the sample rate. The objective of the `.iq.tar` file format is to separate I/Q data from the meta information while still having both inside one file. In addition, the file format allows you to preview the I/Q data in a web browser, and allows you to include user-specific data.



### Contained files

An `iq-tar` file must contain the following files:

- **I/Q parameter XML file**, e.g. `xyz.xml`  
Contains meta information about the I/Q data (e.g. sample rate). The filename can be defined freely, but there must be only one single I/Q parameter XML file inside an `iq-tar` file.
- **I/Q data binary file**, e.g. `xyz.complex.float32`  
Contains the binary I/Q data of all channels. There must be only one single I/Q data binary file inside an `iq-tar` file.

Optionally, an `iq-tar` file can contain the following file:

- **I/Q preview XSLT file**, e.g. `open_IqTar_xml_file_in_web_browser.xslt`  
Contains a stylesheet to display the I/Q parameter XML file and a preview of the I/Q data in a web browser.

### I/Q Parameter XML File Specification



The content of the I/Q parameter XML file must comply with the XML schema `RsIqTar.xsd` available at: <http://www.rohde-schwarz.com/file/RsIqTar.xsd>.

In particular, the order of the XML elements must be respected, i.e. `iq-tar` uses an "ordered XML schema". For your own implementation of the `iq-tar` file format make sure to validate your XML file against the given schema.

The following example shows an I/Q parameter XML file. The XML elements and attributes are explained in the following sections.

#### Sample I/Q parameter XML file: `xyz.xml`

```
<?xml version="1.0" encoding="UTF-8"?>
<?xml-stylesheet type="text/xsl"
href="open_IqTar_xml_file_in_web_browser.xslt"?>
<RS_IQ_TAR_FileFormat fileFormatVersion="1"
xsi:noNamespaceSchemaLocation="RsIqTar.xsd"
xmlns:xsi="http://www.w3.org/2001/XMLSchema-instance">
  <Name>FSV-K10</Name>
  <Comment>Here is a comment</Comment>
  <DateTime>2011-01-24T14:02:49</DateTime>
  <Samples>68751</Samples>
  <Clock unit="Hz">6.5e+006</Clock>
  <Format>complex</Format>
  <DataType>float32</DataType>
  <ScalingFactor unit="V">1</ScalingFactor>
  <NumberOfChannels>1</NumberOfChannels>
  <DataFilename>xyz.complex.float32</DataFilename>
  <UserData>
    <UserDefinedElement>Example</UserDefinedElement>
  </UserData>
```

## Saving and Recalling Settings Files – SAVE/RCL Key

```
<PreviewData>...</PreviewData>
</RS_IQ_TAR_FileFormat>
```

Element	Description
RS_IQ_TAR_FileFormat	The root element of the XML file. It must contain the attribute <code>fileFormatVersion</code> that contains the number of the file format definition. Currently, <code>fileFormatVersion</code> "2" is used.
Name	Optional: describes the device or application that created the file.
Comment	Optional: contains text that further describes the contents of the file.
DateTime	Contains the date and time of the creation of the file. Its type is <code>xs:dateTime</code> (see <code>RsIqTar.xsd</code> ).
Samples	Contains the number of samples of the I/Q data. For multi-channel signals all channels have the same number of samples. One sample can be: <ul style="list-style-type: none"> <li>• A complex number represented as a pair of I and Q values</li> <li>• A complex number represented as a pair of magnitude and phase values</li> <li>• A real number represented as a single real value</li> </ul> See also <code>Format</code> element.
Clock	Contains the clock frequency in Hz, i.e. the sample rate of the I/Q data. A signal generator typically outputs the I/Q data at a rate that equals the clock frequency. If the I/Q data was captured with a signal analyzer, the signal analyzer used the clock frequency as the sample rate. The attribute <code>unit</code> must be set to "Hz".
Format	Specifies how the binary data is saved in the I/Q data binary file (see <code>DataFilename</code> element). Every sample must be in the same format. The format can be one of the following: <ul style="list-style-type: none"> <li>• Complex: Complex number in cartesian format, i.e. I and Q values interleaved. I and Q are unitless</li> <li>• Real: Real number (unitless)</li> <li>• Polar: Complex number in polar format, i.e. magnitude (unitless) and phase (rad) values interleaved. Requires <code>DataType = float32</code> or <code>float64</code></li> </ul>
DataType	Specifies the binary format used for samples in the I/Q data binary file (see <code>DataFilename</code> element and " <a href="#">I/Q Data Binary File</a> " on page 513). The following data types are allowed: <ul style="list-style-type: none"> <li>• <code>int8</code>: 8 bit signed integer data</li> <li>• <code>int16</code>: 16 bit signed integer data</li> <li>• <code>int32</code>: 32 bit signed integer data</li> <li>• <code>float32</code>: 32 bit floating point data (IEEE 754)</li> <li>• <code>float64</code>: 64 bit floating point data (IEEE 754)</li> </ul>
ScalingFactor	Optional: describes how the binary data can be transformed into values in the unit Volt. The binary I/Q data itself has no unit. To get an I/Q sample in the unit Volt the saved samples have to be multiplied by the value of the <code>ScalingFactor</code> . For polar data only the magnitude value has to be multiplied. For multi-channel signals the <code>ScalingFactor</code> must be applied to all channels. <p>The <code>ScalingFactor</code> must be &gt; 0. If the <code>ScalingFactor</code> element is not defined, a value of 1 V is assumed.</p>
NumberOfChannels	Optional: specifies the number of channels, e.g. of a MIMO signal, contained in the I/Q data binary file. For multi-channels, the I/Q samples of the channels are expected to be interleaved within the I/Q data file (see " <a href="#">I/Q Data Binary File</a> " on page 513). If the <code>NumberOfChannels</code> element is not defined, one channel is assumed.

Element	Description
DataFilename	<p>Contains the filename of the I/Q data binary file that is part of the <code>iq-tar</code> file.</p> <p>It is recommended that the filename uses the following convention:  <code>&lt;xyz&gt;.&lt;Format&gt;.&lt;Channels&gt;ch.&lt;Type&gt;</code></p> <ul style="list-style-type: none"> <li>• <code>&lt;xyz&gt;</code> = a valid Windows file name</li> <li>• <code>&lt;Format&gt;</code> = complex, polar or real (see <code>Format</code> element)</li> <li>• <code>&lt;Channels&gt;</code> = Number of channels (see <code>NumberOfChannels</code> element)</li> <li>• <code>&lt;Type&gt;</code> = float32, float64, int8, int16, int32 or int64 (see <code>DataType</code> element)</li> </ul> <p>Examples:</p> <ul style="list-style-type: none"> <li>• xyz.complex.1ch.float32</li> <li>• xyz.polar.1ch.float64</li> <li>• xyz.real.1ch.int16</li> <li>• xyz.complex.16ch.int8</li> </ul>
UserData	<p>Optional: contains user, application or device-specific XML data which is not part of the <code>iq-tar</code> specification. This element can be used to store additional information, e.g. the hardware configuration. It is recommended that you add user data as XML content.</p>
PreviewData	<p>Optional: contains further XML elements that provide a preview of the I/Q data. The preview data is determined by the routine that saves an <code>iq-tar</code> file (e.g. R&amp;S ESRP). For the definition of this element refer to the <code>RsIqTar.xsd</code> schema. Note that the preview can be only displayed by current web browsers that have JavaScript enabled and if the XSLT stylesheet <code>open_IqTar_xml_file_in_web_browser.xslt</code> is available.</p>

### Example: ScalingFactor

Data stored as `int16` and a desired full scale voltage of 1 V

$$\text{ScalingFactor} = 1 \text{ V} / \text{maximum int16 value} = 1 \text{ V} / 2^{15} = 3.0517578125e-5 \text{ V}$$

	Numerical value	Numerical value x ScalingFactor
Minimum (negative) int16 value	$-2^{15} = -32768$	-1 V
Maximum (positive) int16 value	$2^{15}-1 = 32767$	0.999969482421875 V

### Example: PreviewData in XML

```

<PreviewData>
  <ArrayOfChannel length="1">
    <Channel>
      <PowerVsTime>
        <Min>
          <ArrayOfFloat length="256">
            <float>-95</float>
            <float>-94</float>
            ...
            <float>-93</float>
          </ArrayOfFloat>
        </Min>
        <Max>
          <ArrayOfFloat length="256">
            <float>0</float>

```

```

        <float>-41</float>
        ...
        <float>0</float>
    </ArrayOfFloat>
</Max>
</PowerVsTime>
<Spectrum>
    <Min>
        <ArrayOfFloat length="256">
            <float>-107</float>
            <float>-96</float>
            ...
            <float>-94</float>
        </ArrayOfFloat>
    </Min>
    <Max>
        <ArrayOfFloat length="256">
            <float>-25</float>
            <float>1</float>
            ...
            <float>1</float>
        </ArrayOfFloat>
    </Max>
</Spectrum>
</Channel>
</ArrayOfChannel>
</PreviewData>

```

### I/Q Data Binary File

The I/Q data is saved in binary format according to the format and data type specified in the XML file (see `Format` element and `Data Type` element). To allow reading and writing of streamed I/Q data all data is interleaved, i.e. complex values are interleaved pairs of I and Q values and multi-channel signals contain interleaved (complex) samples for channel 1, channel 2, channel 3 etc.

#### Example: NumberOfChannels - Element ordering for complex cartesian data

Complex data: I[channel no][time index], Q[channel no][time index]

```

I[0][0], Q[0][0],           // Channel 0, Complex sample 0
I[1][0], Q[1][0],           // Channel 1, Complex sample 0
I[2][0], Q[2][0],           // Channel 2, Complex sample 0

I[0][1], Q[0][1],           // Channel 0, Complex sample 1
I[1][1], Q[1][1],           // Channel 1, Complex sample 1
I[2][1], Q[2][1],           // Channel 2, Complex sample 1

I[0][2], Q[0][2],           // Channel 0, Complex sample 2
I[1][2], Q[1][2],           // Channel 1, Complex sample 2
I[2][2], Q[2][2],           // Channel 2, Complex sample 2

```

```

I[0][3], Q[0][3],           // Channel 0, Complex sample 3
I[1][3], Q[1][3],           // Channel 1, Complex sample 3
I[2][3], Q[2][3],           // Channel 2, Complex sample 3

...

```

## 10.2 Measurement Documentation – PRINT Key

The PRINT key is used to select and configure the printer and to customize the screen printout.

For detailed information on printer selection and installation refer to [Chapter 3.2.4.6, "Selecting and Configuring Printers"](#), on page 51.

### To open the Print menu

- ▶ Press the PRINT key.  
The "Print" menu is displayed.

### Softkeys of the Print Menu

The following table shows all softkeys available in the "Print" menu. It is possible that your instrument configuration does not provide all softkeys. If a softkey is only available with a special option, model or (measurement) mode, this information is delivered in the corresponding softkey description.

Print Screen.....	514
Device Setup.....	515
Device (1/2).....	515
Colors.....	515
L Select Print Color Set.....	516
L Color (On/Off).....	516
L Select Object.....	516
L Predefined Colors.....	516
L User Defined Colors.....	516
L Set to Default.....	516
Comment.....	516
Install Printer.....	516
Report.....	516

### Print Screen

Starts to printout all test results displayed on the screen: diagrams, traces, markers, marker lists, limit lines etc. Comments, title, date, and time are included at the bottom margin of the printout. All displayed items belonging to the instrument software (softkeys, tables, dialog boxes) are not printed out.

The output is defined via the ["Device Setup"](#) on page 515 softkey. If the output is saved in a file, the file name used in the last saving process is counted up to the next unused name. If you use a file name that already exists, upon saving, a message is displayed. Selecting "Yes" overwrites the existing file, selecting "No" aborts the saving process. For further details on the file name and an example, refer to the "Save/Recall" menu, ["Edit File Name"](#) on page 502 softkey.

Path	Directory in which the file is stored. The default path is C:\r_s\instr\user
Files	List of the existing files in the same format
File Name	Name of the file

Remote command:

[HCOPY\[:IMMEDIATE<1|2>\]](#) on page 931

[HCOPY\[:IMMEDIATE<1|2>\]:NEXT](#) on page 932

[HCOPY:ITEM:ALL](#) on page 930

### Device Setup

Opens the "Hardcopy Setup" dialog box to define the output: image file, clipboard, or the printer. The dialog box consists of two tabs which are selected via the ["Device \(1/2\)"](#) on page 515 softkey.

For further information refer to [Chapter 3.2.4.6, "Selecting and Configuring Printers"](#), on page 51.

Remote command:

[HCOPY:DEVICE:LANGUAGE<1|2>](#) on page 929

[HCOPY:DESTINATION<1|2>](#) on page 928

[HCOPY:PAGE:ORIENTATION<1|2>](#) on page 931

[HCOPY:TDSTAMP:STATE<1|2>](#) on page 931

[SYSTEM:COMMUNICATE:PRINTER:ENUMERATE:FIRST?](#) on page 933

[SYSTEM:COMMUNICATE:PRINTER:ENUMERATE\[:NEXT\]?](#) on page 933

### Device (1/2)

Selects the tab of the device in the "Device Setup" dialog box. The analyzer is able to manage two print settings independently of each other. For each device the print setting is displayed on the corresponding tab of the "Device Setup" dialog box (["Device Setup"](#) on page 515 softkey).

For further information refer to [Chapter 3.2.4.6, "Selecting and Configuring Printers"](#), on page 51.

### Colors

Opens a submenu to define the colors to be used. For details see ["Print Colors"](#) on page 493 softkey of the "Setup" menu.

The submenu contains the following commands:

- ["Select Print Color Set"](#) on page 516
- ["Color \(On/Off\)"](#) on page 516
- ["Select Object"](#) on page 516
- ["Predefined Colors"](#) on page 516
- ["User Defined Colors"](#) on page 516

- ["Set to Default"](#) on page 516

**Select Print Color Set ← Colors**

For details see ["Select Print Color Set"](#) on page 494 softkey of the "Setup" menu.

**Color (On/Off) ← Colors**

For details see ["Color \(On/Off\)"](#) on page 492 softkey of the "Setup" menu.

**Select Object ← Colors**

For details see ["Select Object"](#) on page 492 softkey of the "Setup" menu.

**Predefined Colors ← Colors**

For details see ["Predefined Colors"](#) on page 493 softkey of the "Setup" menu.

**User Defined Colors ← Colors**

For details see ["User Defined Colors"](#) on page 493 softkey of the "Setup" menu.

**Set to Default ← Colors**

For details see ["Set to Default"](#) on page 493 softkey of the "Setup" menu.

**Comment**

Opens dialog box to enter a comment. Max. 120 characters are allowed. 60 characters fit in one line. In the first line, at any point a manual line-feed can be forced by entering "@".

Date and time are inserted automatically. The comment is printed below the diagram area, but not displayed on the screen. If a comment should not be printed, it must be deleted.

For details on the alphanumeric entries refer to [Chapter 3.4.3.2, "Entering Alphanumeric Parameters"](#), on page 76.

Remote command:

`HCOPY:ITEM:WINDOW:TEXT` on page 930

**Install Printer**

Opens the "Printers and Faxes" window to install a new printer. All printers that are already installed are displayed.

For further information refer to [Chapter 3.2.4.6, "Selecting and Configuring Printers"](#), on page 51.

Only user accounts with administrator rights can install a printer.

**Report**

Provides access to the test report tool. For more information see [Chapter 10.3, "Working with Test Reports"](#), on page 517.

## 10.3 Working with Test Reports

The R&S ESRP features a test report generator. A test report is a document that summarizes the results and configuration of measurements.

A test report is made up out of one or more datasets. Each dataset contains the results and configuration of one measurement.

- [Designing a Test Report Template](#)..... 517
- [Creating a Test Report](#)..... 520

### 10.3.1 Designing a Test Report Template

The R&S ESRP allows you to create test report templates, for example if you handle different measurement tasks that require different information or a different layout in the test report. The following topics show you ways to customize your test reports and save those settings in a template.

[Selecting the Test Report Contents](#).....517

[Designing the Header of the Test Report](#)..... 518

[Defining the Contents of the Title Page](#).....519

[Managing Templates](#)..... 520

#### Selecting the Test Report Contents

The "Configuration" tab selects the information that each dataset in the test report contains. You can add or remove the items as required.

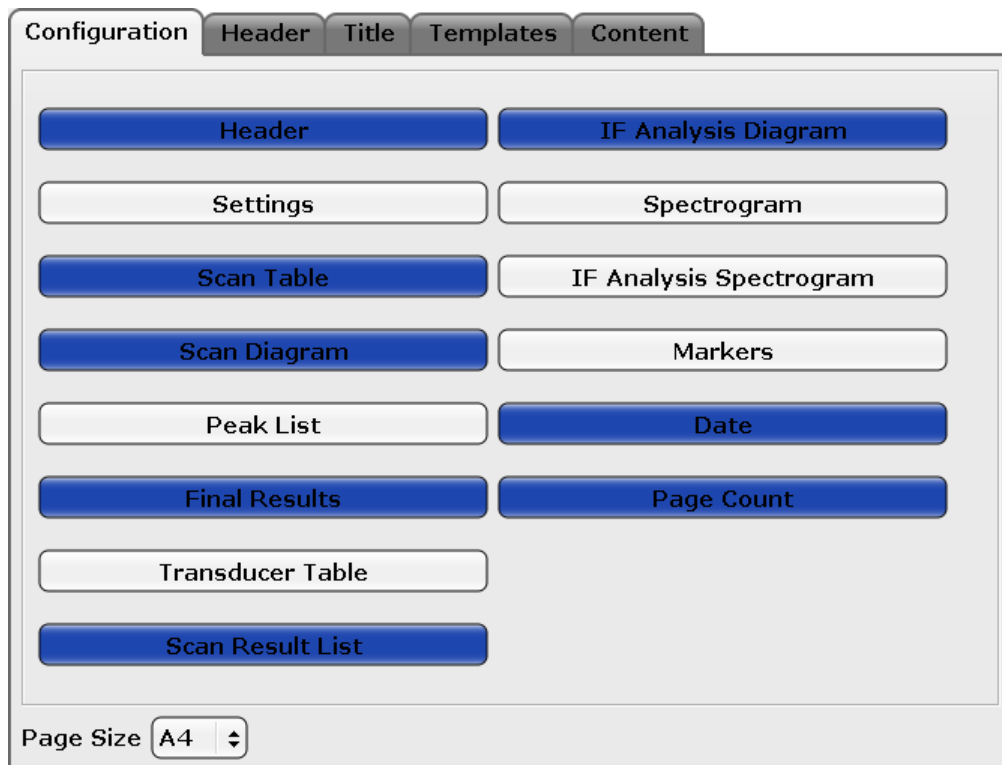



You can select to include the following types of information. (Note that the Spectrum application does not support all elements.)

- Header  
Adds a page header to the dataset.  
For more information see ["Designing the Header of the Test Report"](#) on page 518.
- Settings  
Adds the general measurement configuration to the dataset (for example the frequency range, the resolution bandwidth or the measurement time).
- Scan Table  
Adds the configuration for each scan subrange as defined in the scan table to the dataset. For more information see [Chapter 5.3.7.2, "Scan Table"](#), on page 165.
- Diagram  
Adds a screenshot of the scan trace to the dataset.
- Final Results  
Adds the (numerical) results of the final measurement to the dataset.
- Transducer Table  
Adds the transducers that you are using for the measurement, and their characteristics to the dataset.  
For more information see ["Transducer"](#) on page 478.
- Scan Result List  
Adds the numerical scan results to the dataset.  
Note that the test report will show only the results of the first 50000 measurement points. The rest is cut off.
- IF Analysis  
Adds a screenshot of the IF analysis trace to the dataset.
- Spectrogram  
Adds a screenshot of the spectrogram trace to the dataset.
- IF Analysis Spectrogram  
Adds a screenshot of the IF analysis spectrogram trace to the dataset.
- Markers  
Adds the marker information to the dataset.
- Date  
Adds a time stamp to the dataset (system date and time).
- Page Count  
Adds a page count to the dataset.

Remote command:

[HCOPY:TREPort:ITEM:SElect](#) on page 934

### Designing the Header of the Test Report

The "Header" tab selects the information displayed in the page header.

You can create page headers consisting of up to **seven lines**, plus **one picture** (for example a company logo). Each of the seven lines consists of a **title** (which is printed in bold characters) and a **value** (which is displayed next to the title, but in normal characters). In addition, you can select how each line in the header is treated (the **visibility**).

Configuration			Header	Title	Templates
Title	Value	Visibility			
Heading	Oooh, a headline!	Always ▾			
Meas Type	Testing features.	Always ▾			
Equipment under Test	Not sure...	Always ▾			
Manufacturer	Homemade!	Always ▾			
OP Condition	What's OP?	Always ▾			
Operator	Me, myself and I	Always ▾			
Test Spec	Not using one...]	Always ▾			
Logo	<input type="text"/>	...	Never ▾		

- **Title**  
Defines a name for a variable that has different values depending on the measurement (for example the name of the EUT). The firmware comes with some predefined titles, but you can change and customize each title.
- **Value**  
Defines the value of the variable defined by the title.
- **Visibility**  
Selects if a line in the page header is displayed on every page in the report ("Always"), on the first page of a dataset ("Once") or not at all ("Never").  
By default, all lines are displayed on all pages in the report.

### Adding a logo

The page header may also contain a picture or logo. You can upload a picture with the "..." symbol. The "..." symbol opens a dialog box to select a file.

Reports in rtf format support pictures in bmp or jpg format. Reports in pdf format support pictures in bmp, jpg and png format.

Similar to the alphanumeric lines in the header, you can select the visibility for the logo as well. By default, the logo is not displayed in the report.

Remote command:

Title: `HCOPY:TREPort:ITEM:HEADer:LINE<line>:TITLe` on page 937

Value: `HCOPY:TREPort:ITEM:HEADer:LINE<line>:TEXT` on page 937

Visibility: `HCOPY:TREPort:ITEM:HEADer:LINE<line>:CONTrol` on page 936

Selection of logo: `HCOPY:TREPort:ITEM:LOGO` on page 938

Visibility of logo: `HCOPY:TREPort:ITEM:LOGO:CONTrol` on page 938

### Defining the Contents of the Title Page

The "Title" tab defines the contents of the first page of the test report (title page).

You can define a title for the test report, which is printed in big and bold letters on the first page, and a short description of the contents of the test report (or the name of the author or something similar). This description is also part of the first test report page, but is printed in normal letters.

In addition you can select the format of the test report (either DIN A4 or US letter size).

Configuration Header **Title** Templates

Title

Description

Page Size  ▾

Remote command:

Title: [HCOpy:TREPort:TITLe](#) on page 939

Description: [HCOpy:TREPort:DESCription](#) on page 939

### Managing Templates

The "Templates" tab allows you manage test report templates.

Configuration Header Title **Templates**

Template	Origin
A test report	Receiver
And another one	Receiver
Another test report	Receiver

- Load  
Restores the selected test report configuration.
- Save  
Saves the current test report configuration. Before you save the configuration as a template, enter a name for the template in the corresponding field.
- Delete  
Deletes the selected test report template.

The table shows all available templates, including the application it has been created in (Receiver, Spectrum or I/Q Analyzer).

## 10.3.2 Creating a Test Report

- ▶ In the "Test Report" softkey menu, press the "Save" button.

The R&S ESRP opens the "Test Report Content Selection" dialog box that contains all necessary functions to create a test report.



**Test report limitations**

The size of the test report is limited to about 50.000 measurement points. If the number of measurement points is greater than that value, only the first 50.000 values are written to the report. The rest will be left out. Try to do an ASCII file export when you have more measurement points.

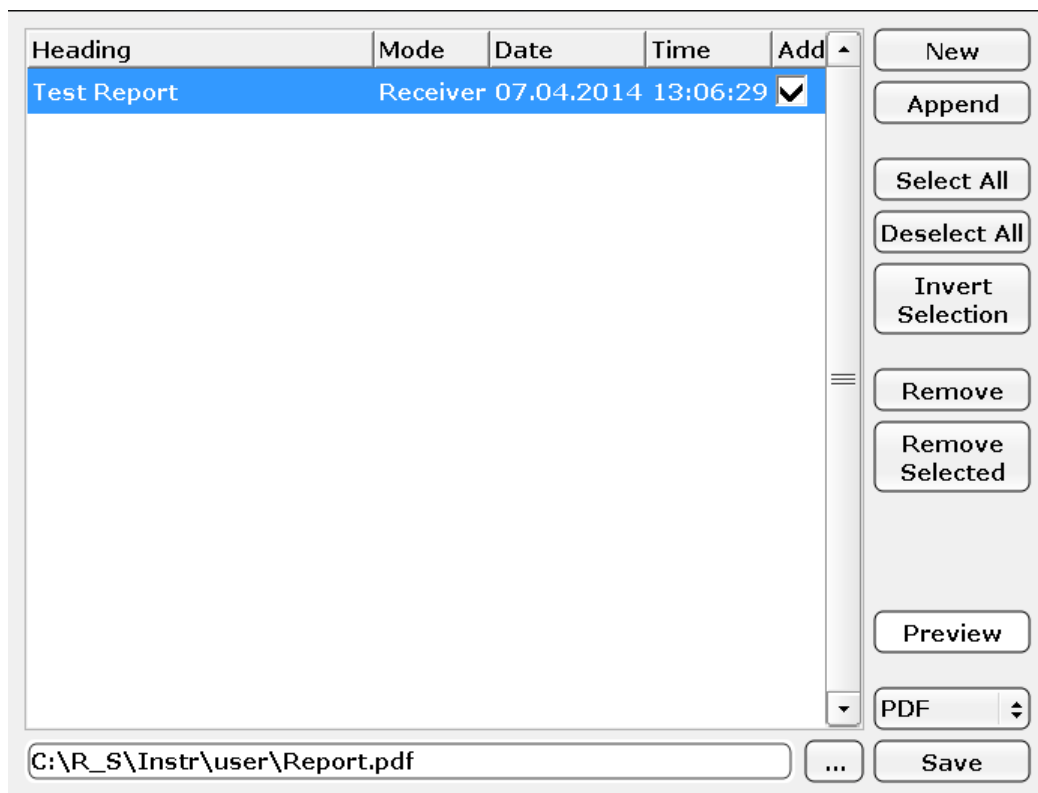

Configuring and Printing the Test Report..... 521  
 Adding and Removing Datasets.....522  
 Selecting Datasets for the Report..... 522

**Configuring and Printing the Test Report**

You can save the test report either as a **pdf** document or an **rtf** document in the corresponding dropdown menu in the "Test Report Content Selection" dialog box.

The "Preview" button opens a preview version of the test report. Available for test reports in pdf format.

The "Save" button saves the test report in the directory you have specified in the input field next to the "Save" button. You can specify the directory with the "..." button or by entering a path and filename into the input field.

Remote command:

- Print report: `HCOPY[:IMMEDIATE<1|2>]` on page 931
- Report name and directory: `MMEMORY:NAME` on page 913
- Format: `HCOPY:DEVICE:LANGUAGE<1|2>` on page 929

### Adding and Removing Datasets

Before you can print a test report, you have to fill it with data.

Data in case of the test report comes in datasets. Each dataset contains the results of one measurement.

The "New" button or softkey creates a new test report. The last measurement result is added to the report. If you create a new report, the datasets of the previous report are lost.

The "Append" button or softkey adds a dataset to the current report.

The "Remove" button removes the selected dataset.

The "Remove Selection" removes all currently selected datasets.

Note that a test report has to contain at least one dataset.

When you add a dataset ("New" or "Append"), the R&S ESRP opens a dialog box to define the values of the header variables.

Heading	<input type="text"/>
Meas Type	<input type="text"/>
Equipment under Test	<input type="text"/>
Manufacturer	<input type="text"/>
OP Condition	<input type="text"/>
Operator	<input type="text"/>
Test Spec	<input type="text"/>
<input type="button" value="Ok"/> <input type="button" value="Cancel"/>	

Enter descriptions of the variables as required.

For more information on changing the labels of the header see ["Designing the Header of the Test Report"](#) on page 518

Remote command:

New report: `HCOPY:TREPort:NEW` on page 942

Add dataset: `HCOPY:TREPort:APPend` on page 941

Remove single dataset: `HCOPY:TREPort:TEST:REMove` on page 942

Remove several datasets: `HCOPY:TREPort:TEST:REMove:SELEcted` on page 942

### Selecting Datasets for the Report

When you add a dataset to the report, it is automatically included in the test report. You can exclude a dataset from the test report without removing the data itself in the "Add" column of the "Test Report Content Selection" dialog box: if a dataset is not checked in that column, the data is still available, but not part of the test report.

To make selecting datasets easier, the R&S ESRP provides the "Select All" (selects all datasets), "Deselect All" (selects no dataset) and "Invert Selection" (selects all currently deselected datasets and vice versa) buttons.

Remote command:

Select a single dataset: [HCOpy:TREPort:TEST:SElect](#) on page 943

Select all datasets: [HCOpy:TREPort:TEST:SElect:ALL](#) on page 943

Invert selection: [HCOpy:TREPort:TEST:SElect:INVert](#) on page 943

Select no dataset: [HCOpy:TREPort:TEST:SElect:NONE](#) on page 944

# 11 Remote Control

• Remote Control - Basics.....	524
• Controlling the R&S ESRP Remotely.....	565
• Selecting the Operating Mode.....	604
• Remote Commands in Receiver Mode.....	605
• Remote Commands in Spectrum Analyzer Mode.....	687
• Remote Commands in I/Q Analyzer Mode.....	855
• Remote Commands to Control the Tracking Generator.....	868
• Common Commands.....	883
• System Configuration.....	887
• Data Management.....	908
• Using Transducers.....	917
• Documentation.....	925
• Working with Test Reports.....	934
• Display Configuration.....	944
• Network Connection.....	955
• Status Register.....	962
• Remote Control – Programming Examples.....	965
• GPIB Commands of HP Models 856xE, 8566A/B, 8568A/B and 8594E.....	1007

## 11.1 Remote Control - Basics

This chapter provides basic information on operating an instrument via remote control.



The computer that is used for remote operation is called "controller" here.

For hints and tricks on remote control of spectrum analyzers see the Rohde & Schwarz Application Note [1EF62](#).

### 11.1.1 Remote Control Interfaces and Protocols

The instrument supports different interfaces for remote control. The following table gives an overview.

**Table 11-1: Remote control interfaces and protocols**

Interface	Protocols, VISA <sup>*)</sup> address string	Remarks
Local Area Network (LAN)	Protocols: <ul style="list-style-type: none"> <li>• <b>HiSLIP</b> High-Speed LAN Instrument Protocol (IVI-6.1) TCPIP:: host address:: hislip0[:: INSTR]</li> <li>• <b>VXI-11</b></li> <li>• <b>socket communication</b> (Raw Ethernet, simple Telnet) TCPIP:: host address[:: LAN device name] : &lt;port&gt;::SOCKET Library: VISA or socketcontroller</li> <li>• <b>RSIB</b></li> <li>• <b>simple telnet</b> (Raw Ethernet)</li> </ul> VISA <sup>*)</sup> address string: TCPIP::host address[::LAN device name][::INSTR]	A LAN connector is located on the rear panel of the instrument. The interface is based on TCP/IP and supports various protocols. For a description of the protocols refer to: <ul style="list-style-type: none"> <li>• <a href="#">HiSLIP Protocol</a></li> <li>• <a href="#">"VXI-11 Protocol"</a> on page 528</li> <li>• <a href="#">Socket Communication</a></li> <li>• <a href="#">"RSIB Protocol"</a> on page 529</li> <li>• <a href="#">"Telnet Protocol"</a> on page 530</li> </ul>
GPIB (IEC/IEEE Bus Interface)	VISA <sup>*)</sup> address string: GPIB::primary address[::INSTR] (no secondary address)	A GPIB bus interface according to the IEC 625.1/IEEE 488.1 standard is located on the rear panel of the instrument. For a description of the interface refer to <a href="#">Chapter 11.1.1.4, "GPIB Interface (IEC 625/IEEE 418 Bus Interface)"</a> , on page 530.
<sup>*)</sup> VISA is a standardized software interface library providing input and output functions to communicate with instruments. A VISA installation on the controller is a prerequisite for remote control using the indicated interfaces (see also <a href="#">Chapter 11.1.1.1, "VISA Libraries"</a> , on page 526).		



Within this interface description, the term GPIB is used as a synonym for the IEC/IEEE bus interface.

### SCPI (Standard Commands for Programmable Instruments)

SCPI commands - messages - are used for remote control. Commands that are not taken from the SCPI standard follow the SCPI syntax rules. The instrument supports the SCPI version 1999. The SCPI standard is based on standard IEEE 488.2 and aims at the standardization of device-specific commands, error handling and the status registers. The tutorial "Automatic Measurement Control - A tutorial on SCPI and IEEE 488.2" from John M. Pieper (R&S order number 0002.3536.00) offers detailed information on concepts and definitions of SCPI.

The requirements that the SCPI standard places on command syntax, error handling and configuration of the status registers are explained in detail in the following sec-



tions. Tables provide a fast overview of the bit assignment in the status registers. The tables are supplemented by a comprehensive description of the status registers.

#### 11.1.1.1 VISA Libraries

VISA is a standardized software interface library providing input and output functions to communicate with instruments. The I/O channel (LAN or TCP/IP, USB, GPIB,...) is selected at initialization time by means of the channel-specific address string ("VISA resource string") indicated in [Table 11-1](#), or by an appropriately defined VISA alias (short name). A VISA installation is a prerequisite for remote control using the VXI-11, raw socket, RSIB or the newer HiSLIP protocol. The necessary VISA library is available as a separate product. For details contact your local R&S sales representative.

For more information on VISA refer to the user documentation.

#### 11.1.1.2 Messages

The messages transferred on the data lines are divided into the following categories:

- **Interface messages**  
Interface messages are transmitted to the instrument on the data lines, with the attention line being active (LOW). They are used to communicate between the controller and the instrument. Interface messages can only be sent by instruments that have GPIB bus functionality. For details see the sections for the required interface.
- **Instrument messages**  
Instrument messages are employed in the same way for all interfaces, if not indicated otherwise in the description. Structure and syntax of the instrument messages are described in [Chapter 11.1.4, "SCPI Command Structure"](#), on page 535. A detailed description of all messages available for the instrument is provided in the chapter "Remote Control Commands".  
There are different types of instrument messages, depending on the direction they are sent:
  - Commands
  - Instrument responses

#### Commands

Commands (program messages) are messages the controller sends to the instrument. They operate the instrument functions and request information. The commands are subdivided according to two criteria:

- According to the effect they have on the instrument:
  - **Setting commands** cause instrument settings such as a reset of the instrument or setting the frequency.
  - **Queries** cause data to be provided for remote control, e.g. for identification of the instrument or polling a parameter value. Queries are formed by directly appending a question mark to the command header.
- According to their definition in standards:

- **Common commands:** their function and syntax are precisely defined in standard IEEE 488.2. They are employed identically on all instruments (if implemented). They refer to functions such as management of the standardized status registers, reset and self-test.
- **Instrument control commands** refer to functions depending on the features of the instrument such as frequency settings. Many of these commands have also been standardized by the SCPI committee. These commands are marked as "SCPI confirmed" in the command reference chapters. Commands without this SCPI label are device-specific; however, their syntax follows SCPI rules as permitted by the standard.

### Instrument responses

Instrument responses (response messages and service requests) are messages the instrument sends to the controller after a query. They can contain measurement results, instrument settings and information on the instrument status.

#### 11.1.1.3 LAN Interface

To be integrated in a LAN, the instrument is equipped with a LAN interface, consisting of a connector, a network interface card and protocols. The network card can be operated with a 10 MHz Ethernet IEEE 802.3 or a 100 MHz Ethernet IEEE 802.3u interface. For remote control via a network, the PC and the instrument must be connected via the LAN interface to a common network with TCP/IP network protocol. They are connected using a commercial RJ45 cable (shielded or unshielded twisted pair category 5). The TCP/IP network protocol and the associated network services are preconfigured on the instrument. Software for instrument control and the VISA program library must be installed on the controller.

### VISA library

Instrument access via VXI-11 or RSIB protocols is usually achieved from high level programming platforms using VISA as an intermediate abstraction layer. VISA encapsulates the low level VXI, RSIB or even GPIB function calls and thus makes the transport interface transparent for the user. See [Chapter 11.1.1.1, "VISA Libraries"](#), on page 526 for details.

### IP address

Only the IP address or a valid DNS host name is required to set up the connection. The host address is part of the "VISA resource string" used by the programs to identify and control the instrument.

The VISA resource string has the form:

```
TCPIP::host address[::LAN device name][::INSTR]
```

or

```
TCPIP::host address::port::SOCKET
```

where:

- **TCPIP** designates the network protocol used
- **host address** is the IP address or host name of the device
- **LAN device name** defines the protocol and the instance number of a sub-instrument;
  - `inst0` selects the VXI-11 protocol (default)
  - `hislip0` selects the newer HiSLIP protocol
- **INSTR** indicates the instrument resource class (optional)
- **port** determines the used port number
- **SOCKET** indicates the raw network socket resource class

**Example:**

- Instrument has the IP address `192.1.2.3`; the valid resource string using VXI-11 protocol is:  
`TCPIP::192.1.2.3::INSTR`
- The instrument name is `RSFSV`; the valid resource string is:  
`TCPIP::RSFSV::INSTR`
- A raw socket connection can be established using:  
`TCPIP::192.1.2.3::5025::SOCKET`
- The DNS host name name is `FSV-123456`; the valid resource string using HiSLIP is:  
`TCPIP::FSV-123456::hislip0`

**Identifying instruments in a network**

If several instruments are connected to the network, each instrument has its own IP address and associated resource string. The controller identifies these instruments by means of the resource string.

For details on configuring the LAN connection, see [Chapter 11.2.5, "Setting Up a Network \(LAN\) Connection"](#), on page 592.

**VXI-11 Protocol**

The VXI-11 standard is based on the ONC RPC (Open Network Computing Remote Procedure Call) protocol which in turn relies on TCP/IP as the network/transport layer. The TCP/IP network protocol and the associated network services are preconfigured. TCP/IP ensures connection-oriented communication, where the order of the exchanged messages is adhered to and interrupted links are identified. With this protocol, messages cannot be lost.

**HiSLIP Protocol**

The HiSLIP (**H**igh **S**peed **L**AN **I**nstrument **P**rotocol) is the successor protocol for VXI-11 for TCP-based instruments specified by the IVI foundation. The protocol uses two TCP sockets for a single connection - one for fast data transfer, the other for non-sequential control commands (e.g. `Device Clear` or `SRQ`).

HiSLIP has the following characteristics:

- High performance as with raw socket network connections
- Compatible IEEE 488.2 support for Message Exchange Protocol, Device Clear, Serial Poll, Remote/Local, Trigger, and Service Request
- Uses a single IANA registered port (4880), which simplifies the configuration of fire-walls
- Supports simultaneous access of multiple users by providing versatile locking mechanisms
- Usable for IPv6 or IPv4 networks



Using VXI-11, each operation is blocked until a VXI-11 device handshake returns. However, using HiSLIP, data is sent to the device using the "fire and forget" method with immediate return. Thus, a successful return of a VISA operation such as `viWrite()` does not guarantee that the instrument has finished or started the requested command, but is delivered to the TCP/IP buffers.

For more information see also the application note:

[1MA208: Fast Remote Instrument Control with HiSLIP](#)

### Socket Communication

An alternative way for remote control of the software is to establish a simple network communication using sockets. The socket communication, also referred to as "Raw Ethernet communication", does not necessarily require a VISA installation on the remote controller side. It is available by default on all operating systems.

The simplest way to establish socket communication is to use the built-in telnet program. The telnet program is part of every operating system and supports a communication with the software on a command-by-command basis. For more convenience and to enable automation by means of programs, user-defined sockets can be programmed.

Socket connections are established on a specially defined port. The socket address is a combination of the IP address or the host name of the instrument and the number of the port configured for remote-control. All R&S ESRP use port number 5025 for this purpose. The port is configured for communication on a command-to-command basis and for remote control from a program.

### RSIB Protocol

The R&S defined RSIB protocol uses the TCP/IP protocol for communication with the instrument. Remote control over RSIB is done on a message level basis using the SCPI command set of the instrument. The RSIB protocol allows you to control the instrument for example via Visual C++- and Visual Basic programs, via the Windows applications Word and Excel, as well as via National Instruments LabView, LabWindows/CVI, Agilent VEE and others. The control applications run on an external computer in the network.

### RSIB Interface Functions

The library functions are adapted to the interface functions of National Instruments for GPIB programming. The functions supported by the libraries are listed in the following table.

Function	Description
RSDLLibfind()	Provides a handle for access to a device.
RSDLLibwrt()	Sends a zero-terminated string to a device.
RSDLLilwrt()	Sends a certain number of bytes to a device.
RSDLLibwrtf()	Sends the contents of a file to a device.
RSDLLibrd()	Reads data from a device into a string.
RSDLLiird()	Reads a certain number of bytes from a device.
RSDLLibrdf()	Reads data from a device into a file.
RSDLLibtmo()	Sets timeout for RSIB functions.
RSDLLibsre()	Switches a device to the local or remote state.
RSDLLibloc()	Temporarily switches a device to the local state.
RSDLLibeot()	Enables/disables the END message for write operations.
RSDLLibrsp()	Performs a serial poll and provides the status byte.
RSDLLibonl()	Sets the device online/offline.
RSDLLTestSrq()	Checks whether a device has generated an SRQ.
RSDLLWaitSrq()	Waits until a device generates an SRQ.
RSDLLSwapBytes	Swaps the byte sequence for binary numericdisplay (only required for non-Intel platforms).

### Telnet Protocol

As an alternative to remote control the instrument can use a simple telnet protocol (port 5025). Unlike using the VXI-11 protocol, no VISA installation is necessary on the remote controller side. This protocol is sometimes also referred to as "socket communication" or "Raw Ethernet mode". To control the instrument, only a Telnet program is required. The Telnet program is part of every operating system.

#### 11.1.1.4 GPIB Interface (IEC 625/IEEE 418 Bus Interface)

To be able to control the instrument via the GPIB bus, the instrument and the controller must be linked by a GPIB bus cable. A GPIB bus card, the card drivers and the program libraries for the programming language used must be provided in the controller. The controller must address the instrument with the GPIB bus address (see "[GPIB Instrument Address](#)" on page 533).

### Notes and Conditions

In connection with the GPIB interface, note the following:

- Up to 15 instruments can be connected
- The total cable length is restricted to a maximum of 15 m or 2 m times the number of devices, whichever is less; the cable length between two instruments should not exceed 2 m.
- A wired "OR"-connection is used if several instruments are connected in parallel.
- Any connected IEC-bus cables should be terminated by an instrument or controller.

### GPIB Interface Messages

Interface messages are transmitted to the instrument on the data lines, with the attention line (ATN) being active (LOW). They are used for communication between the controller and the instrument and can only be sent by a computer which has the function of a GPIB bus controller. GPIB interface messages can be further subdivided into:

- **Universal commands:** act on all instruments connected to the GPIB bus without previous addressing
- **Addressed commands:** only act on instruments previously addressed as listeners

The following figure provides an overview of the available communication lines used by the GPIB interface.

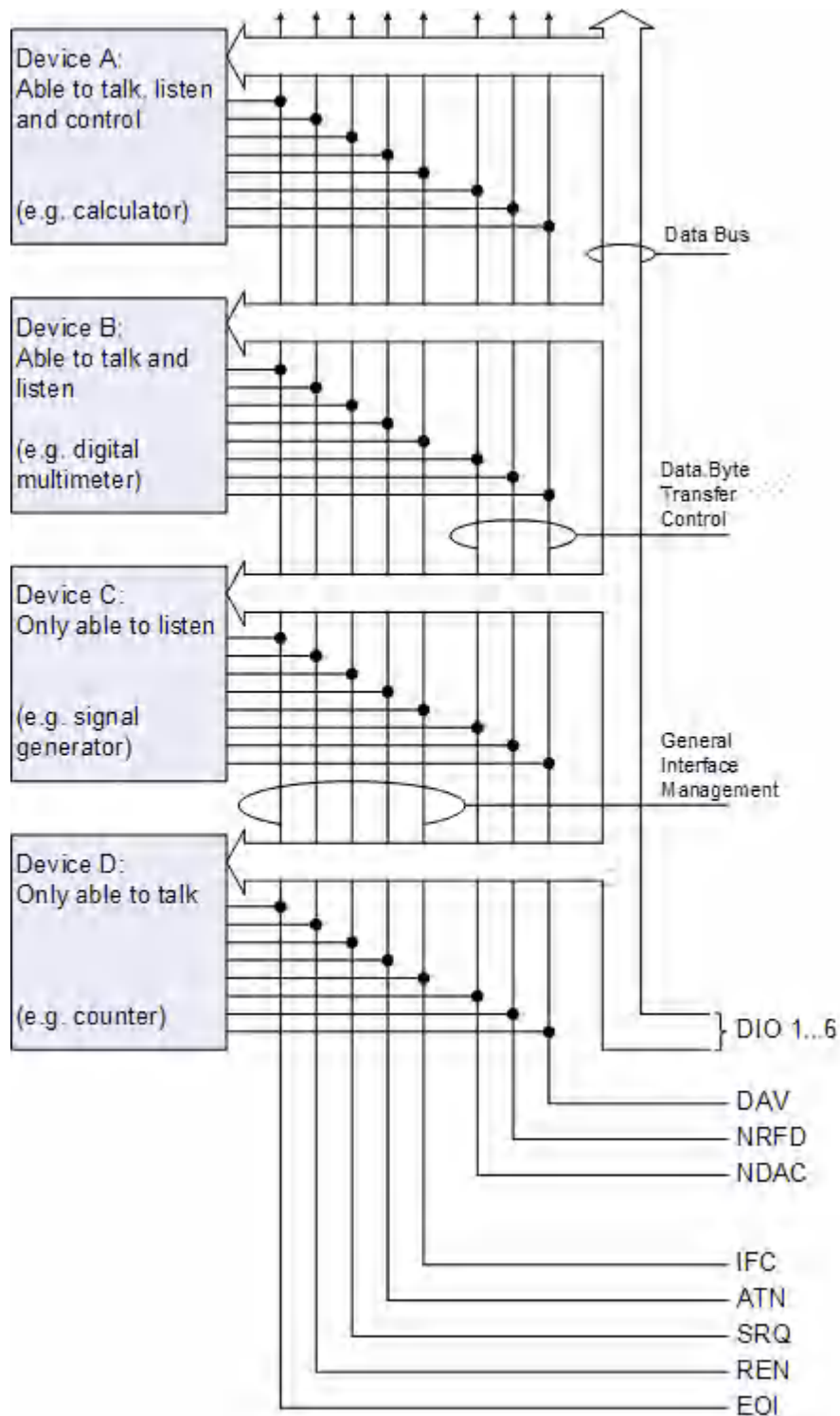

Figure 11-1: Communication lines used by the GPIB interface

### Universal Commands

Universal commands are encoded in the range 10 through 1F hex. They affect all instruments connected to the bus and do not require addressing.

Command	Effect on the instrument
DCL (Device Clear)	Aborts the processing of the commands just received and sets the command processing software to a defined initial state. Does not change the instrument settings.
IFC (Interface Clear *)	Resets the interfaces to the default setting.
LLO (Local Lockout)	The "Local" softkey is disabled. Manual operation is no longer available until <i>GTL</i> is executed.
SPE (Serial Poll Enable)	Ready for serial poll.
SPD (Serial Poll Disable)	End of serial poll.
PPU (Parallel Poll Unconfigure)	End of the parallel-poll state.
*) IFC is not a real universal command, it is sent via a separate line; however, it also affects all instruments connected to the bus and does not require addressing	

### Addressed Commands

Addressed commands are encoded in the range 00 through 0F hex. They only affect instruments addressed as listeners.

Command	Effect on the instrument
GET (Group Execute Trigger)	Triggers a previously active instrument function (e.g. a sweep). The effect of the command is the same as with that of a pulse at the external trigger signal input.
GTL (Go to Local)	Transition to the "local" state (manual control).
	Transition to the "remote" state (remote control).
PPC (Parallel Poll Configure)	Configures the instrument for parallel poll.
SDC (Selected Device Clear)	Aborts the processing of the commands just received and sets the command processing software to a defined initial state. Does not change the instrument setting.

### GPIB Instrument Address

In order to operate the instrument via remote control, it must be addressed using the GPIB address. The remote control address is factory-set to 20, but it can be changed if it does not fit in the network environment. For remote control, addresses 0 through 30 are allowed. The GPIB address is maintained after a reset of the instrument settings.

#### Setting the GPIB address

1. On the R&S ESRP, press the [SETUP] key.
2. Press the "General Setup" softkey.
3. Press the "GPIB" softkey.



The submenu for setting the parameters of the remote control interface is displayed.

4. Press the "GPIB Address" softkey.

The edit dialog box for the GPIB address is displayed.

5. Enter a value between 0 and 30.

Remote command: `SYST:COMM:GPIB:ADDR 18`

### 11.1.2 Starting a Remote Control Session

When you switch on the instrument, it is always in manual operation state ("local" state) and can be operated via the front panel.

#### Starting remote control

1. Send an addressed command (`GTR` - Go to Remote) from a controller to the instrument.

The instrument is switched to remote control ("remote" state). Operation via the front panel is disabled. Only the "Local" softkey is displayed to return to manual operation. The instrument remains in the remote state until it is reset to the manual state via the instrument or via remote control interfaces. Switching from manual operation to remote control and vice versa does not affect the other instrument settings.

2. During program execution, send the `SYSTem:DISPlay:UPDate ON` command to activate the display of results.

The changes in the device settings and the recorded measurement values are displayed on the instrument screen.

3. To obtain optimum performance during remote control, send the `SYSTem:DISPlay:UPDate OFF` command to hide the display of results and diagrams again (default setting in remote control).

4. To prevent unintentional return to manual operation, disable the keys of the instrument using the universal command `LLO`.

Switching to manual mode is only possible via remote control then. This function is only available for the GPIB interface.

5. To enable the keys of the R&S ESRP again, switch the instrument to local mode (`GTL` - Go to Local), i.e. deactivate the `REN` line of the remote control interface.



If the instrument is operated exclusively in remote control, it is recommended that you switch on the power-save mode for the display. For more details on this mode refer to ["Switching the Screen Display On and Off"](#) on page 576.

### 11.1.3 Returning to Manual Operation

Before you switch back to manual operation, all remote command processing must be completed. Otherwise, the instrument will switch back to remote control immediately.

- ▶ Press the "Local" softkey or the [PRESET] key, or use the following GPIB command:

```
status = viGpibControlREN(vi, VI_GPIB_REN_ADDRESS_GTL)
```



If you select the "Local" softkey while a self-alignment or a self-test is still running (which was started remotely), the instrument only returns to the manual operation state when the alignment or test is completed.

### 11.1.4 SCPI Command Structure

SCPI commands consist of a header and, in most cases, one or more parameters. The header and the parameters are separated by a "white space" (ASCII code 0 to 9, 11 to 32 decimal, e.g. blank). The headers may consist of several mnemonics (keywords). Queries are formed by appending a question mark directly to the header.

The commands can be either device-specific or device-independent (common commands). Common and device-specific commands differ in their syntax.

#### 11.1.4.1 Syntax for Common Commands

Common (= device-independent) commands consist of a header preceded by an asterisk (\*), and possibly one or more parameters.

**Table 11-2: Examples of common commands**

*RST	RESET	Resets the instrument.
*ESE	EVENT STATUS ENABLE	Sets the bits of the event status enable registers.
*ESR?	EVENT STATUS QUERY	Queries the contents of the event status register.
*IDN?	IDENTIFICATION QUERY	Queries the instrument identification string.

### 11.1.4.2 Syntax for Device-Specific Commands



Not all commands used in the following examples are necessarily implemented in the instrument. For demonstration purposes only, assume the existence of the following commands for this section:

- DISPLAY[:WINDow<1...4>]:MAXimize <Boolean>
- FORMat:READings:DATA <type>[,<length>]
- HCOpy:DEvIce:COLor <Boolean>
- HCOpy:DEvIce:CMAP:COLor:RGB <red>,<green>,<blue>
- HCOpy[:IMMediate]
- HCOpy:ITEM:ALL
- HCOpy:ITEM:LABel <string>
- HCOpy:PAGE:DIMensions:QUADrant [<N>]
- HCOpy:PAGE:ORientation LANDscape | PORTrait
- HCOpy:PAGE:SCALE <numeric value>
- MMEMoRY:COpy <file\_source>,<file\_destination>
- SENSE:BANDwidth|BWIDth[:RESolution] <numeric\_value>
- SENSE:FREQuency:STOP <numeric value>
- SENSE:LIST:FREQuency <numeric\_value>{,<numeric\_value>}

• <a href="#">Long and short form</a> .....	536
• <a href="#">Numeric Suffixes</a> .....	536
• <a href="#">Optional Mnemonics</a> .....	537

#### Long and short form

The mnemonics feature a long form and a short form. The short form is marked by upper case letters, the long form corresponds to the complete word. Either the short form or the long form can be entered; other abbreviations are not permitted.

#### Example:

HCOpy:DEvIce:COLor ON is equivalent to HCOP:DEV:COL ON.



#### Case-insensitivity

Upper case and lower case notation only serves to distinguish the two forms in the manual, the instrument itself is case-insensitive.

#### Numeric Suffixes

If a command can be applied to multiple instances of an object, e.g. specific channels or sources, the required instances can be specified by a suffix added to the command. Numeric suffixes are indicated by angular brackets (<1...4>, <n>, <i>) and are replaced by a single value in the command. Entries without a suffix are interpreted as having the suffix 1.

**Example:**

Definition: `HCOPY:PAGE:DIMensions:QUADrant [<N>]`

Command: `HCOP:PAGE:DIM:QUAD2`

This command refers to the quadrant 2.

**Different numbering in remote control**

For remote control, the suffix may differ from the number of the corresponding selection used in manual operation. SCPI prescribes that suffix counting starts with 1. Suffix 1 is the default state and used when no specific suffix is specified.

Some standards define a fixed numbering, starting with 0. If the numbering differs in manual operation and remote control, it is indicated for the corresponding command.

**Optional Mnemonics**

Some command systems permit certain mnemonics to be inserted into the header or omitted. These mnemonics are marked by square brackets in the description. The instrument must recognize the long command to comply with the SCPI standard. Some commands are considerably shortened by these optional mnemonics.

**Example:**

Definition: `HCOPY[:IMMEDIATE]`

Command: `HCOP:IMM` is equivalent to `HCOP`

**Optional mnemonics with numeric suffixes**

Do not omit an optional mnemonic if it includes a numeric suffix that is relevant for the effect of the command.

**Example:**

Definition: `DISPlay[:WINDow<1...4>]:MAXimize <Boolean>`

Command: `DISP:MAX ON` refers to window 1.

In order to refer to a window other than 1, you must include the optional `WINDow` parameter with the suffix for the required window.

`DISP:WIND2:MAX ON` refers to window 2.

**11.1.4.3 SCPI Parameters**

Many commands are supplemented by a parameter or a list of parameters. The parameters must be separated from the header by a "white space" (ASCII code 0 to 9, 11 to 32 decimal, e.g. blank).

The parameters required for each command and the allowed range of values are specified in the command description.

Allowed parameters are:

• <a href="#">Numeric Values</a> .....	538
• <a href="#">Special Numeric Values</a> .....	538
• <a href="#">Boolean Parameters</a> .....	539
• <a href="#">Text Parameters</a> .....	539
• <a href="#">Character Strings</a> .....	539
• <a href="#">Block Data</a> .....	540

### Numeric Values

Numeric values can be entered in any form, i.e. with sign, decimal point and exponent. Values exceeding the resolution of the instrument are rounded up or down. The mantissa may comprise up to 255 characters, the exponent must lie inside the value range -32000 to 32000. The exponent is introduced by an "E" or "e". Entry of the exponent alone is not allowed.

#### Example:

```
SENS:FREQ:STOP 1500000 = SENS:FREQ:STOP 1.5E6
```

### Units

For physical quantities, the unit can be entered. If the unit is missing, the basic unit is used. Allowed unit prefixes are:

- G (giga)
- MA (mega), MOHM, MHZ
- K (kilo)
- M (milli)
- U (micro)
- N (nano)

#### Example:

```
SENSe:FREQ:STOP 1.5GHz = SENSe:FREQ:STOP 1.5E9
```

Some settings allow relative values to be stated in percent. According to SCPI, this unit is represented by the `PCT` string.

#### Example:

```
HCOP:PAGE:SCAL 90PCT
```

### Special Numeric Values

The following mnemonics are special numeric values. In the response to a query, the numeric value is provided.

- **MIN and MAX:** denote the minimum and maximum value.
- **DEF:** denotes a preset value which has been stored in the EPROM. This value conforms to the default setting, as it is called by the `*RST` command.
- **UP and DOWN:** increases or reduces the numeric value by one step. The step width can be specified via an allocated step command for each parameter which can be set via `UP` and `DOWN`.

- **INF and NINF:** INFinity and negative INFinity (NINF) represent the numeric values 9.9E37 or -9.9E37, respectively. INF and NINF are only sent as instrument responses.
- **NAN:** Not A Number (NAN) represents the value 9.91E37. NAN is only sent as a instrument response. This value is not defined. Possible causes are the division of zero by zero, the subtraction of infinite from infinite and the representation of missing values.

**Example:**

Setting command: `SENSe:LIST:FREQ MAXimum`

Query: `SENS:LIST:FREQ?`

Response: `3.5E9`

**Queries for special numeric values**

The numeric values associated to `MAXimum`/`MINimum`/`DEFault` can be queried by adding the corresponding mnemonic after the quotation mark.

Example: `SENSe:LIST:FREQ? MAXimum`

Returns the maximum numeric value as a result.

**Boolean Parameters**

Boolean parameters represent two states. The "ON" state (logically true) is represented by "ON" or a numeric value 1. The "OFF" state (logically untrue) is represented by "OFF" or the numeric value 0. The numeric values are provided as the response for a query.

**Example:**

Setting command: `HCOPY:DEV:COL ON`

Query: `HCOPY:DEV:COL?`

Response: `1`

**Text Parameters**

Text parameters observe the syntactic rules for mnemonics, i.e. they can be entered using a short or long form. Like any parameter, they have to be separated from the header by a white space. In the response to a query, the short form of the text is provided.

**Example:**

Setting command: `HCOPY:PAGE:ORIENTATION LANDscape`

Query: `HCOP:PAGE:ORI?`

Response: `LAND`

**Character Strings**

Strings must always be entered in quotation marks (' or ").

**Example:**

```
HCOP:ITEM:LABel "Test1"
```

```
HCOP:ITEM:LABel 'Test1'
```

**Block Data**

Block data is a format which is suitable for the transmission of large amounts of data. For example, a command using a block data parameter has the following structure:

```
FORMat:READings:DATA #45168xxxxxxxx
```

The ASCII character # introduces the data block. The next number indicates how many of the following digits describe the length of the data block. In the example the 4 following digits indicate the length to be 5168 bytes. The data bytes follow. During the transmission of these data bytes all end or other control signs are ignored until all bytes are transmitted.

#0 specifies a data block of indefinite length. The use of the indefinite format requires a NL^END message to terminate the data block. This format is useful when the length of the transmission is not known or if speed or other considerations prevent segmentation of the data into blocks of definite length.

**11.1.4.4 Overview of Syntax Elements**

The following tables provide an overview of the syntax elements and special characters.

**Table 11-3: Syntax elements**

:	The colon separates the mnemonics of a command.
;	The semicolon separates two commands of a command line. It does not alter the path.
,	The comma separates several parameters of a command.
?	The question mark forms a query.
*	The asterisk marks a common command.
' '	Quotation marks introduce a string and terminate it (both single and double quotation marks are possible).
#	The hash symbol introduces binary, octal, hexadecimal and block data. <ul style="list-style-type: none"> <li>• Binary: #B10110</li> <li>• Octal: #O7612</li> <li>• Hexa: #HF3A7</li> <li>• Block: #21312</li> </ul>
	A "white space" (ASCII-Code 0 to 9, 11 to 32 decimal, e.g. blank) separates the header from the parameters.

**Table 11-4: Special characters**

<b> </b>	<p><b>Parameters</b></p> <p>A vertical stroke in parameter definitions indicates alternative possibilities in the sense of "or". The effect of the command differs, depending on which parameter is used.</p> <p>Example:</p> <p>Definition:HCOPY:PAGE:ORIENTATION LANDscape   PORTRait</p> <p>Command HCOP:PAGE:ORI LAND specifies landscape orientation</p> <p>Command HCOP:PAGE:ORI PORT specifies portrait orientation</p> <p><b>Mnemonics</b></p> <p>A selection of mnemonics with an identical effect exists for several commands. These mnemonics are indicated in the same line; they are separated by a vertical stroke. Only one of these mnemonics needs to be included in the header of the command. The effect of the command is independent of which of the mnemonics is used.</p> <p>Example:</p> <p>DefinitionSENSE:BANDwidth BWIDTH[:RESolution] &lt;numeric_value&gt;</p> <p>The two following commands with identical meaning can be created:</p> <p>SENS:BAND:RES 1</p> <p>SENS:BWID:RES 1</p>
<b>[]</b>	<p>Mnemonics in square brackets are optional and may be inserted into the header or omitted.</p> <p>Example: HCOpy[:IMMediate]</p> <p>HCOP: IMM is equivalent to HCOP</p>
<b>{}</b>	<p>Parameters in curly brackets are optional and can be inserted once or several times, or omitted.</p> <p>Example: SENSE:LIST:FREQuency &lt;numeric_value&gt;{,&lt;numeric_value&gt;}</p> <p>The following are valid commands:</p> <p>SENS:LIST:FREQ 10</p> <p>SENS:LIST:FREQ 10,20</p> <p>SENS:LIST:FREQ 10,20,30,40</p>

#### 11.1.4.5 Structure of a Command Line

A command line may consist of one or several commands. It is terminated by one of the following:

- <New Line>
- <New Line> with EOI
- EOI together with the last data byte

Several commands in a command line must be separated by a semicolon ";".

**Example:**

```
MMEM:COPY "Test1","MeasurementXY";:HCOP:ITEM ALL
```

This command line contains two commands. The first command belongs to the MMEM system, the second command belongs to the HCOP system. If the next command belongs to a different command system, the semicolon is followed by a colon.



**Example:**

```
HCOP:ITEM ALL;:HCOP:IMM
```

This command line contains two commands. Both commands are part of the HCOP command system, i.e. they have one level in common.

If the successive commands belong to the same system, having one or several levels in common, the command line can be abbreviated. When abbreviating the command line, the second command begins with the level below HCOP. The colon after the semi-colon is omitted. The abbreviated form of the command line reads as follows:

```
HCOP:ITEM ALL;IMM
```

**Example:**

```
HCOP:ITEM ALL
```

```
HCOP:IMM
```

A new command line always begins with the complete path.

**11.1.4.6 Responses to Queries**

A query is defined for each setting command unless explicitly specified otherwise. It is formed by adding a question mark to the associated setting command. According to SCPI, the responses to queries are partly subject to stricter rules than in standard IEEE 488.2.

- The requested parameter is transmitted without a header.  
**Example:** HCOP:PAGE:ORI?, **Response:** LAND
- Maximum values, minimum values and all other quantities that are requested via a special text parameter are returned as numeric values.  
**Example:** SENSE:FREQUENCY:STOP? MAX, **Response:** 3.5E9
- Numeric values are output without a unit. Physical quantities are referred to the basic units or to the units set using the Unit command. The response 3.5E9 in the previous example stands for 3.5 GHz.
- Truth values (Boolean values) are returned as 0 (for OFF) and 1 (for ON).  
**Example:**  
Setting command: HCOpy:DEV:COL ON  
Query: HCOpy:DEV:COL?  
Response: 1
- Text (character data) is returned in a short form.  
**Example:**  
Setting command: HCOpy:PAGE:ORIENTATION LANDscape  
Query: HCOP:PAGE:ORI?  
Response: LAND
- Invalid numerical results  
In some cases, particularly when a result consists of multiple numeric values, invalid values are returned as 9.91E37 (not a number).

### 11.1.5 Command Sequence and Synchronization

IEEE 488.2 defines a distinction between overlapped and sequential commands:

- A **sequential command** is one which finishes executing before the next command starts executing. Commands that are processed quickly are usually implemented as sequential commands.
- An **overlapping command** is one which does not automatically finish executing before the next command starts executing. Usually, overlapping commands take longer to process and allow the program to do other tasks while being executed. If overlapping commands do have to be executed in a defined order, e.g. in order to avoid wrong measurement results, they must be serviced sequentially. This is called synchronization between the controller and the instrument.

Setting commands within one command line, even though they may be implemented as sequential commands, are not necessarily serviced in the order in which they have been received. In order to make sure that commands are actually carried out in a certain order, each command must be sent in a separate command line.

#### Example: Commands and queries in one message

The response to a query combined in a program message with commands that affect the queried value is not predictable.

The following commands always return the specified result:

```
:FREQ:STAR 1GHZ;SPAN 100 :FREQ:STAR?
```

Result:

```
1000000000 (1 GHz)
```

Whereas the result for the following commands is not specified by SCPI:

```
:FREQ:STAR 1GHz;STAR?;SPAN 1000000
```

The result could be the value of `START` before the command was sent since the instrument might defer executing the individual commands until a program message terminator is received. The result could also be 1 GHz if the instrument executes commands as they are received.



As a general rule, send commands and queries in different program messages.

**Example: Overlapping command with \*OPC**

The instrument implements `INITiate[:IMMediate]` as an overlapped command. Assuming that `INITiate[:IMMediate]` takes longer to execute than `*OPC`, sending the following command sequence results in initiating a sweep and, after some time, setting the `OPC` bit in the `ESR`:

```
INIT; *OPC.
```

Sending the following commands still initiates a sweep:

```
INIT; *OPC; *CLS
```

However, since the operation is still pending when the instrument executes `*CLS`, forcing it into the "Operation Complete Command Idle" State (OCIS), `*OPC` is effectively skipped. The `OPC` bit is not set until the instrument executes another `*OPC` command.

The following list includes the commands for which a synchronization via `*OPC`, `*OPC?` or `*WAI` is mandatory:

Command	Purpose
INIT	start measurement
INIT:CONM	continue measurement
CALC:MARK:FUNC:ZOOM	zoom frequency range around marker 1
CALC:STAT:SCAL:AUTO ONCE	optimize level settings for signal statistic measurement functions
[SENS:]POW:ACH:PRES:RLEV	optimize level settings for adjacent channel power measurements

**11.1.5.1 Preventing Overlapping Execution**

To prevent an overlapping execution of commands, one of the commands `*OPC`, `*OPC?` or `*WAI` can be used. All three commands cause a certain action only to be carried out after the hardware has been set. The controller can be forced to wait for the corresponding action to occur.

**Table 11-5: Synchronization using \*OPC, \*OPC? and \*WAI**

Command	Action	Programming the controller
*OPC	Sets the Operation Complete bit in the <code>ESR</code> after all previous commands have been executed.	<ul style="list-style-type: none"> <li>Setting bit 0 in the <code>ESE</code></li> <li>Setting bit 5 in the <code>SRE</code></li> <li>Waiting for service request (<code>SRQ</code>)</li> </ul>
*OPC?	Stops command processing until 1 is returned. This occurs when all pending operations are completed.	Send <code>*OPC?</code> directly after the command whose processing must be terminated before other commands can be executed.
*WAI	Stops further command processing until all commands sent before <code>*WAI</code> have been executed.	Send <code>*WAI</code> directly after the command whose processing must be terminated before other commands are executed.

Command synchronization using `*WAI` or `*OPC?` is a good choice if the overlapped command takes only little time to process. The two synchronization commands simply

block overlapped execution of the command. Append the synchronization command to the overlapping command, for example:

```
SINGLE; *OPC?
```

For time consuming overlapped commands, you can allow the controller or the instrument to do other useful work while waiting for command execution. Use one of the following methods:

#### **\*OPC with a service request**

1. Set the OPC mask bit (bit no. 0) in the ESE: \*ESE 1
2. Set bit no. 5 in the SRE: \*SRE 32 to enable ESB service request.
3. Send the overlapped command with \*OPC .
4. Wait for a service request.

The service request indicates that the overlapped command has finished.

#### **\*OPC? with a service request**

1. Set bit no. 4 in the SRE: \*SRE 16 to enable MAV service request.
2. Send the overlapped command with \*OPC?.
3. Wait for a service request.

The service request indicates that the overlapped command has finished.

#### **Event status register (ESE)**

1. Set the OPC mask bit (bit no. 0) in the ESE: \*ESE 1
2. Send the overlapped command without \*OPC, \*OPC? or \*WAI.
3. Poll the operation complete state periodically (with a timer) using the sequence:  
\*OPC; \*ESR?

A return value (LSB) of 1 indicates that the overlapped command has finished.

## **11.1.6 Status Reporting System**

The status reporting system stores all information on the current operating state of the instrument, and on errors which have occurred. This information is stored in the status registers and in the error queue. Both can be queried via GPIB bus or LAN interface (STATus... commands).

### **11.1.6.1 Hierarchy of Status Registers**

- **STB, SRE**  
The SStatus Byte (STB) register and its associated mask register Service Request Enable (SRE) form the highest level of the status reporting system. The STB pro-

vides a rough overview of the instrument status, collecting the information of the lower-level registers.

- **ESR, SCPI registers**

The STB receives its information from the following registers:

- The Event Status Register (ESR) with the associated mask register standard Event Status Enable (ESE)
- The STATUS:OPERation and STATUS:QUEStionable registers which are defined by SCPI and contain detailed information on the instrument

- **IST, PPE**

The IST flag ("Individual Status"), like the SRQ, combines the entire instrument status in a single bit. The PPE fulfills the same function for the IST flag as the SRE for the service request.

- **Output buffer**

The output buffer contains the messages the instrument returns to the controller. It is not part of the status reporting system but determines the value of the MAV bit in the STB and thus is represented in the overview.

All status registers have the same internal structure.



#### **SRE, ESE**

The service request enable register SRE can be used as ENABLE part of the STB if the STB is structured according to SCPI. By analogy, the ESE can be used as the ENABLE part of the ESR.

### **11.1.6.2 Structure of a SCPI Status Register**

Each standard SCPI register consists of 5 parts. Each part has a width of 16 bits and has different functions. The individual bits are independent of each other, i.e. each hardware status is assigned a bit number which is valid for all five parts. Bit 15 (the most significant bit) is set to zero for all parts. Thus the contents of the register parts can be processed by the controller as positive integers.

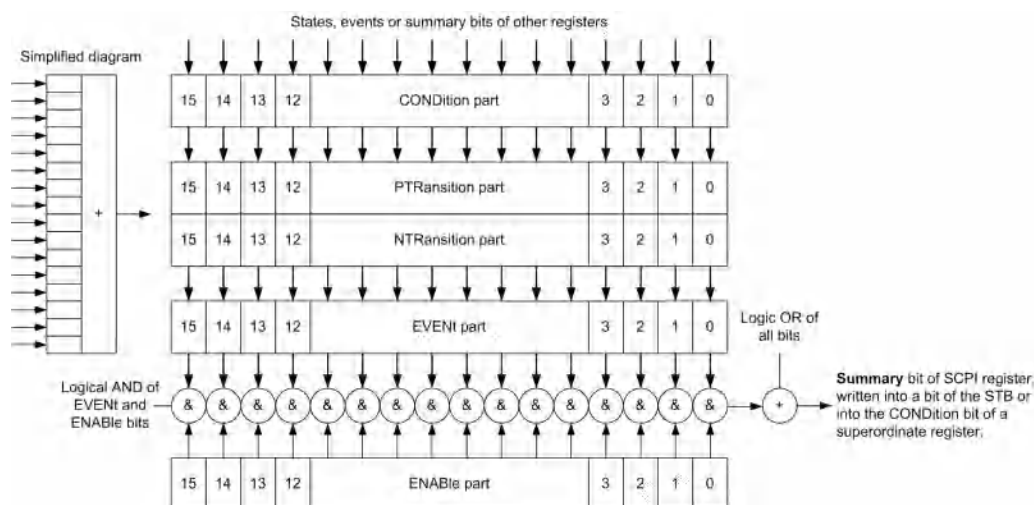

Figure 11-2: The status-register model

### Description of the five status register parts

The five parts of a SCPI register have different properties and functions:

- **CONDition**

The **CONDition** part is written into directly by the hardware or the sum bit of the next lower register. Its contents reflect the current instrument status. This register part can only be read, but not written into or cleared. Its contents are not affected by reading.

- **PTRansition / NTRansition**

The two transition register parts define which state transition of the **CONDition** part (none, 0 to 1, 1 to 0 or both) is stored in the **EVENT** part.

The **Positive-TRansition** part acts as a transition filter. When a bit of the **CONDition** part is changed from 0 to 1, the associated **PTR** bit decides whether the **EVENT** bit is set to 1.

- **PTR** bit =1: the **EVENT** bit is set.
- **PTR** bit =0: the **EVENT** bit is not set.

This part can be written into and read as required. Its contents are not affected by reading.

The **Negative-TRansition** part also acts as a transition filter. When a bit of the **CONDition** part is changed from 1 to 0, the associated **NTR** bit decides whether the **EVENT** bit is set to 1.

- **NTR** bit =1: the **EVENT** bit is set.
- **NTR** bit =0: the **EVENT** bit is not set.

This part can be written into and read as required. Its contents are not affected by reading.

- **EVENT**

The **EVENT** part indicates whether an event has occurred since the last reading, it is the "memory" of the condition part. It only indicates events passed on by the transition filters. It is permanently updated by the instrument. This part can only be

read by the user. Reading the register clears it. This part is often equated with the entire register.

- **ENABLE**

The `ENABLE` part determines whether the associated `EVENT` bit contributes to the sum bit (see below). Each bit of the `EVENT` part is "ANDed" with the associated `ENABLE` bit (symbol '&'). The results of all logical operations of this part are passed on to the sum bit via an "OR" function (symbol '+').

`ENABLE` bit = 0: the associated `EVENT` bit does not contribute to the sum bit

`ENABLE` bit = 1: if the associated `EVENT` bit is "1", the sum bit is set to "1" as well.

This part can be written into and read by the user as required. Its contents are not affected by reading.

### **Sum bit**

The sum bit is obtained from the `EVENT` and `ENABLE` part for each register. The result is then entered into a bit of the `CONDition` part of the higher-order register.

The instrument automatically generates the sum bit for each register. Thus an event can lead to a service request throughout all levels of the hierarchy.

#### **11.1.6.3 Contents of the Status Register**

This chapter provides information on the contents of each status register the meaning for all bits that are used available for each operating mode.

#### **Status Registers in Receiver Mode**

This chapter contains the description of the registers and bits specific to spectrum mode.

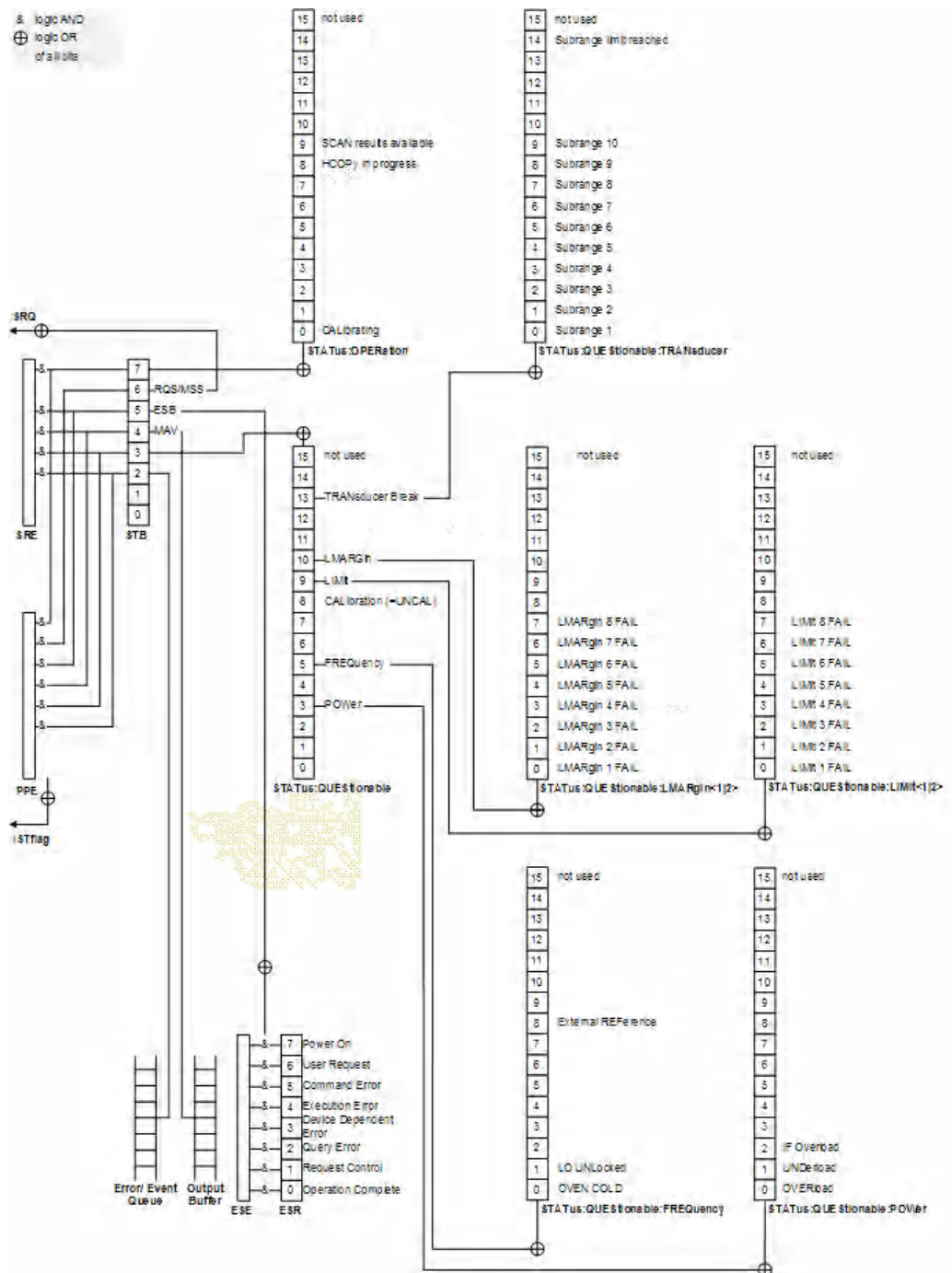

Figure 11-3: Overview of status registers in receiver mode

**Status Byte (STB) and Service Request Enable Register (SRE)**

The *Status Byte* (STB) is already defined in IEEE 488.2. It provides a rough overview of the instrument status by collecting the pieces of information of the lower registers. A special feature is that bit 6 acts as the sum bit of the remaining bits of the status byte.



The STB can thus be compared with the `CONDition` part of an SCPI register and assumes the highest level within the SCPI hierarchy.

The STB is read using the command `*STB?` or a serial poll.

The `STatus Byte` (STB) is linked to the `Service Request Enable` (SRE) register. Each bit of the STB is assigned a bit in the SRE. Bit 6 of the SRE is ignored. If a bit is set in the SRE and the associated bit in the STB changes from 0 to 1, a service request (SRQ) is generated. The SRE can be set using the command `*SRE` and read using the command `*SRE?`.

**Table 11-6: Meaning of the bits used in the status byte**

Bit No.	Meaning
0...1	Not used
2	Error Queue not empty The bit is set when an entry is made in the error queue. If this bit is enabled by the SRE, each entry of the error queue generates a service request. Thus an error can be recognized and specified in greater detail by polling the error queue. The poll provides an informative error message. This procedure is to be recommended since it considerably reduces the problems involved with remote control.
3	QUESTIONable status register summary bit The bit is set if an <code>EVENT</code> bit is set in the <code>QUESTIONable</code> status register and the associated <code>ENABLE</code> bit is set to 1. A set bit indicates a questionable instrument status, which can be specified in greater detail by querying the <code>STATUS:QUESTIONable</code> status register.
4	MAV bit (message available) The bit is set if a message is available in the output queue which can be read. This bit can be used to enable data to be automatically read from the instrument to the controller.
5	ESB bit Sum bit of the event status register. It is set if one of the bits in the event status register is set and enabled in the event status enable register. Setting of this bit indicates a serious error which can be specified in greater detail by polling the event status register.
6	MSS bit (master status summary bit) The bit is set if the instrument triggers a service request. This is the case if one of the other bits of this registers is set together with its mask bit in the service request enable register SRE.
7	<code>STATUS:OPERation</code> status register summary bit The bit is set if an <code>EVENT</code> bit is set in the <code>OPERation</code> status register and the associated <code>ENABLE</code> bit is set to 1. A set bit indicates that the instrument is just performing an action. The type of action can be determined by querying the <code>STATUS:OPERation</code> status register.

### IST Flag and Parallel Poll Enable Register (PPE)

As with the SRQ, the IST flag combines the entire status information in a single bit. It can be read by means of a parallel poll (see "[Parallel Poll](#)" on page 561) or using the command `*IST?`.

The parallel poll enable register (PPE) determines which bits of the STB contribute to the IST flag. The bits of the STB are "ANDed" with the corresponding bits of the PPE, with bit 6 being used as well in contrast to the SRE. The IST flag results from the "ORing" of all results. The PPE can be set using commands `*PRE` and read using command `*PRE?`.

### Event Status Register (ESR) and Event Status Enable Register (ESE)

The Event Status Register (ESR) is the source for the registers on the highest levels and is similar to the `EVENT` part of a SCPI register. It is defined by IEEE 488.2. You can read out the ESR with `*ESR?`.

The corresponding `ENABLE` part of the ESR is the Event Status Enable mask register (ESE). The ESE is directly linked to the ESR. You can control the ESE with `*ESE`.

**Table 11-7: Meaning of the bits used in the event status register**

Bit No.	Meaning
0	Operation Complete This bit is set on receipt of the command <code>*OPC</code> exactly when all previous commands have been executed.
1	Unused
2	Query Error This bit is set if either the controller wants to read data from the instrument without having sent a query, or if it does not fetch requested data and sends new instructions to the instrument instead. The cause is often a query which is faulty and hence cannot be executed.
3	Device-dependent Error This bit is set if a device-dependent error occurs. The R&S ESRP adds a number to the error queue. The number is either in the range between -300 and -399 or greater than 0. If the number is positive, it indicates the error type in greater detail.
4	Execution Error This bit is set if a received command is syntactically correct but cannot be performed for other reasons. An error message with a number between -200 and -300, which denotes the error in greater detail, is entered into the error queue.
5	Command Error This bit is set if a remote command is undefined or has a incorrect syntax. The R&S ESRP adds a number to the error queue. The number is in the range between -100 and -200 and indicates the error type in greater detail.
6	User Request This bit is set when you press the "Local" softkey.
7	Power On (supply voltage on) This bit is set when you turn on the instrument.

### STATus:OPERation Register

The `STATus:OPERation` register contains information about actions the R&S ESRP is currently executing. It also contains information about the actions the R&S ESRP has executed since the last reading.

You can read out the state of the register with `STATus:OPERation:CONDition?` or `STATus:OPERation[:EVENT]?`.

**Table 11-8: Meaning of the bits used in the STATUS:OPERation register**

Bit No.	Meaning
0	CALibrating This bit is set as long as the instrument is performing a calibration.
1 to 7	Not used
8	HardCOpy in progress This bit is set while the instrument is printing a hardcopy.
9	SCAN results available This bit is set when a block of scan results is available. Note that this function must be enabled by TRACe:FEED:CONTol ALWays.
10	Sweep Break This bit is set when the end of a scan range is reached. To proceed, you have to use the INITiate:CONMeas command.
11	Not used
12	Threshold signal active
13 to 14	Not used
15	This bit is always 0.

**STATUS:QUESTionable Register**

The STATUS:QUESTionable register contains information about states that may occur if the R&S ESRP is operated without meeting the specifications.

You can read out the state of the register with `STATUS:QUESTionable:CONDition?` and `STATUS:QUESTionable[:EVENT]?`.

**Table 11-9: Meaning of the bits used in the STATUS:QUESTionable register**

Bit No.	Meaning
0 - 2	These bits are not used
3	POWer This bit is set if a questionable power occurs (see " <a href="#">STATUS:QUESTionable:POWer Register</a> " on page 555).
4	TEMPerature This bit is set if a questionable temperature occurs.
5	FREQuency The bit is set if a frequency is questionable (see " <a href="#">STATUS:QUESTionable:FREQuency Register</a> " on page 553).
6 - 7	Not used
8	CALibration The bit is set if a measurement is performed unaligned ("UNCAL" display)
9	LIMit (device-specific) This bit is set if a limit value is violated (see " <a href="#">STATUS:QUESTionable:LIMit Register</a> " on page 553)

Bit No.	Meaning
10	LMARgin (device-specific) This bit is set if a margin is violated (see " <a href="#">STATus:QUEStionable:LMARgin Register</a> " on page 554)
11	Not used
12	ACPLimit (device-specific) This bit is set if a limit for the adjacent channel power measurement is violated (see " <a href="#">STATus:QUEStionable:ACPLimit Register</a> " on page 559)
13	TRANsducer break This bit is set if a transducer break occurs and indicates the next range.
14	Not used
15	This bit is always 0.

### STATus:QUEStionable:FREQuency Register

The STATus:QUEStionable:FREQuency register contains information about the condition of the local oscillator and the reference frequency.

You can read out the register with `STATus:QUEStionable:FREQuency:CONDition?` or `STATus:QUEStionable:FREQuency[:EVENT]?`.

**Table 11-10: Meaning of the bits used in the STATus:QUEStionable:FREQuency register**

Bit No.	Meaning
0	OVEN COLD This bit is set if the reference oscillator has not yet attained its operating temperature. "OCXO" is displayed.
1	LO UNLocked This bit is set if the local oscillator no longer locks. "LOUNL" is displayed.
2 to 7	Unused
8	EXTernalREFerence This bit is set if you have selected an external reference oscillator but did not connect a useable external reference source. In that case the synthesizer can not lock. The frequency in all probability is not accurate.
9 to 14	Unused
15	This bit is always 0.

### STATus:QUEStionable:LIMit Register

The STATus:QUEStionable:LIMit register contains information about the results of a limit check when you are working with limit lines.

The number of LIMit registers depends on the number of measurement windows available in any operating mode.

You can read out the register with `STATus:QUEStionable:LIMit<n>:CONDition?` or `STATus:QUEStionable:LIMit<n>[:EVENT]?`.

**Table 11-11: Meaning of the bits used in the STATUS:QUESTIONable:LIMit register**

Bit No.	Meaning
0	LIMit 1 FAIL This bit is set if limit line 1 is violated.
1	LIMit 2 FAIL This bit is set if limit line 2 is violated.
2	LIMit 3 FAIL This bit is set if limit line 3 is violated.
3	LIMit 4 FAIL This bit is set if limit line 4 is violated.
4	LIMit 5 FAIL This bit is set if limit line 5 is violated.
5	LIMit 6 FAIL This bit is set if limit line 6 is violated.
6	LIMit 7 FAIL This bit is set if limit line 7 is violated.
7	LIMit 8 FAIL This bit is set if limit line 8 is violated.
8 to 14	Unused
15	This bit is always 0.

**STATUS:QUESTIONable:LMARgin Register**

This register contains information about the observance of limit margins.

You can read out the register with `STATUS:QUESTIONable:LMARgin<n>:CONDition?` or `STATUS:QUESTIONable:LMARgin<n>[:EVENT]?`.

**Table 11-12: Meaning of the bits used in the STATUS:QUESTIONable:LMARgin register**

Bit No.	Meaning
0	LMARgin 1 FAIL This bit is set if limit margin 1 is violated.
1	LMARgin 2 FAIL This bit is set if limit margin 2 is violated.
2	LMARgin 3 FAIL This bit is set if limit margin 3 is violated.
3	LMARgin 4 FAIL This bit is set if limit margin 4 is violated.
4	LMARgin 5 FAIL This bit is set if limit margin 5 is violated.
5	LMARgin 6 FAIL This bit is set if limit margin 6 is violated.

Bit No.	Meaning
6	LMARgin 7 FAIL This bit is set if limit margin 7 is violated.
7	LMARgin 8 FAIL This bit is set if limit margin 8 is violated.
8 to 14	Not used
15	This bit is always 0.

### STATus:QUEStionable:POWer Register

The STATus:QUEStionable:POWer register contains information about possible overload situations that may occur during operation of the R&S ESRP.

You can read out the registers with `STATus:QUEStionable:POWer:CONDition?` or `STATus:QUEStionable:POWer[:EVENT]?`.

**Table 11-13: Meaning of the bits used in the STATus:QUEStionable:POWer register**

Bit No.	Meaning
0	OVERload This bit is set if an overload occurs at the RF input. The R&S ESRP displays the enhancement label "OVLD".
1	UNDerload This bit is set if an underload occurs at the RF input. The R&S ESRP displays the enhancement label "UNLD".
2	IF_OVERload This bit is set if an overload occurs in the IF path. The R&S ESRP displays the enhancement label "IFOVL".
3 to 14	Unused
15	This bit is always 0.

### STATus:QUEStionable:TRANsducer Register

The STATus:QUEStionable:TRANsducer register contains information about transducer breaks.

It indicates that a transducer break has been reached. It also indicates the next range that is to be swept. You can continue the sweep with `INITiate<n>:CONMeas`.

You can read out the registers with `STATus:QUEStionable:TRANsducer:CONDition?` or `STATus:QUEStionable:TRANsducer[:EVENT]?` on page 963.

**Table 11-14: Meaning of the bits used in the STATUS:QUESTIONable:TRANSDUCER register**

Bit No.	Meaning
0	Range 1 This bit is set if subrange 1 has been reached.
1	Range 2 This bit is set if subrange 2 has been reached.
2	Range 3 This bit is set if subrange 3 has been reached.
3	Range 4 This bit is set if subrange 4 has been reached.
4	Range 5 This bit is set if subrange 5 has been reached.
5	Range 6 This bit is set if subrange 6 has been reached.
6	Range 7 This bit is set if subrange 7 has been reached.
7	Range 8 This bit is set if subrange 8 has been reached.
8	Range 9 This bit is set if subrange 9 has been reached.
9	Range 10 This bit is set if subrange 10 has been reached.
10 to 13	Unused
14	Subrange limit This bit is set when the transducer is at the point of changeover from one subrange to another.
15	This bit is always 0.

### Status Registers in Spectrum Mode

This chapter contains the description of the registers and bits specific to spectrum mode. For a comprehensive description of the other status registers see "[Status Registers in Receiver Mode](#)" on page 548.

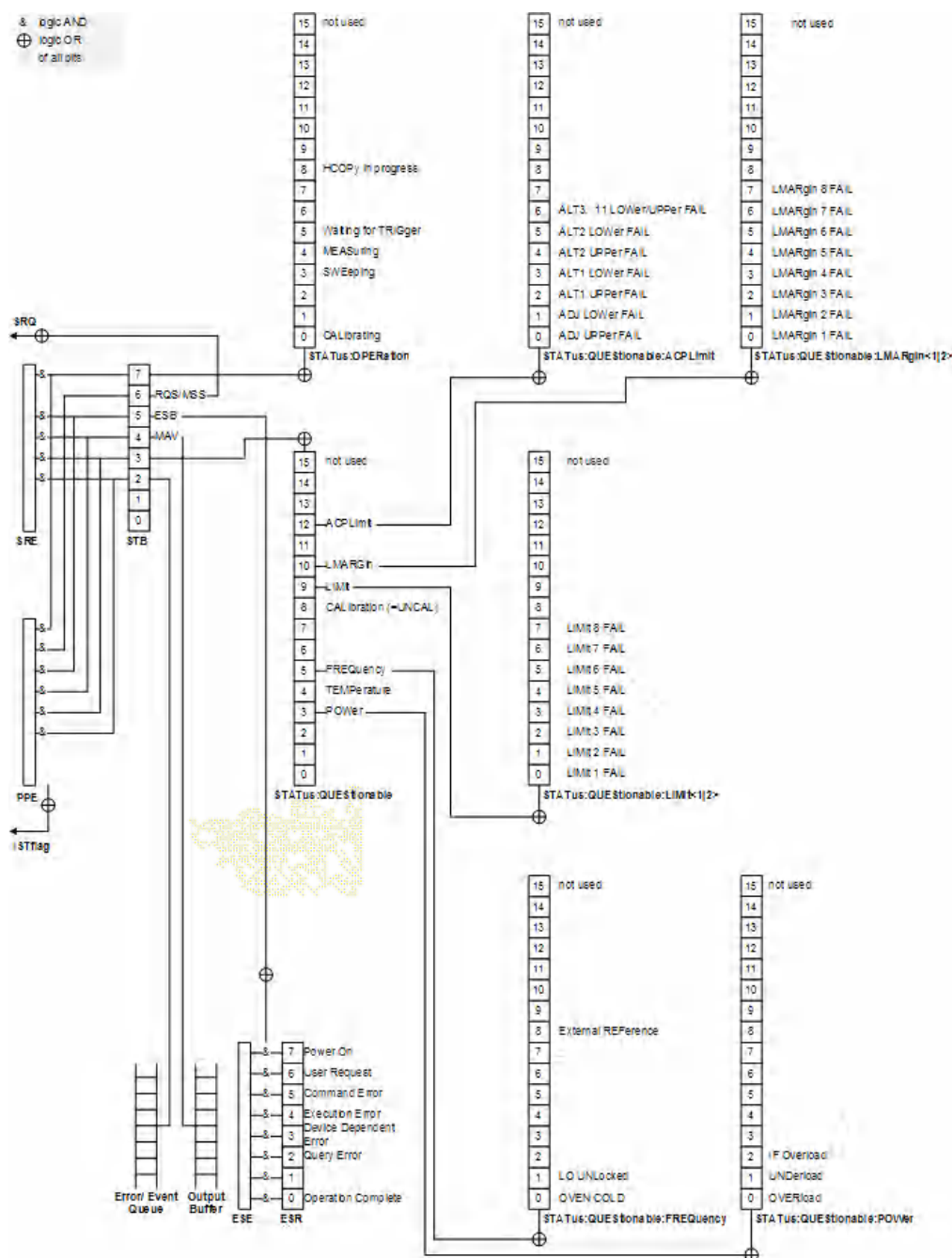

Figure 11-4: Overview of status registers in spectrum mode

### STATUS:OPERation Register

The STATUS:OPERation register contains information on current activities of the R&S ESRP. It also contains information on activities that have been executed since the last read out.

You can read out the register with `STATUS:OPERation:CONDition?` or `STATUS:OPERation[:EVENT]?`.



**Table 11-15: Meaning of the bits used in the STATUS:OPERation register**

Bit No.	Meaning
0	CALibrating This bit is set as long as the instrument is performing a calibration.
1-2	Not used
3	SWEeping Sweep is being performed; identical to bit 4
4	MEASuring Measurement is being performed; identical to bit 3
5	Waiting for TRigger Instrument is ready to trigger and waiting for trigger signal
6-7	Not used
8	HardCOpy in progress This bit is set while the instrument is printing a hardcopy.
9	Not used
10	Stop after Range This bit is set when a range in the sweep list has been completed if "Stop after Range" has been activated.
11-14	Not used
15	This bit is always 0.

**STATUS:QUESTionable Register**

The STATUS:QUESTionable register contains information on instrument states that do not meet the specifications.

You can read out the register with `STATUS:QUESTionable:CONDition?` or `STATUS:QUESTionable[:EVENT]?`.

**Table 11-16: Meaning of the bits used in the STATUS:QUESTionable register**

Bit No.	Meaning
0 - 2	Unused
3	POWer This bit is set if the measured power level is questionable. The <a href="#">STATUS:QUESTionable:POWer Register</a> provides more information on the error type.
4	TEMPerature This bit is set if the temperature is questionable.
5	FREQuency This bit is set if there is anything wrong with the frequency of the local oscillator or the reference frequency. The <a href="#">STATUS:QUESTionable:FREQuency Register</a> provides more information on the error type.
6 - 7	Unused

Bit No.	Meaning
8	CALibration This bit is set if the R&S ESRP is unaligned ("UNCAL" display)
9	LIMit (device-specific) This bit is set if a limit value is violated. The <a href="#">STATus:QUEStionable:LIMit Register</a> provides more information on the error type.
10	LMARgin (device-specific) This bit is set if a margin is violated. The <a href="#">STATus:QUEStionable:LMARgin Register</a> provides more information on the error type.
11	Not used
12	ACPLimit (device-specific) This bit is set if a limit during ACLR measurements is violated. The <a href="#">STATus:QUEStionable:ACPLimit Register</a> provides more information on the error type.
13 - 14	Not used
15	This bit is always 0.

### STATus:QUEStionable:ACPLimit Register

The STATus:QUEStionable:ACPLimit register contains information about the results of a limit check during ACLR measurements.

You can read out the register with [STATus:QUEStionable:ACPLimit:CONDition?](#) or [STATus:QUEStionable:ACPLimit\[:EVENT\]?](#).

**Table 11-17: Meaning of the bits used in the STATus:QUEStionable:ACPLimit register**

Bit No.	Meaning
0	ADJ UPPer FAIL This bit is set if the limit is exceeded in the <b>upper adjacent</b> channel
1	ADJ LOWer FAIL This bit is set if the limit is exceeded in the <b>lower adjacent</b> channel.
2	ALT1 UPPer FAIL This bit is set if the limit is exceeded in the <b>upper 1st alternate</b> channel.
3	ALT1 LOWer FAIL This bit is set if the limit is exceeded in the <b>lower 1st alternate</b> channel.
4	ALT2 UPPer FAIL This bit is set if the limit is exceeded in the <b>upper 2nd alternate</b> channel.
5	ALT2 LOWer FAIL This bit is set if the limit is exceeded in the <b>lower 2nd alternate</b> channel.
6	ALT3 ... 11 LOWer/UPPer FAIL This bit is set if the limit is exceeded in one of the lower or upper alternate channels 3 ... 11.

Bit No.	Meaning
7 to 14	Unused
15	This bit is always 0.

#### 11.1.6.4 Application of the Status Reporting System

The purpose of the status reporting system is to monitor the status of one or several devices in a measuring system. To do this and react appropriately, the controller must receive and evaluate the information of all devices. The following standard methods are used:

- **Service request** (SRQ) initiated by the instrument
- **Serial poll** of all devices in the bus system, initiated by the controller in order to find out who sent a SRQ and why
- **Parallel poll** of all devices
- Query of a **specific instrument status** by means of commands
- Query of the **error queue**

##### Service Request

##### Use of the command \*OPC to generate an SRQ at the end of a sweep

1. `CALL InstrWrite(analyzer, "*ESE 1")` 'Set bit 0 in the ESE (Operation Complete)
2. `CALL InstrWrite(analyzer, "*SRE 32")` 'Set bit 5 in the SRE (ESB)
3. `CALL InstrWrite(analyzer, "**INIT;*OPC")` 'Generate an SRQ after operation complete

After its settings have been completed, the instrument generates an SRQ.

The SRQ is the only possibility for the instrument to become active on its own. Each controller program should cause the instrument to initiate a service request if errors occur. The program should react appropriately to the service request.

A detailed example for a service request routine can be found in [Chapter 11.17.1, "Service Request"](#), on page 967.

##### Serial Poll

In a serial poll, just as with command \*STB, the status byte of an instrument is queried. However, the query is realized via interface messages and is thus clearly faster.

The serial poll method is defined in IEEE 488.1 and used to be the only standard possibility for different instruments to poll the status byte. The method also works for instruments which do not adhere to SCPI or IEEE 488.2.

The serial poll is mainly used to obtain a fast overview of the state of several instruments connected to the controller.

### Parallel Poll

In a parallel poll, up to eight instruments are simultaneously requested by the controller using a single command to transmit 1 bit of information each on the data lines, i.e., to set the data line allocated to each instrument to a logical "0" or "1".

In addition to the SRE register, which determines the conditions under which an SRQ is generated, there is a Parallel Poll Enable register (PPE) which is ANDed with the STB bit by bit, considering bit 6 as well. This register is ANDed with the STB bit by bit, considering bit 6 as well. The results are ORed, the result is possibly inverted and then sent as a response to the parallel poll of the controller. The result can also be queried without parallel poll using the command `*IST?`.

The instrument first has to be set for the parallel poll using the command `PPC`. This command allocates a data line to the instrument and determines whether the response is to be inverted. The parallel poll itself is executed using `PPE`.

The parallel poll method is mainly used to find out quickly which one of the instruments connected to the controller has sent a service request. To this effect, SRE and PPE must be set to the same value.

### Query of an instrument status

Each part of any status register can be read using queries. There are two types of commands:

- The common commands `*ESR?`, `*IDN?`, `*IST?`, `*STB?` query the higher-level registers.
- The commands of the `STATus` system query the SCPI registers (`STATus:QUEStionable...`)

The returned value is always a decimal number that represents the bit pattern of the queried register. This number is evaluated by the controller program.

Queries are usually used after an SRQ in order to obtain more detailed information on the cause of the SRQ.

### Decimal representation of a bit pattern

The STB and ESR registers contain 8 bits, the SCPI registers 16 bits. The contents of a status register are specified and transferred as a single decimal number. To make this possible, each bit is assigned a weighted value. The decimal number is calculated as the sum of the weighted values of all bits in the register that are set to 1.

Bits	0	1	2	3	4	5	6	7	...
Weight	1	2	4	8	16	32	64	128	...

**Example:**

The decimal value 40 = 32 + 8 indicates that bits no. 3 and 5 in the status register (e.g. the `QUEStionable` status summary bit and the `ESB` bit in the `STatus Byte`) are set.

**Error Queue**

Each error state in the instrument leads to an entry in the error queue. The entries of the error queue are detailed plain text error messages that can be looked up in the Error Log or queried via remote control using `SYSTem:ERRor[:NEXT]?`. Each call of `SYSTem:ERRor[:NEXT]?` provides one entry from the error queue. If no error messages are stored there any more, the instrument responds with 0, "No error".

The error queue should be queried after every SRQ in the controller program as the entries describe the cause of an error more precisely than the status registers. Especially in the test phase of a controller program the error queue should be queried regularly since faulty commands from the controller to the instrument are recorded there as well.

**11.1.6.5 Reset Values of the Status Reporting System**

The following table contains the different commands and events causing the status reporting system to be reset. None of the commands, except `*RST` and `SYSTem:PRESet`, influence the functional instrument settings. In particular, `DCL` does not change the instrument settings.

**Table 11-18: Resetting the status reporting system**

Event	Switching on supply voltage Power-On-Status-Clear		DCL, SDC (Device Clear, Selected Device Clear)	*RST or SYS- Tem:PRE Set	STA- Tus:PRE- Set	*CLS
	0	1				
Clear STB, ESR	-	yes	-	-	-	yes
Clear SRE, ESE	-	yes	-	-	-	-
Clear PPE	-	yes	-	-	-	-
Clear EVENT parts of the registers	-	yes	-	-	-	yes
Clear ENABLE parts of all OPERation and QUEStionable registers; Fill ENABLE parts of all other registers with "1".	-	yes	-	-	yes	-
Fill PTRansition parts with "1"; Clear NTRansition parts	-	yes	-	-	yes	-
Clear error queue	yes	yes	-	-	-	yes
Clear output buffer	yes	yes	yes	1)	1)	1)

Event	Switching on supply voltage Power-On-Status-Clear		DCL, SDC (Device Clear, Selected Device Clear)	*RST or SYS-Tem:PRE Set	STA-Tus:PRE-Set	*CLS
	0	1				
Clear command processing and input buffer	yes	yes	yes	-	-	-
1) The first command in a command line that immediately follows a <PROGRAM MESSAGE TERMINATOR> clears the output buffer.						

### 11.1.7 General Programming Recommendations

#### Initial instrument status before changing settings

Manual operation is designed for maximum possible operating convenience. In contrast, the priority of remote control is the "predictability" of the instrument status. Thus, when a command attempts to define incompatible settings, the command is ignored and the instrument status remains unchanged, i.e. other settings are not automatically adapted. Therefore, control programs should always define an initial instrument status (e.g. using the \*RST command) and then implement the required settings.

#### Command sequence

As a general rule, send commands and queries in different program messages. Otherwise, the result of the query may vary depending on which operation is performed first (see also Preventing Overlapping Execution).

#### Reacting to malfunctions

The service request is the only possibility for the instrument to become active on its own. Each controller program should instruct the instrument to initiate a service request in case of malfunction. The program should react appropriately to the service request.

#### Error queues

The error queue should be queried after every service request in the controller program as the entries describe the cause of an error more precisely than the status registers. Especially in the test phase of a controller program the error queue should be queried regularly since faulty commands from the controller to the instrument are recorded there as well.

### 11.1.8 The IECWIN Tool

The R&S ESRP is delivered with *IECWIN* installed, an auxiliary tool provided free of charge by R&S. IECWIN is a program to send SCPI commands to a measuring instrument either interactively or from a command script.



The R&S IECWIN32 tool is provided free of charge. The functionality may change in a future version without notice.

IECWIN offers the following features:

- Connection to instrument via several interfaces/protocols (GPIB, VISA, named pipe (if IECWIN is run on the instrument itself), RSIB)
- Interactive command entry
- Browsing available commands on the instrument
- Error checking following every command
- Execution of command scripts
- Storing binary data to a file
- Reading binary data from a file
- Generation of a log file

For command scripts, IECWIN offers the following features:

- Synchronization with the instrument on every command
- Checking expected result for query commands (as string or numeric value)
- Checking for expected errors codes
- Optional pause on error
- Nested command scripts
- Single step mode
- Conditional execution, based on the \*IDN and \*OPT strings



You can use the IECWIN to try out the programming examples provided in the R&S ESRP User Manuals.

### Starting IECWIN

IECWIN is available from the Windows "Start" menu on the R&S ESRP, or by executing the following file:

```
C:\Program Files\Rohde-Schwarz\FSV\<<version>\iecwin32.exe
```

You can also copy the program to any Windows PC or laptop. Simply copy the `iecwin32.exe`, `iecwin.chm` and `rsib32.dll` files from the location above to the same folder on the target computer.

When the tool is started, a "Connection settings" dialog box is displayed. Define the connection from the computer the IECWIN tool is installed on to the R&S ESRP you want to control. If you are using the tool directly on the R&S ESRP, you can use an NT Pipe (COM Parser) connection, which requires no further configuration. For help on setting up other connection types, check the tool's online help (by clicking the "Help" button in the dialog box).



The IECWIN offers an online help with extensive information on how to work with the tool.

## 11.2 Controlling the R&S ESRP Remotely

In addition to working with the R&S ESRP interactively, located directly at the instrument, it is also possible to operate and control it from a remote PC.

Various methods for remote control are supported:

- Using the Windows Remote Desktop application in a LAN network (see [Chapter 11.2.1, "Operation with Windows Remote Desktop"](#), on page 565)
- Using Virtual Network Computing (VNC, see [Chapter 11.2.2, "Operation with a VNC Client"](#), on page 571)
- Connecting the instrument to a (LAN) network (see [Chapter 11.2.5, "Setting Up a Network \(LAN\) Connection"](#), on page 592)

• <a href="#">Operation with Windows Remote Desktop</a> .....	565
• <a href="#">Operation with a VNC Client</a> .....	571
• <a href="#">Brief Introduction to Remote Control</a> .....	572
• <a href="#">Configuring the GPIB Interface</a> .....	592
• <a href="#">Setting Up a Network (LAN) Connection</a> .....	592
• <a href="#">How to Configure the LAN Using the LXI Web Browser Interface</a> .....	598
• <a href="#">Configuring the Network</a> .....	600

### 11.2.1 Operation with Windows Remote Desktop

In production test and measurement, a common requirement is central monitoring of the T&M instruments for remote maintenance and remote diagnostics. Equipped with the Windows Remote Desktop software, the R&S ESRP ideally meets requirements for use in production. (The computer that is used for remote operation is called "controller" here.)

- Access to the control functions via a virtual front panel (soft front panel)
- Printout of measurement results directly from the controller
- Storage of measured data on the controller's hard disk

The R&S ESRP is connected via a LAN, in which case the Windows operating system also supports a connection via a modem. This section describes the configuration of the R&S ESRP and the Remote Desktop Client of the controller. Details on how to set up a modem connection are described in the Windows documentation.



### 11.2.1.1 Configuring the R&S ESRP for Remote Operation



To avoid problems, use a fixed IP address.

When a DHCP server is used, a new IP address is assigned each time the instrument is restarted. This address must first be determined on the instrument itself. Thus, using a DHCP server is not suitable for remote operation of the R&S ESRP via Remote Desktop.



With the factory settings, the default "instrument" user can connect to the R&S ESRP with the Remote Desktop program of the controller immediately. No further configuration is required. However, if the connection fails or other users need to connect, this section provides basic instructions on setting up the Remote Desktop for the R&S ESRP.

1. Press the "Windows" key on the external keyboard or the [CTRL + ESC] key combination on your keyboard to access the operating system.
2. In the Windows "Start" menu, select "Settings > System".
3. Search for "remote access".
4. Select "Allow remote access to your computer".
5. Define which users are to be given access to the R&S ESRP via Remote Desktop.  
**Note:** The user account under which configuration is carried out is automatically enabled for Remote Desktop.

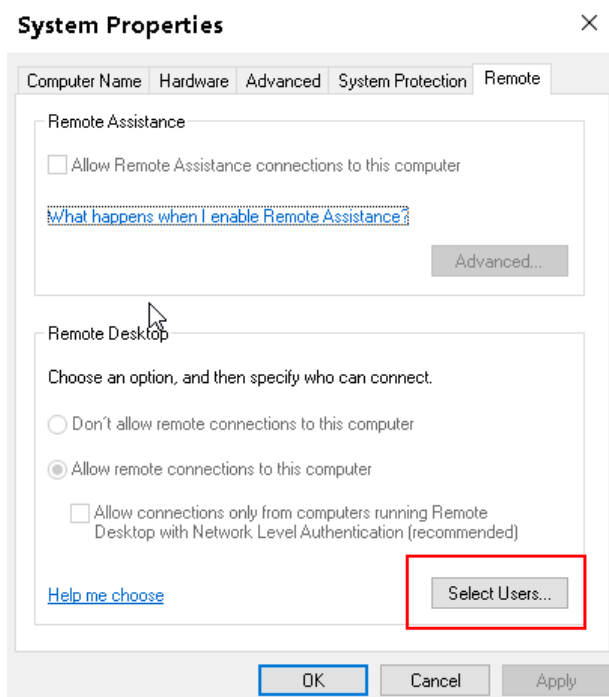

- a) Select the "Select Users" button.
  - b) Select the users or create new user accounts as described in [Chapter 11.2.7.2, "Creating Users"](#), on page 601.
  - c) Select "OK" to confirm the settings.
6. The R&S ESRP is now ready for connection setup with the Remote Desktop program of the controller.

### 11.2.1.2 Configuring the Controller



#### Remote Desktop Client

The Windows Remote Desktop Client is part of the operating system and can be accessed via "Start > All Applications > Windows Accessories > Remote Desktop Connection".

1. Press the "Windows" key on the external keyboard or the [CTRL + ESC] key combination on your keyboard to access the operating system.
2. From the "Start" menu, select "All Programs > Accessories > Remote Desktop Connection".  
The "Remote Desktop Connection" dialog box is displayed.
3. Select the "Options >>" button.  
The dialog box is expanded to display the configuration data.

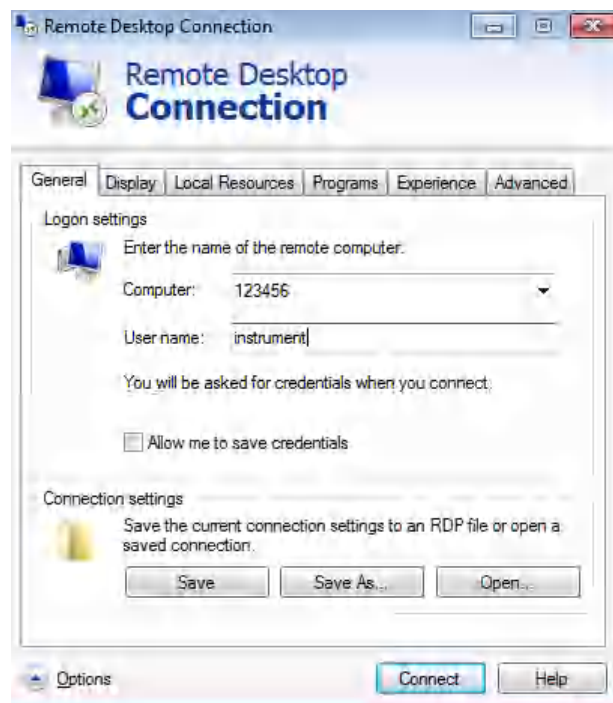

4. Open the "Experience" tab.  
The settings on this tab are used to select and optimize the connection speed.

- In the list, select the appropriate connection (for example: LAN (10 Mbps or higher)).  
Depending on your selection (and how powerful the connection is), the options are activated or deactivated.
- To improve the performance, you can deactivate the "Desktop background", "Show contents of window while dragging" and "Menu and window animation" options.
- Open the "Local Resources" tab for enabling printers, local drives and serial interfaces.
- If you will need to access drives of the controller from the R&S ESRP (e.g. in order to store settings or to copy files from the controller to the R&S ESRP), select "More", then enable the "Drives" option.

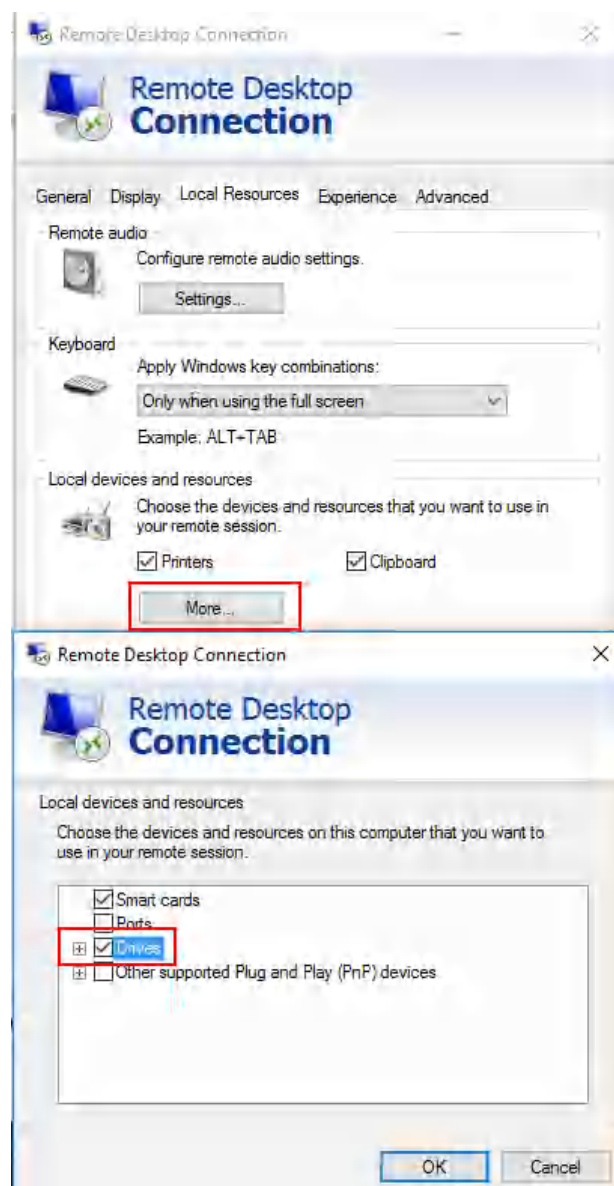

Windows will then map drives of the controller to the corresponding network drives.

9. To use printers connected to the controller while accessing them from the R&S ESRP, activate the "Printers" option. Do not change the remaining settings.
10. Open the "Display" tab.  
The options for configuring the R&S ESRP screen display are displayed.
11. Under "Remote desktop size", you can set the size of the R&S ESRP window on the desktop of the controller.
12. Under "Colors", do not change the settings.
13. Set the "Display the connection bar when I use the full screen" option:
  - If activated, a bar showing the network address of the R&S ESRP will appear at the top edge of the screen. You can use this bar to reduce, minimize or close the window.
  - If deactivated, the only way you can return to the controller desktop from the R&S ESRP screen in full screen mode is to select "Disconnect" from the "Start" menu.

### 11.2.1.3 Starting and Terminating Remote Operation

#### Setting up a connection to the R&S ESRP

1. In the "Remote Desktop Connection" dialog box (see [Chapter 11.2.1, "Operation with Windows Remote Desktop"](#), on page 565), open the "General" tab.
2. In the "Computer" field, enter the IP address of the R&S ESRP.  
In the "User name" field, enter *instrument* to log in as an administrator, or *Normal User* to log in as a standard user.  
In the "Password" field, enter *894129*.
3. To save the connection configuration for later use:
  - a) Select the "Save As" button.  
The "Save As" dialog box is displayed.
  - b) Enter the name for the connection information (\*.RDP).
4. To load an existing connection configuration:
  - a) Select the "Open" button.  
The "Open" dialog box is displayed.
  - b) Select the \*.RDP file.
5. Select the "Connect" button.  
The connection is set up.
6. If the "Drives" option is activated on the "Local Resources" tab, a warning is displayed indicating that the drives are enabled for access from the R&S ESRP.  
Select "OK" to confirm the warning.

7. After a few moments, the R&S ESRP screen is displayed.  
If a dark screen appears or a dark square appears in the upper left-hand corner of the screen, you must restart the R&S ESRP in order to see the modified screen resolution.

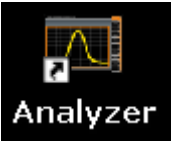
	<ul style="list-style-type: none"> <li>• Press the key combination [ALT] + [F4].</li> <li>• The R&amp;S ESRP firmware is shut down, which may take a few seconds.</li> <li>• On the desktop, double-tap the "Analyzer" icon.</li> </ul>
-----------------------------------------------------------------------------------	-----------------------------------------------------------------------------------------------------------------------------------------------------------------------------------------------------------------------------------------

The firmware restarts and then automatically opens the "Soft Front Panel", i.e. the user interface on which all front panel controls and the rotary knob are mapped to buttons.

8. To deactivate or activate the "Soft Front Panel", press the [F6] key.  
After the connection is established, the R&S ESRP screen is displayed in the "Remote Desktop" application window.

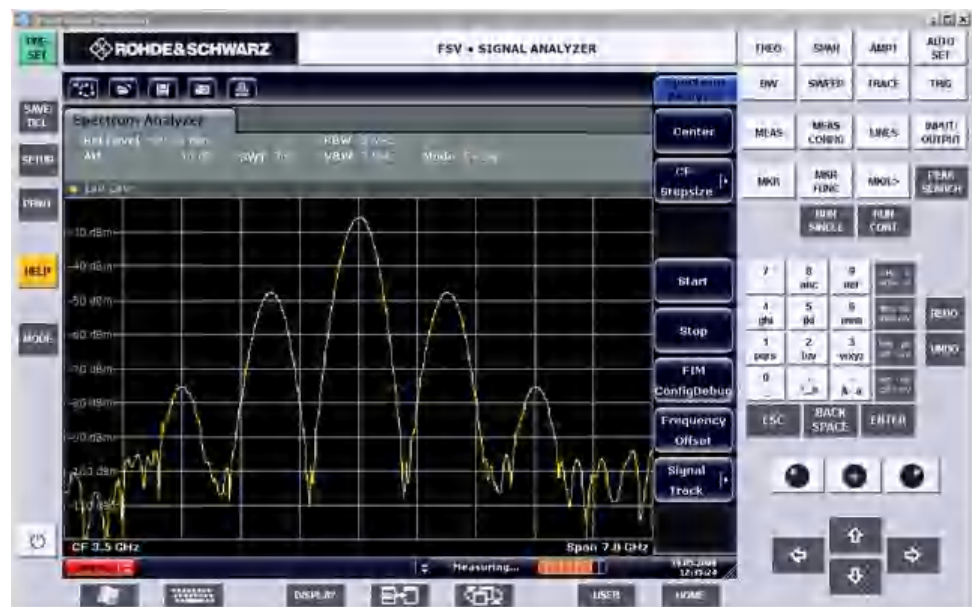

You can operate all keys and softkeys using the mouse. The rotary knob is simulated using the knob buttons.

The Windows "Start" menu can be made available by expanding the "Remote Desktop" window to full size.

During the connection with the controller, the login entry is displayed on the R&S ESRP screen.

### Terminating Remote Desktop control

The connection can be terminated by the controller or by a user at the R&S ESRP:

- ▶ • On the controller, close the "Remote Desktop" window.  
The connection to the R&S ESRP is terminated (any time is possible).

- On the R&S ESRP, a user logs on.  
The connection to the controller is terminated as a result. A message is displayed on the controller display indicating that another user has assumed control of the instrument.

### Restoring the connection to the R&S ESRP

Follow the instructions above for setting up a connection to the R&S ESRP. If the connection is terminated and then restored, the R&S ESRP remains in the same state.

#### 11.2.1.4 Deactivating the R&S ESRP via Remote Operation

1. Click the R&S ESRP soft front panel and close the application with the key combination [ALT] + [F4].
2. Click the desktop and press the key combination [ALT] + [F4] to shut down the R&S ESRP.  
A safety query is displayed to warn you that the instrument cannot be reactivated via remote operation and asks you whether you want to continue the shutdown process.
3. Respond to the safety query with "Yes".  
The connection with the controller is terminated and the R&S ESRP is shut down.

### 11.2.2 Operation with a VNC Client

Virtual Network Computing (VNC) allows you to control the R&S ESRP (the VNC server) from a remote computer (the VNC client), for example to monitor the instruments in a production line. The handling of a VNC system is similar to using the Windows Remote Desktop, but VNC has some advantages compared to the Remote Desktop.

- You can view the contents of the instrument display on more than one client
- VNC clients are available for many operating systems. Thus, a VNC is independent of the platform you are using.
- You can still control the instrument itself when a remote connection has been established, and see what is happening on both the instrument display and the client. With the display running, you can also change settings both on the instrument and with the client simultaneously. (Using the Remote Desktop turns off the display and viewing the display contents is only possible on the controlling computer.)
- The complete mini soft front panel is available on the client ("Alt-M" opens the mini soft front panel).

All R&S ESRP instruments support a VNC and are delivered with a version of the TightVNC software. On the client side, you can use a web browser or a VNC client to access the instrument.

### Using a web browser

If you are using a web browser (for example Microsoft Internet Explorer), enter the IP address of the instrument and the port you are using for the connection into the address bar to establish a connection (for example "192.0.2.0:5800").

The browser then opens an interface that allows you to control the instrument after you have entered the password.

The default port is 5800 and the default password is 894129, but you can change this on the VNC software that comes with the instrument if required.

Note that using a browser requires you to install Java in order to run properly.

### Using a VNC client

Alternatively, you can install a VNC client on your computer (for example a program like TightVNC) and use that to access the instrument. In that case, start the client and enter the IP address of the instrument to establish a connection.

## 11.2.3 Brief Introduction to Remote Control

The following programming examples are structured hierarchically, i.e. the later examples are based on the preceding ones. This allows you to easily assemble a well-functioning program by using the modules of the program examples. More complex examples are provided in the User Manual, chapter "Remote Control - Programming Examples"

### 11.2.3.1 Basic Steps in Remote Control Programming

The following examples explain how to program the instrument and can be used as a basis for solving enhanced programming tasks.

Visual Basic was used as the programming language. However, the programs can be implemented in other languages as well.



#### Using backslashes

In programming languages such as C, C++ or programs such as MATLAB or NI Interactive Control, a backslash starts an escape sequence (e.g. "\n" is used to start a new line). In these programming languages and programs, two backslashes instead of one must be used in remote commands, e.g. in ["Storing Instrument Settings"](#) on page 588

```
instead of MMEM:STOR:STAT 1, 'C:\USER\DATA\TEST1 '  
use MMEM:STOR:STAT 1, 'C:\\USER\\DATA\\TEST1 '
```

## Linking the Remote Control Library for Visual Basic

### Programming notes:

- **Outputting text using the print function**

Using the print method, this example displays the value of the variable `MyVar` in the "Immediate" window of the Visual Basic development environment. Note that the print method only applies to objects that can display text.

```
Debug.Print MyVar
```

- **Accessing the functions of the `VISA32.DLL`**

To enable users to create Visual Basic control applications, the `VISA32.BAS` file must be added to a project so that functions of the `VISA32.DLL` can be called. In addition, the `VPPTYPE.BAS` file must be added to the project. This file contains constants and definitions for error handling, timeout values, etc.

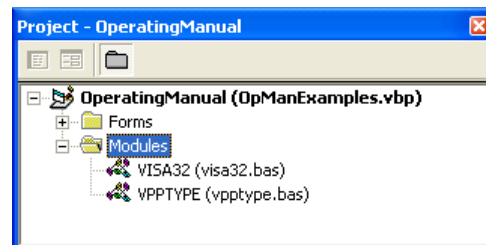

The modules `visa32.bas` and `vpptype.bas` can be found under

`<VXIpnPath>\WinNT\include` (typically `C:\VXIpnPath\WinNT\include`).

As an alternative, a reference to the `VISA32.DLL` can be added to the project.

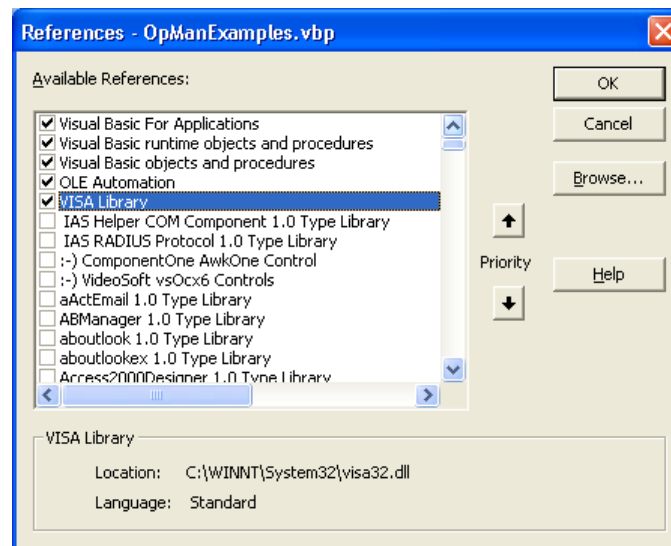

- **Creating a response buffer**

Since the DLL returns zero-terminated strings in responses, a string of sufficient length must be created before the functions `InstrRead()` and `ilrd()` are called, because Visual Basic inserts a length specification in front of the strings and this specification is not updated by the DLL. The following two means of creating the length specification for a string are provided:

```
Dim Rd as String * 100
```



```
Dim Rd as String
Rd = Space$(100)
```

- **Creating Wrapper Procedures for Writing and Reading**

Since the "VISA" functions require command and response strings and their corresponding length in two separate parameters, the main program code is easier to read and maintain if the read and write functions are encapsulated. Here, the procedure `InstrWrite()` encapsulates the function `viWrite()` and `InstrRead()` encapsulates `viRead()`. In addition, these wrappers include status checking:

```
Public Sub InstrWrite(ByVal vi As Long, ByVal Cmd As String)
Dim status As Long
Dim retCount As Long
    'Send command to instrument and check for status
status = viWrite(vi, Cmd, Len(Cmd), retCount)
    'Check for errors - this will raise an error if status is not VI_SUCCESS
CALL CheckError(vi, status)
End Sub

Public Sub InstrRead(ByVal vi As Long, Response As String, _
    ByVal count As Long, retCount As Long)
Dim status As Long
'Initialize response string
Response = Space(count)
    '...and read
status = viRead(vi, Response, count, retCount)
    'Check for errors - this will raise an error if status is not VI_SUCCESS
CALL CheckError(vi, status)
    'adjust string length
Response = Left(Response, retCount)
End Sub
```

The following function illustrates status/error checking. The procedure raises an exception when a VISA error occurs:

```
Public Sub CheckError(ByVal vi As Long, status As Long)
Dim ErrorMessage As String * 1024

'Initialize error message string
ErrorMessage = ""
If (status < 0) Then
    'Query the error message from VISA
If (viStatusDesc(vi, status, ErrorMessage) = VI_SUCCESS) Then
    Err.Description = ErrorMessage
End If
    Err.Raise (status)
End If
End Sub
```

## Initialization and Default State

At the start of each program, the global variables used by all subroutines must be created. The remote control and the instrument settings will then be changed to a defined default state. The two subroutines `InitController` and `InitDevice` are used for this.

## Creating Global Variables

In Visual Basic, global variables are stored in modules (data extension `.BAS`). Thus, at least one module (e.g. `GLOBALS.BAS`) must be created that contains the variables used by all subroutines, e.g. the variables for device addresses used by the remote control driver.

For all example programs shown below, the file must contain the following instructions:

```
Global analyzer As Long
Global defaultRM As Long
```

## Initializing the Remote Control Session

```
REM ----- Initializing the remote control session -----
Public SUB Initialize()
    Dim status As Long
    'CALL viOpenDefaultRM to get the resource manager handle
    'Store this handle in defaultRM. The function viStatusDesc
    'returns a text description of the status code returned by viOpenDefaultRM
    status = viOpenDefaultRM(defaultRM)
    status = viStatusDesc(defaultRM, status, Response)
    'Open the connection to the device and store the handle
    'Note: The timeout value in viOpen() applies only for opening the interface
    'For setting the communication timeout, set the VI_ATTR_TMO_VALUE attribute
    'timeout values are in milliseconds
    'This example assumes the instrument IP address 10.0.0.10
    'If the network provides a name resolution mechanism, the hostname of
    'the instrument can be used instead of the numeric IP address
    'the resource string for GPIB would be "GPIB::20::INSTR"
    status = viOpen(defaultRM, "TCPIP::10.0.0.10::INSTR", 0, 1000, analyzer)
    'status = viOpen(defaultRM, "TCPIP::<hostname>::INSTR", 0, 1000, analyzer)
    'status = viOpen(defaultRM, "GPIB::20::INSTR", 0, 1000, analyzer)
    'Set timeout value - here 5s
    status = viSetAttribute(vi, VI_ATTR_TMO_VALUE, 5000)
END SUB
REM *****
```

## Initializing the Instrument

Set the remote control status registers and instrument settings to the default state.

```
REM ----- Initializing the instrument -----
Public SUB InitDevice()
    CALL InstrWrite(analyzer, "*CLS")    'Reset status register
    CALL InstrWrite(analyzer, "*RST")    'Reset instrument
```

```
END SUB
REM*****
```

### Switching the Screen Display On and Off

In the default setting, all remote control commands are carried out with the screen display switched off in order to attain optimum measurement speed. During the development phase of remote control programs, however, the screen display is required in order to visually check both the programming of the settings and the measurement results.

The following examples show functions with which the screen display can be switched on or off during remote control operation.

```
REM ----- Switching on the screen display -----
Public SUB DisplayOn()
CALL InstrWrite(analyzer, "SYST:DISP:UPD ON")
    'Switch on screen display
END SUB
REM*****
REM ----- Switching off the screen display -----
Public SUB DisplayOff()
CALL InstrWrite(analyzer, "SYST:DISP:UPD OFF")
    'Switch off screen display
END SUB
REM*****
```

### Configuring the Power Save Function for the Display

During remote control operation, it is often unnecessary to display the measurement results on screen. Although the command `SYSTem:DISPlay:UPDate OFF` switches off the display of the measurement results, thus significantly improving speed in remote control operation, the display itself and the background lighting in particular remain switched on.

If you also want to switch off the display itself, you must use the power save function by setting the response time in minutes prior to activation.



The display is reactivated immediately when you press a key on the instrument's front panel.

```
Public SUB PowerSave()
CALL InstrWrite(analyzer, "DISPlay:PSAVE:HOLDoff 1")
    'Set response time to 1 minute
CALL InstrWrite(analyzer, "DISPlay:PSAVE ON")
    'Switch on Power Save function
```

### Sending Simple Instrument Setting Commands

This example shows how the center frequency, span and reference level of the instrument are set.

```

REM ----- Instrument setting commands -----
PUBLIC SUB SimpleSettings()
CALL InstrWrite(analyzer, "FREQUENCY:CENTER 128MHZ")
    'Center frequency 128 MHz
CALL InstrWrite(analyzer, "FREQUENCY:SPAN 10MHZ")
    'Set span to 10 MHz
CALL InstrWrite(analyzer, "DISPLAY:TRACE:Y:RLEVEL -10dBm")
    'Set reference level to -10dBm
END SUB
REM *****

```

### Switching to Manual Operation

```

REM ----- Switching instrument to manual operation -----
CALL viGpibControlREN(analyzer, VI_GPIB_REN_ADDRESS_GTL)
    'Set instrument to Local state
REM *****

```

### Reading Out Instrument Settings

The settings made above can now be read out. To do so, the abbreviated commands are used.

```

REM ----- Reading out instrument settings -----
PUBLIC SUB ReadSettings()
Dim retCount as Long
CFfrequency$ = SPACE$(20)    'Provide text variable (20 characters)
CALL InstrWrite(analyzer, "FREQ:CENT?")
    'Request center frequency
CALL InstrRead(analyzer, CFfrequency$, 20, retCount)
    'Read value
CR&S FSVan$ = SPACE$(20)    'Provide text variable (20 characters)
CALL InstrWrite(analyzer, "FREQ:SPAN?")
    'Request span
CALL InstrRead(analyzer, CR&S FSVan$, 20, retCount)
    'Read value
RLlevel$ = SPACE$(20)    'Provide text variable (20 characters)
CALL InstrWrite(analyzer, "DISP:TRAC:Y:RLEV?")
    'Request ref level setting
CALL InstrRead(analyzer, RLlevel$, 20, retCount)
    'Read value
REM ----- Displaying values in the Immediate window -----
Debug.Print "Center frequency: "; CFfrequency$,
Debug.Print "Span:           "; CR&S FSVan$,
Debug.Print "Reference level: "; RLlevel$,
END SUB
REM *****

```

### Marker Positioning and Readout

```

REM ----- Example of marker function -----
PUBLIC SUB ReadMarker()

```

```

Dim retCount as Long
CALL InstrWrite(analyzer, "CALC:MARKER ON;MARKER:MAX")
    'Activate marker 1 and search for peak
MKmark$ = SPACE$(30)    'Provide text variable (30 characters)
CALL InstrWrite(analyzer, "CALC:MARK:X?;Y?")
    'Query frequency and level
CALL InstrRead(analyzer, MKmark$, 30, retCount)
    'Read value
REM ----- Displaying values in the Immediate window -----
Debug.Print "Marker frequency/level "; MKmark$,
END SUB
REM *****

```

### Command Synchronization

The synchronization methods used in the following example are described in the Operating Manual, chapter "Remote Control - Basics", section "Command Sequence and Command Synchronization".

```

REM ----- Commands for command synchronization -----
PUBLIC SUB SweepSync()
Dim retCount as Long
Dim SRQWaitTimeout As Long
Dim eventType As Long
Dim eventVi As Long
REM The command INITiate[:IMMediate] starts a single sweep if the
REM command INIT:CONT OFF has already been sent. The next command
REM must not be carried out until a full sweep has been completed.
CALL InstrWrite(analyzer, "INIT:CONT OFF")
REM ----- First method: Using *WAI -----
CALL InstrWrite(analyzer, "ABOR;INIT:IMM; *WAI")
REM ----- Second method: Using *OPC? -----
OpcOk$ = SPACE$(2)    'Provide space for *OPC? response
CALL InstrWrite(analyzer, "ABOR;INIT:IMM; *OPC?")
REM ----- In this case, the controller can use other instruments -----
CALL InstrRead(analyzer, OpcOk$, 2, retCount)
    'Wait for "1" from *OPC?
REM ----- Third method: Using *OPC -----
REM In order for the Service Request function to be used with a GPIB
REM driver from National Instruments, the setting "Disable
REM Auto Serial Poll" must be set to "yes" with IBCONF!
CALL InstrWrite(analyzer, "*SRE 32")    'Enable Service Request for ESR
CALL InstrWrite(analyzer, "*ESE 1")    'Set event enable bit for operation
    'complete bit
CALL viEnableEvent(vi, VI_EVENT_SERVICE_REQ, VI_QUEUE, 0)
    'Enable the event for service request
CALL InstrWrite(analyzer, "ABOR;INIT:IMM; *OPC")
    'Start sweep with Synchronization to OPC
SRQWaitTimeout = 5000    'Allow 5s for sweep completion
    'Now wait for the service request
CALL viWaitOnEvent(vi, VI_EVENT_SERVICE_REQ, SRQWaitTimeout, _

```

```

        eventType, eventVi)
CALL viClose(eventVi)      'Close the context before continuing
CALL viDisableEvent(vi, VI_EVENT_SERVICE_REQ, VI_QUEUE)
        'Disable subsequent events
REM Resume main program here.
END SUB
REM *****

```

### Reading Output Buffers

```

REM ----- Subroutine for the individual STB bits -----
Public SUB Outputqueue()  'Reading the output queue
Dim retCount as Long
result$ = SPACE$(100)    'Create space for response
CALL InstrRead(analyzer, result$, 100, retCount)
Debug.Print "Contents of Output Queue : "; result$
END SUB
REM *****

```

### Reading Error Messages

```

REM ----- Subroutine for evaluating the error queue -----
Public SUB ErrorQueueHandler()
Dim retCount as Long
ERROR$ = SPACE$(100)    Subroutine for evaluating the error queue
CALL InstrWrite(analyzer, "SYSTEM:ERROR?")
CALL InstrRead(analyzer, ERROR$, 100, retCount)
Debug.Print "Error Description : "; ERROR$
END SUB
REM *****

```

## 11.2.3.2 Detailed Programming Examples

In the following sections, typical programming examples for setting measurement parameters and functions, general settings, printout and data management are provided.

### Default Setting of the R&S ESRP

The following settings provide typical examples of how to change the default setting of the R&S ESRP.

Note that only some of the settings are necessary depending on the application example. In many cases, it is not necessary to set resolution bandwidth, video bandwidth and sweep time since these parameters are automatically calculated in the default setting when the span is changed. Likewise, the input attenuation is automatically calculated in the default setting as a function of the reference level. Last of all, the level detectors are linked to the selected trace mode in the default setting.

The settings automatically calculated in the default setting are indicated with an asterisk (\*) in the following program example.

## Setting the Remote Control Status Registers

```

REM *****
Public Sub SetupStatusReg()

'----- IEEE 488.2 status register -----
CALL InstrWrite(analyzer,"*CLS")      'Reset status registers
CALL InstrWrite(analyzer,"*SRE 168")  'Enable Service Request for
    'STAT:OPER-,STAT:QUES- and ESR-Register
CALL InstrWrite(analyzer,"*ESE 61")  'Set event enable bit for:
    'operation complete 'command-, execution-,
    'device dependent- and query error
'----- SCPI status register -----
CALL InstrWrite(analyzer,"STAT:OPER:ENAB 0")
    'Disable OPERation Status reg
CALL InstrWrite(analyzer,"STAT:QUES:ENAB 0")
    'Disable questionable Statusreg
End Sub
REM *****

```

## Default Settings for Measurements

```

REM *****
Public Sub SetupInstrument()

'----- Default setting f the R&S FSV -----
CALL SetupStatusReg      'Configure status registers
CALL InstrWrite(analyzer,"*RST")  'Reset instrument
CALL InstrWrite(analyzer,"SYST:DISP:UPD ON")
    'ON: screen display on
    'OFF: off (improved performance)
CALL InstrWrite(analyzer,"INIT:CONT OFF")
    'Single sweep mode
'----- Frequency setting -----
CALL InstrWrite(analyzer,"FREQUENCY:CENTER 100MHz")
    'Center frequency
CALL InstrWrite(analyzer,"FREQ:SPAN 1 MHz")
    'Span
'----- Level setting -----
CALL InstrWrite(analyzer,"DISP:WIND:TRAC:Y:RLEV -20dBm")
    'Reference level
CALL InstrWrite(analyzer,"INP:ATT 10dB")
    'Input attenuation (*)
'----- Level scaling -----
CALL InstrWrite(analyzer,"DISP:WIND:TRAC:Y:SPAC LOG")
    'Log level axis
CALL InstrWrite(analyzer,"DISP:WIND:TRAC:Y:SCAL 100dB")
    'Level range
CALL InstrWrite(analyzer,"DISP:WIND:TRAC:Y:SCAL:MODE ABS")
    'Absolute scaling
CALL InstrWrite(analyzer,"CALC:UNIT:POW DBM")

```

```

'y meas. unit
'----- Trace and detector setting -----
CALL InstrWrite(analyzer,"DISP:TRAC1:MODE AVER")
'Trace1 average
CALL InstrWrite(analyzer,"AVER:TYPE VID")
'Average mode video; "LIN" for linear
CALL InstrWrite(analyzer,"SWE:COUN 10")
'Sweep count
CALL InstrWrite(analyzer,"DISP:TRAC2 OFF")
'Trace2 blank
CALL InstrWrite(analyzer,"DISP:TRAC3 OFF")
'Trace3 blank
CALL InstrWrite(analyzer,"DISP:TRAC4 OFF")
'Trace4 blank
CALL InstrWrite(analyzer,"DISP:TRAC5 OFF")
'Trace5 blank
CALL InstrWrite(analyzer,"DISP:TRAC6 OFF")
'Trace6 blank
CALL InstrWrite(analyzer,"CALC:MATH:STAT OFF")
'Trace difference off
CALL InstrWrite(analyzer,"DET1 RMS")
'Detector Trace1  (*)
CALL InstrWrite(analyzer,"DET2:AUTO ON")
'Detector Trace2  (*)
CALL InstrWrite(analyzer,"DET3:AUTO ON")
'Detector Trace3  (*)
CALL InstrWrite(analyzer,"DET4:AUTO ON")
'Detector Trace4  (*)
CALL InstrWrite(analyzer,"DET5:AUTO ON")
'Detector Trace5  (*)
CALL InstrWrite(analyzer,"DET6:AUTO ON")
'Detector Trace6  (*)
'----- Bandwidths and sweep time -----
CALL InstrWrite(analyzer,"BAND:RES 100KHz")
'Resolution bandwidth (*)
CALL InstrWrite(analyzer,"BAND:VID 1MHz")
'Video bandwidth (*)
CALL InstrWrite(analyzer,"SWE:TIME 100ms")
'Sweep time (*)
END SUB

```

### Using Markers and Delta Markers

The markers are used for marking points on traces, reading out measurement results and for selecting a display area quickly.

### Marker Search Functions, Restricting the Search Range

The following example is based on an AM-modulated signal at 100 MHz that has the following characteristics:



<b>Carrier signal level</b>	-30 dBm
<b>AF frequency</b>	100 kHz
<b>Modulation depth</b>	50 %

Marker 1 and then delta marker 2 are set to the largest maximum points on the trace. The frequency and level are then read. In the following measurements, the instrument's default setting can be used for measurements (SetupInstrument).

```

REM *****
Public Sub MarkerSearch()
Dim retCount as Long
result$ = Space$(100)
CALL SetupInstrument 'Default Setting
'----- Peak search without search range limits-----
CALL InstrWrite(analyzer,"INIT:CONT OFF")
'Switch to single sweep
CALL InstrWrite(analyzer,"CALC:MARK:PEXC 6DB")
'Define peak excursion
CALL InstrWrite(analyzer,"CALC:MARK:STAT ON")
'Enable marker 1
CALL InstrWrite(analyzer,"CALC:MARK:TRAC 1")
'Set marker 1 to trace 1
CALL InstrWrite(analyzer,"INIT;*WAI") 'Perform sweep with sync
CALL InstrWrite(analyzer,"CALC:MARK:MAX;X?;Y?")
'Marker to peak; read frequency and level
CALL InstrRead(analyzer, result$, 100, retCount)
Debug.Print "Marker 1: ";result$
CALL InstrWrite(analyzer,"CALC:DELT2:STAT ON;MAX;MAX:LEFT")
'Activate delta marker 2,
'set to peak and then to next peak left
CALL InstrWrite(analyzer,"CALC:DELT2:X?;Y?")
'Read delta marker 2 frequency and level
result$ = Space$(100)
CALL InstrRead(analyzer, result$, 100, retCount)
Debug.Print "Delta 2: ";result$
'----- Peak search with search range limit in x direction -----
CALL InstrWrite(analyzer,"CALC:MARK:X:SLIM:STAT ON;LEFT _
0Hz;RIGHT 100.05MHz")
'Activate search limit,
'set at right below AF
CALL InstrWrite(analyzer,"CALC:DELT3:STAT ON;MAX;MAX:RIGHT")
'Activate delta marker 3,
'set to peak and then to next peak right
CALL InstrWrite(analyzer,"CALC:DELT3:X:REL?;:CALC:DELT3:Y?")
'Read delta marker 3 frequency and level;
'both must have a value of 0
result$ = Space$(100)
CALL InstrRead(analyzer, result$, 100, retCount)
Print "Delta 3: ";result$

```

```

'----- Peak search with search range limit in y direction -----
CALL InstrWrite(analyzer,"CALC:THR:STAT ON")
CALL InstrWrite(analyzer,"CALC:THR -35DBM")
'Activate threshold and set it above the AF
CALL InstrWrite(analyzer,"CALC:DELT3:STAT ON;MAX;MAX:NEXT")
'Activate delta marker 3,
'set to peak and then to next peak
'=> is not found
CALL InstrWrite(analyzer,"CALC:DELT3:X:REL?;:CALC:DELT3:Y?")
'Query and read delta marker 3
'frequency and level;
'both must have a value of 0
result$ = Space$(100)
CALL InstrRead(analyzer, result$, 100, retCount)
Debug.Print "Delta 3: ";result$
'---- Setting center frequency and reference level with markers -----
CALL InstrWrite(analyzer,"CALC:MARK2:FUNC:CENT")
'Delta marker 2 -> marker and
'center frequency = marker 2
CALL InstrWrite(analyzer,"CALC:MARK2:FUNC:REF")
'Ref level = marker 2
CALL InstrWrite(analyzer,"INIT;*WAI") 'Sweep with sync
END SUB
REM *****

```

## Frequency Counting

The following example is based on a signal at 100 MHz with a level of -30 dBm. Again, the instrument's default setting can be used (SetupInstrument). The purpose of frequency counting is to determine the exact frequency of the signal at 100 MHz.

```

REM *****
Public Sub MarkerCount()
Dim retCount as Long
CALL SetupInstrument 'Default setting
'----- Defining signal frequency with frequency counter -----
CALL InstrWrite(analyzer,"INIT:CONT OFF")
'Switch to single sweep
CALL InstrWrite(analyzer,"CALC:MARK:PEXC 6DB")
'Define peak excursion
CALL InstrWrite(analyzer,"CALC:MARK:STAT ON")
'Activate marker 1
CALL InstrWrite(analyzer,"CALC:MARK:TRAC 1")
'Set marker 1 to trace 1
CALL InstrWrite(analyzer,"CALC:MARK:X 100MHz")
'Set marker 1 to 100 MHz
CALL InstrWrite(analyzer,"CALC:MARK:COUNT ON")
'Activate frequency counter
CALL InstrWrite(analyzer,"INIT;*WAI") 'Perform sweep with sync
CALL InstrWrite(analyzer,"CALC:MARK:COUNT:FREQ?")
'Query and read measured frequency

```

```

result$ = Space$(100)
CALL InstrRead(analyzer, result$, 100, retCount)
Debug.Print "Marker Count Freq: ";result$
END SUB
REM *****

```

### Working with a Fixed Reference Point

The following example is based on a signal at 100 MHz with a level of -20 dBm. Thus, the harmonics of the signal are located at 200 MHz, 300 MHz, etc. For high-quality signal sources, these harmonics may be located outside the dynamic range of the R&S ESRP. Nevertheless, to measure the harmonic suppression, the level setting must be changed to higher sensitivity when measuring the harmonics. In this case, it may be necessary to suppress the carrier by using a notch filter in order to prevent the RF input of the R&S ESRP from being overloaded.

Thus, two measurements with different level settings are performed in the following example. First, a high reference level is used on the carrier frequency, and then a low reference level is used on the frequency of the third harmonic.

The default setting of the R&S ESRP for measurements ("SetupInstrument") is also used as a starting point here, after which adaptations for the measurement are carried out.

```

REM *****
Public Sub RefFixed()
Dim retCount as Long
CALL SetupInstrument 'Default setting
'----- Measuring the reference point -----
CALL InstrWrite(analyzer,"INIT:CONT OFF")
'Switch to single sweep
CALL InstrWrite(analyzer,"CALC:MARK:PEXC 6DB")
'Define peak excursion
CALL InstrWrite(analyzer,"CALC:MARK:STAT ON")
'Activate marker 1
CALL InstrWrite(analyzer,"CALC:MARK:TRAC 1")
'Set marker 1 to trace 1
CALL InstrWrite(analyzer,"INIT;*WAI") 'Perform sweep with sync
CALL InstrWrite(analyzer,"CALC:MARK:MAX")
'Set marker 1 to 100 MHz
CALL InstrWrite(analyzer,"CALC:DELT:FUNC:FIX ON")
'Define reference point
'----- Setting frequency, level and bandwidth for measuring harmonics -----
CALL InstrWrite(analyzer,"FREQ:CENT 400MHz;Span 1MHz")
'Set freq of 3rd harmonic
CALL InstrWrite(analyzer,"BAND:RES 1kHz")
'Set suitable RBW
CALL InstrWrite(analyzer,"SWEEP:TIME:AUTO ON")
'Couple sweep time
CALL InstrWrite(analyzer,"INP:ATT:AUTO ON")
'Select more sensitive level setting
CALL InstrWrite(analyzer,"DISP:WIND:TRAC:Y:RLEV -50dBm")

```

```

CALL InstrWrite(analyzer,"INIT;*WAI")      'Perform sweep with sync
CALL InstrWrite(analyzer,"CALC:DELT:MAX;X:REL?;Y?")
      'Read delta marker
result$ = Space$(100)
CALL InstrRead(analyzer, result$, 100, retCount)
      'Read frequency and level
Debug.Print "Deltamarker 1: "; result$
END SUB
REM *****

```

### Measuring Noise and Phase Noise

When phase noise is measured, the noise power related to a bandwidth of 1 Hz is set in relation to the power of an adjacent carrier signal. A commonly used offset between the measured frequency and the carrier frequency is 10 kHz.

When noise is measured, the measured absolute level is related to a bandwidth of 1 Hz.

The following example is also based on a signal at 100 MHz with a level of -30 dBm. Two markers are used to determine both the noise and the phase noise at a 10 kHz offset from the carrier signal.

```

REM *****
Public Sub Noise()
Dim retCount as Long
'----- Default setting of the R&S FSV -----
CALL SetupStatusReg      'Configure status register
CALL InstrWrite(analyzer,"*RST")      'Reset instrument
CALL InstrWrite(analyzer,"INIT:CONT OFF")
      'Single sweep mode
'----- Setting the frequency -----
CALL InstrWrite(analyzer,"FREQUENCY:CENTER 100MHz")
      'Center frequency
CALL InstrWrite(analyzer,"FREQ:SPAN 100 kHz")
      'Span
'----- Setting the level -----
CALL InstrWrite(analyzer,"DISP:WIND:TRAC:Y:RLEV -20dBm")
      'Reference level
CALL InstrWrite(analyzer,"INIT;*WAI")      'Perform sweep with sync
'----- Setting the reference point -----
CALL InstrWrite(analyzer,"CALC:MARK:PEXC 6DB")
      'Define peak excursion
CALL InstrWrite(analyzer,"CALC:MARK:STAT ON")
      'Activate marker 1
CALL InstrWrite(analyzer,"CALC:MARK:TRAC 1")
      'Set marker 1 to trace 1
CALL InstrWrite(analyzer,"CALC:MARK:MAX")
      'Set marker 1 to 100 MHz
CALL InstrWrite(analyzer,"CALC:DELT:FUNC:PNO ON")
      'Define reference point for phase noise
'----- Measuring the phase noise -----

```

```

CALL InstrWrite(analyzer,"CALC:DELT:X 10kHz")
    'Position delta marker
CALL InstrWrite(analyzer,"CALC:DELT:FUNC:PNO:RES?")
    'Query and output phase noise result
result$ = Space$(100)
CALL InstrRead(analyzer, result$, 100, retCount)
Debug.Print "Phase Noise [dBc/Hz]: "; result$
'----- Measuring the noise -----
CALL InstrWrite(analyzer,"CALC:MARK:X 99.96MHz")
    'Position marker 1
CALL InstrWrite(analyzer,"CALC:MARK:FUNC:NOIS:RES?")
    'Query and output result
result$ = Space$(100)
CALL InstrRead(analyzer, result$, 100, retCount)
Print "Noise [dBm/Hz]: "; result$
END SUB
REM *****

```

### Reading Out Trace Data

In the following example, the trace data obtained with the default setting is read from the instrument and displayed in a list on the screen. Readout occurs first in binary format and then in ASCII format, once with the span > 0 and once with the span = 0.

In binary format, the header of the message with the length specification is evaluated and used to calculate the x-axis values.

In ASCII format, merely the list of level values is output.

Binary data is read out in three steps:

1. The number of digits in the length specification is read out.
2. The length specification itself is read out.
3. The trace data itself is read out.

The procedure is required for programming languages that only support structures with data types of the same type (arrays, such as with Visual Basic), because the data types of the header and data sections are different in binary data.

The "VISA" library provides only a mechanism for reading into string buffers. In order to convert the data into an array of single precision values, the string contents must be copied into a buffer of that type. The following example uses an operating system function for the copy operation. The function declaration must be added to a module (.bas) as follows:



#### Array dimensions

The arrays for the measured data are dimensioned so they provide sufficient space for trace data of the R&S ESRP (691 measurement points).

```

REM *****
Public Sub ReadTrace()
'----- Creating variables -----
Dim traceData(1400) As Single      'Buffer for floating point binary data
Dim digits As Byte                'Number of characters in
    'length specification
Dim traceBytes As Integer         'Len. of trace data in bytes
Dim traceValues As Integer       'No. of meas. values in buff.
Dim BinBuffer as String * 5600   'String buffer for binary data
Dim retCount as Long
asciiResult$ = Space$(28000)     'Buffer for ASCII trace data
result$ = Space$(100)           'Buffer for simple results
startFreq$ = Space$(100)       'Buffer for start frequency
span$ = Space$(100)            'Buffer for span
'----- Default setting of the R&S FSV -----
CALL SetupInstrument             'Default setting
CALL InstrWrite(analyzer,"INIT:CONT OFF")
    'Switch to single sweep
CALL InstrWrite(analyzer,"INIT;*WAI")    'Perform sweep with sync
'----- Defining the frequency range for output -----
CALL InstrWrite(analyzer,"FREQ:START?")  'Read start frequency
CALL InstrRead(analyzer,startFreq$, 100, retCount)
startFreq = Val(startFreq$)
CALL InstrWrite(analyzer,"FREQ:SPAN?")    'Read span
CALL InstrRead(analyzer,span$, 100, retCount)
span = Val(span$)
'----- Reading out in binary format -----
CALL InstrWrite(analyzer, "FORMAT REAL,32")
    'Set binary format
CALL InstrWrite(analyzer, "TRAC1? TRACE1")
    'Read trace 1
CALL InstrRead(analyzer, result$, 2, retCount)
    'Read and store length
digits = Val(Mid$(result$, 2, 1))        'spec. for number of characters
result$ = Space$(100)                    'Reinitialize buffer
CALL InstrRead(analyzer, result$, digits, retCount)
    'Read and store length
traceBytes = Val(Left$(result$, digits))
    'specification
CALL InstrRead(analyzer, BinBuffer, traceBytes, retCount)
    'Read trace data into buffer
CopyMemory traceData(0), ByVal BinBuffer, traceBytes
    'Copy data into float array
'----- Outputting binary data as frequency/level pairs -----
traceValues = traceBytes/4              'Single precision = 4 bytes
stepsize = span/traceValues            'Calculate frequency step size
For i = 0 To traceValues - 1
Debug.Print "Value["; i; "] = "; startFreq+stepsize*i; ", "; traceData(i)
Next i
'----- Default setting of zero span -----

```

```

CALL InstrWrite(analyzer,"FREQ:SPAN 0Hz")
    'Switch to zero span
CALL InstrWrite(analyzer,"INIT;*WAI")      'Perform sweep with sync
'----- Reading out in ASCII format -----
CALL InstrWrite(analyzer,"FORMAT ASCII")
    'Set ASCII format
CALL InstrWrite(analyzer,"TRAC1? TRACE1")
    'Read and output
CALL InstrRead(analyzer, asciiResult$)
Print "Contents of Trace1: ",asciiResult$   'trace 1
END SUB
REM *****

```

### Storing and Loading Instrument Settings

Settings and measured data can be stored and loaded. You can define which data set is loaded when the instrument is preset or started.

#### Storing Instrument Settings

In the following example, the settings/measured data to be stored are defined initially, in which case only the hardware settings are stored. However, the selection commands for the other settings are specified with the state "OFF" for the sake of completeness.

```

REM *****
Public Sub StoreSettings()
'This subroutine selects the settings to be stored and creates the
'data record "TEST1" in the directory C:\R_S\Instr\user. It uses the default
'setting and resets the instrument after the setting is stored.
'----- Default settings of the R&S FSV -----
CALL SetupInstrument
CALL InstrWrite(analyzer,"INIT:CONT OFF")
    'Change to single sweep
CALL InstrWrite(analyzer,"INIT;*WAI")      'Perform sweep with sync
'----- Selection of settings to be stored -----
CALL InstrWrite(analyzer,"MMEM:SEL:HWS ON")
    'Store hardware settings
CALL InstrWrite(analyzer,"MMEM:SEL:TRAC OFF")
    'Do not store any traces
CALL InstrWrite(analyzer,"MMEM:SEL:LIN:ALL OFF")
    'Store only the activated limit lines
'----- Storing on the instrument -----
CALL InstrWrite(analyzer,"MMEM:STOR:STAT 1,'C:\R_S\Instr\user\TEST1'")
'----- Resetting the instrument -----
CALL InstrWrite(analyzer,"*RST")
END SUB
REM *****

```

#### Loading Instrument Settings

In the following example, the TEST1 data record stored under C:\R\_S\Instr\user is loaded by the instrument:

```

REM *****
Public Sub LoadSettings()
'This subroutine loads the TEST1 data record in the directory
'C:\R_S\Instr\user.
'----- Default setting of the status register -----
CALL SetupStatusReg      'Configure status register
'----- Loading the data record -----
CALL InstrWrite(analyzer,"MMEM:LOAD:STAT 1,'C:\R_S\Instr\user\TEST1'")
'----- Perform measurement using loaded data record -----
CALL InstrWrite(analyzer,"DISP:TRAC1:MODE WRIT")
      'Set trace to Clr/Write
CALL InstrWrite(analyzer,"INIT;*WAI")      'Start sweep
END SUB
REM *****

```

### Setting the Data Record for Startup Recall

In the following example, the first step is to change the R&S ESRP to the default state. In the next step, the TEST1 data record stored under C:\R\_S\Instr\user is selected for the startup recall function, i.e. the data record is then set after each \*RST, presetting and each time the instrument is started. For demonstration purposes, the command \*RST is carried out again.

```

REM *****
Public Sub StartupRecallSettings()
'----- Resetting the R&S FSV -----
CALL InstrWrite(analyzer,"*RST")
'----- Default setting of the status register -----
CALL SetupStatusReg      'Configure status register
'----- Selecting the startup recall data record -----
CALL InstrWrite(analyzer,"MMEM:LOAD:AUTO 1,'C:\R_S\Instr\user\TEST1'")
'----- Activating the startup recall data record -----
CALL InstrWrite(analyzer,"*RST")
END SUB
REM *****

```

### Configuring and Starting a Printout

The following example shows how to configure the output format and output device for printing out a measurement screen. The procedure is as follows:

1. Set the measurement you want for the printout.
2. Check which output devices are available on the instrument.
3. Select an output device.
4. Select the output interface.
5. Configure the output format.
6. Start the printout with synchronization to completion.



It is assumed that the desired setting is a signal at 100 MHz with a power of -20 dBm. It is also assumed that the sixth printer out of the available printers that are listed is the one you want. The printout is first output to the selected printer and then to a file.

```

REM *****
Public Sub HCopy()
Dim retCount as Long
Dim SRQWaitTimeout As Long
Dim eventType As Long
Dim eventVi As Long
Dim statusSRQ As Long
DIM Devices(100) as string      'Create buffer for printer name
FOR i = 0 TO 49
    Devices$(i) = Space$(50)    'Preallocate buffer for printer name
NEXT i
'----- Default setting of the R&S FSV -----
CALL SetupStatusReg      'Configure status register
CALL InstrWrite(analyzer,"*RST")      'Reset instrument
CALL InstrWrite(analyzer,"INIT:CONT OFF")
    'Single sweep mode
CALL InstrWrite(analyzer,"SYST:DISP:UPD ON")
    'Screen display on
'----- Measurement settings -----
CALL InstrWrite(analyzer,"FREQ:CENT 100MHz;SPAN 10MHz")
    'Frequency setting
CALL InstrWrite(analyzer,"DISP:TRAC:Y:RLEV -10dBm")
    'Reference level
CALL InstrWrite(analyzer,"INIT;*WAI")      'Perform measurement
'----- Querying the available output devices -----
CALL InstrWrite(analyzer,"SYST:COMM:PRIN:ENUM:FIRST?")
    'Read out and display first output device
CALL InstrRead(analyzer,Devices$(0), 50, retCount)
Debug.Print "Printer 0: "+Devices$(0)
For i = 1 to 99
    CALL InstrWrite(analyzer,"SYST:COMM:PRIN:ENUM:NEXT?")
        'Read out next printer name
    CALL InstrRead(analyzer,Devices$(i))
    IF Left$(Devices$(i),2) = "" THEN GOTO SelectDevice
        'Stop at end of list
    Debug.Print "Printer"+Str$(i)+"": " Devices$(i)
        'Display printer name
NEXT i
SelectDevice:
'---- Selection of output device, printer language and output interface ----
CALL InstrWrite(analyzer,"SYST:COMM:PRIN:SEL "+ Devices(6))
    'Printer selection #6
CALL InstrWrite(analyzer,"HCOP:DEST 'SYST:COMM:PRIN'")
    'Configuration: "Printout to
    'printer interface"
CALL InstrWrite(analyzer,"HCOP:DEV:LANG GDI")

```

```

        'Printers require printer language 'GDI'
'----- Selection of orientation (portrait/landscape) and colour/BW -----
CALL InstrWrite(analyzer,"HCOP:PAGE:ORI PORT")
        'Portrait orientation
CALL InstrWrite(analyzer,"HCOP:DEV:COL OFF")
        'Black-and-white printout
'----- Configuring and starting the printout -----
CALL InstrWrite(analyzer,"HCOP:ITEM:ALL")
        'All screen contents
'CALL InstrWrite(analyzer,"HCOP:ITEM:TRAC:STAT ON")
        'Alternative: only traces
CALL InstrWrite(analyzer,"*CLS")      'Reset status registers
CALL viEnableEvent(vi, VI_EVENT_SERVICE_REQ, VI_QUEUE, 0)
        'Enable the event for service request
CALL InstrWrite(analyzer,"HCOP;*OPC")
        'Start printout
SRQWaitTimeout = 5000      'Allow 5s for completion
        'Now wait for the service request
statusSRQ = viWaitOnEvent(vi, VI_EVENT_SERVICE_REQ, SRQWaitTimeout, _
        eventType, eventVi)
CALL viClose(eventVi)      'Close the context before continuing
CALL viDisableEvent(vi, VI_EVENT_SERVICE_REQ, VI_QUEUE)
        'Disable subsequent events
IF NOT(statusSRQ = 0) THEN CALL Srq      'If SRQ not detected =>
        'Subroutine for evaluation
'----- Printout in WMF format (BMP format) to file -----
CALL InstrWrite(analyzer,"HCOP:DEST 'MMEM'")
        'Configuration: "Printout to file"
CALL InstrWrite(analyzer,"HCOP:DEV:LANG WMF")
        'WMF file format
'CALL InstrWrite(analyzer,"HCOP:DEV:LANG BMP")
        'BMP file format
CALL InstrWrite(analyzer,"MMEM:NAME 'C:\R_S\Instr\user\PRINT1.WMF'")
        'Define file name
CALL InstrWrite(analyzer,"*CLS")      'Reset Status registers
CALL viEnableEvent(vi, VI_EVENT_SERVICE_REQ, VI_QUEUE, 0)
        'Enable the event for service request
CALL InstrWrite(analyzer,"HCOP:IMMediate;*OPC")
        'Start printout
SRQWaitTimeout = 5000      'Allow 5s for completion
        ' Now wait for the service request
statusSRQ = viWaitOnEvent(vi, VI_EVENT_SERVICE_REQ, SRQWaitTimeout, _
        eventType, eventVi)
CALL viClose(eventVi)      'Close the context before continuing
CALL viDisableEvent(vi, VI_EVENT_SERVICE_REQ, VI_QUEUE)
        'Disable subsequent events
IF NOT(statusSRQ = 0) THEN CALL Srq      'If SRQ not detected =>
        'Subroutine for evaluation

```

```
END SUB
REM *****
```

## 11.2.4 Configuring the GPIB Interface

A GPIB interface is integrated on the rear panel of the instrument. You can set the GPIB address and the ID response string. The GPIB language is set as SCPI by default and cannot be changed for the R&S ESRP.

### Displaying the GPIB submenu

1. Press the [SETUP] key.
2. Press the "General Setup" softkey.
3. Press the "GPIB" softkey.

The submenu for setting the parameters of the remote control interface is displayed.

### Setting the GPIB address

- ▶ In the "GPIB" menu, press the "GPIB Address" softkey.

The edit dialog box for the GPIB address is displayed. The setting range is from 0 to 30. If SCPI is selected as the GPIB language, the default address is 20.

Remote command:

```
SYST:COMM:GPIB:ADDR 20
```

### Setting the default ID response string

- ▶ In the "GPIB" menu, press the "ID String Factory" softkey to select the default response to the \*IDN? command.

### Setting a user-defined ID response string

- ▶ In the "GPIB" menu, press the "ID String User" softkey to enter a user-defined response to the \*IDN? command. The maximum length of the output string is 36 characters.

## 11.2.5 Setting Up a Network (LAN) Connection

A LAN connection is the prerequisite for all network operations. The LAN connection settings can be configured directly in the Windows operating system.

The R&S ESRP is equipped with a network interface and can be connected to an Ethernet LAN (local area network). Provided the network administrator has assigned you the appropriate rights and adapted the Windows firewall configuration, you can use the interface, for example:

- To transfer data between a controlling device and the test device, e.g. to run a remote control program.

See chapter "Remote Control".

- To access or control the measurement from a remote computer using the "Remote Desktop" application (or a similar tool)
- To connect external network devices (e.g. printers)
- To transfer data from a remote computer and back, e.g. using network folders

This section describes how to configure the LAN interface. It includes the following topics:

- [Chapter 11.2.5.1, "Connecting the Instrument to the Network"](#), on page 593
- [Chapter 11.2.5.2, "Assigning the IP Address"](#), on page 594

Note that only user accounts with administrator rights can configure LAN networks.



### LXI

The R&S ESRP supports the LXI core features. LXI gives you direct access to the LAN settings described below.

---

For further information on the LXI interface, refer to the "LXI Configuration".

#### 11.2.5.1 Connecting the Instrument to the Network

There are two methods to establish a LAN connection to the instrument:

- A non-dedicated network (Ethernet) connection from the instrument to an existing network made with an ordinary RJ-45 network cable. The instrument is assigned an IP address and can coexist with a computer and with other hosts on the same network.
- A dedicated network connection (Point-to-point connection) between the instrument and a single computer made with a (crossover) RJ-45 network cable. The computer must be equipped with a network adapter and is directly connected to the instrument. The use of hubs, switches, or gateways is not required, however, data transfer is still performed using the TCP/IP protocol. You must assign an IP address to the instrument and the computer, see [Chapter 11.2.5.2, "Assigning the IP Address"](#), on page 594.

**Note:** As the R&S ESRP uses a 1 GBit LAN, a crossover cable is not necessary (due to Auto-MDI(X) functionality).

**NOTICE****Risk of network failure**

Consult your network administrator before performing the following tasks:

- Connecting the instrument to the network
- Configuring the network
- Changing IP addresses
- Exchanging hardware

Errors can affect the entire network.

- ▶ To establish a non-dedicated network connection, connect a commercial RJ-45 cable to one of the LAN ports.  
To establish a dedicated connection, connect a (crossover) RJ-45 cable between the instrument and a single PC.

If the instrument is connected to the LAN, Windows automatically detects the network connection and activates the required drivers.

The network card can be operated with a 1 GBit Ethernet IEEE 802.3u interface.

**11.2.5.2 Assigning the IP Address**

Depending on the network capacities, the TCP/IP address information for the instrument can be obtained in different ways.

- If the network supports dynamic TCP/IP configuration using the Dynamic Host Configuration Protocol (DHCP), all address information can be assigned automatically.
- If the network does not support DHCP, or if the instrument is set to use alternate TCP/IP configuration, the addresses must be set manually.

By default, the instrument is configured to use dynamic TCP/IP configuration and obtain all address information automatically. This means that it is safe to establish a physical connection to the LAN without any previous instrument configuration.

**NOTICE****Risk of network errors**

Connection errors can affect the entire network. If your network does not support DHCP, or if you choose to disable dynamic TCP/IP configuration, you must assign valid address information before connecting the instrument to the LAN. Contact your network administrator to obtain a valid IP address.

**Assigning the IP address on the instrument**

1. Press the [SETUP] key.
2. Press the "General Setup" softkey.

3. Press the "Network Address" softkey.  
The submenu is displayed.
4. Toggle the "DHCP On/Off" softkey to the required mode.  
If DHCP is "Off", you must enter the IP address manually, as described in the following steps.  
**Note:** When DHCP is changed from "On" to "Off", the previously set IP address and subnet mask are retrieved.  
If DHCP is "On", the IP address of the DHCP server is obtained automatically. The configuration is saved, and you are prompted to restart the instrument. You can skip the remaining steps.  
**Note:** When a DHCP server is used, a new IP address may be assigned each time the instrument is restarted. This address must first be determined on the instrument itself. Thus, when using a DHCP server, it is recommended that you use the permanent computer name, which determines the address via the DNS server (see [Chapter 11.2.5.3, "Using Computer Names"](#), on page 597).
5. Press the "IP Address" softkey and enter the IP address, for example *192.0.2.0*.  
The IP address consists of four number blocks separated by dots. Every block contains a maximum of 3 numbers.
6. Press the "Subnet Mask" softkey and enter the subnet mask, for example *255.255.255.0*. The subnet mask consists of four number blocks separated by dots. Every block contains a maximum of 3 numbers.  
  
If you have entered an invalid IP address or subnet mask, the message "out of range" is displayed in the status line. The "Edit" dialog box remains open, and you can start again. If the settings are correct, the configuration is saved, and you are prompted to restart the instrument.
7. Confirm the displayed message ("Yes" button) to restart the instrument.

#### Assigning the IP address on the instrument

1. Press the [SETUP] key.
2. Press the "Network + Remote" softkey.
3. Select the "Network" tab.
4. In the "Network + Remote" dialog, toggle the "DHCP On/Off" setting to the required mode.  
If DHCP is "Off", you must enter the IP address manually, as described in the following steps.  
**Note:** When DHCP is changed from "On" to "Off", the previously set IP address and subnet mask are retrieved.  
If DHCP is "On", the IP address of the DHCP server is obtained automatically. The configuration is saved, and you are prompted to restart the instrument. You can skip the remaining steps.  
**Note:** When a DHCP server is used, a new IP address may be assigned each time the instrument is restarted. This address must first be determined on the instrument

itself. Thus, when using a DHCP server, it is recommended that you use the permanent computer name, which determines the address via the DNS server (See ["Using a DNS server to determine the IP address"](#) on page 596 and [Chapter 11.2.5.3, "Using Computer Names"](#), on page 597).

5. Enter the "IP Address", for example *192.0.2.0*. The IP address consists of four number blocks separated by dots. Every block contains a maximum of 3 numbers.
6. Enter the "Subnet Mask", for example *255.255.255.0*. The subnet mask consists of four number blocks separated by dots. Every block contains a maximum of 3 numbers.
7. Select "Configure Network".

If you have entered an invalid IP address or subnet mask, the message "out of range" is displayed in the status line. If the settings are correct, the configuration is saved, and you are prompted to restart the instrument.

8. Confirm the displayed message ("Yes" button) to restart the instrument.

### Using a DNS server to determine the IP address

If a DNS server is configured on the R&S ESRP, the server can determine the current IP address for the connection using the permanent computer name.

1. Obtain the name of your DNS domain and the IP addresses of the DNS and WINS servers on your network.
2. Press the "Windows" key on the external keyboard or the [CTRL + ESC] key combination on your keyboard to access the operating system.
3. Select "Start > Settings > Network & Internet > Ethernet > Network and Sharing Center > Connections: Ethernet".

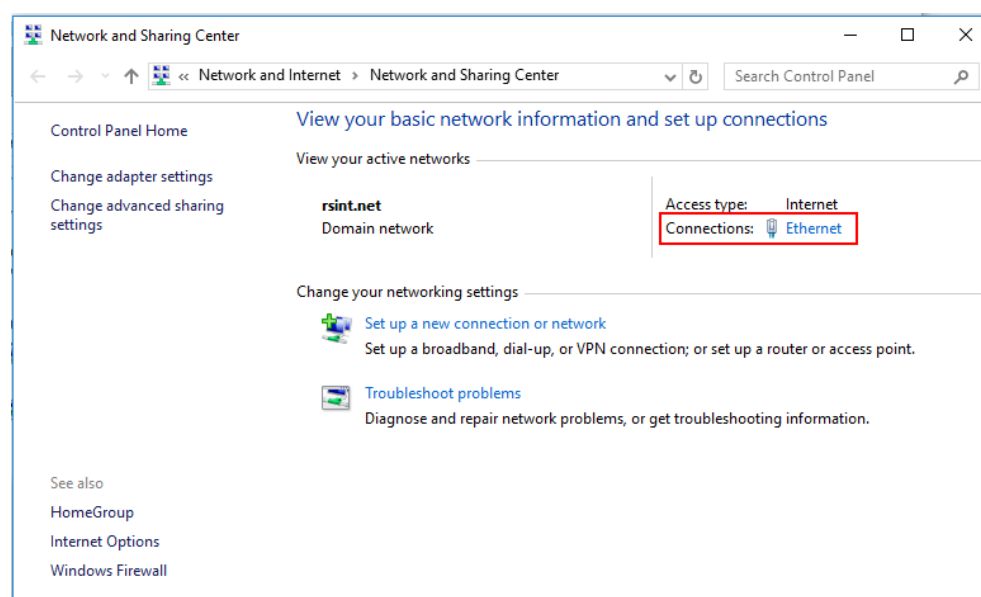

4. In the "Ethernet Status" dialog box, select the "Properties" button.

The items used by the LAN connection are displayed.

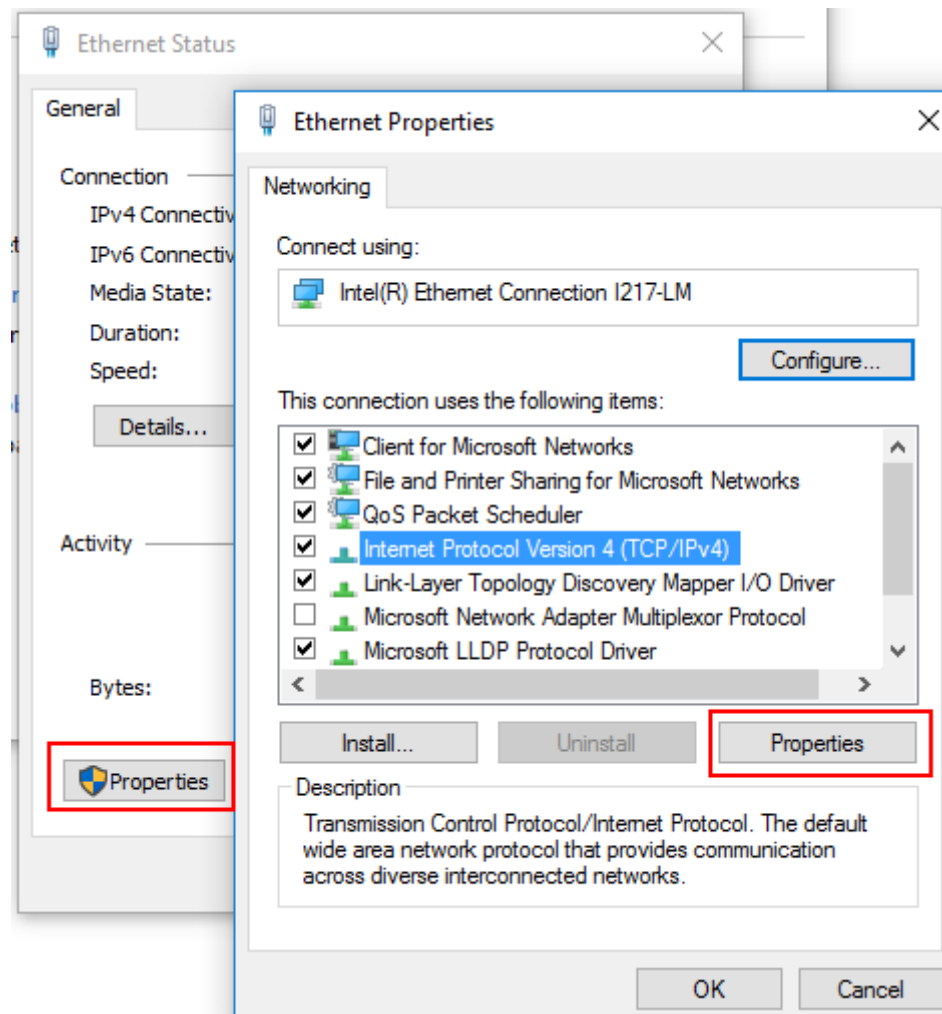

5. Tap the entry named "Internet Protocol Version 4 (TCP/IPv4)" to highlight it.
6. Select the "Properties" button.
7. On the "General" tab, select "Use the following DNS server addresses" and enter your own DNS addresses.

For more information, refer to the Windows operating system help.

### 11.2.5.3 Using Computer Names

In a LAN that uses a DNS server (Domain Name System server), each PC or instrument connected in the LAN can be accessed via an unambiguous computer name instead of the IP address. The DNS server translates the host name to the IP address. This is especially useful when a DHCP server is used, as a new IP address may be assigned each time the instrument is restarted.

Each instrument is delivered with an assigned computer name, but this name can be changed.



The default instrument name is a non-case-sensitive string with the following syntax:

<Type><variant>-<serial\_number>

The serial number can be found on the rear panel of the instrument. It is the third part of the device ID printed on the bar code sticker:



#### To change the computer name

1. Press the [Setup] key and select "General setup" > "Computer name".  
The current computer name is displayed here.
2. Enter the new computer name.
3. Confirm the entry.

#### 11.2.5.4 Changing the Windows Firewall Settings

A firewall protects an instrument by preventing unauthorized users from gaining access to it through a network. Rohde & Schwarz highly recommends the use of the firewall on your instrument. Rohde & Schwarz instruments are shipped with the Windows firewall enabled and preconfigured in such a way that all ports and connections for remote control are enabled.

For more details on firewall configuration, see the following Rohde & Schwarz White Paper:

- [1EF96: Malware Protection Windows 10](#)

Note that changing firewall settings requires administrator rights.

#### 11.2.6 How to Configure the LAN Using the LXI Web Browser Interface

The instrument's LXI browser interface works correctly with all W3C compliant browsers.

- ▶ In the web browser, open the `http://<instrument-hostname>` or `http://<instrument-ip-address>` page, e.g. `http://10.113.10.203`.

The default password to change LAN configurations is *LxiWebIfc*.

The "Instrument Home Page" (welcome page) opens.

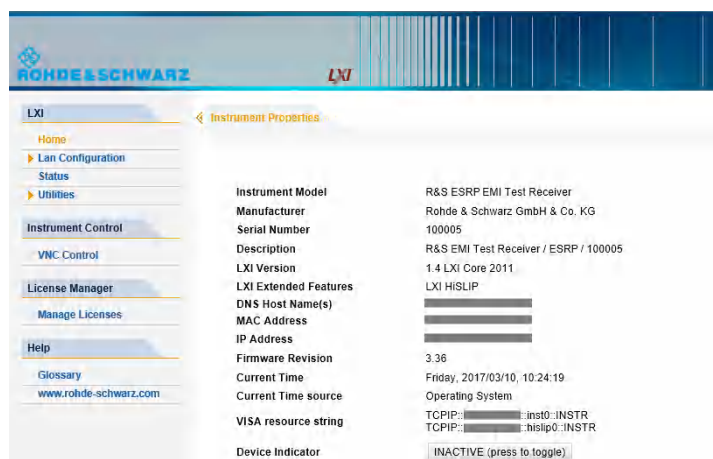

The instrument home page displays the device information required by the LXI standard including the VISA resource string in read-only format.

The most important control elements in the navigation pane of the browser interface are the following:

- "LAN Configuration" opens the menu with configuration pages.
- "Status" displays information about the LXI status of the instrument.
- "Help > Glossary" opens a document with a glossary of terms related to the LXI standard.

### 11.2.6.1 LAN Configuration

The LAN configuration consists of three parts:

- "IP configuration" provides all mandatory LAN parameters.
- "Advanced LAN Configuration" provides LAN settings that are not declared mandatory by the LXI standard.
- "Ping Client" provides the ping utility to verify the connection between the instrument and other devices.

#### IP Configuration

The "LAN Configuration > IP configuration" web page displays all mandatory LAN parameters and allows their modification.

For the manual configuration mode, the static IP address, subnet mask, and default gateway are used to configure the LAN. The automatic configuration mode uses DHCP server or Dynamic Link Local Addressing (Automatic IP) to obtain the instrument IP address.



Changing the LAN configuration is password-protected. The default password is *Lxi-WebIfc* (notice upper and lower case characters).

### Advanced LAN Configuration

The "LAN Configuration > Advanced LAN Configuration" parameters are used as follows:

- The "Negotiation" configuration field provides different Ethernet speed and duplex mode settings. In general, the "Auto Detect" mode is sufficient.
- "ICMP Ping" must be enabled to use the ping utility.
- "VXI-11" is the protocol that is used to detect the instrument in the LAN. According to the standard, LXI devices must use VXI-11 to provide a detection mechanism; other additional detection mechanisms are permitted.
- mDNS and DNS-SD are two additional protocols: Multicast DNS and DNS Service Discovery. They are used for device communication in zero configuration networks working without DNS and DHCP

### Ping Client

Ping is a utility that verifies the connection between the LXI-compliant instrument and another device. The ping command uses the ICMP echo request and echo reply packets to determine whether the LAN connection is functional. Ping is useful for diagnosing IP network or router failures. The ping utility is not password-protected.

To initiate a ping between the LXI-compliant instrument and a second connected device:

1. Enable "ICMP Ping" on the "Advanced LAN Configuration" page (enabled after an LCI).
2. Enter the IP address of the second device **without the ping command and without any further parameters** into the "Destination Address" field (e.g. *10.113.10.203*).
3. Select "Submit".

## 11.2.7 Configuring the Network

After network support has been installed, data can be exchanged between the instrument and other computers, and network printers can be used.

Network operation is only possible if you are authorized to access network resources. Typical resources are file directories of other computers or even central printers. Authorization is assigned by the network or server administrator.

**⚠ WARNING****Connection to networks**

Before connecting the instrument to the network or configuring the network, consult your network administrator, particularly for large LAN installations. Errors may affect the entire network.

Never connect your analyzer to a network unprotected against virus infection because this may cause damage to the instrument software.

To integrate the instrument into your network, you can change the following system properties:

- Computer name
- Domain
- Workgroup

Operation on the network includes the following administrative tasks:

- [Operating the Instrument Without a Network](#)..... 601
- [Creating Users](#)..... 601
- [Changing the User Password](#)..... 602
- [Mapping Network Drives](#)..... 602
- [Sharing Directories \(only with Microsoft Networks\)](#)..... 604

**11.2.7.1 Operating the Instrument Without a Network**

To operate the instrument without a network connection either temporarily or permanently, no special measures are necessary. Windows automatically detects the interruption of the network connection and does not set up the connection when the instrument is switched on.

If you are not prompted to enter the user name and password, see "[Automatic Login Function](#)" on page 55.

**11.2.7.2 Creating Users**

After the software for the network has been installed, the instrument issues an error message the next time it is switched on because there is no user named "instrument" (= user ID for Windows automatic login) in the network. Thus, a matching user must be created in Windows and in the network, the password must be adapted to the network password, and the automatic login mechanism must then be deactivated.

The network administrator is responsible for creating new users in the network.

1. Press the "Windows" key on the external keyboard or the [CTRL + ESC] key combination on your keyboard to access the operating system.
2. Select "Start > Settings > Accounts > Other users".
3. Select "Add someone else to this PC".

4. In the "Microsoft account" dialog box, enter the new user name and password.
5. Select "OK".
6. Select "Finish".  
The new user is created.

### 11.2.7.3 Changing the User Password

After the new user has been created on the instrument, the password must be adapted to the network password.

1. Press the "Windows" key on the external keyboard or the [CTRL + ESC] key combination on your keyboard to access the operating system.
2. Press [Ctrl + Alt + Delete], then select "Change a password".
3. Enter the user account name.
4. Enter the old password.
5. Enter the new password in the upper text line and repeat it in the following line.
6. Press [Enter].  
The new password is now active.



### Logging on to the Network

At the same time you log on to the operating system, you are automatically logged on to the network (see "[Automatic Login Function](#)" on page 55). As a prerequisite, the user name and the password must be identical under Windows and on the network.

### 11.2.7.4 Mapping Network Drives

1. Press the [SAVE/ RCL] key on the front panel of the R&S ESRP.
2. Press the "File Manager" softkey.
3. Press the "More" softkey.
4. Press the "Network Drive" softkey.  
The "Map Network Drive" dialog box is displayed.

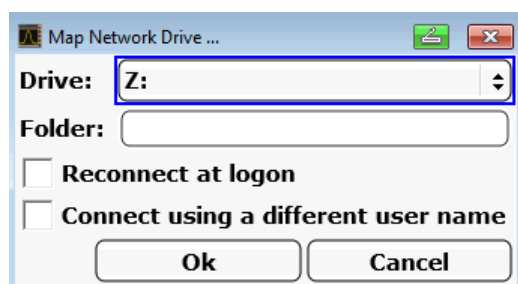

5. Press the "Drive" list to open the network drive list and select the drive you want to map.  
Alternatively:
  - Press the "Map Network Drive" softkey to set the focus on the "Drive" list.
  - Press [ENTER] to open the network drive list and select the drive you want to map using the arrow keys.
6. To have the connection set up automatically each time the instrument is started, in the "Map Network Drive" dialog box, activate the "Reconnect at logon" option.
7. To connect using a different user name, activate the "Connect using a different user name" option.  
The "Map Network Drive" dialog box is extended by the "User name" and "Password" fields.

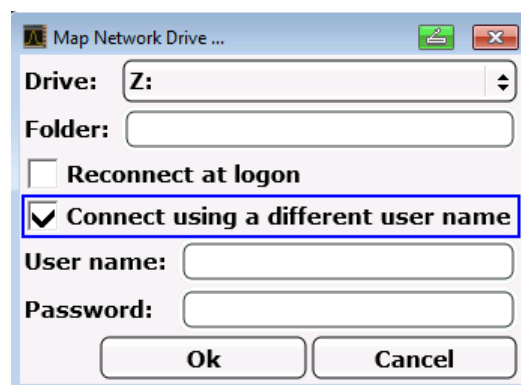

8. Enter your user name and password.
  9. Confirm with "OK".  
The drive is displayed in the Explorer.
- Note:** Only networks that you authorized to access are connected.

#### Disconnecting network drives

1. Press the [SAVE/ RCL] key on the front panel of the R&S ESRP.
2. Press the "File Manager" softkey.
3. Press the "More" softkey.
4. Press the "Network Drive" softkey.
5. Press the "Disconnect Network Drive" softkey.  
The "Disconnect Network Drive" dialog box is displayed.
6. In the "Drive" list, select the drive you want to disconnect.
7. Confirm with "OK".

### 11.2.7.5 Sharing Directories (only with Microsoft Networks)

Sharing directories makes data available for other users. This is only possible in Microsoft networks. Sharing is a property of a file or directory.

1. Press the "Windows" key on the external keyboard or the [CTRL + ESC] key combination on your keyboard to access the operating system.
2. Open the "Windows Explorer".
3. Select the desired folder with the right mouse button.
4. In the context menu, select "Share with > Specific people".
5. Select the users on your network you want to allow access to the directory to.
6. Select "Share" to confirm the settings.
7. Select "Done" to close the dialog box.  
The drive is shared and can be accessed by the selected users.

## 11.3 Selecting the Operating Mode

<a href="#">INSTrument:CREate[:NEW]</a> .....	604
<a href="#">INSTrument:DELeTe</a> .....	605
<a href="#">INSTrument[:SELeCt]</a> .....	605

---

### **INSTrument:CREate[:NEW]** <ChannelType>, <ChannelName>

This command adds an additional spectrum display. You can add up to three additional spectrum displays.

Also see

- [INSTrument\[:SELeCt\]](#) on page 605
- [INSTrument:DELeTe](#) on page 605
- Remote program example: [Chapter 11.17.16, "Usage of Four Spectrum Instances"](#), on page 1005

#### **Parameters:**

<ChannelType>	<b>SANalyzer</b> The channel type is always <code>SANalyzer</code> to add a new spectrum display.
<ChannelName>	String containing the name of the channel you want to create.

#### **Example:**

```
INST:CRE SAN, 'Spectrum 2'
```

Adds a second spectrum display.

**INSTrument:DELeTe** <ChannelName>

This command deletes a spectrum display.

Also see

- [INSTrument:CREate\[:NEW\]](#) on page 604
- Remote program example: [Chapter 11.17.16, "Usage of Four Spectrum Instances"](#), on page 1005

**Parameters:**

<ChannelName> String containing the name of the channel you want to delete.  
A channel must exist in order to be able delete it.

**Example:**

```
INST:DEL 'Spectrum 4'
```

Deletes the fourth spectrum display.

**INSTrument[:SELeCt]** <Mode> | <ChannelName>

This command activates a new measurement channel with the defined channel type, or selects an existing measurement channel with the specified name.

- [INSTrument:CREate\[:NEW\]](#) on page 604
- Remote program example: [Chapter 11.17.16, "Usage of Four Spectrum Instances"](#), on page 1005

**Parameters:**

<Mode>

**RECeiver**

Receiver mode

**SANalyzer**

Spectrum mode

**Spectrum 2 | Spectrum 3 | Spectrum 4**

Selects one of the additional spectrum displays. The first spectrum display is always active. You can select it with `SANalyzer`.  
A spectrum display must exist in order to be able to select it.

\*RST: RECeiver

## 11.4 Remote Commands in Receiver Mode

The following remote commands configure and perform EMI measurements. They are available in receiver mode only.

- [Measurements and Result Displays](#).....606
- [Defining the Frequency](#).....633
- [Configuring the Vertical Axis](#).....636
- [Selecting the Bandwidth](#).....639
- [Controlling Inputs and Outputs](#).....641
- [Test Automation](#).....641
- [Working with Markers](#).....656
- [Limit Lines](#).....672



## 11.4.1 Measurements and Result Displays

• Display Configuration.....	606
• Bargraph Control.....	606
• Scan Control.....	608
• Final Measurements and Automated Test Sequence Control.....	610
• Trace Data and Result Query.....	612
• Demodulating Analog Signals.....	616
• Spectrogram Control.....	617

### 11.4.1.1 Display Configuration

CALCulate<n>:FEED.....	606
------------------------	-----

---

#### CALCulate<n>:FEED <ResultDisplay>

This command selects the result display.

##### Suffix:

<n> 1...3  
Selects the measurement window.

##### Parameters:

<ResultDisplay> **'NONE'**  
Removes the window selected with the suffix <n>.

**'XTIM:SPECTrum'**  
Selects the IF analysis result display.

**'XTIM:BARGraph'**  
Selects the bargraph.  
Note that the Bargraph always has to be in window 1.

**'XFRequency[:SPECTrum]'**  
Selects the scan result display.

**'XFRequency:SGRam'**  
Selects the spectrogram result display.  
Note that you can add a spectrogram only if you have already turned on either Scan or IF Analysis. If you are displaying Scan and IF Analysis simultaneously, the Spectrogram is unavailable.

### 11.4.1.2 Bargraph Control

DISPlay:BARGraph:LEVel:LOWer?.....	607
DISPlay:BARGraph:LEVel:UPPer?.....	607
DISPlay:BARGraph:PHOLd[:STATe].....	607
DISPlay:BARGraph:PHOLd:RESet.....	607
DISPlay:BARGraph:TCOupling[:STATe].....	607
[SENSe:]DETEctor:RECeiver[:FUNCTion].....	608
[SENSe:]SWEep:TIME.....	608

---

**DISPlay:BARGraph:LEVel:LOWer?**

This command queries the minimum level of the bargraph.

**Example:**                   :DISP:BARG:LEV:LOW?

**Usage:**                    Query only

---

**DISPlay:BARGraph:LEVel:UPPer?**

This command queries the maximum level of the bargraph.

**Example:**                   :DISP:BARG:LEV:UPP?

**Usage:**                    Query only

---

**DISPlay:BARGraph:PHOLd[:STATe] <State>**

This command switches the indication of the maxhold value of the bar graph measurement on or off.

**Parameters:**

<State>                    **ON**  
                              **OFF**  
                              \*RST:       OFF

**Example:**                   DISP:BARG:PHOL ON

**Manual operation:** See "[Bargraph Maxhold](#)" on page 134

---

**DISPlay:BARGraph:PHOLd:RESet**

This command resets the maxhold value of the numeric indication of the bargraph measurement.

**Example:**                   :DISP:BARG:PHOL:RES

**Usage:**                    Event

**Manual operation:** See "[Maxhold Reset](#)" on page 134

---

**DISPlay:BARGraph:TCOupling[:STATe] <State>**

This command couples or decouples the bargraph detector and scan trace detector.

**Parameters:**

<State>                    ON | OFF  
                              \*RST:       OFF

**Example:**                   DISP:BARG:TCO ON  
                              Couples the type and color of bargraph and scan trace.

**Manual operation:** See "[Couple to Scan Trace](#)" on page 139

---

---

**[SENSe:]DETECTOR:RECEIVER[:FUNCTION] <Detector>, [<Detector>, <Detector>]**

This command selects the detector for the bargraph measurement.

**Parameters:**

<Detector>,                    You can select up to three detectors, one for each active bargraph.  
 [<Detector>,  
 <Detector>]

**AVERage**

Selects the Average detector.

**CAverage**

Selects the CISPR Average detector.

**CRMS**

Selects the CISPR RMS detector.

**NEGative**

Selects the Min Peak detector.

**POSitive**

Selects the Max Peak detector.

**QPEak**

Selects the Quasipeak detector.

**RMS**

Selects the RMS detector.

\*RST:            AVERage

**Example:**

DET:REC POS,AVER,QPE

Selects the peak, average and quasipeak detectors.

**Manual operation:** See "[Bargraph Detector](#)" on page 139

---

**[SENSe:]SWEep:TIME <Time>**

This command defines the measurement or acquisition time for bargraph measurements, scans and CISPR APD measurements.

**Parameters:**

<Time>                    Range:        10  $\mu$ s to 100 s

**Example:**

SWE:TIME 10s

Defines a measurement time of 10 s.

**Manual operation:** See "[Measurement Time](#)" on page 139

### 11.4.1.3 Scan Control

ABORT .....	609
HOLD.....	609
INITiate<n>:CONMeas.....	609
INITiate<n>:CONTInuous.....	609
INITiate<n>[:IMMEDIATE].....	610

---

**ABORt**

This command stops a measurement and resets the trigger system.

**Example:**            ABOR; INIT: IMM  
                      Aborts the measurement and restarts it.

**Usage:**             SCPI confirmed

**Manual operation:** See "Stop Scan" on page 135  
                          See "Stop Final Measurement" on page 138  
                          See "Meas Start/Stop" on page 243

---

**HOLD**

This command interrupts a running scan measurement.

To resume the scan, use `INITiate<n>[:IMMEDIATE]`.

**Example:**            HOLD  
                      Interrupts the scan.

**Manual operation:** See "Hold Scan" on page 135  
                          See "Continue at Rec Frequency" on page 135  
                          See "Hold Final Measurement" on page 137

---

**INITiate<n>:CONMeas**

This command resumes a scan that was interrupted by a transducer stop at the current receiver frequency.

If the scan was interrupted by the `HOLD` command, you have to resume it with `INITiate<n>[:IMMEDIATE]` on page 610.

**Example:**            INIT2:CONT OFF  
                          Selects single scan mode.  
                          SWE:COUN 20  
                          Forms an average over 20 scans.  
                          INIT2;\*WAI  
                          Starts the measurement and waits for the end of the 20 scans.  
                          INIT2:CONM;\*WAI  
                          Continues the measurement (next 20 sequences) and waits for the end.

**Usage:**             Event

**Manual operation:** See "Continue at Hold" on page 135

---

**INITiate<n>:CONTinuous <State>**

This command turns single measurements on and off.

The measurement starts immediately.

**Parameters:**

<State>                    **ON**  
 Continuous measurements.

**OFF**  
 Single measurements.

**Example:**                `INIT2:CONT OFF`  
 Turns on a single measurement.

**Manual operation:** See "[Continuous Bargraph / Single Bargraph](#)" on page 133  
 See "[Run Continuous / Run Single](#)" on page 161  
 See "[Continuous Sweep](#)" on page 341  
 See "[Single Sweep](#)" on page 341

### **INITiate<n>[:IMMediate]**

The command initiates a new measurement.

In case of a single measurement, the R&S ESRP stops measuring when it has reached the end frequency. When you start a continuous measurement, it stops only if you abort it deliberately.

If you are using trace modes MAXHold, MINHold and AVERage, previous results are reset when you restart the measurement.

In single sweep mode, you can synchronize to the end of the measurement with \*OPC, \*OPC? or \*WAI. In continuous sweep mode, synchronization to the end of the measurement is not possible. Thus, it is not recommended that you use continuous sweep mode in remote control, as results like trace data or markers are only valid after a single sweep end synchronization.

**Example:**                `INIT2:CONT OFF`  
 Selects single measurement mode.

`SWE:COUN 20`  
 Forms an average over 20 measurements.

`INIT2;*WAI`  
 Starts the measurement and waits for the end of the complete measurement.

**Usage:**                    Event

**Manual operation:** See "[Continue at Rec Frequency](#)" on page 135  
 See "[Run Continuous / Run Single](#)" on page 161

#### **11.4.1.4 Final Measurements and Automated Test Sequence Control**

<a href="#">INITiate&lt;n&gt;:EMITest</a> .....	611
<a href="#">INITiate&lt;n&gt;:FMEasurement</a> .....	611
<a href="#">[SENSe:]DETEctor&lt;t&gt;:FMEasurement</a> .....	611
<a href="#">[SENSe:]FMEasurement:AUTO</a> .....	612
<a href="#">[SENSe:]FMEasurement:TIME</a> .....	612

---

**INITiate<n>:EMITest**

This command initiates an automated test sequence.

The sequence consists of a scan, a peak search and a final measurement.

**Example:**           INIT2:EMIT  
Starts the test sequence.

**Usage:**            Event

---

**INITiate<n>:FMEasurement**

This command initiates a final measurement based on the peak list.

**Example:**           INIT2:FME  
Starts the final measurement.

**Usage:**            Event

---

**[SENSe:]DETEctor<t>:FMEasurement <Detector>**

This command selects the detector for the final measurement.

**Parameters:**

<Detector>

**AVERage**

Selects the Average detector.

**CAVerage**

Selects the CISPR Average detector.

**CRMS**

Selects the CISPR RMS detector.

**NEGative**

Selects the Min Peak detector.

**NONE**

Ignores the peaks found on that trace during the final measurement.

**POSitive**

Selects the Max Peak detector.

**QPEak**

Selects the Quasipeak detector.

**RMS**

Selects the RMS detector.

\*RST:            QPEak

**Example:**           DET:FME POS

**Manual operation:** See "[Trace 1 to 6](#)" on page 172  
See "[Trace 1 - 6](#)" on page 175

**[SENSe:]FMEasurement:AUTO <State>**

This command turns automatic final measurements on and off.

**Parameters:**

<State>                    **ON**  
Turns on automatic final measurement.

**OFF**  
Turns on interactive final measurement.

\*RST:                    ON

**Example:**                    FME:AUTO ON

**Manual operation:**    See "[Automatic Final](#)" on page 137  
                                  See "[Interactive Final](#)" on page 137  
                                  See "[Interactive Mode](#)" on page 172

**[SENSe:]FMEasurement:TIME <Time>**

This command defines the time each frequency in the peak list is measured during the final measurement.

**Parameters:**

<Time>                    \*RST:                    1 s

**Example:**                    FME:TIME 1us  
                                  Defines a measurement time of 1  $\mu$ s.

**11.4.1.5 Trace Data and Result Query**

This section contains information on the TRACe:DATA command and a detailed description of the characteristics of that command. Basically, the command queries the results of the current measurement. The command supports various SCPI parameters in combination with the query. Each SCPI parameter returns a different aspect of the measurement.

The format of the return values is either in ASCII or binary characters and depends on the format you have set with FORMat [:DATA] on page 818.

**Querying trace data**

The SCPI parameters TRACE1 | ... | TRACE6 return the trace data for the corresponding trace.

**Example:**

TRAC? TRACE1

The number of results depends on the currently selected number of sweep points. For each sweep point, the command returns one level value. The unit depends on the measurement and on the unit you have currently set.

The trace has to be active for the command to work.

### Querying bargraph results

The SCPI parameters `SINGLE` and `PHOLD` return the results of the bargraph measurement.

`SINGLE` returns the current bargraph results for each active bargraph detector.

The order of detectors is as shown in the user interface: maximum peak, minimum peak, quasipeak, average, RMS. Inactive detectors are ignored.

#### Example:

```
TRAC? SINGLE
```

`PHOLD` returns the bargraph maxhold results for each active bargraph detector.

Each result is made up out of two values:

- Absolute level
- Frequency

The order of detectors is as shown in the user interface: maximum peak, minimum peak, quasipeak, average, RMS. Inactive detectors are ignored.

#### Example:

```
TRAC? PHOLD
```

### Querying scan characteristics

The SCPI parameter `SCAN` returns the scan characteristics while the scan is running.

The amount of returned results depends on the scan settings.

The type of returned data is as follows:

- 4 byte, trace status:
  - bit 0 to 9 represent the subscan
  - bit 10 represents the last block of a subscan
  - bit 11 represents the last block of the last subscan
  - bit 12 represents the last of all blocks (for multiple scans after the last scan)
- 4 byte, number  $n$  of measurement results contained in one trace
- 4 byte, bit 0 represents the state of trace 1 (0/1)
- 4 byte, bit 0 represents the state of trace 2 (0/1)
- 4 byte, bit 0 represents the state of trace 3 (0/1)
- 4 byte, bit 0 represents the state of trace 4 (0/1)

#### Note:

If more than 4 traces are active, the state of trace 5 and 6 is indicated by an additional bit (bit 8) in the UINT32 field of trace 1 and 2.

- $n*4$  byte, measurement results for trace 1; only if trace 1 is active
- $n*4$  byte, measurement results for trace 2; only if trace 2 is active
- $n*4$  byte, measurement results for trace 3; only if trace 3 is active



- n\*4 byte, measurement results for trace 4; only if trace 4 is active
- n\*4 byte, measurement results for trace 5; only if trace 5 is active
- n\*4 byte, measurement results for trace 6; only if trace 6 is active
- n\*1 byte, status information for each measurement result  
→ bit 2 represents overrange for trace 1 to trace 6

The data is always returned in binary format ([FORM REAL, 32](#)).

Note that the `SCAN` parameter only works while the scan is actually running.

**Example:**

```
TRAC? SCAN
```

**Querying results for a peak search**

The SCPI parameters `PLIST1 | ... | PLIST6` returns the results of a peak search for a particular trace or detector (1 to 6).

Each result is made up out of three values:

- 4 byte, frequency
- 4 byte, absolute level
- 4 byte, Delta between absolute level and limit line value at corresponding frequency  
If no limit line is active, the delta value is set to 0.0

The trace has to be active for the command to work.

**Example:**

```
TRAC? PLIST3
```

**Querying results for the final measurement**

The SCPI parameters `FINAL1 | ... | FINAL6` return the results of the final measurement for a particular trace or detector (1 to 6).

Each result is made up out of three values:

- 4 byte, frequency
- 4 byte, absolute level
- 4 byte, Delta between absolute level and limit line value at corresponding frequency  
If no limit line is active, the delta value is set to 0.0

The trace has to be active for the command to work.

**Querying the status of the measurement results**

The SCPI parameter `STATUS` returns the status information for each measurement result. Thus, the number of returned values depends on the number of measurement results *n*. For each measurement result, the parameter queries 1 byte of status information.

→ bit 2 represents overrange for trace 1 to trace 6

Note that the `SCAN` parameter only works while the scan is actually running.

**Example:**

```
TRAC? STATUS
```

**Querying spectrogram data**

The SCPI parameter `SGRam` returns the contents of the spectrogram.

For every frame (horizontal line) in the spectrogram, the command returns the power levels that have been measured, one for each sweep or measurement point. The number of frames depends on the size of the history depth. The power level depends on the unit you have currently set.

---

**FORMat:DEXPort:TRACes** <Selection>

This command selects the data to be included in a data export file.

**Parameters:**

<Selection>

**ALL**

Selects all active traces for export to an ASCII file.

The <trace> parameter for the `MMEMoRY:STORe<n>:TRACe` command is ignored.

**SINGLE**

Only a single trace is selected for export, namely the one specified by the `MMEMoRY:STORe<n>:TRACe` command.

\*RST: SINGLE

**Manual operation:** See "[ASCII Trace Export](#)" on page 175

---

**TRACe[:DATA]** <ResultType>

This command queries current trace data and measurement results.

The data format depends on `FORMat[:DATA]`.

**Query parameters:**

<Trace>

**TRACE1 | ... | TRACE6**

See "[Querying trace data](#)" on page 612.

**FINAL1 | ... | FINAL6**

See "[Querying results for the final measurement](#)" on page 614.

**PLIST1 | ... | PLIST6**

See "[Querying results for a peak search](#)" on page 614.

**PHOLD**

See "[Querying bargraph results](#)" on page 613.

**SCAN**

See "[Querying scan characteristics](#)" on page 613.

**SGRam**

See "[Querying spectrogram data](#)" on page 615

**SINGLE**

See "Querying bargraph results" on page 613.

**STATUS**

See "Querying scan characteristics" on page 613.

**Return values:**

&lt;TraceData&gt; For more information see tables below.

**Example:**

TRAC? TRACE1

Queries the level for each trace point of trace 1.

**TRACe<n>:IF[:DATA] <ResultType>**

This command queries current trace data and measurement results for IF analysis.

The data format depends on FORMat [:DATA].

**Suffix:**

&lt;n&gt; irrelevant

**Parameters:**<ResultType> **TRACE1 | ... | TRACE3**

Returns the level values displayed on the corresponding trace.

**Example:**

TRAC:IF? TRACE1

Queries the level for each trace point of trace 1.

**11.4.1.6 Demodulating Analog Signals**

[SENSe:]DEMod.....	616
[SENSe:]DEMod:SQUelch:LEVel.....	617
[SENSe:]DEMod:SQUelch[:STATe].....	617

**[SENSe:]DEMod <Demod>**

This command turns analog demodulation at the receiver frequency on and off and selects the type of analog demodulation.

**Parameters:**<Demod> **OFF**  
Turns demodulation off.**AM**

Turns AM demodulation on.

**FM**

Turns FM demodulation on.

\*RST: OFF

**Example:**

DEM FM

Turns FM demodulation on.

**Manual operation:** See "Demod (On Off)" on page 139

See "AM / FM" on page 139

**[SENSe:]DEMod:SQUelch:LEVel <Threshold>**

This command defines the threshold for selective demodulation. Squelching must be active for this command to work (see [\[SENSe:\]DEMod:SQUelch\[:STATe\]](#)).

All signals below the threshold are not demodulated.

This command is only available if the R&S FSV-B3 option (Audio Demodulation) is installed.

**Parameters:**

<Threshold>                    The threshold level as a percentage of the display height.  
 Range:                    0 to 100  
 \*RST:                    60

**Example:**

DEMod:SQU:LEV 80  
 Sets the squelch level to 80% of the displayed signal.

**Usage:**

SCPI confirmed

**Manual operation:**

See ["Squelch"](#) on page 139  
 See ["Squelch Level"](#) on page 392

**[SENSe:]DEMod:SQUelch[:STATe] <State>**

This command turns selective demodulation at the marker position on and off.

A video trigger is automatically activated with the same level as the squelch level, any other trigger or gate settings are deactivated.

This command is only available if the R&S FSV-B3 option (Audio Demodulation) is installed.

**Parameters:**

<State>                    ON | OFF  
 \*RST:                    OFF

**Example:**

DEMod:SQU ON  
 Signals below the level threshold are not sent to the audio output.

**Usage:**

SCPI confirmed

**Manual operation:**

See ["Squelch"](#) on page 139  
 See ["Squelch"](#) on page 392

**11.4.1.7 Spectrogram Control**

- [Configuring Spectrograms](#)..... 618
- [Using Markers](#)..... 621
- [Using Deltamarkers](#)..... 627

## Configuring Spectrograms

CALCulate<n>:SGRam:CLEar[:IMMediate].....	618
DISPlay:WINDow:SGRam:COLor:DEFault.....	618
DISPlay:WINDow:SGRam:COLor:LOWer.....	618
DISPlay:WINDow:SGRam:COLor:SHAPe.....	619
DISPlay:WINDow:SGRam:COLor:UPPer.....	619
DISPlay:WINDow:SGRam:COLor[:STYLE].....	619
CALCulate<n>:SGRam:HDEPth.....	620
CALCulate:SGRam:TRACe.....	620
CALCulate<n>:SGRam:TSTamp:DATA?.....	620
MMEMoRY:STORe:SGRam.....	621

---

### CALCulate<n>:SGRam:CLEar[:IMMediate]

This command resets the Spectrogram result display and clears the history buffer.

**Suffix:**

<n>                    1...4  
Selects the measurement window.

**Example:**

CALC:SGR:CLE  
Resets the result display and clears the memory.

**Usage:**

Event

**Manual operation:**

See "Spectrogram Clear" on page 345  
See "Clear Spectrogram" on page 377

---

### DISPlay:WINDow:SGRam:COLor:DEFault

This command sets the color settings for the spectrogram result display to its default state.

**Usage:**

Event

---

### DISPlay:WINDow:SGRam:COLor:LOWer <Percentage>

This command sets the lower percentage boundary of the spectrogram.

**Parameters:**

<Percentage>        Statistical frequency percentage.  
Range:            0 to 66  
\*RST:            0  
Default unit: %

**Example:**

DISP:WIND:SGR:COL:LOW 10  
Sets the start of the color map to 10%.

**Manual operation:**

See "Color Mapping" on page 377

**DISPlay:WINDow:SGRam:COLor:SHAPE** <Shape>

This command defines the shape and focus of the color curve for the spectrogram result display.

**Parameters:**

<Shape>                      Shape of the color curve.  
 Range:                      -1 to 1  
 \*RST:                        0

**DISPlay:WINDow:SGRam:COLor:UPPer** <Percentage>

This command sets the upper percentage boundary of the spectrogram.

**Parameters:**

<Percentage>                Statistical frequency percentage.  
 Range:                      0 to 66  
 \*RST:                        0  
 Default unit: %

**Example:**

DISP:WIND:SGR:COL:UPP 95  
 Sets the start of the color map to 95%.

**Manual operation:** See "[Color Mapping](#)" on page 377

**DISPlay:WINDow:SGRam:COLor[:STYLE]** <ColorScheme>

This command sets the color scheme for the spectrogram.

**Parameters:**

<ColorScheme>              **HOT**  
 Uses a color range from blue to red. Blue colors indicate low levels, red colors indicate high ones.

**COLD**  
 Uses a color range from red to blue. Red colors indicate low levels, blue colors indicate high ones.

**RADar**  
 Uses a color range from black over green to light turquoise with shades of green in between. Dark colors indicate low levels, light colors indicate high ones.

**GRAYscale**  
 Shows the results in shades of gray. Dark gray indicates low levels, light gray indicates high ones.

\*RST:                        HOT

**Example:**

DISP:WIND:SGR:COL GRAY  
 Changes the color scheme of the spectrogram to black and white.

**CALCulate<n>:SGRam:HDEPth** <HistoryDepth>

This command sets the number of frames to be stored in the R&S ESRP's memory.

**Suffix:**

<n> 1...4  
Selects the measurement window.

**Parameters:**

<HistoryDepth> The maximum number of frames depends on the number of sweep points.  
Range: 781 to 20000  
Increment: 1  
\*RST: 3000

**Example:**

CALC:SGR:HDEP 1500  
Sets the history depth to 1500.

**Manual operation:** See "[Frame Count](#)" on page 344  
See "[History Depth](#)" on page 376

**CALCulate:SGRam:TRACe** <Trace>

This command selects the trace the spectrogram is based on.

**Parameters:**

<Trace> Number of the trace. The range depends on the result display. Scans support six traces, IF Analysis supports three traces.

**Example:**

CALC:SGR:TRAC 2  
Assigns trace two to the spectrogram.

**Manual operation:** See "[Trace to Spectrogram](#)" on page 141

**CALCulate<n>:SGRam:TSTamp:DATA?** <Mode>

This command queries the time stamp of the frames.

All available frame results are returned by [TRACe<n>:DATA](#) on page 694.

**Suffix:**

<n> 1...4  
Selects the measurement window.

**Query parameters:**

<Mode> **CURRENT**  
Returns the time stamp of the current frame.  
**ALL**  
Returns the time stamps of all frames. The result are sorted in descending order, beginning with the current frame.

**Return values:**

<TimeStamp> The return values consist of four values for each frame.

The first value is the date of the measurement in seconds that have passed since 01.01.1970 in seconds. For a better resolution the second value shows the additional milliseconds. This value is also displayed on screen.

These numbers are appropriate for relative uses, but you can also calculate the absolute date and time as displayed on the screen.

The third and fourth value are reserved for future uses.

If the Spectrogram is empty, the command returns '0,0,0,0'

**Example:**

```
CALC:SGR:TST ON
```

Activates the time stamp.

```
CALC:SGR:TST:DATA? ALL
```

Returns the time stamp of all frames sorted in a descending order.

**Usage:**

Query only

**MMEMory:STORe:SGRam <File>**

This command exports the spectrogram data to a ASCII file.

The file contains the data for every frame in the history buffer. The data corresponding to a particular frame begins with information about the frame number and the time that frame was recorded.

Note that, depending on the size of the history buffer, the process of exporting the data can take a while.

**Parameters:**

<File> string containing the file name of the destination file

**Example:**

```
MMEM:STOR:SGR
```

Copies the spectrogram data to a file.

**Manual operation:** See "[ASCII Trace Export](#)" on page 175

**Using Markers**

Commands useful to work with markers in the spectrogram described elsewhere:

- [CALCulate<n>:MARKer<m>:MAXimum:LEFT](#) on page 660
- [CALCulate<n>:MARKer<m>:MAXimum:NEXT](#) on page 660
- [CALCulate<n>:MARKer<m>:MAXimum\[:PEAK\]](#) on page 661
- [CALCulate<n>:MARKer<m>:MAXimum:RIGHT](#) on page 661
- [CALCulate<n>:MARKer<m>:MINimum:LEFT](#) on page 662
- [CALCulate<n>:MARKer<m>:MINimum:NEXT](#) on page 662
- [CALCulate<n>:MARKer<m>:MINimum\[:PEAK\]](#) on page 662
- [CALCulate<n>:MARKer<m>:MINimum:RIGHT](#) on page 663



**Command exclusive to position markers in the spectrogram:**

CALCulate<n>:MARKer<m>:SGRam:FRAMe.....	622
CALCulate<n>:MARKer<m>:SGRam:SARea.....	622
CALCulate<n>:MARKer<m>:SGRam:XY:MAXimum[:PEAK].....	623
CALCulate<n>:MARKer<m>:SGRam:XY:MINimum[:PEAK].....	623
CALCulate<n>:MARKer<m>:SGRam:Y:MAXimum:ABOVe.....	624
CALCulate<n>:MARKer<m>:SGRam:Y:MAXimum:BELOW.....	624
CALCulate<n>:MARKer<m>:SGRam:Y:MAXimum:NEXT.....	625
CALCulate<n>:MARKer<m>:SGRam:Y:MAXimum[:PEAK].....	625
CALCulate<n>:MARKer<m>:SGRam:Y:MINimum:ABOVe.....	625
CALCulate<n>:MARKer<m>:SGRam:Y:MINimum:BELOW.....	626
CALCulate<n>:MARKer<m>:SGRam:Y:MINimum:NEXT.....	626
CALCulate<n>:MARKer<m>:SGRam:Y:MINimum[:PEAK].....	627

**CALCulate<n>:MARKer<m>:SGRam:FRAMe <Frame> | <Time>**

This command positions the marker on a particular frame.

The command is available for the spectrogram.

**Suffix:**

<n>	1...4 Selects the measurement window.
<m>	1...16 Selects the marker.

**Parameters:**

<Frame>   <Time>	<b>&lt;Frame&gt; (if time stamp is off)</b> Defines the frame to place the marker on. The range is {0...number of recorded frames-1} Note that in receiver mode, it is not possible to select a frame, only a time.  <b>&lt;time&gt; (if time stamp is on)</b> Defines the distance of the marker in seconds to the last measured frame (frame 0).
------------------	-------------------------------------------------------------------------------------------------------------------------------------------------------------------------------------------------------------------------------------------------------------------------------------------------------------------------------------------------------------------

**Example:**

```
CALC:MARK:SGR:FRAM -20
Sets the marker on the 20th frame before the present.
CALC:MARK2:SGR:FRAM 2 s
Sets second marker on the frame 2 seconds ago.
```

**CALCulate<n>:MARKer<m>:SGRam:SARea <SearchArea>**

This command defines the marker search area.

The command is available for the spectrogram.

**Suffix:**

<n>	1...4 Selects the measurement window.
-----	------------------------------------------

<m> 1...16  
Selects the marker.

**Parameters:**

<SearchArea>

**VISible**

Performs a search in the visible frames.

Note that VISible is ignored if Spectrogram is not visible for any reason (e.g. if the Spectrum Analyzer is in full screen mode or display update is inactive).

**MEMory**

Performs a search over all frames in the memory.

\*RST: VISible

**Example:**

CALC:DELT:SGR:SAR MEM

Performs a search over all frames in the memory.

**Manual operation:** See ["Select Search Area"](#) on page 184

**CALCulate<n>:MARKer<m>:SGRam:XY:MAXimum[:PEAK]**

This command positions the specified marker on the current peak level of the spectrogram. The possible position depends on the marker search area.

The command is available for the spectrogram.

For more information, see [CALCulate<n>:MARKer<m>:SGRam:SARea](#) on page 622.

**Suffix:**

<n> 1...4  
Selects the measurement window.

<m> 1...16  
Selects the marker.

**Example:**

CALC:MARK2:SGR:SAR VIS

CALC:MARK2:SGR:XY:MAX

Activates and positions marker 2 on the peak level in the visible Spectrogram.

**Usage:** Event

**CALCulate<n>:MARKer<m>:SGRam:XY:MINimum[:PEAK]**

This command positions the specified marker on the current minimum level of the spectrogram. The possible position depends on the marker search area.

The command is available for the spectrogram.

For more information, see [CALCulate<n>:MARKer<m>:SGRam:SARea](#) on page 622 .

**Suffix:**

<n> 1...4  
Selects the measurement window.

<m> 1...16  
Selects the marker.

**Example:** `CALC:MARK3:SGR:SAR VIS`  
`CALC:MARK3:SGR:XY:MIN`  
Activates and positions marker 3 on the minimum level in the visible Spectrogram.

**Usage:** Event

#### **CALCulate<n>:MARKer<m>:SGRam:Y:MAXimum:ABOVE**

This command positions the specified marker on the next peak level of the vertical axis. The search includes only frames above the current marker position. It does not change the horizontal position of the marker.

The command is available for the spectrogram.

**Suffix:**

<n> 1...4  
Selects the measurement window.

<m> 1...16  
Selects the marker.

**Example:** `CALC:MARK2:SGR:Y:MAX`  
Activates and positions marker 2 on the peak level of the y-axis.  
`CALC:MARK2:SGR:Y:MAX:ABV`  
Positions marker 2 on the next higher level found in the diagram area above the current marker position.

**Usage:** Event

#### **CALCulate<n>:MARKer<m>:SGRam:Y:MAXimum:BELOW**

This command positions the specified marker on the next peak level of the vertical axis. The search includes only frames below the current marker position. It does not change the horizontal position of the marker.

The command is available for the spectrogram.

**Suffix:**

<n> 1...4  
Selects the measurement window.

<m> 1...16  
Selects the marker.

**Example:** `CALC:MARK2:SGR:Y:MAX`  
Activates and positions marker 2 on the peak level of the y-axis.  
`CALC:MARK2:SGR:Y:MAX:BEL`  
Positions marker 2 on the next higher level found in the diagram area below the current marker position.

**Usage:** Event

**CALCulate<n>:MARKer<m>:SGRam:Y:MAXimum:NEXT**

This command positions the specified marker on the next peak level of the vertical axis. The search includes frames above and below the current marker position. It does not change the horizontal position of the marker.

The command is available for the spectrogram.

**Suffix:**

<n> 1...4  
Selects the measurement window.

<m> 1...16  
Selects the marker.

**Example:**

`CALC:MARK2:SGR:Y:MAX`

Activates and positions marker 2 on the peak level of the y-axis.

`CALC:MARK2:SGR:Y:MAX:NEXT`

Positions marker 2 on the next higher level.

**Usage:** Event

**CALCulate<n>:MARKer<m>:SGRam:Y:MAXimum[:PEAK]**

This command positions the specified marker on the current peak level of the vertical axis. The search is performed over all frames. It does not change the horizontal position of the marker.

The command is available for the spectrogram.

**Suffix:**

<n> 1...4  
Selects the measurement window.

<m> 1...16  
Selects the marker.

**Example:**

`CALC:MARK2:SGR:Y:MAX`

Activates and positions marker 2 on the peak level of the y-axis.

**Usage:** Event

**CALCulate<n>:MARKer<m>:SGRam:Y:MINimum:ABOVE**

This command positions the specified marker on the next minimum level of the vertical axis. The search includes only frames above the current marker position. It does not change the horizontal position of the marker.

The command is available for the spectrogram.

**Suffix:**

<n> 1...4  
Selects the measurement window.

<m> 1...16  
Selects the marker.

**Example:** `CALC:MARK2:SGR:Y:MIN`  
Activates and positions marker 2 on the minimum level of the y-axis.  
`CALC:MARK2:SGR:Y:MIN:ABOV`  
Positions marker 2 on the next minimum level found in the diagram area above the current marker position.

**Usage:** Event

#### **CALCulate<n>:MARKer<m>:SGRam:Y:MINimum:BELOW**

This command positions the specified marker on the next minimum level of the vertical axis. The search includes only frames below the current marker position. It does not change the horizontal position of the marker.

The command is available for the spectrogram.

**Suffix:**

<n> 1...4  
Selects the measurement window.

<m> 1...16  
Selects the marker.

**Example:** `CALC:MARK2:SGR:Y:MIN`  
Activates and positions marker 2 on the minimum level of the y-axis.  
`CALC:MARK2:SGR:Y:MAX:BEL`  
Positions marker 2 on the next minimum level found in the diagram area below the current marker position.

**Usage:** Event

#### **CALCulate<n>:MARKer<m>:SGRam:Y:MINimum:NEXT**

This command positions the specified marker on the next minimum level of the vertical axis. The search includes frames above and below the current marker position. It does not change the horizontal position of the marker.

The command is available for the spectrogram.

**Suffix:**

<n> 1...4  
Selects the measurement window.

<m> 1...16  
Selects the marker.

**Example:**            `CALC:MARK2:SGR:Y:MIN`  
 Activates and positions marker 2 on the minimum level of the y-axis.  
`CALC:MARK2:SGR:Y:MIN:NEXT`  
 Positions marker 2 on the next minimum level.

**Usage:**            Event

### **CALCulate<n>:MARKer<m>:SGRam:Y:MINimum[:PEAK]**

This command positions the specified marker on the current minimum level of the vertical axis. The search is performed over all captured frames. It does not change the horizontal position of the delta marker.

The command is available for the spectrogram.

**Suffix:**

<n>                    1...4  
 Selects the measurement window.

<m>                    1...16  
 Selects the marker.

**Example:**            `CALC:MARK2:SGR:Y:MIN`  
 Activates and positions marker 2 on the minimum level of the y-axis.

**Usage:**            Event

### **Using Deltamarkers**

Commands useful to work with markers in the spectrogram described elsewhere:

- [CALCulate<n>:DELTamarker<m>:MAXimum:LEFT](#) on page 666
- [CALCulate<n>:DELTamarker<m>:MAXimum:NEXT](#) on page 667
- [CALCulate<n>:DELTamarker<m>:MAXimum\[:PEAK\]](#) on page 667
- [CALCulate<n>:DELTamarker<m>:MAXimum:RIGHT](#) on page 667
- [CALCulate<n>:DELTamarker<m>:MINimum:LEFT](#) on page 668
- [CALCulate<n>:DELTamarker<m>:MINimum:NEXT](#) on page 668
- [CALCulate<n>:DELTamarker<m>:MINimum\[:PEAK\]](#) on page 668
- [CALCulate<n>:DELTamarker<m>:MINimum:RIGHT](#) on page 669

### **Command exclusive to position markers in the spectrogram:**

<a href="#">CALCulate&lt;n&gt;:DELTamarker&lt;m&gt;:SGRam:FRAME</a> .....	628
<a href="#">CALCulate&lt;n&gt;:DELTamarker&lt;m&gt;:SGRam:SARea</a> .....	628
<a href="#">CALCulate&lt;n&gt;:DELTamarker&lt;m&gt;:SGRam:XY:MAXimum[:PEAK]</a> .....	629
<a href="#">CALCulate&lt;n&gt;:DELTamarker&lt;m&gt;:SGRam:XY:MINimum[:PEAK]</a> .....	629
<a href="#">CALCulate&lt;n&gt;:DELTamarker&lt;m&gt;:SGRam:Y:MAXimum:ABOVE</a> .....	630
<a href="#">CALCulate&lt;n&gt;:DELTamarker&lt;m&gt;:SGRam:Y:MAXimum:BELOW</a> .....	630
<a href="#">CALCulate&lt;n&gt;:DELTamarker&lt;m&gt;:SGRam:Y:MAXimum:NEXT</a> .....	631

CALCulate<n>:DELTamarker<m>:SGRam:Y:MAXimum[:PEAK].....	631
CALCulate<n>:DELTamarker<m>:SGRam:Y:MINimum:ABOVE.....	632
CALCulate<n>:DELTamarker<m>:SGRam:Y:MINimum:BELOW.....	632
CALCulate<n>:DELTamarker<m>:SGRam:Y:MINimum:NEXT.....	632
CALCulate<n>:DELTamarker<m>:SGRam:Y:MINimum[:PEAK].....	633

---

### CALCulate<n>:DELTamarker<m>:SGRam:FRAME <Frame> | <Time>

This command positions the delta marker on a particular frame. The frame is relative to the position of marker 1.

The command is available for the spectrogram.

#### Suffix:

<n>	1...4	Selects the measurement window.
<m>	1...16	Selects the marker.

#### Parameters:

<Frame>   <Time>	<b>&lt;Frame&gt; (if time stamp is off)</b>
	Defines the distance of the deltamarker in frames and in relation to the position of marker 1. Note that in receiver mode, it is not possible to select a frame, only a time.
	<b>&lt;time&gt; (if time stamp is on)</b>
	Defines the distance of the deltamarker in seconds and in relation to the position of marker 1. The reference is the time stamp of marker 1.

#### Example:

```
CALC:DELT4:SGR:FRAM -20
Sets fourth deltamarker 20 frames below marker 1.
CALC:DELT4:SGR:FRAM 2 s
Sets fourth deltamarker 2 seconds above the position of marker 1.
```

---

### CALCulate<n>:DELTamarker<m>:SGRam:SAREa <SearchArea>

This command defines the deltamarker search area.

The command is available for the spectrogram.

#### Suffix:

<n>	1...4	Selects the measurement window.
-----	-------	---------------------------------

<m> 1...16  
Selects the marker.

**Parameters:**

<SearchArea>

**VISible**

Performs a search in the visible frames.

Note that VISible is ignored if Spectrogram is not visible for any reason (e.g. if the Spectrum Analyzer is in full screen mode or display update is inactive).

**MEMory**

Performs a search over all frames in the memory.

\*RST: VISible

**Example:**

CALC:DELT:SGR: SAR MEM

Performs a search over all frames in the memory.

**CALCulate<n>:DELTamarker<m>:SGRam:XY:MAXimum[:PEAK]**

This command positions the specified delta marker on the current peak level of the spectrogram. The possible position depends on the deltamarker search area.

The command is available for the spectrogram.

For more information, see [CALCulate<n>:DELTamarker<m>:SGRam:SARea](#) on page 628.

**Suffix:**

<n> 1...4  
Selects the measurement window.

<m> 1...16  
Selects the marker.

**Example:**

CALC:DELT2:SGR: SAR VIS

CALC:DELT2:SGR: XY:MAX

Activates and positions delta marker 2 on the peak level in the visible Spectrogram.

**Usage:** Event

**CALCulate<n>:DELTamarker<m>:SGRam:XY:MINimum[:PEAK]**

This command positions the specified delta marker on the current minimum level of the spectrogram. The possible position depends on the deltamarker search area.

The command is available for the spectrogram.

For more information, see [CALCulate<n>:DELTamarker<m>:SGRam:SARea](#) on page 628.

**Suffix:**

<n> 1...4  
Selects the measurement window.



<m> 1...16  
Selects the marker.

**Example:** `CALC:DELT3:SGR:SAR:VIS`  
`CALC:DELT3:SGR:XY:MIN`  
Activates and positions delta marker 3 on the minimum level in the visible Spectrogram.

**Usage:** Event

#### **CALCulate<n>:DELTamarker<m>:SGRam:Y:MAXimum:ABOVe**

This command positions the specified delta marker on the next peak level of the vertical axis. The search includes only frames above the current marker position. It does not change the horizontal position of the delta marker.

The command is available for the spectrogram.

**Suffix:**

<n> 1...4  
Selects the measurement window.

<m> 1...16  
Selects the marker.

**Example:** `CALC:DELT2:SGR:Y:MAX`  
Activates and positions delta marker 2 on the peak level of the y-axis.  
`CALC:DELT2:SGR:Y:MAX:ABOV`  
Positions delta marker 2 on the next higher level found in the diagram area above the current marker position.

**Usage:** Event

#### **CALCulate<n>:DELTamarker<m>:SGRam:Y:MAXimum:BELow**

This command positions the specified delta marker on the next peak level of the vertical axis. The search includes only frames below the current marker position. It does not change the horizontal position of the delta marker.

The command is available for the spectrogram.

**Suffix:**

<n> 1...4  
Selects the measurement window.

<m> 1...16  
Selects the marker.

**Example:** `CALC:DELT2:SGR:Y:MAX`  
 Activates and positions delta marker 2 on the peak level of the y-axis.

`CALC:DELT2:SGR:Y:MAX:BEL`  
 Positions delta marker 2 on the next higher level found in the diagram area below the current marker position.

**Usage:** Event

#### **CALCulate<n>:DELTamarker<m>:SGRam:Y:MAXimum:NEXT**

This command positions the specified delta marker on the next peak level of the vertical axis. The search includes frames above and below the current marker position. It does not change the horizontal position of the delta marker.

The command is available for the spectrogram.

**Suffix:**

<n> 1...4  
 Selects the measurement window.

<m> 1...16  
 Selects the marker.

**Example:** `CALC:DELT2:SGR:Y:MAX`  
 Activates and positions delta marker 2 on the peak level of the y-axis.

`CALC:DELT2:SGR:Y:MAX:NEXT`  
 Positions delta marker 2 on the next higher level.

**Usage:** Event

#### **CALCulate<n>:DELTamarker<m>:SGRam:Y:MAXimum[:PEAK]**

This command positions the specified delta marker on the current peak level of the vertical axis. The search is performed over all frames. It does not change the horizontal position of the deltamarker.

The command is available for the spectrogram.

**Suffix:**

<n> 1...4  
 Selects the measurement window.

<m> 1...16  
 Selects the marker.

**Example:** `CALC:DELT2:SGR:Y:MAX`  
 Activates and positions delta marker 2 on the peak level of the y-axis.

**Usage:** Event

**CALCulate<n>:DELTamarker<m>:SGRam:Y:MINimum:ABOVE**

This command positions the specified delta marker on the next minimum level of the vertical axis. The search includes only frames above the current marker position. It does not change the horizontal position of the delta marker.

The command is available for the spectrogram.

**Suffix:**

<n> 1...4  
Selects the measurement window.

<m> 1...16  
Selects the marker.

**Example:**

`CALC:DELT2:SGR:Y:MIN`

Activates and positions delta marker 2 on the minimum level of the y-axis.

`CALC:DELT2:SGR:Y:MIN:ABOV`

Positions delta marker 2 on the next minimum level found in the diagram area above the current marker position.

**Usage:** Event

**CALCulate<n>:DELTamarker<m>:SGRam:Y:MINimum:BELOW**

This command positions the specified delta marker on the next minimum level of the vertical axis. The search includes only frames below the current marker position. It does not change the horizontal position of the delta marker.

The command is available for the spectrogram.

**Suffix:**

<n> 1...4  
Selects the measurement window.

<m> 1...16  
Selects the marker.

**Example:**

`CALC:DELT2:SGR:Y:MIN`

Activates and positions delta marker 2 on the minimum level of the y-axis.

`CALC:DELT2:SGR:Y:MAX:BEL`

Positions delta marker 2 on the next minimum level found in the diagram area below the current marker position.

**Usage:** Event

**CALCulate<n>:DELTamarker<m>:SGRam:Y:MINimum:NEXT**

This command positions the specified delta marker on the next minimum level of the vertical axis. The search includes frames above and below the current marker position. It does not change the horizontal position of the delta marker.

The command is available for the spectrogram.

**Suffix:**

<n> 1...4  
Selects the measurement window.

<m> 1...16  
Selects the marker.

**Example:**

CALC:DELT2:SGR:Y:MIN

Activates and positions delta marker 2 on the minimum level of the y-axis.

CALC:DELT2:SGR:Y:MIN:NEXT

Positions delta marker 2 on the next minimum level.

**Usage:** Event

**CALCulate<n>:DELTamarker<m>:SGRam:Y:MINimum[:PEAK]**

This command positions the specified delta marker on the current minimum level of the vertical axis. The search is performed over all captured frames. It does not change the horizontal position of the delta marker.

The command is available for the spectrogram.

**Suffix:**

<n> 1...4  
Selects the measurement window.

<m> 1...16  
Selects the marker.

**Example:**

CALC:DELT2:SGR:Y:MIN

Activates and positions delta marker 2 on the minimum level of the y-axis.

**Usage:** Event

## 11.4.2 Defining the Frequency

DISPlay[:WINDow<n>]:TRACe<t>:X:SPACing.....	634
[SENSe:]FREQuency:CENTer.....	634
[SENSe:]FREQuency:CENTer:STEP.....	634
[SENSe:]FREQuency:MODE.....	635
[SENSe:]FREQuency:START.....	635
[SENSe:]FREQuency:STOP.....	635

---

**DISPlay[:WINDow<n>]:TRACe<t>:X:SPACing <Scale>**

This command selects the scale of the frequency axis.

**Parameters:**

<Scale>                    **LINEar**  
 Linear scale of the frequency axis.

**LOGarithmic**  
 Logarithmic scale of the frequency axis.

\*RST:                    LOGarithmic

**Example:**

DISP:TRAC:X:SPAC LIN  
 Selects linear scale for the frequency axis.

**Manual operation:** See "[Freq Axis \(Lin Log\)](#)" on page 161  
 See "[Freq \(Lin Log\)](#)" on page 277

---

**[SENSe:]FREQUency:CENTer <Frequency>**

This command defines the receiver frequency for measurements in the frequency or time domain.

**Parameters:**

<Frequency>                0 to fmax  
 Range:                    0 Hz to fmax  
 \*RST:                    fmax /2

**Example:**

FREQ:CENT 100MHz  
 Defines a receiver frequency of 100 MHz.

**Manual operation:** See "[Continue at Rec Frequency](#)" on page 135  
 See "[Receiver Frequency](#)" on page 138

---

**[SENSe:]FREQUency:CENTer:STEP <StepSize>**

This command defines the center frequency step size.

**Parameters:**

<StepSize>                Range:                    1 to fmax  
 \*RST:                    0.1 x <span value>  
 Default unit: Hz

**Example:**

FREQ:CENT:STEP 120 MHz

**Manual operation:** See "[Stepsize](#)" on page 155  
 See "[Manual](#)" on page 318

**[SENSe:]FREQuency:MODE <Mode>**

This command selects the scan mode.

**Parameters:**

<Mode>

**SCAN**

Selects the stepped scans in the frequency domain.

In the frequency domain, define the frequency with:

- [SENSe:]FREQuency:STARt on page 635
- [SENSe:]FREQuency:STOP on page 635
- [SENSe:]SCAN<range>:STARt on page 645
- [SENSe:]SCAN<range>:STOP on page 646
- [SENSe:]FREQuency:SPAN on page 793
- [SENSe:]FREQuency:CENTer on page 634

**TDOMain**

Selects time domain scans in the frequency domain. See SCAN on how to define the frequency.

Time domain scans are available with options R&S ESRP-B50 and R&S ESRP-K53.

\*RST: TDOMain

**Example:**

FREQ:MODE TDOM

Selects time domain scans.

**Manual operation:** See "[Time Domain Scan \(On Off\)](#)" on page 166

**[SENSe:]FREQuency:STARt <Start>**

This command defines the start frequency for scans in the frequency domain.

**Parameters:**

<Start>

Range: 0 Hz to fmax

\*RST: 0 Hz

**Example:**

FREQ:STAR 20MHz

**Manual operation:** See "[Start / Stop Frequency](#)" on page 156

**[SENSe:]FREQuency:STOP <Stop>**

This command defines the stop frequency for scans in the time domain.

**Parameters:**

<Stop>

Range: 0 Hz to fmax

\*RST: fmax

**Example:**

FREQ:STOP 20MHz

**Manual operation:** See "[Start / Stop Frequency](#)" on page 156

### 11.4.3 Configuring the Vertical Axis

CALCulate<n>:UNIT:POWER.....	636
DISPlay[:WINDow<n>]:TRACe<t>:Y[:SCALe]:BOTTom.....	636
DISPlay[:WINDow<n>]:TRACe<t>:Y:SPACing.....	636
INPut:ATTenuation.....	637
INPut:ATTenuation:AUTO.....	637
INPut:ATTenuation:PROTection[:STATe].....	638
INPut:GAIN:AUTO.....	638
INPut:GAIN:STATe.....	638
INPut:IMPedance.....	638

---

#### CALCulate<n>:UNIT:POWER <Unit>

This command selects the unit for the y-axis.

##### Suffix:

<n> irrelevant

##### Parameters:

<Unit> DBM | V | A | W | DBPW | DBPW\_MHZ | DBUV | DBUV\_MHZ |  
 DBMV | DBMV\_MHZ | DBUA | DBUA\_MHZ | DBPT |  
 DBPT\_MHZ | DBUV\_M | DBUV\_MMHZ | DBUA\_M |  
 DBUA\_MMHZ  
 \*RST: dB $\mu$ V

##### Example:

CALC:UNIT:POW DBM  
 Selects the unit dBm.

**Manual operation:** See "Unit" on page 158  
 See "dBx/MHz" on page 158

---

#### DISPlay[:WINDow<n>]:TRACe<t>:Y[:SCALe]:BOTTom <Level>

This command defines the minimum level displayed on the vertical diagram axis.

##### Parameters:

<Level> Minimum displayed level. The unit depends on the one you have selected.

##### Example:

DISP:TRAC:Y:BOTT -20  
 The minimum grid level is set to -20 dBuV (pre-condition: the default unit has not been changed)

**Manual operation:** See "Grid Range / Grid Min Level" on page 159

---

#### DISPlay[:WINDow<n>]:TRACe<t>:Y:SPACing <ScalingType>

This command selects the scaling of the y-axis.

##### Suffix:

<n> Selects the measurement window.

<t> irrelevant

**Parameters:**

<ScalingType>

**LOGarithmic**

Logarithmic scaling.

**LINear**

Linear scaling in %.

**LDB**

Linear scaling in dB.

\*RST: LOGarithmic

**Example:**

DISP:TRAC:Y:SPAC LIN

Select a linear scale.

**Manual operation:**

See "[Range Log 100 dB](#)" on page 288

See "[Range Log 50 dB](#)" on page 288

See "[Range Log 10 dB](#)" on page 289

See "[Range Log 5 dB](#)" on page 289

See "[Range Log 1 dB](#)" on page 289

See "[Range Log Manual](#)" on page 289

See "[Range Linear %](#)" on page 289

See "[Range Lin. Unit](#)" on page 290

**INPut:ATTenuation** <Attenuation>

This command defines the attenuation level at the RF input.

To protect the input mixer, attenuation levels of 10 dB or less are possible only if you have turned the input protection off with [INPut:ATTenuation:PROTection\[:STATe\]](#).

**Parameters:**

<Attenuation>

Range: 0 dB to 75 dB

Increment: 5 dB

\*RST: 10 dB

**Example:**

INP:ATT 40dB

Defines an attenuation level of 40 dB.

**Manual operation:**

See "[RF Atten Manual](#)" on page 157

**INPut:ATTenuation:AUTO** <State>

This command turns automatic configuration of the attenuation on and off.

If on, the R&S ESRP selects an attenuation that results in a good signal-to-noise ratio without overloading the receiver.

**Parameters:**

<State>

ON | OFF

\*RST: ON



**Example:** `INP:ATT:AUTO ON`  
Turns the auto ranging function on.

**Manual operation:** See ["Auto Range \(On Off\)"](#) on page 158

#### **INPut:ATTenuation:PROTection[:STATe] <State>**

This command turns the availability of attenuation levels of 10 dB or less on and off.

**Parameters:**  
<State> ON | OFF  
\*RST: OFF

**Example:** `INP:ATT:PROT ON`

**Manual operation:** See ["10 dB Min"](#) on page 157

#### **INPut:GAIN:AUTO <State>**

Turns automatic selection of the preamplifier state on and off.

**Parameters:**  
<State> ON | OFF  
\*RST: OFF

**Example:** `:INP:GAIN:AUTO ON`  
Includes the preamplifier into the auto range function

**Manual operation:** See ["Auto Preamp \(On Off\)"](#) on page 158

#### **INPut:GAIN:STATe <State>**

This command turns the preamplifier on and off. (For the exact amplification value, see the data sheet).

**Parameters:**  
<State> ON | OFF  
\*RST: OFF

**Example:** `INP:GAIN:STAT ON`  
Turns the preamplifier on.

**Manual operation:** See ["Preamp On/Off"](#) on page 157

#### **INPut:IMPedance <Impedance>**

This command selects the nominal input impedance.

75 Ω should be selected if the 50 Ω input impedance is transformed to a higher impedance using a 75 Ω adapter of the RAZ type (= 25 Ω in series to the input impedance of the instrument). The correction value in this case is 1.76 dB = 10 log (75Ω/50Ω).

**Parameters:**

<Impedance> 50 | 75  
 \*RST: 50  $\Omega$

**Example:**

INP:IMP 75

**Manual operation:** See "[Input 50  \$\Omega\$ /75  \$\Omega\$](#) " on page 160

#### 11.4.4 Selecting the Bandwidth

<a href="#">[SENSe:]BANDwidth:IF.....</a>	639
<a href="#">[SENSe:]BANDwidth BWIDth[:RESolution].....</a>	639
<a href="#">[SENSe:]BANDwidth BWIDth[:RESolution]:AUTO.....</a>	640
<a href="#">[SENSe:]BANDwidth BWIDth[:RESolution]:TYPE.....</a>	640

---

##### **[SENSe:]BANDwidth:IF <Bandwidth>**

This command defines the resolution bandwidth for IF analysis.

**Parameters:**

<Bandwidth> Resolution filter bandwidth with a 6 dB bandwidth in the range from 10 Hz to 100 kHz in steps of 1-3-10-....  
 The available bandwidths depend on the current frequency span.  
 \*RST: 3 kHz

**Example:**

BAND:IF 10KHZ

Defines a resolution bandwidth of 10 kHz.

**Manual operation:** See "[IF Analysis RBW](#)" on page 161

---

##### **[SENSe:]BANDwidth|BWIDth[:RESolution] <Bandwidth>**

This command defines the resolution bandwidth.

The available bandwidths depend on the selected filter type. For more information see [Chapter 5.2.1, "Measurement Bandwidth"](#), on page 142.

**Parameters:**

<Bandwidth> refer to data sheet  
 \*RST: (AUTO is set to ON)

**Example:**

BAND 1 MHz

Sets the resolution bandwidth to 1 MHz

**Manual operation:**

See "[Res BW Manual](#)" on page 160

See "[Res BW CISPR / CISPR \(6 dB\)](#)" on page 277

See "[Res BW Mil Std/ MIL Std \(6 dB\)](#)" on page 277

See "[Res BW](#)" on page 287

See "[Res BW Manual](#)" on page 332

**[SENSe:]BANDwidth|BWIDth[:RESolution]:AUTO <State>**

This command couples or decouples the resolution bandwidth to the selected frequency.

The resolution bandwidth is coupled to the frequency only if you have selected the Quasipeak, CISPR Average or CISPR RMS detector.

For more information see [Chapter 5.2.1, "Measurement Bandwidth"](#), on page 142.

**Parameters:**

<State>                    ON | OFF  
\*RST:                    ON

**Example:**

BAND:AUTO OFF  
Decouples the measurement bandwidth from the frequency range.

**Manual operation:** See "[CISPR RBW Uncoupled](#)" on page 160

**[SENSe:]BANDwidth|BWIDth[:RESolution]:TYPE <FilterType>**

This command selects the type of resolution filter.

For detailed information on filters see [Chapter 6.2.6.3, "Selecting the Appropriate Filter Type"](#), on page 337 and [Chapter 6.2.6.4, "List of Available RRC and Channel Filters"](#), on page 338.

When changing the filter type, the next larger filter bandwidth is selected if the same filter bandwidth is not available for the new filter type.

5 Pole filters are not available when using the sweep type "FFT".

**Parameters:**

<FilterType>                **NORMAL**  
Gaussian filters  
**CFILter**  
Channel filters  
**RRC**  
RRC filters  
**P5**  
5 Pole filters  
**CISPr (PULSe)**  
6 dB CISPR filter (commercial EMI standards)  
Note: when the filter type is queried, the CISPR filter returns 'PULS'.  
\*RST:                    NORMAL

**Example:**                BAND:TYPE NORM

- Manual operation:** See "Filter Type" on page 160  
 See "Filter Type" on page 276  
 See "Res BW CISPR / CISPR (6 dB)" on page 277  
 See "Res BW Mil Std/ MIL Std (6 dB)" on page 277

### 11.4.5 Controlling Inputs and Outputs

INPut:COUPling.....641  
 INPut:TYPE.....641

---

#### INPut:COUPling <CouplingType>

Toggles the RF input of the R&S ESRP between AC and DC coupling.

**Parameters:**

<CouplingType> AC | DC  
 \*RST: AC

**Example:** INP:COUP DC

**Manual operation:** See "Input (AC/DC)" on page 163

---

#### INPut:TYPE <Input>

The command selects the signal source.

**Parameters:**

<Input> **INPUT1**  
 Selects RF input 1.  
**INPUT2**  
 Selects RF input 2.  
 \*RST: INPUT1

**Example:** INP:TYPE INPUT1  
 Selects RF input 1.

### 11.4.6 Test Automation

- [General Scan Configuration](#).....642
- [Scan Table](#).....643
- [Peak Search](#).....647
- [Peak Lists](#).....650
- [Trace Configuration](#).....651
- [LISN Settings](#).....653

### 11.4.6.1 General Scan Configuration

[SENSe:]SWEep:COUNT.....	642
[SENSe:]SWEep:COUNT:CURRent.....	642
TRACe<n>:FEED:CONTRol<t>.....	642
TRACe<n>:POINTs.....	643

---

#### [SENSe:]SWEep:COUNT <SweepCount>

This command defines the number of scans performed during a single sweep.

##### Parameters:

<SweepCount>      Range:      0 to 32767  
                          \*RST:        0

##### Example:

```
SWE:COUN 64
Sets the number of sweeps to 64.
INIT:CONT OFF
Switches to single-sweep mode.
INIT;*WAI
Starts a sweep and waits for its end.
```

**Manual operation:** See "[Scan Count](#)" on page 165

---

#### [SENSe:]SWEep:COUNT:CURRent

This command queries the number of scans that have started in single scan mode with more than one scan (`SENSe:SWEep:COUNT > 1`).

##### Example:

```
SWE:COUNT 64
sets scan count to 64
INIT:CONT OFF
switches to single scan mode
INIT
starts a scan (without waiting for the scan end!)
SWE:COUN:CURR?
queries the number of started scans
```

**Manual operation:** See "[Scan Count](#)" on page 165

---

#### TRACe<n>:FEED:CONTRol<t> <Occasion>

This command turns block data transmission during a scan on and off.

The availability of data is reported in the STATus:OPERation-Register.

The block size depends on scan time and the upper limit defined by [TRACe<n>:POINTs](#) on page 643.

##### Suffix:

<n>                      irrelevant

<t>	Selects a trace.
<b>Parameters:</b>	
<Occasion>	<b>ALWays</b> Block data transmission is on.
	<b>NEVer</b> Block data transmission is off.
	*RST:       NEVer
<b>Example:</b>	TRAC:FEED:CONT ALW Switches to single sweep mode.

---

#### TRACe<n>:POINts LIMit, <Points>

This command defines the maximum number of measurement points that are transferred in one block after using TRAC? SCAN.

The total amount of bytes which is transferred depends on the number of active traces.

#### Suffix:

<n>                   irrelevant

#### Parameters:

<Points>             Range:       1 to 10000  
                      \*RST:       1000

**Example:**         TRAC:POIN LIM, 8000  
                      Transfers a maximum of 8000 measurement values per trace with a single query.

### 11.4.6.2 Scan Table

[SENSe:]SCAN<range>:BANDwidth:RESolution.....	643
[SENSe:]SCAN<range>:INPut:ATTenuation.....	644
[SENSe:]SCAN<range>:INPut:ATTenuation:AUTO.....	644
[SENSe:]SCAN<range>:INPut:GAIN:AUTO.....	644
[SENSe:]SCAN<range>:INPut:GAIN[:STATE].....	645
[SENSe:]SCAN<range>:INPut:TYPE.....	645
[SENSe:]SCAN:RANGes[:COUNt].....	645
[SENSe:]SCAN<range>:START.....	645
[SENSe:]SCAN<range>:STEP.....	646
[SENSe:]SCAN<range>:STOP.....	646
[SENSe:]SCAN<range>:TIME.....	646
[[SENSe:]SWEep:SPACing.....	647

---

#### [SENSe:]SCAN<range>:BANDwidth:RESolution <Bandwidth>

This command defines the measurement bandwidth for a particular scan range.

#### Suffix:

<range>             1...10  
                      Selects the scan range.

**Parameters:**

<Bandwidth>            Range:     10 Hz to 10 MHz  
                              \*RST:     9 kHz

**Example:**

SCAN4 : BAND : RES 1MHz  
 Defines a measurement bandwidth of 1 MHz for the 4th scan range.

**[SENSe:]SCAN<range>:INPut:ATTenuation <Attenuation>**

This command defines the attenuation level for a particular scan range.

**Suffix:**

<range>                 1...10  
 Selects the scan range.

**Parameters:**

<Attenuation>           dBmin to dBmax  
 Range:            Att(min) to Att(max)  
 \*RST:            10 dB

**Example:**

SCAN4 : INP : ATT 30dB  
 Defines an attenuation level of 30 dB for the 4th scan range.

**[SENSe:]SCAN<range>:INPut:ATTenuation:AUTO <State>**

This command turns auto ranging in a particular scan range on and off.

**Suffix:**

<range>                 1...10  
 Selects the scan range.

**Parameters:**

<State>                 ON | OFF  
 \*RST:            OFF

**Example:**

SCAN4 : INP : ATT : AUTO OFF  
 Turns off auto ranging in the 4th scan range.

**[SENSe:]SCAN<range>:INPut:GAIN:AUTO <State>**

This command includes the preamplifier in the autoranging function of the selected receiver scan range.

**Parameters:**

<State>                 **ON**  
                              **OFF**  
 \*RST:            OFF

**Example:**

:SCAN1 : INP : GAIN : AUTO ON  
 Includes the preamplifier in the autoranging function for scan range 1

---

**[SENSe:]SCAN<range>:INPut:GAIN[:STATE] <State>**

This command turns the preamplifier in a particular scan range on and off.

**Suffix:**

<range>                    1...10  
Selects the scan range.

**Parameters:**

<State>                    ON | OFF  
\*RST:                    OFF

**Example:**

SCAN4:INP:GAIN:STAT ON  
Turns on the preamplifier for the 4th scan range.

---

**[SENSe:]SCAN<range>:INPut:TYPE <Input>**

This command selects the signal source for a particular scan range.

**Suffix:**

<range>                    1...10  
Selects the scan range.

**Parameters:**

<Input>                    **INPUT1**  
Selects RF input 1.  
**INPUT2**  
Selects RF input 2.  
\*RST:                    INPUT1

**Example:**

SCAN4:INP:TYPE INPUT2  
Selects RF input 2 as the signal source for the 4th scan range.

---

**[SENSe:]SCAN:RANGes[:COUNT] <Ranges>**

This command defines the number of scan ranges.

**Parameters:**

<Ranges>                    Number of ranges in the scan table.  
If you enter the value "0", the R&S ESRP ignores the configuration of the scan table. instead, it performs the measurement based on the current receiver configuration.  
Range:                    0 to 10  
\*RST:                    0

**Example:**

SCAN:RANG:COUN 4  
Defines 4 scan ranges.

---

**[SENSe:]SCAN<range>:STARt <Frequency>**

This command defines the start frequency of a particular scan range.



**Suffix:**

<range> 1...10  
Selects the scan range.

**Parameters:**

<Frequency> Range: fmin to fmax  
\*RST: 150 kHz

**Example:**

SCAN4:STAR 30MHz  
Defines a start frequency of 30 MHz for the 4th scan range.

**[SENSe:]SCAN<range>:STEP <Frequency>**

This command defines the frequency stepsize within a particular scan range.

**Suffix:**

<range> 1...10  
Selects the scan range.

**Parameters:**

<Frequency> Range: fmin to fmax  
\*RST: 4 kHz

**Example:**

SCAN4:STEP 1MHz  
Defines a step size of 1 MHz for the 4th scan range.

**[SENSe:]SCAN<range>:STOP <Frequency>**

This command defines the stop frequency of a particular scan range.

**Suffix:**

<range> 1...10  
Selects the scan range.

**Parameters:**

<Frequency> Range: fmin to fmax  
\*RST: 30 MHz

**Example:**

SCAN4:STOP 500MHz  
Defines a stop frequency of 500 MHz for the 4th scan range.

**[SENSe:]SCAN<range>:TIME <Time>**

This command defines the measurement time for a particular scan range.

Note that for time domain scans (R&S ESRP-K53), the available measurement time range depends on the resolution bandwidth.

**Suffix:**

<range> 1...10  
Selects the scan range.

**Parameters:**

<Time>                   Range:     10  $\mu$ s to 100 s  
                               \*RST:     1 ms

**Example:**

SCAN4:TIME 1 ms  
 Defines a measurement time of 1 ms for the 4th scan range.

**[[SENSe:]SWEep:SPACing <Spacing>**

This command selects the frequency step mode.

Note that the command has no effect on the scale and display of the frequency axis.

**Parameters:**

<Spacing>

**LINear**  
 Linear frequency steps with a fix stepsize.

**LOGarithmic**  
 Logarithmic frequency steps with the stepsize being a percentage of the current frequency.

**AUTO**  
 The stepsize is coupled to the resolution bandwidth to get the best measurement results.

\*RST:     LINear

**Example:**

SWE:SPAC LOG  
 Selects logarithmic frequency steps.

**Manual operation:** See "[Step Mode](#)" on page 166

**11.4.6.3 Peak Search**

CALCulate<n>:MARKer<m>:PEXCursion.....	647
CALCulate<n>:PEAKsearch PSEarch:ADD.....	648
CALCulate:PEAKsearch PSEarch:CLEAR[:IMMEDIATE].....	648
CALCulate<n>:PEAKsearch PSEarch[:IMMEDIATE].....	648
CALCulate<n>:PEAKsearch PSEarch:MARGIN.....	648
CALCulate<n>:PEAKsearch PSEarch:METHod.....	649
CALCulate<n>:PEAKsearch PSEarch:SUBRanges.....	649
CALCulate<n>:PEAKsearch PSEarch:SUBRanges:PCOunt.....	650

**CALCulate<n>:MARKer<m>:PEXCursion <Excursion>**

This command defines the peak excursion

The peak excursion sets the requirements for a peak to be detected during a peak search.

**Suffix:**

<n>                   Selects the measurement window.  
 <m>                   irrelevant

**Parameters:**

<Excursion> The peak excursion is the distance to a trace maximum that must be attained before a new maximum is recognized, or the distance to a trace minimum that must be attained before a new minimum is recognized

\*RST: 6 dB

**Example:**

CALC:MARK:PEXC 10dB  
Defines peak excursion 10 dB.

**Manual operation:** See ["Peak Excursion"](#) on page 169  
See ["Peak Excursion"](#) on page 183

**CALCulate<n>:PEAKsearch|PSEarch:ADD <Frequency>**

This command manually adds a particular frequency to the peak list, regardless if the level threshold conditions have been fulfilled for that frequency.

Note that the frequency has to be in the displayed frequency range.

**Suffix:**

<n> irrelevant

**Parameters:**

<Frequency> Numeric value in Hz. The range depends on the measurement.

**Example:**

CALC:PEAK:ADD 93MHz  
Adds the frequency 93 MHz to the peak list.

**Manual operation:** See ["Insert Frequency"](#) on page 170

**CALCulate:PEAKsearch|PSEarch:CLEar[:IMMediate]**

This command deletes the contents of the peak list.

**Example:**

CALC:PEAK:CLE  
Deletes the contents of the peak list.

**Usage:**

Event

**CALCulate<n>:PEAKsearch|PSEarch[:IMMediate]**

This command initiates a peak search and creates a peak list.

**Example:**

CALC:PEAK  
Initiates a peak search.

**Usage:**

Event

**CALCulate<n>:PEAKsearch|PSEarch:MARGin <Margin>**

This command defines a margin for the peak search.

<b>Suffix:</b>	
<n>	irrelevant
<b>Parameters:</b>	
<Margin>	Range: -200 dB to 200 dB *RST: 6 dB
<b>Example:</b>	CALC:PEAK:MARG 5 dB
<b>Manual operation:</b>	See " <a href="#">Margin</a> " on page 169 See " <a href="#">Margin</a> " on page 240 See " <a href="#">Margin</a> " on page 269

---

### CALCulate<n>:PEAKsearch|PSEarch:METHOD <Method>

This command selects the way the R&S ESRP creates a peak list.

<b>Suffix:</b>	
<n>	irrelevant
<b>Parameters:</b>	
<Method>	<b>SUBRange</b> Divides the scan range into smaller subranges and looks for a particular number of peaks in each subrange. <b>PEAK</b> Looks for a particular number of peaks over the complete scan range. *RST: PEAK
<b>Example:</b>	CALC:PEAK:METH SUBR Divides the scan range into smaller subranges for the peak search.
<b>Manual operation:</b>	See " <a href="#">Peak Search Mode (Peaks Subranges)</a> " on page 168

---

### CALCulate<n>:PEAKsearch|PSEarch:SUBRanges <Peaks> | <Subranges>

The effects of this command depend on the peak search mode that you have selected.

<b>Suffix:</b>	
<n>	irrelevant
<b>Parameters:</b>	
<Peaks>	If you have selected the "Peaks" search mode, the command defines the number of peaks to look for during the peak search. Range: 1 to 500 *RST: 50
<Subranges>	If you have selected the Subranges search mode, the command defines the number of subranges that the scan range is split into. Range: 1 to 50 *RST: 10

**Example:**            `CALC:PEAK:METH SUBR`  
                          `CALC:PEAK:SUBR 25`  
 Selects a subrange search and defines 25 subranges.

**Manual operation:** See "No Of Peaks" on page 168  
 See "No of Subranges / Peaks per Subrange" on page 168

#### **CALCulate<n>:PEAKsearch|PSEarch:SUBRanges:PCOunt <Peaks>**

This command defines the number of peaks to be found in each subrange.

Before you can use this command, you have to select the subrange peak search mode with `CALCulate<n>:PEAKsearch|PSEarch:METHOD`.

#### **Parameters:**

<Peaks>                    Number of peaks in one subrange.  
 Note that the maximum number of peaks is 500. Thus, the maximum number of peaks per subrange depends on the number of subranges you have defined.  
 Range:            1 to depends on the number of subranges  
 \*RST:            1

**Example:**            `CALC:PSE:METH SUBR`  
                          `CALC:PSE:SUBR 20`  
                          `CALC:PSE:SUBR:PCO 5`  
 Looks for 5 peaks in each of 20 subranges.

**Manual operation:** See "No of Subranges / Peaks per Subrange" on page 168

### 11.4.6.4 Peak Lists

Commands useful to read peak lists described elsewhere:

- `FORMat:DEXPort:DSEPARATOR` on page 818

<code>DISPlay[:WINDow&lt;n&gt;]:TRACe&lt;t&gt;:SYMBOL</code> .....	650
<code>MMEory:STORE:FINal</code> .....	651
<code>MMEory:STORE:PEAKlist</code> .....	651

#### **DISPlay[:WINDow<n>]:TRACe<t>:SYMBOL <Symbol>**

This command turns the peak labels in the diagram on and off.

#### **Parameters:**

<Symbol>                    **CROSSs**  
 Each peak is labelled by a symbol. The symbol and its color depend on the trace the peak is on.  
**OFF**  
 Peak labels are off.  
 \*RST:            OFF

**Example:**            `DISP:TRAC:SYMB CROSS`

**Manual operation:** See ["Symbols \(On Off\)"](#) on page 171

#### **MMEMory:STORe:FINal** <FileName>

This command exports the contents of the final measurement peak list to a file in ASCII format.

**Parameters:**

<FileName> String containing the file name. The extension of the file is \*.dat.

**Example:** :MMEM:STOR:FIN 'A:\TEST.DAT'

**Usage:** Event

**Manual operation:** See ["Peak List Export"](#) on page 171

#### **MMEMory:STORe:PEAKlist** <FileName>

This command exports the contents of a peak list to a file in ASCII format.

**Parameters:**

<FileName> String containing the file name. The extension of the file is \*.dat.

**Example:** MMEM:STOR:PEAK 'D:\TEST.DAT'

**Manual operation:** See ["Peak List Export"](#) on page 171

### 11.4.6.5 Trace Configuration

Commands useful to configure traces and final measurements described elsewhere:

- [\[SENSe:\]FMEasurement:AUTO](#) on page 612
- [\[SENSe:\]FMEasurement:TIME](#) on page 612
- [\[SENSe:\]DETECTOR<t>:FMEasurement](#) on page 611

[\[SENSe:\]\[WINDow:\]DETECTOR<trace>\[:FUNCTION\].....](#) 651  
[DISPlay\[:WINDow<n>\]:TRACe<t>:MODE.....](#) 652

#### **[SENSe:][WINDow:]DETECTOR<trace>[:FUNCTION]** <Detector>

This command selects the detector for the scan.

**Suffix:**

<trace> 1...6  
 Selects the trace.

**Parameters:**

<Detector> NEGative | POSitive | RMS | AVERage | QPEak | CAverage |  
 CRMS  
 \*RST: APEak

**Example:** DET RMS  
 Selects the RMS detector.

**Manual operation:** See "Trace 1 to 6" on page 172

---

**DISPlay[:WINDow<n>]:TRACe<t>:MODE <Mode>**

This command defines the type of display and the evaluation of the traces. WRITE corresponds to the Clr/Write mode of manual operation. The trace is switched off (= BLANK in manual operation) with `DISPlay[:WINDow<n>]:TRACe<t>[:STATe]`.

The number of measurements for AVERage, MAXHold and MINHold is defined with the `[SENSe:]AVERage<n>:COUNT` or `[SENSe:]SWEep:COUNT` commands. It should be noted that synchronization to the end of the indicated number of measurements is only possible in single sweep mode.

If calculation of average values is active, selection between logarithmic and linear averaging is possible. For more detail see `[SENSe:]AVERage<n>:TYPE` on page 820.

**Suffix:**

<n> window; For applications that do not have more than 1 measurement window, the suffix <n> is irrelevant.

<t> trace

**Parameters:**

<Mode> For more information on trace modes see [Chapter 5.2.3, "Trace Modes"](#), on page 147.

**AVERage**

Average trace mode.

**BLANK**

Blank trace.

**MAXHold**

Maximum value trace.

**MINHold**

Minimum value trace.

**VIEW**

Frozen trace.

**WRITe**

Clear write trace mode.

**Example:**

```
INIT:CONT OFF
```

Switching to single sweep mode.

```
SWE:COUN 16
```

Sets the number of measurements to 16.

```
DISP:TRAC3:MODE MAXH
```

Switches on the calculation of the maximum peak for trace 3.

```
INIT;*WAI
```

Starts the measurement and waits for the end of the 16 sweeps.

**Manual operation:** See "Clear Write" on page 147  
 See "Max Hold" on page 147  
 See "Min Hold" on page 148  
 See "View" on page 148  
 See "Trace 1 to 6" on page 172  
 See "Trace 1 - 6" on page 175  
 See "Average" on page 361

#### 11.4.6.6 LISN Settings

[SENSe:]FMEasurement:LISN:FILTER:HPAS[:STATe].....	653
[SENSe:]FMEasurement:LISN:PHASe.....	653
[SENSe:]FMEasurement:LISN[:TYPE].....	654
INPut:LISN:FILTER:HPAS[:STATe].....	654
INPut:LISN:PHASe.....	655
INPut:LISN[:TYPE].....	655

---

#### [SENSe:]FMEasurement:LISN:FILTER:HPAS[:STATe] <State>

This command turns the 150 kHz highpass filter of the ENV216 network for the final measurement on and off.

The command is available for the R&S ENV216 network.

**Parameters:**

<State>                    ON | OFF  
 \*RST:                    ON

**Example:**

FME:LISN:FILT:HPAS ON  
 Turns on the highpass filter.

**Manual operation:** See "150 kHz Highpass Filter" on page 174

---

#### [SENSe:]FMEasurement:LISN:PHASe <Phase>, [<Phase>]

This command selects the phase of the network used for the final measurement.

**Parameters:**

<Phase>                    **L1**  
                               **L2**  
                               Available for networks with four phases (R&S ESH2Z5,  
                               R&S ENV4200 and R&S ENV432)  
                               **L3**  
                               Available for networks with four phases (R&S ESH2Z5,  
                               R&S ENV4200 and R&S ENV432)  
                               **N**  
 \*RST:                    L1

**Example:**

FME:LISN:PHAS L1,N

**Manual operation:** See "Final Test Phase" on page 173



**[SENSe:]FMEasurement:LISN[:TYPE] <Type>**

This command turns automatic control of the network used for the final measurement on and off. It also selects the type of network in use.

**Parameters:**

&lt;Type&gt;

**ENV216**

R&amp;S ENV 216: two phases and highpass are controllable.

**ENV432**

R&amp;S ENV 432: four phases are controllable.

**ENV4200**

R&amp;S ENV 4200: four phases are controllable.

**ESH2Z5**

R&amp;S ESH2-Z5: four phases and protective earth are controllable.

**ESH3Z5**

R&amp;S ESH3-Z5: two phases and protective earth are controllable.

**FOURphase**

R&amp;S ESH2-Z5: four phases and protective earth are controllable.

**OFF**

Turns off remote control of the LISN.

**TWOPhase**

R&amp;S ESH3-Z5: two phases and protective earth are controllable.

\*RST: OFF

**Example:**

FME:LISN TWOP

Turns automatic control of the network on and selects the R&amp;S ESH3-Z5 network.

**Manual operation:** See "[LISN Type](#)" on page 173**INPut:LISN:FILTer:HPAS[:STATE] <State>**

This command turns the 150 kHz highpass filter of the ENV216 network for the pre-measurement on and off.

The command is available for the R&S ENV216 network.

**Parameters:**

&lt;State&gt;

ON | OFF

\*RST: OFF

**Example:**

INP:LISN:FILT:HPAS ON

Turns on the highpass filter.

**Manual operation:** See "[150 kHz Highpass Filter](#)" on page 174

**INPut:LISN:PHASe** <Phase>, [<Phase>]

This command selects the phase of the network used for the premeasurement.

**Parameters:**

<Phase>	<b>L1</b>
	<b>L2</b>
	Available for networks with four phases (R&S ESH2Z5, R&S ENV4200 and R&S ENV432)
	<b>L3</b>
	Available for networks with four phases (R&S ESH2Z5, R&S ENV4200 and R&S ENV432)
	<b>N</b>
*RST:	L1

**Example:**

```
INP:LISN:PHAS L1,L2
```

Selects phases L1 and L2 for the scan.

**Manual operation:** See "[Prescan Phase](#)" on page 173

**INPut:LISN[:TYPE]** <Type>

This command turns automatic control of the network used for the premeasurement on and off. It also selects the type of network in use.

**Parameters:**

<Type>	<b>ENV216</b>
	R&S ENV 216: two phases and highpass are controllable.
	<b>ENV432</b>
	R&S ENV 432: four phases are controllable.
	<b>ENV4200</b>
	R&S ENV 4200: four phases are controllable.
	<b>ESH2Z5</b>
	R&S ESH2-Z5: four phases and protective earth are controllable.
	<b>ESH3Z5</b>
	R&S ESH3-Z5: two phases and protective earth are controllable.
	<b>FOURphase</b>
	R&S ESH2-Z5: four phases and protective earth are controllable.
	<b>OFF</b>
	Turns off remote control of the LISN.
	<b>TWOPhase</b>
	R&S ESH3-Z5: two phases and protective earth are controllable.
*RST:	OFF

**Example:**

```
INP:LISN TWOP
```

Turns automatic control of the network on and selects the R&S ESH3-Z5 network.

**Manual operation:** See "LISN Type" on page 173

## 11.4.7 Working with Markers

- [Configuring Marker Functionality](#)..... 656
- [Using Markers](#)..... 659
- [Using Delta Markers](#)..... 665

### 11.4.7.1 Configuring Marker Functionality

<a href="#">CALCulate&lt;n&gt;:MARKer&lt;m&gt;:COUPlEd[:STATe]</a> .....	656
<a href="#">CALCulate&lt;n&gt;:MARKer&lt;m&gt;:FUNCTion:CENTer</a> .....	656
<a href="#">CALCulate&lt;n&gt;:MARKer&lt;m&gt;:FUNCTion:CSep</a> .....	657
<a href="#">CALCulate&lt;n&gt;:MARKer&lt;m&gt;:FUNCTion:ZOOM</a> .....	657
<a href="#">CALCulate&lt;n&gt;:MARKer&lt;m&gt;:SCOuPlEd[:STATe]</a> .....	657
<a href="#">CALCulate&lt;n&gt;:MARKer&lt;m&gt;:X:SLIMits:LEFT</a> .....	658
<a href="#">CALCulate&lt;n&gt;:MARKer&lt;m&gt;:X:SLIMits:RIGHT</a> .....	658
<a href="#">CALCulate&lt;n&gt;:MARKer&lt;m&gt;:X:SLIMits[:STATe]</a> .....	659
<a href="#">DISPlay[:WINDow&lt;n&gt;]:MINFo:STATe</a> .....	659

---

#### **CALCulate<n>:MARKer<m>:COUPlEd[:STATe] <State>**

This command couples or decouples the receiver frequency to the current marker frequency.

**Parameters:**

<State>                    ON | OFF  
 \*RST:                    OFF

**Example:**

CALC:MARK:COUP ON  
 Couples the frequency to the marker frequency.

**Manual operation:** See "Marker Track" on page 180

---

#### **CALCulate<n>:MARKer<m>:FUNCTion:CENTer**

This command matches the center or receiver frequency to the frequency of a marker.

If you use the command in combination with a delta marker, that delta marker is turned into a normal marker.

**Suffix:**

<n>                         Selects the measurement window.  
 <m>                         Selects the marker.

**Example:**

CALC:MARK2:FUNC:CENT  
 Sets the center frequency to the frequency of marker 2.

**Manual operation:** See "Tune to Marker" on page 179  
 See "Center =Mkr Freq (span > 0)" on page 383

**CALCulate<n>:MARKer<m>:FUNcTion:CSTep**

This command matches the frequency step size to the current marker frequency.

The command turns delta markers into normal markers.

**Suffix:**

<n> Selects the measurement window.

<m> Selects the marker.

**Example:**

```
CALC:MARK3:FUNC:CST
```

Sets the center frequency to the same value as the frequency of marker 3.

**Usage:** Event

**Manual operation:** See "[Marker to Stepsize](#)" on page 180

**CALCulate<n>:MARKer<m>:FUNcTion:ZOOM <Range>**

This command defines the range to be zoomed around marker 1. Marker 1 is activated first, if necessary.

The marker frequency becomes the new receiver or center frequency and the span is adjusted according to the zoom factor.

Note that you should perform a complete measurement with synchronization to the end of the measurement. This is only possible for single sweeps.

**Suffix:**

<n> Selects the measurement window.

<m> Selects the marker.

**Parameters:**

<Range> **<numeric\_value>**

**Example:**

```
INIT:CONT OFF
```

Switches to single sweep mode

```
CALC:MARK:FUNC:ZOOM 1kHz;*WAI
```

Activates zooming and waits for its end.

**Manual operation:** See "[Marker Zoom \(span > 0\)](#)" on page 379

**CALCulate<n>:MARKer<m>:SCOupled[:STATe] <State>**

This command couples or decouples the marker frequency to the scan range settings.

**Parameters:**

<State> ON | OFF

\*RST: ON

**Example:**

```
CALC:MARK:SCO ON
```

Couples the scan range settings to the marker frequency.

**Manual operation:** See "[Settings Coupled](#)" on page 180

**CALCulate<n>:MARKer<m>:X:SLIMits:LEFT <Limit>**

This command sets the left limit of the marker search range.

If the power measurement in zero span is active, this command limits the evaluation range to the trace.

**Note:** The function is only available if the search limit for marker and delta marker is switched on (see `CALCulate<n>:MARKer<m>:X:SLIMits[:STATe]`).

**Suffix:**

<n>                      Selects the measurement window.  
 <m>                      irrelevant

**Parameters:**

<Limit>                      The value range depends on the span or sweep time.  
                                     The unit is Hz for frequency domain measurements and s for  
                                     time domain measurements.

Range:            0 to MAX  
 \*RST:            left diagram border

**Example:**

```
CALC:MARK:X:SLIM ON
Switches the search limit function on.
CALC:MARK:X:SLIM:LEFT 10MHz
Sets the left limit of the search range to 10 MHz.
```

**Manual operation:** See "[Left Limit](#)" on page 182  
 See "[Left Limit](#)" on page 273

**CALCulate<n>:MARKer<m>:X:SLIMits:RIGHT <Limit>**

This command sets the right limit of the marker search range.

If the power measurement in zero span is active, this command limits the evaluation range to the trace.

**Note:** The function is only available if the search limit for marker and delta marker is switched on ( `CALCulate<n>:MARKer<m>:X:SLIMits[:STATe]` ).

**Suffix:**

<n>                      Selects the measurement window.  
 <m>                      irrelevant

**Parameters:**

<Limit>                      The value range depends on the span or sweep time.  
                                     The unit is Hz for frequency domain measurements and s for  
                                     time domain measurements.

Range:            0 to MAX  
 \*RST:            left diagram border

- Example:**            `CALC:MARK:X:SLIM ON`  
Switches the search limit function on.  
`CALC:MARK:X:SLIM:RIGH 20MHz`  
Sets the right limit of the search range to 20 MHz.
- Manual operation:** See ["Right Limit"](#) on page 182  
See ["Right Limit"](#) on page 273

#### **CALCulate<n>:MARKer<m>:X:SLIMits[:STATe] <State>**

This command turns marker search limits on and off.

If the power measurement in zero span is active, this command limits the evaluation range on the trace.

- Suffix:**
- <n>                    Selects the measurement window.
- <m>                    marker

- Parameters:**
- <State>                ON | OFF  
\*RST:                 OFF

- Example:**            `CALC:MARK:X:SLIM ON`  
Switches on search limitation.

- Manual operation:** See ["Search Limits"](#) on page 182  
See ["Search Lim Off"](#) on page 183  
See ["Limits \(On/Off\)"](#) on page 272

#### **DISPlay[:WINDow<n>]:MINFo:STATe <State>**

This command turns the marker info field in the diagram on and off.

- Parameters:**
- <State>                ON | OFF  
\*RST:                 ON

- Example:**            `DISP:MINF:STAT ON`  
Turns the marker info field on.

- Manual operation:** See ["Marker Info \(On Off\)"](#) on page 179

### 11.4.7.2 Using Markers

<code>CALCulate&lt;n&gt;:MARKer&lt;m&gt;:AOFF</code> .....	660
<code>CALCulate&lt;n&gt;:MARKer&lt;m&gt;:MAXimum:LEFT</code> .....	660
<code>CALCulate&lt;n&gt;:MARKer&lt;m&gt;:MAXimum:NEXT</code> .....	660
<code>CALCulate&lt;n&gt;:MARKer&lt;m&gt;:MAXimum[:PEAK]</code> .....	661
<code>CALCulate&lt;n&gt;:MARKer&lt;m&gt;:MAXimum:RIGHT</code> .....	661
<code>CALCulate&lt;n&gt;:MARKer&lt;m&gt;:MINimum:LEFT</code> .....	662
<code>CALCulate&lt;n&gt;:MARKer&lt;m&gt;:MINimum:NEXT</code> .....	662

CALCulate<n>:MARKer<m>:MINimum[:PEAK]	662
CALCulate<n>:MARKer<m>:MINimum:RIGHT	663
CALCulate<n>:MARKer<m>[:STATE]	663
CALCulate<n>:MARKer<m>:TRACe	664
CALCulate<n>:MARKer<m>:X	664
CALCulate<n>:MARKer<m>:Y	664

---

### CALCulate<n>:MARKer<m>:AOFF

This command all markers off, including delta markers and marker measurement functions.

**Suffix:**

<n>	Selects the measurement window.
<m>	depends on mode irrelevant

**Example:**

CALC:MARK:AOFF  
Switches off all markers.

**Usage:**

Event

**Manual operation:**

See ["All Marker Off"](#) on page 179  
See ["Marker Configuration"](#) on page 279

---

### CALCulate<n>:MARKer<m>:MAXimum:LEFT

This command positions a marker to the next smaller trace maximum on the left of the current position (i.e. in descending X values).

If no next smaller maximum value is found on the trace (level spacing to adjacent values < peak excursion), an execution error (error code: -200) is produced.

**Suffix:**

<n>	Selects the measurement window.
<m>	Selects the marker.

**Example:**

CALC:MARK2:MAX:LEFT  
Positions marker 2 to the next lower maximum value to the left of the current value.

**Usage:**

Event

**Manual operation:**

See ["Next Mode"](#) on page 181

---

### CALCulate<n>:MARKer<m>:MAXimum:NEXT

This command positions the marker to the next smaller trace maximum.

If no next smaller maximum value is found on the trace (level spacing to adjacent values < peak excursion), an execution error (error code: -200) is produced.

<b>Suffix:</b>	
<n>	Selects the measurement window.
<m>	Selects the marker.
<b>Example:</b>	CALC:MARK2:MAX:NEXT Positions marker 2 to the next lower maximum value.
<b>Usage:</b>	Event
<b>Manual operation:</b>	See "Next Peak" on page 181 See "Next Mode" on page 181

---

#### CALCulate<n>:MARKer<m>:MAXimum[:PEAK]

This command positions the marker on the current trace maximum.

The corresponding marker is activated first or switched to the marker mode.

If no maximum value is found on the trace (level spacing to adjacent values < peak excursion), an execution error (error code: -200) is produced.

<b>Suffix:</b>	
<n>	Selects the measurement window.
<m>	depends on mode Selects the marker.
<b>Example:</b>	CALC:MARK2:MAX Positions marker 2 to the maximum value of the trace.
<b>Usage:</b>	Event
<b>Manual operation:</b>	See "Peak" on page 181

---

#### CALCulate<n>:MARKer<m>:MAXimum:RIGHT

This command positions a marker to the next smaller trace maximum on the right of the current value (i.e. in ascending X values).

If no next smaller maximum value is found on the trace (level spacing to adjacent values < peak excursion), an execution error (error code: -200) is produced.

<b>Suffix:</b>	
<n>	Selects the measurement window.
<m>	Selects the marker.
<b>Example:</b>	CALC:MARK2:MAX:RIGH Positions marker 2 to the next lower maximum value to the right of the current value.
<b>Usage:</b>	Event
<b>Manual operation:</b>	See "Next Mode" on page 181



**CALCulate<n>:MARKer<m>:MINimum:LEFT**

This command positions a marker to the next higher trace minimum on the left of the current value (i.e. in descending X direction).

If no next higher minimum value is found on the trace (level spacing to adjacent values < peak excursion), an execution error (error code: -200) is produced.

**Suffix:**

<n> Selects the measurement window.

<m> Selects the marker.

**Example:**

`CALC:MARK2:MIN`

Positions marker 2 to the minimum value of the trace.

`CALC:MARK2:MIN:LEFT`

Positions marker 2 to the next higher minimum value to the left of the current value.

**Usage:** Event

**Manual operation:** See "Next Mode" on page 181

**CALCulate<n>:MARKer<m>:MINimum:NEXT**

This command positions a marker to the next higher trace minimum.

If no next higher minimum value is found on the trace (level spacing to adjacent values < peak excursion), an execution error (error code: -200) is produced.

**Suffix:**

<n> Selects the measurement window.

<m> Selects the marker.

**Example:**

`CALC:MARK2:MIN`

Positions marker 2 to the minimum value of the trace.

`CALC:MARK2:MIN:NEXT`

Positions marker 2 to the next higher maximum value.

**Usage:** Event

**Manual operation:** See "Next Min" on page 181

See "Next Mode" on page 181

**CALCulate<n>:MARKer<m>:MINimum[:PEAK]**

This command positions the marker on the current trace minimum.

The corresponding marker is activated first or switched to marker mode, if necessary.

If no minimum value is found on the trace (level spacing to adjacent values < peak excursion), an execution error (error code: -200) is produced.

**Suffix:**

<n> Selects the measurement window.

<m> depends on mode  
Selects the marker.

**Example:** `CALC:MARK2:MIN`  
Positions marker 2 to the minimum value of the trace.

**Usage:** Event

**Manual operation:** See "[Min](#)" on page 181

#### **CALCulate<n>:MARKer<m>:MINimum:RIGHT**

This command positions a marker to the next higher trace minimum on the right of the current value (i.e. in ascending X direction).

If no next higher minimum value is found on the trace (level spacing to adjacent values < peak excursion), an execution error (error code: -200) is produced.

**Suffix:**

<n> Selects the measurement window.

<m> Selects the marker.

**Example:** `CALC:MARK2:MIN`  
Positions marker 2 to the minimum value of the trace.  
`CALC:MARK2:MIN:RIGH`  
Positions marker 2 to the next higher minimum value to the right of the current value.

**Usage:** Event

**Manual operation:** See "[Next Mode](#)" on page 181

#### **CALCulate<n>:MARKer<m>[:STATe] <State>**

This command turns markers on and off.

If the corresponding marker number is currently active as a deltamarker, it is turned into a normal marker.

**Suffix:**

<n> Selects the measurement window.

<m> depends on mode  
Selects the marker.

**Parameters:**

<State> ON | OFF  
\*RST: OFF

**Example:** `CALC:MARK3 ON`  
Switches on marker 3 or switches to marker mode.

**Manual operation:** See "[Marker 1 / Marker 2 / Marker 3 / ... Marker 16, / Marker Norm/Delta](#)" on page 177  
See "[Marker Wizard](#)" on page 178

**CALCulate<n>:MARKer<m>:TRACe <Trace>**

This command selects the trace a marker is positioned on.

The corresponding trace must have a trace mode other than "Blank".

If necessary, the corresponding marker is switched on prior to the assignment.

**Suffix:**

<n> Selects the measurement window.

<m> depends on mode  
Selects the marker.

**Parameters:**

<Trace> **1 ... 6**  
Trace number the marker is positioned on.

**Example:** `CALC:MARK3:TRAC 2`  
Assigns marker 3 to trace 2.

**Manual operation:** See ["Marker to Trace"](#) on page 178  
See ["Marker Wizard"](#) on page 178  
See ["Marker Configuration"](#) on page 279

**CALCulate<n>:MARKer<m>:X <Position>**

This command positions a marker on a particular coordinate on the x-axis.

If marker 2, 3 or 4 is selected and used as delta marker, it is switched to marker mode.

**Suffix:**

<n> Selects the measurement window.

<m> Selects the marker.

**Parameters:**

<Position> Numeric value that defines the marker position on the x-axis.  
The unit is either Hz (frequency domain) or s (time domain) or dB (statistics).

Range: The range depends on the current x-axis range.

**Example:** `CALC:MARK2:X 1.7MHz`  
Positions marker 2 to frequency 1.7 MHz.

**Manual operation:** See ["Marker 1 / Marker 2 / Marker 3 / ... Marker 16, / Marker Norm/Delta"](#) on page 177

**CALCulate<n>:MARKer<m>:Y <MarkerPosition>**

This command queries the measured value of a marker.

If necessary, the command activates the marker or turns a delta marker into a normal marker.

To get a valid result, you have to perform a complete measurement with synchronization to the end of the measurement before reading out the result. This is only possible for single sweeps.

The unit of results depends on the result display and the unit you have selected.

In the default setting, the output is made depending on the unit determined with `CALCulate<n>:UNIT:POWer`; only with linear level scaling the output is in %.

**Suffix:**

<n> Selects the measurement window.  
 <m> Selects the marker.

**Parameters:**

<MarkerPosition> Defines the vertical marker position in the persistence spectrum result display.

**Return values:**

<Result> The measured value of the selected marker is returned.  
 In I/Q Analyzer mode, if the result display configuration "Real/Imag (I/Q)" is selected, this query returns the Real (Q) value of the marker first, then the Imag (I) value.

**Example:**

```
INIT:CONT OFF
Switches to single sweep mode.
CALC:MARK2 ON
Switches marker 2.
INIT;*WAI
Starts a sweep and waits for the end.
CALC:MARK2:Y?
Outputs the measured value of marker 2.
In I/Q Analyzer mode, for "Real/Imag (I/Q)", for example:
1.852719887E-011,0
```

**Manual operation:** See "Marker 1 / Marker 2 / Marker 3 / ... Marker 16,/ Marker Norm/Delta" on page 177

### 11.4.7.3 Using Delta Markers

<code>CALCulate&lt;n&gt;:DELTamarker&lt;m&gt;:AOFF</code> .....	666
<code>CALCulate&lt;n&gt;:DELTamarker&lt;m&gt;:LINK</code> .....	666
<code>CALCulate&lt;n&gt;:DELTamarker&lt;m&gt;:MAXimum:LEFT</code> .....	666
<code>CALCulate&lt;n&gt;:DELTamarker&lt;m&gt;:MAXimum:NEXT</code> .....	667
<code>CALCulate&lt;n&gt;:DELTamarker&lt;m&gt;:MAXimum[:PEAK]</code> .....	667
<code>CALCulate&lt;n&gt;:DELTamarker&lt;m&gt;:MAXimum:RIGHT</code> .....	667
<code>CALCulate&lt;n&gt;:DELTamarker&lt;m&gt;:MINimum:LEFT</code> .....	668
<code>CALCulate&lt;n&gt;:DELTamarker&lt;m&gt;:MINimum:NEXT</code> .....	668
<code>CALCulate&lt;n&gt;:DELTamarker&lt;m&gt;:MINimum[:PEAK]</code> .....	668
<code>CALCulate&lt;n&gt;:DELTamarker&lt;m&gt;:MINimum:RIGHT</code> .....	669
<code>CALCulate&lt;n&gt;:DELTamarker&lt;m&gt;:MODE</code> .....	669
<code>CALCulate&lt;n&gt;:DELTamarker&lt;m&gt;[:STATE]</code> .....	669
<code>CALCulate&lt;n&gt;:DELTamarker&lt;m&gt;:TRACe</code> .....	670

CALCulate<n>:DELTamarker<m>:X.....	670
CALCulate<n>:DELTamarker<m>:X:RELative?.....	671
CALCulate<n>:DELTamarker<m>:Y.....	671

---

### CALCulate<n>:DELTamarker<m>:AOFF

This command turns all active delta markers off.

#### Suffix:

<n>	Selects the measurement window.
<m>	Selects the marker.

**Example:**            CALC:DELT:AOFF  
Switches off all delta markers.

**Manual operation:** See "[Marker Configuration](#)" on page 279

---

### CALCulate<n>:DELTamarker<m>:LINK <State>

This command links delta marker 1 to marker 1.

If you change the horizontal position of the marker, so does the delta marker.

#### Suffix:

<n>	Selects the measurement window.
<m>	1 irrelevant

#### Parameters:

<State>	ON   OFF
*RST:	OFF

**Example:**            CALC:DELT:LINK ON

**Manual operation:** See "[Link Mkr1 and Delta1](#)" on page 379

---

### CALCulate<n>:DELTamarker<m>:MAXimum:LEFT

This command positions the delta marker to the next smaller trace maximum on the left of the current value (i.e. descending X values). The corresponding delta marker is activated first, if necessary.

If no next higher minimum value is found on the trace (level spacing to adjacent values < peak excursion), an execution error (error code: -200) is produced.

#### Suffix:

<n>	Selects the measurement window.
<m>	Selects the marker.

**Example:**            CALC:DELT:MAX:LEFT  
Sets delta marker 1 to the next smaller maximum value to the left of the current value.

**Manual operation:** See "Next Mode" on page 181

---

#### **CALCulate<n>:DELTamarker<m>:MAXimum:NEXT**

This command positions the delta marker to the next smaller trace maximum. The corresponding delta marker is activated first, if necessary.

If no next higher minimum value is found on the trace (level spacing to adjacent values < peak excursion), an execution error (error code: -200) is produced.

**Suffix:**

<n> Selects the measurement window.

<m> Selects the marker.

**Example:**

`CALC:DELT2:MAX:NEXT`

Sets delta marker 2 to the next smaller maximum value.

**Manual operation:** See "Next Peak" on page 181

See "Next Mode" on page 181

---

#### **CALCulate<n>:DELTamarker<m>:MAXimum[:PEAK]**

This command positions the delta marker to the current trace maximum. If necessary, the corresponding delta marker is activated first.

**Suffix:**

<n> Selects the measurement window.

<m> Selects the marker.

**Example:**

`CALC:DELT3:MAX`

Sets delta marker 3 to the maximum value of the associated trace.

**Manual operation:** See "Peak" on page 181

---

#### **CALCulate<n>:DELTamarker<m>:MAXimum:RIGHT**

This command positions the delta marker to the next smaller trace maximum on the right of the current value (i.e. ascending X values). The corresponding delta marker is activated first, if necessary.

If no next higher minimum value is found on the trace (level spacing to adjacent values < peak excursion), an execution error (error code: -200) is produced.

**Suffix:**

<n> Selects the measurement window.

<m> Selects the marker.

**Example:**

`CALC:DELT:MAX:RIGH`

Sets delta marker 1 to the next smaller maximum value to the right of the current value.

**Manual operation:** See "Next Mode" on page 181

---

#### **CALCulate<n>:DELTamarker<m>:MINimum:LEFT**

This command positions the delta marker to the next higher trace minimum on the left of the current value (i.e. descending X values). The corresponding delta marker is activated first, if necessary.

If no next higher minimum value is found on the trace (level spacing to adjacent values < peak excursion), an execution error (error code: -200) is produced.

**Suffix:**

<n> Selects the measurement window.

<m> Selects the marker.

**Example:**

`CALC:DELT:MIN:LEFT`

Sets delta marker 1 to the next higher minimum to the left of the current value.

**Manual operation:** See "Next Mode" on page 181

---

#### **CALCulate<n>:DELTamarker<m>:MINimum:NEXT**

This command positions the delta marker to the next higher trace minimum. The corresponding delta marker is activated first, if necessary.

If no next higher minimum value is found on the trace (level spacing to adjacent values < peak excursion), an execution error (error code: -200) is produced.

**Suffix:**

<n> Selects the measurement window.

<m> Selects the marker.

**Example:**

`CALC:DELT2:MIN:NEXT`

Sets delta marker 2 to the next higher minimum value.

**Manual operation:** See "Next Min" on page 181  
See "Next Mode" on page 181

---

#### **CALCulate<n>:DELTamarker<m>:MINimum[:PEAK]**

This command positions the delta marker to the current trace minimum. The corresponding delta marker is activated first, if necessary.

**Suffix:**

<n> Selects the measurement window.

<m> Selects the marker.

**Example:**

`CALC:DELT3:MIN`

Sets delta marker 3 to the minimum value of the associated trace.

**Manual operation:** See "Min" on page 181

---

#### **CALCulate<n>:DELTamarker<m>:MINimum:RIGHT**

This command positions the delta marker to the next higher trace minimum on the right of the current value (i.e. ascending X values). The corresponding delta marker is activated first, if necessary.

If no next higher minimum value is found on the trace (level spacing to adjacent values < peak excursion), an execution error (error code: -200) is produced.

**Suffix:**

<n> Selects the measurement window.

<m> Selects the marker.

**Example:**

`CALC:DELT:MIN:RIGH`

Sets delta marker 1 to the next higher minimum value to the right of the current value.

**Manual operation:** See "Next Mode" on page 181

---

#### **CALCulate<n>:DELTamarker<m>:MODE <Mode>**

This command selects the delta marker mode.

**Suffix:**

<n> Selects the measurement window.

<m> Selects the marker.

**Parameters:**

<Mode>

**ABSolute**

Delta marker position in absolute terms.

**RELative**

Delta marker position in relation to a reference marker.

\*RST: REL

**Example:**

`CALC:DELT:MODE ABS`

Absolute delta marker position.

---

#### **CALCulate<n>:DELTamarker<m>[:STATe] <State>**

This command turns delta markers on and off.

If the corresponding marker was a normal marker, it is turned into a delta marker.

No suffix at DELTmarker turns on delta marker 1.

**Suffix:**

<n> Selects the measurement window.

<m> Selects the marker.



**Parameters:**

<State> ON | OFF  
 \*RST: OFF

**Example:**

CALC:DELT1 ON  
 Switches marker 1 to delta marker mode.

**Manual operation:**

See "[Marker 1 / Marker 2 / Marker 3 / ... Marker 16, / Marker Norm/Delta](#)" on page 177  
 See "[Marker Wizard](#)" on page 178

**CALCulate<n>:DELTamarker<m>:TRACe <TraceNumber>**

This command selects the trace a delta marker is positioned on.

The corresponding trace must have a trace mode other than "Blank".

**Suffix:**

<n> Selects the measurement window.  
 <m> Selects the marker.

**Parameters:**

<TraceNumber> 1 ... 6  
 Trace number the marker is positioned on.

**Example:**

CALC:DELT3:TRAC 2  
 Assigns delta marker 3 to trace 2.

**Manual operation:**

See "[Marker to Trace](#)" on page 178  
 See "[Marker Wizard](#)" on page 178  
 See "[Marker Configuration](#)" on page 279

**CALCulate<n>:DELTamarker<m>:X <Position>**

This command positions a delta marker on a particular coordinate on the x-axis.

The position is an absolute value.

You can enter a relative value, if you activate relative entry first with `CALCulate<n>:DELTamarker<m>:MODE`.

If fixed reference is active, the position is relative to the fixed reference (`CALCulate<n>:DELTamarker<m>:FUNCTION:FIXed[:STATE]` is ON). A query always returns the absolute position.

**Suffix:**

<n> Selects the measurement window.  
 <m> Selects the marker.

**Parameters:**

<Position> 0 to maximum frequency or sweep time

**Example:**

CALC:DELT:X?  
 Outputs the absolute frequency/time of delta marker 1.

**Manual operation:** See "[Marker 1 / Marker 2 / Marker 3 / ... Marker 16, / Marker Norm/Delta](#)" on page 177

---

### CALCulate<n>:DELTamarker<m>:X:RELative?

This command queries the x-value of the selected delta marker relative to marker 1 or to the reference position (for `CALC:DELT:FUNC:FIX:STAT ON`). The command activates the corresponding delta marker, if necessary.

**Suffix:**

<n> Selects the measurement window.

<m> Selects the marker.

**Example:**

`CALC:DELT3:X:REL?`

Outputs the frequency of delta marker 3 relative to marker 1 or relative to the reference position.

**Usage:**

Query only

**Manual operation:** See "[Marker 1 / Marker 2 / Marker 3 / ... Marker 16, / Marker Norm/Delta](#)" on page 177

---

### CALCulate<n>:DELTamarker<m>:Y

This command queries the measured value of a delta marker. The corresponding delta marker is activated, if necessary. The output is always a relative value referred to marker 1 or to the reference position (reference fixed active).

To get a valid result, you have to perform a complete measurement with synchronization to the end of the measurement before reading out the result. This is only possible for single sweeps.

The unit of results depends on the result display and the unit you have selected.

**Table 11-19: Base unit**

Parameter, measuring function or result display	Output unit
DBM   DBPW   DBUV   DBMV   DBUA	dB (lin/log)
WATT   VOLT   AMPere	dB (lin), % (log)
statistics function (APD or CCDF) on	dimensionless output

**Suffix:**

<n> Selects the measurement window.

<m> Selects the marker.

**Example:**           INIT:CONT OFF  
Switches to single sweep mode.  
INIT;\*WAI  
Starts a sweep and waits for its end.  
CALC:DELT2 ON  
Switches on delta marker 2.  
CALC:DELT2:Y?  
Outputs measurement value of delta marker 2.

**Manual operation:** See "[Marker 1 / Marker 2 / Marker 3 / ... Marker 16, / Marker Norm/Delta](#)" on page 177

## 11.4.8 Limit Lines

- [Using Display Lines](#).....672
- [Using Frequency Lines](#)..... 673
- [Using Limit Lines](#).....674

### 11.4.8.1 Using Display Lines

[CALCulate<n>:DLINe<k>](#).....672  
[CALCulate<n>:DLINe<k>:STATe](#)..... 672

---

#### **CALCulate<n>:DLINe<k>** <Position>

This command defines the (vertical) position of a display line.

##### **Suffix:**

<n>                   Selects the measurement window.

<k>                   1 | 2  
Selects the display line.

##### **Parameters:**

<Position>           The value range is variable.  
The unit depends on [CALCulate<n>:UNIT:POWer](#).  
\*RST:               (state is OFF)

**Example:**           CALC:DLIN -20dBm

**Manual operation:** See "[Display Line 1 / Display Line 2](#)" on page 188

---

#### **CALCulate<n>:DLINe<k>:STATe** <State>

This command turns a display line on and off.

##### **Suffix:**

<n>                   Selects the measurement window.

<k>                   1 | 2  
Selects the display line.

**Parameters:**

<State> ON | OFF  
 \*RST: OFF

**Example:**

CALC:DLIN2:STAT OFF

**Manual operation:** See "Display Line 1 / Display Line 2" on page 188

**11.4.8.2 Using Frequency Lines**

CALCulate<n>:FLINe<k>.....	673
CALCulate<n>:FLINe<k>:STATe.....	673
CALCulate:TFLINe:STATe.....	673

**CALCulate<n>:FLINe<k> <Frequency>**

This command defines the position of a frequency line.

**Suffix:**

<n> Selects the measurement window.  
 <k> 1 | 2  
 Selects the frequency line.

**Parameters:**

<Frequency> Range: 0 Hz to fmax  
 \*RST: (STATe to OFF)

**Example:**

CALC:FLIN2 120MHz

**Manual operation:** See "Frequency Line 1 / Frequency Line 2 " on page 189

**CALCulate<n>:FLINe<k>:STATe <State>**

This command turns a frequency line on and off.

**Suffix:**

<n> Selects the measurement window.  
 <k> 1 | 2  
 Selects the frequency line.

**Parameters:**

<State> ON | OFF  
 \*RST: OFF

**Example:**

CALC:FLIN2:STAT ON

**Manual operation:** See "Frequency Line 1 / Frequency Line 2 " on page 189

**CALCulate:TFLINe:STATe <State>**

This command turns a frequency line coupled to the receiver frequency on and off.

**Parameters:****<State>** ON | OFF**Example:**

CALC:TFL:STAT ON

Turns on the frequency line.

**Manual operation:** See "Tuned Frequency (On Off)" on page 189**11.4.8.3 Using Limit Lines**

- [Managing Limit Lines](#)..... 674
- [Configuring Limit Lines](#)..... 677
- [Checking Limits](#)..... 686

**Managing Limit Lines**

<a href="#">CALCulate&lt;n&gt;:LIMit&lt;k&gt;:ACTive?</a> .....	674
<a href="#">CALCulate&lt;n&gt;:LIMit&lt;k&gt;:COMMent</a> .....	674
<a href="#">CALCulate&lt;n&gt;:LIMit&lt;k&gt;:COpy</a> .....	675
<a href="#">CALCulate&lt;n&gt;:LIMit&lt;k&gt;:DELeTe</a> .....	675
<a href="#">CALCulate&lt;n&gt;:LIMit&lt;k&gt;:NAME</a> .....	675
<a href="#">CALCulate&lt;n&gt;:LIMit&lt;k&gt;:TRACe</a> .....	676
<a href="#">CALCulate&lt;n&gt;:LIMit&lt;k&gt;:UNIT</a> .....	676

**CALCulate<n>:LIMit<k>:ACTive?**

This command queries the names of all active limit lines.

**Suffix:****<n>** irrelevant**<k>** irrelevant**Return values:****<LimitLines>** String containing the names of all active limit lines in alphabetical order.**Example:**

CALC:LIM:ACT?

Queries the names of all active limit lines.

**Usage:**

Query only

**CALCulate<n>:LIMit<k>:COMMent <Comment>**

This command defines a comment for the selected limit line in all windows.

**Suffix:****<n>** irrelevant**<k>** Selects the limit line.**Parameters:****<Comment>** String containing the comment. The maximum number of characters the string may contain is 40.

**Example:** `CALC:LIM5:COMM 'Upper limit for spectrum'`  
Defines the comment for limit line 5.

**Manual operation:** See ["Edit Comment"](#) on page 186

### **CALCulate<n>:LIMit<k>:COPY <Line>**

This command copies a limit line.

**Suffix:**

<n> irrelevant

<k> Selects the limit line.

**Parameters:**

<Line> **1 to 8**  
number of the new limit line

**<name>**

String containing the name of the limit line.

**Example:** `CALC:LIM1:COPY 2`  
Copies limit line 1 to line 2.  
`CALC:LIM1:COPY 'FM2'`  
Copies limit line 1 to a new line named FM2.

**Manual operation:** See ["Copy to"](#) on page 187

### **CALCulate<n>:LIMit<k>:DELete**

This command deletes a limit line.

**Suffix:**

<n> irrelevant

<k> Selects the limit line.

**Example:** `CALC:LIM1:DEL`  
Deletes limit line 1.

**Usage:** Event

**Manual operation:** See ["Delete"](#) on page 188

### **CALCulate<n>:LIMit<k>:NAME <Name>**

This command selects a limit line that already exists or defines a name for a new limit line.

**Suffix:**

<n> irrelevant

<k> 1...8 (NF: 1...6)  
Selects the limit line.

**Parameters:**

<Name> String containing the limit line name.  
 \*RST: REM1 to REM8 for lines 1 to 8

**Example:**

CALC:LIM1:NAME 'FM1'  
 Assigns the name FM1 to limit line 1.

**CALCulate<n>:LIMit<k>:TRACe <TraceNumber>**

This command links a limit line to one or more traces.

**Suffix:**

<n> irrelevant  
 <k> Selects the limit line.

**Parameters:**

<TraceNumber> Range: 1 to 6  
 \*RST: 1

**Example:**

CALC:LIM2:TRAC 3  
 Assigns limit line 2 to trace 3.

**Manual operation:** See ["Select Traces to check"](#) on page 186

**CALCulate<n>:LIMit<k>:UNIT <Unit>**

This command defines the unit of a limit line.

Upon selection of the unit DB the limit line is automatically switched to the relative mode. For units different from DB the limit line is automatically switched to absolute mode.

**Suffix:**

<n> irrelevant  
 <k> Selects the limit line.

**Parameters:**

<Unit> DBM | DBPW | WATT | DBUV | DBMV | VOLT | DBUA |  
 AMPere | DB | DBUV\_M | DBUA\_M | DEG | RAD | S | HZ |  
 PCT | (unitless)

If you select dB as the limit line unit, the command automatically turns the limit line into a relative limit line.

In spectrum mode, units deg, rad, s, Hz and PCT are unavailable.

\*RST: DBM

**Example:**

CALC:LIM4:UNIT DBUV  
 Sets the unit of limit line 4 to dB $\mu$ V.

## Configuring Limit Lines

CALCulate<n>:LIMit<k>:CONTrol[:DATA]	677
CALCulate<n>:LIMit<k>:CONTrol:DOMain	678
CALCulate<n>:LIMit<k>:CONTrol:MODE	678
CALCulate<n>:LIMit<k>:CONTrol:OFFSet	678
CALCulate<n>:LIMit<k>:CONTrol:SHIFt	679
CALCulate<n>:LIMit<k>:CONTrol:SPACing	679
CALCulate<n>:LIMit<k>:LOWer[:DATA]	679
CALCulate<n>:LIMit<k>:LOWer:MARGin	680
CALCulate<n>:LIMit<k>:LOWer:MODE	680
CALCulate<n>:LIMit<k>:LOWer:OFFSet	681
CALCulate<n>:LIMit<k>:LOWer:SHIFt	681
CALCulate<n>:LIMit<k>:LOWer:SPACing	681
CALCulate<n>:LIMit<k>:LOWer:STATe	682
CALCulate<n>:LIMit<k>:LOWer:THReshold	682
CALCulate<n>:LIMit<k>:UPPer[:DATA]	683
CALCulate<n>:LIMit<k>:UPPer:MARGin	683
CALCulate<n>:LIMit<k>:UPPer:MODE	683
CALCulate<n>:LIMit<k>:UPPer:OFFSet	684
CALCulate<n>:LIMit<k>:UPPer:SHIFt	684
CALCulate<n>:LIMit<k>:UPPer:SPACing	685
CALCulate<n>:LIMit<k>:UPPer:STATe	685
CALCulate<n>:LIMit<k>:UPPer:THReshold	685

---

### CALCulate<n>:LIMit<k>:CONTrol[:DATA] <LimitLinePoints>

This command defines the horizontal definition points of a lower limit line.

#### Suffix:

<n>	Selects the measurement window.
<k>	1...8 Selects the limit line.

#### Parameters:

<LimitLinePoints>	Variable number of x-axis values. Note that the number of horizontal values has to be the same as the number of vertical values set with <code>CALCulate&lt;n&gt;:LIMit&lt;k&gt;:LOWer[:DATA]</code> or <code>CALCulate&lt;n&gt;:LIMit&lt;k&gt;:UPPer[:DATA]</code> . If not, the R&S ESRP either adds missing values or ignores surplus values. The unit is Hz or s, depending on <code>CALCulate&lt;n&gt;:LIMit&lt;k&gt;:CONTrol:DOMain</code> .
-------------------	----------------------------------------------------------------------------------------------------------------------------------------------------------------------------------------------------------------------------------------------------------------------------------------------------------------------------------------------------------------------------------------------------------------------------------------------------------

\*RST: - (CALC:LIM is set to OFF)

#### Example:

```
CALC:LIM2:CONT 1 MHz,30 MHz,100 MHz,300 MHz,1
GHz
```

Defines 5 reference values for the x-axis of limit line 2.

```
CALC:LIM2:CONT?
```

Outputs the reference values for the x-axis of limit line 2 separated by a comma.



**Manual operation:** See "Edit Value" on page 187

---

### CALCulate<n>:LIMit<k>:CONTrol:DOMain <SpanSetting>

This command selects the domain of the limit line.

**Suffix:**

<n>                      Selects the measurement window.  
 <k>                      1...8  
                              Selects the limit line.

**Parameters:**

<SpanSetting>        FREQuency | TIME  
 \*RST:                  FREQuency

**Example:**

CALC:LIM2:CONT:DOM TIME  
 Defines zero span for the x-axis of limit line 2.

---

### CALCulate<n>:LIMit<k>:CONTrol:MODE <Mode>

This command selects the horizontal limit line scaling.

**Suffix:**

<n>                      Selects the measurement window.  
 <k>                      1...8  
                              Selects the limit line.

**Parameters:**

<Mode>                      **ABSolute**  
                                     Limit line is defined by absolute physical values (Hz or s).  
                                     **RELative**  
                                     Limit line is defined by relative values related to the center frequency (frequency domain) or the left diagram border (time domain).  
 \*RST:                      ABSolute

**Example:**

CALC:LIM2:CONT:MODE REL  
 Defines the x-axis of limit line 2 as relatively scaled.

---

### CALCulate<n>:LIMit<k>:CONTrol:OFFSet <Offset>

This command defines an offset for a complete limit line.

Compared to shifting the limit line, an offset does not actually change the limit line definition points.

**Suffix:**

<n>                      Selects the measurement window.  
 <k>                      1...8  
                              Selects the limit line.

**Parameters:**

<Offset>                    Numeric value that defines the offset.  
 The unit of the offset depends on the scale of the x-axis.  
 \*RST:                    0

**Example:**

`CALC:LIM2:CONT:OFFS 100us`  
 Sets the X offset for limit line 2 (defined in zero span) to 100µs.

**Manual operation:** See "[X Offset](#)" on page 188

**CALCulate<n>:LIMit<k>:CONTrol:SHIFt <Distance>**

This command moves a complete limit line horizontally.

Compared to defining an offset, this command actually changes the limit line definition points by the value you define.

**Suffix:**

<n>                            Selects the measurement window.  
 <k>                            Selects the limit line.

**Parameters:**

<Distance>                    Numeric value that defines the distance of the shift.  
 The unit depends on the scale of the x-axis.

**Example:**

`CALC:LIM2:CONT:SHIF 50KHZ`  
 Shifts all reference values of limit line 2 by 50 kHz.

**CALCulate<n>:LIMit<k>:CONTrol:SPACing <InterpolMode>**

This command selects linear or logarithmic interpolation for the calculation of limit lines from frequency points.

**Suffix:**

<n>                            Selects the measurement window.  
 <k>                            1...8  
                                   Selects the limit line.

**Parameters:**

<InterpolMode>                LINear | LOGarithmic  
 \*RST:                    LIN

**Example:**

`CALC:LIM:CONT:SPAC LIN`

**CALCulate<n>:LIMit<k>:LOWer[:DATA] <LimitLinePoints>**

This command defines the vertical definition points of a lower limit line.

If the measured values are smaller than the LOWER limit line, the limit check is violated.

**Suffix:**

<n>                            irrelevant

<k> 1...8  
Selects the limit line.

**Parameters:**

<LimitLinePoints> Variable number of x-axis values.  
Note that the number of horizontal values has to be the same as the number of vertical values set with `CALCulate<n>:LIMit<k>:CONTRol[:DATA]`. If not, the R&S ESRP either adds missing values or ignores surplus values.  
The unit depends on `CALCulate<n>:LIMit<k>:UNIT`.

\*RST: (LIMit:STATe is set to OFF)

**Example:**

```
CALC:LIM2:LOW -30,-40,-10,-40,-30
```

Defines 5 lower limit values for limit line 2 in the preset unit.

```
CALC:LIM2:LOW?
```

Outputs the lower limit values of limit line 2 separated by a comma.

**Manual operation:** See "Edit Value" on page 187

**CALCulate<n>:LIMit<k>:LOWer:MARGin <Margin>**

This command defines an area around a lower limit line where limit check violations are still tolerated.

**Suffix:**

<n> irrelevant

<k> 1...8  
Selects the limit line.

**Parameters:**

<Margin> Numeric value that defines the margin.  
In spectrum mode, the unit is always dB.

\*RST: 0

**Example:**

```
CALC:LIM:LOW:MARG 10dB
```

**CALCulate<n>:LIMit<k>:LOWer:MODE <Mode>**

This command selects the vertical limit line scaling.

**Suffix:**

<n> irrelevant

<k> 1...8  
Selects the limit line.

**Parameters:**

<Mode> **ABSolute**  
Limit line is defined by absolute physical values. The unit is variable.

**RELative**

Limit line is defined by values relative to the reference level (dB).

\*RST: ABSolute

**Example:**

CALC:LIM:LOW:MODE REL

Defines the y-axis of limit line 2 as relative scaled.

**Manual operation:** See "Edit Name" on page 186

**CALCulate<n>:LIMit<k>:LOWer:OFFSet <Offset>**

This command defines an offset for a complete lower limit line.

Compared to shifting the limit line, an offset does not actually change the limit line definition points.

**Suffix:**

<n> irrelevant

<k> 1...8  
Selects the limit line.

**Parameters:**

<Offset> Numeric value that defines the offset.

\*RST: 0

**Example:**

CALC:LIM2:LOW:OFFS 3dB

Shifts limit line 2 by 3 dB upwards.

**Manual operation:** See "Y Offset" on page 188

**CALCulate<n>:LIMit<k>:LOWer:SHIFt <Distance>**

This command moves a complete lower limit line vertically.

Compared to defining an offset, this command actually changes the limit line definition points by the value you define.

**Suffix:**

<n> irrelevant

<k> Selects the limit line.

**Parameters:**

<Distance> Numeric value that defines the distance of the shift.  
The unit depends on [CALCulate<n>:LIMit<k>:UNIT](#) on page 676.

**Example:**

CALC:LIM3:LOW:SHIF 20DB

Shifts all Y values of limit line 3 by 20 dB.

**CALCulate<n>:LIMit<k>:LOWer:SPACing <InterpolType>**

This command selects linear or logarithmic interpolation for the lower limit line.

**Suffix:**

<n> irrelevant

<k> 1...8  
Selects the limit line.

**Parameters:**

<InterpolType> LINear | LOGarithmic

\*RST: LIN

**Example:**

CALC:LIM:LOW:SPAC LIN

**CALCulate<n>:LIMit<k>:LOWer:STATe <State>**

This command turns a lower limit line on and off.

Before you can use this command, you have to select a limit line with [CALCulate<n>:LIMit<k>:NAME](#).

The limit check is turned on separately. For more information see "[Using Frequency Lines](#)" on page 828.

**Suffix:**

<n> irrelevant

<k> 1...8  
Selects the limit line.

**Parameters:**

<State> ON | OFF

\*RST: OFF

**Example:**

CALC:LIM4:LOW:STAT ON  
Switches on limit line 4 (lower limit).

**CALCulate<n>:LIMit<k>:LOWer:THReshold <Threshold>**

This command defines a threshold for relative limit lines.

The R&S ESRP uses the threshold for the limit check, if the limit line violates the threshold.

**Suffix:**

<n> irrelevant

<k> 1...8  
Selects the limit line.

**Parameters:**

<Threshold> Numeric value that defines the threshold.

The unit depends on [CALCulate<n>:LIMit<k>:UNIT](#).

\*RST: -200 dBm

**Example:**

CALC:LIM2:LOW:THR -35DBM  
Defines an absolute threshold value for limit line 2.

**CALCulate<n>:LIMit<k>:UPPer[:DATA] <LimitLinePoints>**

This command defines the vertical definition points of an upper limit line.

If the measured values exceed the UPPer limit line, the limit is violated.

**Suffix:**

<n>	irrelevant
<k>	1...8 Selects the limit line.

**Parameters:**

<LimitLinePoints>	Variable number of x-axis values. Note that the number of horizontal values has to be the same as the number of vertical values set with <code>CALCulate&lt;n&gt;:LIMit&lt;k&gt;:CONTrol[:DATA]</code> . If not, the R&S ESRP either adds missing values or ignores surplus values. The unit depends on <code>CALCulate&lt;n&gt;:LIMit&lt;k&gt;:UNIT</code> . <b>*RST:</b> (LIMit:STATe is set to OFF)
-------------------	-----------------------------------------------------------------------------------------------------------------------------------------------------------------------------------------------------------------------------------------------------------------------------------------------------------------------------------------------------------------------------------------------------------------

**Example:**

```
CALC:LIM2:UPP -10,0,0,-10,-5
```

Defines 5 upper limit values for limit line 2 in the preset unit.

```
CALC:LIM2:UPP?
```

Outputs the upper limit values for limit line 2 separated by a comma.

**Manual operation:** See "Edit Value" on page 187

**CALCulate<n>:LIMit<k>:UPPer:MARGin <Margin>**

This command defines an area around a upper limit line where limit check violations are still tolerated.

**Suffix:**

<n>	irrelevant
<k>	1...8 Selects the limit line.

**Parameters:**

<Margin>	Numeric value that defines the margin. In spectrum mode, the unit is always dB. <b>*RST:</b> 0
----------	------------------------------------------------------------------------------------------------------

**Example:**

```
CALC:LIM2:UPP:MARG 10dB
```

Defines the margin of limit line 2 to 10 dB below the limit value.

**CALCulate<n>:LIMit<k>:UPPer:MODE <Mode>**

This command selects the vertical limit line scaling.

**Suffix:**

<n>	irrelevant
-----	------------

<k> 1...8  
Selects the limit line.

**Parameters:**

<Mode> **ABSolute**  
Limit line is defined by absolute physical values. The unit is variable.

**RELative**  
Limit line is defined by values relative to the reference level (dB).

\*RST: ABSolute

**Example:**

`CALC:LIM2:UPP:MODE REL`  
Defines the y-axis of limit line 2 as relative scaled.

**CALCulate<n>:LIMit<k>:UPPer:OFFSet <Offset>**

This command defines an offset for a complete upper limit line.

Compared to shifting the limit line, an offset does not actually change the limit line definition points.

**Suffix:**

<n> irrelevant

<k> 1...8  
Selects the limit line.

**Parameters:**

<Offset> Numeric value that defines the offset.

\*RST: 0

**Example:**

`CALC:LIM2:UPP:OFFS 3dB`  
Shifts limit line 2 by 3 dB upwards.

**Manual operation:** See "[Y Offset](#)" on page 188

**CALCulate<n>:LIMit<k>:UPPer:SHIFt <Value>**

This command moves a complete upper limit line vertically.

Compared to defining an offset, this command actually changes the limit line definition points by the value you define.

**Suffix:**

<n> irrelevant

<k> 1...8  
Selects the limit line.

**Parameters:**

<Distance> Numeric value that defines the distance of the shift.  
The unit depends on `CALCulate<n>:LIMit<k>:UNIT` on page 676.

**Example:** `CALC:LIM3:UPP:SHIF 20`  
Shifts all Y values of limit line 3 by 20 limit line units, e.g. dB.

**Usage:** Event

#### **CALCulate<n>:LIMit<k>:UPPer:SPACing <InterpolType>**

This command selects linear or logarithmic interpolation for the upper limit line.

**Suffix:**

<n> irrelevant  
<k> 1...8  
Selects the limit line.

**Parameters:**

<InterpolType> LINear | LOGarithmic  
\*RST: LIN

**Example:** `CALC:LIM:UPP:SPAC LIN`

#### **CALCulate<n>:LIMit<k>:UPPer:STATe <State>**

This command turns a lower limit line on and off.

Before you can use this command, you have to select a limit line with `CALCulate<n>:LIMit<k>:NAME`.

The limit check is turned on separately. For more information see "[Using Frequency Lines](#)" on page 828.

**Suffix:**

<n> irrelevant  
<k> 1...8  
Selects the limit line.

**Parameters:**

<State> ON | OFF  
\*RST: OFF

**Example:** `CALC:LIM4:UPP:STAT ON`  
Switches on limit line 4 (upper limit).

#### **CALCulate<n>:LIMit<k>:UPPer:THReshold <Threshold>**

This command defines a threshold for relative limit lines.

The R&S ESRP uses the threshold for the limit check, if the limit line violates the threshold.

**Suffix:**

<n> irrelevant



<k> 1...8  
Selects the limit line.

**Parameters:**

<Threshold> Numeric value that defines the threshold.  
The unit depends on `CALCulate<n>:LIMit<k>:UNIT`.  
\*RST: -200 dBm

**Example:**

`CALC:LIM2:UPP:THR -35DBM`  
Defines an absolute threshold value for limit line 2.

**Checking Limits**

`CALCulate<n>:LIMit<k>:CLEar[:IMMediate]`.....686  
`CALCulate<n>:LIMit<k>:FAIL?`.....686  
`CALCulate<n>:LIMit<k>:STATe`.....687

**CALCulate<n>:LIMit<k>:CLEar[:IMMediate]**

This command deletes the result of the current limit check for all limit lines in all windows.

**Suffix:**

<n> irrelevant  
<k> irrelevant

**Example:**

`CALC:LIM:CLE`  
Deletes the result of the limit check.

**Usage:** Event

**CALCulate<n>:LIMit<k>:FAIL?**

This command queries the result of a limit check.

Note that for SEM measurements, the limit line suffix <k> is irrelevant, as only one specific SEM limit line is checked for the currently relevant power class.

To get a valid result, you have to perform a complete measurement with synchronization to the end of the measurement before reading out the result. This is only possible for single sweeps.

**Suffix:**

<n> irrelevant  
<k> limit line

**Return values:**

<Result> 0  
PASS  
1  
FAIL

<b>Example:</b>	INIT; *WAI Starts a new sweep and waits for its end. CALC:LIM3:FAIL? Queries the result of the check for limit line 3.
<b>Usage:</b>	Query only
<b>Manual operation:</b>	See " <a href="#">Limit Check 1-4</a> " on page 237 See " <a href="#">Limit Check 1-4</a> " on page 267

---

#### CALCulate<n>:LIMit<k>:STATe <State>

This command turns the limit check on and off.

To query the limit check result, use `CALCulate<n>:LIMit<k>:FAIL?`.

#### Suffix:

<n>	irrelevant
<k>	Selects the limit line.

#### Parameters:

<State>	ON   OFF
*RST:	OFF

<b>Example:</b>	CALC:LIM:STAT ON Switches on the limit check for limit line 1.
-----------------	-------------------------------------------------------------------

<b>Manual operation:</b>	See " <a href="#">Select Traces to check</a> " on page 186 See " <a href="#">Deselect All</a> " on page 186
--------------------------	----------------------------------------------------------------------------------------------------------------

## 11.5 Remote Commands in Spectrum Analyzer Mode

The following remote commands configure and perform spectrum measurements. They are available in spectrum analyzer mode only.

- [Measurements and Result Displays](#).....687
- [Configuring Spectrum Measurements](#).....790
- [Analyzing Spectrum Measurements](#)..... 815

### 11.5.1 Measurements and Result Displays

- [Controlling Power Measurements](#)..... 688
- [Measuring Channel Power](#).....695
- [Measuring the Occupied Bandwidth](#)..... 716
- [Measuring Spurious Emissions](#).....717
- [Testing Against a Spectrum Emission Mask](#)..... 727
- [Performing EMI Measurements](#)..... 746
- [Measuring the Modulation Depth](#)..... 752
- [Measuring the Harmonic Distortion](#).....754
- [Measuring the Carrier-to-Noise Ratio](#)..... 758

- [Measuring the Third Order Intercept Point](#).....758
- [Measuring Statistics](#).....759
- [Measuring in the Time Domain](#).....767
- [Measuring the Pulse Power](#).....779
- [Performing List Evaluations](#).....783
- [Probe Configuration](#).....788

### 11.5.1.1 Controlling Power Measurements

The following commands control power measurements (channel power, occupied bandwidth etc.) in general.

<a href="#">CALCulate&lt;n&gt;:MARKer&lt;m&gt;:FUNCTION:POWER:SElect</a> .....	688
<a href="#">CALCulate&lt;n&gt;:MARKer&lt;m&gt;:FUNCTION:POWER:RESult?</a> .....	689
<a href="#">CALCulate&lt;n&gt;:MARKer&lt;m&gt;:FUNCTION:POWER[:STATe]</a> .....	692
<a href="#">CALCulate&lt;n&gt;:MARKer&lt;m&gt;:FUNCTION:POWER:MODE</a> .....	692
<a href="#">[SENSe:]POWER:TRACe</a> .....	693
<a href="#">[SENSe:]POWER:ACHannel:PRESet</a> .....	693
<a href="#">[SENSe:]POWER:ACHannel:PRESet:RLEVel</a> .....	694
<a href="#">TRACe&lt;n&gt;:DATA</a> .....	694

---

#### **CALCulate<n>:MARKer<m>:FUNCTION:POWER:SElect <MeasType>**

This command selects – and switches on – the specified power measurement type in the window specified by the suffix <n>.

The channel spacings and channel bandwidths are configured in the `SENSe:POWER` subsystem.

**Note:** If CPOWER is selected, the number of adjacent channels ( `[SENSe:]POWER:ACHannel:ACPairs` ) is set to 0. If ACPower is selected, the number of adjacent channels is set to 1, unless adjacent-channel power measurement is switched on already.

The channel/adjacent-channel power measurement is performed for the trace selected with `[SENSe:]POWER:TRACe`.

The occupied bandwidth measurement is performed for the trace on which marker 1 is positioned. To select another trace for the measurement, marker 1 is to be positioned on the desired trace by means of `CALCulate<n>:MARKer<m>:TRACe`.

#### **Suffix:**

<n>	Selects the measurement window.
<m>	Selects the marker.

#### **Parameters:**

<MeasType>	ACPower   CPOWER   MCACpower   OBANdwidth   OBWidth   CN   CNO
	<b>ACPower</b>
	Adjacent-channel power measurement with a single carrier signal

**CPOWer**

Channel power measurement with a single carrier signal (equivalent to adjacent-channel power measurement with "NO. OF ADJ CHAN" = 0)

**MCACpower**

Channel/adjacent-channel power measurement with several carrier signals

**OBANdwidth | OBWidth**

Measurement of occupied bandwidth

**CN**

Measurement of carrier-to-noise ratio

**CNO**

Measurement of carrier-to-noise ratio referenced to 1 Hz bandwidth

**Example:**

```
CALC:MARK:FUNC:POW:SEL ACP
```

Switches on adjacent-channel power measurement.

**Manual operation:**

See ["Ch Power ACLR"](#) on page 199

See ["OBW \(span > 0\)"](#) on page 199

See ["Ch Power ACLR"](#) on page 212

See ["C/N"](#) on page 227

See ["C/No"](#) on page 227

See ["OBW"](#) on page 230

**CALCulate<n>:MARKer<m>:FUNction:POWer:RESult? <ResultType>**

This command queries the result of the performed power measurement in the window specified by the suffix <n>. If necessary, the measurement is switched on prior to the query.

The channel spacings and channel bandwidths are configured in the `SENSe:POWer` subsystem.

To obtain a correct result, a complete sweep with synchronization to the end of the sweep must be performed before a query is output. Synchronization is possible only in the single sweep mode.

**Suffix:**

<n> Selects the measurement window.

<m> Selects the marker.

**Parameters:**

<ResultType> ACPower | AOBW | CN | CN0 | CPOWer | PPOWer | MCACpower | OBANdwidth | OBWidth | BANDwidth

**ACPower**

Adjacent-channel power measurement

Results are output in the following sequence, separated by commas:

Power of transmission channel  
 Power of lower adjacent channel  
 Power of upper adjacent channel  
 Power of lower alternate channel 1  
 Power of upper alternate channel 1  
 Power of lower alternate channel 2  
 Power of upper alternate channel 2

The number of measured values returned depends on the number of adjacent/alternate channels selected with `[SENSe:]POWER:ACHannel:ACPairs`.

With logarithmic scaling (RANGE "LOG"), the power is output in the currently selected level unit; with linear scaling (RANGE "LIN dB" or "LIN %"), the power is output in W. If `[SENSe:]POWER:ACHannel:MODE` is set to "REL", the adjacent/alternate-channel power is output in dB.

**AOBW (AllOccupiedBandWidth)**

Returns the occupied bandwidth, as well as the position and level of the temporary markers T1 and T2 used to calculate the occupied bandwidth.

The syntax of the result is:

<Occupied bandwidth>,<T1 x-value>,<T1 y-value>,<T2 x-value>,<T2 y-value>

**CN**

Measurement of carrier-to-noise ratio

The carrier-to-noise ratio in dB is returned.

**CNO**

Measurement of carrier-to-noise ratio referenced to 1 Hz bandwidth.

The carrier-to-noise ratio in dB/Hz is returned.

**CPOWER**

Channel power measurement

In a Spectrum Emission Mask measurement, the query returns the power result for the reference range, if this power reference type is selected.

With logarithmic scaling (RANGE LOG), the channel power is output in the currently selected level unit; with linear scaling (RANGE LIN dB or LIN %), the channel power is output in W.

**PPOWER**

Power of the highest peak

In a Spectrum Emission Mask measurement, the query returns the power result for the reference range, if this power reference type is selected.

**MCACpower**

Channel/adjacent-channel power measurement with several carrier signals

Results are output in the following sequence, separated by commas:

Power of carrier signal 1 to 18s in ascending order

Total power of all carrier signals

Power of lower adjacent channel

Power of upper adjacent channel

Power of lower alternate channel 1

Power of upper alternate channel 1

Power of lower alternate channel 2

Power of upper alternate channel 2

The number of measured values returned depends on the number of carrier signals and adjacent/alternate channels selected with `[SENSe:]POWer:ACHannel:TXChannel:COUNT` and

`[SENSe:]POWer:ACHannel:ACPairs`.

If only one carrier signal is measured, the total value of all carrier signals is not output.

With logarithmic scaling (RANGE LOG), the power is output in dBm; with linear scaling (RANGE LIN dB or LIN %), the power is output in W. If `[SENSe:]POWer:ACHannel:MODE` is set to "REL", the adjacent/alternate-channel power is output in dB.

**OBANdwidth | OBWidth**

Measurement of occupied bandwidth

The occupied bandwidth in Hz is returned.

**Example:**

**For an example of channel/adjacent-channel power measurement see [Chapter 11.17.4, "Measuring the Channel and Adjacent Channel Power"](#), on page 978.**

**Example of occupied bandwidth measurement**

```
POW:BAND 90PCT
```

Defines 90 % as the percentage of the power to be contained in the bandwidth range to be measured.

```
INIT:CONT OFF
```

Switches over to single sweep mode.

```
INIT;*WAI
```

Starts a sweep and waits for the end of the sweep.

```
CALC:MARK:FUNC:POW:RES? OBW
```

Queries the occupied bandwidth measured.

**Manual operation:**

See "[Ch Power ACLR](#)" on page 199

See "[OBW \(span > 0\)](#)" on page 199

See "[Ch Power ACLR](#)" on page 212

See "[C/N](#)" on page 227

See "[C/No](#)" on page 227

See "[OBW](#)" on page 230

**CALCulate<n>:MARKer<m>:FUNction:POWer[:STATe] <State>**

This command switches off the power measurement in the window specified by the suffix <n>.

**Suffix:**

<n> Selects the measurement window.

<m> Selects the marker.

**Parameters:**

<State> OFF

**Example:**

CALC:MARK:FUNC:POW OFF

Switches off the power measurement.

**Usage:**

Event

**Manual operation:**

See "Ch Power ACLR" on page 199

See "OBW (span > 0)" on page 199

See "Ch Power ACLR" on page 212

See "C/N" on page 227

See "C/No" on page 227

See "OBW" on page 230

**CALCulate<n>:MARKer<m>:FUNction:POWer:MODE <Mode>**

This commands defines the method by which the channel power values are calculated from the current trace in the window specified by the suffix <n>.

**Suffix:**

<n> Selects the measurement window.

<m> Selects the marker.

**Parameters:**

<Mode> WRITe | MAXHold

**WRITe**

The channel power and the adjacent channel powers are calculated directly from the current trace

**MAXHold**

The power values are calculated from the current trace and compared with the previous power value using a maximum algorithm.

**Example:**

CALC:MARK:FUNC:POW:MODE MAXH

Sets the Maxhold channel power mode.

**Manual operation:**

See "Clear/Write" on page 218

See "Max Hold" on page 219

**[SENSe:]POWer:TRACe <TraceNumber>**

This command assigns the channel/adjacent channel power measurement to the indicated trace. The corresponding trace must be active, i.e. its state must be different from blank.

**Note:** The measurement of the occupied bandwidth (OBW) is performed on the trace on which marker 1 is positioned. To evaluate another trace, marker 1 must be positioned to another trace with `CALCulate<n>:MARKer<m>:TRACe`.

**Parameters:**

<TraceNumber> 1 to 6

**Example:**

```
POW:TRAC 2
Assigns the measurement to trace 2.
```

**Manual operation:** See ["Select Trace"](#) on page 219

**[SENSe:]POWer:ACHannel:PRESet <Setting>**

This command adjusts the frequency span, the measurement bandwidths and the detector as required for the number of channels, the channel bandwidths and the channel spacings selected in the active power measurement. If necessary, adjacent-channel power measurement is switched on prior to the adjustment.

To obtain correct results, a complete sweep with synchronization to the end of the sweep must be performed after the adjustment. Synchronization is possible only in the single sweep mode.

The result is queried with the `CALCulate<n>:MARKer<m>:FUNCTION:POWer:RESult?` command.

**Parameters:**

<Setting> ACPower | CPOWer | MCACpower | OBANdwidth | OBWidth | CN | CNO

**Example:**

```
POW:ACH:PRES ACP
Sets the frequency span, the measurement bandwidths and the
detector as required for the ACLR measurement.
INIT:CONT OFF
Switches over to single sweep mode.
INIT;*WAI
Starts a sweep and waits for the end of the sweep.
CALC:MARK:FUNC:POW:RES? ACP
Queries the result of the adjacent-channel power measurement.
```

**Manual operation:** See ["Adjust Settings"](#) on page 219  
See ["Adjust Settings"](#) on page 228



**[SENSe:]POWER:ACHannel:PRESet:RLEVel**

This command adapts the reference level to the measured channel power and – if required – switches on previously the adjacent channel power measurement. This ensures that the signal path of the instrument is not overloaded. Since the measurement bandwidth is significantly smaller than the signal bandwidth in channel power measurements, the signal path can be overloaded although the trace is still significantly below the reference level. If the measured channel power equals the reference level, the signal path is not overloaded.

Subsequent commands have to be synchronized with \*WAI, \*OPC or \*OPC? to the end of the auto range process which would otherwise be aborted.

**Example:** POW:ACH:PRESet:RLEV; \*WAI  
Adapts the reference level to the measured channel power.

**Manual operation:** See ["Adjust Ref Lvl"](#) on page 222  
See ["Adjust Ref Lvl \(span > 0\)"](#) on page 231

**TRACe<n>:DATA <Trace>, <Data> | <ResultType>**

This command queries current trace data and measurement results.

If you use it as a setting command, it transfers trace data from an external source to the R&S ESRP.

The data format depends on FORMat [:DATA].

**Parameters:**

<Trace> Selects the trace to write data to.  
**TRACE1 | ... | TRACE6**

<Data> Contains the data to transfer.

**Query parameters:**

<ResultType> Selects the type of result to be returned.

**TRACE1 | ... | TRACE6**

Returns the trace data for the corresponding trace.

**LIST**

Returns the results of the peak list evaluation for Spurious Emission and Spectrum Emission Mask measurements.

**SPURious**

Returns the peak list of Spurious Emission measurements.

**Return values:**

<TraceData> For more information see tables below.

**Example:** TRAC TRACE1,+A\$  
Transfers trace data ('+A\$') to trace 1.

**Example:** TRAC? TRACE3  
Queries the data of trace 3.

**Manual operation:** See "List Evaluation (On/Off)" on page 240  
See "List Evaluation (On/Off)" on page 269

**Table 11-20: Return values for TRACE1 to TRACE6 parameter**

The trace data consists of a list of power levels that have been measured. The number of power levels in the list depends on the currently selected number of sweep points. The unit depends on the measurement and on the unit you have currently set.

If you are measuring with the auto peak detector, the command returns positive peak values only.

If you are working with the "Real/Imag (I/Q)" result display in I/Q Analyzer mode, the command returns two values for each trace point, first the real parts of the signal, then the imaginary parts ( $I_1, \dots, I_n, Q_1, \dots, Q_n$ ).

For SEM or Spurious Emission measurement results, the x-values should be queried as well, as they are not equi-distant (see `TRACe<n>[:DATA]:X?` on page 824).

**Table 11-21: Return values for LIST parameter**

For every measurement range you have defined (range 1...n), the command returns eight values in the following order.

<No>, <StartFreq>, <StopFreq>, <RBW>, <PeakFreq>, <PowerAbs>, <PowerRel>, <PowerDelta>, <LimitCheck>, <Unused1>, <Unused2>

- <No>: range number
- <StartFreq>, <StopFreq>: start and stop frequency of the range
- <RBW>: resolution bandwidth
- <PeakFreq>: frequency of the peak in a range
- <PowerAbs>: absolute power of the peak in dBm
- <PowerRel>: power of the peak in relation to the channel power in dBc
- <PowerDelta>: distance from the peak to the limit line in dB, positive values indicate a failed limit check
- <LimitCheck>: state of the limit check (0 = PASS, 1 = FAIL)
- <Unused1>, <Unused2>: reserved (0.0)

### 11.5.1.2 Measuring Channel Power

The following commands configure and perform channel power or ACLR measurements.

• <a href="#">Managing Measurement Configurations</a> .....	695
• <a href="#">Configuring ACLR Channels</a> .....	697
• <a href="#">Defining Weighting Filters</a> .....	702
• <a href="#">Selecting the Reference Channel</a> .....	704
• <a href="#">Checking Limits</a> .....	705
• <a href="#">Analyzing Results</a> .....	713
• <a href="#">Predefined CP/ACLR Standards</a> .....	716

#### Managing Measurement Configurations

The following commands control measurement configurations for ACLR measurements.

<a href="#">CALCulate&lt;n&gt;:MARKer&lt;m&gt;:FUNCTION:POWER:PRESet</a> .....	696
<a href="#">CALCulate&lt;n&gt;:MARKer&lt;m&gt;:FUNCTION:POWER:STANdard:CATalog?</a> .....	697
<a href="#">CALCulate&lt;n&gt;:MARKer&lt;m&gt;:FUNCTION:POWER:STANdard:DELeTe</a> .....	697
<a href="#">CALCulate&lt;n&gt;:MARKer&lt;m&gt;:FUNCTION:POWER:STANdard:SAVE</a> .....	697

---

**CALCulate**<n>:**MARKer**<m>:**FUNCTION:POWer:PRESet** <Standard> |  
<UserStandard>

This command selects the power measurement setting for a standard and switches on the corresponding measurement, if required.

The configuration for a standard comprises of the parameters weighting filter, channel bandwidth and spacing, resolution and video bandwidth, as well as detector and sweep time.

The settings for standards IS95A and C differ as far as the calculation method of channel spacings is concerned. For IS95A and J-STD008 the spacing is calculated from the center of the main channel to the center of the corresponding adjacent channel, for IS95C from the center of the main channel to the nearest border of the adjacent channel.

**Suffix:**

<n> Selects the measurement window.

<m> Selects the marker.

**Setting parameters:**

<Standard> Note that predefined standards go without quotes, while user standards have to be in quotes ('user standard').

**<Predefined standard>**

Predefine standard according to table in "[Predefined CP/ACLR Standards](#)" on page 716.

**'<string>'**

User-defined standard with <string> being the name of the user standard.

**Return values:**

<Standard> <Predefined standard> | USER | NONE

**<Predefined standard>**

Predefine standard according to table in "[Predefined CP/ACLR Standards](#)" on page 716.

**USER**

User-defined standard is set

**NONE**

not yet defined

with <string> being the name of a user standard. Note that predefined standards go without quotes, while user standards have to be in quotes ('user standard').

For further details refer to "[Predefined CP/ACLR Standards](#)" on page 716.

**Example:**

CALC:MARK:FUNC:POW:PRES TETRA

Selects the standard setting for TETRA

**Example:**

CALC:MARK:FUNC:POW:PRES 'my\_aclr\_standard'

Selects the user standard my\_aclr\_standard

**Manual operation:** See "CP/ACLR Standard" on page 212  
See "Load" on page 221

---

#### **CALCulate<n>:MARKer<m>:FUNCtion:POWer:STANdard:CATalog?**

This command queries all available standards, including user standards.

The numeric suffix at MARKer is irrelevant.

**Example:** `CALC:MARK:FUNC:POW:STAN:CAT?`  
Queries the available standards.

**Usage:** Query only

**Manual operation:** See "Load" on page 221

---

#### **CALCulate<n>:MARKer<m>:FUNCtion:POWer:STANdard:DELeTe <Standard>**

This command deletes an ACLR standard.

The numeric suffix at MARKer is irrelevant.

**Parameters:**  
<Standard> Name of the standard you want to delete.

**Example:** `CALC:MARK:FUNC:POW:STAN:DEL 'CDMA2000'`  
Deletes the CDMA2000 standard.

**Manual operation:** See "Delete" on page 221

---

#### **CALCulate<n>:MARKer<m>:FUNCtion:POWer:STANdard:SAVE <Standard>**

This command saves a customized ACLR standard.

The numeric suffix at MARKer is irrelevant.

**Parameters:**  
<Standard> Specifies the name of the user standard.

**Example:** `CALC:MARK:FUNC:POW:STAN:SAVE 'CDMA2000'`  
Saves the user standard with the name CDMA2000.

**Manual operation:** See "Save" on page 221

### **Configuring ACLR Channels**

The following commands configure channels for channel power and ACLR measurements.

<code>[SENSe:]POWer:ACHannel:ACPairs</code> .....	698
<code>[SENSe:]POWer:ACHannel:BANDwidth BWIDth:ACHannel</code> .....	698
<code>[SENSe:]POWer:ACHannel:BANDwidth BWIDth:ALTerNate&lt;channel&gt;</code> .....	698
<code>[SENSe:]POWer:ACHannel:BANDwidth BWIDth[:CHANnel&lt;channel&gt;]</code> .....	699
<code>[SENSe:]POWer:ACHannel:NAME:ACHannel</code> .....	699
<code>[SENSe:]POWer:ACHannel:NAME:ALTerNate&lt;channel&gt;</code> .....	700

[SENSe:]POWer:ACHannel:NAME:CHANnel<channel>.....	700
[SENSe:]POWer:ACHannel:SPACing[:ACHannel].....	700
[SENSe:]POWer:ACHannel:SPACing:ALTErnate<channel>.....	701
[SENSe:]POWer:ACHannel:SPACing:CHANnel<channel>.....	701
[SENSe:]POWer:ACHannel:TXCHannel:COUNT.....	701

---

### [SENSe:]POWer:ACHannel:ACPairs <ChannelPairs>

This command sets the number of adjacent channels (upper and lower channel in pairs). The figure 0 stands for pure channel power measurement.

#### Parameters:

<ChannelPairs>      0 to 12  
 \*RST:                1

#### Example:

POW:ACH:ACP 3  
 Sets the number of adjacent channels to 3, i.e. the adjacent channel and alternate adjacent channels 1 and 2 are switched on.

**Manual operation:** See "[# of Adj Chan](#)" on page 213  
 See "[Channel Bandwidth](#)" on page 227

---

### [SENSe:]POWer:ACHannel:BANDwidth|BWIDth:ACHannel <Bandwidth>

This command defines the channel bandwidth of the adjacent channel of the radio transmission system. If the bandwidth of the adjacent channel is changed, the bandwidths of all alternate adjacent channels are automatically set to the same value.

With [SENSe<source>:]POWer:HSPeed set to ON, steep-edged channel filters are available. For further information on filters refer to [Chapter 6.2.6.4, "List of Available RRC and Channel Filters"](#), on page 338 .

#### Parameters:

<Bandwidth>        100 Hz to 40 GHz  
 \*RST:                14 kHz

#### Example:

POW:ACH:BWID:ACH 30 kHz  
 Sets the bandwidth of all adjacent channels to 30 kHz.

**Manual operation:** See "[Bandwidth](#)" on page 214

---

### [SENSe:]POWer:ACHannel:BANDwidth|BWIDth:ALTErnate<channel> <Bandwidth>

This command defines the channel bandwidth of the specified alternate adjacent channels of the radio transmission system. If the channel bandwidth of one alternate adjacent channel is changed (e.g. channel 3), the bandwidth of all subsequent alternate adjacent channels (e.g. 4–11) is automatically set to the same value.

With [SENSe<source>:] POWer:HSPEED set to ON, steep-edged channel filters are available. For further information on filters refer to [Chapter 6.2.6.4, "List of Available RRC and Channel Filters"](#), on page 338 .

**Suffix:**

<channel> 1...11  
the alternate adjacent channel

**Parameters:**

<Bandwidth> 100 Hz to 40 GHz  
\*RST: 14 kHz

**Example:**

POW:ACH:BWID:ALT2 30 kHz

**Manual operation:** See "[Bandwidth](#)" on page 214

**[SENSe:]POWer:ACHannel:BANDwidth|BWIDth[:CHANnel<channel>]  
<Bandwidth>**

This command sets the channel bandwidth of the specified TX channel in the radio communication system. The bandwidths of adjacent channels are not influenced by this modification.

With [SENSe<source>:] POWer:HSPEED set to ON, steep-edged channel filters are available. For further information on filters refer to [Chapter 6.2.6.4, "List of Available RRC and Channel Filters"](#), on page 338.

**Parameters:**

<Bandwidth> 100 Hz to 40 GHz  
\*RST: 14 kHz

**Example:**

POW:ACH:BWID:CHAN2 30 kHz  
Sets the bandwidth of the TX channel 2 to 30 kHz.

**Manual operation:** See "[Bandwidth](#)" on page 214  
See "[Channel Bandwidth \(span > 0\)](#)" on page 231

**[SENSe:]POWer:ACHannel:NAME:ACHannel <Name>**

This command defines a name for the adjacent channel. The name is displayed in the result diagram and the result table.

**Parameters:**

<Name> \*RST: Adj

**Example:**

POW:ACH:NAME:ACH 'XYZ'  
Defines the name of the adjacent channel as 'XYZ'.

**Manual operation:** See "[Names](#)" on page 216

**[SENSe:]POWer:ACHannel:NAME:ALternate<channel> <Name>**

This command defines a name for the specified alternate channel. The name is displayed in the result diagram and the result table.

**Suffix:**

<channel>            1...11  
the alternate channel

**Parameters:**

<Name>            \*RST:        ALT<1...11>

**Example:**

POW:ACH:NAME:ALT3 'XYZ'  
Defines the name of the third alternate channel as 'XYZ'.

**Manual operation:** See "[Names](#)" on page 216

**[SENSe:]POWer:ACHannel:NAME:CHANnel<channel> <Name>**

This command defines a name for the specified TX channel. The name is displayed in the result diagram and the result table.

**Suffix:**

<channel>            1...12  
the TX channel

**Parameters:**

<Name>            \*RST:        TX<1...12>

**Example:**

POW:ACH:NAME:CHAN3 'XYZ'  
Defines the name of the third transmission channel as 'XYZ'.

**Manual operation:** See "[Names](#)" on page 216

**[SENSe:]POWer:ACHannel:SPACing[:ACHannel] <Spacing>**

This command defines the spacing between the carrier signal and the adjacent channel (ADJ). The modification of the adjacent-channel spacing (ADJ) causes a change in all higher adjacent-channel spacings (ALT1, ALT2, ...): they are all multiplied by the same factor (new spacing value/old spacing value).

**Parameters:**

<Spacing>            100 Hz to 20 GHz  
\*RST:            14 kHz

**Example:**

POW:ACH:SPAC 33kHz  
Sets the spacing between the carrier signal and the adjacent channel to 33 kHz, the alternate adjacent channel 1 to 66 kHz, the alternate adjacent channel 2 to 99 kHz, and so on.

**Manual operation:** See "[Spacing](#)" on page 215

**[SENSe:]POWer:ACHannel:SPACing:ALTerNate<channel> <Spacing>**

This command defines the spacing between the alternate adjacent channels and the TX channel (ALT1, ALT2, ...). A modification of a higher adjacent-channel spacing causes a change by the same factor (new spacing value/old spacing value) in all higher adjacent-channel spacings, while the lower adjacent-channel spacings remain unchanged.

**Suffix:**

<channel> 1...11  
the alternate adjacent channel

**Parameters:**

<Spacing> 100 Hz to 20 GHz  
\*RST: 40 kHz (ALT1), 60 kHz (ALT2), 80 kHz (ALT3), ...

**Example:**

POW:ACH:SPAC:ALT1 100 kHz

Sets the spacing between TX channel and alternate adjacent channel 1 (ALT1) from 40 kHz to 100 kHz. In consequence, the spacing between the TX channel and all higher alternate adjacent channels is increased by the factor  $100/40 = 2.5$ : ALT2 = 150 kHz, ALT3 = 200 kHz, ALT4 = 250 kHz.

**Manual operation:** See "[Spacing](#)" on page 215

**[SENSe:]POWer:ACHannel:SPACing:CHANnel<channel> <Spacing>**

This command defines the channel spacing for the carrier signals.

**Suffix:**

<channel> 1...11  
the TX channel

**Parameters:**

<Spacing> 14 kHz to 20 GHz  
\*RST: 20 kHz

**Example:**

POW:ACH:SPAC:CHAN 25kHz

**Manual operation:** See "[Spacing](#)" on page 215

**[SENSe:]POWer:ACHannel:TXChannel:COUNT <Number>**

This command selects the number of carrier signals.

The command is available only for multicarrier channel and adjacent-channel power measurements with span > 0 (see [CALCulate<n>:MARKer<m>:FUNction:POWer:SElect](#) on page 688).

**Parameters:**

<Number> 1 to 18  
\*RST: 1

**Example:**

POW:ACH:TXCH:COUN 3



**Manual operation:** See "[# of TX Chan](#)" on page 213

### Defining Weighting Filters

The following commands define weighting filters for ACLR measurements.

[SENSe:]POWer:ACHannel:FILTer:ALPHa:ACHannel.....	702
[SENSe:]POWer:ACHannel:FILTer:ALPHa[:ALL].....	702
[SENSe:]POWer:ACHannel:FILTer:ALPHa:ALTErnate<channel>.....	702
[SENSe:]POWer:ACHannel:FILTer:ALPHa:CHANnel<channel>.....	703
[SENSe:]POWer:ACHannel:FILTer[:STATE]:ACHannel.....	703
[SENSe:]POWer:ACHannel:FILTer[:STATE]:ALTErnate<channel>.....	703
[SENSe:]POWer:ACHannel:FILTer[:STATE]:CHANnel<channel>.....	703
[SENSe:]POWer:ACHannel:FILTer[:STATE]:ALL.....	704

---

#### [SENSe:]POWer:ACHannel:FILTer:ALPHa:ACHannel <Alpha>

This command defines the roll-off factor for the weighting filter of the adjacent channel.

**Parameters:**

<Alpha>                    <numeric value>  
                               \*RST:        0,22

**Example:**                POW:ACH:FILT:ALPH:ACH 0,35

**Manual operation:** See "[Weighting Filter](#)" on page 216

---

#### [SENSe:]POWer:ACHannel:FILTer:ALPHa[:ALL] <Alpha>

This command defines the roll-off factor for the weighting filter of all channels.

**Parameters:**

<Alpha>                    <numeric value>  
                               \*RST:        0,22

**Example:**                POW:ACH:FILT:ALPH:ALL 0,35

---

#### [SENSe:]POWer:ACHannel:FILTer:ALPHa:ALTErnate<channel> <Alpha>

This command defines the roll-off factor for the weighting filter of the specified alternate channel.

**Suffix:**

<channel>                1...11  
                               the alternate channel

**Parameters:**

<Alpha>                    <numeric value>  
                               \*RST:        0,22

**Example:**                POW:ACH:FILT:ALPH:ALT3 0,35  
 Sets the alpha value for the weighting filter for the alternate channel 3 to 0,35.

**Manual operation:** See ["Weighting Filter"](#) on page 216

---

**[SENSe:]POWer:ACHannel:FILTer:ALPHA:CHANnel<channel> <Alpha>**

This command defines the roll-off factor for the weighting filter of the specified TX channel.

**Suffix:**

<channel>            1...11  
the TX channel

**Parameters:**

<Alpha>            <numeric value>  
\*RST:            0,22

**Example:**

POW:ACH:FILT:ALPH:CHAN3 0,35  
Sets the alpha value for the weighting filter for the TX channel 3 to 0,35.

**Manual operation:** See ["Weighting Filter"](#) on page 216

---

**[SENSe:]POWer:ACHannel:FILTer[:STATe]:ACHannel <State>**

This command activates the weighting filter for the adjacent channel.

**Parameters:**

<State>            ON | OFF  
\*RST:            OFF

**Example:**

POW:ACH:FILT:ACH ON

**Manual operation:** See ["Weighting Filter"](#) on page 216

---

**[SENSe:]POWer:ACHannel:FILTer[:STATe]:ALTErnate<channel> <State>**

This command activates the weighting filter for the specified alternate channel.

**Suffix:**

<channel>            1...11  
the alternate adjacent channel

**Parameters:**

<State>            ON | OFF  
\*RST:            OFF

**Example:**

POW:ACH:FILT:ALT3 ON  
Activates the weighting filter for alternate channel 3.

**Manual operation:** See ["Weighting Filter"](#) on page 216

---

**[SENSe:]POWer:ACHannel:FILTer[:STATe]:CHANnel<channel> <State>**

This command activates the weighting filter for the specified TX channel.

**Suffix:**  
 <channel> 1...18  
 the TX channel

**Parameters:**  
 <State> ON | OFF  
 \*RST: OFF

**Example:** POW:ACH:FILT:CHA3 ON  
 Activates the weighting filter for TX channel 3.

**Manual operation:** See "[Weighting Filter](#)" on page 216

**[SENSe:]POWer:ACHannel:FILTer[:STATe]:ALL <State>**

This command activates the weighting filter for all channels.

**Parameters:**  
 <State> ON | OFF  
 \*RST: OFF

**Example:** POW:ACH:FILT ON

### Selecting the Reference Channel

The following commands define the reference channel for relative ACLR measurements.

<a href="#">[SENSe:]POWer:ACHannel:REFerence:AUTO ONCE.....</a>	704
<a href="#">[SENSe:]POWer:ACHannel:REFerence:TXCHannel:AUTO.....</a>	704
<a href="#">[SENSe:]POWer:ACHannel:REFerence:TXCHannel:MANual.....</a>	705

**[SENSe:]POWer:ACHannel:REFerence:AUTO ONCE**

This command sets the reference value to the currently measured channel power for the relative measurement.

**Example:** POW:ACH:REF:AUTO ONCE

**Manual operation:** See "[Set CP Reference](#)" on page 220

**[SENSe:]POWer:ACHannel:REFerence:TXCHannel:AUTO <Channel>**

This command activates the automatic selection of a transmission channel to be used as a reference channel in relative adjacent-channel power measurements.

The transmission channel with the highest power, the transmission channel with the lowest power, or the transmission channel nearest to the adjacent channels can be defined as a reference channel.

The command is available only for multicarrier channel and adjacent-channel power measurements with span > 0 ( `CALCulate<n>:MARKer<m>:FUNction:POWer:SElect` on page 688).

**Parameters:**

<Channel>                    MINimum | MAXimum | LHIGhest

**MINimum**  
Transmission channel with the lowest power

**MAXimum**  
Transmission channel with the highest power

**LHIGhest**  
Lowermost transmission channel for the lower adjacent channels, uppermost transmission channel for the upper adjacent channels

**Example:**

`POW:ACH:REF:TXCH:AUTO MAX`  
The transmission channel with the highest power is used as a reference channel.

**Manual operation:** See "[ACLR Reference](#)" on page 215

**[SENSe:]POWer:ACHannel:REFerence:TXCHannel:MANual** <ChannelNumber>

This command selects a transmission channel to be used as a reference channel in relative adjacent-channel power measurements.

The command is available only for multicarrier channel and adjacent-channel power measurements with span > 0 ( `CALCulate<n>:MARKer<m>:FUNction:POWer:SElect` on page 688).

**Parameters:**

<ChannelNumber>    1 to 18

\*RST:                1

**Example:**

`POW:ACH:REF:TXCH:MAN 3`  
Transmission channel 3 is used as a reference channel.

**Manual operation:** See "[ACLR Reference](#)" on page 215

**Checking Limits**

The following commands configure limit checks for channel power and ACLR measurements.

<code>CALCulate&lt;n&gt;:LIMit&lt;k&gt;:ACPower:ACHannel:ABSolute</code> .....	706
<code>CALCulate&lt;n&gt;:LIMit&lt;k&gt;:ACPower:ACHannel:ABSolute:STATe</code> .....	706
<code>CALCulate&lt;n&gt;:LIMit&lt;k&gt;:ACPower:ACHannel[:RELative]</code> .....	707
<code>CALCulate&lt;n&gt;:LIMit&lt;k&gt;:ACPower:ACHannel[:RELative]:STATe</code> .....	708
<code>CALCulate&lt;n&gt;:LIMit&lt;k&gt;:ACPower:ACHannel:RESult</code> .....	708
<code>CALCulate&lt;n&gt;:LIMit&lt;k&gt;:ACPower:ALTErnate&lt;Channel&gt;:ABSolute</code> .....	709
<code>CALCulate&lt;n&gt;:LIMit&lt;k&gt;:ACPower:ALTErnate&lt;Channel&gt;:ABSolute:STATe</code> .....	710
<code>CALCulate&lt;n&gt;:LIMit&lt;k&gt;:ACPower:ALTErnate&lt;channel&gt;[:RELative]</code> .....	711

CALCulate<n>:LIMit<k>:ACPoweR:ALTeRnate<Channel>[:RELative]:STATe.....	711
CALCulate<n>:LIMit<k>:ACPoweR:ALTeRnate<Channel>:RESult?.....	712
CALCulate<n>:LIMit<k>:ACPoweR[:STATe].....	713

---

**CALCulate<n>:LIMit<k>:ACPoweR:ACHannel:ABSolute <LowerLimit>, <UpperLimit>**

This command defines the absolute limit value for the lower/upper adjacent channel during adjacent-channel power measurement (Adjacent Channel Power).

Note that the absolute limit value has no effect on the limit check as soon as it is below the relative limit value defined with `CALCulate<n>:LIMit<k>:ACPoweR:ACHannel[:RELative]`. This mechanism allows automatic checking of the absolute basic values of adjacent-channel power as defined in mobile radio standards.

**Suffix:**

<n>                      Selects the measurement window.  
 <k>                      irrelevant

**Parameters:**

<LowerLimit>,            first value: -200DBM to 200DBM; limit for the lower and the  
 <UpperLimit>            upper adjacent channel  
 \*RST:                    -200DBM

**Example:**

`CALC:LIM:ACP:ACH:ABS -35DBM, -35DBM`  
 Sets the absolute limit value for the power in the lower and upper adjacent channel to -35 dBm.

---

**CALCulate<n>:LIMit<k>:ACPoweR:ACHannel:ABSolute:STATe <State>**

This command activates the limit check for the adjacent channel when adjacent-channel power measurement (Adjacent Channel Power) is performed. Before the command, the limit check for the channel/adjacent-channel measurement must be globally switched on using `CALCulate<n>:LIMit<k>:ACPoweR[:STATe]`.

The result can be queried with `CALCulate<n>:LIMit<k>:ACPoweR:ACHannel:RESult`. It should be noted that a complete measurement must be performed between switching on the limit check and the result query, since otherwise no correct results are available.

**Suffix:**

<n>                      Selects the measurement window.  
 <k>                      irrelevant

**Parameters:**

<State>                    ON | OFF  
 \*RST:                    OFF

**Example:**

```
CALC:LIM:ACP:ACH 30DB, 30DB
```

Sets the relative limit value for the power in the lower and upper adjacent channel to 30 dB below the channel power.

```
CALC:LIM:ACP:ACH:ABS -35DBM, -35DBM
```

Sets the absolute limit value for the power in the lower and upper adjacent channel to -35 dBm.

```
CALC:LIM:ACP ON
```

Switches on globally the limit check for the channel/adjacent-channel measurement.

```
CALC:LIM:ACP:ACH:REL:STAT ON
```

Switches on the check of the relative limit values for adjacent channels.

```
CALC:LIM:ACP:ACH:ABS:STAT ON
```

Switches on the check of absolute limit values for the adjacent channels.

```
INIT;*WAI
```

Starts a new measurement and waits for the sweep end.

```
CALC:LIM:ACP:ACH:RES?
```

Queries the limit check result in the adjacent channels.

**Manual operation:** See "[Absolute Limit](#)" on page 218

---

**CALCulate<n>:LIMit<k>:ACPpower:ACHannel[:RELative] <LowerLimit>, <UpperLimit>**

This command defines the relative limit of the upper/lower adjacent channel for adjacent-channel power measurements. The reference value for the relative limit value is the measured channel power.

It should be noted that the relative limit value has no effect on the limit check as soon as it is below the absolute limit value defined with the [CALCulate<n>:LIMit<k>:ACPpower:ACHannel:ABSolute](#) command. This mechanism allows automatic checking of the absolute basic values of adjacent-channel power as defined in mobile radio standards.

**Suffix:**

<n> Selects the measurement window.

<k> irrelevant

**Parameters:**

<LowerLimit>, <UpperLimit> 0 to 100dB; the value for the lower limit must be lower than the value for the upper limit

\*RST: 0 dB

**Example:**

```
CALC:LIM:ACP:ACH 30DB, 30DB
```

Sets the relative limit value for the power in the lower and upper adjacent channel to 30 dB below the channel power.

**CALCulate<n>:LIMit<k>:ACPpower:ACHannel[:RELative]:STATe <State>**

This command activates the limit check for the relative limit value of the adjacent channel when adjacent-channel power measurement is performed. Before this command, the limit check must be activated using `CALCulate<n>:LIMit<k>:ACPpower[:STATe]`.

The result can be queried with `CALCulate<n>:LIMit<k>:ACPpower:ACHannel:RESult`. Note that a complete measurement must be performed between switching on the limit check and the result query, since otherwise no correct results are available.

**Suffix:**

<n>                      Selects the measurement window.  
 <k>                      irrelevant

**Parameters:**

<State>                ON | OFF  
 \*RST:                OFF

**Example:**

```
CALC:LIM:ACP:ACH 30DB, 30DB
```

Sets the relative limit value for the power in the lower and upper adjacent channel to 30 dB below the channel power.

```
CALC:LIM:ACP:ACH:ABS -35DBM, -35DBM
```

Sets the absolute limit value for the power in the lower and upper adjacent channel to -35 dBm.

```
CALC:LIM:ACP ON
```

Switches on globally the limit check for the channel/adjacent channel measurement.

```
CALC:LIM:ACP:ACH:STAT ON
```

Switches on the check of the relative limit values for adjacent channels.

```
CALC:LIM:ACP:ACH:ABS:STAT ON
```

Switches on the check of absolute limit values for the adjacent channels.

```
INIT;*WAI
```

Starts a new measurement and waits for the sweep end.

```
CALC:LIM:ACP:ACH:RES?
```

Queries the limit check result in the adjacent channels.

**CALCulate<n>:LIMit<k>:ACPpower:ACHannel:RESult**

This command queries the result of the limit check for the upper/lower adjacent channel when adjacent channel power measurement is performed.

If the power measurement of the adjacent channel is switched off, the command produces a query error.

**Suffix:**

<n>                      Selects the measurement window.  
 <k>                      irrelevant

**Return values:**

**Result** The result is returned in the form <result>, <result> where <result> = PASSED | FAILED, and where the first returned value denotes the lower, the second denotes the upper adjacent channel.

**Example:**

```
CALC:LIM:ACP:ACH 30DB, 30DB
```

Sets the relative limit value for the power in the lower and upper adjacent channel to 30 dB below the channel power.

```
CALC:LIM:ACP:ACH:ABS -35DBM, -35DBM
```

Sets the absolute limit value for the power in the lower and upper adjacent channel to -35 dB.

```
CALC:LIM:ACP ON
```

Switches on globally the limit check for the channel/adjacent channel measurement.

```
CALC:LIM:ACP:ACH:STAT ON
```

Switches on the limit check for the adjacent channels.

```
INIT;*WAI
```

Starts a new measurement and waits for the sweep end.

```
CALC:LIM:ACP:ACH:RES?
```

Queries the limit check result in the adjacent channels.

**Manual operation:** See "[Limit Checking](#)" on page 217

---

**CALCulate<n>:LIMit<k>:ACPpower:ALternate<Channel>:ABSolute <LowerLimit>, <UpperLimit>**

This command defines the absolute limit value for the lower/upper alternate adjacent-channel power measurement (Adjacent Channel Power).

Note that the absolute limit value for the limit check has no effect as soon as it is below the relative limit value defined with [CALCulate<n>:LIMit<k>:ACPpower:ACHannel\[:RELative\]](#). This mechanism allows automatic checking of the absolute basic values defined in mobile radio standards for the power in adjacent channels.

**Suffix:**

<n> Selects the measurement window.

<k> irrelevant

<Channel> 1...11  
the alternate channel

**Parameters:**

<LowerLimit>, <UpperLimit> first value: -200DBM to 200DBM; limit for the lower and the upper alternate adjacent channel

\*RST: -200DBM

**Example:**

```
CALC:LIM:ACP:ALT2:ABS -35DBM, -35DBM
```

Sets the absolute limit value for the power in the lower and upper second alternate adjacent channel to -35 dBm.



**CALCulate<n>:LIMit<k>:ACPpower:ALternate<Channel>:ABSolute:STATe <State>**

This command activates the limit check for the alternate adjacent channels for adjacent-channel power measurement (Adjacent Channel Power).

Before the command, the limit check must be globally switched on for the channel/adjacent-channel power with the `CALCulate<n>:LIMit<k>:ACPpower[:STATe]` command.

The result can be queried with `CALCulate<n>:LIMit<k>:ACPpower:ALternate<channel>[:RELative]`. Note that a complete measurement must be performed between switching on the limit check and the result query, since otherwise no correct results are available.

**Suffix:**

<n>	Selects the measurement window.
<k>	irrelevant
<Channel>	1...11 the alternate channel

**Parameters:**

<State>	ON   OFF
*RST:	OFF

**Example:**

```
CALC:LIM:ACP:ALT2 30DB, 30DB
```

Sets the relative limit value for the power in the lower and upper second alternate adjacent channel to 30 dB below the channel power.

```
CALC:LIM:ACP:ALT2:ABS -35DBM, -35DBM
```

Sets the absolute limit value for the power in the lower and upper second alternate adjacent channel to -35 dBm.

```
CALC:LIM:ACP ON
```

Switches on globally the limit check for the channel/adjacent channel measurement.

```
CALC:LIM:ACP:ALT2:STAT ON
```

Switches on the check of the relative limit values for the lower and upper second alternative adjacent channels.

```
CALC:LIM:ACP:ALT2:ABS:STAT ON
```

Switches on the check of absolute limit values for the lower and upper second alternative adjacent channels.

```
INIT; *WAI
```

Starts a new measurement and waits for the sweep end.

```
CALC:LIM:ACP:ALT2:RES?
```

Queries the limit check result in the second alternate adjacent channels.

---

**CALCulate<n>:LIMit<k>:ACPpower:ALternate<channel>[:RELative] <LowerLimit>, <UpperLimit>**

This command defines the limit for the alternate adjacent channels for adjacent channel power measurements. The reference value for the relative limit value is the measured channel power.

Note that the relative limit value has no effect on the limit check as soon as it is below the absolute limit defined with `CALCulate<n>:LIMit<k>:ACPpower:ALternate<Channel>:ABSolute`. This mechanism allows automatic checking of the absolute basic values of adjacent-channel power as defined in mobile radio standards.

**Suffix:**

<n>                      Selects the measurement window.  
 <k>                      irrelevant  
 <Channel>              1...11  
                             the alternate channel

**Parameters:**

<LowerLimit>,            first value: 0 to 100dB; limit for the lower and the upper alternate adjacent channel  
 <UpperLimit>  
 \*RST:                    0 DB

**Example:**

`CALC:LIM:ACP:ALT2 30DB, 30DB`

Sets the relative limit value for the power in the lower and upper second alternate adjacent channel to 30 dB below the channel power.

**Manual operation:** See "[Limit Checking](#)" on page 217

---

**CALCulate<n>:LIMit<k>:ACPpower:ALternate<Channel>[:RELative]:STATE <State>**

This command activates the limit check for the alternate adjacent channels for adjacent channel power measurements. Before the command, the limit check must be activated using `CALCulate<n>:LIMit<k>:ACPpower[:STATE]`.

The result can be queried with `CALCulate<n>:LIMit<k>:ACPpower:ALternate<channel>[:RELative]`. Note that a complete measurement must be performed between switching on the limit check and the result query, since otherwise no correct results are obtained.

**Suffix:**

<n>                      Selects the measurement window.  
 <k>                      irrelevant  
 <Channel>              1...11  
                             the alternate channel

**Parameters:**

<State> ON | OFF  
 \*RST: OFF

**Example:**

CALC:LIM:ACP:ALT2 30DB, 30DB

Sets the relative limit value for the power in the lower and upper second alternate adjacent channel to 30 dB below the channel power.

CALC:LIM:ACP:ALT2:ABS -35DBM, -35DBM

Sets the absolute limit value for the power in the lower and upper second alternate adjacent channel to -35 dBm.

CALC:LIM:ACP ON

Switches on globally the limit check for the channel/adjacent channel measurement.

CALC:LIM:ACP:ALT2:STAT ON

Switches on the check of the relative limit values for the lower and upper second alternate adjacent channel.

CALC:LIM:ACP:ALT2:ABS:STAT ON

Switches on the check of absolute limit values for the lower and upper second alternate adjacent channel.

INIT;\*WAI

Starts a new measurement and waits for the sweep end.

CALC:LIM:ACP:ALT2:RES?

Queries the limit check result in the second alternate adjacent channels.

**CALCulate<n>:LIMit<k>:ACPpower:ALTErnate<Channel>:RESult?**

This command queries the result of the limit check for the alternate adjacent channels for adjacent channel power measurements.

If the power measurement of the adjacent channel is switched off, the command produces a query error.

**Suffix:**

<n> Selects the measurement window.

<k> irrelevant

<Channel> 1...11  
 the alternate channel

**Return values:**

<Result> The result is returned in the form <result>, <result> where <result> = PASSED | FAILED and where the first (second) returned value denotes the lower (upper) alternate adjacent channel.

<b>Example:</b>	<pre>CALC:LIM:ACP:ALT2 30DB, 30DB</pre> <p>Sets the relative limit value for the power in the lower and upper second alternate adjacent channel to 30 dB below the channel power.</p> <pre>CALC:LIM:ACP:ALT2:ABS -35DBM, -35DBM</pre> <p>Sets the absolute limit value for the power in the lower and upper second alternate adjacent channel to -35 dBm.</p> <pre>CALC:LIM:ACP ON</pre> <p>Switches on globally the limit check for the channel/adjacent channel measurement.</p> <pre>CALC:LIM:ACP:ALT2:STAT ON</pre> <p>Switches on the limit check for the lower and upper second adjacent channel.</p> <pre>INIT;*WAI</pre> <p>Starts a new measurement and waits for the sweep end.</p> <pre>CALC:LIM:ACP:ALT2:RES?</pre> <p>Queries the limit check result in the second alternate adjacent channels.</p>
<b>Usage:</b>	Query only

---

### **CALCulate<n>:LIMit<k>:ACPpower[:STATe] <State>**

This command switches on and off the limit check for adjacent-channel power measurements. The commands `CALCulate<n>:LIMit<k>:ACPpower:ACHannel[:RELative]:STATe` or `CALCulate<n>:LIMit<k>:ACPpower:ALternate<Channel>[:RELative]:STATe` must be used in addition to specify whether the limit check is to be performed for the upper/lower adjacent channel or for the alternate adjacent channels.

**Suffix:**

<n>	Selects the measurement window.
<k>	irrelevant

**Parameters:**

<State>	ON   OFF
*RST:	OFF

<b>Example:</b>	<pre>CALC:LIM:ACP ON</pre> <p>Switches on the ACLR limit check.</p>
-----------------	---------------------------------------------------------------------

<b>Manual operation:</b>	<p>See <a href="#">"Limit Checking"</a> on page 217</p> <p>See <a href="#">"Relative Limit"</a> on page 218</p> <p>See <a href="#">"Absolute Limit"</a> on page 218</p>
--------------------------	-------------------------------------------------------------------------------------------------------------------------------------------------------------------------

**Analyzing Results**

The following commands analyze and retrieve measurement results for ACLR measurements.

CALCulate<n>:MARKer<m>:FUNction:POWer:RESult:PHZ.....	714
[SENSe:]POWer:ACHannel:MODE.....	714
[SENSe:]POWer:HSPeed.....	715
[SENSe:]POWer:NCORrection.....	715

---

### CALCulate<n>:MARKer<m>:FUNction:POWer:RESult:PHZ <State>

This command switches the query response of the power measurement results between output of absolute values and output referred to the measurement bandwidth.

The measurement results are output with the [CALCulate<n>:MARKer<m>:FUNction:POWer:RESult?](#) command.

#### Suffix:

<n>	Selects the measurement window.
<m>	Selects the marker.

#### Parameters:

<State>	ON   OFF
	<b>ON</b>
	Results output: channel power density in dBm/Hz
	<b>OFF</b>
	Results output: channel power is displayed in dBm
	*RST: OFF

#### Example:

CALC:MARK:FUNC:POW:RES:PHZ ON  
 Output of results referred to the channel bandwidth.  
 For details on a complete measurement example refer to [CALCulate<n>:MARKer<m>:FUNction:POWer:RESult?](#) on page 689.

**Manual operation:** See "[Chan Pwr/Hz](#)" on page 218

---

### [SENSe:]POWer:ACHannel:MODE <Mode>

This command switches between absolute and relative adjacent channel measurement. The command is only available with span > 0 and if the number of adjacent channels is greater than 0.

For the relative measurement the reference value is set to the currently measured channel power using the command [\[SENSe:\]POWer:ACHannel:REFerence:AUTO ONCE](#).

#### Parameters:

<Mode>	ABSolute   RELative
	<b>ABSolute</b>
	absolute adjacent channel measurement
	<b>RELative</b>
	relative adjacent channel measurement
	*RST: RELative

**Example:** `POW:ACH:MODE REL`  
Sets the adjacent channel measurement mode to relative.

**Manual operation:** See "[ACLR \(Abs/Rel\)](#)" on page 219

#### **[SENSe:]POWer:HSPeed <State>**

This command switches on or off the high-speed channel/adjacent channel power measurement. The measurement itself is performed in zero span on the center frequencies of the individual channels. The command automatically switches to zero span and back.

Depending on the selected mobile radio standard, weighting filters with characteristic or very steep-sided channel filters are used for band limitation.

#### **Parameters:**

<State>                   ON | OFF  
\*RST:                   OFF

**Example:** `POW:HSP ON`

**Manual operation:** See "[Fast ACLR \(On/Off\)](#)" on page 220

#### **[SENSe:]POWer:NCORrection <Mode>**

This command turns noise cancellation on and off.

If noise cancellation is on, the R&S ESRP performs a reference measurement to determine its inherent noise and subtracts the result from the channel power measurement result (first active trace only).

The inherent noise of the instrument depends on the selected center frequency, resolution bandwidth and level setting. Therefore, the correction function is disabled whenever one of these parameters is changed. A corresponding message is displayed on the screen. Noise correction must be turned on again manually after the change.

#### **Parameters:**

<Mode>                   **ON**  
                              Performs noise correction.  
                              **OFF**  
                              Performs no noise correction.  
                              **AUTO**  
                              Performs noise correction.  
                              After a parameter change, noise correction is restarted automatically and a new correction measurement is performed.  
\*RST:                   OFF

**Example:** `POW:NCOR ON`

**Manual operation:** See "[Noise Correction](#)" on page 221

### Predefined CP/ACLR Standards

Parameter	Standard
W-CDMA 3GPP FWD	W-CDMA 3.84 MHz forward
W-CDMA 3GPP REV	W-CDMA 3.84 MHz reverse
CDMA IS95A FWD	CDMA IS95A forward
CDMA IS95A REV	CDMA IS95A reverse
CDMA IS95C Class 0 FWD	CDMA IS95C Class 0 forward
CDMA IS95C Class 0 REV	CDMA IS95C Class 0 reverse
CDMA J-STD008 FWD	CDMA J-STD008 forward
CDMA J-STD008 REV	CDMA J-STD008 reverse
CDMA IS95C Class 1 FWD	CDMA IS95C Class 1 forward
CDMA IS95C Class 1 REV	CDMA IS95C Class 1 reverse
CDMA 2000	CDMA 2000
TD SCDMA FWD	TD-SCDMA forward
TD SCDMA REV	TD-SCDMA reverse
WLAN 802.11A	WLAN 802.11A
WLAN 802.11B	WLAN 802.11B
WiMAX	WiMAX
WiBRO	WiBRO
RFID 14443	RFID 14443
EUTRa	EUTRA/LTE Square
REUTra	EUTRA/LTE Square/RRC
TETRA	TETRA
PDC	PDC
PHS	PHS
CDPD	CDPD
GSM	GSM

#### 11.5.1.3 Measuring the Occupied Bandwidth

The following commands configure measurements of the occupied bandwidth.

Commands useful to measure the occupied bandwidth described elsewhere:

- `CALCulate<n>:MARKer<m>:FUNction:POWer:RESult?` on page 689
- `CALCulate<n>:MARKer<m>:FUNction:POWer:SElect` on page 688
- `CALCulate<n>:MARKer<m>:FUNction:POWer[:STATe]` on page 692

- [SENSe:]POWER:ACHannel:BANDwidth|BWIDth[:CHANnel<channel>] on page 699
- [SENSe:]POWER:ACHannel:PRESet on page 693
- [SENSe:]POWER:ACHannel:PRESet:RLEVel on page 694
- TRACe<n>:DATA on page 694

[SENSe:]POWER:BANDwidth|BWIDth..... 717

**[SENSe:]POWER:BANDwidth|BWIDth <Percentage>**

This command defines the percentage of the power with respect to the total power.

This value is the basis for the occupied bandwidth measurement (see [SENSe:]POWER:ACHannel:PRESet on page 693).

**Parameters:**

<Percentage> 10 to 99.9PCT  
 \*RST: 99PCT

**Example:** POW:BWID 95PCT

**Manual operation:** See "% Power Bandwidth (span > 0)" on page 231

**11.5.1.4 Measuring Spurious Emissions**

The following commands configure and perform spurious emission measurements.

- Controlling the Measurement..... 717
- Managing a Sweep List..... 718
- Configuring List Evaluation..... 726
- Retrieving Results..... 727

**Controlling the Measurement**

Note that the spurious measurement must be initialized before you can start configuring the sweep list or list evaluation.

Commands useful to retrieve results described elsewhere:

- [SENSe:]SWEep:MODE on page 729

INITiate<n>:SPURious..... 717  
 MMEMory:STORe<n>:SPURious..... 718

**INITiate<n>:SPURious**

This command initiates a Spurious Emissions measurement.

**Suffix:**

<n> irrelevant

**Example:**

INIT:SPUR  
 Starts a Spurious Emissions measurement.

**Usage:**

Event



**MMEMory:STORe<n>:SPURious <FileName>**

This command exports the marker peak list available for spurious emission measurements to a file.

**Suffix:**

<n> irrelevant

**Parameters:**

<FileName> String containing the path and name of the target file.

**Example:**

MMEM:STOR:SPUR 'test'

Saves the current marker peak list in the file test.dat.

**Usage:**

Event

**Managing a Sweep List**

The following commands configure the sweep list for spurious emission measurements.

[SENSe:]LIST:RANGe<range>:BANDwidth[:RESolution]	718
[SENSe:]LIST:RANGe<range>:BANDwidth:VIDeo	719
[SENSe:]LIST:RANGe<range>:BREak	719
[SENSe:]LIST:RANGe<range>:COUNT	719
[SENSe:]LIST:RANGe<range>:DELete	720
[SENSe:]LIST:RANGe<range>:DETector	720
[SENSe:]LIST:RANGe<range>:FILTer:TYPE	720
[SENSe:]LIST:RANGe<range>[:FREQuency]:START	721
[SENSe:]LIST:RANGe<range>[:FREQuency]:STOP	721
[SENSe:]LIST:RANGe<range>:INPut:ATTenuation	722
[SENSe:]LIST:RANGe<range>:INPut:ATTenuation:AUTO	722
[SENSe:]LIST:RANGe<range>:INPut:GAIN:STATe	722
[SENSe:]LIST:RANGe<range>:LIMit:START	723
[SENSe:]LIST:RANGe<range>:LIMit:STATe	723
[SENSe:]LIST:RANGe<range>:LIMit:STOP	724
[SENSe:]LIST:RANGe<range>:POINts	724
[SENSe:]LIST:RANGe<range>:RLEVel	724
[SENSe:]LIST:RANGe<range>:SWEep:TIME	725
[SENSe:]LIST:RANGe<range>:SWEep:TIME:AUTO	725
[SENSe:]LIST:RANGe<range>:TRANsducer	725

**[SENSe:]LIST:RANGe<range>:BANDwidth[:RESolution] <Value>**

This command sets the RBW value for the specified range.

**Suffix:**

<range> 1...20  
range

**Parameters:**

<Value> Refer to the data sheet.  
\*RST: 30.0 kHz

**Example:** `LIST:RANG2:BAND:RES 5000`  
Sets the RBW for range 2 to 5 kHz.

**Manual operation:** See "[RBW](#)" on page 266

### **[SENSe:]LIST:RANGe<range>:BANDwidth:VIDeo**

This command sets the VBW value for the specified range.

**Suffix:**  
<range> 1...20  
range

**Parameters:**  
<Value> Refer to the data sheet.  
\*RST: 10.0 MHz

**Example:** `LIST:RANG1:BAND:VID 5000000`  
Sets the VBW for range 1 to 5 MHz.

**Manual operation:** See "[VBW](#)" on page 266

### **[SENSe:]LIST:RANGe<range>:BREak <State>**

This command configures the sweep behavior.

The suffixes are irrelevant.

**Suffix:**  
<range> 1...20  
range

**Parameters:**  
<State> **ON**  
The R&S ESRP stops after one range is swept and continues only if you confirm (a message box is displayed).  
**OFF**  
The R&S ESRP sweeps all ranges in one go.  
\*RST: OFF

**Example:** `LIST:RANG:BRE ON`  
Configures a stop after each range.

**Manual operation:** See "[Stop After Sweep](#)" on page 267

### **[SENSe:]LIST:RANGe<range>:COUNT**

This command returns the number of defined ranges.

**Suffix:**  
<range> 1...20  
range

**Example:** `LIST:RANG:COUNT?`  
Returns the number of defined ranges.

---

### **[SENSe:]LIST:RANGe<range>:DELeTe**

This command deletes the specified range. The range numbers are updated accordingly. The reference range cannot be deleted. A minimum of three ranges is mandatory.

**Suffix:**  
<range>            1...20  
                         range

**Example:** `LIST:RANG4:DEL`  
Deletes range 4.

**Manual operation:** See "[Delete Range](#)" on page 268

---

### **[SENSe:]LIST:RANGe<range>:DETEctor <Detector>**

This command sets the detector for the specified range. For details refer to "[Detector](#)" on page 266.

**Suffix:**  
<range>            1...20  
                         range

**Parameters:**  
<Detector>        NEGative | POSitive | SAMPlE | RMS | AVERAge  
**NEGative**  
                         minimum peak detector  
**POSitive**  
                         peak detector  
**SAMPlE**  
                         sample detector  
**RMS**  
                         RMS detector  
**AVERAge**  
                         average detector  
\*RST:            RMS

**Example:** `LIST:RANGe3:DET SAMP`  
Sets the sample detector for range 3.

**Manual operation:** See "[Detector](#)" on page 266

---

### **[SENSe:]LIST:RANGe<range>:FILTer:TYPE <Type>**

This command sets the filter type for the specified range.

<b>Suffix:</b>	
<range>	1...20 range
<b>Parameters:</b>	
<Type>	<b>NORMal</b> Gaussian filters <b>CFILter</b> channel filters <b>RRC</b> RRC filters <b>P5</b> 5 Pole filters <b>*RST:</b> NORM The available bandwidths of the filters are specified in the data sheet.
<b>Example:</b>	<code>LIST:RANG1:FILT:TYPE RRC</code> Sets the RRC filter type for range 1.
<b>Manual operation:</b>	See " <a href="#">Filter Type</a> " on page 265

#### **[SENSe:]LIST:RANGe<range>[:FREQUENCY]:STARt <Frequency>**

This command sets the start frequency for the specified range.

In order to change the start/stop frequency of the first/last range, select the appropriate span. If you set a span that is smaller than the overall span of the ranges, the measurement includes only the ranges that lie within the defined span and have a minimum span of 20 Hz. The first and last range are adapted to the given span as long as the minimum span of 20 Hz is not violated.

<b>Suffix:</b>	
<range>	1...20 range
<b>Parameters:</b>	
<Frequency>	see rules in chapter 4, "Ranges and settings" <b>*RST:</b> -250.0 MHz (range 1), -2.52 MHz (range 2), 2.52 MHz (range 3)
<b>Example:</b>	<code>LIST:RANG1:STAR 100000000</code> Sets the start frequency for range 1 to 100 MHz.
<b>Manual operation:</b>	See " <a href="#">Range Start / Range Stop</a> " on page 265

#### **[SENSe:]LIST:RANGe<range>[:FREQUENCY]:STOP <Frequency>**

This command sets the stop frequency for the specified range. See also [\[SENSe:\]LIST:RANGe<range>\[:FREQUENCY\]:STARt](#) on page 721.

<b>Suffix:</b>	
<range>	1...20 range
<b>Parameters:</b>	
<Frequency>	see rules in chapter 4, "Ranges and settings"
*RST:	-2.52 MHz (range 1), 2.52 MHz (range 2), 250.0 MHz (range 3)
<b>Example:</b>	LIST:RANG3:STOP 10000000 Sets the stop frequency for range 2 to 10 MHz.
<b>Manual operation:</b>	See " <a href="#">Range Start / Range Stop</a> " on page 265

**[SENSe:]LIST:RANGe<range>:INPut:ATTenuation <Value>**

This command sets the attenuation for the specified range.

<b>Suffix:</b>	
<range>	1...20 range
<b>Parameters:</b>	
<Value>	Refer to the data sheet.
*RST:	0 dB
<b>Example:</b>	LIST:RANG3:INP:ATT 10 Sets the attenuation of range 3 to 10 dB.
<b>Manual operation:</b>	See " <a href="#">RF Attenuator</a> " on page 266

**[SENSe:]LIST:RANGe<range>:INPut:ATTenuation:AUTO <State>**

This command activates or deactivates the automatic RF attenuation setting for the specified range.

<b>Suffix:</b>	
<range>	1...20 range
<b>Parameters:</b>	
<State>	ON   OFF
*RST:	ON
<b>Example:</b>	LIST:RANG2:INP:ATT:AUTO OFF Deactivates the RF attenuation auto mode for range 2.
<b>Manual operation:</b>	See " <a href="#">RF Att. Mode</a> " on page 266

**[SENSe:]LIST:RANGe<range>:INPut:GAIN:STATe <State>**

This command switches the preamplifier on or off for the specified range.

**Suffix:**  
 <range> 1...20  
 range

**Parameters:**  
 <State> ON | OFF  
 \*RST: OFF

**Example:** LIST:RANG3:INP:GAIN:STATE ON  
 Switches the preamplifier for range 3 on or off.

**Manual operation:** See "[Preamp](#)" on page 266

#### [SENSe:]LIST:RANGe<range>:LIMit:STARt <Limit>

This command sets an absolute limit value at the start frequency of the specified range. Different from manual operation, this setting is independent of the defined limit check type.

**Suffix:**  
 <range> 1...20  
 range

**Parameters:**  
 <Limit> -400 to in 400 dBm  
 \*RST: 13 dBm

**Example:** LIST:RANG1:LIM:ABS:STAR 10  
 Sets an absolute limit of 10 dBm at the start frequency of the range.

**Manual operation:** See "[Abs Limit Start](#)" on page 267

#### [SENSe:]LIST:RANGe<range>:LIMit:STATe

This command activates or deactivates the limit check for all ranges.

**Suffix:**  
 <range> irrelevant

**Parameters:**  
 <State> ON | OFF  
 \*RST: OFF

**Example:** LIST:RANG3:LIM:STAT ON  
 Activates a limit check for all ranges.

**Manual operation:** See "[Limit Check 1-4](#)" on page 267

**[SENSe:]LIST:RANGe<range>:LIMit:STOP <Limit>**

This command sets an absolute limit value at the stop frequency of the specified range. Different from manual operation, this setting is independent of the defined limit check type.

**Suffix:**

<range>            1...20  
range

**Parameters:**

<Limit>            -400 to in 400 dBm  
\*RST:            13 dBm

**Example:**

LIST:RANG1:LIM:STOP 20

Sets an absolute limit of 20 dBm at the stop frequency of the range.

**Manual operation:** See "[Abs Limit Stop](#)" on page 267

**[SENSe:]LIST:RANGe<range>:POINts <Value>**

This command sets the number of sweep points for the specified range.

**Suffix:**

<range>            1...20  
range

**Parameters:**

<Value>            For details on possible values refer to chapter 4, **Sweep Points** softkey of the "Sweep" menu.

\*RST:            691

**Example:**

LIST:RANG3:POIN 601

Sets 601 sweep points for range 3.

**Manual operation:** See "[Sweep Points](#)" on page 267

**[SENSe:]LIST:RANGe<range>:RLEVel <Value>**

This command sets the reference level for the specified range.

**Suffix:**

<range>            1...20  
range

**Parameters:**

<Value>            Refer to the data sheet.

\*RST:            -20 dBm

**Example:**

LIST:RANG2:RLEV 0

Sets the reference level of range 2 to 0 dBm.

**Manual operation:** See "[Ref. Level](#)" on page 266

**[SENSe:]LIST:RANGe<range>:SWEep:TIME**

This command sets the sweep time for the specified range.

**Suffix:**

<range>            1...20  
range

**Parameters:**

<SweepTime>      Allowed values depend on the ratio of span to RBW and RBW to VBW. For details refer to the data sheet.

\*RST:            0.27 s

**Example:**

LIST:RANG1:SWE:TIME 1

Sets the sweep time for range 1 to 1 s.

**Manual operation:** See "[Sweep Time](#)" on page 266

**[SENSe:]LIST:RANGe<range>:SWEep:TIME:AUTO**

This command activates or deactivates the automatic sweep time setting for the specified range.

**Suffix:**

<range>            1...20  
range

**Parameters:**

<State>            ON | OFF

\*RST:            ON

**Example:**

LIST:RANG3:SWE:TIME:AUTO OFF

Deactivates the sweep time auto mode for range 3.

**Manual operation:** See "[Sweep Time Mode](#)" on page 266

**[SENSe:]LIST:RANGe<range>:TRANsducer <TransducerName>**

This command sets a transducer for the specified range. You can only choose a transducer that fulfills the following conditions:

- The transducer overlaps or equals the span of the range.
- The x-axis is linear.
- The unit is dB.

**Suffix:**

<range>            1...20  
range

**Parameters:**

<TransducerName> 'string' = name of the transducer

**Example:**

SENS:LIST:RANG1:TRAN 'test'

Sets the transducer called "test" for range 1.



**Manual operation:** See "Transd. Factor" on page 267

### Configuring List Evaluation

The following commands configure the list evaluation.

- `CALCulate<n>:PEAKsearch|PSEarch:MARGIN` on page 648
- `MMEMoRY:STORe<n>:LIST` on page 745

<code>CALCulate&lt;n&gt;:PEAKsearch PSEarch[:IMMEDIATE]</code> .....	726
<code>CALCulate&lt;n&gt;:PEAKsearch PSEarch:AUTO</code> .....	726
<code>CALCulate&lt;n&gt;:PEAKsearch PSEarch:PSHOW</code> .....	726
<code>CALCulate&lt;n&gt;:PEAKsearch PSEarch:SUBRANGES</code> .....	727

---

#### `CALCulate<n>:PEAKsearch|PSEarch[:IMMEDIATE]`

This command switches the spurious limit check off.

If you want to read out the values peak values including the delta to a limit, you have to switch on the limit again.

This command is only for FSP compatibility, and not necessary to use on the R&S ESRP.

**Suffix:**

<n> irrelevant

**Example:**

`CALC:PSE`  
Starts to determine the list.

---

#### `CALCulate<n>:PEAKsearch|PSEarch:AUTO <State>`

This command activates or deactivates the list evaluation.

**Suffix:**

<n> Selects the measurement window.

**Parameters:**

<State> ON | OFF  
\*RST: ON

**Example:**

`CALC:ESP:PSE:AUTO OFF`  
Deactivates the list evaluation.

**Manual operation:** See "List Evaluation (On/Off)" on page 240  
See "List Evaluation (On/Off)" on page 269

---

#### `CALCulate<n>:PEAKsearch|PSEarch:PSHOW`

This command marks all peaks with blue squares in the diagram.

**Suffix:**

<n> Selects the measurement window.

**Parameters:**

<State> ON | OFF  
 \*RST: OFF

**Example:**

CALC:ESP:PSE:PSH ON  
 Marks all peaks with blue squares.

**Manual operation:** See ["Show Peaks"](#) on page 269

**CALCulate<n>:PEAKsearch|PSEarch:SUBRanges <NumberPeaks>**

This command sets the number of peaks per range that are stored in the list. Once the selected number of peaks has been reached, the peak search is stopped in the current range and continued in the next range.

**Suffix:**

<n> irrelevant

**Parameters:**

<NumberPeaks> 1 to 50  
 \*RST: 25

**Example:**

CALC:PSE:SUBR 10  
 Sets 10 peaks per range to be stored in the list.

**Manual operation:** See ["Peaks per Range"](#) on page 269

**Retrieving Results**

The following commands analyze and retrieve measurement results for spurious emission measurements.

- [CALCulate<n>:LIMIT<k>:FAIL?](#) on page 686
- [TRACe<n>:DATA](#) on page 694

**11.5.1.5 Testing Against a Spectrum Emission Mask**

The following commands configure and perform spectrum emission mask (SEM) measurements.

- [Managing Measurement Configurations](#)..... 727
- [Controlling the Measurement](#)..... 729
- [Managing a Sweep List](#)..... 730
- [Configuring the Reference Range](#)..... 739
- [Configuring Power Classes](#)..... 740
- [Configuring List Evaluation](#)..... 744
- [Retrieving Results](#)..... 746

**Managing Measurement Configurations**

The following commands control measurement configurations for SEM measurements.

CALCulate<n>:LIMit<k>:ESPectrum:RESTore.....	728
[SENSe:]ESPectrum:PRESet[:STANdard].....	728
[SENSe:]ESPectrum:PRESet:RESTore.....	728
[SENSe:]ESPectrum:PRESet:STORe.....	728

---

### CALCulate<n>:LIMit<k>:ESPectrum:RESTore

This command restores the predefined limit lines for the Spectrum Emission Mask measurement. All modifications made to the predefined limit lines are lost and the factory-set values are restored.

#### Suffix:

<n>                    1...4  
                          window

<k>                    irrelevant

#### Example:

```
CALC:LIM:ESP:REST
```

Resets the limit lines for the Spectrum Emission Mask to the default setting.

---

### [SENSe:]ESPectrum:PRESet[:STANdard]

This command selects the specified XML file under C:\r\_s\instr\sem\_std. If the file is stored in a subdirectory, include the relative path.

#### Example:

```
ESP:PRES 'WCDMA\3GPP\DL\PowerClass_31_39.xml'
```

Selects the PowerClass\_31\_39.xml XML file in the C:\R\_S\instr\sem\_std\WCDMA\3GPP\DL directory.

```
ESP:PRES?
```

```
W-CDMA 3GPP DL (31,39) dBm
```

The query returns information about the selected standard, the link direction and the power class. If no standard has been selected, the query returns None.

**Manual operation:** See "[Load Standard](#)" on page 243

---

### [SENSe:]ESPectrum:PRESet:RESTore

This command copies the XML files from the C:\R\_S\instr\sem\_backup folder to the C:\R\_S\instr\sem\_std folder. Files of the same name are overwritten.

#### Example:

```
ESP:PRES:REST
```

Restores the originally provided XML files.

**Manual operation:** See "[Restore Standard Files](#)" on page 243

---

### [SENSe:]ESPectrum:PRESet:STORe <FileName>

This command stores the current settings as presettings in the specified XML file under C:\r\_s\instr\sem\_backup.

**Parameters:**

&lt;FileName&gt;

**Example:**

ESP:PRE:STOR

'WCDMA\3GPP\DL\PowerClass\_31\_39.xml'

Stores the settings in the PowerClass\_31\_39.xml file in the C:\R\_S\instr\sem\_std\WCDMA\3GPP\DL directory.

**Manual operation:** See ["Save As Standard"](#) on page 243

**Controlling the Measurement**

The following commands control the measurement itself.

<a href="#">INITiate&lt;n&gt;:ESpectrum</a> .....	729
<a href="#">[SENSe:]SWEep:MODE</a> .....	729

**INITiate<n>:ESpectrum**

This command starts a Spectrum Emission Mask measurement.

**Suffix:**

&lt;n&gt; irrelevant

**Example:**

INIT:ESP

Starts a Spectrum Emission Mask measurement.

**Manual operation:** See ["Meas Start/Stop"](#) on page 243

**[SENSe:]SWEep:MODE <Mode>**

This command selects the spurious emission and spectrum emission mask measurements.

**Parameters:**

&lt;Mode&gt; AUTO | ESpectrum | LIST

**AUTO**

Switches to "Spectrum" measurement mode or stays in the current mode if it is not ESP/LIST

**ESpectrum**

"Spectrum Emission Mask" measurement mode

**LIST**

"Spurious Emissions" measurement mode

\*RST: AUTO

**Example:**

SWE:MODE ESP

Sets the Spectrum Emission Mask measurement mode.

**Manual operation:** See ["Spectrum Emission Mask"](#) on page 199

See ["Spurious Emissions"](#) on page 199

See ["Spectrum Emission Mask"](#) on page 234

See ["Spurious Emissions"](#) on page 265

## Managing a Sweep List

The following commands define a sweep list for SEM measurements.

[SENSe:]ESpectrum:HighSPeed.....	730
[SENSe:]ESpectrum:RANGe<range>:BANDwidth[:RESolution].....	731
[SENSe:]ESpectrum:RANGe<range>:BANDwidth:VIDeo.....	731
[SENSe:]ESpectrum:RANGe<range>:COUNT.....	732
[SENSe:]ESpectrum:RANGe<range>:DELeTe.....	732
[SENSe:]ESpectrum:RANGe<range>:FILTer:TYPE.....	732
[SENSe:]ESpectrum:RANGe<range>[:FREQuency]:STARt.....	733
[SENSe:]ESpectrum:RANGe<range>[:FREQuency]:STOP.....	733
[SENSe:]ESpectrum:RANGe<range>:INPut:ATTenuation.....	734
[SENSe:]ESpectrum:RANGe<range>:INPut:ATTenuation:AUTO.....	734
[SENSe:]ESpectrum:RANGe<range>:INPut:GAIN:STATe.....	734
[SENSe:]ESpectrum:RANGe<range>:INSert.....	735
[SENSe:]ESpectrum:RANGe<range>:LIMit<source>:ABSolute:STARt.....	735
[SENSe:]ESpectrum:RANGe<range>:LIMit<source>:ABSolute:STOP.....	735
[SENSe:]ESpectrum:RANGe<range>:LIMit<source>:RELative:STARt.....	736
[SENSe:]ESpectrum:RANGe<range>:LIMit<source>:RELative:STOP.....	736
[SENSe:]ESpectrum:RANGe<range>:LIMit<source>:STATe.....	737
[SENSe:]ESpectrum:RANGe<range>:RLEVel.....	737
[SENSe:]ESpectrum:RANGe<range>:SWEep:TIME.....	737
[SENSe:]ESpectrum:RANGe<range>:SWEep:TIME:AUTO.....	738
[SENSe:]ESpectrum:RANGe<range>:TRANSDucer.....	738

---

### [SENSe:]ESpectrum:HighSPeed <State>

This command activates Fast SEM mode to accelerate spurious emission mask measurements. For details see "[Fast Spectrum Emission Mask Measurements](#)" on page 257.

Note that in Fast SEM mode, the following parameters cannot be changed in all ranges:

- Filter type, see [SENSe:]ESpectrum:RANGe<range>:FILTer:TYPE on page 732
- RBW, see [SENSe:]ESpectrum:RANGe<range>:BANDwidth[:RESolution] on page 731
- VBW, see [SENSe:]ESpectrum:RANGe<range>:BANDwidth:VIDeo on page 731
- Sweep Time Mode, see [SENSe:]ESpectrum:RANGe<range>:SWEep:TIME:AUTO on page 738
- Sweep Time, see [SENSe:]ESpectrum:RANGe<range>:SWEep:TIME on page 737
- Reference level, see [SENSe:]ESpectrum:RANGe<range>:RLEVel on page 737
- RF Att Mode, see [SENSe:]ESpectrum:RANGe<range>:INPut:ATTenuation:AUTO on page 734

- Rf Attenuation, see [\[SENSe:\]ESpectrum:RANGe<range>:INPut:ATTenuation](#) on page 734
- Preamp, see [\[SENSe:\]ESpectrum:RANGe<range>:INPut:GAIN:STATE](#) on page 734

**Parameters:**

<State> ON | OFF  
 \*RST: OFF

**Example:** ESP:HSP ON

**Manual operation:** See "Fast SEM" on page 235

**[SENSe:]ESpectrum:RANGe<range>:BANDwidth[:RESolution] <Value>**

This command sets the RBW value for the specified range.

Note that this parameter can not be set for all ranges if "Fast SEM" mode is activated (see [\[SENSe:\]ESpectrum:HighSPeed](#) on page 730).

**Suffix:**

<range> 1...20  
 range

**Parameters:**

<Value> Refer to the data sheet.  
 \*RST: 30.0 kHz

**Example:** ESP:RANG2:BAND:RES 5000  
 Sets the RBW for range 2 to 5 kHz.

**Manual operation:** See "RBW" on page 235

**[SENSe:]ESpectrum:RANGe<range>:BANDwidth:VIDeo <Value>**

This command sets the VBW value for the specified range.

Note that this parameter can not be set for all ranges if "Fast SEM" mode is activated (see [\[SENSe:\]ESpectrum:HighSPeed](#) on page 730).

**Suffix:**

<range> 1...20  
 range

**Parameters:**

<Value> Refer to the data sheet.  
 \*RST: 10.0 MHz

**Example:** ESP:RANG1:BAND:VID 5000000  
 Sets the VBW for range 1 to 5 MHz.

**Manual operation:** See "VBW" on page 236

**[SENSe:]ESpectrum:RANGe<range>:COUNT**

This command returns the number of defined ranges.

**Suffix:**

<range>                    1...20  
range

**Example:**

ESP:RANG:COUNT?  
Returns the number of defined ranges.

**[SENSe:]ESpectrum:RANGe<range>:DELEte**

This command deletes the specified range. The range numbers are updated accordingly. The reference range cannot be deleted. A minimum of three ranges is mandatory.

**Suffix:**

<range>                    1...20  
range

**Example:**

ESP:RANG4:DEL  
Deletes range 4.

**Manual operation:** See "[Delete Range](#)" on page 238

**[SENSe:]ESpectrum:RANGe<range>:FILTer:TYPE <Type>**

This command sets the filter type for the specified range.

Note that this parameter can not be set for all ranges if "Fast SEM" mode is activated (see [\[SENSe:\]ESpectrum:HighSPeed](#) on page 730).

**Suffix:**

<range>                    1...20  
range

**Parameters:**

<Type>                    **NORMAL**  
Gaussian filters  
**CFILter**  
channel filters  
**RRC**  
RRC filters  
**P5**  
5 Pole filters  
\*RST:                    NORM  
The available bandwidths of the filters are specified in the data sheet.

**Example:**

ESP:RANG1:FILT:TYPE RRC  
Sets the RRC filter type for range 1.

**Manual operation:** See ["Filter Type"](#) on page 235

---

**[SENSe:]ESpectrum:RANGe<range>[:FREQUENCY]:STARt <Frequency>**

This command sets the start frequency for the specified range.

In order to change the start/stop frequency of the first/last range, select the appropriate span. If you set a span that is smaller than the overall span of the ranges, the measurement includes only the ranges that lie within the defined span and have a minimum span of 20 Hz. The first and last range are adapted to the given span as long as the minimum span of 20 Hz is not violated.

Note the rules for the <Frequency> parameter specified in ["Ranges and Range Settings"](#) on page 245.

**Suffix:**

<range>                    1...20  
range

**Parameters:**

<Frequency>                numeric value  
\*RST:                    -250.0 MHz (range 1), -2.52 MHz (range 2), 2.52 MHz (range 3)

**Example:**

ESP:RANG1:STAR 100000000  
Sets the start frequency for range 1 to 100 MHz.

**Manual operation:** See ["Range Start / Range Stop"](#) on page 235

---

**[SENSe:]ESpectrum:RANGe<range>[:FREQUENCY]:STOP <Frequency>**

This command sets the stop frequency for the specified range. For further details refer to the [\[SENSe:\]ESpectrum:RANGe<range>\[:FREQUENCY\]:STARt](#) command.

Note the rules for the <Frequency> parameter specified in ["Ranges and Range Settings"](#) on page 245.

**Suffix:**

<range>                    1...20  
range

**Parameters:**

<Frequency>                numeric value  
\*RST:                    -2.52 MHz (range 1), 2.52 MHz (range 2), 250.0 MHz (range 3)

**Example:**

ESP:RANG3:STOP 100000000  
Sets the stop frequency for range 2 to 10 MHz.

**Manual operation:** See ["Range Start / Range Stop"](#) on page 235



**[SENSe:]ESpectrum:RANGe<range>:INPut:ATTenuation <Value>**

This command sets the attenuation for the specified range.

Note that this parameter can not be set for all ranges if "Fast SEM" mode is activated (see [SENSe:]ESpectrum:HighSPeed on page 730).

**Suffix:**

<range> 1...20  
range

**Parameters:**

<Value> Refer to the data sheet.  
\*RST: 0 dB

**Example:**

ESP:RANG3:INP:ATT 10  
Sets the attenuation of range 3 to 10 dB.

**Manual operation:** See "RF Attenuator" on page 236

**[SENSe:]ESpectrum:RANGe<range>:INPut:ATTenuation:AUTO <State>**

This command activates or deactivates the automatic RF attenuation setting for the specified range.

Note that this parameter can not be set for all ranges if "Fast SEM" mode is activated (see [SENSe:]ESpectrum:HighSPeed on page 730).

**Suffix:**

<range> 1...20  
range

**Parameters:**

<State> ON | OFF  
\*RST: ON

**Example:**

ESP:RANG2:INP:ATT:AUTO OFF  
Deactivates the RF attenuation auto mode for range 2.

**Manual operation:** See "RF Att. Mode" on page 236

**[SENSe:]ESpectrum:RANGe<range>:INPut:GAIN:STATe <State>**

This command switches the preamplifier on or off for the specified range.

Note that this parameter can not be set for all ranges if "Fast SEM" mode is activated (see [SENSe:]ESpectrum:HighSPeed on page 730).

**Suffix:**

<range> 1...20  
range

**Parameters:**

<State> ON | OFF  
\*RST: OFF

**Example:** `ESP:RANG3:INP:GAIN:STATe ON`  
Switches the preamplifier for range 3 on or off.

**Manual operation:** See ["Preamp"](#) on page 236

#### **[SENSe:]ESpectrum:RANGe<range>:INSert <Mode>**

This command inserts a new range before or after the specified range. The range numbers are updated accordingly.

**Suffix:**  
<range>                    1...20  
                                  range

**Parameters:**  
<Mode>                    AFTer | BEFore

**Example:** `ESP:RANG3:INS BEF`  
Inserts a new range before range 3.  
`ESP:RANG1:INS AFT`  
Inserts a new range after range 1.

**Manual operation:** See ["Insert before Range"](#) on page 238  
See ["Insert after Range"](#) on page 238

#### **[SENSe:]ESpectrum:RANGe<range>:LIMit<source>:ABSolute:STARt <Level>**

This command sets an absolute limit value at the start frequency of the specified range. Different from manual operation, this setting is independently of the defined limit check type.

**Suffix:**  
<range>                    1...20  
                                  range

**Parameters:**  
<Level>                    -400 to in 400 dBm  
                                  \*RST:            13 dBm

**Example:** `ESP:RANG1:LIM:ABS:STAR 10`  
Sets an absolute limit of 10 dBm at the start frequency of the range.

**Manual operation:** See ["Abs Limit Start"](#) on page 237

#### **[SENSe:]ESpectrum:RANGe<range>:LIMit<source>:ABSolute:STOP <Level>**

This command sets an absolute limit value at the stop frequency of the specified range. Different from manual operation, this setting is independent of the defined limit check type.

<b>Suffix:</b>	
<range>	1...20 range
<b>Parameters:</b>	
<Level>	-400 to in 400 dBm *RST: 13 dBm
<b>Example:</b>	ESP:RANG1:LIM:ABS:STOP 20 Sets an absolute limit of 20 dBm at the stop frequency of the range.
<b>Manual operation:</b>	See " <a href="#">Abs Limit Stop</a> " on page 237

**[SENSe:]ESpectrum:RANGe<range>:LIMit<source>:RELative:STARt <Limit>**

This command sets a relative limit value at the start frequency of the specified range. Different from manual operation, this setting is independent of the defined limit check type.

<b>Suffix:</b>	
<range>	1...20 range
<b>Parameters:</b>	
<Limit>	-400 to in 400 dBc *RST: -50 dBc
<b>Example:</b>	ESP:RANG3:LIM:REL:STAR -20 Sets a relative limit of -20 dBc at the start frequency of the range.
<b>Manual operation:</b>	See " <a href="#">Rel Limit Start</a> " on page 237

**[SENSe:]ESpectrum:RANGe<range>:LIMit<source>:RELative:STOP <Limit>**

This command sets a relative limit value at the stop frequency of the specified range. Different from manual operation, this setting is independently of the defined limit check type.

<b>Suffix:</b>	
<range>	1...20 range
<b>Parameters:</b>	
<Limit>	-400 to in 400 dBc *RST: -50 dBc
<b>Example:</b>	ESP:RANG3:LIM:REL:STOP 20 Sets a relative limit of 20 dBc at the stop frequency of the range.
<b>Manual operation:</b>	See " <a href="#">Rel Limit Stop</a> " on page 237

---

**[SENSe:]ESpectrum:RANGe<range>:LIMit<source>:STATe <State>**

This command sets the type of limit check for all ranges.

**Suffix:**

<range>                      irrelevant

**Parameters:**

<State>                      ABSolute | RELative | AND | OR

**ABSolute**

Checks only the absolute limits defined.

**RELative**

Checks only the relative limits. Relative limits are defined as relative to the measured power in the reference range.

**AND**

Combines the absolute and relative limit. The limit check fails when both limits are violated.

**OR**

Combines the absolute and relative limit. The limit check fails when one of the limits is violated.

\*RST:                      REL

**Example:**

ESP:RANG3:LIM:STAT AND

Sets for all ranges the combined absolute/relative limit check.

**Manual operation:** See "[Limit Check 1-4](#)" on page 237

---

**[SENSe:]ESpectrum:RANGe<range>:RLEVel <Value>**

This command sets the reference level for the specified range.

Note that this parameter can not be set for all ranges if "Fast SEM" mode is activated (see [\[SENSe:\]ESpectrum:HighSpeed](#) on page 730).

**Suffix:**

<range>                      1...20  
range

**Parameters:**

<Value>                      Refer to the data sheet.

\*RST:                      -20 dBm

**Example:**

ESP:RANG2:RLEV 0

Sets the reference level of range 2 to 0 dBm.

**Manual operation:** See "[Ref. Level](#)" on page 236

---

**[SENSe:]ESpectrum:RANGe<range>:SWEep:TIME <SweepTime>**

This command sets the sweep time for the specified range.

Note that this parameter can not be set for all ranges if "Fast SEM" mode is activated (see [SENSe:]ESpectrum:HighSpeed on page 730).

**Suffix:**

<range> 1...20  
range

**Parameters:**

<SweepTime> Allowed values depend on the ratio of span to RBW and RBW to VBW. For details refer to the data sheet.

\*RST: 0.27 s

**Example:**

ESP:RANG1:SWE:TIME 1

Sets the sweep time for range 1 to 1 s.

**Manual operation:** See "Sweep Time" on page 236

**[SENSe:]ESpectrum:RANGe<range>:SWEep:TIME:AUTO <State>**

This command activates or deactivates the automatic sweep time setting for the specified range.

Note that this parameter can not be set for all ranges if "Fast SEM" mode is activated (see [SENSe:]ESpectrum:HighSpeed on page 730).

**Suffix:**

<range> 1...20  
range

**Parameters:**

<State> ON | OFF

\*RST: ON

**Example:**

ESP:RANG3:SWE:TIME:AUTO OFF

Deactivates the sweep time auto mode for range 3.

**Manual operation:** See "Sweep Time Mode" on page 236

**[SENSe:]ESpectrum:RANGe<range>:TRANsducer <TransducerName>**

This command sets a transducer for the specified range. You can only choose a transducer that fulfills the following conditions:

- The transducer overlaps or equals the span of the range.
- The x-axis is linear.
- The unit is dB.

**Suffix:**

<range> 1...20  
range

**Parameters:**

<TransducerName> 'string' = name of the transducer

**Example:** `ESP:RANG1:TRAN 'test'`  
Sets the transducer called test for range 1.

**Manual operation:** See "[Transd. Factor](#)" on page 236

### Configuring the Reference Range

The following commands define the reference range for the SEM sweep list.

<code>[SENSe:]ESpectrum:BWID</code> .....	739
<code>[SENSe:]ESpectrum:FILTer[:RRC]:ALPHA</code> .....	739
<code>[SENSe:]ESpectrum:FILTer[:RRC][:STATe]</code> .....	740
<code>[SENSe:]ESpectrum:RRANge</code> .....	740
<code>[SENSe:]ESpectrum:RTYPE</code> .....	740

---

#### `[SENSe:]ESpectrum:BWID <Bandwidth>`

This command defines the bandwidth used for measuring the channel power (reference range). This setting takes only effect if channel power is selected as power reference type (see `[SENSe:]ESpectrum:RTYPE` on page 740).

#### Parameters:

<Bandwidth>            minimum span ≤ value ≤ span of reference range  
\*RST:                    3.84 MHz

**Example:** `ESP:RTYP CPOW`  
Sets the power reference type to channel power.  
`ESP:BWID 1 MHZ`  
Sets the Tx bandwidth to 1 MHz.

**Manual operation:** See "[Edit Reference Range](#)" on page 239

---

#### `[SENSe:]ESpectrum:FILTer[:RRC]:ALPHA <Value>`

This command sets the alpha value of the RRC filter. This setting takes only effect if channel power is selected as power reference type (`[SENSe:]ESpectrum:RTYPE` command) and if the RRC filter is activated (`[SENSe:]ESpectrum:FILTer[:RRC][:STATe]` command).

#### Parameters:

<Value>                    0 to 1  
\*RST:                    0.22

**Example:** `ESP:RTYP CPOW`  
Sets the power reference type to channel power.  
`ESP:FILT ON`  
Activates the use of an RRC filter.  
`ESP:FILT:ALPH 0.5`  
Sets the alpha value of the RRC filter to 0.5.

**Manual operation:** See "[Edit Reference Range](#)" on page 239

**[SENSe:]ESpectrum:FILTer[:RRC][:STATe] <State>**

This command activates or deactivates the use of an RRC filter. This setting only takes effect if channel power is selected as power reference type (see [SENSe:]ESpectrum:RTYPE on page 740).

**Parameters:**

<State> ON | OFF  
\*RST: ON

**Example:**

```
ESP:RTYP CPOW
Sets the power reference type to channel power.
ESP:FILT OFF
Deactivates the use of an RRC filter.
```

**Manual operation:** See "Edit Reference Range" on page 239

**[SENSe:]ESpectrum:RRANge**

This command returns the current position (number) of the reference range.

**Example:**

```
ESP:RRAN?
Returns the current position (number) of the reference range.
```

**[SENSe:]ESpectrum:RTYPE <Type>**

This command sets the power reference type.

**Parameters:**

<Type> PEAK | CPOWer  
**PEAK**  
Measures the highest peak within the reference range.  
**CPOWer**  
Measures the channel power within the reference range (integral bandwidth method).  
\*RST: CPOWer

**Example:**

```
ESP:RTYP PEAK
Sets the peak power reference type.
```

**Manual operation:** See "Edit Reference Range" on page 239

**Configuring Power Classes**

The following commands define the power classes for SEM measurements.

CALCulate<n>:LIMit<k>:ESpectrum:LIMits.....	741
CALCulate<n>:LIMit<k>:ESpectrum:MODE.....	741
CALCulate<n>:LIMit<k>:ESpectrum:PCLass<Class>:COUNT.....	742
CALCulate<n>:LIMit<k>:ESpectrum:PCLass<Class>[:EXCLusive].....	742
CALCulate<n>:LIMit<k>:ESpectrum:PCLass<Class>:LIMit[:STATe].....	742

CALCulate<n>:LIMit<k>:ESpectrum:PCLass<Class>:MAXimum.....	743
CALCulate<n>:LIMit<k>:ESpectrum:PCLass<Class>:MINimum.....	743
CALCulate<n>:LIMit<k>:ESpectrum:VALue.....	744

---

### CALCulate<n>:LIMit<k>:ESpectrum:LIMits <Limits>

This command sets or queries up to 4 power classes in one step.

#### Suffix:

<n> irrelevant

<k> irrelevant

#### Parameters:

<Limits> 1–3 numeric values between -200 and 200, separated by commas

-200, <0-3 numeric values between -200 and 200, in ascending order, separated by commas>, 200

#### Example:

```
CALC:LIM:ESP:LIM -50,50,70
```

Defines the following power classes:

```
<-200, -50>
```

```
<-50, 50>
```

```
<50, 70>
```

```
<70, 200>
```

Query:

```
CALC:LIM:ESP:LIM?
```

Response:

```
-200,-50,50,70,200
```

---

### CALCulate<n>:LIMit<k>:ESpectrum:MODE <Mode>

This command activates or deactivates the automatic selection of the limit line in the Spectrum Emission Mask measurement.

#### Suffix:

<n> 1...4  
window

<k> irrelevant

#### Parameters:

<Mode> AUTO | MANUAL

#### AUTO

The limit line depends on the measured channel power.

#### MANUAL

One of the three specified limit lines is set.

\*RST: AUTO

#### Example:

```
CALC:LIM:ESP:MODE AUTO
```

Activates automatic selection of the limit line.



**CALCulate<n>:LIMit<k>:ESPectrum:PCLass<Class>:COUNT <NoPowerClasses>**

This command sets the number of power classes to be defined.

**Suffix:**

<n>	irrelevant
<k>	irrelevant
<Class>	irrelevant

**Parameters:**

<NoPowerClasses>	1 to 4
*RST:	1

**Example:**

```
CALC:LIM:ESP:PCL:COUN 2
```

Two power classes can be defined.

**CALCulate<n>:LIMit<k>:ESPectrum:PCLass<Class>[:EXCLusive] <State>**

This command sets the power classes used in the spectrum emission mask measurement. It is only possible to use power classes for which limits are defined. Also, either only one power class at a time or all power classes together can be selected.

**Suffix:**

<n>	irrelevant
<k>	irrelevant
<Class>	1...4 the power class to be evaluated

**Parameters:**

<State>	ON   OFF
*RST:	OFF

**Example:**

```
CALC:LIM:ESP:PCL1 ON
```

Activates the first defined power class.

**Manual operation:** See ["Used Power Classes"](#) on page 242  
See ["Add/Remove"](#) on page 243

**CALCulate<n>:LIMit<k>:ESPectrum:PCLass<Class>:LIMit[:STATe] <State>**

This command defines which limits are evaluated in the measurement.

**Suffix:**

<n>	irrelevant
<k>	irrelevant
<Class>	1...4 the power class to be evaluated

**Parameters:**

<State>	ABSolute   RELative   AND   OR
---------	--------------------------------

**ABSolute**

Evaluates only limit lines with absolute power values

**RELative**

Evaluates only limit lines with relative power values

**AND**

Evaluates limit lines with relative and absolute power values. A negative result is returned if both limits fail.

**OR**

Evaluates limit lines with relative and absolute power values. A negative result is returned if at least one limit failed.

\*RST: REL

**Example:** CALC:LIM:ESP:PCL:LIM ABS

**Manual operation:** See "Used Power Classes" on page 242

**CALCulate<n>:LIMit<k>:ESPectrum:PCLass<Class>:MAXimum <Level>**

This command sets the upper limit level for one power class. The unit is dBm. The limit always ends at + 200 dBm, i.e. the upper limit of the last power class can not be set. If more than one power class is in use, the upper limit must equal the lower limit of the next power class.

**Suffix:**

<n>	irrelevant
<k>	irrelevant
<Class>	1...4 the power class to be evaluated

**Parameters:**

<Level>	<numeric value>
*RST:	+200

**Example:** CALC:LIM:ESP:PCL1:MAX -40 dBm  
Sets the maximum power value of the first power class to -40 dBm.

**Manual operation:** See "PMin/PMax" on page 242

**CALCulate<n>:LIMit<k>:ESPectrum:PCLass<Class>:MINimum <Level>**

This command sets the minimum lower level limit for one power class. The unit is dBm. The limit always start at – 200 dBm, i.e. the first lower limit can not be set. If more than one power class is in use, the lower limit must equal the upper limit of the previous power class.

**Suffix:**

<n>	irrelevant
<k>	irrelevant

<Class> 1...4  
the power class to be evaluated

**Parameters:**

<Level> <numeric\_value>  
\*RST: -200 for class1, otherwise +200

**Example:**

CALC:LIM:ESP:PCL2:MIN -40 dBm  
Sets the minimum power value of the second power class to -40 dBm.

**Manual operation:** See "PMin/PMax" on page 242

**CALCulate<n>:LIMit<k>:ESPectrum:VALue <Power>**

This command activates the manual limit line selection and specifies the expected power as a value. Depending on the entered value, one of the predefined limit lines is selected.

**Suffix:**

<n> 1...4  
window  
  
<k> irrelevant

**Parameters:**

<Power> 33 | 28 | 0  
**33**  
P ≥ 33  
**28**  
28 < P < 33  
**0**  
P < 28  
\*RST: 0

**Example:**

CALC:LIM:ESP:VAL 33  
Activates manual selection of the limit line and selects the limit line for P = 33.

**Configuring List Evaluation**

The following commands configure the list evaluation.

MMEMory:STORe<n>:LIST.....	745
CALCulate<n>:ESPectrum:PSEarch PEAKsearch:[IMMediate].....	745
CALCulate<n>:ESPectrum:PSEarch PEAKsearch:AUTO.....	745
CALCulate<n>:ESPectrum:PSEarch PEAKsearch:MARGin.....	745
CALCulate<n>:ESPectrum:PSEarch PEAKsearch:PSHow.....	746

**MMEMory:STORe<n>:LIST <FileName>**

This command stores the current list evaluation results in a `<file name>.dat` file. The file consists of a data section containing the list evaluation results.

**Suffix:**

<n> irrelevant

**Parameters:**

<FileName> <file name>

**Example:**

MMEM:STOR:LIST 'test'

Stores the current list evaluation results in the `test.dat` file.

**Manual operation:**

See ["Save Evaluation List"](#) on page 240

See ["ASCII File Export"](#) on page 240

See ["Save Evaluation List"](#) on page 269

See ["ASCII File Export"](#) on page 269

**CALCulate<n>:ESPectrum:PSEarch|:PEAKsearch:[IMMediate]**

This command starts the list evaluation.

**Suffix:**

<n> Selects the measurement window.

**Example:**

CALC:ESP:PSE

**Usage:**

Event

**CALCulate<n>:ESPectrum:PSEarch|:PEAKsearch:AUTO <State>**

This command activates or deactivates the list evaluation.

**Suffix:**

<n> Selects the measurement window.

**Parameters:**

<State> ON | OFF

\*RST: ON

**Example:**

CALC:ESP:PSE:AUTO OFF

Deactivates the list evaluation.

**CALCulate<n>:ESPectrum:PSEarch|:PEAKsearch:MARGin <Margin>**

This command sets the margin used for the limit check/peak search.

**Suffix:**

<n> Selects the measurement window.

**Parameters:**

<Margin> -200 to 200 dB

\*RST: 200 dB

**Example:**            `CALC:ESP:PSE:MARG 100`  
Sets the margin to 100 dB.

---

### **CALCulate<n>:ESpectrum:PSEarch|:PEAKsearch:PSHow <State>**

This command marks all peaks with blue squares in the diagram.

**Suffix:**  
<n>                      Selects the measurement window.

**Parameters:**  
<State>                ON | OFF  
\*RST:                OFF

**Example:**            `CALC:ESP:PSE:PSH ON`  
Marks all peaks with blue squares.

**Manual operation:** See "Show Peaks" on page 240

### **Retrieving Results**

The following commands analyze and retrieve measurement results for SEM measurements.

- [CALCulate<n>:LIMit<k>:FAIL?](#) on page 686
- [CALCulate<n>:MARKer<m>:FUNction:POWer:RESult?](#) on page 689
- [TRACe<n>:DATA](#) on page 694

## **11.5.1.6 Performing EMI Measurements**

The following commands configure and perform EMI measurements.

- [Configuring the Measurement](#)..... 746
- [Performing a Peak Search](#)..... 747
- [Evaluating the Results](#)..... 749

### **Configuring the Measurement**

Commands useful to configure EMI measurements described elsewhere:

- [DISPlay\[:WINDow<n>\]:TRACe<t>:X:SPACing](#) on page 634
- [INPut:LISN:FILTer:HPAS\[:STATe\]](#) on page 654
- [INPut:LISN:PHASe](#) on page 655
- [INPut:LISN\[:TYPE\]](#) on page 655
- [\[SENSe:\]BANDwidth|BWIDth\[:RESolution\]](#) on page 639
- [\[SENSe:\]BANDwidth|BWIDth\[:RESolution\]:TYPE](#) on page 640
- [\[SENSe:\] \[WINDow:\]DETEctor<trace>\[:FUNction\]](#) on page 651
- [\[SENSe:\]SWEep:POINts](#) on page 802

**Remote commands exclusive to EMI measurements:**

[CALCulate<n>:MARKer<m>:FUNctio:n:FMEasurement:STATe](#)..... 747

**CALCulate<n>:MARKer<m>:FUNctio:n:FMEasurement:STATe <State>**

This command turns the EMI measurement marker functionality on and off.

**Suffix:**

<n> irrelevant

<m> irrelevant

**Parameters:**

<State> **ON | OFF**

**Performing a Peak Search**

Commands useful to perform EMI measurements described elsewhere:

- [CALCulate<n>:DELTamarker<m>:AOff](#) on page 666
- [CALCulate<n>:DELTamarker<m>:TRACe](#) on page 670
- [CALCulate<n>:MARKer<m>:AOff](#) on page 660
- [CALCulate<n>:MARKer<m>:TRACe](#) on page 664

**Remote commands exclusive to EMI measurements:**

[CALCulate<n>:DELTamarker<m>:FUNctio:n:FMEasurement:DETEctor](#)..... 747

[CALCulate<n>:MARKer<m>:FUNctio:n:FMEasurement:DETEctor](#)..... 748

[CALCulate<n>:MARKer<m>:FUNctio:n:FMEasurement:DWELl](#)..... 748

[CALCulate<n>:MARKer<m>:FUNctio:n:FMEasurement:PSEarch:AUTO](#)..... 749

**CALCulate<n>:DELTamarker<m>:FUNctio:n:FMEasurement:DETEctor <Detector>**

This command selects the detector for a specific deltamarker during the final evaluation.

If the deltamarker hasn't been active yet, the command also turns the deltamarker on.

**Suffix:**

<n> irrelevant

<m> deltamarker

**Parameters:**

<Detector> **OFF**  
turns the deltamarker off

**AVER**  
average detector

**CAV**  
CISPR Average detector

**CRMS**  
RMS Average detector

**POS**

maximum peak detector

**QPE**

quasi-peak detector

\*RST: OFF

**Manual operation:** See "[Marker Configuration](#)" on page 279**CALCulate<n>:MARKer<m>:FUNction:FMEasurement:DETEctor <Detector>**

This command selects the detector for a specific marker during the final measurement.

If the marker hasn't been active yet, the command also turns the marker on.

**Suffix:**

&lt;n&gt; irrelevant

&lt;m&gt; marker

**Parameters:**<Detector> **OFF**  
turns the marker off**AVER**

average detector

**CAV**

CISPR Average detector

**CRMS**

RMS Average detector

**POS**

maximum peak detector

**QPE**

quasi-peak detector

\*RST: OFF

**Manual operation:** See "[Marker Configuration](#)" on page 279**CALCulate<n>:MARKer<m>:FUNction:FMEasurement:DWELI <Time>**

This command defines the dwell time during the final measurement.

**Suffix:**

&lt;n&gt; irrelevant

&lt;m&gt; irrelevant

**Parameters:**<Time> Range: min value to max value  
\*RST: 1 s  
Default unit: seconds**Manual operation:** See "[Marker Configuration](#)" on page 279  
See "[Dwell Time](#)" on page 281

**CALCulate<n>:MARKer<m>:FUNction:FMEasurement:PSEarch:AUTO**

This command initiates a marker peak search.

Instead of the syntax element PSEarch you can also use PEAKsearch.

**Suffix:**

<n> irrelevant

<m> irrelevant

**Usage:** Event

**Manual operation:** See "Auto Peak Search" on page 279  
See "Marker Configuration" on page 279

**Evaluating the Results**

CALCulate<n>:DELTamarker<m>:FUNction:FMEasurement:LIMit<k>:CONDition ?.....	749
CALCulate<n>:DELTamarker<m>:FUNction:FMEasurement:LIMit<k>:DELTA?.....	750
CALCulate<n>:DELTamarker<m>:FUNction:FMEasurement:RESult?.....	750
CALCulate<n>:MARKer<m>:FUNction:FMEasurement:LIMit<k>:CONDition ?.....	750
CALCulate<n>:MARKer<m>:FUNction:FMEasurement:LIMit<k>:DELTA?.....	751
CALCulate<n>:MARKer<m>:FUNction:FMEasurement:RESult?.....	751

**CALCulate<n>:DELTamarker<m>:FUNction:FMEasurement:LIMit<k>:CONDition ? <Condition>**

This command queries the condition of a deltamarker position in relation to a certain limit line.

**Suffix:**

<n> irrelevant

<m> 1...16  
deltamarker

<k> 1...8  
limit line

**Return values:**

<Condition> **0**  
The deltamarker has passed the limit check.

**1**  
The deltamarker is inside the margins of a limit line.

**2**  
The deltamarker has failed the limit check.

**Example:** CALC : DELT2 : FUNC : FME : LIM2 : COND?  
Queries the condition of deltamarker 2 in relation to limit line 2.

**Usage:** Query only

**Manual operation:** See "Marker Table" on page 281



**CALCulate<n>:DELTamarker<m>:FUNction:FMEasurement:LIMit<k>:DELta?**

This command queries the vertical distance from the deltamarker position to the limit line. The unit is dB.

If the deltamarker has been assigned to a different trace than the limit line, the command returns -200.

**Suffix:**

<n>	irrelevant
<m>	1...16 deltamarker
<k>	1...8 limit line

**Return values:**

<Amplitude> Vertical distance to the limit line in dB.

**Example:**

CALC:DELT3:FUNC:FME:LIM2:DELTA?

Queries the distance of deltamarker 3 to the second limit line.

**Usage:**

Query only

**Manual operation:** See "[Marker Table](#)" on page 281

**CALCulate<n>:DELTamarker<m>:FUNction:FMEasurement:RESult? <Result>**

This command queries the result of the EMI measurement at the deltamarker position.

**Suffix:**

<n>	irrelevant
<m>	1...16 marker

**Return values:**

<Result> Power level in dB related to the reference marker you have set for that delta marker.

**Example:**

CALC:DELT3:FUNC:FME:RES?

Queries the result of delta marker 3.

**Usage:**

Query only

**Manual operation:** See "[Marker Table](#)" on page 281

**CALCulate<n>:MARKer<m>:FUNction:FMEasurement:LIMit<k>:CONDition ? <Condition>**

This command queries the condition of a marker position in relation to a certain limit line.

**Suffix:**

<n>	irrelevant
-----	------------

<m> 1...16  
marker

<k> 1...8  
limit line

**Return values:**

<Condition> **0**  
The marker has passed the limit check.

**1**  
The marker is inside the margins of a limit line.

**2**  
The marker has failed the limit check.

**Example:**

CALC:MARK1:FUNC:FME:LIM2:COND?  
Queries the condition of marker 1 in relation to limit line 2.

**Usage:** Query only

**Manual operation:** See "[Marker Table](#)" on page 281

**CALCulate<n>:MARKer<m>:FUNCTion:FMEasurement:LIMit<k>:DELTA?**  
<Amplitude>

This command queries the vertical distance from the marker position to the limit line. The unit is dB.

If the marker has been assigned to a different trace than the limit line, the command returns -200.

**Suffix:**

<n> irrelevant

<m> 1...16  
marker

<k> 1...8  
limit line

**Return values:**

<Amplitude> Vertical distance to the limit line in dB.

**Example:**

CALC:MARK3:FUNC:FME:LIM2:DELT?  
Queries the distance of marker 3 to the second limit line.

**Usage:** Query only

**Manual operation:** See "[Marker Table](#)" on page 281

**CALCulate<n>:MARKer<m>:FUNCTion:FMEasurement:RESult? <Result>**

This command queries the result of the EMI measurement at the marker position.

**Suffix:**

<n> irrelevant

<m>	1...16 marker
<b>Return values:</b>	
<Result>	Power level. The unit depends on the one you have currently set.
<b>Example:</b>	CALC:MARK1:FUNC:FME:RES? Queries the result of marker 1.
<b>Usage:</b>	Query only
<b>Manual operation:</b>	See " <a href="#">Marker Table</a> " on page 281

### 11.5.1.7 Measuring the Modulation Depth

The following commands configure and perform AM modulation depth measurements.

CALCulate<n>:MARKer<m>:FUNCTION:MDEPth:SEARChsignal ONCE.....	752
CALCulate<n>:MARKer<m>:FUNCTION:MDEPth:RESult?.....	752
CALCulate<n>:MARKer<m>:FUNCTION:MDEPth[:STATE].....	753

---

#### CALCulate<n>:MARKer<m>:FUNCTION:MDEPth:SEARChsignal ONCE

This command initiates a search for the signals required for the AM depth measurement.

Note that the command does not perform a new measurement, but looks for the signals on the current trace.

**Suffix:**

<n>	Selects the measurement window.
<m>	irrelevant

**Example:** CALC:MARK:FUNC:MDEP:SEAR ONCE  
Executes the search of an AM modulated signal at the currently available trace.

**Usage:** Event  
SCPI confirmed

**Manual operation:** See "[Search Signals](#)" on page 308

---

#### CALCulate<n>:MARKer<m>:FUNCTION:MDEPth:RESult?

This command queries the results of the AM modulation depth measurement..

To get a valid result, you have to perform a complete measurement with synchronization to the end of the measurement before reading out the result. This is only possible for single sweeps.

**Suffix:**

<n>	Selects the measurement window.
<m>	irrelevant

<b>Example:</b>	<pre>INIT:CONT OFF Switches to single sweep mode. CALC:MARK:X 10MHZ Sets the reference marker (marker 1) to the carrier signal at 10 MHz. CALC:MARK:FUNC:MDEP ON Switches on the modulation depth measurement. INIT;*WAI Starts a sweep and waits for the end. CALC:MARK:FUNC:MDEP:RES? Outputs the measured value.</pre>
<b>Usage:</b>	Query only
<b>Manual operation:</b>	See <a href="#">"AM Mod Depth"</a> on page 200 See <a href="#">"AM Mod Depth"</a> on page 307

---

#### **CALCulate<n>:MARKer<m>:FUNCtion:MDEPth[:STATe] <State>**

This command turns the AM Modulation Depth measurement on and off.

To work correctly, the measurement requires an AM modulated signal.

If necessary, the command positions marker 1 on the signal with the highest level.

The level value of marker 1 is regarded as the carrier level. On activating the function, marker 2 and marker 3 are automatically set as delta markers symmetrically to the carrier to the adjacent maxima of the trace.

If the position of delta marker 2 is changed, delta marker 3 is moved symmetrically with respect to the reference marker (marker 1). If the position of delta marker 3 is changed, fine adjustment can be performed independently of delta marker 2.

The power at the marker positions is calculated from the measured levels.

The AM modulation depth is calculated from the ratio of power values at the reference marker and the delta markers. If the two AM sidebands differ in power, the average value of the two power values is used for calculating the AM modulation depth.

#### **Suffix:**

<n> Selects the measurement window.

<m> irrelevant

#### **Parameters:**

<State> ON | OFF

\*RST: OFF

- Example:**
- `CALC:MARK:X 10MHZ`  
Sets the reference marker (marker 1) to the carrier signal at 10 MHz.
- `CALC:MARK:FUNC:MDEP ON`  
Switches on the modulation depth measurement.
- `CALC:DELT2:X 10KHZ`  
Sets delta markers 2 and 3 to the signals at 10 kHz from the carrier signal.
- `CALC:DELT3:X 9.999KHZ`  
Corrects the position of delta marker 3 relative to delta marker 2.
- Manual operation:** See "AM Mod Depth" on page 200  
See "AM Mod Depth" on page 307

### 11.5.1.8 Measuring the Harmonic Distortion

The following commands configure and perform measurements to determine the harmonic distortion of a signal.

Commands useful to retrieve results described elsewhere:

- `TRACe<n>:DATA` on page 694

<code>CALCulate&lt;n&gt;:MARKer&lt;m&gt;:FUNCtion:HARMonics:BANDwidth:AUTO</code> .....	754
<code>CALCulate&lt;n&gt;:MARKer&lt;m&gt;:FUNCtion:HARMonics:DISToRTion?</code> .....	755
<code>CALCulate&lt;n&gt;:MARKer&lt;m&gt;:FUNCtion:HARMonics:LIST?</code> .....	755
<code>CALCulate&lt;n&gt;:MARKer&lt;m&gt;:FUNCtion:HARMonics:NHARmonics</code> .....	756
<code>CALCulate&lt;n&gt;:MARKer&lt;m&gt;:FUNCtion:HARMonics:PRESet</code> .....	756
<code>CALCulate&lt;n&gt;:MARKer&lt;m&gt;:FUNCtion:HARMonics[:STATe]</code> .....	757
<code>UNIT:THD</code> .....	757

---

#### `CALCulate<n>:MARKer<m>:FUNCtion:HARMonics:BANDwidth:AUTO <State>`

This command selects the resolution bandwidth of the harmonic in respect to the bandwidth of the first harmonic.

For details refer to "Harmonic RBW Auto" on page 312.

#### Suffix:

`<n>` Selects the measurement window.

`<m>` irrelevant

#### Parameters:

`<State>` OFF | ON

**OFF**  
identical

**ON**  
a multiple

\*RST: ON

- Example:**
- `CALC:MARK:FUNC:HARM:BAND:AUTO OFF`  
Deactivates the automatic bandwidth enlargement.

**Manual operation:** See ["Harmonic RBW Auto"](#) on page 312

---

### CALCulate<n>:MARKer<m>:FUNCtion:HARMonics:DISToRTion?

This command queries the total harmonic distortion of the signal.

To get a valid result, you have to perform a complete measurement with synchronization to the end of the measurement before reading out the result. This is only possible for single sweeps.

**Suffix:**

<n> Selects the measurement window.

<m> irrelevant

**Parameters:**

TOTAL

**Return values:**

<Result> <Distortion\_%>,<Distortion\_dB>  
Pair of values, one showing the THD in %, one in dB.

**Example:**

```
INIT:CONT OFF
```

Switches to single sweep mode.

```
CALC:MARK:FUNC:HARM:NHARM 3
```

Sets the number of harmonics to be measured to 3.

```
CALC:MARK:FUNC:HARM ON
```

Activates the harmonic distortion measurement.

```
INIT;*WAI
```

Starts a sweep and waits for the end of the sweep.

```
CALC:MARK:FUNC:HARM:DIS? TOT
```

Returns the total distortion in % and dB.

**Usage:** Query only

**Manual operation:** See ["Harmonic Distortion"](#) on page 201  
See ["Harmonic Distortion"](#) on page 311

---

### CALCulate<n>:MARKer<m>:FUNCtion:HARMonics:LIST?

This command queries the position of the harmonics.

To get a valid result, you have to perform a complete measurement with synchronization to the end of the measurement before reading out the result. This is only possible for single sweeps.

**Suffix:**

<n> Selects the measurement window.

<m> Selects the marker.

**Parameters:**

<Harmonics> Returns one value for every harmonic. The first value is the absolute power of the first harmonic. The unit is variable. The other values are power levels relative to the first harmonic. The unit for these is dB.

**Example:**

```
INIT:CONT OFF
```

Switches to single sweep mode.

```
CALC:MARK:FUNC:HARM:NHARM 3
```

Sets the number of harmonics to be measured to 3.

```
CALC:MARK:FUNC:HARM ON
```

Activates the harmonic distortion measurement.

```
INIT;*WAI
```

Starts a sweep and waits for the end of the sweep.

```
CALC:MARK:FUNC:HARM:LIST?
```

Returns the values for the 3 measured harmonics.

**Usage:**

Query only

**Manual operation:**

See "[Harmonic Distortion](#)" on page 201

See "[Harmonic Distortion](#)" on page 311

**CALCulate<n>:MARKer<m>:FUNCTION:HARMonics:NHARmonics <NoHarmonics>**

This command sets the number of harmonics to be measured.

**Suffix:**

<n> Selects the measurement window.

<m> irrelevant

**Parameters:**

<NoHarmonics> Range: 1 to 26  
\*RST: 10

**Example:**

```
CALC:MARK:FUNC:HARM:NHARM 3
```

Sets the number of harmonics to be measured to 3.

**Manual operation:**

See "[No. of Harmonics](#)" on page 312

**CALCulate<n>:MARKer<m>:FUNCTION:HARMonics:PRESet**

This command initiates a measurement to determine the ideal configuration for the harmonic distortion measurement.

The method depends on the span.

- Frequency domain (span > 0)  
Frequency and level of the first harmonic are determined and used for the measurement list.
- Time domain (span = 0)  
The level of the first harmonic is determined. The frequency remains unchanged.

**Suffix:**  
 <n> Selects the measurement window.  
 <m> irrelevant

**Example:** `CALC:MARK:FUNC:HARM:PRES`  
 Optimizes the device settings for the harmonic measurement.

**Usage:** Event

**Manual operation:** See ["Adjust Settings"](#) on page 312

#### **CALCulate<n>:MARKer<m>:FUNCTion:HARMonics[:STATe] <State>**

This command turns the harmonic distortion measurement on and off.

Note the following:

- If you perform the measurement in the frequency domain, the search range for the frequency of the first harmonic, whose power is determined, is defined by the last span.
- If you perform the measurement in the time domain, the current center frequency is used as the frequency of the first harmonic. Thus, the frequency search is bypassed. The first harmonic frequency is set by a specific center frequency in zero span before the harmonic measurement is started.

**Suffix:**  
 <n> Selects the measurement window.  
 <m> irrelevant

**Parameters:**  
 <State> ON | OFF  
 \*RST: OFF

**Example:** `CALC:MARK:FUNC:HARM ON`  
 Activates the harmonic distortion measurement.

**Manual operation:** See ["Harmonic Distortion"](#) on page 201  
 See ["Harmonic Distortion"](#) on page 311

#### **UNIT:THD <Mode>**

This command selects the unit for THD measurements.

**Parameters:**  
 <Mode> DB | PCT  
 \*RST: DB

**Example:** `UNIT:THD PCT`



### 11.5.1.9 Measuring the Carrier-to-Noise Ratio

Commands useful to measure the C/N ratio described elsewhere:

- `CALCulate<n>:MARKer<m>:FUNction:POWer:RESult?` on page 689
- `CALCulate<n>:MARKer<m>:FUNction:POWer:SElect` on page 688
- `CALCulate<n>:MARKer<m>:FUNction:POWer[:STATe]` on page 692
- `[SENSe:]POWer:ACHannel:BANDwidth|BWIDth[:CHANnel<channel>]` on page 699
- `[SENSe:]POWer:ACHannel:PRESet` on page 693

### 11.5.1.10 Measuring the Third Order Intercept Point

The following commands configure and control measurements to determine the third intercept point (TOI).

<code>CALCulate&lt;n&gt;:MARKer&lt;m&gt;:FUNction:TOI:SEARChsignal ONCE</code> .....	758
<code>CALCulate&lt;n&gt;:MARKer&lt;m&gt;:FUNction:TOI[:STATe]</code> .....	758
<code>CALCulate&lt;n&gt;:MARKer&lt;m&gt;:FUNction:TOI:RESult?</code> .....	759

---

#### **`CALCulate<n>:MARKer<m>:FUNction:TOI:SEARChsignal ONCE`**

This command initiates a search for signals in the current trace to determine the third intercept point.

No new measurement is performed. Only the currently available trace selected for the TOI measurement is used.

#### **Suffix:**

`<n>` Selects the measurement window.  
`<m>` Selects the marker.

#### **Example:**

`CALC:MARK:FUNC:TOI:SEAR ONCE`  
 Executes the search for 2 signals and their intermodulation product at the currently available trace.

#### **Usage:**

Event  
 SCPI confirmed

**Manual operation:** See "[Search Signals](#)" on page 306

---

#### **`CALCulate<n>:MARKer<m>:FUNction:TOI[:STATe] <State>`**

This command initiates a measurement to determine the third intercept point.

A two-tone signal with equal carrier levels is expected at the RF input of the instrument. Marker 1 and marker 2 (both normal markers) are set to the maximum of the two signals. Delta marker 3 and delta marker 4 are positioned to the intermodulation products. The delta markers can be modified separately afterwards with `CALCulate<n>:DELTAmarker<m>:X`.

The third-order intercept is calculated from the level spacing between the normal markers and the delta markers.

**Suffix:**

<n> Selects the measurement window.

<m> irrelevant

**Parameters:**

<State> ON | OFF

\*RST: OFF

**Example:**

CALC:MARK:FUNC:TOI ON

Switches on the measurement of the third-order intercept.

**Manual operation:** See "TOI" on page 200

See "TOI" on page 306

**CALCulate<n>:MARKer<m>:FUNctio:n:TOI:RESult?**

This command queries the results for the third order intercept point measurement.

To get a valid result, you have to perform a complete measurement with synchronization to the end of the measurement before reading out the result. This is only possible for single sweeps.

**Suffix:**

<n> Selects the measurement window.

<m> irrelevant

**Return values:**

<TOI> Third order intercept point.

**Example:**

INIT:CONT OFF

Switches to single sweep mode.

CALC:MARK:FUNC:TOI ON

Switches the intercept measurement.

INIT;\*WAI

Starts a sweep and waits for the end.

CALC:MARK:FUNC:TOI:RES?

Outputs the measured value.

**Usage:** Query only

**Manual operation:** See "TOI" on page 200

See "TOI" on page 306

**11.5.1.11 Measuring Statistics**

The following commands configure and perform statistics measurements.

- [Configuring Statistical Measurements](#).....760
- [Retrieving Results](#).....761
- [Using Gate Ranges for Statistical Measurements](#).....762
- [Scaling the Diagram](#).....764

### Configuring Statistical Measurements

The following commands configure the measurement.

<a href="#">CALCulate&lt;n&gt;:STATistics:APD[:STATe]</a> .....	760
<a href="#">CALCulate&lt;n&gt;:STATistics:CCDF[:STATe]</a> .....	760
<a href="#">CALCulate&lt;n&gt;:STATistics:NSAMPLES</a> .....	761

---

#### **CALCulate<n>:STATistics:APD[:STATe] <State>**

This command switches on or off the measurement of amplitude distribution (APD). On activating this function, the CCDF measurement is switched off.

**Suffix:**

<n>                      irrelevant

**Parameters:**

<State>                ON | OFF  
 \*RST:                OFF

**Example:**

CALC:STAT:APD ON  
 Switches on the APD measurement.

**Manual operation:** See ["APD"](#) on page 200  
 See ["APD"](#) on page 287

---

#### **CALCulate<n>:STATistics:CCDF[:STATe] <State>**

This command switches on or off the measurement of the complementary cumulative distribution function (CCDF). On activating this function, the APD measurement is switched off.

**Suffix:**

<n>                      irrelevant

**Parameters:**

<State>                ON | OFF  
 \*RST:                OFF

**Example:**

CALC:STAT:CCDF ON  
 Switches on the CCDF measurement.

**Manual operation:** See ["CCDF"](#) on page 200  
 See ["CCDF"](#) on page 292

**CALCulate<n>:STATistics:NSAMples <NoMeasPoints>**

This command sets the number of measurement points to be acquired for the statistical measurement functions.

**Suffix:**

<n> irrelevant

**Parameters:**

<NoMeasPoints> 100 to 1E9  
\*RST: 100000

**Example:**

CALC:STAT:NSAM 500  
Sets the number of measurement points to be acquired to 500.

**Manual operation:** See "[# of Samples](#)" on page 288

**Retrieving Results**

The following commands are required to retrieve the measurement results.

Commands useful to retrieve results described elsewhere:

- [CALCulate<n>:MARKer<m>:X](#) on page 664
- [TRACe<n>:DATA](#) on page 694

<a href="#">CALCulate&lt;n&gt;:STATistics:CCDF:X&lt;Trace&gt;</a> .....	761
<a href="#">CALCulate&lt;n&gt;:STATistics:RESult&lt;Trace&gt;</a> .....	762

**CALCulate<n>:STATistics:CCDF:X<Trace> <Probability>**

This command queries the results of the complementary cumulative distribution function (CCDF) for the specified probability (corresponding to the "Percent Marker" in the display, see "[Percent Marker](#)" on page 293). The suffix of X defines the trace number.

**Suffix:**

<n> irrelevant  
<Trace> 1...6  
trace

**Parameters:**

<Probability> P0\_01: Level value for 0.01 % probability  
P0\_1: Level value for 0.1 % probability  
P1: Level value for 1 % probability  
P10: Level value for 10 % probability

**Example:**

CALC:STAT:CCDF:X1? P10  
Returns the level values that are over 10 % above the mean value.

**Manual operation:** See "[CCDF](#)" on page 292

**CALCulate<n>:STATistics:RESult<Trace> <ResultType>**

This command reads out the results of statistical measurements of a recorded trace.

**Suffix:**

<n>	irrelevant
<Trace>	1...6 trace

**Parameters:**

<ResultType> MEAN | PEAK | CFACTor | ALL

**MEAN**

Average (=RMS) power in dBm measured during the measurement time.

**PEAK**

Peak power in dBm measured during the measurement time.

**CFACTor**

Determined CREST factor (= ratio of peak power to average power) in dB.

**ALL**

Results of all three measurements mentioned before, separated by commas: <mean power>,<peak power>,<crest factor>

The required result is selected via the following parameters:

**Example:**

```
CALC:STAT:RES2? ALL
```

Reads out the three measurement results of trace 2. Example of answer string: 5.56,19.25,13.69 i.e. mean power: 5.56 dBm, peak power 19.25 dBm, CREST factor 13.69 dB

**Using Gate Ranges for Statistical Measurements**

The following commands control gated statistical measurements.

[SENSe:]SWEep:EGATe:TRACe<k>:COMMENT.....	762
[SENSe:]SWEep:EGATe:TRACe<k>:PERiod.....	763
[SENSe:]SWEep:EGATe:TRACe<k>:STARt<range>.....	763
[SENSe:]SWEep:EGATe:TRACe<k>[:STATe<range>].....	763
[SENSe:]SWEep:EGATe:TRACe<k>:STOP<range>.....	764

**[SENSe:]SWEep:EGATe:TRACe<k>:COMMENT <Comment>**

Defines a comment for one of the traces for gated triggering.

**Suffix:**

<k>	1...6 trace
-----	----------------

**Parameters:**

<Comment>

**Example:**

```
SWE:EGAT:TRAC1:COMM "SlotA"
```

**Manual operation:** See "Gate Ranges" on page 291

**[SENSe:]SWEep:EGATe:TRACe<k>:PERiod <Value>**

This command defines the length of the period to be traced using gated triggering.

**Suffix:**

<k> 1...6  
trace

**Parameters:**

<Value> <numeric value>  
\*RST: 0 s

**Example:**

SWE:EGAT:TRAC1:PER 5ms  
Defines the period for gated triggering to 5 ms.

**Manual operation:** See "Gate Ranges" on page 291

**[SENSe:]SWEep:EGATe:TRACe<k>:STARt<range> <Value>**

This command defines the starting point for the range to be traced using gated triggering.

**Suffix:**

<k> 1...6  
trace

<range> 1...3  
range

**Parameters:**

<Value> <numeric value>  
\*RST: OFF

**Example:**

SWE:EGAT:TRAC1:STAR1 3ms  
Sets the Starting point for range 1 on trace 1 at 3 ms.

**Manual operation:** See "Gate Ranges" on page 291

**[SENSe:]SWEep:EGATe:TRACe<k>[:STATe<range>] <State>**

This command activates or deactivates tracing for a specific range using gated triggering.

**Suffix:**

<k> 1...6  
trace

<range> 1...3  
range

**Parameters:**

<State> ON | OFF  
 \*RST: OFF

**Example:**

SWE:EGAT:TRAC1:STAT1 ON  
 Activates tracing for range 1 of trace 1.

**Manual operation:** See ["Gate Ranges"](#) on page 291

**[SENSe:]SWEEp:EGATe:TRACe<k>: STOP<range> <Value>**

This command defines the stopping point for the range to be traced using gated triggering

**Suffix:**

<k> 1...6  
 trace  
 <range> 1...3  
 range

**Parameters:**

<Value> <numeric value>  
 \*RST: 1  $\mu$ s

**Example:**

SWE:EGAT:TRAC1:STOP1 5ms  
 Sets the stopping point for range 1 on trace 1 at 5 ms.

**Manual operation:** See ["Gate Ranges"](#) on page 291

**Scaling the Diagram**

The following commands configure the diagram for statistical measurements.

<a href="#">CALCulate&lt;n&gt;:STATistics:PRESet</a> .....	764
<a href="#">CALCulate&lt;n&gt;:STATistics:SCALE:AUTO ONCE</a> .....	765
<a href="#">CALCulate&lt;n&gt;:STATistics:SCALE:X:RANGe</a> .....	765
<a href="#">CALCulate&lt;n&gt;:STATistics:SCALE:X:RLEVel</a> .....	766
<a href="#">CALCulate&lt;n&gt;:STATistics:SCALE:Y:LOWer</a> .....	766
<a href="#">CALCulate&lt;n&gt;:STATistics:SCALE:Y:UNIT</a> .....	766
<a href="#">CALCulate&lt;n&gt;:STATistics:SCALE:Y:UPPer</a> .....	767

**CALCulate<n>:STATistics:PRESet**

This command resets the scaling of the X and Y axes in a statistical measurement. The following values are set:

x-axis ref level:	-20 dBm
x-axis range APD:	100 dB
x-axis range CCDF:	20 dB

y-axis upper limit:	1.0
y-axis lower limit:	1E-6

**Suffix:**

<n> irrelevant

**Example:**

CALC:STAT:PRES

Resets the scaling for statistical functions

**Manual operation:** See ["Default Settings"](#) on page 290

**CALCulate<n>:STATistics:SCALE:AUTO ONCE**

This command optimizes the level setting of the instrument depending on the measured peak power, in order to obtain maximum instrument sensitivity.

To obtain maximum resolution, the level range is set as a function of the measured spacing between peak power and the minimum power for the APD measurement and of the spacing between peak power and mean power for the CCDF measurement. In addition, the probability scale for the number of test points is adapted.

Subsequent commands have to be synchronized with \*WAI, \*OPC or \*OPC? to the end of the auto range process which would otherwise be aborted.

**Suffix:**

<n> irrelevant

**Example:**

CALC:STAT:SCAL:AUTO ONCE;\*WAI

Adapts the level setting for statistical measurements.

**Manual operation:** See ["Adjust Settings"](#) on page 291

**CALCulate<n>:STATistics:SCALE:X:RANGe <Value>**

This command defines the level range for the x-axis of the measurement diagram. The setting is identical to the level range setting defined with the [DISPlay\[:WINDow<n>\]:TRACe<t>:Y\[:SCALE\]](#) command.

**Suffix:**

<n> irrelevant

**Parameters:**

<Value> 10dB to 200dB

\*RST: 100dB

**Example:**

CALC:STAT:SCAL:X:RANG 20dB

**Manual operation:** See ["x-Axis Range"](#) on page 288



**CALCulate<n>:STATistics:SCALe:X:RLEVel <Value>**

This command defines the reference level for the x-axis of the measurement diagram. The setting is identical to the reference level setting using the `DISPlay[:WINDow<n>]:TRACe<t>:Y[:SCALe]:RLEVel` command.

With the reference level offset  $\neq 0$  the indicated value range of the reference level is modified by the offset.

The unit depends on the setting performed with `CALCulate<n>:UNIT:POWer`.

**Suffix:**

<n> irrelevant

**Parameters:**

<Value> -120dBm to 20dBm  
\*RST: -20dBm

**Example:** `CALC:STAT:SCAL:X:RLEV -60dBm`

**Manual operation:** See "[x-Axis Ref Level](#)" on page 288

**CALCulate<n>:STATistics:SCALe:Y:LOWer <Value>**

This command defines the lower limit for the y-axis of the diagram in statistical measurements. Since probabilities are specified on the y-axis, the entered numeric values are dimensionless.

**Suffix:**

<n> selects the screen

**Parameters:**

<Value> 1E-9 to 0.1  
\*RST: 1E-6

**Example:** `CALC:STAT:SCAL:Y:LOW 0.001`

**Manual operation:** See "[y-Axis Min Value](#)" on page 290

**CALCulate<n>:STATistics:SCALe:Y:UNIT <Unit>**

This command defines the scaling type of the y-axis.

**Suffix:**

<n> selects the screen

**Parameters:**

<Unit> PCT | ABS  
\*RST: ABS

**Example:** `CALC:STAT:SCAL:Y:UNIT PCT`  
Sets the percentage scale.

**Manual operation:** See "[y-Unit % / Abs](#)" on page 290

**CALCulate<n>:STATistics:SCALe:Y:UPPer <Value>**

This command defines the upper limit for the y-axis of the diagram in statistical measurements. Since probabilities are specified on the y-axis, the entered numeric values are dimensionless.

**Suffix:**

<n> irrelevant

**Parameters:**

<Value> 1E-8 to 1.0  
\*RST: 1.0

**Example:** CALC:STAT:SCAL:Y:UPP 0.01

**Manual operation:** See "y-Axis Max Value" on page 290

**11.5.1.12 Measuring in the Time Domain**

The following commands configure and perform time domain power measurements.

**Configuring the Measurement**

The following commands control measurement configurations for measurements of the time domain power

CALCulate<n>:MARKer<m>:FUNction:SUMMery:AOff.....	767
CALCulate<n>:MARKer<m>:FUNction:SUMMery:AVERage.....	767
CALCulate<n>:MARKer<m>:FUNction:SUMMery:MODE.....	768
CALCulate<n>:MARKer<m>:FUNction:SUMMery:PHOLd.....	768
CALCulate<n>:MARKer<m>:FUNction:SUMMery:REFerence:AUTO ONCE.....	769
CALCulate<n>:MARKer<m>:FUNction:SUMMery[:STATe].....	769

**CALCulate<n>:MARKer<m>:FUNction:SUMMery:AOff**

This command turns all time domain power measurements off.

**Suffix:**

<n> Selects the measurement window.

<m> Selects the marker.

**Example:**

CALC:MARK:FUNC:SUMM:AOff

Switches off the functions for power measurement in zero span.

**Usage:**

Event

**CALCulate<n>:MARKer<m>:FUNction:SUMMery:AVERage <State>**

This command turns averaging for the active power measurement in zero span on and off.

Averaging is reset by switching it off and on again.

The number of results required for the calculation of average is defined with `[SENSe:]AVERAge<n>:COUNT`.

To get a valid result, you have to perform a complete measurement with synchronization to the end of the measurement before reading out the result. This is only possible for single sweeps.

**Suffix:**

<n>                      Selects the measurement window.  
 <m>                      Selects the marker.

**Parameters:**

<State>                ON | OFF  
 \*RST:                OFF

**Example:**

```
INIT:CONT OFF
Switches to single sweep mode.
CALC:MARK:FUNC:SUMM:AVER ON
Switches on the calculation of average.
AVER:COUN 200
Sets the measurement counter to 200.
INIT;*WAI
Starts a sweep and waits for the end.
```

**CALCulate<n>:MARKer<m>:FUNctioN:SUMMery:MODE <Mode>**

This command selects absolute or relative power measurement in zero span.

The reference power for relative measurement is defined with `CALCulate<n>:MARKer<m>:FUNctioN:SUMMery:REfereNce:AUTO ONCE`. If the reference power is not defined, the value 0 dBm is used.

**Suffix:**

<n>                      Selects the measurement window.  
 <m>                      irrelevant

**Parameters:**

<Mode>                ABSolute | RELative  
 \*RST:                ABSolute

**Example:**

```
CALC:MARK:FUNC:SUMM:MODE REL
Switches the power measurement in zero span to relative.
```

**CALCulate<n>:MARKer<m>:FUNctioN:SUMMery:PHOLd <State>**

This command turns the peak hold function for the active power measurement in zero span on and off.

If on, the measurement results show only the maximum power that has been measured for each sweep point.

The peak hold function is reset by switching it off and on again.

**Suffix:**

<n> Selects the measurement window.

<m> Selects the marker.

**Parameters:**

<State> ON | OFF

\*RST: OFF

**Example:**

CALC:MARK:FUNC:SUMM:PHOL ON  
Switches on the function.

**CALCulate<n>:MARKer<m>:FUNction:SUMMery:REFerence:AUTO ONCE**

This command sets the currently measured average value (`CALCulate<n>:MARKer<m>:FUNction:SUMMery:MEAN[:STATe]`) and RMS value (`CALCulate<n>:MARKer<m>:FUNction:SUMMery:RMS[:STATe]`) as reference values for relative measurements in zero span.

If the measurement of RMS value and average is not activated, the reference value 0 dBm is used.

If the function `CALCulate<n>:MARKer<m>:FUNction:SUMMery:AVERage` or `CALCulate<n>:MARKer<m>:FUNction:SUMMery:PHOLd` is switched on, the current value is the accumulated measurement value at the time considered.

**Suffix:**

<n> Selects the measurement window.

<m> irrelevant

**Example:**

CALC:MARK:FUNC:SUMM:REF:AUTO ONCE

Takes the currently measured power as reference value for the relative power measurement in zero span.

**Usage:**

Event

**CALCulate<n>:MARKer<m>:FUNction:SUMMery[:STATe] <State>**

This command turns time domain power measurements on and off. This measurement is only available in zero span.

Thus one or several measurements can be first selected and then switched on and off together using this command.

**Suffix:**

<n> Selects the measurement window.

<m> Selects the marker.

**Parameters:**

<State> ON | OFF

\*RST: OFF

**Example:**

CALC:MARK:FUNC:SUMM:STAT ON

**Manual operation:** See "Time Domain Power (zero span)" on page 200  
See "Time Domain Power" on page 272

### Retrieving Measurement Results

The following commands analyze and retrieve measurement results for time domain power measurements.

Commands useful to retrieve results described elsewhere:

- [TRACe<n>:DATA](#) on page 694

<a href="#">CALCulate&lt;n&gt;:MARKer&lt;m&gt;:FUNCTion:SUMMery:MEAN:AVERage:RESult?</a> .....	770
<a href="#">CALCulate&lt;n&gt;:MARKer&lt;m&gt;:FUNCTion:SUMMery:MEAN:PHOLd:RESult?</a> .....	771
<a href="#">CALCulate&lt;n&gt;:MARKer&lt;m&gt;:FUNCTion:SUMMery:MEAN:RESult?</a> .....	771
<a href="#">CALCulate&lt;n&gt;:MARKer&lt;m&gt;:FUNCTion:SUMMery:MEAN[:STATe]</a> .....	772
<a href="#">CALCulate&lt;n&gt;:MARKer&lt;m&gt;:FUNCTion:SUMMery:PPEak:AVERage:RESult?</a> .....	772
<a href="#">CALCulate&lt;n&gt;:MARKer&lt;m&gt;:FUNCTion:SUMMery:PPEak:PHOLd:RESult?</a> .....	773
<a href="#">CALCulate&lt;n&gt;:MARKer&lt;m&gt;:FUNCTion:SUMMery:PPEak:RESult?</a> .....	773
<a href="#">CALCulate&lt;n&gt;:MARKer&lt;m&gt;:FUNCTion:SUMMery:PPEak[:STATe]</a> .....	774
<a href="#">CALCulate&lt;n&gt;:MARKer&lt;m&gt;:FUNCTion:SUMMery:RMS:AVERage:RESult?</a> .....	774
<a href="#">CALCulate&lt;n&gt;:MARKer&lt;m&gt;:FUNCTion:SUMMery:RMS:PHOLd:RESult?</a> .....	775
<a href="#">CALCulate&lt;n&gt;:MARKer&lt;m&gt;:FUNCTion:SUMMery:RMS:RESult?</a> .....	776
<a href="#">CALCulate&lt;n&gt;:MARKer&lt;m&gt;:FUNCTion:SUMMery:RMS[:STATe]</a> .....	776
<a href="#">CALCulate&lt;n&gt;:MARKer&lt;m&gt;:FUNCTion:SUMMery:SDEViation:AVERage:RESult?</a> .....	777
<a href="#">CALCulate&lt;n&gt;:MARKer&lt;m&gt;:FUNCTion:SUMMery:SDEViation:PHOLd:RESult?</a> .....	777
<a href="#">CALCulate&lt;n&gt;:MARKer&lt;m&gt;:FUNCTion:SUMMery:SDEViation:RESult?</a> .....	778
<a href="#">CALCulate&lt;n&gt;:MARKer&lt;m&gt;:FUNCTion:SUMMery:SDEViation[:STATe]</a> .....	778

---

### **CALCulate<n>:MARKer<m>:FUNCTion:SUMMery:MEAN:AVERage:RESult?**

This command queries the average mean time domain power. The query is only possible if averaging has been activated previously using [CALCulate<n>:MARKer<m>:FUNCTion:SUMMery:AVERage](#).

To get a valid result, you have to perform a complete measurement with synchronization to the end of the measurement before reading out the result. This is only possible for single sweeps.

#### **Suffix:**

<n>                      Selects the measurement window.  
<m>                      Selects the marker.

#### **Return values:**

<MeanPower>              Mean power of the signal during the measurement time.

**Example:**

```
INIT:CONT OFF
Switches to single sweep mode.
CALC:MARK:FUNC:SUMM:MEAN ON
Switches on the function.
CALC:MARK:FUNC:SUMM:AVER ON
Switches on the average value calculation.
INIT;*WAI
Starts a sweep and waits for the end.
CALC:MARK:FUNC:SUMM:MEAN:AVER:RES?
Outputs the result.
```

**Usage:** Query only

---

#### **CALCulate<n>:MARKer<m>:FUNction:SUMMery:MEAN:PHOLd:RESult?**

This command queries the maximum mean time domain power. The query is only possible if the peak hold function has been activated previously using [CALCulate<n>:MARKer<m>:FUNction:SUMMery:PHOLd](#).

To get a valid result, you have to perform a complete measurement with synchronization to the end of the measurement before reading out the result. This is only possible for single sweeps.

**Suffix:**

<n> Selects the measurement window.

<m> Selects the marker.

**Return values:**

<MeanPower> Mean power of the signal during the measurement time.

**Example:**

```
INIT:CONT OFF
Switches to single sweep mode.
CALC:MARK:FUNC:SUMM:MEAN ON
Switches on the function.
CALC:MARK:FUNC:SUMM:PHOL ON
Switches on the peak value measurement.
INIT;*WAI
Starts a sweep and waits for the end.
CALC:MARK:FUNC:SUMM:MEAN:PHOL:RES?
Outputs the result.
```

**Usage:** Query only

---

#### **CALCulate<n>:MARKer<m>:FUNction:SUMMery:MEAN:RESult?**

This command queries the mean time domain power.

To get a valid result, you have to perform a complete measurement with synchronization to the end of the measurement before reading out the result. This is only possible for single sweeps.

**Suffix:**

<n> Selects the measurement window.

<m> Selects the marker.

**Return values:**

<MeanPower> Mean power of the signal during the measurement time.

**Example:**

```
INIT:CONT OFF
```

Switches to single sweep mode.

```
CALC:MARK:FUNC:SUMM:MEAN ON
```

Switches on the function.

```
INIT;*WAI
```

Starts a sweep and waits for the end.

```
CALC:MARK:FUNC:SUMM:MEAN:RES?
```

Outputs the result.

**Usage:** Query only

**Manual operation:** See "Mean" on page 272

**CALCulate<n>:MARKer<m>:FUNction:SUMMary:MEAN[:STATe] <State>**

This command turns the measurement of the mean time domain power on and off.

**Note:** The measurement is performed on the trace marker 1 is positioned. In order to evaluate another trace, marker 1 must be positioned on another trace with

[CALCulate<n>:MARKer<m>:TRACe](#).

**Suffix:**

<n> Selects the measurement window.

<m> Selects the marker.

**Parameters:**

<State> ON | OFF

```
*RST: OFF
```

**Example:**

```
CALC:MARK:FUNC:SUMM:MEAN ON
```

Switches on the function.

**Manual operation:** See "Mean" on page 272

**CALCulate<n>:MARKer<m>:FUNction:SUMMary:PPEak:AVERage:RESult?**

This command queries the average positive peak time domain power. The query is only possible if averaging has been activated previously using [CALCulate<n>:](#)

[MARKer<m>:FUNction:SUMMary:AVERage](#).

To get a valid result, you have to perform a complete measurement with synchronization to the end of the measurement before reading out the result. This is only possible for single sweeps.

**Suffix:**

<n> Selects the measurement window.

<m>	Selects the marker.
<b>Return values:</b>	
<PeakPower>	Peak power of the signal during the measurement time.
<b>Example:</b>	<pre>INIT:CONT OFF Switches to single sweep mode. CALC:MARK:FUNC:SUMM:PPE ON Switches on the function. CALC:MARK:FUNC:SUMM:AVER ON Switches on the calculation of average. INIT;*WAI Starts a sweep and waits for the end. CALC:MARK:FUNC:SUMM:PPE:AVER:RES? Outputs the result.</pre>
<b>Usage:</b>	Query only

#### **CALCulate<n>:MARKer<m>:FUNction:SUMMary:PPEak:PHOLd:RESult?**

This command queries the maximum positive peak time domain power. The query is only possible if the peak hold function has been activated previously using [CALCulate<n>:MARKer<m>:FUNction:SUMMary:PHOLd](#).

To get a valid result, you have to perform a complete measurement with synchronization to the end of the measurement before reading out the result. This is only possible for single sweeps.

<b>Suffix:</b>	
<n>	Selects the measurement window.
<m>	Selects the marker.
<b>Return values:</b>	
<PeakPower>	Peak power of the signal during the measurement time.
<b>Example:</b>	<pre>INIT:CONT OFF Switches to single sweep mode. CALC:MARK:FUNC:SUMM:PPE ON Switches on the function. CALC:MARK:FUNC:SUMM:PHOL ON Switches on the measurement of the peak value. INIT;*WAI Starts a sweep and waits for the end. CALC:MARK:FUNC:SUMM:PPE:PHOL:RES? Outputs the result.</pre>
<b>Usage:</b>	Query only

#### **CALCulate<n>:MARKer<m>:FUNction:SUMMary:PPEak:RESult?**

This command queries the positive peak time domain power.



To get a valid result, you have to perform a complete measurement with synchronization to the end of the measurement before reading out the result. This is only possible for single sweeps.

**Suffix:**

<n>                      Selects the measurement window.  
 <m>                      Selects the marker.

**Return values:**

<PeakPower>            Peak power of the signal during the measurement time.

**Example:**

```
INIT:CONT OFF
Switches to single sweep mode.
CALC:MARK:FUNC:SUMM:PPE ON
Switches on the function.
INIT;*WAI
Starts a sweep and waits for the end.
CALC:MARK:FUNC:SUMM:PPE:RES?
Outputs the result.
```

**Usage:**                Query only

**Manual operation:** See "Peak" on page 272

**CALCulate<n>:MARKer<m>:FUNCTION:SUMMARY:PPEak[:STATE] <State>**

This command turns the measurement of the positive peak time domain power on and off.

**Note:** The measurement is performed on the trace marker 1 is positioned. In order to evaluate another trace, marker 1 must be positioned on another trace with

[CALCulate<n>:MARKer<m>:TRACe](#).

**Suffix:**

<n>                      Selects the measurement window.  
 <m>                      Selects the marker.

**Parameters:**

<State>                ON | OFF  
 \*RST:                OFF

**Example:**

```
CALC:MARK:FUNC:SUMM:PPE ON
```

  
Switches on the function.

**Manual operation:** See "Peak" on page 272

**CALCulate<n>:MARKer<m>:FUNCTION:SUMMARY:RMS:AVERAGE:RESULT?**

This command queries the average RMS time domain power. The query is only possible if averaging has been activated previously using [CALCulate<n>:MARKer<m>:FUNCTION:SUMMARY:AVERAGE](#).

To get a valid result, you have to perform a complete measurement with synchronization to the end of the measurement before reading out the result. This is only possible for single sweeps.

**Suffix:**

<n> Selects the measurement window.  
 <m> Selects the marker.

**Return values:**

<RMSPower> RMS power of the signal during the measurement time.

**Example:**

```
INIT:CONT OFF
Switches to single sweep mode.
CALC:MARK:FUNC:SUMM:RMS ON
Switches on the function.
CALC:MARK:FUNC:SUMM:AVER ON
Switches on the average value calculation.
INIT;*WAI
Starts a sweep and waits for the end.
CALC:MARK:FUNC:SUMM:RMS:AVER:RES?
Outputs the result.
```

**Usage:** Query only

**CALCulate<n>:MARKer<m>:FUNction:SUMMary:RMS:PHOLd:RESult?**

This command queries the maximum RMS time domain power. The query is only possible if the peak hold function has been activated previously using [CALCulate<n>:MARKer<m>:FUNction:SUMMary:PHOLd](#).

To get a valid result, you have to perform a complete measurement with synchronization to the end of the measurement before reading out the result. This is only possible for single sweeps.

**Suffix:**

<n> Selects the measurement window.  
 <m> Selects the marker.

**Return values:**

<RMSPower> RMS power of the signal during the measurement time.

**Example:**

```
INIT:CONT OFF
Switches to single sweep mode.
CALC:MARK:FUNC:SUMM:RMS ON
Switches on the function.
CALC:MARK:FUNC:SUMM:PHOL ON
Switches on the peak value measurement.
INIT;*WAI
Starts a sweep and waits for the end.
CALC:MARK:FUNC:SUMM:RMS:PHOL:RES?
Outputs the result.
```

**Usage:** Query only

**CALCulate<n>:MARKer<m>:FUNcTion:SUMMary:RMS:RESult?**

This command queries the RMS time domain power.

To get a valid result, you have to perform a complete measurement with synchronization to the end of the measurement before reading out the result. This is only possible for single sweeps.

**Suffix:**

<n>                      Selects the measurement window.  
 <m>                      Selects the marker.

**Return values:**

<RMSPower>            RMS power of the signal during the measurement time.

**Example:**

```
INIT:CONT OFF
Switches to single sweep mode.
CALC:MARK:FUNC:SUMM:RMS ON
Switches on the function.
INIT;*WAI
Starts a sweep and waits for the end.
CALC:MARK:FUNC:SUMM:RMS:RES?
Outputs the result.
```

**Usage:**                Query only

**Manual operation:**   See "RMS" on page 272

**CALCulate<n>:MARKer<m>:FUNcTion:SUMMary:RMS[:STATe] <State>**

This command turns the measurement of the RMS time domain power on and off.

**Note:** The measurement is performed on the trace marker 1 is positioned. In order to evaluate another trace, marker 1 must be positioned on another trace with [CALCulate<n>:MARKer<m>:TRACe](#).

**Suffix:**

<n>                      Selects the measurement window.  
 <m>                      Selects the marker.

**Parameters:**

<State>                ON | OFF  
 \*RST:                OFF

**Example:**

```
CALC:MARK:FUNC:SUM:RMS ON
Switches on the function.
```

**Manual operation:**   See "RMS" on page 272

**CALCulate<n>:MARKer<m>:FUNction:SUMMary:SDEViation:AVERage:RESult?**

This command queries the average standard deviation of the time domain power. The query is only possible if averaging has been activated previously using [CALCulate<n>:MARKer<m>:FUNction:SUMMary:AVERage](#).

To get a valid result, you have to perform a complete measurement with synchronization to the end of the measurement before reading out the result. This is only possible for single sweeps.

**Suffix:**

<n>                      Selects the measurement window.  
 <m>                      Selects the marker.

**Return values:**

<StandardDeviation> Standard deviation of the signal during the measurement time.

**Example:**

```
INIT:CONT OFF
Switches to single sweep mode.
CALC:MARK:FUNC:SUMM:SDEV ON
Switches on the function.
CALC:MARK:FUNC:SUMM:AVER ON
Switches on the calculation of average.
INIT;*WAI
Starts a sweep and waits for the end.
CALC:MARK:FUNC:SUMM:MEAN:SDEV:RES?
Outputs the result.
```

**Usage:**                      Query only

**CALCulate<n>:MARKer<m>:FUNction:SUMMary:SDEViation:PHOLd:RESult?**

This command queries the maximum standard deviation of the time domain power. The query is only possible if the peak hold function has been activated previously using [CALCulate<n>:MARKer<m>:FUNction:SUMMary:PHOLd](#).

To get a valid result, you have to perform a complete measurement with synchronization to the end of the measurement before reading out the result. This is only possible for single sweeps.

**Suffix:**

<n>                      Selects the measurement window.  
 <m>                      Selects the marker.

**Return values:**

<StandardDeviation> Standard deviation of the signal during the measurement time.

**Example:**           INIT:CONT OFF  
                           Switches to single sweep mode.  
                           CALC:MARK:FUNC:SUMM:SDEV ON  
                           Switches on the function.  
                           CALC:MARK:FUNC:SUMM:PHOL ON  
                           Switches on the peak value measurement.  
                           INIT;\*WAI  
                           Starts a sweep and waits for the end.  
                           CALC:MARK:FUNC:SUMM:SDEV:PHOL:RES?  
                           Outputs the result.

**Usage:**             Query only

### **CALCulate<n>:MARKer<m>:FUNCtion:SUMMary:SDEViation:RESult?**

This command queries the standard deviation of the time domain power.

To get a valid result, you have to perform a complete measurement with synchronization to the end of the measurement before reading out the result. This is only possible for single sweeps.

**Suffix:**

<n>                    Selects the measurement window.

<m>                    Selects the marker.

**Return values:**  
 <StandardDeviation> Standard deviation of the signal during the measurement time.

**Example:**           INIT:CONT OFF  
                           Switches to single sweep mode.  
                           CALC:MARK:FUNC:SUMM:SDEV ON  
                           Switches on the function.  
                           INIT;\*WAI  
                           Starts a sweep and waits for the end.  
                           CALC:MARK:FUNC:SUMM:SDEV:RES?  
                           Outputs the result.

**Usage:**             Query only

**Manual operation:** See "[Std Dev](#)" on page 272

### **CALCulate<n>:MARKer<m>:FUNCtion:SUMMary:SDEViation[:STATE] <State>**

This command turns the measurement of the standard deviation of the time domain power on and off.

**Note:** The measurement is performed on the trace marker 1 is positioned. In order to evaluate another trace, marker 1 must be positioned on another trace with [CALCulate<n>:MARKer<m>:TRACe](#).

**Suffix:**

<n>                    Selects the measurement window.

<m> Selects the marker.

**Parameters:**

<State> ON | OFF

\*RST: OFF

**Example:**

CALC:MARK:FUNC:SUMM:SDEV ON

Switches on the measurement of the standard deviation.

**Manual operation:** See "Std Dev" on page 272

### 11.5.1.13 Measuring the Pulse Power

The commands of this subsystem are used to determine the mean burst power or peak burst power for a given number of signal bursts, and for outputting the results in a list. Since all the settings required for a measurement are combined in a single command, the measurement speed is considerably higher than when using individual commands.

For measuring the signal bursts, the gated sweep function is used in zero span. The gate is controlled either by an external trigger signal or by the video signal. An individual trigger event is required for each burst to be measured. If an external trigger signal is used, the threshold is fixed to TTL level, while with a video signal the threshold can be set as desired.

The following graphics shows the relation between trigger time, trigger offset (for delayed gate opening) and measurement time.

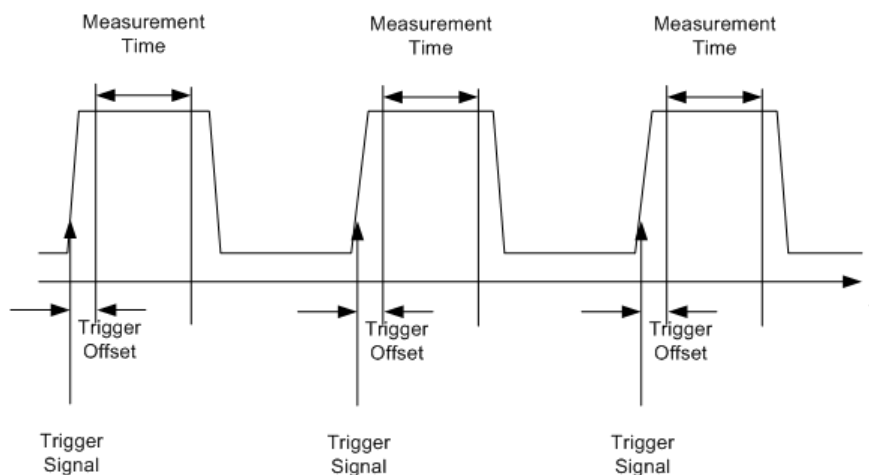

Depending on the settings made, the measurements are performed with the RMS detector for RMS power or the PEAK detector for peak power. For all these measurements, trace 1 of the selected system is used.

The commands of this subsystem can be used in two different ways:

- Setting up the instrument and at the same time querying the result list: This method ensures the smallest delay between measurement and the output of the measured values, but requires the control computer to wait actively for the response of the instrument.

- Setting up the instrument and querying the result list after synchronization to the end of measurement: With this method the control computer can be used for other activities while the instrument is performing the measurement at the cost of additional time needed for synchronization via service request.

[SENSe:]MPOWer:FTYPE.....	780
[SENSe:]MPOWer:RESult[:LIST]?.....	780
[SENSe:]MPOWer:RESult:MIN?.....	781
[SENSe:]MPOWer[:SEQUence].....	781

---

### [SENSe:]MPOWer:FTYPE <FilterType>

This command selects the filter type for pulse power measurements.

#### Parameters:

<FilterType>            NORMAl | CFILter | RRC

**Example:**                SENSe:MPOWer:FTYPE CFILter

---

### [SENSe:]MPOWer:RESult[:LIST]?

This command queries the results of the pulse power measurement.

This command may be used to obtain measurement results in an asynchronous way, using the service request mechanism for synchronization to the end of the measurement.

If there are no results, the command returns an error.

#### Parameters:

<PulsePower>            List of pulse powers.  
The number of values depends on the number of pulses you have been measuring.  
The unit is dBm.

**Example:**                \*ESE 1  
\*SRE 32  
Configuration of status reporting systems for the generation of an SRQ on operation complete  
SENSe:MPOWer 935.2MHz,1MHz,434us,VIDEO,50PCT,5us,MEAN,20;\*OPC  
Configuring and starting the measurement  
...  
Further actions of the control computer during measurement  
On SRQ:  
Response to service request  
SENSe:MPOWer:RESult?

**Usage:**                    Query only

**[SENSe:]MPOWer:RESult:MIN?**

This command queries the lowest pulse power that has been measured during a pulse power measurement.

If there are no results, the command returns an error.

**Return values:**

<PulsePower>      Lowest power level of the pulse power measurement.  
The unit is dBm.

**Example:**

```
*ESE 1
*SRE 32
Configuration of status reporting systems for the generation of
an SRQ on operation complete
SENSe:MPOWer 935.2MHz,1MHz,434us,VIDEO,50PCT,
5us,MEAN,20;*OPC
Configuring and starting the measurement
...
Further actions of the control computer during measurement
On SRQ:
Response to service request
SENSe:MPOWer:RESult:MIN?
```

**Usage:**            Query only

**[SENSe:]MPOWer[:SEQuence]** <Frequency>, <RBW>, <MeasTime>, <TriggerSource>, <TriggerLevel>, <TriggerOffset>, <Detector>, <#OfPulses>

This command configures and initiates the pulse power measurement.

The R&S ESRP caches all measurement parameters that you can set with this command. If you use the command repeatedly, the R&S ESRP only changes those settings that you have actually changed before initiating the measurement. Thus, measurement times are kept as low as possible.

If you synchronize the measurement with \*OPC, the R&S ESRP produces a service request when all frequencies have been measured and the number of individual measurements has been performed.

Note that using the command as a query initiates the measurement and returns the results if all frequencies have been measured. For more information on querying the results see .

To reduce the setting time, the setup is performed simultaneously for all selected parameters.

The query adapts the instrument settings, performs the defined number of measurements and outputs the measurement results list.

This measurement is not compatible with other measurements, especially as far as marker functions, adjacent-channel measurement or statistics are concerned. The corresponding functions are therefore automatically switched off. In return, incompatible commands automatically deactivate the multi burst power function.



The function is only available in the REMOTE operation. It is deactivated on switching back to LOCAL.

**Parameters:**

<Frequency>	Defines the pulse frequency. Range: 0 Hz to fmax
<RBW>	Defines the resolution bandwidth. Range: 10 Hz to 10 MHz in steps of 1, 3, 10
<MeasTime>	Defines the measurement time. Range: 1 $\mu$ s to 30 s
<TriggerSource>	Selects a trigger source. <b>EXTERNAL</b> The trigger signal is fed from the "Ext. Trigger/Gate" input on the rear of the unit. <b>VIDEO</b> The internal video signal is used as trigger signal.
<TriggerLevel>	Defines a trigger level. The trigger level is available for the video trigger. In that case, the level is a percentage of the diagram height. In case of an external trigger, the R&S ESRP uses a fix TTL level. Range: 0 PCT to 100 PCT
<TriggerOffset>	Defines the trigger delay. The trigger delay is the time between the detection of the trigger signal and the start of the measurement. Range: see data sheet
<Detector>	Selects the detector and therefore the way the measurement is evaluated. <b>MEAN</b> Calculates the RMS pulse power. <b>PEAK</b> Calculates the peak pulse power.
<#OfPulses>	Defines the number of pulses included in the measurement. Range: 1 to 32001
<b>Return values:</b>	
<PowerLevel>	Pulse power level. The result is a list of floating point values separated by commas. The unit is dBm.

**Example:****Sample setting:**

```
SENSE:MPOWer 935.2MHz, 1MHz, 434us, VIDEO, 50PCT,
5us, MEAN, 20
```

Performs a measurement sequence with the following settings:

```
Frequency = 935.2 MHz,
Resolution bandwidth = 1 MHz
Measurement time = 434 µs
Trigger source = VIDEO
Trigger threshold = 50 %
Trigger offset = 5 µs
Type of measurement = MEAN power
No. of measurements = 20
```

**Sample query:**

```
SENSe:MPOWer? 935.2MHz, 1MHz, 434us, VIDEO,
50PCT, 5us, MEAN, 20
```

Performs the same measurement and in addition returns the results list immediately after completion of the last measurement.

**Sample result:**

```
18.3,18.6,18.1,18.0,17.9,18.3,18.6,18.1,18.0,17.9,18.3,18.6,18.
1,18.0,17.9,18.3,18.6,18.1,18.0,17.9
```

**11.5.1.14 Performing List Evaluations**

The commands of this subsystem are used for measuring the power at a list of frequency points with different device settings. The measurement is always performed in zero span. A new trigger event is required for each test point (exception: trigger "FREE RUN").

The results are output as a list in the order of the entered frequency points. The number of results per test point depends on the number of concurrently active measurements (peak/RMS/average). The number of frequencies is limited to 200 entries.

Selection of concurrently active measurements and setting of parameters that are constant for the whole measurement is performed via a configuration command (`[SENSe:]LIST:POWer:SET`). This also includes the setting for trigger and gate parameters.



Settings that are not directly included in commands of this subsystem can be configured by sending the corresponding commands prior to the `[SENSe:]LIST:... commands`.

Please note that changes to the trigger level have to be executed in zero span in order to take effect for the `[SENSe:]LIST:... commands`.

The commands of this subsystem can be used in two different ways:

- Instrument setup, measurement and querying of the results in a single command line. With this method, there is the least delay between the measurement and the result output. However, it requires the control computer to wait for the response from the instrument.

- Instrument setup and querying of the result list at the end of the measurement: With this method, the control computer may be used for other activities while the measurement is being performed. However, more time is needed for synchronization via service request.

[SENSe:]LIST:POWer:RESult?.....	784
[SENSe:]LIST:POWer[:SEQuence].....	785
[SENSe:]LIST:POWer:SET.....	787
[SENSe:]LIST:POWer:STATe.....	788

---

### [SENSe:]LIST:POWer:RESult?

This command queries the results of the list evaluation.

This command may be used to obtain measurement results in an asynchronous way, using the service request mechanism for synchronization to the end of the measurement.

If there are no results, the command returns an error.

#### Return values:

<PowerLevel> Power level for each frequency included in the measurement. The command returns up to 3 power levels for each frequency, depending on the number of evaluation modes you have turned on with [SENSe:]LIST:POWer:SET on page 787. The result is a list of floating point values separated by commas. The unit depends on [SENSe:]LIST:POWer[:SEQuence].

#### Example:

```
*ESE 1
*SRE 32
Configuration of the status reporting system for the generation of
an SRQ on operation complete
SENSe:LIST:POWer
935.2 MHz,-20dBm,10dB,OFF,NORM,1 MHz,3 MHz,
434us,0,
935.4 MHz,-20dBm,10dB,10dB,NORM,30 kHz,100 kHz,
434us,0,
935.6 MHz,-20dBm,10dB,20dB,NORM,30 kHz,100 kHz,
434us,0;
*OPC
Configuring and starting the measurement
...
Further actions of the control computer during measurement
On SRQ:
SENSe:LIST:POWer:RESult?
Response to service request
```

**Usage:** Query only

**[SENSe:]LIST:POWer[:SEQuence]**

<Frequency>, <RefLevel>, <RfAtt>, <EIAtt>, <FilterType>, <RBW>, <VBW>, <Meas Time>, <TriggerLevel>

This command configures and initiates the List Evaluation measurement.

The list can contain up to 200 entries (frequencies). You can define a different instrument setup for each frequency that is in the list.

If you synchronize the measurement with \*OPC, the R&S ESRP produces a service request when all frequencies have been measured and the number of individual measurements has been performed.

To reduce the setting time, all indicated parameters are set up simultaneously at each test point.

The measurement is performed in zero span and therefore the span is set to 0 Hz. If the span > 0 is set, the function is automatically switched off.

The measurement is not compatible with other measurements, especially as far as marker, adjacent channel power measurement or statistics are concerned. The corresponding commands thus automatically deactivate the function.

The function is only available in REMOTE operation. It is deactivated when switching the instrument back to LOCAL.

Note that using the command as a query initiates the measurement and returns the results if all frequencies have been measured. For more information on querying the results see [\[SENSe:\]LIST:POWer:RESult?](#) on page 784 .

The following parameters are the settings for an individual frequency point. They are repeated for each frequency point.

**Setting parameters:**

<Frequency>	Defines the receive frequency. Each frequency corresponds to one list entry. Range: 0 Hz to fmax
<RefLevel>	Defines the reference level for a list entry. Range: -130 dBm to 30 dBm Increment: 0.01 dBm
<RfAtt>	Defines the RF attenuation for a list entry. Range: 0 dB to 70 dB Increment: 10 dB
<FilterType>	Selects the filter type for a list entry. For more information see <a href="#">[SENSe:]BANDwidth BWIDth[:RESolution]:TYPE</a> on page 640.
<RBW>	Defines the resolution bandwidth for a list entry. For the range of values refer to "Res BW Manual" on page 332. Refer to <a href="#">Chapter 6.2.6.3, "Selecting the Appropriate Filter Type"</a> , on page 337 for possible combinations of filter type and filter bandwidth for the <filter type> = CFILter and <filter type> = RRC.

<VBW>	<p>Defines the video bandwidth for a list entry. The value is ignored for &lt;filter type&gt; = "CFILter" or "RRC"</p> <p>Range: 1 Hz to 10 MHz in 1, 3, 10 steps</p>
<MeasTime>	<p>Defines the measurement time for a list entry. For details refer to "<a href="#">Sweeptime Manual</a>" on page 333.</p> <p>Range: 1 <math>\mu</math>s to 16000 s</p>
<TriggerLevel>	The trigger level must be 0.
<b>Return values:</b>	
<PowerLevel>	<p>Power level for each frequency included in the measurement. The command returns up to 3 power levels for each frequency, depending on the number of evaluation modes you have turned on with <a href="#">[SENSE:]LIST:POWer:SET</a> on page 787. The result is a list of floating point values separated by commas. The unit depends on <a href="#">CALCulate&lt;n&gt;:UNIT:POWer</a>.</p>
<b>Example:</b>	<pre>SENSE:LIST:POWer? 935.2 MHz,0 dBm,10 dB,OFF,NORM,1 MHz,3 MHz, 440us,0, 935.4 MHz,0dBm,10dB,10dB,NORM,30 kHz,100 kHz, 440us,0, 935.6 MHz,0dBm,10dB,20dB,NORM,30 kHz,100 kHz, 440us,0</pre> <p>Result list: -28.3,-30.6,-38.1</p>
<b>Example:</b>	<pre>SENSE:LIST:POWer:SET ON,ON,ON,IMM,POS,0,0</pre> <p>Activates the power measurement of the peak, RMS and average values.</p> <pre>SENSE:LIST:POWer? 935.2 MHz,0dBm,10dB,OFF,NORM,1 MHz,3 MHz,440us, 0, 935.4 MHz,0dBm,10dB,10dB,NORM,30 kHz,100 kHz, 440us,0, 935.6 MHz,0dBm,10dB,20dB,NORM,30 kHz,100 kHz, 440us,0</pre> <p>Result list (3 results per frequency point): -28.3, -29.6, 1.5, -30.6, -31.9, 0.9, -38.1, -40.0, 2.3</p>

**Example:**

```
SENSe:LIST:POWer
935.2 MHz,0dBm,10dB,OFF,NORM,1 MHz,3 MHz,440us,
0,
935.4 MHz,0dBm,10dB,10dB,CFIL,30 kHz,100 kHz,
440us,0,
935.6 MHz,0dBm,10dB,20dB,CFIL,30 kHz,100 kHz,
440us,0
```

Performs a measurement sequence with the settings described in [Table 11-22](#).

```
SENSe:LIST:POWer?
935.2 MHz,0dBm,10dB,OFF,NORM,1 MHz,3 MHz,440us,
0,
935.4 MHz,0dBm,10dB,10dB,CFIL,30 kHz,100 kHz,
440us,0,
935.6 MHz,0dBm,10dB,20dB,CFIL,30 kHz,100 kHz,
440us,0
```

Performs the same measurement and returns the result list immediately after the last frequency point.

**Table 11-22: Settings for power list example**

Step	Freq. [MHz]	Ref Level [dBm]	RF Att [dB]	el Att [dB]	Filter type	RBW	VBW	Meas Time [us]	TRG Level (reserved)
1	935.2	0	10	OFF	Normal	1 MHz	3 MHz	440	0
2	935.4	0	10	10	Channel	30 kHz	100 kHz	440	0
3	935.6	0	10	20	Channel	30 kHz	100 kHz	440	0

**[SENSe:]LIST:POWer:SET**

<PeakPower>,<RMSPower>,<AVGPower>,<TriggerSource>,<TriggerSlope>,<TriggerOffset>,<GateLength>

This command defines global List Evaluation parameters.

These parameters are valid for every frequency you want to measure.

The state of the first three parameters (<PeakPower>, <RMSPower> and <AVGPower>) define the number of results for each frequency in the list.

Note that you have to set the trigger level *after* sending this command.

**Parameters:**

<PeakPower> ON | OFF

Turns peak power evaluation on and off.

\*RST: ON

<RMSPower> ON | OFF

Turns RMS power evaluation on and off.

\*RST: OFF

<AVGPower>	ON   OFF Turns average power evaluation on and off. *RST: OFF
<TriggerSource>	IMMediate   EXTernal   VIDEo   IFPower   RFPower Selects a trigger source. For more information see " <a href="#">Trg/Gate Source</a> " on page 346. *RST: IMM
<TriggerSlope>	NEGative   POSitive Selects the trigger slope. *RST: POS
<TriggerOffset>	Defines the trigger delay. The trigger delay is the time between the detection of the trigger signal and the start of the measurement at the next frequency point. Range: span = 0 Hz: (-sweep time) to 30 s; span > 10 Hz: 31.25 ns to 30 s *RST: 0 s
<GateLength>	Defines the gate length for gated measurements. Setting 0 seconds turns gated measurements off. Other values activate the gated trigger function. To perform gated measurements, the trigger source must be different from IMMEDIATE. Range: 31.25 ns to 30 s *RST: 0 s
<b>Example:</b>	<code>SENSe:LIST:POWer:SET ON,OFF,OFF,EXT,POS,10US,434US</code>

---

#### [SENSe:]LIST:POWer:STATe <State>

This command turns the List Evaluation off.

#### Parameters:

<State> OFF

**Example:** `SENS:LIST:POW:STAT OFF`

### 11.5.1.15 Probe Configuration

<a href="#">PROBe:ID:PARTnumber?</a> .....	789
<a href="#">PROBe:ID:SRNumber?</a> .....	789
<a href="#">PROBe:SETup:MODE</a> .....	789
<a href="#">PROBe:SETup:NAME?</a> .....	789
<a href="#">PROBe:SETup:STATe?</a> .....	789
<a href="#">PROBe[:STATe]</a> .....	790

---

**PROBe:ID:PARTnumber?**

This command returns the material part number of the connected probe.

**Example:**           PROB:ID:PART?

**Usage:**            Query only

**Manual operation:** See "[Part number](#)" on page 358

---

**PROBe:ID:SRNumber?**

This command returns the serial number of the connected probe.

**Example:**           PROB:ID:SRN?

**Usage:**            Query only

**Manual operation:** See "[Serial Number](#)" on page 358

---

**PROBe:SETup:MODE <Mode>**

This command defines which action is taken when the probe's micro button is pressed.

**Parameters:**

<Mode>

**RSINgLe**

A single sweep is performed.

**NOACtion**

No action is taken.

\*RST:       OFF

**Example:**           PROB:SET:STAT ON

**Manual operation:** See "[Probe Config](#)" on page 355  
See "[Micro Button Action](#)" on page 358

---

**PROBe:SETup:NAME?**

This command returns the name of the connected probe.

**Example:**           PROB:SET:NAME?

**Usage:**            Query only

**Manual operation:** See "[Name](#)" on page 358

---

**PROBe:SETup:STATe?**

This command queries whether a probe is connected to the instrument's [RF Input] and USB connectors and was recognized by the R&S ESRP.

**Example:**           PROB:SET:STAT ON

**Usage:**            Query only



**PROBe]:STATe] <State>**

This command activates a connected probe. Use this command to switch off the probe and measure the digital input without considering the transducer factor of the probe.

**Parameters:**

<State>                    **ON | OFF**  
 \*RST:                    OFF

**Example:**                    PROB:STAT ON

**Manual operation:**    See "[Probe Config](#)" on page 355  
 See "[State](#)" on page 358

## 11.5.2 Configuring Spectrum Measurements

- [Frequency Settings](#)..... 790
- [Automatic Measurement Configuration](#)..... 795
- [Bandwidth Settings](#)..... 798
- [Sweep Configuration](#)..... 801
- [Trigger Configuration](#)..... 804
- [Vertical Axis Configuration](#)..... 811

### 11.5.2.1 Frequency Settings

The following commands select the frequency characteristics the R&S ESRP uses for the measurement.

#### Defining Frequency Characteristics

Commands useful to define the frequency described elsewhere:

- [\[SENSe:\]FREQUENCY:CENTer:STEP](#) on page 634

<a href="#">[SENSe:]FREQUENCY:CENTer</a> .....	790
<a href="#">[SENSe:]FREQUENCY:CENTer:STEP:AUTO</a> .....	791
<a href="#">[SENSe:]FREQUENCY:CENTer:STEP:LINK</a> .....	791
<a href="#">[SENSe:]FREQUENCY:CENTer:STEP:LINK:FACTor</a> .....	792
<a href="#">[SENSe:]FREQUENCY:MODE</a> .....	792
<a href="#">[SENSe:]FREQUENCY:OFFSet</a> .....	792
<a href="#">[SENSe:]FREQUENCY:STARt</a> .....	793
<a href="#">[SENSe:]FREQUENCY:STOP</a> .....	793
<a href="#">[SENSe:]FREQUENCY:SPAN</a> .....	793
<a href="#">[SENSe:]FREQUENCY:SPAN:FULL</a> .....	793

**[SENSe:]FREQUENCY:CENTer <Frequency>**

This command defines the center frequency (frequency domain) or measuring frequency (time domain).

**Parameters:**

<Frequency>            Range:        0 to f<sub>max</sub>  
                               \*RST:        f<sub>max</sub>/2  
                               Default unit: Hz  
                               f<sub>max</sub> is specified in the data sheet. min span is 10 Hz  
                               (SEM and Spurious: min span = 20 Hz)

**Example:**                `FREQ:CENT 100 MHz`

**Manual operation:**    See "[Center](#)" on page 316

**[SENSe:]FREQuency:CENTer:STEP:AUTO <State>**

This command couples the step size of the center frequency to the span (ON) or sets the value of the center frequency entered via `[SENSe:]FREQuency:CENTer` (OFF).

**Parameters:**

<State>                    ON | OFF  
                               \*RST:        ON

**Example:**                `FREQ:CENT:STEP:AUTO ON`  
 Activates the coupling of the step size to the span.

**[SENSe:]FREQuency:CENTer:STEP:LINK <CouplingType>**

This command couples and decouples the center frequency step size to the span or the resolution bandwidth.

**Parameters:**

<CouplingType>        **SPAN**  
 Couples the step size to the span. Available for measurements in the frequency domain.

**RBW**  
 Couples the step size to the resolution bandwidth. Available for measurements in the time domain.

**OFF**  
 Decouples the step size (manual input).

                              \*RST:        SPAN

**Example:**                `FREQ:CENT:STEP:LINK SPAN`

**Manual operation:**    See "[0.1\\*Span \(span > 0\)](#)" on page 316  
 See "[0.1\\*RBW \(span > 0\)](#)" on page 316  
 See "[0.5\\*Span \(span > 0\)](#)" on page 317  
 See "[0.5\\*RBW \(span > 0\)](#)" on page 317  
 See "[x\\*Span \(span > 0\)](#)" on page 317  
 See "[x\\*RBW \(span > 0\)](#)" on page 317

**[SENSe:]FREQuency:CENTer:STEP:LINK:FACTor <Factor>**

This command defines a step size factor if the center frequency step size is coupled to the span or the resolution bandwidth.

**Parameters:**

<Factor>                    Range:        1 to 100  
                                  \*RST:        10  
                                  Default unit: PCT

**Example:**                    `FREQ:CENT:STEP:LINK:FACT 20PCT`

**Manual operation:**    See "[0.1\\*Span \(span > 0\)](#)" on page 316  
                                  See "[0.1\\*RBW \(span > 0\)](#)" on page 316  
                                  See "[0.5\\*Span \(span > 0\)](#)" on page 317  
                                  See "[0.5\\*RBW \(span > 0\)](#)" on page 317

**[SENSe:]FREQuency:MODE <Mode>**

This command selects the frequency mode.

between span > 0 and zero span in the "Spectrum" mode.

**Parameters:**

<Mode>                    **CW**  
                                  Selects the time domain (span = 0).  
                                  In the time domain, define the measurement frequency with  
                                  [\[SENSe:\]FREQuency:CENTer](#).

**FIXed**  
                                  Selects the time domain (span = 0).  
                                  In the time domain, define the measurement frequency with  
                                  [\[SENSe:\]FREQuency:CENTer](#).

**SWEep**  
                                  Selects the frequency domain (span > 0).  
                                  In the frequency domain, define the frequency characteristics  
                                  with the following commands:

- [\[SENSe:\]FREQuency:START](#)
- [\[SENSe:\]FREQuency:STOP](#)
- [\[SENSe:\]FREQuency:SPAN](#)
- [\[SENSe:\]FREQuency:CENTer](#)

\*RST:                    SWEep

**Example:**                    `FREQ:MODE SWE`  
                                  Selects the frequency domain.

**Usage:**                    SCPI confirmed

**[SENSe:]FREQuency:OFFSet <Offset>**

This command defines the frequency offset.

**Parameters:**

<Offset>                    Range:     -100 GHz to 100 GHz  
                                  \*RST:     0 Hz  
                                  Default unit: Hz

**Example:**                `FREQ:OFFS 1GHZ`

**Manual operation:**    See "[Frequency Offset](#)" on page 318

**[SENSe:]FREQUENCY:START <Frequency>**

This command defines the start frequency for measurements in the frequency domain.

**Parameters:**

<Frequency>                0 to (fmax - min span)  
                                  \*RST:     0

**Example:**                `FREQ:STAR 20MHz`

**Manual operation:**    See "[Start](#)" on page 318

**[SENSe:]FREQUENCY:STOP <Frequency>**

This command defines the stop frequency for measurements in the frequency domain.

**Parameters:**

<Frequency>                min span to fmax  
                                  \*RST:     fmax

**Example:**                `FREQ:STOP 2000 MHz`

**Manual operation:**    See "[Stop](#)" on page 318

**[SENSe:]FREQUENCY:SPAN <Span>**

This command defines the frequency span.

**Parameters:**

<Span>                      \*RST:     fmax

**Example:**                `FREQ:SPAN 10MHz`

**Manual operation:**    See "[IF Span Manual](#)" on page 156  
                                  See "[Span Manual](#)" on page 321  
                                  See "[Zero Span](#)" on page 321

**[SENSe:]FREQUENCY:SPAN:FULL**

This command sets the frequency span to its maximum.

**Example:**                `FREQ:SPAN:FULL`

**Manual operation:**    See "[Full Span](#)" on page 156

## Tracking Signals

CALCulate<n>:MARKer<m>:FUNction:STRack:BANDwidth BWIDth.....	794
CALCulate<n>:MARKer<m>:FUNction:STRack[:STATe].....	794
CALCulate<n>:MARKer<m>:FUNction:STRack:THReshold.....	795
CALCulate<n>:MARKer<m>:FUNction:STRack:TRACe.....	795

---

### CALCulate<n>:MARKer<m>:FUNction:STRack:BANDwidth|BWIDth <Bandwidth>

This command defines the bandwidth around the center frequency that is included in the signal tracking process.

Note that you have to turn on signal tracking before you can use the command (CALCulate<n>:MARKer<m>:FUNction:STRack[:STATe]).

#### Suffix:

<n>	Selects the measurement window.
<m>	Selects the marker.

#### Parameters:

<Bandwidth>	10 Hz to MAX (span)
*RST:	(= span/10 on activating the function)

#### Example:

```
CALC:MARK:FUNC:STR:BAND 1 MHZ
Sets the search bandwidth to 1 MHz.
CALC:MARK:FUNC:STR:BWID 1 MHZ
Alternative command for the same function.
```

**Manual operation:** See "Track BW (span > 0)" on page 319

---

### CALCulate<n>:MARKer<m>:FUNction:STRack[:STATe] <State>

This command turns signal tracking on and off.

When signal tracking is on, the R&S ESRP determines the maximum signal after each frequency sweep. The center frequency is then set to the frequency of this signal. Thus, the center frequency follows the frequency when you measure drifting signals.

#### Suffix:

<n>	Selects the measurement window.
<m>	Selects the marker.

#### Parameters:

<State>	ON   OFF
*RST:	OFF

#### Example:

```
CALC:MARK:FUNC:STR ON
Switches on the signal track function.
```

**Manual operation:** See "Track On/Off (span > 0)" on page 319

**CALCulate<n>:MARKer<m>:FUNction:STRack:THReshold <Level>**

This command defines a threshold above which the signal is tracked.

Note that you have to turn on signal tracking before you can use the command (`CALCulate<n>:MARKer<m>:FUNction:STRack[:STATE]`).

The unit depends on `CALCulate<n>:UNIT:POWER`.

**Suffix:**

<n>                      Selects the measurement window.  
 <m>                      Selects the marker.

**Parameters:**

<Level>                Range:        -130 dBm to 30 dBm  
                          \*RST:        -120 dBm  
                          Default unit: dBm

**Example:**

`CALC:MARK:FUNC:STR:THR -50DBM`  
 Sets the threshold for signal tracking to -50 dBm.

**Manual operation:** See "[Track Threshold \(span > 0\)](#)" on page 319

**CALCulate<n>:MARKer<m>:FUNction:STRack:TRACe <TraceNumber>**

This command defines the trace on which the signal is tracked.

**Suffix:**

<n>                      Selects the measurement window.  
 <m>                      Selects the marker.

**Parameters:**

<TraceNumber>        Range:        1 to 6  
                          \*RST:        1

**Example:**

`CALC:MARK:FUNC:STR:TRAC 3`  
 Defines trace 3 as the trace for signal tracking.

**Manual operation:** See "[Select Trace \(span > 0\)](#)" on page 319

**11.5.2.2 Automatic Measurement Configuration**

The following commands initiate and perform automatic test routines to configure the current measurement.

<code>[SENSe:]ADJust:ALL</code> .....	796
<code>[SENSe:]ADJust:CONFiguration:HYSTeresis:LOWer</code> .....	796
<code>[SENSe:]ADJust:CONFiguration:HYSTeresis:UPPer</code> .....	796
<code>[SENSe:]ADJust:CONFigure:LEVel:DURation</code> .....	796
<code>[SENSe:]ADJust:CONFigure:LEVel:DURation:MODE</code> .....	797
<code>[SENSe:]ADJust:CONFigure:TRIG</code> .....	797
<code>[SENSe:]ADJust:FREQuency</code> .....	797
<code>[SENSe:]ADJust:LEVel</code> .....	798

**[SENSe:]ADJust:ALL**

This command determines the ideal frequency and level configuration for the current measurement.

**Example:** ADJ:ALL

**Manual operation:** See ["Auto All"](#) on page 328

**[SENSe:]ADJust:CONFIguration:HYSTeresis:LOWer <Threshold>**

This command defines a lower threshold the signal must drop below before the reference level is automatically adjusted when the "Auto Level" function is performed.

For more information see [\[SENSe:\]ADJust:LEVel](#)).

**Parameters:**

<Threshold> Range: 0 to 200  
\*RST: +1 dB  
Default unit: dB

**Example:** SENS:ADJ:CONF:HYST:LOW 2

**Example:** For an input signal level of currently 20 dBm, the reference level will only be adjusted when the signal level falls below 18 dBm.

**Manual operation:** See ["Lower Level Hysteresis"](#) on page 329

**[SENSe:]ADJust:CONFIguration:HYSTeresis:UPPer <Threshold>**

This command defines an upper threshold the signal must exceed before the reference level is automatically adjusted when the "Auto Level" function is performed.

For more information see [\[SENSe:\]ADJust:LEVel](#)).

**Parameters:**

<Threshold> Range: 0 to 200  
\*RST: +1 dB  
Default unit: dB

**Example:** SENS:ADJ:CONF:HYST:UPP 2

For an input signal level of currently 20 dBm, the reference level will only be adjusted when the signal level rises above 22 dBm.

**Manual operation:** See ["Upper Level Hysteresis"](#) on page 329

**[SENSe:]ADJust:CONFIgure:LEVel:DURation <Duration>**

This command defines the duration of the level measurement used to determine the optimal reference level automatically (for SENS:ADJ:LEV ON).

**Parameters:**

<Duration> <numeric value> in seconds  
 Range: 0.001 to 16000.0  
 \*RST: 0.001  
 Default unit: s

**Example:** ADJ:CONF:LEV:DUR:5

**Manual operation:** See "[Meas Time Manual](#)" on page 329

**[SENSe:]ADJJust:CONFigure:LEVel:DURation:MODE <Mode>**

This command selects the way the R&S ESRP determines the length of the measurement that is performed while determining the ideal reference level.

**Parameters:**

<Mode> **AUTO**  
 Automatically determines the measurement length.  
**MANual**  
 Manual definition of the measurement length.  
 \*RST: AUTO

**Example:** ADJ:CONF:LEV:DUR:MODE MAN  
 Specifies manual definition of the measurement duration.  
 ADJ:CONF:LEV:DUR:5  
 Specifies the duration manually.

**[SENSe:]ADJJust:CONFigure:TRIG <State>**

This command defines the behaviour of the measurement when adjusting a setting automatically (using `SENS:ADJ:LEV ON`, for example).

For more information see "[Adjusting settings automatically during triggered measurements](#)" on page 328.

**Parameters:**

<State> **ON**  
 The measurement for automatic adjustment waits for the trigger.  
**OFF**  
 The measurement for automatic adjustment is performed immediately, without waiting for a trigger.  
 \*RST: ON

**Example:** ADJ:CONF:TRIG OFF

**[SENSe:]ADJJust:FREQuency**

This command defines the center frequency and the reference level automatically by determining the highest level in the frequency span.

**Example:** ADJ:FREQ



**Manual operation:** See "Auto Freq" on page 328

---

### [SENSe:]ADJust:LEVel

This command automatically sets the optimal reference level for the current measurement.

You can define a threshold that the signal must exceed before the reference level is adjusted, see [SENSe:]ADJust:CONFIguration:HYSTeresis:UPPer and [SENSe:]ADJust:CONFIguration:HYSTeresis:LOWer.

**Example:** ADJ:LEV

**Manual operation:** See "Adjust Ref Lvl (span > 0)" on page 268  
 See "Adjust Ref Lvl (span > 0)" on page 270  
 See "Auto Level" on page 329

### 11.5.2.3 Bandwidth Settings

The following commands select the measurement filter bandwidths and characteristics.

#### Selecting the Resolution Bandwidth

Commands useful to configure the RBW described elsewhere:

- [SENSe:]BANDwidth|BWIDth[:RESolution] on page 639
- [SENSe:]BANDwidth|BWIDth[:RESolution]:TYPE on page 640

[SENSe:]BANDwidth BWIDth[:RESolution]:AUTO.....	798
[SENSe:]BANDwidth BWIDth[:RESolution]:FFT.....	799
[SENSe:]BANDwidth BWIDth[:RESolution]:RATIo.....	799

---

### [SENSe:]BANDwidth|BWIDth[:RESolution]:AUTO <State>

This command couples and decouples the resolution bandwidth to the span.

The automatic coupling adapts the resolution bandwidth to the current frequency span according to the relationship between frequency span and resolution bandwidth.

Use [SENSe:]BANDwidth|BWIDth[:RESolution]:RATIo to define the ratio RBW/span.

#### Parameters:

<State> ON | OFF  
 \*RST: ON

**Example:** BAND:AUTO OFF  
 Switches off the coupling of the resolution bandwidth to the span.

**Manual operation:** See "Res BW Manual" on page 332  
 See "Res BW Auto" on page 332  
 See "Default Coupling" on page 336

**[SENSe:]BANDwidth|BWIDth[:RESolution]:FFT <FilterMode>**

This command defines the filter mode of FFT filters by defining the partial span size. The partial span is the span which is covered by one FFT analysis.

This command is only available for sweep type "FFT".

**Parameters:**

&lt;FilterMode&gt;

**AUTO**

The firmware determines whether to use wide or narrow filters to obtain the best measurement results.

**NARRow**

The FFT filters with the smaller partial span are used. This allows you to perform measurements near a carrier with a reduced reference level due to a narrower analog prefilter.

\*RST: AUTO

**Example:**

```
BAND:TYPE FFT
Select FFT filter.
```

**Example:**

```
BAND:FFT NARR
Select narrow partial span for FFT filter.
```

**Manual operation:** See ["Auto"](#) on page 330  
See ["Narrow"](#) on page 330

**[SENSe:]BANDwidth|BWIDth[:RESolution]:RATio <Ratio>**

This command defines the ratio between the resolution bandwidth (Hz) and the span (Hz).

Note that the ratio defined with the remote command (RBW/span) is reciprocal to that of the manual operation (span/RBW).

**Parameters:**

&lt;Ratio&gt;

Range: 0.0001 to 1

\*RST: 0.01

**Example:**

BAND:RAT 0.01

**Manual operation:** See ["Span/RBW Manual"](#) on page 336

**Selecting the Video Bandwidth**

<a href="#">[SENSe:]BANDwidth BWIDth:VIDeo</a> .....	799
<a href="#">[SENSe:]BANDwidth BWIDth:VIDeo:AUTO</a> .....	800
<a href="#">[SENSe:]BANDwidth BWIDth:VIDeo:RATio</a> .....	800
<a href="#">[SENSe:]BANDwidth BWIDth:VIDeo:TYPE</a> .....	801

**[SENSe:]BANDwidth|BWIDth:VIDeo <Bandwidth>**

This command defines the video bandwidth. The available video bandwidths are specified in the data sheet.

**Parameters:**

<Bandwidth> refer to data sheet  
 \*RST: (AUTO is set to ON)

**Example:** BAND:VID 10 kHz

**Manual operation:** See "[Video BW Manual](#)" on page 332

**[SENSe:]BANDwidth|BWIDth:VIDeo:AUTO <State>**

This command couples and decouples the VBW to the RBW.

Use [SENSe:]BANDwidth|BWIDth:VIDeo:RATio to define the ratio VBW/RBW.

**Parameters:**

<State> ON | OFF  
 \*RST: ON

**Example:** BAND:VID:AUTO OFF

**Manual operation:** See "[Video BW Manual](#)" on page 332  
 See "[Video BW Auto](#)" on page 333  
 See "[Default Coupling](#)" on page 336

**[SENSe:]BANDwidth|BWIDth:VIDeo:RATio <Ratio>**

This command defines the ratio between video bandwidth (Hz) and resolution bandwidth (Hz).

Note that the ratio defined with the remote command (VBW/RBW) is reciprocal to that of the manual operation (RBW/VBW).

**Parameters:**

<Ratio> Range: 0.01 to 1000  
 \*RST: 3

**Example:** BAND:VID:RAT 3  
 Sets the coupling of video bandwidth to video bandwidth = 3\*resolution bandwidth

**Manual operation:** See "[RBW/VBW Sine \[1/1\]](#)" on page 335  
 See "[RBW/VBW Pulse \[.1\]](#)" on page 335  
 See "[RBW/VBW Noise \[10\]](#)" on page 335  
 See "[RBW/VBW Manual](#)" on page 336  
 See "[Span/RBW Auto \[100\]](#)" on page 336

---

**[SENSe:]BANDwidth|BWIDth:VIDeo:TYPE <Mode>**

This command selects the position of the video filter in the signal path.

**Parameters:**

<Mode>

**LINear**

The video filter is applied in front of the logarithmic amplifier. In linear mode, measurements with a logarithmic level scale result in flatter falling edges compared to logarithmic mode. The reason is the conversion of linear power values into logarithmic level values: if you halve the linear power, the logarithmic level decreases by 3 dB.

**LOGarithmic**

The video filter is applied after the logarithmic amplifier.

\*RST: LINear

**Example:**

BAND:VID:TYPE LIN

Video filter ahead of the logarithmic amplifier

### 11.5.2.4 Sweep Configuration

Commands useful to configure the sweep described elsewhere:

- [ABORt](#) on page 609
- [INITiate<n>\[:IMMediate\]](#) on page 610
- [INITiate<n>:CONTInuous](#) on page 609

<a href="#">INITiate&lt;n&gt;:CONMeas</a> .....	801
<a href="#">[SENSe:]SWEep:COUNT</a> .....	802
<a href="#">[SENSe:]SWEep:POINTs</a> .....	802
<a href="#">[SENSe:]SWEep:TIME</a> .....	803
<a href="#">[SENSe:]SWEep:TIME:AUTO</a> .....	803
<a href="#">[SENSe:]SWEep:TYPE</a> .....	803
<a href="#">[SENSe:]SWEep:TYPE:USED?</a> .....	804

---

#### **INITiate<n>:CONMeas**

This command restarts a measurement that has been stopped in single sweep mode.

The measurement is restarted at the first sweep point.

As opposed to [INITiate<n>\[:IMMediate\]](#), this command does not reset traces in maxhold, minhold or average mode. Therefore it can be used to continue measurements using max hold or averaging functions.

In single sweep mode, you can synchronize to the end of the measurement with \*OPC, \*OPC? or \*WAI. In continuous sweep mode, synchronization to the end of the measurement is not possible. Thus, it is not recommended that you use continuous sweep mode in remote control, as results like trace data or markers are only valid after a single sweep end synchronization.

**Suffix:**

<n> irrelevant

**Example:**

```
INIT:CONT OFF
```

Switches to single sweep mode.

```
DISP:WIND:TRAC:MODE AVER
```

Switches on trace averaging.

```
SWE:COUN 20
```

Setting the sweep counter to 20 sweeps.

```
INIT;*WAI
```

Starts the measurement and waits for the end of the 20 sweeps.

```
INIT:CONM;*WAI
```

Continues the measurement (next 20 sequences) and waits for the end.

**Manual operation:** See ["Continue Single Sweep"](#) on page 341

**[SENSe:]SWEep:COUNT <NumberSweeps>**

This command defines the number of sweeps started with single sweep, which are used for calculating the average or maximum value. If the values 0 or 1 are set, one sweep is performed.

**Parameters:**

<NumberSweeps> 0 to 32767

\*RST: 0 (GSM: 200, PHN:1)

**Example:**

```
SWE:COUN 64
```

Sets the number of sweeps to 64.

```
INIT:CONT OFF
```

Switches to single sweep mode.

```
INIT;*WAI
```

Starts a sweep and waits for its end.

**Manual operation:** See ["Sweep Count"](#) on page 343

**[SENSe:]SWEep:POINTs <NumberPoints>**

This command defines the number of measurement points to be collected during one sweep.

Note: For Spurious Emissions measurements the maximum number of sweep points in all ranges is limited to 100001.

**Parameters:**

<NumberPoints> Range: 101 to 32001

\*RST: 691

**Example:**

```
SWE:POIN 150
```

**Manual operation:** See ["Sweep Points"](#) on page 277  
See ["Sweep Points"](#) on page 343

---

**[SENSe:]SWEep:TIME <Time>**

This command defines the sweep time.

The range depends on the frequency span.

If this command is used in "Spectrum" mode, automatic coupling to resolution bandwidth and video bandwidth is switched off.

**Parameters:**

<Time> refer to data sheet  
\*RST: (automatic)

**Example:** SWE:TIME 1s

**Manual operation:** See "Sweep Time" on page 219  
See "Sweeptime Manual" on page 333  
See "Meas Time" on page 431

---

**[SENSe:]SWEep:TIME:AUTO <State>**

In realtime mode, this command automatically sets the sweep time to 32 ms.

In analyzer mode, this command controls the automatic coupling of the sweep time to the frequency span and bandwidth settings. If [SENSe:]SWEep:TIME is used, automatic coupling is switched off.

**Parameters:**

<State> ON | OFF  
\*RST: ON

**Example:** SWE:TIME:AUTO ON  
Activates automatic sweep time.

**Manual operation:** See "Sweeptime Manual" on page 333  
See "Sweeptime Auto" on page 334  
See "Default Coupling" on page 336

---

**[SENSe:]SWEep:TYPE <Type>**

This command selects the sweep type.

**Parameters:**

<Type> **SWE**  
Selects analog frequency sweeps.  
**AUTO**  
Automatically selects the sweep type (FFT or analog frequency sweep).  
**FFT**  
Selects FFT sweeps.  
\*RST: AUTO

**Example:** `SWE:TYPE FFT`  
Selects FFT sweeps.

**Manual operation:** See "Sweep" on page 330  
See "FFT" on page 330  
See "Auto" on page 330

#### [SENSe:]SWEep:TYPE:USED?

This command queries the sweep type if you have turned on automatic selection of the sweep type.

**Return values:**  
<Type> SWE | FFT  
**SWE**  
Normal sweep  
**FFT**  
FFT mode  
\*RST: SWE

**Example:** `SWE:TYPE:USED?`

**Usage:** Query only

### 11.5.2.5 Trigger Configuration

The following commands configure triggered or gated measurements.

#### Triggering Measurements

TRIGger<n>[:SEQuence]:HOLDoff[:TIME].....	804
TRIGger<n>[:SEQuence]:IFPower:HOLDoff.....	805
TRIGger<n>[:SEQuence]:IFPower:HYSTeresis.....	805
TRIGger<n>[:SEQuence]:LEVel[:EXTernal].....	805
TRIGger<n>[:SEQuence]:LEVel:IFPower.....	806
TRIGger<n>[:SEQuence]:LEVel:RFPower.....	806
TRIGger<n>[:SEQuence]:LEVel:VIDeo.....	806
TRIGger<n>[:SEQuence]:SLOPe.....	807
TRIGger<n>[:SEQuence]:SOURce.....	807
TRIGger<n>[:SEQuence]:TIME:RINTerval.....	808

#### TRIGger<n>[:SEQuence]:HOLDoff[:TIME] <Delay>

This command defines the length of the trigger delay.

A negative delay time (pretrigger) can be set in zero span only.

**Suffix:**  
<n> irrelevant





**Suffix:**

&lt;n&gt; irrelevant

**Parameters:**

&lt;TriggerLevel&gt; Range: 0.5 V to 3.5 V

\*RST: 1.4 V

**Example:**

TRIG:LEV 2V

**TRIGger<n>[:SEquence]:LEVel:IFPower <TriggerLevel>**

This command defines the power level at the third intermediate frequency that must be exceeded to cause a trigger event. Note that any RF attenuation or preamplification is considered when the trigger level is analyzed. If defined, a reference level offset is also considered.

**Suffix:**

&lt;n&gt; irrelevant

**Parameters:**

&lt;TriggerLevel&gt; \*RST: -20 dBm

**Example:**

TRIG:LEV:IFP -30DBM

**Manual operation:** See ["Trg/Gate Level"](#) on page 348See ["Trigger Level"](#) on page 443**TRIGger<n>[:SEquence]:LEVel:RFPower <TriggerLevel>**

This command defines the power level at the third intermediate frequency that must be exceeded to cause a trigger event. Note that any RF attenuation or preamplification is considered when the trigger level is analyzed. If defined, a reference level offset is also considered.

**Suffix:**

&lt;n&gt; irrelevant

**Parameters:**

&lt;TriggerLevel&gt; \*RST: -20 dBm

**Example:**

TRIG:LEV:RFP -30dBm

**TRIGger<n>[:SEquence]:LEVel:VIDeo <Value>**

This command sets the level of the video trigger source.

**Suffix:**

&lt;n&gt; irrelevant

**Parameters:**

&lt;Value&gt; 0 to 100 PCT

\*RST: 50 PCT

**Example:**

TRIG:LEV:VID 50PCT

**Manual operation:** See "Video" on page 162  
 See "Trg/Gate Level" on page 348  
 See "Trigger Level" on page 443

### TRIGger<n>[:SEQuence]:SLOPe <Type>

This command selects the slope of the trigger signal. The selected trigger slope applies to all trigger signal sources.

**Suffix:**

<n> irrelevant

**Parameters:**

<Type> POSitive | NEGative  
 \*RST: POSitive

**Example:** TRIG:SLOP NEG

**Manual operation:** See "Trigger Polarity" on page 162  
 See "Trg/Gate Polarity" on page 348  
 See "Trigger Polarity" on page 443

### TRIGger<n>[:SEQuence]:SOURce <Source>

This command selects the trigger source.

**Note:** Using gating with gate mode "level" ( `TRACe<n>:IQ:EGATe:TYPE` on page 865/ `[SENSe:]SWEep:EGATe:TYPE`) and an IFP trigger, the holdoff time for the IFP trigger (see `TRIGger<n>[:SEQuence]:HOLDoff[:TIME]` on page 804) is ignored for frequency sweep, FFT sweep, zero span and IQ mode measurements.

When triggering or gating is activated, the squelch function is automatically disabled (see `[SENSe:]DEMod:SQUelch[:STATe]`).

For details on trigger modes refer to "Trg/Gate Source" on page 346.

For details on trigger modes refer to the "Trg/Gate Source" softkey in the base unit description.

**Suffix:**

<n> irrelevant

**Parameters:**

<Source> Note that the availability of the trigger source depends on the measurement you are in.

**EXternal**

Selects an external trigger.

**IFPower**

Selects the trigger on the second intermediate frequency.

**IMMediate**

Selects the free run mode (= no trigger).

**MASK**

Selects the frequency mask trigger.

**TDTRigger**

Selects the time domain trigger.

**TIME**

Selects the time trigger.

**VIDeo**

Selects the video trigger. The video trigger is available for time domain measurements.

\*RST: IMMEDIATE

**Example:**

TRIG:SOUR EXT

Selects the external trigger input as source of the trigger signal

**Manual operation:**

See "External" on page 162

See "Free Run" on page 162

See "Video" on page 162

See "Trg/Gate Source" on page 346

See "Free Run" on page 346

See "External" on page 346

See "Video" on page 347

See "RF Power" on page 347

See "IF Power/BB Power" on page 347

See "Time" on page 348

**TRIGger<n>[:SEQUence]:TIME:RINTerval <Interval>**

This command sets the repetition interval for the time trigger source.

**Suffix:**

<n> irrelevant

**Parameters:**

<Interval> 2.0 ms to 5000

\*RST: 1.0

**Example:**

TRIG:SOUR TIME

Selects the time trigger input for triggering.

TRIG:TIME:RINT 50

The sweep starts every 50 s.

**Mode:**

All

**Manual operation:** See "Repetition Interval" on page 349

**Gated Measurements**

[SENSe:]SWEp:EGATe.....	809
[SENSe:]SWEp:EGATe:HOLDoff.....	809
[SENSe:]SWEp:EGATe:LENGth.....	810

[SENSe:]SWEep:EGATe:POLarity.....	810
[SENSe:]SWEep:EGATe:SOURce.....	810
[SENSe:]SWEep:EGATe:TYPE.....	811

---

### [SENSe:]SWEep:EGATe <State>

This command switches on/off the sweep control by an external gate signal. If the external gate is selected the trigger source is automatically switched to EXTERNAL as well.

In case of measurement with external gate, the measured values are recorded as long as the gate is opened. During a sweep the gate can be opened and closed several times. The synchronization mechanisms with \*OPC, \*OPC? and \*WAI remain completely unaffected.

The sweep end is detected when the required number of measurement points (691 in "Spectrum" mode) has been recorded.

#### Parameters:

<State>                    ON | OFF  
 \*RST:                    OFF

#### Example:

```
SWE:EGAT ON
Switches on the external gate mode.
SWE:EGAT:TYPE EDGE
Switches on the edge-triggered mode.
SWE:EGAT:HOLD 100US
Sets the gate delay to 100 µs.
SWE:EGAT:LEN 500US
Sets the gate opening time to 500 µs.
INIT;*WAI
Starts a sweep and waits for its end.
```

**Manual operation:** See "Gated Trigger (On/Off)" on page 291  
 See "Gate Ranges" on page 291  
 See "Gated Trigger" on page 349

---

### [SENSe:]SWEep:EGATe:HOLDoff <DelayTime>

This command defines the delay time between the external gate signal and the continuation of the sweep.

**Note:** Using gate mode "level" (see [SENSe:]SWEep:EGATe:TYPE on page 811) and an IFP trigger (see TRIGger<n>[:SEQUENCE]:SOURCE on page 807), the hold-off time for the IFP trigger is ignored for frequency sweep, FFT sweep, zero span and IQ mode measurements.

#### Parameters:

<DelayTime>              0 s to 30 s  
 \*RST:                    0s

**Example:**                SWE:EGAT:HOLD 100us

**Manual operation:** See ["Gate Delay"](#) on page 350

---

**[SENSe:]SWEep:EGATe:LENGth** <TimeInterval>

This command defines a gate length.

**Parameters:**

<TimeInterval> 125 ns to 30 s  
\*RST: 400µs

**Example:** SWE:EGAT:LENG 10ms

**Manual operation:** See ["Gate Length \(Gate Mode Edge\)"](#) on page 351

---

**[SENSe:]SWEep:EGATe:POLarity** <Polarity>

This command determines the polarity of the external gate signal. The setting applies both to the edge of an edge-triggered signal and the level of a level-triggered signal.

**Parameters:**

<Polarity> POSitive | NEGative  
\*RST: POSitive

**Example:** SWE:EGAT:POL POS

**Manual operation:** See ["Trg/Gate Polarity"](#) on page 348  
See ["Trigger Polarity"](#) on page 443

---

**[SENSe:]SWEep:EGATe:SOURce** <Source>

This command selects the signal source for gated measurements.

If an IF power signal is used, the gate is opened as soon as a signal at > -20 dBm is detected within the IF path bandwidth (10 MHz).

For details see the ["Trg/Gate Source"](#) on page 346 softkey.

**Parameters:**

<Source> EXTernal | IFPower | VIDEo | RFPower | PSEN  
\*RST: IFPower

**Example:** SWE:EGAT:SOUR IFP  
Switches the gate source to IF power.

**Manual operation:** See ["Gated Trigger \(On/Off\)"](#) on page 291  
See ["Trg/Gate Source"](#) on page 346  
See ["External"](#) on page 346  
See ["Video"](#) on page 347  
See ["RF Power"](#) on page 347  
See ["IF Power/BB Power"](#) on page 347  
See ["Gated Trigger"](#) on page 349

**[SENSe:]SWEep:EGATe:TYPE <Type>**

This command sets the type of triggering by the external gate signal.

A delay between applying the gate signal and the start of recording measured values can be defined, see [SENSe:]SWEep:EGATe:HOLDoff on page 809.

**Parameters:**

&lt;Type&gt;

LEVel | EDGE

**LEVel**

The gate is level-triggered:

After detection of the gate signal, the gate remains open until the gate signal disappears. The gate opening time cannot be defined with the command [SENSe:]SWEep:EGATe:HOLDoff.

**Note:** Using gating with gate mode "level" and an IFP trigger (see TRIGger<n>[:SEQuence]:SOURce on page 807), the holdoff time for the IFP trigger is ignored for frequency sweep, FFT sweep, zero span and IQ mode measurements.

**EDGE**

The gate is edge-triggered:

After detection of the set gate signal edge, the gate remains open until the gate delay ([SENSe:]SWEep:EGATe:HOLDoff) has expired.

\*RST: EDGE

**Example:**

SWE:EGAT:TYPE EDGE

**Manual operation:** See "Gate Mode (Lvl/Edge)" on page 350

**11.5.2.6 Vertical Axis Configuration**

The following commands configure the characteristics of the vertical diagram axis.

Commands useful to configure the vertical axis described elsewhere:

- DISPlay[:WINDow<n>]:TRACe<t>:Y:SPACing on page 636
- INPut:ATTenuation on page 637
- INPut:COUpling on page 641
- INPut:GAIN:STATe on page 638
- INPut:IMPedance on page 638

CALCulate<n>:UNIT:POWer.....	812
DISPlay[:WINDow<n>]:TRACe<t>:Y[:SCALE]	812
DISPlay[:WINDow<n>]:TRACe<t>:Y[:SCALE]:MODE.....	812
DISPlay[:WINDow<n>]:TRACe<t>:Y[:SCALE]:RLEVel.....	813
DISPlay[:WINDow<n>]:TRACe<t>:Y[:SCALE]:RLEVel:OFFSet.....	813
DISPlay[:WINDow<n>]:TRACe<t>:Y[:SCALE]:RPOSition.....	814
INPut:ATTenuation:AUTO.....	814
UNIT<n>:POWer.....	814

**CALCulate<n>:UNIT:POWER <Unit>**

This command selects the unit of the y-axis.

The unit applies to all measurement windows.

**Suffix:**

<n> irrelevant

**Parameters:**

<Unit> DBM | V | A | W | DBPW | WATT | DBUV | DBMV | VOLT |  
DBUA | AMPere  
\*RST: dBm

**Example:**

CALC:UNIT:POW DBM  
Sets the power unit to dBm.

**Manual operation:** See ["Unit"](#) on page 325

**DISPlay[:WINDow<n>]:TRACe<t>:Y[:SCALe] <Range>**

This command defines the display range of the y-axis with logarithmic scaling.

The command works only for a logarithmic scaling. You can select the scaling with [DISPlay\[:WINDow<n>\]:TRACe<t>:Y:SPACing](#) on page 636.

**Suffix:**

<n> window; For applications that do not have more than 1 measurement window, the suffix <n> is irrelevant.

<t> irrelevant

**Parameters:**

<Range> Range: 10 to 200  
\*RST: 100  
Default unit: dB

**Example:**

DISP:TRAC:Y 110dB

**Manual operation:** See ["Grid Range / Grid Min Level"](#) on page 159  
See ["Range Log 100 dB"](#) on page 288  
See ["Range Log 50 dB"](#) on page 288  
See ["Range Log 10 dB"](#) on page 289  
See ["Range Log 5 dB"](#) on page 289  
See ["Range Log 1 dB"](#) on page 289  
See ["Range Log Manual"](#) on page 289

**DISPlay[:WINDow<n>]:TRACe<t>:Y[:SCALe]:MODE <Mode>**

This command selects the type of scaling of the y-axis.

When `SYSTEM:DISPlay:UPDate` is turned off, this command has no immediate effect on the screen.

**Suffix:**

<n> window; For applications that do not have more than 1 measurement window, the suffix <n> is irrelevant.

<t> irrelevant

**Parameters:**

<Mode> **ABSolute**  
absolute scaling of the y-axis

**RELative**  
relative scaling of the y-axis

\*RST: ABS

**Example:** DISP:TRAC:Y:MODE REL

**Manual operation:** See "Grid Abs/Rel " on page 326

**DISPlay[:WINDow<n>]:TRACe<t>:Y[:SCALe]:RLEVel <ReferenceLevel>**

This command defines the reference level.

With the reference level offset  $\neq 0$ , the value range of the reference level is modified by the offset.

The unit depends on the setting defined with `CALCulate<n>:UNIT:POWer`.

**Suffix:**

<n> irrelevant.

<t> irrelevant

**Parameters:**

<ReferenceLevel> The unit is variable.

Range: see datasheet

\*RST: -10dBm

**Example:** DISP:TRAC:Y:RLEV -60dBm

**Manual operation:** See "Ref Level" on page 323

**DISPlay[:WINDow<n>]:TRACe<t>:Y[:SCALe]:RLEVel:OFFSet <Value>**

This command defines a reference level offset.

**Suffix:**

<n> irrelevant.

<t> irrelevant

**Parameters:**

<Value> Range: -200 to 200

\*RST: 0

Default unit: dB

**Example:** DISP:TRAC:Y:RLEV:OFFS -10dB



**Manual operation:** See ["Ref Level Offset"](#) on page 325

---

### DISPlay[:WINDow<n>]:TRACe<t>:Y[:SCALe]:RPOStion <Position>

This command defines the position of the reference level on the display grid..

**Suffix:**

<n> Selects the measurement window.

<t> irrelevant

**Parameters:**

<Position> 0 PCT corresponds to the lower display border, 100% corresponds to the upper display border.

Range: 0 to 100

\*RST: 100 PCT = frequency domain, 50 PCT = time domain

Default unit: PCT

**Example:** DISP:TRAC:Y:RPOS 50PCT

**Manual operation:** See ["Ref Level Position"](#) on page 326  
See ["Reference Value Position"](#) on page 449

---

### INPut:ATTenuation:AUTO <State>

This command automatically couples the input attenuation to the reference level (state ON) or switches the input attenuation to manual entry (state OFF).

**Parameters:**

<State> ON | OFF

\*RST: ON

**Example:** INP:ATT:AUTO ON  
Couples the attenuation set on the attenuator to the reference level.

**Manual operation:** See ["RF Atten Auto"](#) on page 325

---

### UNIT<n>:POWer <Unit>

This command selects the default unit.

The unit is the same for all measurement windows.

**Parameters:**

<Unit> DBM | V | A | W | DBPW | WATT | DBPT | DBUV | DBMV | VOLT | DBUA | AMPere

\*RST: DBM

**Example:** UNIT:POW DBUV  
Sets the power unit to dBm.

**Usage:** SCPI confirmed

### 11.5.3 Analyzing Spectrum Measurements

• Trace Configuration.....	815
• Spectrogram.....	824
• Limit Lines.....	828
• Markers.....	829

#### 11.5.3.1 Trace Configuration

Commands to configure trace described elsewhere:

- `DISPlay[:WINDow<n>]:TRACe<t>:MODE` on page 652

#### Commands exclusive in spectrum mode

<code>CALCulate&lt;n&gt;:MATH[:EXpression][:DEFine]</code> .....	815
<code>CALCulate&lt;n&gt;:MATH:MODE</code> .....	816
<code>CALCulate&lt;n&gt;:MATH:POSition</code> .....	816
<code>CALCulate&lt;n&gt;:MATH:STATe</code> .....	816
<code>DISPlay[:WINDow&lt;n&gt;]:TRACe&lt;t&gt;:MODE:HCONtinuous</code> .....	817
<code>DISPlay[:WINDow&lt;n&gt;]:TRACe&lt;t&gt;[:STATe]</code> .....	817
<code>FORMat[:DATA]</code> .....	818
<code>FORMat:DEXPort:DSEParator</code> .....	818
<code>MMEMory:STORe&lt;n&gt;:TRACe</code> .....	819
<code>[SENSe:]AVERAge&lt;n&gt;:COUNT</code> .....	819
<code>[SENSe:]AVERAge&lt;n&gt;[:STATe&lt;Trace&gt;]</code> .....	820
<code>[SENSe:]AVERAge&lt;n&gt;:TYPE</code> .....	820
<code>[SENSe:][WINDow:]DETEctor&lt;trace&gt;[:FUNCTion]</code> .....	821
<code>[SENSe:][WINDow:]DETEctor&lt;trace&gt;[:FUNCTion]:AUTO</code> .....	821
<code>TRACe&lt;n&gt;:COPY</code> .....	822
<code>TRACe&lt;n&gt;:DATA</code> .....	822
<code>TRACe&lt;n&gt;[:DATA]:MEMory?</code> .....	823
<code>TRACe&lt;n&gt;[:DATA]:X?</code> .....	824

---

#### `CALCulate<n>:MATH[:EXpression][:DEFine] <Expression>`

This command defines the mathematical expression for relating traces to trace1.

#### Suffix:

<n> irrelevant

#### Parameters:

<Expression> (TRACe1-TRACe2) | (TRACe1-TRACe3) | (TRACe1-TRACe4) | (TRACe1-TRACe5) | (TRACe1-TRACe6)

#### **(TRACe1-TRACe2)**

Subtracts trace 2 from trace 1.

#### **(TRACe1-TRACe3)**

Subtracts trace 3 from trace 1.

#### **(TRACe1-TRACe4)**

Subtracts trace 4 from trace 1.

**(TRACe1-TRACe5)**

Subtracts trace 5 from trace 1.

**(TRACe1-TRACe6)**

Subtracts trace 6 from trace 1.

**Example:** `CALC1:MATH (TRACe1 - TRACe2)`  
 Selects the subtraction of trace 2 from trace 1.

**Manual operation:** See ["Trace Math"](#) on page 365

**CALCulate<n>:MATH:MODE <Method>**

This command selects the method for the trace math calculations.

For details see ["Trace Math Mode"](#) on page 365.**Suffix:**

&lt;n&gt; irrelevant

**Parameters:**

&lt;Method&gt; LINear | LOGarithmic | POWer

\*RST: LOG

**Example:** `CALC:MATH:MODE LIN`  
 Selects linear averaging for trace math calculations.

**Manual operation:** See ["Lin"](#) on page 365  
 See ["Log"](#) on page 366  
 See ["Power"](#) on page 366

**CALCulate<n>:MATH:POSition <Position>**

This command defines the position of the result of the trace mathematics. The indication is in % of the screen height, with 100 % corresponding to the upper diagram border.

**Suffix:**

&lt;n&gt; Selects the measurement window.

**Parameters:**

&lt;Position&gt; -100PCT to 200PCT

\*RST: 50PCT

**Example:** `CALC:MATH:POS 50PCT`  
 Sets the position to the horizontal diagram center.

**Manual operation:** See ["Trace Math Position"](#) on page 366

**CALCulate<n>:MATH:STATe <State>**

This command switches the mathematical relation of traces on or off.

**Suffix:**

&lt;n&gt; irrelevant

**Parameters:**

<State> ON | OFF  
 \*RST: OFF

**Example:**

CALC:MATH:STAT ON  
 Switches on the trace mathematics.

**Manual operation:**

See "Trace Math" on page 365  
 See "Trace Math Off" on page 366

**DISPlay[:WINDow<n>]:TRACe<t>:MODE:HCONtinuous <State>**

This command defines whether traces in Min Hold, Max Hold and Average mode (see [DISPlay\[:WINDow<n>\]:TRACe<t>:MODE](#) on page 652) are reset after a parameter is changed.

Normally, the measurement is started anew after parameter changes, before the measurement results are evaluated (e.g. using a marker). In all cases that require a new measurement after parameter changes, the trace is reset automatically to avoid false results (e.g. with span changes). For applications that require no reset after parameter changes, the automatic reset can be switched off.

**Suffix:**

<n> window; For applications that do not have more than 1 measurement window, the suffix <n> is irrelevant.

<t> trace

**Parameters:**

<State> **ON**  
 The automatic reset is switched off.  
**OFF**  
 After certain parameter changes the traces are reset.  
 \*RST: OFF

**Example:**

DISP:WIND:TRAC3:MODE:HCON ON  
 Switches off the reset function.

**Manual operation:**

See "Hold/Cont" on page 362

**DISPlay[:WINDow<n>]:TRACe<t>[:STATe] <State>**

This command switches on or off the display of the corresponding trace. The other measurements are not aborted but continue running in the background.

**Suffix:**

<n> window; For applications that do not have more than 1 measurement window, the suffix <n> is irrelevant.

<t> trace

**Parameters:**

<State> ON | OFF  
 \*RST: ON for TRACe1, OFF for TRACe2 to 6

**Example:** DISP:TRAC3 ON

**Manual operation:** See ["Blank"](#) on page 148

**FORMat[:DATA] <Format>**

This command selects the data format for the data transmitted from the R&S ESRP to the controlling computer. It is used for the transmission of trace data. The data format of trace data received by the instrument is automatically recognized, regardless of the format which is programmed.

In the "Spectrum" mode, the format setting REAL, 32 is used for the binary transmission of trace data.

**Parameters:**

<Format> **ASCIi**  
 ASCII data are transmitted in plain text, separated by commas.  
**REAL**  
 REAL data are transmitted as 32-bit IEEE 754 floating-point numbers in the "definite length block format".  
 \*RST: ASCII

**Example:** FORM REAL, 32  
 FORM ASC

**FORMat:DEXPort:DSEParator <Separator>**

This command defines which decimal separator (decimal point or comma) is to be used for outputting measurement data to the file in ASCII format. Different languages of evaluation programs (e.g. MS-Excel) can thus be supported.

**Parameters:**

<Separator> POINT | COMMA  
 \*RST: (factory setting is POINT; \*RST does not affect setting)

**Example:** FORM:DEXP:DSEP POIN  
 Sets the decimal point as separator.

**Manual operation:** See ["Peak List Export"](#) on page 171  
 See ["ASCII Trace Export"](#) on page 175  
 See ["Decim Sep"](#) on page 176  
 See ["ASCII File Export"](#) on page 240

**MMEMory:STORe<n>:TRACe** <Trace>, <FileName>

This command stores the selected trace in the specified window in a file with ASCII format. The file format is described in [Chapter 6.3.1.6, "ASCII File Export Format"](#), on page 370

The decimal separator (decimal point or comma) for floating-point numerals contained in the file is defined with the `FORMat:DEXPort:DSEParator` command (see [FORMat:DEXPort:DSEParator](#) on page 818).

**Suffix:**

<n> window; For applications that do not have more than 1 measurement window, the suffix <n> is irrelevant.

**Parameters:**

<Trace> 1 to 6

Selected a trace.

When you export all traces (`FORMat:DEXPort:TRACes`), this parameter is not required.

<FileName>

DOS file name

The file name includes indication of the path and the drive name. Indication of the path complies with DOS conventions.

**Example:**

```
MMEM:STOR:TRAC 3, 'TEST.ASC'
```

Stores trace 3 in the file TEST.ASC.

**Manual operation:** See ["ASCII Trace Export"](#) on page 175

**[SENSe:]AVERAge<n>:COUNT** <NoMeasurements>

This command defines the number of measurements which contribute to the average value.

Note that continuous averaging is performed after the indicated number has been reached in continuous sweep mode.

In single sweep mode, the sweep is stopped as soon as the indicated number of measurements (sweeps) is reached. Synchronization to the end of the indicated number of measurements is only possible in single sweep mode.

This command has the same effect as the `[SENSe<source>:]SWEep:COUNT` command. In both cases, the number of measurements is defined whether the average calculation is active or not.

The number of measurements applies to all traces in the window.

**Suffix:**

<n> Selects the measurement window.

**Parameters:**

<NoMeasurements> 0 to 32767

\*RST: 0

**Example:**

```
SWE:CONT OFF
Switching to single sweep mode.
AVER:COUN 16
Sets the number of measurements to 16.
AVER:STAT ON
Switches on the calculation of average.
INIT;*WAI
Starts the measurement and waits for the end of the 16 sweeps.
```

---

**[SENSe:]AVERage<n>[:STATe<Trace>] <State>**

This command turns averaging for a particular trace in a particular window on and off.

**Suffix:**

<n> Selects the measurement window.

<Trace> 1...6  
Selects the trace.

**Parameters:**

<State> ON | OFF  
\*RST: OFF

**Example:**

```
AVER OFF
Switches off the average calculation for trace 1.
AVER:STAT3 ON
Switches on the average calculation for trace 3.
```

---

**[SENSe:]AVERage<n>:TYPE <FunctionType>**

This command selects the type of average function.

**Suffix:**

<n> Selects the measurement window.

**Parameters:**

<FunctionType> VIDEo | LINear | POWer

**VIDeo**

The logarithmic power values are averaged.

**LINear**

The power values are averaged before they are converted to logarithmic values.

**POWer**

The power level values are converted into unit Watt prior to averaging. After the averaging, the data is converted back into its original unit.

\*RST: VIDEo

**Example:**

```
AVER:TYPE LIN
Switches to linear average calculation.
```

**Manual operation:** See "Lin" on page 364  
 See "Log" on page 364  
 See "Power" on page 365

---

**[SENSe:][WINDow:]DETEctor<trace>[:FUNCTion] <Function>**

This command selects the detector for the data acquisition in the selected trace.

**Suffix:**

<trace> 1...4  
 Selects the trace.

<trace> 1...6  
 trace

**Parameters:**

<Function> APEak | NEGative | POSitive | SAMPlE | RMS | AVERage |  
 QPEak | CAVERage | CRMS  
 \*RST: APEak

**Example:** DET POS  
 Sets the detector to "positive peak".

**Manual operation:** See "Trace 1 - 6" on page 175  
 See "Auto Peak" on page 363  
 See "Positive Peak" on page 363  
 See "Negative Peak" on page 363  
 See "Sample" on page 363  
 See "RMS" on page 363  
 See "Average" on page 363  
 See "Quasipeak" on page 363  
 See "CISPR Average" on page 363  
 See "RMS Average" on page 364

---

**[SENSe:][WINDow:]DETEctor<trace>[:FUNCTion]:AUTO <State>**

This command either couples the detector to the current trace setting or turns coupling off.

**Suffix:**

<trace> 1...6  
 trace

**Parameters:**

<State> ON | OFF  
 \*RST: ON

**Example:** DET:AUTO OFF

**Manual operation:** See "Auto Select" on page 362



**TRACe<n>:COPY** <TraceNumber>, <TraceNumber>

This command copies data from one trace to another.

**Suffix:**

<n> window; For applications that do not have more than 1 measurement window, the suffix <n> is irrelevant.

**Parameters:**

<TraceNumber>,  
<TraceNumber>

TRACE1 | TRACE2 | TRACE3 | TRACE4 | TRACE5 | TRACE6,  
TRACE1 | TRACE2 | TRACE3 | TRACE4 | TRACE5 | TRACE6  
The first argument is the destination of the data to be copied, the second argument describes the source.

**Example:**

TRAC:COPY TRACE1,TRACE2

**Manual operation:** See "[Copy Trace](#)" on page 175

**TRACe<n>:DATA** <Trace>, <Data> | <ResultType>

This command queries current trace data and measurement results.

If you use it as a setting command, it transfers trace data from an external source to the R&S ESRP.

The data format depends on `FORMat[:DATA]`.

**Parameters:**

<Trace> Selects the trace to write data to.  
**TRACE1 | ... | TRACE6**

<Data> Contains the data to transfer.

**Query parameters:**

<ResultType> Selects the type of result to be returned.

**TRACE1 | ... | TRACE6**

Returns the trace data for the corresponding trace.

**LIST**

Returns the results of the peak list evaluation for Spurious Emission and Spectrum Emission Mask measurements.

**SPURious**

Returns the peak list of Spurious Emission measurements.

**Return values:**

<TraceData> For more information see tables below.

**Example:**

TRAC TRACE1,+A\$  
Transfers trace data ('+A\$') to trace 1.

**Example:**

TRAC? TRACE3  
Queries the data of trace 3.

**Manual operation:** See "[List Evaluation \(On/Off\)](#)" on page 240  
See "[List Evaluation \(On/Off\)](#)" on page 269

**Table 11-23: Return values for TRACE1 to TRACE6 parameter**

The trace data consists of a list of power levels that have been measured. The number of power levels in the list depends on the currently selected number of sweep points. The unit depends on the measurement and on the unit you have currently set.

If you are measuring with the auto peak detector, the command returns positive peak values only.

If you are working with the "Real/Imag (I/Q)" result display in I/Q Analyzer mode, the command returns two values for each trace point, first the real parts of the signal, then the imaginary parts ( $I_1, \dots, I_n, Q_1, \dots, Q_n$ ).

For SEM or Spurious Emission measurement results, the x-values should be queried as well, as they are not equi-distant (see `TRACe<n>[:DATA]:X?` on page 824).

**Table 11-24: Return values for LIST parameter**

For every measurement range you have defined (range 1...n), the command returns eight values in the following order.

<No>, <StartFreq>, <StopFreq>, <RBW>, <PeakFreq>, <PowerAbs>, <PowerRel>, <PowerDelta>, <LimitCheck>, <Unused1>, <Unused2>

- <No>: range number
- <StartFreq>, <StopFreq>: start and stop frequency of the range
- <RBW>: resolution bandwidth
- <PeakFreq>: frequency of the peak in a range
- <PowerAbs>: absolute power of the peak in dBm
- <PowerRel>: power of the peak in relation to the channel power in dBc
- <PowerDelta>: distance from the peak to the limit line in dB, positive values indicate a failed limit check
- <LimitCheck>: state of the limit check (0 = PASS, 1 = FAIL)
- <Unused1>, <Unused2>: reserved (0.0)

### **TRACe<n>[:DATA]:MEMory? <Trace>, <OffsSwPoint>, <NoOfSwPoints>**

This command queries the previously acquired trace data for the specified trace from the memory. As an offset and number of sweep points to be retrieved can be specified, the trace data can be retrieved in smaller portions, making the command faster than the `TRAC:DATA?` command. This is useful if only specific parts of the trace data are of interest.

If no parameters are specified with the command, the entire trace data is retrieved; in this case, the command is identical to `TRAC:DATA? TRACE1`

#### **Suffix:**

<n> 1...4  
Selects the measurement window.

#### **Query parameters:**

<Trace> TRACE1 | TRACE2 | TRACE3 | TRACE4 | TRACE5 | TRACE6

<OffsSwPoint> The offset in sweep points related to the start of the measurement at which data retrieval is to start.

<NoOfSwPoints> Number of sweep points to be retrieved from the trace.

#### **Example:**

`TRAC:DATA:MEM? TRACE1,25,100`

Retrieves 100 sweep points from trace 1, starting at sweep point 25.

**Usage:** Query only

**TRACe<n>[:DATA]:X? <TraceNumber>**

This command reads the x-values of the selected trace.

**Suffix:**

<n> 1...4  
window; For applications that have only one measurement screen, the suffix is irrelevant.

**Query parameters:**

<TraceNumber> TRACE1 | TRACE2 | TRACE3 | TRACE4 | TRACE5 | TRACE6  
Trace number

**Example:**

TRACe:DATA:X? TRACE1  
Returns the x-values for trace 1.

**Usage:**

Query only

**11.5.3.2 Spectrogram****Configuring Spectrograms**

Commands useful to work with markers in the spectrogram described elsewhere:

- [CALCulate<n>:SGRam:CLEAr\[:IMMediate\]](#) on page 618
- [CALCulate<n>:SGRam:HDEPth](#) on page 620
- [CALCulate<n>:SGRam:TSTamp:DATA?](#) on page 620

<a href="#">CALCulate&lt;n&gt;:SGRam:COLor</a> .....	824
<a href="#">CALCulate&lt;n&gt;:SGRam:CONT</a> .....	825
<a href="#">CALCulate&lt;n&gt;:SGRam:FRAMe:COUNT</a> .....	825
<a href="#">CALCulate&lt;n&gt;:SGRam:FRAMe:SElect</a> .....	826
<a href="#">CALCulate&lt;n&gt;:SGRam:TSTamp[:STATe]</a> .....	826
<a href="#">CALCulate&lt;n&gt;:SGRam[:STATe]</a> .....	826

**CALCulate<n>:SGRam:COLor <Color>**

This command selects the color scheme of the spectrogram result display.

**Suffix:**

<n> 1...4  
Selects the measurement window.

**Parameters:**

<Color> **COLor**  
RGB colors

**RADar**  
black - green - white

**GRAYscale**  
black and white

\*RST: COLor

**Example:** `CALC:SGR:COL GRAY`  
Selects black and white color scheme.

**Manual operation:** See ["Color Mapping"](#) on page 377

### **CALCulate<n>:SGRam:CONT <State>**

This command determines whether the results of the last measurement are deleted before starting a new measurement in single sweep mode.

**Suffix:**  
<n> 1...4  
Selects the measurement window.

**Parameters:**  
<State> **ON | OFF**  
\*RST: OFF

**Example:** `INIT:CONT OFF`  
Selects single sweep mode.  
`INIT;*WAI`  
Starts the sweep and waits for the end of the sweep.  
`CALC:SGR:CONT ON`  
Repeats the single sweep measurement without deleting the results of the last measurement.

**Manual operation:** See ["Continue Frame \(On Off\)"](#) on page 344

### **CALCulate<n>:SGRam:FRAMe:COUNT <Frames>**

This command sets the number of frames to be recorded in a single sweep.

**Suffix:**  
<n> 1...4  
Selects the measurement window.

**Parameters:**  
<Frames> The maximum number of frames depends on the `.CALCulate<n>:SGRam:HDEPth` on page 620  
Range: 1 to depends on history depth  
Increment: 1  
\*RST: 1

**Example:** `INIT:CONT OFF`  
Selects single sweep mode.  
`CALC:SGR:FRAM:COUN 200`  
Sets the number of frames to 200.

**Manual operation:** See ["Frame Count"](#) on page 344

**CALCulate<n>:SGRam:FRAMe:SElect <Frame>**

This command selects a specific frame for further analysis. The command is available only if no measurement is running or after a single sweep has ended.

**Suffix:**

<n> 1...4  
Selects the measurement window.

**Parameters:**

<Frame> **<frame\_number> (if time stamp is off)**  
Selects the frame. The range is {0...number of recorded frames-1}

**<time> (if time stamp is on)**  
Time distance in seconds. It selects the frame that is x seconds away from frame 0.

**Example:**

```
INIT:CONT OFF
Stop the continuous sweep.
CALC:SGR:FRAM:SEL -25
Selects frame number -25.
```

**Manual operation:** See "[Select Frame](#)" on page 344

**CALCulate<n>:SGRam:TSTamp[:STATe] <State>**

This command activates and deactivates the time stamp.

If the time stamp is active, some commands do not address frames as numbers, but as (relative) time values:

- [CALCulate<n>:DELTaMarker<m>:SGRam:FRAMe](#) on page 628
- [CALCulate<n>:MARKer<m>:SGRam:FRAMe](#) on page 622
- [CALCulate<n>:SGRam:FRAMe:SElect](#) on page 826

**Suffix:**

<n> 1...4  
Selects the measurement window.

**Parameters:**

<State> **ON | OFF**  
**\*RST: OFF**

**Example:**

```
CALC:SGR:TST ON
Activates the time stamp.
```

**Manual operation:** See "[Time Stamp \(On Off\)](#)" on page 377

**CALCulate<n>:SGRam[:STATe] <State>**

This command turns the spectrogram result display on and off.

**Suffix:**

<n> 1...4  
Selects the measurement window.

**Parameters:**

<State> **ON | OFF**  
\*RST: OFF

**Example:**

CALC:SGR ON  
Activates the Spectrogram result display.

**Manual operation:** See "[Spectrogram \(On Off\)](#)" on page 376

**Configuring the Color Map**

Commands useful to work with markers in the spectrogram described elsewhere:

- [DISPlay:WINDow:SGRam:COLor:DEFault](#) on page 618
- [DISPlay:WINDow:SGRam:COLor:LOWer](#) on page 618
- [DISPlay:WINDow:SGRam:COLor:SHAPE](#) on page 619
- [DISPlay:WINDow:SGRam:COLor:UPPer](#) on page 619
- [DISPlay:WINDow:SGRam:COLor\[:STYLE\]](#) on page 619

**Using Markers and Deltamarkers****Positioning Marker**

Commands useful to work with markers in the spectrogram described elsewhere:

- [CALCulate<n>:MARKer<m>:MAXimum:LEFT](#) on page 660
- [CALCulate<n>:MARKer<m>:MAXimum:NEXT](#) on page 660
- [CALCulate<n>:MARKer<m>:MAXimum\[:PEAK\]](#) on page 661
- [CALCulate<n>:MARKer<m>:MAXimum:RIGHT](#) on page 661
- [CALCulate<n>:MARKer<m>:MINimum:LEFT](#) on page 662
- [CALCulate<n>:MARKer<m>:MINimum:NEXT](#) on page 662
- [CALCulate<n>:MARKer<m>:MINimum\[:PEAK\]](#) on page 662
- [CALCulate<n>:MARKer<m>:MINimum:RIGHT](#) on page 663
- [CALCulate<n>:MARKer<m>:SGRam:FRAME](#) on page 622
- [CALCulate<n>:MARKer<m>:SGRam:SAREa](#) on page 622
- [CALCulate<n>:MARKer<m>:SGRam:XY:MAXimum\[:PEAK\]](#) on page 623
- [CALCulate<n>:MARKer<m>:SGRam:XY:MINimum\[:PEAK\]](#) on page 623
- [CALCulate<n>:MARKer<m>:SGRam:Y:MAXimum:ABOVE](#) on page 624
- [CALCulate<n>:MARKer<m>:SGRam:Y:MAXimum:BELOW](#) on page 624
- [CALCulate<n>:MARKer<m>:SGRam:Y:MAXimum:NEXT](#) on page 625
- [CALCulate<n>:MARKer<m>:SGRam:Y:MAXimum\[:PEAK\]](#) on page 625
- [CALCulate<n>:MARKer<m>:SGRam:Y:MINimum:ABOVE](#) on page 625

- `CALCulate<n>:MARKer<m>:SGRam:Y:MINimum:BELOW` on page 626
- `CALCulate<n>:MARKer<m>:SGRam:Y:MINimum:NEXT` on page 626
- `CALCulate<n>:MARKer<m>:SGRam:Y:MINimum[:PEAK]` on page 627

### Using Deltamarkers

Commands useful to work with markers in the spectrogram described elsewhere:

- `CALCulate<n>:DELTamarker<m>:MAXimum:LEFT` on page 666
- `CALCulate<n>:DELTamarker<m>:MAXimum:NEXT` on page 667
- `CALCulate<n>:DELTamarker<m>:MAXimum[:PEAK]` on page 667
- `CALCulate<n>:DELTamarker<m>:MAXimum:RIGHT` on page 667
- `CALCulate<n>:DELTamarker<m>:MINimum:LEFT` on page 668
- `CALCulate<n>:DELTamarker<m>:MINimum:NEXT` on page 668
- `CALCulate<n>:DELTamarker<m>:MINimum[:PEAK]` on page 668
- `CALCulate<n>:DELTamarker<m>:MINimum:RIGHT` on page 669
- `CALCulate<n>:DELTamarker<m>:SGRam:FRAMe` on page 628
- `CALCulate<n>:DELTamarker<m>:SGRam:SARea` on page 628
- `CALCulate<n>:DELTamarker<m>:SGRam:XY:MAXimum[:PEAK]` on page 629
- `CALCulate<n>:DELTamarker<m>:SGRam:XY:MINimum[:PEAK]` on page 629
- `CALCulate<n>:DELTamarker<m>:SGRam:Y:MAXimum:ABOVE` on page 630
- `CALCulate<n>:DELTamarker<m>:SGRam:Y:MAXimum:BELOW` on page 630
- `CALCulate<n>:DELTamarker<m>:SGRam:Y:MAXimum:NEXT` on page 631
- `CALCulate<n>:DELTamarker<m>:SGRam:Y:MAXimum[:PEAK]` on page 631
- `CALCulate<n>:DELTamarker<m>:SGRam:Y:MINimum:ABOVE` on page 632
- `CALCulate<n>:DELTamarker<m>:SGRam:Y:MINimum:BELOW` on page 632
- `CALCulate<n>:DELTamarker<m>:SGRam:Y:MINimum:NEXT` on page 632
- `CALCulate<n>:DELTamarker<m>:SGRam:Y:MINimum[:PEAK]` on page 633

### 11.5.3.3 Limit Lines

#### Using Display Lines

For commands that control display lines see [Chapter 11.4.8.1, "Using Display Lines"](#), on page 672.

#### Using Frequency Lines

For commands that control frequency lines see [Chapter 11.4.8.2, "Using Frequency Lines"](#), on page 673.

#### Using Time Lines

<code>CALCulate&lt;n&gt;:TLINe&lt;Line&gt;</code> .....	829
<code>CALCulate&lt;n&gt;:TLINe&lt;Line&gt;:STATe</code> .....	829

**CALCulate<n>:TLINe<Line> <Time>**

This command defines the position of a time line.

**Suffix:**

<n> irrelevant

<Line> 1 | 2  
Selects the time line.

**Parameters:**

<Time> Range: 0 to 30000000000  
\*RST: (STATe to OFF)  
Default unit: s

**Example:** CALC:TLIN 10ms

**Manual operation:** See ["Time Line 1 / Time Line 2"](#) on page 189

**CALCulate<n>:TLINe<Line>:STATe <State>**

This command turns a time line on and off.

**Suffix:**

<n> irrelevant

<Line> 1 | 2  
Selects the time line.

**Parameters:**

<State> ON | OFF  
\*RST: OFF

**Example:** CALC:TLIN2:STAT ON

**Manual operation:** See ["Time Line 1 / Time Line 2"](#) on page 189

**Using Limit Lines**

For commands that control limit lines see [Chapter 11.4.8.3, "Using Limit Lines"](#), on page 674.

**11.5.3.4 Markers**

- [Using Markers](#)..... 829
- [Using Delta Markers](#)..... 834
- [Controlling Fixed Reference Markers](#)..... 835
- [Using Marker Functions](#)..... 837

**Using Markers**

Commands useful to control markers described elsewhere:

- [CALCulate<n>:MARKer<m>:AOFF](#) on page 660
- [CALCulate<n>:MARKer<m>:FUNCTion:CENTer](#) on page 656



- `CALCulate<n>:MARKer<m>:FUNction:CSTep` on page 657
- `CALCulate<n>:MARKer<m>:FUNction:ZOOM` on page 657
- `CALCulate<n>:MARKer<m>:MAXimum:LEFT` on page 660
- `CALCulate<n>:MARKer<m>:MAXimum:NEXT` on page 660
- `CALCulate<n>:MARKer<m>:MAXimum[:PEAK]` on page 661
- `CALCulate<n>:MARKer<m>:MAXimum:RIGHT` on page 661
- `CALCulate<n>:MARKer<m>:MINimum:LEFT` on page 662
- `CALCulate<n>:MARKer<m>:MINimum:NEXT` on page 662
- `CALCulate<n>:MARKer<m>:MINimum[:PEAK]` on page 662
- `CALCulate<n>:MARKer<m>:MINimum:RIGHT` on page 663
- `CALCulate<n>:MARKer<m>[:STATe]` on page 663
- `CALCulate<n>:MARKer<m>:TRACe` on page 664
- `CALCulate<n>:MARKer<m>:X` on page 664
- `CALCulate<n>:MARKer<m>:X:SLIMits:LEFT` on page 658
- `CALCulate<n>:MARKer<m>:X:SLIMits:RIGHT` on page 658
- `CALCulate<n>:MARKer<m>:X:SLIMits[:STATe]` on page 659
- `CALCulate<n>:MARKer<m>:Y` on page 664

<code>CALCulate&lt;n&gt;:MARKer&lt;m&gt;:FUNction:REFerence</code> .....	830
<code>CALCulate&lt;n&gt;:MARKer&lt;m&gt;:LOEXclude</code> .....	831
<code>CALCulate&lt;n&gt;:MARKer&lt;m&gt;:MAXimum:AUTO</code> .....	831
<code>CALCulate&lt;n&gt;:MARKer&lt;m&gt;:MINimum:AUTO</code> .....	831
<code>CALCulate&lt;n&gt;:MARKer&lt;m&gt;:X:SLIMits:ZOOM</code> .....	832
<code>CALCulate&lt;n&gt;:MARKer&lt;m&gt;:X:SSIZe</code> .....	832
<code>CALCulate&lt;n&gt;:MARKer&lt;m&gt;:Y:PERCent</code> .....	833
<code>CALCulate&lt;n&gt;:THReshold</code> .....	833
<code>CALCulate&lt;n&gt;:THReshold:STATe</code> .....	833
<code>DISPlay:MTABLE</code> .....	834

---

### **`CALCulate<n>:MARKer<m>:FUNction:REFerence`**

This command sets the reference level to the power measured by a marker.

If you use the command in combination with a delta marker, that delta marker is turned into a normal marker.

#### **Suffix:**

`<n>` Selects the measurement window.

`<m>` Selects the marker.

#### **Example:**

`CALC:MARK2:FUNC:REF`

Sets the reference level to the level of marker 2.

**Manual operation:** See "[Ref Lvl =Mkr Lvl](#)" on page 383

**CALCulate<n>:MARKer<m>:LOEXclude <State>**

This command turns the local oscillator suppression during a peak search on or off.

**Suffix:**

<n>                      Selects the measurement window.  
 <m>                      irrelevant

**Parameters:**

<State>                ON | OFF  
 \*RST:                ON

**Example:**            CALC:MARK:LOEX ON

**Manual operation:** See ["Exclude LO"](#) on page 383

**CALCulate<n>:MARKer<m>:MAXimum:AUTO <State>**

This command turns an automatic marker peak search for a trace maximum on and off. The command performs the peak search after each sweep.

An automatic peak search may be used during adjustments of a device under test to keep track of the actual peak marker position and level.

If no maximum value is found on the trace (level spacing to adjacent values < peak excursion), an execution error (error code: -200) is produced.

**Suffix:**

<n>                      Selects the measurement window.  
 <m>                      Selects the marker.

**Parameters:**

<State>                ON | OFF  
 \*RST:                OFF

**Example:**            CALC:MARK:MAX:AUTO ON  
 Activates the automatic peak search function for marker 1 at the end of each particular sweep.

**Usage:**                Event

**Manual operation:** See ["Auto Max Peak/Auto Min Peak"](#) on page 383

**CALCulate<n>:MARKer<m>:MINimum:AUTO <State>**

This command turns an automatic marker peak search for a trace maximum on and off. The command performs the peak search after each sweep.

An automatic peak search may be used during adjustments of a device under test to keep track of the actual peak marker position and level.

If no maximum value is found on the trace (level spacing to adjacent values < peak excursion), an execution error (error code: -200) is produced.

**Suffix:**

<n> Selects the measurement window.

<m> Selects the marker.

**Parameters:**

<State> ON | OFF

\*RST: OFF

**Example:**

```
CALC:MARK:MIN:AUTO ON
```

Activates the automatic minimum value search function for marker 1 at the end of each particular sweep.

**Manual operation:** See ["Auto Max Peak/Auto Min Peak"](#) on page 383

**CALCulate<n>:MARKer<m>:X:SLIMits:ZOOM <State>**

This command sets the limits of the marker search range to the zoom area.

**Note:** The function is only available if the search limit for marker and delta marker is switched on (see [CALCulate<n>:MARKer<m>:X:SLIMits\[:STATE\]](#)).

**Suffix:**

<n> irrelevant

<m> irrelevant

**Parameters:**

<State> ON | OFF

\*RST: OFF

**Example:**

```
CALC:MARK:X:SLIM:ZOOM ON
```

Switches the search limit function on.

```
CALC:MARK:X:SLIM:RIGH 20MHz
```

Sets the right limit of the search range to 20 MHz.

**Manual operation:** See ["Use Zoom Limits"](#) on page 183

**CALCulate<n>:MARKer<m>:X:SSIZE <StepSize>**

This command defines the step size of the rotary knob for marker or delta marker value changes. It only takes effect in manual operation.

The marker step size is unavailable for statistical measurements.

**Suffix:**

<n> irrelevant

<m> irrelevant

**Parameters:**

<StepSize>

**STANDARD**

step size corresponds to space between two pixels

**POINTS**

step size corresponds to space between two measured values

\*RST: POINTs

**Example:** `CALC:MARK:X:SSIZ STAN`  
Sets the measured value step size.

**Manual operation:** See "[Stepsize Standard](#)" on page 378  
See "[Stepsize Sweep Points](#)" on page 378

### **CALCulate<n>:MARKer<m>:Y:PERCent <Probability>**

This command positions the selected marker to the given probability.

If you use the command in combination with a delta marker, that delta marker is turned into a normal marker.

**Note:** The command is only available for CCDF measurements. You can query the associated level value with `CALCulate<n>:MARKer<m>:X`.

**Suffix:**  
<n> Selects the measurement window.  
<m> Selects the marker.

**Parameters:**  
<Probability> Range: 0 to 100  
Default unit: PCT

**Example:** `CALC1:MARK:Y:PERC 95PCT`  
Positions marker 1 to a probability of 95 %.

**Manual operation:** See "[Percent Marker](#)" on page 293

### **CALCulate<n>:THReshold <Threshold>**

This command defines a threshold value for the marker peak search.

A threshold line is automatically turned on.

**Suffix:**  
<n> irrelevant

**Parameters:**  
<Threshold> The unit depends on `CALCulate<n>:UNIT:POWer`.  
\*RST: (STATe to OFF)

**Example:** `CALC:THR -82DBM`  
Sets the threshold value to -82 dBm.

**Manual operation:** See "[Threshold](#)" on page 182

### **CALCulate<n>:THReshold:STATe <State>**

This command turns the threshold line for the marker peak search on and off.

**Suffix:**  
<n> irrelevant

**Parameters:**

<State> ON | OFF  
 \*RST: OFF

**Example:**

CALC:THR:STAT ON  
 Switches on the threshold line.

**Manual operation:**

See ["Threshold"](#) on page 182  
 See ["Search Lim Off"](#) on page 183

**DISPlay:MTABLE** <DisplayMode>

This command turns the marker table on and off.

**Parameters:**

<DisplayMode> **ON**  
 Marker table is displayed.  
**OFF**  
 Marker table is not displayed.  
**AUTO**  
 Marker table is only displayed if 2 or more markers are active.  
 \*RST: AUTO

**Example:**

To activate the table display:  
 DISP:MTAB ON  
 To query the current state of the marker table display:  
 DISP:MTAB?

**Manual operation:**

See ["Marker Table"](#) on page 179

**Using Delta Markers**

Commands useful to control delta markers described elsewhere:

- [CALCulate<n>:DELTamarker<m>:AOFF](#) on page 666
- [CALCulate<n>:DELTamarker<m>:LINK](#) on page 666
- [CALCulate<n>:DELTamarker<m>:MAXimum:LEFT](#) on page 666
- [CALCulate<n>:DELTamarker<m>:MAXimum:NEXT](#) on page 667
- [CALCulate<n>:DELTamarker<m>:MAXimum\[:PEAK\]](#) on page 667
- [CALCulate<n>:DELTamarker<m>:MAXimum:RIGHT](#) on page 667
- [CALCulate<n>:DELTamarker<m>:MINimum:LEFT](#) on page 668
- [CALCulate<n>:DELTamarker<m>:MINimum:NEXT](#) on page 668
- [CALCulate<n>:DELTamarker<m>:MINimum\[:PEAK\]](#) on page 668
- [CALCulate<n>:DELTamarker<m>:MINimum:RIGHT](#) on page 669
- [CALCulate<n>:DELTamarker<m>:MODE](#) on page 669
- [CALCulate<n>:DELTamarker<m>\[:STATE\]](#) on page 669
- [CALCulate<n>:DELTamarker<m>:TRACe](#) on page 670
- [CALCulate<n>:DELTamarker<m>:X](#) on page 670

- [CALCulate<n>:DELTamarker<m>:X:RELative?](#) on page 671
- [CALCulate<n>:DELTamarker<m>:Y](#) on page 671

[CALCulate<n>:DELTamarker<m>:MREF](#)..... 835

---

### **CALCulate<n>:DELTamarker<m>:MREF <RefMarkerNo>**

This command defines the reference marker for a delta marker other than marker 1.

The reference may be another marker or the fixed reference.

#### **Suffix:**

<n>                      Selects the measurement window.

<m>                      Selects the marker.

#### **Parameters:**

<RefMarkerNo>        **1 ... 16**  
Selects markers 1 to 16 as the reference.

#### **FIXed**

Selects the fixed reference as the reference.

#### **Example:**

`CALC:DELT3:MREF 2`

Specifies that the values of delta marker 3 are relative to marker 2.

**Manual operation:** See "[Marker Wizard](#)" on page 178

### **Controlling Fixed Reference Markers**

[CALCulate<n>:DELTamarker<m>:FUNction:FIXed:RPOint:MAXimum\[:PEAK\]](#)..... 835

[CALCulate<n>:DELTamarker<m>:FUNction:FIXed:RPOint:X](#)..... 836

[CALCulate<n>:DELTamarker<m>:FUNction:FIXed:RPOint:Y](#)..... 836

[CALCulate<n>:DELTamarker<m>:FUNction:FIXed:RPOint:Y:OFFSet](#)..... 836

[CALCulate<n>:DELTamarker<m>:FUNction:FIXed\[:STATe\]](#)..... 837

---

### **CALCulate<n>:DELTamarker<m>:FUNction:FIXed:RPOint:MAXimum[:PEAK]**

This command moves the fixed reference marker to the peak power.

When measuring the phase noise, the command defines a new reference point level for delta marker 2.

#### **Suffix:**

<n>                      Selects the measurement window.

<m>                      Selects the marker.

#### **Example:**

`CALC:DELT:FUNC:FIX:RPO:MAX`

Sets the reference point level for delta markers to the peak of the selected trace.

**Usage:**                Event

**Manual operation:** See "[Peak Search](#)" on page 389

**CALCulate<n>:DELTamarker<m>:FUNctioN:FIXed:RPOint:X <Reference>**

This command defines the horizontal position of the fixed delta marker reference point. The coordinates of the reference may be anywhere in the diagram.

When measuring the phase noise, the command defines the frequency reference for delta marker 2.

**Suffix:**

<n> Selects the measurement window.

<m> Selects the marker.

**Parameters:**

<Reference> Numeric value that defines the horizontal position of the reference.

For frequency domain measurements, it is a frequency in Hz.

For time domain measurements, it is a point in time in s.

\*RST: Fixed reference: OFF

**Example:**

CALC:DELT:FUNC:FIX:RPO:X 128 MHz

Sets the frequency reference to 128 MHz.

**Manual operation:** See ["Ref Point Frequency \(span > 0\)/Ref Point Time \(zero span\)"](#) on page 389

**CALCulate<n>:DELTamarker<m>:FUNctioN:FIXed:RPOint:Y <RefPointLevel>**

This command defines the vertical position of the fixed delta marker reference point. The coordinates of the reference may be anywhere in the diagram.

When measuring the phase noise, the command defines the level reference for delta marker 2.

**Suffix:**

<n> Selects the measurement window.

<m> Selects the marker.

**Parameters:**

<RefPointLevel> Numeric value that defines the vertical position of the reference. The unit and value range is variable.

\*RST: Fixed reference: OFF

**Example:**

CALC:DELT:FUNC:FIX:RPO:Y -10dBm

Sets the reference point level for delta markers to -10 dBm.

**Manual operation:** See ["Ref Point Level"](#) on page 389

**CALCulate<n>:DELTamarker<m>:FUNctioN:FIXed:RPOint:Y:OFFSet <Offset>**

This command defines a level offset for the fixed delta marker reference point.

When measuring the phase noise, the command defines an additional level offset for delta marker 2.

**Suffix:**

<n> Selects the measurement window.

<m> Selects the marker.

**Parameters:**

<Offset> Level offset that is added to the display of all delta markers.

\*RST: 0 dB

**Example:**

```
CALC:DELT:FUNC:FIX:RPO:Y:OFFS 10dB
```

Sets the level offset for the measurement with fixed reference value or the phase-noise measurement to 10 dB.

**CALCulate<n>:DELTamarker<m>:FUNctioN:FIXed[:STATe] <State>**

This command switches the relative measurement to a fixed reference value on or off. Marker 1 is activated previously and a peak search is performed, if necessary. If marker 1 is activated, its position becomes the reference point for the measurement. The reference point can then be modified with the `CALCulate<n>:DELTamarker<m>:FUNctioN:FIXed:RPOint:X` commands and `CALCulate<n>:DELTamarker<m>:FUNctioN:FIXed:RPOint:Y` independently of the position of marker 1 and of a trace. It applies to all delta markers as long as the function is active.

**Suffix:**

<n> Selects the measurement window.

<m> Selects the marker.

**Parameters:**

<State> ON | OFF

\*RST: OFF

**Example:**

```
CALC:DELT:FUNC:FIX ON
```

Switches on the measurement with fixed reference value for all delta markers.

```
CALC:DELT:FUNC:FIX:RPO:X 128 MHZ
```

Sets the frequency reference to 128 MHz.

```
CALC:DELT:FUNC:FIX:RPO:Y 30 DBM
```

Sets the reference level to +30 dBm.

**Manual operation:** See "Ref. Fixed On/Off" on page 390

**Using Marker Functions**

The following commands control the measurements available as marker functions.

- [Signal Count](#).....838
- [Noise Density](#).....839
- [Phase Noise](#).....840
- [Marker Demodulation](#).....842
- [n dB Down Marker](#).....844
- [Marker Peak List](#).....847
- [Band Power](#).....852



**Signal Count**

<code>CALCulate&lt;n&gt;:MARKer&lt;m&gt;:COUNT</code> .....	838
<code>CALCulate&lt;n&gt;:MARKer&lt;m&gt;:COUNT:FREQUency?</code> .....	838
<code>CALCulate&lt;n&gt;:MARKer&lt;m&gt;:COUNT:RESolution</code> .....	839

**CALCulate<n>:MARKer<m>:COUNT <State>**

This command turns the frequency counter at the marker position for marker 1 on and off.

The count result is queried with `CALCulate<n>:MARKer<m>:COUNT:FREQUency?`.

The frequency counter works for one marker only. If you perform a frequency count with another marker, the R&S ESRP deactivates the frequency count of the first marker.

To get a valid result, you have to perform a complete measurement with synchronization to the end of the measurement before reading out the result. This is only possible for single sweeps.

**Suffix:**

<n> Selects the measurement window.

<m> irrelevant

**Parameters:**

<State> ON | OFF

\*RST: OFF

**Example:**

```
INIT:CONT OFF
```

Switches to single sweep mode.

```
CALC:MARK ON
```

Switches on marker 1.

```
CALC:MARK:COUN ON
```

Switches on the frequency counter for marker 1.

```
INIT;*WAI
```

Starts a sweep and waits for the end.

```
CALC:MARK:COUN:FREQ?
```

Outputs the measured value.

**Manual operation:** See "[Signal Count](#)" on page 388

**CALCulate<n>:MARKer<m>:COUNT:FREQUency?**

This command queries the result of the frequency counter for marker 1.

To get a valid result, you have to perform a complete measurement with synchronization to the end of the measurement before reading out the result. This is only possible for single sweeps.

**Suffix:**

<n> Selects the measurement window.

<m> irrelevant

**Return values:**

<Frequency> Frequency at the marker position.

**Example:**

```
INIT:CONT OFF
Switches to single sweep mode.
CALC:MARK ON
Switches on marker 2.
CALC:MARK:COUN ON
Activates the frequency counter for marker 1.
INIT;*WAI
Starts a sweep and waits for the end.
CALC:MARK:COUN:FREQ?
Outputs the measured value of marker 1.
```

**Usage:** Query only

**Manual operation:** See "Signal Count" on page 388

**CALCulate<n>:MARKer<m>:COUNT:RESolution <Resolution>**

This command specifies the resolution of the frequency counter (marker 1).

**Suffix:**

<n> Selects the measurement window.

<m> irrelevant

**Parameters:**

<Resolution> 0.001 | 0.01 | 0.1 | 1 | 10 | 100 | 1000 | 10000 Hz  
\*RST: 0.1 Hz

**Example:**

```
CALC:MARK:COUN:RES 1kHz
Sets the resolution of the frequency counter to 1 kHz.
```

**Noise Density**

<a href="#">CALCulate&lt;n&gt;:MARKer&lt;m&gt;:FUNCTION:NOISe:RESult</a> .....	839
<a href="#">CALCulate&lt;n&gt;:MARKer&lt;m&gt;:FUNCTION:NOISe[:STATe]</a> .....	840

**CALCulate<n>:MARKer<m>:FUNCTION:NOISe:RESult**

This command queries the result of the noise measurement.

To get a valid result, you have to perform a complete measurement with synchronization to the end of the measurement before reading out the result. This is only possible for single sweeps.

**Suffix:**

<n> Selects the measurement window.

<m> Selects the marker.

**Example:**

```
INIT:CONT OFF
Switches to single sweep mode.
CALC:MARK2 ON
Switches on marker 2.
CALC:MARK:FUNC:NOIS ON
Switches on noise measurement.
INIT;*WAI
Starts a sweep and waits for the end.
CALC:MARK2:NOIS:RES?
Outputs the noise result of marker 2.
```

**Manual operation:** See "Noise Meas On/Off" on page 389

---

### CALCulate<n>:MARKer<m>:FUNCtion:NOISe[:STATe] <State>

This command turns the noise measurement for all markers on or off.

If on, the R&S ESRP measures the noise power density at the marker position.

The result can be queried with `CALCulate<n>:MARKer<m>:FUNCtion:NOISe:RESult`.

**Suffix:**

<n> Selects the measurement window.

<m> Selects the marker.

**Parameters:**

<State> ON | OFF  
\*RST: OFF

**Example:**

```
CALC:MARK:FUNC:NOIS ON
Switches on the noise measurement.
```

**Manual operation:** See "Noise Meas On/Off" on page 389

### Phase Noise

<code>CALCulate&lt;n&gt;:DELTamarker&lt;m&gt;:FUNCtion:PNOise:AUTO</code> .....	840
<code>CALCulate&lt;n&gt;:DELTamarker&lt;m&gt;:FUNCtion:PNOise:RESult?</code> .....	841
<code>CALCulate&lt;n&gt;:DELTamarker&lt;m&gt;:FUNCtion:PNOise[:STATe]</code> .....	841

---

### CALCulate<n>:DELTamarker<m>:FUNCtion:PNOise:AUTO <State>

This command turns an automatic peak search for the fixed reference marker at the end of a sweep on and off.

**Suffix:**

<n> Selects the measurement window.

<m> irrelevant

**Parameters:**

<State> ON | OFF  
 \*RST: OFF

**Example:**

CALC:DELT:FUNC:PNO:AUTO ON

Activates an automatic peak search for the reference marker in a phase-noise measurement.

**Manual operation:** See ["Ph. Noise Auto Peak Search"](#) on page 390

**CALCulate<n>:DELTamarker<m>:FUNCTION:PNOise:RESult?**

This command queries the result of the phase noise measurement.

If necessary, the command activates the measurement first..

**Suffix:**

<n> Selects the measurement window.

<m> 2  
 Marker 2 is always the deltamarker for phase noise measurements.

**Example:**

CALC:DELT2:FUNC:PNO:RES?

Outputs the result of phase-noise measurement of the delta-marker 2.

**Usage:** Query only

**Manual operation:** See ["Phase Noise On/Off"](#) on page 389

**CALCulate<n>:DELTamarker<m>:FUNCTION:PNOise[:STATe] <State>**

This command turns the phase noise measurement at the delta marker position on and off.

The correction values for the bandwidth and the log amplifier are taken into account in the measurement.

The reference marker for phase noise measurements is either a normal marker or a fixed reference. If necessary, the command turns on the reference marker

A fixed reference point can be modified with the [CALCulate<n>:DELTamarker<m>:FUNCTION:FIXed:RPOint:X](#) and [CALCulate<n>:DELTamarker<m>:FUNCTION:FIXed:RPOint:Y](#) commands independent of the position of marker 1 and of a trace.

**Suffix:**

<n> Selects the measurement window.

<m> irrelevant

**Note:** marker 2 is always the deltamarker for phase noise measurement results.

**Parameters:**

<State> ON | OFF  
 \*RST: OFF

**Example:**

CALC:DELT:FUNC:PNO ON  
 Switches on the phase-noise measurement with all delta markers.  
 CALC:DELT:FUNC:FIX:RPO:X 128 MHZ  
 Sets the frequency reference to 128 MHz.  
 CALC:DELT:FUNC:FIX:RPO:Y 30 DBM  
 Sets the reference level to +30 dBm

**Manual operation:** See ["Phase Noise On/Off"](#) on page 389

**Marker Demodulation**

Commands useful to configure the marker demodulation described elsewhere:

- [\[SENSe:\]DEMod:SQUelch:LEVel](#) on page 617
- [\[SENSe:\]DEMod:SQUelch\[:STATe\]](#) on page 617

<a href="#">CALCulate&lt;n&gt;:MARKer&lt;m&gt;:FUNCTION:DEModulation:CONTinuous</a> .....	842
<a href="#">CALCulate&lt;n&gt;:MARKer&lt;m&gt;:FUNCTION:DEModulation:HOLDoff</a> .....	842
<a href="#">CALCulate&lt;n&gt;:MARKer&lt;m&gt;:FUNCTION:DEModulation:SElect</a> .....	843
<a href="#">CALCulate&lt;n&gt;:MARKer&lt;m&gt;:FUNCTION:DEModulation[:STATe]</a> .....	843

**CALCulate<n>:MARKer<m>:FUNCTION:DEModulation:CONTinuous <State>**

This command turns continuous demodulation of the signal at the marker position in the frequency domain on and off.

Thus acoustic monitoring of the signals can be performed.

In the time domain continuous demodulation is always on.

**Suffix:**

<n> Selects the measurement window.  
 <m> Selects the marker.

**Parameters:**

<State> ON | OFF  
 \*RST: OFF

**Example:**

CALC2:MARK3:FUNC:DEM:CONT ON  
 Switches on the continuous ' demodulation.

**Manual operation:** See ["Continuous Demod \(span > 0\)"](#) on page 391

**CALCulate<n>:MARKer<m>:FUNCTION:DEModulation:HOLDoff <Duration>**

This command defines for how long the the signal at the marker position is demodulated.

**Suffix:**

<n> Selects the measurement window.

<m> Selects the marker.

**Parameters:**

<Duration> Range: 10 ms to 1000 s  
\*RST: Marker demodulation = OFF

**Example:** CALC:MARK:FUNC:DEM:HOLD 3s

**Manual operation:** See "Mkr Stop Time" on page 391

**CALCulate<n>:MARKer<m>:FUNCTion:DEModulation:SElect <DemodMode>**

This command selects the demodulation mode for the audio demodulator.

**Suffix:**

<n> Selects the measurement window.

<m> irrelevant

**Parameters:**

<DemodMode> AM | FM  
\*RST: AM

**Example:** CALC:MARK:FUNC:DEM:SEL FM

**Manual operation:** See "AM" on page 391  
See "FM" on page 391

**CALCulate<n>:MARKer<m>:FUNCTion:DEModulation[:STATe] <State>**

This command turns the audio demodulator on and off when the measurement reaches a marker position.

In the frequency domain, the hold time can be defined at the corresponding marker position with `CALCulate<n>:MARKer<m>:FUNCTion:DEModulation:HOLDoff`.

In the time domain continuous demodulation is always on.

**Suffix:**

<n> Selects the measurement window.

<m> Selects the marker.

**Parameters:**

<State> ON | OFF  
\*RST: OFF

**Example:** CALC:MARK3:FUNC:DEM ON  
Switches on the demodulation for marker 3.

**Manual operation:** See "Mkr Demod On/Off" on page 391

**n dB Down Marker**

CALCulate<n>:MARKer<m>:FUNction:NDBDown.....	844
CALCulate<n>:MARKer<m>:FUNction:NDBDown:FREquency?.....	844
CALCulate<n>:MARKer<m>:FUNction:NDBDown:QFACTOR.....	845
CALCulate<n>:MARKer<m>:FUNction:NDBDown:RESult?.....	845
CALCulate<n>:MARKer<m>:FUNction:NDBDown:STATE.....	846
CALCulate<n>:MARKer<m>:FUNction:NDBDown:TIME?.....	846

**CALCulate<n>:MARKer<m>:FUNction:NDBDown <Distance>**

This command defines the distance of the n dB down markers to the reference marker.

The temporary markers T1 and T2 are positioned n dB below the active reference marker. The frequency and time position of these markers can be queried with `CALCulate<n>:MARKer<m>:FUNction:NDBDown:FREquency?` and `CALCulate<n>:MARKer<m>:FUNction:NDBDown:TIME?`. The bandwidth between the markers can be queried with `CALCulate<n>:MARKer<m>:FUNction:NDBDown:RESult?`.

**Suffix:**

<n>	Selects the measurement window.
<m>	irrelevant

**Parameters:**

<Distance>	Distance of the temporary markers to the reference marker in dB.
*RST:	6dB

**Example:**

```
CALC:MARK:FUNC:NDBD 3dB
Sets the level spacing to 3 dB.
```

**Manual operation:** See "n dB down" on page 392

**CALCulate<n>:MARKer<m>:FUNction:NDBDown:FREquency?**

This command queries the position of the n dB down markers on the x-axis when measuring in the frequency domain.

To get a valid result, you have to perform a complete measurement with synchronization to the end of the measurement before reading out the result. This is only possible for single sweeps.

**Suffix:**

<n>	Selects the measurement window.
<m>	irrelevant

**Return values:**

<Frequency>	<b>&lt;frequency 1&gt;</b> absolute frequency of the n dB marker to the left of the reference marker in Hz
-------------	---------------------------------------------------------------------------------------------------------------

**<frequency 2>**

absolute frequency of the n dB marker to the right of the reference marker in Hz

**Example:**

```
INIT:CONT OFF
```

Switches to single sweep mode.

```
CALC:MARK:FUNC:NDBD ON
```

Switches on the n dB down function.

```
INIT;*WAI
```

Starts a sweep and waits for the end.

```
CALC:MARK:FUNC:NDBD:FREQ?
```

Outputs the frequencies of the temporary markers.

**Usage:**

Query only

**Manual operation:** See "[n dB down](#)" on page 392

**CALCulate<n>:MARKer<m>:FUNCTion:NDBDown:QFACtor**

This command queries the Q factor (quality) of n dB down measurements.

**Suffix:**

<n> Selects the measurement window.

<m> Selects the marker.

**Example:**

```
INIT:CONT OFF
```

Switches to single sweep mode.

```
CALC:MARK:FUNC:NDBD ON
```

Switches on the n dB down function.

```
INIT;*WAI
```

Starts a sweep and waits for the end.

```
CALC:MARK:FUNC:NDBD:QFAC?
```

Queries the Q factor of the measured bandwidth.

**Manual operation:** See "[n dB down](#)" on page 392

**CALCulate<n>:MARKer<m>:FUNCTion:NDBDown:RESult?**

This command queries the distance of the n dB down markers from each other.

To get a valid result, you have to perform a complete measurement with synchronization to the end of the measurement before reading out the result. This is only possible for single sweeps.

**Suffix:**

<n> Selects the measurement window.

<m> irrelevant



**Parameters:**

<Distance> The result depends on the span.  
 In case of frequency domain measurements, the command returns the bandwidth between the two n dB down markers in Hz. In case of time domain measurements, the command returns the pulse width between the two n dB down markers in seconds.

**Example:**

```
INIT:CONT OFF
Switches to single sweep mode.
CALC:MARK:FUNC:NDBD ON
Switches on the n dB down function.
INIT;*WAI
Starts a sweep and waits for the end.
CALC:MARK:FUNC:NDBD:RES?
Outputs the measured value.
```

**Usage:** Query only

**Manual operation:** See "[n dB down](#)" on page 392

**CALCulate<n>:MARKer<m>:FUNCTION:NDBDown:STATE <State>**

This command turns the n dB Down marker function on and off.

**Suffix:**

<n> Selects the measurement window.  
 <m> irrelevant

**Parameters:**

<State> ON | OFF  
 \*RST: OFF

**Example:**

```
CALC:MARK:FUNC:NDBD:STAT ON
Switches on the "N dB Down" function.
```

**Manual operation:** See "[n dB down](#)" on page 392

**CALCulate<n>:MARKer<m>:FUNCTION:NDBDown:TIME?**

This command queries the position of the n dB down markers on the x-axis when measuring in the time domain.

To get a valid result, you have to perform a complete measurement with synchronization to the end of the measurement before reading out the result. This is only possible for single sweeps.

**Suffix:**

<n> Selects the measurement window.

<m> irrelevant

**Return values:**

<Time>            **<time 1>**  
absolute position in time of the n dB marker to the left of the reference marker in seconds

**<time 2>**  
absolute position in time of the n dB marker to the right of the reference marker in seconds

**Example:**

```
INIT:CONT OFF
Switches to single sweep mode
CALC:MARK:FUNC:NDBD ON
Switches on the n dB down function.
INIT;*WAI
Starts a sweep and waits for the end.
CALC:MARK:FUNC:NDBD:TIME?
Outputs the time values of the temporary markers.
```

**Usage:** Query only

**Manual operation:** See "n dB down" on page 392

**Marker Peak List**

Commands useful to perform a peak search described elsewhere:

- [CALCulate<n>:MARKer<m>:PEXCursion](#) on page 647
- [MMEMorY:STORe:PEAKlist](#) on page 651

<a href="#">CALCulate&lt;n&gt;:MARKer&lt;m&gt;:FUNCTION:FPEaks:ANNotation:LABel:STATe</a> .....	847
<a href="#">CALCulate&lt;n&gt;:MARKer&lt;m&gt;:FUNCTION:FPEaks:COUNt?</a> .....	848
<a href="#">CALCulate&lt;n&gt;:MARKer&lt;m&gt;:FUNCTION:FPEaks:[IMMediate]</a> .....	848
<a href="#">CALCulate&lt;n&gt;:MARKer&lt;m&gt;:FUNCTION:FPEaks:LIST:SIZE</a> .....	849
<a href="#">CALCulate&lt;n&gt;:MARKer&lt;m&gt;:FUNCTION:FPEaks:SEAR:AUTO</a> .....	849
<a href="#">CALCulate&lt;n&gt;:MARKer&lt;m&gt;:FUNCTION:FPEaks:SORT</a> .....	850
<a href="#">CALCulate&lt;n&gt;:MARKer&lt;m&gt;:FUNCTION:FPEaks:STAT</a> .....	850
<a href="#">CALCulate&lt;n&gt;:MARKer&lt;m&gt;:FUNCTION:FPEaks:X</a> .....	850
<a href="#">CALCulate&lt;n&gt;:MARKer&lt;m&gt;:FUNCTION:FPEaks:Y?</a> .....	851

**CALCulate<n>:MARKer<m>:FUNCTION:FPEaks:ANNotation:LABel:STATe <State>**

This command turns labels for peaks found during a peak search on and off.

The labels correspond to the marker number in the marker peak list.

**Suffix:**

<n>            Selects the measurement window.

<m>            Selects the marker.

**Parameters:**

<State>            **ON | OFF**  
\*RST:            ON

**Example:** `CALC:MARK:FUNC:FPE:ANN:LAB:STAT OFF`  
Removes the peak labels from the diagram

**Manual operation:** See "[Marker Number](#)" on page 395

### **CALCulate<n>:MARKer<m>:FUNCTION:FPEaks:COUNT?**

This command queries the number of peaks that have been found during a peak search.

**Suffix:**

<n> irrelevant  
<m> Selects the marker.

**Return values:**

<NumberOfPeaks>

**Example:** `CALC:MARK:FUNC:FPE 3`  
Searches the 3 highest maxima for trace 1  
`CALC:MARK:FUNC:FPE:COUN?`  
Queries the number of maxima found

**Usage:** Query only

**Manual operation:** See "[Marker Peak List](#)" on page 393

### **CALCulate<n>:MARKer<m>:FUNCTION:FPEaks[:IMMEDIATE] <NoMaxima>**

This command initiates a peak search.

The results can be queried with:

- Position of a peak on the x-axis: `CALCulate<n>:MARKer<m>:FUNCTION:FPEaks:X`
- Position of a peak on the y-axis: `CALCulate<n>:MARKer<m>:FUNCTION:FPEaks:Y?`
- Number of peaks in the list: `CALCulate<n>:MARKer<m>:FUNCTION:FPEaks:COUNT?`

The order the results are returned in is selected with `CALCulate<n>:MARKer<m>:FUNCTION:FPEaks:SORT`.

The trace the peaks search is performed on is selected with `CALCulate<n>:MARKer<m>:TRACe`.

#### **Number of found maxima**

The number of maxima found depends on the waveform and value set for the Peak Excursion parameter (see `CALCulate<n>:MARKer<m>:PEXCursion`), however, a maximum number of 200 maxima are determined. Only the signals which exceed their surrounding values at least by the value indicated by the peak excursion parameter are recognized as maxima. Therefore, the number of maxima found is not automatically the same as the number of maxima desired.

**Suffix:**

<n> Selects the measurement window.

<m> Selects the marker.

**Parameters:**

<NoMaxima> Range: 1 to 200

**Example:**

```
INIT:CONT OFF
```

Switches to single sweep mode

```
INIT;*WAI
```

Starts measurement and synchronizes to end

```
CALC:MARK:TRAC 1
```

Sets marker 1 to trace 1

```
CALC:MARK:FUNC:FPE:SORT X
```

Sets the sort mode to increasing X values

```
CALC:MARK:FUNC:FPE 3;*WAI
```

Searches the 3 highest maxima for trace 1 and synchronizes to end

```
CALC:MARK:FUNC:FPE:COUN?
```

Queries the number of maxima found

```
CALC:MARK:FUNC:FPE:Y?
```

Queries the level of maxima found

```
CALC:MARK:FUNC:FPE:X?
```

Queries the frequencies (span <> 0) or time (span = 0) of maxima found.

**CALCulate<n>:MARKer<m>:FUNCTion:FPEaks:LIST:SIZE <MaxNoPeaks>**

This command defines the maximum number of peaks the marker peak list may contain.

**Suffix:**

<n> Selects the measurement window.

<m> Selects the marker.

**Parameters:**

<MaxNoPeaks> Maximum number of peaks to be determined.

```
*RST: 50
```

**Example:**

```
CALC:MARK:FUNC:FPE:LIST:SIZE 10
```

The marker peak list will contain a maximum of 10 peaks.

**Manual operation:** See "[Max Peak Count](#)" on page 393

**CALCulate<n>:MARKer<m>:FUNCTion:FPEaks:SEAR:AUTO <State>**

This command turns the marker peak search on and off.

This command is retained for compatibility with R&S FSP only. Use [CALCulate<n>:MARKer<m>:FUNCTion:FPEaks:STAT](#) instead.

**Suffix:**

<n> Selects the measurement window.

<m> Selects the marker.

**Parameters:**

<State> ON | OFF

\*RST: OFF

**Example:**

CALC:MARK:FUNC:FPE:SEAR:AUTO ON  
Activates marker peak search

**CALCulate<n>:MARKer<m>:FUNCTion:FPEaks:SORT <SortMode>**

This command selects the order in which the results of a peak search are returned.

**Suffix:**

<n> Selects the measurement window.

<m> Selects the marker.

**Parameters:**

<SortMode>

**X**

Sorts the peaks according to increasing position on the x-axis.

**Y**

Sorts the peaks according to decreasing position on the y-axis.

**Example:**

CALC:MARK:FUNC:FPE:SORT Y  
Sets the sort mode to decreasing y values

**Manual operation:** See "[Sort Mode Freq/Lvl](#)" on page 393

**CALCulate<n>:MARKer<m>:FUNCTion:FPEaks:STAT <State>**

This command turns a peak search on and off.

**Suffix:**

<n> Selects the measurement window.

<m> Selects the marker.

**Parameters:**

<State> ON | OFF

\*RST: OFF

**Example:**

CALC:MARK:FUNC:FPE:STAT ON  
Activates marker peak search

**Manual operation:** See "[Peak List On/Off](#)" on page 393

**CALCulate<n>:MARKer<m>:FUNCTion:FPEaks:X**

This command queries the position of the peaks on the x-axis.

The order depends on the sort order that has been set with `CALCulate<n>:MARKer<m>:FUNCTION:FPEaks:SORT` on page 850.

The number of peaks on the number that has been set with `CALCulate<n>:MARKer<m>:FUNCTION:FPEaks:COUNt?`.

**Suffix:**

<n> Selects the measurement window.

<m> Selects the marker.

**Return values:**

<PeakPosition> Position of the peaks on the x-axis. The unit depends on the measurement.

**Example:**

```
CALC:MARK:FUNC:FPE:SORT Y
```

Sets the sort mode to decreasing y values

```
CALC:MARK:FUNC:FPE 3
```

Searches the 3 highest maxima for trace 1

```
CALC:MARK:FUNC:FPE:COUN?
```

Queries the number of maxima found

```
CALC:MARK:FUNC:FPE:X?
```

Queries the frequencies (span <> 0) or. time (span = 0) of the maxima found

```
107.5E6,153.8E6,187.9E6
```

frequencies in increasing order

```
2.05E-3,2.37E-3, 3.71e-3
```

times in increasing order

**Manual operation:** See "[Marker Peak List](#)" on page 393

**CALCulate<n>:MARKer<m>:FUNCTION:FPEaks:Y?**

This command queries the position of the peaks on the y-axis.

The order depends on the sort order that has been set with `CALCulate<n>:MARKer<m>:FUNCTION:FPEaks:SORT` on page 850.

The number of peaks on the number that has been set with `CALCulate<n>:MARKer<m>:FUNCTION:FPEaks:COUNt?`.

**Suffix:**

<n> Selects the measurement window.

<m> Selects the marker.

**Return values:**

<PeakPosition> Position of the peaks on the y-axis. The unit depends on the measurement.

**Example:**            `CALC:MARK:FUNC:FPE:SORT Y`  
 Sets the sort mode to decreasing y values  
`CALC:MARK:FUNC:FPE 3`  
 Searches the 3 highest maxima for trace 1  
`CALC:MARK:FUNC:FPE:COUN?`  
 Queries the number of maxima found  
`CALC:MARK:FUNC:FPE:Y?`  
 Queries the levels of the maxima found

**Usage:**            Query only

**Manual operation:** See "[Marker Peak List](#)" on page 393

### Band Power

<code>CALCulate&lt;n&gt;:MARKer&lt;m&gt;:FUNction:BPOWer:MODE</code> .....	852
<code>CALCulate&lt;n&gt;:MARKer&lt;m&gt;:FUNction:BPOWer:RESult?</code> .....	852
<code>CALCulate&lt;n&gt;:MARKer&lt;m&gt;:FUNction:BPOWer:SPAN</code> .....	853
<code>CALCulate&lt;n&gt;:MARKer&lt;m&gt;:FUNction:BPOWer[:STATe]</code> .....	853
<code>CALCulate&lt;n&gt;:DELTamarker&lt;m&gt;:FUNction:BPOWer:MODE</code> .....	854
<code>CALCulate&lt;n&gt;:DELTamarker&lt;m&gt;:FUNction:BPOWer:RESult?</code> .....	854
<code>CALCulate&lt;n&gt;:DELTamarker&lt;m&gt;:FUNction:BPOWer:SPAN</code> .....	854
<code>CALCulate&lt;n&gt;:DELTamarker&lt;m&gt;:FUNction:BPOWer[:STATe]</code> .....	855

---

#### `CALCulate<n>:MARKer<m>:FUNction:BPOWer:MODE <Mode>`

This command selects the way the results for a band power marker are displayed.

#### Suffix:

`<n>`                    irrelevant  
`<m>`                    irrelevant

#### Parameters:

`<Mode>`                **POWER**  
 Result is displayed as a power in dBm.

**DENSity**  
 Result is displayed as a density in dBm/Hz.

\*RST:                POW

**Example:**            `CALC:MARK:FUNC:BPOW:MODE DENS`

**Manual operation:** See "[Power](#)" on page 395  
 See "[Density](#)" on page 396

---

#### `CALCulate<n>:MARKer<m>:FUNction:BPOWer:RESult?`

This command queries the results of the band power measurement.

#### Suffix:

`<n>`                    irrelevant  
`<m>`                    irrelevant

**Return values:**

<Power> Signal power over the marker bandwidth.

**Example:**

Activate the band power marker:

```
CALC:MARK:FUNC:BPOW:STAT ON
```

Select the density mode for the result:

```
CALC:MARK:FUNC:BPOW:MODE DENS
```

Query the result:

```
CALC:MARK:FUNC:BPOW:RES?
```

Response:

```
20dBm/Hz
```

**Usage:**

Query only

**Manual operation:**

See ["Power"](#) on page 395

See ["Density"](#) on page 396

**CALCulate<n>:MARKer<m>:FUNCTion:BPOWer:SPAN <Span>**

This command defines the bandwidth around the marker position.

**Suffix:**

<n> irrelevant

<m> irrelevant

**Parameters:**

<Span> Numeric value that defines the span in Hz.  
The maximum span depends on the marker position and R&S FSV model.

\*RST: 5% of current span

**Example:**

```
CALC:MARK:FUNC:BPOW:SPAN 20
```

**Manual operation:**

See ["Span"](#) on page 395

**CALCulate<n>:MARKer<m>:FUNCTion:BPOWer[:STATe] <State>**

This command turns markers for band power measurements on and off.

If necessary, the command also turns on a marker. If a marker is already on, the currently active marker is used as the band power marker (all other marker functions for this marker are deactivated).

For details see ["Performing Band Power Measurements"](#) on page 399.

**Suffix:**

<n> irrelevant

<m> irrelevant

**Parameters:**

<State> **ON | OFF**

\*RST: OFF



**Example:** `CALC:MARK:FUNC:BPOW:STAT ON`

**Manual operation:** See "Band Power On/Off" on page 395

#### **CALCulate<n>:DELTamarker<m>:FUNctioN:BPOWer:MODE <Mode>**

This command selects the way the results for a band power delta marker are displayed.

**Suffix:**

<n> irrelevant

<m> irrelevant

**Parameters:**

<Mode> **POWER**  
Result is displayed as a power in dBm.

**DENSity**  
Result is displayed as a density in dBm/Hz.

\*RST: POW

**Example:** `CALC:DELT:BPOW:MODE DENS`

#### **CALCulate<n>:DELTamarker<m>:FUNctioN:BPOWer:RESult?**

This command queries the results of the band power measurement.

**Suffix:**

<n> irrelevant

<m> irrelevant

**Return values:**

<Power> Signal power over the delta marker bandwidth.

**Example:** Activate the delta band power marker:

`CALC:DELT:BPOW:STAT ON`

Select the density mode for the result:

`CALC:DELT:BPOW:MODE DENS`

Query the result:

`CALC:DELT:BPOW:RES?`

Response:

20dBm/Hz

**Usage:** Query only

#### **CALCulate<n>:DELTamarker<m>:FUNctioN:BPOWer:SPAN <Span>**

This command defines the bandwidth around the delta marker position. The span is indicated by lines in the diagram.

**Suffix:**

<n> irrelevant

<m> irrelevant

**Parameters:**

<Span> Numeric value that defines the span in Hz.  
The maximum span depends on the marker position and R&S FSV model.  
\*RST: 5% of current span

**Example:** CALC:DELT:BPOW:SPAN 20

**CALCulate<n>:DELTa<m>:FUNCTION:BPOWer[:STATe] <State>**

This command turns delta markers for band power measurements on and off.

If necessary, the command also turns on a reference marker.

For details see "[Performing Band Power Measurements](#)" on page 399.

**Suffix:**

<n> irrelevant

<m> irrelevant

**Parameters:**

<State> **ON | OFF**  
When switched to on, if no marker is active yet, marker 1 is activated. Otherwise, the currently active marker is used as a delta band power marker (all other marker functions for this marker are deactivated).  
\*RST: OFF

**Example:** CALC:DELT:BPOW:STAT ON

## 11.6 Remote Commands in I/Q Analyzer Mode

### 11.6.1 Using the I/Q Analyzer

CALCulate<n>:FORMat.....	856
CALCulate<n>:MARKer<m>:SEARch.....	856
DISPlay[:WINDow<n>]:TRACe<t>:Y[:SCALE]:RVALue.....	857
MMEMory:LOAD:IQ:STATe.....	857
TRACe<n>:IQ:BWIDth.....	857
TRACe<n>:IQ:RLENgth.....	858
TRACe<n>:IQ:SET.....	858
TRACe<n>:IQ:SRATe.....	859
TRACe<n>:IQ:DATA.....	860
TRACe<n>:IQ:DATA:FORMat.....	860
TRACe<n>:IQ:AVERAge:COUNT.....	862
TRACe<n>:IQ:AVERAge[:STATe].....	862

TRACe<n>:IQ:DATA:MEMory?	863
TRACe<n>:IQ:EGATe	864
TRACe<n>:IQ:EGATe:GAP	864
TRACe<n>:IQ:EGATe:LENGth	865
TRACe<n>:IQ:EGATe:NOFgateperiods	865
TRACe<n>:IQ:EGATe:TYPE	865
TRACe<n>:IQ:EVAL	866
TRACe<n>:IQ[:STATe]	866
TRACe<n>:IQ:TPISample?	867

---

### CALCulate<n>:FORMat <Format>

This command defines the display type of the IQ data.

#### Suffix:

<n> irrelevant

#### Parameters:

<Format>

- RIMag**  
IQ data
- MAGNitude**  
Magnitude
- FREQuency**  
Spectrum
- VECTor**  
IQ-Vector

**Manual operation:** See "I/Q Analyzer" on page 430  
See "Display Config" on page 431

---

### CALCulate<n>:MARKer<m>:SEARch <MarkReallmag>

This command selects the trace type a marker search is performed on.

#### Suffix:

<n> Selects the measurement window.

<m> Selects the marker.

#### Parameters:

<MarkReallmag>

- REAL**  
Marker search functions are performed on the real trace of the "I/Q" measurement.
- IMAG**  
Marker search functions are performed on the imaginary trace of the "I/Q" measurement.
- MAGN**  
Marker search functions are performed on the magnitude of the I and Q data.

\*RST: REAL

**Example:** `CALC4:MARK:SEAR IMAG`

**Manual operation:** See ["Search Settings"](#) on page 440

**DISPlay[:WINDow<n>]:TRACe<t>:Y[:SCALe]:RVALue <Value>**

The command defines the power value assigned to the reference position in the grid.

**Suffix:**

<n> irrelevant

<t> irrelevant

**Parameters:**

<Value> \*RST: 0 dB, coupled to reference level

**Example:**

`DISP:TRAC:Y:RVAL -20dBm`

Defines a reference position of -20 dBm.

**Manual operation:** See ["Reference Level"](#) on page 431

See ["Reference Value"](#) on page 449

**MMEMy:LOAD:IQ:STATe 1, <FileName>**

This command loads the I/Q data from the specified `.iq.tar` file.

**Note:** switch to single sweep mode (`INIT:CONT OFF`) before importing I/Q data as otherwise the instrument will continue to measure data and display the current results rather than the imported data.

**Parameters:**

<FileName> Complete file name including the path

**Example:**

`MMEM:LOAD:IQ:STAT 1, 'C:\R_S\Instr\user\data.iq.tar'`  
Loads I/Q data from the specified file.

**Usage:** Setting only

**Manual operation:** See ["IQ Import"](#) on page 505

**TRACe<n>:IQ:BWIDth**

This command queries the flat, usable filter bandwidth of the final I/Q data.

**Suffix:**

<n> irrelevant

**Example:**

`TRAC:IQ:BWID?`

**Manual operation:** See ["Filter BW"](#) on page 431

**TRACe<n>:IQ:RLENgth <NoOfSamples>**

This command sets the record length for the acquired I/Q data. Increasing the record length automatically also increases the measurement time.

**Note:** Alternatively, you can define the measurement time using the `SENS:SWE:TIME` command.

**Suffix:**

<n> irrelevant

**Parameters:**

<NoOfSamples> Number of measurement values to record.  
 Range: 1 ... 209715200(= 200\*1024\*1024);  
 \*RST: 691

**Example:** `TRAC:IQ:RLEN 256`

**Manual operation:** See "[Record Length](#)" on page 431

---

**TRACe<n>:IQ:SET NORM,<Placeholder>, <SampleRate>, <TriggerMode>,  
 <TriggerSlope>, <PretriggerSamp>, <NumberSamples>**

This command defines the settings of the R&S ESRP hardware for the measurement of I/Q data. This allows setting the sample rate, trigger conditions and the record length.

If this command is omitted, the current instrument settings are used for the corresponding parameters.

This command switches to IQ mode automatically (see also `TRACe<n>:IQ[:STATE]` on page 866).

The trigger level can be set using the `TRIGger<n>[:SEQUENCE]:SOURCE` command.

**Note:** When using the default settings with the `TRACe<n>:IQ:DATA` command, the following minimum buffer sizes for the response data are recommended: ASCII format 10 kBytes, Binary format 2 kBytes.

**Tip:** To determine the trigger point in the sample (for "External" or "IF Power" trigger mode), use the `TRACe<n>:IQ:TPISample?` on page 867 command.

**Parameters:**

NORM is not evaluated, but must be inserted

<Placeholder> numeric value  
 is not evaluated, but must be inserted

<TriggerMode> IMMEDIATE | EXTERNAL | IFPOWER | BBPOWER | PSE  
 Selection of the trigger source used for the measurement.  
 For IMM mode, gating is automatically deactivated.  
 \*RST: IMM

<TriggerSlope>	POSitive   NEGative Used trigger slope. *RST: POS
<PretriggerSamp>	Defines the trigger offset in terms of pretrigger samples. Negative values correspond to a trigger delay. This value also defines the interval between the trigger signal and the gate edge in samples. Range: RF input without gating: 0 to (200 MS - 1) RF input with gating: 0 to [(200 MS * SR/128 MHz)-1] Range: 0 to (MaxPreTriggerSamples * 128 MHz/sample rate). *RST: 0
<NumberSamples>	Number of measurement values to record (including the pretrigger samples). Range: 1 ... 209715200(= 200*1024*1024); *RST: 128

**Example:**

```
TRAC:IQ:SET NORM,10 MHz,32 MHz,EXT,POS,0,2048
```

Reads 2048 I/Q-values starting at the trigger point.

sample rate = 32 MHz

trigger = External

slope = Positive

```
TRAC:IQ:SET NORM,10 MHz,4 MHz,EXT,POS,1024,512
```

Reads 512 I/Q-values from 1024 measurement points before the trigger point.

sample rate = 4 MHz

trigger = External

slope = Positive

**Manual operation:** See "[Record Length](#)" on page 431

**TRACe<n>:IQ:SRATe <SampleRate>**

This command sets the final user sample rate for the acquired I/Q data. Thus, the sample rate can be modified without affecting the other settings.

**Note:** The smaller the user sample rate, the smaller the usable I/Q bandwidth, see [TRACe<n>:IQ:BWIDth](#) on page 857.

**Suffix:**

<n> irrelevant

**Example:** `TRAC:IQ:SRAT 4 MHz`

**Manual operation:** See "[Sample Rate](#)" on page 431

**TRACe<n>:IQ:DATA**

This command starts a measurement with the settings defined via `TRACe<n>:IQ:SET` and returns the list of measurement results (I/Q samples) immediately after they are corrected in terms of frequency response. The number of measurement results depends on the settings defined with `TRACe<n>:IQ:SET`, the output format depends on the settings of the `FORMat` subsystem. The format of the data list is defined by the command `TRACe<n>:IQ:DATA:FORMat`.

The command requires all response data to be read out completely before the instrument accepts further commands.

The result values are scaled linearly in Volts and correspond to the voltage at the RF or digital input of the instrument. The number of the returned values is 2 \* the number of samples.

**Note:** Using the command with the \*RST values for the `TRACe<n>:IQ:SET` command, the following minimum buffer sizes for the response data are recommended:

ASCII format: 10 kBytes

Binary format: 2 kBytes

**Suffix:**

<n> irrelevant

**Example:**

```
TRAC:IQ:STAT ON
Enables acquisition of I/Q data
TRAC:IQ:SET NORM,10MHz,32MHz,EXT,POS,0,4096
Measurement configuration:
Sample Rate = 32 MHz
Trigger Source = External
Trigger Slope = Positive
Pretrigger Samples = 0
Number of Samples = 4096
FORMat REAL,32
Selects format of response data
TRAC:IQ:DATA?
Starts measurement and reads results
```

**TRACe<n>:IQ:DATA:FORMat <Format>**

This command defines the transfer format of the I/Q data.

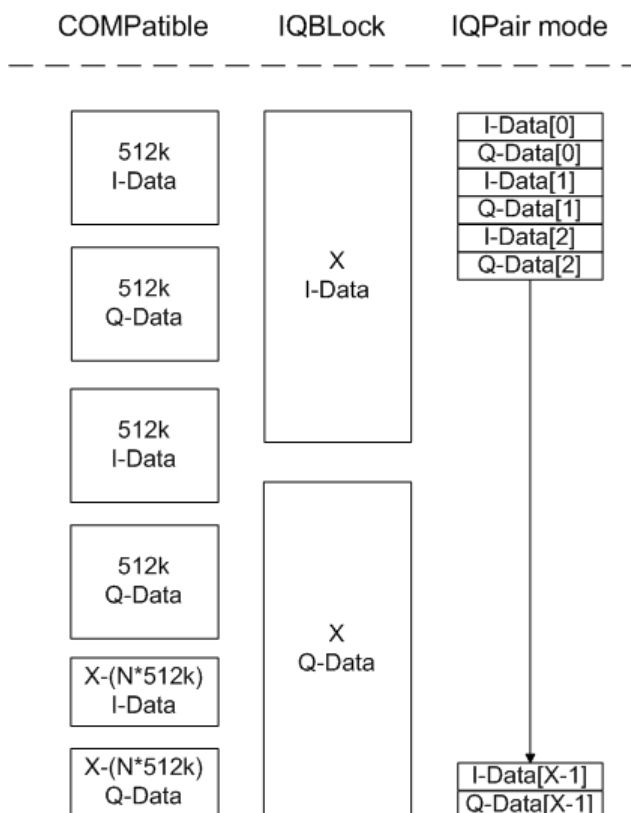

Figure 11-5: IQ data formats

**Note:** 512k corresponds to 524288 samples

$$\# \text{ of } I\text{-Data} = \# \text{ of } Q\text{-Data} = \frac{\# \text{ of } DataBytes}{8}$$

$$Q\text{-Data - Offset} = \frac{(\# \text{ of } DataBytes)}{2} + LengthIndicatorDigits$$

**Suffix:**

<n> irrelevant

**Parameters:**

<Format> COMPatible | IQBLock | IQPair

\*RST: IQBL

For maximum performance, the formats "Compatible" or "IQPair" should be used. Furthermore, for large amounts of data, the data should be in binary format to improve performance.

For further details on formats refer to [Chapter 5.2.9, "Formats for Returned Values: ASCII Format and Binary Format"](#), on page 153 .



**TRACe<n>:IQ:AVERAge:COUNT <NumberSets>**

This command defines the number of I/Q data sets that are to serve as a basis for averaging.

**Suffix:**

<n> irrelevant

**Parameters:**

<NumberSets> 0 to 32767  
\*RST: 0

**Example:**

```
TRAC:IQ ON
Switches on acquisition of I/Q data.
TRAC:IQ:AVER ON
Enables averaging of the I/Q measurement data
TRAC:IQ:AVER:COUN 10
Selects averaging over 10 data sets
TRAC:IQ:DATA?
Starts the measurement and reads out the averaged data.
```

**Usage:** SCPI confirmed

**TRACe<n>:IQ:AVERAge[:STATe] <State>**

The command enables averaging of the recorded I/Q data, provided that I/Q data acquisition was previously enabled with [TRACe<n>:IQ\[:STATe\]](#) on page 866.

With I/Q data averaging enabled, the maximum amount of I/Q data is limited to 512kS (524288 complex samples).

**Suffix:**

<n> irrelevant

**Parameters:**

<State> ON | OFF  
\*RST: OFF

**Example:**

```
TRAC:IQ ON
Switches on acquisition of I/Q data.
TRAC:IQ:AVER ON
Enables averaging of the I/Q measurement data.
TRAC:IQ:AVER:COUN 10
Selects averaging over 10 data sets.
TRAC:IQ:DATA?
Starts the measurement and reads out the averaged data.
```

**TRACe<n>:IQ:DATA:MEMory? <OffsetSamples>,<NoOfSamples>**

This command reads out previously acquired (and frequency response corrected) I/Q data from the memory. Furthermore, the offset related to the start of measurement and the number of I/Q samples are given. Thus, a previously acquired data set can be read out in smaller portions. If no parameters are given, all data is read from the memory. The maximum amount of available data depends on the settings of the [TRACe<n>:IQ:SET](#) command, the output format on the settings in the FORMat subsystem.

The returned values are scaled linear in unit Volt and correspond to the voltage at the RF or digital input of the instrument.

The format of the output buffer corresponds to the [TRACe<n>:IQ:DATA](#) command.

The command requires all response data to be read out completely before the instrument accepts further commands.

If no I/Q data is available in memory because the corresponding measurement was not started, the command causes a query error.

**Suffix:**

<n> irrelevant

**Parameters:**

<OffsetSamples>	Offset of the values to be read, in relation to the start of the acquired data. Range: 0 to <# of samples> – 1, with <# of samples> being the value set by the "TRACe:IQ:SET" command *RST: 0
<NoOfSamples>	Number of measurement values to be read. Range: 1 to <# of samples> - <offset samples> with <# of samples> being the value set by the "TRACe:IQ:SET" command *RST: <# of samples>

**Example:**

```
TRAC:IQ:STAT ON
```

Enables acquisition of I/Q data

```
TRAC:IQ:SET NORM,10MHz,32MHz,EXT,POS,100,4096
```

**Measurement configuration:**

Sample Rate = 32 MHz

Trigger Source = External

Trigger Slope = Positive

Pretrigger Samples = 100

Number of Samples = 4096

```
INIT;*WAI
```

Starts measurement and wait for sync

```
FORMat REAL,32
```

Determines output format

**To read the results:**

```
TRAC:IQ:DATA:MEM?
```

Reads all 4096 I/Q data

```
TRAC:IQ:DATA:MEM? 0,2048
```

Reads 2048 I/Q data starting at the beginning of data acquisition

```
TRAC:IQ:DATA:MEM? 2048,1024
```

Reads 1024 I/Q data from half of the recorded data

```
TRAC:IQ:DATA:MEM? 100,512
```

Reads 512 I/Q data starting at the trigger point (<Pretrigger Samples> was 100)

**Usage:**

Query only

**TRACe<n>:IQ:EGATe <State>**

Activates or deactivates the gate function for IQ data measurements. This command is only valid for TRAC:IQ ON and trigger modes "EXT" and "IFP". The gate trigger is specified using [TRACe<n>:IQ:SET](#) on page 858. For details see [Chapter 11.6.2, "I/Q Gating"](#), on page 867.

**Suffix:**

<n> irrelevant

**Parameters:**

<State> ON | OFF

\*RST: OFF

**Example:**

```
TRAC:IQ:EGAT: ON
```

**TRACe<n>:IQ:EGATe:GAP <Samples>**

Defines the interval between several gate periods in samples. For details see [Chapter 11.6.2, "I/Q Gating"](#), on page 867.

**Suffix:**

<n> irrelevant

**Parameters:**

<Samples> <numeric value>  
 Max = MaxPreTriggerSamples \* 128 MHz/sample rate  
 pretrigger samples defined by TRACe<n>:IQ:SET;  
 sample rate defined by TRACe<n>:IQ:SRATe)  
 Range: 1...Max (samples)  
 \*RST: 100

**Example:** TRAC:IQ:EGAT:GAP 2

**TRACe<n>:IQ:EGATe:LENGth <GateLength>**

Defines the gate length in samples in edge mode. For details see [Chapter 11.6.2, "I/Q Gating"](#), on page 867.

**Suffix:**

<n> irrelevant

**Parameters:**

<GateLength> <numeric value>  
 Max = MaxPreTriggerSamples \* 128 MHz/sample rate  
 pretrigger samples defined by TRACe<n>:IQ:SET;  
 sample rate defined by TRACe<n>:IQ:SRATe)  
 Range: 1...Max (samples)  
 \*RST: 100

**Example:** TRAC:IQ:EGAT:LENG 2000

**TRACe<n>:IQ:EGATe:NOFgateperiods <Number>**

Defines the number of gate periods after a trigger signal. For details see [Chapter 11.6.2, "I/Q Gating"](#), on page 867.

**Suffix:**

<n> irrelevant

**Parameters:**

<Number> 1...1023  
 \*RST: 1

**Example:** TRAC:IQ:EGAT:NOF 2

**TRACe<n>:IQ:EGATe:TYPE <Type>**

Specifies the gate trigger type used for data collection. For details see [Chapter 11.6.2, "I/Q Gating"](#), on page 867.

**Note:** Using gating with gate mode "level" and an IFP trigger ( TRIGger<n>[: SEQuence] : SOURce), the holdoff time for the IFP trigger (see TRIGger<n>[: SEQuence] : IFPower : HOLDoFF on page 805) is ignored.

**Suffix:**  
 <n> irrelevant

**Parameters:**  
 <Type> LEV | EDGE  
 \*RST: EDGE

**Example:** TRAC:IQ:EGAT:TYPE LEV

### TRACe<n>:IQ:EVAL <State>

This command enables or disables the IQ data evaluation mode and is a prerequisite for the IQ Analyzer functions.

Before this command can be executed, IQ data acquisition must be enabled (see [TRACe<n>:IQ\[:STATe\]](#) on page 866). This command automatically disables the IQ data evaluation mode to provide optimum performance for IQ-data acquisition.

If you start the IQ Analyzer manually by selecting the "IQ Analyzer" mode in the R&S ESRP, or use the [CALCulate<n>:FORMat](#) command, the IQ data evaluation mode is automatically activated.

The maximum number of samples for RF input is 200 MS. For details see [Chapter 7.5, "Working with I/Q Data"](#), on page 444.

**Suffix:**  
 <n> irrelevant

**Parameters:**  
 <State> ON | OFF

**ON**  
 all functions of the IQ Analyzer are available

**OFF**  
 no traces or marker operations are available; IQ data can only be captured, but with a better performance than in active IQ data evaluation mode

\*RST: OFF

**Example:** TRAC:IQ ON  
 Enables IQ data acquisition  
 TRAC:IQ:EVAL ON  
 Enables the IQ data evaluation mode.

**Manual operation:** See ["I/Q Analyzer"](#) on page 430

### TRACe<n>:IQ[:STATe] <State>

This command switches the I/Q data acquisition on or off.

I/Q data acquisition is not compatible with other measurement functions. Therefore, all other measurement functions are switched off as soon as the I/Q measurement function is switched on. The trace display is also switched off by this command. Therefore, all traces are set to "BLANK".

To switch trace display back on, use the `TRACe<n>:IQ:EVAL` command.

**Note:** to enable the evaluation functions of the IQ Analyzer, you must also execute the command `TRACe<n>:IQ:EVAL`.

**Suffix:**

<n> irrelevant

**Parameters:**

<State> ON | OFF  
\*RST: OFF

**Example:**

TRAC:IQ ON  
Switches on I/Q data acquisition

**Manual operation:** See "[I/Q Analyzer](#)" on page 430

### TRACe<n>:IQ:TPISample?

This command determines the time offset of the trigger in the sample (trigger position in sample = TPIS). This value can only be determined in triggered measurements using external or IFPower triggers, otherwise the value is 0. The value is not user-definable.

**Suffix:**

<n> irrelevant

**Example:**

TRAC:IQ:TPIS?

**Usage:**

Query only

**Manual operation:** See "[Trigger Offset](#)" on page 349

## 11.6.2 I/Q Gating

Sometimes in spectrum analysis, measurements are based on a certain length of time called the gate area. With I/Q gating, you can define the gate area using the gate length, the distance between the periods and the number of periods. The gate length and the distance between the capture periods are specified in samples.



I/Q gating is only available using remote commands; manual configuration is not possible.

Using I/Q gating, the gate area can be defined using the following methods:

- Edge triggered recording  
After a trigger signal, the gate period is defined by a gate length and a gate distance. All data in the gate period is recorded until the required number of samples has been recorded.

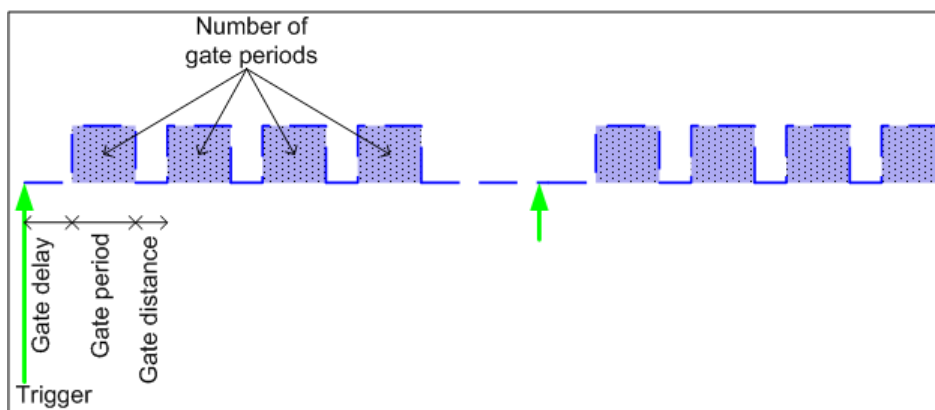

SCPI command: TRACE:IQ:EGATE:TYPE EDGE, see TRACe<n>:IQ:EGATE:TYPE on page 865

- Level triggered recording  
After a trigger signal, all data is recorded in which the gate signal is set to 1, which means it has exceeded a level. In this case, the gate signal can be generated by the IFP trigger, for example: each time the IFP level is exceeded, the IFP trigger signal is set to 1 and the samples in this area are recorded as gate samples.

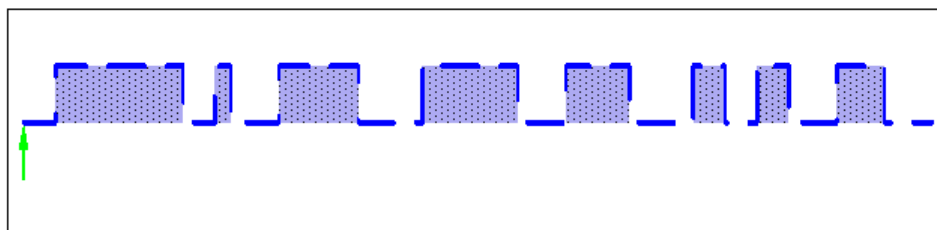

The number of complex samples to be recorded prior to the trigger event can be selected (see TRACe<n>:IQ:SET on page 858) for all available trigger sources, except for "Free Run".

SCPI command: TRACE:IQ:EGATE:TYPE LEV, see TRACe<n>:IQ:EGATE:TYPE on page 865

## 11.7 Remote Commands to Control the Tracking Generator

The following commands control the optional tracking generator.

- Controlling the Internal Tracking Generator..... 868
- Controlling the External Tracking Generator..... 875

### 11.7.1 Controlling the Internal Tracking Generator

OUTPut[:STATe].....	869
[SENSe:]CORRection:COLLect[:ACQuire].....	869
[SENSe:]CORRection:METHod.....	870
[SENSe:]CORRection:RECall.....	870

[SENSe:]CORRection[:STATe].....	870
SOURce<n>:AM:STATe.....	871
SOURce<n>:DM:STATe.....	871
SOURce<n>:FM:DEVIation.....	872
SOURce<n>:FM:STATe.....	872
SOURce<n>:FREQUency:OFFSet.....	873
SOURce<n>:POWer[:LEVel][:IMMediate][:AMPLitude].....	873
SOURce<n>:POWer[:LEVel][:IMMediate]:OFFSet.....	873
SOURce<n>:POWer:MODE.....	874
SOURce<n>:POWer:START.....	874
SOURce<n>:POWer:STOP.....	875

---

### OUTPut[:STATe] <State>

This command switches the selected tracking generator on or off.

The command is available with a tracking generator (option R&S FSV-B9).

#### Parameters:

<State>                    ON | OFF  
 \*RST:                    OFF

#### Example:

OUTP1 ON  
 Switches on the external tracking generator 1.

#### Usage:

SCPI confirmed

**Manual operation:** See "[Source RF Internal \(On/ Off\)](#)" on page 448

---

### [SENSe:]CORRection:COLLEct[:ACQuire] <MeasType>

This command initiates a reference measurement (calibration). The reference measurement is the basis for the measurement normalization.

To obtain a correct reference measurement, a complete sweep with synchronization to the end of the sweep must have been carried out. This is only possible in the single sweep mode.

The command is available if a tracking generator is installed and has been turned on.

#### Parameters:

<MeasType>                    **THRough**  
 "TRANsmission" mode: calibration with direct connection  
 between tracking generator and device input  
 "REFLection" mode: calibration with short circuit at the input  
**OPEN**  
 only allowed in "REFLection" mode: calibration with open input



<b>Example:</b>	<pre>INIT:CONT OFF</pre> <p>Selects single sweep operation</p> <pre>CORR:COLL THR;*WAI</pre> <p>Starts the measurement of reference data using direct connection between generator and device input and waits for the sweep end.</p>
<b>Usage:</b>	<p>Setting only</p> <p>SCPI confirmed</p>
<b>Manual operation:</b>	<p>See <a href="#">"Calibrate Reflection Short"</a> on page 448</p> <p>See <a href="#">"Calibrate Reflection Open"</a> on page 448</p>

---

#### [SENSe:]CORRection:METhod <Type>

This command selects the type of measurement to be performed with the tracking generator.

The command is available if a tracking generator is installed and has been turned on.

#### Parameters:

<Type>	<p><b>REFlection</b> Selects reflection measurements.</p> <p><b>TRANsmission</b> Selects transmission measurements.</p> <p>*RST:       TRANsmission</p>
--------	-----------------------------------------------------------------------------------------------------------------------------------------------------------------

<b>Example:</b>	<pre>CORR:METH TRAN</pre> <p>Sets the type of measurement to "transmission".</p>
<b>Manual operation:</b>	<p>See <a href="#">"Calibrate Transmission"</a> on page 448</p> <p>See <a href="#">"Calibrate Reflection Short"</a> on page 448</p> <p>See <a href="#">"Calibrate Reflection Open"</a> on page 448</p>

---

#### [SENSe:]CORRection:RECall

This command restores the measurement configuration used for calibration.

The command is available if a tracking generator is installed and has been turned on.

<b>Example:</b>	<pre>CORR:REC</pre>
<b>Usage:</b>	<p>Event</p> <p>SCPI confirmed</p>
<b>Manual operation:</b>	See <a href="#">"Recall"</a> on page 449

---

#### [SENSe:]CORRection[:STATe] <State>

This command turns correction of measurement results (normalization) on and off.

The command is available after you have defined a reference trace for the selected measurement type with `[SENSe:]CORRection:COLLect[:ACQuire]` on page 869.

The command is available if a tracking generator is installed and has been turned on.

**Parameters:**

<State> ON | OFF  
\*RST: OFF

**Example:**

CORR ON  
Activates normalization.

**Usage:**

SCPI confirmed

**Manual operation:** See ["Normalize"](#) on page 449

**SOURce<n>:AM:STATe <State>**

This command turns external amplitude modulation of the tracking generator on and off.

External I/Q modulation is switched off, if active. This command is available with a tracking generator (option R&S FSV-B9).

**Suffix:**

<n> 1...4  
Selects the measurement window.

**Parameters:**

<State> ON | OFF  
\*RST: OFF

**Example:**

SOUR2 : AM : STAT ON  
Switches on the external amplitude modulation of the tracking generator for screen B.

**Usage:**

SCPI confirmed

**Manual operation:** See ["External AM"](#) on page 450  
See ["Modulation OFF"](#) on page 450

**SOURce<n>:DM:STATe <State>**

This command turns external I/Q modulation of the tracking generator on and off.

External AM and external FM are switched off, if active. This command is available with a tracking generator (option R&S FSV-B9).

**Suffix:**

<n> 1...4  
Selects the measurement window.

**Parameters:**

<State> ON | OFF  
\*RST: OFF

<b>Example:</b>	SOUR2:DM:STAT ON Switches on the external I/Q modulation of the tracking generator for screen B.
<b>Usage:</b>	SCPI confirmed
<b>Manual operation:</b>	See "External I/Q" on page 450 See "Modulation OFF" on page 450 See "External IQ" on page 470

**SOURce<n>:FM:DEVIation** <Frequency>

This command defines the maximum frequency deviation at 1 V input voltage at the FM input of the tracking generator.

This command is available with a tracking generator (option R&S FSV-B9).

**Suffix:**

<n> 1...4  
Selects the measurement window.

**Parameters:**

<Frequency> The possible value range is 100 Hz to 10 MHz in steps of 10 Hz.  
Range: 100 Hz to 10 MHz  
Increment: 10 Hz  
\*RST: 100 Hz

**Example:** SOUR1:FM:DEV 1 MHz  
Sets the maximum frequency deviation of the tracking generator for screen A to 1 MHz.

**Usage:** SCPI confirmed

**Manual operation:** See "External FM" on page 450

**SOURce<n>:FM:STATe** <State>

This command turns external frequency modulation of the tracking generator on and off.

External I/Q modulation is switched off, if active. This command is available with a tracking generator (option R&S FSV-B9).

**Suffix:**

<n> 1...4  
Selects the measurement window.

**Parameters:**

<State> ON | OFF  
\*RST: OFF

**Example:** SOUR2:FM:STAT ON  
Switches on the external frequency modulation of the tracking generator for screen B.

**Usage:** SCPI confirmed

**Manual operation:** See ["External FM"](#) on page 450  
See ["Modulation OFF"](#) on page 450

#### **SOURce<n>:FREQUENCY:OFFSet <Offset>**

This command defines a frequency offset of the tracking generator. Frequency-converting DUTs can be measured with this setting.

External I/Q modulation is switched off, if active. This command is available with a tracking generator (option R&S FSV-B9).

#### **Suffix:**

<n> 1...4  
Selects the measurement window.

#### **Parameters:**

<Offset> Note that the values (start frequency – tracking frequency offset) and (stop frequency – tracking frequency offset) are both > 1 kHz or both < –1 kHz.

Range: -200 MHz to 200 MHz  
\*RST: 0 Hz

**Example:** `SOUR:FREQ:OFFS 10MHz`  
Defines a frequency offset of the tracking generator of 10 MHz.

**Usage:** SCPI confirmed

**Manual operation:** See ["Frequency Offset"](#) on page 458

#### **SOURce<n>:POWER[:LEVel][:IMMediate][:AMPLitude] <Level>**

This command defines the output level of the tracking generator.

#### **Parameters:**

<Level> Output level in dBm. The level range is specified in the data sheet.

\*RST: -20 dBm

**Example:** `SOUR:POW -20dBm`  
Sets the tracking generator level to -20 dBm.

**Usage:** SCPI confirmed

**Manual operation:** See ["Source Power"](#) on page 448  
See ["Source Power"](#) on page 457

#### **SOURce<n>:POWER[:LEVel][:IMMediate]:OFFSet <Offset>**

This command defines a level offset for the tracking generator level. Thus, for example, attenuators or amplifiers at the output of the tracking generator can be taken into account for the setting.

**Parameters:**

<Offset>                   Range:       -200 dB to +200 dB  
                               \*RST:        0dB

**Example:**

SOUR:POW:OFFS -10dB  
 Sets the level offset of the tracking generator to – 20 dBm.

**Usage:**

SCPI confirmed

**Manual operation:**

See "Power Offset" on page 457  
 See "Power Offset" on page 460

**SOURce<n>:POWER:MODE <Mode>**

This command turns the power sweep on and off.

**Suffix:**

<n>                         1...4  
 Selects the measurement window.

**Parameters:**

<Mode>

**FIXed**

Power sweep is off.

**SWEEp**

Power sweep is on.

If the power sweep is on, the R&S ESRP enters the time domain (span = 0 Hz). During the sweep time, the power at the internal tracking generator is changed linearly from start power to stop power. The start and stop power for the power sweep are displayed in the diagram header ("INT TG <start power>... <stop power>").

\*RST:        FIXed

**Example:**

SOUR:POW:MODE SWE  
 Activates power sweep.

**Usage:**

SCPI confirmed

**Manual operation:**

See "Power Sweep (On /Off)" on page 451

**SOURce<n>:POWER:START <Power>**

This command defines the start power of the power sweep.

**Suffix:**

<n>                         1...4  
 Selects the measurement window.

**Parameters:**

<Power>

Range:       -30 dBm to +5 dBm  
 \*RST:        0 dBm

**Example:**

SOUR:POW:STAR -20dBm

**Usage:** SCPI confirmed

**Manual operation:** See ["Power Sweep Start"](#) on page 451

---

**SOURce<n>:POWER:STOP <Power>**

This command defines the stop power of the power sweep. The stop value can be smaller than the start value.

**Suffix:**

<n> 1...4  
Selects the measurement window.

**Parameters:**

<Power> Range: -30 dBm to +5 dBm  
\*RST: 0 dBm

**Example:** SOUR:POW:STOP -20dBm

**Usage:** SCPI confirmed

**Manual operation:** See ["Power Sweep Stop"](#) on page 451

## 11.7.2 Controlling the External Tracking Generator

[SENSe:]CORRection:TRANsducer:GENerator.....	875
SOURce<n>:EXTeRnal<generator>:FREQUency.....	876
SOURce<n>:EXTeRnal<generator>:FREQUency:COUPling[:STATe].....	876
SOURce<n>:EXTeRnal<generator>:FREQUency[:FACtor]:DENominator.....	877
SOURce<n>:EXTeRnal<generator>:FREQUency[:FACtor]:NUMerator.....	877
SOURce<n>:EXTeRnal<generator>:FREQUency:OFFSet<m>.....	878
SOURce<n>:EXTeRnal<generator>:FREQUency:SWEep[:STATe].....	879
SOURce<n>:EXTeRnal<generator>:POWER[:LEVel].....	879
SOURce<n>:EXTeRnal<generator>:ROSCillator[:SOURce].....	879
SOURce<n>:EXTeRnal<generator>[:STATe].....	880
SYSTem:COMMunicate:GPIB:RDEvice:GENerator<generator>:ADDResS.....	881
SYSTem:COMMunicate:RDEvice:GENerator<generator>:INTerface.....	881
SYSTem:COMMunicate:RDEvice:GENerator<generator>:LINK.....	881
SYSTem:COMMunicate:RDEvice:GENerator<generator>:TYPE.....	882

---

**[SENSe:]CORRection:TRANsducer:GENerator <Name>**

This command uses the normalized measurement data to generate a transducer factor with up to 625 points. The trace data is converted to a transducer with unit dB and stored in a file with the specified name and the suffix.trd under `c:\r_s\instr\trd`. The frequency points are allocated in equidistant steps between start and stop frequency. The generated transducer factor can be further adapted using the commands of the `[SENSe<source>:]CORRection:TRANsducer` subsystem (see [\[SENSe:\]CORRection:TRANsducer:DELeTe](#) on page 920).

This command is only available if the R&S FSV-B10 option (External Tracking Generator) is installed and normalization is switched on.

**Parameters:****<Name>**                    '<name>**Example:**

CORR:TRAN:GEN 'SMU01'

Creates the transducer file C:\r\_s\instr\trd\SMU01.trd.

**Manual operation:** See "[Save As Trd Factor](#)" on page 450**SOURce<n>:EXTernal<generator>:FREQuency <Frequency>**

This command defines a fixed source frequency for the external tracking generator.

This command is only valid for the External Tracking Generator option (R&amp;S FSV-B10).

**Suffix:****<n>**                            1...4  
window**<m>**                            1 | 2  
tracking generator**Parameters:****<Frequency>**                Source frequency of the external tracking generator.

\*RST:                    RST value

**Example:**

SOUR:EXT2:FREQ 10MHz

**Manual operation:** See "[\(Fixed\) Generator Frequency](#)" on page 459**SOURce<n>:EXTernal<generator>:FREQuency:COUPling[:STATe] <State>**

This command couples or decouples the analyzer and generator frequencies.

This command is only valid for the External Tracking Generator option (R&amp;S FSV-B10).

**Suffix:****<generator>**                1 | 2  
tracking generator**Parameters:****<State>**                      ON | OFF**ON****OFF**The fixed frequency defined using [SOURce<n>:](#)[EXTernal<generator>:FREQuency](#) is used as a source frequency.

\*RST:                    OFF

**Example:**

SOUR:EXT2:FREQ:COUP ON

**Manual operation:** See "[Source Frequency Coupling](#)" on page 459

**SOURce<n>:EXTernal<generator>:FREQuency[:FACTor]:DENominator <Value>**

This command defines the denominator of the factor with which the analyzer frequency is multiplied in order to obtain the transmit frequency of the selected generator.

This command is only valid for the External Tracking Generator option (R&S FSV-B10).

Select the multiplication factor such that the frequency range of the generator is not exceeded if the following formula is applied to the start and stop frequency of the analyzer:

$$F_{Generator} = \left| F_{Analyzer} * \frac{Numerator}{Denominator} + F_{Offset} \right|$$

**Suffix:**

<n> irrelevant  
 <generator> 1 | 2  
 tracking generator  
 For Noise Figure measurements (K30): 1 only

**Parameters:**

<Value> <numeric value>  
 \*RST: 1

**Example:**

```
SOUR:EXT:FREQ:NUM 4"
"SOUR:EXT:FREQ:DEN 3"
```

Sets a multiplication factor of 4/3, i.e. the transmit frequency of the generator is 4/3 times the analyzer frequency.

**Mode:** A, NF

**Manual operation:** See "[Generator Frequency \(Numerator/Denominator/Offset\)](#)" on page 460

**SOURce<n>:EXTernal<generator>:FREQuency[:FACTor]:NUMerator <Value>**

This command defines the numerator of the factor with which the analyzer frequency is multiplied in order to obtain the transmit frequency of the selected generator.

This command is only valid for the External Tracking Generator option (R&S FSV-B10).

Select the multiplication factor such that the frequency range of the generator is not exceeded if the following formula is applied to the start and stop frequency of the analyzer:

$$F_{Generator} = \left| F_{Analyzer} * \frac{Numerator}{Denominator} + F_{Offset} \right|$$

**Suffix:**

<n> irrelevant



## Remote Commands to Control the Tracking Generator

**<generator>** 1 | 2  
tracking generator  
For Noise Figure measurements (K30): 1 only

**Parameters:**

**<Value>** <numeric value>  
**\*RST:** 1

**Example:**

```
SOUR:EXT:FREQ:NUM 4"
"SOUR:EXT:FREQ:DEN 3"
```

Sets a multiplication factor of 4/3, i.e. the transmit frequency of the generator is 4/3 times the analyzer frequency.

**Mode:** A, NF

**Manual operation:** See "[Generator Frequency \(Numerator/Denominator/Offset\)](#)" on page 460

**SOURce<n>:EXTernal<generator>:FREQUENCY:OFFSet<m> <Offset>**

This command defines the frequency offset of the selected generator with reference to the receive frequency.

This command is only valid for the External Tracking Generator option (R&S FSV-B10).

**Suffix:**

**<n>** irrelevant

**<generator>** 1 | 2  
tracking generator  
For Noise Figure measurements (K30): 1 only

**<m>** 1 | 2  
offset (for Noise Figure measurements (K30) only)

**Parameters:**

**<Offset>** <numeric value>, specified in Hz, kHz, MHz or GHz, rounded to the nearest Hz

**\*RST:** 0 Hz

Select the multiplication factor such that the frequency range of the generator is not exceeded if the following formula is applied to the start and stop frequency of the analyzer:

$$F_{\text{generator}} = \left[ \frac{F_{\text{stop}} - F_{\text{start}}}{\text{Denominator}} + F_{\text{start}} \right]$$

For Noise Figure measurements (R&S FSV-K30), the following formula applies:

Generator Frequency = [(LO + Offset 1) \* Factor 1 / Factor 2] + Offset 2

**Example:**

```
SOUR:EXT:FREQ:OFFS 1GHZ
```

Sets a frequency offset of the generator transmit frequency compared to the analyzer receive frequency of 1 GHz.

**Mode:** A, NF

**Manual operation:** See "[Generator Frequency \(Numerator/Denominator/Offset\)](#)" on page 460

---

### **SOURce<n>:EXTernal<generator>:FREQuency:SWEep[:STATe] <State>**

This command activates or deactivates the frequency sweep for the selected generator.

This command is requires the optional External Tracking Generator.

**Suffix:**

<n> irrelevant  
 <generator> 1 | 2  
 external generator

**Parameters:**

<State> ON | OFF  
 \*RST: OFF

**Example:**

SOUR:EXT1:FREQ:SWE ON  
 Activates the frequency sweep for external generator 1.

---

### **SOURce<n>:EXTernal<generator>:POWer[:LEVel] <Level>**

This command sets the output power of the selected generator.

This command is only valid for the External Tracking Generator option (R&S FSV-B10).

**Suffix:**

<n> irrelevant  
 <generator> 1 | 2  
 tracking generator  
 For Noise Figure measurements (K30): 1 only

**Parameters:**

<Level> <numeric value>  
 \*RST: -20 dBm

**Example:**

SOUR:EXT:POW -30dBm  
 Sets the generator level to -30 dBm

**Mode:** A, NF

**Manual operation:** See "[Source Power](#)" on page 460

---

### **SOURce<n>:EXTernal<generator>:ROSCillator[:SOURce] <Source>**

This command controls selection of the reference oscillator for the external tracking generator (requires option R&S FSV-B10).

If the external reference oscillator is selected, the reference signal must be connected to the rear panel of the instrument.

**Suffix:**

<n> irrelevant

<generator> 1 | 2  
tracking generator  
For Noise Figure measurements (K30): 1 only

**Parameters:**

<Source> **INTernal**  
the internal reference is used

**EXTernal**  
the external reference is used; if none is available, an error flag is displayed in the status bar

**EAUTO**  
the external reference is used as long as it is available, then the instrument switches to the internal reference (Spectrum mode only)

\*RST: INT

**Example:**

SOUR:EXT:ROSC EXT  
Switches to external reference oscillator

**Mode:** A, NF

**Manual operation:** See "Reference" on page 462

**SOURce<n>:EXTernal<generator>[:STATe] <State>**

This command activates or deactivates the external generator indicated by the suffix <generator>.

This command is only valid for the External Tracking Generator option (R&S FSV-B10).

**Suffix:**

<n> irrelevant

<generator> 1 | 2  
external generator

**Parameters:**

<State> ON | OFF

\*RST: OFF

**Example:**

```
SYST:COMM:RDEV:GEN1:TYPE 'SMP02'
```

Selects SMP02 as generator 1.

```
"SYST:COMM:RDEV:GEN1:LINK TTL"
```

Selects GPIB + TTL link as interface.

```
"SYST:COMM:RDEV:GEN1:ADDR 28"
```

Sets the generator address to 28.

```
"SOUR:EXT1:FREQ:SWE ON"
```

Activates the frequency sweep for generator 1.

```
"SOUR:EXT ON"
```

Activates the external generator

**Manual operation:** See "[Source RF Internal \(On/ Off\)](#)" on page 448

---

**SYSTem:COMMunicate:GPIB:RDEvice:GENerator<generator>:ADDRess**  
<Number>

Changes the IEC/IEEE-bus address of the external tracking generator.

This command is only available if the R&S FSV-B10 option (External Tracking Generator) is installed.

**Suffix:**

<generator>            1 | 2  
                          tracking generator  
                          For Noise Figure measurements (K30): 1 only

**Parameters:**

<Number>            Range:     0 to 30  
                          \*RST:     28

**Example:**

SYST:COMM:GPIB:RDEV:GEN1:ADDR 15

**Mode:**            A, NF

---

**SYSTem:COMMunicate:RDEvice:GENerator<generator>:INTerface <Type>**

Defines the interface used for the connection to the external tracking generator.

This command is only available if the R&S FSV-B10 option (External Tracking Generator) is installed.

**Suffix:**

<generator>            1 | 2  
                          tracking generator  
                          For Noise Figure measurements (K30): 1 only

**Parameters:**

<Type>            GPIB | TCPip  
                          \*RST:     GPIB

**Example:**

SYST:COMM:RDEV:GEN1:INT TCP

**Mode:**            A, NF

**Manual operation:** See "[Interface](#)" on page 462

---

**SYSTem:COMMunicate:RDEvice:GENerator<generator>:LINK <Type>**

This command selects the link type of the external generator if the GPIB interface is used.

The difference between the two GPIB operating modes is the execution speed. While, during GPIB operation, each frequency to be set is transmitted to the generator separately, a whole frequency list can be programmed in one go if the TTL interface is also used. Frequency switching can then be performed per TTL handshake which results in considerable speed advantages.

**Notes:** Only one of the two generators can be operated via the TTL interface at a time. The other generator must be configured via GPIB.

For Noise Figure measurements (K30), TTL synchronization has no effect.

This command is only available if the R&S FSV-B10 option (External Tracking Generator) is installed.

**Suffix:**

<generator>            1 | 2  
                              tracking generator  
                              For Noise Figure measurements (K30): 1 only

**Parameters:**

<Type>                    GPIB | TTL

**GPIB**  
GPIB connection without TTL synchronization (for all generators of other manufacturers and some Rohde & Schwarz devices)

**TTL**  
GPIB connection with TTL synchronization (if available; for most Rohde&Schwarz devices)

\*RST:                    GPIB

**Example:**

SYST:COMM:RDEV:GEN:LINK TTL  
Selects GPIB + TTL interface for generator operation.

**Mode:**                    A, NF

**Manual operation:**    See "[TTL Synchronization](#)" on page 462  
                                  See "[Address](#)" on page 462

---

**SYSTem:COMMunicate:RDEVice:GENerator<generator>:TYPE <Name>**

This command selects the type of external generator. For a list of the available generator types including the associated interface, see [Chapter 8.2.1, "Overview of Generators Supported by the R&S ESRP"](#), on page 453.

If no external generator type is currently configured, the query returns "NONE".

This command is only available if the R&S FSV-B10 option (External Tracking Generator) is installed.

**Suffix:**

<generator>            1 | 2  
                              tracking generator  
                              For Noise Figure measurements (K30): 1 only

**Parameters:**

<Name> Generator name | NONE  
 \*RST: NONE

**Example:**

SYST:COMM:RDEV:GEN2:TYPE 'SME02'  
 Selects SME02 as generator 2

**Mode:** A, NF

**Manual operation:** See "Type" on page 461

## 11.8 Common Commands

Common commands are described in the IEEE 488.2 (IEC 625-2) standard. These commands have the same effect and are employed in the same way on different devices. The headers of these commands consist of "\*" followed by three letters. Many common commands are related to the Status Reporting System.

Available common commands:

*CAL?	883
*CLS	884
*ESE	884
*ESR?	884
*IDN?	884
*IST?	884
*OPC	885
*OPT?	885
*PCB	885
*PRE	885
*PSC	885
*RST	886
*SRE	886
*STB?	886
*TRG	886
*TST?	886
*WAI	887

---

### \*CAL?

Calibration query

Initiates a calibration of the instrument and subsequently queries the calibration status. Responses > 0 indicate errors.

**Note:** If you start a self-alignment remotely, then select the "Local" softkey while the alignment is still running, the instrument only returns to the manual operation state after the alignment is completed.

**Usage:** Query only

**Manual operation:** See "Self Alignment" on page 482

---

**\*CLS**

Clear status

Sets the status byte (STB), the standard event register (ESR) and the `EVENT` part of the `QUESTIONABLE` and the `OPERATION` registers to zero. The command does not alter the mask and transition parts of the registers. It clears the output buffer.

**Usage:**                   Setting only

---

**\*ESE <Value>**

Event status enable

Sets the event status enable register to the specified value. The query returns the contents of the event status enable register in decimal form.

**Parameters:****<Value>**                   Range:     0 to 255

---

**\*ESR?**

Event status read

Returns the contents of the event status register in decimal form and subsequently sets the register to zero.

**Return values:****<Contents>**               Range:     0 to 255**Usage:**                   Query only

---

**\*IDN?**

Identification

Returns the instrument identification.

**Usage:**                   Query only**Manual operation:** See "[\\*IDN Format Leg./New](#)" on page 489See "[Versions+Options](#)" on page 495

---

**\*IST?**

Individual status query

Returns the contents of the IST flag in decimal form. The IST flag is the status bit which is sent during a parallel poll.

**Return values:****<ISTflag>**               0 | 1**Usage:**                   Query only

---

**\*OPC**

Operation complete

Sets bit 0 in the event status register when all preceding commands have been executed. This bit can be used to initiate a service request. The query form writes a "1" into the output buffer as soon as all preceding commands have been executed. This is used for command synchronization.

---

**\*OPT?**

Option identification query

Queries the options included in the instrument. For a list of all available options and their description refer to the data sheet.

**Usage:** Query only

**Manual operation:** See "[Versions+Options](#)" on page 495

---

**\*PCB <Address>**

Pass control back

Indicates the controller address to which remote control is returned after termination of the triggered action.

**Setting parameters:**

<Address> Range: 0 to 30

**Usage:** Setting only

---

**\*PRE <Value>**

Parallel poll register enable

Sets parallel poll enable register to the indicated value. The query returns the contents of the parallel poll enable register in decimal form.

**Parameters:**

<Value> Range: 0 to 255

---

**\*PSC <Action>**

Power on status clear

Determines whether the contents of the `ENABLE` registers are preserved or reset when the instrument is switched on. Thus a service request can be triggered when the instrument is switched on, if the status registers ESE and SRE are suitably configured. The query reads out the contents of the "power-on-status-clear" flag.

**Parameters:**

<Action> 0 | 1



**0**

The contents of the status registers are preserved.

**1**

Resets the status registers.

---

**\*RST**

Reset

Sets the instrument to a defined default status. The default settings are indicated in the description of commands.

The command is equivalent to `SYSTem:PRESet`.

**Usage:**                   Setting only

---

**\*SRE <Contents>**

Service request enable

Sets the service request enable register to the indicated value. This command determines under which conditions a service request is triggered.

**Parameters:**

<Contents>                   Contents of the service request enable register in decimal form.  
Bit 6 (MSS mask bit) is always 0.  
Range:           0 to 255

---

**\*STB?**

Status byte query

Reads the contents of the status byte in decimal form.

**Usage:**                   Query only

---

**\*TRG**

Trigger

Triggers all actions waiting for a trigger event. In particular, \*TRG generates a manual trigger signal. This common command complements the commands of the `TRIGger` subsystem.

**Usage:**                   Event

---

**\*TST?**

Self-test query

Initiates self-tests of the instrument and returns an error code

**Note:** If you start a self-test remotely, then select the "Local" softkey while the test is still running, the instrument only returns to the manual operation state after the test is completed. In this case, the self-test cannot be aborted.

**Return values:**

<ErrorCode>            **integer > 0 (in decimal format)**  
 An error occurred.  
 (For details see the Service Manual supplied with the instrument).  
**0**  
 No errors occurred.

**Usage:**                Query only

**Manual operation:**   See "Selftest" on page 498

---

**\*WAI**

Wait to continue

Prevents servicing of the subsequent commands until all preceding commands have been executed and all signals have settled (see also command synchronization and \*OPC).

**Usage:**                Event

## 11.9 System Configuration

- [General System Configuration](#).....887
- [Checking the System Configuration](#).....893
- [Coupling Parameters](#).....895
- [Controlling In- and Outputs](#).....899
- [Configuring the Reference Frequency](#).....902
- [Calibrating the R&S ESRP](#).....903
- [Using Service Functions](#).....906

### 11.9.1 General System Configuration

<a href="#">SYSTem:APPLication:SRECovery[:STATe]</a> .....	888
<a href="#">SYSTem:CLOGging</a> .....	888
<a href="#">SYSTem:COMPatible</a> .....	888
<a href="#">SYSTem:DISPlay:UPDate</a> .....	889
<a href="#">SYSTem:FIRMware:UPDate</a> .....	889
<a href="#">SYSTem:FORMat:IDENt</a> .....	889
<a href="#">SYSTem:KLOCK</a> .....	890
<a href="#">SYSTem:PRESet</a> .....	890
<a href="#">SYSTem:PRESet:COMPatible</a> .....	890
<a href="#">SYSTem:REBoot</a> .....	891
<a href="#">SYSTem:SHUTdown</a> .....	891

SYSTem:SPEaker:VOLume.....	891
SYSTem:TIME.....	891
SYSTem:TIME:TSTamp?.....	891
SYSTem:VERSion?.....	891
SYSTem:DISPlay:FPANel.....	892
SYSTem:DEVice:ID?.....	892
SYSTem:DATE.....	892

---

### SYSTem:APPLication:SRECovery[:STATe] <State>

Controls instrument behavior when switching between measurement applications, e.g. from "Spectrum" to "Analog Demod" and back.

If activated, the current instrument settings are stored when you switch to a different application. When you switch back to the previous application, the corresponding instrument settings are restored. Thus, the settings of the individual applications are independent of each other.

If deactivated (default), only a few parameters of the current instrument setting are passed between applications (e.g. center frequency, level settings).

Note that although the default value is "OFF", this parameter is not reset using the [PRESET] key. Thus it must be deactivated manually, if necessary.

#### Parameters:

<State>                    ON | OFF  
                               \*RST:        OFF (not restored using the "PRESET" function)

**Example:**                SYST:APPL:SREC ON

**Manual operation:**    See "[Application Setup Recovery](#)" on page 497

---

### SYSTem:CLOGging <State>

This command turns logging of remote commands on and off.

#### Parameters:

<State>                    **ON**  
                               Writes all remote commands that have been sent to a file.  
                               The destination is C:  
                               \R\_S\instr\ScpiLogging\ScpiLog.txt.  
                               **OFF**  
                               \*RST:        OFF

**Manual operation:**    See "[I/O Logging \(On/Off\)](#)" on page 489

---

### SYSTem:COMPatible <Mode>

Sets the device in a state compatible to previous R&S signal analyzers, e.g. regarding the number of sweep points.

#### Parameters:

<Mode>                    DEFault | FSU | FSP

<b>Example:</b>	SYST:COMP FSP
<b>Usage:</b>	SCPI confirmed
<b>Manual operation:</b>	See " <a href="#">Compatibility Mode</a> " on page 485 See " <a href="#">Mode Default</a> " on page 486 See " <a href="#">Mode R&amp;S FSP</a> " on page 486 See " <a href="#">Mode R&amp;S FSU</a> " on page 486

### SYSTem:DISPlay:UPDate <State>

In remote control mode, this command switches on or off the instrument display. If switched on, only the diagrams, traces and display fields are displayed and updated.

The best performance is obtained if the display output is switched off during remote control.

#### Parameters:

<State> ON | OFF  
\*RST: OFF

**Example:** SYST:DISP:UPD ON

**Manual operation:** See "[Display Update \(On/Off\)](#)" on page 488

### SYSTem:FIRMware:UPDate

This command starts a firmware update using the \*.msi files in the selected directory. The default path is D:\FW\_UPDATE. The path is changed via the [MMEMory:COMMENT](#) command. To store the update files the [MMEMory:DATA](#) command is used.

Only user accounts with administrator rights can perform a firmware update.

**Example:** SYST:FIRM:UPD 'D:\FW\_UPDATE'  
Starts the firmware update from directory "D:\FW\_UPDATE".

**Usage:** Event

**Manual operation:** See "[Firmware Update](#)" on page 496

### SYSTem:FORMat:IDENT <Format>

This command defines the response format to the [\\*IDN?](#) on page 884 command. This function is intended for re-use of existing control programs together with the R&S ESRP.

#### Parameters:

<Format> FSL | LEGacy | NEW  
**LEGacy**  
Format is compatible to the R&S FSP/FSU/FSQ family  
**NEW**  
R&S ESRP format

**FSL**

Format is compatible to the R&S FSL family

\*RST: not reset!

**Example:**

SYST:FORM:IDEN LEG

Adapts the return value of \*IDN? to the R&S FSP/FSU/FSQ family.

**Manual operation:** See "[\\*IDN Format Leg./New](#)" on page 489

**SYSTem:KLOCK <State>**

This command activates the local lockout (remote control) or returns to the local mode.

**Parameters:**

<State>

**ON**

LLO (local lockout)

**OFF**

GTL (go to local)

\*RST: OFF

**Example:**

SYST:KLOCK ON

Activates LLO (remote control)

**SYSTem:PRESet**

This command initiates an instrument reset.

The effect of this command corresponds to that of the **PRESET** key with manual operation or to the \*RST command. For details on preset settings refer to [Chapter 6.2.1, "Initializing the Configuration – PRESET Key"](#), on page 313.

**Example:**

SYST:PRES

**Usage:**

SCPI confirmed

**SYSTem:PRESet:COMPAtible <Mode>**

This command selects the type of settings that are restored when you preset the instrument.

**Parameters:**

<Mode>

**RECeiver**

Restore the default settings defined for Receiver mode.

**SANalyzer**

Restore the default settings defined for Spectrum mode.

**Manual operation:**

See "[Preset Receiver](#)" on page 497

See "[Preset Spectrum](#)" on page 497

---

**SYSTem:REBoot**

This command reboots the instrument, including the operating system.

**Usage:** Event

---

**SYSTem:SHUTdown**

This command shuts down the instrument.

**Usage:** Event

---

**SYSTem:SPEaker:VOLume <Volume>**

This command defines the volume of the built-in loudspeaker for demodulated signals.

**Parameters:**

<Volume> Range: 0 to 1  
\*RST: 0.5

**Example:** SYST:SPE:VOL 0  
Switches the loudspeaker to mute.

---

**SYSTem:TIME <Time>**

This command sets the internal clock. The sequence of entry is hour, minute, second.

Only user accounts with administrator rights are able to set the time.

**Parameters:**

<Time> 0 to 23, 0 to 59, 0 to 59

**Example:** SYST:TIME 12,30,30

**Usage:** SCPI confirmed

**Manual operation:** See "[Time+Date](#)" on page 489

---

**SYSTem:TIME:TSTamp?**

This command queries the time and date from the internal real time clock.

**Return values:**

<TimeStamp>

**Example:** SYST:TIME:TSTamp?

**Usage:** Query only

---

**SYSTem:VERSion?**

This command queries the number of the SCPI version, which is relevant for the instrument.

This command is a query and therefore has no \*RST value.

**Example:**                `SYST:VERS?`

**Usage:**                Query only  
                             SCPI confirmed

#### **SYSTem:DISPlay:FPANel <State>**

This command activates or deactivates the display of the front panel keys on the screen.

With the display activated, the instrument can be operated on the screen using the mouse by pressing the corresponding buttons.

**Parameters:**

<State>                ON | OFF  
                             \*RST:        OFF

**Example:**                `SYST:DISP:FPAN ON`

**Manual operation:**    See "[Soft Frontpanel](#)" on page 490

#### **SYSTem:DEVice:ID?**

Returns the unique ID of the R&S ESRP instrument.

**Example:**                `SYST:DEV:ID?`  
                             `1307.9002K07-100123-aZ`

**Usage:**                Query only  
                             SCPI confirmed

**Manual operation:**    See "[Versions+Options](#)" on page 495

#### **SYSTem:DATE <Date>**

This command is used to enter the date for the internal calendar.

The sequence of entry is year, month, day.

Only user accounts with administrator rights can set the date.

**Parameters:**

<Date>                1980 to 2099, 1 to 12, 1 to 31

**Example:**                `SYST:DATE 2000,6,1`

**Usage:**                SCPI confirmed

**Manual operation:**    See "[Time+Date](#)" on page 489

## 11.9.2 Checking the System Configuration

DIAGnostic<n>:SERvice:BIOSinfo?	893
DIAGnostic<n>:SERvice:HWInfo?	893
DIAGnostic<n>:SERvice:VERSinfo?	894
SYSTem:IDENtify:FACTory	894
SYSTem:IDENtify[:STRing]	894
SYSTem:ERRor:CLEar:ALL	894
SYSTem:ERRor:LIST?	895
SYSTem:ERRor[:NEXT]?	895

---

### DIAGnostic<n>:SERvice:BIOSinfo?

This command queries the CPU board BIOS version.

**Suffix:**

<n> irrelevant

**Return values:**

<Version> ASCII string containing the BIOS version, e.g. 47.11.

**Example:**

DIAG:SERV:BIOS?  
Returns the BIOS version.

**Usage:**

Query only

---

### DIAGnostic<n>:SERvice:HWInfo?

This command queries the hardware information.

**Suffix:**

<n> irrelevant

**Return values:**

<HardwareInfo> "<component 1>|<serial #>|<order #>|<model>| <hardware code>|<revision>|<subrevision>",  
"<component 2>|<serial #>|<order #>|<model>| <hardware code>|<revision>|<subrevision>",  
...  
Table lines are output as string data and are separated by commas. The individual columns of the table are separated from each other by |.

**Example:**

DIAG:SERV:HWIN?  
Queries the hardware information.  
"FRONTEND|100001/003|1300.3009|03|01|00|00",  
"MOTHERBOARD|123456/002|1300.3080|02|00|00|00",  
...

**Usage:**

Query only

**Manual operation:** See "[Hardware Info](#)" on page 495



---

**DIAGnostic<n>:SERvice:VERSinfo?**

This command queries information about the hardware and software components.

**Suffix:**

<n> irrelevant

**Return values:**

<Information> String containing the version of hardware and software components including the types of licenses for installed firmware options.

**Usage:** Query only  
SCPI confirmed

---

**SYSTem:IDENTify:FACTory**

Resets the response to the \*IDN? query to the default value, e.g. after a user string was defined using the [ID String User](#) softkey.

**Example:**           SYST:IDEN:FACT  
                  \*IDN?  
                  **Response:**  
                  Rohde&Schwarz,R&S ESRP-7,1307.9002K07/101768,  
                  1.05

**Usage:** Event  
SCPI confirmed

**Manual operation:** See "[ID String Factory](#)" on page 485

---

**SYSTem:IDENTify[:STRing] <String>**

Sets the response to the \*IDN? query to the defined string, e.g. after the default value was reset using the [ID String Factory](#) softkey.

**Parameters:**

<String>

**Example:**           Set the response to 'MyDevice':  
                  SYST:IDEN:STR 'MyDevice'  
                  **Query the response:**  
                  SYST:IDEN:STR?  
                  **Response:**  
                  MyDevice

**Usage:** SCPI confirmed

**Manual operation:** See "[ID String User](#)" on page 485

---

**SYSTem:ERRor:CLEar:ALL**

This command deletes all entries in the table SYSTEM MESSAGES.

**Example:**                `SYST:ERR:CLE:ALL`

**Usage:**                Event

**Manual operation:**   See "[Clear All Messages](#)" on page 496

#### **SYSTem:ERRor:LIST?**

This command reads all system messages and returns a list of comma separated strings. Each string corresponds to an entry in the table SYSTEM MESSAGES.

If the error list is empty, an empty string " " is returned.

This command is a query and therefore has no \*RST value.

**Example:**                `SYST:ERR:LIST?`

**Usage:**                Query only

**Manual operation:**   See "[System Messages](#)" on page 495

#### **SYSTem:ERRor[:NEXT]?**

This command queries the earliest error queue entry and deletes it.

Positive error numbers indicate device-specific errors, negative error numbers are error messages defined by SCPI. If the error queue is empty, the error number 0, "No error", is returned.

This command is a query and therefore has no \*RST value.

**Example:**                `STAT:ERR?`

**Usage:**                Query only  
SCPI confirmed

### **11.9.3 Coupling Parameters**

<a href="#">INSTrument:COUPle:ATTen</a> .....	896
<a href="#">INSTrument:COUPle:BANDwidth</a> .....	896
<a href="#">INSTrument:COUPle:CENTer</a> .....	896
<a href="#">INSTrument:COUPle:DEMod</a> .....	897
<a href="#">INSTrument:COUPle:GAIN</a> .....	897
<a href="#">INSTrument:COUPle:LIMit</a> .....	897
<a href="#">INSTrument:COUPle:MARKer</a> .....	898
<a href="#">INSTrument:COUPle:PRESel</a> .....	898
<a href="#">INSTrument:COUPle:PROT</a> .....	898
<a href="#">INSTrument:COUPle:SPAN</a> .....	899

---

**INSTrument:COUPle:ATTen** <State>

This command turns synchronization of the attenuation and unit between measurement channels on and off.

**Parameters:**

<State>                   **ALL | 1**  
Turns on synchronization.  
**NONE | 0**  
Turns off synchronization.  
**\*RST:           ALL**

**Example:**               INST:COUP:ATT ALL  
Synchronizes the attenuation.

---

**INSTrument:COUPle:BANDwidth** <State>

This command turns synchronization of the resolution bandwidth (and filter type) between measurement channels on and off.

**Parameters:**

<State>                   **ALL | 1**  
Turns on synchronization.  
**NONE | 0**  
Turns on synchronization.  
**\*RST:           NONE**

**Example:**               INST:COUP:BWID ALL  
Synchronizes the resolution bandwidth.

---

**INSTrument:COUPle:CENTer** <State>

This command turns synchronization of the frequency between measurement channels on and off.

**Parameters:**

<State>                   **ALL | 1**  
Turns on synchronization.  
**NONE | 0**  
Turns off synchronization.  
**\*RST:           ALL**

**Example:**               INST:COUP:CENT ALL  
Synchronizes the receiver (or center) frequency.

---

**INSTrument:COUPle:DEMod** <State>

This command turns synchronization of the audio demodulator configuration between measurement channels on and off.

**Parameters:**

<State>                   **ALL | 1**  
Turns on synchronization.  
**NONE | 0**  
Turns off synchronization.  
\*RST:           NONE

**Example:**

INST:COUP:DEM ALL  
Synchronizes the audio demodulator configuration.

---

**INSTrument:COUPle:GAIN** <State>

This command turns synchronization of the preamplifier configuration between measurement channels on and off.

**Parameters:**

<State>                   **ALL | 1**  
Turns on synchronization.  
**NONE | 0**  
Turns off synchronization.  
\*RST:           NONE

**Example:**

INST:COUP:GAIN ALL  
Synchronizes the preamplifier configuration.

---

**INSTrument:COUPle:LIMit** <State>

This command turns synchronization of limit lines between measurement channels on and off.

**Parameters:**

<State>                   **ALL | 1**  
Turns on synchronization.  
Limit lines have to be compatible to the x-axis and y-axis configuration for successful synchronization.  
**NONE | 0**  
Turns off synchronization.  
\*RST:           ALL

**Example:**

INST:COUP:LIM ALL  
Synchronizes the limit lines.

---

**INSTrument:COUPlE:MARKer** <State>

This command turns synchronization of the marker frequency between measurement channels on and off.

**Parameters:**

<State>                   **ALL | 1**  
Turns on synchronization.

**NONE | 0**  
Turns off synchronization.

\*RST:                   NONE

**Example:**

INST:COUP:MARK ALL  
Synchronizes the receiver frequency and the marker frequency.

---

**INSTrument:COUPlE:PRESel** <State>

This command turns synchronization of the preselector state between measurement channels on and off.

Note that it is not possible to turn off the preselector in receiver mode. Thus, the preselector is always turned on when you enter receiver mode.

**Parameters:**

<State>                   **ALL | 1**  
Turns on synchronization.

**NONE | 0**  
Turns off synchronization.

\*RST:                   ALL

**Example:**

INST:COUP:PRES ALL  
Synchronizes the preselector configuration.

---

**INSTrument:COUPlE:PROT** <State>

This command turns synchronization of the input protection between measurement channels on and off.

(→ 10 dB Min)

**Parameters:**

<State>                   **ALL | 1**  
Turns on synchronization.

**NONE | 0**  
Turns off synchronization.

\*RST:                   NONE

**Example:**

INST:COUP:PROT ALL  
Synchronizes the "10 dB Min" parameter.

**INSTrument:COUPle:SPAN** <State>

This command turns synchronization of the start and stop frequency between measurement channels on and off.

**Parameters:**

<State>                   **ALL | 1**  
Turns on synchronization.

**NONE | 0**  
Turns off synchronization.

\*RST:                   NONE

**Example:**

INST:COUP:SPAN ALL  
Synchronizes the start and stop frequency.

**11.9.4 Controlling In- and Outputs**

DIAGnostic<n>:SERvice:NSource.....	899
INPut:PRESelection:STATE.....	899
INPut<ip>:UPORt:STATE.....	900
INPut<ip>:UPORt[:VALue].....	900
OUTPut:IF[:SOURce].....	900
OUTPut:TRIGger.....	901
OUTPut:UPORt:STATE.....	901
OUTPut:UPORt[:VALue].....	901

**DIAGnostic<n>:SERvice:NSource** <State>

This command switches the 28 V supply of the noise source on the front panel on or off.

**Suffix:**

<n>                   irrelevant

**Parameters:**

<State>                   ON | OFF

\*RST:                   OFF

**Example:**

DIAG:SERV:NSO ON

**Manual operation:** See "Noise Source" on page 355

**INPut:PRESelection:STATE** <State>

This command turns the preselector on and off.

The command is available with option R&S ESRP-B2.

**Parameters:**

<State>                   ON | OFF

\*RST:                   ON

**Example:** `INP:PREs:STAT OFF`  
Turns off the preselector.

**Manual operation:** See "[Preselector \(On Off\)](#)" on page 355

#### **INPut<ip>:UPORt:STATe <State>**

This command toggles the control lines of the user ports for the **AUX PORT** connector. This 9-pole SUB-D male connector is located on the rear panel of the R&S ESRP.

See the R&S ESRP Getting Started manual for details.

**Suffix:**

<ip> 1 | 2  
irrelevant

**Parameters:**

<State> **ON | 1**  
User port is switched to INPut  
**OFF | 0**  
User port is switched to OUTPut  
\*RST: 1

**Manual operation:** See "[User Port](#)" on page 163

#### **INPut<ip>:UPORt[:VALue]**

This command queries the control lines of the user ports.

For details see [OUTPut:UPORt\[:VALue\]](#) on page 901.

**Suffix:**

<ip> 1 | 2  
irrelevant

**Example:** `INP:UPOR?`  
`//Result: #B00100100`  
Pins 5 and 7 are active.

**Manual operation:** See "[User Port](#)" on page 163

#### **OUTPut:IF[:SOURce] <Source>**

This command selects the source of the IF output.

**Parameters:**

<Source> **IF**  
Outputs the intermediate frequency.  
**OFF**  
Turns off the output of a signal.  
**VIDeo**  
Outputs the video signal (200 mV).

\*RST: IF

**Example:**            OUTP:IF VID  
Selects the video signal for the IF output connector.

**Manual operation:** See "[Video Output](#)" on page 355

#### OUTPut:TRIGger <PortLevel>

This command selects level of the Trigger Out port. Thus, you can trigger an additional device via the external trigger port, for example.

**Parameters:**

<PortLevel>            LOW | HIGH  
\*RST:                 LOW

**Example:**            OUTP:TRIG HIGH

**Manual operation:** See "[Trigger Out](#)" on page 355

#### OUTPut:UPORt:STATe <State>

This command toggles the control lines of the user ports for the **AUX PORT** connector. This 9-pole SUB-D male connector is located on the rear panel of the R&S ESRP.

**Parameters:**

<State>                **ON | 1**  
User port is switched to OUTPut  
**OFF | 0**  
User port is switched to INPut  
\*RST:                 0

**Manual operation:** See "[User Port](#)" on page 163

#### OUTPut:UPORt[:VALue] <Value>

This command sets the control lines of the user ports.

The assignment of the pin numbers to the bits is as follows:

Bit	7	6	5	4	3	2	1	0
Pin	N/A	N/A	5	3	4	7	6	2

Bits 7 and 6 are not assigned to pins and must always be 0.

The user port is written to with the given binary pattern. If the user port is programmed to input instead of output (see [INPut<ip>:UPORt:STATe](#) on page 900), the output value is temporarily stored.



**Parameters:**

<Value> bit values in hexadecimal format  
 TTL type voltage levels (max. 5V)  
 Range: #B00000000 to #B00111111

**Example:**

OUTP:UPOR #B00100100  
 Sets pins 5 and 7 to 5 V.

**Manual operation:** See "User Port" on page 163

## 11.9.5 Configuring the Reference Frequency

[SENSe:]ROSCillator:EXTernal:FREQuency.....	902
[SENSe:]ROSCillator:SOURce.....	902
[SENSe:]ROSCillator:SOURce:EAUTO?.....	903

---

### [SENSe:]ROSCillator:EXTernal:FREQuency <Frequency>

This command defines the frequency of the external reference oscillator.

If the external reference oscillator is selected, the reference signal must be connected to the rear panel of the instrument.

**Parameters:**

<Frequency> Range: 1 MHz to 20 MHz

**Example:**

ROSC:EXT:FREQ 13  
 Sets the frequency to 13 MHz.  
 SOUR:EXT:ROSC:EXT:FREQ 13

**Usage:**

SCPI confirmed

---

### [SENSe:]ROSCillator:SOURce <Source>

This command selects the reference oscillator.

If the external reference oscillator is selected, the reference signal must be connected to the rear panel of the instrument.

**Parameters:**

<Source> **INTernal**  
 The internal reference is used (10 MHz)

**EXTernal**  
 The external reference is used; if none is available, an error flag is displayed in the status bar

**EAUTO**  
 The external reference is used as long as it is available, then the instrument switches to the internal reference

**Example:**

ROSC:SOUR EXT

**Usage:**

SCPI confirmed

**Manual operation:** See "Reference Int/Ext" on page 478  
 See "Show Error Flag" on page 478  
 See "Auto select Reference" on page 478

---

#### [SENSe:]ROSCillator:SOURce:EAUTO?

This command queries the current reference type in case you have activated an automatic switch to the internal reference if the external reference is missing.

#### Return values:

<Reference>           **INT**  
                           internal reference  
                           **EXT**  
                           external reference

**Example:**           SENS:ROSC:SOUR:EAUT?  
 Queries the currently available reference type.

**Usage:**             Query only

## 11.9.6 Calibrating the R&S ESRP

CALibration:ABORt.....	903
CALibration[:ALL]?	903
CALibration:RESult?	904
CALibration:STATe.....	904
DIAGnostic<n>:SERVice:INPut:PULSed:CFRequency.....	904
DIAGnostic<n>:SERVice:INPut[:SElect].....	905
DIAGnostic<n>:SERVice:STESt:RESult?.....	905
DIAGnostic<n>:SERVice:TEMPerature:FRONt?.....	906

---

#### CALibration:ABORt

This command aborts the current calibration routine.

**Example:**           CAL:ABORt  
 Aborts calibration.

**Usage:**             Event  
                           SCPI confirmed

---

#### CALibration[:ALL]?

This command initiates a calibration routine and queries if calibration was successful.

During the acquisition of correction data the instrument does not accept any remote control commands.

In order to recognize when the acquisition of correction data is completed, the MAV bit in the status byte can be used. If the associated bit is set in the Service Request Enable Register, the instrument generates a service request after the acquisition of correction data has been completed.

**Return values:**

<CalibrationState> **0**  
The command returns a '0' if calibration was successful.

**Example:**

```
*CLS
Resets the status management.
*SRE 16
Enables MAV bit in the Service Request Enable Register.
*CAL?
Starts the correction data recording, and then a service request
is generated.
```

**Usage:**

Query only  
SCPI confirmed

**CALibration:RESult?**

This command returns the results collected during calibration.

**Return values:**

<CalibrationData> String containing the calibration data.

**Example:**

```
CAL:RES?
would return, e.g.
Total Calibration Status:
PASSED, Date (dd/mm/yyyy): 12/07/2004,
Time: 16:24:54, Runtime: 00.06
```

**Usage:**

Query only

**Manual operation:** See "[Show Align Results](#)" on page 483

**CALibration:STATe <State>**

This command includes or excludes calibration data in the actual measurement.

**Parameters:**

<State> ON | OFF

**Example:**

```
CAL:STAT OFF
Sets up the instrument to ignore the calibration data.
```

**Usage:**

SCPI confirmed

**DIAGnostic<n>:SERVice:INPut:PULSed:CFrequency <Frequency>**

This command defines the frequency of the calibration signal.

Before you can use the command, you have to feed in a calibration signal with [DIAGnostic<n>:SERvice:INPut\[:SElect\]](#) on page 905.

**Suffix:**

<n> irrelevant

**Parameters:**

<Frequency> Possible frequencies of the calibration signal are fix. If you define a frequency that is not available, the R&S ESRP uses the next available frequency. Example: a frequency of 20 MHz is rounded up to the next available frequency (21.33 MHz).

\*RST: 64 MHz

**Example:**

DIAG:SERV:INP:PULS:CFR 128 MHz

Defines a calibration signal frequency of 128 MHz.

**Usage:**

SCPI confirmed

**Manual operation:** See "[Calibration Frequency RF](#)" on page 498

**DIAGnostic<n>:SERvice:INPut[:SElect] <Signal>**

This command selects the source of the signal.

You can feed in a signal from the RF input or the calibration signal.

**Suffix:**

<n> irrelevant

**Parameters:**

<Signal> **RF**  
RF input

**CALibration**  
Calibration

\*RST: RF

**Example:**

DIAG:SERV:INP CAL

Selects the calibration signal as the input signal

**Manual operation:** See "[RF](#)" on page 498

**DIAGnostic<n>:SERvice:STESt:RESult?**

This command queries the self test results.

**Suffix:**

<n> irrelevant

**Parameters:**

<Results> String of data containing the results.  
The rows of the self test result table are separated by commas.

**Example:** `DIAG:SERV:STES:RES?`  
 would return, e.g.:  
 "Total Selftest Status:  
 PASSED", "Date (dd/mm/yyyy): 09/07/2004 TIME:  
 16:24:54", "Runtime: 00:06", "..."

**Usage:** Query only

**Manual operation:** See "[Selftest Results](#)" on page 498

---

#### **DIAGnostic<n>:SERVice:TEMPerature:FRONT?**

This command queries the temperature of the frontend.

**Parameters:**

<Temperature> Temperature of the frontend.

**Example:** `DIAG:SERV:TEMP:FRON?`

**Usage:** Query only

### 11.9.7 Using Service Functions

<a href="#">DIAGnostic&lt;n&gt;:SERVice:SFUNction</a> .....	906
<a href="#">DIAGnostic&lt;n&gt;:SERVice:SFUNction:LASTresult?</a> .....	907
<a href="#">DIAGnostic&lt;n&gt;:SERVice:SFUNction:RESults:DELete</a> .....	907
<a href="#">DIAGnostic&lt;n&gt;:SERVice:SFUNction:RESults:SAVE</a> .....	907
<a href="#">SYSTem:PASSword:RESet</a> .....	907
<a href="#">SYSTem:PASSword[:CENable]</a> .....	907

---

#### **DIAGnostic<n>:SERVice:SFUNction <ServiceFunction>**

This command starts a service function.

The service functions are available after you have entered the level 1 or level 2 system password.

**Suffix:**

<n> irrelevant

**Parameters:**

<ServiceFunction> String containing the ID of the service function.  
 The ID of the service function is made up out of five numbers, separated by a point.

- function group number
- board number
- function number
- parameter 1 (see the Service Manual)
- parameter 2 (see the Service Manual)

**Example:** `DIAG:SERV:SFUN '2.0.2.12.1'`

**Usage:** Event

**Manual operation:** See ["Service Function"](#) on page 499

---

#### **DIAGnostic<n>:SERvice:SFUNction:LASTresult?**

This command queries the results of the most recent service function you have used.

**Suffix:**

<n> irrelevant

**Example:**

DIAG:SERV:SFUN:LAST?

**Usage:**

Query only

---

#### **DIAGnostic<n>:SERvice:SFUNction:RESults:DELeTe**

This command deletes the results of the most recent service function you have used.

**Suffix:**

<n> irrelevant

**Example:**

DIAG:SERV:SFUN:RES:DEL

**Usage:**

Event

---

#### **DIAGnostic<n>:SERvice:SFUNction:RESults:SAVE <FileName>**

This command saves the results of the most recent service function you have used in a file.

**Suffix:**

<n> irrelevant

**Parameters:**

<FileName> String containing the file name.

**Example:**

DIAG:SERV:SFUN:RES:SAVE "C:\diag"

---

#### **SYSTem:PASSword:RESet**

This command resets the service password.

**Example:**

SYST:PASS:RES

**Usage:**

Event  
SCPI confirmed

**Manual operation:** See ["Reset Password"](#) on page 498

---

#### **SYSTem:PASSword[:CENable] <Password>**

This command enables access to the service functions by means of the password.

**Parameters:**

<Password> <password>

<b>Example:</b>	SYST:PASS XXXX
<b>Usage:</b>	Event SCPI confirmed
<b>Manual operation:</b>	See " <a href="#">Password</a> " on page 499

## 11.10 Data Management

- [Managing Data Files](#)..... 908
- [Saving and Restoring Customized Data](#)..... 913

### 11.10.1 Managing Data Files

<a href="#">MMEMory:CATalog?</a> .....	908
<a href="#">MMEMory:CATalog:LONG?</a> .....	909
<a href="#">MMEMory:CDIRectory</a> .....	910
<a href="#">MMEMory:COMMeNt</a> .....	910
<a href="#">MMEMory:COpy</a> .....	910
<a href="#">MMEMory:DATA</a> .....	911
<a href="#">MMEMory:DELeTe</a> .....	911
<a href="#">MMEMory:MDIRectory</a> .....	912
<a href="#">MMEMory:MOVe</a> .....	912
<a href="#">MMEMory:MSIS</a> .....	912
<a href="#">MMEMory:NAME</a> .....	913
<a href="#">MMEMory:RDIRectory</a> .....	913

---

#### MMEMory:CATalog?

This command reads the indicated directory.

##### Query parameters:

<Path>                    <path>

DOS Path name

The path name should be conform to DOS conventions and may also include the drive name. According to DOS convention, wild-card characters can be entered in order to query e.g. a list of all files of a certain type.

##### Return values:

Result                    List of file names in the form of strings separated by commas

##### Example:

```
MMEM:CAT? 'C:\R_S\Instr\user\*.DFL'
```

Returns all files in C:\R\_S\Instr\user with extension ".DFL"

```
MMEM:CAT? 'C:\R_S\Instr\user\SPOOL?.WMF'
```

Returns all files in C:\R\_S\Instr\user whose names start with SPOOL, have 6 letters and the extension ".WMF".

```
SPOOL1.WMF, SPOOL2.WMF, SPOOL3.WMF
```

**Usage:** Query only  
SCPI confirmed

**Manual operation:** See "Select File" on page 502

---

### MMEMory:CATalog:LONG?

Corresponds to [MMEMory:CATalog?](#) on page 908, but displays extended information on the files contained in the current or specified directory.

This command is an event and therefore has no \*RST value and no query.

#### Query parameters:

**<Path>**                   <path>  
DOS Path name  
The path name should be in conformance with DOS conventions and may also include the drive name.  
Following this value, for each file, a string is listed according to the following syntax:  
"<File name>, <suffix>, <Length of file in bytes>"

#### Return values:

**Result**                   <total number of bytes the directory contains>,"<File name1>, <suffix1>, <Length of file 2 in bytes>","<File name 2>, <suffix2>, <Length of file2 in bytes>","...","<File name n>, <suffix n>, <Length of file n in bytes>"  
  
The response value consists of a list of strings, separated by commas. It begins with the total number of bytes the directory contains. Then the information for each file is returned.  
The <suffix> may be:  
– ASCii  
– BINary  
– STAT

**Example:**               MMEM:CAT:LONG? 'C:\R\_S\Instr\user  
Returns all files in C:\R\_S\Instr\user:  
1776,3331993600, "autolog.txt,ASC,1520",  
"autologin.reg,BIN,144", "no\_autologin.reg,BIN,112"  
Query for the current directory:  
MMEM:CDIR?  
Response:  
C:\R\_S\Instr\user  
MMEM:CAT:LONG?  
Returns all files in C:\R\_S\Instr\user.

**Usage:** Query only  
SCPI confirmed



**MMEMory:CDIRectory** <Directory>

This command changes the current directory.

**Parameters:**

<Directory>                    <directory\_name>

**<directory\_name>**

DOS path name

In addition to the path name, the indication of the directory may contain the drive name. The path name complies with the DOS conventions.

**Example:**                    MMEM:CDIR 'C:\R\_S\Instr\user'  
Selects the directory C:\R\_S\Instr\user.

**Usage:**                    SCPI confirmed

**Manual operation:**    See ["Edit Path"](#) on page 505

**MMEMory:COMMent** <Comment>

This command defines a comment for the stored settings.

**Parameters:**

<Comment>

**Example:**                    MMEMory:COMMent "ACP measurement with Standard  
Tetra from 23.05."  
MMEMory::MMEMory:STORel:STATe 1, "ACP\_T"  
As a result, in the selection list for recall settings, the comment  
"ACP measurement with Standard Tetra from  
23.05." is added to the ACP entry.

**Usage:**                    SCPI confirmed

**MMEMory:COPI** <FileSource>,<FileDestination>

This command copies the files indicated in <file\_source> to the destination directory indicated with <file\_destination> or to the destination file indicated by <file\_destination> if <file\_source> is just a file.

**Parameters:**

<FileSource>,<FileDestination>,<file\_source> = <file\_name>

**<file\_source>,<file\_destination> = <file\_name>**

DOS file name

The indication of the file name may include the path and the drive name. The file names and path information must be in accordance with the DOS conventions.

**Example:**                    MMEM:COPI 'C:\R\_S\Instr\user\SETUP.CFG', 'E:'

**Usage:**                    Event  
SCPI confirmed

**Manual operation:** See "Copy" on page 506

---

### MMEMory:DATA <FileName>, [<Block>]

This command writes the block data contained in <block> into the file characterized by <file\_name>. The delimiter must be set to EOI to obtain error-free data transfer.

The associated query command reads the indicated file from the mass memory and transfers it to the remote control computer. It should be noted that the buffer memory of the control computer should be large enough to store the file. The setting of the delimiter is irrelevant in this case.

The command is useful for reading stored settings files or trace data from the instrument or for transferring them to the instrument.

#### Parameters:

<FileName>	'<file name>' (file name in single quotes) selects the file to be transferred
<Block>	binary data block with the following structure: #<digit for the length of the length information><length information (number of bytes) for the binary data><binary data>

#### Example:

```
MMEM:DATA 'TEST01.HCP',#216 This is the file
where:
#2: the next 2 characters are the length indication
16: number of subsequent binary data bytes
This is the file: 16 bytes stored as binary data in the file
TEST01.HCP
MMEM:DATA? 'TEST01.HCP'
Transfers the file TEST01.HCP from the instrument to the control computer.
```

**Usage:** SCPI confirmed

---

### MMEMory:DELeTe <FileName>

This command deletes the indicated files.

#### Parameters:

<FileName>	<file_name> = DOS file name The indication of the file name contains the path and, optionally, the drive name. Indication of the path complies with DOS conventions.
------------	-------------------------------------------------------------------------------------------------------------------------------------------------------------------------

#### Example:

```
MMEM:DEL 'TEST01.HCP'
The file TEST01.HCP is deleted.
```

**Usage:** SCPI confirmed

**Manual operation:** See "Delete" on page 506

**MMEMory:MDIRectory** <Directory>

This command creates a new directory. The file name includes indication of the path and may also include the drive name. The path name complies with DOS conventions.

**Parameters:**

<Directory>                    <directory\_name> = DOS path name

**Example:**                    MMEM:MDIR 'C:\R\_S\Instr\user'

**Usage:**                    Event

**Manual operation:**    See "New Folder" on page 505

**MMEMory:MOVE** <FileSource>,<FileDestination>

This command renames existing files, if <file\_destination> contains no path indication. Otherwise the file is moved to the indicated path and stored under the file name specified there, if any.

**Parameters:**

<FileSource>,<FileDestination>,<file\_name> = <file\_name> = DOS file name

The file name includes indication of the path and may also include the drive. The path name complies with DOS conventions.

**Example:**

MMEM:MOVE 'C:\TEST01.CFG', 'SETUP.CFG'

Renames TEST01.CFG in SETUP.CFG in directory C:\.

MMEM:MOVE 'C:\TEST01.CFG', 'C:\R\_S\Instr\user'

Moves TEST01.CFG from C:\ to C:\R\_S\Instr\user.

MMEM:MOVE 'C:\TEST01.CFG', 'C:

\R\_S\Instr\user\SETUP.CFG'

Moves TEST01.CFG from C:\ to C:\R\_S\Instr\user and renames the file in SETUP.CFG.

**Usage:**                    Event  
SCPI confirmed

**Manual operation:**    See "Rename" on page 506

**MMEMory:MSIS** <Device>

This command changes to the drive indicated. The drive may be the internal hard disk C:.

**Parameters:**

<Device>                    <device> = A: | C: ... Z:

\*RST:                    n.a.

The path name complies with DOS conventions.

**Example:**                    MMEM:MSIS 'C: '

**Usage:**                    SCPI confirmed

**Manual operation:** See ["Edit Path"](#) on page 505

---

#### **MMEMory:NAME** <FileName>

This command defines a destination file for the printout started with the [HCOPY\[: IMMEDIATE<1|2>\]](#) on page 931 command. In this case the printer output must be routed to a file as destination.

In receiver mode, the command also defines the name and directory of a test report.

#### **Parameters:**

<FileName>                    <file\_name> = DOS file name  
 The file name includes indication of the path and may also include the drive name. The file name and path information comply with DOS conventions.

**Example:**                    MMEM:NAME 'C:\R\_S\instr\user\PRINT1.BMP'  
 Selects the file name.

**Usage:**                      Event  
                                   SCPI confirmed

**Manual operation:** See ["Configuring and Printing the Test Report"](#) on page 521

---

#### **MMEMory:RDIRectory** <Directory>

This command deletes the indicated directory. The directory name includes indication of the path and may also include the drive name. The path name complies with DOS conventions.

#### **Parameters:**

<Directory>                    <directory\_name> = DOS path name

**Example:**                    MMEM:RDIR 'C:\TEST'

**Usage:**                      Event

**Manual operation:** See ["Delete"](#) on page 506

## 11.10.2 Saving and Restoring Customized Data

<a href="#">MMEMory:CLEar:ALL</a> .....	914
<a href="#">MMEMory:CLEar:STATe 1</a> ,.....	914
<a href="#">MMEMory:LOAD:AUTO</a> .....	914
<a href="#">MMEMory:LOAD:STATe</a> .....	915
<a href="#">MMEMory:STORe:IQ:COMM</a> .....	916
<a href="#">MMEMory:STORe:IQ:STATe</a> .....	916
<a href="#">MMEMory:STORe&lt;n&gt;:STATe</a> .....	916
<a href="#">MMEMory:STORe&lt;n&gt;:STATe:NEXT</a> .....	917

**MMEMory:CLEar:ALL**

This command deletes all instrument configuration files in the current directory.

You can select the directory with `MMEMory:CDIRectory` on page 910. The default directory is `C:\R_S\Instr\user`.

**Example:** `MMEM:CLE:ALL`

**Usage:** Event

**MMEMory:CLEar:STATe 1, <FileName>**

This command deletes the instrument settings file selected by `<file_name>`. All associated files on the mass memory storage are cleared.

**Parameters:**

`<FileName>` 1,<file\_name>  
with `<file_name>` = DOS file name without extension  
The file name includes indication of the path and may also include the drive. The path name complies with DOS conventions.

**Example:** `MMEM:CLE:STAT 1, 'TEST'`

**Usage:** Event

**Manual operation:** See "[Delete File](#)" on page 503

**MMEMory:LOAD:AUTO <Mode>**

This command defines which settings file is automatically loaded after the device is switched on. The contents of the file are read after switching on the device and used to define the new device state.

The settings file defined as auto recall set can also be restored by the `*RST` on page 886 command.

**Parameters:**

`<Mode>` 1,'FACTORY' | 1,'<file\_name>' | with `<file_name>`  
**1,'FACTORY'**  
deactivates the startup recall function  
**1,'<file\_name>'**  
activates the startup recall function and defines the settings file to be loaded  
**with <file\_name>**  
DOS file name with or without extension  
The file name includes indication of the path and may also include the drive name. The path name complies with DOS conventions.

**Example:** `MMEM:LOAD:AUTO 1, 'C:\R_S\Instr\user\TEST'`

**Usage:** Event

**Manual operation:** See "[Startup Recall \(On/Off\)](#)" on page 504

---

### **MMEMory:LOAD:STATe 1, <FileName>**

This command restores and activates an instrument configuration stored in a \*.dfi file.

Note that files with other formats cannot be loaded with this command.

The contents that are reloaded from the file are defined by the last selection made either in the "Save/Recall" dialogs (manual operation) or through the `MMEMory:SELEct[:ITEM]` commands (remote operation; the settings are identical in both cases).

By default, the selection is limited to the user settings ("User Settings" selection in the dialogs, `HWSettings` in SCPI). The selection is not reset by `[Preset]` or `*RST`.

As a consequence, the results of a SCPI script using the `MMEMory:LOAD:STATe` command without a previous `MMEMory:SELEct[:ITEM]` command may vary, depending on previous actions in the GUI or in previous scripts, even if the script starts with the `*RST` command.

It is therefore recommended that you use the appropriate `MMEMory:SELEct[:ITEM]` command before using `MMEMory:LOAD:STATe`.

#### **Parameters:**

1

<FileName> DOS file name with or without extension  
The file name includes indication of the path and may also include the drive name. The path name complies with DOS conventions.

#### **Example:**

```
MMEM:SEL:ALL
//Save all items (User Settings, All Traces, All Limit Lines) from
the R&S ESRP.
MMEM:LOAD:STAT 1, 'C:\R_S\Instr\user\TEST01'
//Reloads all items
In the "Recall" dialog, select only "User Settings" and "All Limit
Lines".
MMEM:LOAD:STAT 1, 'C:\R_S\Instr\user\TEST01'
//Reloads user settings and all limit lines.
*RST
//Reset instrument.
MMEM:LOAD:STAT 1, 'C:\R_S\Instr\user\TEST01'
//Selected items are retained. Reloads user settings and all limit
lines.
Restart the instrument (using the [ON/OFF] key on the front
panel).
MMEM:LOAD:STAT 1, 'C:\R_S\Instr\user\TEST01'
// Selected items are set to default. Reloads only the user set-
tings.
```

**Usage:** SCPI confirmed

**Manual operation:** See "Save File / Recall File" on page 502  
See "Recall" on page 503

#### **MMEMory:STORe:IQ:COMM** <Description>

Defines a description of the export file which is stored with the data and also displayed in the file selection dialog box for I/Q data import and export.

**Parameters:**  
<Description>

**Example:** `MMEM:STOR:IQ:COMM 'Device test 1b'`  
Creates a description for the export file.  
`MMEM:STOR:IQ:STAT 1, 'C:  
\R_S\Instr\user\data.iq.tar'`  
Stores I/Q data and the comment to the specified file.

**Manual operation:** See "IQ Export" on page 505

#### **MMEMory:STORe:IQ:STATe** 1, <FileName>

This command stores the complex I/Q data to the specified `.iq.tar` file in 32-bit floating point format.

**Parameters:**  
<FileName> Complete file name including the path

**Example:** `MMEM:STOR:IQ:STAT 1, 'C:  
\R_S\Instr\user\data.iq.tar'`  
Stores I/Q data to the specified file.

**Manual operation:** See "IQ Export" on page 505

#### **MMEMory:STORe<n>:STATe** <State>

This command stores the current device settings in a `*.dfl` file.

**Suffix:**  
<n> irrelevant

**Parameters:**  
<State> 1,<file\_name>  
**with <file\_name>**  
DOS file name with or without extension  
The file name includes the indication of the path and may also include the drive name. The path name complies with DOS conventions.

**Example:** `MMEM:STOR:STAT 1, 'Save'`  
Saves the current device settings in the file `Save.dfl`.

**Usage:** Event  
SCPI confirmed

**Manual operation:** See "[Save File / Recall File](#)" on page 502

### MMEMory:STORe<n>:STATe:NEXT

This command stores the current device settings in a \*.df1 file. The file name used in the last saving process is automatically counted up to the next unused name.

**Suffix:**  
<n> irrelevant

**Example:** `MMEM:STOR:STAT 1, 'Save'`  
Saves the current device settings in the file `Save.df1`.  
`MMEM:STOR:STAT:NEXT`  
Saves the current device settings in the file `Save_001.df1`  
`MMEM:STOR:STAT:NEXT`  
Saves the current device settings in the file `Save_002.df1`

**Usage:** Event

**Manual operation:** See "[Save File / Recall File](#)" on page 502

## 11.11 Using Transducers



Before making any changes to a transducer factor or set, you have to select one by name with `[SENSe:]CORRection:TRANsducer:SElect`.

Compared to manual configuration of transducers, any changes made to a transducer factor or set via remote control are saved after the corresponding command has been sent.

### Designing a transducer factor

```
//Select a transducer factor
CORR:TRAN:SEL 'Transducer1'
//Define a comment for the transducer factor
CORR:TRAN:COMM 'Correction values for device x'
//Define the transducer factor unit
CORR:TRAN:UNIT 'DB'
//Select the scale of the frequency axis
CORR:TRAN:SCAL LOG
//Define the data points of the transducer factor
CORR:TRAN:DATA 1MHZ,-10,10MHZ,-10,100MHZ,-15,1GHZ,-15
//Turn on the transducer
CORR:TRAN ON
//Automatically adjust the reference level
CORR:TRAN:ADJ:RLEV ON
```



## Managing a transducer set

```
//Select or create a transducer set
CORR:TSET:SEL 'Transducer Set'
//Define a comment for the transducer set
CORR:TSET:COMM 'Transducer set example'
//Define a unit for the transducer set
CORR:TSET:UNIT 'DB'
//Turn the transducer break on
CORR:TSET:BRE ON
//Define the first transducer range
CORR:TSET:RANG1 150KHZ,1MHZ,'Transducer 1','Transducer 3'
CORR:TSET:RANG2 1MHZ,10MHZ,'Transducer 3','Transducer 4'
CORR:TSET:RANG3 10MHZ,30MHZ,'Transducer 3'
//Turn on the transducer set
CORR:TSET ON
```

[SENSe:]CORRection:TRANsducer:ADJust:RLEVel[:STATe].....	918
[SENSe:]CORRection:TRANsducer:ACTive?.....	919
[SENSe:]CORRection:TRANsducer:CATalog?.....	919
[SENSe:]CORRection:TRANsducer:COMMeNt.....	919
[SENSe:]CORRection:TRANsducer:DATA.....	920
[SENSe:]CORRection:TRANsducer:DELeTe.....	920
[SENSe:]CORRection:TRANsducer:SCALing.....	920
[SENSe:]CORRection:TRANsducer:SELeCt.....	921
[SENSe:]CORRection:TRANsducer[:STATe].....	921
[SENSe:]CORRection:TRANsducer:UNIT.....	921
[SENSe:]CORRection:TRANsducer:VIEW.....	922
[SENSe:]CORRection:TSET:BReak.....	922
[SENSe:]CORRection:TSET:CATalog?.....	922
[SENSe:]CORRection:TSET:COMMeNt.....	923
[SENSe:]CORRection:TSET:DELeTe.....	923
[SENSe:]CORRection:TSET:RANGe<range>.....	923
[SENSe:]CORRection:TSET:SELeCt.....	924
[SENSe:]CORRection:TSET[:STATe].....	924
[SENSe:]CORRection:TSET:UNIT.....	924

---

### [SENSe:]CORRection:TRANsducer:ADJust:RLEVel[:STATe] <State>

This command turns automatic adjustment of the reference level regarding the transducer factor characteristics on and off.

Before you can use the command, you have to select a transducer factor with

[SENSe:]CORRection:TRANsducer:SELeCt.

#### Parameters:

<State>

#### ON

Automatically adjusts the reference level with respect to the transducer factor characteristics.

#### OFF

Manual adjustment of the reference level with respect to the transducer factor characteristics is necessary.

\*RST: OFF

**Example:** See "Designing a transducer factor" on page 917.

**Manual operation:** See "Defining characteristics of a transducer factor" on page 479

### **[SENSe:]CORRection:TRANsducer:ACTive?**

This command queries the currently active transducer factor.

**Parameters:**

<TransducerFactor> String containing the name of the transducer factor.  
If no transducer factor is active, the string is empty.

**Example:** CORR:TRAN:ACT?  
Queries the active transducer factor.

**Usage:** Query only

### **[SENSe:]CORRection:TRANsducer:CATalog?**

This command queries all transducer factors stored on the R&S ESRP.

**Parameters:**

<FileInformation> String containing the file information.  
'<NameFileN>,<SizeFileN>'  
**<NameFileN>**  
Name of the file.  
**<SizeFileN>**  
Size of the file in bytes.

**Return values:**

<UsedDiskSpace> Size of all available files containing transducer factors in byte.  
<FreeDiskSpace> Remaining disk space in bytes.

**Example:** CORR:TRAN:CAT?  
would return, e.g.  
1579,34482896896,'FACTOR1,823','FACTOR2,756'

**Usage:** Query only

### **[SENSe:]CORRection:TRANsducer:COMMeNt <Comment>**

This command defines a comment for a transducer factor.

Before you can use the command, you have to select a transducer factor with [\[SENSe:\]CORRection:TRANsducer:SELeCt](#) on page 921.

**Parameters:**

<Comment> String containing the comment.  
\*RST: (empty comment)

**Example:** See ["Designing a transducer factor"](#) on page 917.

**Manual operation:** See ["Defining characteristics of a transducer factor"](#) on page 479

#### **[SENSe:]CORRection:TRANsducer:DATA <Frequency>,<Level>**

This command defines the shape of the transducer factor.

A transducer factor may contain up to 625 reference values. Each reference value is a combination of a frequency and a level value.

Before you can use this command, you have to select a transducer factor with [\[SENSe:\]CORRection:TRANsducer:SELEct](#) on page 921.

**Parameters:**

<Frequency>      Numeric value in Hz.  
                          The frequency values have to be in ascending order.

<Level>            The unit depends on [\[SENSe:\]CORRection:TRANsducer:UNIT](#) on page 921. By default, it is dB.

**Example:** See ["Designing a transducer factor"](#) on page 917.

**Manual operation:** See ["Defining characteristics of a transducer factor"](#) on page 479

#### **[SENSe:]CORRection:TRANsducer:DELEte**

This command deletes a transducer factor.

Before you can use the command, you have to select a transducer factor with [\[SENSe:\]CORRection:TRANsducer:SELEct](#).

**Example:**            CORR:TRAN:SEL 'Transducer 1'  
                          CORR:TRAN:DEL  
                          Deletes the selected transducer.

**Usage:**              Event

**Manual operation:** See ["Defining characteristics of a transducer factor"](#) on page 479

#### **[SENSe:]CORRection:TRANsducer:SCALing <Scale>**

This command selects the scale of the transducer factor.

Before you can use the command, you have to select a transducer factor with [\[SENSe:\]CORRection:TRANsducer:SELEct](#) on page 921R&S ESRP.

**Parameters:**

<Scale>            LINear | LOGarithmic  
                          \*RST:          LINear

**Example:**            See ["Designing a transducer factor"](#) on page 917.

**Manual operation:** See ["Defining characteristics of a transducer factor"](#) on page 479

---

**[SENSe:]CORRection:TRANsducer:SELEct** <FileName>

This command creates or selects a transducer factor.

**Parameters:**

<FileName> String containing the name of the transducer factor.  
If the name does not exist yet, the R&S ESRP creates a transducer factor by that name.

**Example:** See ["Designing a transducer factor"](#) on page 917.

**Manual operation:** See ["Using transducer factors or transducer sets"](#) on page 479  
See ["Defining characteristics of a transducer factor"](#) on page 479

---

**[SENSe:]CORRection:TRANsducer[:STATe]** <State>

This command turns a transducer factor on and off.

Before you can use the command, you have to select a transducer factor with [\[SENSe:\]CORRection:TRANsducer:SELEct](#).

You can turn on up to 8 transducer factors at the same time.

**Parameters:**

<State> ON | OFF  
\*RST: OFF

**Example:** See ["Designing a transducer factor"](#) on page 917.

**Manual operation:** See ["Using transducer factors or transducer sets"](#) on page 479

---

**[SENSe:]CORRection:TRANsducer:UNIT** <Unit>

This command selects the unit of a transducer factor.

Before you can use the command, you have to select a transducer factor with [\[SENSe:\]CORRection:TRANsducer:SELEct](#).

**Parameters:**

<Unit> String containing one of the following units:  
DB | DBM | DBMV | DBUV | DBUV/M | DBUA DBUA/M | DBPW | DBPT  
\*RST: DB

**Example:** See ["Designing a transducer factor"](#) on page 917.

**Manual operation:** See ["Defining characteristics of a transducer factor"](#) on page 479

**[SENSe:]CORRection:TRANsducer:VIEW <State>**

This command includes or excludes a figure of a transducer factor in the diagram.

Before you can use the command, you have to select a transducer factor with

[\[SENSe:\]CORRection:TRANsducer:SElect](#).

**Parameters:**

<State> ON | OFF  
\*RST: OFF

**Example:**

```
CORR:TRAN:SEL 'FACTOR'
CORR:TRAN:VIEW ON
Selects and displays a transducer factor.
```

**[SENSe:]CORRection:TSET:BREak <State>**

This command turns a transducer break on and off.

Before you can use the command, you have to select a transducer set with [\[SENSe:\]CORRection:TSET:SElect](#).

**Parameters:**

<State> ON | OFF  
\*RST: OFF

**Example:** See ["Managing a transducer set"](#) on page 918.

**Manual operation:** See ["Managing transducer sets"](#) on page 481

**[SENSe:]CORRection:TSET:CATalog?**

This command queries all transducer sets stored on the R&S ESRP.

**Return values:**

<UsedDiskSpace> Size of all available files containing transducer factors in byte.

<FreeDiskSpace> Remaining disk space in bytes.

<FileInfo> String containing the file information.  
'<NameFileN>,<SizeFileN>'

**<NameFileN>**

Name of the file.

**<SizeFileN>**

Size of the file in bytes.

**Example:**

```
CORR:TSET:CAT?
would return, e.g.
3298,34482896896,'SET1,1520','SET2,1756'
```

**Usage:** Query only

**[SENSe:]CORRection:TSET:COMMeNT <Comment>**

This command defines a comment for a transducer set.

Before you can use the command, you have to select a transducer set with [\[SENSe:\]CORRection:TSET:SELEct](#).

**Parameters:**

<Comment> String containing the comment.

**Example:** See ["Managing a transducer set"](#) on page 918.

**Manual operation:** See ["Managing transducer sets"](#) on page 481

**[SENSe:]CORRection:TSET:DELEte**

This command deletes a transducer set.

Before you can use the command, you have to select a transducer set with [\[SENSe:\]CORRection:TSET:SELEct](#).

**Example:**           CORR:TSET:SEL 'Transducer Set'  
                          CORR:TSET:DEL  
                          Deletes the transducer set.

**Usage:** Event

**Manual operation:** See ["Managing transducer sets"](#) on page 481

**[SENSe:]CORRection:TSET:RANGe<range> <Frequency>, <Frequency>, <FileName>**

This command selects a set of transducer factors used for a particular frequency range.

Ranges 1 to 10 must be sent in ascending order.

Before you can use the command, you have to select a transducer set with [\[SENSe:\]CORRection:TSET:SELEct](#).

**Suffix:**

<range>           1...10  
                          Selects the range.

**Parameters:**

<Frequency>       Defines the start frequency of the frequency range.

<Frequency>       Defines the stop frequency of the frequency range.

<FileName>       String containing the name of the transducer factor.  
Note that you can assign up to eight transducer factors to a particular frequency range. In that case, add additional strings containing the file name after the first one separated by comma.

**Example:** See ["Managing a transducer set"](#) on page 918.

**Manual operation:** See ["Managing transducer sets"](#) on page 481

---

**[SENSe:]CORRection:TSET:SElect** <FileName>

This command creates or selects a transducer set.

**Parameters:**

<FileName> String containing the name of the transducer set.  
If the name does not exist yet, the R&S ESRP creates a transducer set by that name.

**Example:** See ["Managing a transducer set"](#) on page 918.

**Manual operation:** See ["Using transducer factors or transducer sets"](#) on page 479  
See ["Managing transducer sets"](#) on page 481

---

**[SENSe:]CORRection:TSET[:STATe]** <State>

This command turns a transducer set on and off.

Before you can use the command, you have to select a transducer set with [\[SENSe:\]CORRection:TSET:SElect](#).

**Parameters:**

<State> ON | OFF  
\*RST: OFF

**Example:** See ["Managing a transducer set"](#) on page 918.

**Manual operation:** See ["Using transducer factors or transducer sets"](#) on page 479

---

**[SENSe:]CORRection:TSET:UNIT** <Unit>

This command selects the unit of a transducer set.

Note that the unit of all transducer factors in a transducer set must be the same or in relative terms (dB).

Before you can use the command, you have to select a transducer set with [\[SENSe:\]CORRection:TSET:SElect](#).

**Parameters:**

<Unit> String containing one of the following units:  
DB | DBM | DBUV | DBUV\_M | DBUA | DBUA\_M | DBPW |  
DBPT  
\*RST: DB

**Example:** See ["Managing a transducer set"](#) on page 918.

**Manual operation:** See ["Managing transducer sets"](#) on page 481

## 11.12 Documentation

*Table 11-25: CMAP assignment*

Suffix	Description
CMAP1	Background
CMAP2	Grid
CMAP3*	Common text
CMAP4*	Check status OK
CMAP5*	Check status error
CMAP6*	Text special 1
CMAP7*	Text special 2
CMAP8	Trace 1
CMAP9	Trace 2
CMAP10	Trace 3
CMAP11	Marker info text
CMAP12	Limit lines
CMAP13	Limit and margin check 'PASS'
CMAP14	Limit and margin check 'FAIL'
CMAP15*	Softkey text
CMAP16*	Softkey background
CMAP17*	Selected field text
CMAP18*	Selected field background
CMAP19*	Softkey 3D bright part
CMAP20*	Softkey 3D dark part
CMAP21*	Softkey state 'On'
CMAP22*	Softkey state 'Dialog Open'
CMAP23*	Softkey text disabled
CMAP24	Logo
CMAP25	Trace 4
CMAP26	Grid (minor lines)
CMAP27	Marker
CMAP28	Display lines
CMAP29*	Sweep count text
CMAP30	Limit and margin check 'Text'
CMAP31	Limit and margin check \"Margin\"



Suffix	Description
CMAP32*	Table overall (Title Text)
CMAP33*	Table overall (Title background)
CMAP34*	Table overall (Text)
CMAP35*	Table overall (Background)
CMAP36*	Table value (Title text)
CMAP37*	Table value (Title background)
CMAP38*	Table value (Text)
CMAP39*	Table value (Background)
CMAP40	Trace 5
CMAP41	Trace 6
CMAP42	Bargraph Max Peak
CMAP43	Bargraph Min Peak
CMAP44	Bargraph Quasipeak
CMAP45	Bargraph Average
CMAP46	Bargraph RMS
CMAP47	Final measurement
CMAP48	Bargraph CISPR Average
CMAP49	Bargraph RMS Average
* these settings can only be defined via the theme, see <a href="#">Chapter 11.14, "Display Configuration"</a> , on page 944, and are thus ignored in the SCPI command	

HCOPY:ABORT.....	927
HCOPY:CMAP<item>:DEFault.....	927
HCOPY:CMAP<item>:HSL.....	927
HCOPY:CMAP<item>:PDEFined.....	928
HCOPY:DESTination<1 2>.....	928
HCOPY:DEvice:COLor.....	929
HCOPY:DEvice:LANGUage<1 2>.....	929
HCOPY:ITEM:ALL.....	930
HCOPY:ITEM:WINDow:TABLE:STATe.....	930
HCOPY:ITEM:WINDow:TEXT.....	930
HCOPY:PAGE:ORientation<1 2>.....	931
HCOPY:TDSamp:STATe<1 2>.....	931
HCOPY[:IMMEDIATE<1 2>].....	931
HCOPY[:IMMEDIATE<1 2>]:NEXT.....	932
SYSTem:COMMunicate:PRINter:ENUMerate:FIRSt?.....	933
SYSTem:COMMunicate:PRINter:ENUMerate[:NEXT]?.....	933
SYSTem:COMMunicate:PRINter:SELect <1 2>.....	933

---

**HCOPY:ABORT**

This command aborts a running hardcopy output.

**Example:** HCOPY:ABOR

**Usage:** Event  
SCPI confirmed

---

**HCOPY:CMAP<item>:DEFault <ColorSet>**

This command defines the color scheme for print jobs.

**Suffix:**  
<item> Selects the display item. For more information see [Table 11-25](#).

**Parameters:**  
<ColorSet> 1 | 2 | 3 | 4

- 1**  
current screen colors with the background in white and the grid in black.
- 2**  
optimized color set
- 3**  
user defined color set
- 4**  
current screen colors without any changes (setting for hardcopies)

**Example:** HCOPY:CMAP:DEF2  
Selects the optimized color set for the color settings of a printout or a hardcopy.

**Usage:** Event  
SCPI confirmed

**Manual operation:** See "[Set to Default](#)" on page 493  
See "[Select Print Color Set](#)" on page 494

---

**HCOPY:CMAP<item>:HSL <hue>,<sat>,<lum>**

This command selects the color for various screen elements in print jobs.

The values set are not changed by \*RST.

**Suffix:**  
<item> Selects the display item. For more information see [Table 11-25](#).

**Parameters:**  
<hue> numeric value  
tint of the color  
Range: 0 to 1

<code>&lt;sat&gt;</code>	numeric value saturation of the color Range: 0 to 1
<code>&lt;lum&gt;</code>	numeric value brightness of the color Range: 0 to 1
<b>Example:</b>	<code>HCOP:CMAP2:HSL 0.3,0.8,1.0</code> Changes the grid color
<b>Usage:</b>	SCPI confirmed
<b>Manual operation:</b>	See <a href="#">"Select Object"</a> on page 492 See <a href="#">"User Defined Colors"</a> on page 493 See <a href="#">"Print Colors"</a> on page 493

**HCOPY:CMAP<item>:PDEFined <Color>**

This command selects a predefined color for various screen elements in print jobs.

The values set are not changed by \*RST.

**Suffix:**

`<item>` Selects the display item. For more information see [Table 11-25](#).

**Parameters:**

`<Color>` BLACK | BLUE | BROWN | GREEN | CYAN | RED | MAGenta |  
YELLOW | WHITE | DGRAY | LGRAY | LBLUe | LGREEN | LCYan |  
LRED | LMAGenta

**Example:** `HCOP:CMAP2:PDEF GRE`

**Usage:** SCPI confirmed

**Manual operation:** See ["Predefined Colors"](#) on page 493

**HCOPY:DESTination<1|2> <Medium>**

This command selects the destination of a print job.

The type of instrument is selected with `SYSTEM:COMMunicate:PRINter:SElect <1|2>`, which automatically selects a default output medium. Therefore `HCOPY:DESTination` should always be sent after setting the device type.

The suffix `<1|2>` selects the printing device.

**Parameters:**

`<Medium>` **'MMEM'**  
Sends the hardcopy to a file.  
You can select the file name with `MMEMory:NAME`  
You can select the file format with `HCOPY:DEVIce:LANGuage<1|2>`.

**'SYST:COMM:PRIN'**

Sends the hardcopy to the printer.

You can select the printer with `SYSTem:COMMunicate:PRINter:SElect <1|2>`.

**'SYST:COMM:CLIP'**

Sends the hardcopy to the clipboard.

The format should be WEMF.

\*RST: SYST:COMM:CLIP

**Example:**

`SYST:COMM:PRIN:SEL2 'LASER on LPT1'`

Selects the printer and output medium for device 2.

`HCOP:DEST2 'SYST:COMM:PRIN'`

Selects the printer interface as device 2.

**Usage:**

SCPI confirmed

**Manual operation:** See "[Device Setup](#)" on page 515

**HCOPY:DEvice:COLor <State>**

This command turns color printing on and off.

**Parameters:**

<State>

ON | OFF

**ON**

Color output

**OFF**

Black and white output

\*RST: OFF

**Example:**

`HCOP:DEV:COL ON`

**Usage:**

SCPI confirmed

**Manual operation:** See "[Color \(On/Off\)](#)" on page 494

**HCOPY:DEvice:LANGuage<1|2> <Format>**

This command selects the file format for a print job.

The suffix <1|2> selects the printing device.

**Parameters:**

<Format>

**GDI**

Graphics Device Interface:

Default format for the output to a printer configured under Windows. Must be selected for the output to the printer interface.

Can be used for the output to a file. The printer driver configured under Windows is used in this case and a printer-specific file format is thus generated.

(see also `HCOPY:DESTination<1|2>` command)

Available for `HCOPY:MODE SCreen`.

**WMF | EWMF**

WINDOWS Metafile and Enhanced Metafile Format:

Data formats for output files which can be integrated in corresponding programs for documentation purposes at a later time. WMF can only be used for output to a file and EWMF also for the output to the clipboard.

(see also `HCOPY:DESTINATION<1|2>` command)

Available for `HCOPY:MODE SCReen`.

**BMP | JPG | PNG**

Data format for output to files only.

Available for `HCOPY:MODE SCReen`.

**PDF | RTF**

Selects the output format of the test report in Receiver mode.

Available for `HCOPY:MODE REPort`.

- Example:** `HCOP:DEV:LANG WMF`
- Usage:** SCPI confirmed
- Manual operation:** See "Device Setup" on page 515  
See "Configuring and Printing the Test Report" on page 521

**HCOPY:ITEM:ALL**

This command includes all screen elements in the printout.

The screen elements include comments, title, time and date.

**Example:** `HCOP:ITEM:ALL`

**Usage:** Event  
SCPI confirmed

**Manual operation:** See "Print Screen" on page 514

**HCOPY:ITEM:WINDOW:TABLE:STATE <State>**

This command turns printing of the currently active table on and off.

**Parameters:**

<State> ON | OFF  
\*RST: OFF

**Example:** `HCOP:ITEM:WIND:TAB:STAT ON`

**HCOPY:ITEM:WINDOW:TEXT <Comment>**

This command defines a comment added to the printout.

**Parameters:**

<Comment> String containing the comment with a maximum of 120 characters. The line feed is by means of the characters @.

**Example:** `HCOP:ITEM:WIND:TEXT 'comment'`

**Manual operation:** See ["Comment"](#) on page 516

### **HCOPY:PAGE:ORIENTATION<1|2> <Orientation>**

The command selects the format of the printout.

The command is only available if the output device is a printer (see [HCOPY:DESTINATION<1|2>](#) on page 928).

**Parameters:**

<Orientation>      LANDscape | PORTrait  
\*RST:              PORT

**Example:** `HCOP:PAGE:ORI LAND`

**Usage:**              SCPI confirmed

**Manual operation:** See ["Device Setup"](#) on page 515

### **HCOPY:TDSTAMP:STATE<1|2> <State>**

This command includes or excludes the time and date in the printout.

The suffix <1|2> selects the printing device.

**Parameters:**

<State>              ON | OFF  
\*RST:              OFF

**Example:** `HCOP:TDST:STAT OFF`

**Manual operation:** See ["Device Setup"](#) on page 515

### **HCOPY[:IMMEDIATE<1|2>]**

This command initiates a print job.

If you are printing to a file, the file name depends on [MMEMORY:NAME](#).

The suffix <1|2> selects the printing device.

The command also generates a measurement report when you have selected [HCOPY:MODE REPORT](#). Note that you have to add at least one dataset to the report with [HCOPY:TREPORT:NEW](#) on page 942 or [HCOPY:TREPORT:APPEND](#). Otherwise creating the report results in an error.

- Example:** HCOP:DEV:LANG BMP  
Selects the data format.  
HCOP:DEST 'MMEM'  
Directs the hardcopy to a file.  
MMEM:NAME 'C:\R\_S\instr\user\Print.bmp'  
Selects the file name. If the file Print.bmp already exists, it is replaced.  
HCOP  
Saves the hardcopy output into the file Print.bmp.
- Example:** HCOP:MODE REpOrt  
HCOP:DEV:LANG PDF  
HCOP:TREP:NEW  
HCOP  
Creates a measurement report (in pdf format).
- Usage:** Event  
SCPI confirmed
- Manual operation:** See ["ScreenShot"](#) on page 504  
See ["Print Screen"](#) on page 514  
See ["Configuring and Printing the Test Report"](#) on page 521

---

### HCOPy[:IMMediate<1|2>]:NEXT

This command initiates a print job.

If you are printing to a file, the file name depends on [MMEMory:NAME](#). This command adds a consecutive number to the file name.

The suffix <1|2> selects the printing device.

- Example:** HCOP:DEV:LANG BMP  
Selects the data format.  
HCOP:DEST 'MMEM'  
Directs the hardcopy to a file.  
MMEM:NAME 'C:\R\_S\instr\user\Print.bmp'  
Selects the file name.  
HCOP  
Saves the hardcopy output into the file Print.bmp.  
HCOP:NEXT  
Saves the hardcopy output into the file Print\_001.bmp.  
HCOP:NEXT  
Saves the hardcopy output into the file Print\_002.bmp.
- Usage:** Event  
SCPI confirmed
- Manual operation:** See ["Print Screen"](#) on page 514

**SYSTem:COMMunicate:PRINter:ENUMerate:FIRSt?**

This command queries the name of the first printer (in the list of printers) available under Windows operating system.

The names of other installed printers can be queried with the `SYSTem:COMMunicate:PRINter:ENUMerate[:NEXT]?` command.

If no printer is configured an empty string is output.

**Return values:**

<PrinterName> \*RST: NONE

**Example:** SYST:COMM:PRIN:ENUM:FIRS?

**Usage:** Query only

**Manual operation:** See "Device Setup" on page 515

**SYSTem:COMMunicate:PRINter:ENUMerate[:NEXT]?**

This command queries the name of the next printer installed under Windows operating system. After all available printer names have been output, an empty string enclosed by quotation marks (") is output for the next query. Further queries are answered by a query error.

The `SYSTem:COMMunicate:PRINter:ENUMerate:FIRSt?` command should be sent previously to return to the beginning of the printer list and query the name of the first printer.

**Example:** SYST:COMM:PRIN:ENUM?

**Usage:** Query only

**Manual operation:** See "Device Setup" on page 515

**SYSTem:COMMunicate:PRINter:SELEct <1|2> <PrinterName>**

This command selects one of the printers configured under Windows operating system, including the associated output destination.

The specified printer name must be a string (entered in quotes) as returned by the commands

`SYSTem:COMMunicate:PRINter:ENUMerate:FIRSt?` or

`SYSTem:COMMunicate:PRINter:ENUMerate[:NEXT]?`

The `HCOPY:DESTination<1|2>` on page 928 command is used to select an output medium other than the default one.

**Parameters:**

<PrinterName> "<printer\_name>"

\*RST: NONE

**Example:** SYST:COMM:PRIN:SEL "LASER on LPT1"



## 11.13 Working with Test Reports

- [Designing a Test Report Template](#)..... 934
- [Creating a Test Report](#)..... 941
- [Deprecated Commands \(Test Report\)](#)..... 944

### 11.13.1 Designing a Test Report Template

- [Selecting the Test Report Contents](#)..... 934
- [Designing the Header of the Test Report](#)..... 936
- [Defining the Contents of the Title Page](#)..... 939
- [Managing Templates](#)..... 939

#### 11.13.1.1 Selecting the Test Report Contents

- [HCOPy:TREPort:ITEM:DEFault](#)..... 934
- [HCOPy:TREPort:ITEM:SElect](#)..... 934

---

#### HCOPy:TREPort:ITEM:DEFault

This command restores the default configuration of the test report regarding the information that is part of the report (in the "Configuration" tab of the "Test Report Settings" dialog box).

It also restores the default names of the header titles (in the "Header" tab of the "Test Report Settings" dialog box).

**Example:** `HCOP:TREP:ITEM:DEF`  
Restores the default test report configuration.

**Usage:** Event

---

#### HCOPy:TREPort:ITEM:SElect '<Item>,<Item>,<Item>,...'

This command defines the type of information that a test report is made up out of.

**Parameters:**

<Item> String containing the information you want to include in the test report.  
Note that the items, separated by commas, have to be written into one string (see example below).  
The available items depend on the application you are using. See the tables below for a short description of each item. Per default, some items are selected (see tables below).

**Example:** `HCOP:TREP:ITEM:SEL 'SETT,MARK,SRES,DIAG'`  
Each dataset consists of the measurement settings, marker information, the scan results and a screenshot of the scan trace (for Receiver channels).

**Manual operation:** See "Selecting the Test Report Contents" on page 517

**Table 11-26: Available <items> in receiver application**

<Item>	Description	Default
DIAGram	Screenshot of the scan results.	x
FRESults	Numerical results for the final measurement.	x
HEADer	Header made up of several lines of information that is (by default) displayed on each page of the test report.	x
IF	Screenshot of the results for IF analysis.	
IFSpectrogram	Screenshot of the IF spectrogram.	
MARKers	Contents of the marker table.	
PAGecount	Page numbers.	x
PREResults	Contents of the peak list.	
SCANtable	Measurement configuration as defined in the scan table.	x
SETTings	Settings that have been used during a measurement.	x
SPECtrogram	Screenshot of the spectrogram.	
SRESults	Numerical results for the scan.	
TDSTamp	Date and time of the measurement.	x
TRANsducer	Characteristics of the transducer.	

**Table 11-27: Available <items> in spectrum application**

<Item>	Description	Default
DIAGram	Screenshot of the scan results.	x
HEADer	Header made up of several lines of information that is (by default) displayed on each page of the test report.	x
PAGecount	Page numbers.	x
RESultlist	Numerical measurement results.	
SETTings	Settings that have been used during a measurement.	x
SPECtrogram	Screenshot of the spectrogram.	
TDSTamp	Date and time of the measurement.	x
TRANsducer	Characteristics of the transducer.	

**Table 11-28: Available <items> in I/Q analyzer**

<Item>	Description	Default
DIAGram	Screenshot of the result diagram.	x
HEADer	Header made up of several lines of information that is (by default) displayed on each page of the test report.	x
PAGecount	Page numbers.	x

<Item>	Description	Default
RESultlist	Numerical measurement results.	
SETTings	Settings that have been used during a measurement.	x
TDSTamp	Date and time of the measurement.	x
TRANsducer	Characteristics of the transducer.	

### 11.13.1.2 Designing the Header of the Test Report

Commands useful to design the test report header described elsewhere:

- `HCOPY:TREPort:ITEM:DEFault` on page 934

<code>HCOPY:TREPort:ITEM:HEADer:LINE&lt;line&gt;:CONTrol</code> .....	936
<code>HCOPY:TREPort:ITEM:HEADer:LINE&lt;line&gt;:TEXT</code> .....	937
<code>HCOPY:TREPort:ITEM:HEADer:LINE&lt;line&gt;:TITLe</code> .....	937
<code>HCOPY:TREPort:ITEM:LOGO</code> .....	938
<code>HCOPY:TREPort:ITEM:LOGO:CONTrol</code> .....	938

---

#### `HCOPY:TREPort:ITEM:HEADer:LINE<line>:CONTrol` <Repetition>

This command selects how often the items in the report header are displayed in the document.

##### Suffix:

<line>                    1...7  
Selects the header line.

##### Parameters:

<Repetition>

##### **ALWays**

The selected header line is displayed at the top of every page of the report.

##### **NEVer**

The selected header line is displayed on no page of the report. Note that a line that does not contain anything is still displayed in the report as a blank line. If you select **NEVer**, the line is not displayed at all.

##### **ONCE**

The selected header line is displayed on the first page each dataset.

\*RST:            ALWays

##### Example:

```
HCOP:TREP:ITEM:HEAD:LINE4:TITL ''
HCOP:TREP:ITEM:HEAD:LINE4:TEXT ''
```

Defines an empty string for line 4 of the report header. In the default state (**ALWays**), the line would be still displayed as a blank line.

```
HCOP:TREP:ITEM:HEAD:LINE4:CONT NEV
```

Removes line 4 from the header of the test report.

**Manual operation:** See "[Designing the Header of the Test Report](#)" on page 518

**HCOPy:TREPort:ITEM:HEADer:LINE<line>:TEXT <Description>**

This command defines a descriptive text for one of the items part of the report header.

You can define up to 7 items in the header.

Use `HCOPy:TREPort:ITEM:HEADer:LINE<line>:TITLe` on page 937 to define custom titles for each item.

Use `HCOPy:TREPort:ITEM:HEADer:LINE<line>:CONTrol` to select the condition under which each item is shown.

**Suffix:**

<line>                    1...7  
Selects the header line.

**Parameters:**

<Description>            String containing the description of one of the value fields.  
By default, the value fields of the items are empty.

**Example:**

```
HCOP:TREP:ITEM:HEAD:LINE3:TITL 'Device under
Test'
```

Renames the third title into "Device under Test".

```
HCOP:TREP:ITEM:HEAD:LINE3:TEXT 'Some Device'
```

Labels the third title as "Some Device".

**Manual operation:** See "[Designing the Header of the Test Report](#)" on page 518

**HCOPy:TREPort:ITEM:HEADer:LINE<line>:TITLe <Title>**

This command defines a custom name for one of the items part of the report header.

You can define up to 7 items in the header.

Use `HCOPy:TREPort:ITEM:HEADer:LINE<line>:TEXT` to add a value to each item.

Use `HCOPy:TREPort:ITEM:HEADer:LINE<line>:CONTrol` to select the condition under which each item is shown.

**Suffix:**

<line>                    1...7  
Selects the header line.

**Parameters:**

<Title>                    String containing the title of the item.  
The default titles are as follows:

- Line 1: "Heading"
- Line 2: "Meas Type"
- Line 3: "Equipment under Test"
- Line 4: "Manufacturer"
- Line 5: "OP Condition"
- Line 6: "Operator"
- Line 7: "Test Spec"

Make sure that the title string is not too long, because strings that are too long could mess up the layout of the report.

**Example:** `HCOP:TREP:ITEM:HEAD:LINE3:TITL 'Device under Test'`

Renames the third title into "Device under Test".

**Manual operation:** See ["Designing the Header of the Test Report"](#) on page 518

#### **HCOPY:TREPort:ITEM:LOGO <FileName>**

This command selects a graphic (for example a company logo) that is shown at the top of each page in the test report.

Use `HCOPY:TREPort:ITEM:LOGO:CONTrol` on page 938 to select the conditions under which the picture is shown.

#### **Parameters:**

<FileName> String containing the location and name of the picture.  
For reports in **pdf** format, you can use the following file types:  
**bmp, jpg, png.**  
For reports in **rtf** format, you can use the following file types:  
**bmp, jpg.**

**Example:** `HCOP:TREP:ITEM:LOGO 'C:\aPicture.jpg'`  
Includes a picture at the top of each page of the report.

**Manual operation:** See ["Designing the Header of the Test Report"](#) on page 518

#### **HCOPY:TREPort:ITEM:LOGO:CONTrol <Repetition>**

This command selects how often the logo is displayed in the document.

#### **Parameters:**

<Repetition> **ALWays**  
The logo is displayed at the top of every page of the report.  
**NEVer**  
The logo is displayed on no page of the report.  
**ONCE**  
The logo is displayed on the first page of each dataset.  
**\*RST: NEVer**

**Example:** `HCOP:TREP:ITEM:LOGO 'c:\logo.png'`  
Selects a picture to be displayed in the report document.  
`HCOP:TREP:ITEM:LOGO:CONT ONCE`  
Displays the logo on the first page of each dataset.

**Manual operation:** See ["Designing the Header of the Test Report"](#) on page 518

### 11.13.1.3 Defining the Contents of the Title Page

HCOPy:TREPort:DESCription.....	939
HCOPy:TREPort:PAGesize.....	939
HCOPy:TREPort:TITLe.....	939

---

#### HCOPy:TREPort:DESCription <Description>

This command defines the description of the test report as shown on its title page.

##### Parameters:

<Description> String containing the description of the test report.

##### Example:

```
HCOP:TREP:DESC 'A short summary of the test
report.'
```

Adds a description to the test report.

**Manual operation:** See ["Defining the Contents of the Title Page"](#) on page 519

---

#### HCOPy:TREPort:PAGesize <Size>

This command selects the size of the test report document.

##### Parameters:

<Size>                   **A4**  
Document pages have an A4 size.

**US**  
Document pages have a US letter size.

\*RST:           A4

##### Example:

```
HCOP:TREP:PAG A4
```

Selects the A4 size for the document.

---

#### HCOPy:TREPort:TITLe <Title>

This command defines the title for the test report as shown on its title page.

##### Parameters:

<Title> String containing the title.

##### Example:

```
HCOP:TREP:TITL 'My first test report'
```

Defines a title for a test report.

**Manual operation:** See ["Defining the Contents of the Title Page"](#) on page 519

### 11.13.1.4 Managing Templates

HCOPy:TREPort:ITEM:TEMPlate:CATalog?.....	940
HCOPy:TREPort:ITEM:TEMPlate:DELete.....	940
HCOPy:TREPort:ITEM:TEMPlate:LOAD.....	940
HCOPy:TREPort:ITEM:TEMPlate:SAVE.....	940

---

**HCOPy:TREPort:ITEM:TEMPlate:CATalog?**

This command queries the test report templates available in the default report directory (and its subdirectories).

**Return values:**

<Templates>           String containing the name of the templates as a comma-separated list.

**Example:**

```
HCOP:TREP:ITEM:TEMP:CAT?
would return, e.g.:
'TemplateX, TemplateY, TemplateZ'
```

**Usage:**               Query only

---

**HCOPy:TREPort:ITEM:TEMPlate:DELeTe <Template>**

This command deletes a test report template.

**Parameters:**

<Template>           String containing the name of the template.

**Example:**

```
HCOP:TREP:ITEM:TEMP:DEL 'myTemplate'
Deletes a test report template.
```

**Usage:**               Event

---

**HCOPy:TREPort:ITEM:TEMPlate:LOAD <Template>**

This command loads a test report template.

**Parameters:**

<Template>           String containing the name of the template.

**Example:**

```
HCOP:TREP:ITEM:TEMP:LOAD 'myTemplate'
Loads a test report template.
```

**Usage:**               Event

---

**HCOPy:TREPort:ITEM:TEMPlate:SAVE <Template>**

This command saves a test report template.

**Parameters:**

<Template>           String containing the name of the template.

**Example:**

```
HCOP:TREP:ITEM:TEMP:SAVE 'myTemplate'
Saves a test report template.
```

**Usage:**               Event

---

## 11.13.2 Creating a Test Report

- [Configuring and Printing the Test Report](#)..... 941
- [Adding and Removing Datasets](#)..... 941
- [Selecting Datasets for the Report](#)..... 943

### 11.13.2.1 Configuring and Printing the Test Report

Commands useful to configure and print the test report described elsewhere:

- [HCOpy:DEvice:LANGUage<1|2>](#) on page 929
- [HCOpy\[:IMMediate<1|2>\]](#) on page 931
- [MMEMoRY:NAME](#) on page 913

[HCOpy:MODE](#).....941

---

#### HCOpy:MODE <Mode>

Selects the output of the [HCOpy\[:IMMediate<1|2>\]](#) command.

##### Parameters:

<Mode>

##### SCReen

HCOpy:IMMediate prints the current screen contents.

##### REPort

HCOpy:IMMediate generates a measurement report.

\*RST: SCReen

##### Example:

```
HCOpy:MODE REPort
```

```
HCOpy
```

Creates a file containing the measurement report.

### 11.13.2.2 Adding and Removing Datasets

[HCOpy:TREPort:APPend](#)..... 941

[HCOpy:TREPort:NEW](#)..... 942

[HCOpy:TREPort:TEST:REMove](#)..... 942

[HCOpy:TREPort:TEST:REMove:SELEcted](#)..... 942

---

#### HCOpy:TREPort:APPend

This command adds the current measurement results to the test report.

The saved data depends on the items you have selected with [HCOpy:TREPort:ITEM:SELEct](#) on page 934.



- Example:** Perform a measurement, then:  
`HCOP:TREP:NEW`  
 Creates a new test report with the results of the first measurement.  
 Perform another measurement, then:  
`HCOP:TREP:APP`  
 Adds the results of the second measurement to the test report.
- Usage:** Event
- Manual operation:** See ["Adding and Removing Datasets"](#) on page 522
- 

### **HCOPy:TREPort:NEW**

This command creates a new test report.

Creating a test report deletes all previously saved datasets. The current measurement results are added as the first dataset to the new report.

The R&S ESRP saves the data selected with `HCOPY:TREPort:ITEM:SElect` on page 934.

- Example:** `HCOP:TREP:NEW`  
 Creates a test report.

**Usage:** Event

**Manual operation:** See ["Adding and Removing Datasets"](#) on page 522

---

### **HCOPy:TREPort:TEST:REMOve <Dataset>**

This command deletes one of the datasets that are currently part of a test report.

**Parameters:**

<Dataset> Index number of the dataset as shown in the "Test Report Content Selection" dialog box.  
 If the index number is greater than the number of available datasets, the command returns an error.

- Example:** `HCOP:TREP:TEST:REM 2`  
 Deletes the second dataset from the current test report.

**Manual operation:** See ["Adding and Removing Datasets"](#) on page 522

---

### **HCOPy:TREPort:TEST:REMOve:SElected**

This command deletes all selected datasets that are currently part of a test report.

**Example:**            `HCOP:TREP:TEST:SEL:NONE`  
                          Deselects all datasets.  
                          `HCOP:TREP:TEST:SEL 2,ON`  
                          `HCOP:TREP:TEST:SEL 3,ON`  
                          Selects the second and third datasets.  
                          `HCOP:TREP:TEST:REM:SEL`  
                          Deletes the selected datasets (the second and third).

**Usage:**             Event

**Manual operation:** See ["Adding and Removing Datasets"](#) on page 522

### 11.13.2.3 Selecting Datasets for the Report

<code>HCOPy:TREPort:TEST:SElect</code> .....	943
<code>HCOPy:TREPort:TEST:SElect:ALL</code> .....	943
<code>HCOPy:TREPort:TEST:SElect:INVert</code> .....	943
<code>HCOPy:TREPort:TEST:SElect:NONE</code> .....	944

---

#### **HCOPy:TREPort:TEST:SElect** <Dataset>, <State>

This command includes or excludes datasets from the test report.

**Parameters:**

<Dataset>            Index number of the dataset as shown in the "Test Report Content Selection" dialog box.  
                          If the index number is greater than the number of available datasets, the command does nothing.

<State>              ON | OFF

**Example:**            `HCOP:TREP:TEST:SEL 2, OFF`  
                          Excludes the second dataset from the test report.

**Manual operation:** See ["Selecting Datasets for the Report"](#) on page 522

---

#### **HCOPy:TREPort:TEST:SElect:ALL**

This command includes all available datasets in a test report.

**Example:**            `HCOP:TREP:TEST:SEL:ALL`  
                          Includes all available datasets in the test report.

**Usage:**              Event

**Manual operation:** See ["Selecting Datasets for the Report"](#) on page 522

---

#### **HCOPy:TREPort:TEST:SElect:INVert**

This command inverts the current selection of datasets to be included in the test report.

Datasets that have been included in the report before will no longer be part of the report. Instead, the previously deselected datasets will be included.

- Example:** HCOPY:TREP:TEST:SEL:INV  
Inverts the selection of dataset to be included in a test report.
- Usage:** Event
- Manual operation:** See ["Selecting Datasets for the Report"](#) on page 522

**HCOPY:TREPort:TEST:SElect:NONE**

This command excludes all datasets from the test report.

- Example:** HCOPY:TREP:TEST:SEL:NONE  
Removes all dataset from the test report.
- Usage:** Event
- Manual operation:** See ["Selecting Datasets for the Report"](#) on page 522

### 11.13.3 Deprecated Commands (Test Report)

Following is a list of deprecated remote commands. The remote commands are still supported to maintain compatibility to previous Rohde & Schwarz receivers (like the R&S ESU), but it is strongly recommended to use the command system in the way it is meant to be used in the R&S ESRP.

Legacy command	Replaced by	Comment
HCOPY:TREPort:ITEM:HEADer:STATe	HCOPY:TREPort:ITEM:SElect	Items now selected by the command parameter.
HCOPY:TREPort:ITEM:DIAGram:STATe	HCOPY:TREPort:ITEM:SElect	Items now selected by the command parameter.
HCOPY:TREPort:ITEM:FRESults:STATe	HCOPY:TREPort:ITEM:SElect	Items now selected by the command parameter.
HCOPY:TREPort:ITEM:PAGecount:STATe	HCOPY:TREPort:ITEM:SElect	Items now selected by the command parameter.
HCOPY:TREPort:ITEM:SCANtable:STATe	HCOPY:TREPort:ITEM:SElect	Items now selected by the command parameter.
HCOPY:TREPort:ITEM:SRESults:STATe	HCOPY:TREPort:ITEM:SElect	Items now selected by the command parameter.
HCOPY:TREPort:ITEM:TDSTamp:STATe	HCOPY:TREPort:ITEM:SElect	Items now selected by the command parameter.
HCOPY:TREPort:ITEM:TRANsdncer:STATe	HCOPY:TREPort:ITEM:SElect	Items now selected by the command parameter.

## 11.14 Display Configuration

- [Controlling Display Elements](#)..... 945
- [Selecting Items to Store and Restore](#)..... 952

### 11.14.1 Controlling Display Elements

DISPlay:ANNotation:FREQuency.....	945
DISPlay:CMAP<item>:DEFault.....	945
DISPlay:CMAP<item>:HSL.....	946
DISPlay:CMAP<item>:PDEFined.....	946
DISPlay:FORMat.....	947
DISPlay:LOGO.....	947
DISPlay:PSAVe:HOLDoff.....	947
DISPlay:PSAVe[:STATe].....	947
DISPlay:SBAR[:STATe].....	948
DISPlay:SKEYs[:STATe].....	948
DISPlay:TBAR[STATe].....	948
DISPlay:THEMe:CATalog?.....	948
DISPlay:THEMe:SElect.....	949
DISPlay:TOUChscreen:STATE.....	949
DISPlay[:WINDow<n>][:SUBWIndow<m>]:SIZE.....	949
DISPlay[:WINDow<n>][:SUBWIndow<m>]:SElect.....	950
DISPlay[:WINDow<n>]:TEXT:STATE.....	950
DISPlay[:WINDow<n>]:TEXT[:DATA].....	951
DISPlay[:WINDow<n>]:TIME.....	951
DISPlay[:WINDow<n>]:TIME:FORMat.....	951
INITiate<n>:DISPlay.....	952

---

#### DISPlay:ANNotation:FREQuency <State>

This command switches the x-axis annotation on or off.

##### Parameters:

<State>                    ON | OFF  
 \*RST:                    ON

**Example:**                DISP:ANN:FREQ OFF

**Usage:**                    SCPI confirmed

**Manual operation:**    See "[Annotation \(On/Off\)](#)" on page 492

---

#### DISPlay:CMAP<item>:DEFault <Setting>

This command resets the screen colors of all display items to their default settings.

##### Suffix:

<item>                    irrelevant

##### Parameters:

<Setting>                1 | 2  
 Default settings DEFault1 and DEFault2

**Example:**                DISP:CMAP:DEF2  
 Selects default setting 2 for setting the colors.

<b>Usage:</b>	Event SCPI confirmed
<b>Manual operation:</b>	See " <a href="#">Select Screen Color Set</a> " on page 492 See " <a href="#">Set to Default</a> " on page 493

**DISPlay:CMAP<item>:HSL <ColorTable>**

This command defines the color table of the instrument.

The set values are not changed by \*RST.

**Suffix:**

<item> Selects the display item. For more information see [Table 11-25](#).

**Parameters:**

<ColorTable> hue | sat | lum

**hue**

TINT

**sat**

SATURATION

**lum**

BRIGHTNESS

The value range is 0 to 1 for all parameters.

**Example:** `DISP:CMAP2:HSL 0.3,0.8,1.0`  
Changes the grid color.

**Usage:** SCPI confirmed

**Manual operation:** See "[Screen Colors](#)" on page 492  
See "[Select Object](#)" on page 492  
See "[User Defined Colors](#)" on page 493

**DISPlay:CMAP<item>:PDEFined <Color>**

This command defines the color table of the instrument using predefined color values. Each suffix of CMAP is assigned to one or several graphical elements which can be modified by varying the corresponding color setting.

The values set are not changed by \*RST.

**Suffix:**

<item> Selects the display item. For more information see [Table 11-25](#).

**Parameters:**

<Color> BLACK | BLUE | BROWN | GREEN | CYAN | RED | MAGenta |  
YELLOW | WHITE | DGRAY | LGRAY | LBLUE | LGREEN | LCYan |  
LRED | LMAGenta

**Example:** `DISP:CMAP2:PDEF GRE`

**Usage:** SCPI confirmed

**Manual operation:** See ["Predefined Colors"](#) on page 493

### DISPlay:FORMat <Format>

This command switches the measurement result display between FULL SCREEN and SPLIT SCREEN.

**Parameters:**

<Format>            SINGle | SPLit

**SPLit**  
Show 2 or more screens on the display

**SINGle**  
Show only 1 screen on the display

\*RST:            SPL

**Example:**            DISP:FORM SING

### DISPlay:LOGO <State>

This command switches the company logo on the screen on or off.

**Parameters:**

<State>            ON | OFF

\*RST:            ON

**Example:**            DISP:LOGO OFF

**Manual operation:** See ["Print Logo \(On/Off\)"](#) on page 491

### DISPlay:PSAVe:HOLDoff <Minutes>

This command sets the holdoff time for the power-save mode of the display. The available value range is 1 to 60 minutes, the resolution 1 minute. The entry is dimensionless.

**Parameters:**

<Minutes>            1 to 60

\*RST:            15

**Example:**            DISP:PSAV:HOLD 30

**Manual operation:** See ["Display Pwr Save \(On/Off\)"](#) on page 494

### DISPlay:PSAVe[:STATe] <State>

This command switches on or off the power-save mode of the display. With the power-save mode activated the display including backlight is completely switched off after the elapse of the response time (see [DISPlay:PSAVe:HOLDoff](#) command).

This mode is recommended to protect the display, especially if the instrument is operated exclusively via remote control.

**Parameters:**

<State> ON | OFF  
 \*RST: OFF

**Example:**

DISP:PSAVe ON  
 Switches on the power-save mode.

**Manual operation:** See "[Display Pwr Save \(On/Off\)](#)" on page 494

**DISPlay:SBAR[:STATe] <State>**

This command turns the status bar in the display on and off.

**Parameters:**

<State> ON | OFF  
 \*RST: ON

**Example:**

DISP:SBAR OFF

**Manual operation:** See "[Status Bar](#)" on page 491

**DISPlay:SKEYs[:STATe] <State>**

This command turns the softkey bar in the display on and off.

**Parameters:**

<State> ON | OFF  
 \*RST: ON

**Example:**

DISP:SKEY OFF

**DISPlay:TBAR[STATe] <State>**

This command turns the toolbar in the display on or off.

**Parameters:**

<State> ON | OFF  
 \*RST: OFF

**Example:**

DISP:TOOL ON

**Manual operation:** See "[Tool Bar State \(On/Off\)](#)" on page 491

**DISPlay:THEMe:CATalog?**

This command queries the available themes for the display.

**Example:**

DISP:THEMe:CAT?

**Usage:**

Query only

---

**DISPlay:THEMe:SElect** <Theme>

This command selects a theme for the screen display. The theme defines the colors used for keys and screen elements, for example.

**Parameters:**

<Theme>                   String containing the name of the theme.  
\*RST:            SPL

**Example:**                DISP:THEM:SEL "OceanBlue"

**Manual operation:**    See "[Theme Selection](#)" on page 492

---

**DISPlay:TOUCHscreen:STATe** <State>

This command turns the touch screen functionality on, off, or partially on.

**Parameters:**

<State>                   ON | OFF | FRAME  
**ON**  
Touch screen function is active for entire screen  
**OFF**  
Touch screen is deactivated for entire screen  
**FRAME**  
Touch screen is deactivated for the diagram area of the screen, but active for the surrounding Softkeys, toolbars and menus.  
\*RST:            ON

**Example:**                DISP:TOUC:STAT ON

---

**DISPlay[:WINDow<n>][:SUBWindow<m>]:SIZE** <Size>

This command configures the measurement display.

**Suffix:**

<n>                        1 | 2  
window;  
Channel and adjacent-channel power measurements: Only "1" is allowed as a suffix for the window.  
Spectrum Emission Mask and Spurious Emissions measurements:  
selects the window that is displayed in full size (if no suffix is defined, "1" is used):  
1: diagram/result list  
2: marker table



<m>	1   2 selects the item in the window to be displayed in full size: 1: diagram 2: result list
<b>Parameters:</b>	
<Size>	LARGE   SMALL <b>LARGE</b> Channel and adjacent-channel power measurements: diagram in full screen. Spectrum Emission Mask and Spurious Emissions measurements: diagram or list in full screen, depending on the value of the suffix. <b>SMALL</b> split screen (diagram and list and table) *RST: SMALL
<b>Example:</b>	DISP:SIZE LARG Displays the measurement diagram in full screen size. DISP:WIND1:SUBW2:SIZE LARG Displays the result list in full screen size. DISP:WIND2:SIZE LARG Displays the marker table in full screen size.
<b>Mode:</b>	all

---

### DISPlay[:WINDow<n>][:SUBWindow<m>]:SElect

This command selects which window (screen) is active for applications with more than one measurement window. For measurements with additional subwindows (e.g. SEM, ACLR), the subwindow can also be selected.

**Suffix:**

<n>	1...4 window; For applications that do not have more than 1 measurement window, the suffix <n> is irrelevant.
<m>	1...2 1: graphic 2: table For applications that do not have subwindows, the suffix <m> is irrelevant.

<b>Example:</b>	DISP:WIND1:SEL Sets the window 1 active. DISP:WIND1:SUBW2:SEL Sets the focus on the table of window 1.
-----------------	-----------------------------------------------------------------------------------------------------------------

---

### DISPlay[:WINDow<n>]:TEXT:STATe <State>

This command turns the display of the comment (screen title) on and off.

**Suffix:**  
<n> Selects the measurement window.

**Parameters:**  
<State> ON | OFF  
\*RST: OFF

**Example:** DISP:TEXT:STAT ON  
Switches on the title.

#### DISPlay[:WINDow<n>]:TEXT[:DATA] <Comment>

This command defines a comment (max. 20 characters) which can be displayed in one of the measurement windows.

**Suffix:**  
<n> Selects the measurement window.

**Parameters:**  
<Comment> \*RST: (empty)

**Example:** DISP:WIND:TEXT 'Noise Measurement'  
Defines the screen title.

**Manual operation:** See ["Screen Title \(On/Off\)"](#) on page 491

#### DISPlay[:WINDow<n>]:TIME <State>

This command turns the display of date and time on and off.

**Suffix:**  
<n> irrelevant

**Parameters:**  
<State> ON | OFF  
\*RST: OFF

**Example:** DISP:TIME ON

**Manual operation:** See ["Screen Title \(On/Off\)"](#) on page 491  
See ["Time+Date \(On/Off\)"](#) on page 491

#### DISPlay[:WINDow<n>]:TIME:FORMat <Format>

This command selects the time and date display format.

**Suffix:**  
<n> irrelevant

**Parameters:**  
<Format> US | DE  
\*RST: DE

**Example:**            `DISP:TIME ON`  
 Switches the screen display of date and time on.  
                       `DISP:TIME:FORM US`  
 Switches the date and time format to US.

**Manual operation:** See ["Time+Date Format \(US/DE\)"](#) on page 491

#### **INITiate<n>:DISPlay <State>**

This command turns the display during a single sweep measurement on or off.

**Suffix:**

<n>                    irrelevant

**Parameters:**

<State>              `ON | OFF`  
                       `*RST:        ON`

**Example:**            `INIT:CONT OFF`  
 Switches to single sweep mode  
                       `INIT:DISP OFF`  
 Sets the display behavior to OFF  
                       `INIT; *WAI`  
 Starts the measurement with display switched off.

## 11.14.2 Selecting Items to Store and Restore

<a href="#">MMEMory:SElect[:ITEM]:ALL</a> .....	952
<a href="#">MMEMory:SElect[:ITEM]:DEFault</a> .....	953
<a href="#">MMEMory:SElect[:ITEM]:HWSettings</a> .....	953
<a href="#">MMEMory:SElect[:ITEM]:LINes:ALL</a> .....	953
<a href="#">MMEMory:SElect[:ITEM]:NONE</a> .....	953
<a href="#">MMEMory:SEL[:ITEM]:SGRam</a> .....	954
<a href="#">MMEMory:SElect[:ITEM]:TRACe[:ACTive]</a> .....	954
<a href="#">MMEMory:SElect[:ITEM]:TRANsducer:ALL</a> .....	954
<a href="#">MMEMory:USER&lt;Softkey&gt;</a> .....	954

#### **MMEMory:SElect[:ITEM]:ALL**

This command includes all data subsets in the list of device settings to be stored/loaded.

**Example:**            `MMEM:SEL:ALL`

**Usage:**              Event

**Manual operation:** See ["Enable all Items"](#) on page 503

---

**MMEMory:SElect[:ITEM]:DEFault**

This command includes the default list in the settings file to be stored/loaded. For details on hardware settings refer to the [MMEMory:SElect\[:ITEM\]:HWSettings](#) on page 953 command.

**Example:** `MMEM:SEL:DEFault`

---

**MMEMory:SElect[:ITEM]:HWSettings <State>**

This command includes the hardware settings in the settings file to be stored/loaded. The hardware settings include:

- current configuration of general device parameters (general setup)
- current setting of the measurement hardware including markers
- activated limit lines:

A settings file may include 8 limit lines at maximum. This number includes the activated limit lines and, if available, the de-activated limit lines last used.

Therefore the combination of the non-activated restored limit lines depends on the sequence of use with the [MMEMory:LOAD:STATe](#) on page 915 command.

- user-defined color setting
- configuration for the hardcopy output

**Parameters:**

<State> ON | OFF  
\*RST: ON

**Example:** `MMEM:SEL:HWS ON`

**Manual operation:** See "[Select Items](#)" on page 502

---

**MMEMory:SElect[:ITEM]:LINes:ALL <State>**

This command includes all limit lines (activated and de-activated) in the settings file to be stored/loaded.

**Parameters:**

<State> ON | OFF  
\*RST: OFF

**Example:** `MMEM:SEL:LIN:ALL ON`

**Manual operation:** See "[Select Items](#)" on page 502

---

**MMEMory:SElect[:ITEM]:NONE**

This command excludes all items from the settings file to be stored/loaded.

**Example:** `MMEM:SEL:NONE`

**Usage:** Event

**Manual operation:** See "[Disable all Items](#)" on page 503

---

#### **MMEMory:SEL[:ITEM]:SGRam** <State>

This command includes or excludes spectrogram data when storing or restoring a configuration file.

**Parameters:**

<State> ON | OFF

**Example:**

MMEM:SEL:SGR ON

Adds spectrogram data to the configuration file.

---

#### **MMEMory:SElect[:ITEM]:TRACe[:ACTive]** <State>

This command includes the active traces in the settings file to be stored/loaded. Active traces are all traces whose state is not blank.

**Parameters:**

<State> ON | OFF

\*RST: OFF, i.e. no traces is stored

**Example:**

MMEM:SEL:TRAC ON

**Manual operation:** See "[Select Items](#)" on page 502

---

#### **MMEMory:SElect[:ITEM]:TRANsducer:ALL** <State>

This command includes all transducer factors and sets in the settings file to be stored/loaded.

**Parameters:**

<State> ON | OFF

\*RST: OFF

**Example:**

MMEM:SEL:TRAN:ALL ON

**Manual operation:** See "[Select Items](#)" on page 502

---

#### **MMEMory:USER<Softkey>** <Filename>, <Label>

This command defines the settings file to be loaded when the specified user-definable softkey is selected. The settings file must exist, otherwise an error occurs.

**Suffix:**

<Softkey> 1 | 2 | 3 | 4 | 5 | 6 | 7 | 8

Number of the softkey in the "User" menu.

**Parameters:**

<Filename> string

This parameter defines the path and file name of the settings to be loaded.

<Label>	string
	This parameter defines the label of the user-definable softkey.
	*RST:        User<Softkey_number>
<b>Example:</b>	MMEM:USER1 'C:\MySaveSets\Set1','Set1' Loads settings file Set1 when the "Set1" softkey in the "User" menu is selected.
<b>Example:</b>	MMEM:USER3 'C:\MySaveSets\Set3','' Loads settings file Set3 when the "User3" softkey in the "User" menu is selected.

## 11.15 Network Connection

- [Configuring Network Connections](#).....955
- [Emulating HP Instruments](#).....958

### 11.15.1 Configuring Network Connections

<a href="#">MMEMory:NETWork:DISConnect</a> .....	955
<a href="#">MMEMory:NETWork:MAP</a> .....	955
<a href="#">MMEMory:NETWork:UNUSeddrives?</a> .....	956
<a href="#">MMEMory:NETWork:USEDdrives?</a> .....	956
<a href="#">SYSTem:COMMunicate:GPIB[:SELF]:ADDRess</a> .....	957
<a href="#">SYSTem:COMMunicate:GPIB[:SELF]:RTERminator</a> .....	957
<a href="#">SYSTem:LXI:INFo?</a> .....	957
<a href="#">SYSTem:LXI:LANReset</a> .....	958
<a href="#">SYSTem:LXI:MDEscription</a> .....	958
<a href="#">SYSTem:LXI:PASSword</a> .....	958

---

#### MMEMory:NETWork:DISConnect <Drive>

This command disconnects the selected drive.

#### Parameters:

<Drive>

**Example:**           MMEM:NETW:DISC 'T:'  
                          Disconnects network drive T:

**Usage:**             Event

**Manual operation:** See "[Disconnect Network Drive](#)" on page 507

---

#### MMEMory:NETWork:MAP <Drive>, <HostName> [, <UserName>, <Password>][, <Reconnect>]

This command maps a drive to a server or server directory of the network.

Note that you have to allow sharing for a server or folder in Microsoft networks first.

**Parameters:**

<Drive>	String containing the drive name or path of the directory you want to map.
<HostName>	String containing the host name of the computer or the IP address and the share name of the drive. '<host name or IP address\share name>'
<UserName>	String containing a user name in the network. The user name is optional.
<Password>	String containing the password corresponding to the <UserName>. The password is optional.
<Reconnect>	ON   OFF <b>ON</b> Reconnects at logon with the same user name. <b>OFF</b> Does not reconnect at logon.

**Usage:** Event

**Manual operation:** See "[Map Network Drive](#)" on page 507

**MMEMory:NETWork:UNUSeddrives?**

This command lists all unused network drive names.

This command is only a query and therefore has no \*RST value.

**Example:** `MMEM:NETW:UNUS?`  
Lists all unused network drive names.

**Usage:** Query only

**Manual operation:** See "[Map Network Drive](#)" on page 507

**MMEMory:NETWork:USEDdrives? <ResultType>**

This command lists all mapped network drives.

**Query parameters:**

<ResultType>	<b>ON</b> Lists all mapped network drives including the folder information. <b>OFF</b> Lists all mapped network drive names. *RST: OFF
--------------	----------------------------------------------------------------------------------------------------------------------------------------------------

**Example:** `MMEM:NETW:USED? ON`  
Lists all mapped network drives including the folder information.

**Usage:** Query only

**Manual operation:** See ["Map Network Drive"](#) on page 507

### **SYSTem:COMMunicate:GPIB[:SELF]:ADDRess** <Address>

This command changes the GPIB address of the unit.

**Parameters:**

<Address>                    0 to 30  
 \*RST:                        (no influence on this parameter, factory default 20)

**Example:**                    SYST:COMM:GPIB:ADDR 18

**Usage:**                        SCPI confirmed

**Manual operation:** See ["GPIB Address"](#) on page 485

### **SYSTem:COMMunicate:GPIB[:SELF]:RTERminator** <Terminator>

This command changes the GPIB receive terminator.

According to the standard the terminator in ASCII is <LF> and/or <EOI>. For binary data transfers (e.g. trace data) from the control computer to the instrument, the binary code (0AH) used for <LF> might be included in the binary data block, and therefore should not be interpreted as a terminator in this particular case. This can be avoided by changing the receive terminator to EOI.

Output of binary data from the instrument to the control computer does not require such a terminator change.

**Parameters:**

<Terminator>                LFEOI | EOI  
 \*RST:                        (no influence on this parameter, factory default LFEOI)

**Example:**                    SYST:COMM:GPIB:RTER EOI

**Manual operation:** See ["GPIB Terminator LFEOI/EOI"](#) on page 489

### **SYSTem:LXI:INFo?**

This query returns the current parameters of the LXI class C.

Only user accounts with administrator rights are able to use LXI functionality.

**Return values:**

Return values                <current version> | <LXI class> | <Computername> |  
 (example)                    <MAC adress> | <IP adress> | <Auto MDIX>

**Usage:**                        Query only

**Manual operation:** See ["Info"](#) on page 484



**SYSTem:LXI:LANReset**

This command resets the LAN configuration to the values required by the LXI standard. In addition, the password is reset to its initial state as well as the LXI instrument description.

Only user accounts with administrator rights are able to use LXI functionality.

**Example:** `SYST:LXI:LANR`

**Usage:** Event

**Manual operation:** See "[LAN Reset](#)" on page 485

**SYSTem:LXI:MDEscription <String>**

This command shows the LXI instrument description. Also, the instrument description can be changed using this command.

Only user accounts with administrator rights are able to use LXI functionality.

**Parameters:**

<String>

**Example:** `SYST:LXI:MDES`

**Manual operation:** See "[Description](#)" on page 485

**SYSTem:LXI:PASSword <Password>**

This command shows or changes the LXI password.

Only user accounts with administrator rights are able to use LXI functionality.

**Parameters:**

<Password>            <password>

**Example:** `SYST:LXI:PASS`

**Manual operation:** See "[Password](#)" on page 484

**11.15.2 Emulating HP Instruments**

<a href="#">SYSTem:REVision:FACTory</a> .....	959
<a href="#">SYSTem:REVision[:STRing]</a> .....	959
<a href="#">SYSTem:RSW</a> .....	959
<a href="#">SYSTem:LANGuage</a> .....	960
<a href="#">SYSTem:HPCoupling</a> .....	960
<a href="#">SYSTem:IFGain:MODE</a> .....	961
<a href="#">SYSTem:TWALking</a> .....	961

---

**SYSTem:REVision:FACTory**

Resets the response to the REV? query to the default value, e.g. after a user string was defined using the `SYSTem:REVision[:STRing]` command. (REV? query available for HP emulation only, see [Chapter 11.18, "GPIB Commands of HP Models 856xE, 8566A/B, 8568A/B and 8594E"](#), on page 1007.)

**Example:**

```

Define the system language:
SYST:LANG '8563E'
Set the response back to factory setting:
SYS:REV:FACT
Query the revision:
REV?
Response:
920528

```

**Usage:** Event  
SCPI confirmed

**Manual operation:** See ["REV String Factory"](#) on page 488

---

**SYSTem:REVision[:STRing] <Name>**

Sets the response to the REV? query to the defined string (HP emulation only, see [Chapter 11.18, "GPIB Commands of HP Models 856xE, 8566A/B, 8568A/B and 8594E"](#), on page 1007).

**Parameters:**  
<Name>

**Example:**

```

Define the system language:
SYST:LANG '8563E'
Query the revision:
REV?
Response:
920528
Set the response to 'NewRevision':
SYST:REV:STR 'NewRevision'
Query the response:
SYST:REV:STR?
Response:
NewRevision

```

**Manual operation:** See ["REV String User"](#) on page 488

---

**SYSTem:RSW <State>**

Controls a repeated sweep of the E1 and MKPK HI/HL HP model commands (for details on the commands refer to [Chapter 11.18, "GPIB Commands of HP Models 856xE, 8566A/B, 8568A/B and 8594E"](#), on page 1007). If the repeated sweep is OFF, the marker is set without sweeping before.

This command is only available if a HP language is selected using [SYSTem:LANGuage](#).

**Parameters:**

<State> ON | OFF  
\*RST: OFF

**Example:** SYSTem:RSW ON

**Usage:** SCPI confirmed

**Manual operation:** See "[Sweep Repeat \(On/Off\)](#)" on page 487

**SYSTem:LANGuage** <Language>

This command defines the system language. Default is SCPI which defines the standard remote control behavior of the instrument. The other parameters are to simulate the corresponding HP analyzer. The parameter "PSA89600" sets the device in a state in which it can be used for IQ capturing from the 89600 vector signal analyzer software.

**Parameters:**

<Language> "SCPI" | "8560E" | "8561E" | "8562E" | "8563E" | "8564E" |  
"8565E" | "8566A" | "8566B" | "8568A" | "8568A\_DC" | "8568B" |  
"8568B\_DC" | "8591E" | "8594E" | "71100C" | "71200C" |  
"71209A" | "PSA89600" | "PSA" | "ESA"  
\*RST: SCPI

**Example:** SYST:LANG '8560E'  
Sets the system language to 8560E to simulate the HP analyzer.

**Manual operation:** See "[GPIB Language](#)" on page 486

**Note:** If you use "PSA89600", you must switch to an HP language first before returning to SCPI (in remote operation only). For the identical language "PSA", this intermediate step is not necessary.

**SYSTem:HPCoupling** <CouplingType>

Controls the default coupling ratios in the HP emulation mode for:

- span and resolution bandwidth (Span/RBW) and
- resolution bandwidth and video bandwidth (RBW/VBW)

For FSP (=FSV), the standard parameter coupling of the instrument is used. As a result, in most cases a shorter sweeptime is used than in case of HP.

This command is only available if a HP language is selected using [SYSTem:LANGuage](#).

**Parameters:**

<CouplingType> HP | FSP  
\*RST: FSP

**Example:** `SYSTem:HPC HP`  
**Usage:** SCPI confirmed  
**Manual operation:** See "[Coupling \(FSx/HP\)](#)" on page 488

#### **SYSTem:IFGain:MODE** <Mode>

Configures the internal IF gain settings in HP emulation mode due to the application needs. This setting is only taken into account for resolution bandwidth < 300 kHz and is only available if a HP language is selected using [SYSTem:LANGuage](#).

#### **Parameters:**

<Mode>                    NORM | PULS

**NORM**  
Optimized for high dynamic range, overload limit is close to reference level.

**PULS**  
Optimized for pulsed signals, overload limit up to 10 dB above reference level.

\*RST:            NORM

**Example:** `SYST:IFG:MODE PULS`  
**Usage:** SCPI confirmed  
**Manual operation:** See "[IF Gain \(Norm/Puls\)](#)" on page 487

#### **SYSTem:TWALking** <Mode>

Defines how remote control programs are evaluated, in particular multiple commands in one command line.

Note that the default setting is `NORM`; however, the setting defined by this command is retained after a [preset] (\*RST) operation.

#### **Parameters:**

<Mode>                    **NORM**  
SCPI-conform behaviour  
The first command is always referenced to the root node. Subsequent commands, however, are referenced to the same tree level as the previous command in a message unit.

**ENHanced**  
If subsequent commands are not found on the same tree level as the previous command, the SCPI parser searches "backwards up the tree" of defined SCPI commands. If the command is found at a higher node, that command is used. Only if the command is not found anywhere, an error message is returned.

\*RST:            setting is retained

**Example:**

```
*RST
:SYSTem:TWALKing ENHanced
:SENSe:SWEep:MODE LIST
INIT:CONT OFF
LIST:RANG4:DEL;RANG3:DEL
```

//without enhanced tree walking this command would deliver an error

**Manual operation:** See ["Tree Walking"](#) on page 488

## 11.16 Status Register

For more information on the contents of the status registers see the following sections.

Status registers in receiver mode:

- ["STATus:OPERation Register"](#) on page 551
- ["STATus:QUEStionable Register"](#) on page 552
- ["STATus:QUEStionable:FREQuency Register"](#) on page 553
- ["STATus:QUEStionable:LIMit Register"](#) on page 553
- ["STATus:QUEStionable:LMARgin Register"](#) on page 554
- ["STATus:QUEStionable:POWer Register"](#) on page 555
- ["STATus:QUEStionable:TRANsducer Register"](#) on page 555

Status registers in spectrum mode:

- ["STATus:OPERation Register"](#) on page 557
- ["STATus:QUEStionable Register"](#) on page 558
- ["STATus:QUEStionable:ACPLimit Register"](#) on page 559
- ["STATus:QUEStionable:FREQuency Register"](#) on page 553
- ["STATus:QUEStionable:LIMit Register"](#) on page 553
- ["STATus:QUEStionable:LMARgin Register"](#) on page 554
- ["STATus:QUEStionable:POWer Register"](#) on page 555

### 11.16.1 General Status Register Commands

<a href="#">STATus:PRESet</a> .....	963
<a href="#">STATus:QUEue[:NEXT?]</a> .....	963

**STATus:PRESet**

This command resets the edge detectors and ENABLE parts of all registers to a defined value. All PTRansition parts are set to FFFFh, i.e. all transitions from 0 to 1 are detected. All NTRansition parts are set to 0, i.e. a transition from 1 to 0 in a CONDition bit is not detected. The ENABLE part of the STATus:OPERation and STATus:QUESTionable registers are set to 0, i.e. all events in these registers are not passed on.

**Example:** STAT:PRES

**Usage:** SCPI confirmed

**STATus:QUEue[:NEXT]??**

This command queries the earliest error queue entry and deletes it.

Positive error numbers indicate device-specific errors, negative error numbers are error messages defined by SCPI. If the error queue is empty, the error number 0, "No error", is returned. This command is identical to the `SYSTEM:ERROR[:NEXT]?` on page 895 command.

**Example:** STAT:QUES?

**Usage:** Query only  
SCPI confirmed

**11.16.2 Reading out the EVENT Part**

For more information on the event part see [Chapter 11.1.6.2, "Structure of a SCPI Status Register"](#), on page 546.

**STATus:OPERation[:EVENT]?**

**STATus:QUESTionable[:EVENT]?**

**STATus:QUESTionable:ACPLimit[:EVENT]?**

**STATus:QUESTionable:FREQuency[:EVENT]?**

**STATus:QUESTionable:LIMit<n>[:EVENT]?**

**STATus:QUESTionable:LMARgin<n>[:EVENT]?**

**STATus:QUESTionable:POWer[:EVENT]?**

**STATus:QUESTionable:TRANsducer[:EVENT]?**

These commands read out the EVENT section of the status register.

At the same time, the commands delete the contents of the EVENT section.

**Usage:** Query only

**11.16.3 Reading Out the CONDition Part**

For more information on the condition part see [Chapter 11.1.6.2, "Structure of a SCPI Status Register"](#), on page 546.

---

```

STATus:OPERation:CONDition?
STATus:QUESTionable:CONDition?
STATus:QUESTionable:ACPLimit:CONDition?
STATus:QUESTionable:FREQuency:CONDition?
STATus:QUESTionable:LIMit<n>:CONDition?
STATus:QUESTionable:LMARgin<n>:CONDition?
STATus:QUESTionable:POWer:CONDition?
STATus:QUESTionable:TRANsducer:CONDition?

```

These commands read out the CONDition section of the status register.

The commands do not delete the contents of the EVENT section.

**Usage:**                   Query only

#### 11.16.4 Controlling the ENABLE Part

For more information on the enable part see [Chapter 11.1.6.2, "Structure of a SCPI Status Register"](#), on page 546.

---

```

STATus:OPERation:ENABLE <SumBit>
STATus:QUESTionable:ENABLE <SumBit>
STATus:QUESTionable:ACPLimit:ENABLE <SumBit>
STATus:QUESTionable:FREQuency:ENABLE <SumBit>
STATus:QUESTionable:LIMit<n>:ENABLE <SumBit>
STATus:QUESTionable:LMARgin<n>:ENABLE <SumBit>
STATus:QUESTionable:POWer:ENABLE <SumBit>
STATus:QUESTionable:TRANsducer:ENABLE <SumBit>

```

These commands control the ENABLE part of a register.

The ENABLE part allows true conditions in the EVENT part of the status register to be reported in the summary bit. If a bit is 1 in the enable register and its associated event bit transitions to true, a positive transition will occur in the summary bit reported to the next higher level.

**Parameters:**

<SumBit>                   Range:     0 to 65535

#### 11.16.5 Controlling the Negative Transition Part

For more information on the positive transition part see [Chapter 11.1.6.2, "Structure of a SCPI Status Register"](#), on page 546.

---

```

STATus:OPERation:NTRansition <SumBit>
STATus:QUESTionable:NTRansition <SumBit>
STATus:QUESTionable:ACPLimit:NTRansition <SumBit>
STATus:QUESTionable:FREQuency:NTRansition <SumBit>
STATus:QUESTionable:LIMit<n>:NTRansition <SumBit>
STATus:QUESTionable:LMARgin<n>:NTRansition <SumBit>

```

**STATus:QUESTIONable:POWER:NTRansition** <SumBit>

**STATus:QUESTIONable:TRANSducer:NTRansition** <SumBit>

These commands control the Negative TRansition part of a register.

Setting a bit causes a 1 to 0 transition in the corresponding bit of the associated register. The transition also writes a 1 into the associated bit of the corresponding EVENT register.

**Parameters:**

<SumBit>                      Range:      0 to 65535

### 11.16.6 Controlling the Positive Transition Part

For more information on the negative transition part see [Chapter 11.1.6.2, "Structure of a SCPI Status Register"](#), on page 546.

---

**STATus:OPERation:PTRansition** <SumBit>

**STATus:QUESTIONable:PTRansition** <SumBit>

**STATus:QUESTIONable:ACPLimit:PTRansition** <SumBit>

**STATus:QUESTIONable:FREQuency:PTRansition** <SumBit>

**STATus:QUESTIONable:LIMit<n>:PTRansition** <SumBit>

**STATus:QUESTIONable:LMARgin<n>:PTRansition** <SumBit>

**STATus:QUESTIONable:POWER:PTRansition** <SumBit>

**STATus:QUESTIONable:TRANSducer:PTRansition** <SumBit>

These commands control the Positive TRansition part of a register.

Setting a bit causes a 0 to 1 transition in the corresponding bit of the associated register. The transition also writes a 1 into the associated bit of the corresponding EVENT register.

**Parameters:**

<SumBit>                      Range:      0 to 65535

## 11.17 Remote Control – Programming Examples

In this chapter, more complex programming examples are given. In [Chapter 11.2.3, "Brief Introduction to Remote Control"](#), on page 572, basic steps in remote control programming are provided.

The following programming examples have a hierarchical structure, i.e. subsequent examples are based on previous ones. It is thus possible to compile an operational program from the modules of the given examples very easily. VISUAL BASIC has been used as programming language. However, the programs can be translated into other languages.





In programming languages as C, C++ or programs as MATLAB, NI Interactive Control, a backslash starts an escape sequence (e.g. "\n" is used to start a new line). In these programming languages and programs, two backslashes instead of one must be used in remote commands (for an example refer to [Chapter 11.2.3.1, "Basic Steps in Remote Control Programming"](#), on page 572.)

11.17.1	Service Request.....	967
11.17.1.1	Initiate Service Request.....	967
11.17.1.2	Waiting for the Arrival of a Service Request.....	968
11.17.1.3	Waiting Without Blocking the Keyboard and Mouse.....	969
11.17.1.4	Service Request Routine.....	970
11.17.1.5	Reading Out the Output Buffer.....	971
11.17.1.6	Reading Error Messages.....	971
11.17.1.7	Evaluation of SCPI Status Registers.....	972
11.17.1.8	Evaluation of Event Status Register.....	973
11.17.2	Using Marker and Delta Marker.....	974
11.17.2.1	Shape Factor Measurement (using n dB down).....	974
11.17.2.2	Measuring the Third Order Intercept Point.....	975
11.17.2.3	Measuring the AM Modulation Depth.....	976
11.17.3	Limit Lines and Limit Test.....	976
11.17.4	Measuring the Channel and Adjacent Channel Power.....	978
11.17.5	Occupied Bandwidth Measurement.....	981
11.17.6	Time Domain Power Measurement.....	982
11.17.7	Fast Power Measurement on Power Ramps.....	983
11.17.7.1	Power Measurement with Multi-Summary Marker.....	983
11.17.7.2	Multi-Burst Power Measurement.....	985
11.17.8	Fast Level Measurement Using Frequency Lists.....	986
11.17.9	Level Correction of Transducers.....	988
11.17.10	Measuring the Magnitude and Phase of a Signal.....	989
11.17.11	Reading and Writing Files.....	991
11.17.11.1	Reading a File from the Instrument.....	991
11.17.11.2	Creating a File on the Instrument.....	992
11.17.12	Spectrum Emission Mask Measurement.....	992
11.17.12.1	Using Predefined Standard Wibro.....	993
11.17.12.2	Defining 5 Ranges with all Parameters.....	993

11.17.13	Spurious Emissions Measurement.....	996
11.17.14	Averaging I/Q Data.....	999
11.17.15	Using IQ Gating.....	1000
11.17.16	Usage of Four Spectrum Instances.....	1005

## 11.17.1 Service Request

The service request routine requires an extended initialization of the instrument in which the relevant bits of the transition and enable registers are set. In addition the service request event must be enabled in the VISA session.

### 11.17.1.1 Initiate Service Request

```

REM ---- Example of initialization of the SRQ in the case
' of errors -----
PUBLIC SUB SetupSRQ()
CALL InstrWrite (analyzer, "*CLS") 'Reset status reporting system
CALL InstrWrite (analyzer, "*SRE 168") 'Enable service request for
' STAT:OPER, STAT:QUES and ESR
' register
CALL InstrWrite (analyzer, "*ESE 60") 'Set event enable bit for
' command, execution, device-
' dependent and query error
CALL InstrWrite (analyzer, "STAT:OPER:ENAB 32767")
' Set OPERATION enable bit for
' all events
CALL InstrWrite (analyzer, "STAT:OPER:PTR 32767")
' Set appropriate OPERATION
' Ptransition bits
CALL InstrWrite (analyzer, "STAT:QUES:ENAB 32767")
' Set questionable enable bits
' for all events
CALL InstrWrite (analyzer, "STAT:QUES:PTR 32767")
' Set appropriate questionable
' Ptransition bits
CALL viEnableEvent(analyzer, VI_EVENT_SERVICE_REQ, VI_QUEUE, 0)
' Enable the event for service
' request
Status = viWaitOnEvent(analyzer, VI_EVENT_SERVICE_REQ, SRQWaitTimeout, VI_NULL,
VI_NULL)
IF (status = VI_SUCCESS) THEN CALL Srq
' If SRQ is recognized =>
' subroutine for evaluation
END SUB
REM *****

```

### 11.17.1.2 Waiting for the Arrival of a Service Request

There are basically two methods of waiting for the arrival of a service request:

#### **Blocking (user inputs not possible):**

This method is appropriate if the waiting time until the event to be signaled by an SRQ is short (shorter than the selected timeout), if no response to user inputs is required during the waiting time, and if – as the main criterion – the event is absolutely certain to occur.

Reason:

From the time the `viWaitOnEvent()` function is called until the occurrence of the expected event, it does not allow the program to respond to mouse clicks or key entries during the waiting time. Moreover, it returns an error if the SRQ event does not occur within the predefined timeout period.

The method is, therefore, in many cases not suitable for waiting for measurement results, especially when using triggered measurements.

The following function calls are required:

```
Status = viWaitOnEvent(analyzer, VI_EVENT_SERVICE_REQ, SRQWaitTimeout, VI_NULL,
    VI_NULL)
'Wait for service request user
'inputs are not possible during
'the waiting time!
IF (status = VI_SUCCESS) THEN CALL Srq
'If SRQ is recognized =>
'subroutine for evaluation

'----- Sweep in first Spectrum Tab and query marker -----
Dim Status = mbSession.WaitOnEvent( _
MessageBasedSessionEventType.ServiceRequest, SRQWaitTimeout)
'Wait for service request user inputs are not possible
'during the waiting time!
If (Status.EventType() = MessageBasedSessionEventType.ServiceRequest) Then
'If SRQ is recognized => subroutine for evaluation
    Srq()
End If
```

#### **Non-blocking (user inputs possible):**

This method is recommended if the waiting time until the event to be signaled by an SRQ is long (longer than the selected timeout), and user inputs should be possible during the waiting time, or if the event is not certain to occur. This method is, therefore, the preferable choice for waiting for the end of measurements, i.e. the output of results, especially in the case of triggered measurements.

The method necessitates a waiting loop that checks the status of the SRQ line at regular intervals and returns control to the operating system during the time the expected

event has not yet occurred. In this way, the system can respond to user inputs (mouse clicks, key entries) during the waiting time.

It is advisable to employ the Hold() auxiliary function, which returns control to the operating system for a selectable waiting time (see section [Waiting Without Blocking the Keyboard and Mouse](#)), so enabling user inputs during the waiting time.

```

result% = 0
For i = 1 To 10 'Abort after max. 10 loop
'iterations
Status = viWaitOnEvent(analyzer, VI_EVENT_SERVICE_REQ, VI_TMO_IMMEDIATE, VI_NULL,
VI_NULL)
'Check event queue
If (status = VI_SUCCESS) Then
result% = 1
CALL Srq 'If SRQ is recognized =>
'subroutine for evaluation
Else
CALL Hold(20) 'Call hold function with
'20 ms 'waiting time. User inputs
'are possible.
Endif
Next i
If result% = 0 Then
Debug.Print "Timeout Error; Program aborted" 'Output error message
STOP 'Stop software
Endif

```

### 11.17.1.3 [Waiting Without Blocking the Keyboard and Mouse](#)

A frequent problem with remote control programs using Visual Basic is to insert waiting times without blocking the keyboard and the mouse.

If the program is to respond to user inputs also during a waiting time, control over the program events during this time must be returned to the operating system. In Visual Basic, this is done by calling the DoEvents function. This function causes keyboard-or mouse-triggered events to be executed by the associated elements. For example, it allows the operation of buttons and input fields while the user waits for an instrument setting to be completed.

The following programming example describes the Hold() function, which returns control to the operating system for the period of the waiting time selectable in milliseconds.

```

Rem *****
Rem The waiting function below expects the transfer of the desired
Rem waiting time in milliseconds. The keyboard and the mouse remain
Rem operative during the waiting period, thus allowing desired elements
Rem to be controlled
Rem *****
Public Sub Hold(delayTime As Single)
Start = Timer 'Save timer count on calling the

```

```

'function
Do While Timer < Start + delayTime/1000 'Check timer count
DoEvents 'Return control to operating
'system to enable control of
'desired elements as long as
'timer has not elapsed
Loop
End Sub
Rem *****

```

The waiting procedure is activated simply by calling Hold(<Waiting time in milliseconds>).

#### 11.17.1.4 Service Request Routine

A service request is processed in the service request routine.



The variables userN% and userM% must be pre-assigned usefully!

```

REM ----- Service request routine -----
Public SUB Srq()
ON ERROR GOTO noDevice 'No user existing
CALL viReadSTB(analyzer, STB%) 'Serial poll, read status byte
IF STB% > 0 THEN 'This instrument has bits set in
'the STB
SRQFOUND% = 1
IF (STB% AND 16) > 0 THEN CALL Outputqueue
IF (STB% AND 4) > 0 THEN CALL ErrorQueueHandler
IF (STB% AND 8) > 0 THEN CALL Questionablestatus
IF (STB% AND 128) > 0 THEN CALL Operationstatus
IF (STB% AND 32) > 0 THEN CALL Esrread
END IF
noDevice:
END SUB 'End of SRQ routine
Rem *****

REM ----- Subroutine for evaluation Service Request Routine -----

Public Sub Srq()
Try
Dim mySTB As Short = mbSession.ReadStatusByte()
'Serial poll, read status byte
Console.WriteLine("Reading Service Request Routine:" + mySTB.ToString())
If mySTB > 0 Then 'This instrument has bits set in the STB
If (mySTB And 16) > 0 Then Call Outputqueue()
If (mySTB And 4) > 0 Then Call ErrorQueueHandler()
If (mySTB And 8) > 0 Then Call Questionablestatus()
If (mySTB And 128) > 0 Then Call Operationstatus()

```

```

        If (mySTB And 32) > 0 Then Call Esrread()
    End If
    Catch exp As Exception
        Console.WriteLine(exp.Message)
    End Try
End Sub 'End of SRQ routine

```

Reading out the status event registers, the output buffer and the error/event queue is effected in subroutines.

### 11.17.1.5 Reading Out the Output Buffer

```

REM ----- Subroutine for the individual STB bits -----
Public SUB Outputqueue() 'Reading the output buffer
result$ = SPACE$(100) 'Make space for response
CALL InstrRead(analyzer, result$)
Debug.Print "Contents of Output Queue:"; result$
END SUB
REM *****

REM ----- Subroutine for the output queue -----
Public Sub Outputqueue() 'Reading the output buffer
    Try
        Dim result As String = mbSession.ReadString()
        Console.WriteLine("Contents of Output Queue:" + result)
    Catch exp As Exception
        Console.WriteLine(exp.Message)
    End Try
End Sub

```

### 11.17.1.6 Reading Error Messages

```

REM ----- Subroutine for reading the error queue -----
Public SUB ErrorQueueHandler()
ERROR$ = SPACE$(100) 'Make space for error variable
CALL InstrWrite (analyzer, "SYSTEM:ERROR?")
CALL InstrRead(analyzer, ERROR$)
Debug.Print "Error Description:"; ERROR$
END SUB
REM *****

REM ----- Subroutine for reading the error queue -----
Sub ErrorQueueHandler()
    Dim result As String
    Dim hasErr As Boolean = True
    Do
        mbSession.Write("SYST:ERR?")
        result = mbSession.ReadString()
        Dim parts As String() = result.Split(",")
        If parts(0) = 0 Then

```

```

        hasErr = False
        Console.WriteLine(result)
    Else
        Console.WriteLine(result)
    End If
    Loop While hasErr
End Sub

```

### 11.17.1.7 Evaluation of SCPI Status Registers

```

REM ----- Subroutine for evaluating Questionable Status Register -----
Public SUB Questionablestatus()
Ques$ = SPACE$(20)
'Preallocate blanks to text
'variable
CALL InstrWrite (analyzer, "STaTus:QUEStionable:EVENT?")
CALL InstrRead(analyzer, Ques$)
Debug.Print "Questionable Status: "; Ques$
END SUB
REM *****
REM ----- Subroutine for evaluating Operation Status Register -----
Public SUB Operationstatus()
Oper$ = SPACE$(20) 'Preallocate blanks to text
'variable
CALL InstrWrite (analyzer, "STaTus:OPERation:EVENT?")
CALL InstrRead(analyzer, Oper$)
Debug.Print "Operation Status: "; Oper$
END SUB
REM *****

REM ----- Subroutine for evaluating Questionable Status Register -----
Public Sub Questionablestatus()
    Dim myQSR As String = Nothing
    Try
        myQSR = mbSession.Query("STaTus:QUEStionable:EVENT?") 'Read QSR
        Console.WriteLine("Questionable Status:" + myQSR)
    Catch exp As Exception
        Console.WriteLine(exp.Message)
    End Try
End Sub

REM ----- Subroutine for evaluating Operation Status Register -----
Public Sub Operationstatus()
    Dim myOSR As String = Nothing
    Try
        myOSR = mbSession.Query("STaTus:OPERation:EVENT?") 'Read OSR
        Console.WriteLine("Operation Status:" + myOSR)
    Catch exp As Exception
        Console.WriteLine(exp.Message)

```

```

    End Try
End Sub

```

### 11.17.1.8 Evaluation of Event Status Register

```

REM ----- Subroutine for evaluating the Event Status Register -----
Public SUB Esrread()
Esr$ = SPACE$(20) 'Preallocate blanks to text
'variable
CALL InstrWrite (analyzer, "*ESR?") 'Read ESR
CALL InstrRead(analyzer, Esr$)
IF (VAL(Esr$) AND 1) > 0 THEN Debug.Print "Operation complete"
IF (VAL(Esr$) AND 2) > 0 THEN Debug.Print "Request Control"
IF (VAL(Esr$) AND 4) > 0
THEN Debug.Print "Query Error"
IF (VAL(Esr$) AND 8) > 0
THEN Debug.Print "Device dependent error"
IF (VAL(Esr$) AND 16) > 0
THEN Debug.Print "Execution Error; Program aborted" 'Output error message
STOP 'Stop software
END IF
IF (VAL(Esr$) AND 32) > 0
THEN Debug.Print "Command Error; Program aborted" 'Output error message
STOP 'Stop software
END IF
IF (VAL(Esr$) AND 64) > 0 THEN Debug.Print "User request"
IF (VAL(Esr$) AND 128) > 0 THEN Debug.Print "Power on"END SUB
REM *****

REM ----- Subroutine for evaluating the Event Status Register -----
Public Sub Esrread()
    Try
        Dim myESR As Short = mbSession.Query("*ESR?") 'Read ESR
        If (myESR And 1) > 0 Then Console.WriteLine("Operation complete")
        If (myESR And 2) > 0 Then Console.WriteLine("Request Control")
        If (myESR And 4) > 0 Then Console.WriteLine("Query Error")
        If (myESR And 8) > 0 Then Console.WriteLine("Device dependent error")
        If (myESR And 16) > 0 Then
            Console.WriteLine("Execution Error; Program aborted") 'Output error message
            Stop 'Stop software
        End If
        If (myESR And 32) > 0 Then
            Console.WriteLine("Command Error; Program aborted") 'Output error message
            Stop 'Stop software
        End If
        If (myESR And 64) > 0 Then Console.WriteLine("User request")
        If (myESR And 128) > 0 Then Console.WriteLine("Power on")
    Catch exp As Exception
        Console.WriteLine(exp.Message)
    End Try
End Sub

```



```

End Try
End Sub

```

## 11.17.2 Using Marker and Delta Marker

### 11.17.2.1 Shape Factor Measurement (using n dB down)

The n-dB-down function of the R&S ESRP is used twice to determine the shape factor of a filter (ratio of bandwidths at 60 dB and 3 dB below the filter maximum).

The following example is again based on a signal with a level of -30 dBm at 100 MHz. The shape factor is determined for the 30 kHz resolution bandwidth. The default setting of the R&S ESRP is used for measurements (SetupInstrument).

```

REM *****
Public Sub ShapeFactor()
result$ = Space$(100)
'----- R&S FSV default setting -----
CALL SetupInstrument 'Default setting
CALL InstrWrite (analyzer, "INIT:CONT OFF") 'Single sweep
'----- Set frequency -----
CALL InstrWrite (analyzer, "FREQ:SPAN 1 MHz")
'Span
CALL InstrWrite (analyzer, "BAND:RES 30 kHz")
'Resolution bandwidth
CALL InstrWrite (analyzer, "INIT;*WAI") 'Perform sweep with sync
'----- Measure 60 dB value -----
CALL InstrWrite (analyzer, "CALC:MARK:PEXC 6 DB")
'Peak excursion
CALL InstrWrite (analyzer, "CALC:MARK:STAT ON")
'Marker1 on
CALL InstrWrite (analyzer, "CALC:MARK:TRAC 1")
'Assign marker1 to trace1
CALL InstrWrite (analyzer, "CALC:MARK:MAX") 'Set marker1 to 100 MHz
CALL InstrWrite (analyzer, "CALC:MARK:FUNC:NDBD 45 dB")
'Read out bandwidth measured at
'45 dB
CALL InstrWrite (analyzer, "CALC:MARK:FUNC:NDBD:RES?")
CALL InstrRead(analyzer, result$)
result60 = Val(result$)
'----- Measure 3 dB down value-----
CALL InstrWrite (analyzer, "CALC:MARK:FUNC:NDBD 3 dB")
'Read out bandwidth measured at
'3 dB
CALL InstrWrite (analyzer, "CALC:MARK:FUNC:NDBD:RES?")
CALL InstrRead(analyzer, result$)
result3 = Val(result$)
'----- Read out shape factor-----

```

```
Print "Shapefaktor 60 dB/3 dB:";result60/result3
END SUB
REM *****
```

### 11.17.2.2 Measuring the Third Order Intercept Point

The third order intercept point (TOI) is the (virtual) level of two adjacent useful signals at which the intermodulation products of third order have the same level as the useful signals.

The intermodulation product at  $f_{s2}$  is obtained by mixing the first harmonic of the useful signal  $P_{N2}$  with signal  $P_{N1}$ , the intermodulation product at  $f_{s1}$  by mixing the first harmonic of the useful signal  $P_{N1}$  with signal  $P_{N2}$ .

$$f_{s1} = 2 \times f_{n1} - f_{n2} \quad (1)$$

$$f_{s2} = 2 \times f_{n2} - f_{n1} \quad (2)$$

The following example is based on two adjacent signals with a level of -30 dBm at 100 MHz and 110 MHz. The intermodulation products lie at 90 MHz and 120 MHz according to the above formula. The frequency is set so that the examined mixture products are displayed in the diagram. Otherwise, the default setting of the R&S ESRP is used for measurements (`SetupInstrument`).

```
REM *****
Public Sub TOI()
result$ = Space$(100)
'----- R&S FSV default setting -----
CALL SetupStatusReg 'Set status registers
CALL InstrWrite (analyzer, "*RST") 'Reset instrument
CALL InstrWrite (analyzer, "INIT:CONT OFF") 'Single sweep
CALL InstrWrite (analyzer, "SYST:DISP:UPD ON")
'ON: display on'OFF: off
'----- Set frequency -----
CALL InstrWrite (analyzer, "FREQ:START 85 MHz;STOP 125 MHz")
'Span
'----- Set level -----
CALL InstrWrite (analyzer, "DISP:WIND:TRAC:Y:RLEV -20 dBm")
'Reference level
CALL InstrWrite (analyzer, "INIT;*WAI") 'Perform sweep with sync
'----- TOI measurement -----
CALL InstrWrite (analyzer, "CALC:MARK:PEXC 6 DB")
'Peak excursion
CALL InstrWrite (analyzer, "CALC:MARK:FUNC:TOI ON")
'Switch on TOI measurement
CALL InstrWrite (analyzer, "CALC:MARK:FUNC:TOI:RES?")
'and read out results
CALL InstrRead(analyzer, result$)
'----- Read out result -----
Print "TOI [dBm]:";result$
```

```
END SUB
REM *****
```

### 11.17.2.3 Measuring the AM Modulation Depth

The example below is based on an AM-modulated signal at 100 MHz with the following characteristics:

Carrier signal level	-30 dBm
AF frequency	100 kHz
Modulation depth	50 %

The default setting of the analyzer for measurements can be used for the measurements described below (SetupInstrument).

```
REM *****
Public Sub AMMod()
result$ = Space$(100)
CALL SetupInstrument 'Default setting
CALL InstrWrite (analyzer, "BAND:RES 30 kHz") 'Set appropriate RBW
'----- Peak search -----
CALL InstrWrite (analyzer, "INIT:CONT OFF") 'Single sweep
CALL InstrWrite (analyzer, "INIT;*WAI") 'Perform sweep with sync
CALL InstrWrite (analyzer, "CALC:MARK:PEXC 6 DB")
'Peak excursion
CALL InstrWrite (analyzer, "CALC:MARK:STAT ON")
'Marker 1 on
CALL InstrWrite (analyzer, "CALC:MARK:TRAC 1")
'Assign marker1 to trace1
'----- Measure modulation depth -----
CALL InstrWrite (analyzer, "CALC:MARK:MAX;FUNC:MDEP ON")
'Marker to Peak;
CALL InstrWrite (analyzer, "CALC:MARK:FUNC:MDEP:RES?")
'Measure mod. depth
CALL InstrRead(analyzer, result$) 'Read out result
'----- Read out result -----
Print "AM Mod Depth [%]:";result$
END SUB
REM *****
```

### 11.17.3 Limit Lines and Limit Test

The example below shows the definition and use of a new limit line 5 for trace 1 with the following characteristics:

- Upper limit line
- Absolute x-axis in the frequency range
- 7 reference values:

- 120 MHz/-70 dB,
- 126 MHz/-40 dB,
- 127 MHz/-40 dB,
- 128 MHz/-10 dB,
- 129 MHz/-40 dB,
- 130 MHz/-40 dB,
- 136 MHz/-70 dB
- Relative y-axis with unit dB
- Absolute threshold at –75 dBm
- No margin

The signal of the integrated calibration source (128 MHz, -30 dBm) is used to check the limit test.

```

REM *****
Public Sub LimitLine()
result$ = Space$(100)
'----- R&S FSV default setting -----
CALL SetupInstrument 'Default setting
CALL InstrWrite (analyzer, "FREQUENCY:CENTER 128 MHz;Span 10 MHz")
'Span
CALL InstrWrite (analyzer, "Diag:Serv:Inp Cal")
'Cal signal on
'----- Definition of limit lines -----
CALL InstrWrite (analyzer, "CALC:LIM5:NAME 'TEST1'")
'Define name
CALL InstrWrite (analyzer, "CALC:LIM5:COMM 'Upper limit'")
'Define comment
CALL InstrWrite (analyzer, "CALC:LIM5:TRAC 1")
'Assign trace
CALL InstrWrite (analyzer, "CALC:LIM5:CONT:DOM FREQ")
'Define x-axis range
CALL InstrWrite (analyzer, "CALC:LIM5:CONT:MODE ABS")
'Define x-axis scaling
CALL InstrWrite (analyzer, "CALC:LIM5:UNIT DB")
'Define y-axis unit
CALL InstrWrite (analyzer, "CALC:LIM5:UPP:MODE REL")
'Define y-axis scaling
'----- Definition of data points and threshold -----
xlimit$ = "CALC:LIM5:CONT 120 MHz,126 MHz,127 MHz,128 MHz,129 MHz,130 MHz,136 MHz"
CALL InstrWrite (analyzer, xlimit$) 'Set values for x-axis
CALL InstrWrite (analyzer, "CALC:LIM5:UPP -70,-40,-40,-20,-40,-40,-70")
'Set values for y-axis
CALL InstrWrite (analyzer, "CALC:LIM5:UPP:THR -75 DBM")
'Set y threshold (only
'possible for relative
'y-axis)
'----- Definition of margin or x/y offset-----
'A margin or an x/y offset can be defined here.

```

```

'----- Activate and evaluate the limit line -----
CALL InstrWrite (analyzer, "CALC:LIM5:UPP:STAT ON")
'Activate line 5
CALL InstrWrite (analyzer, "CALC:LIM5:STAT ON")
'Activate limit check
CALL InstrWrite (analyzer, "INIT;*WAI") 'Perform sweep with sync
CALL InstrWrite (analyzer, "CALC:LIM5:FAIL?")
'Query result of limit check
CALL InstrRead(analyzer, result$) 'Result: 1 (= FAIL)
'----- Read out result -----
Print "Limit Result Line 5: ";result$
'----- Evaluate limit line by means of status register -----
CALL InstrWrite (analyzer, "*CLS") 'Reset status register
'----- Measure -----
CALL InstrWrite (analyzer, "INIT;*OPC") 'Perform sweep with sync
CALL viEnableEvent(analyzer, VI_EVENT_SERVICE_REQ, VI_QUEUE, 0)
Status = viWaitOnEvent(analyzer, VI_EVENT_SERVICE_REQ, SRQWaitTimeout, VI_NULL, VI_NULL)
IF (status = VI_SUCCESS) THEN CALL Srq 'If SRQ is recognized =>
'subroutine for evaluation
'----- Read out result -----
IF (status% = 1) THEN
CALL InstrWrite (analyzer, "STAT:QUES:LIM1:COND?")
'Read out STAT:QUES:LIMit
'register
CALL InstrRead(analyzer, result$)
IF ((Val(result$) And 16) <> 0) THEN
Print "Limit5 failed"ELSE
Print "Limit5 passed"END IF
END IF
END SUB
REM *****

```

#### 11.17.4 Measuring the Channel and Adjacent Channel Power

In the following example, the channel and adjacent channel power is first measured on a signal with a level of 0 dBm at 800 MHz to IS95. Then the channel and adjacent channel power is measured on a GSM signal at 935.2 MHz with fast ACP measurement (FAST ACP).

In addition, the limit test is activated.

```

REM *****
Public Sub ACP()
result$ = Space$(100)
'----- R&S FSV default setting -----
CALL SetupStatusReg 'Set status register
CALL InstrWrite (analyzer, "*RST") 'Reset instrument
CALL InstrWrite (analyzer, "INIT:CONT OFF") 'Single sweep
CALL InstrWrite (analyzer, "SYST:DISP:UPD ON")
'ON: display on

```

```

'OFF: off
'----- Set frequency -----
CALL InstrWrite (analyzer, "FREQ:CENT 800 MHz")
'Set frequency
'----- Set level -----
CALL InstrWrite (analyzer, "DISP:WIND:TRAC:Y:RLEV 10 dBm")
'Reference level
'----- Example 1: Configure CP/ACP for CDMA-----
CALL InstrWrite (analyzer, "CALC:MARK:FUNC:POW:SEL ACP")
'ACP measurement on
CALL InstrWrite (analyzer, "CALC:MARK:FUNC:POW:PRES F8CDMA")
'Select CDMA800 FWD
CALL InstrWrite (analyzer, "SENS:POW:ACH:ACP 2")
'Select 2 adjacent channels
CALL InstrWrite (analyzer, "SENS:POW:ACH:PRES ACP")
'Optimize settings
CALL InstrWrite (analyzer, "SENS:POW:ACH:PRES:RLEV")
'Optimize reference level
CALL InstrWrite (analyzer, "SENS:POW:ACH:MODE ABS")
'Absolute measurement
CALL InstrWrite (analyzer, "SENS:POW:HSP ON")
'Fast ACP measurement
'----- Perform measurement and query results -----
CALL InstrWrite (analyzer, "INIT;*WAI") 'Perform sweep with sync
CALL InstrWrite (analyzer, "CALC:MARK:FUNC:POW:RES? ACP")
'Query result CALL InstrRead(analyzer, result$)
'----- Read out result -----
Print "Result (CP, ACP low, ACP up, Alt low, Alt up):"Print result$
'----- Example 2: Configure CP/ACP manually for GSM-----
result$ = Space$(100)
CALL InstrWrite (analyzer, "FREQ:CENT 935.2 MHz")
'Set frequency
CALL InstrWrite (analyzer, "CALC:MARK:FUNC:POW:SEL ACP")
'ACP measurement on
CALL InstrWrite (analyzer, "SENS:POW:ACH:ACP 1")
'1 adjacent channel
CALL InstrWrite (analyzer, "SENS:POW:ACH:BAND 200 KHZ")
'Channel bandw. 200 kHz
CALL InstrWrite (analyzer, "SENS:POW:ACH:BAND:ACH 200 KHZ")
'Adjacent channel band-
'width 200 kHz
CALL InstrWrite (analyzer, "SENS:POW:ACH:SPAC 200 KHZ")
'Channel spacing 200 kHz
CALL InstrWrite (analyzer, "SENS:POW:ACH:PRES ACP")
'Optimize settings
CALL InstrWrite (analyzer, "SENS:POW:ACH:PRES:RLEV")
'Optimize reference level
CALL InstrWrite (analyzer, "SENS:POW:ACH:MODE ABS")
'Absolute measurement
'----- Start measurement and query result -----

```

```

CALL InstrWrite (analyzer, "INIT;*WAI") 'Perform sweep with sync
CALL InstrWrite (analyzer, "CALC:MARK:FUNC:POW:RES? ACP")
'Query result
CALL InstrRead(analyzer, result$)
'----- Read out result -----
Print "Result (CP, ACP low, ACP up):"Print result$
'----- Active limit check -----
result$ = Space$(100)
CALL InstrWrite (analyzer, "CALC:LIM:ACP:ACH 30 DB, 30 DB")
'Set relative limit
CALL InstrWrite (analyzer, "CALC:LIM:ACP:ACH:ABS -35 DBM,-35 DBM")
'Set absolute limit
CALL InstrWrite (analyzer, "CALC:LIM:ACP:ACH:STAT ON")
'Rel. limit check on
CALL InstrWrite (analyzer, "CALC:LIM:ACP:ACH:ABS:STAT ON")
'Abs. limit check on
CALL InstrWrite (analyzer, "CALC:LIM:ACP ON")
'Limit check on
'----- Start measurement and query result -----
CALL InstrWrite (analyzer, "INIT;*WAI") 'Perform sweep with sync
CALL InstrWrite (analyzer, "CALC:LIM:ACP:ACH:RES?")
'Query result of limit check
CALL InstrRead(analyzer, result$)
'----- Read out result -----
Print "Result Limit Check:";result$
END SUB
REM *****

```

### Example of channel/adjacent-channel power measurement

```
POW:ACH:ACP 3
```

Sets the number of adjacent/alternate channels to 3.

```
POW:ACH:BAND 30 KHZ
```

Sets the bandwidth of the transmission channel to 30 kHz.

```
POW:ACH:BAND:ACH 40 KHZ
```

Sets the bandwidth of each adjacent channel to 40 kHz.

```
POW:ACH:BAND:ALT1 50 KHZ
```

Sets the bandwidth of each alternate channel to 50 kHz.

```
POW:ACH:BAND:ALT2 60 KHZ
```

Sets the bandwidth of alternate channel 2 to 60 kHz.

```
POW:ACH:SPAC 30 KHZ
```

Sets the spacing between the transmission channel and the adjacent channel to 30 kHz, the spacing between the transmission channel and alternate channel 1 to 60 kHz, and the spacing between the transmission channel and alternate channel 2 to 90 kHz.

```
POW:ACH:SPAC:ALT1 100 KHZ
```

Sets the spacing between the alternate adjacent channels and the TX channel. For details refer to [\[SENSe:\]POWer:ACHannel:SPACing:ALTernate<channel>](#) on page 701.

```
POW:ACH:SPAC:ALT2 140 KHZ
```

Sets the spacing between the transmission channel and alternate channel 2 to 140 kHz.

```
POW:ACH:MODE ABS
```

Switches on absolute power measurement.

```
CALC:MARK:FUNC:POW:SEL ACP
```

Switches on the adjacent-channel power measurement.

```
INIT:CONT OFF
```

Switches over to single sweep mode.

```
INIT;*WAI
```

Starts a sweep and waits for the end of the sweep.

```
CALC:MARK:FUNC:POW:RES? ACP
```

Queries the result of adjacent-channel power measurement.

```
POW:ACH:REF:AUTO ONCE
```

Defines the measured channel power as the reference value for relative power measurements.

If the channel power only is to be measured, all commands relating to adjacent/alternate channel bandwidth and channel spacings are omitted. The number of adjacent/alternate channels is set to 0 with [\[SENSe:\]POWer:ACHannel:ACPairs](#) on page 698.

### 11.17.5 Occupied Bandwidth Measurement

In the following example, the bandwidth is to be found in which 95 % of the power of a GSM signal is contained. Signal frequency is 935.2 MHz; channel bandwidth is 200 kHz.

```
REM *****
Public Sub OBW()
result$ = Space$(100)
'----- R&S FSV default setting -----
CALL SetupStatusReg 'Set status register
CALL InstrWrite (analyzer, "*RST") 'Reset instrument
CALL InstrWrite (analyzer, "INIT:CONT OFF") 'Single sweep
CALL InstrWrite (analyzer, "SYST:DISP:UPD ON")
'ON: display on
'OFF: off
```



```

'----- Configure R&S FSV for OBW for GSM-----
CALL InstrWrite (analyzer, "FREQ:CENT 935.2 MHz")
'Set frequency
CALL InstrWrite (analyzer, "CALC:MARK:FUNC:POW:SEL OBW")
'OBW measurement on
CALL InstrWrite (analyzer, "SENS:POW:ACH:BAND 200 KHZ")
'Channel bandw. 200 kHz
CALL InstrWrite (analyzer, "SENS:POW:BWID 95PCT")
'Percentage of power
CALL InstrWrite (analyzer, "SENS:POW:ACH:PRES OBW")
'Set frequency and optimize reference level
CALL InstrWrite (analyzer, "SENS:POW:ACH:PRES:RLEV")
CALL InstrWrite (analyzer, "SENS:POW:NCOR OFF")
'Noise correction
'OFF: switch off
'ON: switch on
'----- Perform measurement and query results -----
CALL InstrWrite (analyzer, "INIT;*WAI") 'Perform sweep with sync
CALL InstrWrite (analyzer, "CALC:MARK:FUNC:POW:RES? OBW")
'Query result
CALL InstrRead(analyzer, result$)
Print result$
END SUB
REM *****

```

### 11.17.6 Time Domain Power Measurement

In the following example, the mean carrier power of a signal with 300 kHz bandwidth at 100 MHz is to be determined. In addition, the peak power, the rms value and the standard deviation are measured. To do this, the time-domain-power measurement functions are used.

```

REM *****
Public Sub TimeDomainPower()
result$ = Space$(100)
'----- R&S FSV default setting -----
CALL SetupStatusReg 'Set status register
CALL InstrWrite (analyzer, "*RST") 'Reset instrument
CALL InstrWrite (analyzer, "INIT:CONT OFF") 'Single sweep
CALL InstrWrite (analyzer, "SYST:DISP:UPD ON")
'ON: display on
'OFF: off
'----- Configure R&S FSV for time domain power measurement -----
CALL InstrWrite (analyzer, "FREQ:CENT 100 MHz;SPAN 0Hz")
'Set frequency
CALL InstrWrite (analyzer, "BAND:RES 300 kHz")
'Resolution bandwidth
CALL InstrWrite (analyzer, "SWE:TIME 200US") 'Sweep time
CALL InstrWrite (analyzer, "CALC:MARK:FUNC:SUMM:PPE ON")

```

```

'Peak measurement on
CALL InstrWrite (analyzer, "CALC:MARK:FUNC:SUMM:MEAN ON")
'Mean measurement on
CALL InstrWrite (analyzer, "CALC:MARK:FUNC:SUMM:RMS ON")
'RMS measurement on
CALL InstrWrite (analyzer, "CALC:MARK:FUNC:SUMM:SDEV ON")
'Standard deviation on
'----- Perform measurement and query results -----
CALL InstrWrite (analyzer, "INIT;*WAI") 'Perform sweep with sync
'Query results:
query$ = "CALC:MARK:FUNC:SUMM:PPE:RES?;" 'Peak measurement
query$ = query$ + ":CALC:MARK:FUNC:SUMM:MEAN:RES?;" 'Mean measurement
query$ = query$ + ":CALC:MARK:FUNC:SUMM:RMS:RES?;" 'RMS measurement
query$ = query$ + ":CALC:MARK:FUNC:SUMM:SDEV:RES?" 'Standard deviation
CALL InstrWrite (analyzer, query$)
CALL InstrRead(analyzer, result$)
Print result$
END SUB
REM *****

```

## 11.17.7 Fast Power Measurement on Power Ramps

A frequent task in mobile radio tests is measurement of a DUT at various power control levels at the highest possible speed. The R&S ESRP offers two test functions for this task, which can be used depending on the signal characteristics.

In the following, the two methods are presented by means of two examples.

### 11.17.7.1 Power Measurement with Multi-Summary Marker

The multi-summary marker function is suitable for measuring the power of a sequence of pulses with the following characteristics:

- The pulses occur at identical time intervals, which is typical of GSM transmission in slots, for example.
- The level of the first signal is reliably above threshold.
- The subsequent pulses may have any levels.
- The function uses the first pulse as a trigger signal. The power of the subsequent pulses is determined exclusively via the timing pattern selected for the pulse sequence. The function is, therefore, suitable for adjustments where the DUT output power varies considerably and is not reliably above the trigger threshold.
- The measurement accuracy is determined by the ratio of pulse duration to total measurement time; this should not be below 1:50.
- The function always uses TRACE 1.

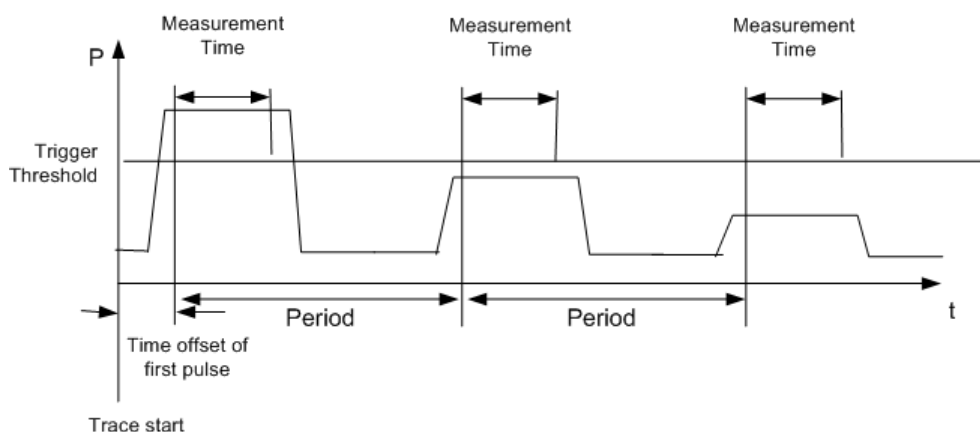

**Figure 11-6: Block diagram illustrating signal processing in analyzer**

In the example below, a GSM pulse sequence of 8 pulses is measured with an offset of 50  $\mu\text{s}$  of the first pulse, 450  $\mu\text{s}$  measurement time/pulse and 576.9  $\mu\text{s}$  pulse period.

```

REM *****
Public Sub MultiSumMarker()
result$ = Space$(200)
'----- R&S FSV default setting-----
CALL SetupStatusReg 'Configure status register
CALL InstrWrite (analyzer, "*RST") 'Reset instrument
CALL InstrWrite (analyzer, "INIT:CONT OFF") 'Single sweep mode
CALL InstrWrite (analyzer, "SYST:DISP:UPD ON")
'ON: switch display on
'OFF: switch display off
'----- Configure R&S FSV for power measurement in time domain -----
CALL InstrWrite (analyzer, "FREQ:CENT 935.2 MHz;SPAN 0Hz")
'Frequency setting
CALL InstrWrite (analyzer, "DISP:WIND:TRAC:Y:RLEV 10 dBm")
'Set reference level to 10 dB
CALL InstrWrite (analyzer, "INP:ATT 30 dB") 'Set input attenuation to 30 dB
CALL InstrWrite (analyzer, "BAND:RES 1 MHz;VID 3 MHz")
'Bandwidth setting
CALL InstrWrite (analyzer, "DET RMS") 'Select RMS detector
CALL InstrWrite (analyzer, "TRIG:SOUR VID") 'Trigger source: video
CALL InstrWrite (analyzer, "TRIG:LEV:VID 50 PCT")
'Trigger threshold: 50 %
CALL InstrWrite (analyzer, "SWE:TIME 50ms") 'Sweep time  $\geq$  1 frame
'----- Perform measurement and query results -----
CALL InstrWrite (analyzer, "INIT;*WAI") 'Perform sweep with sync
'Query results:
cmd$ = "CALC:MARK:FUNC:MSUM?"cmd$ = cmd$ + "50US," 'Offset of first pulse
cmd$ = cmd$ + "450US," 'Measurement time
cmd$ = cmd$ + "576.9US," 'Pulse period
cmd$ = cmd$ + "8" 'Number of bursts
CALL InstrWrite (analyzer, cmd$)
CALL InstrRead(analyzer, result$) 'Read results

```

```

Print result$
END SUB
REM *****

```

### 11.17.7.2 Multi-Burst Power Measurement

The multi-burst power measurement function is suitable for measuring the power of a sequence of pulses with the following characteristics:

- The pulses occur at variable time intervals.
- The levels of all pulses of the sequence are reliably above the trigger threshold, or an external trigger signal is used.
- The function requires one trigger event per pulse. This means that if the video trigger or the IF power trigger is used, the levels of all pulses must be above the trigger threshold.
- The function is, therefore, particularly suitable for re-measuring DUTs already adjusted and whose output power is within the specified range. The measurement is optimized for minimum overhead relative to the actual measurement time.

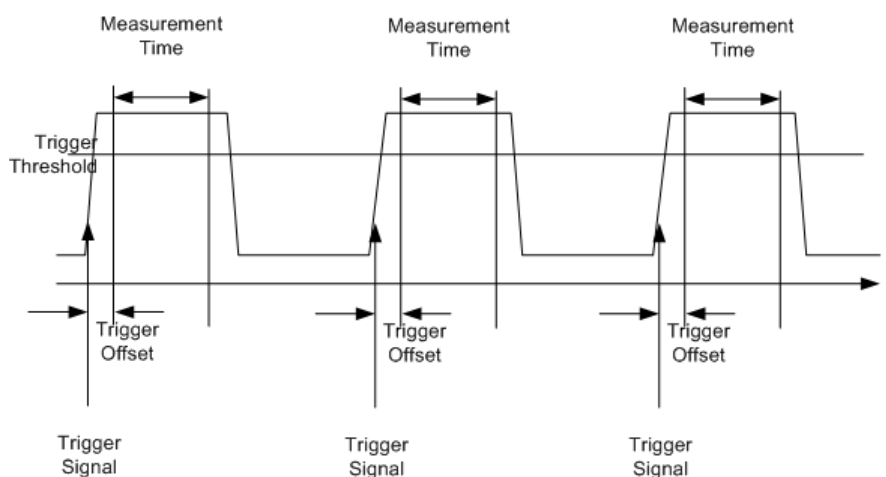

**Figure 11-7: Block diagram illustrating signal processing in analyzer**

Either the root-mean-square power or the peak power is measured, depending on whether the RMS detector or the PEAK detector is selected. The function always uses TRACE 1.

The following parameters are to be set for this measurement:

- Analyzer frequency
- Resolution bandwidth
- Measurement time per single pulse
- Trigger source
- Trigger threshold
- Trigger offset
- Type of power measurement (PEAK, MEAN)

- Number of pulses to be measured

During the measurement, each pulse is mapped into a pixel of the screen, i.e. any change of the trace can be detected only at the left-hand edge of the screen. Maximum measurement speed is as usual achieved with the display switched off.

In the example below, a GSM pulse sequence of 8 pulses is measured with 5  $\mu$ s trigger offset, 434  $\mu$ s measurement time/pulse, video trigger with 50 % trigger threshold, and peak detection:

```
REM *****
Public Sub MultiBurstPower()
result$ = Space$(200)
'----- R&S FSV default setting -----
CALL SetupStatusReg 'Configure status register
CALL InstrWrite (analyzer, "*RST") 'Reset instrument
CALL InstrWrite (analyzer, "INIT:CONT OFF") 'Single sweep mode
CALL InstrWrite (analyzer, "SYST:DISP:UPD OFF")
'OFF: display off
'----- Perform measurement and query results -----
cmd$ = "MPOW? "cmd$ = cmd$ + "935.2 MHZ," 'Center frequency
cmd$ = cmd$ + "1 MHZ," 'Resolution bandwidth
cmd$ = cmd$ + "434US," 'Measurement time
cmd$ = cmd$ + "VID," 'Trigger source
cmd$ = cmd$ + "50PCT," 'Trigger threshold
cmd$ = cmd$ + "1US," 'Trigger offset
cmd$ = cmd$ + "PEAK," 'Peak detector
cmd$ = cmd$ + "8" 'Number of bursts
CALL InstrWrite (analyzer, cmd$)
CALL InstrRead(analyzer, result$) 'Read results
Print result$
END SUB
REM *****
```

### 11.17.8 Fast Level Measurement Using Frequency Lists

A typical task for the R&S ESRP is power measurement at a number of frequency points, e.g. at multiples of the fundamental (harmonics measurement), or at frequencies defined by a mobile radio standard (e.g. spectrum due to transients at  $\pm 200$  kHz,  $\pm 400$  kHz, etc about the carrier frequency of a GSM signal). In many cases, different level and/or bandwidth settings are required for the different frequency points to match the channel spacing and meet the requirements of dynamic range.

Especially for this application, the R&S ESRP offers a number of remote-control functions (commands available in SENSE:LIST subsystem) that allow level measurement based on a frequency list with different instrument settings assigned to different frequencies. Not only the frequency list can be programmed, but also the measurement types (PEAK, RMS, AVG) to be performed simultaneously can be selected.

The example below describes a harmonics measurement on a dual-band amplifier. The harmonics level in general decreases as the frequency increases. To boost mea-

surement sensitivity, therefore, the reference level is lowered by 10 dB from the third harmonic.

The following settings are used:

Reference level:	10.00 dBm up to first harmonic, 0 dBm from 2nd harmonic
RF attenuation:	20 dB
Electronic attenuation:	0 dB (OFF)
Filter type:	NORMal
RBW:	1 MHz
VBW:	3 MHz
Measurement time:	300 $\mu$ s
Trigger delay:	100 $\mu$ s
Trigger:	video, 45 %

Frequency	Type
935.2 MHz	GSM 900 fundamental
1805.2 MHz	GSM 1800 fundamental
1870.4 MHz	GSM 900 2 <sup>nd</sup> harmonic
2805.6 MHz	GSM 900 3 <sup>rd</sup> harmonic
3610.4 MHz	GSM 1800 2 <sup>nd</sup> harmonic
3740.8 MHz	GSM 900 4 <sup>th</sup> harmonic
5815.6 MHz	GSM 1800 3 <sup>rd</sup> Harmonic

The frequencies are selected in ascending order to minimize system-inherent waiting times resulting from frequency changes.

At each frequency point the peak power and the rms power are measured. The peak power and the rms power values are stored alternately in the results memory.

```
REM *****
Public Sub FrequencyList()
result$ = Space$(500)
'----- R&S FSV default setting -----
CALL SetupStatusReg 'Configure status register
CALL InstrWrite (analyzer, "*RST") 'Reset instrument
CALL InstrWrite (analyzer, "INIT:CONT OFF") 'Single sweep mode
CALL InstrWrite (analyzer, "SYST:DISP:UPD OFF") 'Display off
'-----Configure R&S FSV for power measurement based on frequency list -
CALL InstrWrite (analyzer, "TRIG:LEV:IFP -20 dBm")
'Set IF power trigger level
CALL InstrWrite (analyzer, "LIST:POWER:SET ON,ON,OFF,IFP,POS,100us,0")
'----- Perform measurement and query results -----
```

```

cmd$ = "LIST:POWer?"cmd$ = cmd$ + "935.2 MHz, 10 dBm, 20 dB,OFF,NORM,1 MHz,3 MHz,
300 us, 0, "
cmd$ = cmd$ + "1805.2 MHz, 10 dBm, 20 dB,OFF,NORM,1 MHz,3 MHz,300 us, 0, "
cmd$ = cmd$ + "1870.4 MHz, 10 dBm, 20 dB,OFF,NORM,1 MHz,3 MHz,300 us, 0, "
cmd$ = cmd$ + "2805.6 MHz, 0 dBm, 20 dB,OFF,NORM,1 MHz,3 MHz,300 us, 0, "
cmd$ = cmd$ + "3610.4 MHz, 10 dBm,20 dB,OFF,NORM,1 MHz,3 MHz,300 us, 0, "
cmd$ = cmd$ + "3740.8 MHz, 0 dBm, 20 dB, OFF, NORM, 1 MHz,3 MHz,300 us, 0, "
cmd$ = cmd$ + "5815.6 MHz, 0 dBm, 20 dB, OFF, NORM, 1 MHz, 3 MHz, 300 us, 0"
CALL InstrWrite (analyzer, cmd$)
CALL InstrRead(analyzer, result$)
Print result$
END SUB
REM *****

```

### 11.17.9 Level Correction of Transducers

In more complex test systems, the frequency response of the test setup must be taken into account in all power measurements to avoid any measurement errors being introduced from sources other than the DUT.

The R&S ESRP offers the possibility of defining a frequency-dependent attenuation correction factor (transducer factor).

In the example below, a factor with the following characteristics is defined:

Name:	Transtest
Unit:	dB
Scaling:	lin
Comment:	simulated cable correction
Frequency	Level
10 MHz	0 dB
100 MHz	3 dB
1 GHz	7 dB
3 GHz	10 dB

The factor is defined and can be activated as required.

```

REM *****
Public Sub TransducerFactor()
'----- Define transducer factor -----
CALL InstrWrite (analyzer, "CORR:TRAN:SEL 'TRANSTEST'")
'Define "Transtest" transducer factor
CALL InstrWrite (analyzer, "CORR:TRAN:UNIT 'DB'")
'Unit 'dB'
CALL InstrWrite (analyzer, "CORR:TRAN:SCAL LIN")
'Linear frequency-axis
CALL InstrWrite (analyzer, "CORR:TRAN:COMM 'Simulated cable correction'")

```

```

cmd$ = "CORR:TRAN:DATA" 'Enter frequency and level
cmd$ = cmd$ + "10 MHz, 0," 'values. Level values without
cmd$ = cmd$ + "100 MHz, 3," 'unit!
cmd$ = cmd$ + "1GHz, 7,"cmd$ = cmd$ + "3GHz, 10"
CALL InstrWrite (analyzer,cmd$) 'Enter frequency and level values
'----- Activate transducer -----
CALL InstrWrite (analyzer, "CORR:TRAN:STAT ON")
'Activate transducer factor
END SUB
REM *****

```

### 11.17.10 Measuring the Magnitude and Phase of a Signal

Due to the R&S ESRP's internal architecture, it is capable of measuring and outputting the magnitude and phase of a signal in addition to its power values. This opens up a variety of possibilities for more in-depth analysis (FFT, demodulation, etc).

I/Q data is stored in memory areas each containing 512 k words. Hardware triggering controls the memory.

The following example shows the steps necessary to collect data at a predefined sampling rate and read it from the I/Q memory.

1. Data is output in the form of voltage values referred to the analyzer input. Data can be read in binary or ASCII format.
  - In binary format, the length information carried in the message header is evaluated and used for calculating the x-axis values.
  - In ASCII format, only a list of voltage values is output.
2. Binary data is read in three steps:
3. The number of digits carrying the length information is read.
4. The length information itself is read.
5. The trace data is read.

This procedure is necessary with programming languages like Visual Basic which support only structures of identical data types (arrays), whereas the binary data format uses different data types in the header and the data section.



The arrays for measured data are dimensioned in such a way that they can accommodate the I/Q data of the R&S ESRP (2 × 512 k).

```

REM *****
Public Sub ReadIQData()
'----- Create variables -----
Dim IData(131072) As Single 'Buffer for floating-point
'I data (= 512*1024 bytes)
Dim QData(131072) As Single 'Buffer for floating-point

```



```

'Q data (= 512*1024 bytes)
'Note:
'Visual Basic cannot read in
'data volumes larger than
'512 k words!
Dim digits As Byte 'No. of digits as length
Dim IQBytes As Long 'Length of trace data in bytes
Dim IQValues As Long 'No. of meas. values in buffer
Dim retCount As Integer 'Return count from read
asciiResult$ = Space$(6553600) 'Buffer for ASCII I/Q data
' (= 25*2*1024 bytes)
result$ = Space$(100) 'Buffer for simple results
'----- Default setting -----
CALL SetupInstrument 'Default setting
CALL InstrWrite (analyzer, "TRAC:IQ:STAT ON")
'Activate I/Q data
'acquisition mode; must be
'done before TRAC:IQ:SET !
'Select number of test points
' (= 512 * 1024 - 512) at
'RBW 10 MHz, 'sample rate 32 MHz,
'trigger free run, pos. trigger
'edge and 0 s trigger delay.
CALL InstrWrite (analyzer, "TRAC:IQ:SET NORM,10 MHz,32 MHz,IMM,POS,0,130560")
'----- Read-out in binary format-----
CALL InstrWrite (analyzer, "FORMAT REAL,32")
'Set binary format
CALL InstrWrite (analyzer, "TRAC:IQ:DATA?")
'Measure + read out I/Q data
CALL viRead(analyzer, result$, 2, retCount)
'Read and store length for
digits = Val(Mid$(result$, 2, 1)) 'number of digits
result$ = Space$(100) 'Re-initialize buffer
CALL viRead(analyzer, result$, digits, retCount)
'Read and store length
IQBytes = Val(Left$(result$, digits))
IQBytes = IQBytes/2 'Divide no. per buffer in half
CALL viRead(analyzer, IData(0), IQBytes, retCount)
'Read I data in buffer
CALL viRead(analyzer, QData(0), IQBytes, retCount)
'Read Q data in buffer
CALL viRead(analyzer, result$, 1, retCount)
'Read in end character <NL>
'----- Output of binary data as frequency/level pair -----
IQValues = IQBytes/4 'Single Precision = 4 Bytes
For i = 0 To IQValues - 1
Print "I-Value["; i; "] = "; IData(i)
Print "Q-Value["; i; "] = "; QData(i)
Next i
'----- Read-out in ASCII format -----

```

```

CALL InstrWrite (analyzer, "FORMAT ASCII") 'Set ASCII format
CALL InstrWrite (analyzer, "TRAC:IQ:DATA?")
'Re-measure and read out
'I/Q data
CALL InstrRead(analyzer, asciiResult$)
CALL InstrWrite (analyzer, "TRAC:IQ:STAT OFF")
'Stop I/Q data aquisition
'mode if no further
'measurements are to be
'done
END SUB
REM *****

```

## 11.17.11 Reading and Writing Files

### 11.17.11.1 Reading a File from the Instrument

In the following example, the TEST1.R&S FSV.DFL file stored under C:\R\_S\Instr\user is read from the instrument and stored in the controller.

```

REM *****
Public Sub ReadFile()
'----- Generate variables -----
Dim digits As Byte 'Number of digits of
'length information
Dim fileBytes As Long 'Length of file with trace data
'in bytes
result$ = Space$(100) 'Buffer for simple results
'----- Default setting of status register -----
CALL SetupStatusReg 'Configure status register
'----- Read out file -----
CALL InstrWrite (analyzer, "MMEM:DATA? 'C:\R_S\Instr\user\TEST1.R&S FSV.DFL'")
'Select file
CALL ilrd(analyzer, result$, 2) 'Read and store number of
digits = Val(Mid$(result$, 2, 1)) 'digits of length information
CALL ilrd(analyzer, result$, digits) 'Read and store length
fileBytes = Val(Left$(result$, digits)) 'information
FileBuffer$ = Space$(fileBytes) 'Buffer for file
CALL ilrd(analyzer, FileBuffer, fileBytes)
'Read file into buffer
CALL ilrd(analyzer, result$, 1) 'Read terminator <NL>
'----- Store file to controller -----
Open "TEST1.R&S FSV.DFL" For Output As #1
Print #1, FileBuffer; '; to avoid linefeed at
'end of file
Close #1

```

```
END SUB
REM *****
```

### 11.17.11.2 Creating a File on the Instrument

In the following example, the TEST1.R&S FSV.DFL file available on the controller is stored in the instrument under C:\R\_S\Instr\user\DUPLICAT.R&S FSV.DFL.

```
REM *****
Public Sub WriteFile()
'----- Generate variables -----
FileBuffer$ = Space$(100000) 'Buffer for file
Dim digits As Long 'Number of digits of
'length information
Dim fileBytes As Long 'Length of file in bytes
fileSize$ = Space$(100) 'Length of file as a string
result$ = Space$(100) 'Buffer for simple results
'----- Default setting of status register -----
CALL SetupStatusReg 'Configure status register
'----- Prepare the definite length block data -----
fileBytes = FileLen("H:\work\vb\TEST1.R&S FSV.DFL")
'Determine length of file
fileSize$ = Str$(fileBytes)
digits = Len(fileSize$) - 1 'Determine number of digits of
fileSize$ = Right$(fileSize$, digits) 'length information
FileBuffer$ = "#" + Right$(Str$(digits), 1) + fileSize$
'Store length information in
'file buffer
'----- Read file from controller -----
Open "H:\work\vb\TEST1.R&S FSV.DFL" For Binary As #1
FileBuffer$ = FileBuffer$ + Left$(Input(fileBytes, #1), fileBytes)
Close #1
'----- Write file -----
CALL InstrWrite (analyzer, "SYST:COMM:GPIB:RTER EOI") 'Set receive
'terminator on the
'instrument
CALL InstrWrite (analyzer, "MMEM:DATA
'DUPLICAT.R&S FSV.DFL', " + FileBuffer$)
'Select file
END SUB
REM *****
```

### 11.17.12 Spectrum Emission Mask Measurement

You can configure Spectrum Emission Mask measurements via XML files provided for different standards or by defining ranges and parameters. For both ways an example is given.

### 11.17.12.1 Using Predefined Standard Wibro

In the following example, the Spectrum Emission Mask measurement is configured using a predefined standard XML file.

```

REM *****
'----- General settings of the instrument -----
CALL InstrWrite (analyzer, "*RST") 'Reset instrument
CALL InstrWrite (analyzer, "INIT:CONT OFF") 'Switch to single sweep
CALL InstrWrite (analyzer, "INIT:IMM;*WAI") 'Make sure no sweep is running
CALL InstrWrite (analyzer, ":SENSE1:SWEep:MODE ESpectrum")
'Set measurement mode
Rem After preset 3 ranges are available where the middle one is
Rem the reference range for calculating the TX power
CALL InstrWrite (analyzer, ":SENSE1:FREQuency:CENTer 2.2 GHz")
'Center frequency 2.2 GHz
CALL InstrWrite (analyzer, ":SENSE1:DETEctor1 RMS")
'Set RMS detector
'----- Setting up the gated trigger -----
CALL InstrWrite (analyzer, ":SENSE1:SWEep:EGATE ON")
'Switch on the external gate mode
CALL InstrWrite (analyzer, ":SENSE1:SWEep:EGATE:SOURce EXTernal")
'Set external gate source
CALL InstrWrite (analyzer, ":SENSE1:SWEep:EGATE:HOLDoff 0s")
'Set delay time to 0 s
CALL InstrWrite (analyzer, ":SENSE1:SWEep:EGATE:LENGth 200 US")
'Set time interval
'----- Setting the standard -----
CALL InstrWrite (analyzer, "SENSE1:ESpectrum:PRESet:STANDARD
'WIBRO\DL\PowerClass_29_40.xml")
'Set WiBro standard
'----- Measuring -----
CALL InstrWrite (analyzer, "INIT;*WAI") 'Perform sweep, wait for sweep
'end
'----- Reading out results -----
CALL InstrWrite (analyzer, ":TRACe1:DATA? LIST")
'Query list results
CALL InstrWrite (analyzer, ":CALCulate:LIMit:FAIL?")
'Query result of limit check
CALL InstrRead(analyzer, result$)
REM *****

```

### 11.17.12.2 Defining 5 Ranges with all Parameters

In the following example, the Spectrum Emission Mask measurement is configured by defining ranges and parameters.

```

REM *****
'----- General settings of the instrument -----
CALL InstrWrite (analyzer, "*RST") 'Reset instrument

```

## Remote Control – Programming Examples

```

CALL InstrWrite (analyzer, "INIT:CONT OFF") 'Switch to single sweep
CALL InstrWrite (analyzer, "INIT:IMM;*WAI") 'Make sure no sweep is running
CALL InstrWrite (analyzer, ":SENSE1:SWEep:MODE ESpectrum")
'Set measurement mode
Rem After preset 3 ranges are available where the middle one is
Rem the reference range for calculating the TX power
CALL InstrWrite (analyzer, ":SENSE1:FREQuency:CENTer 2.2GHz")
'Center frequency 2.2 GHz
CALL InstrWrite (analyzer, ":SENSE1:DETEctor1 RMS")
'Set RMS detector
CALL InstrWrite (analyzer, ":TRIGger1:SEQUence:SOURce IMMEDIATE")
'Trigger setup
'----- Setting up the gated trigger -----
Rem If a free run trigger is not appropriate a gated trigger can
Rem the be set up (just comment in the following lines).
Rem CALL InstrWrite (analyzer, ":SENSE1:SWEep:EGATE ON")
Rem Switch on the external gate mode
Rem CALL InstrWrite (analyzer, ":SENSE1:SWEep:EGATE:SOURce EXTERNAL")
Rem Set external gate source
Rem CALL InstrWrite (analyzer, ":SENSE1:SWEep:EGATE:HOLDoff 0s")
Rem Set delay time to 0 s
Rem CALL InstrWrite (analyzer, ":SENSE1:SWEep:EGATE:LENGth 200 US")
Rem Set time interval
'----- Setting the span -----
CALL InstrWrite (analyzer, ":SENSE1:FREQuency:SPAN 8 MHz")
'Set the span to 8 MHz
'----- Inserting new ranges -----
Rem Enlarge number of ranges to 5 by adding one at the end
Rem and one at the beginnig. This ensures that the reference range
Rem remains in the middle
CALL InstrWrite (analyzer, ":SENSE1:ESpectrum:RANGe2:INSert AFter")
'Insert a range after range 2
CALL InstrWrite (analyzer, ":SENSE1:ESpectrum:RANGe1:INSert BEFore")
'Insert a range before range 1
'----- Defining the limit check for all ranges -----
CALL InstrWrite (analyzer, ":SENSE1:ESpectrum:RANGe:LIMit:STATe AND")
'Set check for absolute and 'relative limit
'----- Defining the reference range settings -----
Rem The bandwidth of the reference range limits the minimum span
Rem of the reference range definition later in the script.
CALL InstrWrite (analyzer, ":SENSE1:ESpectrum:RTYPE CPOWer")
'Set power reference type
CALL InstrWrite (analyzer, ":SENSE1:ESpectrum:BWID 2 MHz")
'Set bandwidth
'----- Defining the settings of range 1 -----
CALL InstrWrite (analyzer, ":SENSE1:ESpectrum:RANGe1:FREQuency:STARt -4 MHz")
'Set the start frequency
CALL InstrWrite (analyzer, ":SENSE1:ESpectrum:RANGe1:FREQuency:STOP -2 MHz")
'Set the stop frequency
CALL InstrWrite (analyzer, ":SENSE1:ESpectrum:RANGe1:BANDwidth:RESolution 1 MHz")

```

## Remote Control – Programming Examples

```

'Set the resolution bandwidth
CALL InstrWrite (analyzer, ":SENSe1:ESpectrum:RANGe1:FiLter:TYPE CFILter")
'Set the channel filters
CALL InstrWrite (analyzer, ":SENSe1:ESpectrum:RANGe1:BAWdwidth:ViDeo 3 MHz")
'Set the video bandwidth to 3 MHz
CALL InstrWrite (analyzer, ":SENSe1:ESpectrum:RANGe1:SWEEp:TiME 20 ms")
'Set the sweep time to 20 ms
CALL InstrWrite (analyzer, ":SENSe1:ESpectrum:RANGe1:RLEVel 5 DBM")
'Set the reference level to 5 dBm
CALL InstrWrite (analyzer, ":SENSe1:ESpectrum:RANGe1:INPut:ATTenuation 20 DB")
'Set the attenuation to 20 dB
CALL InstrWrite (analyzer, ":SENSe1:ESpectrum:RANGe1:LIMit:ABSolute:STARt -50")
'Set an absolute limit of -50 dBm
CALL InstrWrite (analyzer, ":SENSe1:ESpectrum:RANGe1:LIMit:ABSolute:STOP -50")
'Set an absolute limit of -50 dBm
CALL InstrWrite (analyzer, ":SENSe1:ESpectrum:RANGe1:LIMit:RELative:STARt -70")
'Set a relative limit of -70 dBc
CALL InstrWrite (analyzer, ":SENSe1:ESpectrum:RANGe1:LIMit:RELative:STOP -60")
'Set a relative limit of -60 dBc
'----- Defining the settings of range 2 -----
CALL InstrWrite (analyzer, ":SENSe1:ESpectrum:RANGe2:FREQuency:STARt -2 MHz")
CALL InstrWrite (analyzer, ":SENSe1:ESpectrum:RANGe2:FREQuency:STOP -1 MHz")
CALL InstrWrite (analyzer, ":SENSe1:ESpectrum:RANGe2:BAWdwidth:RESolution
100 kHz")
CALL InstrWrite (analyzer, ":SENSe1:ESpectrum:RANGe2:FiLter:TYPE NORM")
CALL InstrWrite (analyzer, ":SENSe1:ESpectrum:RANGe2:BAWdwidth:ViDeo 300 kHz")
CALL InstrWrite (analyzer, ":SENSe1:ESpectrum:RANGe2:SWEEp:TiME 50 ms")
CALL InstrWrite (analyzer, ":SENSe1:ESpectrum:RANGe2:RLEVel 10 DBM")
CALL InstrWrite (analyzer, ":SENSe1:ESpectrum:RANGe2:INPut:ATTenuation 30 DB")
CALL InstrWrite (analyzer, ":SENSe1:ESpectrum:RANGe2:LIMit:ABSolute:STARt
-40")
CALL InstrWrite (analyzer, ":SENSe1:ESpectrum:RANGe2:LIMit:RELative:STARt
-60")
CALL InstrWrite (analyzer, ":SENSe1:ESpectrum:RANGe2:LIMit:ABSolute:STOP -40")
CALL InstrWrite (analyzer, ":SENSe1:ESpectrum:RANGe2:LIMit:RELative:STOP -40")
'----- Defining the settings of range 3 -----
CALL InstrWrite (analyzer, ":SENSe1:ESpectrum:RANGe3:FREQuency:STARt -1 MHz")
CALL InstrWrite (analyzer, ":SENSe1:ESpectrum:RANGe3:FREQuency:STOP 1 MHz")
CALL InstrWrite (analyzer, ":SENSe1:ESpectrum:RANGe3:BAWdwidth:RESolution
30 kHz")
CALL InstrWrite (analyzer, ":SENSe1:ESpectrum:RANGe3:FiLter:TYPE NORM")
CALL InstrWrite (analyzer, ":SENSe1:ESpectrum:RANGe3:BAWdwidth:ViDeo 100 kHz")
CALL InstrWrite (analyzer, ":SENSe1:ESpectrum:RANGe3:SWEEp:TiME 5 ms")
CALL InstrWrite (analyzer, ":SENSe1:ESpectrum:RANGe3:RLEVel 20 DBM")
CALL InstrWrite (analyzer, ":SENSe1:ESpectrum:RANGe3:INPut:ATTenuation 30 DB")
CALL InstrWrite (analyzer, ":SENSe1:ESpectrum:RANGe3:LIMit:ABSolute:STARt 200")
CALL InstrWrite (analyzer, ":SENSe1:ESpectrum:RANGe3:LIMit:ABSolute:STOP 200")
CALL InstrWrite (analyzer, ":SENSe1:ESpectrum:RANGe3:LIMit:RELative:STARt 200")
CALL InstrWrite (analyzer, ":SENSe1:ESpectrum:RANGe3:LIMit:RELative:STOP 200")
'----- Defining the settings of range 4 -----

```

```

CALL InstrWrite (analyzer, ":SENSe1:ESpectrum:RANGe4:FREQuency:STARt 1 MHz")
CALL InstrWrite (analyzer, ":SENSe1:ESpectrum:RANGe4:FREQuency:STOP 2 MHz")
CALL InstrWrite (analyzer, ":SENSe1:ESpectrum:RANGe4:BANDwidth:RESolution
100 kHz")
CALL InstrWrite (analyzer, ":SENSe1:ESpectrum:RANGe4:FILTer:TYPE NORM")
CALL InstrWrite (analyzer, ":SENSe1:ESpectrum:RANGe4:BANDwidth:VIDeo 300 kHz")
CALL InstrWrite (analyzer, ":SENSe1:ESpectrum:RANGe4:SWEep:TIME 50 ms")
CALL InstrWrite (analyzer, ":SENSe1:ESpectrum:RANGe4:RLEVel 10 DBM")
CALL InstrWrite (analyzer, ":SENSe1:ESpectrum:RANGe4:INPut:ATTenuation 30 DB")
CALL InstrWrite (analyzer, ":SENSe1:ESpectrum:RANGe4:LIMit:ABSolute:STARt
-40")
CALL InstrWrite (analyzer, ":SENSe1:ESpectrum:RANGe4:LIMit:ABSolute:STOP -40")
CALL InstrWrite (analyzer, ":SENSe1:ESpectrum:RANGe4:LIMit:RELative:STARt
-40")
CALL InstrWrite (analyzer, ":SENSe1:ESpectrum:RANGe4:LIMit:RELative:STOP -60")
'----- Defining the settings of range 5 -----
CALL InstrWrite (analyzer, ":SENSe1:ESpectrum:RANGe5:FREQuency:STARt 2 MHz")
CALL InstrWrite (analyzer, ":SENSe1:ESpectrum:RANGe5:FREQuency:STOP 4 MHz")
CALL InstrWrite (analyzer, ":SENSe1:ESpectrum:RANGe5:BANDwidth:RESolution 1 MHz")
CALL InstrWrite (analyzer, ":SENSe1:ESpectrum:RANGe5:FILTer:TYPE CFILter")
CALL InstrWrite (analyzer, ":SENSe1:ESpectrum:RANGe5:BANDwidth:VIDeo 3 MHz")
CALL InstrWrite (analyzer, ":SENSe1:ESpectrum:RANGe5:SWEep:TIME 20 ms")
CALL InstrWrite (analyzer, ":SENSe1:ESpectrum:RANGe5:RLEVel 5 DBM")
CALL InstrWrite (analyzer, ":SENSe1:ESpectrum:RANGe5:INPut:ATTenuation 20 DB")
CALL InstrWrite (analyzer, ":SENSe1:ESpectrum:RANGe5:LIMit:ABSolute:STARt
-50")
CALL InstrWrite (analyzer, ":SENSe1:ESpectrum:RANGe5:LIMit:ABSolute:STOP -50")
CALL InstrWrite (analyzer, ":SENSe1:ESpectrum:RANGe5:LIMit:RELative:STARt -60")
CALL InstrWrite (analyzer, ":SENSe1:ESpectrum:RANGe5:LIMit:RELative:STOP -70")
'----- Measuring -----
CALL InstrWrite (analyzer, "INIT;*WAI") 'Perform sweep, wait for sweep
'end
'----- Reading out results -----
CALL InstrWrite (analyzer, ":TRACe1:DATA? LIST")
'Query list results
CALL InstrWrite (analyzer, ":CALCulate:LIMit:FAIL?")
'Query result of limit check
CALL InstrRead(analyzer, result$)
REM *****

```

### 11.17.13 Spurious Emissions Measurement

In the following example, the Spurious Emissions measurement is configured by defining ranges and parameters.

```

REM *****
'----- General settings of the instrument -----
CALL InstrWrite (analyzer, "*RST") 'Reset instrument
Rem After preset 4 ranges are available. Range settings can be questioned

```

```

Rem independent from the set measurement mode.
'----- Deleting all ranges -----
Rem Delete all ranges to prepare for setting up a new measurement
CALL InstrWrite (analyzer, "SENSe1:LIST:RANGe4:DELeTe")
'Delete range 4
CALL InstrWrite (analyzer, "SENSe1:LIST:RANGe3:DELeTe")
CALL InstrWrite (analyzer, "SENSe1:LIST:RANGe2:DELeTe")
CALL InstrWrite (analyzer, "SENSe1:LIST:RANGe1:DELeTe")
'----- Defining the start frequency for all ranges -----
CALL InstrWrite (analyzer, "SENSe1:LIST:RANGe1:FREQuency:START 1000000")
Rem Setting the start frequency of range 1 will create the ranges and
Rem every other range value will be set to the default value.
CALL InstrWrite (analyzer, "SENSe1:LIST:RANGe2:FREQuency:START 2000000")
CALL InstrWrite (analyzer, "SENSe1:LIST:RANGe3:FREQuency:START 3000000")
CALL InstrWrite (analyzer, "SENSe1:LIST:RANGe4:FREQuency:START 4000000")
CALL InstrWrite (analyzer, "SENSe1:LIST:RANGe5:FREQuency:START 5000000")
CALL InstrWrite (analyzer, "SENSe1:LIST:RANGe:COUNT?")
'Queries the number of defined
'ranges
'----- Querying the parameters of range 1 -----
CALL InstrWrite (analyzer, "SENSe1:LIST:RANGe1:FREQuency:START?")
CALL InstrWrite (analyzer, "SENSe1:LIST:RANGe1:FREQuency:STOP?")
CALL InstrWrite (analyzer, "SENSe1:LIST:RANGe1:FILTEr:TYPE?")
CALL InstrWrite (analyzer, "SENSe1:LIST:RANGe1:BANdwidth:RESolution?")
CALL InstrWrite (analyzer, "SENSe1:LIST:RANGe1:BANdwidth:VIDeo?")
CALL InstrWrite (analyzer, "SENSe1:LIST:RANGe1:SWEep:TIME:AUTO?")
CALL InstrWrite (analyzer, "SENSe1:LIST:RANGe1:DETEctor?")
CALL InstrWrite (analyzer, "SENSe1:LIST:RANGe1:RLEVel?")
CALL InstrWrite (analyzer, "SENSe1:LIST:RANGe1:INPut:ATTenuation:AUTO?")
CALL InstrWrite (analyzer, "SENSe1:LIST:RANGe1:INPut:GAIN:STATe?")
CALL InstrWrite (analyzer, "SENSe1:LIST:RANGe1:BREak?")
CALL InstrWrite (analyzer, "SENSe1:LIST:RANGe1:TRANsducer?")
CALL InstrWrite (analyzer, "SENSe1:LIST:RANGe1:SWEep:TIME?")
CALL InstrWrite (analyzer, "SENSe1:LIST:RANGe1:INPut:ATTenuation?")
CALL InstrWrite (analyzer, "SENSe1:LIST:RANGe1:POINts?")
CALL InstrWrite (analyzer, "SENSe1:LIST:RANGe1:LIMit:START?")
CALL InstrWrite (analyzer, "SENSe1:LIST:RANGe1:LIMit:STOP?")
CALL InstrWrite (analyzer, "SENSe1:LIST:RANGe1:LIMit:STATe?")
'----- Changing into the Spurious Emissions measurement mode -----
CALL InstrWrite (analyzer, ":SENSe1:SWEEP:MODE LIST")
Rem In continuous sweep mode, editing the ranges is not allowed.
Rem You have to stop the measurement first.
Rem In single sweep mode, you can edit the ranges at the end of the sweep.
'----- Single sweep version -----
CALL InstrWrite (analyzer, "INIT:CONT OFF") 'Switch to single sweep
CALL InstrWrite (analyzer, "SENSe1:LIST:RANGe1:FREQuency:START 500000")
'Change the start frequency
CALL InstrWrite (analyzer, "INIT;*WAI") 'Perform sweep, wait for sweep
'end
'----- Continuous sweep version -----

```



## Remote Control – Programming Examples

```

CALL InstrWrite (analyzer, "INIT:CONT ON") 'Switch to continuous sweep
CALL InstrWrite (analyzer, "ABORT") 'Stop the measurement
CALL InstrWrite (analyzer, "SENSE1:LIST:RANGE1:FREQUENCY:START 500000")
'Change the start frequency
CALL InstrWrite (analyzer, ":INITiate1:SPURious") 'Restart the measurement
'----- Defining the range settings in single sweep mode -----
CALL InstrWrite (analyzer, "INIT:CONT OFF") 'Switch to single sweep
CALL InstrWrite (analyzer, "INIT;*WAI") 'Perform sweep, wait for sweep
'end

Rem Edit one range at a time. Make sure to edit the ranges in a correct
Rem order to prevent limit violations. Ranges cannot overlap.
Rem The best way is to start with range 1.
CALL InstrWrite (analyzer, "SENSE1:LIST:RANGE1:FREQUENCY:START 500000")
CALL InstrWrite (analyzer, "SENSE1:LIST:RANGE1:FREQUENCY:STOP 550000")
CALL InstrWrite (analyzer, "SENSE1:LIST:RANGE1:FILTer:TYPE NORM")
CALL InstrWrite (analyzer, "SENSE1:LIST:RANGE1:BANDwidth:RESolution 3000000")
CALL InstrWrite (analyzer, "SENSE1:LIST:RANGE1:BANDwidth:VIDeo 10000000")
CALL InstrWrite (analyzer, "SENSE1:LIST:RANGE1:SWEep:TIME:AUTO ON")
CALL InstrWrite (analyzer, "SENSE1:LIST:RANGE1:DETECTOR RMS")
CALL InstrWrite (analyzer, "SENSE1:LIST:RANGE1:RLEVel -10")
CALL InstrWrite (analyzer, "SENSE1:LIST:RANGE1:INPut:ATTenuation:AUTO ON")
CALL InstrWrite (analyzer, "SENSE1:LIST:RANGE1:POINts 8001")
CALL InstrWrite (analyzer, "SENSE1:LIST:RANGE1:INPut:GAIN:STATE OFF")
CALL InstrWrite (analyzer, "SENSE1:LIST:RANGE1:BREak OFF")
CALL InstrWrite (analyzer, "SENSE1:LIST:RANGE1:LIMit:START -20")
CALL InstrWrite (analyzer, "SENSE1:LIST:RANGE1:LIMit:STOP -20")
CALL InstrWrite (analyzer, "SENSE1:LIST:RANGE1:LIMit:STATE ON")
Rem Proceed with range 2.
CALL InstrWrite (analyzer, "SENSE1:LIST:RANGE2:FREQUENCY:START 1000000")
CALL InstrWrite (analyzer, "SENSE1:LIST:RANGE2:FREQUENCY:STOP 2000000000")
CALL InstrWrite (analyzer, "SENSE1:LIST:RANGE2:FILTer:TYPE CFILter")
CALL InstrWrite (analyzer, "SENSE1:LIST:RANGE2:BANDwidth:RESolution 5000000")
CALL InstrWrite (analyzer, "SENSE1:LIST:RANGE2:DETECTOR POS")
CALL InstrWrite (analyzer, "SENSE1:LIST:RANGE2:RLEVel -20")
CALL InstrWrite (analyzer, "SENSE1:LIST:RANGE2:INPut:ATTenuation 0")
CALL InstrWrite (analyzer, "SENSE1:LIST:RANGE2:POINts 32001")
CALL InstrWrite (analyzer, "SENSE1:LIST:RANGE2:INPut:GAIN:STATE ON")
Rem Proceed with range 3.
CALL InstrWrite (analyzer, "SENSE1:LIST:RANGE3:FREQUENCY:START 2500000000")
CALL InstrWrite (analyzer, "SENSE1:LIST:RANGE3:FREQUENCY:STOP 10000000000")
CALL InstrWrite (analyzer, "SENSE1:LIST:RANGE3:FILTer:TYPE RRC")
CALL InstrWrite (analyzer, "SENSE1:LIST:RANGE3:POINts 32001")
Rem Proceed with range 4.
CALL InstrWrite (analyzer, "SENSE1:LIST:RANGE4:FREQUENCY:START 1200000000")
CALL InstrWrite (analyzer, "SENSE1:LIST:RANGE4:FREQUENCY:STOP 4000000000")
CALL InstrWrite (analyzer, "SENSE1:LIST:RANGE4:FILTer:TYPE PULSe")
CALL InstrWrite (analyzer, "SENSE1:LIST:RANGE4:POINts 251")
Rem Proceed with range 5.
CALL InstrWrite (analyzer, "SENSE1:LIST:RANGE5:FREQUENCY:START 5000000000")
CALL InstrWrite (analyzer, "SENSE1:LIST:RANGE5:FREQUENCY:STOP 6000000000")

```

```

CALL InstrWrite (analyzer, "SENSE1:LIST:RANGE5:POINTS 7001")
'----- Defining the limit check for all ranges -----
CALL InstrWrite (analyzer, "SENSE1:LIST:RANGE1:LIMIT:STATE ON")
'Activate the limit check
'----- Setting the span to include all ranges -----
CALL InstrWrite (analyzer, ":SENSE1:FREQUENCY:START 500000")
CALL InstrWrite (analyzer, ":SENSE1:FREQUENCY:STOP 6000000000")
'----- Measuring -----
CALL InstrWrite (analyzer, "INIT;*WAI") 'Perform sweep, wait for sweep
'end
'----- Reading out results -----
CALL InstrWrite (analyzer, ":TRACE1:DATA? LIST")
'Query list results
CALL InstrWrite (analyzer, ":CALCULATE1:PSEARCH[:IMMEDIATE]")
'Deactivate limit line and
'just look for peaks
Rem Or set margin to 200 in order to find all peaks
CALL InstrWrite (analyzer, ":TRACE1:DATA? SPUR")
'Query just the peaks
CALL InstrWrite (analyzer, ":CALCULATE:LIMIT:FAIL?")
'Query result of limit check
CALL InstrRead(analyzer, result$)
REM *****

```

### 11.17.14 Averaging I/Q Data

The R&S ESRP has averaging capability also for I/Q measurements, i.e. I/Q data can be averaged over several test runs. This is subject to the following conditions:

- An external trigger signal must be available for data measurement, and the trigger signal must be phase-locked to the signal measured.
- The same reference-frequency signal must be used for the DUT and the R&S ESRP.
- Internal I/Q data averaging is supported up to 512 k I/Q samples.

If all of the above conditions are fulfilled, no phase shift will occur between consecutive test runs. Phase shift may falsify the measured average so that in extreme cases a value of 0 is obtained.

The default setting of the instrument for data measurement without averaging has to be changed as follows:

```

REM *****
'----- R&S FSV default setting -----
CALL SetupInstrument 'Default setting
CALL InstrWrite (analyzer, "TRAC:IQ:STAT ON")
'Activate I/Q data acquisition
'mode; this must be
'done before TRAC:IQ:SET!
'Select max. number of test points (= 512 * 1024) at 10 MHz RBW,

```

```
'32 MHz sampling rate, external
'trigger, pos. trigger edge and
'0 s trigger delay.
CALL InstrWrite (analyzer, "TRAC:IQ:SET NORM,10 MHz,32 MHz,EXT,POS,0,524288")
CALL InstrWrite (analyzer, "TRAC:IQ:AVER ON") 'Switch on I/Q averaging
CALL InstrWrite (analyzer, "TRAC:IQ:AVER:COUN 10") 'Set 10 test runs
'----- Read data in binary format -----
...
REM *****
```

### 11.17.15 Using IQ Gating

IQ gating refers to recording IQ samples in certain time intervals – the gate areas. There are different modes to define the gate areas:

- Edge triggered recording
- Level triggered recording

For more information, see "IQ Gating" in the "Remote Commands" chapter under "Trace:IQ" subsystem.

#### Measurement example: Level mode

With IQ gating in level mode, the area in which the gate signal is active is recorded. In this example, the gate signal is generated by the IFP trigger. The [Figure 11-8](#) shows the signal (triggered externally) in IQ mode. The following sample program records the signal in level mode with an external trigger.

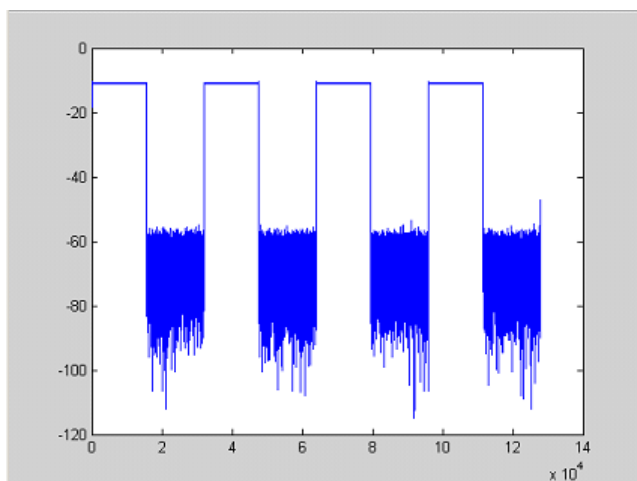

*Figure 11-8: Signal to be recorded in IQ mode*

#### Used values

sample rate: 32 MHz

number of IQ samples: 128000

trigger mode: IFP

## Program

```
:TRACel:IQ ON
Trace:iq:set NORM,0,32000000,IFP,POS,0,128000
:TRIGger1:SEQuence:LEVel:IFPower -20
:TRACel:IQ:EGATe ON
:TRACel:IQ:EGATe:TYPE LEVel
```

## Result

In [Figure 11-9](#), the recorded signal using IQ gating in level mode is displayed. Edges are only visible around the IFP trigger point, otherwise only the signal level is recorded.

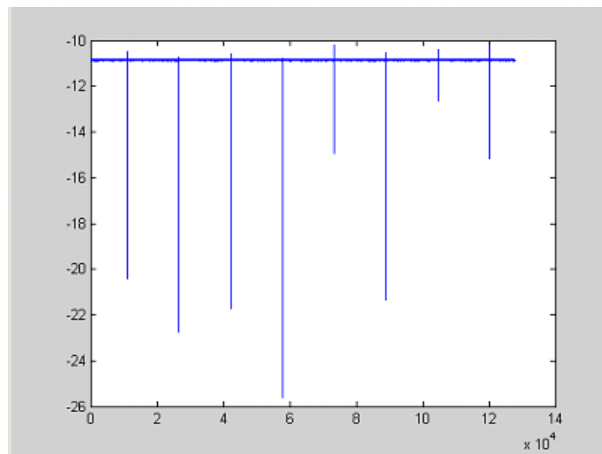

*Figure 11-9: Recorded signal using IQ gating in level mode*

## Measurement example: Edge mode

In edge mode, the gate area is defined by:

- delay (pretrigger samples)
- length
- number of periods
- gap between the periods

The gate starting point can be defined using an IFP or external trigger.

The [Figure 11-10](#) shows the signal to be recorded in IQ mode.

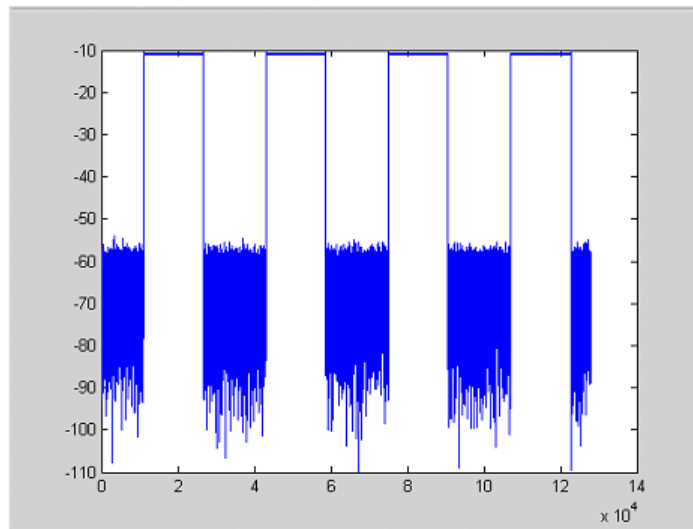

**Figure 11-10: Signal to be recorded in IQ mode**

### Example 1: Signal only

The following sample program records the signal in edge mode and displays only the signal, without gaps and noise.

#### Used values

sample rate: 32 MHz

number of IQ samples: 128000

delay = 11020 samples

length = 15500 samples

trigger mode: EXT

#### Program

```
:TRACel:IQ ON
Trace:iq:set NORM,0,32000000,EXT,POS, 11020,128000
:TRACel:IQ:EGATe ON
:TRACel:IQ:EGATe:TYPE EDGE
:TRACel:IQ:EGATe:LENGth 15500
```

## Result

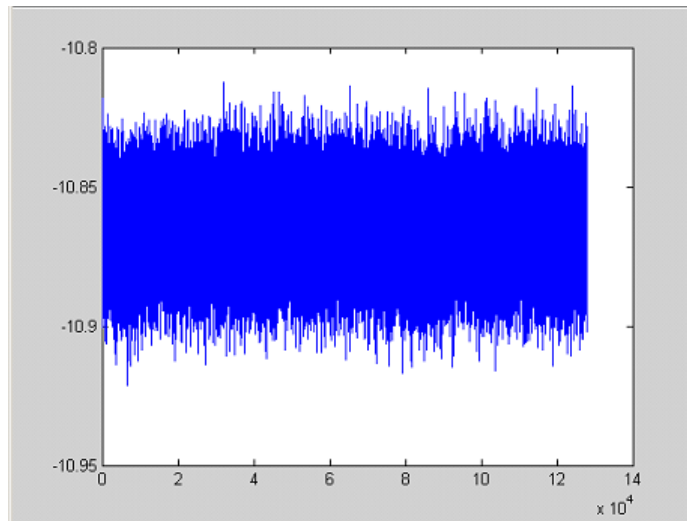

Figure 11-11: Result: signal only (no gaps, no noise)

## Example 2: Noise only

The following sample program records the signal in edge mode and displays only the noise.

### Used values

sample rate: 32 MHz

number of IQ samples: 128000

delay = 0 samples

length = 9000 samples

trigger mode: EXT

### Program

```
:TRACel:IQ ON  
  
Trace:iq:set NORM,0,32000000,EXT,POS, 0,128000  
  
:TRACel:IQ:EGATE ON  
  
:TRACel:IQ:EGATE:TYPE EDGE  
  
:TRACel:IQ:EGATE:LENGTH 9000
```

## Result

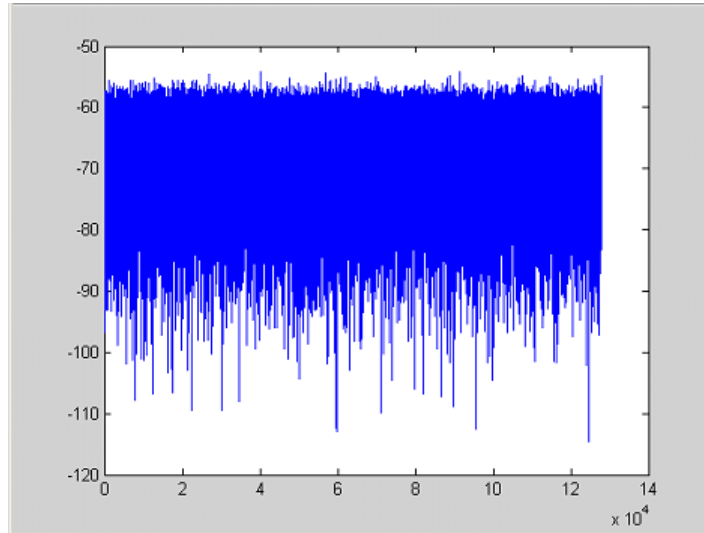

*Figure 11-12: Result: noise only*

## Measurement example: Periodic signal intervals in edge mode

The gate area can also be defined by a number of gate periods and the distance between two periods (gap). In this example, a power ramp is recorded, triggered by the IFP on the highest edge (see [Figure 11-13](#)). As a result, only the levels of the individual ramp areas of the first 3 periods are displayed (see [Figure 11-14](#)).

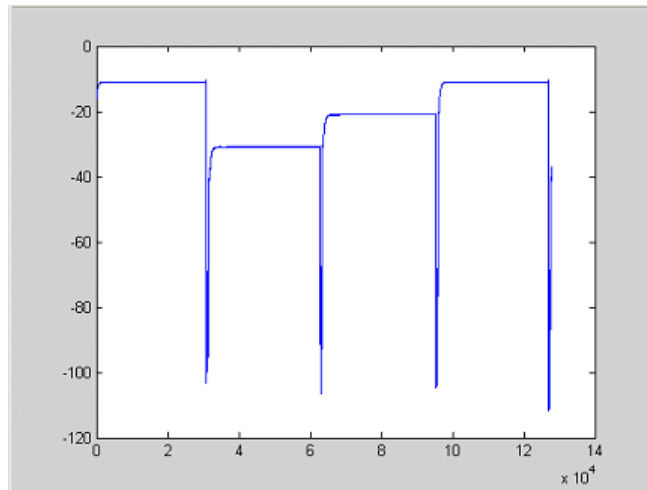

*Figure 11-13: Periodic signal recording in edge mode*

### Used values:

sample rate: 3,2 MHz

number of IQ samples: 228000

trigger mode: IFP

length: 28800

number of periods: 3

gap: 3800 samples

### Program

```
:TRACel:IQ ON
:trace:iq:set NORM,0,3200000,IFP,POS,0,228000
:TRIGger1:SEQuence:LEVel:IFPower -20
:TRACel:IQ:EGATe ON
:TRACel:IQ:EGATe:TYPE EDGE
:TRACel:IQ:EGATe:LENGth 28800
:TRACel:IQ:EGATe:NOF 3
:TRACel:IQ:EGATe:GAP 3800
```

### Result

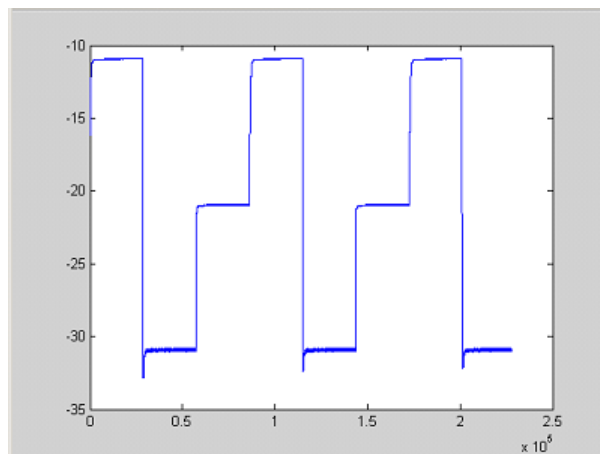

Figure 11-14: Result: periodic power ramp levels

## 11.17.16 Usage of Four Spectrum Instances

As of R&S ESRP firmware version 1.50, you can open up to four tabs for spectrum mode with the softkey "New Spectrum" in the "MODE" menu. The following remote example shows how to set up four tabs with four different measurements on a WCDMA signal.

```
REM *****
Public Sub 4SpectrumTabs()
result$ = Space$(100)

'----- R&S FSV default setting -----
CALL SetupStatusReg           'Set status registers
```



## Remote Control – Programming Examples

```

CALL InstrWrite(analyzer,"*RST")          'Reset instrument
CALL InstrWrite(analyzer,"INIT:CONT OFF")  'Single sweep

'----- Setup the first Spectrum tab (Spectrum Overview Measurement) -----
CALL InstrWrite(analyzer,"INIT:CONT OFF")  'Single sweep
CALL InstrWrite(analyzer,"DISP:WIND:TRAC:Y:SCAL:RLEV 10 dBm")'Reference level
CALL InstrWrite(analyzer,"FREQ:START 100MHz;STOP 6 GHz")    'Span

'----- Setup the Spectrum 2 Tab (ACLR measurement) -----
CALL InstrWrite(analyzer,"INST:CRE SAN,'Spectrum 2'")      'Create Tab 2

'--- After creation the tab is in standard preset setup ---
CALL InstrWrite(analyzer,"INIT:CONT OFF")  'Single sweep
CALL InstrWrite(analyzer,"DISP:WIND:TRAC:Y:SCAL:RLEV 10 dBm")'Reference level
CALL InstrWrite(analyzer,"FREQ:CENT 2.1175GHz")            'different CF
CALL InstrWrite(analyzer,"CALC:MARK:FUNC:POW:SEL ACP")      'select ACLR meas
CALL InstrWrite(analyzer,"CALC:MARK:FUNC:POW:PRES FW3Gppcdma")
      'select WCDMA BTS standard

'----- Setup the Spectrum 3 Tab (OBW measurement) -----
CALL InstrWrite(analyzer,"INST:CRE SAN,'Spectrum 3'")      'Create Tab 3
CALL InstrWrite(analyzer,"INIT:CONT OFF")  'Single sweep
CALL InstrWrite(analyzer,"DISP:WIND:TRAC:Y:SCAL:RLEV 10 dBm")'Reference level
CALL InstrWrite(analyzer,"FREQ:CENT 2.1175GHz")            'different CF
CALL InstrWrite(analyzer,"CALC:MARK:FUNC:POW:SEL OBW")      'select OBW meas
CALL InstrWrite(analyzer,"CALC:MARK:FUNC:POW:PRES FW3Gppcdma")
      ' select WCDMA BTS standard

'----- Setup the Spectrum 4 Tab (CCDF measurement) -----
CALL InstrWrite(analyzer,"INST:CRE SAN,'Spectrum 4'")      'Create Tab 4
CALL InstrWrite(analyzer,"INIT:CONT OFF")  'Single sweep
CALL InstrWrite(analyzer,"DISP:WIND:TRAC:Y:SCAL:RLEV 10 dBm")'Reference level
CALL InstrWrite(analyzer,"FREQ:CENT 2.1175GHz")            'different CF
CALL InstrWrite(analyzer," CALC:STAT:CCDF ON")              'select CCDF meas

'----- Sweep in first Spectrum Tab and query marker -----
CALL InstrWrite(analyzer,"INST:SEL SAN")                    'Select Tab 1
CALL InstrWrite(analyzer,"INIT;*WAI")                      'Perform sweep with sync
CALL InstrWrite(analyzer,"CALC:MARK1:MAX")                 'Marker to peak
CALL InstrWrite(analyzer,"CALC:MARK1:X?")                  'Query Marker x value
CALL InstrRead(analyzer,result$)
Print "Spectrum 1 Marker x [Hz]: ";result$
CALL InstrWrite(analyzer,"CALC:MARK1:Y?")                  'Query Marker y value
CALL InstrRead(analyzer,result$)
Print "Spectrum 1 Marker y [dBm]: ";result$

'----- Sweep in Spectrum 2 Tab and query ACLR results -----
CALL InstrWrite(analyzer," INST:SEL 'Spectrum 2'")          'Select Tab 2
CALL InstrWrite(analyzer,"INIT;*WAI")                      'Perform sweep with sync
CALL InstrWrite(analyzer,"CALC:MARK:FUNC:POW:RES? ACP")    'Query ACLR results
CALL InstrRead(analyzer,result$)
Print "Spectrum 2 ACRL results : ";result$

'----- Sweep in Spectrum 3 Tab and query OBW results -----
CALL InstrWrite(analyzer," INST:SEL 'Spectrum 3'")          'Select Tab 3

```

```
CALL InstrWrite(analyzer,"INIT;*WAI")           'Perform sweep with sync
CALL InstrWrite(analyzer,"CALC:MARK:FUNC:POW:RES? OBW") 'Query OBW results
CALL InstrRead(analyzer,result$)
Print "Spectrum 3 OBW results : ";result$

'----- Sweep in Spectrum 4 Tab and query CCDF results -----
CALL InstrWrite(analyzer," INST:SEL 'Spectrum 4'") 'Select Tab 4
CALL InstrWrite(analyzer,"INIT;*WAI")           'Perform sweep with sync
CALL InstrWrite(analyzer,"CALC:STAT:RES1? ALL") 'Query CCDF results
CALL InstrRead(analyzer,result$)
Print "Spectrum 4 CCDF results : ";result$
'----- Now the sweep part can be redone without the need of -----
'----- doing the setup of all 4 measurements again. -----
END SUB
REM *****
```

## 11.18 GPIB Commands of HP Models 856xE, 8566A/B, 8568A/B and 8594E

The R&S FSV analyzer family supports a subset of the GPIB commands of HP models 8560E, 8561E, 8562E, 8563E, 8564E, 8565E, 8566A, 8566B, 8568A, 8568B and 8594E.

Despite the differences in system architecture and device features, the supported commands have been implemented in a way to ensure a sufficiently high degree of correspondence with the original.

This includes the support of syntax rules for not only newer device families (B and E models) but for the previous A family as well.

In many cases the selection of commands supported by the R&S FSV is sufficient to run an existing GPIB program without adaptation.

After the introduction, this section includes the following topics:

- [GPIB Languages](#).....1008
- [Command Set of Models 8560E, 8561E, 8562E, 8563E, 8564E, 8565E, 8566A/B, 8568A/B, 8591E, 8594E, 71100C, 71200C, and 71209A](#)..... 1009
- [Special Features of the Syntax Parsing Algorithms for 8566A and 8568A Models](#) ..... 1033
- [Special Behavior of Commands](#).....1034
- [Model-Dependent Default Settings](#)..... 1035
- [Data Output Formats](#).....1036
- [Trace Data Output Formats](#)..... 1036
- [Trace Data Input Formats](#)..... 1036
- [GPIB Status Reporting](#).....1036

### 11.18.1 GPIB Languages

The R&S ESRP analyzer family supports a subset of the GPIB commands used by other devices. Thus it can emulate other devices in order to use existing remote control programs.

#### Supported languages

Language	Comment
SCPI	
71100C	Compatible to 8566A/B
71200C	Compatible to 8566A/B
71209A	Compatible to 8566A/B
8560E	
8561E	
8562E	
8563E	
8564E	
8565E	
8566A	Command sets A and B are available. Command sets A and B differ in the rules regarding the command structure.
8566B	
8568A	Command sets A and B are available. Command sets A and B differ in the rules regarding the command structure.
8568A_DC	Uses DC input coupling by default if supported by the instrument
8568B	Command sets A and B are available. Command sets A and B differ in the rules regarding the command structure.
8568B_DC	Uses DC input coupling by default if supported by the instrument
8591E	Compatible to 8594E
8594E	Command sets A and B are available. Command sets A and B differ in the rules regarding the command structure.
PSA89600	
PSA	
ESA	

#### Notes:

- If you select a language other than "SCPI", the GPIB address is set to 18 if it was 20 before.
- The Start/stop frequency, reference level and number of sweep points are adapted to the selected instrument model.

- When you switch between remote control languages, the following settings or changes are made:

**SCPI:**

The instrument performs a PRESET.

**8566A/B, 8568A/B, 8594E; FSEA, FSEB, FSEM; FSEK:**

- The instrument performs a PRESET.
- The following instrument settings are changed:

**Table 11-29: Instrument settings for emulation of 8566A/B, 8568A/B, 8594E; FSEA, FSEB, FSEM; FSEK instruments**

Model	# of Trace Points	Start Freq.	Stop Freq.	Ref Level	Input Coupling
8566A/B	1001	2 GHz	22 GHz	0 dBm	AC
8568A/B	1001	0 Hz	1.5 GHz	0 dBm	AC
8560E	601	0 Hz	2.9 GHz	0 dBm	AC
8561E	601	0 Hz	6.5 GHz	0 dBm	AC
8562E	601	0 Hz	13.2 GHz	0 dBm	AC
8563E	601	0 Hz	26.5 GHz	0 dBm	AC
8564E	601	0 Hz	40 GHz	0 dBm	AC
8565E	601	0 Hz	50 GHz	0 dBm	AC
8594E	401	0 Hz	3 GHz	0 dBm	AC

**Note:** The stop frequency indicated in the table may be limited to the corresponding frequency of the R&S ESRP, if required.

### 11.18.2 Command Set of Models 8560E, 8561E, 8562E, 8563E, 8564E, 8565E, 8566A/B, 8568A/B, 8591E, 8594E, 71100C, 71200C, and 71209A

As with the original units, the R&S ESRP includes the command set of the A models in the command set of the B models.



The HP model 8591E is compatible to HP model 8594E, the HP models 71100C, 71200C, and 71209A are compatible to HP models 8566A/B.

Command	Supported subset	Function	Corresp. HP-Models	Status
A1	A1	Clear/Write A	HP 8566A/ HP 8568A	available
A2	A2	Max Hold A	HP 8566A/ HP 8568A	available

Command	Supported subset	Function	Corresp. HP-Models	Status
A3	A3	View A	HP 8566A/ HP 8568A	available
A4	A4	Blank A	HP 8566A/ HP 8568A	available
ABORT <sup>1)</sup>	ABORT	Stop previous function	HP 856xE/ HP 8566B/HP 8568B/HP 8594E	available
ADD		Add	HP 8566B/ HP 8568B/ HP 8594E	available
ADJALL	ADJALL	Adjust all	HP 856xE/ HP 8566B/ HP 8568B/ HP 8594E	available
ADJCRT <sup>2)</sup>	ADJCRT	Adjust CRT	HP 856xE/ HP 8566B/ HP 8568B/ HP 8594E	available
ADJIF <sup>2)</sup>	ADJIF	Auto adjust IF	HP 856xE/ HP 8566B/ HP 8568B/ HP 8594E	available
AMB	AMB ON OFF AMB 1 0 AMB?	Trace A – B -> Trace A	HP 856xE/ HP 8594E	available
AMBPL	AMBPL ON OFF AMBPL 1 0 AMBPL?		HP 856xE/ HP 8566B/ HP 8568B/ HP 8594E	available
ANNOT	ANNOT ON OFF ANNOT 1 0 ANNOT?	Annotation	HP 856xE/ HP 8566B/ HP 8568B/ HP 8594E	available
APB	APB	Trace A + B -> Trace A	HP 856xE/ HP 8566B/ HP 8568B/ HP 8594E	available

## GPIB Commands of HP Models 856xE, 8566A/B, 8568A/B and 8594E

Command	Supported subset	Function	Corresp. HP-Models	Status
AT	AT <numeric_value> DB   DM AT DN AT UP AT AUTO AT?	Attenuation	HP 8566A/ HP 8568A/ HP 856xE/ HP 8566B/ HP 8568B/ HP 8594E	available
AUNITS	AUNITS DBM   DBMV   DBUV   AUNITS?	Amplitude Units	HP 856xE/ HP 8566B/ HP 8568B/ HP 8594E	available
AUTOCP	AUTOCP	Coupling default	HP 856xE/ HP 8566B/ HP 8568B/ HP 8594E	available
AXB	AXB	Exchange trace A and B	HP 856xE/ HP 8566B/ HP 8568B/ HP 8594E	available
B1	B1	Clear/Write B	HP 8566A/ HP 8568A	available
B2	B2	Max Hold B	HP 8566A/ HP 8568A	available
B3	B3	View B	HP 8566A/ HP 8568A	available
B4	B4	Blank B	HP 8566A/ HP 8568A	available
BL	BL	Trace B – Display Line - > Trace B	HP 8566A/ HP 8568A	available
BML	BML	Trace B – Display Line - > Trace B	HP 856xE/ HP8594E	available
BTC	BTC	Transfer Trace B -> C	HP 856xE/ HP 8566B/ HP 8568B/ HP 8594E	available
BXC	BXC	Exchange Trace B and C	HP 856xE/ HP 8566B/ HP 8568B/ HP 8594E	available

## GPIB Commands of HP Models 856xE, 8566A/B, 8568A/B and 8594E

Command	Supported subset	Function	Corresp. HP-Models	Status
BLANK	BLANK TRA TRB TRC	Blank Trace	HP 856xE/ HP 8566B/ HP 8568B/ HP 8594E	available
C1	C1	A-B off	HP 8566A/ HP 8568A	available
C2	C2	A-B -> A	HP 8566A/ HP 8568A	available
CA	CA	Couple Attenuation	HP 8566A/ HP 8568A	available
CAL <sup>1)</sup>	CAL ALL CAL ON CAL OFF	Start analyzer self alignment	HP 856xE/ HP 8566B/ HP 8568B/ HP 8594E	available
CF	CF <numeric_value> HZ KHZ MHZ GHZ CF UP CF DN CF?	Center Frequency	HP 8566A/ HP 8568A/ HP 856xE/ HP 8566B/ HP 8568B/ HP 8594E	available
CHANPWR	CHANPWR TRA TRB, <numeric_value>,<?>	Channel Power Measurement	HP 856xE/ HP 8594E	available
CHPWRBW	CHPWRBW <numeric_value> HZ  KHZ MHZ GHZ	Channel Power Bandwidth	HP 856xE/ HP 8594E	available
CLRW	CLRW TRA TRB TRC	Clear/Write Trace	HP 856xE/ HP 8566B/ HP 8568B/ HP 8594E	available
CLS <sup>1)</sup>	CLS	Clear all status bits	HP 856xE/ HP 8566B/ HP 8568B/ HP 8594E	available
CONTS	CONTS		HP 856xE/ HP 8566B/ HP 8568B/ HP 8594E	available

## GPIB Commands of HP Models 856xE, 8566A/B, 8568A/B and 8594E

Command	Supported subset	Function	Corresp. HP-Models	Status
COUPLE	COUPLE AC DC	Input coupling	HP 856xE/ HP 8566B/ HP 8568B/ HP 8594E	available
CR	CR	Couple RBW	HP 8566A/ HP 8568A	available
CS	CS	Couple Step Size	HP 8566A/ HP 8568A	available
CT	CT	Couple SWT	HP 8566A/ HP 8568A	available
CTA		Convert to absolute units	HP 8566B/ HP 8568B/ HP 8594E	available
CV	CV	Couple VBW	HP 8566A/ HP 8568A	available
D1 <sup>2)</sup>	D1	Display Size normal	HP 8566A/ HP 8568A	available
DA <sup>2)</sup>	DA	Display address		available
DEMODO <sup>1)</sup>	DEMODO ON OFF AM  FM	AF Demodulator	HP 856xE/ HP 8566B/ HP 8568B/ HP 8594E	available
DEMODOAGC <sup>2)</sup>	DEMODOAGC ON OFF 1  0 DEMODOAGC?	Demodulation AGC	HP 856xE/ HP 8566B/ HP 8568B/ HP 8594E	available
DEMODT	DEMODT <numeric_value> S MS  US SC DEMODT UP DN DEMODT?	Demodulation time	HP 856xE/ HP 8566B/ HP 8568B/ HP 8594E	available
DET	DET POS SMP NEG DET?	Detector	HP 856xE/ HP 8566B/ HP 8568B/ HP 8594E	available
DISPOSE <sup>2)</sup>	ONEOS   TRMATH   ONSWP   ALL   <numeric_value>			available



Command	Supported subset	Function	Corresp. HP-Models	Status
DIV		Divide	HP 8566B/ HP 8568B/ HP 8594E	available
DL	DL <numeric_value> DB DM DL DN DL UP DL ON DL OFF DL?	Display Line	HP 856xE/ HP 8566B/ HP 8568B/ HP 8594E	available
DLE	DLE ON OFF	Display Line enable	HP 856xE/ HP 8566B/ HP 8568B/ HP 8594E	available
DONE	DONE DONE?	Done query	HP 856xE/ HP 8566B/ HP 8568B/ HP 8594E	available
DW <sup>2)</sup>	DW	Write to display and increment address		available
E1	E1	Peak Search	HP 8566A/ HP 8568A	available
E2	E2	Marker to Center Freq.	HP 8566A/ HP 8568A	available
E3	E3	Deltamarker Step Size	HP 8566A/ HP 8568A	available
E4	E4	Marker to Ref. Level	available	available
EDITDONE		limit line edit done	HP 856xE	available
EDITLIML		edit limit line	HP 856xE	available

## GPIB Commands of HP Models 856xE, 8566A/B, 8568A/B and 8594E

Command	Supported subset	Function	Corresp. HP-Models	Status
ERR	ERR 250 cal level error ERR 300 LO unlock ERR 472 cal error digital filter ERR 473 cal error analog filter ERR 552 cal error log amp ERR 902 unscale tracking generator ERR 906 oven cold ERR 117 numeric unit error ERR 112 Unrecognized Command	Now some FSx errors are mapped to HP errors.	HP8568A HP856xE	not yet available
ERR?	ERR?	Error queue query	HP 856xE/ HP 8566B/ HP 8568B/ HP 8594E	not yet available
EX	EX	Exchange trace A and B	HP 8566A/ HP 8568A	available
FA	FA <numeric_value> HZ  KHZ MHZ GHZ FA UP FA DN FA?	Start Frequency	HP 8566A/ HP 8568A/ HP 856xE/ HP 8566B/ HP 8568B/ HP 8594E	available
FB	FB <numeric_value> HZ  KHZ MHZ GHZ FB UP FB DN FB?	Stop Frequency	HP 8566A/ HP 8568A/ HP 856xE/ HP 8566B/ HP 8568B/ HP 8594E	available
FDSP		Frequency display off	8560E 8561E 8562E 8563E 8564E 8565E	available
FOFFSET <sup>1)</sup>	FOFFSET <numeric_value> HZ  KHZ MHZ GHZ FOFFSET?	Frequency Offset	HP 856xE/ HP 8566B/ HP 8568B/ HP 8594E	available

## GPIB Commands of HP Models 856xE, 8566A/B, 8568A/B and 8594E

Command	Supported subset	Function	Corresp. HP-Models	Status
FREF	FREF INT EXT	Reference Frequency	HP 856xE/ HP 8566B/ HP 8568B/ HP 8594E	available
FS	FS	Full Span	HP 8566A/ HP 8568A	available
FUNCDEF		Define Function Function must be in one line between delimiters @	HP 8594E/ HP 856xE/ HP 8566B	available
GATE <sup>1)</sup>	GATE ON OFF GATE 1 0		HP 856xE/ HP 8566B/ HP 8568B/ HP 8594E	available
GATECTL <sup>1)</sup>	GATECTL EDGE LEVEL GATECTL?		HP 856xE/ HP 8566B/ HP 8568B/ HP 8594E	available
GD <sup>1)</sup>	GD <numeric_value> US MS SC GD DN GD UP GD?		HP 856xE/ HP 8566B/ HP 8568B/ HP 8594E	available
GL <sup>1)</sup>	GL <numeric_value> US MS SC GL DN GL UP GL?		HP 856xE/ HP 8566B/ HP 8568B/ HP 8594E	available
GP <sup>1)</sup>	GP POS NEG GP?		HP 856xE/ HP 8566B/ HP 8568B/ HP 8594E	available
GRAT <sup>2)</sup>	GRAT ON OFF	Graticule	HP 856xE/ HP 8566B/ HP 8568B/ HP 8594E	available
I1	I1		HP 8566A/ HP 8568A	available
I2	I2		HP 8566A/ HP 8568A	available

Command	Supported subset	Function	Corresp. HP-Models	Status
ID	ID ID?	Identify	HP 8566A/ HP 8568A/ HP 856xE/ HP 8566B/ HP 8568B/ HP 8594E	available
INZ <sup>1)</sup>	INZ 75 INZ 50 INZ?	Input Impedance	HP 856xE/ HP 8566B/ HP 8568B/ HP 8594E	available
IP	IP	Instrument preset	HP 8566A/ HP 8568A	available
KEYDEF	KEYDEF	Key definition	HP 8566B/ HP 856xE/ HP 859xE	available
KEYEXEC	KEYEXEC	Key execute	HP 8566B	available
KS=	KS= <numeric_value> HZ KHZ MHZ GHZ KS= DN KS= UP KS=?	Marker Frequency Counter Resolution	HP 8566A/ HP 8568A	available
KS/	KS/	Manual Peaking	HP 8566A/ HP 8568A	available
KS(	KS(	Lock register	HP 8566A/ HP 8568A	available
KS)	KS)	Unlock register	HP 8566A/ HP 8568A	available
KS91	KS91	Read Amplitude Error	HP 8566A/ HP 8568A	available
KSA	KSA	Amplitude Units in dBm	HP 8566A/ HP 8568A	available
KSB	KSB	Amplitude Units in dBmV	HP 8566A/ HP 8568A	available
KSC	KSC	Amplitude Units in dBuV	HP 8566A/ HP 8568A	available
KSD	KSD	Amplitude Units in V	HP 8566A/ HP 8568A	available
KSE	KSE <numeric_value>  <char data>@	Title mode	HP 8566A/ HP 8568A	available

## GPIB Commands of HP Models 856xE, 8566A/B, 8568A/B and 8594E

Command	Supported subset	Function	Corresp. HP-Models	Status
KSG	KSG KSG ON KSG <numeric_value>	Video Averaging on	HP 8566A/ HP 8568A	available
KSH	KSH	Video Averaging Off	HP 8566A/ HP 8568A	available
KSK		Marker to Next Peak	HP 8566A/ HP 8568A	available
KSL		Marker Noise off	HP 8566A/ HP 8568A	available
KSM		Marker Noise on	HP 8566A/ HP 8568A	available
KSO	KSO	Deltamarker to span	HP 8566A/ HP 8568A	available
KSP	KSP <numeric_value>	HPIB address	HP 8566A/ HP 8568A	available
KSQ <sup>2)</sup>	KSQ	Band lock off	HP 8566A/ HP 8568A	available
KST	KST	Fast Preset	HP 8566A/ HP 8568A	available
KSV	KSV <numeric_value> HZ KHZ MHZ GHZ KSV?	Frequency Offset	HP 8566A/ HP 8568A	available
KSW	KSW	Error Correction Routine	HP 8566A/ HP 8568A	available
KSX	KSX	Correction Values On	HP 8566A/ HP 8568A	available
KSY	KSY	Correction Values Off	HP 8566A/ HP 8568A	available
KSZ	KSZ <numeric_value> DB KSZ?	Reference Value Offset	HP 8566A/ HP 8568A	available
KSa	KSa	Normal Detection	HP 8566A/ HP 8568A	available
KSb	KSb	Pos Peak Detection	HP 8566A/ HP 8568A	available
KSd	KSd	Neg Peak Detection	HP 8566A/ HP 8568A	available

## GPIB Commands of HP Models 856xE, 8566A/B, 8568A/B and 8594E

Command	Supported subset	Function	Corresp. HP-Models	Status
KSe	KSe	Sample Detection	HP 8566A/ HP 8568A	available
KSg		CRT beam off		available
KSh		CRT beam on		available
KSj	KSj	View Trace C	HP 8566A/ HP 8568A	available
KSk	KSk	Blank Trace C	HP 8566A/ HP 8568A	available
KSl	KSl	Transfer B to C	HP 8566A/ HP 8568A	available
KSm	KSm	Graticule off	HP 8566A/ HP 8568A	available
KSn <sup>2)</sup>	KSn	Grid on	HP 8566A/ HP 8568A	available
KSo	KSn	Character display off	HP 8566A/ HP 8568A	available
KSp	KSp	Character display on	HP 8566A/ HP 8568A	available
KSr	KSr	Create service request	HP 8566A/ HP 8568A	available
KSt <sup>2)</sup>	KSt	Band lock on	HP 8566A/ HP 8568A	available
KV <sup>2)</sup>	KV	Signal ident on	HP 8566A/ HP 8568A	available
L0	L0	Display line off	HP 8566A/ HP 8568A	available
LB	LB <numeric_value>  <char data>@	Label	HP 8566A/ HP 8568A	available
LF	LF	Low frequency band pre- set	HP 8566A/ HP 8568A	available
LIMD		limit line delta	HP 856xE	available
LIMF		limit line frequency	HP 856xE	available
LIMIFAIL		limit fail query	HP 856xE	available
LIMIPURGE		purge limit line	HP 856xE	available
LIMIRCL		recall limit line	HP 856xE	available
LIMIREL		relative limit line	HP 856xE	available

## GPIB Commands of HP Models 856xE, 8566A/B, 8568A/B and 8594E

Command	Supported subset	Function	Corresp. HP-Models	Status
LIMISAV		save limit line	HP 856xE	available
LIMITEST		limit line test	HP 856xE	available
LIML		lower limit line value	HP 856xE	available
LIMM		middle limit line value	HP 856xE	available
LIMTFL		flat limit line segment	HP 856xE	available
LIMITSL		slope limit line segment	HP 856xE	available
LIMU		upper limit line value	HP 856xE	available
LG	LG <numeric_value> DB   DM LG?	Amplitude Scale Log	HP 856xE/ HP 8566B/ HP 8568B/ HP 8594E	available
LL <sup>2)</sup>	LL	Plot command	HP 8566A/ HP 8568A	available
LN	LN	Amplitude Scale Lin	HP 856xE/ HP 8566B/ HP 8568B/ HP 8594E	available
M1	M1	Marker Off	HP 8566A/ HP 8568A	available
M2	M2 M2 <numeric_value> HZ KHZ MHZ GHZ M2 DN M2 UP M2?	Marker Normal	HP 8566A/ HP 8568A	available
M3	M3 M3 <numeric_value> HZ KHZ MHZ GHZ M3 DN M3 UP M3?	Delta Marker	HP 8566A/ HP 8568A	available
M4	M4 <numeric_value> HZ KHZ MHZ GHZ	Marker Zoom	HP 8566A/ HP 8568A	available
MA	MA	Marker Amplitude	HP 8566A/ HP 8568A	available
MC0	MC0	Marker Count off	HP 8566A/ HP 8568A	available

## GPIB Commands of HP Models 856xE, 8566A/B, 8568A/B and 8594E

Command	Supported subset	Function	Corresp. HP-Models	Status
MC1	MC1	Marker Count on	HP 8566A/ HP 8568A	available
MDS	MDS	Measurement data size	HP 8566B	available
MEAS		Measurement status	HP 856xE	available
MF	MF MF?	Marker Frequency	HP 8566A/ HP 8568A/ HP 856xE/ HP 8566B/ HP 8568B/ HP 8594E	available
MINH <sup>1)</sup>	MINH TRC	Minimum Hold	HP 856xE/ HP 8566B/ HP 8568B/ HP 8594E	available
MKA	MKA <numeric_value> MKA?	Marker Amplitude	HP 856xE/ HP 8566B/ HP 8568B/ HP 8594E	available
MKACT	MKACT 1 MKACT?	Select the active marker	HP 856xE/ HP 8566B/ HP 8568B/ HP 8594E	not available
MKBW <sup>1)</sup>	MKBW <numeric_value> MKBW ON MKBW OFF	N dB Down	HP 856xE/ HP 8566B/ HP 8568B/ HP 8594E	available
MKD	MKD MKD <numeric_value> HZ KHZ  MHZ GHZ MKD DN MKD UP MKD ON MKD OFF MKD?	Delta Marker	HP 856xE/ HP 8566B/ HP 8568B/ HP 8594E	available
MKDR	MKDR <numeric_value> HZ KHZ  MHZ GHZ  S SC MS MSEC  USMKDR?	Delta Marker reverse	HP 856xE/ HP 8566B/ HP 8568B/ HP 8594E	available



Command	Supported subset	Function	Corresp. HP-Models	Status
MKDR?		Delta Marker reverse query		available
MKF	MKF <numeric_value> HZ KHZ MHZ GHZ MKF?	Set Marker Frequency	HP 856xE/ HP 8566B/ HP 8568B/ HP 8594E	available
MKFC	MKFC ON OFF	Frequency Counter on/off	HP 856xE/ HP 8566B/ HP 8568B/ HP 8594E	available
MKFCR <sup>1)</sup>	MKFCR <numeric_value> HZ KHZ  MHZ GHZ MKFCR DN MKFCR UP MKFCR?	Frequency Counter Resolution	HP 856xE/ HP 8566B/ HP 8568B/ HP 8594E	available
MKMIN	MKMIN	Marker -> Min	HP 856xE/ HP 8566B/ HP 8568B/ HP 8594E	available
MKN	MKN MKN <numeric_value> HZ KHZ MHZ GHZ MKN DN MKN UP MKN ON MKN OFF MKN?	Normal Marker	HP 856xE/ HP 8566B/ HP 8568B/ HP 8594E	available
MKNOISE	MKNOISE ON OFF MKNOISE 1 0 MKNOISE?	Noise Measurement	HP 856xE/ HP 8566B/ HP 8568B/ HP 8594E	available
MKOFF	MKOFF MKOFF ALL	Marker off	HP 856xE/ HP 8566B/ HP 8568B/ HP 8594E	available
MKP	MKP <numeric_value> MKP?	Marker position	HP 856xE/ HP 8566B/ HP 8568B/ HP 8594E	available

Command	Supported subset	Function	Corresp. HP-Models	Status
MKPK	MKPK MKPK HI MKPK NH MKPK NR MKPK NL	Marker Search	HP 856xE/ HP 8566B/ HP 8568B/ HP 8594E	available
MKPT	MKPT MKPT HI MKPT NH MKPT NR MKPT NL	Marker Peak Threshold	HP 856xE/ HP 8566B/ HP 8568B/ HP 8594E	available
MKPX	MKPX <numeric_value> DB MKPX DN MKPX UP MKPX?	Peak Excursion	HP 856xE/ HP 8566B/ HP 8568B/ HP 8594E	available
MKRL	MKRL	Ref Level = Marker Level	HP 856xE/ HP 8566B/ HP 8568B/ HP 8594E	available
MKSP	MKSP	Deltamarker to span	HP 856xE/ HP 8566B/ HP 8568B/ HP 8594E	available
MKSS	MKSS	CF Stepsize = Marker Freq	HP 856xE/ HP 8566B/ HP 8568B/ HP 8594E	available
MKT	MKT <numeric_value> S MS US SC MKT?	MKF = fstart + MKT/ SWT*Span	HP 856xE/ HP 8594E	available
MKTRACE	MKTRACE TRA TRB  TRC	Marker to Trace	HP 856xE/ HP 8566B/ HP 8568B/ HP 8594E	available
MKTRACK	MKTRACK ON OFF MKTRACK 1 0 MKTRACK?	Signal Track	HP 856xE/ HP 8566B/ HP 8568B/ HP 8594E	available

## GPIB Commands of HP Models 856xE, 8566A/B, 8568A/B and 8594E

Command	Supported subset	Function	Corresp. HP-Models	Status
MKTYPE	MKTYPE AMP MK TYPE?	Marker type	HP 856xE/ HP 8566B/ HP 8568B/ HP 8594E	available
ML		Mixer level	HP 856xE	available
MOV	MOV TRA TRB TRC, TRA TRB T RC	Move Trace Contents	HP 856xE/ HP 8566B/ HP 8568B/ HP 8594E	available
MPY		Multiply	HP 8566B/ HP 8568B/ HP 8594E	available
MT0	MT0	Marker Track Off	HP 8566A/ HP 8568A	available
MT1	MT1	Marker Track On	HP 8566A/ HP 8568A	available
MXMH	MXMH TRA TRB	Maximum Hold	HP 856xE/ HP 8566B/ HP 8568B/ HP 8594E	available
NORMALIZE	NORMALIZE	Normalize trace	HP 856xE/ HP 8566B/ HP 8568B/ HP 8594E	not available available
NRL <sup>1)</sup>	NRL <numeric_value> DB   DM NRL?	Normalized Reference Level	HP 856xE/ HP 8566B/ HP 8568B/ HP 8594E	available
NRPOS	NRPOS <numeric_value> NRL?	Normalize position	HP 856xE/ HP 8566B/ HP 8568B/ HP 8594E	available
O1	O1	Format ASCII, Values 0 to 4095	HP 8566A/ HP 8568A	available
O2	O2	Format Binary, Values 0 to 4095	HP 8566A/ HP 8568A	available
O3	O3	Format ASCII	HP 8566A/ HP 8568A	available

## GPIB Commands of HP Models 856xE, 8566A/B, 8568A/B and 8594E

Command	Supported subset	Function	Corresp. HP-Models	Status
OA	OA	Output All	HP 8566A/ HP 8568A	available
OL	OL <80 characters> OL?	Output Learn String	HP 8566A/ HP 8568A	available
OT	OT	Output Trace Annotations	HP 8566A/ HP 8568A	available
PA	PA <numeric_value>, <numeric_value	Plot command	HP 8566A/ HP 8568A	available
PD	PD <numeric_value>, <numeric_value	Plot command	HP 8566A/ HP 8568A	available
PH_MKF		Spot frequency in Hz	HP 856xE	available
PH_FMIN		Min offset frequency to be measured	HP 856xE	available
PH_FMAX		Max offset frequency to be measured	HP 856xE	available
PH_MKA		Queries amplitude at the spot frequency	HP 856xE	available
PH_DRIFT		0: for stable signals, 1: for drifty	HP 856xE	available
PH_RLVL		Reference level for the log plot	HP 856xE	available
PH_SMTHV		Trace smoothing	HP 856xE	available
PH_VBR		Filtering	HP 856xE	available
PH_RMSPT		Amount of data points to skip when doing the integration	HP 856xE	available
PH_RMSFL		Lower integration frequency in Hz	HP 856xE	available
PH_RMSFU		Upper integration frequency in Hz	HP 856xE	available
PH_EXIT		Quits phase noise	HP 856xE	available
PH_F_UDT		Updates internal frequency variables	HP 856xE	available
PH_LMT_L		Apply limits to PH_FMIN and PH_FMAX	HP 856xE	available
PH_MEAS		Generates log frequency plot	HP 856xE	available
PH_MKF_D		Updates the spot frequency	HP 856xE	available

## GPIB Commands of HP Models 856xE, 8566A/B, 8568A/B and 8594E

Command	Supported subset	Function	Corresp. HP-Models	Status
PH_RMS		Requests the rms phase noise	HP 856xE	available
PH_RMSFT		Updates internal frequency variables	HP 856xE	available
PH_RMSX		Calculates the rms phase noise	HP 856xE	available
PH_SPOTF		Executes the spot frequency measurement	HP 856xE	available
PLOTORG <sup>2)</sup>	PLOTORG DSP GRT	Plot command	HP 856xE/ HP 8566B/ HP 8568B/ HP 8594E	available
PLOTSRC <sup>2)</sup>	PLOTSRC ANNT GRT  TRB  TRA ALLDSP GRT	Plot command	HP 856xE/ HP 8566B/ HP 8568B/ HP 8594E	available
PP	PP	Preselector Peaking	HP 8566A/ HP 8568A	available
PRINT <sup>1)</sup>	PRINT PRINT 1 0	Hardcopy	HP 856xE/ HP 8566B/ HP 8568B/ HP 8594E	available
PSDAC <sup>2)</sup>	PSDAC <numeric_value> PSDAC UP DN	Preselector DAC value	HP 856xE/ HP 8566B/ HP 8568B/ HP 8594E	available
PSTATE <sup>2)</sup>	PSTATE ON OFF 1 0	Protect State	HP 856xE/ HP 8566B/ HP 8568B/ HP 8594E	available
PU	PU	Pen Up	HP 8566A/ HP 8568A	available
PWRBW	PWRBW	Power Bandwidth	HP 8566B/ HP 859x/ HP 856xE	available
R1	R1	Set Status Bit Enable	HP 8566A/ HP 8568A	available
R2	R2	Set Status Bit Enable	HP 8566A/ HP 8568A	available

## GPIB Commands of HP Models 856xE, 8566A/B, 8568A/B and 8594E

Command	Supported subset	Function	Corresp. HP-Models	Status
R3	R3	Set Status Bit Enable	HP 8566A/ HP 8568A	available
R4	R4	Set Status Bit Enable	HP 8566A/ HP 8568A	available
RB	RB <numeric_value> HZ KHZ MHZ GHZ RB DN RB UP RB AUTO RB?	Resolution Bandwidth	HP 856xE/ HP 8566B/ HP 8568B/ HP 8594E	available
RBR	RBR <numeric_value> RBR DN RBR UP RBR?	Resolution Bandwidth Ratio	HP 856xE/ HP 8566B/ HP 8568B/ HP 8594E	available
RC1...6	RC1...6	Recall Last State	HP 8566A/ HP 8568A	available
RCLS	RCLS <numeric_value>	Recall State Register	HP 856xE/ HP 8566B/ HP 8568B/ HP 8594E	available
RCLT	RCLT TRA TRB, <number>	Recall Trace	HP856xE/ HP8594E	available
RESET	RESET	Instrument preset	HP 856xE/ HP 8566B/ HP 8568B/ HP 8594E	available
REV	REV REV?	Firmware revision	HP 856xE/ HP 8566B/ HP 8568B/ HP 8594E	available
RL	RL <numeric_value> DB DM RL DN RL UP RL?	Reference Level	HP 856xE/ HP 8566B/ HP 8568B/ HP 8594E	available
RLCAL	RLCAL <numeric_value> RL?	Reference Level Calibration	HP 856xE/ HP 8566B/ HP 8568B/ HP 8594E	available

## GPIB Commands of HP Models 856xE, 8566A/B, 8568A/B and 8594E

Command	Supported subset	Function	Corresp. HP-Models	Status
RCLOSCAL	RCLOSCAL	Recall Open/Short Average	HP 856xE/ HP 8594E	not available
RCLTHRU	RCLTHRU	Recall Thru	HP 856xE/ HP 8594E	not available
RLPOS <sup>1)</sup>	RLPOS <numeric_value> RLPOS DN RLPOS UP RLPOS?	Reference Level Position	HP 856xE/ HP 8566B/ HP 8568B/ HP 8594E	available
ROFFSET	ROFFSET <numeric_value> DB   DM ROFFSET?	Reference Level Offset	HP 856xE/ HP 8566B/ HP 8568B/ HP 8594E	available
RQS	RQS	Service Request Bit mask	HP 856xE/ HP 8566B/ HP 8568B/ HP 8594E	available
S1	S1	Continuous Sweep	HP 8566A/ HP 8568A	available
S2	S2	Single Sweep	HP 8566A/ HP 8568A	available
SADD		add a limit line segment	HP 856xE	available
SAVES	SAVES <numeric_value>	Save State Register	HP 856xE/ HP 8566B/ HP 8568B/ HP 8594E	available
SAVET	SAVET TRA TRB,<number>	Save Trace	HP856xE/ HP8594E	available
SDEL		delete limit line segment	HP 856xE	available
SDON		limit line segment done	HP 856xE	available
SEDI		edit limit line segment	HP 856xE	available
SMOOTH	SMOOTH TRA TRB  TRC, <number of points>	Smooth Trace	HP 856xE/ HP 8566B/ HP 8568B/ HP 8594E	available
SNGLS	SNGLS	Single Sweep	HP 856xE/ HP 8566B/ HP 8568B/ HP 8594E	available

## GPIB Commands of HP Models 856xE, 8566A/B, 8568A/B and 8594E

Command	Supported subset	Function	Corresp. HP-Models	Status
SQUELCH <sup>2)</sup>	SQUELCH <numeric_value> DM   DB SQUELCH UP DN SQUELCH ON OFF	Squelch	HP 856xE/ HP 8566B/ HP 8568B/ HP 8594E	available
SP	SP <numeric_value> HZ KHZ MHZ GHZ SP DN SP UP SP?	Span	HP 8566A/ HP 8568A/ HP 856xE/ HP 8566B/ HP 8568B/ HP 8594E	available
SRCNORM <sup>1)</sup>	SRCNORM ON OFF SRCNORM 1 0	Source Normalization	HP 856xE/ HP 8566B/ HP 8568B/ HP 8594E	not available
SRCPOFS <sup>1)</sup>	SRCPOFS <numeric_value> DB   DM SRCPOFS DN SRCPOFS UP SRCPOFS?	Source Power Offset	HP 856xE/ HP 8566B/ HP 8568B/ HP 8594E	not available
SRCPWR <sup>1)</sup>	SRCPWR <numeric_value> DB   DM SRCPWR DN SRCPWR UP SRCPWR ON SRCPWR OFF SRCPWR?	Source Power	HP 856xE/ HP 8566B/ HP 8568B/ HP 8594E	not available
SS	SS <numeric_value> HZ KHZ MHZ GHZ SS DN SS UP SS AUTO SS?	CF Step Size	HP 8566A/ HP 8568A/ HP 856xE/ HP 8566B/ HP 8568B/ HP 8594E	available
ST	ST <numeric_value> US MS SC ST DN ST UP ST AUTO ST?	Sweep Time	HP 8566A/ HP 8568A/ HP 856xE/ HP 8566B/ HP 8568B/ HP 8594E	available



## GPIB Commands of HP Models 856xE, 8566A/B, 8568A/B and 8594E

Command	Supported subset	Function	Corresp. HP-Models	Status
STB	STB	Status byte query	HP 856xE/ HP 8566B/ HP 8568B/ HP 8594E	available
STOREOPEN	STOREOPEN	Store Open	HP 856xE/ HP 8594E	not available
STORESHORT	STORESHORT	Store Short	HP 856xE/ HP 8594E	not available
STORETHRU	STORETHRU	Store Thru	HP 856xE/ HP 8594E	not available
SUB		Subtract	HP 8566B/ HP 8568B/ HP 8594E	available
SUM		sum of trace amplitudes	HP 8566B/ HP 8568B/ HP 8594E	available
SV1...6	SV1...6	Save State	HP 8566A/ HP 8568A	available
SWPCPL <sup>2)</sup>	SWPCPL SA   SR SWPCPL?	Sweep Couple	HP 856xE/ HP 8566B/ HP 8568B/ HP 8594E	available
SWPOUT <sup>2)</sup>	SWPOUT FAV FAVA  RAMP SWPOUT?	Sweep Output	HP 856xE/ HP 8566B/ HP 8568B/ HP 8594E	available
T0	T0	Threshold off	HP 8566A/ HP 8568A	available
T1	T1	Free Run Trigger	HP 8566A/ HP 8568A	available
T2 <sup>2)</sup>	T2	Line Trigger	HP 8566A/ HP 8568A	available
T3	T3	External Trigger	HP 8566A/ HP 8568A	available
T4	T4	Video Trigger	HP 8566A/ HP 8568A	available
TA	TA	Transfer A	HP 8566A/ HP 8568A	available

## GPIB Commands of HP Models 856xE, 8566A/B, 8568A/B and 8594E

Command	Supported subset	Function	Corresp. HP-Models	Status
TACL	TACL?	Returns instantaneous measurement results. See TRACe<trace #>:IMMediate:LEVel? for full description.		not available
TBCL	TBCL?			
TCCL	TCCL?			
TACR	TACR?	Returns instantaneous measurement results. See TRACe<trace #>:IMMediate:LEVel? for full description.		not available
TBCR	TBCR?			
TCCR	TCCR?			
TB	TB	Transfer B	HP 8566A/ HP 8568A	available
TDF	TDF P TDF M TDF B TDF A TDF I	Trace Data Format	HP 856xE/ HP 8566B/ HP 8568B/ HP 8594E	available
TH	TH <numeric_value> DB DM TH DN TH UP TH ON TH OFF TH AUTO TH?	Threshold	HP 856xE/ HP 8566B/ HP 8568B/ HP 8594E	available
THE	THE ON  OFF	Threshold Line enable	HP 856xE/ HP 8566B/ HP 8568B/ HP 8594E	available
TIMEDSP <sup>1)</sup>	TIMEDSP ON OFF TIMEDSP 1 0 TIMEDSP?	Time Display	HP 856xE/ HP 8566B/ HP 8568B/ HP 8594E	available
TM	TM FREE VID EXT  LINE <sup>2)</sup> TM?	Trigger Mode	HP 856xE/ HP 8566B/ HP 8568B/ HP 8594E	available
TM LINE <sup>2)</sup>	TM LINE	Trigger Line	HP 8566B	available

## GPIB Commands of HP Models 856xE, 8566A/B, 8568A/B and 8594E

Command	Supported subset	Function	Corresp. HP-Models	Status
TRA	TRA B TRA A TRA I	Transfer A	HP 856xE/ HP 8566B/ HP 8568B/ HP 8594E	available
TRB	TRB B TRB A TRB I	Transfer B	HP 856xE/ HP 8566B/ HP 8568B/ HP 8594E	available
TRSTAT	TRSTAT?	Trace State Query	HP 856xE/ HP 8566B/ HP 8568B/ HP 8594E	available
TS	TS	Take Sweep	HP 856xE/ HP 8566B/ HP 8568B/ HP 8594E	available
UR <sup>2)</sup>	UR	Plot Command	HP 8566A/ HP 8568A	available
VARDEF	VARDEF	Variable definition, arrays are not supported	HP 8566B/ HP 8568B/ HP 8594E	available
VAVG	VAVG VAVG TRA TRB TRC	Video Averaging	HP 856xE/ HP 8566B/ HP 8568B/ HP 8594E	available
VB	VB <numeric_value> HZ KHZ MHZ GHZ VB DN VB UP VB AUTO VB?	Video Bandwidth	HP 856xE/ HP 8566B/ HP 8568B/ HP 8594E	available
VBR <sup>1)</sup>	VBR <numeric_value> VBR DN VBR UP VBR?	Video Bandwidth Ratio	HP 856xE/ HP 8566B/ HP 8568B/ HP 8594E	available
VIEW	VIEW TRA TRB TRC		HP 856xE/ HP 8566B/ HP 8568B/ HP 8594E	available

Command	Supported subset	Function	Corresp. HP-Models	Status
VTL	VTL <numeric_value> DB DM VTL DN VTL UP VTL?	Video Trigger Level	HP 856xE/ HP 8594E	not available
1) HP 8594E only				
2) Command is accepted without error message, but is ignored				

### 11.18.3 Special Features of the Syntax Parsing Algorithms for 8566A and 8568A Models

The command syntax is very different for models A and B. Different names are assigned to identical instrument functions, and the command structure likewise differs considerably between models A and models B.

The command structure for models A is as follows:

```
<command> ::= <command
code> [<SPC>] [<data> | <step>] [<SPC>] [<delimiter>] [<command
code>] ... <delimiter>
```

```
<data> ::= <Value> [<SPC>] [<units
code>] [<SPC>] [<delimiter>] [<SPC>] [<data>] ...
```

```
<step> ::= UP | DN
```

where

<command code> = see Table "Supported Commands"

<Value> = integer or floating-point numerical value

<units code> = DM | -DM | DB | HZ | KZ | MZ | GZ | MV | UV | SC | MS | US

<delimiter> = <CR> | <LF> | <, > | <; > | <ETX>

<SPC> = 32<sub>10</sub>

<ETX> = 3<sub>10</sub>

Command sections given in [ ] are optional.

The R&S ESRP GPIB hardware differs from that used in the HP analyzers. Therefore, the following constraint exists:

<LF> | <EOI> are still used as delimiters since the GPIB hardware is able to identify them. The other delimiters are identified and evaluated during syntax analysis.

### 11.18.4 Special Behavior of Commands

Command	Known Differences
ABORT	Does not automatically set the command complete bit (bit 4) in the status byte. An additional DONE is required for that purpose.
ANNOT	Only frequency axis annotation is affected.
AT	AT DN/UP: Step size
CAL	The CAL commands do not automatically set the command complete bit (bit 4) in the status byte. An additional DONE command is required for that purpose.
CF	Default value, range, step size
CR	Default ratio Span/RBW
CT	Formula for coupled sweep time
CV	Default ratio RBW/VBW
DET	DET? returns SAMP instead of SMP on the R&S ESRP. DET not automatically set the command complete bit (bit 4) in the status byte. An additional DONE is required for that purpose.
ERR?	Deletes the error bit in the status register but always returns a '0' in response.
FA	Default value, range, step size
FB	Default value, range, step size
ID	
M2	Default value, range, step size
M3	Default value, range, step size
MKACT	Only marker 1 is supported as the active marker.
MKBW	Default value
MKPT	Step size
MKPX	Step size
OL?	Storage of instrument settings: 80 characters are returned as information on the instrument settings. The contents of the 80 characters returned does not correspond to the original data contents of the 8566A/8568A family.
OL	Readout of instrument settings: The 80 characters read by means of OL? are accepted as information on the corresponding instrument settings. The contents of the 80 characters read does not correspond to the original data contents of the 8566A/8568A family.
RB	Default value, range, step size
RL	Default value, step size

Command	Known Differences
RLPOS	Adapts the position of the reference level even if the tracking generator normalization is not active.
RQS	Supported bits: 1 (Units key pressed) 2 (End of Sweep) 3 (Device error) 4 (Command complete) 5 (Illegal command)

### 11.18.5 Model-Dependent Default Settings

If the GPIB language is switched over to an 85xx model, the GPIB address is automatically switched over to 18 provided that the default address of the R&S ESRP (20) is still set. If a different value is set, this value is maintained. Upon return to SCPI, this address remains unchanged.

The following table shows the default settings obtained after a change of the GPIB language and for the commands IP, KST and RESET:

Model	# of Trace Points	Start Freq.	Stop Freq.	Ref Level	Input Coupling
8566A/B	1001	2 GHz	22 GHz	0 dBm	AC
8568A/B	1001	0 Hz	1.5 GHz	0 dBm	AC
8560E	601	0 Hz	2.9 GHz	0 dBm	AC
8561E	601	0 Hz	6.5 GHz	0 dBm	AC
8562E	601	0 Hz	13.2 GHz	0 dBm	AC
8563E	601	0 Hz	26.5 GHz	0 dBm	AC
8564E	601	0 Hz	40 GHz	0 dBm	AC
8565E	601	0 Hz	50 GHz	0 dBm	AC
8594E	401	0 Hz	3 GHz	0 dBm	AC



#### Stop frequency

The stop frequency given in the table may be limited to the corresponding frequency range of the R&S ESRP.

Command LF sets the stop frequency for 8566A/B to a maximum value of 2 GHz.

#### Test points (trace points)

The number of trace points is switched over only upon transition to the REMOTE state.

### 11.18.6 Data Output Formats

In the case of the SCPI and IEEE488.2 standards, the output formats for numerical data are flexible to a large extent. The output format for the HP units, by contrast, is accurately defined with respect to the number of digits. The memory areas for reading instrument data have therefore been adapted accordingly in the remote-control programs for instruments of this series.

Therefore, in response to a query, the R&S ESRP returns data of the same structure as that used by the original instruments; this applies in particular to the number of characters returned.

Two formats are currently supported when trace data is output: Display Units (command O1) and physical values (command O2, O3 or TDF P). As to the "Display Units" format, the level data of the R&S ESRP is converted to match the value range and the resolution of the 8566/8568 series. Upon transition to the **REMOTE** state, the R&S ESRP is reconfigured such that the number of test points (trace points) corresponds to that of the 85xx families (1001 for 8566A/B and 8568A/B, 601 for 8560E to 8565E, 401 for 8594E).

### 11.18.7 Trace Data Output Formats

All formats are supported for trace data output: display units (command O1), display units in two byte binary data (command O2 or TDF B and MDS W), display units in one byte binary data (command O4 or TDF B and MDS B) and physical values (commands O3 or TDF P). With format "display units" the level data is converted into value range and resolution of the 8566/8568 models. On transition to REMOTE state the number of trace points are reconfigured in order to be conform to the selected instrument model (1001 for 8566A/B and 8568 A/B, 601 for 8560E to 8565E, 401 for 8594E).

### 11.18.8 Trace Data Input Formats

Trace data input is only supported for binary date (TDF B, TDF A, TDF I, MDS W, MDS B).

### 11.18.9 GPIB Status Reporting

The assignment of status bits by commands R1, R2, R3, R4, RQS is supported.

The STB command and the serial poll respond with an 8-bit value with the following assignment:

Bit enabled by RQS	Description
0	not used (value 0)
1	Units key pressed
2	End of Sweep

Bit enabled by RQS	Description
3	Device Error
4	Command Complete
5	Illegal Command
6	Service Request
7	not used (value 0)

Bits 0 and 7 are not used and always have the value 0.

Please note that the R&S ESRP reports any key pressed on the front panel rather than only the unit keys if bit 1 was enabled.

Another difference is the behavior of bit 6 when using the STB? query. On the HP analyzers this bit monitors the state of the SRQ line on the bus. On the R&S ESRP this is not possible. Therefore this bit is set, as soon as one of the bits 1 to 5 is set. It won't be reset by performing a serial poll.



## 12 Maintenance

The following chapter contains information on the maintenance of the R&S ESRP. The instrument does not need a periodic maintenance. What is necessary is essentially the cleaning of the instrument. However, it is recommended to check the rated data from time to time.

Follow the instructions in the service manual and the safety instructions when exchanging modules or ordering spares. The order no. for spare parts is included in the service manual. The service manual includes further information particularly on troubleshooting, repair, exchange of modules (including battery exchange, adjustment of the OCXO oscillator) and alignment.

The address of our support center and a list of all Rohde & Schwarz service centers can be found at the beginning of this manual.

### 12.1 Cleaning

---

**⚠ WARNING****Risk of electric shock**

If moisture enters the casing, for example if you clean the instrument using a moist cloth, contact with the instrument can lead to electric shock. Before cleaning the instrument other than with a dry cloth, make sure that the instrument is switched off and disconnected from all power supplies.

---

**NOTICE****Instrument damage caused by cleaning agents**

Cleaning agents contain substances such as solvents (thinners, acetone, etc.), acids, bases, or other substances. Solvents can damage the front panel labeling, plastic parts, or screens, for example.

Never use cleaning agents to clean the outside of the instrument. Use a soft, dry, lint-free dust cloth instead.

---

**NOTICE****Risk of instrument damage due to obstructed fans**

If the instrument is operated in dusty areas, the fans become obstructed by dust or other particles over time. Check and clean the fans regularly to ensure that they always operate properly. If the instrument is run with obstructed fans for a longer period, the instrument overheats, which can disturb the operation and even cause damage.

---

1. Clean the outside of the instrument using a soft, dry, lint-free dust cloth.
2. Check and clean the fans regularly to ensure that they always operate properly.
3. Clean the touchscreen as follows:
  - a) Apply a small amount of standard screen cleaner to a soft cloth.
  - b) Wipe the screen gently with the moist, but not wet, cloth.
  - c) If necessary, remove any excess moisture with a dry, soft cloth.

## 12.2 Storing and Packing

The storage temperature range of the instrument is given in the data sheet. If the instrument is to be stored for a longer period of time, it must be protected against dust.

Repack the instrument as it was originally packed when transporting or shipping. The two protective foam plastic parts prevent the control elements and connectors from being damaged. The antistatic packing foil avoids any undesired electrostatic charging to occur.

If you do not use the original packaging, provide for sufficient padding to prevent the instrument from slipping inside the package. Wrap antistatic packing foil around the instrument to protect it from electrostatic charging.

## 12.3 List of Available Power Cables

*Table 12-1: List of power cables available*

Stock No.	Earthed-contact connector	Preferably used in
DS 006.7013.00	BS1363: 1967' complying with IEC 83: 1975 standard B2	Great Britain
DS 006.7020.00	Type 12 complying with SEV-regulation 1011.1059, standard sheet S 24 507	Switzerland
DS 006.7036.00	Type 498/13 complying with US-regulation UL 498, or with IEC 83	USA/Canada
DS 006.7107.00	Type SAA3 10 A, 250 V, complying with AS C112-1964 Ap.	Australia
DS 0025.2365.00	DIN 49 441, 10 A, 250 V, angular	Europe (except Switzerland)
DS 0099.1456.00	DIN 49 441, 10 A, 250 V, straight	

## 13 Error Messages

Error messages are entered in the error/event queue of the status reporting system in the remote control mode and can be queried with the command `SYSTem:ERRor?`. The answer format of R&S ESRP to the command is as follows:

```
<error code>, "<error text with queue query>;
<remote control command concerned>"
```

The indication of the remote control command with prefixed semicolon is optional.

Example:

The command `"TEST:COMMAND"` generates the following answer to the query `SYSTem:ERRor?`

```
-113, "Undefined header;TEST:COMMAND"
```

There are two types of error messages:

- Error messages defined by SCPI are marked by negative error codes. These messages are defined and described in the SCPI standard and not listed here.
- Device-specific error messages use positive error codes. These messages are listed below.

The right-hand column in the following tables contains the error text in bold which is entered in the error/event queue and can be read out by means of query `SYSTem:ERRor?`. A short explanation of the error cause is given. The left-hand column contains the associated error code.

Additionally, option-specific warnings and error messages displayed in the status bar are explained.

**Table 13-1: Device-specific error messages**

Error code	Error text in the case of queue poll Error explanation
1052	<b>Frontend LO is Unlocked</b> This message is displayed when the phase regulation of the local oscillator fails in the RF front-end.
1060	Trigger-Block Gate Delay Error- gate length < Gate Delay This message is displayed when the gate signal length is not sufficient for the pull-in delay with a predefined gate delay.
1064	<b>Tracking LO is Unlocked</b> This message is displayed when the phase regulation of the local oscillator fails on the tracking generator module.
2028	<b>Hardcopy not possible during measurement sequence</b> This message is displayed when a printout is started during scan sequences that cannot be interrupted. Such sequences are for example: <ul style="list-style-type: none"> <li>• Recording the system error correction data (alignment)</li> <li>• Instrument self test</li> </ul> In such cases synchronization to the end of the scan sequence should be performed prior to starting the printout.

Error code	Error text in the case of queue poll Error explanation
2033	<b>Printer Not Available</b> This message is displayed when the selected printer is not included in the list of available output devices. A possible cause is that the required printer driver is missing or incorrectly installed.
2034	<b>CPU Temperature is too high</b> This message is displayed when the temperature of the processor exceeds 70 °C.

## 14 Appendix: LAN Interface

In this appendix, additional information on the LAN interface is given. How to connect the instrument to the network and configure the network protocols is described in [Chapter 11.2.5, "Setting Up a Network \(LAN\) Connection"](#), on page 592.



### Network restrictions and entering passwords

Only user accounts with administrator rights can configure LAN networks. For details see [Chapter 3.2.5.3, "Login"](#), on page 54.

In some of the following step-by-step instructions, user names and passwords must be entered. This requires using the touchscreen and the on-screen keyboard, or a mouse and an external keyboard (see [Chapter 3.4, "Basic Operations"](#), on page 60 and [Chapter 3.2.2, "Connecting USB Devices"](#), on page 44.

- [Configuring the Network](#)..... 1042
- [Operation with Windows Remote Desktop](#) ..... 1049
- [Operation with a VNC Client](#)..... 1053
- [Starting and Terminating Remote Operation](#)..... 1054
- [Deactivating the R&S ESRP via Remote Operation](#)..... 1055

### 14.1 Configuring the Network

After network support has been installed, data can be exchanged between the instrument and other computers, and network printers can be used.

Network operation is only possible if you are authorized to access network resources. Typical resources are file directories of other computers or even central printers. Authorization is assigned by the network or server administrator.

#### **WARNING**

##### Connection to networks

Before connecting the instrument to the network or configuring the network, consult your network administrator, particularly for large LAN installations. Errors may affect the entire network.

Never connect your analyzer to a network unprotected against virus infection because this may cause damage to the instrument software.

To integrate the instrument into your network, you can change the following system properties:

- Computer name
- Domain
- Workgroup

Operation on the network includes the following administrative tasks:

• <a href="#">Changing the Computer Name</a> .....	1043
• <a href="#">Changing the Domain or Workgroup</a> .....	1043
• <a href="#">Operating the Instrument Without a Network</a> .....	1044
• <a href="#">Creating Users</a> .....	1045
• <a href="#">Changing the User Password</a> .....	1045
• <a href="#">Logging on to the Network</a> .....	1045
• <a href="#">Automatic Login Function</a> .....	1046
• <a href="#">Mapping Network Drives</a> .....	1047
• <a href="#">Sharing Directories (only with Microsoft Networks)</a> .....	1048

### 14.1.1 Changing the Computer Name

1. Press the [SETUP] function key on the front panel of the R&S ESRP.
2. Press the "General Setup" softkey.
3. Press the "Network Address" softkey.  
The submenu is displayed.
4. Press the "Computer Name" softkey and enter the computer name.
5. If you enter an invalid name, the error "message out of range" is displayed in the status line. The edit dialog box remains open, and you can start again.  
If the settings are correct, the configuration is saved, and you are prompted to restart the instrument.
6. Confirm the displayed message ("Yes" button) to restart the instrument.

### 14.1.2 Changing the Domain or Workgroup



#### Changing settings

Before you change other settings than described here, contact your network administrator.

1. Press the "Windows" key on the external keyboard or the [CTRL + ESC] key combination on your keyboard to access the operating system.
2. Select "Start > Settings > System > About > Rename PC".

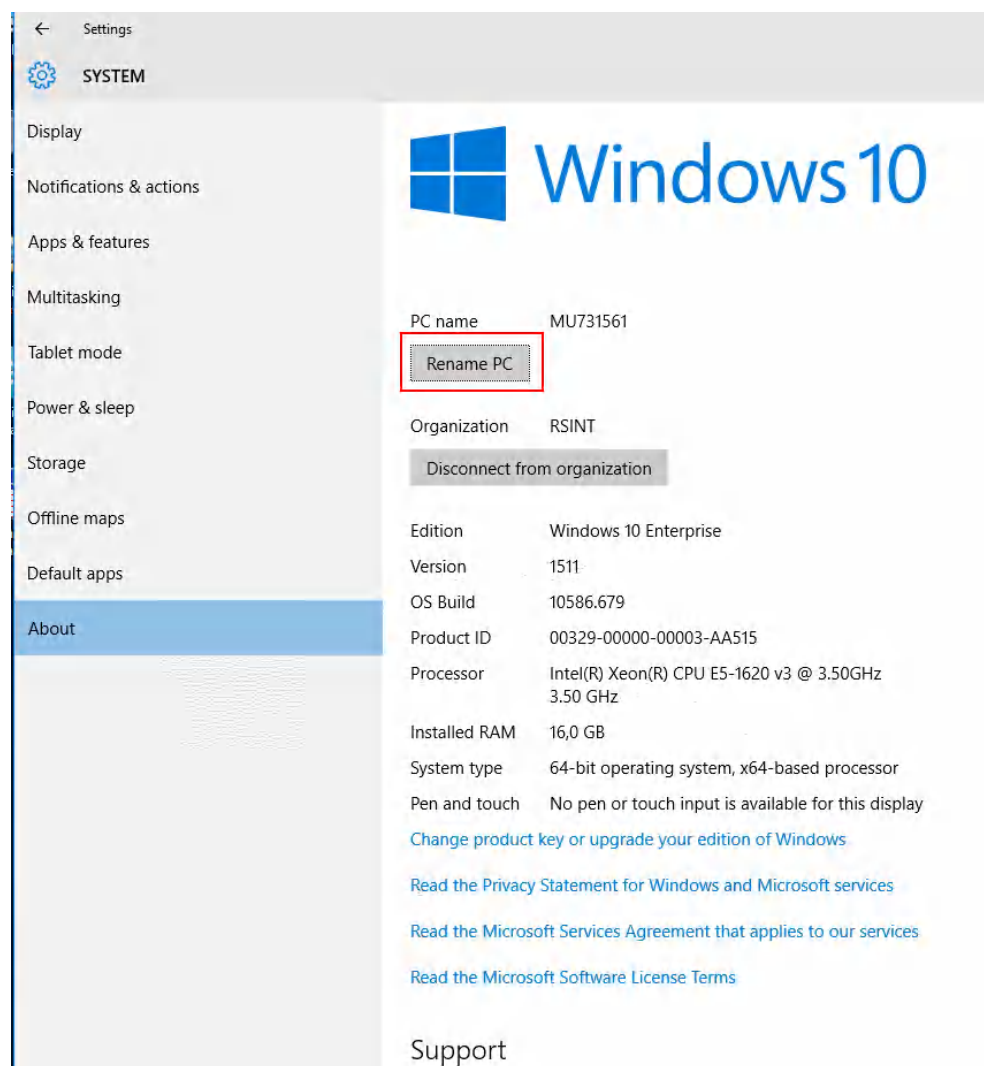

3. Select "Change..."  
The dialog box for computer name and domain changes is displayed.
4. Enter a "Domain" or "Workgroup."
5. Confirm the changes with "OK".
6. Confirm the prompt to restart the instrument.

### 14.1.3 Operating the Instrument Without a Network

To operate the instrument without a network connection either temporarily or permanently, no special measures are necessary. Windows automatically detects the interruption of the network connection and does not set up the connection when the instrument is switched on.

If you are not prompted to enter the user name and password, see "[Automatic Login Function](#)" on page 55.

#### 14.1.4 Creating Users

After the software for the network has been installed, the instrument issues an error message the next time it is switched on because there is no user named "instrument" (= user ID for Windows automatic login) in the network. Thus, a matching user must be created in Windows and in the network, the password must be adapted to the network password, and the automatic login mechanism must then be deactivated.

The network administrator is responsible for creating new users in the network.

1. Press the "Windows" key on the external keyboard or the [CTRL + ESC] key combination on your keyboard to access the operating system.
2. Select "Start > Settings > Accounts > Other users".
3. Select "Add someone else to this PC".
4. In the "Microsoft account" dialog box, enter the new user name and password.
5. Select "OK".
6. Select "Finish".  
The new user is created.

#### 14.1.5 Changing the User Password

After the new user has been created on the instrument, the password must be adapted to the network password.

1. Press the "Windows" key on the external keyboard or the [CTRL + ESC] key combination on your keyboard to access the operating system.
2. Press [Ctrl + Alt + Delete], then select "Change a password".
3. Enter the user account name.
4. Enter the old password.
5. Enter the new password in the upper text line and repeat it in the following line.
6. Press [Enter].  
The new password is now active.

#### 14.1.6 Logging on to the Network

At the same time you log on to the operating system, you are automatically logged on to the network. As a prerequisite, the user name and the password must be identical under Windows and on the network.



## 14.1.7 Automatic Login Function

When shipped, the instrument automatically logs on the default "Instrument" user to Windows 7 using the default password.

### Switching users when using the automatic login function

Which user account is used is defined during login. If automatic login is active, the login window is not displayed. However, you can also switch the user account to be used when the automatic login function is active.



1. Press the "Windows" key or the [CTRL + ESC] key combination on your keyboard to access the operating system of the R&S ESRP (see also [Chapter 3.2.5.4, "Accessing the Start Menu"](#), on page 56).
2. Press [CTRL + ALT + DEL], then select "Sign out".  
The "Login" dialog box is displayed, in which you can enter the different user account name and password.

### Deactivating the automatic login function

To deactivate the automatic login function, perform the following steps:



1. Press the "Windows" key or the [CTRL + ESC] key combination on your keyboard to access the operating system of the R&S ESRP (see also [Chapter 3.2.5.4, "Accessing the Start Menu"](#), on page 56).
2. In the "Start" menu, select "All applications > Windows System > Run".  
The "Run" dialog box is displayed.
3. Enter the command `C:\R_S\INSTR\USER\NO_AUTOLOGIN.REG`.
4. Press the [ENTER] key to confirm.  
This command deactivates the automatic login function. The next time you switch on the instrument, the operating system prompts you to enter your user name and password before it starts the firmware.

### Adapting the automatic login function to a new password

If you change the "Instrument" user's password, which is used during automatic login, this function no longer works. Adapt the settings for the command that activates the auto login function first.

1. Open the `C:\R_S\INSTR\USER\NO_AUTOLOGIN.REG` file in any text editor (e.g. Notepad).
2. In the line `"DefaultPassword"="894129"`, replace the default password (894129) by the new password for automatic login.
3. Save the changes to the file.

### Reactivating the automatic login function



1. Press the "Windows" key or the [CTRL + ESC] key combination on your keyboard to access the operating system of the R&S ESRP (see also [Chapter 3.2.5.4, "Accessing the Start Menu"](#), on page 56).
2. In the "Start" menu, select "All applications > Windows System > Run". The "Run" dialog box is displayed.
3. Enter the command `C:\R_S\INSTR\USER\AUTOLOGIN.REG`.
4. Press the [ENTER] key to confirm. This command reactivates automatic login function. It is active the next time the instrument reboots.

### 14.1.8 Mapping Network Drives

1. Press the [SAVE/ RCL] key on the front panel of the R&S ESRP.
2. Press the "File Manager" softkey.
3. Press the "More" softkey.
4. Press the "Network Drive" softkey. The "Map Network Drive" dialog box is displayed.

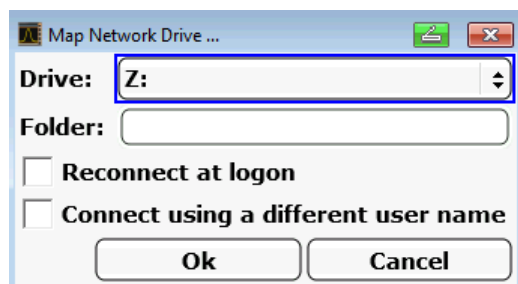

5. Press the "Drive" list to open the network drive list and select the drive you want to map. Alternatively:
  - Press the "Map Network Drive" softkey to set the focus on the "Drive" list.
  - Press [ENTER] to open the network drive list and select the drive you want to map using the arrow keys.
6. To have the connection set up automatically each time the instrument is started, in the "Map Network Drive" dialog box, activate the "Reconnect at logon" option.
7. To connect using a different user name, activate the "Connect using a different user name" option. The "Map Network Drive" dialog box is extended by the "User name" and "Password" fields.

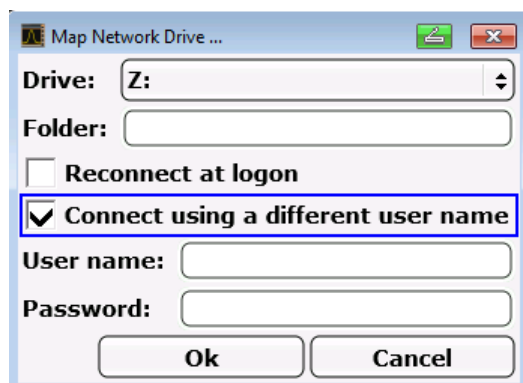

8. Enter your user name and password.
  9. Confirm with "OK".  
The drive is displayed in the Explorer.
- Note:** Only networks that you authorized to access are connected.

#### Disconnecting network drives

1. Press the [SAVE/ RCL] key on the front panel of the R&S ESRP.
2. Press the "File Manager" softkey.
3. Press the "More" softkey.
4. Press the "Network Drive" softkey.
5. Press the "Disconnect Network Drive" softkey.  
The "Disconnect Network Drive" dialog box is displayed.
6. In the "Drive" list, select the drive you want to disconnect.
7. Confirm with "OK".

### 14.1.9 Sharing Directories (only with Microsoft Networks)

Sharing directories makes data available for other users. This is only possible in Microsoft networks. Sharing is a property of a file or directory.

1. Press the "Windows" key on the external keyboard or the [CTRL + ESC] key combination on your keyboard to access the operating system.
2. Open the "Windows Explorer".
3. Select the desired folder with the right mouse button.
4. In the context menu, select "Share with > Specific people".
5. Select the users on your network you want to allow access to the directory to.
6. Select "Share" to confirm the settings.

7. Select "Done" to close the dialog box.  
The drive is shared and can be accessed by the selected users.

## 14.2 Operation with Windows Remote Desktop

In production test and measurement, a common requirement is central monitoring of the T&M instruments for remote maintenance and remote diagnostics. Equipped with the Windows Remote Desktop software, the R&S ESRP ideally meets requirements for use in production. (The computer that is used for remote operation is called "controller" here.)

- Access to the control functions via a virtual front panel (soft front panel)
- Printout of measurement results directly from the controller
- Storage of measured data on the controller's hard disk

The R&S ESRP is connected via a LAN, in which case the Windows operating system also supports a connection via a modem. This section describes the configuration of the R&S ESRP and the Remote Desktop Client of the controller. Details on how to set up a modem connection are described in the Windows documentation.

### 14.2.1 Configuring the R&S ESRP for Remote Operation



To avoid problems, use a fixed IP address.

When a DHCP server is used, a new IP address is assigned each time the instrument is restarted. This address must first be determined on the instrument itself. Thus, using a DHCP server is not suitable for remote operation of the R&S ESRP via Remote Desktop.



With the factory settings, the default "instrument" user can connect to the R&S ESRP with the Remote Desktop program of the controller immediately. No further configuration is required. However, if the connection fails or other users need to connect, this section provides basic instructions on setting up the Remote Desktop for the R&S ESRP.

1. Press the "Windows" key on the external keyboard or the [CTRL + ESC] key combination on your keyboard to access the operating system.
2. In the Windows "Start" menu, select "Settings > System".
3. Search for "remote access".
4. Select "Allow remote access to your computer".
5. Define which users are to be given access to the R&S ESRP via Remote Desktop.  
**Note:** The user account under which configuration is carried out is automatically enabled for Remote Desktop.

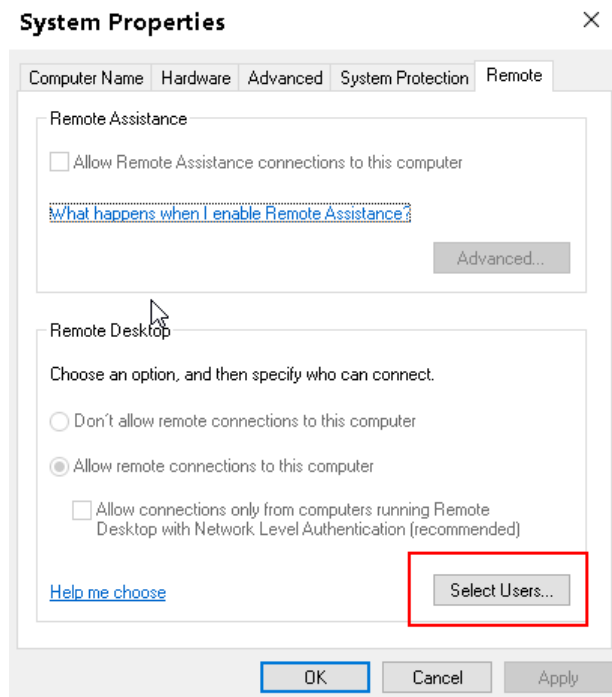

- a) Select the "Select Users" button.
  - b) Select the users or create new user accounts as described in [Chapter 14.1.4, "Creating Users"](#), on page 1045.
  - c) Select "OK" to confirm the settings.
6. The R&S ESRP is now ready for connection setup with the Remote Desktop program of the controller.

## 14.2.2 Configuring the Controller



### Remote Desktop Client

The Windows Remote Desktop Client is part of the operating system and can be accessed via "Start > All Applications > Windows Accessories > Remote Desktop Connection".

1. Press the "Windows" key on the external keyboard or the [CTRL + ESC] key combination on your keyboard to access the operating system.
2. From the "Start" menu, select "All Programs > Accessories > Remote Desktop Connection".  
The "Remote Desktop Connection" dialog box is displayed.
3. Select the "Options >>" button.  
The dialog box is expanded to display the configuration data.



4. Open the "Experience" tab.  
The settings on this tab are used to select and optimize the connection speed.
5. In the list, select the appropriate connection (for example: LAN (10 Mbps or higher)).  
Depending on your selection (and how powerful the connection is), the options are activated or deactivated.
6. To improve the performance, you can deactivate the "Desktop background", "Show contents of window while dragging" and "Menu and window animation" options.
7. Open the "Local Resources" tab for enabling printers, local drives and serial interfaces.
8. If you will need to access drives of the controller from the R&S ESRP (e.g. in order to store settings or to copy files from the controller to the R&S ESRP), select "More", then enable the "Drives" option.

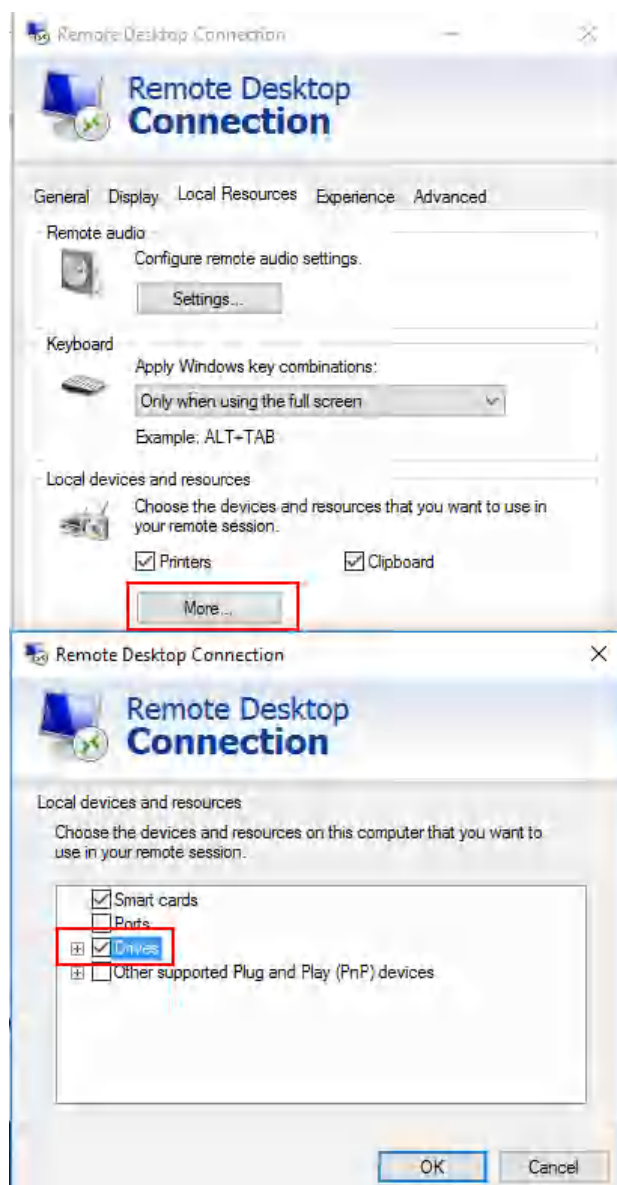

Windows will then map drives of the controller to the corresponding network drives.

9. To use printers connected to the controller while accessing them from the R&S ESRP, activate the "Printers" option. Do not change the remaining settings.
10. Open the "Display" tab.  
The options for configuring the R&S ESRP screen display are displayed.
11. Under "Remote desktop size", you can set the size of the R&S ESRP window on the desktop of the controller.
12. Under "Colors", do not change the settings.
13. Set the "Display the connection bar when I use the full screen" option:

- If activated, a bar showing the network address of the R&S ESRP will appear at the top edge of the screen. You can use this bar to reduce, minimize or close the window.
- If deactivated, the only way you can return to the controller desktop from the R&S ESRP screen in full screen mode is to select "Disconnect" from the "Start" menu.

## 14.3 Operation with a VNC Client

Virtual Network Computing (VNC) allows you to control the R&S ESRP (the VNC server) from a remote computer (the VNC client), for example to monitor the instruments in a production line. The handling of a VNC system is similar to using the Windows Remote Desktop, but VNC has some advantages compared to the Remote Desktop.

- You can view the contents of the instrument display on more than one client
- VNC clients are available for many operating systems. Thus, a VNC is independent of the platform you are using.
- You can still control the instrument itself when a remote connection has been established, and see what is happening on both the instrument display and the client. With the display running, you can also change settings both on the instrument and with the client simultaneously. (Using the Remote Desktop turns off the display and viewing the display contents is only possible on the controlling computer.)
- The complete mini soft front panel is available on the client ("Alt-M" opens the mini soft front panel).

All R&S ESRP instruments support a VNC and are delivered with a version of the TightVNC software. On the client side, you can use a web browser or a VNC client to access the instrument.

### Using a web browser

If you are using a web browser (for example Microsoft Internet Explorer), enter the IP address of the instrument and the port you are using for the connection into the address bar to establish a connection (for example "192.0.2.0:5800").

The browser then opens an interface that allows you to control the instrument after you have entered the password.

The default port is 5800 and the default password is 894129, but you can change this on the VNC software that comes with the instrument if required.

Note that using a browser requires you to install Java in order to run properly.

### Using a VNC client

Alternatively, you can install a VNC client on your computer (for example a program like TightVNC) and use that to access the instrument. In that case, start the client and enter the IP address of the instrument to establish a connection.



## 14.4 Starting and Terminating Remote Operation

### Setting up a connection to the R&S ESRP

1. In the "Remote Desktop Connection" dialog box (see [Chapter 14.2, "Operation with Windows Remote Desktop"](#), on page 1049), open the "General" tab.
2. In the "Computer" field, enter the IP address of the R&S ESRP.  
In the "User name" field, enter *instrument* to log in as an administrator, or *Normal User* to log in as a standard user.  
In the "Password" field, enter *894129*.
3. To save the connection configuration for later use:
  - a) Select the "Save As" button.  
The "Save As" dialog box is displayed.
  - b) Enter the name for the connection information (\*.RDP).
4. To load an existing connection configuration:
  - a) Select the "Open" button.  
The "Open" dialog box is displayed.
  - b) Select the \*.RDP file.
5. Select the "Connect" button.  
The connection is set up.
6. If the "Drives" option is activated on the "Local Resources" tab, a warning is displayed indicating that the drives are enabled for access from the R&S ESRP.  
Select "OK" to confirm the warning.
7. After a few moments, the R&S ESRP screen is displayed.  
If a dark screen appears or a dark square appears in the upper left-hand corner of the screen, you must restart the R&S ESRP in order to see the modified screen resolution.

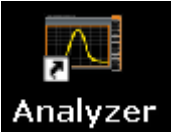
	<ul style="list-style-type: none"> <li>• Press the key combination [ALT] + [F4].</li> <li>• The R&amp;S ESRP firmware is shut down, which may take a few seconds.</li> <li>• On the desktop, double-tap the "Analyzer" icon.</li> </ul>
-------------------------------------------------------------------------------------	-----------------------------------------------------------------------------------------------------------------------------------------------------------------------------------------------------------------------------------------

The firmware restarts and then automatically opens the "Soft Front Panel", i.e. the user interface on which all front panel controls and the rotary knob are mapped to buttons.

8. To deactivate or activate the "Soft Front Panel", press the [F6] key.  
After the connection is established, the R&S ESRP screen is displayed in the "Remote Desktop" application window.

## Deactivating the R&amp;S ESRP via Remote Operation

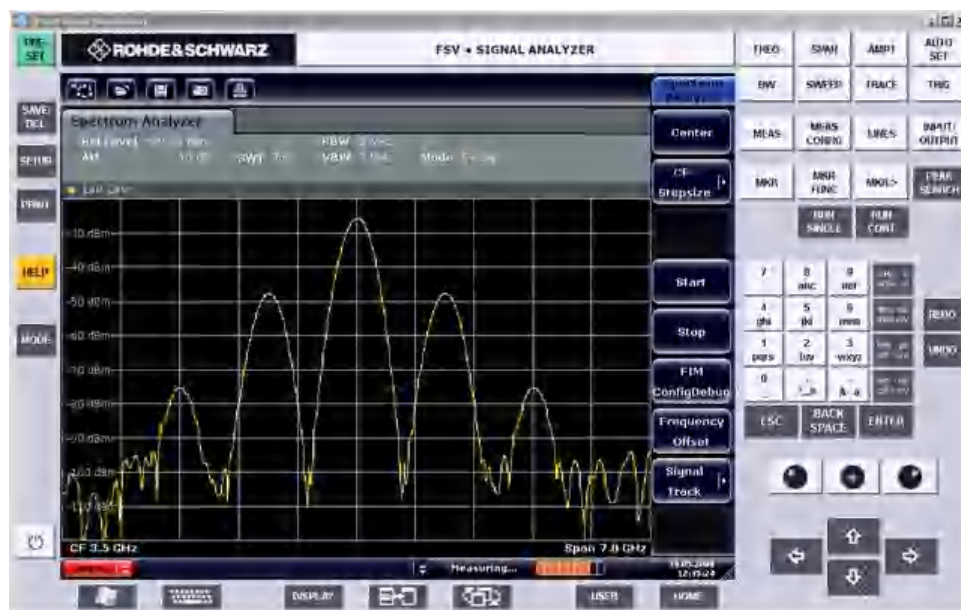

You can operate all keys and softkeys using the mouse. The rotary knob is simulated using the knob buttons.

The Windows "Start" menu can be made available by expanding the "Remote Desktop" window to full size.

During the connection with the controller, the login entry is displayed on the R&S ESRP screen.

### Terminating Remote Desktop control

The connection can be terminated by the controller or by a user at the R&S ESRP:

- ▶ ● On the controller, close the "Remote Desktop" window.  
The connection to the R&S ESRP is terminated (any time is possible).
- On the R&S ESRP, a user logs on.  
The connection to the controller is terminated as a result. A message is displayed on the controller display indicating that another user has assumed control of the instrument.

### Restoring the connection to the R&S ESRP

Follow the instructions above for setting up a connection to the R&S ESRP. If the connection is terminated and then restored, the R&S ESRP remains in the same state.

## 14.5 Deactivating the R&S ESRP via Remote Operation

1. Click the R&S ESRP soft front panel and close the application with the key combination [ALT] + [F4].

2. Click the desktop and press the key combination [ALT] + [F4] to shut down the R&S ESRP.  
A safety query is displayed to warn you that the instrument cannot be reactivated via remote operation and asks you whether you want to continue the shutdown process.
3. Respond to the safety query with "Yes".  
The connection with the controller is terminated and the R&S ESRP is shut down.

## List of Commands

[[SENSe:]SWEep:SPACing.....	647
[SENSe:][WINDow:]DETEctor<trace>[:FUNction].....	651
[SENSe:][WINDow:]DETEctor<trace>[:FUNction].....	821
[SENSe:][WINDow:]DETEctor<trace>[:FUNction]:AUTO.....	821
[SENSe:]ADJust:ALL.....	796
[SENSe:]ADJust:CONFIguration:HYSteresis:LOWer.....	796
[SENSe:]ADJust:CONFIguration:HYSteresis:UPPer.....	796
[SENSe:]ADJust:CONFIgure:LEVel:DURation.....	796
[SENSe:]ADJust:CONFIgure:LEVel:DURation:MODE.....	797
[SENSe:]ADJust:CONFIgure:TRIG.....	797
[SENSe:]ADJust:FREQuency.....	797
[SENSe:]ADJust:LEVel.....	798
[SENSe:]AVERAge<n>:COUNT.....	819
[SENSe:]AVERAge<n>:TYPE.....	820
[SENSe:]AVERAge<n>[:STATe<Trace>].....	820
[SENSe:]BANDwidth:IF.....	639
[SENSe:]BANDwidth BWIDth:VIDeo.....	799
[SENSe:]BANDwidth BWIDth:VIDeo:AUTO.....	800
[SENSe:]BANDwidth BWIDth:VIDeo:RATio.....	800
[SENSe:]BANDwidth BWIDth:VIDeo:TYPE.....	801
[SENSe:]BANDwidth BWIDth[:RESolution].....	639
[SENSe:]BANDwidth BWIDth[:RESolution]:AUTO.....	640
[SENSe:]BANDwidth BWIDth[:RESolution]:AUTO.....	798
[SENSe:]BANDwidth BWIDth[:RESolution]:FFT.....	799
[SENSe:]BANDwidth BWIDth[:RESolution]:RATio.....	799
[SENSe:]BANDwidth BWIDth[:RESolution]:TYPE.....	640
[SENSe:]CORRection:COLLect[:ACQuire].....	869
[SENSe:]CORRection:METHod.....	870
[SENSe:]CORRection:RECall.....	870
[SENSe:]CORRection:TRANsdUcer:ACTive?.....	919
[SENSe:]CORRection:TRANsdUcer:ADJust:RLEVel[:STATe].....	918
[SENSe:]CORRection:TRANsdUcer:CATalog?.....	919
[SENSe:]CORRection:TRANsdUcer:COMMeNt.....	919
[SENSe:]CORRection:TRANsdUcer:DATA.....	920
[SENSe:]CORRection:TRANsdUcer:DELeTe.....	920
[SENSe:]CORRection:TRANsdUcer:GENerator.....	875
[SENSe:]CORRection:TRANsdUcer:SCALing.....	920
[SENSe:]CORRection:TRANsdUcer:SELect.....	921
[SENSe:]CORRection:TRANsdUcer:UNIT.....	921
[SENSe:]CORRection:TRANsdUcer:VIEW.....	922
[SENSe:]CORRection:TRANsdUcer[:STATe].....	921
[SENSe:]CORRection:TSET:BReak.....	922
[SENSe:]CORRection:TSET:CATalog?.....	922
[SENSe:]CORRection:TSET:COMMeNt.....	923
[SENSe:]CORRection:TSET:DELeTe.....	923
[SENSe:]CORRection:TSET:RANGe<range>.....	923
[SENSe:]CORRection:TSET:SELect.....	924

[SENSe:]CORRection:TSET:UNIT.....	924
[SENSe:]CORRection:TSET[:STATe].....	924
[SENSe:]CORRection[:STATe].....	870
[SENSe:]DEMod.....	616
[SENSe:]DEMod:SQUelch:LEVel.....	617
[SENSe:]DEMod:SQUelch[:STATe].....	617
[SENSe:]DETEctor:RECeiver[:FUNction].....	608
[SENSe:]DETEctor<t>:FMEasurement.....	611
[SENSe:]ESPEctrum:BWID.....	739
[SENSe:]ESPEctrum:FILTer[:RRC]:ALPHa.....	739
[SENSe:]ESPEctrum:FILTer[:RRC][:STATe].....	740
[SENSe:]ESPEctrum:HighSPeed.....	730
[SENSe:]ESPEctrum:PRESet:RESToRe.....	728
[SENSe:]ESPEctrum:PRESet:STORe.....	728
[SENSe:]ESPEctrum:PRESet[:STANdard].....	728
[SENSe:]ESPEctrum:RANGe<range>:BANDwidth:VIDeo.....	731
[SENSe:]ESPEctrum:RANGe<range>:BANDwidth[:RESolution].....	731
[SENSe:]ESPEctrum:RANGe<range>:COUNt.....	732
[SENSe:]ESPEctrum:RANGe<range>:DELEte.....	732
[SENSe:]ESPEctrum:RANGe<range>:FILTer:TYPE.....	732
[SENSe:]ESPEctrum:RANGe<range>:INPut:ATTenuation.....	734
[SENSe:]ESPEctrum:RANGe<range>:INPut:ATTenuation:AUTO.....	734
[SENSe:]ESPEctrum:RANGe<range>:INPut:GAIN:STATe.....	734
[SENSe:]ESPEctrum:RANGe<range>:INSert.....	735
[SENSe:]ESPEctrum:RANGe<range>:LIMit<source>:ABSolute:START.....	735
[SENSe:]ESPEctrum:RANGe<range>:LIMit<source>:ABSolute:STOP.....	735
[SENSe:]ESPEctrum:RANGe<range>:LIMit<source>:RELative:START.....	736
[SENSe:]ESPEctrum:RANGe<range>:LIMit<source>:RELative:STOP.....	736
[SENSe:]ESPEctrum:RANGe<range>:LIMit<source>:STATe.....	737
[SENSe:]ESPEctrum:RANGe<range>:RLEVel.....	737
[SENSe:]ESPEctrum:RANGe<range>:SWEep:TIME.....	737
[SENSe:]ESPEctrum:RANGe<range>:SWEep:TIME:AUTO.....	738
[SENSe:]ESPEctrum:RANGe<range>:TRANsducer.....	738
[SENSe:]ESPEctrum:RANGe<range>[:FREQuency]:START.....	733
[SENSe:]ESPEctrum:RANGe<range>[:FREQuency]:STOP.....	733
[SENSe:]ESPEctrum:RRANGe.....	740
[SENSe:]ESPEctrum:RTYPE.....	740
[SENSe:]FMEasurement:AUTO.....	612
[SENSe:]FMEasurement:LISN:FILTer:HPAS[:STATe].....	653
[SENSe:]FMEasurement:LISN:PHASe.....	653
[SENSe:]FMEasurement:LISN[:TYPE].....	654
[SENSe:]FMEasurement:TIME.....	612
[SENSe:]FREQuency:CENTer.....	634
[SENSe:]FREQuency:CENTer.....	790
[SENSe:]FREQuency:CENTer:STEP.....	634
[SENSe:]FREQuency:CENTer:STEP:AUTO.....	791
[SENSe:]FREQuency:CENTer:STEP:LINK.....	791
[SENSe:]FREQuency:CENTer:STEP:LINK:FACTor.....	792
[SENSe:]FREQuency:MODE.....	635
[SENSe:]FREQuency:MODE.....	792

[SENSe:]FREQUency:OFFSet.....	792
[SENSe:]FREQUency:SPAN.....	793
[SENSe:]FREQUency:SPAN:FULL.....	793
[SENSe:]FREQUency:STARt.....	635
[SENSe:]FREQUency:STARt.....	793
[SENSe:]FREQUency:STOP.....	635
[SENSe:]FREQUency:STOP.....	793
[SENSe:]LIST:POWer:RESult?.....	784
[SENSe:]LIST:POWer:SET.....	787
[SENSe:]LIST:POWer:STATe.....	788
[SENSe:]LIST:POWer[:SEQuence].....	785
[SENSe:]LIST:RANGe<range>:BANDwidth:VIDeo.....	719
[SENSe:]LIST:RANGe<range>:BANDwidth[:RESolution].....	718
[SENSe:]LIST:RANGe<range>:BREak.....	719
[SENSe:]LIST:RANGe<range>:COUNt.....	719
[SENSe:]LIST:RANGe<range>:DELeTe.....	720
[SENSe:]LIST:RANGe<range>:DETEctor.....	720
[SENSe:]LIST:RANGe<range>:FILTer:TYPE.....	720
[SENSe:]LIST:RANGe<range>:INPut:ATTenuation.....	722
[SENSe:]LIST:RANGe<range>:INPut:ATTenuation:AUTO.....	722
[SENSe:]LIST:RANGe<range>:INPut:GAIN:STATe.....	722
[SENSe:]LIST:RANGe<range>:LIMit:STARt.....	723
[SENSe:]LIST:RANGe<range>:LIMit:STATe.....	723
[SENSe:]LIST:RANGe<range>:LIMit:STOP.....	724
[SENSe:]LIST:RANGe<range>:POINts.....	724
[SENSe:]LIST:RANGe<range>:RLEVel.....	724
[SENSe:]LIST:RANGe<range>:SWEep:TIME.....	725
[SENSe:]LIST:RANGe<range>:SWEep:TIME:AUTO.....	725
[SENSe:]LIST:RANGe<range>:TRANsducer.....	725
[SENSe:]LIST:RANGe<range>[:FREQUency]:STARt.....	721
[SENSe:]LIST:RANGe<range>[:FREQUency]:STOP.....	721
[SENSe:]MPOWer:FTYPE.....	780
[SENSe:]MPOWer:RESult:MIN?.....	781
[SENSe:]MPOWer:RESult[:LIST]?.....	780
[SENSe:]MPOWer[:SEQuence].....	781
[SENSe:]POWer:ACHannel:ACPairs.....	698
[SENSe:]POWer:ACHannel:BANDwidth BWIDth:ACHannel.....	698
[SENSe:]POWer:ACHannel:BANDwidth BWIDth:ALTErnatE<channel>.....	698
[SENSe:]POWer:ACHannel:BANDwidth BWIDth[:CHANnel<channel>].....	699
[SENSe:]POWer:ACHannel:FILTer:ALPHa:ACHannel.....	702
[SENSe:]POWer:ACHannel:FILTer:ALPHa:ALTErnatE<channel>.....	702
[SENSe:]POWer:ACHannel:FILTer:ALPHa:CHANnel<channel>.....	703
[SENSe:]POWer:ACHannel:FILTer:ALPHa[:ALL].....	702
[SENSe:]POWer:ACHannel:FILTer[:STATe]:ACHannel.....	703
[SENSe:]POWer:ACHannel:FILTer[:STATe]:ALL.....	704
[SENSe:]POWer:ACHannel:FILTer[:STATe]:ALTErnatE<channel>.....	703
[SENSe:]POWer:ACHannel:FILTer[:STATe]:CHANnel<channel>.....	703
[SENSe:]POWer:ACHannel:MODE.....	714
[SENSe:]POWer:ACHannel:NAME:ACHannel.....	699
[SENSe:]POWer:ACHannel:NAME:ALTErnatE<channel>.....	700

[SENSe:]POWer:ACHannel:NAME:CHANnel<channel>.....	700
[SENSe:]POWer:ACHannel:PRESet.....	693
[SENSe:]POWer:ACHannel:PRESet:RLEVel.....	694
[SENSe:]POWer:ACHannel:REFerence:AUTO ONCE.....	704
[SENSe:]POWer:ACHannel:REFerence:TXCHannel:AUTO.....	704
[SENSe:]POWer:ACHannel:REFerence:TXCHannel:MANual.....	705
[SENSe:]POWer:ACHannel:SPACing:ALTErnate<channel>.....	701
[SENSe:]POWer:ACHannel:SPACing:CHANnel<channel>.....	701
[SENSe:]POWer:ACHannel:SPACing[:ACHannel].....	700
[SENSe:]POWer:ACHannel:TXCHannel:COUNT.....	701
[SENSe:]POWer:BANDwidth BWIDth.....	717
[SENSe:]POWer:HSPeed.....	715
[SENSe:]POWer:NCORrection.....	715
[SENSe:]POWer:TRACe.....	693
[SENSe:]ROSCillator:EXTernal:FREQuency.....	902
[SENSe:]ROSCillator:SOURce.....	902
[SENSe:]ROSCillator:SOURce:EAUTO?.....	903
[SENSe:]SCAN:RANGes[:COUNT].....	645
[SENSe:]SCAN<range>:BANDwidth:RESolution.....	643
[SENSe:]SCAN<range>:INPut:ATTenuation.....	644
[SENSe:]SCAN<range>:INPut:ATTenuation:AUTO.....	644
[SENSe:]SCAN<range>:INPut:GAIN:AUTO.....	644
[SENSe:]SCAN<range>:INPut:GAIN[:STATE].....	645
[SENSe:]SCAN<range>:INPut:TYPE.....	645
[SENSe:]SCAN<range>:START.....	645
[SENSe:]SCAN<range>:STEP.....	646
[SENSe:]SCAN<range>:STOP.....	646
[SENSe:]SCAN<range>:TIME.....	646
[SENSe:]SWEep:COUNT.....	642
[SENSe:]SWEep:COUNT.....	802
[SENSe:]SWEep:COUNT:CURRent.....	642
[SENSe:]SWEep:EGATE.....	809
[SENSe:]SWEep:EGATE:HOLDoff.....	809
[SENSe:]SWEep:EGATE:LENGth.....	810
[SENSe:]SWEep:EGATE:POLarity.....	810
[SENSe:]SWEep:EGATE:SOURce.....	810
[SENSe:]SWEep:EGATE:TRACe<k>: PERiod.....	763
[SENSe:]SWEep:EGATE:TRACe<k>: STOP<range>.....	764
[SENSe:]SWEep:EGATE:TRACe<k>:COMMENT.....	762
[SENSe:]SWEep:EGATE:TRACe<k>:START<range>.....	763
[SENSe:]SWEep:EGATE:TRACe<k>[:STATE<range>].....	763
[SENSe:]SWEep:EGATE:TYPE.....	811
[SENSe:]SWEep:MODE.....	729
[SENSe:]SWEep:POINTS.....	802
[SENSe:]SWEep:TIME.....	608
[SENSe:]SWEep:TIME.....	803
[SENSe:]SWEep:TIME:AUTO.....	803
[SENSe:]SWEep:TYPE.....	803
[SENSe:]SWEep:TYPE:USED?.....	804
*CAL?.....	883

*CLS.....	884
*ESE.....	884
*ESR?.....	884
*IDN?.....	884
*IST?.....	884
*OPC.....	885
*OPT?.....	885
*PCB.....	885
*PRE.....	885
*PSC.....	885
*RST.....	886
*SRE.....	886
*STB?.....	886
*TRG.....	886
*TST?.....	886
*WAI.....	887
ABORT.....	609
CALCulate:PEAKsearch PSEarch:CLEar[:IMMediate].....	648
CALCulate:SGRam:TRACe.....	620
CALCulate:TFLine:STATe.....	673
CALCulate<n>:DELTamarker<m>:AOFF.....	666
CALCulate<n>:DELTamarker<m>:FUNctIon:BPOWer:MODE.....	854
CALCulate<n>:DELTamarker<m>:FUNctIon:BPOWer:RESult?.....	854
CALCulate<n>:DELTamarker<m>:FUNctIon:BPOWer:SPAN.....	854
CALCulate<n>:DELTamarker<m>:FUNctIon:BPOWer[:STATe].....	855
CALCulate<n>:DELTamarker<m>:FUNctIon:FIXed:RPOint:MAXimum[:PEAK].....	835
CALCulate<n>:DELTamarker<m>:FUNctIon:FIXed:RPOint:X.....	836
CALCulate<n>:DELTamarker<m>:FUNctIon:FIXed:RPOint:Y.....	836
CALCulate<n>:DELTamarker<m>:FUNctIon:FIXed:RPOint:Y:OFFSet.....	836
CALCulate<n>:DELTamarker<m>:FUNctIon:FIXed[:STATe].....	837
CALCulate<n>:DELTamarker<m>:FUNctIon:FMEasurement:DETEctor.....	747
CALCulate<n>:DELTamarker<m>:FUNctIon:FMEasurement:LIMit<k>:CONDition ?.....	749
CALCulate<n>:DELTamarker<m>:FUNctIon:FMEasurement:LIMit<k>:DELTA?.....	750
CALCulate<n>:DELTamarker<m>:FUNctIon:FMEasurement:RESult?.....	750
CALCulate<n>:DELTamarker<m>:FUNctIon:PNOise:AUTO.....	840
CALCulate<n>:DELTamarker<m>:FUNctIon:PNOise:RESult?.....	841
CALCulate<n>:DELTamarker<m>:FUNctIon:PNOise[:STATe].....	841
CALCulate<n>:DELTamarker<m>:LINK.....	666
CALCulate<n>:DELTamarker<m>:MAXimum:LEFT.....	666
CALCulate<n>:DELTamarker<m>:MAXimum:NEXT.....	667
CALCulate<n>:DELTamarker<m>:MAXimum:RIGHT.....	667
CALCulate<n>:DELTamarker<m>:MAXimum[:PEAK].....	667
CALCulate<n>:DELTamarker<m>:MINimum:LEFT.....	668
CALCulate<n>:DELTamarker<m>:MINimum:NEXT.....	668
CALCulate<n>:DELTamarker<m>:MINimum:RIGHT.....	669
CALCulate<n>:DELTamarker<m>:MINimum[:PEAK].....	668
CALCulate<n>:DELTamarker<m>:MODE.....	669
CALCulate<n>:DELTamarker<m>:MREF.....	835
CALCulate<n>:DELTamarker<m>:SGRam:FRAME.....	628
CALCulate<n>:DELTamarker<m>:SGRam:SARea.....	628



CALCulate<n>:DELTamarker<m>:SGRam:XY:MAXimum[:PEAK].....	629
CALCulate<n>:DELTamarker<m>:SGRam:XY:MINimum[:PEAK].....	629
CALCulate<n>:DELTamarker<m>:SGRam:Y:MAXimum:ABOVE.....	630
CALCulate<n>:DELTamarker<m>:SGRam:Y:MAXimum:BELOW.....	630
CALCulate<n>:DELTamarker<m>:SGRam:Y:MAXimum:NEXT.....	631
CALCulate<n>:DELTamarker<m>:SGRam:Y:MAXimum[:PEAK].....	631
CALCulate<n>:DELTamarker<m>:SGRam:Y:MINimum:ABOVE.....	632
CALCulate<n>:DELTamarker<m>:SGRam:Y:MINimum:BELOW.....	632
CALCulate<n>:DELTamarker<m>:SGRam:Y:MINimum:NEXT.....	632
CALCulate<n>:DELTamarker<m>:SGRam:Y:MINimum[:PEAK].....	633
CALCulate<n>:DELTamarker<m>:TRACe.....	670
CALCulate<n>:DELTamarker<m>:X.....	670
CALCulate<n>:DELTamarker<m>:X:RELative?.....	671
CALCulate<n>:DELTamarker<m>:Y.....	671
CALCulate<n>:DELTamarker<m>[:STATe].....	669
CALCulate<n>:DLINe<k>.....	672
CALCulate<n>:DLINe<k>:STATe.....	672
CALCulate<n>:ESPectrum:PSEarch[:PEAKsearch[:IMMediate].....	745
CALCulate<n>:ESPectrum:PSEarch[:PEAKsearch:AUTO.....	745
CALCulate<n>:ESPectrum:PSEarch[:PEAKsearch:MARGIn.....	745
CALCulate<n>:ESPectrum:PSEarch[:PEAKsearch:PSHOW.....	746
CALCulate<n>:FEED.....	606
CALCulate<n>:FLINe<k>.....	673
CALCulate<n>:FLINe<k>:STATe.....	673
CALCulate<n>:FORMat.....	856
CALCulate<n>:LIMit<k>:ACPowEr:ACHannel:ABSolute.....	706
CALCulate<n>:LIMit<k>:ACPowEr:ACHannel:ABSolute:STATe.....	706
CALCulate<n>:LIMit<k>:ACPowEr:ACHannel:RESult.....	708
CALCulate<n>:LIMit<k>:ACPowEr:ACHannel[:RELative].....	707
CALCulate<n>:LIMit<k>:ACPowEr:ACHannel[:RELative]:STATe.....	708
CALCulate<n>:LIMit<k>:ACPowEr:ALTErnate<Channel>:ABSolute.....	709
CALCulate<n>:LIMit<k>:ACPowEr:ALTErnate<Channel>:ABSolute:STATe.....	710
CALCulate<n>:LIMit<k>:ACPowEr:ALTErnate<Channel>:RESult?.....	712
CALCulate<n>:LIMit<k>:ACPowEr:ALTErnate<channel>[:RELative].....	711
CALCulate<n>:LIMit<k>:ACPowEr:ALTErnate<Channel>[:RELative]:STATe.....	711
CALCulate<n>:LIMit<k>:ACPowEr[:STATe].....	713
CALCulate<n>:LIMit<k>:ACTive?.....	674
CALCulate<n>:LIMit<k>:CLear[:IMMediate].....	686
CALCulate<n>:LIMit<k>:COMMent.....	674
CALCulate<n>:LIMit<k>:CONTRol:DOMain.....	678
CALCulate<n>:LIMit<k>:CONTRol:MODE.....	678
CALCulate<n>:LIMit<k>:CONTRol:OFFSet.....	678
CALCulate<n>:LIMit<k>:CONTRol:SHIFt.....	679
CALCulate<n>:LIMit<k>:CONTRol:SPACing.....	679
CALCulate<n>:LIMit<k>:CONTRol[:DATA].....	677
CALCulate<n>:LIMit<k>:COPY.....	675
CALCulate<n>:LIMit<k>:DELeTe.....	675
CALCulate<n>:LIMit<k>:ESPectrum:LIMits.....	741
CALCulate<n>:LIMit<k>:ESPectrum:MODE.....	741
CALCulate<n>:LIMit<k>:ESPectrum:PCLass<Class>:COUNT.....	742

CALCulate<n>:LIMit<k>:ESpectrum:PCLass<Class>:LIMit[:STATe].....	742
CALCulate<n>:LIMit<k>:ESpectrum:PCLass<Class>:MAXimum.....	743
CALCulate<n>:LIMit<k>:ESpectrum:PCLass<Class>:MINimum.....	743
CALCulate<n>:LIMit<k>:ESpectrum:PCLass<Class>[:EXCLusive].....	742
CALCulate<n>:LIMit<k>:ESpectrum:RESTore.....	728
CALCulate<n>:LIMit<k>:ESpectrum:VALue.....	744
CALCulate<n>:LIMit<k>:FAIL?.....	686
CALCulate<n>:LIMit<k>:LOWer:MARGin.....	680
CALCulate<n>:LIMit<k>:LOWer:MODE.....	680
CALCulate<n>:LIMit<k>:LOWer:OFFSet.....	681
CALCulate<n>:LIMit<k>:LOWer:SHIFt.....	681
CALCulate<n>:LIMit<k>:LOWer:SPACing.....	681
CALCulate<n>:LIMit<k>:LOWer:STATe.....	682
CALCulate<n>:LIMit<k>:LOWer:THReshold.....	682
CALCulate<n>:LIMit<k>:LOWer[:DATA].....	679
CALCulate<n>:LIMit<k>:NAME.....	675
CALCulate<n>:LIMit<k>:STATe.....	687
CALCulate<n>:LIMit<k>:TRACe.....	676
CALCulate<n>:LIMit<k>:UNIT.....	676
CALCulate<n>:LIMit<k>:UPPer:MARGin.....	683
CALCulate<n>:LIMit<k>:UPPer:MODE.....	683
CALCulate<n>:LIMit<k>:UPPer:OFFSet.....	684
CALCulate<n>:LIMit<k>:UPPer:SHIFt.....	684
CALCulate<n>:LIMit<k>:UPPer:SPACing.....	685
CALCulate<n>:LIMit<k>:UPPer:STATe.....	685
CALCulate<n>:LIMit<k>:UPPer:THReshold.....	685
CALCulate<n>:LIMit<k>:UPPer[:DATA].....	683
CALCulate<n>:MARKer<m>:AOFF.....	660
CALCulate<n>:MARKer<m>:COUNT.....	838
CALCulate<n>:MARKer<m>:COUNT:FREQuency?.....	838
CALCulate<n>:MARKer<m>:COUNT:RESolution.....	839
CALCulate<n>:MARKer<m>:COUPled[:STATe].....	656
CALCulate<n>:MARKer<m>:FUNCTion:BPOWer:MODE.....	852
CALCulate<n>:MARKer<m>:FUNCTion:BPOWer:RESult?.....	852
CALCulate<n>:MARKer<m>:FUNCTion:BPOWer:SPAN.....	853
CALCulate<n>:MARKer<m>:FUNCTion:BPOWer[:STATe].....	853
CALCulate<n>:MARKer<m>:FUNCTion:CENTer.....	656
CALCulate<n>:MARKer<m>:FUNCTion:CSTep.....	657
CALCulate<n>:MARKer<m>:FUNCTion:DEModulation:CONTinuous.....	842
CALCulate<n>:MARKer<m>:FUNCTion:DEModulation:HOLDoff.....	842
CALCulate<n>:MARKer<m>:FUNCTion:DEModulation:SElect.....	843
CALCulate<n>:MARKer<m>:FUNCTion:DEModulation[:STATe].....	843
CALCulate<n>:MARKer<m>:FUNCTion:FMEasurement:DETEctor.....	748
CALCulate<n>:MARKer<m>:FUNCTion:FMEasurement:DWELL.....	748
CALCulate<n>:MARKer<m>:FUNCTion:FMEasurement:LIMit<k>:CONDition ?.....	750
CALCulate<n>:MARKer<m>:FUNCTion:FMEasurement:LIMit<k>:DELTA?.....	751
CALCulate<n>:MARKer<m>:FUNCTion:FMEasurement:PSEArch:AUTO.....	749
CALCulate<n>:MARKer<m>:FUNCTion:FMEasurement:RESult?.....	751
CALCulate<n>:MARKer<m>:FUNCTion:FMEasurement:STATe.....	747
CALCulate<n>:MARKer<m>:FUNCTion:FPEaks:ANNOtation:LABel:STATe.....	847

CALCulate<n>:MARKer<m>:FUNction:FPEaks:COUNT?	848
CALCulate<n>:MARKer<m>:FUNction:FPEaks:LIST:SIZE	849
CALCulate<n>:MARKer<m>:FUNction:FPEaks:SEAR:AUTO	849
CALCulate<n>:MARKer<m>:FUNction:FPEaks:SORT	850
CALCulate<n>:MARKer<m>:FUNction:FPEaks:STAT	850
CALCulate<n>:MARKer<m>:FUNction:FPEaks:X	850
CALCulate<n>:MARKer<m>:FUNction:FPEaks:Y?	851
CALCulate<n>:MARKer<m>:FUNction:FPEaks[:IMMediate]	848
CALCulate<n>:MARKer<m>:FUNction:HARMonics:BANDwidth:AUTO	754
CALCulate<n>:MARKer<m>:FUNction:HARMonics:DISTortion?	755
CALCulate<n>:MARKer<m>:FUNction:HARMonics:LIST?	755
CALCulate<n>:MARKer<m>:FUNction:HARMonics:NHARmonics	756
CALCulate<n>:MARKer<m>:FUNction:HARMonics:PRESet	756
CALCulate<n>:MARKer<m>:FUNction:HARMonics[:STATe]	757
CALCulate<n>:MARKer<m>:FUNction:MDEPth:RESult?	752
CALCulate<n>:MARKer<m>:FUNction:MDEPth:SEARChsignal ONCE	752
CALCulate<n>:MARKer<m>:FUNction:MDEPth[:STATe]	753
CALCulate<n>:MARKer<m>:FUNction:NDBDown	844
CALCulate<n>:MARKer<m>:FUNction:NDBDown:FREQuency?	844
CALCulate<n>:MARKer<m>:FUNction:NDBDown:QFACtor	845
CALCulate<n>:MARKer<m>:FUNction:NDBDown:RESult?	845
CALCulate<n>:MARKer<m>:FUNction:NDBDown:STATe	846
CALCulate<n>:MARKer<m>:FUNction:NDBDown:TIME?	846
CALCulate<n>:MARKer<m>:FUNction:NOISe:RESult	839
CALCulate<n>:MARKer<m>:FUNction:NOISe[:STATe]	840
CALCulate<n>:MARKer<m>:FUNction:POWer:MODE	692
CALCulate<n>:MARKer<m>:FUNction:POWer:PRESet	696
CALCulate<n>:MARKer<m>:FUNction:POWer:RESult:PHZ	714
CALCulate<n>:MARKer<m>:FUNction:POWer:RESult?	689
CALCulate<n>:MARKer<m>:FUNction:POWer:SELEct	688
CALCulate<n>:MARKer<m>:FUNction:POWer:STANdard:CATalog?	697
CALCulate<n>:MARKer<m>:FUNction:POWer:STANdard:DELEte	697
CALCulate<n>:MARKer<m>:FUNction:POWer:STANdard:SAVE	697
CALCulate<n>:MARKer<m>:FUNction:POWer[:STATe]	692
CALCulate<n>:MARKer<m>:FUNction:REFerence	830
CALCulate<n>:MARKer<m>:FUNction:STRack:BANDwidth BWIDTH	794
CALCulate<n>:MARKer<m>:FUNction:STRack:THREshold	795
CALCulate<n>:MARKer<m>:FUNction:STRack:TRACe	795
CALCulate<n>:MARKer<m>:FUNction:STRack[:STATe]	794
CALCulate<n>:MARKer<m>:FUNction:SUMMary:AOFF	767
CALCulate<n>:MARKer<m>:FUNction:SUMMary:AVERAge	767
CALCulate<n>:MARKer<m>:FUNction:SUMMary:MEAN:AVERAge:RESult?	770
CALCulate<n>:MARKer<m>:FUNction:SUMMary:MEAN:PHOLd:RESult?	771
CALCulate<n>:MARKer<m>:FUNction:SUMMary:MEAN:RESult?	771
CALCulate<n>:MARKer<m>:FUNction:SUMMary:MEAN[:STATe]	772
CALCulate<n>:MARKer<m>:FUNction:SUMMary:MODE	768
CALCulate<n>:MARKer<m>:FUNction:SUMMary:PHOLd	768
CALCulate<n>:MARKer<m>:FUNction:SUMMary:PPEak:AVERAge:RESult?	772
CALCulate<n>:MARKer<m>:FUNction:SUMMary:PPEak:PHOLd:RESult?	773
CALCulate<n>:MARKer<m>:FUNction:SUMMary:PPEak:RESult?	773

CALCulate<n>:MARKer<m>:FUNction:SUMMary:PPEak[:STATe].....	774
CALCulate<n>:MARKer<m>:FUNction:SUMMary:REFEreNce:AUTO ONCE.....	769
CALCulate<n>:MARKer<m>:FUNction:SUMMary:RMS:AVErAge:RESult?.....	774
CALCulate<n>:MARKer<m>:FUNction:SUMMary:RMS:PHOLd:RESult?.....	775
CALCulate<n>:MARKer<m>:FUNction:SUMMary:RMS:RESult?.....	776
CALCulate<n>:MARKer<m>:FUNction:SUMMary:RMS[:STATe].....	776
CALCulate<n>:MARKer<m>:FUNction:SUMMary:SDEVIation:AVErAge:RESult?.....	777
CALCulate<n>:MARKer<m>:FUNction:SUMMary:SDEVIation:PHOLd:RESult?.....	777
CALCulate<n>:MARKer<m>:FUNction:SUMMary:SDEVIation:RESult?.....	778
CALCulate<n>:MARKer<m>:FUNction:SUMMary:SDEVIation[:STATe].....	778
CALCulate<n>:MARKer<m>:FUNction:SUMMary[:STATe].....	769
CALCulate<n>:MARKer<m>:FUNction:TOI:RESult?.....	759
CALCulate<n>:MARKer<m>:FUNction:TOI:SEARChsignal ONCE.....	758
CALCulate<n>:MARKer<m>:FUNction:TOI[:STATe].....	758
CALCulate<n>:MARKer<m>:FUNction:ZOOM.....	657
CALCulate<n>:MARKer<m>:LOEXclude.....	831
CALCulate<n>:MARKer<m>:MAXimum:AUTO.....	831
CALCulate<n>:MARKer<m>:MAXimum:LEFT.....	660
CALCulate<n>:MARKer<m>:MAXimum:NEXT.....	660
CALCulate<n>:MARKer<m>:MAXimum:RIGHT.....	661
CALCulate<n>:MARKer<m>:MAXimum[:PEAK].....	661
CALCulate<n>:MARKer<m>:MINimum:AUTO.....	831
CALCulate<n>:MARKer<m>:MINimum:LEFT.....	662
CALCulate<n>:MARKer<m>:MINimum:NEXT.....	662
CALCulate<n>:MARKer<m>:MINimum:RIGHT.....	663
CALCulate<n>:MARKer<m>:MINimum[:PEAK].....	662
CALCulate<n>:MARKer<m>:PEXCursion.....	647
CALCulate<n>:MARKer<m>:SCOupled[:STATe].....	657
CALCulate<n>:MARKer<m>:SEARCh.....	856
CALCulate<n>:MARKer<m>:SGRam:FRAME.....	622
CALCulate<n>:MARKer<m>:SGRam:SARea.....	622
CALCulate<n>:MARKer<m>:SGRam:XY:MAXimum[:PEAK].....	623
CALCulate<n>:MARKer<m>:SGRam:XY:MINimum[:PEAK].....	623
CALCulate<n>:MARKer<m>:SGRam:Y:MAXimum:ABOVE.....	624
CALCulate<n>:MARKer<m>:SGRam:Y:MAXimum:BELOW.....	624
CALCulate<n>:MARKer<m>:SGRam:Y:MAXimum:NEXT.....	625
CALCulate<n>:MARKer<m>:SGRam:Y:MAXimum[:PEAK].....	625
CALCulate<n>:MARKer<m>:SGRam:Y:MINimum:ABOVE.....	625
CALCulate<n>:MARKer<m>:SGRam:Y:MINimum:BELOW.....	626
CALCulate<n>:MARKer<m>:SGRam:Y:MINimum:NEXT.....	626
CALCulate<n>:MARKer<m>:SGRam:Y:MINimum[:PEAK].....	627
CALCulate<n>:MARKer<m>:TRACe.....	664
CALCulate<n>:MARKer<m>:X.....	664
CALCulate<n>:MARKer<m>:X:SLIMits:LEFT.....	658
CALCulate<n>:MARKer<m>:X:SLIMits:RIGHT.....	658
CALCulate<n>:MARKer<m>:X:SLIMits:ZOOM.....	832
CALCulate<n>:MARKer<m>:X:SLIMits[:STATe].....	659
CALCulate<n>:MARKer<m>:X:SSIZe.....	832
CALCulate<n>:MARKer<m>:Y.....	664
CALCulate<n>:MARKer<m>:Y:PERCent.....	833

CALCulate<n>:MARKer<m>[:STATe].....	663
CALCulate<n>:MATH:MODE.....	816
CALCulate<n>:MATH:POSition.....	816
CALCulate<n>:MATH:STATe.....	816
CALCulate<n>:MATH[:EXPRession][:DEFine].....	815
CALCulate<n>:PEAKsearch PSEarch:ADD.....	648
CALCulate<n>:PEAKsearch PSEarch:AUTO.....	726
CALCulate<n>:PEAKsearch PSEarch:MARGin.....	648
CALCulate<n>:PEAKsearch PSEarch:METHod.....	649
CALCulate<n>:PEAKsearch PSEarch:PSHow.....	726
CALCulate<n>:PEAKsearch PSEarch:SUBRanges.....	649
CALCulate<n>:PEAKsearch PSEarch:SUBRanges.....	727
CALCulate<n>:PEAKsearch PSEarch:SUBRanges:PCOunt.....	650
CALCulate<n>:PEAKsearch PSEarch[:IMMEDIATE].....	648
CALCulate<n>:PEAKsearch PSEarch[:IMMEDIATE].....	726
CALCulate<n>:SGRam:CLEar[:IMMEDIATE].....	618
CALCulate<n>:SGRam:COLor.....	824
CALCulate<n>:SGRam:CONT.....	825
CALCulate<n>:SGRam:FRAME:COUnT.....	825
CALCulate<n>:SGRam:FRAME:SElect.....	826
CALCulate<n>:SGRam:HDEPTH.....	620
CALCulate<n>:SGRam:TSTamp:DATA?.....	620
CALCulate<n>:SGRam:TSTamp[:STATe].....	826
CALCulate<n>:SGRam[:STATe].....	826
CALCulate<n>:STATistics:APD[:STATe].....	760
CALCulate<n>:STATistics:CCDF:X<Trace>.....	761
CALCulate<n>:STATistics:CCDF[:STATe].....	760
CALCulate<n>:STATistics:NSAMples.....	761
CALCulate<n>:STATistics:PRESet.....	764
CALCulate<n>:STATistics:RESult<Trace>.....	762
CALCulate<n>:STATistics:SCALE:AUTO ONCE.....	765
CALCulate<n>:STATistics:SCALE:X:RANGe.....	765
CALCulate<n>:STATistics:SCALE:X:RLEVel.....	766
CALCulate<n>:STATistics:SCALE:Y:LOWer.....	766
CALCulate<n>:STATistics:SCALE:Y:UNIT.....	766
CALCulate<n>:STATistics:SCALE:Y:UPPer.....	767
CALCulate<n>:THReshold.....	833
CALCulate<n>:THReshold:STATe.....	833
CALCulate<n>:TLINe<Line>.....	829
CALCulate<n>:TLINe<Line>:STATe.....	829
CALCulate<n>:UNIT:POWer.....	636
CALCulate<n>:UNIT:POWer.....	812
CALibration:ABORT.....	903
CALibration:RESult?.....	904
CALibration:STATe.....	904
CALibration[:ALL]?.....	903
DIAGnostic<n>:SERVice:BIOSinfo?.....	893
DIAGnostic<n>:SERVice:HWInfo?.....	893
DIAGnostic<n>:SERVice:INPut:PULSed:CFRequency.....	904
DIAGnostic<n>:SERVice:INPut[:SElect].....	905

DIAGnostic<n>:SERvice:NSource.....	899
DIAGnostic<n>:SERvice:SFUNction.....	906
DIAGnostic<n>:SERvice:SFUNction:LASTresult?.....	907
DIAGnostic<n>:SERvice:SFUNction:RESults:DELete.....	907
DIAGnostic<n>:SERvice:SFUNction:RESults:SAVE.....	907
DIAGnostic<n>:SERvice:STESt:RESult?.....	905
DIAGnostic<n>:SERvice:TEMPerature:FRONt?.....	906
DIAGnostic<n>:SERvice:VERSinfo?.....	894
DISPlay:ANNotation:FREQuency.....	945
DISPlay:BARGraph:LEVel:LOWer?.....	607
DISPlay:BARGraph:LEVel:UPPer?.....	607
DISPlay:BARGraph:PHOLd:RESet.....	607
DISPlay:BARGraph:PHOLd[:STATe].....	607
DISPlay:BARGraph:TCOupling[:STATe].....	607
DISPlay:CMAP<item>:DEFault.....	945
DISPlay:CMAP<item>:HSL.....	946
DISPlay:CMAP<item>:PDEFined.....	946
DISPlay:FORMat.....	947
DISPlay:LOGO.....	947
DISPlay:MTABle.....	834
DISPlay:PSAVe:HOLDoff.....	947
DISPlay:PSAVe[:STATe].....	947
DISPlay:SBAR[:STATe].....	948
DISPlay:SKEYs[:STATe].....	948
DISPlay:TBAR[STATe].....	948
DISPlay:THEMe:CATalog?.....	948
DISPlay:THEMe:SElect.....	949
DISPlay:TOUChscreen:STATe.....	949
DISPlay:WINDow:SGRam:COLor:DEFault.....	618
DISPlay:WINDow:SGRam:COLor:LOWer.....	618
DISPlay:WINDow:SGRam:COLor:SHAPE.....	619
DISPlay:WINDow:SGRam:COLor:UPPer.....	619
DISPlay:WINDow:SGRam:COLor[:STYLe].....	619
DISPlay[:WINDow<n>]:MINFo:STATe.....	659
DISPlay[:WINDow<n>]:TEXT:STATe.....	950
DISPlay[:WINDow<n>]:TEXT[:DATA].....	951
DISPlay[:WINDow<n>]:TIME.....	951
DISPlay[:WINDow<n>]:TIME:FORMat.....	951
DISPlay[:WINDow<n>]:TRACe<t>:MODE.....	652
DISPlay[:WINDow<n>]:TRACe<t>:MODE:HCONtinuous.....	817
DISPlay[:WINDow<n>]:TRACe<t>:SYMBol.....	650
DISPlay[:WINDow<n>]:TRACe<t>:X:SPACing.....	634
DISPlay[:WINDow<n>]:TRACe<t>:Y:SPACing.....	636
DISPlay[:WINDow<n>]:TRACe<t>:Y[:SCALE].....	812
DISPlay[:WINDow<n>]:TRACe<t>:Y[:SCALE]:BOTTom.....	636
DISPlay[:WINDow<n>]:TRACe<t>:Y[:SCALE]:MODE.....	812
DISPlay[:WINDow<n>]:TRACe<t>:Y[:SCALE]:RLEVel.....	813
DISPlay[:WINDow<n>]:TRACe<t>:Y[:SCALE]:RLEVel:OFFSet.....	813
DISPlay[:WINDow<n>]:TRACe<t>:Y[:SCALE]:RPOSition.....	814
DISPlay[:WINDow<n>]:TRACe<t>:Y[:SCALE]:RVALue.....	857

DISPlay[:WINDow<n>]:TRACe<t>[:STATe].....	817
DISPlay[:WINDow<n>][:SUBWindow<m>]:SElect.....	950
DISPlay[:WINDow<n>][:SUBWindow<m>]:SIZE.....	949
FORMat:DEXPort:DSEParator.....	818
FORMat:DEXPort:TRACes.....	615
FORMat[:DATA].....	818
HCOPy:ABORt.....	927
HCOPy:CMAP<item>:DEFault.....	927
HCOPy:CMAP<item>:HSL.....	927
HCOPy:CMAP<item>:PDEFined.....	928
HCOPy:DESTination<1 2>.....	928
HCOPy:DEVice:COLor.....	929
HCOPy:DEVice:LANGUage<1 2>.....	929
HCOPy:ITEM:ALL.....	930
HCOPy:ITEM:WINDow:TABLE:STATe.....	930
HCOPy:ITEM:WINDow:TEXT.....	930
HCOPy:MODE.....	941
HCOPy:PAGE:ORientation<1 2>.....	931
HCOPy:TDSamp:STATe<1 2>.....	931
HCOPy:TREPort:APPend.....	941
HCOPy:TREPort:DESCRiption.....	939
HCOPy:TREPort:ITEM:DEFault.....	934
HCOPy:TREPort:ITEM:HEADer:LINE<line>:CONTrol.....	936
HCOPy:TREPort:ITEM:HEADer:LINE<line>:TEXT.....	937
HCOPy:TREPort:ITEM:HEADer:LINE<line>:TITLE.....	937
HCOPy:TREPort:ITEM:LOGO.....	938
HCOPy:TREPort:ITEM:LOGO:CONTrol.....	938
HCOPy:TREPort:ITEM:SElect.....	934
HCOPy:TREPort:ITEM:TEMPlate:CATalog?.....	940
HCOPy:TREPort:ITEM:TEMPlate:DELeTe.....	940
HCOPy:TREPort:ITEM:TEMPlate:LOAD.....	940
HCOPy:TREPort:ITEM:TEMPlate:SAVE.....	940
HCOPy:TREPort:NEW.....	942
HCOPy:TREPort:PAGesize.....	939
HCOPy:TREPort:TEST:REMOve.....	942
HCOPy:TREPort:TEST:REMOve:SElected.....	942
HCOPy:TREPort:TEST:SElect.....	943
HCOPy:TREPort:TEST:SElect:ALL.....	943
HCOPy:TREPort:TEST:SElect:INVert.....	943
HCOPy:TREPort:TEST:SElect:NONE.....	944
HCOPy:TREPort:TITLe.....	939
HCOPy[:IMMEDIATE<1 2>].....	931
HCOPy[:IMMEDIATE<1 2>]:NEXT.....	932
HOLD.....	609
INITiate<n>:CONMeas.....	609
INITiate<n>:CONMeas.....	801
INITiate<n>:CONTinuous.....	609
INITiate<n>:DISPlay.....	952
INITiate<n>:EMITest.....	611
INITiate<n>:ESPectrum.....	729

INITiate<n>:FMEasurement.....	611
INITiate<n>:SPURious.....	717
INITiate<n>[:IMMediate].....	610
INPut:ATTenuation.....	637
INPut:ATTenuation:AUTO.....	637
INPut:ATTenuation:AUTO.....	814
INPut:ATTenuation:PROTection[:STATe].....	638
INPut:COUPling.....	641
INPut:GAIN:AUTO.....	638
INPut:GAIN:STATe.....	638
INPut:IMPedance.....	638
INPut:LISN:FILTer:HPAS[:STATe].....	654
INPut:LISN:PHASe.....	655
INPut:LISN[:TYPE].....	655
INPut:PRESelection:STATe.....	899
INPut:TYPE.....	641
INPut<ip>:UPORt:STATe.....	900
INPut<ip>:UPORt[:VALue].....	900
INSTRument:COUPlE:ATTen.....	896
INSTRument:COUPlE:BANDwidth.....	896
INSTRument:COUPlE:CENTer.....	896
INSTRument:COUPlE:DEMod.....	897
INSTRument:COUPlE:GAIN.....	897
INSTRument:COUPlE:LIMit.....	897
INSTRument:COUPlE:MARKer.....	898
INSTRument:COUPlE:PRESel.....	898
INSTRument:COUPlE:PROT.....	898
INSTRument:COUPlE:SPAN.....	899
INSTRument:CREate[:NEW].....	604
INSTRument:DELeTe.....	605
INSTRument[:SElect].....	605
MMEMory:CATalog:LONG?.....	909
MMEMory:CATalog?.....	908
MMEMory:CDIRectory.....	910
MMEMory:CLEar:ALL.....	914
MMEMory:CLEar:STATe 1.....	914
MMEMory:COMMeNt.....	910
MMEMory:COpy.....	910
MMEMory:DATA.....	911
MMEMory:DELeTe.....	911
MMEMory:LOAD:AUTO.....	914
MMEMory:LOAD:IQ:STATe.....	857
MMEMory:LOAD:STATe.....	915
MMEMory:MDIRectory.....	912
MMEMory:MOVE.....	912
MMEMory:MSIS.....	912
MMEMory:NAME.....	913
MMEMory:NETWork:DISConnect.....	955
MMEMory:NETWork:MAP.....	955
MMEMory:NETWork:UNUSeddrives?.....	956



MMEMory:NETWork:USEDdrives?.....	956
MMEMory:RDIRECTory.....	913
MMEMory:SEL[:ITEM]:SGRam.....	954
MMEMory:SELEct[:ITEM]:ALL.....	952
MMEMory:SELEct[:ITEM]:DEFault.....	953
MMEMory:SELEct[:ITEM]:HWSettings.....	953
MMEMory:SELEct[:ITEM]:LINES:ALL.....	953
MMEMory:SELEct[:ITEM]:NONE.....	953
MMEMory:SELEct[:ITEM]:TRACe[:ACTive].....	954
MMEMory:SELEct[:ITEM]:TRANSDucer:ALL.....	954
MMEMory:STORE:FINAL.....	651
MMEMory:STORE:IQ:COMM.....	916
MMEMory:STORE:IQ:STATe.....	916
MMEMory:STORE:PEAKlist.....	651
MMEMory:STORE:SGRam.....	621
MMEMory:STORE<n>:LIST.....	745
MMEMory:STORE<n>:SPURious.....	718
MMEMory:STORE<n>:STATe.....	916
MMEMory:STORE<n>:STATe:NEXT.....	917
MMEMory:STORE<n>:TRACe.....	819
MMEMory:USER<Softkey>.....	954
OUTPut:IF[:SOURce].....	900
OUTPut:TRIGger.....	901
OUTPut:UPORt:STATe.....	901
OUTPut:UPORt[:VALue].....	901
OUTPut[:STATe].....	869
PROBE:ID:PARTnumber?.....	789
PROBE:ID:SRNumber?.....	789
PROBE:SETup:MODE.....	789
PROBE:SETup:NAME?.....	789
PROBE:SETup:STATe?.....	789
PROBE[:STATe].....	790
SOURce<n>:AM:STATe.....	871
SOURce<n>:DM:STATe.....	871
SOURce<n>:EXTErnal<generator>:FREQUency.....	876
SOURce<n>:EXTErnal<generator>:FREQUency:COUPLing[:STATe].....	876
SOURce<n>:EXTErnal<generator>:FREQUency:OFFSet<m>.....	878
SOURce<n>:EXTErnal<generator>:FREQUency:SWEep[:STATe].....	879
SOURce<n>:EXTErnal<generator>:FREQUency[:FACTor]:DENominator.....	877
SOURce<n>:EXTErnal<generator>:FREQUency[:FACTor]:NUMerator.....	877
SOURce<n>:EXTErnal<generator>:POWER[:LEVel].....	879
SOURce<n>:EXTErnal<generator>:ROSCillator[:SOURce].....	879
SOURce<n>:EXTErnal<generator>[:STATe].....	880
SOURce<n>:FM:DEViation.....	872
SOURce<n>:FM:STATe.....	872
SOURce<n>:FREQUency:OFFSet.....	873
SOURce<n>:POWER:MODE.....	874
SOURce<n>:POWER:STARt.....	874
SOURce<n>:POWER:STOP.....	875
SOURce<n>:POWER[:LEVel][:IMMediate]:OFFSet.....	873

SOURce<n>:POWer[:LEVel][:IMMediate][:AMPLitude].....	873
STATus:OPERation:CONDition?.....	964
STATus:OPERation:ENABle.....	964
STATus:OPERation:NTRansition.....	964
STATus:OPERation:PTRansition.....	965
STATus:OPERation[:EVENT]?.....	963
STATus:PRESet.....	963
STATus:QUEStionable:ACPLimit:CONDition?.....	964
STATus:QUEStionable:ACPLimit:ENABle.....	964
STATus:QUEStionable:ACPLimit:NTRansition.....	964
STATus:QUEStionable:ACPLimit:PTRansition.....	965
STATus:QUEStionable:ACPLimit[:EVENT]?.....	963
STATus:QUEStionable:CONDition?.....	964
STATus:QUEStionable:ENABle.....	964
STATus:QUEStionable:FREQuency:CONDition?.....	964
STATus:QUEStionable:FREQuency:ENABle.....	964
STATus:QUEStionable:FREQuency:NTRansition.....	964
STATus:QUEStionable:FREQuency:PTRansition.....	965
STATus:QUEStionable:FREQuency[:EVENT]?.....	963
STATus:QUEStionable:LIMit<n>:CONDition?.....	964
STATus:QUEStionable:LIMit<n>:ENABle.....	964
STATus:QUEStionable:LIMit<n>:NTRansition.....	964
STATus:QUEStionable:LIMit<n>:PTRansition.....	965
STATus:QUEStionable:LIMit<n>[:EVENT]?.....	963
STATus:QUEStionable:LMARgin<n>:CONDition?.....	964
STATus:QUEStionable:LMARgin<n>:ENABle.....	964
STATus:QUEStionable:LMARgin<n>:NTRansition.....	964
STATus:QUEStionable:LMARgin<n>:PTRansition.....	965
STATus:QUEStionable:LMARgin<n>[:EVENT]?.....	963
STATus:QUEStionable:NTRansition.....	964
STATus:QUEStionable:POWer:CONDition?.....	964
STATus:QUEStionable:POWer:ENABle.....	964
STATus:QUEStionable:POWer:NTRansition.....	965
STATus:QUEStionable:POWer:PTRansition.....	965
STATus:QUEStionable:POWer[:EVENT]?.....	963
STATus:QUEStionable:PTRansition.....	965
STATus:QUEStionable:TRANSDucer:CONDition?.....	964
STATus:QUEStionable:TRANSDucer:ENABle.....	964
STATus:QUEStionable:TRANSDucer:NTRansition.....	965
STATus:QUEStionable:TRANSDucer:PTRansition.....	965
STATus:QUEStionable:TRANSDucer[:EVENT]?.....	963
STATus:QUEStionable[:EVENT]?.....	963
STATus:QUEue[:NEXT]?.....	963
SYSTem:APPLication:SRECovery[:STATe].....	888
SYSTem:CLOGging.....	888
SYSTem:COMMunicate:GPIB:RDEvice:GENerator<generator>:ADDRess.....	881
SYSTem:COMMunicate:GPIB[:SELF]:ADDRess.....	957
SYSTem:COMMunicate:GPIB[:SELF]:RTERminator.....	957
SYSTem:COMMunicate:PRINter:ENUMerate:FIRSt?.....	933
SYSTem:COMMunicate:PRINter:ENUMerate[:NEXT]?.....	933

SYSTem:COMMunicate:PRINter:SElect <1 2>.....	933
SYSTem:COMMunicate:RDEvice:GENerator<generator>:INTERface.....	881
SYSTem:COMMunicate:RDEvice:GENerator<generator>:LINK.....	881
SYSTem:COMMunicate:RDEvice:GENerator<generator>:TYPE.....	882
SYSTem:COMPatible.....	888
SYSTem:DATE.....	892
SYSTem:DEvice:ID?.....	892
SYSTem:DISPlay:FPANel.....	892
SYSTem:DISPlay:UPDate.....	889
SYSTem:ERRor:CLEar:ALL.....	894
SYSTem:ERRor:LIST?.....	895
SYSTem:ERRor[:NEXT]?.....	895
SYSTem:FIRMware:UPDate.....	889
SYSTem:FORMat:IDENT.....	889
SYSTem:HPCoupling.....	960
SYSTem:IDENTify:FACTory.....	894
SYSTem:IDENTify[:STRing].....	894
SYSTem:IFGain:MODE.....	961
SYSTem:KLOCK.....	890
SYSTem:LANGuage.....	960
SYSTem:LXI:INFo?.....	957
SYSTem:LXI:LANReset.....	958
SYSTem:LXI:MDEscription.....	958
SYSTem:LXI:PASSword.....	958
SYSTem:PASSword:RESet.....	907
SYSTem:PASSword[:CENable].....	907
SYSTem:PRESet.....	890
SYSTem:PRESet:COMPatible.....	890
SYSTem:REBoot.....	891
SYSTem:REvision:FACTory.....	959
SYSTem:REvision[:STRing].....	959
SYSTem:RSW.....	959
SYSTem:SHUTdown.....	891
SYSTem:SPEaker:VOLume.....	891
SYSTem:TIME.....	891
SYSTem:TIME:TSTamp?.....	891
SYSTem:TWALking.....	961
SYSTem:VERsion?.....	891
TRACe[:DATA].....	615
TRACe<n>:COPY.....	822
TRACe<n>:DATA.....	694
TRACe<n>:DATA.....	822
TRACe<n>:FEED:CONTRol<t>.....	642
TRACe<n>:IF[:DATA].....	616
TRACe<n>:IQ:AVERage:COUNT.....	862
TRACe<n>:IQ:AVERage[:STATe].....	862
TRACe<n>:IQ:BWIDth.....	857
TRACe<n>:IQ:DATA.....	860
TRACe<n>:IQ:DATA:FORMat.....	860
TRACe<n>:IQ:DATA:MEMory?.....	863

TRACe<n>:IQ:EGATe.....	864
TRACe<n>:IQ:EGATe:GAP.....	864
TRACe<n>:IQ:EGATe:LENGth.....	865
TRACe<n>:IQ:EGATe:NOFGateperiods.....	865
TRACe<n>:IQ:EGATe:TYPE.....	865
TRACe<n>:IQ:EVAL.....	866
TRACe<n>:IQ:RENGth.....	858
TRACe<n>:IQ:SET.....	858
TRACe<n>:IQ:SRATe.....	859
TRACe<n>:IQ:TPISample?.....	867
TRACe<n>:IQ[:STATe].....	866
TRACe<n>:POINts.....	643
TRACe<n>[:DATA]:MEMory?.....	823
TRACe<n>[:DATA]:X?.....	824
TRIGger<n>[:SEQuence]:HOLDoff[:TIME].....	804
TRIGger<n>[:SEQuence]:IFPower:HOLDoff.....	805
TRIGger<n>[:SEQuence]:IFPower:HYSteresis.....	805
TRIGger<n>[:SEQuence]:LEVel:IFPower.....	806
TRIGger<n>[:SEQuence]:LEVel:RFPower.....	806
TRIGger<n>[:SEQuence]:LEVel:VIDeo.....	806
TRIGger<n>[:SEQuence]:LEVel[:EXTernal].....	805
TRIGger<n>[:SEQuence]:SLOPe.....	807
TRIGger<n>[:SEQuence]:SOURce.....	807
TRIGger<n>[:SEQuence]:TIME:RINterval.....	808
UNIT:THD.....	757
UNIT<n>:POWer.....	814

# Index

## Symbols

*OPC .....	544
*OPC? .....	544
*RST .....	563
*WAI .....	544
6 dB bandwidth .....	142
9.91E37	
Remote control .....	542
75 Ω (enhancement label) .....	63, 64

## A

AC supply fuse .....	40
ACLR	
absolute limit .....	218
adjacent channel name (remote control) .....	699
alternate channel name (remote control) .....	700
Channel Bandwidth .....	214
channel name (remote control) .....	700
channel names .....	216
Channel Spacing .....	215
limit check .....	217
Limit Checking .....	217
number of channels .....	213
reference .....	215
relative limit .....	218
Weighting Filter .....	216
ACLR User Standard .....	220
Delete .....	221
Load .....	221
Save .....	221
Acquisition time	
Statistics .....	284
ACT	
Statistics .....	284
Active probes	
Activating .....	355
Configuring .....	357
Connecting .....	356
State .....	358
Using .....	356
Administrator rights .....	58
Aligning	
Touchscreen .....	47
Alignment	
Results .....	483
Touch screen .....	483
Alphanumeric parameters .....	76
AM demodulation .....	391
AM modulation .....	450, 470
depth .....	307
Depth .....	200
AM Modulation depth	
Measurement .....	307
Results .....	307
Amplitude	
Menu .....	322
Amplitude distribution .....	282
AMPT key .....	322
Analysis	
Bandwidth, definition .....	445
Annotation .....	492

AP (trace information) .....	65
Application cards .....	24
Application notes .....	24
APX	
tracking generator .....	463, 471
Arrow Keys .....	72
ASCII Trace export .....	370
Att (hardware setting) .....	63
Attenuation	
Automatic .....	325, 438
Manual .....	157
Audio demodulation	
volume (remote control) .....	891
Auto adjustment	
triggered measurement .....	797
Auto level	
Hysteresis .....	329
Auto Peak detector .....	370
Auto peak search .....	275, 279
AUTO SET key .....	327
Automatic loading	
Settings .....	115
AUX PORT	
Connector .....	35
AV (trace information) .....	65
Average detector .....	370
Average trace mode .....	361
averaging	
continuous sweep .....	368
single sweep .....	368
sweep count .....	368

## B

Band Power	
remote control .....	853, 855
softkey .....	395
Bandwidth .....	142
Maximum usable .....	445
Menu .....	331
Occupied .....	228
Resolution .....	332, 351
Video .....	332
Baseband power	
Trigger mode .....	347, 442
Blank trace mode .....	148, 361
Block data .....	540
Boolean parameters .....	539
Brackets .....	540
Brochures .....	24
BW key .....	331

## C

CA (trace information) .....	65
calibration	
reflection measurement .....	464
tracking generator .....	463
transmission measurement .....	448, 464
Calibration	
Remote .....	883
Canceling entry .....	71

- Case-sensitivity
    - SCPI ..... 536
  - Center frequency ..... 316
    - Step size ..... 316
  - channel
    - bandwidth ..... 214, 231
    - number ..... 213
    - spacing ..... 215
  - Channel ..... 61
    - Bandwidth ..... 227, 434
  - Channel bar
    - Information ..... 63
  - Channel Power
    - Configuring ..... 207
    - Fast ACLR ..... 203
    - Measurement Repeatability ..... 203
    - Measurements ..... 201
    - Methods ..... 202
    - Performing ..... 207
    - Results ..... 205
  - CISPR bandwidth ..... 142, 277
  - Cleaning ..... 1038
  - Clear status
    - Remote ..... 884
  - Clear Write trace mode ..... 147, 360
  - CLRWR (trace information) ..... 65
  - CNT (marker functions) ..... 65, 381
  - Colon ..... 540
  - Color printout ..... 493
  - Color settings
    - Default ..... 492
  - Color setup dialog box ..... 493
  - Colors
    - Screen ..... 48
  - Comma ..... 540
  - Command sequence
    - recommendation ..... 563
    - Remote ..... 887
  - Commands ..... 526
    - Brackets ..... 540
    - Colon ..... 540
    - Comma ..... 540
    - Command line structure ..... 541
    - Common ..... 526
    - Double dagger ..... 540
    - GBIP, addressed ..... 533
    - GBIP, universal ..... 533
    - Instrument control ..... 526
    - Overlapping ..... 543
    - Question mark ..... 540
    - Quotation mark ..... 540
    - SCPI confirmed ..... 526
    - Sequential ..... 543
    - Syntax elements ..... 540
    - Tracking ..... 489
    - Vertical stroke ..... 540
    - White space ..... 540
  - Commands
    - Programming examples ..... 965
  - Common commands
    - Syntax ..... 535
  - Compatible mode (hardware setting) ..... 63
  - Computer name
    - Changing ..... 597, 1043
  - Concluding entry ..... 71
  - CONDition ..... 547
  - Connector
    - AC power supply ..... 33
    - AF output ..... 32
    - AUX PORT ..... 35
    - EXT TRIGGER / GATE IN ..... 34
    - GPIO interface ..... 34
    - IF/VIDEO ..... 35
    - LAN ..... 34
    - MONITOR (VGA) ..... 34
    - Noise source control ..... 31
    - OcXO ..... 36
    - Probe power ..... 31
    - REF IN ..... 34
    - REF OUT ..... 34
    - RF Input 50Ω ..... 31
    - Tracking generator ..... 32
    - TRIGGER OUTPUT ..... 35
    - USB ..... 31, 35
  - Connectors
    - Front panel ..... 30
  - Continuous sweep ..... 341
  - Controller ..... 524
  - Correction
    - inherent noise ..... 221, 326, 439
  - coupling
    - default settings ..... 336
  - Coupling
    - Resolution bandwidth ..... 332
    - Sweep time ..... 334, 342
    - Video bandwidth ..... 333
  - create folder ..... 506
- ## D
- Data Acquisition
    - Softkey ..... 431
  - Data sheets ..... 24
  - Date ..... 491
    - Setting ..... 46
  - DC power supply
    - Option B30 ..... 40
  - DCL ..... 533
  - DEF ..... 538
  - Default color settings ..... 492
  - default scalings of x- and y-axis ..... 290, 296
  - Default values
    - Remote ..... 886
  - definition of transducer factors ..... 988
  - delay
    - gate signal ..... 350
  - Delta markers ..... 176
  - Density
    - remote control ..... 852, 853, 854
    - softkey ..... 396
  - detector
    - overview ..... 370
  - Detector ..... 143
    - Auto Peak ..... 363
    - Autoselect ..... 362
    - Average ..... 363
    - CISPR Average ..... 363
    - Negative Peak ..... 363
    - Positive Peak ..... 363
    - Quasi Peak ..... 363
    - RMS ..... 363
    - RMS Average ..... 364
    - Sample ..... 363

- Device ID ..... 495
- Device-specific commands ..... 526
- DHCP ..... 594
- DHCP server
  - LAN configuration ..... 597
- Diagram area
  - Enhancement labels ..... 63
  - Hardware settings ..... 63
  - Status display ..... 66
  - Trace information ..... 65
- diagram header
  - tracking generator ..... 471
- Diagram title ..... 491
- Dialog boxes
  - Working with ..... 75
- Display
  - Date ..... 491
  - Enlarging ..... 84
  - maximized ..... 81, 949
  - Power-save mode ..... 494
  - split ..... 81, 949
  - Split screen ..... 81
  - Table ..... 81
  - Time ..... 491
  - Update Rate ..... 88
- Display Config
  - Softkey ..... 431
- Display lines ..... 188, 189
- display range
  - level ..... 288, 289, 294, 295, 323, 324, 436, 437
- Display range
  - Frequency ..... 316
- display settings
  - Softkey Bar State (remote control) ..... 948
  - Status Bar State (remote control) ..... 948
- DNS server
  - LAN configuration ..... 597
- Double dagger ..... 540
- DOWN ..... 538
- Dwell time ..... 276, 281
- Dynamic range
  - Intermodulation-free ..... 304
  - Measuring ..... 309
- E**
- Edit dialog box ..... 75
- Edit Limit Line dialog box ..... 192, 195
- Electrostatic discharge ..... 37
- EMI detector ..... 143
- EMI marker ..... 279
- EMI marker evaluation ..... 276, 281
- ENABLE ..... 547
- Enable registers
  - Remote ..... 885
- Enhancement labels ..... 63
- Entry
  - Canceling ..... 71
  - Concluding ..... 71
- error messages
  - device-specific ..... 1040
- Error messages ..... 1040
- Error queue ..... 550
- Error queues
  - recommendations ..... 563
- ESD ..... 37
- ESE (Event Status Enable register ) ..... 551
- ESR (Event Status Register) ..... 545, 551
- EVENT ..... 547
- Event status enable register (ESE)
  - Remote ..... 884
- Event Status Enable register (ESE) ..... 551
- Event status register (ESR)
  - Remote ..... 884
- Event Status Register (ESR) ..... 551
- Export
  - I/Q data (remote) ..... 916
- export format ..... 370
- Exporting
  - I/Q data (remote) ..... 916
- EXREF (status display) ..... 67
- Ext ..... 67
- EXT TRIGGER
  - Connector ..... 34
- external noise source ..... 355
- external trigger ..... 346, 441
- F**
- Fast ACLR ..... 203
- FFT Filter Mode
  - Auto ..... 330, 335, 343
  - Narrow ..... 330, 335, 343
  - softkey ..... 330, 335, 343
- file
  - copying ..... 506
  - deleting ..... 506
  - renaming ..... 506
- File Manager dialog box ..... 505
- Filter bandwidth
  - Baseband Digital ..... 431
  - Digital I/Q (remote control) ..... 857
- Filter type (EMI) ..... 277
- Filter types
  - 5-Pole ..... 337
  - Normal (3dB) ..... 337
  - RRC ..... 337
- Filters
  - Overview ..... 338
  - Selecting ..... 337
  - Types ..... 337
- Final evaluation ..... 276, 281
- Firmware
  - Options ..... 59
  - Update ..... 58
  - Version ..... 495
- fixed reference ..... 390
- FM demodulation ..... 391
- FM modulation ..... 450, 470
- Focus
  - Changing ..... 81
- folder
  - renaming ..... 506
- FREQ key ..... 315
- frequency
  - line ..... 190
  - offset ..... 318
  - reference ..... 46
  - start ..... 318
  - stop ..... 318
- Frequency
  - Axis ..... 315
  - Center ..... 316
  - Display ..... 492

- Lines ..... 189
    - tracking generator ..... 459
  - Frequency axis scaling ..... 277
  - Frequency Denominator
    - tracking generator ..... 460
  - Frequency Max.
    - tracking generator ..... 458, 463
  - Frequency menu ..... 315
  - Frequency Min.
    - tracking generator ..... 458, 463
  - Frequency Numerator
    - tracking generator ..... 460
  - Frequency Offset
    - tracking generator ..... 458, 460
  - FRQ
    - tracking generator ..... 471
  - Frq (enhancement label) ..... 64
  - Full screen
    - see Display, maximized ..... 81
  - Fuse ..... 40
  - FXD (marker functions) ..... 65, 381
- G**
- GAT (enhancement label) ..... 64
  - gate
    - delay ..... 350
    - length ..... 351
    - ranges ..... 298
  - Gate
    - External/internal ..... 349
    - MODE <mode> ..... 350
  - GATE IN
    - Connector ..... 34
  - gated statistics
    - configuration ..... 298
    - configuration example ..... 300
    - example ..... 300
  - gated trigger ..... 298
  - generator type
    - tracking generator ..... 461
  - GET ..... 533
  - Getting started ..... 23
  - GPIB
    - Address ..... 533
    - Characteristics ..... 530
    - interface messages ..... 531
    - Remote control interface ..... 524
    - tracking generator ..... 462
  - GPIB bus control
    - Remote ..... 885
  - GPIB interface
    - Configuring ..... 57, 592
    - Connector ..... 34
  - GPIB Language ..... 1008
  - GTL ..... 533
- H**
- Hardware information dialog box ..... 495
  - Hardware settings
    - Display ..... 63
  - Harmonic Distortion
    - Measurement ..... 308
    - Results ..... 311
  - Harmonics
    - Measurement ..... 201, 311
  - HiSLIP
    - Protocol ..... 528
    - Resource string ..... 527
  - HOME key ..... 118
  - HP emulation ..... 1007
  - Hysteresis
    - Lower (Auto level) ..... 329
    - Upper (Auto level) ..... 329
- I**
- I/Q Analyzer
    - Softkey ..... 430
  - I/Q data
    - Export (remote control) ..... 916
    - Import (remote control) ..... 857
    - Maximum bandwidth ..... 445
    - Sample rate ..... 445
    - trigger point in sample (TPIS) ..... 867
  - I/Q data acquisition ..... 989
  - I/Q Gating
    - edge triggered ..... 867
    - level triggered ..... 867
  - I/Q modulation ..... 450, 470
  - I/Q-Vector
    - I/Q Analyzer ..... 431
  - Icons
    - Toolbar ..... 68
  - ID String User ..... 1008
  - Identification
    - Remote ..... 884
  - IECWIN ..... 563
    - Accessing ..... 57
  - IF power
    - Trigger mode ..... 347, 442
  - IF/VIDEO
    - Connector ..... 35
  - IFC ..... 533
  - IFOVL
    - tracking generator ..... 463, 471
  - IFOVL (status display) ..... 67
  - Impedance
    - Input ..... 160, 326, 439
  - Importing
    - I/Q data (remote) ..... 857
  - INF ..... 538
  - Inherent noise
    - correction ..... 221, 326, 439
  - initial configuration ..... 314
  - Input sample rate (ISR)
    - Definition ..... 445
  - Input/Output menu ..... 354
  - Instrument messages ..... 526
  - Interface
    - LAN ..... 1042
  - Interface functions
    - RSIB ..... 530
  - Interface messages ..... 526
  - Interfaces
    - GPIB ..... 530
  - intermodulation product ..... 301
  - Interrupt ..... 560
  - Invalid results
    - Remote control ..... 542
  - IP address ..... 527
    - Changing ..... 594



- IP configuration
  - LXI ..... 599
- IQ Export
  - Softkey ..... 505
- IQ Import
  - Softkey ..... 505
- IST ..... 545
- IST flag ..... 550
  - Remote ..... 884
- K**
- key
  - AMPT ..... 322
  - AUTO SET ..... 327
  - BW ..... 331
  - DISPLAY ..... 949
  - ESC ..... 686
  - LINES ..... 184, 401
  - MEAS ..... 198
  - MEAS CONFIG ..... 312
  - MKR FUNC ..... 387
  - MKR-> ..... 180
  - MKR→ ..... 382
  - PEAK SEARCH ..... 386
  - PRESET ..... 313, 890
  - PRINT ..... 514
  - RUN CONT ..... 312
  - RUN SINGLE ..... 312
  - SAVE/RCL ..... 500
  - SETUP ..... 475
  - SPAN ..... 320
  - SWEEP ..... 340
  - TRACE ..... 174, 358
  - TRIG ..... 345
  - USER ..... 474
- Key
  - Alphanumeric ..... 71
  - BACK ..... 71
  - Decimal point ..... 71
  - DNARROW ..... 72
  - ENTER ..... 71
  - ESC/CANCEL ..... 71
  - FREQ ..... 315
  - GHz/dBm ..... 71
  - HOME ..... 73, 118
  - Hz/-dB ..... 71
  - kHz/dB ..... 71
  - LEFTARROW ..... 72
  - MKR ..... 176
  - MODE ..... 117
  - REDO ..... 73
  - RIGHTARROW ..... 72
  - Sign ..... 71
  - UNDO ..... 73
  - Unit ..... 71
  - UPARROW ..... 72
- Keyboard
  - On-screen ..... 70
- Keys
  - SPLIT/MAXIMIZE key ..... 81
- Keywords
  - see Mnemonics ..... 535
- L**
- labels
  - tracking generator ..... 471
- LAN
  - Configuration ..... 592
  - Configuring ..... 598
  - Connector ..... 34
  - Interface ..... 527
  - IP address ..... 527
  - Remote control interface ..... 524
  - RSIB protocol ..... 529
  - VISA ..... 527
  - VXI protocol ..... 528
- LAN interface ..... 1042
- level
  - axis ..... 325, 438
  - display range ... 288, 289, 294, 295, 323, 324, 436, 437
  - range ..... 288, 289, 294, 295, 323, 324, 436, 437
  - trigger ..... 348
- Level
  - Reference ..... 323, 435
  - Softkey ..... 431
- limit
  - ACLR measurement ..... 218
- Limit
  - Evaluation range ..... 272
- limit check
  - ACLR measurement ..... 217
- limit line ..... 190
  - scaling ..... 193
  - shift ..... 195
  - span setting ..... 193
- Limit lines
  - Copying ..... 187
  - Deleting ..... 188
  - Editing ..... 187, 195
  - New ..... 186
  - Offset ..... 188
  - Recalling ..... 500
  - Saving ..... 500
  - Spurious Emissions ..... 262
  - Time Domain Power measurement ..... 271
- line
  - frequency ..... 190
  - limit ..... 190
  - threshold ..... 182, 394
  - time ..... 190
- Linear scaling ..... 277
- Lines
  - display ..... 189
  - Frequency (Frequency Line 1, 2) ..... 189
  - Menu ..... 185
  - Time (Time Line 1, 2) ..... 189
- LINES key ..... 184, 401
- LISN ..... 149, 278
- LLO ..... 533
- LO exclude ..... 383
- Loading
  - Instrument configuration ..... 115
  - Measurement data ..... 115
- local menu ..... 473
- Logarithmic scaling ..... 277
- Login
  - Operating system ..... 54
- Logo ..... 491
- LOUNL (status display) ..... 67

- Lower Level Hysteresis
  - Softkey ..... 329
- LVL
  - tracking generator ..... 471
- LXI
  - Browser interface ..... 598
  - LAN configuration ..... 599
  - Ping ..... 600
- M**
- Magnitude
  - I/Q Analyzer ..... 431
- maintenance ..... 1038
- Maintenance ..... 42
- Malfunctions
  - reacting ..... 563
- manual operation ..... 473
  - changing to ..... 473
- Manual peak search ..... 275
- marker
  - center frequency to ..... 383
  - peak ..... 181
  - reference level to ..... 383
  - search limit ..... 182
- Marker
  - Zoom ..... 379
- Marker Function menu ..... 387
- Marker Number
  - softkey ..... 395
- Marker Peak List
  - Activating/Deactivating ..... 393
  - Configuring ..... 393
  - Number display ..... 395
  - Number of entries ..... 393
- Marker table ..... 281
- Marker wizard ..... 279
- Marker Wizard
  - softkey ..... 178
- Markers ..... 176
  - Field ..... 176
  - Set to trace ..... 178
  - Signal track ..... 319
- MAX ..... 538
- Max Hold trace mode ..... 147, 361
- Max Peak Count
  - softkey ..... 393
- MAXH (trace information) ..... 65
- maximum search ..... 181
- maximum value ..... 272
- MC-ACLR ..... 212
- Mean power (GSM burst) ..... 272
- MEAS CONFIG key ..... 312
- MEAS key ..... 198
- Meas Time
  - Baseband Digital ..... 431
- measurement
  - reflection ..... 465
  - transmission ..... 465
- measurement accuracy
  - tracking generator ..... 463
- Measurement data
  - Loading ..... 115
  - Storing ..... 115
- measurement example
  - amplitude distribution ..... 426
  - harmonics ..... 402
  - high-sensitivity harmonics ..... 310
  - intermodulation ..... 301
  - modulated signals ..... 419
  - noise ..... 412
  - signals in the vicinity of noise ..... 407
  - spectra of complex signals ..... 404
  - test setup ..... 401
- Measurement example
  - AF of AM-modulated signal ..... 101
  - AF of FM-modulated signal ..... 110
  - AM modulation ..... 100
  - First and second harmonic ..... 93
  - Level and frequency ..... 89
  - Power of burst signals ..... 103
  - Separating signals ..... 96
  - Signal frequency using frequency counter ..... 91
  - Signal-to-noise ratio ..... 107
- Measurement menu ..... 198
- Measurement modes
  - Changing ..... 117
  - Displaying main menus ..... 118
- Measurement time ..... 281
- menu
  - Auto Set ..... 327
  - Input/Output ..... 354
  - Marker Function ..... 387
  - Phase Noise ..... 389
  - Print ..... 514
  - SAVE/RCL ..... 501
  - Span ..... 321
  - Sweep ..... 340
  - Trigger ..... 345, 440
  - User ..... 474
- Menu
  - Amplitude ..... 322
  - Bandwidth ..... 331
  - Frequency ..... 315
  - Lines ..... 185
  - Meas ..... 198
  - Setup ..... 476
- Messages
  - Commands ..... 526
  - Instrument ..... 526
  - Instrument responses ..... 527
  - Interface ..... 526
- MI (trace information) ..... 65
- MIL Std bandwidth ..... 277
- MIN ..... 538
- Min Hold trace mode ..... 148, 361
- MINH (trace information) ..... 65
- Mini Front Panel ..... 81
- minimum search ..... 181
- MKR FUNC key ..... 387
- MKR key ..... 176
- MKR-> key ..... 180
- MKR→ key ..... 382
- Mnemonics ..... 535
  - Optional ..... 537
- MOD (marker functions) ..... 66, 381
- mode
  - trigger ..... 346, 441
- Mode
  - see also Measurement modes ..... 117
  - Mode (hardware setting) ..... 63
  - MODE key ..... 117
- Modulation
  - Depth ..... 200, 307

- Modulation depth ..... 307
  - Modulation index ..... 307
  - MONITOR (VGA)
    - Connector ..... 34
  - More
    - Softkey ..... 73
  - More Traces
    - softkey ..... 175
  - MT (hardware setting) ..... 62
  - Multi-carrier
    - ACLR ..... 212
  - multi-carrier ACLR measurement ..... 202
  - Multiple signals measurement ..... 96
- N**
- n dB down
    - marker function ..... 392
  - NAN ..... 538
  - NAN (not a number)
    - Remote control ..... 542
  - NCoR (enhancement label) ..... 64
  - Negative Peak detector ..... 370
  - Network ..... 600, 1042
    - Automatic logon ..... 1045
    - Changing configuration ..... 1043
    - Changing user passwords ..... 602, 1045
    - Connecting drives ..... 602, 1047
    - Creating users ..... 601, 1045
    - Disconnecting drives ..... 602, 1047
    - Setting up ..... 565
    - Sharing directories ..... 604, 1048
  - NINF ..... 538
  - NOI (marker functions) ..... 66, 381
  - noise
    - correction ..... 221, 326, 439
    - source, external ..... 355
  - Noise source control
    - Connector ..... 31
  - NOR
    - tracking generator ..... 463, 471
  - normalization ..... 449, 465
    - tracking generator ..... 471
  - NTRansition ..... 547
  - Numeric parameters ..... 76, 538
  - Numeric values
    - Special ..... 538
- O**
- OBW
    - Multi-carrier signal ..... 229
    - Search limits ..... 229
  - Occupied bandwidth ..... 228
  - OCXO ..... 42
    - Connector ..... 36
  - offset
    - frequency ..... 318
    - gate signal ..... 350
    - reference level ..... 325, 438
  - Offset
    - Limit line ..... 188
    - Trigger ..... 349, 443
  - Offset (hardware setting) ..... 63
  - On-screen keyboard ..... 70
  - Online help
    - Working with ..... 20
  - Operating system ..... 53
    - Login ..... 54
    - service packs ..... 54
  - Operation complete
    - Remote ..... 885
  - Options
    - Activating ..... 59
    - B30 ..... 40
    - Identification (remote) ..... 885
    - Installed ..... 495
    - Licenses ..... 59
    - RF Preamplifier (B22) ..... 157, 325, 431, 438
  - Output
    - Sample rate, definition ..... 445
  - Output buffer ..... 545
  - OVEN (status display) ..... 67
  - Overlapping commands ..... 543
    - Preventing ..... 544
  - overload
    - tracking generator ..... 463
  - Overwrite mode ..... 147, 360
  - OVLd
    - tracking generator ..... 463, 471
  - OVLd (status display) ..... 67
- P**
- Pa (enhancement label) ..... 64
  - packing ..... 1039
  - Paint
    - Accessing ..... 57
  - Parallel poll register enable
    - Remote ..... 885
  - Parameters
    - Block data ..... 540
    - Boolean ..... 539
    - Entering ..... 76
    - Numeric values ..... 538
    - SCPI ..... 537
    - Special numeric values ..... 538
    - String ..... 539
    - Text ..... 539
  - Passwords
    - Changing ..... 602, 1045
  - path ..... 502
  - Peak List On/Off
    - softkey ..... 393
  - Peak search ..... 275, 279
  - PEAK SEARCH key ..... 386
  - PEAKSEARCH ..... 181
  - Ph. Noise Auto Peak Search
    - remote control ..... 840
  - Phase ..... 149, 278
  - PHN (marker functions) ..... 65, 381
  - Ping ..... 600
  - PK (trace information) ..... 65
  - polarity
    - external trigger ..... 443
    - external trigger/gate ..... 348
    - trigger edge ..... 348, 443
  - Ports
    - User ..... 901
  - Positive Peak detector ..... 370
  - power
    - bandwidth percentage ..... 231

- Power
    - Mean ..... 272
    - remote control ..... 852, 853, 854
    - Remote control ..... 854
    - softkey ..... 395
  - power cables ..... 1039
  - Power Classes
    - SEM ..... 242
  - Power Max.
    - tracking generator ..... 458, 463
  - power measurement ..... 198
    - trace ..... 219
    - zero span ..... 270
  - Power measurement
    - Occupied bandwidth ..... 228
  - Power Min.
    - tracking generator ..... 458, 463
  - Power Offset
    - tracking generator ..... 457, 460
  - Power supply
    - Connector ..... 33
    - Switching on ..... 41
  - power sweep
    - tracking generator ..... 451
  - PPC ..... 533
  - PPE ..... 545
  - PPE register ..... 550
  - PPU ..... 533
  - pre-trigger ..... 349, 443
  - Preamplifier (B22) ..... 157, 325, 431, 438
  - preset instrument ..... 313
  - PRESET key ..... 313
  - print
    - screen ..... 514
  - PRINT key ..... 514
  - Print menu ..... 514
  - Printers
    - Selecting ..... 51
  - Printers and Faxes window ..... 516
  - Probe power
    - Connector ..... 31
  - Probes
    - Activating ..... 355
    - Active ..... 356
    - Configuration (Softkey) ..... 355
  - programming examples
    - averaging I/Q data ..... 999
    - channel power measurement ..... 978
    - I/Q data ..... 989
    - level measurement ..... 986
    - limit lines and limit test ..... 976
    - occupied bandwidth measurement ..... 981
    - power ramp measurement ..... 983
    - reading files ..... 991
    - Spectrum Emission Mask measurement ..... 992
    - Spurious Emissions measurement ..... 996
    - time domain power measurement ..... 982
    - transducers ..... 988
    - writing files ..... 992
  - Programming examples
    - Service request ..... 967
  - Protocol
    - RSIB ..... 529
    - VXI ..... 528
  - PTRansition ..... 547
- Q**
- QP (trace information) ..... 65
  - Queries ..... 526, 542
    - Status ..... 561
  - Question mark ..... 540, 542
  - Quotation mark ..... 540
- R**
- R&S Digital I/Q Interface (B17)
    - settings (remote control) ..... 858
  - RA (trace information) ..... 65
  - Rackmounting ..... 40
  - RBW (hardware setting) ..... 63
  - Ready for trigger
    - Status register ..... 557
  - Real/Imag (I/Q)
    - I/Q Analyzer ..... 431
  - Rebooting
    - Remote control ..... 891
  - Recall dialog box ..... 503, 507
  - Recalling
    - Settings ..... 507
  - Recommendations
    - remote control programming ..... 563
  - Record Length
    - Baseband Digital ..... 431
  - Ref (hardware setting) ..... 63
  - REF IN
    - Connector ..... 34
  - REF OUT
    - Connector ..... 34
  - reference
    - external ..... 46
    - fixed ..... 390
    - internal ..... 46
    - level to marker level ..... 383
    - tracking generator ..... 462
    - value (channel power) ..... 220
  - Reference
    - External ..... 478
    - Internal ..... 478
  - Reference frequency
    - OCXO ..... 36
  - reference level
    - channel power ..... 222
    - offset ..... 325, 438
    - to marker level ..... 383
  - Reference level ..... 323, 435
  - Reference Level
    - Baseband Digital ..... 431
  - reference point
    - frequency ..... 389, 390
    - level ..... 389, 390
    - peak search ..... 389, 391
    - time ..... 389, 390
  - reflection measurement ..... 465
    - calibration ..... 464
  - Registers ..... 545
  - Release notes ..... 24
  - remote ..... 866
  - remote control
    - changing to ..... 473
  - Remote control
    - Basics ..... 524
    - Command synchronization ..... 578

- Configuration ..... 565, 1049
- Deactivating the instrument ..... 571, 1055
- Display power save ..... 576
- Ending session ..... 569, 1054
- Global variables ..... 575
- GPIO address ..... 533
- Improving performance ..... 88
- Initialization ..... 575
- Instrument settings ..... 577
- Interfaces ..... 524
- Library ..... 572
- Programming examples ..... 965
- Protocols ..... 524
- Sending commands ..... 576
- Setting up a connection ..... 569, 1054
- Starting ..... 534
- Stopping ..... 535
- Switching screen display on and off ..... 576
- Using markers ..... 577
- VNC ..... 571, 1053
- Remote control programming example
  - Changing default settings ..... 579
  - Printout ..... 589
  - Reading out trace data ..... 586
  - Storing and loading settings ..... 588
  - Using markers and delta markers ..... 581
- Remote operation
  - Setting up ..... 565
- Repetition interval
  - Time trigger ..... 349, 444
- Report ..... 517
- reset
  - switch on or off ..... 362
- Reset values
  - Remote ..... 886
- Resolution bandwidth ..... 332, 351
- Resolution bandwidth (EMI) ..... 277
- Result Frequency Start
  - tracking generator ..... 458, 461
- Result Frequency Stop
  - tracking generator ..... 458, 461
- REV string factory
  - Softkey ..... 488
- REV string user
  - Softkey ..... 488
- RF Input
  - Active probes ..... 356
- RF Power trigger ..... 347, 441
- RF Preamplifier (B22) ..... 157, 325, 431, 438
- RM (trace information) ..... 65
- RMS
  - VBW ..... 333, 370
- RMS detector ..... 370
- RMS value ..... 272
- Rotary knob ..... 72
- RSIB
  - interface functions ..... 530
  - protocol ..... 529
- RUN CONT key ..... 312
- RUN SINGLE key ..... 312
- S**
- SA (trace information) ..... 65
- Safety instructions ..... 24
- Sample detector ..... 370
- sample number ..... 288, 293
- Sample rate
  - Definition ..... 445
  - Maximum ..... 445
- Sample Rate
  - I/Q Analyzer ..... 431
- Samples
  - Statistics ..... 284
- Save dialog box ..... 502, 507
- SAVE/RCL key ..... 500
- SAVE/RCL menu ..... 501
- Saving
  - Results ..... 507
- scalar reflection measurement ..... 465
- scaling
  - level axis ..... 326, 439
  - x- and y-axis (signal statistic) ..... 288, 294
- SCPI
  - Parameters ..... 537
  - Syntax ..... 535
  - Version ..... 525
- SCPI confirmed commands ..... 526
- Screen
  - Colors ..... 48
- SDC ..... 533
- search
  - minimum ..... 181
  - peak ..... 181
  - range ..... 182
- Search
  - Bandwidth ..... 319
- Search limits
  - OBW ..... 229
- Search Settings
  - softkey (B17) ..... 440
- Select Limit Line dialog box ..... 195
- Select screen color set dialog box ..... 492
- Self test ..... 498
- Self-test
  - Remote ..... 886
- SEM
  - Results ..... 244
- sensitivity
  - APD measurement ..... 291, 292, 297, 298
  - CCDF measurement ..... 291, 292, 297, 298
- Sequential commands ..... 543
- Service manual ..... 23
- Service packs ..... 54
- Service request (SRQ) ..... 549, 550, 560
- Service request enable register (SRE) ..... 549
  - Remote ..... 886
- Setting commands ..... 526
- Settings
  - Automatic loading ..... 115
  - Loading ..... 115
  - Recalling ..... 507
  - Saving ..... 507
  - Storing ..... 114
- setup
  - general ..... 483
- SETUP key ..... 475
- Setup menu ..... 476
- Sgl (enhancement label) ..... 64
- shutdown
  - remote control ..... 891
- signal count ..... 388

Signal Source		
I/Q Analyzer	430	
Softkey	430	
Signal tracking	319	
Search bandwidth	319	
Sinusoidal signal measurements	89	
Harmonics	93	
Soft Front Panel	81	
mini	81	
softkey	219, 231	
-	291, 292, 297, 298	
(remote control)	879, 880	
# of Adj Chan	213	
# of Adj Chan (remote control)	698	
# of Samples	288, 293	
# of Samples (remote control)	761	
# of TX Chan	213	
# of TX Chan (remote control)	701	
% Power Bandwidth	231	
% Power Bandwidth (remote control)	717	
= Center	317	
= Marker	317	
0.1 * RBW	316	
0.1 * RBW (remote control)	791, 792	
0.1 * Span	316	
0.1 * Span (remote control)	791, 792	
0.1*Demod BW (K7)	316	
0.5 * RBW	317	
0.5 * RBW (remote control)	791, 792	
0.5 * Span	317	
0.5 * Span (remote control)	791, 792	
0.5*Demod BW (K7)	317	
ACLR Abs/Rel	219	
ACLR Abs/Rel (remote control)	714	
ACLR Ref Setting (remote control)	704	
ACLR Ref Spacing (remote control)	705	
Active On/Off (remote control)	921	
Adjust Ref Level	222	
Adjust Ref Level (remote control)	694	
Adjust Ref Lvl	231	
Adjust Settings (remote control)	693, 765	
All Functions off	200, 201	
All Functions off (remote control)	767	
All Marker Off	179	
AM (remote control)	843	
Ampere	325, 438	
APD (remote control)	760, 762	
Application Setup Recovery(remote control)	888	
ASCII File Export	240, 394	
ASCII File Export (remote control)	745	
ASCII Trace Export	175, 504	
ASCII Trace Export (remote control)	718	
Auto (remote control)	803	
Auto All	328	
Auto Max Peak	383	
Auto Max Peak (remote control)	831	
Auto Min Peak	383	
Auto Min Peak (remote control)	831	
Average Mode (remote control)	820	
Band Power	395	
Band Power On/Off	395	
C/N (remote control)	688, 689	
C/No (remote control)	688, 689	
Calibrate Reflection Open	448	
Calibrate Reflection Short	448	
Calibrate Transmission	448	
Calibration Frequency RF	904	
CCDF (remote control)	760, 762	
Center =Mkr Freq	383	
Center =Mkr Freq (remote control)	656	
CF StepSize (remote control)	634	
Chan Pwr/Hz	218	
Chan Pwr/Hz (remote control)	714	
Channel Bandwidth	231	
Channel Bandwidth (remote control)	698, 699	
Channel Settings	213	
Channel Spacing (remote control)	700, 701	
Clear All Messages (remote control)	894, 895	
Clear/Write	218	
Color (On/Off)	516	
Color On/Off (remote control)	929	
Colors	515	
Comment	516	
Cont Demod (remote control)	842	
Continue Single Sweep (remote control)	801	
Copy	506	
Copy (remote control)	910	
Copy to (remote control)	675	
Copy Trace	175	
Copy Trace (remote control)	822	
Corr Data On/Off (remote control)	903, 904	
Coupling (FSx/HP)(remote control)	960	
Coupling Ratio	335	
CP, ACP, MC-ACLR (remote control)	688, 689	
CP/ACLR Config	213	
CP/ACLR Standard	212	
Current File List (1/2)	506	
Cut	506	
Date	506	
dBm	325, 438	
dBmV	325, 438	
dBpW	325, 438	
dBμA	325, 438	
dBμV	325, 438	
Decim Sep	176, 241, 270, 395, 505	
Default Coupling	336	
Default Settings	290, 296	
Default Settings (remote control)	764, 766	
Delete	506	
Delete (remote control)	675, 911, 913, 920	
Delete File	503	
Delete File (remote control)	914	
Delete Range	238, 268	
Delete Range (remote control)	732	
Density	396	
Description	958	
Detector Auto Select (remote control)	821	
Detector Manual Select (remote control)	821	
Deviation Lin/Log (remote control)	636	
Device (1/2)	515	
Device 1/2 (remote control)	913	
Device Setup	515	
Device Setup (remote control)	928, 929, 931, 933	
Disable all Items	503	
Disable all Items (remote control)	953	
Disconnect Network Drive	507	
Disconnect Network Drive (remote control)	955	
Display Line 1 (remote control)	672	
Display Line 2 (remote control)	672	
Edit (remote control)	674, 676, 678, 679, 683, 685, 919	
Edit ACLR Limit (remote control)	706, 707, 708, 709, 710, 711	
Edit Comment	502	
Edit File Name	502	

- Edit Name (remote control) ..... 921
- Edit Path ..... 505
- Edit Path (remote control) ..... 910, 912
- Edit Power Classes ..... 242
- Edit Reference Range ..... 239, 241
- Edit Reference Range (remote control) ..... 739, 740
- Edit Unit (remote control) ..... 921
- Edit Values (remote control) ..... 920
- Enable all Items ..... 503
- Enable all Items (remote control) ..... 952
- Exclude LO (remote control) ..... 831
- Export ..... 504
- Extension ..... 506
- External ..... 346, 441
- External AM ..... 450, 470
- External AM (remote control) ..... 871
- External FM ..... 450, 470
- External FM (remote control) ..... 872
- External I/Q ..... 450
- External IQ (remote control) ..... 871
- Fast ACLR On/Off ..... 220
- Fast ACLR On/Off (remote control) ..... 715
- File Lists (1/2) ..... 506
- File Manager ..... 505
- Filter Type ..... 276, 337
- Filter Type (remote control) ..... 640, 799
- Firmware Update (remote control) ..... 889
- FM (remote control) ..... 843
- Free Run ..... 346, 441
- Frequency Line 1 (remote control) ..... 673
- Frequency Line 2 (remote control) ..... 673
- Frequency Offset ..... 318
- Full Span (remote control) ..... 793
- Gate Delay (remote control) ..... 809
- Gate Length (remote control) ..... 810
- Gate Mode Lvl/Edge (remote control) ..... 804, 811
- Gate Ranges ..... 291, 297
- Gate Ranges (remote control) ..... 762, 763, 764
- Gated Trigger (On/Off) ..... 291, 297
- Gated Trigger (remote control) ..... 809, 810
- GPIO Address (remote control) ..... 957
- GPIO Language (remote control) ..... 960
- GPIO Terminator LFEOI/EOI (remote control) ..... 957
- Grid Abs/Rel ..... 326, 439
- Grid Abs/Rel (remote control) ..... 812
- Hardware Info (remote control) ..... 893
- Hold/Cont ..... 362
- ID String Factory (remote control) ..... 894, 959
- ID String User (remote control) ..... 894
- IF Gain (Norm/Puls)(remote control) ..... 961
- IF Output IF/Video (remote control) ..... 900
- Import ..... 505
- Info ..... 957
- Input 50 W/75 W (remote control) ..... 638
- Input RF/Cal/TG (remote control) ..... 905
- Insert after Range ..... 238, 268
- Insert after Range (remote control) ..... 735
- Insert before Range ..... 238, 268
- Insert before Range (remote control) ..... 735
- Install Printer ..... 516
- Installed Options (remote control) ..... 893
- Interpolation Lin/Log (remote control) ..... 920
- LAN Reset ..... 958
- Last Span ..... 156
- Left Limit ..... 182, 394
- Left Limit (remote control) ..... 658
- Limit Chk On/Off (remote control) ..... 708, 712, 713
- Limit Line Select dialog box (remote control) .... 682, 685
- Limits On/Off (remote control) ..... 659
- Lin ..... 364, 365
- Link Mkr1 and Delta1 ..... 379
- Link Mrk1 and Delta1 (remote control) ..... 666
- List Evaluation ..... 239
- List Evaluation On/Off ..... 240
- List Evaluation On/Off (remote control) ..... 745
- Load Standard ..... 243
- Local ..... 473
- Log ..... 366
- Manual ..... 318
- Manual (remote control) ..... 634
- Map Network Drive ..... 507
- Map Network Drive (remote control) ..... 956
- Margin ..... 240
- Margin (remote control) ..... 745
- Marker 1 (remote control) ..... 669
- Marker 1 to 4 (remote control) ..... 663, 664, 670, 671
- Marker 1-16 ..... 177, 306, 308
- Marker 1, Marker 2 ... 16 ..... 177, 306, 308
- Marker 2 (remote control) ..... 669
- Marker 3 (remote control) ..... 669
- Marker 4 (remote control) ..... 669
- Marker List (remote control) ..... 848
- Marker Norm/Delta ..... 177, 306, 308
- Marker Norm/Delta (remote control) ..... 669
- Marker Stepsize ..... 378
- Marker Stepsize (remote control) ..... 832
- Marker Table (Off/On/Aut) (remote control) ..... 834
- Marker Table (On/Off) ..... 179
- Marker to Trace (remote control) ..... 670, 835
- Marker Wizard ..... 178
- Marker Zoom (remote control) ..... 657
- Max Hold ..... 219
- Mean (remote control) ..... 771, 772
- Meas Start/Stop ..... 243
- Meas Start/Stop (remote control) ..... 717, 729
- Meas Time Auto ..... 329, 797
- Meas Time Manual ..... 329, 796, 797
- Min ..... 181
- Min (remote control) ..... 662, 668
- Mkr Demod On/Off (remote control) ..... 843
- Mkr List On/Off (remote control) ..... 848
- Mkr Stop Time (remote control) ..... 842
- Modulation ..... 450
- Modulation OFF ..... 450
- More Markers ..... 178
- n dB down ..... 392
- n dB down (remote control) ..... 844, 845, 846
- Name ..... 506
- Name (remote control) ..... 675
- Network Drive ..... 507
- New (remote control) ..... 674, 676, 678, 679, 683, 685
- New Folder ..... 505
- New Folder (remote control) ..... 912
- Next Min ..... 181
- Next Min (remote control) ..... 662, 663, 668
- Next Mode </abs/> ..... 181
- Next Peak ..... 181
- Next Peak (remote control) ..... 660, 661, 662, 663, 666, 667, 668, 669
- Noise Correction ..... 221, 326, 439
- Noise Meas On/Off ..... 389
- Noise Meas On/Off (remote control) ..... 839, 840
- Noise Source ..... 355
- Noise Src On/Off (remote control) ..... 899

Normalize	449	Ref Point Time (remote control)	836
NORMALIZE	465	Ref Value (remote control)	857
OBW (remote control)	688	Ref Value Position (remote control)	814
Password	958	Reference Fixed On/Off	390
Password (remote control)	907	Reference Int/Ext (remote control)	879, 902
Paste	506	Reference Position (remote control)	814
Peak	181	Reference Value	449
Peak (remote control)	661, 667, 773, 774	Reference Value Position	449
Peak Excursion	183, 394	Rename	506
Peak Excursion (remote control)	647	Rename (remote control)	912
Peak Search	389, 391	Res BW	287, 293
Peak Search (remote control)	835, 848, 850, 851	Res BW (remote control)	639
Percent Marker	293, 761	Res BW Auto (remote control)	798, 799
Percent Marker (remote control)	833	Res BW Manual (remote control)	639, 798
Ph Noise On/Off (remote control)	837, 841	Restore Standard Files	243
Ph Noise/Ref Fixed (remote control)	837, 841	Right Limit	182, 394
Phase Noise	389	Right Limit (remote control)	658
Phase Noise Auto Peak Search	390	RMS (remote control)	776
Phase Noise On/Off	389	Save	502
Power	365, 366, 395	Save As Standard	243
Power Mode	218	Save As Standard (remote control)	728
Power Mode (remote control)	692	Save As Trd Factor	450
Power Sensor	354	Save Evaluation List	240
Power Sweep	451	Save Evaluation List (remote control)	745
Power Sweep (On /Off)	451	Save File	502
Power Sweep (On/Off) (remote control)	874	Save File (remote control)	916, 917
Power Sweep Start	451, 874	Scaling	288, 294
Power Sweep Start (remote control)	874	Screen Colors (remote control)	927
Power Sweep Stop	451	ScreenShot	504
Power Sweep Stop (remote control)	875	Search Lim Off	183
Predefined Colors	516	Search Lim Off (remote control)	659, 833
Predefined Colors (remote control)	928	Search Limits	182
Print Screen	514	Search Limits (remote control)	659
Print Screen (remote control)	913, 930, 931, 932	Select 1 2 3 4 (remote control)	663
Range	323, 436	Select Dataset	504
Range Lin. Unit	290, 296, 325, 437	Select Directory (remote control)	921
Range Lin. Unit (remote control)	636	Select File	502
Range Linear %	289, 295, 324, 437	Select Items	502
Range Linear % (remote control)	636	Select Items (remote control)	953, 954
Range Log (remote control)	636, 812	Select Marker (No)	388, 390, 395
Range Log 1 dB	289, 295, 324, 437	Select Object	516
Range Log 5 dB	289, 295, 324, 437	Select Path	502
Range Log 10 dB	289, 294, 323, 436	Select Print Color Set	516
Range Log 50 dB	288, 294, 323, 436	Select Print Color Set (remote control)	927
Range Log 100 dB	288, 294, 323, 436	Select Trace	219
Range Log Manual	289, 295, 324, 437	Select Trace (remote control)	693, 795
RBW/VBW Manual	336	Select Traces to check (remote control)	676, 687
RBW/VBW Noise [10]	335	Self Align (remote control)	903
RBW/VBW Pulse [1]	335	Selftest Results (remote control)	905
RBW/VBW Sine [1/3]	335	Service Function (remote control)	906, 907
Recall	449, 503	Set CP Reference	220
Recall (remote control)	728	Set Standard (remote control)	728
Recall File	502	Set to Default	516
Recall File (remote control)	915	Set to Default (remote control)	927
Ref Fixed	390	Settings	329
Ref Level (remote control)	766	Shift X Limit Line (remote control)	679
Ref Level Adjust Man/Auto (remote control)	918	Shift Y Limit Line (remote control)	684
Ref Level Offset	325, 438	Show Align Results (remote control)	904
Ref Level Offset (remote control)	813	Show Peaks	240
Ref Level Position	326, 439	Show Peaks (remote control)	746
Ref Level Position (remote control)	814	Sig Count	388
Ref Lvl =Mkr Lvl	383	Sig Count On/Off (remote control)	838
Ref Lvl =Mkr Lvl (remote control)	830	Signal Track (remote control)	794
Ref Point Frequency	389, 390	Size	506
Ref Point Frequency (remote control)	836	Soft Frontpanel (remote control)	892
Ref Point Level	389, 390	Sort Mode	506
Ref Point Level (remote control)	836	Sort Mode Freq/Lvl (remote control)	850



Source Cal .....	448	Unit .....	325, 438
Source Config .....	452	Unit (remote control) .....	812, 814
Source Power .....	448	Update Path (remote control) .....	889
Source Power (remote control) .....	873, 879	Use Zoom Limits .....	183
Source RF (On/ Off) .....	448	Use Zoom Limits (remote control) .....	832
Source RF (On/Off) (remote control) .....	869	User Defined Colors .....	516
Span .....	395	User Defined Colors (remote control) .....	927
Span Manual .....	321	User Pref Setup .....	474
Span Manual (remote control) .....	793	Value (remote control) .....	677, 679, 683
Span/RBW Auto [50] .....	336	Versions + Options (remote control) .....	894
Span/RBW Manual .....	336	Versions+Options (remote control) .....	892
Start .....	318	Video .....	347, 441
Start (remote control) .....	793	Video BW Auto (remote control) .....	800
Start Frequency (remote control) .....	793	Video BW Manual (remote control) .....	799
Startup Recall .....	503	Video Output .....	355
Startup Recall (On/Off) .....	504	Volt .....	325, 438
Startup Recall On/Off(remote control) .....	914	Watt .....	325, 438
Std Dev (remote control) .....	778	Weight ADJ (On/Off) (remote control) .....	703
Stepsize Standard .....	378	Weight TX (On/Off) (remote control) .....	703
Stepsize Standard (remote control) .....	832	Weighting Filter (remote control) .....	702, 703, 704
Stepsize Sweep Points .....	378	X * RBW .....	317
Stepsize Sweep Points (remote control) .....	832	X * RBW (remote control) .....	791, 792
Stop .....	318	X * Span .....	317
Stop (remote control) .....	793	X * Span (remote control) .....	791, 792
Stop Frequency (remote control) .....	793	x Offset (remote control) .....	678
Sweep Count .....	343	x-Axis Range .....	288, 294
Sweep List (remote control) .... 718, 719, 720, 721, 722, 723, 724, 725, 731, 732, 733, 734, 735, 736, 737, 738		x-Axis Range (remote control) .....	765
Sweep Points .....	343	x-Axis Ref Level .....	288, 294
Sweep Points (remote control) .....	802	x-Axis Ref Level (remote control) .....	766
Sweep Rep (On/Off)(remote control) .....	959	x*Demod BW (K7) .....	317
Sweep Time .....	219, 351	y Offset (remote control) .....	684
Sweeptime Auto (remote control) .....	803	y-Axis Max Value .....	290, 296
System Messages (remote control) .....	894, 895	y-Axis Max Value (remote control) .....	767
T1-T2 ->T1 .....	365	y-Axis Min Value .....	290, 296
T1-T3 ->T1 .....	365	y-Unit %/Abs .....	290, 296
T1-T4 ->T1 .....	365	y-Unit %/Abs (remote control) .....	766
T1-T5 ->T1 .....	365	Zero Span .....	321
T1-T6 ->T1 .....	365	Zero Span (remote control) .....	793
THD Unit %/DB (remote control) .....	757	Softkey .....	73
Threshold .....	182, 394	*IDN format legacy .....	489
Threshold (remote control) .....	833	= Marker (remote control) .....	657
Time Domain Power (remote control) .....	769	Adjust Settings .....	228, 312, 434
Time Line 1 (remote control) .....	829	Adjust X-Axis .....	268, 270
Time Line 2 (remote control) .....	829	Alignment .....	482
Time+Date (remote control) .....	888, 891, 892	AM .....	391
Trace 1 2 3 4 5 6 (remote control) .....	817	AM Mod Depth .....	200, 307
Trace Math .....	365	AM Mod Depth (remote control) .....	752, 753
Trace Math (remote control) .....	815, 816	Annotation (On/Off) .....	492
Trace Math Mode .....	365	Annotation On/Off (remote control) ...	945, 947, 948, 949
Trace Math Mode (remote control) .....	816	APD .....	200, 287
Trace Math Off .....	366	Application setup recovery .....	497
Trace Math Position .....	366	ASCII File Export .....	269
Trace Mode (remote control) ... 767, 768, 770, 771, 772, 773, 774, 775, 777, 812		AUTO .....	330, 334, 342
Track BW (remote control) .....	794	Auto Freq .....	328
Track On/Off (remote control) .....	794	Auto Level .....	329
Track Threshold (remote control) .....	795	Auto select reference .....	478
Tracking Generator .....	354	Average .....	361
Trg/Gate Level .....	348	Average Mode .....	364
Trg/Gate Level (remote control) .....	806	Band Power (remote control) .....	853, 855
Trg/Gate Polarity Pos/Neg .....	348	BB Power .....	347, 442
Trg/Gate Polarity Pos/Neg (remote control) .....	807, 810	Blank .....	148, 361
Trg/Gate Source (remote control) .....	805, 806, 810	C/N .....	227, 434
Trigger Holdoff (remote control) .....	804	C/N (remote control) .....	692
Trigger Out (Low/High)(remote control) .....	901	C/N, C/No .....	199, 227, 433
Trigger Polarity .....	443	C/No .....	227, 434
		C/No (remote control) .....	692
		Calibrate Reflection Open (remote control) .....	869, 870

Calibrate Reflection Short (remote control) .....	870
Calibrate Transmission (remote control) .....	870
Calibration frequency RF .....	498
CCDF .....	200, 292
Center .....	316
Center (remote control) .....	790
CF Stepsize .....	316
Ch Power ACLR .....	199, 212
Channel Bandwidth .....	227, 434
Clear all messages .....	496
Clear Write .....	147, 360
Close Sweep List .....	238, 268
Color (On/Off) .....	492, 494
Colors .....	492
Compatibility mode .....	485
Computer name .....	483
Configure monitor .....	489
Cont Demod .....	391
Continue Single Sweep .....	341
Continuous Sweep .....	341
Copy to .....	187
Coupling (FSx/HP) .....	488
CP, ACP, MC-ACLR (remote control) .....	692
CP/ACLR Standard (remote control) .....	696
Decim Sep (remote control) .....	818
Default Colors 1 (remote control) .....	945
Default Colors 2 (remote control) .....	945
Delete .....	188
Delete (ACLR User Standard) .....	221
Delete Value .....	187
Density (remote control) .....	852, 853, 854
Description .....	485
Deselect all .....	186
Details On/Off .....	269
DHCP (On/Off) .....	484
Display Line 1 .....	188
Display Line 2 .....	188
Display lines .....	188
Display pwr save .....	494
Display Pwr Save (remote control) .....	947
Display setup .....	490
Display update (On/Off) .....	488
Edit .....	187
Edit (remote control) .....	680, 681, 682
Edit Comment .....	186
Edit Margin .....	187
Edit Name .....	186
Edit Value .....	187
Exclude LO .....	383
Export (remote control) .....	916
FFT .....	330, 334, 342
FFT Filter Mode .....	330, 335, 343
Firmware update .....	496
FM .....	391
Frequency Line 1 .....	189
Frequency Line 2 .....	189
Frequency Offset (remote control) .....	792
Full Span .....	156
Gate Delay .....	350
Gate Length .....	351
Gate Mode Lvl/Edge .....	350
Gate Settings .....	350
Gated Trigger .....	349
General setup .....	483
GPIO .....	485
GPIO address .....	485
GPIO language .....	486
GPIO terminator LFEOI/EOI .....	489
Handle missing Ext. ref .....	478
Hardware info .....	495
Harmonic Distortion .....	201, 311
Harmonic RBW Auto .....	312
Harmonic Sweep Time .....	312
I/O logging (On/Off) .....	489
ID string factory .....	485
ID string user .....	485
IF gain (Norm/Puls) .....	487
IF Power .....	347, 442
IF Power Retrigger Holdoff (remote control) .....	805
IF Power Retrigger Hysteresis (remote control) .....	805
Import (remote control) .....	857
Info (LXI) .....	484
Input (AC/DC) .....	163, 326, 355, 439
Input (AC/DC)(remote control) .....	641
Input 50 Ω/75 Ω .....	160, 326, 439
Input source .....	498
Insert Value .....	187
Install option .....	497
Install option by XML .....	497
IP address .....	484
IQ Export .....	505
IQ Import .....	505
LAN reset .....	485
Left Limit .....	273
Limits On/Off .....	272
List Evaluation .....	268
List Evaluation On/Off .....	269
Load (ACLR User Standard) .....	221
Log .....	364
Logo (On/Off) .....	491
Logo On/Off (remote control) .....	947
LXI .....	484
Margin .....	269
Marker 1 to 4 (remote control) .....	664
Marker Demod .....	391
Marker Number .....	395
Marker Number (remote control) .....	847
Marker Peak List .....	393
Marker to Trace .....	178
Marker to Trace (remote control) .....	664
Marker Zoom .....	379
Max Hold .....	147, 361
Max Peak Count .....	393
May Peak Size (remote control) .....	849
Mean .....	272
Meas Start/Stop .....	270
Mech Atten Auto (remote control) .....	814
Min Hold .....	148, 361
Mkr Demod On/Off .....	391
Mkr Stop Time .....	391
Mode default .....	486
Mode R&S FSP .....	486
Mode R&S FSU .....	486
Network address .....	483
New .....	186
New (remote control) .....	680, 681, 682
New Spectrum (remote control) .....	604
No. of Harmonics .....	312
Normalize (remote control) .....	870
OBW .....	199, 230
OBW (remote control) .....	692
Option licenses .....	496
Other LAN settings .....	483
Password .....	484, 499

- Peak ..... 272
- Peak List (remote control) ..... 849
- Peak List On/Off ..... 393
- Peaks per Range ..... 269
- Power (remote control) ..... 852, 853, 854
- Preamp On/Off ..... 157, 325, 431, 438
- Preamp On/Off (remote control) ..... 638
- Predefined colors ..... 493
- Predefined Colors (remote control) ..... 946
- Print colors ..... 493
- Recall (remote control) ..... 870
- Ref Level ..... 323, 435
- Ref Level (remote control) ..... 813
- Reference Int/Ext ..... 478
- Res BW Auto ..... 332
- Res BW Manual ..... 332, 351
- Reset password ..... 498
- RF ..... 498
- RF Atten Auto ..... 325, 438
- RF Atten Auto (remote control) ..... 814
- RF Atten Manual ..... 157
- RF Power ..... 347, 441
- Right Limit ..... 273
- RMS ..... 272
- Save (ACLR User Standard) ..... 221
- Save (remote control) ..... 819
- Save As Trd Factor (remote control) ..... 875
- Save Evaluation List ..... 269
- Save Limit Line ..... 187
- Screen Colors (remote control) ..... 946
- Screen title ..... 491
- Screen Title (remote control) ..... 950, 951
- Search Signals ..... 306, 308
- Select 1 2 3 4 (remote control) ..... 664
- Select color set ..... 492, 494
- Select object ..... 492
- Select Trace ..... 319
- Select Traces to check ..... 186
- Self-Alignment ..... 482
- Selftest ..... 498
- Selftest results ..... 498
- Service ..... 498
- Service function ..... 499
- Set to default ..... 493
- Set to Default (remote control) ..... 945
- Shift Y Limit Line (remote control) ..... 681
- Show align results ..... 483
- Show error flag ..... 478
- Show Peaks ..... 269
- Signal Track ..... 318
- Single Sweep ..... 341
- Soft frontpanel ..... 490
- Sort Mode Freq/Lvl ..... 393
- Spectrum Emission Mask ..... 199, 234
- Spurious Emissions ..... 199, 265
- Squelch ..... 392
- Squelch (remote control) ..... 617
- Squelch Level ..... 392
- Std Dev ..... 272
- Subnet mask ..... 484
- Sweep ..... 330, 334, 342
- Sweep Count (remote control) ..... 802
- Sweep List ..... 234, 265
- Sweep repeat (On/Off) ..... 487
- Sweep Time (remote control) ..... 803
- Sweep Type ..... 329, 334, 342
- Sweptime Auto ..... 334, 342
- Sweptime Manual ..... 333, 341
- Sweptime Manual (remote control) ..... 803
- System info ..... 494
- System messages ..... 495
- Theme selection ..... 492
- Time Domain Power ..... 200, 272
- Time Line 1 ..... 189
- Time Line 2 ..... 189
- Time+date ..... 489
- Time+date (On/Off) ..... 491
- Time+date format ..... 491
- Time+Date Format (remote control) ..... 951
- Time+Date On/Off (remote control) ..... 951
- TOI ..... 200, 306
- TOI (remote control) ..... 758, 759
- Tool bar state (On/Off) ..... 491
- Tool Bar State On/Off (remote control) ..... 948
- Touch screen alignment ..... 483
- Trace 1 ..... 360
- Trace 2 ..... 360
- Trace 3 ..... 360
- Trace 4 ..... 360
- Trace 5 ..... 360
- Trace 6 ..... 360
- Trace Mode (remote control) ..... 652
- Track BW ..... 319
- Track On/Off ..... 319
- Track Threshold ..... 319
- Trg/Gate Source ..... 346, 441
- Trg/Gate Source (remote control) ..... 806, 807
- Trigger Holdoff ..... 349, 444
- Trigger Hysteresis ..... 349, 444
- Trigger Offset ..... 349, 443
- Trigger Out ..... 355
- User Standard ..... 220
- User-Defined colors ..... 493
- Versions+options ..... 495
- Video BW Auto ..... 333
- Video BW Manual ..... 332
- View ..... 148, 361
- X Offset ..... 188
- Y Offset ..... 188
- y Offset (remote control) ..... 681
- Softkeys
  - Autoselect ..... 362
  - Detector Auto Peak ..... 363
  - Detector Average ..... 363
  - Detector CISPR Average ..... 363
  - Detector Manual Select ..... 362
  - Detector Negative Peak ..... 363
  - Detector Positive Peak ..... 363
  - Detector Quasi Peak ..... 363
  - Detector RMS ..... 363
  - Detector RMS Average ..... 364
  - Detector Sample ..... 363
  - Firmware Update ..... 58
  - Lower Level Hysteresis ..... 329
  - More ..... 73
  - Probe Config ..... 355
  - Up ..... 73
  - Upper Level Hysteresis ..... 329
- Source Power
  - tracking generator ..... 457, 460
- Span
  - softkey ..... 395
- SPAN key ..... 320
- Span menu ..... 321

- SPD ..... 533
  - SPE ..... 533
  - Speaker
    - remote control ..... 891
  - Spectrogram
    - Menu ..... 376
  - Spectrum Emission Mask
    - Measurements ..... 232
    - Power Classes ..... 242
    - Softkey ..... 199, 234
  - SPLIT/MAXIMIZE
    - Key ..... 81, 949
  - Spurious Emissions
    - Limit lines ..... 262
    - Measurements ..... 259
    - Results ..... 261
    - Softkey ..... 199
  - Squelch
    - Remote control ..... 617
    - Softkey ..... 392
  - Squelch Level
    - Softkey ..... 392
  - SRE ..... 545
  - SRE (service request enable register) ..... 549
  - SRQ (service request) ..... 549, 560
  - Stand-alone operation ..... 601, 1044
  - start frequency ..... 318
  - statistic measurements
    - gated trigger ..... 298
  - Status
    - Queries ..... 561
  - Status bar
    - Hiding/restoring ..... 491
  - Status byte
    - Remote ..... 884, 886
  - Status byte (STB) ..... 550
  - Status display ..... 66
  - Status registers ..... 545
    - CONDition ..... 547
    - ENABle ..... 547
    - EVENT ..... 547
    - model ..... 547
    - NTRansition ..... 547
    - parts ..... 547
    - PTRansition ..... 547
    - STATus:OPERation ..... 551, 557
    - STATus:QUESTionable ..... 552, 558
    - STATus:QUESTionable:ACPLimit ..... 559
    - STATus:QUESTionable:FREQuency ..... 553
    - STATus:QUESTionable:LIMit ..... 553
    - STATus:QUESTionable:LMARgin ..... 554
    - STATus:QUESTionable:POWER ..... 555
  - Status reporting system ..... 545
    - Application ..... 560
    - Common commands ..... 883
  - STB ..... 545
  - Step size
    - Center frequency ..... 316
  - stop frequency ..... 318
  - storing ..... 1039
  - Storing
    - Instrument configuration ..... 114
    - Measurement data ..... 115
  - String in remote commands ..... 539
  - Suffixes ..... 536
  - supply voltage, external noise source ..... 355
  - sweep
    - count ..... 343
    - Free Run ..... 346, 441
    - gated ..... 352
  - Sweep
    - Continue single sweep ..... 341
    - Continuous ..... 341
    - Gated ..... 349
    - Single ..... 341
    - Time ..... 333, 341
  - SWEEP key ..... 340
  - sweep list
    - Fast SEM (remote control) ..... 730
  - Sweep List
    - Symmetrical ..... 238
  - Sweep menu ..... 340
  - Sweep points ..... 274
  - Sweep status
    - Status register ..... 557
  - Sweep time
    - Coupling ..... 334, 342
    - Statistics ..... 284
  - SWT (hardware setting) ..... 63
  - Syntax elements
    - SCPI ..... 540
  - System messages dialog box ..... 495
- ## T
- Task bar
    - Accessing ..... 57
  - TCP/IP
    - tracking generator ..... 462
  - TCP/IP address
    - tracking generator ..... 462
  - Tdf (enhancement label) ..... 64
  - Template ..... 517
  - Test
    - Self test ..... 498
  - Test report ..... 517
  - Text paramters in remote commands ..... 539
  - Themes
    - Display ..... 87
  - threshold
    - line ..... 182, 394
  - Threshold
    - Signal tracking ..... 319
  - Time
    - Setting ..... 46
    - softkey ..... 348, 443
  - Time Domain Power
    - Restricting range ..... 271
    - Results ..... 270
  - time line ..... 190
  - Time line ..... 189
  - Time trigger
    - Repetition interval ..... 349, 444
  - timestamp
    - instrument (remote control) ..... 891
  - Title
    - Diagram ..... 491
  - Toggleing
    - Span values ..... 71
  - TOI
    - Measurement ..... 301
    - Results ..... 305
  - TOI (marker functions) ..... 66, 381

- Toolbar
    - Icon ..... 68
    - Toggle ..... 68
  - Touch screen
    - Alignment ..... 483
  - Touchscreen
    - Aligning ..... 47
    - Display ..... 29
  - TPIS
    - I/Q data ..... 867
  - trace
    - power measurement ..... 219
  - Trace
    - Clear Write ..... 147, 360
    - Signal tracking ..... 319
  - Trace information
    - Detector type ..... 65
    - Trace number ..... 65
  - TRACE key ..... 174, 358
  - Trace mode ..... 360
    - Average ..... 361
    - Blank ..... 148, 361
    - Clear Write ..... 147, 360
    - Max Hold ..... 147, 361
    - Min Hold ..... 148, 361
    - View ..... 148, 361
  - Traces
    - Loading ..... 115
    - Storing ..... 115
  - tracking generator
    - configuration (remote control) ..... 881
    - display ..... 471
    - error messages ..... 471
    - Power Offset (remote control) ..... 873
    - power sweep ..... 451
    - reverse sweep ..... 451
    - selecting ..... 457, 459
    - TTL Synchronization (remote control) ..... 881
  - Tracking generator
    - Connector ..... 32
  - Tracking Generator
    - Denominator (remote control) ..... 877
    - Frequency Offset (remote control) ..... 873, 878
    - Numerator (remote control) ..... 877
  - Transducer ..... 150
  - Transducer break ..... 151
  - Transducer factors ..... 151, 479
  - Transducer set ..... 151, 481
  - Transducers
    - Recalling ..... 500
    - Saving ..... 500
  - transmission measurement
    - calibration ..... 464
    - tracking generator ..... 465
  - Tree walking
    - Softkey ..... 488
  - TRG (enhancement label) ..... 63, 64
  - TRIG key ..... 345
  - trigger
    - external ..... 346, 441
    - level ..... 348
    - slope ..... 348, 443
  - Trigger
    - Event (remote) ..... 886
    - External gate ..... 349
    - Gated sweep ..... 350
    - Holdoff ..... 349, 444
    - Hysteresis ..... 349, 444
    - Level ..... 443
    - Offset ..... 349, 443
    - Status register ..... 557
  - Trigger menu ..... 345, 440
  - trigger mode ..... 346, 441
    - External ..... 346, 441
    - Free Run ..... 346, 441
    - Video ..... 347, 441
  - Trigger mode
    - BB power ..... 347, 442
    - IF power ..... 347, 442
    - RF power ..... 347, 441
  - TRIGGER OUTPUT
    - Connector ..... 35
  - TRK (marker functions) ..... 65, 381
  - TTL synchronization
    - tracking generator ..... 462
- ## U
- UNCAL (status display) ..... 67
  - Unit ..... 158
  - Up
    - Softkey ..... 73
  - UP ..... 538
  - Update rate
    - Display ..... 88
  - Updates ..... 58
  - Upper Level Hysteresis
    - Softkey ..... 329
  - Usable I/Q bandwidth
    - Definition ..... 445
  - USB
    - Connector ..... 35
  - User account ..... 58
  - USER key ..... 474
    - Remote ..... 954
  - User ports
    - Remote control ..... 901
  - User sample rate
    - Definition ..... 445
  - user-defined menu ..... 474
- ## V
- V network ..... 149, 278
  - VBW
    - RMS detector ..... 333, 370
  - VBW (hardware setting) ..... 63
  - Versions/Options dialog box ..... 495
  - Vertical stroke ..... 540
  - Video bandwidth ..... 332
  - video triggering ..... 347, 441
  - View Filter ..... 192
  - View trace mode ..... 148, 361
  - Virus protection ..... 54
  - VISA ..... 525, 527
    - Libraries ..... 526
    - Resource string ..... 526, 527
  - VNC ..... 571, 1053
  - Volume
    - remote control ..... 891
  - VXI protocol ..... 528

**W**

Wait	
Remote .....	887
Waiting for trigger	
Status register .....	557
Web browser	
Configuration interface .....	598
weighting filter .....	216
White papers .....	24
White space .....	540
Windows 7 .....	53
Access .....	56
WordPad	
Accessing .....	57

**Y**

Y-Axis Max	
I/Q Analyzer .....	436

**Z**

zero span .....	321
Zero span measurements .....	103
Zoom .....	379
Amplitude .....	148, 361