

R&S® FSL

Spectrum Analyzer

High-end functions in an extremely lightweight, compact package



3
year
warranty

R&S®FSL

Spectrum Analyzer

At a glance

You no longer have to make compromises when buying a spectrum analyzer. You can now get high-end features without stretching your budget – the R&S®FSL.

The R&S®FSL is an lightweight and compact spectrum analyzer that is ideal for a large number of applications in development, service and production. Despite its compact size, it offers a wealth of functions more typical of the high-end range, thus ensuring an excellent price/performance ratio. The R&S®FSL is the only instrument in its class that features a tracking generator up to 18 GHz and can analyze signals with a bandwidth of 28 MHz. In addition, the R&S®FSL18, which operates at frequencies up to 18 GHz, supports applications in the microwave range.

The high-end approach is also evident in the operating features. When equipped with a tracking generator up to 18 GHz, the R&S®FSL18 is an easily portable, microwave scalar network analyzer. As with the higher-class analyzers from Rohde&Schwarz, the main functions of the R&S®FSL are directly accessible by fixed-assignment function keys, with additional functions accessed using softkeys and tables. This shortens the learning curve for new users.

Its compact size and low weight, plus its optional battery pack, make the R&S®FSL ideal for mobile use.

The R&S®FSL has unique plug&play upgrade abilities. All options can be added without opening the instrument.

Main features

- ▀ Frequency range from 9 kHz to 3 GHz/6 GHz/18 GHz
- ▀ 3 GHz, 6 GHz and 18 GHz models with and without tracking generator
- ▀ Best RF characteristics in its class
- ▀ Largest signal analysis bandwidth in its class (28 MHz)
- ▀ Low measurement uncertainty, even in microwave range
- ▀ High resolution filter accuracy owing to all-digital implementation
- ▀ Robust and compact
- ▀ Carrying handle and low weight (<8 kg/18 lbs)
- ▀ Optional battery operation
- ▀ Wide range of functions, simple operation
- ▀ Easy on-site upgrading with options

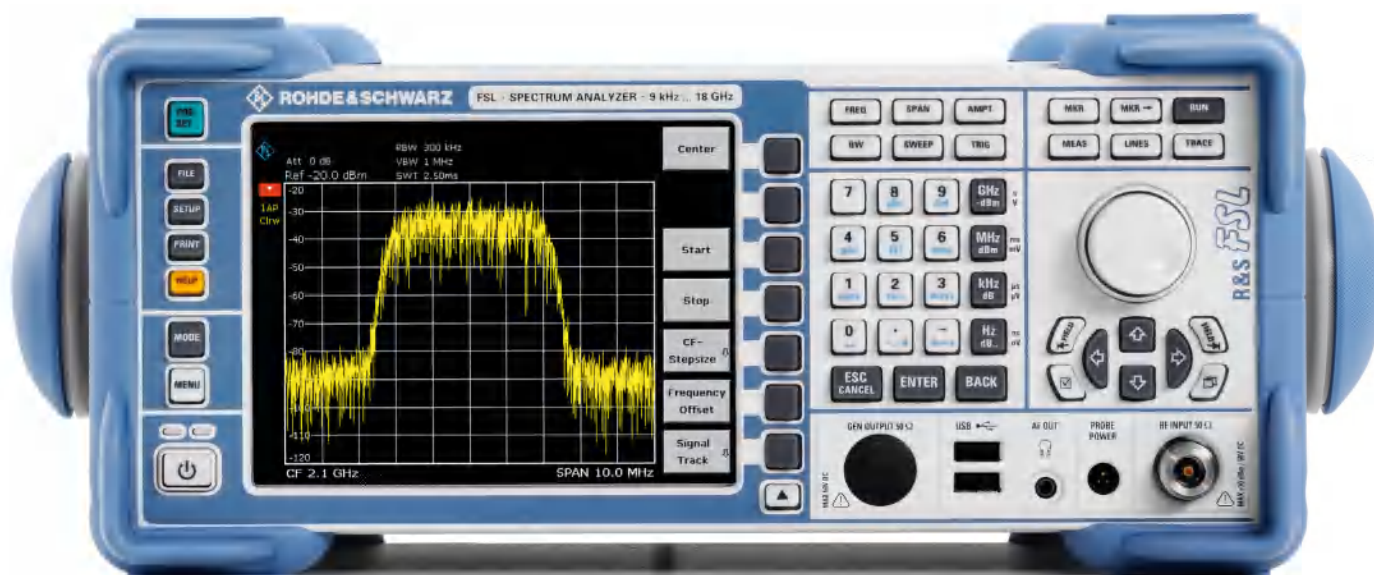

R&S®FSL

Spectrum Analyzer

Benefits and key features

Exceptional performance for its class

- ▮ Continuous RF frequency range from 9 kHz to 18 GHz and 28 MHz demodulation bandwidth
 - ▮ Low measurement uncertainty even in microwave range
- ▷ [page 4](#)

Fast and versatile in production

- ▮ High measurement speed and time-saving routines improve throughput
 - ▮ Remote control via LAN or IEC/IEEE bus in line with SCPI
- ▷ [page 5](#)

At home in every development lab

- ▮ Excellent price/performance ratio
 - ▮ General-purpose signal analysis
 - ▮ Wide range of personalities for various wireless/cellular digital standards
- ▷ [page 6](#)

Lightweight and compact for on-site installation, maintenance and service

- ▮ Easy portability due to small size and low weight
 - ▮ Optional internal battery pack for cordless use
 - ▮ Power measurements with R&S®NRP-xx power sensors
 - ▮ Ideal for service
- ▷ [page 7](#)

Easy upgrades and a wide range of interfaces

- ▮ On-site plug&play installation of options without opening the instrument
 - ▮ Additional interfaces expand the application range of the R&S®FSL
- ▷ [page 8](#)

Wide range of functions – simple operation

- ▮ Comprehensive set of measurement functions and features more typical of high-end analyzers
 - ▮ Built-in measurement routines and versatile selection of firmware options
- ▷ [page 9](#)

Exceptional performance for its class

With phase noise of typ. -103 dBc (1 Hz) at 10 kHz from the carrier, a third order intercept point of typ. $+18$ dBm, a bandwidth range from 10 Hz to 10 MHz, and a displayed average noise level (DANL) of typ. -162 dBm, the R&S®FSL compares favorably with high-end analyzers. This makes it very useful in production, service, field use and in labs. The RF attenuator, which is adjustable in steps of 5 dB, and the optional preamplifier ensure an optimum usable dynamic range.

Continuous RF frequency range from 9 kHz to 18 GHz and 28 MHz demodulation bandwidth

The R&S®FSL is the only instrument in its class with a bandwidth of 28 MHz. Featuring an analysis bandwidth of 28 MHz, the spectrum analyzer is ideal for measuring both spectral and modulation parameters of broadband signals such as WLAN and WiMAX™, including harmonic signals up to 18 GHz. In the time domain, its fast digitizer allows the detection of pulsed signals and the measurement of pulse widths.

There are six different R&S®FSL models available (see page 21 for specifications):

- R&S®FSL3: 9 kHz to 3 GHz
(available with and without tracking generator)
- R&S®FSL6: 9 kHz to 6 GHz
(available with and without tracking generator)
- R&S®FSL18: 9 kHz to 18 GHz (20 GHz overrange, available with and without tracking generator)

The R&S®FSL18 covers frequencies up to 18 GHz, which makes it ideal for a large number of development, service and production applications at microwave frequencies. Examples include the installation and maintenance of radar systems and microwave links, as well as the production of microwave components or satellite surveillance.

Low measurement uncertainty even in microwave range

Another unrivaled characteristic in its class is the low overall measurement uncertainty, which yields accurate and reliable results even in the microwave range.

The analyzer's low measurement uncertainty makes tests and alignment more accurate and reliable and allows a separate power meter to be replaced. Moreover, it reduces the margin needed for test instrument uncertainty and thus increases the margin left for the DUT.

Typical applications of the R&S®FSL18 include measurements in the microwave range, for example measuring the pulse width using the n-dB down marker.

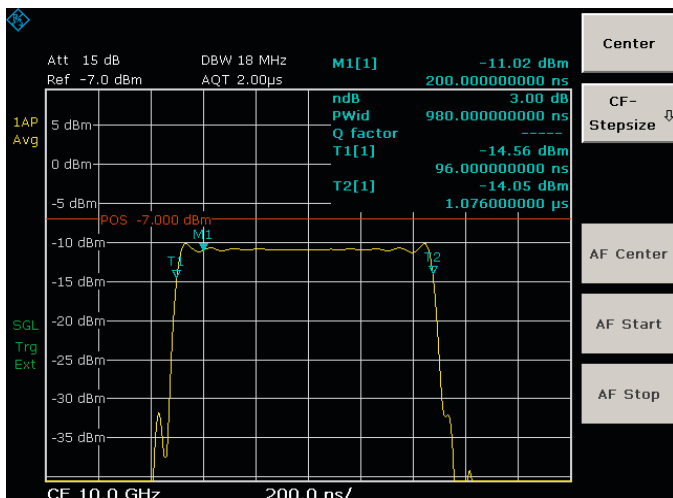

Fast and versatile in production

The R&S®FSL is ideal for fast, easy measurements during production. A quick check of the level and frequency is often all that's needed.

The R&S®FSL's high speed of > 80 sweeps/s in zero span, including remote output of data (or trace data), ensures high production throughput. Even a simple level calibration can be streamlined and accelerated with the R&S®FSL's integrated complex measurement functions – a special multisummary marker measures different levels in the time domain in a single sweep. This eliminates reset and remote control overhead time. For fast synchronization or triggering, the R&S®FSL-B5 additional interfaces option – which includes a special trigger interface – can be added.

In addition, the R&S®FSL offers the following functions:

- Fast ACP measurements in the time domain for the major wireless communications standards, with very good repeatability and short measurement times
- List mode: measurements with up to 300 analyzer settings with a single IEC/IEEE bus command
- Fast power measurement in the time domain using channel or RRC filters
- Fast frequency counter with 1 Hz resolution and measurement times < 50 ms

Remote control via LAN or IEC/IEEE bus in line with SCPI

The standard remote interface is a 10/100BASE-T LAN interface that provides significantly higher speeds than an IEC/IEEE bus for transferring large data volumes. It also offers considerable cost advantages over IEC/IEEE bus wiring. However, IEC/IEEE bus remote control can be added by installing the R&S®FSL-B10 option.

The command set of the R&S®FSL follows SCPI conventions and is thus largely compatible with the R&S®FSP and R&S®FSU analyzers.

Remote control of the R&S®FSL via IEC/IEEE bus in list mode cuts down on measurement time.

Input command

```
SENSE:LIST:POW
100MHz,-0dBm,10dB,10dB,NORM,1MHz,3MHz,434us,0,
200MHz,-20dBm,10dB,0dB,NORM,30kHz,100kHz,1ms,0,
300MHz,-20dBm,10dB,0dB,NORM,30kHz,100kHz,1ms,0;
```

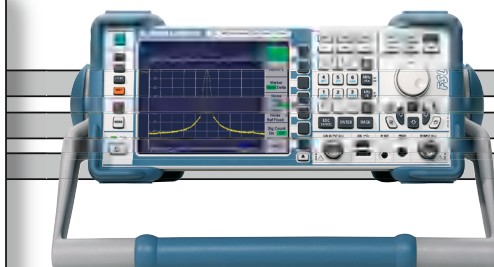

Output R&S® FSL

```
-28.3,
-30.6,
-38.1
```

At home in every development lab

The R&S®FSL's excellent price/performance ratio makes it a must for every developer's lab bench, as indispensable as an oscilloscope or multimeter. Its range of functions and operation are largely identical with those of the R&S®FSU high-end analyzers, simplifying the reproducible verification of measurements.

- ▀ Good RF performance at a low price
- ▀ Widest I/Q demodulation bandwidth in its class
- ▀ Quasi-peak detectors and EMC bandwidths of 200 Hz, 9 kHz and 120 kHz for EMC checks during development and precompliance testing
- ▀ Tracking generator for transmission and reflection measurements (e.g. with the R&S®ZRB2 or R&S®FSH-Z2 VSWR bridge)
- ▀ High measurement accuracy
- ▀ Easy output of measurement results to USB printer, network printer or file
- ▀ Easy remote control via LAN
- ▀ Connection to MATLAB®

The R&S®FSL's wide scope of functions also extends to channel/adjacent channel power measurements. To simplify use, many default settings can be selected by pressing a button.

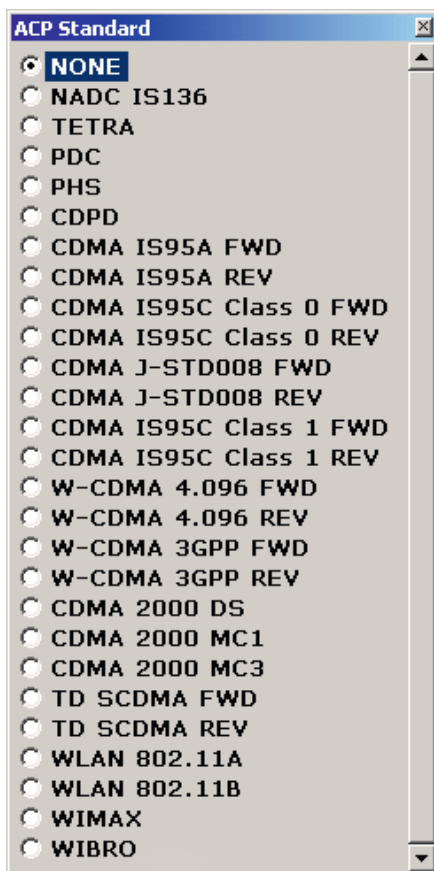

The R&S®FSL offers many different firmware options (see page 22). The user can switch between the different applications.

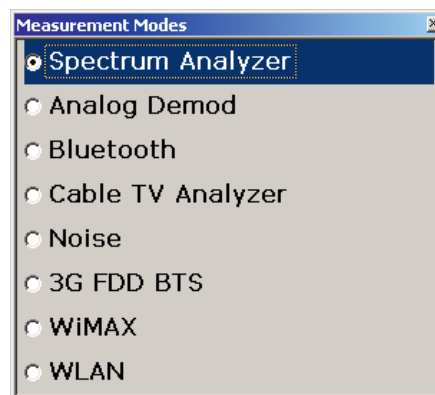

Lightweight and compact for on-site installation, maintenance and service

The low weight (< 8 kg), the small size and the ruggedized housing make the R&S®FSL ideal for mobile applications. Due to these properties it is easy to carry to remote or hard-to-reach locations. The carrying bag with space for an extra battery pack and accessories and the protective hardcover are also very convenient for field use.

Optional internal battery pack for cordless use

When equipped with the optional internal battery pack (R&S®FSL-B31), the R&S®FSL can be used independent of the mains supply for at least one hour. Easy and fast battery exchange in the field increases battery operation time. In addition, a DC power supply (R&S®FSL-B30) is available for the R&S®FSL. This option allows the R&S®FSL to be used anywhere where DC power is available, e.g. in a car.

Power measurements with R&S®NRP-xx power sensors

Another special feature of the R&S®FSL is the fact that you can directly connect a power sensor from the R&S®NRP series. The R&S®FSL-K9 option and a connected power sensor allow very precise measurements of the DUT power – an enormous advantage for applications where level accuracy is crucial. The R&S®FSL can thus replace a power meter. This is particularly important in mobile applications.

Ideal for service

- Cost-effectiveness
- High measurement accuracy
- Extensive evaluation options
- Wide range of functions
- Built-in frequency counter
- AM/FM audio demodulator for interference identification
- Extensive functions for power measurements
- Storage of settings and measurement results in the R&S®FSL or on a USB memory stick



Soft carrying bag for the R&S®FSL.

Easy upgrades and a wide range of interfaces

The R&S®FSL has unique plug&play upgrade abilities. All options can be added without opening the instrument.

This has several important advantages:

- ▮ No extra alignment after installation
- ▮ No recalibration
- ▮ No need to send in the instrument, thus negligible downtime
- ▮ No installation costs
- ▮ Easy installation of additional functions

The wide range of additional interfaces provided by the R&S®FSL-B5 option expands the application range of the R&S®FSL:

- ▮ IF output/video output for connecting further instruments
- ▮ 28 V, switchable for connecting noise sources
- ▮ Trigger interface for fast measurement on frequency lists
- ▮ Connector for R&S®NRP power sensors with ODU Mlni-Snap® plug

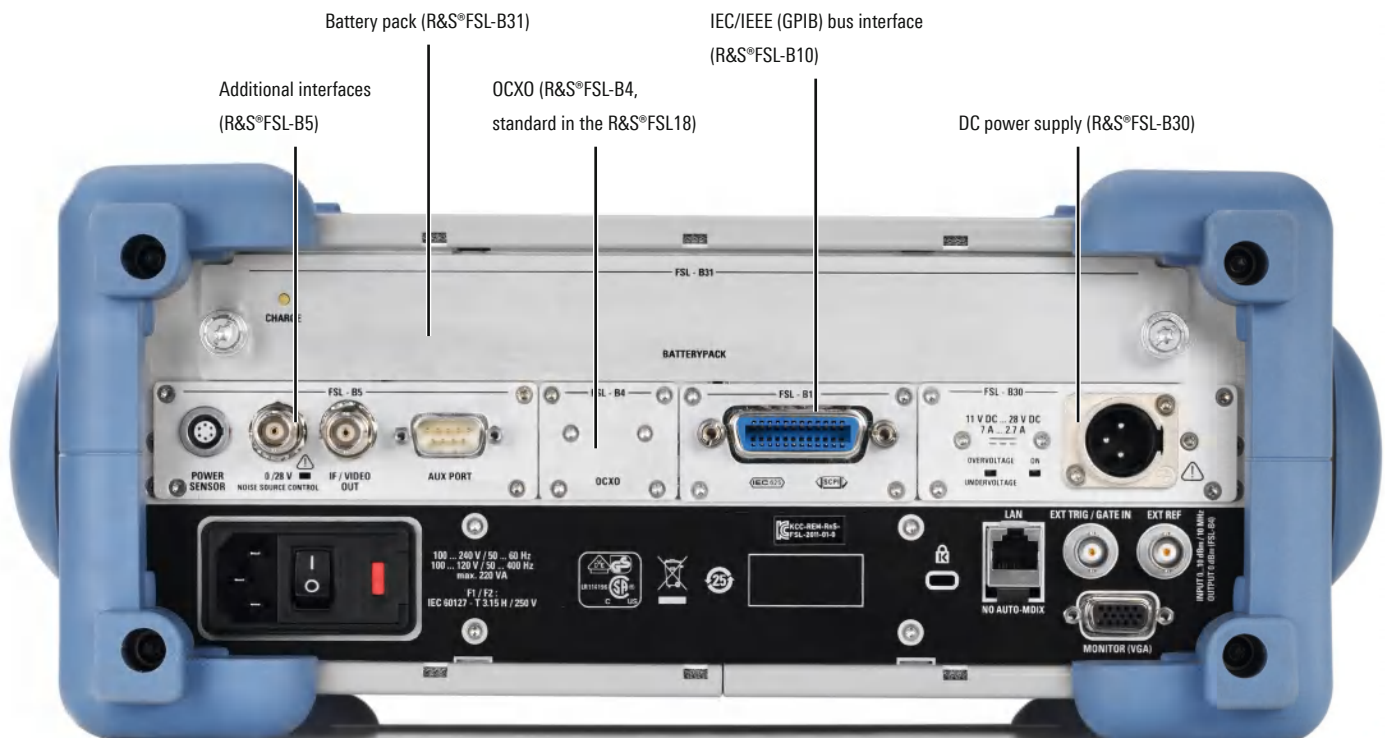

Wide range of functions – simple operation

The R&S®FSL offers a comprehensive set of measurement functions and features that are more typical of high-end analyzers. A versatile selection of firmware options helps save costs as a low-budget spectrum analyzer can be used whenever the specifications of a high-end spectrum analyzer are not required. An intuitive user interface supports users with measurements in line with standards. In addition, preconfigured, built-in measurement routines help the user to quickly get results.

Measurement routines for:

Third order intercept measurement (TOI)
Occupied bandwidth measurement (OBW)
Time domain power measurement
Channel power measurement (CP)
Adjacent channel power and multicarrier adjacent channel power measurement (ACP and MC-ACP)
Fast adjacent channel power measurement (ACP)
Carrier-to-noise ratio measurement (C/N, C/N ₀)
Modulation depth measurement (AM%)

Standard features

28 MHz I/Q demodulation bandwidth
Complete range of detectors
RRC and channel filters
FFT filters 1 Hz/300 Hz to 30 kHz
Frequency counter
Noise and phase noise markers
n-dB down marker
Limit lines
Level units
Selectable number of trace points
Transducer factors
LAN interface
USB
Help function

Application firmware for general-purpose signal analysis

AM/FM/φM measurement demodulator (R&S®FSL-K7 option, page 14)
Power measurement with R&S®NRP power sensors (R&S®FSL-K9 option)
Spectrogram measurements (R&S®FSL-K14 option, page 13)
Cable TV measurements (R&S®FSL-K20 option, page 16)
Noise figure and gain measurement (R&S®FSL-K30 option, page 17)
TV trigger (R&S®FSL-B6 option, page 11)
Gated sweep (R&S®FSL-B8 option, page 11)

Application firmware for various wireless/cellular standards

Bluetooth® modulation and spectrum measurements (R&S®FSL-K8 option, page 15)
WCDMA (R&S®FSL-K72 option)
CDMA2000®/1xEV-DO modulation and spectrum measurement (R&S®FSL-K82/-K84 options, page 18)
WLAN transmitter measurements (R&S®FSL-K91/-K91n options, page 19)
WiMAX™ modulation and spectrum measurements (R&S®FSL-K92/-K93 options)

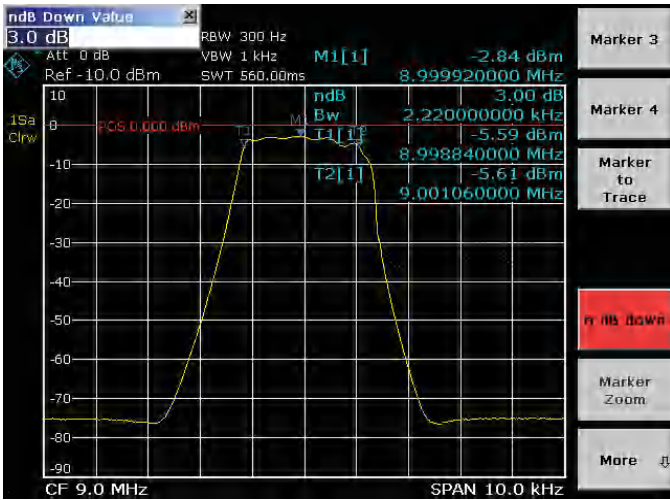

Scalar network analysis

Models .13, .16 and .28 of the R&S®FSL, which include a tracking generator, can quickly and easily measure frequency response, filters and attenuation. The n-dB down marker determines the 3 dB bandwidth of a bandpass filter at the press of a button, for example. The R&S®FSL measures return loss or matching by using an external VSWR bridge. Precision is enhanced by through, short and open normalization methods.

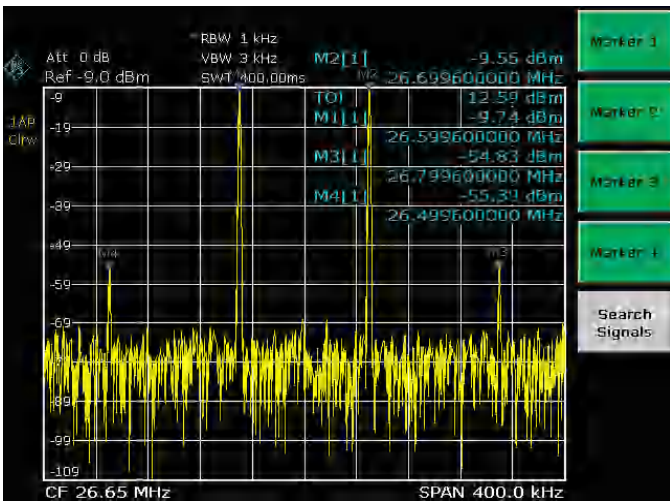

Third-order intercept (TOI)

The R&S®FSL can determine the TOI from the spectrum at the press of a button. It automatically detects the useful carriers and thus determines the intermodulation sidebands. The instrument's maximum dynamic range of 95 dB is high for its class. RF attenuation steps of 5 dB further enhance its usefulness.

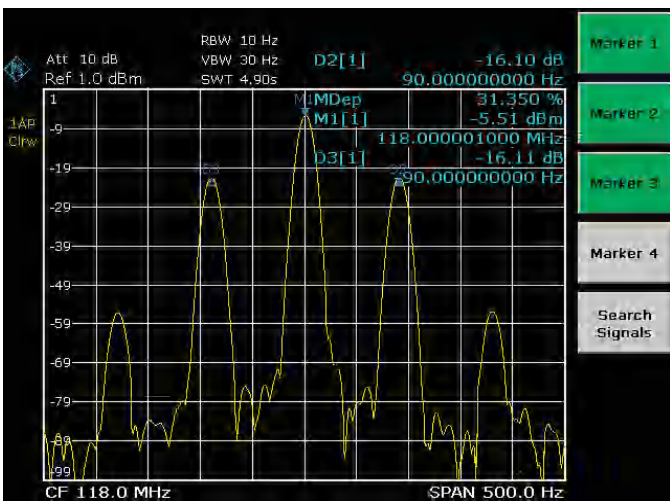

Modulation depth measurement (AM%)

The R&S®FSL measures the modulation depth of an AM signal at the press of a button. The AM% marker function positions three markers – one each on the carrier, the upper sideband and the lower sideband – and uses the sideband suppression to determine the modulation depth. The modulation depth of a two-tone signal can be determined selectively by predefining the modulation frequency, for example by starting with a 90 Hz sideband and then moving to the 150 Hz sideband of an ILS signal. The high linearity of < 0.2 dB ensures a small absolute measurement error.

Sweep List				
	Range 1	Range 2	Range 3	Range 4
Range Stop	150.0 kHz	30.0 MHz	1.0 GHz	6.0 GHz
Filter Type	Gaussian	Gaussian	Gaussian	Gaussian
RBW	1.0 kHz	10.0 kHz	100.0 kHz	1.0 MHz
VBW	3.0 kHz	30.0 kHz	300.0 kHz	3.0 MHz
Sweep Time Mode	Auto	Auto	Auto	Auto
Sweep Time	140.0 ms	300.0 ms	100.0 ms	40.0 ms
Detector	RMS	RMS	RMS	RMS
Ref. Level	-20.0 dBm	-20.0 dBm	-20.0 dBm	-20.0 dBm
RF Att. Mode	Auto	Auto	Auto	Auto
RF Attenuator	0.0 dB	0.0 dB	0.0 dB	0.0 dB
Preamp	Off	Off	Off	Off
Sweep Points	501	4001	8001	8001
Stop After Sweep	Off	Off	Off	Off
Transd. Factor	None	None	None	None
Limit Check 1	Absolute	Absolute	Absolute	Absolute

Spurious emissions measurements

Spurious emissions measurements very often require different measurement bandwidths for different frequency ranges. They can easily be performed by using the spurious emissions functions in the sweep list table, which allows to set parameters such as RBW, VBW, detector, level, number of sweep points individually for different frequency ranges. This makes a complete spurious emissions measurement very fast and easy as setup and measurement is made only once and not separately for each frequency range. A segmented sweep can also easily be set up using this function.

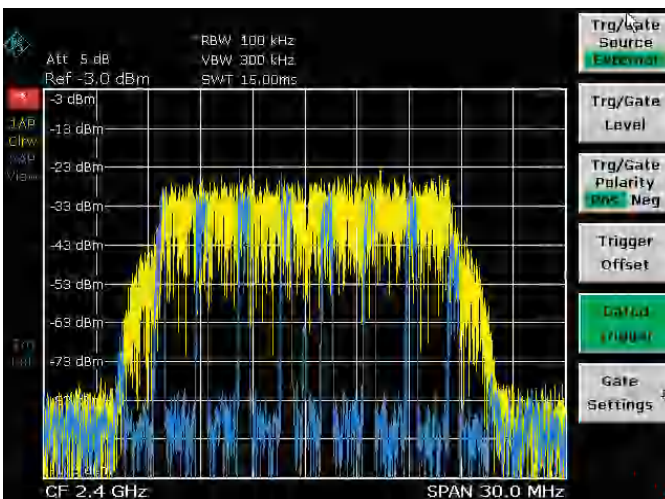

Gated sweep

The R&S®FSL uses the gated sweep function (R&S®FSL-B8 option) for burst signal measurements. This function can display the modulation spectrum of a GSM signal or a burst WLAN signal (as shown in the example).

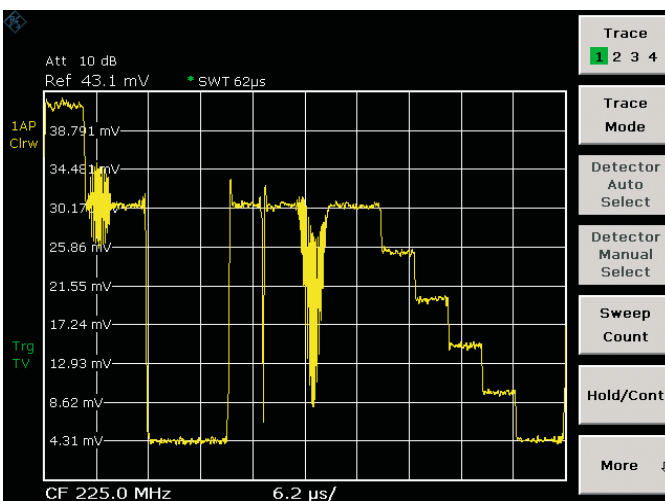

TV trigger option

The R&S®FSL-B6 TV trigger generates a trigger in response to selectable lines and the horizontal or vertical blanking interval. Video formats with 525 or 625 lines with positive or negative modulation are covered.

Channel power measurements

Channel power measurements use integration to determine the power within a defined channel bandwidth. The full-featured RMS detector is used to measure the correct power independent of the signal, which ensures good repeatability and accuracy. The channel width can be defined by the user or selected from an extensive list of transmission standards.

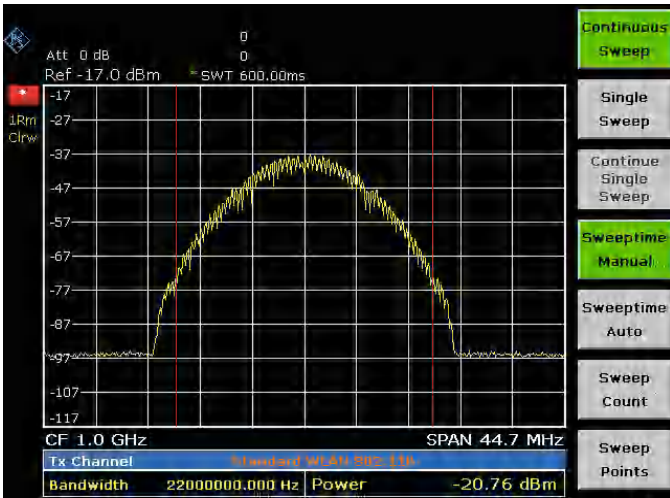

Adjacent channel power (ACP, MC-ACP) measurements, for example cdmaOne

The ACP measurement function determines the adjacent channel power as an absolute value or relative to the useful carrier. The R&S®FSL offers predefined settings for many transmission standards, but parameters can also be user-defined, with channel widths and spacings for up to 12 channels and up to 12 adjacent channels.

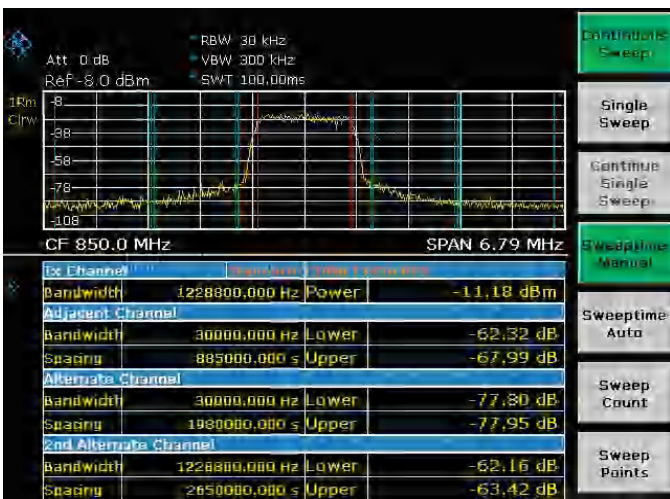

Fast ACP in time domain with standard-compliant channel filters

The fast ACP function measures the adjacent channel power in the time domain using standard-compliant channel filters. This reduces the measurement time necessary for a specific repeatability by a factor of 10. It also provides an easy way to determine transient, time-dependent adjacent channel power.

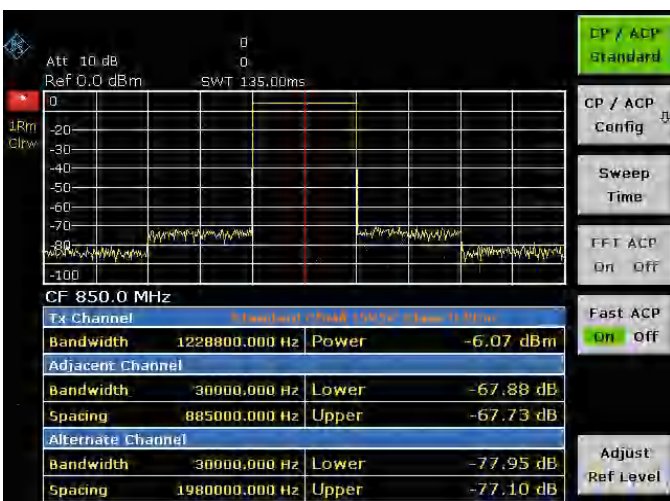

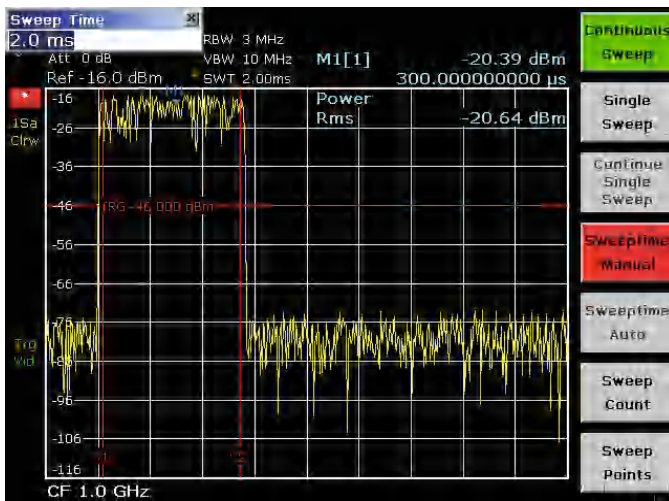

Burst power measurement: time domain power

This feature allows the burst power to be measured in the time domain. Display lines delimit the evaluation area, thus making it possible to determine the power during the 147 useful bits of a GSM burst, for example.

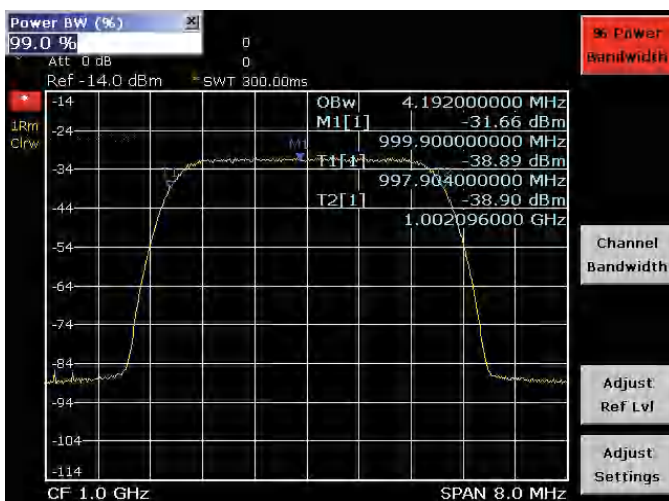

Occupied bandwidth (OBW)

OBW is a measure of the bandwidth occupied by the signal. The R&S®FSL determines the bandwidth containing, for example, 99% of the signal power from the total power within the span. The points from the right and left edge of the trace are summed up until 1% of the power is reached. The remaining power then corresponds to 99% of the power and the distance between the two frequency markers is the occupied bandwidth, which is displayed in the marker field. The fully synchronous frequency sweep and the high number of trace points make this measurement very precise.

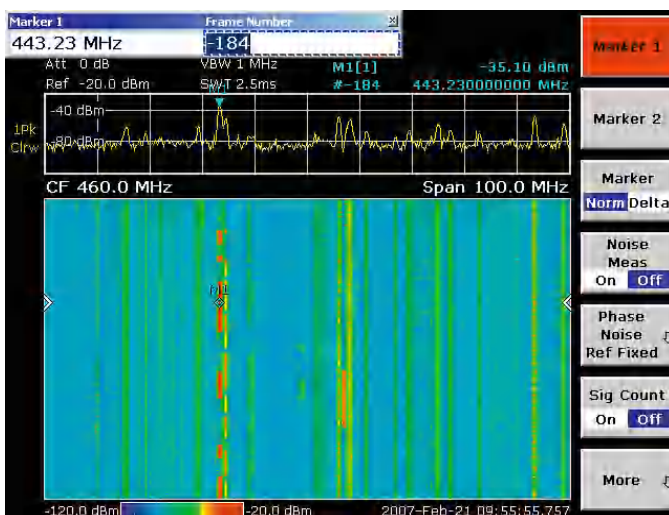

Spectrogram measurements

The R&S®FSL-K14 option adds a spectrogram display and trace recording to the R&S®FSL. The spectrogram view shows a history of the spectrum and helps to analyze intermittent problems or variations in frequency and level versus time. It also adds a new trigger, i.e. a time trigger that makes it possible to record a trace at a regular time interval.

- Recording of up to 20 000 traces: approx. 5.5 h continuous monitoring with repetition interval set at 1 s
- Time trigger, repetition interval 100 ms to 5000 s: allows unattended continuous monitoring
- Scrolling through recorded traces with markers: replay and repeatedly analyze the recorded data

R&S®FSL-K7 option

AM/FM/φM

measurement demodulator

The R&S®FSL-K7 AM/FM/φM measurement demodulator converts the R&S®FSL into an analog modulation analyzer for amplitude-, frequency- or phase-modulated signals. It measures not only characteristics of the useful modulation, but also factors such as residual FM or synchronous modulation.

Display and evaluation capabilities

- ▮ Modulation signal versus time
- ▮ Spectrum of modulation signal (FFT)
- ▮ RF signal power versus time
- ▮ Spectrum of RF signal (FFT versus max. 18 MHz)
- ▮ Table with numeric display of
 - Deviation or modulation depth,
 - +peak, -peak, ± peak/2 and RMS weighted
 - Modulation frequency
 - Carrier frequency offset
 - Carrier power
 - Total harmonic distortion (THD) and SINAD

Condensed data

Demodulation bandwidth	100 Hz to 18 MHz
Recording time (depends on demodulation bandwidth)	12.5 ms to 3276 s
AF filters	
Highpass filter	50 Hz, 300 Hz
Lowpass filter	3 kHz, 15 kHz, 150 kHz and 5%, 10% or 25% of demodulation bandwidth
Deemphasis	25/50/75/750 μs
Modulation frequency	< 5 MHz, max. 0.5 × demodulation bandwidth
Measurement uncertainty (deviation or modulation depth)	3%

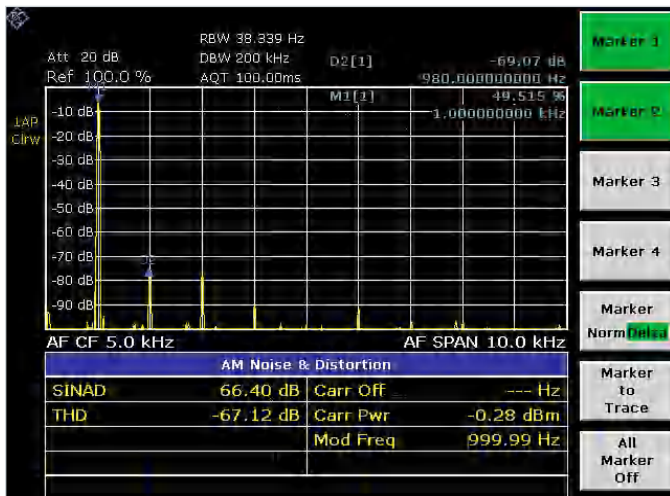

THD measurement on an amplitude-modulated signal: The first harmonic of the modulation signal is well suppressed by 69 dB. This corresponds to a THD (D2) of less than 0.1%.

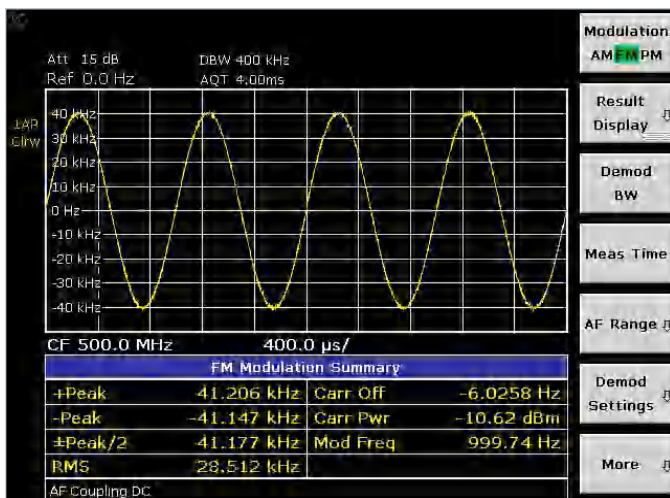

Frequency deviation measurement: display of modulation signal together with peak and RMS deviation, carrier frequency offset and carrier power.

R&S®FSL-K8 option

Transmitter measurements for Bluetooth® V2.0 and EDR

The R&S®FSL-K8 application firmware enhances the range of applications of the R&S®FSL spectrum analyzer to include measurements on Bluetooth® transmitters.

All measurements are carried out in line with the Bluetooth® RF Test Specification (Bluetooth® SIG) Rev. 2.0+EDR and cover basic rate as well as EDR. Integrated limit value monitoring is provided for all measurements and allows analysis of the results in the development and production of Bluetooth® modules.

Bluetooth® measurements

Basic rate measurements

- Output power
- ACP over up to 79 channels
- Modulation characteristics
- Initial carrier frequency tolerance
- Carrier frequency drift

EDR measurements

- Output power and relative transmit power
- Inband spurious emissions, gated
- Carrier frequency stability and modulation accuracy (DEVm)
- Differential phase encoding

Relative transmit power: The EDR relative transmit power determines the power of the GFSK-modulated and the DPSK-modulated part and the power difference.

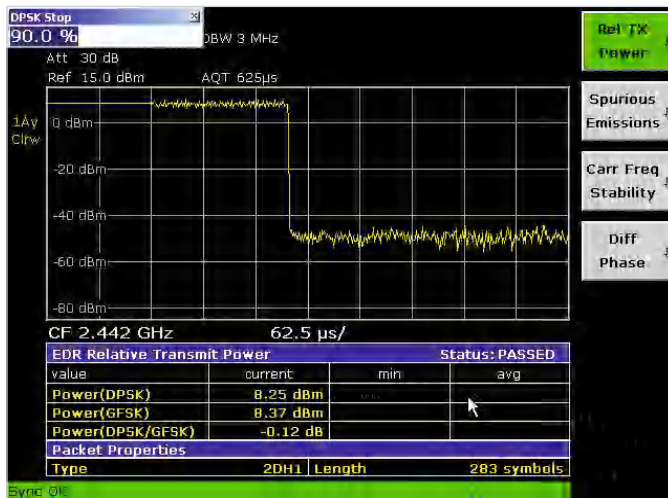

Adjacent channel power (ACP): This measurement determines the power of all adjacent channels. The power of up to 79 channels in total can be measured. For EDR inband spurious, the measurement can be gated.

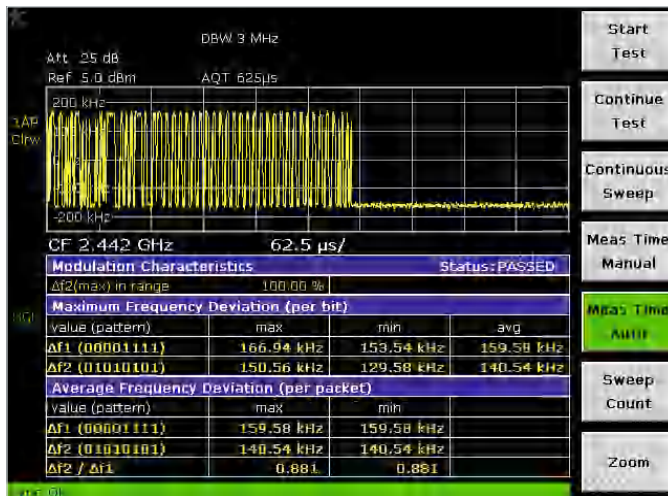
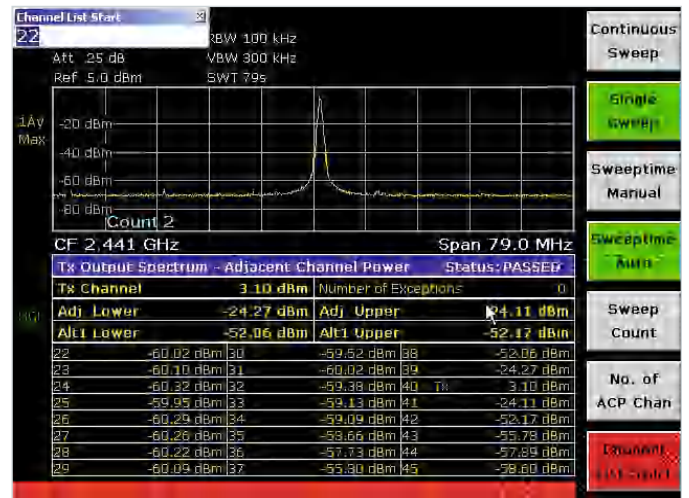

Modulation characteristics: This measurement determines the maximum frequency deviation of all 8-bit test sequences of the payload. In addition, the average value of the maximum frequency deviations per packet is calculated and displayed.

R&S®FSL-K20 option

Analog and digital cable TV measurements

The R&S®FSL-K20 CATV option provides easy-to-use push-button measurements for analog and digital cable TV networks as well as for analog TV transmitters.

TV standards	
Selectable analog TV standards	Selectable digital cable TV standards
B/G, D/K, I, K1, L, M, N	QAM J.83/A (EU), J.83/B (US), J.83/C (Japan)
PAL, NTSC, SECAM	4QAM to 1024QAM
	Symbol rate: 0.1 Msymbol/s to 7.15 Msymbol/s
Measurements	
Analog TV	Digital TV
Carrier levels (picture and sound carriers)	Channel power
C/N (in-service, off-service, quiet line)	Modulation parameters and errors: carrier frequency offset, symbol frequency offset, MER, EVM, phase jitter, carrier suppression, quadrature offset, imbalance
CTB (composite triple beat) and CSO (composite second order), off-service or during quiet line	Constellation diagram
Vision modulation	Echo pattern
Hum	Signal statistics/CCDF, APD
Video scope function for detailed line analysis	
Tilt: determines the frequency response of the cable TV network by measuring the channel power of every channel	

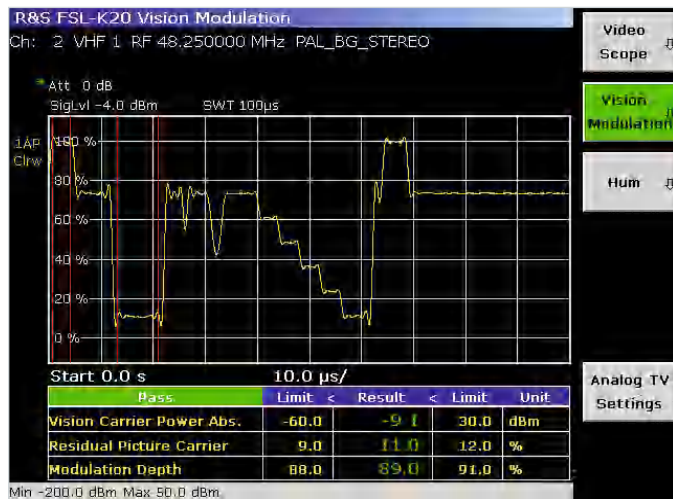

Channel tables

Channel tables make it possible to preconfigure the R&S®FSL for a specific network:

- Channel numbers can be assigned to frequencies
- The signal type for each channel can be defined (analog TV signal, digital TV signal) as well as even more detailed properties such as the position of test lines

The R&S®FSL is set up correctly just by entering the channel number. Channel tables can be easily copied and multiplied between different instruments.

Video scope function (video line analysis) and vision modulation

A dedicated video line trigger allows selected lines of the video signals to be displayed for detailed analysis. The vision modulation measurement further determines the modulation depth and residual picture carrier level.

Digital TV signals

A table provides a quick overview of the most important modulation quality parameters such as MER, EVM (both peak and RMS), carrier frequency offset and symbol frequency offset.

Typical I/Q modulator impairments such as quadrature offset or gain imbalance can be evaluated from the modulation error table (see picture). A constellation diagram enables further analysis of faults and their cause.



R&S®FSL-K30 option

Noise figure and gain measurements

The R&S®FSL-K30 application firmware provides the R&S®FSL spectrum analyzer with features otherwise only provided by special noise measurement analyzers.

The following parameters can be measured at a specified frequency or in a selectable frequency range:

- ▮ Noise figure in dB
- ▮ Noise temperature in K
- ▮ Gain in dB

Compared with conventional noise measurement systems, R&S®FSL-K30 has the advantage that a wide variety of further RF measurements can also be performed. The R&S®FSL also allows the measurement of harmonics, intermodulation, spurious responses and many other RF-relevant criteria (for measurements on amplifiers and on frequency-converting DUTs, e.g. low-noise converters).

Noise measurements

- ▮ Measurement range 0 dB to 35 dB
- ▮ Resolution 0.01 dB
- ▮ Measurement accuracy ± 0.3 dB (measurement with external preamplifier (gain 30 dB, noise figure < 5 dB) and 1 MHz resolution bandwidth, valid for DUTs with noise figure 1 dB to 10 dB and gain > 10 dB)

Gain measurements

- ▮ Measurement range 0 dB to 60 dB
- ▮ Resolution 0.01 dB
- ▮ Measurement accuracy ± 0.2 dB (measurement with preamplifier (gain 30 dB, noise figure < 5 dB) and 1 MHz resolution bandwidth)

Required hardware

- ▮ R&S®FSL-B5 noise source power supply (via 28 V connector on the R&S®FSL rear panel)
- ▮ Noise source, e.g. NoiseCom NC346
- ▮ External preamplifier (for improved accuracy and repeatability of measurements)

Test setup (schematics).

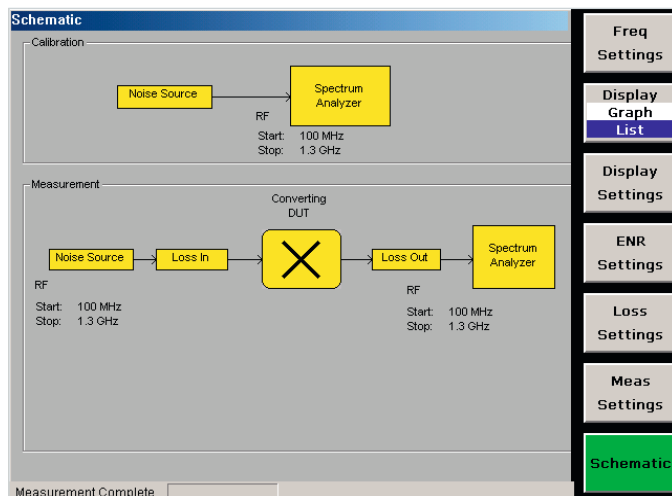

Tabular representation of measurement results.

R&S FSL-K30 Noise & Gain				
RBW: 1 MHz	RF Attenuation: 0 dB	2nd Stage Corr: On		
Average: 1	Auto Ref Level: On	Image Rej: ...		
Direct		Current Value		CALIBRATED
RF: 100 MHz	ENR: 15 dB	NF: 2.62 dB	2.62 dB	
LO: ...	Loss In: 0 dB	Noise Temp: 240.47 K	240.47 K	
IF: ...	Loss Out: 0 dB	Gain: 21.65 dB	21.65 dB	
Frequency List Results				
RF	NF	Noise Temp	Gain	
100.000 MHz	2.623 dB	240.469 K	21.646 dB	
150.000 MHz	2.652 dB	244.085 K	21.642 dB	
200.000 MHz	2.696 dB	249.456 K	21.610 dB	
250.000 MHz	2.721 dB	252.580 K	21.605 dB	
300.000 MHz	2.784 dB	260.527 K	21.644 dB	
350.000 MHz	2.746 dB	255.814 K	21.668 dB	
400.000 MHz	2.775 dB	259.409 K	21.709 dB	
450.000 MHz	2.737 dB	254.684 K	21.759 dB	
500.000 MHz	2.760 dB	257.493 K	21.739 dB	
550.000 MHz	2.730 dB	253.748 K	21.720 dB	
600.000 MHz	2.751 dB	256.370 K	21.685 dB	
650.000 MHz	2.723 dB	252.875 K	21.609 dB	
700.000 MHz	2.749 dB	256.165 K	21.511 dB	
770.000 MHz	2.781 dB	260.226 K	21.251 dB	
800.000 MHz	2.773 dB	259.102 K	21.140 dB	

Measurements on an amplifier.

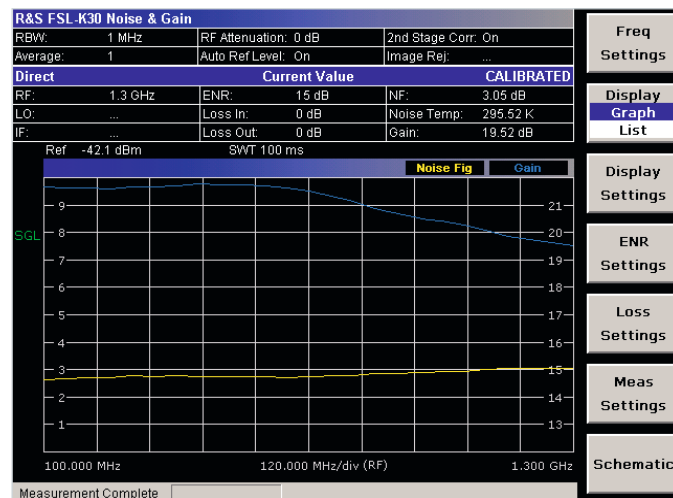

R&S® FSL-K82/-K84 options

CDMA2000®/ 1xEV-DO transmitter measurements

The R&S®FSL-K82 application firmware enhances the application range of the R&S®FSL spectrum analyzer to include code domain power and modulation measurements on CDMA2000® signals for radio configurations 1 to 5 and 10. The R&S®FSL-K84 application firmware adds capability for the analysis of 1xEV-DO signals.

The R&S® FSL is the ideal tool for CDMA2000® base station transmitter measurements in service and production. The main application is the determination of the power in the individual code channels referred to as code domain power measurement. The power ratios between the individual channels, for example, can be checked for compliance with the nominal values. Moreover, this measurement is a very efficient tool for detecting transmitter impairments such as clipping or intermodulation that are not obvious from the spectrum alone.

Equipped with the R&S®FSL-K82/-K84, the R&S®FSL provides the functionality needed for base station testing as well as the related parameters:

- ▮ Code domain power (code domain analyzer)
- ▮ Code domain power versus time (R&S®FSL-K82)
- ▮ Power versus chip (R&S®FSL-K84)
- ▮ Rho
- ▮ Error vector magnitude (EVM)
- ▮ Peak code domain error
- ▮ Power versus symbol
- ▮ Symbol constellation
- ▮ Channel table
- ▮ Code domain error power

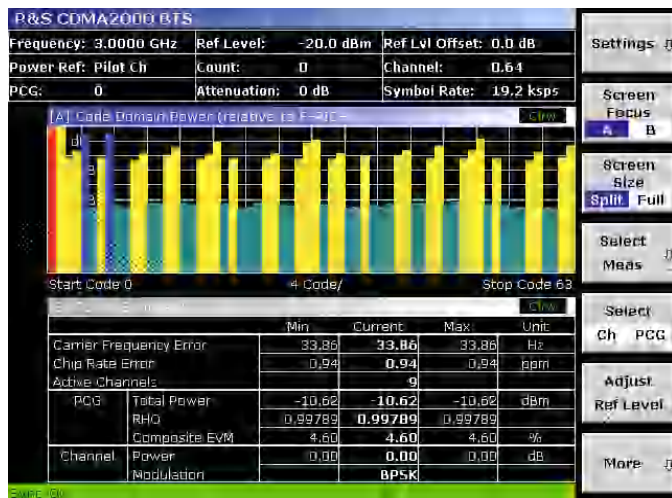

For 1xEV-DO, the rho measurement is subdivided into several new measurements due to the time division structure:

- ▮ Rho_{MAC}
- ▮ Rho_{data}
- ▮ Rho_{pilot}
- ▮ Rho_{overall-1}
- ▮ Rho_{overall-2}

The code domain power measurement displays the active and inactive channels in bit-reversed order. The result summary provides a quick overview of the main parameters of the signal at a glance, e.g. total power, channel power, rho and EVM.

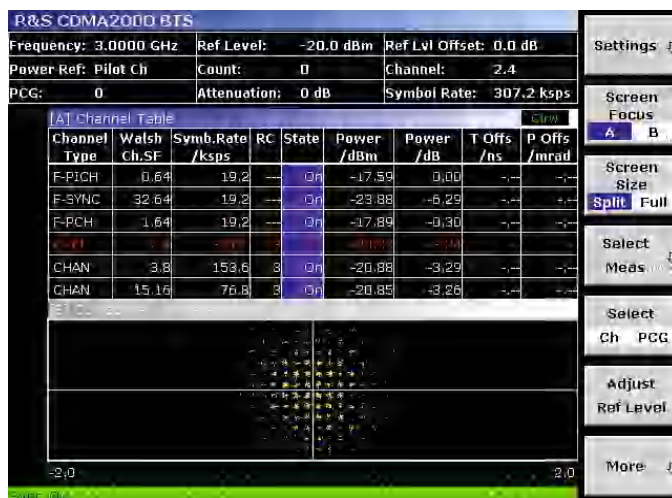

The upper part of the screen shows an overview of the detected channels and a number of parameters such as power and timing offset. The lower part shows the composite constellation diagram of the signal.

R&S®FSL-K91/-K91n options

WLAN transmitter measurements

The R&S®FSL-K91 WLAN application firmware expands the application range of the R&S®FSL spectrum analyzer by spectrum and modulation measurements on signals in line with the WLAN IEEE 802.11a/b/g/j standards. The R&S®FSL-K91n application firmware adds capability to analyze 20 MHz signals in line with IEEE 802.11n.

The result summary provides a quick overview of the most important measurement values.

R&S FSL-K91 Wireless LAN		IEEE 802.11g			
Frequency:	2.4 GHz	Ref Level:	-0.9 dBm	External Att:	0 dB
Preamble Type:	OFDM	Modulation:	54 Mbps 64 QAM	PSDU Len:	1/1366
* Result Summary					
Bursts:	3	Min	Mean	Limit	Max
EVM All Carr.	0.89	0.92	5.62	0.94	5.62
	-41.03	-40.77	-25.00	-40.56	-25.00
EVM Data Carr.	0.89	0.92	5.62	0.94	5.62
	-40.97	-40.71	-25.00	-40.62	-25.00
EVM Pilot Carr.	0.81	0.84	39.81	0.88	39.81
	-41.79	-41.50	-8.00	-41.09	-8.00
IQ Offset	-60.62	-60.06	-15.00	-59.11	-15.00
Gain Imbalance	-0.07	-0.02		0.03	
	-0.01	-0.00		0.00	
Quadrature Err	-0.06	-0.03		-0.00	
Freq. Err	278.39	288.09 ± 60000		294.76 ± 60000	
Symb Clock Err	-0.02	0.03 ± 25		0.14 ± 25	
Burst Power	-11.46	-11.46		-11.46	
Crest Factor	10.24	10.24		10.25	

OFDM allows the constellation diagram to be displayed for all or for selected carriers.

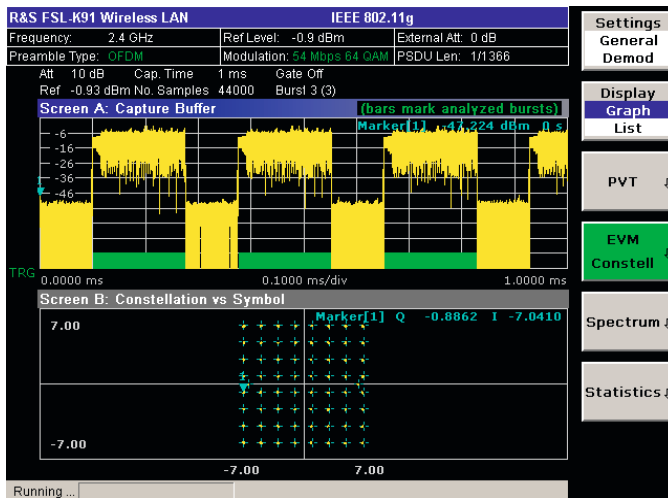

The excellent price/performance ratio, the compact size and the capability to be remote-controlled make the R&S®FSL an ideal WLAN tester in production. The R&S®FSL's analysis and evaluation capabilities, which enable measurements beyond the scope of the standard, make it indispensable for applications in development and troubleshooting. Functions, operation and remote control commands are essentially identical to those of the R&S®FSQ signal and spectrum analyzer with the R&S®FSQ-K91/-K91n option.

Measurement

- ▮ Output power
- ▮ Spectrum mask with limit lines and pass/fail indication
- ▮ Adjacent channel power
- ▮ Burst rise and fall times
- ▮ EVM
- ▮ EVM versus carrier or time
- ▮ Constellation diagram (for specific or all carriers)
- ▮ Constellation overview
- ▮ Selectable tracking: phase, level, timing
- ▮ RF carrier leakage
- ▮ Carrier frequency and symbol clock error
- ▮ CCDF and crest factor
- ▮ Bit stream
- ▮ Header information
- ▮ Automatic modulation selection

Setup tables provide a quick overview of the selected settings and quick access to the setting parameters.

The screenshot shows the 'General Settings' menu in the R&S FSL-K91n software. It is divided into several sections:

- Signal Characteristics:** Standard (IEEE 802.11a), Frequency (IEEE 802.11a), Channel No (IEEE 802.11b), Level Settings (Signal Level: IEEE 802.11j (10 MHz), Ext Att: IEEE 802.11g).
- Advanced Settings:** Auto Level Time (100 ms), Ref. Level (-20 dBm), Attenuation (0 dB), Sample Rate (20 MHz).
- Demod Settings:** Burst To Analyze (Signal Field Content), Burst Type (Direct Link Burst), Auto Demodulation, Demodulator (54 Mbps 64 QAM), Equal Burst Length, Min Data Symbols (1), Max Data Symbols (1366), Channel Estimation (Preamble).
- Trigger Settings:** Trigger Mode (Free Run), Trigger Offset (-10 µs), Power Level (Auto Lvl, 0 dBm).
- IQ Settings:** Swap IQ (unchecked), Advanced Settings (checked).

Benefit from the advantages of networking

Versatile documentation and networking capabilities

The Windows XP Embedded operating system coupled with a wide variety of interfaces makes it easy to insert measurement results into documentation. Simply save the screen contents as a BMP or WMF file and import the file into your word processing system. To process trace data, save it as an ASCII file (CSV format), together with the main instrument settings.

Make use of the advantages offered by networking

The standard LAN interface opens up versatile networking capabilities:

- Link to standard network (Ethernet 10/100BASE-T)
- Running under Windows XP Embedded, the R&S®FSL can be configured for network operation. Applications such as data output to a central network printer or saving results on a central server can easily be implemented. The R&S®FSL can thus be optimally matched to any work environment
- You can import screen contents directly into Word for Windows or, by using an Excel macro, into your documentation programs and thus immediately create data sheets for your products or documents for quality assurance
- The R&S®FSL is LXI class C compliant. LXI is the LAN-based successor to the IEC/IEEE bus, combining the advantages of Ethernet with the simplicity and familiarity of the IEC/IEEE bus. LXI instruments use the VXI11 protocol for remote control, which is supported by all VISA implementations. The common LAN configuration of LXI instruments makes integration into a network easy

The standard USB host interface allows functions such as the following:

- Quick firmware update from a USB flash memory stick or a USB CD-ROM drive
- Connection of PC peripheral devices (mouse, keyboard)
- Simple file transfer, including large volumes of data via a USB flash memory stick

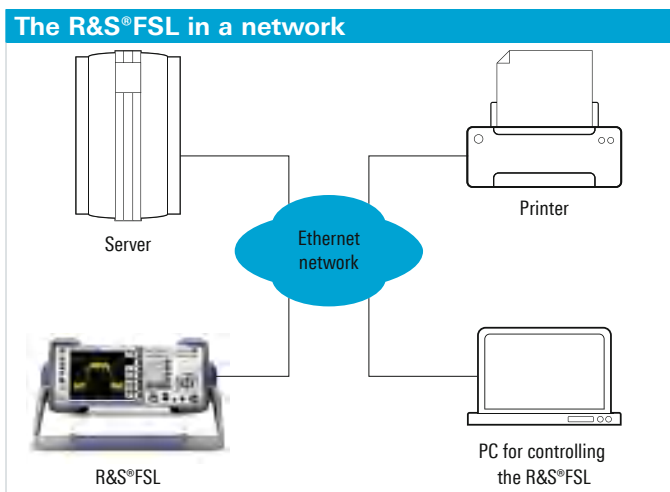

Specifications in brief

	R&S®FSL3, model .03	R&S®FSL3, model .13	R&S®FSL6, model .06	R&S®FSL6, model .16	R&S®FSL18 model .18	R&S®FSL18 model .28
Frequency range	9 kHz to 3 GHz	9 kHz to 3 GHz	9 kHz to 6 GHz	9 kHz to 6 GHz	9 kHz to 18 GHz (overrange 20 GHz)	
Frequency accuracy	1 × 10 ⁻⁶					
With R&S®FSL-B4, OCXO	1 × 10 ⁻⁷				standard with the R&S®FSL18	
Resolution bandwidths						
Standard	300 Hz to 10 MHz in 1/3 sequence, zero span additionally 20 MHz					
With R&S®FSL-B7	10 Hz to 10 MHz in 1/3 sequence, additionally 1 Hz (FFT filter)					
Video bandwidths	10 Hz to 10 MHz					
Signal analysis bandwidth	28 MHz					
Phase noise	typ. -103 dBc (1 Hz) at 10 kHz from carrier, 1 GHz					
Displayed average noise level (DANL)						
With 300 Hz RBW	typ. -117 dBm					
With 1 Hz FFT RBW and preamplifier (R&S®FSL-B7, R&S®FSL-B22 options)	500 MHz: typ. -162 dBm 3 GHz: typ. -158 dBm					
Third-order intercept (TOI)	typ. +18 dBm					
Detectors	pos./neg. peak, auto peak, RMS, quasi-peak, average, sample					
Level measurement uncertainty	< 0.5 dB (30 kHz ≤ f ≤ 3 GHz), < 0.8 dB (3 GHz < f ≤ 6 GHz), < 1.2 dB (6 GHz < f ≤ 18 GHz)					
Tracking generator	no	yes	no	yes	no	yes
Frequency range	-	1 MHz to 3 GHz	-	1 MHz to 6 GHz	-	10 MHz to 18 GHz
Output level	-	-20 dBm to 0 dBm	-	-20 dBm to 0 dBm	-	-30 dBm to -10 dBm

Ordering information

Designation	Type	Order No.
Spectrum Analyzer, 9 kHz to 3 GHz	R&S®FSL3	1300.2502.03
Spectrum Analyzer, 9 kHz to 3 GHz, with tracking generator	R&S®FSL3	1300.2502.13
Spectrum Analyzer, 9 kHz to 6 GHz	R&S®FSL6	1300.2502.06
Spectrum Analyzer, 9 kHz to 6 GHz, with tracking generator	R&S®FSL6	1300.2502.16
Spectrum Analyzer, 9 kHz to 18 GHz (overrange 20 GHz)	R&S®FSL18	1300.2502.18
Spectrum Analyzer, 9 kHz to 18 GHz, with tracking generator	R&S®FSL18	1300.2502.28

Options

Designation	Type	Order No.	Comments
OCXO Reference Frequency, aging 1×10^{-7} /year	R&S®FSL-B4	1300.6008.02	standard with the R&S®FSL18
Additional Interfaces	R&S®FSL-B5	1300.6108.02	video out, IF out, noise source control, AUX port, connector for R&S®NRP power sensors
TV Trigger	R&S®FSL-B6	1300.5901.02	
Narrow Resolution Filters	R&S®FSL-B7	1300.5601.02	
Gated Sweep	R&S®FSL-B8	1300.5701.02	
GPIB Interface	R&S®FSL-B10	1300.6208.02	
RF Preamp (3 GHz/6 GHz)	R&S®FSL-B22	1300.5953.02	
DC Power Supply, 12 V to 28 V	R&S®FSL-B30	1300.6308.02	
NiMH Battery Pack	R&S®FSL-B31	1300.6408.02	requires R&S®FSL-B30
Firmware/options			
AM/FM/φM Measurement Demodulator	R&S®FSL-K7	1300.9246.02	
Transmitter Measurements for Bluetooth® V2.0 and EDR	R&S®FSL-K8	1301.9398.02	
Power Sensor Support with R&S®NRP Power Sensors	R&S®FSL-K9	1301.9530.02	requires R&S®FSL-B5 or R&S®NRP-Z4 and R&S®NRP power sensor
Spectrogram Measurements	R&S®FSL-K14	1302.0913.02	
Cable TV Measurements	R&S®FSL-K20	1301.9675.02	
Application Firmware for Noise Figure and Gain Measurements	R&S®FSL-K30	1301.9817.02	requires R&S®FSL-B5 and preamplifier
3GPP FDD BTS Application Firmware	R&S®FSL-K72	1302.0620.02	
CDMA2000® Base Station Analysis	R&S®FSL-K82	1302.7803.02	
1xEV-DO Base Station Analysis	R&S®FSL-K84	1302.0159.02	
WLAN Transmitter Measurements for IEEE 802.11a, b, g, j	R&S®FSL-K91	1302.0094.02	
Upgrade of R&S®FSL-K91 to IEEE 802.11n	R&S®FSL-K91n	1308.7903.02	
WiMAX™ IEEE 802.16 OFDM Application Firmware	R&S®FSL-K92	1302.0236.02	see PD 5213.8550.12
WiMAX™ IEEE 802.16 OFDM/OFDMA Application Firmware	R&S®FSL-K93	1302.0736.02	see PD 5213.8550.12
Upgrade from R&S®FSL-K92 to R&S®FSL-K93	R&S®FSL-K92U	1302.0307.02	

The Bluetooth® word mark and logos are owned by the Bluetooth SIG, Inc. and any use of such marks by Rohde&Schwarz is under license.

CDMA2000® is a registered trademark of the Telecommunications Industry Association (TIA-USA).

“WiMAX Forum” is a registered trademark of the WiMAX Forum. “WiMAX,” the WiMAX Forum logo, “WiMAX Forum Certified,” and the WiMAX Forum Certified logo are trademarks of the WiMAX Forum.

Recommended extras

Designation	Type	Order No.
19" Rackmount Adapter	R&S®ZZA-S334	1109.4487.00
Soft Carrying Bag	R&S®FSL-Z3	1300.5401.00
Protective Hard Cover	R&S®EVS-Z6	5201.7760.00
Additional Charger Unit	R&S®FSL-Z4	1300.5430.02
Matching Pad 75 Ω, L section	R&S®RAM	0358.5414.02
Matching Pad 75 Ω, series resistor 25 Ω	R&S®RAZ	0358.5714.02
Matching Pad 75 Ω, L section, N to BNC	R&S®FSH-Z38	1300.7740.02
SWR Bridge, 5 MHz to 3 GHz	R&S®ZRB2	0373.9017.52
SWR Bridge, 40 kHz to 4 GHz	R&S®ZRC	1039.9492.52
SWR Bridge, 10 MHz to 3 GHz (incl. Open, Short, Load calibration standards)	R&S®FSH-Z2	1145.5767.02

Warranty		
Base unit		3 years
All other items ¹⁾		1 year
Options		
Extended Warranty, one year	R&S®WE1	Please contact your local Rohde & Schwarz sales office.
Extended Warranty, two years	R&S®WE2	
Extended Warranty with Calibration Coverage, one year	R&S®CW1	
Extended Warranty with Calibration Coverage, two years	R&S®CW2	
Extended Warranty with Accredited Calibration Coverage, one year	R&S®AW1	
Extended Warranty with Accredited Calibration Coverage, two years	R&S®AW2	

¹⁾ For options that are installed, the remaining base unit warranty applies if longer than 1 year. Exception: all batteries have a 1 year warranty.

Service that adds value

- | Worldwide
- | Local and personalized
- | Customized and flexible
- | Uncompromising quality
- | Long-term dependability

Rohde & Schwarz

The Rohde & Schwarz electronics group offers innovative solutions in the following business fields: test and measurement, broadcast and media, secure communications, cybersecurity, monitoring and network testing. Founded more than 80 years ago, the independent company which is headquartered in Munich, Germany, has an extensive sales and service network with locations in more than 70 countries.

Sustainable product design

- | Environmental compatibility and eco-footprint
- | Energy efficiency and low emissions
- | Longevity and optimized total cost of ownership

Certified Quality Management

ISO 9001

Certified Environmental Management

ISO 14001

Rohde & Schwarz GmbH & Co. KG

www.rohde-schwarz.com

Rohde & Schwarz training

www.training.rohde-schwarz.com

Regional contact

- | Europe, Africa, Middle East | +49 89 4129 12345
customersupport@rohde-schwarz.com
- | North America | 1 888 TEST RSA (1 888 837 87 72)
customer.support@rsa.rohde-schwarz.com
- | Latin America | +1 410 910 79 88
customersupport.la@rohde-schwarz.com
- | Asia Pacific | +65 65 13 04 88
customersupport.asia@rohde-schwarz.com
- | China | +86 800 810 82 28 | +86 400 650 58 96
customersupport.china@rohde-schwarz.com

R&S® is a registered trademark of Rohde & Schwarz GmbH & Co. KG

Trade names are trademarks of the owners

PD 0758.2790.12 | Version 08.00 | July 2017 (as)

R&S®FSL Spectrum Analyzer

Data without tolerance limits is not binding | Subject to change

© 2008 - 2017 Rohde & Schwarz GmbH & Co. KG | 81671 Munich, Germany



0758279012