

C.A 1227











Thermo-anemometer

Thank you for purchasing this **C.A 1227 thermo-anemometer**.

For best results from your instrument:

- **read** these operating instructions carefully,
- **comply** with the precautions for use.

	Information or useful tip.
	Battery.
	Magnet.
	The product is declared recyclable following an analysis of the life cycle in accordance with standard ISO 14040.
 	Chauvin Arnoux has adopted an Eco-Design approach in order to design this appliance. Analysis of the complete life-cycle has enabled us to control and optimize the effects of the product on the environment. In particular this appliance exceeds regulation requirements with respect to recycling and reuse.
	The CE marking indicates conformity with European directives, in particular LVD and EMC.
	The rubbish bin with a line through it indicates that, in the European Union, the product must undergo selective disposal in compliance with Directive WEEE 2002/96/EC. This equipment must not be treated as household waste.

PRECAUTIONS FOR USE

This instrument is compliant with safety standard IEC 61010-2-030, for voltages up to 5V with respect to ground. Failure to observe the safety instructions may result in electric shock, fire, explosion, and destruction of the instrument and of the installations.

- The operator and/or the responsible authority must carefully read and clearly understand the various precautions to be taken in use. Sound knowledge and a keen awareness of electrical hazards are essential when using this instrument.
- Observe the conditions of use, namely the temperature, the relative humidity, the altitude, the degree of pollution, and the place of use.
- Do not use the instrument if it seems to be damaged, incomplete, or poorly close.
- Before each use, check the condition of the housing. Any item of which the insulation is deteriorated (even partially) must be set aside for repair or scrapping.
- Always hold the handle of the sensor, and keep your fingers away from the propeller.
- All troubleshooting and metrological checks must be done by competent, accredited personnel.

CONTENTS

1. FIRST USE	4
1.1. Delivery condition	4
1.2. Accessories	4
1.3. Spare parts	4
1.4. Inserting the batteries	5
2. PRESENTATION OF THE INSTRUMENT	6
2.1. C.A 1227	6
2.2. Functions of the instrument	7
2.3. Function keys	7
2.4. On/Off key	8
2.5. Display	8
3. USE IN STAND-ALONE MODE	9
3.1. Air temperature and speed measurement	9
3.2. Temperature and air flow measurement	10
3.3. Other functions	11
3.4. Recording the measurements	12
3.5. Errors.....	12
4. USE IN RECORDING MODE	13
4.1. Connection	13
4.2. Get data logger transfer software	13
4.3. USB link	13
4.4. Bluetooth link	14
4.5. Data Logger Transfer software	14
5. TECHNICAL CHARACTERISTICS	17
5.1. Reference conditions.....	17
5.2. Electrical characteristics	17
5.3. Memory.....	18
5.4. USB	18
5.5. Bluetooth	18
5.6. Power supply	18
5.7. Environmental conditions	19
5.8. Mechanical characteristics	19
5.9. Compliance with international standards.....	19
5.10. Electromagnetic compatibility (CEM).....	19
6. MAINTENANCE	20
6.1. Cleaning	20
6.2. Replacement of batteries.....	20
6.3. Updating the embedded software.....	20
7. WARRANTY	22

1. FIRST USE

1.1. DELIVERY CONDITION

Thermo-anemometer C.A 1227

Supplied in a cardboard box with:

- three AA or LR6 alkaline batteries,
- one USB-micro USB cord,
- one multilingual getting started guide,
- one multilingual safety data sheet,
- one test report,
- one carrying case.

1.2. ACCESSORIES

- Multi-purpose attachment accessory
- Carrying bag.
- USB-Bluetooth adapter
- USB-mains adapter with USB-micro USB cord.
- Protecting sheath
- DataView application software
- Air flow measurement cones kit containing:
 - one cone with round opening
 - one cone with square opening

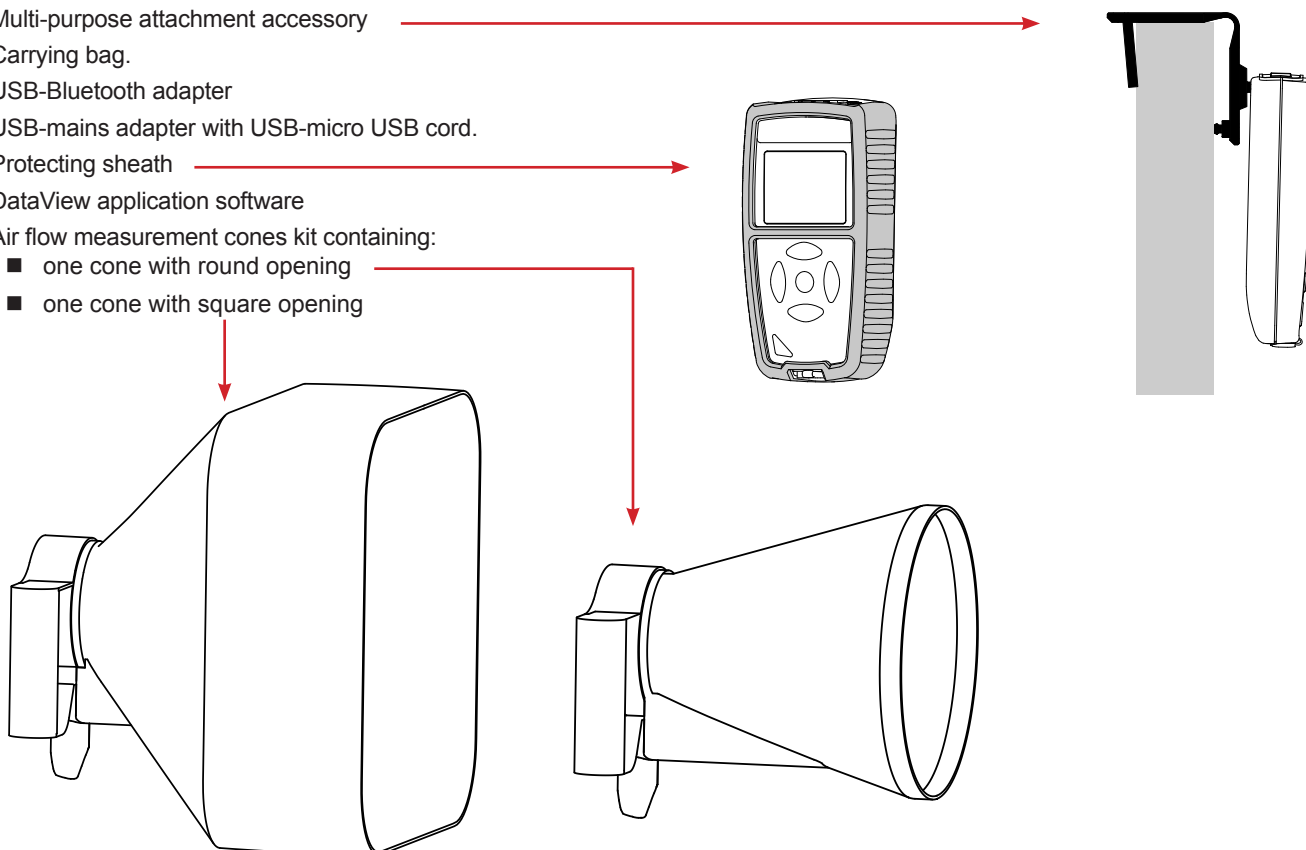

1.3. SPARE PARTS

- USB-micro USB cord
- Thermo-anemometer sensor

For the accessories and spares, consult our web site:

www.chauvin-arnoux.com

1.4. INSERTING THE BATTERIES

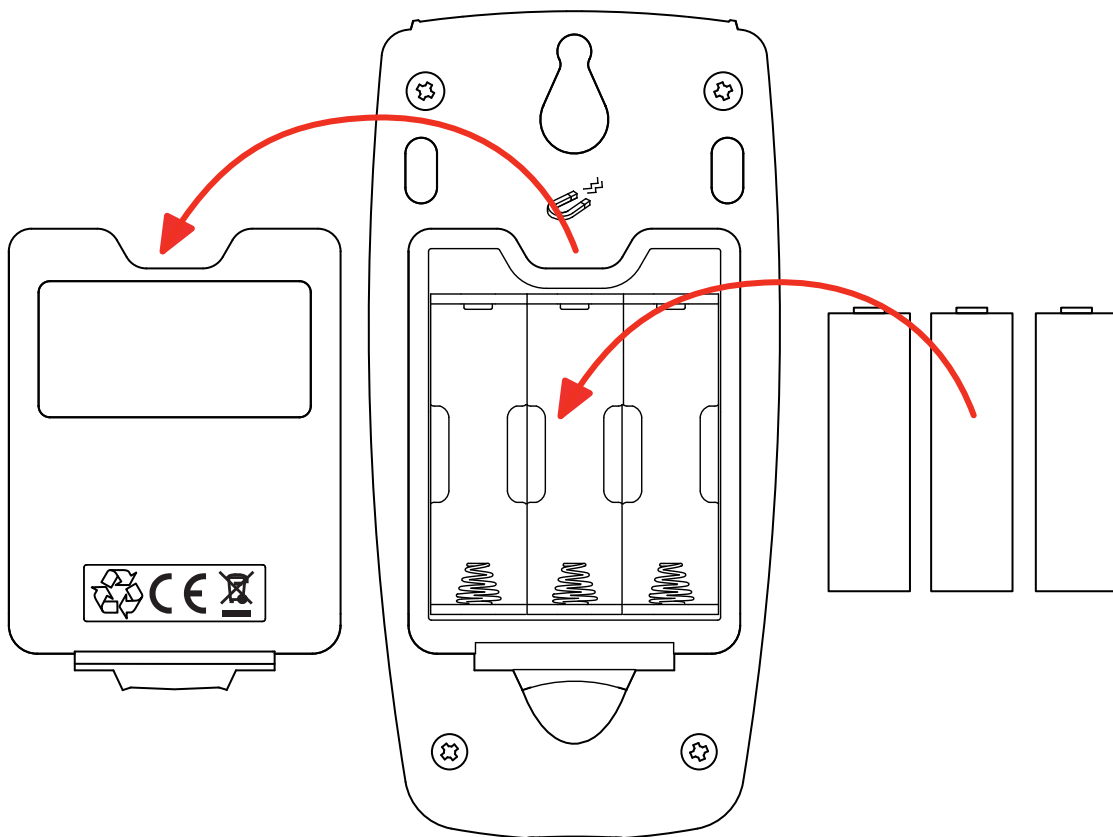
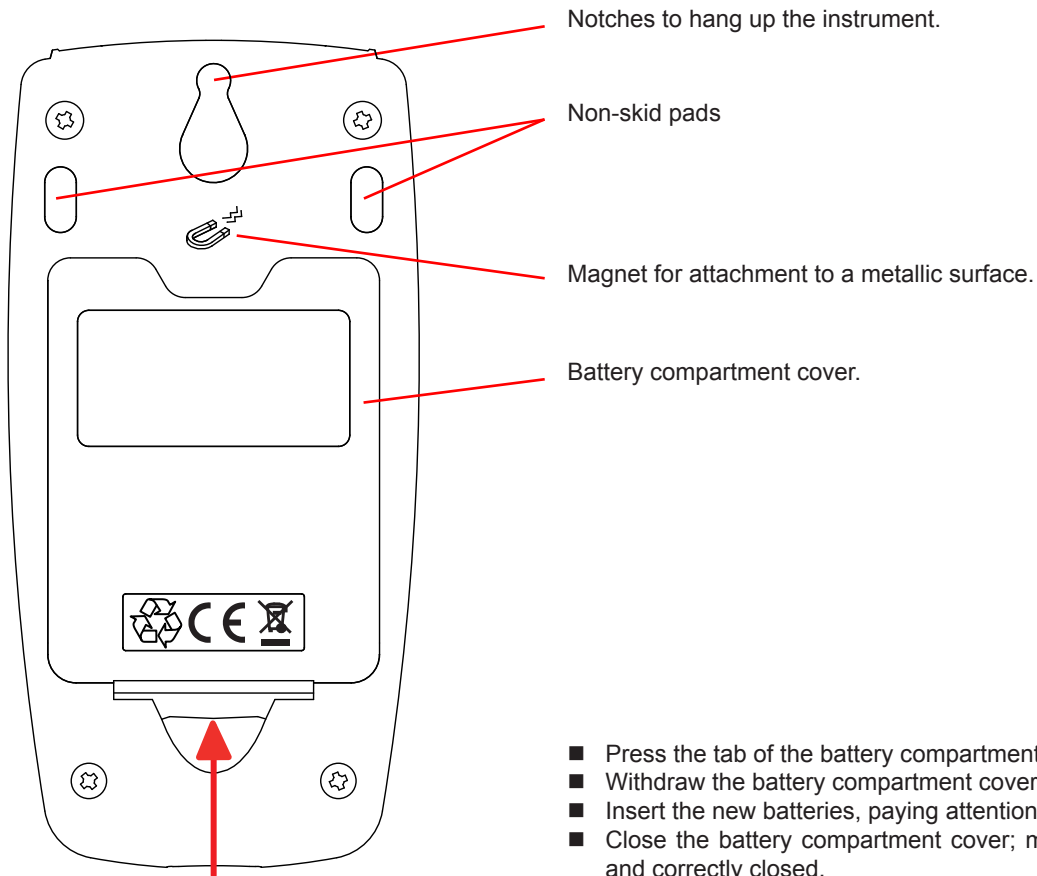

2. PRESENTATION OF THE INSTRUMENT

2.1. C.A 1227

Propeller of the anemometer.

Arrow indicating the direction of flow. ←

Temperature sensor.

Handle of the sensor.

Spiral-wound cable connecting the sensor to the instrument.

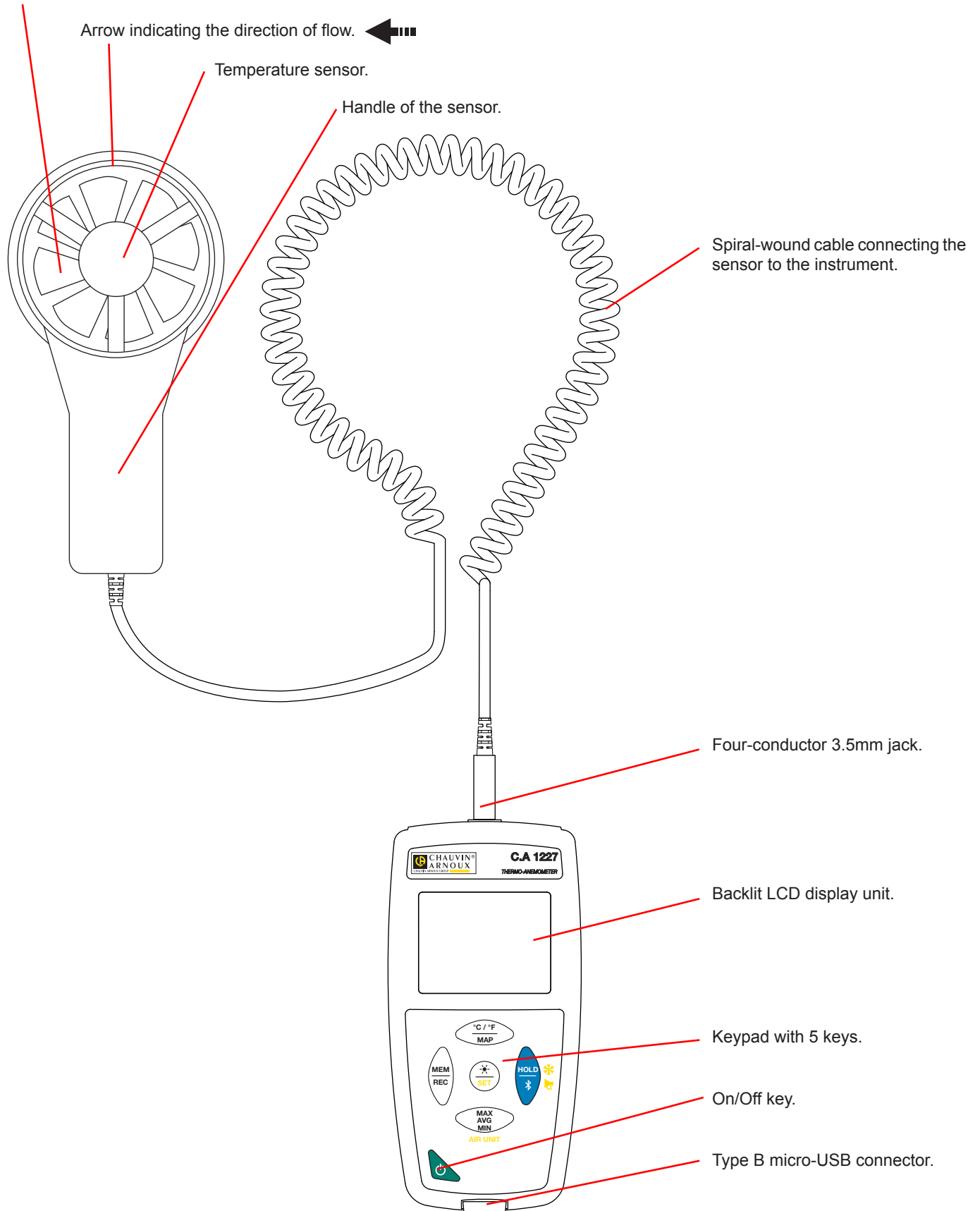

Four-conductor 3.5mm jack.

Backlit LCD display unit.

Keypad with 5 keys.

On/Off key.

Type B micro-USB connector.

2.2. FUNCTIONS OF THE INSTRUMENT

The C.A 1227 is a thermo-anemometer. It is used to measure:





- temperatures from -20 to +50°C,
- air speeds from 0.5 to 27m/s,
- volume flows from 0 to 99.999m3/h.

This instrument is easy to use. It can display:

- temperature measurements in °C or in °F,
- air speeds in m/s and km/h or in fpm and mph,
- volume flows in m3/s, m3/h, l/s, or CFM,
- to record a minimum, an average (mean), and a maximum in a specified period,
- to record a minimum, an average (mean), and a maximum on a surface,
- to record the measurements,
- to communicate with a PC via a Bluetooth link or a USB cable.

The Data Logger Transfer software can be installed on a PC and is used to configure the instruments and to recover the recorded measurements.

2.3. FUNCTION KEYS

Key	Function
°C/°F MAP	<ul style="list-style-type: none"> ■ A short press on the °C/°F key toggles the unit in which the temperature is displayed between °C and °F. ■ A long press on the MAP key opens the MAP mode.
MEM REC	<ul style="list-style-type: none"> ■ A short press on the MEM key records the measurement and the date. In MAP mode, pressing the MEM key adds a measurement to the measurements of the MAP. ■ A long press on the REC key starts or stops a recording session.
 SET	<ul style="list-style-type: none"> ■ A short press on the  key switches on the back-lighting. ■ A sustained press on the SET key makes it possible: <ul style="list-style-type: none"> ■ by pressing the  key, to choose among using the anemometer to measure the speed of the air (VELOC) or the air flow (FLOW), either with an air flow measurement cone, oriented for an incoming flow (In) or an outgoing flow (out), or without a cone, after measuring the area (CUST). ■ by pressing the AIR UNIT key, to choose the unit of display of the air speed (M/S, F/M, KM/H, M/H) or air flow (M3/S, M3/H, L/S, CF/M).
HOLD 	<ul style="list-style-type: none"> ■ A short press on the HOLD key freezes the display. ■ A long press on the  key activates or deactivates the Bluetooth link.
MAX AVG MIN	<ul style="list-style-type: none"> ■ A short press on the MAX AVG MIN key opens the MAX AVG MIN mode; the current values continue to be displayed. ■ A second press displays the maximum value. ■ A third press displays the average (mean) value. ■ A fourth press displays the minimum value. ■ A fifth press results in a return to the first-press condition and display of the current values ■ A long press is used to exit from the MAX AVG MIN mode. <p>In the MAP mode, presses on the MAX AVG MIN key display in turn the maximum, average (mean), and minimum of the MAP measurements.</p>

2.4. ON/OFF KEY

A long press on the  key switches the instrument on.

A second long press on the  key switches the instrument off when it is on. However, it is not possible to switch the instrument off when it is in record mode and is recording.

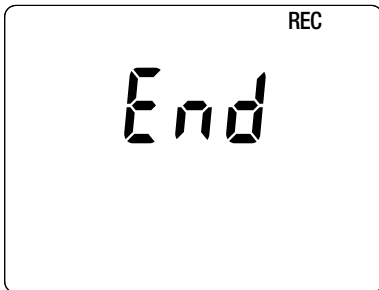

If during start-up the instrument displays the screen shown opposite, it means that a recording session has been brutally interrupted by a power outage.

During the display of this screen, the instrument recovers the recorded data. The longer the record, the longer the recovery. Do not interrupt the recovery or the data will be lost.

2.5. DISPLAY

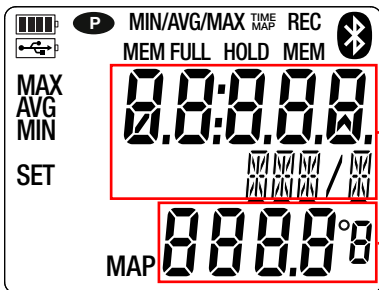

Air speed and flow display unit.

Temperature display unit/MAP function counter.

When the measurement exceeds the limits, the instrument displays OL.

P: indicates that auto-off is disabled and the instrument is in permanent mode.

This occurs when:

- the instrument is recording, in MAX AVG MIN mode, in MAP mode, or in HOLD;
- the instrument is connected via the USB cord either to an external power supply or for communication with a PC;
- the instrument is in communication via Bluetooth;
- or auto-off is disabled (see §4.5.3).

3. USE IN STAND-ALONE MODE

- The instrument can operate in two modes:
- the stand-alone mode described in this section,
- the record mode, in which it is controlled by a PC. This mode is described in the next section.

3.1. AIR TEMPERATURE AND SPEED MEASUREMENT

- Connect the sensor to the instrument.
- Long-press the  key to switch the instrument on.

The instrument displays the time, then the measurement. The time is set using the Data Logger Transfer software (see §4).

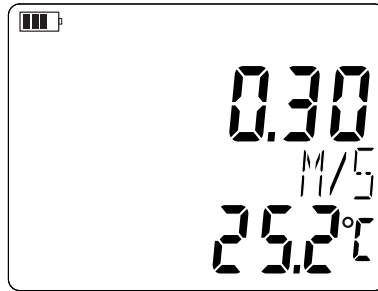

- To display the measurements in °F, press the °C/°F key.
- Set the instrument to air speed measurement:
 - Press and hold the **SET** key.
 - Press the  key until the instrument displays VELOC (velocity).
 - Press the **AIR UNIT** key to choose the unit of display of the air speed:
 - M/S: m/s or meter per second
 - F/M: fpm or feet per minute
 - KM/H: km/h or kilometre per hour
 - M/H: mph or miles per hour
 - Release the **SET** key.

The instrument will remain in this configuration when next started up.

- Place the sensor in the air flow. The arrow on the inside of the propeller must point in the direction of the flow. In this configuration, the temperature sensor will face the incoming air and will reach the final value more rapidly.

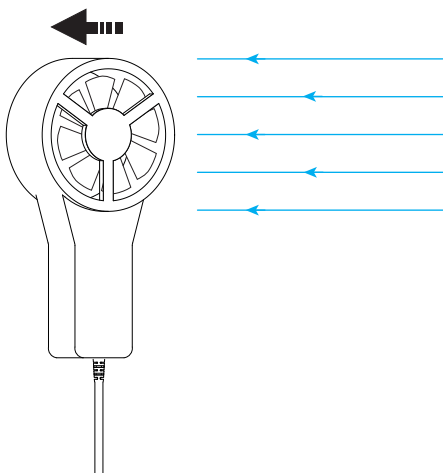

Always hold the handle of the sensor, and keep your fingers away from the propeller.



Wait for the display to stabilize before reading the measurement.

3.2. TEMPERATURE AND AIR FLOW MEASUREMENT

- Place the air flow measurement cone on the sensor. The air flow cones are sold as optional accessories. One has a round opening 20cm diameter and the other a square opening measuring approximately 33cm on a side (see §1.2). Depending on the measurement you want to make, place the sensor with the arrow pointing towards the cone (outgoing flow) or away from it (incoming flow).
It is also possible to make air flow measurements without a cone.
- Connect the sensor to the instrument.
- Long-press the  key to switch the instrument on.

The instrument displays the time, then the measurement. The time is set using the Data Logger Transfer software (see §4).

- To display the measurements in °F, press the °C/°F key.
- Set the instrument to air flow measurement:
 - Press and hold the **SET** key.
 - Press the  key until the instrument displays FLOW (air flow), then choose In, out, or CUS:
 - **In** for an incoming flow measurement with a cone (blowing),
 - **out** for an outgoing flow measurement with a cone (suction),
 - **CUS**t for use without a cone. It is in this case necessary to enter the area of the ventilation register using the Data Logger Transfer software (see §4.5.5). The instrument will calculate the product of the area of the ventilation register times the measured air speed in order to display the air flow across the whole surface.
 - Press the **AIR UNIT** key to choose the unit of display of the air flow:
 - M3/S: m³/s or cubic meters per second
 - M3/H: m³/h or cubic meters per hour
 - L/S: l/s or litres per second
 - CF/M: CFM or CFPM or cubic feet per minute
 - Release the **SET** key.

The instrument will remain in this configuration when next started up.

- Place the cone on the ventilation register. The arrow inside the propeller must point in the direction of air flow: towards the outside of the cone for a blowing measurement, towards the inside of the cone for a suction measurement.

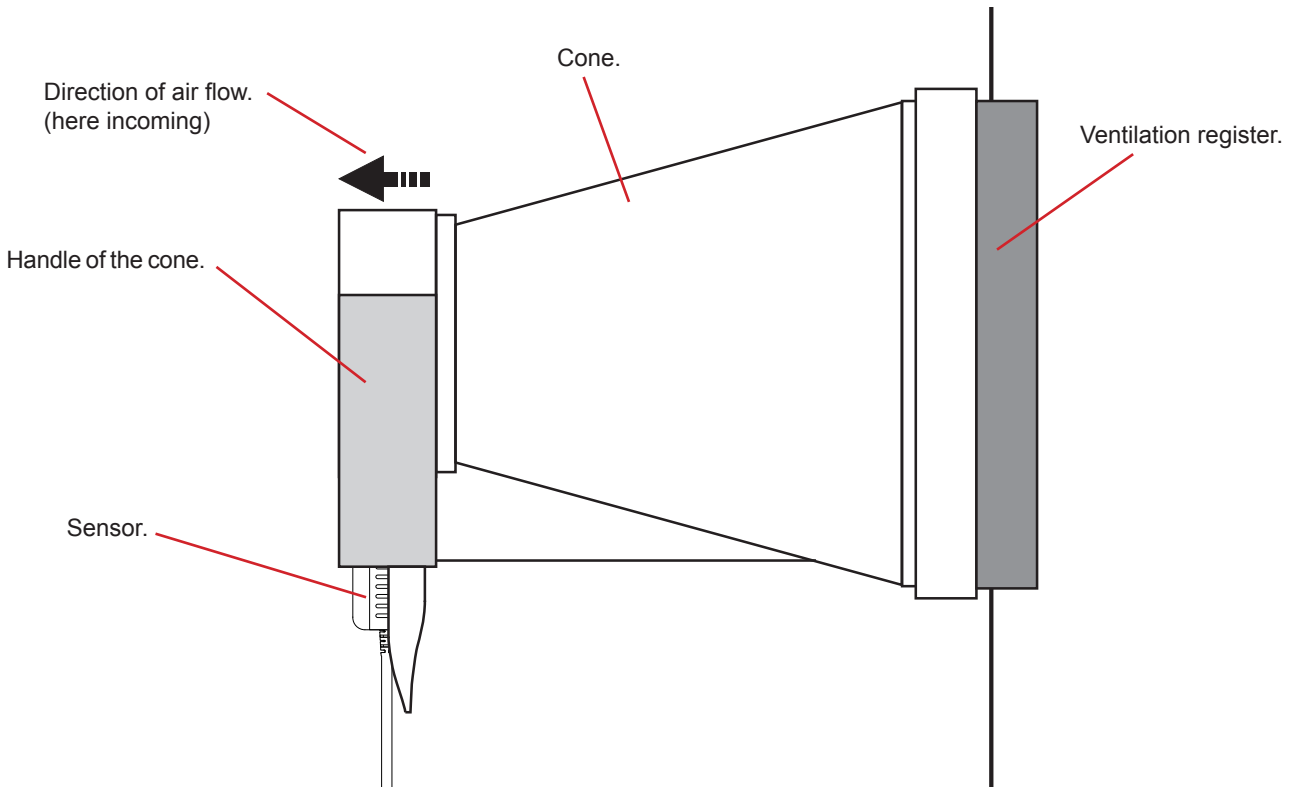

 When handling the sensor, keep your fingers away from the propeller.

 Wait for the display to stabilize before reading the measurement.

3.3. OTHER FUNCTIONS

3.3.1. HOLD FUNCTION

Pressing the **HOLD** key freezes the display. A second press unfreezes it.

3.3.2. MAX AVG MIN FUNCTION

The MAX AVG MIN function is used to monitor the evolution of the measurements over time.

Pressing the **MAX AVG MIN** key activates the function and starts recording of the extrema and calculation of the mean.

Press the **MAX AVG MIN** key a second time and the instrument displays the maximum. Press it a third time and the instrument displays the mean. A fourth time and the instrument displays the minimum. A fifth time and it returns to the current value.

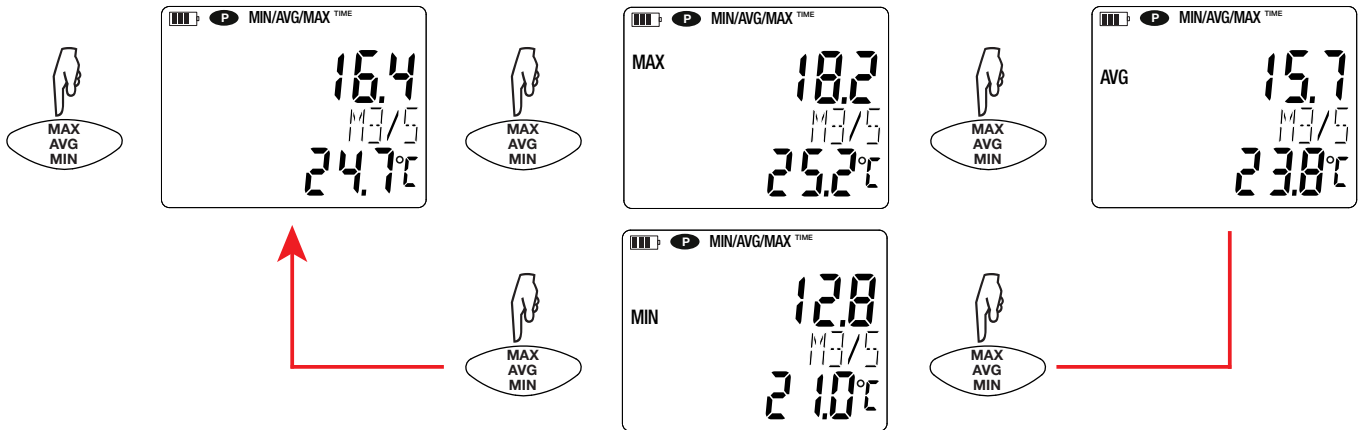

To exit from the MAX AVG MIN mode, long-press the **MAX AVG MIN** key.

When the MAX AVG MIN function is active, the MAP function is deactivated.

3.3.3. MAP FUNCTION

The MAP function is used to create a map of the air speed or flow.

A sustained press on the **MAP** key activates the function. The counter of the number of points recorded reads zero.

Plot a map of the zone to be measured and mark the measurement points.

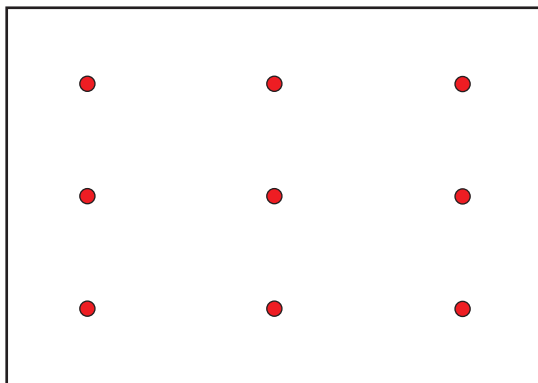

● = measurement points.

Place the sensor on the first measurement point and press the **MEM** key to record the value in memory. The counter is incremented. Proceed in the same way for all the other points of the map.

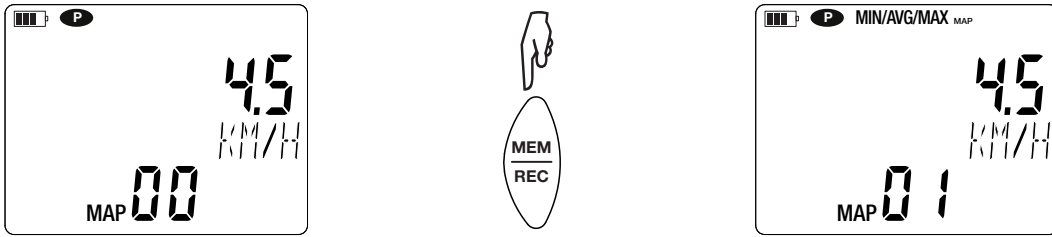

When all of the points have been entered, you can look up the maximum, the mean, and the minimum of the values entered. To do this, press the **MAX AVG MIN** key **3 times**.

To exit from the MAP mode, long-press the **MAP** key.

For each map measurement, a file is created with all of the measurement points. This file can then be recovered for analysis.

3.4. RECORDING THE MEASUREMENTS

- A short press on the **MEM** key records the measurement and the date.
- A long press on the **REC** key starts or stops a recording session.

To see the records, you must use a PC and install the Data Logger Transfer software (see §4).

3.5. ERRORS

The instrument detects errors and displays them in the form Er.XX. The main errors are the following:

- Er.01: Hardware malfunction detected. The instrument must be sent in for repair.
- Er.02: Error in internal memory. Format it using Windows.
- Er.03: Hardware malfunction detected. The instrument must be sent in for repair.
- Er.10: The instrument has not been adjusted or is not correctly adjusted. The instrument must be sent back to customer service.
- Er.11: The update of the internal software is not compatible with the instrument (the software is that of another instrument of the line). Install the correct internal software in your instrument.
- Er.12: The update of the internal software is not compatible with the electronic boards in the instrument. Reload the previous internal software into your instrument.
- Er.13: Recording scheduling error. Check that the instrument's time and the time of the Data Logger Transfer software are the same.

4. USE IN RECORDING MODE

The instrument can operate in two modes:

- the stand-alone mode described in the previous section,
- the record mode, in which it is controlled by a PC. This mode is described below.

4.1. CONNECTION

The device has 2 communication modes:

- A USB link via a USB-micro USB cord,
- A Bluetooth 4.0 BLE wireless link.

4.2. GET DATA LOGGER TRANSFER SOFTWARE

Visit our web site to download the latest version of the application software:

www.chauvin-arnoux.com

Go to the **Support** tab, then **Download our software**. Then search on the name of your instrument.

Download the software, then install it on your PC.



You must have administrator privileges on your PC to install the Data Logger Transfer software.

Minimum computer requirements:

- Windows 7 (32/64 bits)
- 2 GB of RAM
- 200 MB of disc space

Windows® is a registered trade mark of Microsoft®.



Do not connect the instrument to the PC until you have installed the Data Logger Transfer software.

4.3. USB LINK

- Long-press the  key to switch the instrument on.

Once the Data Logger Transfer software has been installed, connect the instrument to the PC.

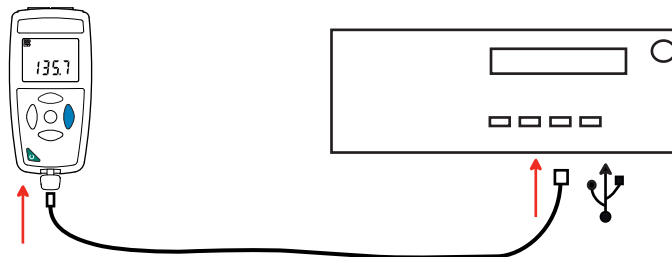

It is treated as a USB key and you can access its content. But to read the records, you must use the Data Logger Transfer software.

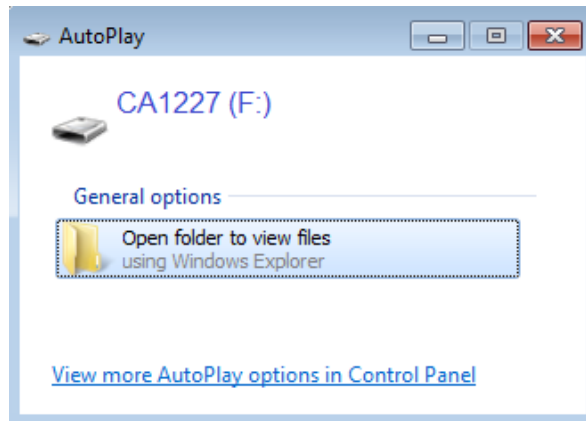



4.4. BLUETOOTH LINK

The instrument has a low-energy Bluetooth 4.0 link that requires no pairing.

- Activate Bluetooth on your PC. If your PC does not have a Bluetooth link, you can add a board or Bluetooth adapter connected to a USB port (see §1.2).



Since Windows 7 does not manage low-energy Bluetooth, a specific USB/Bluetooth adapter must be used (see §1.2).

- Switch the instrument on by a long press on the  key, then activate the Bluetooth link by a long press on the  key. The  symbol is displayed.
- The instrument is then ready to communicate with the PC.



4.5. DATA LOGGER TRANSFER SOFTWARE

Once the instrument has been connected to the PC, whether by USB or by Bluetooth, open the Data Logger Transfer software.





For context-sensitive information about the use of the Data Logger Transfer software, refer to the **Help** menu.

4.5.1. CONNECTING THE INSTRUMENT

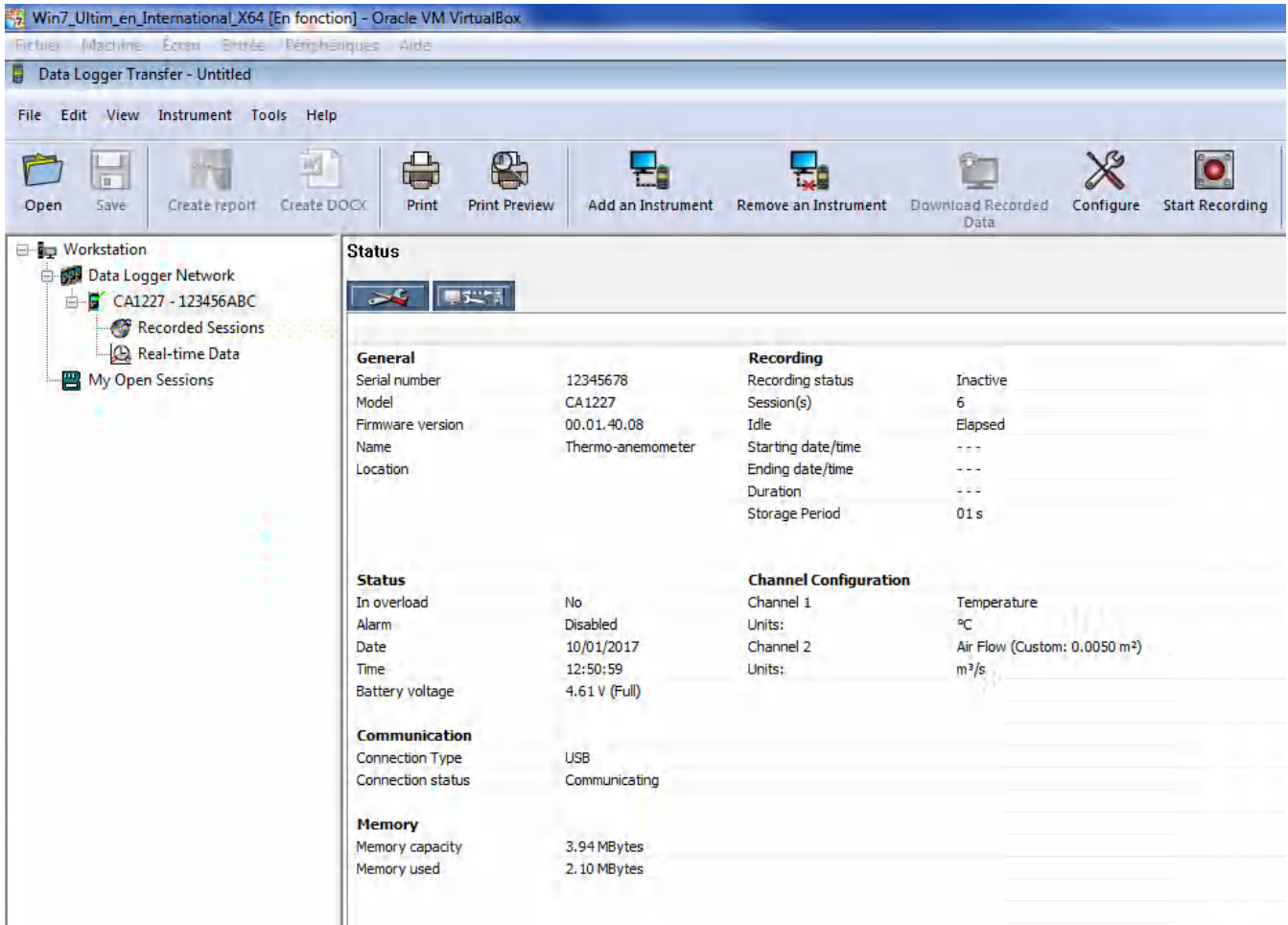
- To connect an instrument, click **Add an instrument**, then choose the type of connection (USB or Bluetooth).
- A window opens with a list of all instruments connected to the PC.
The name of the instrument will be formed from the model of the instrument and the warranty number: C.A 1227 - 123456ABC
You can personalize your instrument by adding a name and a location, by clicking on  or .
- Choose your instrument in the list. The software then displays complete information about the instrument and its measurements in progress.



4.5.2. DATE AND HOUR

The **Instrument**  menu lets you set the your instrument's date and time. These cannot be changed while recording or when a recording session has been scheduled. By clicking , you can choose the date and time display formats.

4.5.3. AUTO OFF

As default, the instrument switches itself off automatically after 3 minutes of operation without the user's presence being confirmed by a key-press. By clicking , you can change this value to 3, 10, or 15 minutes.

It is also possible to disable this auto-off function; the instrument then displays the **P** symbol.

4.5.4. PROGRAMMED RECORDING SESSIONS

By clicking , you can program a recording session. Assign a name to the recording session. Then enter a starting date and time and an ending date and time or a duration. The maximum duration of a recording session depends on the memory available.

Choose a sampling period. The possible values are: 1 s, 2 s, 5 s, 10 s, 20 s, 30 s, 1 min, 2 min, 5 min, 10 min, 15 min, 30 min and 1 hour. The shorter the sampling period, the larger the recorded file.

Before and after the recording session, if the instrument is switched on, the sampling period will be that of the stand-alone mode (1s).

If the instrument is off when recording starts, it switches itself on by itself. Then it displays the measurement, which it refreshes at each sampling period.



Before starting a recording session, make sure that the battery life is sufficient, or else connect the instrument to an external power supply on/to a wall outlet using a micro USB cord.

4.5.5. CONFIGURING THE AIR FLOW MEASUREMENT

By clicking , then opening the **Thermo-anemometer** tab, you can modify the units in which the measurements are displayed in the same way as by pressing the °C/°F or the **SET** key. You can also choose the direction of flow for an air flow measurement with a cone, or enter the area of the ventilation register without a cone.

You can choose among three possibilities:

- **In** for an incoming flow measurement with a cone (blowing),
- **out** for an outgoing flow measurement with a cone (suction),
- **CUS**t for use without a cone. Enter the area of the ventilation register.

4.5.6. READING THE RECORDS

The Data Logger Transfer software lets you read the records made. Click **Recorded Sessions** under the name of your instrument to obtain a list of the records.

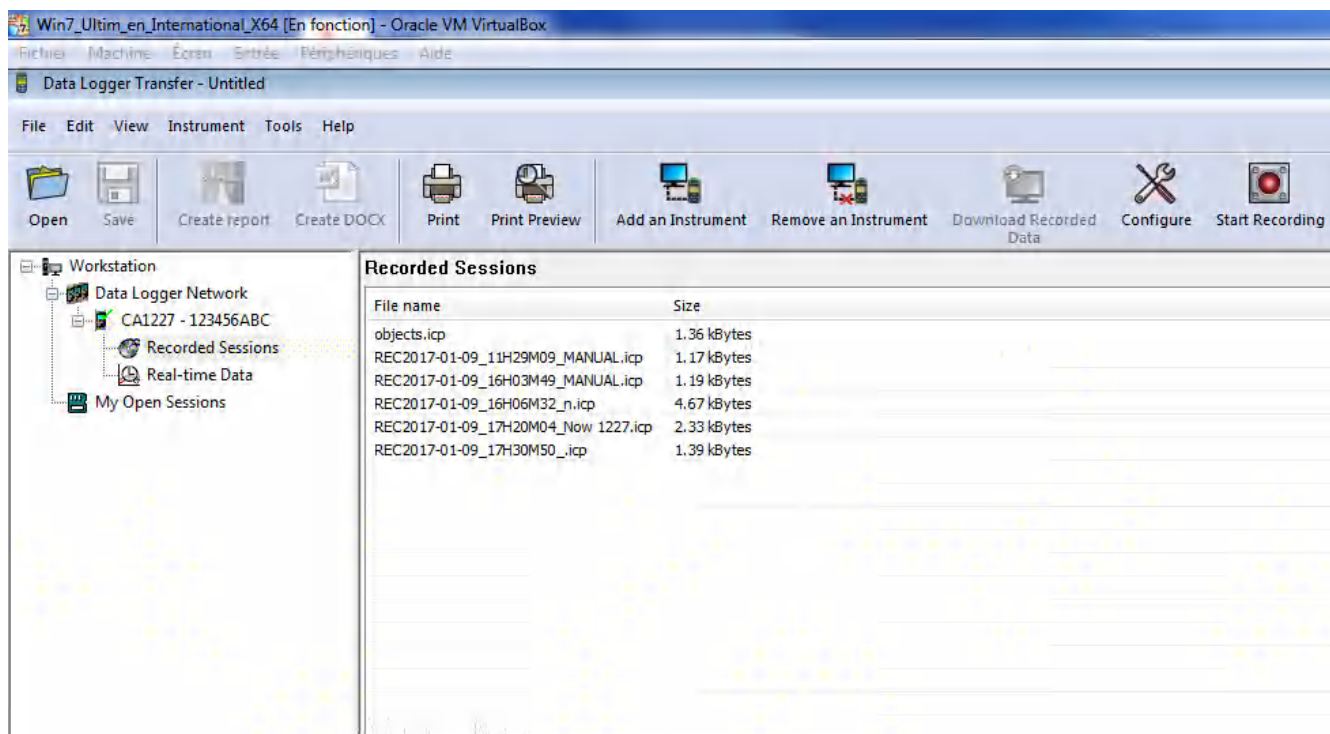

4.5.7. EXPORTING RECORDS

Once the list of the records is displayed, choose the one you want to export and convert it into a word-processing document (docx) or a spreadsheet (xlsx), in order to be able to use it in the form of reports or curves.

It is also possible to export the data to the DataView application software (see §1.2).

4.5.8. REAL-TIME MODE

Click **Real-time data** under the name of your instrument to see the measurements being made on the instrument as they are made.

4.5.9. FORMATTING THE MEMORY OF THE INSTRUMENT

The internal memory of the instrument is already formatted. But if there is a problem (if it becomes impossible to read or to write), it may be necessary to reformat it (in Windows).



In this case, all of the data will be lost.

5. TECHNICAL CHARACTERISTICS

5.1. REFERENCE CONDITIONS

Quantity of influence	Reference values
Temperature	23 ± 2°C
Relative humidity	45% to 75%
Supply voltage	3 to 4.5V
Electric field	< 1V/m
Magnetic field	< 40A/m

The intrinsic uncertainty is the error specified for the reference conditions. It is expressed in the form: a %R + b pt, where R = reading.

5.2. ELECTRICAL CHARACTERISTICS

5.2.1. TEMPERATURE MEASUREMENTS

Specified measurement range	- 20 to + 50°C	-4 to + 122°F
Resolution	Display in °C: 0.1°C	Display in °F: 0.1°F
Intrinsic uncertainty	from 0 to 50°C: ± 0,8°C from -20 to 0°C: ± 1,6°C	

5.2.2. AIR SPEED MEASUREMENTS

Specified measurement range	m/s		km/h	
	0.5 to 2.99 m/s	3.0 to 27.0 m/s	1,80 to 2.99 km/h	3.0 to 97.2 km/h
Resolution	0.01 m/s	0.1 m/s	0.01 km/h	0.1 km/h
Intrinsic uncertainty	± 3 % R ± 0,1 m/s	± 3 % R ± 0,1 m/s		

Specified measurement range	fpm		mph	
	98.0 to 99.9 fpm	100 to 5,315 fpm	1.12 to 2.99 mph	3.0 to 60.4 mph
Resolution	0.1 fpm	1 fpm	0.01 mph	0.1 mph

5.2.3. AIR FLOW MEASUREMENTS

Specified measurement range	m³/s				
	0.0000 to 0.9999 m³/s	0.100 to 0.999 m³/s	1.00 to 2.99 m³/s	3.0 to 99.9 m³/s	100 to 99999 m³/s
Resolution	0.0001 m³/s	0.001 m³/s	0.01 m³/s	0.1 m³/s	1 m³/s
Intrinsic uncertainty	± 8% R				

Specified measurement range	m³/h			R/s
	0.00 to 2.99 m³/h	3.0 to 99.9 m³/h	100 to 2999 m³/h	0.00 to 2.99 R/s
Resolution	0.01 m³/h	0.1 m³/h	1 m³/h	0.01 R/s
Intrinsic uncertainty	± 8% R			± 8% R

Specified measurement range	0.00 to 2.99 cfm	3.0 to 99.9 cfm	100 to 2999 cfm
Resolution	0.01 cfm	0.1 cfm	1 cfm
Intrinsic uncertainty	± 8% R		

5.3. MEMORY

The size of the flash memory containing the records is 4 MB.

This capacity is sufficient to record a million measurements. At each measurement, the temperature and the air speed or air flow are recorded with the date, the time, and the unit.



5.4. USB

Protocol: USB Mass Storage
 Maximum transmission speed: 12 Mbit/s
 Type B micro-USB connector

5.5. BLUETOOTH

Bluetooth 4.0 BLE
 Range 10m typical and up to 30m in line of sight.
 Output power: +0 to -23 dBm
 Nominal sensitivity: -93 dBm
 Maximum transfer rate: 10 kbits/s
 Average consumption: 3.3 µA to 3.3 V.

5.6. POWER SUPPLY

The instrument is supplied by three 1.5V LR6 or AA alkaline batteries. It is possible to replace the batteries by rechargeable NiMH batteries of the same size. But the rechargeable batteries, even when correctly charged, will not reach the voltage of the alkaline batteries and the life indicated will be  or .

The voltage range ensuring correct operation is from 3 to 4.5V for the alkaline batteries and 3.6V for the rechargeable batteries. Below 3V, the instrument stops making measurements and displays BAT.

Battery life (with the Bluetooth connection deactivated) is:

- in stand-alone mode, 200h
- in recording mode: 8 days at rate of one measurement every 15 minutes.

The instrument can also be powered via a USB-micro USB cord, connected either to a PC or to a wall outlet via a mains adapter.

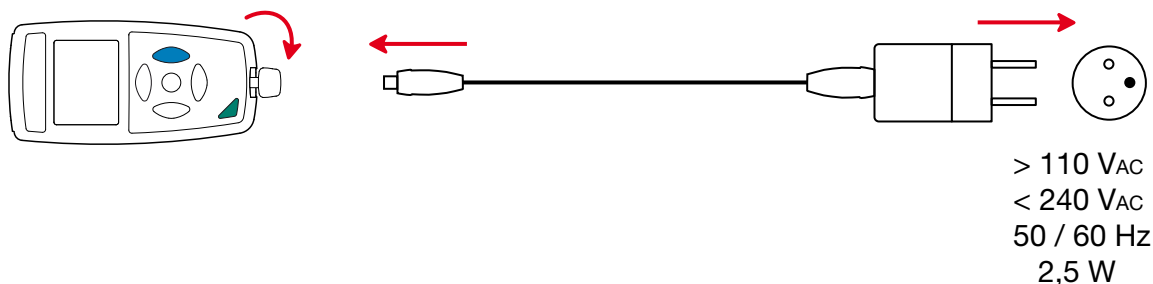

5.7. ENVIRONMENTAL CONDITIONS

For use indoors and outdoors.

Operating range	-10 to 60°C and 10 to 90%RH without condensation
Storage range	-20 to +70°C and 10 to 95%RH without condensation, without batteries
Altitude	< 2000m, and 10,000m in storage.
Pollution degree	2

5.8. MECHANICAL CHARACTERISTICS

Dimensions (L x W x H)

Housing	150 x 72 x 32mm
Sensor	160 x 80 x 38mm
Spiral-wound cable	24 to 120cm
Mass	400g approx.

Inrush protection IP 40, with the USB connector closed, per IEC 60 529.

Drop impact test 1 m per IEC 61010-1.

5.9. COMPLIANCE WITH INTERNATIONAL STANDARDS

The instrument is compliant with standard IEC 61010-1.

5.10. ELECTROMAGNETIC COMPATIBILITY (CEM)

The instrument is compliant with standard IEC 61326-1.

6. MAINTENANCE



Except for the batteries, the instrument contains no parts that can be replaced by personnel who have not been specially trained and accredited. Any unauthorized repair or replacement of a part by an “equivalent” may gravely impair safety.

6.1. CLEANING



To preserve good measurement quality, the propeller of the sensor must be kept perfectly clean.

Switch the instrument off.

Use a soft cloth, dampened with soapy water. Rinse with a damp cloth and dry rapidly with a dry cloth or forced air. Do not use alcohol, solvents, or hydrocarbons.

See to it that nothing interferes with the rotation of the propeller.

6.2. REPLACEMENT OF BATTERIES

The  symbol indicates the remaining battery life. When the  symbol is empty, all of the batteries must be replaced.

- Switch the instrument off.
 - Refer to §1.4 for the replacement procedure.
-



Spent batteries must not be treated as ordinary household waste. Take them to the appropriate recycling collection point.

6.3. UPDATING THE EMBEDDED SOFTWARE

With a view to providing, at all times, the best possible service in terms of performance and technical improvements, Chauvin-Arnoux offers you the possibility of updating the internal software of this instrument by downloading, free of charge, the new version available on our web site.

See you on our site:

www.chauvin-arnoux.com

Then go to “Support”, then “Download our software”, then “C.A 1227”.



Updating the embedded software may reset the configuration and cause the loss of the recorded data. As a precaution, save the data in memory to a PC before updating the embedded software.

Embedded software update procedure

- Download the .bin file from our web site, then press and hold the **MEM** key and switch the instrument on by pressing the  key. The instrument displays BOOT.

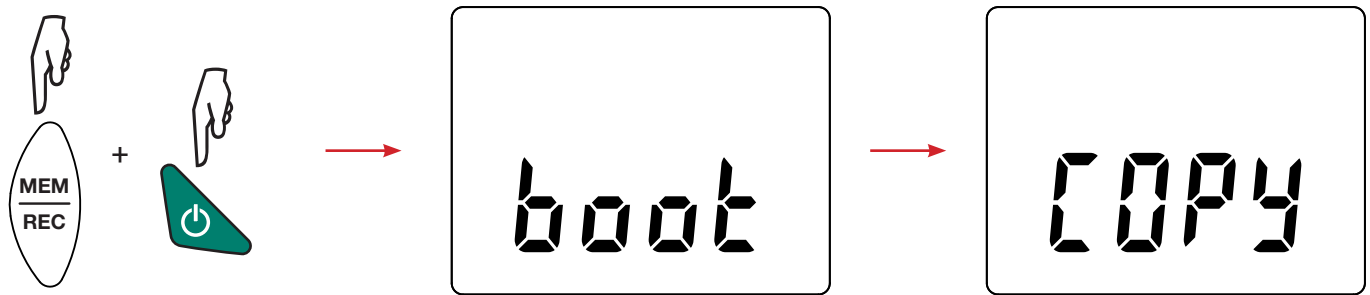

- Release the keys and the instrument displays COPY, indicating that it is ready to receive the new software.
- Connect the instrument to your PC using the USB cord provided.

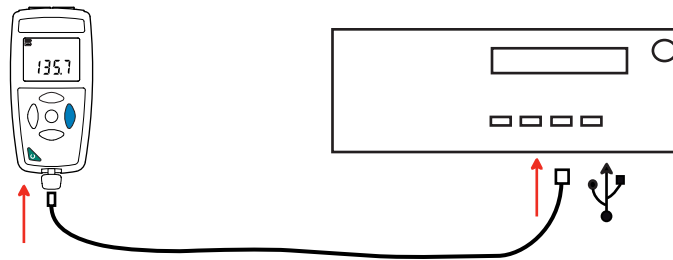

- Copy the .bin file to the instrument as if were a USB key.
- When the copying is done, press the MEM key and the instrument displays LOAD, indicating that the software is being installed.

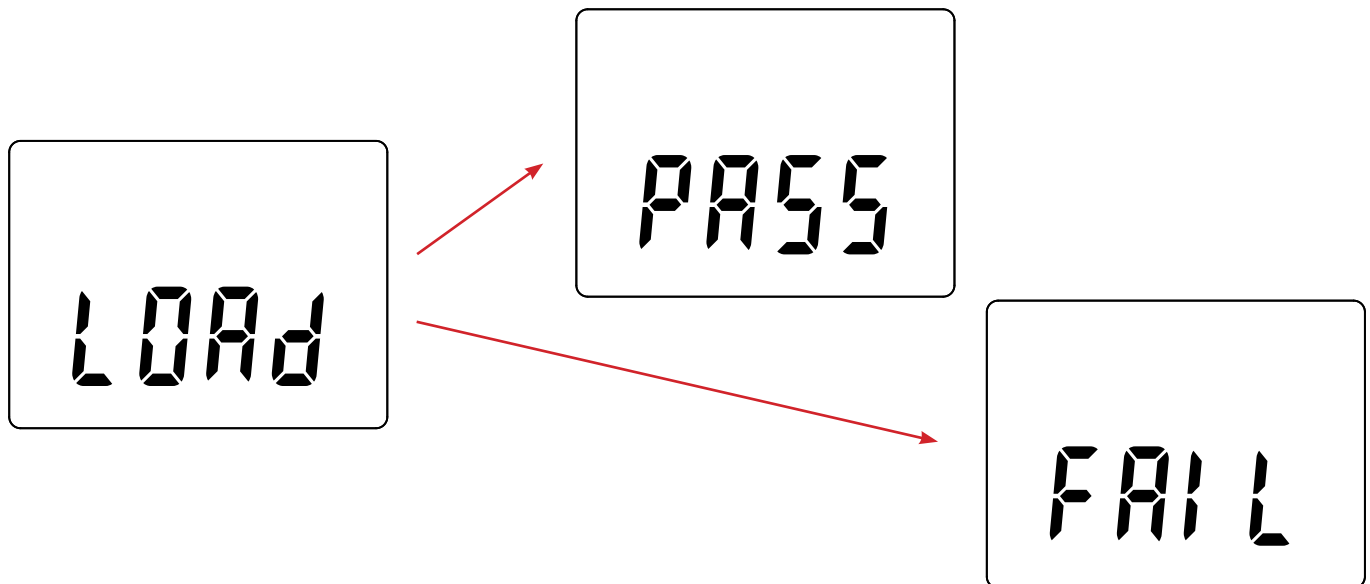

- When installation is done, the instrument displays PASS or FAIL according to whether or not the operation succeeded. If installation fails, download the software again and repeat the procedure.
- Then the instrument restarts normally.



After the internal software is updated, it may be necessary to reconfigure the instrument; see §4.5.

7. WARRANTY

Except as otherwise stated, our warranty is valid for **24 months** starting from the date on which the equipment was sold. Extract from our General Conditions of Sale provided on request.

The warranty does not apply in the following cases:

- Inappropriate use of the equipment or use with incompatible equipment;
- Modifications made to the equipment without the explicit permission of the manufacturer's technical staff;
- Work done on the device by a person not approved by the manufacturer;
- Adaptation to a particular application not anticipated in the definition of the equipment or not indicated in the user's manual;
- Damage caused by shocks, falls, or floods.

FRANCE

Chauvin Arnoux Group
190, rue Championnet
75876 PARIS Cedex 18
Tél : +33 1 44 85 44 85
Fax : +33 1 46 27 73 89
info@chauvin-arnoux.com
www.chauvin-arnoux.com

INTERNATIONAL

Chauvin Arnoux Group
Tél : +33 1 44 85 44 38
Fax : +33 1 46 27 95 69

Our international contacts
www.chauvin-arnoux.com/contacts

