

HIGH-SPEED MULTISERVICE TEST MODULE

# FTBx-88000 Series

Power Blazer

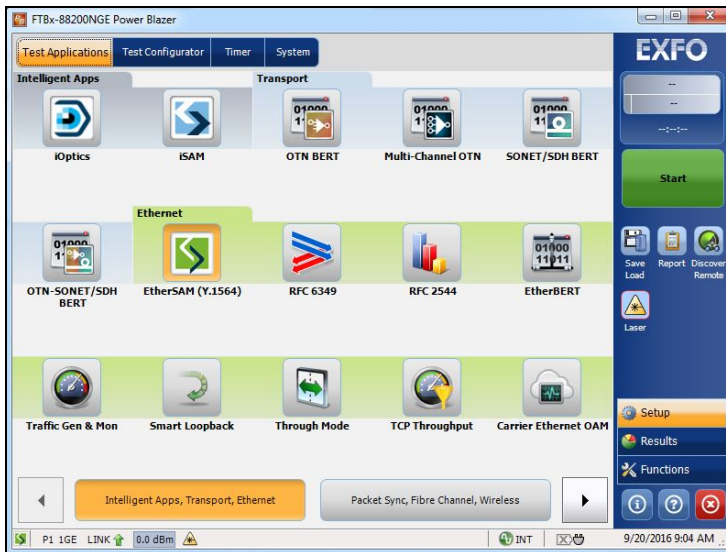

---

Copyright © 2014–2022 EXFO Inc. All rights reserved. No part of this publication may be reproduced, stored in a retrieval system or transmitted in any form, be it electronically, mechanically, or by any other means such as photocopying, recording or otherwise, without the prior written permission of EXFO Inc. (EXFO).

Information provided by EXFO is believed to be accurate and reliable. However, no responsibility is assumed by EXFO for its use nor for any infringements of patents or other rights of third parties that may result from its use. No license is granted by implication or otherwise under any patent rights of EXFO.

EXFO's Commerce And Government Entities (CAGE) code under the North Atlantic Treaty Organization (NATO) is 0L8C3.

The information contained in this publication is subject to change without notice.

### ***Trademarks***

EXFO's trademarks have been identified as such. However, the presence or absence of such identification does not affect the legal status of any trademark.

Where applicable, the Bluetooth® word mark and logos are registered trademarks owned by Bluetooth SIG, Inc. and any use of such marks by EXFO Inc. is under license. Other third party trademarks and trade names are those of their respective owners.

### ***Units of Measurement***

Units of measurement in this publication conform to SI standards and practices.

### ***Patents***

The exhaustive list of patents is available at [EXFO.com/patent](http://EXFO.com/patent).

May 2, 2022

Document version: 23.0.0.1

---

# Contents

Regulatory Information .....	xiv
<b>1 Introducing the High-Speed Multiservice Test Module .....</b>	<b>1</b>
Test Applications .....	1
Technical Specifications .....	3
Conventions .....	4
<b>2 Safety Information .....</b>	<b>5</b>
Laser Safety Information .....	7
Installation Instruction Warnings .....	8
<b>3 Getting Started .....</b>	<b>11</b>
Inserting and Removing Test Modules .....	12
Inserting and Removing Transceiver System .....	13
Turning On the Unit .....	19
Starting the Module Application .....	19
<b>4 Physical Interfaces and LEDs .....</b>	<b>21</b>
Port Availability per Module .....	27
Transceivers .....	32
RJ45 .....	32
BNC .....	33
SMB .....	33
LEDs .....	33
<b>5 Graphical User Interface Overview .....</b>	<b>35</b>
Main Application Window .....	35
Main Window .....	35
Navigation Buttons .....	36
Status Bar .....	36
Title Bar .....	39
Global Indicator .....	40
Test Control .....	42
Test Menu .....	42
Application Buttons .....	43
Zoomed-In/Zoomed-Out Views .....	47
Arrow Buttons .....	47
Keyboard Usage .....	48

---

<b>6 Test Setup - Test Applications .....</b>	<b>51</b>
iOptics .....	53
iSAM .....	55
Multi-Channel OTN .....	56
FlexO BERT .....	57
OTN BERT .....	58
OTN-SONET/SDH BERT .....	61
SONET/SDH BERT .....	64
DCO BERT .....	67
DSn/PDH BERT .....	69
SONET/SDH - DSn/PDH BERT .....	71
NI/CSU Emulation .....	74
EtherSAM (Y.1564) .....	75
RFC 2544 .....	77
RFC 6349 .....	79
FlexE BERT .....	80
EtherBERT .....	81
Traffic Gen & Mon .....	83
Smart Loopback .....	85
Through Mode .....	87
TCP Throughput .....	88
Carrier Ethernet OAM .....	89
Cable Test .....	91
1588 PTP .....	92
SyncE .....	93
Time Error / Wander .....	94
FC BERT .....	95
CPRI/OBSAI BERT .....	96
eCPRI BERT .....	98
<b>7 Selecting and Starting a Test .....</b>	<b>101</b>
Intelligent Apps .....	101
Transport Test Applications .....	105
Ethernet Test Applications .....	107
Sync Test Applications .....	109
Fibre Channel Test Application .....	111
Wireless Test Application .....	113

---

<b>8 Setup .....</b>	<b>115</b>
Test Configurator .....	115
Test Configurator Overview .....	125
Modify Structure .....	132
Modify Structure - 1588 PTP .....	134
Modify Structure - Cable Test .....	135
Modify Structure - Carrier Ethernet OAM .....	136
Modify Structure - CPRI/OBSAI BERT .....	137
Modify Structure - DCO BERT .....	140
Modify Structure - DS <sub>n</sub> /PDH BERT .....	141
Modify Structure - eCPRI BERT .....	143
Modify Structure - EtherBERT .....	145
Modify Structure - EtherSAM .....	154
Modify Structure - FC BERT .....	157
Modify Structure - FlexE BERT .....	158
Modify Structure - FlexO BERT .....	160
Modify Structure - Multi-Channel OTN .....	161
Modify Structure - NI/CSU Emulation .....	162
Modify Structure - OTN BERT .....	163
Modify Structure - OTN-SONET/SDH BERT .....	170
Modify Structure - RFC 2544 .....	175
Modify Structure - RFC 6349 .....	178
Modify Structure - Smart Loopback .....	180
Modify Structure - SONET/SDH BERT .....	183
Modify Structure - SONET/SDH - DS <sub>n</sub> /PDH BERT .....	187
Modify Structure - SyncE .....	191
Modify Structure - TCP Throughput .....	192
Modify Structure - Through Mode .....	193
Modify Structure - Time Error / Wander .....	195
Modify Structure - Traffic Gen & Mon .....	197
Signal Auto-Detect .....	200
1588 PTP .....	201
BERT and Unframed BERT .....	209
BERT and Unframed BERT - CPRI/OBSAI .....	216
BERT and Unframed BERT - eCPRI .....	220
BERT - DCO BERT .....	223
BERT - FlexE BERT .....	225
Cable Test .....	227
CFP/OSFP/QSFP/SFP .....	229
Clock .....	231
Device Under Test - iOptics .....	239
eCPRI Flow - Profile .....	243

---

EtherBERT and Unframed BERT .....	247
EtherSAM - Burst .....	256
EtherSAM - Global .....	258
EtherSAM - L2CP .....	263
EtherSAM - Ramp .....	269
External Reference .....	270
FC BERT .....	271
Fibre Channel .....	274
FlexE Group .....	277
FlexO/OTN .....	279
Frequency .....	280
Frequency - DCO BERT (Client) .....	283
FTFL/PT / PT .....	284
GFP-F/GFP-T .....	288
Interface .....	289
Interface - DCO BERT .....	302
Labels .....	306
Link OAM .....	308
Local Details - iSAM .....	310
MAC/IP/UDP .....	315
Network .....	328
Network / Network Details - iSAM .....	331
ODU Channels - Global .....	341
Path OAM .....	344
Profile - DCO BERT .....	347
Profile - FlexE BERT .....	349
Remote Details - iSAM .....	350
RFC 2544 - Global .....	354
RFC 2544 - Subtests .....	357
RFC 6349 .....	364
S-OAM and MPLS-TP OAM .....	368
Services - Global .....	377
Services - L2CP .....	380
Services - Profile .....	381
Signal .....	387
Signal - Signal Configuration - DS <sub>n</sub> /PDH .....	394
Signal - Signal Configuration - OTN .....	398
Signal - Signal Configuration - SONET/SDH .....	401
Smart Loopback .....	405
Streams - Global .....	407
Streams - Profile .....	409
SyncE .....	416

System - General .....	418
System - GNSS .....	420
Transceiver System (TA/TA4) .....	424
TCP Throughput .....	426
Test Sequence - iOptics .....	428
Time Error / Wander .....	429
Timer .....	433
Traces - OTN .....	435
Traces - SONET/SDH .....	438
Traces/PT - FlexO .....	440
<b>9 Test Results .....</b>	<b>445</b>
Alarms/Errors Overview .....	454
Analysis - MTIE/TDEV .....	461
Analysis - Time Error / Time Interval Error .....	463
FEC Statistics .....	465
FTFL/PT / PT .....	466
GFP-F/GFP-T .....	468
Graph - RFC 2544 .....	471
Labels .....	472
Link OAM .....	473
Logger .....	477
Measurements - DCO BERT .....	480
Messages .....	483
MPLS .....	485
OTL-SDT .....	486
Performance Monitoring .....	488
PTP Stats .....	495
Quality Level - 1588 PTP .....	497
Quality Level - SyncE .....	500
S-OAM and MPLS-TP OAM .....	503
SDT - Multi-Channel OTN .....	508
Service Configuration - Burst .....	510
Service Configuration - L2CP .....	511
Service Configuration - Ramp .....	513
Service Performance .....	515
Streams - Frame Loss / Out-of-Sequence .....	517
Streams - Jitter .....	517
Streams - Latency .....	518
Streams - Throughput / Customer Frame Throughput .....	519
Summary - OTN/SONET/SDH/DSn/PDH .....	520
Summary - 1588 PTP .....	524

---

Summary - Cable Test .....	527
Summary - CPRI/OBSAI BERT .....	533
Summary - DCO BERT .....	538
Summary - eCPRI BERT .....	540
Summary - EtherBERT .....	545
Summary - EtherSAM .....	549
Summary - FC BERT .....	552
Summary - FlexE BERT .....	556
Summary - Client Summary - FlexE BERT .....	559
Summary - Path OAM - FlexE BERT .....	560
Summary - FlexO BERT .....	564
Summary - iOptics .....	566
Summary - iSAM .....	569
Summary - Link OAM .....	573
Summary - Multi-Channel OTN .....	575
Summary - NI/CSU Emulation .....	577
Summary - RFC 2544 .....	578
Summary - RFC 6349 .....	581
Summary - Smart Loopback .....	585
Summary - S-OAM and MPLS-TP OAM .....	586
Summary - SyncE .....	591
Summary - TCP Throughput .....	594
Summary - Through Mode .....	597
Summary - Traffic Gen & Mon .....	599
Summary - Stream - Traffic Gen & Mon .....	601
Summary - Time Error / Wander .....	602
Traces - OTN .....	608
Traces - SONET/SDH .....	611
Traces/PT - FlexO .....	613
Traffic - Ethernet .....	616
Traffic - Flow Control .....	619
Traffic - Graph .....	621
Traffic - Path OAM .....	622
Traffic - OAM, S-OAM, and MPLS-TP OAM .....	624
Window Sweep .....	626
WIS .....	627



---

<b>10 Test Functions</b> .....	<b>629</b>
<rate> Advanced - <transceiver> Control .....	634
<rate> Advanced - Lanes Mapping & Skew .....	637
<rate> Advanced - Pre-Emphasis/RX EQ .....	641
<rate> Advanced - PAM-4 Histogram .....	643
APS .....	644
BFD (Bidirectional Forwarding Detection) .....	647
Client Offset .....	649
FDL - Bit-Oriented Message .....	652
FDL - Performance Report Message .....	656
FEAC .....	659
Filters .....	663
Filter Configuration .....	664
FlexE Advanced .....	666
GMP .....	668
OH BERT .....	669
OH - FlexE .....	672
OH - GFP-F/GFP-T .....	677
OH - OTN .....	682
OH - SONET/SDH .....	688
Packet Capture .....	702
Path OAM APS .....	708
Ping & Trace Route .....	711
Pointer Adjustment .....	716
RTD .....	726
RTD/RTT (CPRI/OBSAI Framed L2) .....	729
S-OAM Link Trace .....	732
Signaling Bits .....	734
Spare Bits .....	736
Traffic Scan .....	738
<b>11 Test Control</b> .....	<b>741</b>
More/Less Button .....	741
Discover Remote .....	742
Inject Button .....	747
Laser Button .....	747
Lpbk Tool Button (Loopback Tool) .....	748
Report Button .....	755
Reset Button .....	761
Save/Load Button .....	762
Start/Stop TX Button .....	766

---

<b>12 Power Failure Recovery .....</b>	<b>767</b>
Enabling Power Failure Recovery .....	768
When Using the Test Timer .....	769
<b>13 Maintenance .....</b>	<b>771</b>
Cleaning LC/MPO-n Connectors .....	772
Battery Safety Information .....	772
Recalibrating the Unit .....	773
Recycling and Disposal .....	774
<b>14 Troubleshooting .....</b>	<b>775</b>
Solving Common Problems .....	775
Contacting the Technical Support Group .....	776
Transportation .....	776
<b>15 Warranty .....</b>	<b>777</b>
General Information .....	777
Gray Market and Gray Market Products .....	778
Liability .....	779
Exclusions .....	779
Certification .....	779
Service and Repairs .....	780
EXFO Service Centers Worldwide .....	781
<b>A Specifications .....</b>	<b>783</b>
General Specifications .....	784
Transceiver System .....	784
<b>B Glossary .....</b>	<b>785</b>
Acronym List .....	785
10G Ethernet Client .....	804
1588 PTP .....	807
CPRI .....	813
Ethernet Cables .....	818
G.709 Optical Transport Network (OTN) .....	820
Generic Framing Procedure (GFP) .....	837
MPLS Labels .....	849
OBSAI .....	850
SONET/DSn/SDH/PDH .....	855
SyncE .....	865
Unicast/Multicast Addresses for Ethernet OAM .....	867

---

<b>C Alarms/Errors .....</b>	<b>869</b>
BER .....	889
Clock .....	890
CPRI .....	890
DCO - TX .....	891
DCO - RX .....	891
DS1 .....	892
DS3 .....	893
E1 .....	894
E2/E3/E4 .....	895
Electrical Interface (DCO BERT) .....	895
Ethernet .....	896
Ethernet - PCS .....	899
Ethernet - PCS Lanes .....	900
FEC (FlexO) .....	902
FEC (OTN) .....	902
Fibre Channel (including RS-FEC) .....	903
FlexE Group .....	904
FlexO Group .....	905
FOICx.y .....	906
GFP .....	907
GMP (ODTU4.x - GMP) .....	911
Interface .....	911
Interface (DCO BERT) .....	914
IP/UDP .....	915
IP/UDP/TCP .....	915
Media RX FEC .....	915
OBSAI .....	916
ODUCn .....	917
ODUx and ODUk (ODUflex) .....	919
ODUx-TCM .....	921
OPUCn .....	922
OPUx and OPUk (OPUflex) .....	923
OTL .....	924
OTUC Frame .....	925
OTUCn .....	926
OTUx .....	927
Path OAM .....	930
PHY .....	931
PHYs/Instances .....	932
PTP .....	933
QoS Metrics .....	934

Reference Signal .....	935
RS-FEC (CPRI) .....	935
RS-FEC (Ethernet) .....	935
S-OAM / MPLS-TP OAM .....	937
Section/Line / RS/MS .....	939
STS-x/AU-x .....	941
SyncE .....	943
TCM (SONET/SDH) .....	943
Transcoding .....	946
VT/TU .....	947
WIS .....	949
<b>D Pop-Up .....</b>	<b>953</b>
Add Channel (Multi-Channel OTN) .....	953
Bulk Read .....	953
Bulk Write .....	953
Config TCM .....	954
Configure Per Frame Size .....	954
Copy Service .....	954
Copy Stream .....	955
DS1 Loopback .....	956
EMIX .....	958
Export Capture .....	959
FEC Degraded SER Thresholds .....	960
Filter Configuration .....	961
FlexE Calendar .....	963
Grand Master Information / Boundary Clock Information .....	965
IPv6 Address Configuration .....	967
L2CP .....	970
Laser ON/OFF .....	971
Manual Skew (PCS/Logical Lane) .....	972
Manual Skew (PHY) .....	973
Default/Random/Manual Mapping .....	974
Modify DS0/E0 .....	975
Modify Frame Structure .....	978
Modify Tributary Slots/Port .....	982
Modify Trib Slots/Channels (Multi-Channel OTN) .....	984
Modify TX Power - DCO BERT .....	988
Modify Wavelength (SFP) .....	990
Modify Wavelength - DCO BERT .....	991
Profile (Stream) .....	995
Profile (Services) .....	996

---

QoS Metrics (eCPRI BERT) .....	997
Remote Interface Discovery .....	999
Shaping .....	1000
Thresholds (eCPRI QoS) .....	1001
Thresholds - FED/FDD .....	1002
Thresholds - RFC 2544 .....	1003
Thresholds (S-OAM) .....	1004
TOS/DS Config .....	1005
Triggered Frame Details .....	1006
Truncation Calculator .....	1007
<b>E Remote ToolBox .....</b>	<b>1009</b>
Overview .....	1009
Remote ToolBox Installation .....	1011
Starting and Using the Remote ToolBox Application .....	1012
Applications for... .....	1014
<b>Index .....</b>	<b>1015</b>

# Regulatory Information

## **Electromagnetic Interference and Compatibility Regulatory Information**

For Electromagnetic Interference and Compatibility Regulatory information on your product, refer to the user documentation of your platform.

## **European Declaration of Conformity**

The full text of the EU declaration of conformity is available at the following Internet address: *[www.exfo.com/en/resources/legal-documentation](http://www.exfo.com/en/resources/legal-documentation)*.

# 1 **Introducing the High-Speed Multiservice Test Module**

Turnkey field-test solution for deploying, validating, and troubleshooting networks up to 400G.

## **Test Applications**

### **Intelligent Apps**

<b>Test Applications</b>	<b>Available on FTBx-...</b>
iOptics	8870, 8880, 88200NGE, 88260, 88460
iSAM	8870, 8880, 88200NGE, 88260

### **Transport**

<b>Test Applications</b>	<b>Available on FTBx-...</b>
DCO BERT	88460
DSn/PDH BERT	8870, 8880
FlexO BERT	88460
Multi-Channel OTN	88200NGE
NI/CSU Emulation	8870, 8880
OTN BERT	8870, 8880, 88200NGE, 88260, 88460
OTN-SONET/SDH BERT	8870, 8880, 88200NGE
SONET/SDH BERT	8870, 8880, 88200NGE, 88260
SONET/SDH - DSn/PDH BERT	8870, 8880, 88260

# Introducing the High-Speed Multiservice Test Module

## Test Applications

---

### Ethernet

Test Applications	Available on FTBx-...
Cable Test	8870, 8880
Carrier Ethernet OAM	8870, 8880, 88260
EtherBERT	8870, 8880, 890, 890NGE, 88200NGE, 88260, 88460
EtherSAM (Y.1564)	8870, 8880, 88200NGE, 88260, 88460
FlexE BERT	88260, 88460
RFC 2544	8870, 8880, 88200NGE, 88260, 88460
RFC 6349	8870, 8880, 88200NGE, 88260
Smart Loopback	8870, 8880, 88200NGE, 88260, 88460
TCP Throughput	8870, 8880
Through Mode	8870, 8880, 88200NGE, 88260
Traffic Gen & Mon	8870, 8880, 88200NGE, 88260, 88460

### Sync

Test Applications	Available on FTBx-...
1588 PTP	8870, 8880, 88200NGE, 88260
SyncE	8870, 8880, 88200NGE, 88260
Time Error / Wander	8880, 890NGE, 88260



## Fibre Channel

Test Applications	Available on FTBx-...
FC BERT	8870, 8880, 88200NGE, 88260

## Wireless

Test Applications	Available on FTBx-...
CPRI/OBSAI BERT	8870, 8880, 88200NGE, 88260
eCPRI BERT	8870, 8880, 88200NGE, 88260

## Technical Specifications

To obtain this product's technical specifications, visit the EXFO Web site at [www.exfo.com](http://www.exfo.com).

### Conventions

Before using the product described in this guide, you should understand the following conventions:



#### **WARNING**

Indicates a potentially hazardous situation which, if not avoided, could result in *death or serious injury*. Do not proceed unless you understand and meet the required conditions.



#### **CAUTION**

Indicates a potentially hazardous situation which, if not avoided, may result in *minor or moderate injury*. Do not proceed unless you understand and meet the required conditions.



#### **CAUTION**

Indicates a potentially hazardous situation which, if not avoided, may result in *component damage*. Do not proceed unless you understand and meet the required conditions.



#### **IMPORTANT**

Refers to information about this product you should not overlook.

## 2 **Safety Information**



### **WARNING**

Do not install or terminate fibers while a light source is active. Never look directly into a live fiber and ensure that your eyes are protected at all times.



### **WARNING**

The use of controls, adjustments and procedures, namely for operation and maintenance, other than those specified herein may result in hazardous radiation exposure or impair the protection provided by this unit.



### **WARNING**

If the equipment is used in a manner not specified by the manufacturer, the protection provided by the equipment may be impaired.



### **WARNING**

Use only accessories designed for your unit and approved by EXFO. For a complete list of accessories available for your unit, refer to its technical specifications or contact EXFO.



### **IMPORTANT**

Refer to the documentation provided by the manufacturers of any accessories used with your EXFO product. It may contain environmental and/or operating conditions limiting their use.



### **IMPORTANT**

When you see the following symbol on your unit , make sure that you refer to the instructions provided in your user documentation. Ensure that you understand and meet the required conditions before using your product.



### **IMPORTANT**

When you see the following symbol on your unit , it indicates that the unit is equipped with a laser source, or that it can be used with instruments equipped with a laser source. These instruments include, but are not limited to, modules and external optical units.



### **IMPORTANT**

Other safety instructions relevant for your product are located throughout this documentation, depending on the action to perform. Make sure to read them carefully when they apply to your situation.

## Laser Safety Information

Your instrument is in compliance with standards IEC 60825-1: 2014 and 21 CFR 1040.10, as per Laser Notice No. 42, dated December 18, 1989.

Laser radiation may be encountered at the optical output port.

The following label indicates that a product contains a Class 1 source:



### **WARNING**

When the LASER LED is on or flashing, the module is transmitting an optical signal on the transceiver ports.

**Note:** *Refer to the platform user guide for additional test equipment safety information and ratings.*

## Safety Information

### Installation Instruction Warnings

---

## Installation Instruction Warnings



### CAUTION

When you use the unit outdoors, ensure that it is protected from liquids, dust, direct sunlight, precipitation, and full wind pressure.



### CAUTION

Except for the dual Bantam connector and the RJ-48C port, all telecom (electrical) interfaces are SELV (Safety Extra Low Voltage) circuitry intended for intra-building use only.



### CAUTION

For the dual Bantam connector and the RJ-48C ports, use only No. 26 AWG or larger telecommunication line cord to reduce the risk of fire.



### CAUTION

No user serviceable parts are contained inside. Contact the manufacturer regarding service of this equipment.



### IMPORTANT

All wiring and installation must be in accordance with local building and electrical codes acceptable to the authorities in the countries where the equipment is installed and used.



### WARNING

Use only accessories designed for your unit and approved by EXFO.



### CAUTION

**Electrostatic Discharge (ESD) Sensitive Equipment:**

**Plug-in modules can be damaged by static electrical discharge. To minimize the risk of damage, dissipate static electricity by touching a grounded unpainted metal object**

- before removing, inserting, or handling the module.
- before connecting or disconnecting cables to/from the **module**.
- before inserting or removing a transceiver to/from the **module**.





# 3 Getting Started

If the module has been purchased at the same time as the platform, the module is pre-installed with the appropriate software version.

## Number of Dedicated Modules per Platform

The following table lists the maximum number of dedicated modules that can run simultaneously on each platform.

Platform	88200NGE	88260	88460	8870/8880
FTB-2	NA	NA	NA	2
FTB-2 Pro	2	2	NA	2
FTB-4 Pro	4	4	1 <sup>a</sup>	4
LTB-2	2	2	NA	2
LTB-8	8	8	2	8

- a. The platform needs to be connected to a power outlet since this module requires too much power to run on battery power.

# Inserting and Removing Test Modules



## CAUTION

There is no need to turn off your unit before inserting or removing FTBx- modules.

However, inserting/removing modules without following the instructions provided in the platform user documentation could result in the following consequences, depending on the operation underway when the modules are inserted/removed:

- unexpected behavior of the test applications,
- instability of the system,
- or cause irreparable damage to your modules.

**Note:** *Refer to the platform user guide for more information on how to insert/remove a module into/from the platform.*

## Inserting and Removing Transceiver System



### CAUTION

There is no need to turn off your unit before inserting or removing transceiver systems.

However, inserting/removing transceiver systems without following the instructions provided in this user documentation could result in the following consequences, depending on the operation underway when the transceiver systems are inserted/removed:

- unexpected behavior of the test applications,
- instability of the system,
- or cause irreparable damage to your transceiver systems.

### FTBx-88260

The following procedure describes insertion and removal of transceiver system for FTBx-88260 modules.

#### ***To insert a transceiver system into the FTBx-88260 module:***

1. Position the FTB-x-88260 module so that its faceplate is facing you.
2. Remove the FILLER (protective cover) from the FTBx-88260.
  - Turn the retaining screw counterclockwise until it is loose.
  - Hold the FILLER by the handle and/or the retaining screw and pull it out.

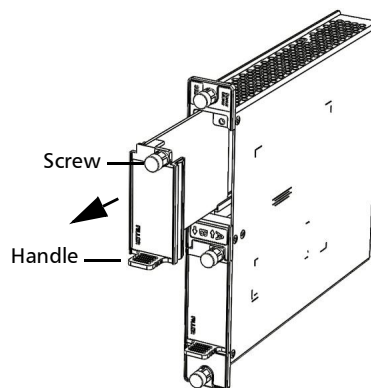

## Getting Started

### Inserting and Removing Transceiver System

---

3. Remove the transceiver system from its packaging:

- 3a. Pull the battery insulator tab to activate the battery.

- 3b. Turn the retaining screw counterclockwise until it is loose.

- 3c. Hold the transceiver system by the handle and/or the retaining screw (NOT by the connectors) and pull it out. Don't throw away the transceiver system packaging, it is recommended to insert the transceiver system into its packaging when carrying it outside the FTBx-88260 module.

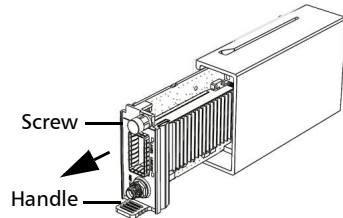
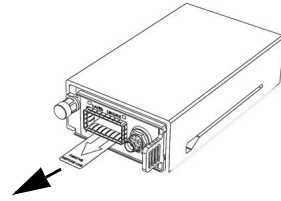

4. Insert the transceiver system into the FTBx-88260 module:

- 4a. Take the transceiver system and place it so that the connector pins are at the back as shown below.

The identification sticker and the protruding edges are on the left side.

- 4b. Insert the protruding edges of the transceiver system into the grooves of the receptacle's module port.

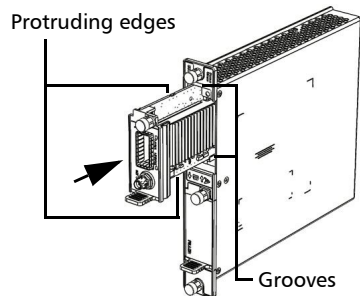

**4c.** Push the transceiver system all the way to the back of the receptacle by pressing firmly on the left edge of the transceiver system until it is fully inserted.

**4d.** Turn the retaining screw clockwise until it is tightened.

This will secure the transceiver system into its “seated” position.

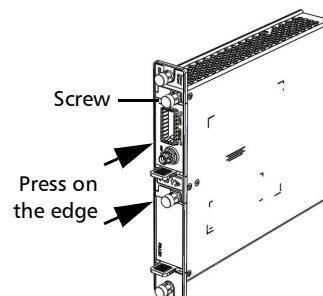

#### **To remove a transceiver system from the FTBx-88260 module:**

**1.** Position the FTB-x-88260 module so that its faceplate is facing you.

**2.** Turn the retaining screw counterclockwise until it is loose.

**3.** Hold the transceiver system by the handle and/or the retaining screw (NOT by the connectors) and pull it out.

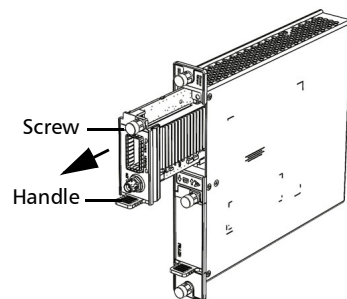

## CAUTION

Pulling out a transceiver system by its connectors could seriously damage both the transceiver system and connectors. Always pull out a transceiver system by its retaining screw, and/or the handle.

**4.** Cover the empty FTBx-88260's receptacle with the supplied FILLER.



## CAUTION

Failure to reinstall the FILLER over an empty receptacle will result in ventilation problems.

## Getting Started

### Inserting and Removing Transceiver System

---

#### FTBx-88460

The following procedures describe the insertion and removal of a transceiver system for FTBx-88460 modules.

##### **To insert a transceiver system into the FTBx-88460 module:**

- 1.** Position the FTBx-88460 module so that its faceplate is facing you. When the FTBx-88460 module is already inserted into an FTB-4 Pro platform, position the FTB-4 Pro so that its display is facing down and the module is oriented as shown in the following picture.
- 2.** Remove the FILLER (protective cover) from the FTBx-88460.
  - Turn the two retaining screws counterclockwise until they are loose.
  - Hold the FILLER by the retaining screws and pull it out.
- 3.** Remove the transceiver system from its packaging:
  - 3a.** Turn the two retaining screws counterclockwise until they are loose.
  - 3b.** Hold the transceiver system by the handle (NOT by the connectors) and pull it out. Do not throw away the transceiver system packaging. It is recommended to insert the transceiver system into its packaging when removing it from the FTBx-88460 module.

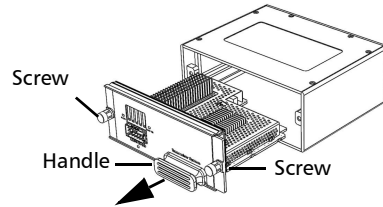
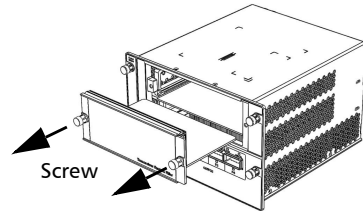

**4.** Insert the transceiver system into the FTBx-88460 module:

**4a.** Take the transceiver system and place it so that the handle is on the right side as shown.

**4b.** Insert the protruding edges of the transceiver system into the grooves of the receptacle's module port.

**4c.** Push the transceiver system all the way to the back of the receptacle by pressing firmly only on the handle of the transceiver system until it is fully inserted.

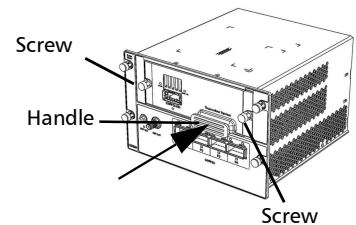
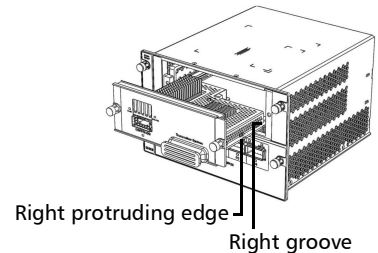

**Note:** *It is very important to push on the handle only to properly align the transceiver system within the FTBx-88460 module ensuring good electrical contact.*

**4d.** Turn the two retaining screws clockwise until they are tightened. This will secure the transceiver system into its “seated” position.

## Getting Started

### Inserting and Removing Transceiver System

---

#### **To remove a transceiver system from the FTBx-88460 module:**

1. Position the FTBx-88460 module so that its faceplate is facing you.
2. Turn the two retaining screws counterclockwise until they are loose.
3. Hold the transceiver system by the handle (NOT by the connectors) and pull it out.

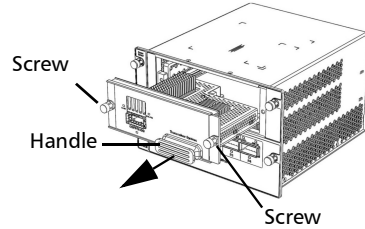

### CAUTION

Pulling out a transceiver system by its connectors could seriously damage both the transceiver system and connectors. Always pull out a transceiver system by its handle.

4. Cover the empty FTBx-88460's receptacle with the supplied FILLER.



### CAUTION

Failure to reinstall the FILLER over an empty receptacle will result in ventilation problems.



## Turning On the Unit

Turn on the platform. Refer to the platform user guide for more information.

## Starting the Module Application

The module can be configured and controlled by starting the application(s) as described in the following table:

Module	Application	Comment
88200NGE 88460	Power Blazer	Only one application available.
88260	Power Blazer iORF <sup>a</sup> OpticalRF <sup>a</sup> BBU-Emulation <sup>a</sup>	Only one application can run at once per module. Furthermore, only one instance of the iORF or OpticalRF application can run on the associated platform.
8880 8870	Power Blazer iORF <sup>a</sup> OpticalRF <sup>a</sup> BBU-Emulation <sup>a</sup>	Only one application can run at once per module. Furthermore, only one instance of the iORF, OpticalRF, or BBU-Emulation application can run on the associated platform.

a. Not supported on FTB-2, LTB-2, and LTB-8.

### **To start the application:**

From **ToolBox X** tap the desired application button.

**Note:** Refer to the respective user guides for more information on iORF, OpticalRF, and BBU-Emulation applications.



## 4 *Physical Interfaces and LEDs*

This section describes all connectors (ports) and LEDs available on the FTBx-88000 Series.



### CAUTION

To prevent exceeding the maximum input/output power level, please refer to this product's technical specifications at [www.exfo.com](http://www.exfo.com).

### FTBx-88200NGE

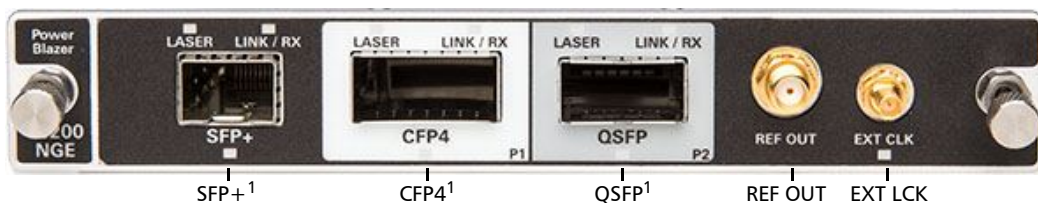

1. Laser radiation is emitted from this port when LASER LED is on.

### FTBx-88260 and Transceiver Systems

**Note:** *The FTBx-88260 module with TA-SFP28 transceiver systems are shown below as examples for connector location purposes.*

## Physical Interfaces and LEDs

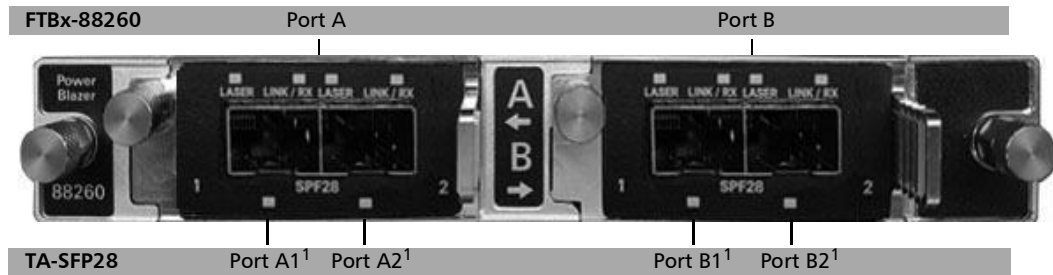

1. Laser radiation is emitted from this port when LASER LED is on.

### ➤ TA-SFP28

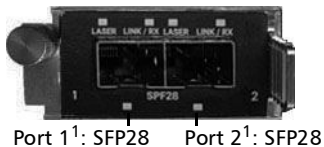

1. Laser radiation is emitted from this port when LASER LED is on.

### ➤ TA-QSFP28

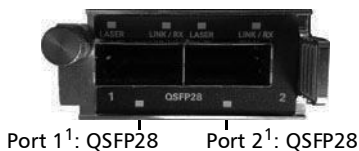

1. Laser radiation is emitted from this port when LASER LED is on.

### ➤ TA-CFP4

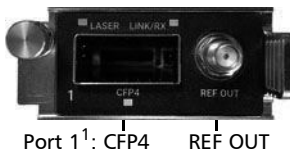

1. Laser radiation is emitted from this port when LASER LED is on.

➤ TA-SYNC

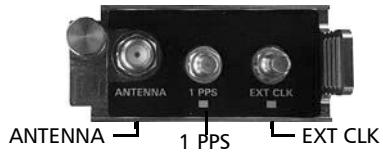

➤ TA-SYNC PREMIUM

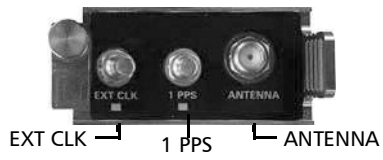

## FTBx-88460 and Transceiver Systems

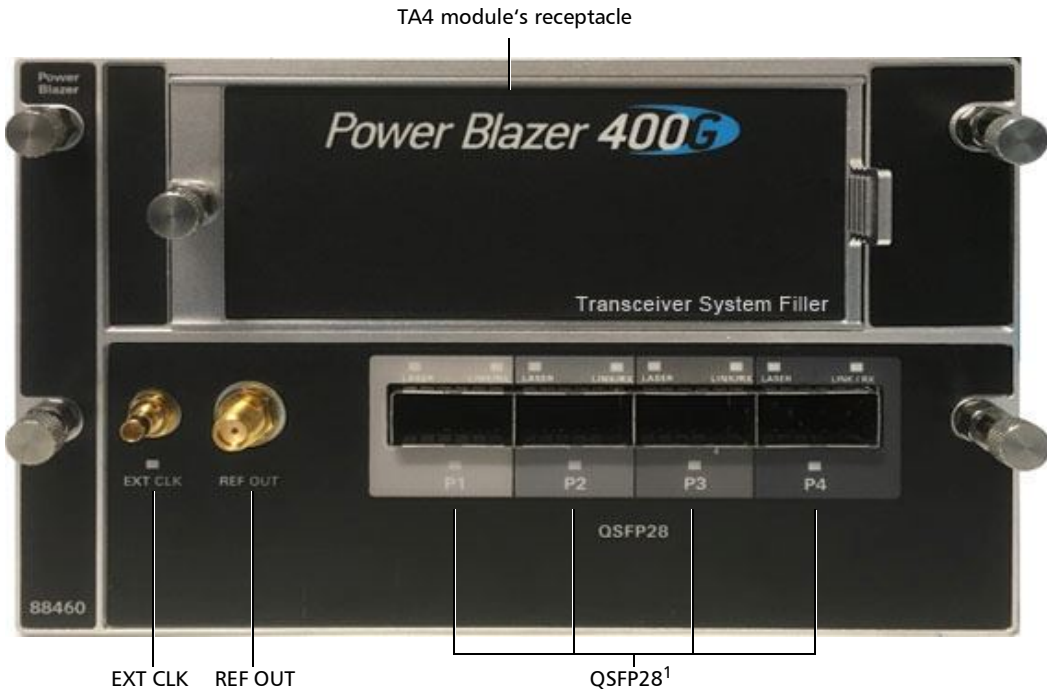

1. Laser radiation is emitted from this port when LASER LED is on.

➤ **TA4-CFP8**



1. Laser radiation is emitted from this port when LASER LED is on.

➤ **TA4-OSFP**



1. Laser radiation is emitted from this port when LASER LED is on.

➤ **TA4-QSFP-DD**

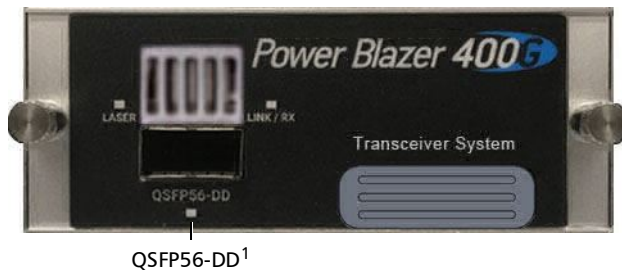

1. Laser radiation is emitted from this port when LASER LED is on.

## Physical Interfaces and LEDs

### FTBx-8870/8880

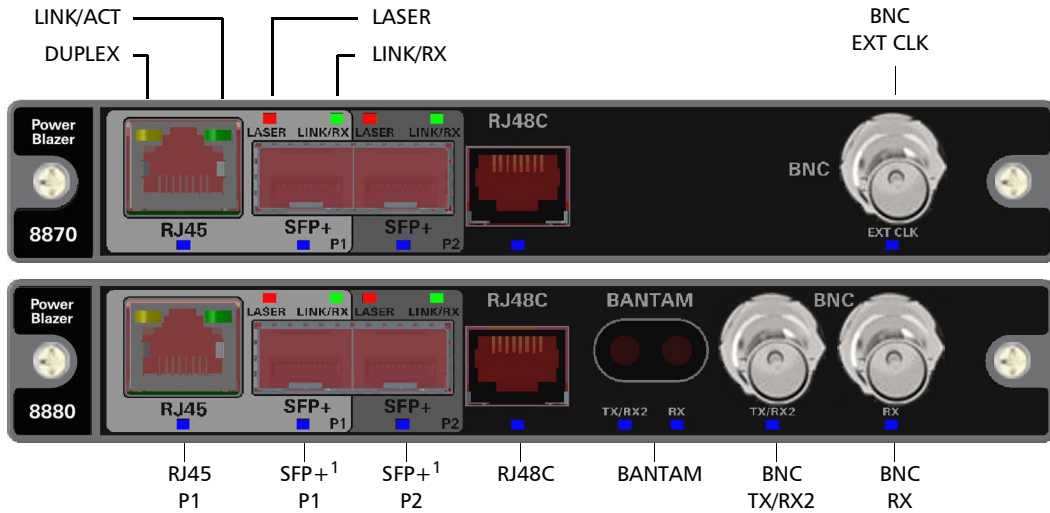

1. Laser radiation is emitted from this port when LASER LED is on.



## Port Availability per Module

### 88200NGE

The following table shows the list of available ports as well as a description and the signals supported on the module.

Port Labelled	Description	Supported Signal(s)
SFP+	Optical IN/OUT port SFP/SFP+ transceiver	Ethernet 100/1000 Mbit/s, 10 Gbit/s optical Ethernet 10/100/1000 Mbit/s electrical (using active copper SFP) Fibre Channel 1X, 2X, 4X, 8X, 10X, 16X eCPRI 10 Gbit/s CPRI 1.2, 2.4, 3.1, 4.9, 6.1, 9.8, 10.1 Gbit/s OBSAI 1.5, 3.1, 6.1 Gbit/s OC-1/STM-0, OC-3/STM-1, OC-12/STM-4, OC-48/STM-16, OC-192/STM-64 OTU1, OTU2, OTU1e, OTU2e, OTU1f, OTU2f.
CFP4	Optical IN/OUT port CFP4 transceiver <sup>a</sup>	Ethernet 100 Gbit/s OTU4
QSFP	Optical IN/OUT port QSFP+ transceiver <sup>b</sup>	Ethernet 40 Gbit/s OTU3e2, OTU3e1, OTU3
	Optical IN/OUT port QSFP28 transceiver <sup>a</sup>	Ethernet 100 Gbit/s OTU4
	Optical IN/OUT port QSFP56 transceiver <sup>c</sup>	Ethernet 100 Gbit/s
REF OUT	Electrical port SMA for eye diagram clock signal generation	
EXT CLK	Electrical port SMB for external clock synchronization	DS1/1.5M, E1/2M, 2MHz, 1PPS <sup>d</sup>

- Only OTU4 (4 Lanes) and 100GE (4 Lanes) are supported.
- Only parallel interfaces are supported.
- Only 100GE (4 Lanes) is supported.
- Available for **Dual Test Set - One-Way Latency** measurement mode.

## Physical Interfaces and LEDs

Port Availability per Module

### 88260 and Transceiver Systems

The following table shows the list of transceiver system supported on each port of the FTBx-88260 module.

Port Labelled	Description	Supported Transceiver System
A	Transceiver system left port	TA-SFP28, TA-QSFP28, TA-CFP4, TA-Sync
B	Transceiver system right port	TA-SFP28, TA-QSFP28, TA-CFP4, TA-Sync

The following table shows the list of port and the supported signals for each transceiver system.

Transceiver System	Port Labelled <sup>a</sup>	Description	Supported Signal(s)
TA-SFP28 (dual port)	1	Optical IN/OUT port SFP/SFP+/SFP28 transceiver	Ethernet 100/1000 Mbit/s, 10 Gbit/s, 25 Gbit/s optical Ethernet 10/100/1000 Mbit/s electrical (using active copper SFP) Fibre Channel 1X, 2X, 4X, 8X, 10X, 16X, 32X eCPRI 10 Gbit/s, 25 Gbit/s CPRI 1.2, 2.4, 3.1, 4.9, 6.1, 9.8, 10.1, 24.3 Gbit/s OBSAI 1.5, 3.1, 6.1 Gbit/s OC-1/STM-0, OC-3/STM-1, OC-12/STM-4, OC-48/STM-16, OC-192/STM-64 OTU1, OTU2, OTU1e, OTU2e, OTU1f, OTU2f
	2		
TA-QSFP28 (dual port)	1 2	Optical IN/OUT port QSFP+ transceiver	Ethernet 40 Gbit/s OTU3e2, OTU3e1, OTU3
		Optical IN/OUT port QSFP28 transceiver	Ethernet 50/100 Gbit/s CPRI 9.8, 10.1, 24.3 Gbit/s eCPRI 10/25/100 Gbit/s OTU4
		Optical IN/OUT port QSFP56 transceiver	Ethernet 100 Gbit/s
TA-CFP4	1	CFP4	Ethernet 100 Gbit/s OTU4
	REF OUT	REF OUT (SMA)	Electrical port for eye diagram REF clock signal generation

Transceiver System	Port Labelled <sup>a</sup>	Description	Supported Signal(s)
TA-SYNC <sup>b</sup> and TA-SYNC- PREMIUM <sup>b, c</sup>	EXT CLK	EXT CLK (SMB)	IN: 2 MHz, 10 MHz, 1PPS OUT: 2 MHz
	1 PPS	1PPS (SMB)	IN: 1PPS <sup>d</sup>
	ANTENNA	ANTENNA (SMA) GNSS	IN: Antenna for GNSS receiver <sup>d</sup>

- The ports are listed/referred as follows in the GUI: **Port**, FTBx-88260's port (**A** or **B**), transceiver system port (**1** or **2**), and connector type; for example **Port A1 - SFP28**.
- Only one TA-SYNC / TA-SYNC PREMIUM transceiver system is supported per module. In case two TA-SYNC are inserted, only one will be active, tap Setup, System, and the TA-Sync tab to see which one is active.
- Provides the same functionalities as a TA-SYNC but with enhanced accuracy.
- Used for **One-Way Latency** measurement mode and Time Error / Wander test application.

## 88460 and Transceiver Systems

The following table shows the list of available ports and the supported signals on the module excluding the TA4 transceiver system ports.

Port Labelled	Description	Supported Signal(s)
QSFP28 (P1, P2, P3, P4)	Optical IN/OUT port QSFP28 transceiver	Ethernet 1000 Mbit/s (optical) <sup>a</sup> , 10 Gbit/s <sup>a</sup> , 25 Gbit/s <sup>a</sup> , 40 Gbit/s, 50 Gbit/s, 100 Gbit/s 100G FlexO-1-RS OTU4, OTU3e2, OTU3e1, OTU3, OTU2f, OTU1f, OTU2e, OTU1e, OTU2, OTU1
	Optical IN/OUT port QSFP56 transceiver	Ethernet 100 Gbit/s 100G FlexO-1-RS
REF OUT	Electrical port SMA for eye diagram clock signal generation	
EXT CLK	Electrical port SMB for external clock synchronization	1PPS <sup>b</sup>

- Requires a QSFP28 to SFP28 transceiver adapter.
- Available for **One-Way Latency** measurement mode.

## Physical Interfaces and LEDs

### Port Availability per Module

The following table shows the list of available transceiver systems and the supported signals.

Transceiver System	Description	Supported Signal(s)
TA4-CFP8	Optical IN/OUT port CFP8 transceiver	400 Gbit/s Ethernet
TA4-OSFP	Optical IN/OUT port OSFP transceiver	400 Gbit/s Ethernet 4 x 100 Gbit/s Ethernet 2 x 200 Gbit/s Ethernet
TA4-OSFPv2 <sup>a</sup>	Optical IN/OUT port OSFP, DCO transceiver	400 Gbit/s Ethernet 400ZR-CFEC-16QAM 4 x 100 Gbit/s Ethernet 2 x 200 Gbit/s Ethernet
TA4-QSFP-DD	Optical IN/OUT port QSFP-DD, DAC, and multiple instance transceiver	400 Gbit/s Ethernet 4 x 100 Gbit/s Ethernet 2 x 100 Gbit/s Ethernet
	Optical IN/OUT port QSFP56 transceiver	200 Gbit/s Ethernet 100 Gbit/s Ethernet
	Optical IN/OUT port QSFP28 transceiver	100 Gbit/s Ethernet
TA4-QSFP-DDv2 <sup>a</sup>	Optical IN/OUT port QSFP-DD, DAC, DCO, and multiple instance transceiver	400 Gbit/s Ethernet 400ZR-CFEC-16QAM 4 x 100 Gbit/s Ethernet 2 x 100 Gbit/s Ethernet
	Optical IN/OUT port QSFP56 transceiver	200 Gbit/s Ethernet 100 Gbit/s Ethernet
	Optical IN/OUT port QSFP28 transceiver	100 Gbit/s Ethernet

- a. Requires revision B of the FTBx-88460 module.

## 8870/8880

The following table shows the list of available ports as well as a description and the signals supported for each module.

Connector	Labelled	Description and supported signal(s)	Module	
			8870	8880
Bantam	BANTAM TX/RX2 RX	TX and RX: DS1/1.5M, E1/2M RX2: DS1/1.5M	-	X
		Clock IN/OUT: DS1/1.5M, E1/2M, 2 MHz		
BNC	BNC TX/RX2	TX: E1/2M, E3/34M, DS3/45M, STS-1e/STM-0e/52M, E4/140M, STS-3e/STM-1e/155M RX2: DS3, 2 MHz, 10 MHz	-	X
		Clock OUT: DS1/1.5M, E1/2M, 2 MHz		
	BNC RX	E1/2M, E3/34M, DS3/45M, STS-1e/STM-0e/52M, E4/140M, STS-3e/STM-1e/155Mk, 1PPS	-	X
		Clock IN: DS1/1.5M, E1/2M, 2 MHz, 10 MHz, 1 PPS		
BNC EXT CLK	Clock IN: DS1/1.5M, E1/2M, 2 MHz, 1 PPS	X	-	
RJ45	RJ45 P1	Ethernet 10/100/1000 Mbit/s electrical	X	X
RJ48C	RJ48C	DS1/1.5M, E1/2M	X	X
		1PPS, 2 MHz, 10 MHz	-	X
		Clock IN: DS1/1.5M, E1/2M, 2 MHz	-	X
		Clock OUT: DS1/1.5M, E1/2M, 2 MHz	-	X
SFP/SFP+	SFP+ P1 or SFP+ P2	Ethernet 100 Mbit/s, 1000 Mbit/s, 10 Gbit/s LAN/WAN optical OC-1/STM-0, OC-3/STM-1, OC-12/STM-4, OC-48/STM-16, OC-192/STM-64 <sup>a</sup> OTU1, OTU2, OTU1e, OTU2e, OTU1f, OTU2f eCPRI 10 Gbit/s CPRI 1.2, 2.4, 3.1, 4.9, 6.1, 9.8, 10.1 Gbit/s OBSAI 1.5, 3.1, 6.1 Gbit/s Fibre Channel 1X, 2X, 4X, 8X, 10X	X	X
	SFP+ P2	Ethernet 10/100/1000 Mbit/s electrical (using active copper SFP) <sup>b</sup>	X	X

- a. Port SFP+ P2 is used with OC-192/STM-64 in Decoupled (TX≠RX) mode.
- b. Available as a second port when the test application requires two ports.

## Transceivers

Carefully connect optical fibre cables to the transceiver IN and OUT ports. To ensure good signal quality, make sure that the optical fibre connector is fully inserted into the optical connector port.



### CAUTION

To prevent exceeding the maximum input power level please use an attenuator when a loopback configuration is used.



### CAUTION

Before inserting an optical module into the interface receptacle, inspect the receptacle to make sure nothing is inside.



### WARNING

Use only EXFO supported transceivers. Refer to [www.exfo.com](http://www.exfo.com) for the list of supported transceivers. Using non-supported transceivers can affect the performance and accuracy of the test.

**Note:** *Do not replace the transceiver while the test is running to avoid distorting results. First stop the test, replace the transceiver, select the connector type (refer to Modify Structure on page 132), and then restart the test.*

## RJ45

The electrical port is RJ45 for category 5 unshielded twisted pair (UTP). Refer to *Ethernet Cables* on page 818 for cable specifications.

### BNC

Connector type is BNC for coaxial 75-ohm cable connection. An adapter cable (BNC to Bantam) is required for Bantam external clock connection (not supplied).

### SMB

The connector type is SMB for coaxial 75-ohm cable connection. An adapter cable (SMB to Bantam) is required for Bantam connection (not supplied).

### LEDs

- **LASER** red LED is on when the **module** is emitting an optical laser signal.
- **LINK/RX** green LED is on when the link is up, off when the link is down, and flashing when frames are transmitted/received. For multiple link interface, the LED is on when all Links have their link up, off when at least one Link has its link down, and flashing when all Links have their link up and Ethernet traffic is received on at least one enabled Link.
- **DUPLEX** green LED is on for Full Duplex mode, off for Half Duplex mode, and flashing when collisions are detected.
- Port blue LED is on when this port is selected for the test, and flashing when this port is selected for clock input.





# 5 Graphical User Interface Overview

This chapter describes the Power Blazer Series graphical user interface.

## Main Application Window

The following main application window is displayed when the Power Blazer application is started.

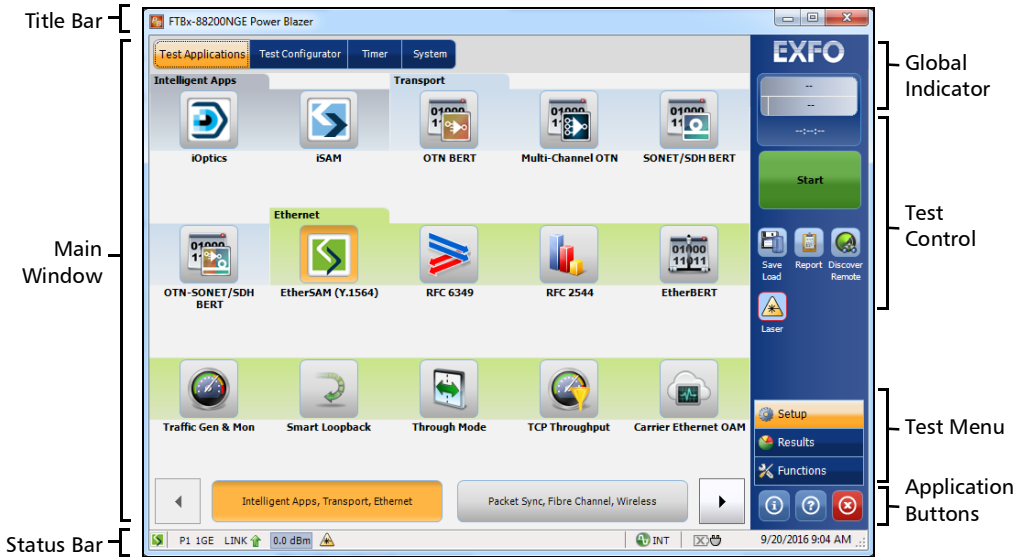

## Main Window

The main window is used to setup a test and to view the test status and results.

## Navigation Buttons

Navigation buttons appear when there is not enough room on one page to display all available test applications. The left and right arrow buttons allow respectively accessing the previous or next window. The buttons in between the left and right arrow buttons allow directly selecting the window for the type of test application listed.

## Status Bar







The status bar displays the following information.





Icon and/or text	Description	Test Application
Test icon	Icon representing the active test application.	All
P1, P2, P3, P4	Port identification number: Port x	All
A1, A2, B1, B2	Port identification number composed of the port of the FTBx-88260 module (A or B) and the transceiver system port (1 or 2)	All
[Lx]	On 88260, indicates the Lane number when using a QSFP28 multilane transceiver for a serial interface rate.	CPRI/OBSAI eCPRI
TX/RX, TX, RX	Indicates the direction of the signal per port.	Transport, Time Error / Wander (DS1/E1)
Interface/ Signal	The interface or signal rate per port: 1GE Optical, 40G, OTU1, OTU2, OTU3, etc.	All
(BTS) or (RRH)	<b>BTS:</b> Emulation mode is Base Station <b>RRH:</b> Emulation mode is Remote Radio Head	CPRI/OBSAI BERT
LINK	For single or dual port, the status per port: Green arrow: Link up. Red arrow: Link down. Gray arrow: Awaiting incoming data to provide a status.	All CPRI/OBSAI BERT
	For multiple link interface, the status of all enabled links: Green arrow: Link up on all links. Red arrow: Link down on at least one link. Gray arrow: Awaiting incoming data to provide a status.	EtherBERT (Multiple link interface)

Icon and/or text	Description	Test Application
FlexO status and size	Indicates the FlexO group status and its size: Green arrow: FlexO Group Up. Red arrow: FlexO Group Down.	FlexO BERT
PTP	<p>For G.8265.1 and G.8275.2: Green arrow: Signaling requests granted. Red arrow: Request denied, session canceled, or no reply. Gray arrow: Pending, inactive, or link down.</p> <p>For G.8275.1: Green arrow: Announce, Sync, and Follow-up are received according with their respective interval. Red arrow: Announce, Sync, or Follow-up are not received. Gray arrow: Pending.</p> <p>Refer to <i>Negotiation Status</i> on page 203 for more information.</p>	1588 PTP, Time Error / Wander
ESMC	Green arrow: ESMC valid information frame received. Red arrow: No ESMC valid information frames received. Gray arrow: Pending state. Refer to <i>ESMC Monitoring</i> on page 416 for more information.	SyncE, Time Error / Wander
Power level	The received optical signal status: Green with "Power": Power level in range <sup>a</sup> . Yellow: Power level out-of-range <sup>b</sup> . Red with "LOS": Loss of signal <sup>b</sup> . Red with "Power": Power level is close to damage. Gray: The power range information is either not available or not supplied by the transceiver.	All except Cable Test
	For multiple link interface, the power level status of all enabled link using the following priority order: 1- Red with "Power": Power level is close to damage on at least one lane of any link. 2- Red with "LOS": Loss of signal on at least one lane of any link. 3- Yellow: Power level out-of-range on at least one lane of any link. 4- Gray: The power range information is either not available or not supplied by the transceiver for at least one lane of any link. 5- Green: Power level in range for all lanes on all link.	EtherBERT (Multiple link interface)

## Graphical User Interface Overview

### Status Bar

Icon and/or text	Description	Test Application
	Laser ON <sup>b</sup> . The laser icon is not displayed when the laser is off <sup>a</sup> . The laser icon is only displayed for optical interfaces. The laser is ON by default when the test is created. The laser control is not affected when turning off the laser by generating a LOS for example. Refer to <i>Laser Button</i> on page 747.	All
	For multiple link interface, the laser status of all enabled link: Laser ON for at least one lane of any link. The laser icon is not displayed when the laser is off for all lanes on all links. The laser is ON by default when the test is created. The laser control is not affected when turning off the laser by generating a LOS for example. Refer to <i>Laser Button</i> on page 747.	EtherBERT (Multiple link interface)
	For single or dual port, the status of the received signal pattern per port: Green: Pattern is synchronized. Red: Loss of pattern. Gray: Test is not running (EtherBERT test or EoOTN client) or the <b>No Pattern Analysis (Live)</b> check box is selected.	Transport EtherBERT Fibre Channel Wireless
	For multiple link interface, the pattern status of all enabled links: Green: Pattern is synchronized on all links having the <b>No Pattern Analysis (Live)</b> check box cleared. Red: Loss of pattern on at least one link. Gray: Test is not running or at least one link is in alarm.	EtherBERT (Multiple link interface)
	Connection established between two testing units in Dual Test Set (DTS) or in Loop Up mode.	Ethernet
	Connection not established between two testing units in Dual Test Set (DTS) or in Loop Up mode.	Ethernet
	Loopback Tool enabled on the port unused by the main test application.	Ethernet
	Clock synchronization signal. The icon is followed by the clock mode: <b>INT</b> for Internal, <b>EXT</b> for External, <b>RCV</b> for Recovered, GNSS for Internal GNSS, <b>BKP</b> for Backplane. <b>AUTO</b> is displayed for dual port test when a different clock is used on each port. Green: Clock Synchronized. Red: Loss of clock.	Transport Ethernet Fibre Channel Wireless
	Reference signal. The icon is followed by the reference mode: <b>EXT</b> for External Reference, <b>GNSS</b> for Internal GNSS. Green: Presence of reference Red: Loss of reference.	Time Error / Wander

Icon and/or text	Description	Test Application
	Indicates a manual change in the OH bytes transmitted. Not displayed when using the default OH values.	Transport FlexE
	Remote PC connection established with the Power Blazer.	N/A
	The test is in loopback mode. Not displayed when not in loopback mode.	NI-CSU Emulation
	Alarm/error is currently injected. Not displayed when there is no alarm/error injection.	Transport EtherBERT Carrier Ethernet OAM Fibre Channel Wireless

- a. For all lanes for parallel interface.
- b. For at least one lane for parallel interface.

The following status are also displayed:

- Battery/AC icons, available on FTB platforms, indicate the battery level and if the platform is connected to an AC power source. Refer to the platform user guide for more information.
- Date and Time indicate the current date and time.

## Title Bar

The Title Bar displays the module's slot number in brackets, the software application name and the minimize, maximize, and close buttons.

# Graphical User Interface Overview

## Global Indicator

### Global Indicator

The global indicator area displays the global pass/fail verdict, global alarm, and the test duration.

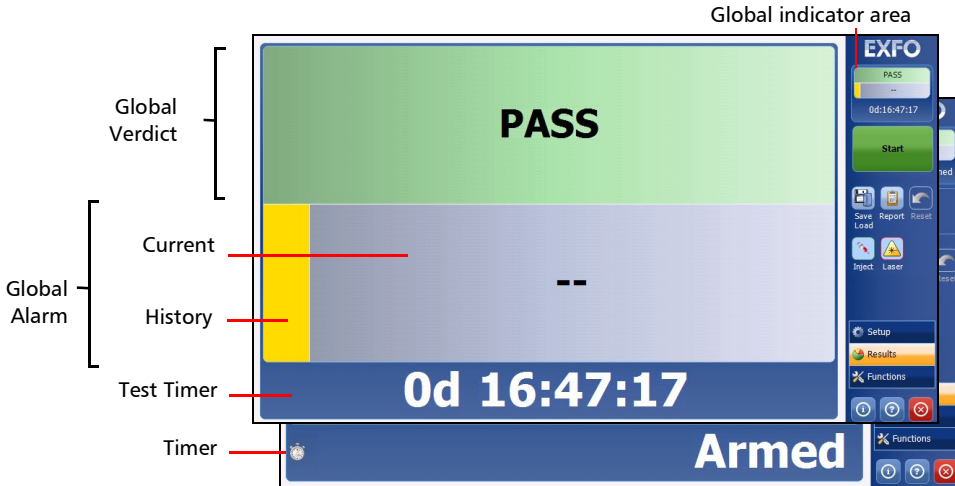

The global indicator area can be maximized for distant viewing. Tap anywhere within the global indicator area to display a maximized view. Tap again to exit the maximized view.

## Global Verdict

Reports the global test verdict status when supported by the test application and enabled (when applicable).

Verdict	Description
PASS	<b>PASS</b> is displayed with a green background when all result values meet the configured threshold criteria.
FAIL	<b>FAIL</b> is displayed with a red background when any result value does not meet the configured threshold criteria or when a specific alarm is detected (refer to each test application for additional information).
"--"	"--" is displayed with a gray background when at least one of the following conditions is met: <ul style="list-style-type: none"> <li>- Pass/Fail verdict is not enabled</li> <li>- there is no defined criterion</li> <li>- the test has not run yet.</li> </ul>

## Global Alarm

Indicates the current and history alarm/error status of the test.

Background color	Alarm/Error	Text displayed	Description
Gray	Current	--	No test result available.
	History		
Green	Current	<b>No Alarm</b>	No alarm/error has occurred in the last second.
	History		No alarm/error has occurred during the test.
Red	Current	<b>Alarms</b> or the name of the alarm.	An alarm/error occurred in the last second.
	History		
Amber	History		No current alarm/error but at least one alarm/error has occurred during the test.

### Test Timer

The test timer without the timer icon indicates the time elapsed since the beginning of the test. No timer action is active. The test timer format is “day hour:minute:second”.

### Timer

The timer icon with **Armed** indicates that a start time is active.

The timer icon with the Test Timer indicates that a duration and/or a stop time is active.

## Test Control

**Note:** Refer to Test Control on page 741 for more information.

## Test Menu

The test menu displays the following buttons:

- **Setup** allows configuring the selected test. Refer to *Setup* on page 115 for more information.
- **Results** allows viewing test results. Refer to *Test Results* on page 445 for more information.
- **Functions** allows configuring additional test functions (refer to *Test Functions* on page 629).



### Application Buttons

- **Help (?)** displays the help information related to the content of the active main window. It is also possible to navigate through the remainder of the help information.
- **Exit (x)** closes the application.
- **About (i)** mainly displays the product version details and technical support information.
- **Send diagnostics** collects diagnostic information from the current FTBx-88000 Series application/module in order to help EXFO technical support investigating any issue encountered with this unit.

Use the **Describe details** field to provide additional information about the problem.

Enter a contact E-mail address in the **Your e-mail** field.

Select the **Display report after saving** check box to automatically open the .zip file once generated.

Click **Save Report** to generate, save, and send the report to EXFO technical support. Once the report is generated and saved a pop-up is displayed showing its file name and location on disk, click **OK**. If the **Display report after saving** check box is selected, the .zip file is open in File Explorer.

- **Module Details** button displays the unit details such as its ID, Serial Number, Software Product Version, etc.
- **View License Agreement** button displays the details of the product license agreement.
- **What's new** link allows displaying the details of the new features introduced with this software release as well as the platform inventory.

## Graphical User Interface Overview

### Application Buttons

---

- **Software Options** button displays the list of software options.

**Note:** For information on how to install and activate software options, refer to the platform User Guide. The Power Blazer application must be restarted once a new software option is installed in order to activate it.

Software Option	Description
10electrical	Ethernet 10Base-T electrical interface
10G_LAN	Ethernet 10G LAN optical interface
10G_WAN	Ethernet 10G WAN optical interface
100electrical	Ethernet 100Base-TX electrical interface
100GE	Ethernet 100G
100optical	Ethernet 100Base-FX optical interface
155M	155 Mbit/s (SONET/SDH)
1588PTP	1588 Precision Time Protocol Test Application
200GE	Ethernet 200G
2488M	2.488 Gbit/s (SONET/SDH)
25GE	Ethernet 25G
2X100GE	Support of 2x100GE (4x25G)
2X200GE	Support of 2x200GE (4x50G)
40GE	Ethernet 40G
400GE	Ethernet 400G
4X100GE	Support of 4x100GE
50GE	Ethernet 50G
52M	52 Mbit/s (SONET/SDH)
622M	622 Mbit/s (SONET/SDH)
8X50GE	8x50GE
9953M	9.953 Gbit/s (SONET/SDH)
CABLE_TEST	Cable Test Application
CPRI	CPRI 2.4576 Gbit/s and 3.072 Gbit/s
CPRI-1.2G	CPRI 1.2288 Gbit/s
CPRI-4.9G	CPRI 4.9152 Gbit/s

Software Option	Description
CPRI-6.1G	CPRI 6.144 Gbit/s
CPRI-9.8G	CPRI 9.8304 Gbit/s
CPRI-10.1G	CPRI 10.1376 Gbit/s
CPRI-24.3G	CPRI 24.33024 Gbit/s
CPRI-ALU-BBUe	Alcatel-Lucent BBUe over CPRI
CPRI-AUTODETECT	CPRI Mapping Auto-Detect
CPRI-Spectrum	RF Spectrum Analysis over CPRI
DCO-400ZR	400ZR
DCO-OpenZRplus	OpenZR+
DS1-FDL	DS1/1.5M Facility Data Link
eCPRI-10G	eCPRI over 10GE
eCPRI-25G	eCPRI over 25GE
eCPRI-100G	eCPRI over 100GE
EoE	Ethernet over Ethernet Encapsulation (10GE)
EoE_40-100GE	Ethernet over Ethernet Encapsulation (40/100GE)
EoOTN	Ethernet over Optical Transport Network
ETH-OAM	Carrier Ethernet OAM test application
FC-1X	Fibre Channel 1X
FC-2X	Fibre Channel 2X
FC-4X	Fibre Channel 4X
FC-8X	Fibre Channel 8X
FC-10X	Fibre Channel 10X
FC-16X	Fibre Channel 16X
FC-32X	Fibre Channel 32X
FlexE-100G	100G FlexE Group
FlexE-200G	200G FlexE Group
FlexE-200G-PHY	FlexE 200G Interface Type
FlexE-300G	300G FlexE Group
FlexE-400G	400G FlexE Group
FlexE-400G-PHY	FlexE 400G Interface Type
FlexE-50G	50G FlexE Group

## Graphical User Interface Overview

### Application Buttons

---

Software Option	Description
FlexE-50G-PHY	FlexE 50G Interface Type
FlexE-HiRateClient	FlexE Clients at 150G and above
FlexE-LoRateClient	FlexE Clients at 100G and below
FlexE-MIX	FlexE Clients at mixed rates
FlexO-100G	100G FlexO Group
FlexO-200G	200G FlexO Group
FlexO-300G	300G FlexO Group
FlexO-400G	400G FlexO Group
G.mtnPathOAM	G.mtn Path OAM
GCC-BERT	OTN Overhead BERT and Synchronization validation
GigE_Electrical	Ethernet 1000Base-T electrical interface
GigE_Optical	Ethernet 1000Base-X optical interface
iOptics	Intelligent Pluggable Optic Test Application
iORF	Intelligent OpticalRF Application
iSAM	Intelligent Service Activation Methodology
L2-Transparency	L2CP Handling Test in EtherSAM
LINK-OAM	Link OAM
MPLS	MPLS Encapsulation (up to 10GE)
MPLS_40-100GE	MPLS Encapsulation (40/100GE)
MULTI-CH-OTN	Multi-Channel OTN Test Application
NI-CSU	NI/CSU Emulation
OBSAI	OBSAI 3.072 Gbit/s
OBSAI-1.5G	OBSAI 1.536 Gbit/s
OBSAI-6.1G	OBSAI 6.144 Gbit/s
ODU0	OTN ODU0
ODUflex	OTN ODUflex
ODUflex-HiRate	ODUflex client at 146.7G and above
ODUflex-LoRate	ODUflex client at 146.7G and below
ODUMUX	ODU Multiplexing Payload Type 20 and 21
OTN-INTR-THRU	OTN Intrusive Through Mode
OTN-MIX-MAPPING	Mix-Mapping capability for Multi-Channel OTN

Software Option	Description
OTU1	Optical Transport Unit-1 (2.7 Gbit/s)
OTU2	Optical Transport Unit-2 (10.7 Gbit/s)
OTU2-1e-2e	Optical Transport Unit-2 Overclocked (11.049/11.096 Gbit/s)
OTU2-1f-2f	Optical Transport Unit-2 Overclocked (11.270/11.317 Gbit/s)
OTU3	Optical Transport Unit-3 (43.018 Gbit/s)
OTU3-e1-e2	Optical Transport Unit-3 Overclocked (44.571/44.583 Gbit/s)
OTU4	Optical Transport Unit-4 (111.81 Gbit/s)
Packet-TE	Packet Time Error
PBBTE	Provider Backbone Bridge Encapsulation (10GE)
PBBTE_40-100GE	Provider Backbone Bridge Encapsulation (40/100GE)
PDH	Plesiochronous Digital Hierarchy
PIM	Passive Intermodulation Analysis
RF-PWR-MASK	Radio Frequency Power Alarming Mask
RFC6349	RFC 6349 test application (up to 10GE)
RFC6349_40-100GE	RFC 6349 test application (40/100GE)
SDH	Synchronous Digital Hierarchy
SONET	Synchronous Optical Network
SONETSDH-INTR-THRU	SONET/SDH Intrusive Through Mode
TCM	Tandem Connection Monitoring STS/AU and VT/TU (SONET/SDH)
TCP-THPUT	TCP Throughput Test Application
TST-OAM	Test Over Service OAM
SyncE	Synchronous Ethernet Test Application
Wander	Time Error / Wander Test Application

## Zoomed-In/Zoomed-Out Views







Some configuration and result blocks give access to zoomed views allowing more detailed configurations/results.

The block title contains the magnifier (+) icon when a zoomed view is available.

To zoom-in, tap the magnifier (+) icon or anywhere on the block.

To zoom-out, tap on the magnifier (-) icon or anywhere on the block title.

## Arrow Buttons

-  Moves to the top of the list.
-  Moves one page up.
-  Moves one line up.
-  Moves one line down.
-  Moves one page down.
-  Moves to the end of the list.

### Keyboard Usage

The GUI pops up different keyboards to modify data. Following are the usual keyboard keys:

- Left arrow moves the cursor one position to the left.
- Right arrow moves the cursor one position to the right.
- Up arrow increases the value by one.
- Down arrow decreases the value by one.
- **Del** deletes the value at the cursor position.
- **Back** deletes the value preceding the cursor position.
- **OK** completes data entry.
- **Cancel** closes the keyboard and discards the keyboard entry.
- **Previous...** allows the selection of previously configured values. This button is only available for certain fields like IP Address, MAC Address, etc.

**Note:** *For certain text fields, the GUI pops up or uses the unit's on-screen keyboard. Refer to the platform user guide for more information on how to use it.*

For full keyboard, the **Back**, **Del**, **Shift**, and **Space** bar keys have the same functionality as a regular PC keyboard.

## Graphical User Interface Overview

### Keyboard Usage

For multiplexing keyboard, tap on all mapped signals that have to be added/removed to/from the test path. A mapped signal with an orange background color is part of the test path. A mapped signal with a gray background color is not part of the test path.

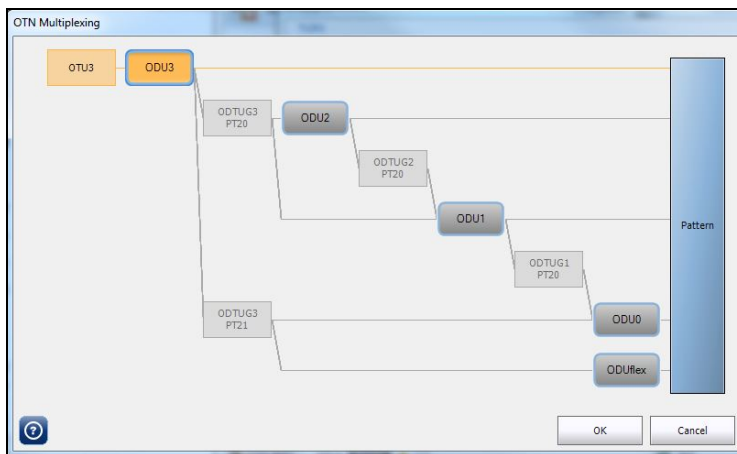



The Trace message keyboard allows entering alphanumerical characters (ITU T.50) required for J0/J1/J2/TTI Trace fields. Tap the **Control Characters** button to access these characters.

ITU T.50 Characters					
b7 to b1	Character	Description	b7 to b1	Character	Description
000 0000	NUL	Null	001 0000	DLE	Data Link Escape
000 0001	SOH	Start Of Heading	001 0001	DC1	Device Control 1
000 0010	STX	Start of Text	001 0010	DC2	Device Control 2
000 0011	ETX	End of Text	001 0011	DC3	Device Control 3
000 0100	EOT	End Of Transmission	001 0100	DC4	Device Control 4
000 0101	ENQ	Enquiry	001 0101	NAK	Negative Acknowledge
000 0110	ACK	Acknowledge	001 0110	SYN	Synchronous idle
000 0111	BEL	Bell	001 0111	ETB	End of Transmission Block
000 1000	BS	Backspace	001 1000	CAN	Cancel
000 1001	HT	Horizontal Tabulation	001 1001	EM	End of Medium
000 1010	LF	Line Feed	001 1010	SUB	Substitute character
000 1011	VT	Vertical Tabulation	001 1011	ESC	Escape
000 1100	FF	Form Feed	001 1100	IS4	Information Separator 4
000 1101	CR	Carriage Return	001 1101	IS3	Information Separator 3
000 1110	SO	Shift-Out	001 1110	IS2	Information Separator 2
000 1111	SI	Shift-In	001 1111	IS1	Information Separator 1



# 6 **Test Setup - Test Applications**

The Power Blazer offers the following test applications.

## **Intelligent Apps**

<b>Test Applications</b>	<b>Page</b>
iOptics	53
iSAM	55

## **Transport**

<b>Test Applications</b>	<b>Page</b>
DCO BERT	67
DSn/PDH BERT	69
FlexO BERT	57
Multi-Channel OTN	56
NI/CSU Emulation	74
OTN BERT	58
OTN-SONET/SDH BERT	61
SONET/SDH BERT	64
SONET/SDH - DSn/PDH BERT	71

## **Ethernet**

<b>Test Applications</b>	<b>Page</b>
Cable Test	91
Carrier Ethernet OAM	89
EtherBERT	81
EtherSAM (Y.1564)	75
FlexE BERT	80

## Test Setup - Test Applications

---

Test Applications	Page
RFC 2544	77
RFC 6349	79
Smart Loopback	85
TCP Throughput	88
Through Mode	87
Traffic Gen & Mon	83

## Sync

Test Applications	Page
1588 PTP	92
SyncE	93
Time Error / Wander	94

## Fibre Channel

Test Applications	Page
FC BERT	95

## Wireless

Test Applications	Page
CPRI/OBSAI BERT	96
eCPRI BERT	98

## iOptics

iOptics test application provides a quick assessment of the proper operation of an optical transceiver before using it in a network or test environment. The validation is done by running sub-tests in addition to monitoring transceiver power consumption and temperature. Result and verdict are reported for each sub-test and monitoring task. Transceiver's manufacturing information is also automatically collected.

- Typical iOptics test applications:

For standard transceivers:

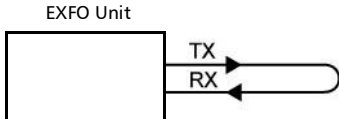

For bidirectional transceivers:

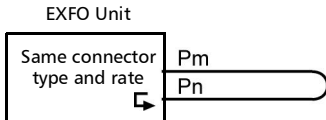

For an Active Optical Cable (AOC):

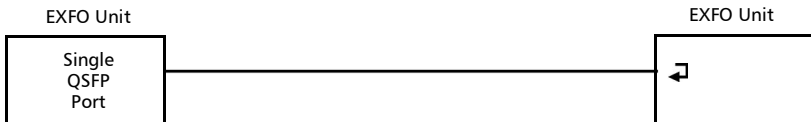
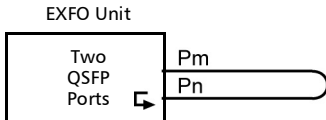

## Test Setup - Test Applications

*iOptics*

---

For a Direct Attached Copper (QSFP-DD DAC):

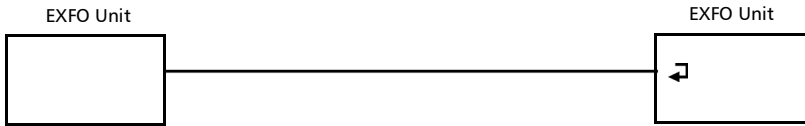

For QSFP56 Host/Media Loopback:

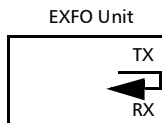

# iSAM

iSAM is a simplified version of EtherSAM that is centered around addressing turn-up of E-Line circuits (EVC). The objective of the test is to validate Carrier Ethernet-based services key performance indicators defined in MEF: Frame Delay (FD), Inter-Frame Delay Variation (IFDV), and Frame Loss Ratio (FLR). In addition the RFC 6349 subtest can be enabled to validate that the Ethernet service is able to properly carry TCP traffic.

The **iSAM** test has to be executed in conjunction with a remote unit. The remote unit can be either in loopback configuration for unidirectional testing or in EtherSAM **Dual Test Set** mode for bidirectional testing.

The **Dual Test Set** test allows bi-directional testing between two compatible units providing independent results for each test direction. The results from local-to-remote and remote-to-local are available on the local testing unit.

➤ Typical iSAM test applications:

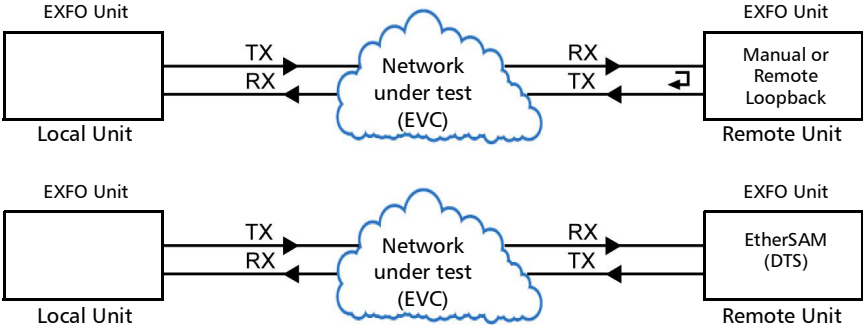

## Test Setup - Test Applications

### Multi-Channel OTN

## Multi-Channel OTN

The Multi-Channel OTN test application validates individual channel connectivity with a device under test by allowing concurrent generation and monitoring of all channels of a single or mixed ODUmux test structure.

- Typical Multi-Channel OTN test applications:

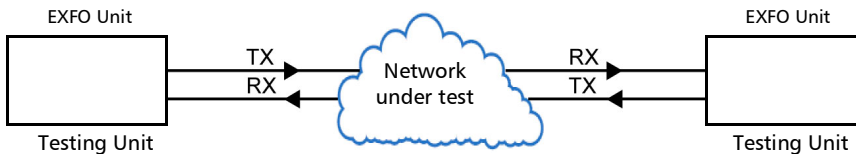
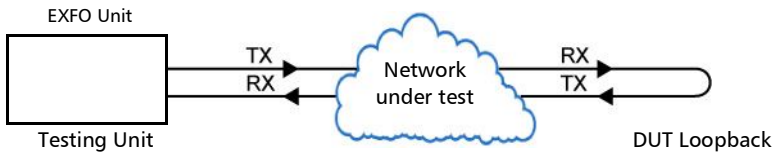

- Path/Mapping

The **Multi-Channel OTN** test application offers the following path/mapping structures depending on the inserted CFP4/QSFP transceivers and enabled options. Mixed mapping is available with the OTN-MIX-MAPPING software option.

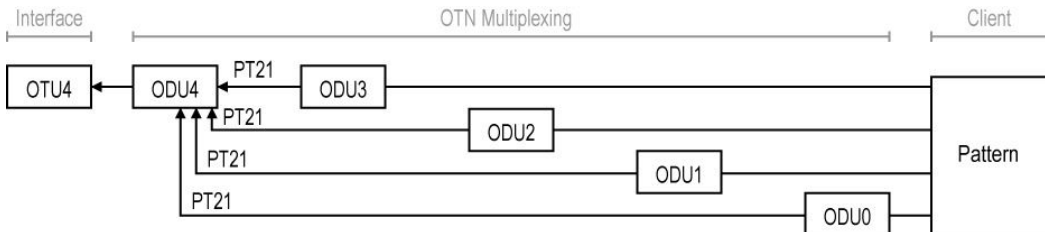



## FlexO BERT

FlexO is an adaptation layer which provides a flexible, modular mechanism to support different line rates with beyond 100G signals. A set of n 100Gbit/s Instances are bonded together to carry an OTUCn, with each FlexO Instance carrying an OTUC slice. The current implementation of FlexO is fixed to 4 x 100G PHYs.

- Typical FlexO BERT test applications:

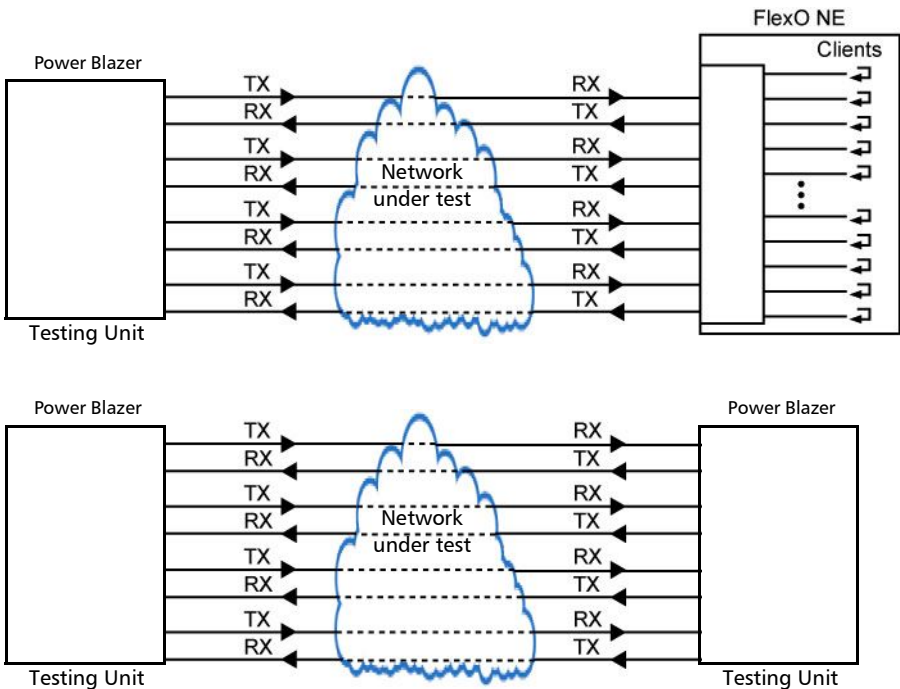

- Supported Interfaces/Rates: 100G.

## OTN BERT

Allows OTN (framed and unframed), OTN multiplexing, and EoOTN traffic generation with specific test pattern for Bit Error Rate analysis.

- Typical OTN BERT test applications:

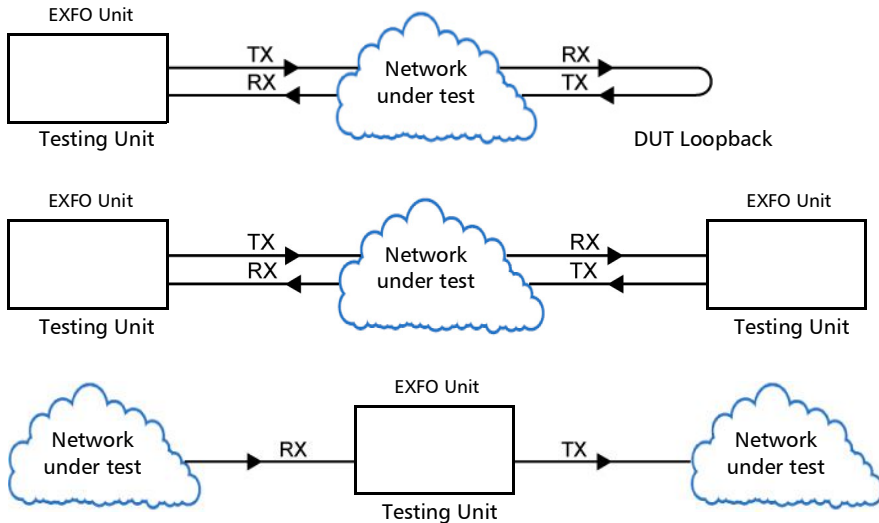

- Path/Mapping

The **OTN BERT** test application offers the following path/mapping structures depending on the inserted transceiver and enabled options.

Up to OTU4 for 88200NGE/88260 and up to OTU2f for 8870/8880.

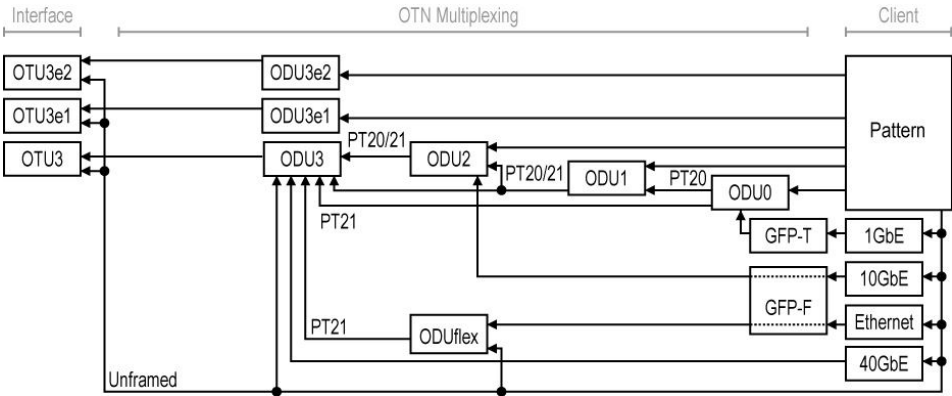
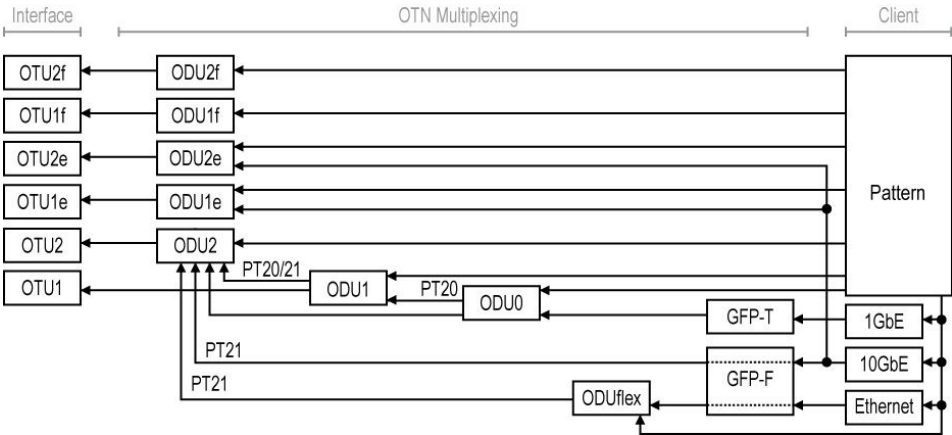

# Test Setup - Test Applications

## OTN BERT

### ➤ OTU4 for 88200NGE/890/890NGE

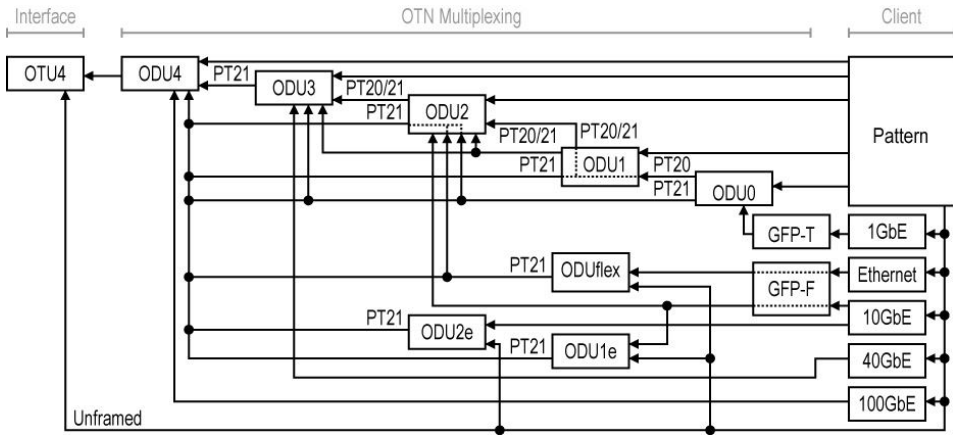

### ➤ OTU4 for 88260

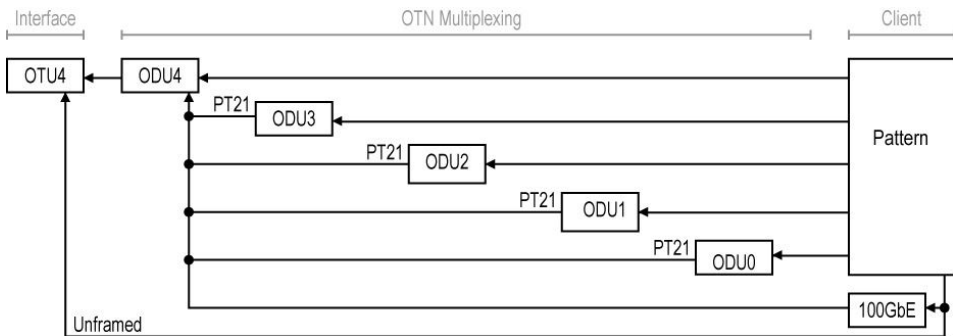

## OTN-SONET/SDH BERT

Allows the validation of the SONET/SDH embedded in OTN transport protocol by performing a BERT test to check the traffic or payload stability over a network facility.

- Typical OTN-SONET/SDH BERT test applications:

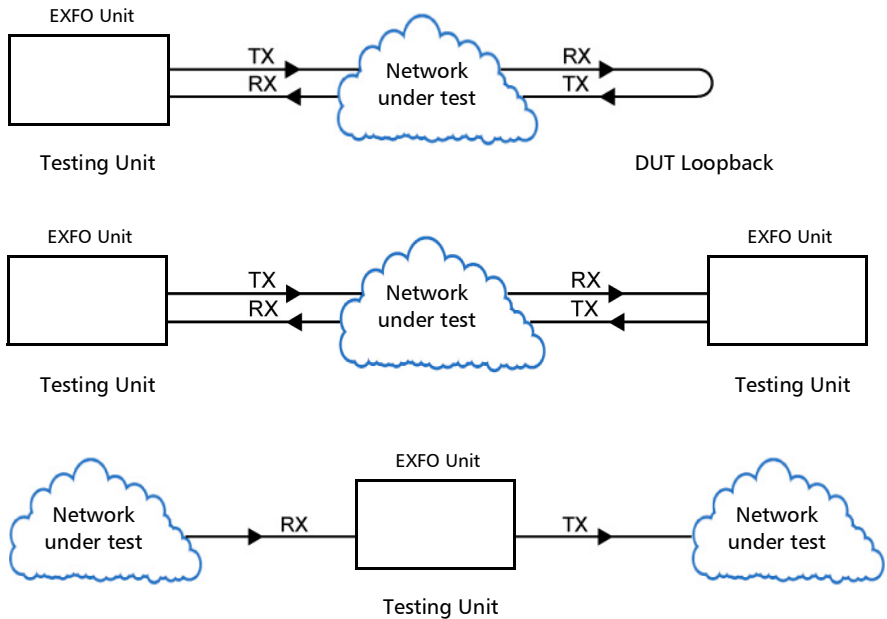

## Test Setup - Test Applications

### OTN-SONET/SDH BERT

#### ► Path/Mapping

The **OTN-SONET/SDH BERT** test application offers the following path/mapping structures depending on the module, inserted transceiver, and enabled options.

For OTN-SONET BERT: up to OTU4 for 88200NGE, up to OTU3 for 88260, and up to OTU2 for 8870/8880.

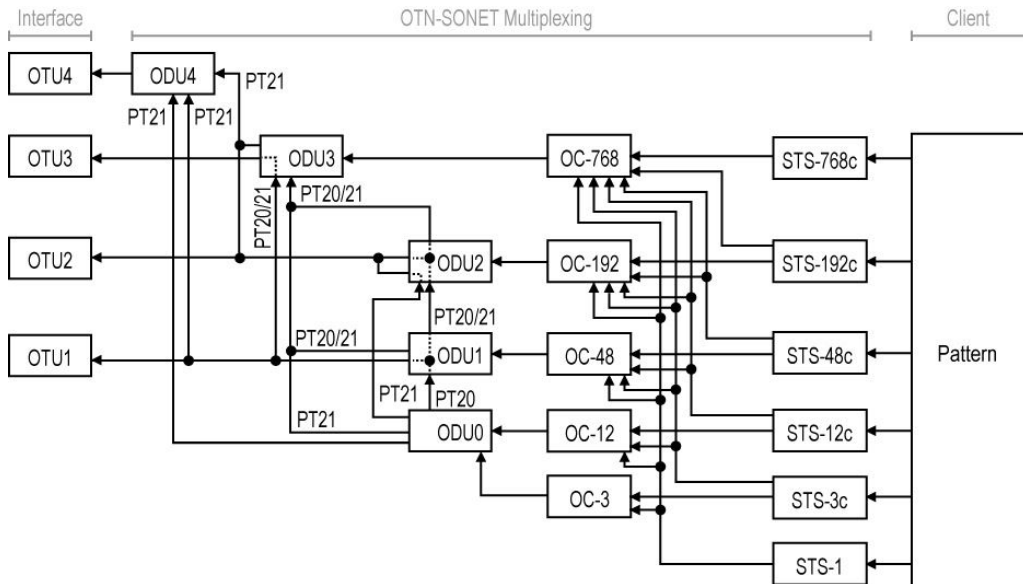

For OTN-SDH BERT: up to OTU4 for 88200NGE, up to OTU3 for 88260, and up to OTU2 for 8870/8880.

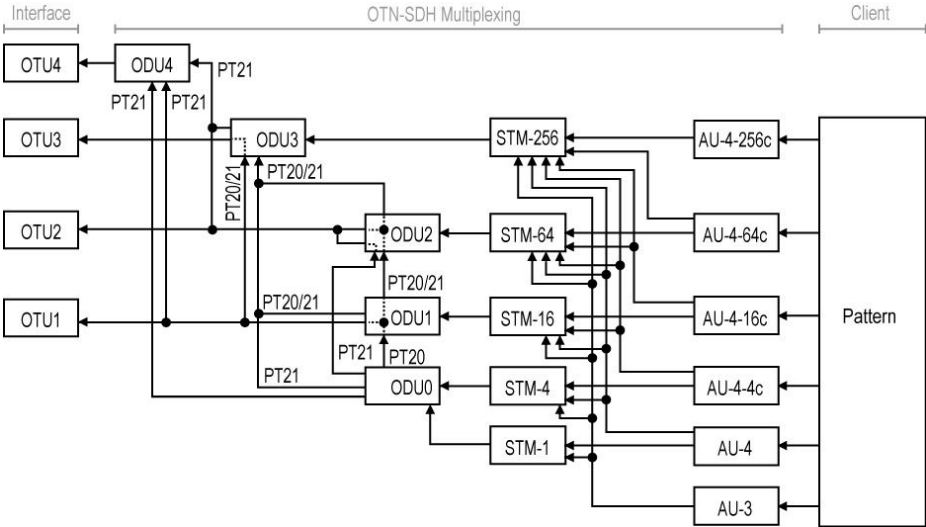

### SONET/SDH BERT

Allows the validation of the SONET or SDH transport protocol by performing a BERT test to check the traffic or payload stability over a network facility.

- Typical SONET/SDH BERT test applications:

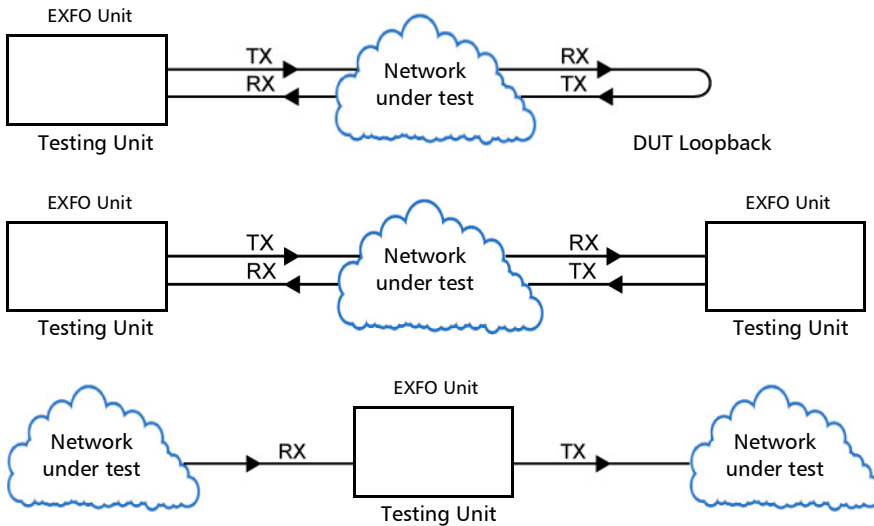



➤ Path/Mapping

The **SONET/SDH BERT** test application offers the following path/mapping structures depending on the inserted transceiver, and enabled options.

For SONET BERT

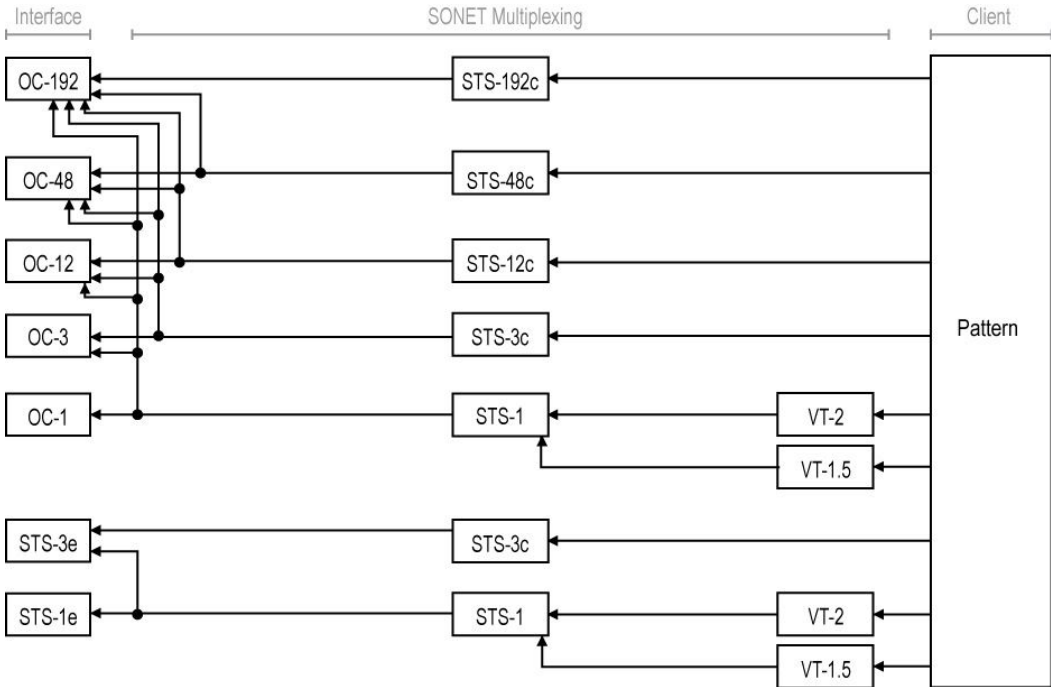

# Test Setup - Test Applications

## SONET/SDH BERT

For SDH BERT

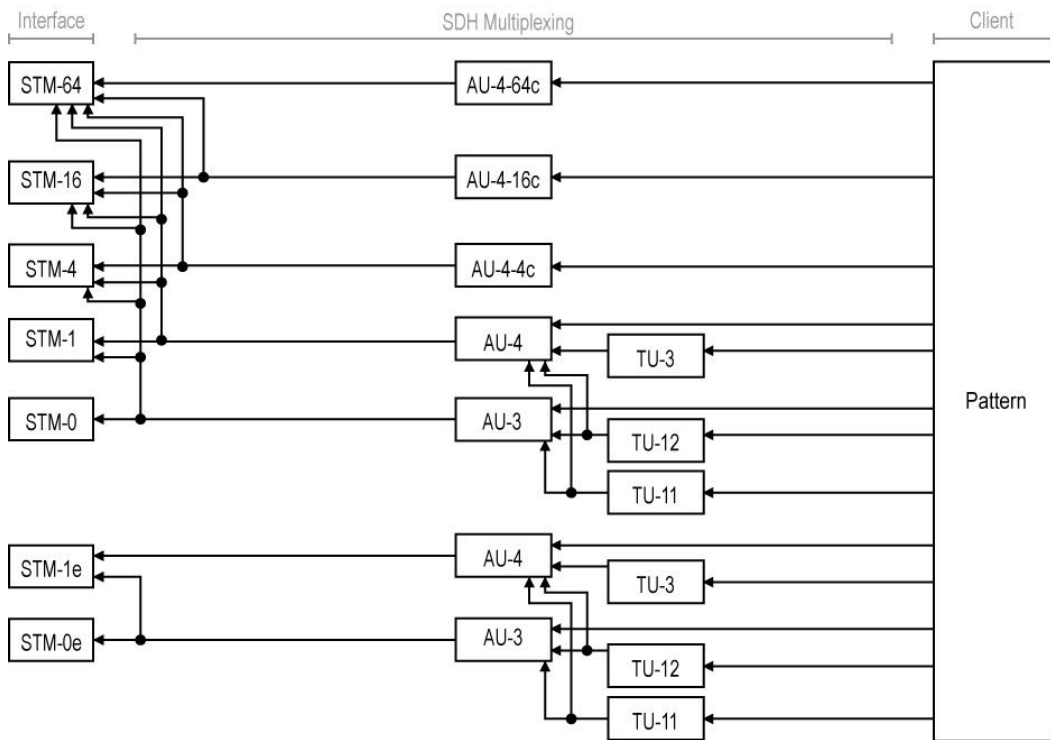

## DCO BERT

DCO BERT test allows to generate and analyze simulated client traffic, perform BERT test, and monitor key optical metrics as well as alarms/errors provided by the DCO Transceiver.

Two EXFO product can be placed at both ends of the DCO link to validate each direction of the link independently or one EXFO product can be used at one end of the DCO link and another product at the other end (client side) can be used to loopback client frames (ex: Smart Loopback application).

➤ Typical DCO BERT test applications:

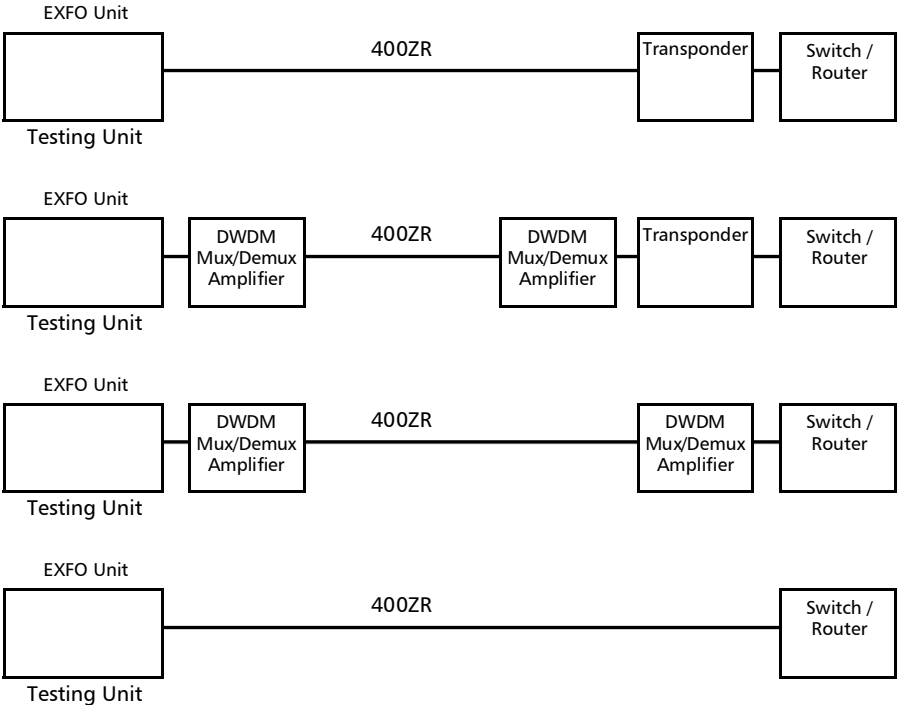

## Test Setup - Test Applications

*DCO BERT*

---

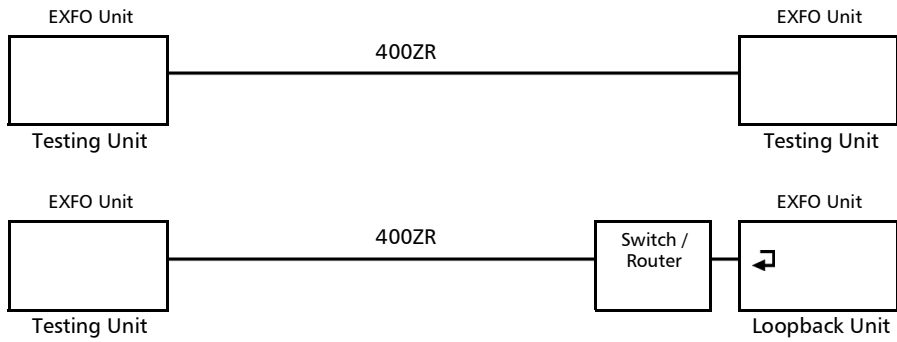

## DSn/PDH BERT

Allows validation of the DSn or PDH transport protocol by performing a BERT test to check the traffic or payload stability over a network facility.

➤ Typical DSn/PDH BERT test applications:

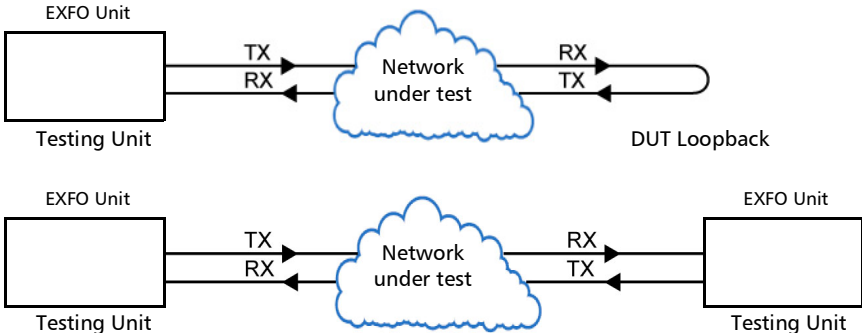

## Test Setup - Test Applications

### DSn/PDH BERT

---

#### ➤ Path/Mapping

The **DSn/PDH BERT** test application offers the following path/mapping structures depending on model and enabled options.

For DSn:

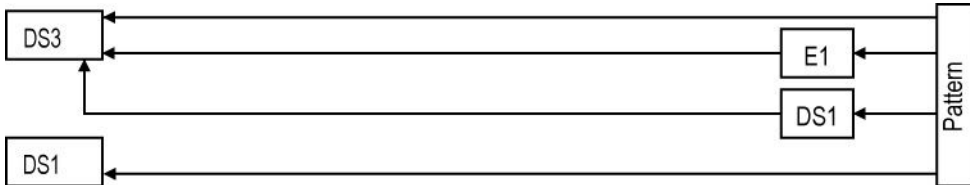

**Note:** It is possible to enable DS0/E0 from Signal - Signal Configuration - DSn/PDH on page 394.

For PDH:

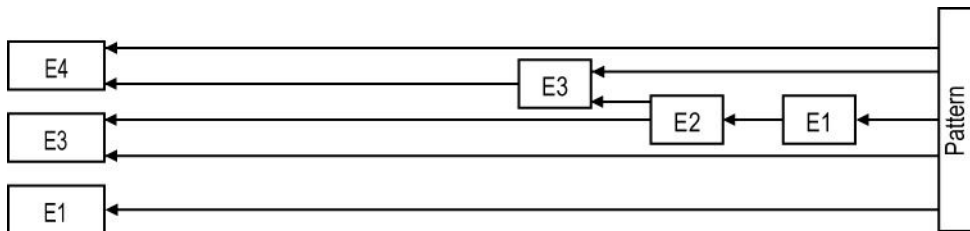

**Note:** It is possible to enable E0 from Signal - Signal Configuration - DSn/PDH on page 394.

## SONET/SDH - DS<sub>n</sub>/PDH BERT

Allows validation of the DS<sub>n</sub> or PDH embedded in SONET or SDH transport protocol by performing a BERT test to check the traffic or payload stability over a network facility.

- Typical SONET/SDH - DS<sub>n</sub>/PDH BERT test applications:

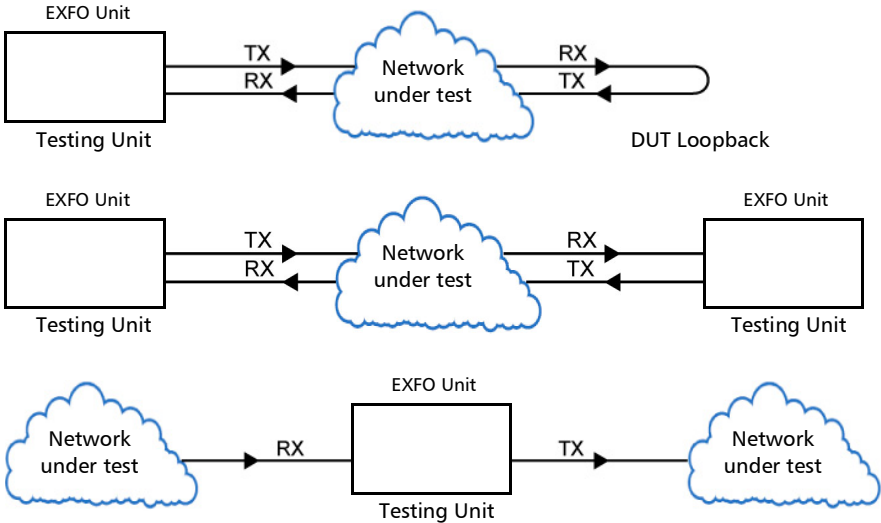

## Test Setup - Test Applications

### SONET/SDH - DSn/PDH BERT

---

#### ► Path/Mapping

The **SONET/SDH - DSn/PDH BERT** test application offers the following path/mapping structures depending on the model and enabled options.

For SONET:

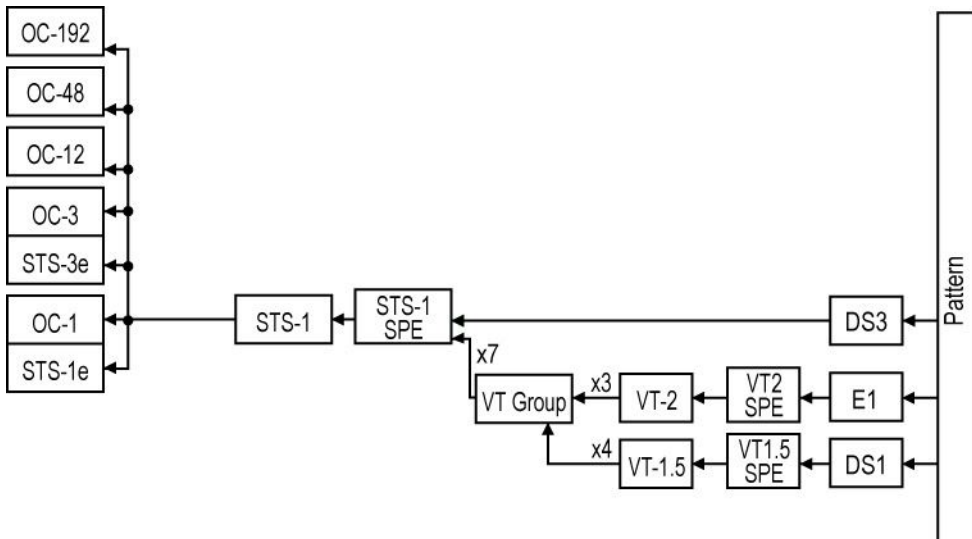



For SDH:

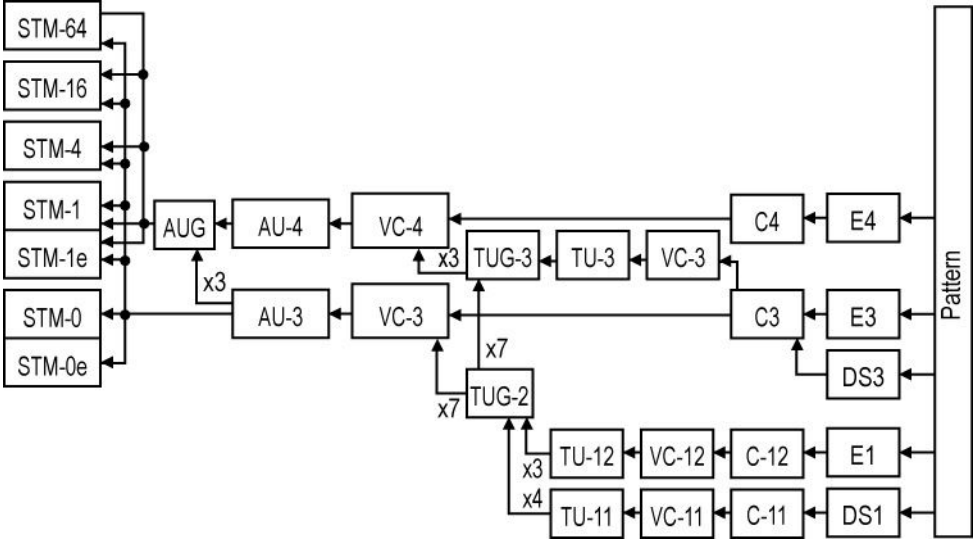

## Test Setup - Test Applications

NI/CSU Emulation

---

### NI/CSU Emulation

Allows DS1 testing in NI/CSU (Network Interface/Customer Service Unit) emulation mode.

Typical NI/CSU Emulation test applications:

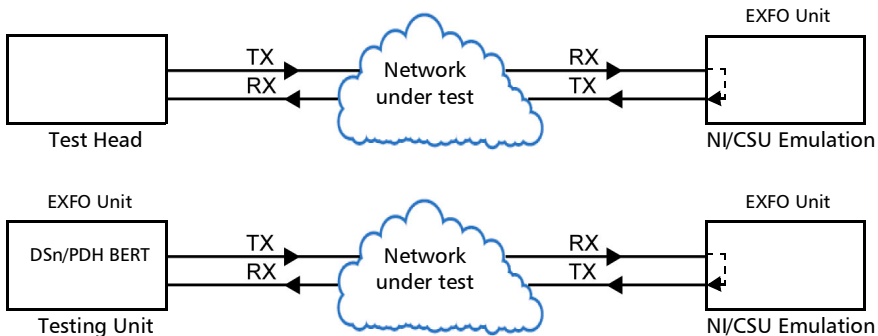

### **EtherSAM (Y.1564)**

EtherSAM can simulate all types of services that will run on the network and simultaneously qualify all key SLA parameters for each of these services. Moreover, it validates the QoS mechanisms provisioned in the network to prioritize the different service types, resulting in more accurate validation and much faster deployment and troubleshooting.

The **EtherSAM (Y.1564)** test, in single port configuration, has to be executed in conjunction with a remote unit. The remote unit can be either in loopback configuration for unidirectional testing or in **EtherSAM Dual Test Set** mode for bidirectional testing.

The **Dual Test Set** test allows bi-directional testing between two compatible units providing independent results for each test direction. The results from local-to-remote and remote-to-local are available on the local testing unit.

The **Dual Port** topology allows simultaneous and bidirectional traffic generation and analysis at 100 percent wire-speed at any packet size.

## Test Setup - Test Applications

*EtherSAM (Y.1564)*

---

- Typical EtherSAM (Y.1564) test applications:

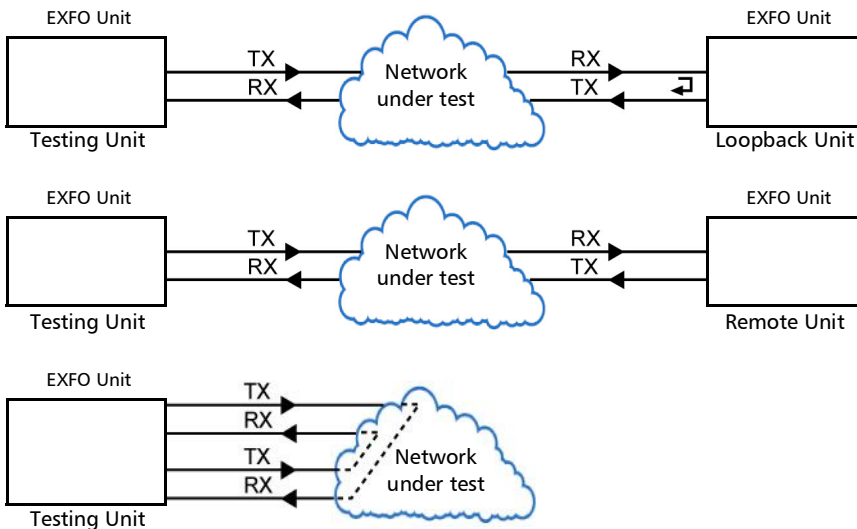

### **RFC 2544**

RFC 2544 allows Ethernet Throughput, Back-to-Back, Frame Loss, and Latency performance testing in accordance with RFC 2544 specifications.

The **RFC 2544** test, in single port configuration, has to be executed in conjunction with a remote unit. The remote unit can be either in loopback configuration for unidirectional testing or in RFC 2544 **Dual Test Set** mode for bidirectional testing.

The **Dual Test Set** test allows bi-directional testing between two compatible units providing independent results for each test direction. The results from local-to-remote and remote-to-local are available on the local testing unit.

The **Dual Port** topology allows simultaneous and bidirectional traffic generation and analysis at 100 percent wire-speed at any packet size.

## Test Setup - Test Applications

RFC 2544

---

- Typical RFC 2544 test applications:

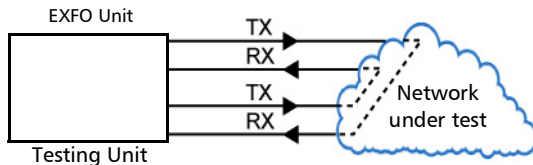
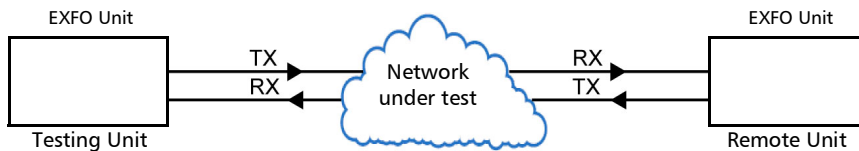
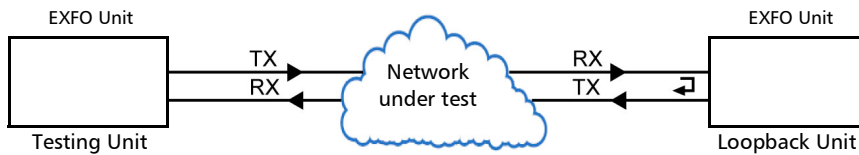

## RFC 6349

RFC 6349 is used to confirm that the Ethernet service is able to properly carry TCP traffic.

The **RFC 6349** test has to be executed in conjunction with a remote compatible unit in RFC 6349 **Dual Test Set** operation mode allowing bidirectional testing. For iPerf Compatible Server operation mode (iPerf v2), a remote iPerf Compatible Client is required at the other end for unidirectional testing. The test provides independent results for each test direction. The results from local-to-remote and remote-to-local are available on the local testing unit.

➤ Typical RFC 6349 test application:

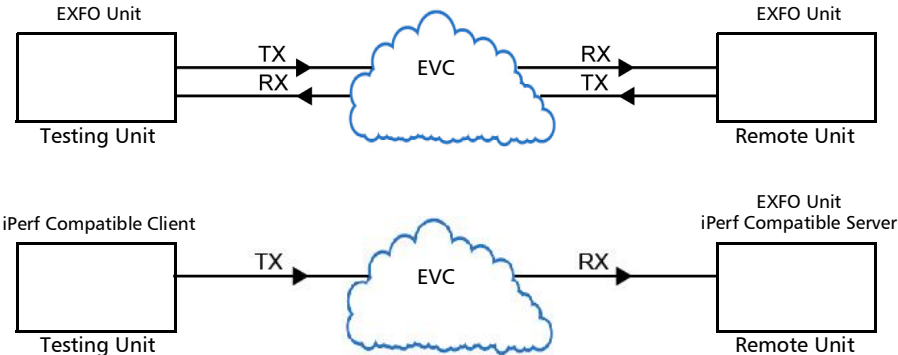

## Test Setup - Test Applications

FlexE BERT

### FlexE BERT

The Flex Ethernet (FlexE) supports up to two (88260) / four (88460) 100GBASE-R PHYs supporting multiple Ethernet MAC operating at a rate of: 5, 10, 25, 40, 50, 100, 150, 200, 250, 300, 350, 400 Gbit/s.

- Typical FlexE BERT test applications:

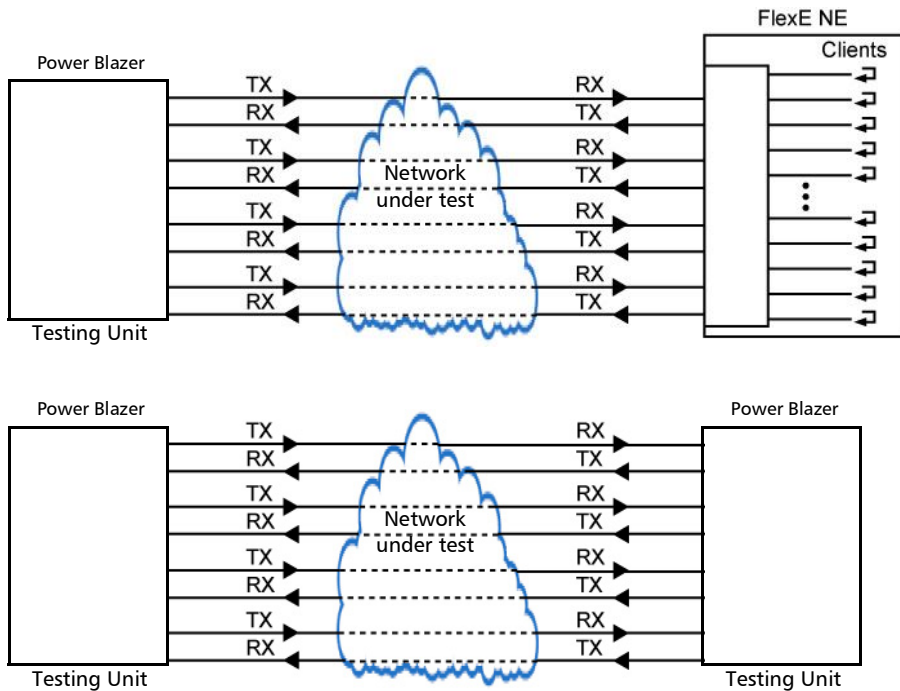



# EtherBERT

Allows Ethernet Layer 1 up to Layer 4 and Unframed Layer 1 traffic generation with specific test pattern for Bit Error Rate analysis.

➤ Typical EtherBERT test applications:

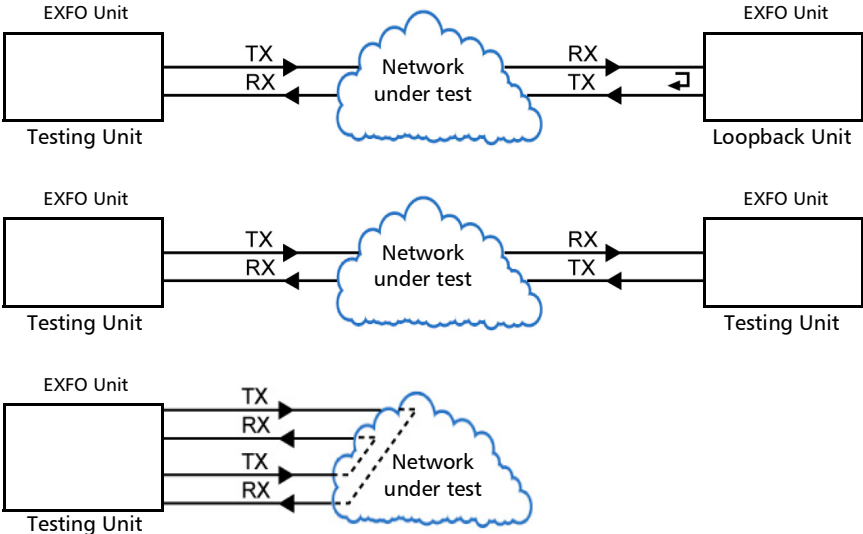

## Test Setup - Test Applications

*EtherBERT*

---

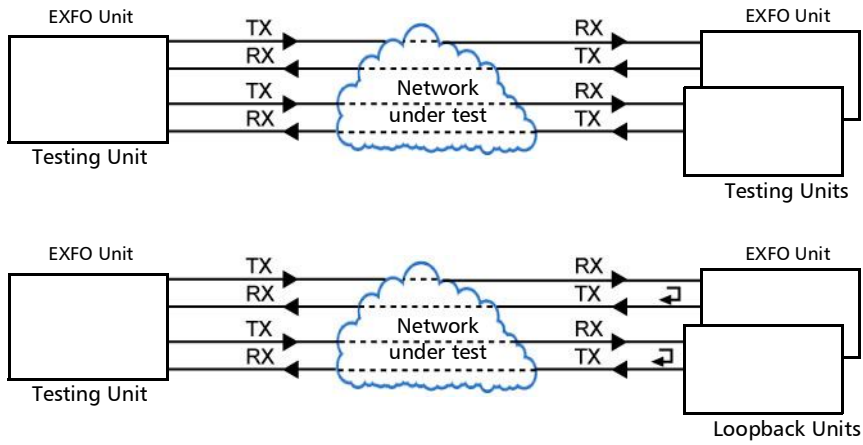

# Traffic Gen & Mon

Allows Ethernet traffic generation and analysis of up to 16 streams.

► Typical Traffic Gen & Mon test applications:

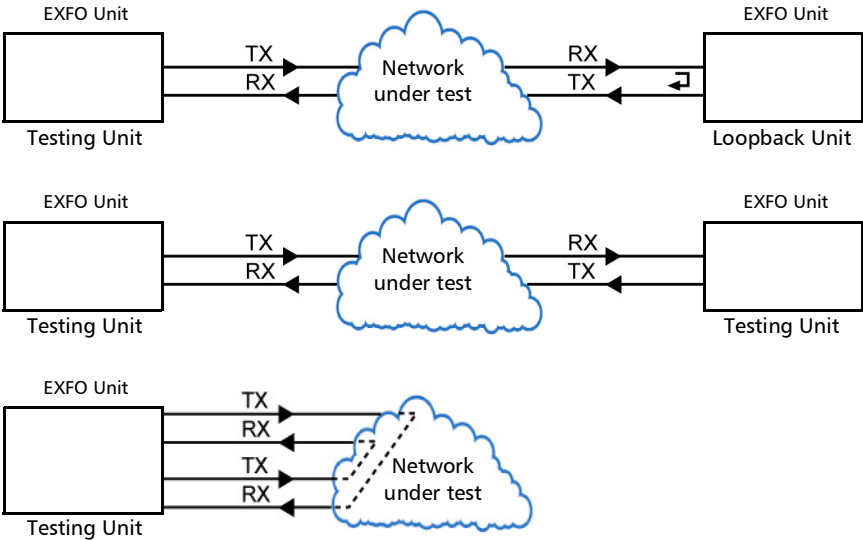

# Test Setup - Test Applications

Traffic Gen & Mon

---

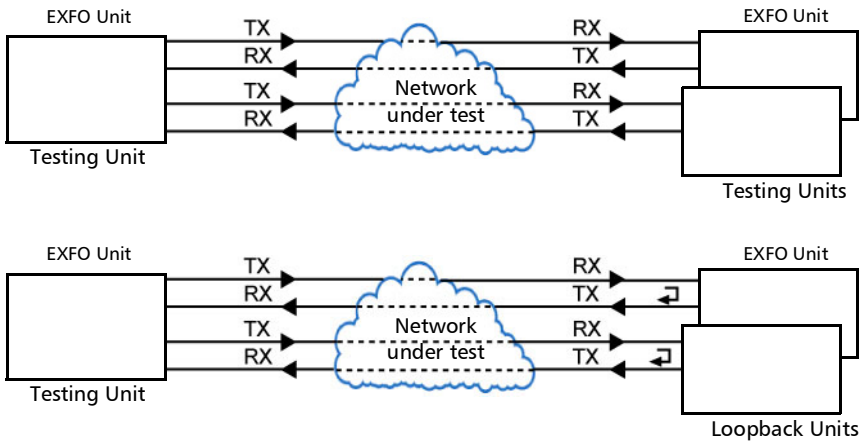

## Smart Loopback

Allows transmitting back the received Ethernet stream of data while interchanging the source and destination MAC addresses, IP addresses, and/or UDP/TCP ports. However in **Transparent (Pseudo-Physical)** mode the Smart Loopback operates as a physical loopback by transmitting all received frames unaltered and without discrimination.

The Smart Loopback test can be created locally (refer to *Ethernet Test Applications* on page 107) or remotely using either an EXFO unit (refer to *Discover Remote* on page 742) or a Third-Party device (see *Third-Party Remote Loopback* on page 86).

➤ Typical Smart Loopback test application:

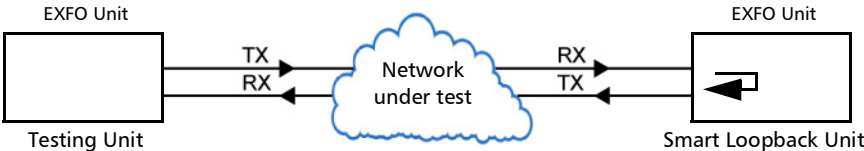

## **Third-Party Remote Loopback**

The Third-party Remote Loopback feature provides the capability to be discovered and react to loop-up and loop-down commands from a third party device. This feature is used for unidirectional testing, where the test stream is transmitted from the third party device to a remote EXFO device. The looped back test stream is received and analyzed by the third-party device.

The third-party loopback supports three levels of messages:

- Layer 2: Only MAC addresses are swapped.
- Layer 3: MAC and IP addresses are swapped.
- Layer 4: MAC and IP addresses are swapped along with the UDP port.

To emulate a third-party remote device, the loopback mode is set in the function of the layer of loop messages received. The loop messages are:

- Layer 2: Ethernet
- Layer 3: IP
- Layer 4: UDP/TCP

On receipt of the third-party loop-up command as per requested layer, the loopback mode is set and initiated on the unit.

Supported Interfaces/Rates: 10M to 100G.

## Through Mode

The Through Mode test application allows traffic to pass through the unit using two electrical or optical ports for in-service troubleshooting of live traffic between the carrier/service provider network and the customer's network.

- Typical Through Mode test application:

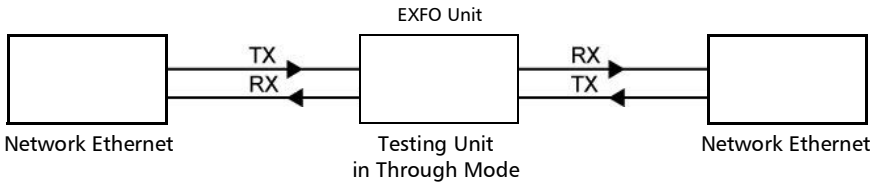

## Test Setup - Test Applications

### TCP Throughput

---

## TCP Throughput

The objective of this test is to find the TCP throughput based on the successfully transported bytes over the test time. Two units running a TCP Throughput test are required. One unit will act as the source (Local) and the other one as the destination (Remote).

The local unit starts sending TCP segments using the Initial Window Size defined. The window size is adjusted following the TCP algorithm. The window size is incremented until the Maximum Window Size or congestion is reached. However, the window size will be reduced when congestion occurs, then incremented again as described above when the congestion is cleared. TCP Throughput and windows size statistics will be gathered throughout the test.

➤ Typical TCP Throughput test application:

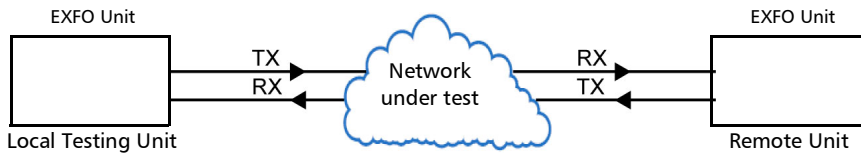



## Carrier Ethernet OAM

The Carrier Ethernet OAM test application supports the following tests: **Ethernet OAM (S-OAM)**, **MPLS-TP OAM**, and **Link OAM**.

### Ethernet OAM and MPLS TP OAM

The Ethernet Service OAM tests are divided into two main categories:

Performance Monitoring measures parameters such as frame delay, frame loss, and synthetic loss (Y.1731/MEF).

Connectivity Fault Management provides the capability for detecting, verifying, and isolating connectivity failure (Y.1731/802.1ag/MEF).

- Typical Ethernet OAM and MPLS TP OAM test applications:

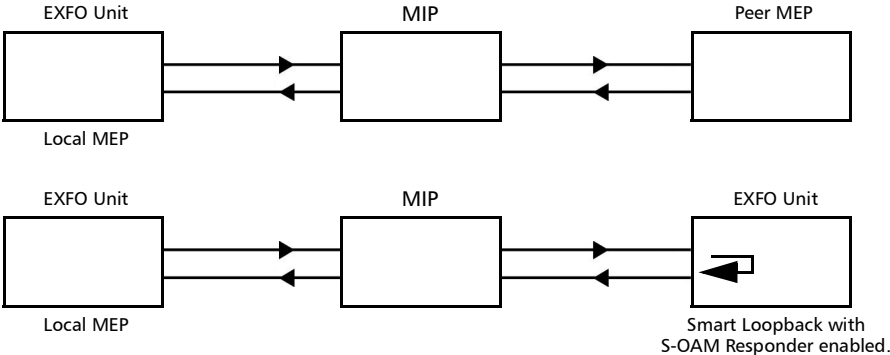

- Supported Interfaces/Rates: 10M to 10G LAN/WAN.

## Test Setup - Test Applications

*Carrier Ethernet OAM*

---

### Link OAM

The Link OAM test validates the Link OAM protocol capabilities and the Ethernet link connection of a remote equipment.

- Typical Link OAM test application:

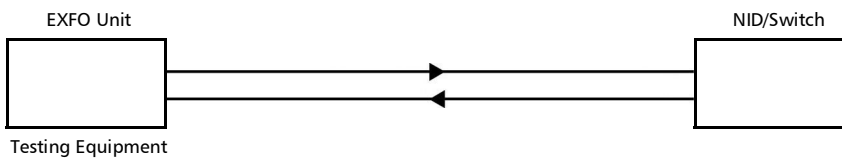

## Cable Test

The cable test application is used to diagnose un-shielded twisted pairs (UTP) cables (up to Category 6e/Class E).

Cable test can be performed everywhere in the network where an electrical 10/100/1000 Mbit/s Ethernet interface is available for testing. Only the pairs used by the Ethernet signal will be tested. For 10BASE-T, and 100BASE-TX, pair 2 and 3 will be tested; for 1000 Base-T, all pairs will be tested. However, if the Ethernet signal is unknown, all four pairs will be tested.

Even if a link up is not required when testing with a far end equipment, it is preferable to have the far end equipment powered up to maximize the cable test results.

Supported Ethernet cable categories are: Category 3/Class C, Category 4, Category 5, Category 5e/Class D, and Category 6e/Class E.

**Note:** *Cable test result is reliable for cable length of 10 meters to 120 meters (32.81 feet to 393.7 feet).*

► Typical Cable Test applications:

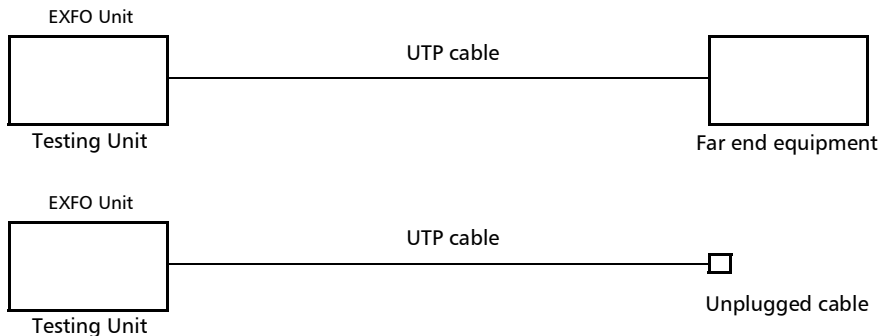

### 1588 PTP

The 1588 PTP (Precision Time Protocol) test application handles the 1588 PTP communication with the Grand Master (GM) clock and/or Boundary clock (BC), collects statistics related to packets, and monitors the clock Quality Level.

- Typical 1588 PTP test application:

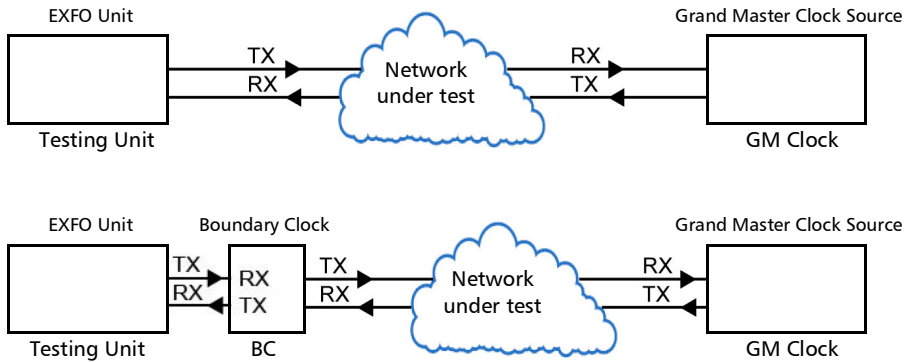

# SyncE

The Synchronous Ethernet (SyncE) test application provides elementary test primitives to interactively validate the clock management functions of a SyncE capable network equipment.

- Typical SyncE test applications:

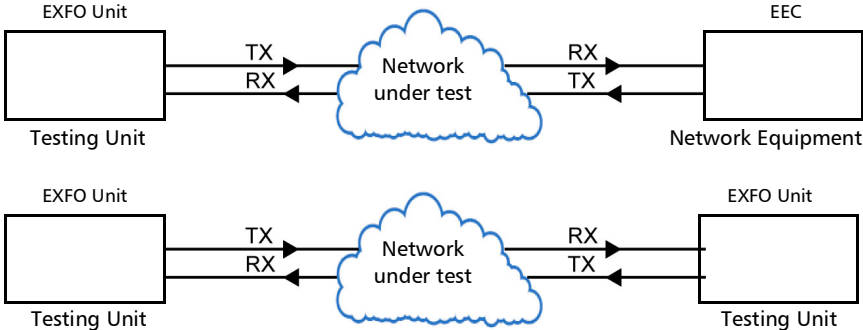

## Test Setup - Test Applications

Time Error / Wander

---

### Time Error / Wander

The **Time Error / Wander** application provides data acquisition and processing capabilities to quantify and validate the Time Error / Time Interval Error (Wander) of a synchronization equipment.

Time Error is defined as the difference between the time reported by a clock signal under test and the time reported by a reference clock.

► Typical Time Error / Wander test applications:

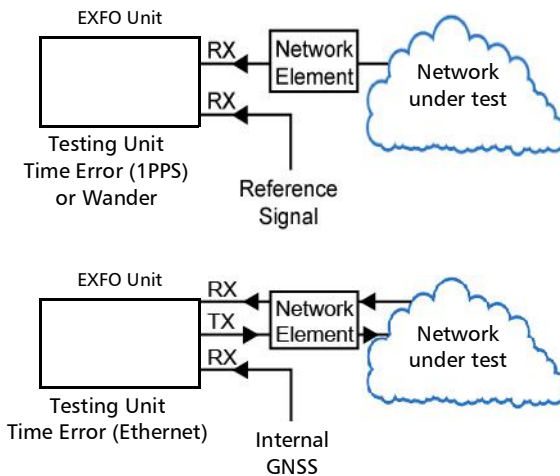

**Note:** Only one instance of the Time Error / Wander application is allowed on a platform due to high processing activity related to MTIE calculation.

**Note:** The Time Error / Wander test automatically stops when one of the following alarms occur: LOS, Link Down, OOF (DS1), LOF (E1), AIS (DS1/E1), Loss Sync (PTP), Loss Announce (PTP), or REF-FAULT.

# FC BERT

The FC BERT (Fibre Channel BERT) application provides full wire-speed traffic generation at the FC-2 layer allowing BER testing for link integrity measurements, latency, buffer-to-buffer credit measurements for optimization as well as login capabilities.

- Typical Fibre Channel BERT test applications:

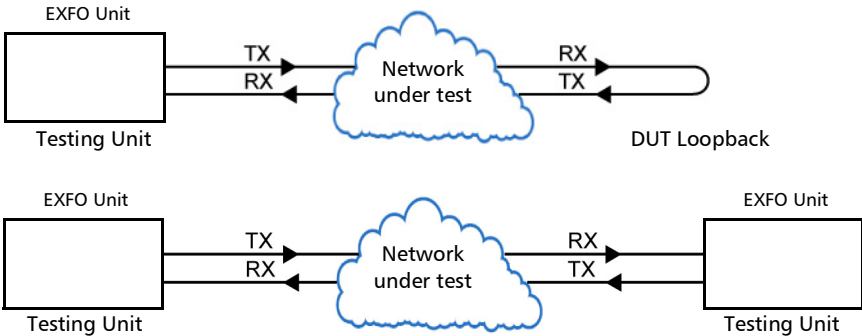

### **CPRI/OBSAI BERT**

The CPRI/OBSAI BERT test application offers the capability to test the fronthaul and dark fiber for Unframed rates and Framed L2 protocol, round trip delay, and Service Disruption Time measurements.

The Common Public Radio Interface (CPRI) is an industry cooperation aimed at defining a publicly available specification for the key internal interface of radio base stations between the Radio Equipment Control (REC) and the Radio Equipment (RE). In the industry the CPRI REC and RE are mainly known as Base Station (BTS) and Remote Radio Head (RRH) respectively.

The Open Base Station Architecture Initiative (OBSAI) separates a traditional radio base station configuration into a Base Transceiver Station (BTS) and a Remote Radio Head (RRH). The BTS processes the digital baseband radio information and performs the control of the RRH. The RRH converts the digital radio information into radio frequency signals transported over the air interface (antenna).



➤ Typical CPRI/OBSAI BERT test applications:

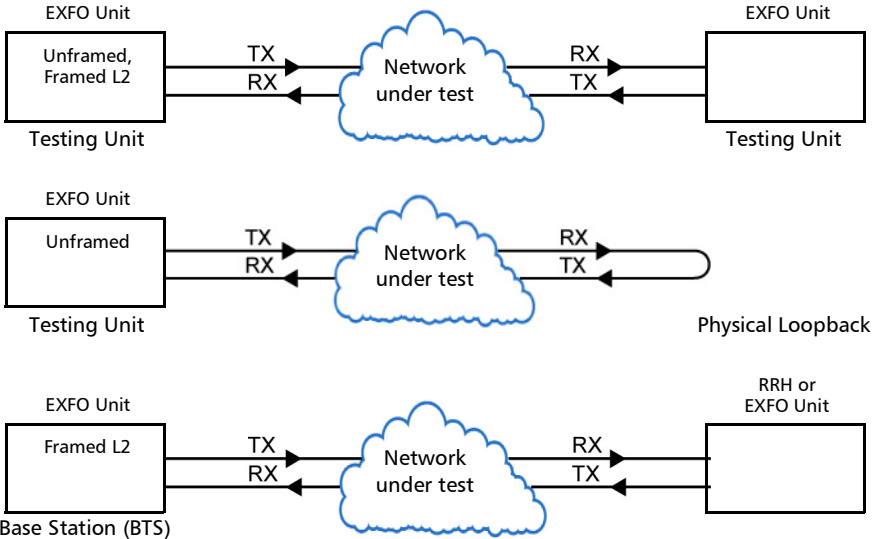

**Note:** A RRH is typically not capable to perform a loopback of the traffic so BERT test monitoring is not applicable. The BERT test is more common when testing between two test units.

Additional CPRI BERT test application:

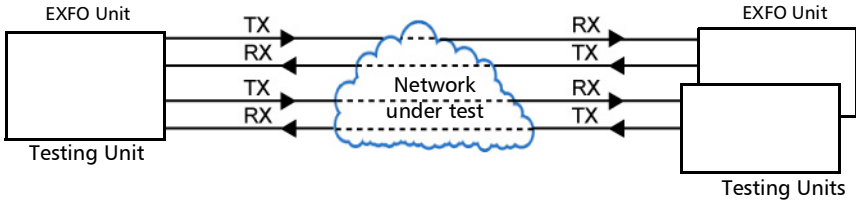

### eCPRI BERT

The eCPRI BERT test application allows the generation and analysis of Framed eCPRI flow using eCPRI messages carried over Ethernet (L2) or Ethernet/IP/UDP (L3/L4) allowing measurements of bit errors/pattern loss based on a PRBS test pattern as well as quality of service metrics such as One-Way or Round-Trip Latency, Jitter, Frame Loss, Out-of-Sequence, and Throughput. It also supports a configurable test pattern when an unframed signal is used to determine the presence of Bit Error or Pattern Loss on a fiber link used to carry eCPRI signals.

- Typical eCPRI BERT test applications:

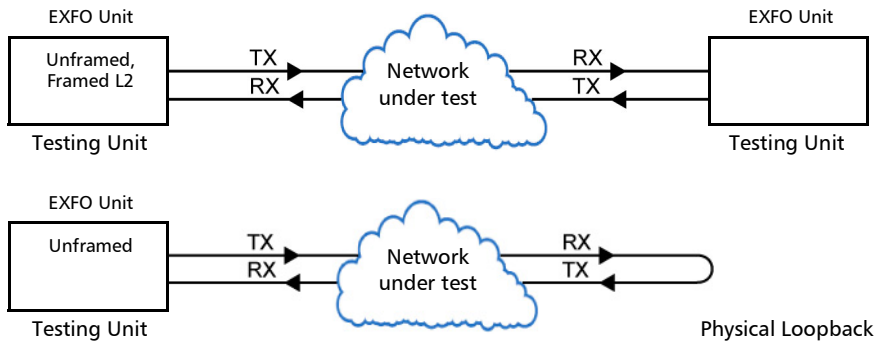

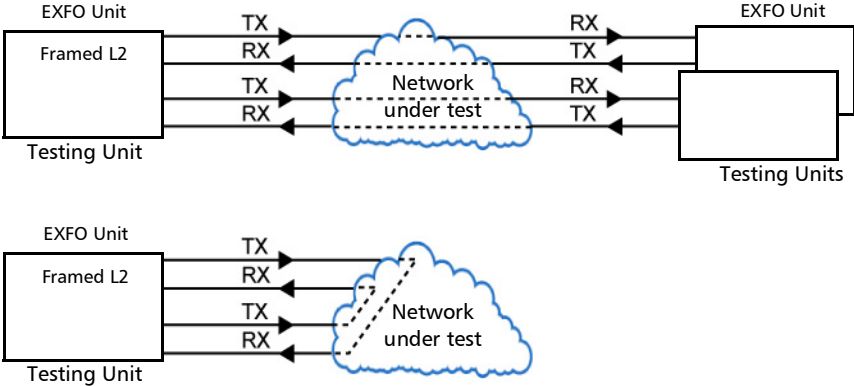



# 7 **Selecting and Starting a Test**

A test can be created either by selecting the test from the Test Applications tab or by loading a previously saved configuration (refer to *Save/Load Button* on page 762 for more information).

<b>Test Applications</b>		<b>Page</b>
<b>Intelligent Apps</b>	<i>iOptics</i>	101
	<i>iSAM</i>	103
<b>Transport</b>	<i>Transport Test Applications</i>	105
<b>Ethernet</b>	<i>Ethernet Test Applications</i>	107
<b>Sync</b>	<i>Sync Test Applications</i>	109
<b>Fibre Channel</b>	<i>Fibre Channel Test Application</i>	111
<b>Wireless</b>	<i>Wireless Test Application</i>	113

## **Intelligent Apps**

### **iOptics**

**To select, configure, and start iOptics:**

- 1.** From the test menu, tap **Setup**.
- 2.** From the **Test Applications** tab, under **Intelligent Apps**, tap the **iOptics** icon.
- 3.** From the **Test Configurator** tab, select the interface/port and its rate.

## Selecting and Starting a Test

### Intelligent Apps

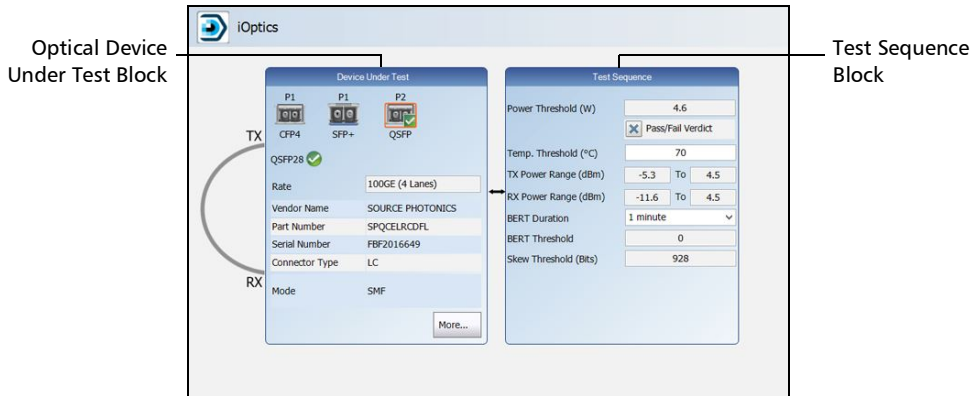

- 3a.** From the **Optical Device Under Test** block, tap the desired port icon.
- 3b.** Once the transceiver is correctly detected , select its rate.
- 3c.** From the **Test Sequence** block, select the test parameters and thresholds (refer to *Test Sequence - iOptics* on page 428).

**Note:** The *iOptics* test application uses **Internal** timing for clock synchronization.

- 4.** Ensure the laser is ON and tap the **Start** button from the right navigation bar to start the test (refer to *Start/Stop | TX Button* on page 766). The **Summary** result page will be automatically displayed when the test is started. For additional results, refer to *Test Results* on page 445. The test automatically stops when the transceiver is invalid or missing.
- 5.** When the test ends automatically or is manually stopped, the generate report pop-up is displayed by default. If required, tap **Yes** to generate a report of the test results and statistics (refer to *Report Button* on page 755 for more information).

## iSAM

### To select, configure, and start iSAM:

1. From the test menu, tap **Setup**.
2. From the **Test Applications** tab, under **Intelligent Apps**, tap the **iSAM** icon.
3. From the **Test Configurator** tab configure the interface structure and its parameters.

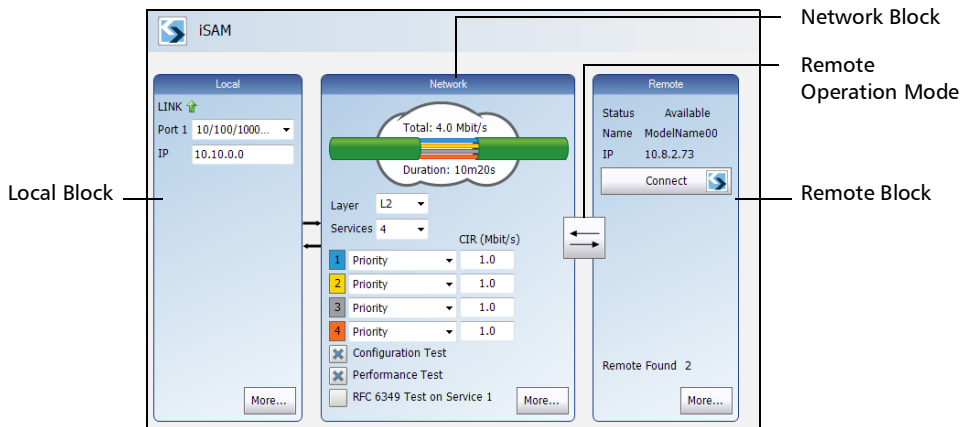



- 3a. From the **Local** block, either select the basic port parameters or click on **More** for all settings (refer to *Local Details - iSAM* on page 310). Ensure that the link is up and the power level for optical interface (when supported) is adequate in the status bar before proceeding to the next step (refer to *Status Bar* on page 36).

For CFP/QSFP interface rates, check for the optical validation check mark  indicating that the transceiver matches the configured interface/rate (refer to *Physical Interface Port - Test Configurator Overview* on page 125).

## Selecting and Starting a Test

- 3b.** From the **Network** block, either select the basic test parameters or click on **More** for all settings (refer to *Network / Network Details - iSAM* on page 331). The total bandwidth and the estimated test duration are displayed.
- 3c.** Select the remote operation mode; DTS is automatically selected when the **RFC 6349 Test** is enabled:

	<b>DTS (Dual Test Set)</b> The remote device is automatically set in EtherSAM when the connection/overtake is successfully established.
	<b>Remote Loopback</b> The remote device is automatically set in Smart Loopback when the connection/overtake is successfully established.
	<b>Manual Loopback</b> The remote device is a physical loopback or has to be manually set in loopback.

- 3d.** From the **Remote** block, either select the basic remote parameters or click on **More** for all settings (refer to *Remote Details - iSAM* on page 350).

**Note:** The *iSAM* test application uses **Internal** timing for clock synchronization.

- 4.** Tap the **Start** button from the right navigation bar to start the test (refer to *Start/Stop | TX Button* on page 766). If the connection with the remote module is not established with either **DTS** or **Remote Loopback** mode, the automatic remote connection process is performed before starting the test. The **Summary** result page will be automatically displayed when the test is started from any **Setup** configuration page. For additional results refer to *Test Results* on page 445.
- 5.** When the test ends automatically or is manually stopped, the generate report pop-up is displayed by default. If required, tap **Yes** to generate a report of the test results and statistics (refer to *Report Button* on page 755 for more information).



### Transport Test Applications

**To select, configure, and start a Transport test:**

1. From the test menu, tap **Setup**.
2. From the **Test Applications** tab, under **Transport**, tap a test icon.
3. From the **Test Configurator** tab configure the signal structure and its parameters.

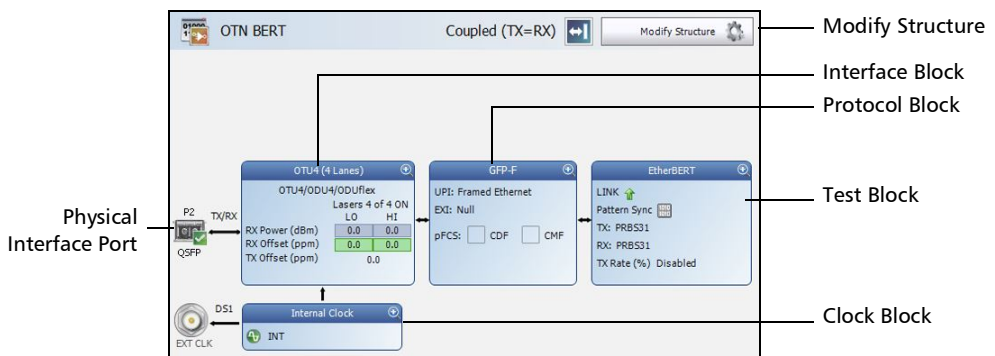

- 3a.** Tap the **Modify Structure** button to set the basic structure of the test such as the interface/rate, connector, etc. Refer respectively to:

*Modify Structure - DCO BERT on page 140*

*Modify Structure - DS<sub>n</sub>/PDH BERT on page 141*

*Modify Structure - FlexO BERT on page 160*

*Modify Structure - Multi-Channel OTN on page 161*

*Modify Structure - NI/CSU Emulation on page 162*

*Modify Structure - OTN BERT on page 163*

*Modify Structure - OTN-SONET/SDH BERT on page 170*

*Modify Structure - SONET/SDH BERT on page 183*

*Modify Structure - SONET/SDH - DS<sub>n</sub>/PDH BERT on page 187*

## Selecting and Starting a Test

### *Transport Test Applications*

---

- 3b.** For CFP/QSFP interface, check for the optical validation check mark  indicating that the transceiver matches the configured interface/rate (refer to *Physical Interface Port - Test Configurator Overview* on page 125).
- 3c.** Tap the interface block to configure the signal parameters (refer to page 115).
- 3d.** For an embedded signal, tap the protocol block to configure the signal (refer to page 115).
- 3e.** Tap the test block to configure the specific test settings (refer to page 115). Not available with **NI/CSU Emulation** test application.
- 3f.** Tap the clock block to configure the clock synchronization (refer to *Clock* on page 231).
- 4.** Tap the **Timer** tab to automatically start and/or stop the test at a given time or for a specific duration (refer to *Timer* on page 433).
- 5.** For additional test configurations refer to *Test Functions* on page 629.
- 6.** Tap the **Start** button from the right navigation bar to start the test. (refer to *Start/Stop | TX Button* on page 766). The **Summary** result page will be automatically displayed when the test is started from any **Setup** configuration page. For additional results, refer to *Test Results* on page 445.
- 7.** Tap the **Stop** button to stop the test. By default the generate report pop-up is displayed. If required, tap **Yes** to generate a report of the test results and statistics (refer to *Report Button* on page 755).

## Ethernet Test Applications

**To select, configure, and start an Ethernet test:**

1. From the test menu, tap **Setup**.
2. From the **Test Applications** tab, under **Ethernet**, tap a test icon.
3. From the **Test Configurator** tab configure the interface structure and its parameters.

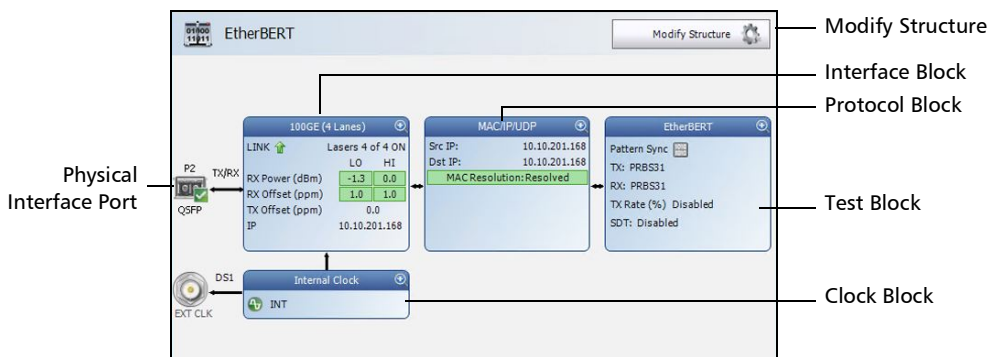

**3a.** Tap the **Modify Structure** button to set the basic structure of the test such as the interface/rate, connector, etc. Refer respectively to:

- Modify Structure - Cable Test on page 135*
- Modify Structure - Carrier Ethernet OAM on page 136*
- Modify Structure - EtherBERT on page 145*
- Modify Structure - EtherSAM on page 154*
- Modify Structure - FlexE BERT on page 158*
- Modify Structure - RFC 2544 on page 175*
- Modify Structure - RFC 6349 on page 178*
- Modify Structure - Smart Loopback on page 180*
- Modify Structure - TCP Throughput on page 192*
- Modify Structure - Through Mode on page 193*
- Modify Structure - Traffic Gen & Mon on page 197*

## Selecting and Starting a Test

- 3b.** For CFP/QSFP interface, check for the optical validation check mark  indicating that the transceiver matches the configured interface/rate (refer to *Physical Interface Port - Test Configurator Overview* on page 125).
- 3c.** Tap the interface block to configure the interface parameters (refer to page 115). For **Dual Port** topology, there is an interface block for each port. Ensure that the link is up and the power level (when supported) is present in the status bar before proceeding to the next step (refer to *Status Bar* on page 36).
- 3d.** Tap the protocol block<sup>1</sup> to configure the frame structure and its parameters. For RFC 2544, EtherBERT, and Traffic Gen & Mon in Dual Port topology, there is a protocol block for each port.
- 3e.** Tap the test block<sup>2</sup> to configure the specific test settings.
- 3f.** Tap the clock block<sup>3</sup> to configure the clock synchronization (refer to *Clock* on page 231).
- 4.** Tap the **Timer** tab to automatically start and/or stop the test at a given time or for a specific duration (refer to *Timer* on page 433).
- 5.** For additional test configurations refer to *Test Functions* on page 629.
- 6.** Tap the **Start** button to start the test (refer to *Start/Stop | TX Button* on page 766). The **Summary** result page is automatically displayed when the test is started from any **Setup** configuration page. For additional results refer to *Test Results* on page 445.
- 7.** Depending on the test, when the test ends automatically or is manually stopped, the generate report pop-up is displayed by default. If required, tap **Yes** to generate a report of the test results and statistics (refer to *Report Button* on page 755 for more information).

---

1. Not available with Smart Loopback, Through Mode, TCP Throughput, Carrier Ethernet OAM, and Cable Test.

2. Not available with Traffic Gen & Mon and Through Mode.

3. Not available with **Dual Port** topology. Not available with 25GE rate. Not available on 88460. Not available when using an active copper SFP. However the clock is either set to **Internal** or **Auto** (1GE electrical).

## Sync Test Applications

**To select, configure, and start a Sync test:**

1. From the test menu, tap **Setup**.
2. From the **Test Applications** tab, under **Sync**, tap a test icon.
3. From the **Test Configurator** tab configure the interface structure and its parameters.

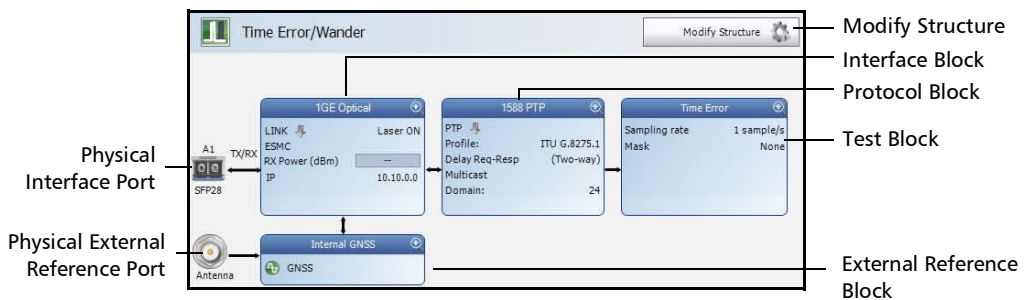

- 3a.** Tap the **Modify Structure** button to set the basic structure of the test such as the interface/rate, connector, etc. Refer respectively to

*Modify Structure - 1588 PTP* on page 134

*Modify Structure - SyncE* on page 191

*Modify Structure - Time Error / Wander* on page 195

- 3b.** Tap the interface block to configure the interface parameters (refer to page 115; no configuration is available with Time Error / Wander 10 MHz, 2 MHz, and 1PPS rates but interface parameters are displayed for an interface/rate from a TA-Sync). Ensure that the link is up and the power level (when supported) is present in the status bar before proceeding to the next step (refer to *Status Bar* on page 36).

## Selecting and Starting a Test

### *Sync Test Applications*

---

- 3c.** For Time Error measurement with an Ethernet interface, tap the protocol block to configure the PTP parameters (refer to *1588 PTP* on page 201).
- 3d.** Tap the test block to configure the specific test settings. Refer respectively to:  
*1588 PTP* on page 201  
*SyncE* on page 416  
*Time Error / Wander* on page 429
- 3e.** For Time Error / Wander test application, tap the external reference block to configure the external reference signal (refer to *External Reference* on page 270).
- 4.** Tap the **Timer** tab to automatically start and/or stop the test at a given time or for a specific duration (refer to *Timer* on page 433). Not supported with Time Error / Wander test application, however a duration can be configured (refer to *Time Error / Wander* on page 429).
- 5.** For additional test configurations refer to *Test Functions* on page 629.
- 6.** Tap the **Start** button from the right navigation bar to start the test (refer to *Start/Stop | TX Button* on page 766). The **Summary** result page will be automatically displayed when the test is started from any **Setup** configuration page. For additional results refer to *Test Results* on page 445.
- 7.** Depending on the test, when the test ends automatically or manually stopped, the generate report pop-up is displayed by default. If required, tap **Yes** to generate a report of the test results and statistics (refer to *Report Button* on page 755 for more information).

### Fibre Channel Test Application

**To select, configure, and start a Fibre Channel test:**

1. From the test menu, tap **Setup**.
2. From the **Test Applications** tab, under **Fibre Channel**, tap the **FC BERT** test icon.
3. From the **Test Configurator** tab configure the interface structure and its parameters.

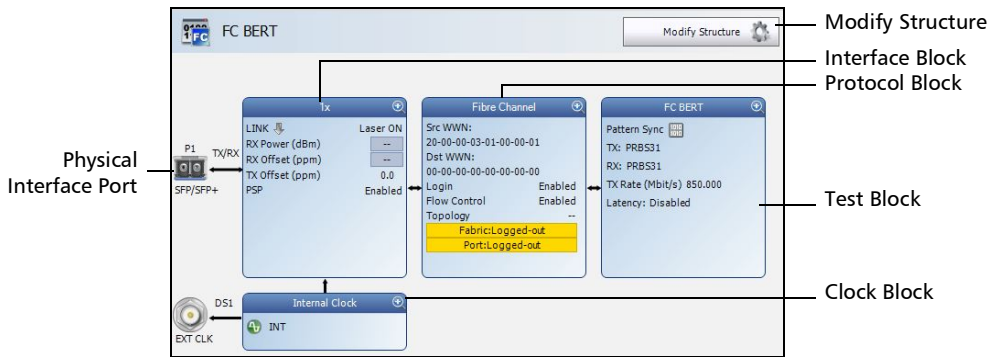

- 3a. Tap the **Modify Structure** button to set the basic structure of the test such as the interface/rate and connector. (refer to *Modify Structure - FC BERT* on page 157).
- 3b. Tap the interface block to configure the interface parameters (refer to page 289). Ensure that the link is up and the power level (when supported) is present in the status bar before proceeding to the next step (refer to *Status Bar* on page 36).
- 3c. Tap the protocol block to configure the frame structure and its parameters (refer to page 274).

## Selecting and Starting a Test

### *Fibre Channel Test Application*

---

- 3d.** Tap the test block to configure the specific test settings (refer to page 247).
- 3e.** Tap the clock block to configure the clock synchronization (refer to *Clock* on page 231).
- 4.** Tap the **Timer** tab to automatically start and/or stop the test at a given time or for a specific duration (refer to *Timer* on page 433).
- 5.** Tap the **Start** button from the right navigation bar to start the test (refer to *Start/Stop | TX Button* on page 766). The **Summary** result page will be automatically displayed when the test is started from any **Setup** configuration page. For additional results refer to *Test Results* on page 445.
- 6.** When the test ends automatically or is manually stopped, the generate report pop-up is displayed by default. If required, tap **Yes** to generate a report of the test results and statistics (refer to *Report Button* on page 755 for more information).



## Wireless Test Application

**To select, configure, and start a Wireless test:**

1. From the test menu, tap **Setup**.
2. From the **Test Applications** tab, under **Wireless**, tap a test icon.
3. From the **Test Configurator** tab configure the interface structure and its parameters.

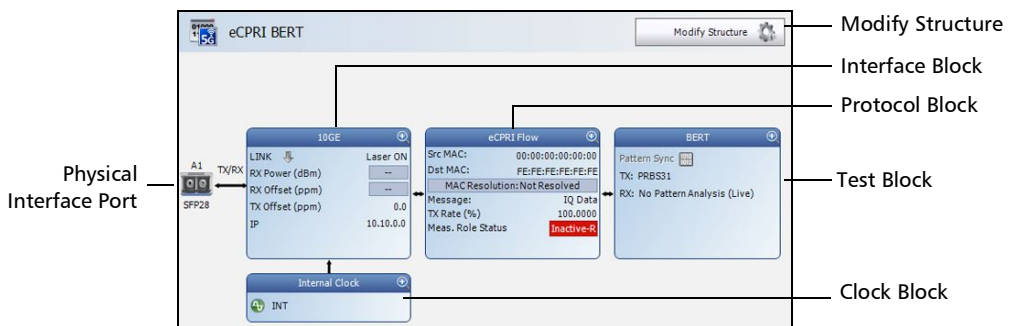

- 3a. Tap the **Modify Structure** button to set the basic structure of the test such as the interface/rate, connector, etc. Refer respectively to:

*Modify Structure - CPRI/OBSAI BERT on page 137*

*Modify Structure - eCPRI BERT on page 143*

- 3b. For QSFP interface connector, check for the optical validation check mark  indicating that the transceiver matches the configured interface/rate (refer to *Physical Interface Port - Test Configurator Overview* on page 125).
- 3c. Tap the interface block to configure the interface parameters (refer to page 289). For **Dual Port** topology, there is an interface block for each port. Ensure that the power level is present in the status bar before proceeding to the next step (refer to *Status Bar* on page 36).

## Selecting and Starting a Test

### Wireless Test Application

---

- 3d.** For eCPRI BERT framed test, tap the protocol block to configure the frame structure and its parameters (refer to page 243). For **Dual Port** topology, there is a protocol block for each port.
- 3e.** Tap the test block to configure the specific test settings (refer to page 247). For **Dual Port** topology, there is a test block for each port.
- 3f.** For CPRI/OBSAI BERT - **Framed L2 in Base Station** emulation mode, tap the clock block<sup>1</sup> to configure the clock synchronization (refer to *Clock* on page 231). The clock is automatically set to **Recovered** for **Remote Radio Head** emulation mode.

**Note:** For *Unframed* test the clock is set to **Internal**. For *eCPRI BERT* framed test the clock is set to **Internal** or is selectable for *One-Way measurement mode*: **External - IPPS** or **Internal GNSS** (88260).

- 4.** Refer to *Test Functions* on page 629 for additional test configurations.
- 5.** Tap the **Timer** tab to automatically start and/or stop the test at a given time or for a specific duration (refer to *Timer* on page 433).
- 6.** Tap the **Start** button from the right navigation bar to start the test (refer to *Start/Stop | TX Button* on page 766). The **Summary** result page will be automatically displayed when the test is started from any **Setup** configuration page. For additional results refer to *Test Results* on page 445.
- 7.** When the test ends automatically or is manually stopped, the generate report pop-up is displayed by default. If required, tap **Yes** to generate a report of the test results and statistics (refer to *Report Button* on page 755 for more information).

---

1. Not available in **Dual Port** topology. However the clock is automatically set to **Internal** for the **Base Station** and **Recovered** for the **Remote Radio Head**.

# 8 Setup

The **Setup** menu offers the following structure:

- **Test Applications**, see page 51.
- **Test Configurator**, see page 115.
- **Timer**, see page 433.
- **System - General**, see page 418.
- **System - GNSS**, see page 420.
- **System - TA-SYNC**, see page 424.

## Test Configurator

The following table shows the setup structure for each test application.

### Intelligent Apps

Test Applications	Block	Subtab or Pop Up	Page
iOptics	Device Under Test	Device Under Test Details	239
	Test Sequence	-	428
iSAM	Local	Local Details	310
		TA-...	424
		CFP/QSFP/SFP	229
	Network	Network Details	331
	Remote	Remote Details	350

### Transport

Test Application	Section	Page or Pop Up	Page
DCO BERT	Button	Modify Structure	140
	Interface	Interface	302
		OSFP/QSFP	229
		TA4-...	424
	Test (Client)	BERT	223
		Frequency	283
		MAC/IP/UDP	315
		Profile	347
DSn/PDH BERT	Button	Modify Structure	141
		Signal Auto-Detect	200
	Interface	Signal	387
	Test	BERT	209
	Clock	Clock	231
FlexO BERT	Button	Modify Structure	160
	Interface	QSFP	229
		Frequency	280
		Interface	289
	Protocol	FlexO/OTN	279
		Traces/PT	440
	Test	BERT	209

Test Application	Section	Page or Pop Up	Page
Multi-Channel OTN	Button	Modify Structure	161
		Interface	CFP/QSFP
	Frequency		280
	FTFL/PT / PT		284
	Signal		387
	Traces - OTN		435
	Test		Global
		Traces	284
		PT	435
	Clock	Clock	231
NI/CSU Emulation	Button	Modify Structure	162
		Signal Auto-Detect	200
	Interface	Signal	387
	Clock	Clock	231
OTN BERT	Button	Modify Structure	163
	Interface	CFP/QSFP/SFP	229
		Frequency	280
		FTFL/PT	284
		Signal	387
		TA-... / TA4-...	424
		Traces (OTN)	435
	Protocol	GFP-F/GFP-T	288
	Test	BERT	209
		EtherBERT (available with EoOTN client)	247
		Unframed BERT	209
	Clock	Clock	231
		TA-Sync	424

## Setup

### Test Configurator

---

Test Application	Section	Page or Pop Up	Page
OTN-SONET/SDH BERT	Button	Modify Structure	170
	Interface	CFP/QSFP/SFP	229
		Frequency	280
		FTFL/PT	284
		Signal	387
		Traces (OTN)	435
	Protocol	Labels	306
		Signal	401
		Traces	438
	Test	BERT	209
	Clock	Clock	231
SONET/SDH BERT	Button	Modify Structure	183
	Interface	SFP	229
		Labels	306
		Signal	387
		Traces (SONET/SDH)	438
	Test	BERT	209
Clock	Clock	231	
SONET/SDH - DS <sub>n</sub> /PDH BERT	Button	Modify Structure	187
	Interface	SFP	229
		Labels	306
		Signal	387
		Traces (SONET/SDH)	438
	Protocol	Signal (DS <sub>n</sub> /PDH)	394
	Test	BERT	209
Clock	Clock	231	

## Ethernet

Test Application	Section	Page or Pop Up	Page
Cable Test	Button	Modify Structure	135
	Interface	Interface	289
		Network	328
	Test	Cable Test	227
Carrier Ethernet OAM	Button	Modify Structure	136
	Interface	SFP	229
		Interface	289
		Network	328
		TA-... / TA4-...	424
	Test	Link OAM	308
		S-OAM / MPLS-TP OAM	368
	Clock	Clock	231
		TA-Sync	424
EtherBERT	Button	Modify Structure	145
	Interface	CFP/OSFP/QSFP/SFP	229
		Frequency	280
		Interface	289
		Network	328
		TA-... / TA4-...	424
	Protocol	MAC/IP/UDP	315
	Test	EtherBERT	247
		Unframed BERT	247
	Clock	Clock	231
		TA-Sync	424

## Setup

### Test Configurator

---

Test Application	Section	Page or Pop Up	Page
EtherSAM (Y.1564)	Button	Modify Structure	154
	Interface	CFP/OSFP/QSFP/SFP	229
		Frequency	280
		Interface	289
		Network	328
		TA-... / TA4-...	424
	Protocol	MAC/IP/UDP	315
		Global (Services)	377
		L2CP	380
		Profile (Services)	381
	Test	Burst (EtherSAM)	256
		Global (EtherSAM)	258
		L2CP (EtherSAM)	263
		Ramp (EtherSAM)	269
	Clock	Clock	231
TA-Sync		424	
FlexE BERT	Button	Modify Structure	158
	Interface	CFP/OSFP/QSFP	229
		Frequency	280
		Interface	289
		TA-... / TA4-...	424
	Protocol	FlexE Group	277
	Test	BERT (Clients)	225
		MAC (Clients)	315
		Path OAM (Clients)	344
		Profile (Clients)	349



Test Application	Section	Page or Pop Up	Page
RFC 2544	Button	Modify Structure	175
	Interface	CFP/OSFP/QSFP/SFP	229
		Frequency	280
		Interface	289
		Network	328
		TA-... / TA4-...	424
	Protocol	MAC/IP/UDP	315
	Test	Global	354
		Subtests	357
	Clock	Clock	231
		TA-Sync	424
RFC 6349	Button	Modify Structure	178
	Interface	CFP/QSFP/SFP	229
		Interface	289
		Network	328
		TA-... / TA4-...	424
	Test	RFC 6349	364
Smart Loopback	Button	Modify Structure	180
	Interface	CFP/OSFP/QSFP/SFP	229
		Frequency	280
		Interface	289
		Network	328
		TA-... / TA4-...	424
	Test	Smart Loopback	405
	Clock	Clock	231
		TA-Sync	424

## Setup

### Test Configurator

---

Test Application	Section	Page or Pop Up	Page
TCP Throughput	Button	Modify Structure	192
	Interface	SFP	229
		Interface	289
		Network	328
	Test	TCP Throughput	426
	Clock	Clock	231
		TA-Sync	424
Through Mode	Button	Modify Structure	193
	Interface	CFP/QSFP/SFP	229
		Frequency	280
		Interface	289
		Network	328
		TA-... / TA4-...	424
Traffic Gen & Mon	Button	Modify Structure	197
	Interface	CFP/OSFP/QSFP/SFP	229
		Frequency	280
		Interface	289
		Network	328
		TA-... / TA4-...	424
	Protocol	Global (Streams)	407
		MAC/IP/UDP	315
		Profile (Streams)	409
	Clock	Clock	231
		TA-Sync	424

## Sync

Test Application	Section	Page or Pop Up	Page
1588 PTP	Button	Modify Structure	134
	Interface	Interface	289
		Network	328
		SFP	229
		TA-...	424
	Test	1588 PTP	201
SyncE	Button	Modify Structure	191
	Interface	Interface	289
		Network	328
		SFP	229
		TA-...	424
	Test	SyncE	416
Time Error / Wander	Button	Modify Structure	195
	Interface	Interface <sup>a</sup>	289
		Frequency	280
		Network <sup>b</sup>	328
		QSFP/SFP	229
		TA-...	424
	Protocol	1588 PTP <sup>b</sup>	201
	Test	Time Error	429
		Wander	429
	External Reference	External Reference	270
		TA-Sync	424

- a. No configuration available.
- b. Available for Time Error measurement with an Ethernet interface (Packet-Based Time Error).

## Fibre Channel

Test Application	Section	Page or Pop Up	Page
FC BERT	Button	Modify Structure	157
	Interface	Interface	289
		SFP	229
	Protocol	Fibre Channel	274
	Test	FC BERT	271

## Wireless

Test Application	Section	Page or Pop Up	Page
CPRI/OBSAI BERT	Button	Modify Structure	137
	Interface	Interface	289
		SFP	229
	Test	BERT	216
		Unframed BERT	216
eCPRI BERT	Button	Modify Structure	143
	Interface	Interface	289
		Network	328
		SFP	229
		TA-...	424
	Test	BERT	220
		Unframed BERT	220
	Clock	Clock	231
		TA-Sync	424

## Test Configurator Overview

The **Test Configurator** tab displays the interconnected blocks composing the test structure. Each block of the test structure gives an overview of its configuration/status. Availability of each block depends on the selected test application and its structure. Arrows are used to indicate the interconnection between blocks as well as the direction of the clock and data flow. Tap on a block or the **More** button for **Intelligent Apps**, to change the configuration parameters of this block.

From the **Test** menu, tap **Setup**, and the **Test Configurator** tab.

- Intelligent Apps:

iOptics:

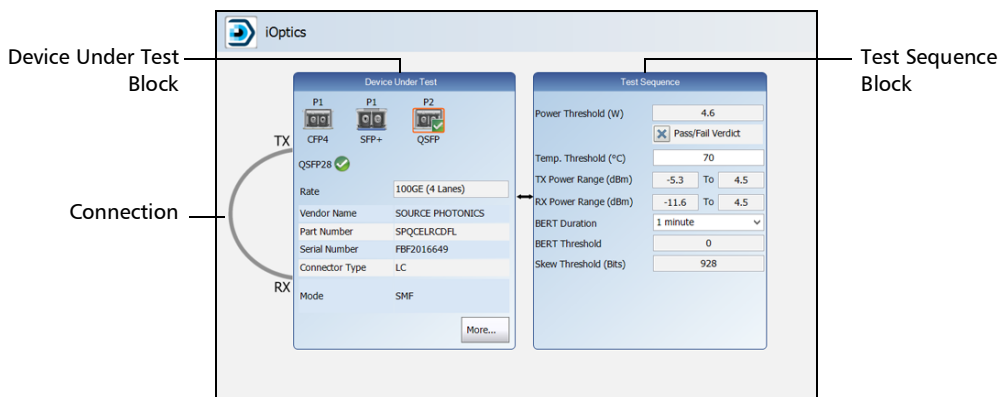

- **Device Under Test** block displays and allows changing the basic interface/port settings. Tap on the **More** button to access more information and settings.
- **Test Sequence** block allows changing the basic test settings.

## Setup

### Test Configurator Overview

iSAM:

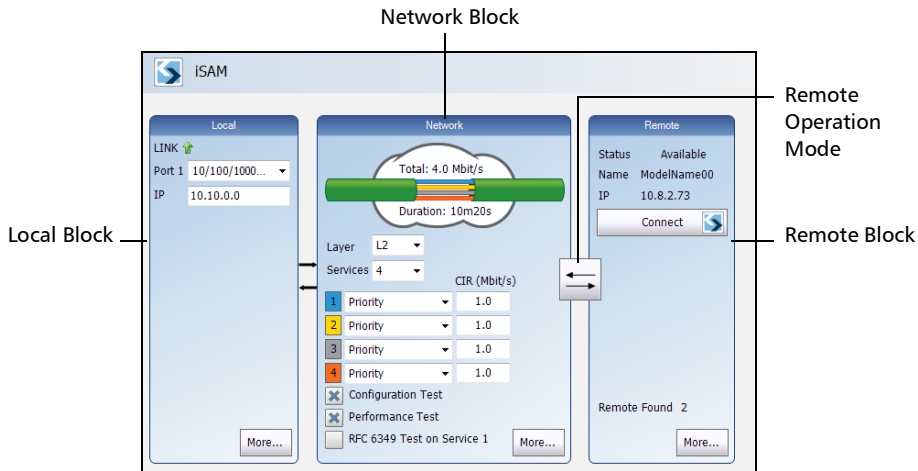

The block arrangement represents the network under test. From any block, either select the basic parameters or click on **More** for all settings.

- **Local** block displays and allows changing the basic interface settings. Tap on the **More** button to access all settings.
- **Network** block displays and allows changing the basic test settings. Tap on the **More** button to access all settings.
- Remote operation mode allows selecting the remote operation mode. Tap on the button to change the remote operation mode.
- **Remote** block displays and allows changing the basic remote settings. Tap on the **More** button to access all settings.

➤ Transport Test Applications:

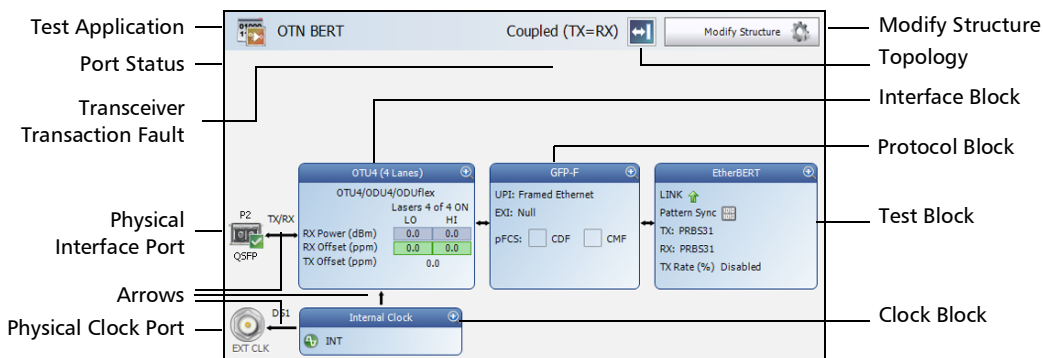

➤ Ethernet Test Applications:

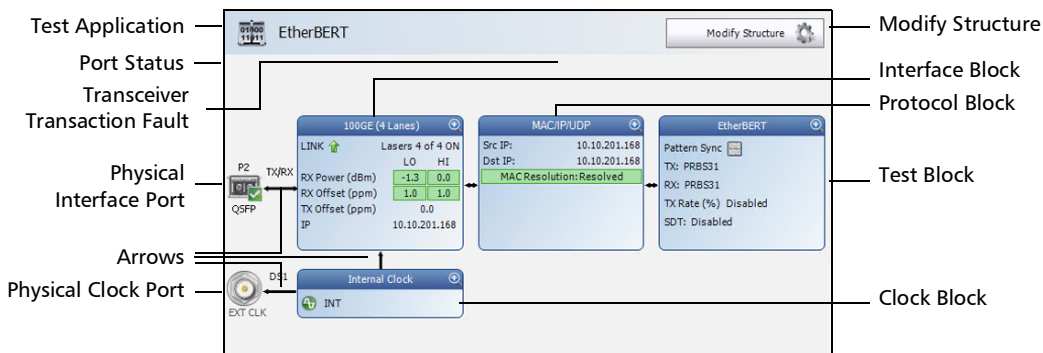

# Setup

## Test Configurator Overview

### ➤ Sync Test Applications:

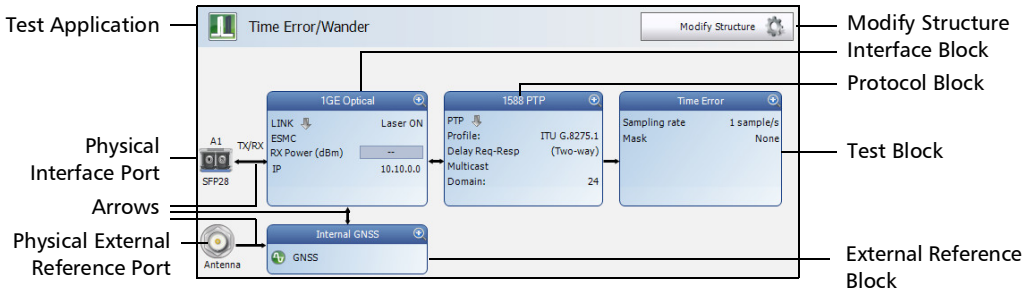

### ➤ Fibre Channel Test Application:

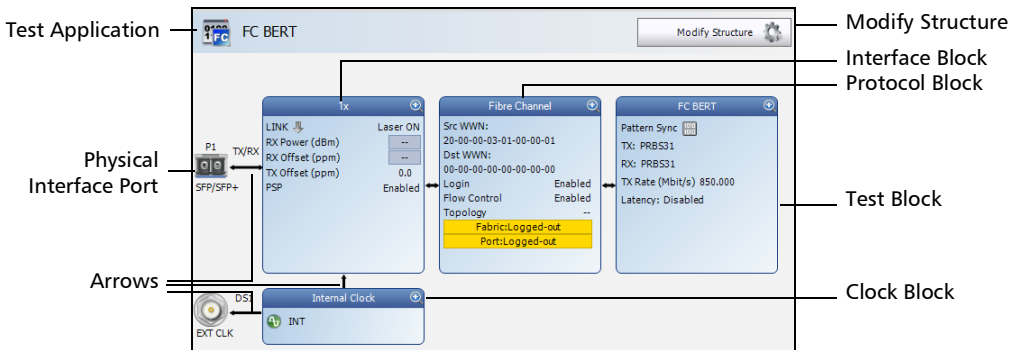



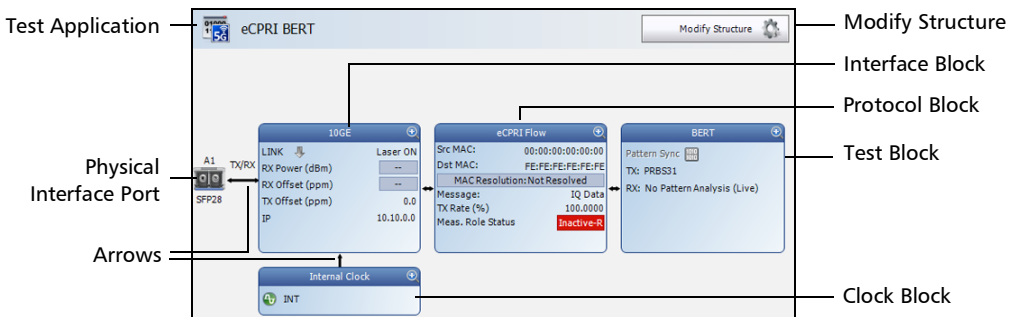

### ➤ Wireless Test Application:







- Test Application indicates the selected test application.
  - Topology, for Transport Test Applications, indicates the selected test topology.
  - Modify Structure button, allows the configuration of the physical port and the signal interface structure.
  - Port Status indicates either the following:
    - Port status icon and its description for a CFP4/CFP8/OSFP/QSFP interface is only displayed when validating or if there is a problem as described in the following table.

	Validating transceiver.
	Missing transceiver, Loopback capability not supported (QSFP56), Transceiver initializing (not ready to carry traffic) (DCO transceivers), or Unable to validate transceiver.
	Invalid transceiver (or mismatch with the selected signal/interface).
	Valid transceiver matching the selected interface/rate. This icon is not displayed here, it is only displayed for the Physical Interface Port. Using a non-EXFO supported transceiver may report that the transceiver is valid but the device may not operate as intended.



Transceiver System status for a transceiver system is only displayed when there is a warning or a problem as described in the following table.

Icon	Displayed Message	Description
	Port A/B / Port 1 - The battery for the insertion counter is low, please contact EXFO Support	The battery is low and must be replaced by an EXFO authorized service center.
	Port A/B / Port 1 - The battery for the insertion counter is depleted, please contact EXFO Support	The battery is dead and must be replaced by an EXFO authorized service center.
	A1/A2/B1/B2 / Port 1 - Missing TA/TA4 Transceiver System	No transceiver system detected

## Setup

### Test Configurator Overview

---

Icon	Displayed Message	Description
	A1/A2/B1/B2 / Port 1 - Validating TA/TA4 Transceiver System	Validation process is on-going
	A1/A2/B1/B2 / Port 1 - Invalid TA/TA4 Transceiver System	Validating process completed and detected transceiver system type not expected
	Port 1 - Invalid TA4 Transceiver System Version	Validating process completed and detected transceiver system version not compatible

- Transceiver Transaction Fault indicates that the module is unable to discover the transceiver device or experiences abnormal communication conditions; refer to page 418 for more information.
- Physical Interface Port indicates the physical interface port. For **Dual Port** topology, there is a physical interface for each port.
- Connection, available with iOptics, graphically represents the connection used for the test. For AOC, the cable length is also displayed.
- Arrows are used to indicate the interconnection between blocks as well as the direction of the clock and data flow.

A line with an arrow on both ends indicates a bidirectional communication (TX/RX).

A line with a single arrow indicates a unidirectional communication, either **TX** when going out of a block or **RX** (or **RX2**) when going into a block. **RX2** indicates the physical **BNC TX/RX2** port.

A line going out of a block returning back to the same block, indicates a loopback communication.

- Physical Clock Port indicates the direction, TX or RX, of the selected clock; not displayed when **Ext Clock Out** is set to **None**. The arrow next to the physical clock image indicates if a clock is generated (TX, arrow pointing to the left) or received (RX, arrow pointing to the right) at/from the physical EXT CLK port.
- Physical External Reference Port indicates the port, signal, and direction (RX) of the selected external reference signal.
- Interface Block displays an overview of the interface settings and status. Tap on the interface block to change the settings and to see detailed status. For **Dual Port** topology, there is an interface block for each port.
- Protocol Block displays an overview of either the frame structure and its parameters for Ethernet test applications or the embedded signal for Transport test applications. This block is not present for all tests. Tap on the protocol block to change the settings and to see detailed status. For RFC 2544, EtherBERT, and Traffic Gen & Mon in **Dual Port** topology, there is a protocol block for each port.
- Test Block displays an overview of the test settings and status. Tap on the test block to change the settings and to see detailed status.
- Clock Block displays an overview of the clock settings and status. Tap on the clock area to change the settings and to see detailed status. For **Dual Port** topology, the clock block is not present but the clock is set to **Internal**.
- External Reference Block displays an overview of the external reference signal settings and status. Tap on the external reference area to change the settings and to see detailed status.

# Modify Structure

From the test menu, tap **Setup, Test Configurator**, and the **Modify Structure** button.

## Transport

*Modify Structure - DCO BERT*

*Modify Structure - DS<sub>n</sub>/PDH BERT*

*Modify Structure - FlexO BERT*

*Modify Structure - Multi-Channel OTN*

*Modify Structure - NI/CSU Emulation*

*Modify Structure - OTN BERT*

*Modify Structure - OTN-SONET/SDH BERT*

*Modify Structure - SONET/SDH BERT*

*Modify Structure - SONET/SDH - DS<sub>n</sub>/PDH BERT*

## Ethernet

*Modify Structure - Cable Test*

*Modify Structure - Carrier Ethernet OAM*

*Modify Structure - EtherBERT*

*Modify Structure - EtherSAM*

*Modify Structure - FlexE BERT*

*Modify Structure - RFC 2544*

*Modify Structure - RFC 6349*

*Modify Structure - Smart Loopback*

*Modify Structure - TCP Throughput*

*Modify Structure - Through Mode*

*Modify Structure - Traffic Gen & Mon*

## Sync

*Modify Structure - 1588 PTP*

*Modify Structure - SyncE*

*Modify Structure - Time Error / Wander*

## **Fibre Channel**

*Modify Structure - FC BERT*

## **Wireless**

*Modify Structure - CPRI/OBSAI BERT*

*Modify Structure - eCPRI BERT*

## Setup

*Modify Structure - 1588 PTP*

---

# Modify Structure - 1588 PTP

From the test menu, tap **Setup**, **Test Configurator**, and the **Modify Structure** button.

- **Interface/Rate** allows the selection of the interface rate.

Unit	Interface/Rate	Connector
8870 8880	10GE LAN 1GE Optical 100M Optical	Port 1 - SFP+ Port 2 - SFP+
	10/100/1000M Electrical	Port 1 - RJ45
88200NGE	10GE LAN 1GE Optical 100M Optical	Port 1 - SFP+
	10/100/1000M Electrical	Port 1 - SFP+ <sup>a</sup>
88260	10GE LAN 1GE Optical 100M Optical	Port A1/A2/B1/B2 - SFP28
	10/100/1000M Electrical	Port A1/A2/B1/B2 - SFP28 (RJ45) <sup>b</sup>

a. Ethernet 10/100/1000M electrical is supported when using an active copper SFP.

- **Connector** allows the selection of the physical port (see the **Interface/Rate** table above).

## Modify Structure - Cable Test

From the test menu, tap **Setup**, **Test Configurator**, and the **Modify Structure** button.

- **Interface/Rate** is set to **10/100/1000M Electrical**.

Unit	Interface/Rate	Connector
8870 8880	10/100/1000M Electrical	Port 1 - RJ45

- **Connector** is set to **Port 1 - RJ45** (see **Interface/Rate** table above).

## Setup

### Modify Structure - Carrier Ethernet OAM

---

## Modify Structure - Carrier Ethernet OAM

From the test menu, tap **Setup**, **Test Configurator**, and the **Modify Structure** button.

- **Interface/Rate** allows the selection of the interface rate.

Unit	Interface/Rate	Connector
8870 8880	10GE LAN 10GE WAN 1GE Optical 100M Optical	Port 1 - SFP+ Port 2 - SFP+
	10/100/1000M Electrical	Port 1 - RJ45
88200NGE	10GE LAN 10GE WAN 1GE Optical 100M Optical	Port 1 - SFP+
	10/100/1000M Electrical	Port 1 - SFP+ <sup>a</sup>
88260	10GE LAN 10GE WAN 1GE Optical 100M Optical	Port B1/B2 - SFP28
	10/100/1000M Electrical	Port B1/B2 - SFP28 (RJ45)

- a. Ethernet 10/100/1000M electrical is supported when using an active copper SFP.

- **Connector** allows the selection of the physical port (see the **Interface/Rate** table above).
- **OAM Type** selects the type of Carrier OAM network: **Ethernet OAM** (S-OAM; default), **MPLS-TP OAM**, or **Link OAM**.



## Modify Structure - CPRI/OBSAI BERT

From the test menu, tap **Setup**, **Test Configurator**, and the **Modify Structure** button.

**Note:** For *Dual Port* topology each port is configurable individually. Both ports must be part of the same group of rates, either rates up to 10.1G or both at 24.3G).

➤ **Interface** allows the selection of the interface rate.

**CPRI:**

Unit	Interface/Rate	Connector
8870 8880	CPRI - 1.2G CPRI - 2.4G CPRI - 3.1G CPRI - 4.9G CPRI - 6.1G CPRI - 9.8G CPRI - 10.1G	Port 1 - SFP+ Port 2 - SFP+
88200NGE	CPRI - 1.2G CPRI - 2.4G CPRI - 3.1G CPRI - 4.9G CPRI - 6.1G CPRI - 9.8G CPRI - 10.1G	Port 1 - SFP+
88260	CPRI - 1.2G CPRI - 2.4G CPRI - 3.1G CPRI - 4.9G CPRI - 6.1G	Port A1/A2/B1/B2 - SFP28
	CPRI - 9.8G CPRI - 10.1G CPRI - 24.3G	Port A1/A2/B1/B2 - SFP28 Port A1/A2/B1/B2 - QSFP28

## Setup

Modify Structure - CPRI/OBSAI BERT

---

### OBSAI:

Unit	Interface/Rate	Connector
8870	OBSAI - 1.5G	Port 1 - SFP+
8880	OBSAI - 3.1G OBSAI - 6.1G	Port 2 - SFP+
88200NGE	OBSAI - 1.5G OBSAI - 3.1G OBSAI - 6.1G	Port 1 - SFP+
88260	OBSAI - 1.5G OBSAI - 3.1G OBSAI - 6.1G	Port A1/A2/B1/B2 - SFP28

- **Connector** allows the selection of the physical port (see **Interface** table above).  
**Lane**, available with 10/25G, allows selecting the Lane number when using a QSFP28 multilane transceiver. Only available on 88260.
- **Framing**
  - **Framed L2** (default) is mainly used to validate connectivity with the base station (REC) or remote radio head (RE) over the fiber interface.
  - **Unframed** is mainly used to validate the continuity of the dark fiber at CPRI (up to 9.8G; not supported with QSFP28) or OBSAI (3.1 Gbit/s) rate.
- **Vendor** defines the interoperability with equipment using vendor specific overhead to generate and analyze the signal over a CPRI link: **Generic** (default, as per CPRI standard) or **Ericsson**.

- **Emulation Mode** (available with **Framed L2**)
  - **Base Station** (default) is used to validate the connectivity with the RRH.

For CPRI, it initiates the start-up sequence and provides synchronization with the RRH.

For OBSAI, it initiates the State Machine events and provides synchronization with the RRH.
  - **Remote Radio Head** is used to validate the communication with a base station.

For CPRI, it begins its start-up sequence when it detects a valid signal from the base station.

For OBSAI, the State Machine events depend on the Base Station signal transmission.
- **Topology**, available on 88260 with **Framed L2**, allows the selection of the network test topology: **Single Port** (default) or **Dual Port** (CPRI only). For **Dual Port** both ports must be part of the same group of rates, either rates up to 10.1G or both at 24.3G).

## Setup

Modify Structure - DCO BERT

# Modify Structure - DCO BERT

From the test menu, tap **Setup**, **Test Configurator**, and the **Modify Structure** button.

- **Interface** indicates the interface rate.

Unit	Interface	Connector
88460	400ZR (CFEC, 16QAM, DWDM Amplified) [478.75 Gbit/s]	Port 1 - QSFP56-DD
	400ZR (CFEC, 16QAM, Unamplified) [478.75 Gbit/s]	Port 1 - OSFP
	400ZR+ (OFEC, 16QAM) [481.108374 Gbit/s]	
	100ZR+ (OFEC, QPSK) [120.277094 Gbit/s]	

- **Connector** allows the selection of the physical port (see **Interface** table above).
- **Client** allows the selection of the Ethernet client:

Interface	Client
400ZR (CFEC, 16QAM, DWDM Amplified) [478.75 Gbit/s]	400G Ethernet
400ZR (CFEC, 16QAM, Unamplified) [478.75 Gbit/s]	
400ZR+ (OFEC, 16QAM) [481.108374 Gbit/s]	
100ZR+ (OFEC, QPSK) [120.277094 Gbit/s]	100G Ethernet (100GAUI-2) 100G Ethernet (CAUI-4 w/o FEC)

## Modify Structure - DS<sub>n</sub>/PDH BERT

From the test menu, tap **Setup**, **Test Configurator**, and the **Modify Structure** button.

**Note:** For *Dual RX* topology both *RX* and *RX2* configurations are coupled.

- **Interface/Rate** allows the selection of the interface rate.

Unit	Interface/Rate	Connector
8870 8880	DS1 [1.544 Mbit/s]	Bantam RJ48C
	E1 [2.048 Mbit/s]	Bantam BNC RJ48C
	DS3 [44.736 Mbit/s] E3 [34.368 Mbit/s] E4 [139.264 Mbit/s]	BNC

- **Connector** allows the selection of the physical port (see the **Interface/Rate** table above).
- **DS<sub>n</sub>/PDH Multiplexing** allows the selection of the DS<sub>n</sub>/PDH multiplexing.

Interface/Rate	DS <sub>n</sub> /PDH Multiplexing
DS3	None (default), DS1, E1
DS1	None
E4	None (default), E3, E3/E2/E1
E3	None (default), E2/E1
E1	None

- **Client** is set to **Pattern**.

## Setup

### Modify Structure - DSn/PDH BERT

---

- **Topology** allows the selection of the network test topology.
- **Coupled (TX=RX)** uses the same settings for both the TX and RX signals.

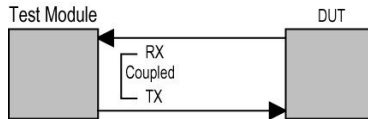

- **Decoupled (TX≠RX)** uses independent settings for TX and RX signals. However, the pattern and some other parameters are always coupled.

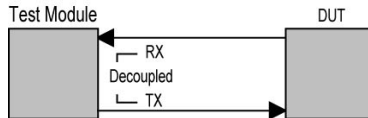

- **Through** loops the RX signal to the TX port without TX overwrite capabilities.

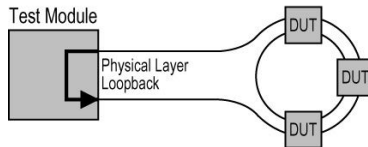

- **Dual RX** uses two DS1 or DS3 signals at the same time. Both RX ports are coupled at the exception of the termination mode. Only available with DS1 and DS3 signal rates.

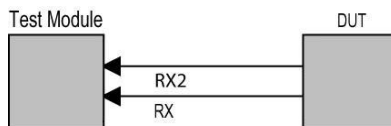

## Modify Structure - eCPRI BERT

From the test menu, tap **Setup**, **Test Configurator**, and the **Modify Structure** button.

**Note:** For *Dual Port* topology each port is configurable individually. Port rates are coupled.

- **Interface** allows the selection of the interface rate.

Unit	Interface/Rate	Connector
8870 8880	10GE	Port 1 - SFP+ Port 2 - SFP+
88200NGE	10GE	Port 1 - SFP+
88260	10GE 25GE	Port A1/A2/B1/B2 - SFP28 Port A1/A2/B1/B2 - QSFP28
	100GE (4 Lanes)	Port A1/A2/B1/B2 - QSFP28 Port A1/B1 - CFP4
	100GE (2 Lanes) [106.25 Gbit/s] 100GE (1 Lane) [106.25 Gbit/s]	Port A1/A2/B1/B2 - QSFP28

- **PHY Type** allows selecting the transceiver PHY type:
  - For 100GE (4 Lanes): **LR4/ER4** (default), **SR4**, **CWDM4**, **CLR4**, or **Other**. The PHY type when set to any except **LR4/ER4**, allows enabling RS-FEC (see page 290); ensure both ends of the circuit have the FEC enabled.
  - For 100GE (1 Lane): **DR1/FR1/LR1** (default and dimmed); ensure the other end of the circuit has the FEC enabled.
  - For 100GE (2 Lanes): **SRBD** (default and dimmed); ensure the other end of the circuit has the FEC enabled.

**Connector** allows the selection of the physical port (see **Interface** table above).

**Lane**, available with 10/25G, allows selecting the Lane number when using a QSFP28 multilane transceiver. Only available on 88260.

## Setup

### Modify Structure - eCPRI BERT

---

#### ➤ Framing

- **Framed Layer 2** (default) is mainly used to validate the transport of eCPRI messages over a plain Ethernet transport network. .

IFG (12 bytes)	Preamble (7 bytes)	SFD (1 byte)	Destination MAC (6 bytes)	Source MAC (6 bytes)	VLAN (4 bytes/level)	EtherType (2 bytes)	eCPRI Message (46-1500+)	CRC (4 bytes)
-------------------	-----------------------	-----------------	------------------------------	-------------------------	-------------------------	------------------------	-----------------------------	------------------

- **Framed Layer 3/4** is mainly used to validate the transport of eCPRI messages over an Ethernet/IP/UDP transport network.

IFG (12 bytes)	Preamble (7 bytes)	SFD (1 byte)	Destination MAC (6 bytes)	Source MAC (6 bytes)	VLAN (4 bytes/level)	EtherType (2 bytes)	IPv4 Header (20 bytes)	UDP Header (8 bytes)	eCPRI Message (46-1500+)	CRC (4 bytes)
-------------------	-----------------------	-----------------	------------------------------	-------------------------	-------------------------	------------------------	---------------------------	-------------------------	-----------------------------	------------------

- **Unframed**, available for single port, is mainly used to validate the presence of Bit Error or Pattern Loss on the fiber link carrying the eCPRI signal. Not supported with QSFP28 and CFP4.

IFG (Min. 12 bytes)	Preamble (7 bytes)	SFD (1 byte)	Test Pattern (Length: infinite)
------------------------	-----------------------	-----------------	------------------------------------

- **Topology**, available on 88260 with Framed Layer 2/3/4, allows the selection of the network test topology: **Single Port** (default) or **Dual Port**. Port rates are coupled.



## Modify Structure - EtherBERT

From the test menu, tap **Setup**, **Test Configurator**, and the **Modify Structure** button.

**Note:** For *Dual Port* topology each port is configurable individually.

**Interface** allows the selection of the interface rate. For Dual Port, both ports must be either 10GE and less, 25GE, 50GE, or 40/100GE.

Unit	Interface/Rate	Connector
8870 8880	10GE LAN 10GE WAN 1GE Optical 100M Optical	Port 1 - SFP+ Port 2 - SFP+
	10/100/1000M Electrical	Port 1 - RJ45 Port 2 - SFP+ (RJ45) <sup>a, b</sup>
88200NGE	100GE (4 Lanes) [103.125 Gbit/s]	Port 1 - CFP4 Port 2 - QSFP (QSFP28)
	100GE (2 Lanes) [106.25 Gbit/s] 100GE (1 Lane) [106.25 Gbit/s]	Port 2 - QSFP (QSFP28)
	40GE (4 Lanes) [41.25 Gbit/s]	Port 2 - QSFP (QSFP+)
	10GE LAN 10GE WAN 1GE Optical 100M Optical	Port 1 - SFP+
	10/100/1000M Electrical	Port 1 - SFP+ <sup>b</sup>

## Setup

*Modify Structure - EtherBERT*

---

<b>Unit</b>	<b>Interface/Rate</b>	<b>Connector</b>
88260	100GE (4 Lanes) [103.125 Gbit/s]	Port A1/A2/B1/B2 - QSFP28 Port A1/B1 - CFP4
	100GE (2 Lanes) [106.25 Gbit/s] 100GE (1 Lane) [106.25 Gbit/s]	Port A1/A2/B1/B2 - QSFP28
	50GE [53.125G]	Port A1/A2/B1/B2 - QSFP28
	40GE (4 Lanes) [41.25 Gbit/s]	Port A1/A2/B1/B2 - QSFP28
	25GE	Port A1/A2/B1/B2 - SFP28
	10GE LAN 10GE WAN 1GE Optical 100M Optical	Port A1/A2/B1/B2 - SFP28
	10/100/1000M Electrical	Port A1/A2/B1/B2 - SFP28 (RJ45)

Unit	Interface/Rate	Connector
88460	400GE (8 Lanes) [425 Gbit/s]	Port 1 - CFP8 Port 1 - QSFP56-DD Port 1 - OSFP
	400GE (4 Lanes) [425 Gbit/s]	Port 1 - QSFP56-DD Port 1 - OSFP
	8 x 50GE [53.125 Gbit/s]	Port 1 - QSFP56-DD Port 1 - OSFP
	4 x 100GE [106.25 Gbit/s]	Port 1 - QSFP56-DD Port 1 - OSFP
	2 x 200GE (4 Lanes) [212.5 Gbit/s]	Port 1 - OSFP
	200GE (4 Lanes) [212.5 Gbit/s]	Port 1 - QSFP56-DD
	2 x 100GE (4 Lanes) [103.125 Gbit/s]	Port 1 - QSFP56-DD
	100GE (4 Lanes) [103.125 Gbit/s] 100GE (2 Lanes) [106.25 Gbit/s] 100GE (1 Lane) [106.25 Gbit/s]	Port 1 - QSFP56-DD Port 1/2/3/4 - QSFP28
	50GE [53.125G]	Port 1/2/3/4 - QSFP28
	40GE (4 Lanes) [41.25 Gbit/s]	Port 1/2/3/4 - QSFP28
	25GE	Port 1/2/3/4 - QSFP28 (with adapter)
	10GE LAN 10GE WAN 1GE Optical	Port 1/2/3/4 - QSFP28 (with adapter)

- a. Only available as a second port when the test application requires two ports.
- b. Ethernet 10/100/1000M electrical is supported when using an active copper SFP.

➤ **PHY Type** allows selecting the transceiver PHY type:

For 100GE (4 Lanes): **LR4/ER4** (default), **SR4**, **CWDM4**, **CLR4**, **AOC**, or **Other**. The PHY type when set to any except **LR4/ER4**, provides access to RS-FEC configuration (see page 290). **AOC** is not supported with multiple link interface.

For 100GE (2 Lanes): **SRBD** (default and dimmed); ensure the other end of the circuit has the FEC enabled.

## Setup

### Modify Structure - EtherBERT

---

For 100GE (1 Lane): **DR1/FR1/LR1** (default and dimmed); ensure the other end of the circuit has the FEC enabled.

For 200GE (4 Lanes): **Optical** (default), and **AOC**.

For 400GE (8 Lanes): **Optical** (default), **AOC**, and **DAC**.

- **Connector** allows the selection of the physical port (see **Interface** table above). Connectors availability depend on the selected **PHY Type**; CFP8 and OSFP connectors are only available when the **PHY Type** is set to **Optical**.
- **Host/Media Loopback** allows the selection of the transceiver loopback mode: **None** (default), **Host Side Input**, **Media Side Output**. Only available on 88460 with 100GE (4 Lanes) / 200GE (4 Lanes) single port test using QSFP56 transceiver on QSFP56-DD connector. Not available with multiple link interface.
- **Framing** allows the selection of the test framing type; otherwise the framing is set to Framed Layer 2. See *Network* on page 328 for more information on frame format. The framing is not configurable and set to **Framed Layer 2** for 40GE/100GE dual port topology and 8 x 50GE multiple link interface.
  - **Framed Layer 1**: Frame of x bytes that allows connection to any interface that complies with 802.3 Ethernet PHY or DWDM fibre. Available with rate up to 10G WAN.

IFG (Min. 12 bytes)	Preamble (7 bytes)	SFD (1 byte)	Test Pattern (Length: 48 to 10/16 Kbytes)
------------------------	-----------------------	-----------------	--

- **Framed Layer 2**: Frames of x bytes without network layer (**None**) that complies with IEEE 802a Ethernet II standard. To set the frame length, see Frame Size on page 349.

SOF	Destination Address	Source Address	Type	Test Pattern (Configurable length)	FCS	IFG
-----	---------------------	----------------	------	---------------------------------------	-----	-----

- **Framed Layer 3/4** (default): Frames of x bytes with UDP (default) or TCP network layer that complies with IEEE 802a Ethernet II standard. To set the frame length, see Frame Size on page 349.

SOF	Destination Address	Source Address	Type	IP Header	UDP Header	BERT Tag	Test Pattern (Configurable length)	FCS	IFG	
SOF	Destination Address	Source Address	Type	IP Header	TCP Header	BERT Tag	Test Pattern (Configurable length)	TCP Checksum Cancellor	FCS	IFG

- **Unframed (Interop)** is only available with optical interface up to 25GE:

For **Seed A** and **Seed B**, available with 10G LAN and 25G, the pattern is generated by the PCS scrambler from a specific seed. The pattern is not encoded.

For **PRBS31 Unscrambled**, available with 10G LAN and 25G, the pattern is generated at the PCS layer. The pattern is not encoded and not scrambled.

For **PRBS** and **User Pattern**: Pattern generated by the PCS scrambler. The pattern is encoded.

IFG (Min. 12 bytes)	Preamble (7 bytes)	SFD (1 byte)	Test Pattern (Length: infinite)
---------------------	--------------------	--------------	---------------------------------

- **Unframed** is only available with optical interface up to 10G LAN. Encoded pattern generated by the PCS scrambler.

IFG (Min. 12 bytes)	Preamble (7 bytes)	SFD (1 byte)	Test Pattern (Length: infinite)
---------------------	--------------------	--------------	---------------------------------

- **Unframed with Sync** is only available with optical interface up to 10G LAN: Pattern of a length corresponding to the number of bytes transmitted in 1 second.

IFG (Min. 12 bytes)	Preamble (7 bytes)	SFD (1 byte)	Test Pattern (Length: about 1 second)
---------------------	--------------------	--------------	---------------------------------------

## Setup

### Modify Structure - EtherBERT

---

- **2 Unframed 50GAUI-2:** Independent infinite length test pattern in each 50GAUI-2 lane (no blocks). Available with 50GE.

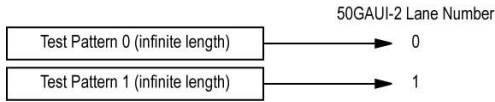

- **4 Unframed XLAUI:** Independent infinite length test pattern in each XLAUI lane (no blocks). Available with 40GE (4 Lanes).

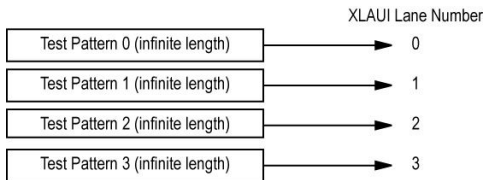

- **4 Unframed CAUI-4:** Independent infinite length test pattern in each CAUI-4 lane (no blocks). Available with 100GE (4 Lanes).

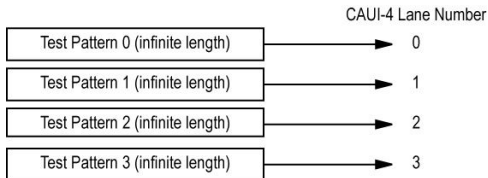

- **20 Unframed PCS:** Independent infinite length test pattern in each PCS lane (no blocks and no lane markers). Available with 100GE (4 Lanes).

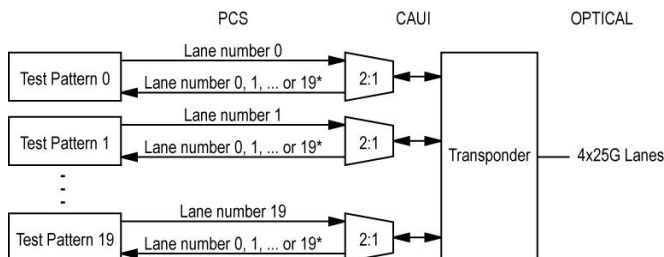

\* It is not possible to predict on which Lane a generated pattern will be detected on the receive side.

- **4 Unframed 200GAUI-4:** Independent infinite length test pattern in each 200GAUI-4 lane. Available with QSFP56 - 200GE (4 Lanes).

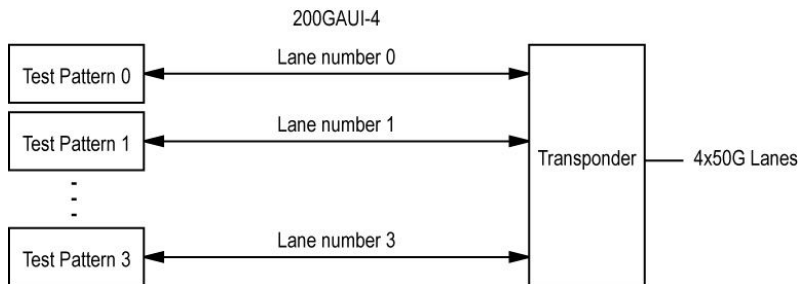

## Setup

### Modify Structure - EtherBERT

- **8 Unframed 200GAUI-4:** Independent infinite length test pattern in each lane driving the Gearbox (no blocks). Available with QSFP56 - 200GE (4 Lanes).

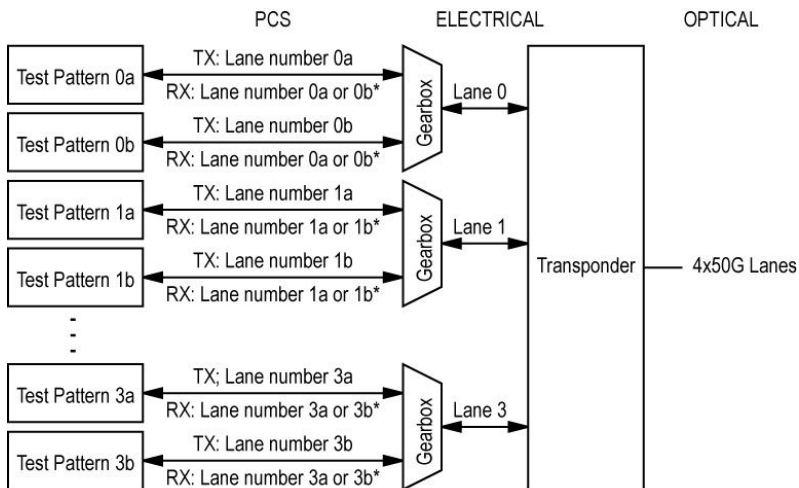

\* It is not possible to predict on which Lane a generated pattern will be detected on the receive side.

- **8 Unframed 400GAUI-8:** Independent infinite length test pattern in each 400GAUI-8 lane. Available with QSFP56-DD - 400GE (8 Lanes) and OSFP - 400GE (4 Lanes).

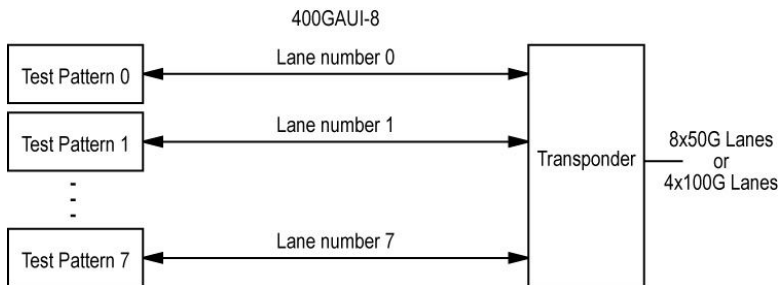



- **16 Unframed 400GAUI-8:** Independent infinite length test pattern in each lane driving the Gearbox (no blocks). Available with QSFP56-DD - 400GE (8 Lanes) and OSFP - 400GE (4 Lanes).

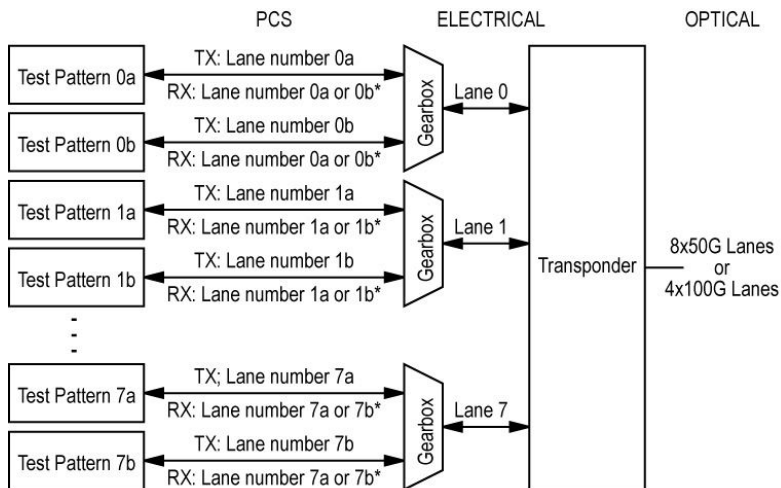

\* It is not possible to predict on which Lane a generated pattern will be detected on the receive side.

- **16 Unframed 400GAUI-16:** Independent infinite length test pattern in each 400GAUI-16 lane (no blocks). Available with CFP8 - 400GE (8 Lanes).

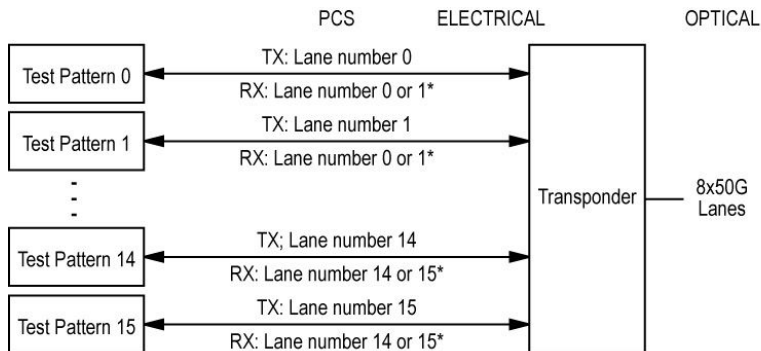

\* It is not possible to predict on which Lane a generated pattern will be detected on the receive side.

## Setup

### *Modify Structure - EtherBERT*

---

- **Topology** allows the selection of the network test topology: **Single Port** (default) or **Dual Port**. Available for rates up to 100G. Both ports must be from the same group of rates, either rates up to 10G WAN framed/unframed, 25G, 50G, or 40/100G Framed Layer 2. For Dual Port 100G on FTBx-88460, both ports have to be from Port 1/2/3/4 - QSFP28. Not available with multiple link interface.

## Modify Structure - EtherSAM

From the test menu, tap **Setup**, **Test Configurator**, and the **Modify Structure** button.

**Note:** For *Dual Port* topology each port is configurable individually.

- **Interface** allows the selection of the interface rate. For Dual Port, both ports must be either 10GE and less, or 40/100GE.

Unit	Interface/Rate	Connector
88708880	10GE LAN 10GE WAN 1GE Optical 100M Optical	Port 1 - SFP+ Port 2 - SFP+
	10/100/1000M Electrical	Port 1 - RJ45 Port 2 - SFP+ (RJ45) <sup>a, b</sup>
88200NGE	100GE (4 Lanes) [103.125 Gbit/s]	Port 1 - CFP4 Port 2 - QSFP (QSFP28)
	100GE (2 Lanes) [106.25 Gbit/s] 100GE (1 Lane) [106.25 Gbit/s]	Port 2 - QSFP (QSFP28)
	40GE (4 Lanes) [41.25 Gbit/s]	Port 2 - QSFP (QSFP+)
	10GE LAN 10GE WAN 1GE Optical 100M Optical	Port 1 - SFP+
	10/100/1000M Electrical	Port 1 - SFP+ <sup>b</sup>

## Setup

### Modify Structure - EtherSAM

Unit	Interface/Rate	Connector
88260	100GE (4 Lanes) [103.125 Gbit/s]	Port A1/A2/B1/B2 - QSFP28 Port A1/B1 - CFP4
	100GE (2 Lanes) [106.25 Gbit/s] 100GE (1 Lane) [106.25 Gbit/s]	Port A1/A2/B1/B2 - QSFP28
	40GE (4 Lanes) [41.25 Gbit/s]	Port A1/A2/B1/B2 - QSFP28
	10GE LAN 10GE WAN 1GE Optical 100M Optical	Port A1/A2/B1/B2 - SFP28
	10/100/1000M Electrical	Port A1/A2/B1/B2 - SFP28 (RJ45)
88460	400GE (8 Lanes) [425 Gbit/s]	Port 1 - CFP8 Port 1 - QSFP56-DD Port 1 - OSFP
	400GE (4 Lanes) [425 Gbit/s]	Port 1 - QSFP56-DD Port 1 - OSFP
	200GE (4 Lanes) [212.5 Gbit/s]	Port 1 - QSFP56-DD
	100GE (4 Lanes) [103.125 Gbit/s] 100GE (2 Lanes) [106.25 Gbit/s] 100GE (1 Lane) [106.25 Gbit/s]	Port 1 - QSFP56-DD Port 1/2/3/4 - QSFP28
	40GE (4 Lanes) [41.25 Gbit/s]	Port 1/2/3/4 - QSFP28
	10GE LAN 10GE WAN 1GE Optical	Port 1/2/3/4 - QSFP28 (with adapter)

- a. Only available as a second port when the test application requires two ports.
- b. Ethernet 10/100/1000M electrical is supported when using an active copper SFP.

- **PHY Type** allows selecting the transceiver PHY type:
  - For 100GE (4 Lanes): **LR4/ER4** (default), **SR4**, **CWDM4**, **CLR4**, **AOC**, or **Other**. The PHY type when set to any except **LR4/ER4**, allows enabling RS-FEC (see page 290); ensure both ends of the circuit have the FEC enabled.
  - For 100GE (1 Lane): **DR1/FR1/LR1** (default and dimmed); ensure the other end of the circuit has the FEC enabled.
  - For 100GE (2 Lanes): **SRBD** (default and dimmed); ensure the other end of the circuit has the FEC enabled.
  - For 200GE (4 Lanes): **Optical** (default), and **AOC**.
  - For 400GE (8 Lanes): **Optical** (default), **AOC**, and **DAC**.
- **Connector** allows the selection of the physical port (see the **Interface/Rate** table above). Connectors availability depend on the selected **PHY Type**; CFP8 and OSFP connectors are only available when the **PHY Type** is set to **Optical**.
- **Topology** allows the selection of the network test topology: **Single Port** (default) or **Dual Port**. Available for rates up to 10G WAN.

## Setup

### Modify Structure - FC BERT

---

## Modify Structure - FC BERT

From the test menu, tap **Setup**, **Test Configurator**, and the **Modify Structure** button.

**Interface/Rate** allows the selection of the interface rate.

Unit	Interface/Rate	Connector
8870 8880	1X 2X 4X 8X 10X	Port 1 - SFP+ Port 2 - SFP+
88200NGE	1X 2X 4X 8X 10X 16X	Port 1 - SFP+
88260	1X 2X 4X 8X 10X 16X 32X	Port A1/A2/B1/B2 - SFP28

- **Connector** allows the selection of the physical port (see the **Interface/Rate** table above).

## Modify Structure - FlexE BERT

From the test menu, tap **Setup**, **Test Configurator**, and the **Modify Structure** button.

- **Interface/Rate** allows the selection of the interface rate.

Unit	Interface/Rate	Connector
88260	100GE (4 Lanes) [103.125 Gbit/s] 100GE (2 Lanes) [106.25 Gbit/s] 100GE (1 Lane) [106.25 Gbit/s]	Port A1/A2/B1/B2 - QSFP28
	50GE [53.125 Gbit/s]	Port A1/A2/B1/B2 - QSFP28
88460	400GE (8 Lanes) [425 Gbit/s]	Port 1 - CFP8 Port 1 - QSFP56-DD Port 1 - OSFP
	400GE (4 Lanes) [425 Gbit/s]	Port 1 - QSFP56-DD Port 1 - OSFP
	200GE (4 Lanes) [212.5 Gbit/s]	Port 1 - QSFP56-DD
	100GE (4 Lanes) [103.125 Gbit/s] 100GE (2 Lanes) [106.25 Gbit/s] 100GE (1 Lane) [106.25 Gbit/s]	Port 1/2/3/4 - QSFP28

- **PHY Type**, available with 100GE/400GE, allows selecting the transceiver PHY type:

For 100GE (4 Lanes): **LR4/ER4** (default), **SR4**, **CWDM4**, **CLR4**, **AOC**, or **Other**. The PHY type when set to any except **LR4/ER4**, allows enabling RS-FEC (see page 290); ensure both ends of the circuit have the FEC enabled.

For 100GE (1 Lane): **DR1/FR1/LR1** (default and dimmed); ensure the other end of the circuit has the FEC enabled.

For 100GE (2 Lanes): **SRBD** (default and dimmed); ensure the other end of the circuit has the FEC enabled.

For 400GE (8 Lanes) QSFP-DD: **Optical** (default), and **DAC**.

## Setup

### *Modify Structure - FlexE BERT*

---

- **Group Size** allows the selection of the size of the group. The group size for 50GE/100GE interface must match the aggregate rate of the selected connectors.

Unit	Interface	Group Size
88260	100GE	100G or 200G
	50GE	50G or 100G
88460	400GE	100G, 200G, 300G, or 400G
	200GE	100G or 200G
	100GE	100G, 200G, 300G, or 400G

- **Connector**, available with 200GE/400GE, allows the selection of the physical port (see the **Interface/Rate** table above).
- **Connectors** check boxes, available with 50GE/100GE, allows enabling and selecting the physical port(s) used for FlexE PHYs (see the **Interface/Rate** table above).



## Modify Structure - FlexO BERT

From the test menu, tap **Setup**, **Test Configurator**, and the **Modify Structure** button.

- **Interface/Rate** allows the selection of the interface rate.  
**Port 1 - QSFP28, Port 2 - QSFP28, Port 3 - QSFP28, and Port 4 - QSFP28** check boxes (all selected by default), available with 100G FlexO-1-RS interface/rate, allows the selection of the ports used for the test.
- **OTN** allows the selection of the OTN mapping : **OTUC1, OTUC2, OTUC3, or OTUC4**. The OTUCn rate must match the aggregate rate of the selected ports.
- **Client** is set to **Pattern**.
- **Topology** indicates the topology of the test:  
**Coupled (TX=RX)** uses the same settings for both the TX and RX signals.

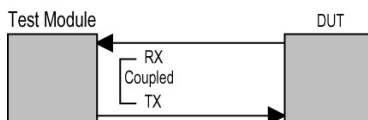

## Setup

### Modify Structure - Multi-Channel OTN

---

## Modify Structure - Multi-Channel OTN

From the test menu, tap **Setup**, **Test Configurator**, and the **Modify Structure** button.

**Note:** *ODU0 mapping is selected by default. Refer to Modify Trib Slots/Channels (Multi-Channel OTN) on page 984 for test mapping selection and Multi-Channel OTN on page 56 for supported path/mapping.*

- **Interface/Rate** allows the selection of the interface rate.

Unit	Interface/Rate	Connector
88200NGE	OTU4 (4 Lanes) [111.81 Gbit/s]	Port 1 - CFP4 Port 2 - QSFP <sup>a</sup>

- a. This port accepts QSFP+ or QSFP28 transceivers.

- **Connector** allows the selection of the physical port (see the **Interface/Rate** table above).
- **Framing** is set to **Framed**.
- **Client** is set to **Pattern**.
- **Topology** indicates the topology of the test:

**Coupled (TX=RX)** uses the same settings for both the TX and RX signals.

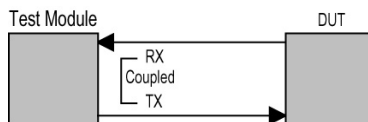

## Modify Structure - NI/CSU Emulation

From the test menu, tap **Setup**, **Test Configurator**, and the **Modify Structure** button.

- **Interface/Rate** allows the selection of the interface rate.

Unit	Interface/Rate	Connector
8870	DS1 [1.544 Mbit/s]	Bantam
8880		RJ48C

- **Connector** allows the selection of the physical port (see the **Interface/Rate** table above).

## Setup

### Modify Structure - OTN BERT

From the test menu, tap **Setup**, **Test Configurator**, and the **Modify Structure** button.

- **Interface/Rate** allows the selection of the interface rate.

Unit	Interface/Rate	Connector
8870 8880	OTU2f [11.318 Gbit/s] OTU1f [11.270 Gbit/s] OTU2e [11.096 Gbit/s] OTU1e [11.049 Gbit/s] OTU2 [10.709 Gbit/s] OTU1 [2.666 Gbit/s]	Port 1 - SFP+
88200NGE	OTU4 (4 Lanes) [111.81 Gbit/s]	Port 1 - CFP4 Port 2 - QSFP <sup>a</sup>
	OTU3e2 (4 Lanes) [44.583 Gbit/s] OTU3e1 (4 Lanes) [44.571 Gbit/s] OTU3 (4 Lanes) [43.018 Gbit/s]	Port 2 - QSFP <sup>a</sup>
	OTU2f [11.318 Gbit/s] OTU1f [11.270 Gbit/s] OTU2e [11.096 Gbit/s] OTU1e [11.049 Gbit/s] OTU2 [10.709 Gbit/s] OTU1 [2.666 Gbit/s]	Port 1 - SFP+
88260	OTU4 (4 Lanes) [111.81 Gbit/s]	Port A1/A2/B1/B2 - QSFP28 Port A1/B1 - CFP4
	OTU3e2 (4 Lanes) [44.583 Gbit/s] OTU3e1 (4 Lanes) [44.571 Gbit/s] OTU3 (4 Lanes) [43.018 Gbit/s]	Port A1/A2/B1/B2 - QSFP28
	OTU2f [11.318 Gbit/s] OTU1f [11.270 Gbit/s] OTU2e [11.096 Gbit/s] OTU1e [11.049 Gbit/s] OTU2 [10.709 Gbit/s] OTU1 [2.666 Gbit/s]	Port A1/A2/B1/B2 - SFP28

Unit	Interface/Rate	Connector
88460	OTU4 (4 Lanes) [111.81 Gbit/s] OTU3e2 (4 Lanes) [44.583 Gbit/s] OTU3e1 (4 Lanes) [44.571 Gbit/s] OTU3 (4 Lanes) [43.018 Gbit/s] OTU2f [11.318 Gbit/s] OTU1f [11.270 Gbit/s] OTU2e [11.096 Gbit/s] OTU1e [11.049 Gbit/s] OTU2 [10.709 Gbit/s] OTU1 [2.666 Gbit/s]	Port 1/2/3/4 - QSFP28

a. This port accepts QSFP+ or QSFP28 transceivers.

- **Connector** allows the selection of the physical port (see the **Interface/Rate** table above).
- **Framing** allows the selection of the test framing type for parallel interfaces and is set to **Framed** for serial interfaces.
- **Framed** (default): A single Pattern or Ethernet client applied toward the physical lanes.

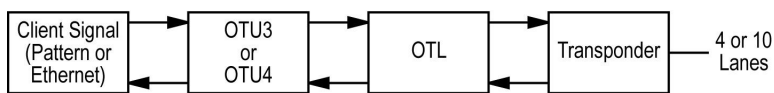

## Setup

### Modify Structure - OTN BERT

- **4 Unframed Physical Lanes:** Independent test pattern in each physical lane. Available with: **OTU3 (4 Lanes) [43.018 Gbit/s]**, **OTU3e1 (4 Lanes) [44.571 Gbit/s]**, **OTU3e2 (4 Lanes) [44.583 Gbit/s]**, and **OTU4 (4 Lanes) [111.81 Gbit/s]**

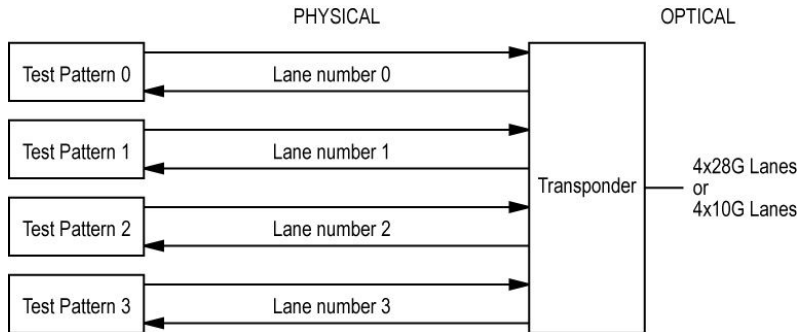

- **20 Unframed Logical Lanes:** Independent test pattern in each logical lane. Available with **OTU4 (4 Lanes) [111.81 Gbit/s]**.  
For 88200NGE:

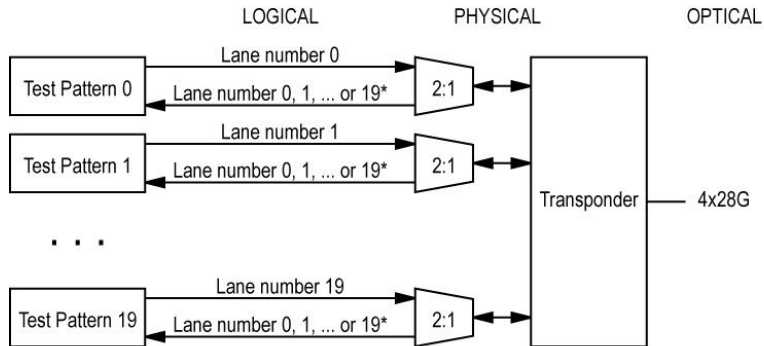

\* It is not possible to predict on which Lane a generated pattern will be detected on the receive side.

For 88260:

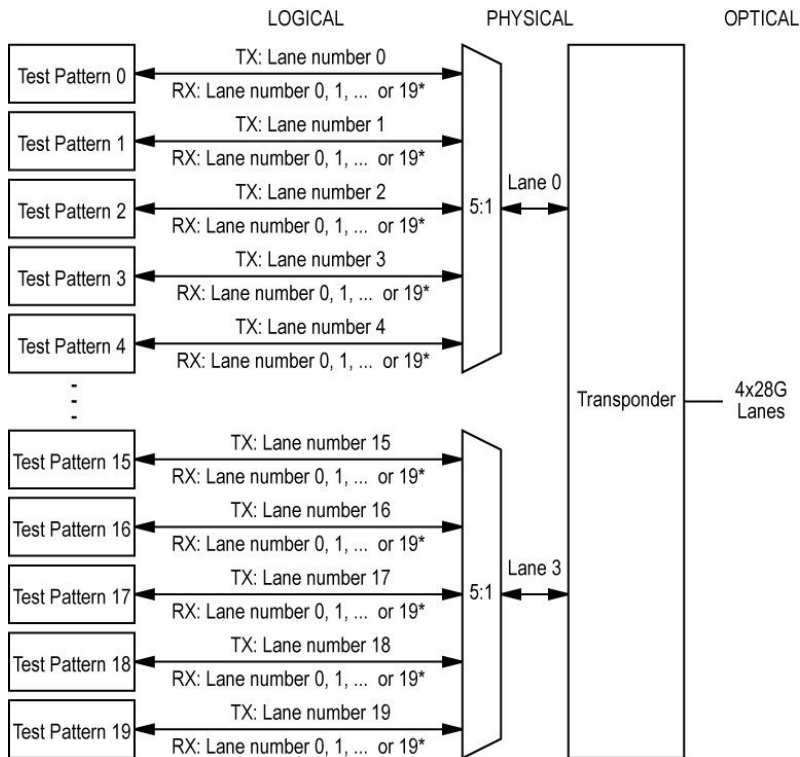

\* It is not possible to predict on which Lane a generated pattern will be detected on the receive side.

## Setup

### Modify Structure - OTN BERT

---

- **OTN Multiplexing / Config Mux** allows the selection of the OTN test mapping including the selection of the payload type (PT20 or PT21) when applicable. Refer to *OTN BERT* on page 58 for supported path/mapping.

Interface/Rate	OTN Multiplexing
OTU1 [2.666 Gbit/s]	ODU1 ODU1/ODU0
OTU2 [10.709 Gbit/s]	ODU2 ODU2/ODU1 ODU2/ODU1/ODU0 ODU2/ODU0 ODU2/ODUflex
OTU1e [11.049 Gbit/s]	ODU1e
OTU2e [11.096 Gbit/s]	ODU2e
OTU1f [11.270 Gbit/s]	ODU1f
OTU2f [11.318 Gbit/s]	ODU2f
OTU3 (4 Lanes) [43.018 Gbit/s]	ODU3 ODU3/ODU2 ODU3/ODU2/ODU1 ODU3/ODU2/ODU1/ODU0 ODU3/ODU1 ODU3/ODU1/ODU0 ODU3/ODU0 ODU3/ODUflex
OTU3e1 (4 Lanes) [44.571 Gbit/s]	ODU3e1
OTU3e2 (4 Lanes) [44.583 Gbit/s]	ODU3e2



Interface/Rate	OTN Multiplexing
OTU4 (4 Lanes) [111.81 Gbit/s]	ODU4 (default) ODU4/ODU3 ODU4/ODU3/ODU2 ODU4/ODU3/ODU2/ODU1 ODU4/ODU3/ODU2/ODU1/ODU0 ODU4/ODU3/ODU1 ODU4/ODU3/ODU0 ODU4/ODU2 ODU4/ODU2/ODU1/ODU0 ODU4/ODU2/ODU1 ODU4/ODU2/ODU0 ODU4/ODU2/ODUflex ODU4/ODU1 ODU4/ODU1/ODU0 ODU4/ODU0 ODU4/ODU2e ODU4/ODU1e ODU4/ODUflex

- **Client** allows the selection of either **Pattern** (default) or an EoOTN (**1 GbE**, **10 GbE**, **40 GbE**, **100 GbE**, or **Ethernet (flex/GFP-F)**) client. The client is set to **Pattern** for OTU1f, OTU2f, OTU3e1, and OTU3e2.
- **Topology** allows the selection of the network test topology.
  - **Coupled (TX=RX)** uses the same settings for both the TX and RX signals.

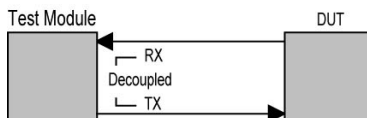
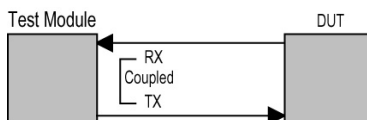

## Setup

### Modify Structure - OTN BERT

---

- **Through** loops the RX signal to the TX port without TX overwrite capabilities.

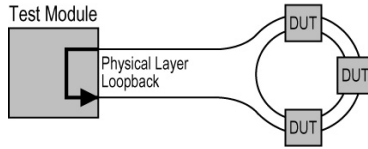

- **Through Intrusive** loops the RX signal to the TX port with TX overwrite capabilities.

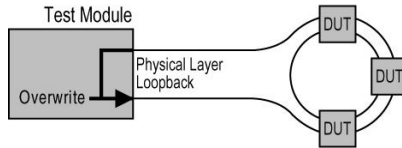

## Modify Structure - OTN-SONET/SDH BERT

From the test menu, tap **Setup**, **Test Configurator**, and the **Modify Structure** button.

**Note:** The OTN-SONET/SDH BERT test is framed.

- **Interface/Rate** allows the selection of the interface rate.

Unit	Interface/Rate	Connector
8870 8880	OTU2 [10.709 Gbit/s] OTU1 [2.666 Gbit/s]	Port 1 - SFP+
88200NGE	OTU4 (4 Lanes) [111.81 Gbit/s]	Port 1 - CFP4 Port 2 - QSFP <sup>a</sup>
	OTU3 (4 Lanes) [43.018 Gbit/s]	Port 2 - QSFP <sup>a</sup>
	OTU2 [10.709 Gbit/s] OTU1 [2.666 Gbit/s]	Port 1 - SFP+
88260	OTU3 (4 Lanes) [43.018 Gbit/s]	Port A1/A2/B1/B2 - QSFP28
	OTU2 [10.709 Gbit/s] OTU1 [2.666 Gbit/s]	Port A1/A2/B1/B2 - SFP28

- a. This port accepts QSFP+ or QSFP28 transceivers.

- **Connector** allows the selection of the physical port (see the **Interface/Rate** table above).

## Setup

### Modify Structure - OTN-SONET/SDH BERT

- **OTN Multiplexing / Config Mux** allows the selection of the OTN test mapping including the selection of the payload type (PT20 or PT21) when applicable. Refer to *OTN-SONET/SDH BERT* on page 61 for supported path/mapping.

Interface/Rate	OTN Multiplexing
OTU1 [2.666 Gbit/s]	ODU1 ODU1/ODU0
OTU2 [10.709 Gbit/s]	ODU2 ODU2/ODU1 ODU2/ODU1/ODU0 ODU2/ODU0 ODU2/ODUflex
OTU3 (4 Lanes) [43.018 Gbit/s]	ODU3 ODU3/ODU2 ODU3/ODU2/ODU1 ODU3/ODU2/ODU1/ODU0 ODU3/ODU1 ODU3/ODU1/ODU0 ODU3/ODU0 ODU3/ODUflex
OTU4 (4 Lanes) [111.81 Gbit/s]	ODU4 (default) ODU4/ODU3 ODU4/ODU3/ODU2 ODU4/ODU3/ODU2/ODU1 ODU4/ODU3/ODU2/ODU1/ODU0 ODU4/ODU3/ODU1 ODU4/ODU3/ODU0 ODU4/ODU2 ODU4/ODU2/ODU1/ODU0 ODU4/ODU2/ODU1 ODU4/ODU2/ODU0 ODU4/ODU2/ODUflex ODU4/ODU1 ODU4/ODU1/ODU0 ODU4/ODU0 ODU4/ODU2e ODU4/ODU1e ODU4/ODUflex

- **Embedded SONET/SDH** allows the selection of the embedded SONET/SDH signal.

OTN Multiplexing	Embedded SONET/SDH
ODU4/ODU3 ODU3	OC-768, STM-256
ODU4/ODU3/ODU2 ODU4/ODU2 ODU3/ODU2 ODU2	OC-192, STM-64
ODU4/ODU3/ODU2/ODU1 ODU4/ODU3/ODU1 ODU4/ODU2/ODU1 ODU4/ODU1 ODU3/ODU2/ODU1 ODU3/ODU1 ODU2/ODU1 ODU1	OC-48, STM-16
ODU4/ODU3/ODU2/ODU1/ODU0 ODU4/ODU3/ODU0 ODU4/ODU2/ODU1/ODU0 ODU4/ODU2/ODU0 ODU4/ODU1/ODU0 ODU4/ODU0 ODU3/ODU2/ODU1/ODU0 ODU3/ODU1/ODU0 ODU3/ODU0 ODU2/ODU1/ODU0 ODU2/ODU0 ODU1/ODU0	OC-3, OC-12, STM-1, STM-4

## Setup

### Modify Structure - OTN-SONET/SDH BERT

---

- **SONET/SDH Multiplexing / Config Mux** button allows the selection of SONET/SDH multiplexing.

<b>Embedded SONET/SDH</b>	<b>SONET/SDH Multiplexing</b>
OC-768	STS-768c, STS-192c, STS-48c, STS-12c, STS-3c, STS-1
STM-256	AU-4-256c, AU-4-64c, AU-4-16c, AU-4-4c, AU-4, AU-3
OC-192	STS-192c, STS-48c, STS-12c, STS-3c, STS-1, STS-1/VT2, STS-1/VT1.5
STM-64	AU-4-64c, AU-4-16c, AU-4-4c, AU-4, AU-4/TU-3, AU-4/TU-12, AU-4/TU-11, AU-3, AU-3/TU-12, AU-3/TU-11
OC-48	STS-48c, STS-12c, STS-3c, STS-1, STS-1/VT2, STS-1/VT1.5
STM-16	AU-4-16c, AU-4-4c, AU-4, AU-4/TU-3, AU-4/TU-12, AU-4/TU-11, AU-3, AU-3/TU-12, AU-3/TU-11
OC-12	STS-12c, STS-3c, STS-1, STS-1/VT2, STS-1/VT1.5
STM-4	AU-4-4c, AU-4, AU-4/TU-3, AU-4/TU-12, AU-4/TU-11, AU-3, AU-3/TU-12, AU-3/TU-11
OC-3	STS-3c, STS-1, STS-1/VT2, STS-1/VT1.5
STM-1	AU-4, AU-4/TU-3, AU-4/TU-12, AU-4/TU-11, AU-3, AU-3/TU-12, AU-3/TU-11

- **Client** is set to **Pattern**.

- **Topology** allows the selection of the network test topology.
- **Coupled (TX=RX)** uses the same settings for both the TX and RX signals.

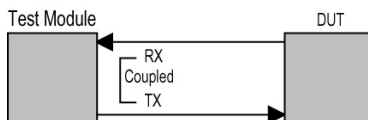

- **Through** loops the RX signal to the TX port without TX overwrite capabilities.

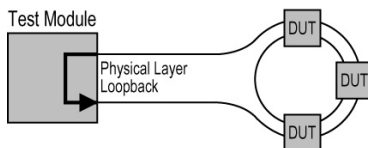

- **Through Intrusive** loops the RX signal to the TX port with TX overwrite capabilities.

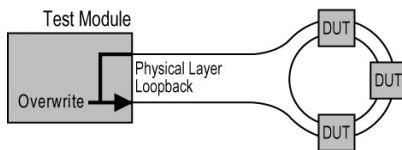

## Setup

Modify Structure - RFC 2544

---

# Modify Structure - RFC 2544

From the test menu, tap **Setup**, **Test Configurator**, and the **Modify Structure** button.

**Note:** For *Dual Port* topology each port is configurable individually.

➤ **Interface/Rate** allows the selection of the interface rate.

Unit	Interface/Rate	Connector
88708880	10GE LAN 10GE WAN 1GE Optical 100M Optical	Port 1 - SFP+ Port 2 - SFP+
	10/100/1000M Electrical	Port 1 - RJ45 Port 2 - SFP+ (RJ45) <sup>a, b</sup>
88200NGE	100GE (4 Lanes) [103.125 Gbit/s]	Port 1 - CFP4 Port 2 - QSFP (QSFP28)
	100GE (2 Lanes) [106.25 Gbit/s] 100GE (1 Lane) [106.25 Gbit/s]	Port 2 - QSFP (QSFP28)
	40GE (4 Lanes) [41.25 Gbit/s]	Port 2 - QSFP (QSFP+)
	10GE LAN 10GE WAN 1GE Optical 100M Optical	Port 1 - SFP+
	10/100/1000M Electrical	Port 1 - SFP+ <sup>b</sup>



Unit	Interface/Rate	Connector
88260	100GE (4 Lanes) [103.125 Gbit/s]	Port A1/A2/B1/B2 - QSFP28 Port A1/B1 - CFP4
	100GE (2 Lanes) [106.25 Gbit/s] 100GE (1 Lane) [106.25 Gbit/s]	Port A1/A2/B1/B2 - QSFP28
	40GE (4 Lanes) [41.25 Gbit/s]	Port A1/A2/B1/B2 - QSFP28
	25GE	Port A1/A2/B1/B2 - SFP28
	10GE LAN 10GE WAN 1GE Optical 100M Optical	Port A1/A2/B1/B2 - SFP28
	10/100/1000M Electrical	Port A1/A2/B1/B2 - SFP28 (RJ45)
88460	400GE (8 Lanes) [425 Gbit/s]	Port 1 - CFP8 Port 1 - QSFP56-DD Port 1 - OSFP
	400GE (4 Lanes) [425 Gbit/s]	Port 1 - QSFP56-DD Port 1 - OSFP
	200GE (4 Lanes) [212.5 Gbit/s]	Port 1 - QSFP56-DD
	100GE (4 Lanes) [103.125 Gbit/s] 100GE (2 Lanes) [106.25 Gbit/s] 100GE (1 Lane) [106.25 Gbit/s]	Port 1 - QSFP56-DD Port 1/2/3/4 - QSFP28
	40GE (4 Lanes) [41.25 Gbit/s]	Port 1/2/3/4 - QSFP28
	25GE	Port 1/2/3/4 - QSFP28 (with adapter)
	10GE LAN 10GE WAN 1GE Optical	Port 1/2/3/4 - QSFP28 (with adapter)

- a. Only available as a second port when the test application requires two ports.
- b. Ethernet 10/100/1000M electrical is supported when using an active copper SFP.

## Setup

*Modify Structure - RFC 2544*

---

- **PHY Type** allows selecting the transceiver PHY type:
  - For 100GE (4 Lanes): **LR4/ER4** (default), **SR4**, **CWDM4**, **CLR4**, **AOC**, or **Other**. The PHY type when set to any except **LR4/ER4**, allows enabling RS-FEC (see page 290); ensure both ends of the circuit have the FEC enabled.
  - For 100GE (1 Lane): **DR1/FR1/LR1** (default and dimmed); ensure the other end of the circuit has the FEC enabled.
  - For 100GE (2 Lanes): **SRBD** (default and dimmed); ensure the other end of the circuit has the FEC enabled.
  - For 200GE (4 Lanes): **Optical** (default), and **AOC**.
  - For 400GE (8 Lanes): **Optical** (default), **AOC**, and **DAC**.
- **Connector** allows the selection of the physical port (see the **Interface/Rate** table above). Connectors availability depend on the selected **PHY Type**; CFP8 and OSFP connectors are only available when the **PHY Type** is set to **Optical**.
- **Topology** allows the selection of the network test topology: **Single Port** (default) or **Dual Port**. Available for rates up to 10G WAN.

## Modify Structure - RFC 6349

From the test menu, tap **Setup**, **Test Configurator**, and the **Modify Structure** button.

- **Interface/Rate** allows the selection of the interface rate.

Unit	Interface/Rate <sup>a</sup>	Connector
8870 8880	10GE LAN 1GE Optical 100M Optical	Port 1 - SFP+ Port 2 - SFP+
	10/100/1000M Electrical	Port 1 - RJ45
88200NGE	100GE (4 Lanes) [103.125 Gbit/s]	Port 1 - CFP4 Port 2 - QSFP (QSFP28)
	100GE (2 Lanes) [106.25 Gbit/s] 100GE (1 Lane) [106.25 Gbit/s]	Port 2 - QSFP (QSFP28)
	40GE (4 Lanes) [41.25 Gbit/s]	Port 2 - QSFP (QSFP+)
	10GE LAN 1GE Optical 100M Optical	Port 1 - SFP+
	10/100/1000M Electrical	Port 1 - SFP+ <sup>b</sup>
88260	100GE (4 Lanes) [103.125 Gbit/s]	Port A1/A2/B1/B2 - QSFP28 Port A1/B1 - CFP4
	100GE (2 Lanes) [106.25 Gbit/s] 100GE (1 Lane) [106.25 Gbit/s]	Port A1/A2/B1/B2 - QSFP28
	40GE (4 Lanes) [41.25 Gbit/s]	Port A1/A2/B1/B2 - QSFP28
	10GE LAN 1GE Optical 100M Optical	Port A1/A2/B1/B2 - SFP28
	10/100/1000M Electrical	Port A1/A2/B1/B2 - SFP28 (RJ45)

- a. Only rates up to 10GE LAN are supported with **iPerf Compatible Server** operation mode.
- b. Ethernet 10/100/1000M electrical is supported when using an active copper SFP.

## Setup

*Modify Structure - RFC 6349*

---

- **PHY Type** allows selecting the transceiver PHY type:

For 100GE (4 Lanes): **LR4/ER4** (default), **SR4**, **CWDM4**, **CLR4**, **AOC**, or **Other**. The PHY type when set to any except **LR4/ER4**, provides access to RS-FEC configuration (see page 290).

For 100GE (1 Lane): **DR1/FR1/LR1** (default and dimmed); ensure the other end of the circuit has the FEC enabled.

For 100GE (2 Lanes): **SRBD** (default and dimmed); ensure the other end of the circuit has the FEC enabled.

**Connector** allows the selection of the physical port (see the **Interface/Rate** table above).

## Modify Structure - Smart Loopback

From the test menu, tap **Setup**, **Test Configurator**, and the **Modify Structure** button.

- **Interface/Rate** allows the selection of the interface rate.

Unit	Interface/Rate	Connector
8870 8880	10GE LAN 10GE WAN 1GE Optical 100M Optical	Port 1 - SFP+ Port 2 - SFP+
	10/100/1000M Electrical	Port 1 - RJ45
88200NGE	100GE (4 Lanes) [103.125 Gbit/s]	Port 1 - CFP4 Port 2 - QSFP (QSFP28)
	100GE (2 Lanes) [106.25 Gbit/s] 100GE (1 Lane) [106.25 Gbit/s]	Port 2 - QSFP (QSFP28)
	40GE (4 Lanes) [41.25 Gbit/s]	Port 2 - QSFP (QSFP+)
	10GE LAN 10GE WAN 1GE Optical 100M Optical	Port 1 - SFP+
	10/100/1000M Electrical	Port 1 - SFP+ <sup>a</sup>
88260	100GE (4 Lanes) [103.125 Gbit/s]	Port A1/A2/B1/B2 - QSFP28 Port A1/B1 - CFP4
	100GE (2 Lanes) [106.25 Gbit/s] 100GE (1 Lane) [106.25 Gbit/s]	Port A1/A2/B1/B2 - QSFP28
	50GE [53.125G]	Port A1/A2/B1/B2 - QSFP28
	40GE (4 Lanes) [41.25 Gbit/s]	Port A1/A2/B1/B2 - QSFP28
	25GE	Port A1/A2/B1/B2 - SFP28
	10GE LAN 10GE WAN 1GE Optical 100M Optical	Port A1/A2/B1/B2 - SFP28
	10/100/1000M Electrical	Port A1/A2/B1/B2 - SFP28 (RJ45)

## Setup

### Modify Structure - Smart Loopback

Unit	Interface/Rate	Connector
88460	400GE (8 Lanes) [425 Gbit/s]	Port 1 - CFP8 Port 1 - QSFP56-DD Port 1 - OSFP
	400GE (4 Lanes) [425 Gbit/s]	Port 1 - QSFP56-DD Port 1 - OSFP
	200GE (4 Lanes) [212.5 Gbit/s]	Port 1 - QSFP56-DD
	100GE (4 Lanes) [103.125 Gbit/s] 100GE (2 Lanes) [106.25 Gbit/s] 100GE (1 Lane) [106.25 Gbit/s]	Port 1 - QSFP56-DD Port 1/2/3/4 - QSFP28
	50GE [53.125G]	Port 1/2/3/4 - QSFP28
	40GE (4 Lanes) [41.25 Gbit/s]	Port 1/2/3/4 - QSFP28
	25GE	Port 1/2/3/4 - QSFP28 (with adapter)
	10GE LAN 10GE WAN 1GE Optical	Port 1/2/3/4 - QSFP28 (with adapter)

- a. Ethernet 10/100/1000M electrical is supported when using an active copper SFP.

➤ **PHY Type** allows selecting the transceiver PHY type:

For 100GE (4 Lanes): **LR4/ER4** (default), **SR4**, **CWDM4**, **CLR4**, **AOC**, or **Other**. The PHY type when set to any except **LR4/ER4**, allows enabling RS-FEC (see page 290); ensure both ends of the circuit have the FEC enabled.

For 100GE (1 Lane): **DR1/FR1/LR1** (default and dimmed); ensure the other end of the circuit has the FEC enabled.

For 100GE (2 Lanes): **SRBD** (default and dimmed); ensure the other end of the circuit has the FEC enabled.

For 200GE (4 Lanes): **Optical** (default), and **AOC**.

For 400GE (8 Lanes): **Optical** (default), **AOC**, and **DAC**.

➤ **Connector** allows the selection of the physical port (see the **Interface/Rate** table above). Connectors availability depend on the selected **PHY Type**; CFP8 and OSFP connectors are only available when the **PHY Type** is set to **Optical**.

➤ **Loopback Mode**

**Transparent (Pseudo-Physical)** check box when selected (cleared by default) determines that the Smart Loopback operates as a physical loopback by transmitting all received frames unaltered and without discrimination. When the check box is cleared, the Loopback mode is selectable from *Loopback* on page 405.

In transparent mode, the **Network** tab and the **Ping & Trace Route** functions are not available.

**Note:** *The **Transparent** mode is intended to be used for point-to-point topology, not for switched or routed networks. Use the **Transparent** mode with caution because all received frames are looped back without discrimination.*

## Setup

### Modify Structure - SONET/SDH BERT

## Modify Structure - SONET/SDH BERT

From the test menu, tap **Setup**, **Test Configurator**, and the **Modify Structure** button.

- **Interface/Rate** allows the selection of the interface rate.

Unit	Interface/Rate	Connector
8870 8880	OC-192 [9.953 Gbit/s] STM-64 [9.953 Gbit/s] OC-48 [2.488 Gbit/s] OC-12 [622.08 Mbit/s] OC-3 [155.520 Mbit/s] OC-1 [51.840 Mbit/s] STM-16 [2.488 Gbit/s] STM-4 [622.080 Mbit/s] STM-1 [155.520 Mbit/s] STM-0 [51.840 Mbit/s]	Port 1 - SFP+ <sup>a</sup>
	STS-3e [155.520 Mbit/s] STS-1e [51.840 Mbit/s] STM-1e [155.520 Mbit/s] STM-0e [51.840 Mbit/s]	BNC
88200NGE	OC-192 [9.953 Gbit/s] STM-64 [9.953 Gbit/s] OC-48 [2.488 Gbit/s] OC-12 [622.08 Mbit/s] OC-3 [155.520 Mbit/s] OC-1 [51.840 Mbit/s] STM-16 [2.488 Gbit/s] STM-4 [622.080 Mbit/s] STM-1 [155.520 Mbit/s] STM-0 [51.840 Mbit/s]	Port 1 - SFP+



Unit	Interface/Rate	Connector
88260	OC-192 [9.953 Gbit/s] STM-64 [9.953 Gbit/s] OC-48 [2.488 Gbit/s] OC-12 [622.08 Mbit/s] OC-3 [155.520 Mbit/s] OC-1 [51.840 Mbit/s] STM-16 [2.488 Gbit/s] STM-4 [622.080 Mbit/s] STM-1 [155.520 Mbit/s] STM-0 [51.840 Mbit/s]	Port A1/A2/B1/B2 - SFP28

a. Port 2 is used with OC-192/STM-64 in Decoupled (TX≠RX) mode.

- **Connector** allows the selection of the physical port (see the **Interface/Rate** table above).
- **Framing** is set to **Framed**.
- **SONET/SDH Multiplexing / Config Mux** button allows the selection of SONET/SDH multiplexing.

Interface/Rate	SONET/SDH Multiplexing
OC-192	STS-192c, STS-48c, STS-12c, STS-3c, STS-1, STS-1/VT2, STS-1/VT1.5
STM-64	AU-4-64c, AU-4-16c, AU-4-4c, AU-4, AU-4/TU-3, AU-4/TU-12, AU-4/TU-11, AU-3, AU-3/TU-12, AU-3/TU-11
OC-48	STS-48c, STS-12c, STS-3c, STS-1, STS-1/VT2, STS-1/VT1.5
STM-16	AU-4-16c, AU-4-4c, AU-4, AU-4/TU-3, AU-4/TU-12, AU-4/TU-11, AU-3, AU-3/TU-12, AU-3/TU-11
OC-12	STS-12c, STS-3c, STS-1, STS-1/VT2, STS-1/VT1.5
STM-4	AU-4-4c, AU-4, AU-4/TU-3, AU-4/TU-12, AU-4/TU-11, AU-3, AU-3/TU-12, AU-3/TU-11
OC-3	STS-3c, STS-1, STS-1/VT2, STS-1/VT1.5
STM-1	AU-4, AU-4/TU-3, AU-4/TU-12, AU-4/TU-11, AU-3, AU-3/TU-12, AU-3/TU-11

## Setup

### Modify Structure - SONET/SDH BERT

Interface/Rate	SONET/SDH Multiplexing
OC-1	STS-1, STS-1/VT2, STS-1/VT1.5
STS-3e	STS-3c, STS-1, STS-1/VT2, STS-1/VT1.5
STS-1e	STS-1, STS-1/VT2, STS-1/VT1.5
STM-0	AU-3, AU-3/TU-12, AU-3/TU-11
STM-1e	AU-4, AU-4/TU-3, AU-4/TU-12, AU-4/TU-11, AU-3, AU-3/TU-12, AU-3/TU-11
STM-0e	AU-3, AU-3/TU-12, AU-3/TU-11

- **Client** is set to **Pattern**.
- **Topology** allows the selection of the network test topology.
  - **Coupled (TX=RX)** uses the same settings for both the TX and RX signals.

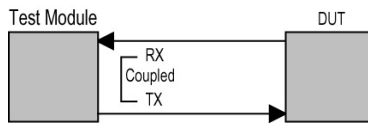

- **Decoupled (TX≠RX)** uses independent settings for TX and RX signals. However, the pattern and some other parameters are always coupled. Available on 8870, 8880, and 88260.

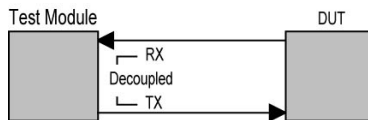

- **Through** loops the RX signal to the TX port without TX overwrite capabilities.

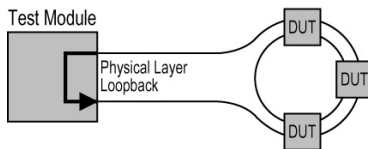

## Setup

*Modify Structure - SONET/SDH - DS<sub>n</sub>/PDH BERT*

---

# Modify Structure - SONET/SDH - DS<sub>n</sub>/PDH BERT

From the test menu, tap **Setup**, **Test Configurator**, and the **Modify Structure** button.

➤ **Interface/Rate** allows the selection of the interface rate.

Unit	Interface/Rate	Connector
8870 8880	OC-192 [9.953 Gbit/s] STM-64 [9.953 Gbit/s] OC-48 [2.488 Gbit/s] OC-12 [622.08 Mbit/s] OC-3 [155.520 Mbit/s] OC-1 [51.840 Mbit/s] STM-16 [2.488 Gbit/s] STM-4 [622.080 Mbit/s] STM-1 [155.520 Mbit/s] STM-0 [51.840 Mbit/s]	Port 1 - SFP+ <sup>a</sup>
	STS-3e [155.520 Mbit/s] STS-1e [51.840 Mbit/s] STM-1e [155.520 Mbit/s] STM-0e [51.840 Mbit/s]	BNC
88200NGE	OC-192 [9.953 Gbit/s] STM-64 [9.953 Gbit/s] OC-48 [2.488 Gbit/s] OC-12 [622.08 Mbit/s] OC-3 [155.520 Mbit/s] OC-1 [51.840 Mbit/s] STM-16 [2.488 Gbit/s] STM-4 [622.080 Mbit/s] STM-1 [155.520 Mbit/s] STM-0 [51.840 Mbit/s]	Port 1 - SFP+

Unit	Interface/Rate	Connector
88260	OC-192 [9.953 Gbit/s] STM-64 [9.953 Gbit/s] OC-48 [2.488 Gbit/s] OC-12 [622.08 Mbit/s] OC-3 [155.520 Mbit/s] OC-1 [51.840 Mbit/s] STM-16 [2.488 Gbit/s] STM-4 [622.080 Mbit/s] STM-1 [155.520 Mbit/s] STM-0 [51.840 Mbit/s]	Port A1/A2/B1/B2 - SFP28

a. Port 2 is used with OC-192/STM-64 in Decoupled (TX≠RX) mode.

- **Connector** allows the selection of the physical port (see the **Interface/Rate** table above).
- **SONET/SDH Multiplexing / Config Mux** button allows the selection of SONET/SDH multiplexing.

Interface/Rate	SONET/SDH Multiplexing
OC-192	STS-192c, STS-48c, STS-12c, STS-3c, STS-1, STS-1/VT2, STS-1/VT1.5
STM-64	AU-4-64c, AU-4-16c, AU-4-4c, AU-4, AU-4/TU-3, AU-4/TU-12, AU-4/TU-11, AU-3, AU-3/TU-12, AU-3/TU-11
OC-48	STS-48c, STS-12c, STS-3c, STS-1, STS-1/VT2, STS-1/VT1.5
STM-16	AU-4-16c, AU-4-4c, AU-4, AU-4/TU-3, AU-4/TU-12, AU-4/TU-11, AU-3, AU-3/TU-12, AU-3/TU-11
OC-12	STS-12c, STS-3c, STS-1, STS-1/VT2, STS-1/VT1.5
STM-4	AU-4-4c, AU-4, AU-4/TU-3, AU-4/TU-12, AU-4/TU-11, AU-3, AU-3/TU-12, AU-3/TU-11
OC-3	STS-3c, STS-1, STS-1/VT2, STS-1/VT1.5
STM-1	AU-4, AU-4/TU-3, AU-4/TU-12, AU-4/TU-11, AU-3, AU-3/TU-12, AU-3/TU-11
OC-1	STS-1, STS-1/VT2, STS-1/VT1.5
STS-3e	STS-3c, STS-1, STS-1/VT2, STS-1/VT1.5

## Setup

### Modify Structure - SONET/SDH - DS<sub>n</sub>/PDH BERT

Interface/Rate	SONET/SDH Multiplexing
STS-1e	STS-1, STS-1/VT2, STS-1/VT1.5
STM-0	AU-3, AU-3/TU-12, AU-3/TU-11
STM-1e	AU-4, AU-4/TU-3, AU-4/TU-12, AU-4/TU-11, AU-3, AU-3/TU-12, AU-3/TU-11
STM-0e	AU-3, AU-3/TU-12, AU-3/TU-11

- **Embedded DS<sub>n</sub> / Embedded PDH** either indicates or allows the selection of the embedded DS<sub>n</sub>/PDH signal. Refer to *SONET/SDH - DS<sub>n</sub>/PDH BERT* on page 71 for supported path/mapping.
- **Client** is set to **Pattern**.
- **Topology** allows the selection of the network test topology.
  - **Coupled (TX=RX)** uses the same settings for both the TX and RX signals.

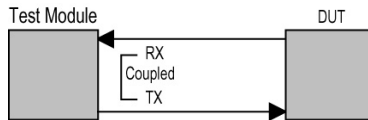

- **Decoupled (TX≠RX)** uses independent settings for TX and RX signals. However, the pattern and some other parameters are always coupled.

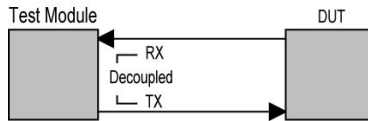

- **Through** loops the RX signal to the TX port without TX overwrite capabilities.

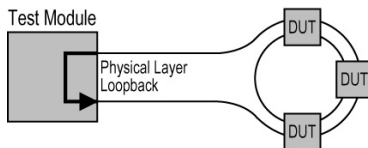

## Setup

### Modify Structure - SyncE

---

## Modify Structure - SyncE

From the test menu, tap **Setup, Test Configurator**, and the **Modify Structure** button.

- **Interface/Rate** allows the selection of the interface rate.

Unit	Interface/Rate	Connector
8870 8880	10GE LAN 1GE Optical 100M Optical	Port 1 - SFP+ Port 2 - SFP+
	10/100/1000M Electrical	Port 1 - RJ45
88200NGE	10GE LAN 1GE Optical 100M Optical	Port 1 - SFP+
	10/100/1000M Electrical	Port 1 - SFP+ <sup>a</sup>
88260	10GE LAN 1GE Optical 100M Optical	Port A1/A2/B1/B2 - SFP28
	10/100/1000M Electrical	Port A1/A2/B1/B2 - SFP28 (RJ45) <sup>b</sup>

- a. Ethernet 10/100/1000M electrical is supported when using an active copper SFP.

- **Connector** allows the selection of the physical port (see the **Interface/Rate** table above).



## Modify Structure - TCP Throughput

From the test menu, tap **Setup**, **Test Configurator**, and the **Modify Structure** button.

- **Interface/Rate** allows the selection of the interface rate.

Unit	Interface/Rate	Connector
8870 8880	1GE Optical	Port 1 - SFP+
	100M Optical	Port 2 - SFP+
	10/100/1000M Electrical	Port 1 - RJ45
88200NGE	1GE Optical	Port 1 - SFP+
	100M Optical	
	10/100/1000M Electrical	Port 1 - SFP+ <sup>a</sup>

- a. Ethernet 10/100/1000M electrical is supported when using an active copper SFP.

- **Connector** allows the selection of the physical port (see the **Interface/Rate** table above).

## Setup

### Modify Structure - Through Mode

---

## Modify Structure - Through Mode

From the test menu, tap **Setup**, **Test Configurator**, and the **Modify Structure** button.

- **Interface** allows the selection of the interface rate.

Unit	Interface/Rate	Connector
8870 8880	10GE LAN 1GE Optical 100M Optical	Port 1 - SFP+ Port 2 - SFP+
	10/100/1000M Electrical	Port 1 - RJ45
88200NGE	100GE (4 Lanes) [103.125 Gbit/s]	Port 1 - CFP4 Port 2 - QSFP (QSFP28)
	10GE LAN 1GE Optical 100M Optical	Port 1 - SFP+
	10/100/1000M Electrical	Port 1 - SFP+ (RJ45) <sup>b</sup>
88260	100GE (4 Lanes) [103.125 Gbit/s]	Port A1/A2/B1/B2 - QSFP28 Port A1/B1 - CFP4
	100GE (2 Lanes) [106.25 Gbit/s] 100GE (1 Lane) [106.25 Gbit/s]	Port A1/A2/B1/B2 - QSFP28
	10GE LAN 1GE Optical 100M Optical	Port A1/A2/B1/B2 - SFP28
	10/100/1000M Electrical	Port A1/A2/B1/B2 - SFP28 (RJ45)

- **Primary Port / Secondary Port** allows selecting the unit's ports that are respectively used as primary and secondary ports. The configuration of the network configuration parameters will be available on the Primary Port only.

- **PHY Type** allows selecting the transceiver PHY type:

For 100GE (4 Lanes): **LR4/ER4** (default), **SR4**, **CWDM4**, **CLR4**, **AOC**, or **Other**. The PHY type when set to any except **LR4/ER4**, allows enabling RS-FEC (see page 290); ensure both ends of the circuit have the FEC enabled.

For 100GE (1 Lane): **DR1/FR1/LR1** (default and dimmed); ensure the other end of the circuit has the FEC enabled.

For 100GE (2 Lanes): **SRBD** (default and dimmed); ensure the other end of the circuit has the FEC enabled.

## Setup

*Modify Structure - Time Error / Wander*

---

# Modify Structure - Time Error / Wander

From the test menu, tap **Setup**, **Test Configurator**, and the **Modify Structure** button.

- **Measurement Type** allows selecting the type of measurement:

**Time Error** (default) allows measuring Time Error (TE) 1PPS or Packet Time Error (Pkt TE).

**Wander** allows measuring Time Interval Error (TIE).

- **Interface/Rate** allows the selection of the interface rate.

### Time Error

Unit	Interface/Rate	Connector
8880	1PPS	BNC (Port labelled TX/RX2) RJ48C
88260	1PPS	Port A1/B1 - 1PPS
	100GE (4 Lanes) [103.125 Gbit/s]	Port A1/A2/B1/B2 - QSFP28 Port A1/B1 - CFP4
	10GE LAN 1GE Optical	Port A1/A2/B1/B2 - SFP28

## Wander

Unit	Interface/Rate	Connector
8880	10GE LAN 1GE Optical 100M Optical	Port 1 - SFP+
	10/100/1000M Electrical	Port 1 - RJ45
	10 MHz 2 MHz	BNC (Port labelled TX/RX2) RJ48C
	DS1 [1.544 Mbit/s]	Port 1 - Bantam Port 1 - RJ48C
	E1 [2.048 Mbit/s]	Port 1 - Bantam Port 1 - BNC Port 1 - RJ48C
88260	100GE (4 Lanes) [103.125 Gbit/s]	Port A1/A2/B1/B2 - QSFP28
	10GE LAN 1GE Optical 100M Optical	Port A1/A2/B1/B2 - SFP28
	10 MHz 2 MHz	Port A1/B1 - EXT-CLK

- **PHY Type** allows selecting the transceiver PHY type: For 100GE (4 Lanes): **LR4/ER4** (default), **SR4**, **CWDM4**, or **CLR4**. The PHY type when set to any except **LR4/ER4**, provides access to RS-FEC configuration (see page 290). **Connector** allows the selection of the physical port (see the **Interface/Rate** table above).

## Setup

Modify Structure - Traffic Gen & Mon

---

# Modify Structure - Traffic Gen & Mon

From the test menu, tap **Setup**, **Test Configurator**, and the **Modify Structure** button.

**Note:** For *Dual Port* topology each port is configurable individually.

- **Interface/Rate** allows the selection of the interface rate. For Dual Port, both ports must be either 10GE and less, 25GE, or 40/100GE.

Unit	Interface/Rate	Connector
8870 8880	10GE LAN 10GE WAN 1GE Optical 100M Optical	Port 1 - SFP+ Port 2 - SFP+
	10/100/1000M Electrical	Port 1 - RJ45 Port 2 - SFP+ (RJ45) <sup>a, b</sup>
88200NGE	100GE (4 Lanes) [103.125 Gbit/s]	Port 1 - CFP4 Port 2 - QSFP (QSFP28)
	100GE (2 Lanes) [106.25 Gbit/s] 100GE (1 Lane) [106.25 Gbit/s]	Port 2 - QSFP (QSFP28)
	40GE (4 Lanes) [41.25 Gbit/s]	Port 2 - QSFP (QSFP+)
	10GE LAN 10GE WAN 1GE Optical 100M Optical	Port 1 - SFP+
	10/100/1000M Electrical	Port 1 - SFP+ <sup>b</sup>

Unit	Interface/Rate	Connector
88260	100GE (4 Lanes) [103.125 Gbit/s]	Port A1/A2/B1/B2 - QSFP28 Port A1/B1 - CFP4
	100GE (2 Lanes) [106.25 Gbit/s] 100GE (1 Lane) [106.25 Gbit/s]	Port A1/A2/B1/B2 - QSFP28
	40GE (4 Lanes) [41.25 Gbit/s]	Port A1/A2/B1/B2 - QSFP28
	25GE	Port A1/A2/B1/B2 - SFP28
	10GE LAN 10GE WAN 1GE Optical 100M Optical	Port A1/A2/B1/B2 - SFP28
	10/100/1000M Electrical	Port A1/A2/B1/B2 - SFP28 (RJ45)
88460	400GE (8 Lanes) [425 Gbit/s]	Port 1 - CFP8 Port 1 - QSFP56-DD Port 1 - OSFP
	400GE (4 Lanes) [425 Gbit/s]	Port 1 - QSFP56-DD Port 1 - OSFP
	200GE (4 Lanes) [212.5 Gbit/s]	Port 1 - QSFP56-DD
	100GE (4 Lanes) [103.125 Gbit/s] 100GE (2 Lanes) [106.25 Gbit/s] 100GE (1 Lane) [106.25 Gbit/s]	Port 1 - QSFP56-DD Port 1/2/3/4 - QSFP28
	40GE (4 Lanes) [41.25 Gbit/s]	Port 1/2/3/4 - QSFP28
	25GE	Port 1/2/3/4 - QSFP28 (with adapter)
	10GE LAN 10GE WAN 1GE Optical	Port 1/2/3/4 - QSFP28 (with adapter)

- a. Only available as a second port when the test application requires two ports.
- b. Ethernet 10/100/1000M electrical is supported when using an active copper SFP.

## Setup

### *Modify Structure - Traffic Gen & Mon*

---

- **PHY Type** allows selecting the transceiver PHY type:
  - For 100GE (4 Lanes): **LR4/ER4** (default), **SR4**, **CWDM4**, **CLR4**, **AOC**, or **Other**. The PHY type when set to any except **LR4/ER4**, allows enabling RS-FEC (see page 290); ensure both ends of the circuit have the FEC enabled.
  - For 100GE (1 Lane): **DR1/FR1/LR1** (default and dimmed); ensure the other end of the circuit has the FEC enabled.
  - For 100GE (2 Lanes): **SRBD** (default and dimmed); ensure the other end of the circuit has the FEC enabled.
  - For 200GE (4 Lanes): **Optical** (default), and **AOC**.
  - For 400GE (8 Lanes): **Optical** (default), **AOC**, and **DAC**.
- **Connector** allows the selection of the physical port (see the **Interface/Rate** table above). Connectors availability depend on the selected **PHY Type**; CFP8 and OSFP connectors are only available when the **PHY Type** is set to **Optical**.
- **Topology** allows the selection of the network test topology: **Single Port** (default) or **Dual Port**. Available for rates up to 10G WAN.



## Signal Auto-Detect

The Signal Auto-Detect allows the detection of the DS1/DS3 interface **Line Coding** (DS1), **Framing**, and **Test Pattern**.

**Signal Auto-Detect** is only available:

- with DS1 and DS3 interfaces.
- when the test is stopped.
- when Loopback is not activated for NI/CSU Emulation test.

**Note:** *Test Pattern is not detected with NI/CSU Emulation test application. and ISDN PRI test applications.*

During the detection process, the following messages may be displayed: **Detecting**, **Successful**, and/or **Failed**.

When the auto-detection is successful, the detected parameters are automatically applied as the test interface configuration.

Upon detection of specific alarms, the detection may not be possible, tap **Retry** to invoke the detection again.

# 1588 PTP

From the test menu tap **Setup, Test Configurator**, and the **1588 PTP** test/protocol block.

## PTP

**Note:** Refer to Status Bar on page 36 for PTP link status.

### ➤ Profile

- **ITU G.8265.1**, also called Telecom Profile, is for frequency synchronization. Not available with **Time Error / Wander** test.
- **ITU G.8275.1** (default), also called Telecom Profile for phase/time synchronization with full timing support from the network, requires that all network elements are equipped with boundary clock to meet stringent time and phase requirements for 4G/5G mobile networks. Full on-path support is typically deployed in Greenfield situations.

For **Time Error / Wander** test with **Time Error** measurement mode, the G.8275.1 profile allows packet time error measurements.

- **ITU G.8275.2**, also called Telecom Profile for phase/time synchronization with partial timing support from the network, requires advanced boundary clocks at intermediate locations through the network to meet the stringent time and phase requirements for 4G/5G mobile networks. Partial on-path support responds to the need for time and phase distribution over existing deployed networks.

For **Time Error / Wander** test with **Time Error** measurement mode, the G.8275.2 profile allows packet selected time error measurements.

- **Domain** is the PTP domain parameter used by the 1588 PTP function to communicate with the Grand Master clock: **0** to **255**. However, the standard values are: **4** (default) to **23** for G.8265.1; **24** (default) to **43** for G.8275.1; **44** (default) to **63** for G.8275.2.
- **Framing** is not selectable and is set to **UDP/IPv4** or **UDP/IPv6** depending on the interface **IP Version** for G.8265.1/G.8275.2 and **Ethernet** for G.8275.1.
- **Mode** is not configurable and is set to **Unicast** for G.8265.1/G.8275.2 and **Multicast** for G.8275.1.
  - **Unicast** implies a dedicated communication link between the master and the slave clock.
  - **Multicast** implies that a master clock send its Sync/Follow Up and Delay Response in a multicast mode.
- **Multicast MAC**, available with G.8275.1, is the multicast address used to send the delay request: **01-1B-19-00-00-00** (forwardable; default), **01-80-C2-00-00-0E** (non-forwardable), or **User Defined** (default user defined address is **01:1B:19:00:00:01**).
- **GM IP Address** is the IP address of the Grand Master Clock used by the 1588 PTP function to communicate with it. Only available with G.8265.1.
- **BC IP Address** is the IP address of the Boundary Clock used by the 1588 PTP function to communicate with it. Only available with G.8275.2.
- **Quick Ping** button allows testing if the Grand Master IP address can be reached. A message is returned indicating if the ping attempt was **Successful** or **Failed**. Only available with **Unicast** mode.
- **Flow Label** (IPv6) is a number used to identify a series of related packets from a source to a destination: **0** (default) to **1048575**. Only available with **Unicast** mode.

## Setup

1588 PTP

---

- **IP TOS/DS (IPv4)** allows entering the Type of Service (TOS) or Differentiated Services (DS): **0x00** (default) to **0xFF**. Only available with **Unicast** mode.
- **Traffic Class (TOS/DS) (IPv6)** allows entering the Type of Service (TOS) or Differentiated Services (DS): **0x00** (default) to **0xFF**. Only available with **Unicast** mode.
- **TOS/DS Config**: Refer to *TOS/DS Config* on page 1005.
- **Mechanism** is not selectable and is set to **Delay Req-Resp** (Delay Request-Response) which specifies the mechanism used by the 1588 PTP function to communicate with the Grand Master clock. Refer to *Delay Request-Response* on page 807 for more information.
- **Delay Mode** is not selectable and is set to **Two-way** which uses Sync/Follow Up, Delay Request, and Delay Response messages.
- **Connect** button is used to initiate the Grand Master Connection process. This process is also automatically initiated when starting the test if not already initiated. The process automatically ends when stopping the test. Only available with **Unicast** mode.
- **Negotiation Status** is displayed during the Unicast negotiation process which is initiated when either the test is started or the **Connect** button is activated. Only available with **Unicast** mode.

Negotiation Status	Description	Background Color <sup>a</sup>
Request Granted	All the Signaling request types have been granted.	Green
[Message type] Request Denied	The Signaling grant message has not been granted.	Red
Session Canceled	The Grand Master has canceled the Unicast session.	Red

Negotiation Status	Description	Background Color <sup>a</sup>
No Reply	No message is received from the Grand Master following transmission of 3 Signaling requests for a message type. Make sure that both IP address and Domain (refer to <i>1588 PTP</i> on page 201) of the Grand Master Clock are valid as well as the IP address of the unit's port used to connect on the network (refer to <i>Network</i> on page 328).	Red
Pending	Unicast negotiation has started and no message has been received from the Grand Master.	Gray
Inactive	The Unicast negotiation is not active.	Gray

a. The gray background color is also used for a Link Down.

- **GM Info / BC Info:** Refer to *Grand Master Information / Boundary Clock Information* on page 965.
- **Message Rate**
  - **Announce** determines the transmission interval of the Announce messages:
    - G.8265.1: **1 msg/16s, 1 msg/8s, 1 msg/4s, 1 msg/2s** (default), **1 msg/s, 2 msg/s, 4 msg/s, or 8 msg/s.**
    - G.8275.1, indicates the announce rate log message interval.
    - G.8275.2: **1 msg/s** (default), **2 msg/s, 4 msg/s, or 8 msg/s.**
  - **Sync** determines the transmission interval of the Sync messages:
    - G.8265.1: **1 msg/16s, 1 msg/8s, 1 msg/4s, 1 msg/2s, 1 msg/s, 2 msg/s, 4 msg/s, 8 msg/s, 16 msg/s, 32 msg/s** (default), **64 msg/s, or 128 msg/s**
    - G.8275.1, indicates the sync rate log message interval.
    - G.8275.2: **1 msg/s, 2 msg/s, 4 msg/s, or 8 msg/s, 16 msg/s, 32 msg/s** (default), **64 msg/s, or 128 msg/s**

- **Delay-Request** determines the transmission interval of the delay request messages. The **Delay-Request** message rate is limited by the **Sync** rate selection; the **Delay-Request** message rate is automatically updated to be smaller than or equal to the **Sync** message rate.

G.8265.1: **1 msg/16s, 1 msg/8s, 1 msg/4s, 1 msg/2s, 1 msg/s, 2 msg/s, 4 msg/s, 8 msg/s, 16 msg/s, 32 msg/s (default), 64 msg/s, or 128 msg/s.**

G.8275.1: **1 msg/16s, 1 msg/8s, 1 msg/4s, 1 msg/2s, 1 msg/s, 2 msg/s, 4 msg/s, 8 msg/s, 16 msg/s (default), 32 msg/s, 64 msg/s, or 128 msg/s.**

G.8275.2: **1 msg/s, 2 msg/s, 4 msg/s, or 8 msg/s. 16 msg/s, 32 msg/s (default), 64 msg/s, or 128 msg/s.**

- **Service Duration** (available with **Unicast** mode)
  - **Lease Duration** is not configurable and is set to **300** seconds which determines the lease duration used between the 1588 PTP function and the Grand Master clock.
  - **Renewal Interval** is not configurable and is set to **150** seconds which determines the interval used by the 1588 PTP function to initiate the renewal of its lease with the Grand Master clock.

## Alarm Timeout/Threshold / Alarm Threshold

**Note:** *The following parameters are also used to declare the Pass/Fail verdict.*

- **Receipt Timeout** defines the threshold used to declare a **Loss Announce** or **Loss Sync** message alarm: **2 to 255** messages (default is **3** messages). A message is considered lost if not received within its expected arrival time and a loss alarm is declared when the number of consecutive lost messages is greater than or equal to the defined **Receipt Timeout**.

- **IPDV Threshold**, available with the 1588 PTP test application, defines the inter packet delay variation threshold used to raise the **Unusable** message alarm. The alarm is raised when IPDV is not within the configured **IPDV Threshold: 0.001 to 1000ms** (default is **2ms**). The minimum value of 0.001 is adjusted when the **Sync** or **Delay-Request** is set to 4 messages/s or less.
- **Unusable (ns)**, available for Time Error measurement with G.8275.2 profile, is based on IPDV but using an independent PTSF-Unusable threshold to raise the **Unusable** alarm: **500 ns to 500000 ns** (default is **5000 ns**).

## Verdict

- **PDV (ns)** check box when selected (default) defines the packet delay variation threshold. The alarm is raised when PDV is not within the configured value: **0 ns to 500 000 ns** (default is **500 ns**). Only available for Time Error measurement type with an Ethernet interface.

## Quality Level

The quality level, available with the 1588 PTP test application, characterizes the clock quality in terms of network synchronization.

- **QL Mismatch Monitoring** when selected (default) enables the quality level mismatch monitoring.
- **Expected QL** allows the selection of the expected quality level value. Available when the **QL Mismatch Monitoring** check box is selected.

## Setup

1588 PTP

Profile ITU	Quality Level value	PTP Clock Class	Description
G.8265.1	QL-PRS	80	Primary Reference Source Traceable (G.811)
	QL-STU/UNK	82	Synchronized - Traceability Unknown
	QL-PRC (default)	84	Primary Reference Clock Traceable (G.811)
	QL-ST2	86	Traceable to Stratum 2 (G.812 Type II)
	QL-INV3	88	Quality Level Invalid 3
	QL-SSU-A/TNC	90	Type I or V slave clock (G.812) Traceable to Transit Node Clock (G.812 Type V)
	QL-INV5	92	Quality Level Invalid 5
	QL-INV6	94	Quality Level Invalid 6
	QL-SSU-B	96	Type VI slave clock (G.812)
	QL-INV9	98	Quality Level Invalid 9
	QL-ST3E	100	Traceable to Stratum 3E (G.812 Type III)
	QL-EEC2/ST3	102	Ethernet Equipment Clock Option 2 Traceable to Stratum 3 (G.812 Type IV)
	QL-EEC1/SEC	104	Ethernet Equipment Clock Option 1 Synchronous Equipment Clock (G.813 or G.8262, Option 1)
	QL-SMC	106	Traceable to SONET Minimum Clock (G.813 or G.8262, Option 2)
	QL-PROV	108	Provisionable by the Network Operator (PNO)
QL-DNU/DUS	110	Do Not Use Do Not Use for Synchronization	
G.8275.1	QL-PRC/PRS (default)	6, 7, 135, 140	Primary Reference Clock Traceable (G.811)
	QL-SSU-A/ST2	150	Type I or V slave clock (G.812) Traceable to Stratum 2 (G.812 Type II)
	QL-SSU-B/ST3E	160	Type VI slave clock (G.812) Traceable to Stratum 3E (G.812 Type III)



Profile ITU	Quality Level value	PTP Clock Class	Description
G.8275.2	QL-PRC/PRS (default)	6, 7, 135, 140	Primary Reference Clock Traceable (G.811)
	QL-SSU-A/ST2	150	Type I or V slave clock (G.812) Traceable to Stratum 2 (G.812 Type II)
	QL-SSU-B/ST3E	160	Type VI slave clock (G.812) Traceable to Stratum 3E (G.812 Type III)
	QL-SEC/EEC1/ST3/EEC2	165, 248, 255	Synchronous equipment clock (G.813 Option I) Ethernet equipment clock (G.8262 Option I) Traceable to Stratum 3E (G.812 Type IV or G.8262 Option II) Ethernet equipment clock (G.8262 Option II)

## Pass/Fail Verdict

**Pass/Fail Verdict** check box when selected (default) enables the use of the pass/fail verdict. The global pass/fail verdict is based on the following criteria: alarms (**Link Down**, **Loss Sync**, **Loss Announce**, **Unusable** (G.8265.1), and/or **QL Mismatch** (when **QL Mismatch Monitoring** is enabled)), or the test is automatically aborted (service request denied, session canceled, or no reply for G.8265.1; sync message rate changed for G.8275.1). Only available with 1588 PTP test.

## Restore 1588 PTP Defaults

Reverts the test application to its default factory settings. Only available with 1588 PTP test.

## Setup

### *BERT and Unframed BERT*

---

## BERT and Unframed BERT

**Note:** Available with Pattern client.

From the test menu, tap **Setup**, **Test Configurator**, and tap on the **BERT** or **Unframed BERT** block.

### Pattern

The icon next to the **Pattern** label indicates the status of the received pattern signal. Refer to *Status Bar* on page 36 for more information.

- **TX Rate**, available with ODUflex mapped to pattern, allows the selection of the transmission rate. Unit choices are %, **Kbit/s**, **Mbit/s**, and **Gbit/s** (default).
- **Coupled RX to TX** check box, when selected (default), couples both the TX and RX signal with the same test pattern. For a framed test, the **Coupled RX to TX** check box is selected and cannot be cleared. For unframed parallel test, the **Coupled RX to TX** check box is selectable (selected by default) when **All Lanes** is selected.
- **No Pattern Analysis (Live)** check box when cleared (default), monitors the received traffic pattern. For live traffic, the **No Pattern Analysis (Live)** check box should be selected as the traffic is a live pattern thus there is no analysis of pattern loss, bit error, and no traffic indications. Only available with a framed test.
- **TX Pattern / RX Pattern** allows selecting the test pattern for each direction. When **User Pattern** is selected, enter the payload pattern hexadecimal value. For Multi-Pattern, see *Multi-Pattern Configuration* on page 215.

For FlexO, OTN, and SONET/SDH:

Test	Framing	Pattern
OTN BERT	Framed <sup>a</sup>	PRBS9, PRBS15, PRBS20, PRBS23, PRBS31 (default), Null Client, and User Pattern.
	Unframed	PRBS9, PRBS11 <sup>b</sup> , PRBS15, PRBS20 <sup>b</sup> , PRBS23, PRBS31 (default), Square Wave 1 zero/one <sup>c</sup> , Square Wave 2 zeros/ones <sup>c</sup> , Square Wave 4 zeros/ones <sup>c</sup> , Square Wave 8 zeros/ones <sup>c</sup> , and Square Wave 16 zeros/ones <sup>c</sup>
OTN-SONET/SDH BERT, SONET/SDH BERT	Framed	PRBS9, PRBS11, PRBS15, PRBS20, PRBS23, PRBS31 (default), 1111, 1100, 1010, 0000, 1in8, 1in16, 2in8, and User Pattern
FlexO BERT	Framed	PRBS31 and Null Client

- Only **PRBS31** is available with ODU0/1/2/3 multiplex in OTU4.
- Not available with OTU4 - 4 **Unframed Physical Lanes**.
- Square Wave patterns are only available when the **All Lanes** check box is selected. Not available with **20 Unframed Physical Lanes** and **OTU4 - 4 Unframed Physical Lanes**.

For DS<sub>n</sub>/PDH interfaces:

Pattern	DS0/E0	DS1	DS3/E1	E3/E4
0000, 1010, 1100, 1111, 1in8, 1in16, 2in8, PRBS9, PRBS20, User Pattern	X	X	X	X
3in24	X	X	X	X (E3 only)
T1 DALY, 55 OCTET, Multi-Pattern	-	X	-	-
PRBS11	X <sup>a</sup>	X	X	X
PRBS15		X	X <sup>a</sup>	X
PRBS23	-	X	X	X <sup>a</sup>
PRBS31	-	X	X	X
QRSS	-	X <sup>a</sup>	-	-
Null Client	-	-	-	-

- Default value.

## Setup

### *BERT and Unframed BERT*

---

- **Invert** check box, when selected (cleared by default), inverts the generated/expected test pattern meaning that every 0 will be changed for 1 and every 1 for 0. For example, the pattern 1100 will be sent as 0011. Patterns **PRBS15**, **PRBS23**, and **PRBS31** are defined inverted as per ITU standard but EXFO uses non-inverted patterns for Transport test applications. Not available when pattern is Multi-Pattern.
- **All Lanes** check box when selected allows setting the same TX and/or RX test pattern for all lanes; when cleared (default) allows setting a different test pattern for each lane: **TX Pattern** with **Invert** and **RX Pattern** with **Invert**). Available with unframed parallel interfaces.

**Pattern Sync**, available for each lane when the **All Lanes** check box is cleared, indicates the status of the received signal pattern. Refer to *Status Bar* on page 36 for more information.

## Bit Error

- **Pass/Fail Verdict** enables or disables the bit-error-rate pass/fail verdict by selecting either **Bit Error Count**, **Bit Error Rate** (default), or **Disabled**.
- **BER Threshold** allows entering the maximum bit error count/rate allowed before declaring a fail verdict: **0** (default) to **999999** for count; **1.0E-14** to **1.9E-01** for rate (default value is **1.0E-12** for framed; **2.1E-5** for **CLR4** unframed; **5.0E-5** for **SR4**, **CWDM4**, **AOC**, and **Other** unframed). The **BER Threshold** applies to individual pattern for **Multi-Pattern**.

## Service Disruption

**Note:** Not available with FlexO BERT, Unframed OTN, and Multi-Pattern.

The presence of a specific Defect triggers the service disruption measurement; this includes any defect above in the hierarchy. If a measurement exceeds the Test Period of 5 minutes, a service disruption equal to the Test Period is recorded. The service disruption measurements are cleared when changing the criteria.

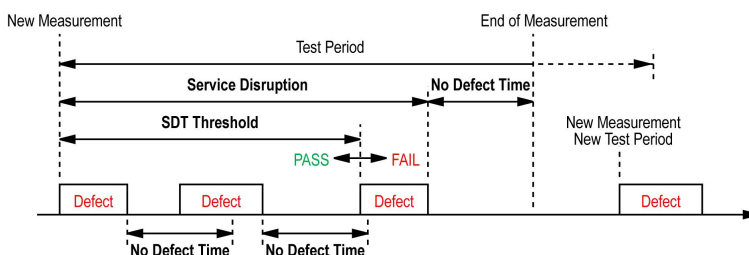

- **Defect** allows choosing on which layer and defect the service disruption time test will be performed. Choices depend on the selected test path.

Layer	Defect
Interface	OTN/SONET/SDH: LOS <sup>a</sup> DSn: LOS, BPV, EXZ PDH: LOS, CV
Section/RS	LOF-S/RS-LOF, B1
Line/MS	AIS-L/MS-AIS, RDI-L/MS-RDI, REI-L/MS-REI, B2
STS/AU Path	AIS-P/AU-AIS, LOP-P/AU-LOP, RDI-P/HP-RDI, REI-P/HP-REI, B3, UNEQ-P/HP-UNEQ, PDI-P (SONET)
VT/TU Path	AIS-V/TU-AIS, LOP-V/TU-LOP, UNEQ-V/LP-UNEQ, RDI-V/LP-RDI, REI-V/LP-REI, BIP-2
DS1	AIS, OOF, RAI, Framing Bit, CRC-6
DS3	AIS, OOF, Idle, RDI, F-Bit, C-Bit, P-Bit, FEBE
E1	AIS, CRC-4, E-Bit, LOMF, TS16 AIS, LOF, FAS, RAI, RAI MF
E4, E3, E2	AIS, LOF, FAS, RAI
OTL <sup>b</sup>	LOF, OOF, LOL, LOR, OOR, Inv. Marker, FAS

## Setup

### BERT and Unframed BERT

---

Layer	Defect
FEC	FEC CORR, FEC UNCORR
OTUk <sup>c</sup>	AIS, LOF, OOF, LOM, OOM, BDI, IAE, BIAE, BIP-8, BEI, FAS, MFAS
ODUk <sup>c</sup>	AIS, OCI, LCK, BDI, BIP-8, BEI, FSF, BSF, FSD, BSD
OPUk <sup>c</sup>	AIS, CSF, PLM <sup>d</sup> , MSIM <sup>e</sup> , LOOMFI <sup>e, f</sup> , OOMFI <sup>e, f</sup> , OMFI <sup>e, f</sup>
BER <sup>g</sup>	Pattern Loss, Bit Error (default)

- a. Not available with QSFP transceivers.
- b. The service disruption time measurement is available per lane for OTL defects at the exception of LOL which is global for all lanes. Refer to *OTL-SDT* on page 486 for results per lanes.
- c. Only available on the top layer.
- d. Available when the PLM check box is selected (refer to page 287 for more information).
- e. Available with multiplex test only.
- f. Available with OPU4 only.
- g. Available when the **No Pattern Analysis (Live)** check box (see page 209) is cleared.

**Note:** *The Service Disruption Time measurement supports a parent defect approach where the SDT measurement is triggered when the selected defect or a higher defect in the signal structure hierarchy is detected. For example, if Bit Error is selected, an OPU AIS error will trigger an SDT event.*

- **No Defect Time (ms)** allows selecting the period without any defects before stopping SDT measurement: **0.005 ms to 2000 ms** (default is **300 ms**).
- **Disruption Monitoring** check box when selected (disabled by default) enables the disruption time measurements. However, the measurement will only start if the test is already started, or when the test will be started. Clearing the **Disruption Monitoring** check box or stopping the test, stops the measurement without clearing the results. Starting the test while the **Disruption Monitoring** check box is selected resets the results.

- **Pass/Fail Verdict** check box when selected (cleared by default) enables service disruption pass/fail verdict and allows setting the threshold value.
- **SDT Threshold (ms)** allows configuring the acceptable maximum service disruption time before failing the test: **0.001** to **299999.999 ms** (default is **50** ms).

## Setup

*BERT and Unframed BERT*

---

### Multi-Pattern Configuration

**Note:** Only available for **DSn/PDH BERT** test application with **DS1** signal (**DS0** disabled) and when the pattern is **Multi-Pattern**.

The **Multi-Pattern** feature allows sending each pattern for a specific duration, sequentially and continuously.

- **Pattern** represents a sequence of patterns that will be generated: **1111**, **1in8**, **2in8**, **3in24**, and **QRSS**.
- **Enable** check box allows enabling the generation of each pattern individually in the pattern sequence. All patterns are enabled by default. All 1's (1111) is disabled for unframed test.
- **Individual Pattern Duration** specifies the transmission duration of each pattern: **15 s**, **30 s**, **45 s**, **1 min**, **2 min**, **3 min** (default),... up to **15 min**.

### Restore < Test Application > Defaults

Reverts the test application to its default factory settings.



## BERT and Unframed BERT - CPRI/OBSAI

From the test menu, tap **Setup**, **Test Configurator** and tap on the **BERT** or **Unframed BERT** block.

### Restore CPRI/OBSAI /BERT Defaults

Reverts the test application to its default factory settings.

### Pattern

The icon next to the **Pattern** label indicates the status of the received pattern signal. Refer to *Status Bar* on page 36 for more information.

- **Coupled RX to TX** check box, when selected (default and dimmed), couples both the TX and RX signal with the same test pattern.
- **No Pattern Analysis (Live)** check box when cleared (default), monitors the incoming traffic pattern and Round-Trip Latency. For live traffic, the **No Pattern Analysis (Live)** check box should be selected as the traffic is a live pattern and in this case no monitoring is required. The **No Pattern Analysis (Live)** check box is however selected by default for framed CPRI.
- **TX Pattern / RX Pattern** allows selecting the test pattern for each direction: **PRBS9**, **PRBS11**, **PRBS15**, **PRBS20**, **PRBS23**, **PRBS31** (default), and **User Pattern**. When **User Pattern** is selected, enter the payload pattern hexadecimal value.
- **Invert** check box, when selected (cleared by default), inverts the generated/expected test pattern meaning that every 0 will be changed for 1 and every 1 for 0. For example, the pattern 1100 will be sent as 0011.

## Setup

### *BERT and Unframed BERT - CPRI/OBSAI*

---

#### **Bit Error**

- **Pass/Fail Verdict** enables and sets the bit error rate/count threshold prior to run the test. This allows for a simple pass/fail verdict, leaving no room for misinterpretation of the test results. To enable the pass/fail verdict, select either **Bit Error Count** or **Bit Error Rate** (default is **Disabled**).
- **BER Threshold** allows entering the maximum bit error count/rate allowed before declaring a fail verdict: **0** (default) to **999999** for count; **1.0E-14** to **1.9E-01** (default is **1.0E-12**) for rate.

#### **CPRI/OBSAI**

**Note:** *Available with Framed L2.*

**Pass/Fail Verdict** check box, when selected (default), enables the pass/fail verdict. A pass verdict is declared when the link status is up and no CPRI/OBSAI alarm and/or error are recorded for the duration of the test. For CPRI 24.3G with RS-FEC enabled, the FEC-COR-CW and Pre-FEC-SYMB errors are not considered in the pass/fail verdict since they are not causing any traffic error.

## Service Disruption

The presence of any defect, listed in the following table, triggers the service disruption measurement; this includes any defect above in the hierarchy. If a measurement exceeds the Test Period of 5 minutes, a service disruption equal to the Test Period is recorded. The service disruption measurements are cleared when changing the criteria. Only available with framed test.

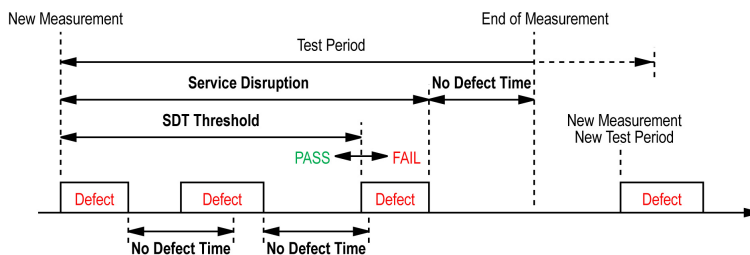

Test	Defect
CPRI BERT	LOS, Code Violation, Sync Header, 66B Block, K30.7, LOF, FAS, R-LOS, R-LOF, RAI, SDI, Bit Error <sup>a</sup> , FEC-UNCORR-CW
OBSAI BERT	LOS, CV, K30.7, CRC, LOF, FAS, Bit Error <sup>a</sup>

- a. Only applicable when the **No Pattern Analysis (Live)** check box is cleared.
- **No Defect Time (ms)** allows selecting the period without any defects before stopping SDT measurement: **0.005 ms to 2000 ms** (default is **300 ms**).
  - **Disruption Monitoring** check box when selected (disabled by default) enables the disruption time measurements. However, the measurement will only start if the test is already started, or when the test will be started. Clearing the **Disruption Monitoring** check box or stopping the test, stops the measurement without clearing the results. Starting the test while the **Disruption Monitoring** check box is selected resets the results.

## Setup

### *BERT and Unframed BERT - CPRI/OBSAI*

---

- **Pass/Fail Verdict** check box when selected (cleared by default) enables the service disruption pass/fail verdict and allows setting the threshold value.
- **SDT Threshold (ms)** allows configuring the acceptable maximum service disruption time before failing the test: **0.001** to **299999.999 ms** (default is **50** ms).

## BERT and Unframed BERT - eCPRI

From the test menu, tap **Setup**, **Test Configurator** and tap on the **BERT** or **Unframed BERT** block.

### Pattern

The icon next to the **Pattern** label indicates the status of the received pattern signal. Refer to *Status Bar* on page 36 for more information.

- **Coupled RX to TX** check box, when selected (default and dimmed), couples both the TX and RX signal with the same test pattern.
- **No Pattern Analysis (Live)** check box when cleared (selected by default), monitors the incoming traffic pattern and Round-Trip Latency. For live traffic, the **No Pattern Analysis (Live)** check box should be selected as the traffic is a live pattern and in this case no monitoring is required.
- **TX Pattern / RX Pattern** indicates **PRBS31** as the test pattern for each direction and is not configurable.
- **Invert** check box, when selected (cleared by default), inverts the generated/expected test pattern meaning that every 0 will be changed for 1 and every 1 for 0. For example, the pattern 1100 will be sent as 0011.
- **Invert** check box, when selected (cleared by default), inverts the generated/expected test pattern meaning that every 0 will be changed for 1 and every 1 for 0. For example, the pattern 1100 will be sent as 0011.

## Setup

### BERT and Unframed BERT - eCPRI

## Bit Error

- **Pass/Fail Verdict** enables and sets the bit error rate/count threshold prior to run the test. This allows for a simple pass/fail verdict, leaving no room for misinterpretation of the test results. To enable the pass/fail verdict, select either **Bit Error Count** or **Bit Error Rate** (default is **Disabled**).
- **BER Threshold** allows entering the maximum bit error count/rate allowed before declaring a fail verdict: **0** (default) to **999999** for count; **1.0E-14** to **1.9E-01** (default is **1.0E-12**) for rate.

## Service Disruption

**Note:** *Not available when **No Pattern Analysis (Live)** check box is selected.*

The absence of traffic exceeding the configured **No Traffic Time** triggers the service disruption measurement. The service disruption event is closed when valid Ethernet frames are received for at least the **Debounce Time** without any service disruption event. Reaching the Test Period or stopping the test also closes the SDT event.

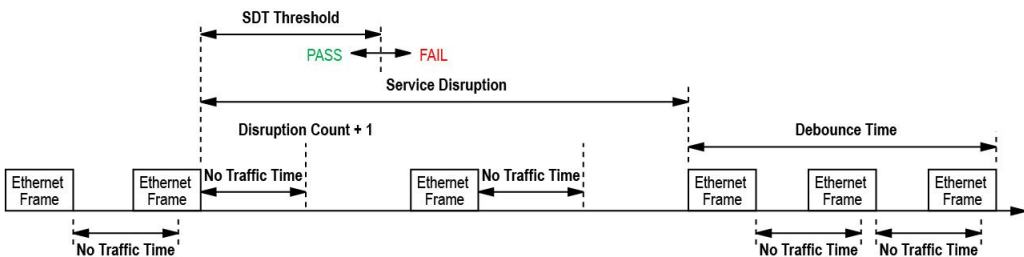

- **No Traffic Time (ms)** is the time acceptable between two Ethernet frames without any service disruption event: **0.005 ms** to **1000 ms** (default is **1 ms**).
- **Debounce Time (ms)** allows setting the period without any service disruption event before stopping the current SDT measurement: **0** (default) to **500 ms**.

- **Disruption Monitoring** check box when selected (disabled by default) enables the disruption time measurements. However, the measurement will only start if the test is already started, or when the test will be started. Clearing the **Disruption Monitoring** check box or stopping the test, stops the measurement without clearing the results. Starting the test while the **Disruption Monitoring** check box is selected resets the results.
- **Pass/Fail Verdict** check box when selected (cleared by default) enables the service disruption pass/fail verdict and allows setting the threshold value.
- **SDT Threshold** allows configuring the acceptable maximum service disruption time before failing the test: **0.005** to **299999.999** ms (default is **50** ms). The threshold value cannot be less than the **No Traffic Time** value.

## **Restore eCPRI BERT Defaults**

Reverts the test application to its default factory settings.

## BERT - DCO BERT

From the test menu, tap **Setup, Test Configurator**, the **Client** block and the **BERT** tab.

### LINK

A green/red arrow is used to indicate the status of the link at the PCS level: link up (green arrow); alarms at the PCS level, the link is down (red arrow).

The **Local Fault Detected**, **Local Fault Received**, **Remote Fault**, **LOA**, and **Hi-BER** alarms are displayed; refer to *Ethernet* on page 896 for more information.

### Pattern

- **Coupled RX to TX** check box, when selected (default), couples both the TX and RX signal with the same test pattern.
- **No Pattern Analysis (Live)** check box when cleared (default), monitors the received traffic pattern. For live traffic, the **No Pattern Analysis (Live)** check box should be selected as the traffic is a live pattern thus there is no analysis of pattern loss and bit error.
- **TX Pattern / RX Pattern** indicates **PRBS31** as the test pattern for each direction and is not configurable.
- **Invert** check box, when selected (cleared by default), inverts the generated/expected test pattern meaning that every 0 will be changed for 1 and every 1 for 0. For example, the pattern 1100 will be sent as 0011.



## Bit Error

- **Pass/Fail Verdict** enables and sets the bit error rate/count threshold prior to run the test. This allows for a simple pass/fail verdict, leaving no room for misinterpretation of the test results. To enable the pass/fail verdict, select either **Bit Error Count** or **Bit Error Rate** (default is **Disabled**).
- **BER Threshold** allows entering the maximum bit error count/rate allowed before declaring a fail verdict: **0** (default) to **999999** for count; **1.0E-14** to **1.9E-01** (default is **1.0E-12**) for rate.

## Setup

*BERT - FlexE BERT*

---

### BERT - FlexE BERT

From the test menu, tap **Setup, Test Configurator**, the **Clients** block, then the **BERT** tab.

- **Pattern on Client ID** selects the Client ID on which the pattern is applied. The pattern applies to a single client only.

### Pattern

- **Coupled RX to TX** check box, when selected (default), couples both the TX and RX signal with the same test pattern.
- **No Pattern Analysis (Live)** check box when cleared (default), monitors the incoming traffic pattern and Round-Trip Latency. For live traffic, the **No Pattern Analysis (Live)** check box should be selected as the traffic is a live pattern and in this case no monitoring is required.
- **TX Pattern / RX Pattern** indicates **PRBS31** as the test pattern for each direction and is not configurable.
- **Invert** check box, when selected (cleared by default), inverts the generated/expected test pattern meaning that every 0 will be changed for 1 and every 1 for 0. For example, the pattern 1100 will be sent as 0011.

## Bit Error

- **Pass/Fail Verdict** enables and sets the bit error rate/count threshold prior to run the test. This allows for a simple pass/fail verdict, leaving no room for misinterpretation of the test results. To enable the pass/fail verdict, select either **Bit Error Count** or **Bit Error Rate** (default is **Disabled**).
- **BER Threshold** allows entering the maximum bit error count/rate allowed before declaring a fail verdict: **0** (default) to **999999** for count; **1.0E-14** to **1.9E-01** (default is **1.0E-12**) for rate.

## Cable Test

From the test menu, tap **Setup**, **Test Configurator**, and the **Cable Test** block.

### Global Options

- **Wiring Standard** is the pin-to-pair assignment corresponding to the UTP cable used: **T568A** (default) or **T568B**.

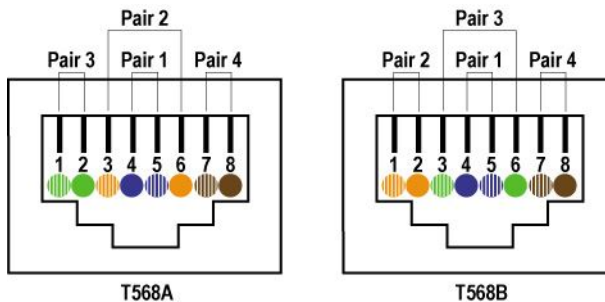

- **Length Unit** is the unit used for cable length and distance to fault results: **Meter** (default) or **Feet**.
- **PoE** check box when selected (cleared by default) allows verifying that the Power Sourcing Equipment (PSE) is capable to deliver appropriate power (PoE) to the Powered Device (PD). The PoE test is performed after the cable test is executed confirming that the cable is ready to carry data and power: either the Wire Map test reported **No fault**, **Straight pair**, **Crossed Pair**, or **Noise** ([link up](#)).

- **Power Class**, available when PoE is enabled, selects the power class of the simulated powered device:

Power Class	Power Device
Class 0 (13.0W) - (default)	Type 1
Class 1 (3.8W)	
Class 2 (6.5W)	
Class 3 (13.0W)	
Class 4 (25.5W)	Type 2

## Pass/Fail Verdict

**Pass/Fail Verdict** check box when selected (default) enables the cable test pass/fail verdict and allows setting the threshold values.

- **Prop. Delay Threshold (ns)** is the maximum time for a pulse to reach the far end: **0** to **1000** ns (default is **1000** ns for 10 Mbit/s, **556** ns for 100 Mbit/s, and **570** ns for 1 Gbit/s).
- **Delay Skew Threshold (ns)** is the maximum time between the fastest and slowest pairs of a 1000BASE-T signal: **0** to **120** ns (default is **50** ns).
- **Length Threshold (m)** is the maximum acceptable cable length: **0** to **120** m (0 to 394 feet) (default is **100** m (328 ft)).
- **PoE Loaded Voltage Threshold (V)**, available when the **PoE** check box is selected, allows the configuration of the acceptable voltage range when a load is applied: minimum value is either **37** (default) for Class 0 to 3 or **42.5** (default) for Class 4; maximum value is 57 (default). A Pass verdict is declared when the measured voltage is within the defined range.

## Restore Cable Test Defaults

Reverts the test application to its default factory settings.

## Setup

CFP/OSFP/QSFP/SFP

---

### CFP/OSFP/QSFP/SFP

This tab gives hardware information related to the inserted transceiver module.

From the test menu, tap **Setup, Test Configurator**, tap on the interface block or on the **Local** block for iSAM, and on the CFP/OSFP/QSFP/SFP tab.

- **Port**, available with FlexE BERT/FlexO BERT, allows selecting the physical port to be displayed.
- **FlexO Instance ID**, available with FlexO BERT, indicates the FlexO instance identifier per port.
- **FlexE PHY Number**, available with FlexE BERT, indicates the FlexE PHY number assigned to the port.

### Parameters

The following parameters are retrieved from the transceiver:

Parameter	CFP4	CFP8	QSFP+ QSFP28 QSFP56-DD OSFP	SFP SFP+ SFP28
Module ID <sup>a</sup>	X	X	X	X
Vendor Name	X	X	X	X
Part Number	X	X	X	X
Serial Number	X	X	X	X
Hardware Revision	X	X	X	X
Firmware Version	X	X	-	-
Revision Compliance	-	-	X	-
Connector Type	X	X	X	X
Speed	X	X	X	X
Type/Compliance Code	X	X	X	X

Parameter	CFP4	CFP8	QSFP+ QSFP28 QSFP56-DD OSFP	SFP SFP+ SFP28
Wavelength	-	-	-	X
Mode	X	X	X	X
Power Class	X	X	X	X
Temperature (Actual/Max) <sup>b</sup>	X	X	X	X
Lane Ratio Type	X	-	-	-
Host Lane Signal Spec	-	X	-	-
WDM Type	X	X	-	-
Signal Code - Modulation	-	X	-	-
Signal Code - Coding	-	X	-	-
CLEI Code	X	X	X	-

- a. Also displays **(Tunable)** for transceivers having the tunable capability.
- b. Displays respectively the current and the maximum temperature recorded. For iOptics this information is available on the *Summary - iOptics* page (refer to *Temperature* on page 568).

## Clock

Allows the configuration of the clock synchronization.

From the **Test** menu, tap **Setup**, **Test Configurator**, and tap on the clock block.

**Note:** *A TA-Sync transceiver system is required on the 88260 module when using an external clock input or when generating an external clock out. In this case a message is displayed when there is an issue with the TA-Sync (see Transceiver System Status on page 129).*

## Clock Synchronization

**Clock Mode** allows selecting the clock source that will be used for transmission (TX). The clock mode for One-way Latency measurement mode is limited to **External 1PPS** or **Internal GNSS**.

- **Internal:** Internal clock of the unit (STRATUM 3). The clock mode is forced to **Internal** for Multi-Channel OTN and for eCPRI BERT in Round-Trip or One-Way P<m> → P<m> Latency mode.
- **Recovered:** Line clock from the input port signal involved in the test. Available with Transport test applications, CPRI/OBSAI RRH, and Ethernet applications using 10G WAN. The clock mode is forced to **Recovered** for 1GE electrical interface using **Slave** local clock (see **Local Clock** on page 292).
- **External:** Clock signal from the EXT CLK port.
- **External 1PPS:** 1PPS clock signal from the EXT CLK or 1PPS (88260) port.
- **Internal GNSS:** 1PPS clock signal provided by the Internal GNSS Receiver. Requires a GNSS antenna connected to the ANTENNA port (88260).



- **Backplane:** Clock from another module on the platform (only supported on FTB-2 and FTB-2 Pro platforms). The other module must support the backplane clock feature and must be enabled. Not available when the **Backplane Clock** check box is selected (see page 237). The Backplane clock cannot be shared between FTB- and FTBx-modules.

**Note:** *For CPRI/OBSAI Base Station single port topology, the clock is configurable to **Internal** or **External**; for CPRI/OBSAI Remote Radio Head, the clock is fixed to **Recovered**; for CPRI dual port topology, the clock block is not displayed and the clock mode is automatically set to **Internal** for the Base Station and **Recovered** for the Remote Radio Head.*

## Internal GNSS

**Note:** *Available when the **Clock Mode** is set to **Internal GNSS**. The Internal GNSS receiver settings are configurable from System - GNSS on page 420.*

- **Reference** is set to **1PPS**.
- **LOPPS-L** on a green background indicates that a valid clock is received.

## Ext Clock In

**Note:** *Available when the **Clock Mode** is set to **External** or **External 1PPS**.*

Allows setting the external clock for test synchronization.

- **Interface** allows the selection of the clock interface: **DS1** (default), **E1**, **2 MHz**, **10 MHz**, or **1PPS**. **2 MHz** is selected by default when DS1 is not supported. **1PPS** is automatically selected in **One-Way** latency measurement mode (**Dual Test Set** and eCPRI BERT). **10 MHz** is only available with CPRI/OBSAI BERT.

**Ext Clock In** on a green background indicates that a valid clock is received.

## Setup

### Clock

---

**LOS** on a red background indicates that the received clock is not valid.

**LOPPS-L**, available with 1PPS, on a green background indicates that a valid clock is received.

- **Connector** either indicates the connector type used for the clock or on 8880 allows the selection of **Bantam** or **RJ48C** when the BNC connector is used by the test application. The module connector blue LED used for Ext Clock In is flashing.
- **Termination** mode specifies how the module is connected to the synchronization signal. The **Termination** mode is set to **TERM** for 2MHz and configurable for DS1 and E1.

For DS1:

- **TERM** provides an input that terminates the DS1 signal.
- **DSX-MON** provides high-input impedance and compensation for resistive loss. This setting is useful for monitoring DS1 signals at DSX monitor points, which are resistor-isolated.
- **BRIDGE** provides high-input impedance for bridging lines that are already terminated. This setting is useful for bridging directly across copper cable pairs.

For E1:

- **TERM** provides an input that terminates the E1 signal.
- **MON** provides high-input impedance and compensation for resistive loss. This setting is useful for monitoring E1 signals at monitor points, which are resistor-isolated.
- **BRIDGE** provides high-input impedance for bridging lines that are already terminated. This setting is useful for bridging directly across copper cable pairs.
- **Line Coding** allows the selection of the interface line coding.

For DS1: **AMI** and **B8ZS** (default).

For E1: **AMI** and **HDB3** (default).

- **Framing:** Allows the selection of the interface framing.  
For DS1: **SF**, **SLC-96**, and **ESF** (default).  
For E1: **PCM30** (default), **PCM30 CRC-4**, **PCM31**, and **PCM31 CRC-4**.
- **Frequency (MHz)** displays the frequency of the received signal rate.
- **Offset (ppm)** displays the positive or negative frequency offset between the standard rate specification and the rate from the received signal. The background color is used to indicate if the received clock meets (green) or not (red) the standard rate specification.

Signal	Standard Rate specification
DS1	1544000 ± 8 bit/s (± 4.6 ppm)
E1	2048000 ± 10 bit/s (± 4.6 ppm)
2MHz	2048000 ± 10 bit/s (± 4.6 ppm)

## Ext Clock Out

**Note:** Available when the **Clock Mode** is set to **Internal**, **Recovered**, or **Backplane**. Not available on 8870.

Allows setting the clock that will be generated.

- **Interface Type** allows the selection of the clock interface: **None** (default when DS1 is not supported), **DS1** (default), **E1**, and **2MHz** (default for 88460). For eCPRI BERT the interface type is fixed to **None**.

**Ext Clock Out** on a green background indicates that a valid clock is generated on the clock port.

**LOC** on a red background indicates that no clock is generated on the clock port.

- **Connector** either indicates the connector type used for the clock or on 8880 allows the selection of **Bantam** or **RJ48C** when the BNC connector is used by the test application.

## Setup

### Clock

---

- **LBO** (Line Build Out), available with DS1 only, allows the selection of the interface Line Build Out that meets the interface requirements over the full range of cable lengths: **DSX-1 (0-133 ft)** (default), **DSX-1 (133-266 ft)**, **DSX-1 (266-399 ft)**, **DSX-1 (399-533 ft)**, and **DSX-1 (533-655 ft)**.
- **Line Coding**, available with DS1 and E1, allows the selection of the interface line coding.  
For DS1: **AMI** and **B8ZS** (default).  
For E1: **AMI** and **HDB3** (default).
- **Framing**, available with DS1 and E1, allows the selection of the interface framing.  
For DS1: **SF**, **SLC-96**, and **ESF** (default).  
For E1: **PCM30** (default), **PCM30 CRC-4**, **PCM31**, and **PCM31 CRC-4**.

## REF OUT

**Source**, available with CFP4 and QSFP28 transceivers, allows selecting the source clock that will be used for transmission (TX) on the **REF OUT** port: **TX MCLK** (default for CFP4), **Internal 1/8**, **Internal 1/40**, **Internal 1/160** (default for QSFP28). **TX MCLK** is a clock derived from the inserted transceiver and its frequency is based on the setting of the `<rate>` *Advanced* - `<transceiver>` *Control* on page 634.

**Frequency (MHz)** displays the frequency of the clock generated on the REF OUT port based on the test interface rate<sup>1</sup> and divider ratio as follows:

Interface/Rate	Divider Ratio			
	1/8 <sup>a</sup>	1/16	1/40 <sup>a</sup>	1/160 <sup>a</sup>
OC-192 STM-64 10G WAN	-	622.08 MHz	-	-
10G LAN 40GE	-	644.5313 MHz	-	-
OTU2	-	669.3266 MHz	-	-
OTU1e	-	690.5692 MHz	-	-
OTU2e	-	693.4813 MHz	-	-
OTU1f	-	704.3806 MHz	-	-
OTU2f	-	707.3527 MHz	-	-
OTU3	-	672.1627 MHz	-	-
OTU3e1	-	696.4214 MHz	-	-
OTU3e2	-	696.6149 MHz	-	-
OTU4	3494.1 MHz	-	698.8123 MHz	174.7031 MHz
100GE	3222.6 MHz	-	644.5313 MHz	161.1328 MHz

- a. Only available with CFP4 and QSFP28 transceivers. Not available for QSFP28 transceivers on FTBx-88260.

---

1. For parallel interfaces, the REF OUT signal is derived from the interface lane rate.

## Setup

### Clock

---

**Clock Out** indicates the status of the clock generated on the **REF OUT** port as follows:

- Green: a valid clock is generated.
- Red: the clock is either not available (--) then not generated, or not valid but generated.

**Note:** *The Ref Out clock port provides an eye diagram timing reference for 10G and above optical devices. This clock is provided for basic assessment. Formal qualification may require specialized external circuitry.*

## Backplane

**Note:** *Only supported on FTB-2 and FTB-2 Pro platforms when the **Clock Mode** is set to **External, Recovered, or Internal**.*

**Backplane Clock** check box when selected (cleared by default) makes available the source clock (**Clock Synchronization - Clock Mode**) to other modules on the platform. Other modules on the platform need to set the **Clock Mode** as **Backplane** to use this clock. The **Backplane Clock** should be only enabled on one module on the same platform. The Backplane clock cannot be shared between FTB- and FTBx- modules.

**Backplane** indicates that the background clock is generated (green) or disabled (gray).

**LOC** on a red background indicates, when the backplane clock is enabled, that the synchronization is not possible with the selected reference clock.

## Tributary Synchronization

**Note:** Only available with SONET/SDH - DS<sub>n</sub>/PDH and DS<sub>n</sub>/PDH test applications. Not supported in Through topology.

**Clock Mode** allows selecting the source clock that will be used for tributary transmission (TX); default is **Internal**. The availability of clock modes is as follows:

Clock Synchronization	Tributary Synchronization
Internal	Internal
Recovered	Internal Recovered
External	Internal External
Backplane	Internal Backplane

- **Internal:** Internal clock of the unit (STRATUM 3).
- **Recovered:** Line clock from the input port signal involved in the test.
- **External:** Clock signal from the EXT CLK port.
- **Backplane:** Clock from another module on the platform (only supported on FTB-2 and FTB-2 Pro platforms). The other module must support the backplane clock feature and must be enabled. The Backplane clock cannot be shared between FTB- and FTBx-modules.

## Setup





### Device Under Test - iOptics

---



## Device Under Test - iOptics

From the test menu, tap **Setup**, and **Test Configurator**.

- **Transceiver selection:** Tap on a transceiver icon to select the interface/port. The selected transceiver is highlighted with an amber contour. The selected transceiver type and its status are displayed.

Status	Description
	Validating the transceiver.
	Transceiver correctly detected.
	Incompatible transceiver detected.
	Missing transceiver.

For 88260 module a message is displayed when either no transceiver systems are inserted or are all invalid. Inserting or removing a transceiver system triggers the transceiver system detection process resulting that the default port is selected and results are cleared.

Status	Description
	Invalid Transceiver System.
	No Transceiver System Detected.

- For standard optical transceivers, a fiber loopback patch cord is required to perform the test with applicable attenuation to protect the optical device. Ensure the laser is turned on.



- For bidirectional transceivers using compatible transceivers, same rate and connector type, for upstream and downstream respectively. Connect a fiber patch cord with the necessary attenuator between the port under test and the port in transparent loopback mode  and ensure the laser is turned on.
- For an Active Optical Cable (AOC):

For a module having at least two transceiver ports with the same connector: Connect the other end of the cable to the port automatically selected and configured in transparent loopback  and ensure the laser is turned on.

For a module having only one transceiver port with the same connector: Connect the other end of the cable to the port with the same connector of another module which must be configured in Smart Loopback with **Transparent (Pseudo-Physical)** mode enabled (see **Loopback Mode on page 182**). Ensure the laser is turned on.
- For a Direct Attached Copper (QSFP-DD DAC):

Connect the other end of the cable to the QSFP-DD port of another module which must be configured in Smart Loopback with **Transparent (Pseudo-Physical)** mode enabled (see **Loopback Mode on page 182**). Ensure the laser is turned on.
- **Use with QSFP28 to SFP28 Adapter** check box need to be selected (cleared by default) when testing low rates (25G and less) using a QSFP28 to SFP28 adapter inserted in the selected QSFP28 port of a 88460 module.
- **Tunable:** For transceivers having tunable capability, **(Tunable)** is written next to the transceiver module ID.

## Setup

### Device Under Test - iOptics

- **Rate:** Once the transceiver is correctly detected , select the interface rate. Rates depend on the selected port, the inserted transceiver, and the rates supported on the module.

Transceiver	Rate			
	Transport	Ethernet	Fibre Channel	CPRI/OBSAI
CFP8, QSFP56-DD	-	400GE (8 Lanes)	-	-
QSFP56	-	200GE (4 Lanes) 100GE (4 Lanes)	-	-
OSFP	-	400GE (4 Lanes)	-	-
CFP4	OTU4 (4 Lanes)	100GE (4 Lanes)	-	-
QSFP28	OTU4 (4 Lanes)	100GE (4 Lanes) 100GE (2 Lanes) 100GE (1 Lane)	-	-
QSFP+	OTU3e2 (4 Lanes) OTU3e1 (4 Lanes) OTU3 (4 Lanes)	40GE (4 Lanes)	-	-
SFP28	-	25GE	32X	-
SFP+ SFP/SFP+ (Port 1 only)	OTU2 OTU1e OTU2e OTU1f OTU2f OTU1 OC-192/STM-64 OC-48/STM-16 OC-12/STM-4 OC-3/STM-1 OC-1/STM-0	10GE WAN 10GE LAN 1GE Optical 100M Optical	1X 2X 4X 8X 10X 16X	CPRI - 1.2G CPRI - 2.4G CPRI - 3.1G CPRI - 4.9G CPRI - 6.1G CPRI - 9.8G CPRI - 10.1G OBSAI- 1.5G OBSAI - 3.1G OBSAI - 6.1G

- **Bidirectional** check box when selected (default, when the transceiver reports that it is bidirectional) allows testing bidirectional transceivers. Available with Ethernet and CPRI rates up to 25G on module having two ports supporting the same connector/rate.

- **Vendor Name, Part Number, Serial Number, Connector Type, Wavelength, and Mode** are information retrieved from the transceiver (see page 242).

**Modify** button beside **Wavelength**, available with tunable transceivers, is used to configure the transceiver wavelength. Refer to *Modify Wavelength (SFP)* on page 990.

- **Host/Media Loopback** allows the selection of the transceiver loopback mode: **None** (default), **Host Side Input**, **Media Side Output**. Only available when the QSFP56 transceiver is supporting host/media loopback.
- **More** gives additional transceiver system/module information and settings.

**Transceiver System** tab: See *Transceiver System (TA/TA4)* on page 424.

**Device Under Test** tab:

- **Parameters** are retrieved from the transceiver (see *Parameters* on page 229).
- **Lasers OFF at Start-Up** allows turning off all lasers automatically when starting the module or when switching from one test application to another. This check box is cleared by default. Not available with DAC and Host/Media Loopback mode.

# eCPRI Flow - Profile

From the **Test** menu, tap **Setup, Test Configurator**, the protocol block, and the **Profile** tab.

## Traffic Shaping

### ► Frame Size (Bytes)

The frame size is programmable from 64 to 16000. The minimum frame size will be adjusted according to the frame structure and components selected. The following table lists each component that may affect the minimum frame size value.

The following table lists each component that may affect the minimum frame size value.

Component	Description
VLAN	4 bytes per VLAN (up to 3 VLAN)
UDP	8 bytes
Ethernet Header	14 bytes
eCPRI	8 or 12 bytes depending on the message type
IPv4	20 bytes
BERT Tag	14 bytes
BERT Minimum payload content (PRBS)	8 or 24 (depending on the Message Type or Transport layer used with the message generation)
Ethernet FCS	4 bytes

- **TX Rate** allows the selection of the transmission rate in percentage of utilization (100 percent by default), Mbit/s, or Gbit/s. The maximum percentage is 105 percent depending on the frame size selected.

## QoS Measurements

**Note:** For Dual Port topology in **One-Way P<m> ↔ P<n>**, these settings are coupled.

- ▶ **Latency/Jitter** check box, when selected (default), allows latency/jitter configuration and monitoring.

- ▶ **Measurement Mode:**

**One-Way** measurement provides the delay measurement for each direction independently on a specific port. This mode requires a 1PPS interface/reference (see *Clock* on page 231); the **LOPPS-L** alarm is displayed reporting its status (refer to *Clock* on page 890). On the 88260 module dual port topology, both ports must be on the same transceiver system since a TA-SYNC is required for the 1PPS interface/reference.

**Round-Trip Latency** measurement provides the total delay measurement for both directions on a specific port.

**One-Way P<m> ↔ P<n>** provides the delay measurement of each direction independently between two separate ports of a single module (Dual Port test). Only available when the rate and framing parameters (Frame Format, Network Layer, and Transport Layer) are the same on both ports.

## Setup

### eCPRI Flow - Profile

---

- **Measurement Role** determines whether the eCPRI node acts as the **Sender** (default) or the **Receiver**.

**Remote Status** indicates whether a configuration mismatch exist between each end based on the one-way delay messages that are exchanged:

Remote Status	Sender	Receiver	Description
Ready-R	X	X	Indicates that one-way delay flows normally between sender and receiver for both request/response and remote request/request
Mismatch-R	X	-	Indicates, for Sender measurement role, that the remote end is also configured as Sender.
Inactive-R	X	X	Indicates that there is no one-way delay message received within 5 seconds that can be caused by: a Link Down condition, an LOPPS-L being present on the local or peer device, both ends configured as Receiver, or incompatible framing.
--	X	X	Indicates pending state which occurs upon starting a test or when a Link Down condition is detected.

- **Measurement Rate**, available with **Sender** measurement role, defines the number of Latency/Jitter measurements to perform per second: **1 Measurements/s**.
- **Frame Loss/Out-of-Sequence** check box, when selected (default), allows Frame Loss and Out-of-Sequence monitoring.

## QoS Thresholds

**Note:** For Dual Port topology in *One-Way P<m> ↔ P<n>*, these enable/disable settings are coupled.

- **Global Pass/Fail Verdict** check box when selected (default) allows enabling and configuring each metrics individually, otherwise all pass/fail verdicts are disabled.
- **Latency** check box when selected (default) enables the latency pass/fail verdict and allows setting the maximum threshold delay per direction when applicable.
- **Jitter** check box when selected (default) enables the jitter pass/fail verdict and allows setting the maximum threshold value per direction when applicable.
- **Frame Loss Rate** check box when selected (default) enables the Frame Loss pass/fail verdict and allows setting the frame loss rate for the port: 0.0E-00 to 5.0E-02 (default is 1.0E-07). However entering a value of 0.0E-00 or below 1.0E-14 is treated as a pass/fail verdict based on loss count instead of rate.
- **Throughput** check box when selected (default) enables the throughput pass/fail verdict and allows setting the minimum and maximum threshold values for the port.

## Setup

### *EtherBERT and Unframed BERT*

---

## EtherBERT and Unframed BERT

From the test menu, tap **Setup, Test Configurator** and tap on the **EtherBERT or Unframed BERT** block.

- **Link**, available with multiple link interface (ex: 2 x 100GE), allows selecting the link to be displayed.
- **Enable** check box when selected (default), available with multiple link interface, includes the selected link in the test. At least one of the links must remain enabled.

## LINK

**Note:** *Available with OTN BERT test application with Ethernet client (EoOTN).*

A green/red arrow is used to indicate the status of the link at the PCS level: link up (green arrow); alarms at the PCS level, the link is down (red arrow).

Refer to *Ethernet* on page 896, *Ethernet - PCS Lanes* on page 900, and *Transcoding* on page 946 for more information on alarms.

## Restore OTN BERT Defaults

Reverts the test application to its default factory settings. Available with OTN BERT test application with Ethernet client (EoOTN).



## Pattern

- **Coupled RX to TX** check box, when selected (default), couples both the TX and RX signal with the same test pattern. For unframed parallel test, the **Coupled RX to TX** check box is selectable (selected by default) when **All Lanes** is selected. For **Seed A**, **Seed B**, and **PRBS31 Unscrambled** patterns, the **Coupled RX to TX** check box is selected and not configurable. Not selectable and cleared with 4 Unframed 200GAUI-4 and 8 Unframed 400GAUI-8.
- **No Pattern Analysis (Live)** check box when cleared (default), monitors the incoming traffic pattern and Round-Trip Latency. For live traffic, the **No Pattern Analysis (Live)** check box should be selected as the traffic is a live pattern and in this case no monitoring is required. Only available with framed test.
- **TX Pattern / RX Pattern** allows selecting the test pattern for each direction. When **User Pattern** is selected, enter the payload pattern hexadecimal value. The patterns are not configurable and set to **PRBS31** for 40/100GE dual port topology, and 200GE/400GE test.

Framing	Pattern
Framed	PRBS9, PRBS11, PRBS15, PRBS20, PRBS23, PRBS31 (default), CSPAT <sup>a</sup> , CJTPAT <sup>a</sup> , CRPAT <sup>a</sup> , Short CRTPAT <sup>a</sup> , Long CRTPAT <sup>a</sup> , User Pattern
Unframed (Interop)	PRBS9, PRBS11, PRBS15, PRBS20, PRBS23, PRBS31 (default), Seed A, Seed B, PRBS31 Unscrambled, User Pattern
Unframed parallel	PRBS9 <sup>b</sup> , PRBS11 <sup>b, c</sup> , PRBS15 <sup>b</sup> , PRBS20 <sup>b, c</sup> , PRBS23, PRBS31 (default)
4 Unframed 200GAUI-4 8 Unframed 400GAUI-8	PRBS13Q <sup>d</sup> , PRBS31Q (default), SSPRQ <sup>d</sup>

- a. Only available for 1G optical with **Framed Layer 1** (see Framing on page 148).
- b. Not available with 2 Unframed 50GAUI-2, 8 Unframed 200GAUI-4, and 16 Unframed 400GAUI-8/16.
- c. Not available with 100GE - 4 **Unframed CAUI-4**.
- d. Only available in TX, the RX pattern parameters and status are not available.

## Setup

### *EtherBERT and Unframed BERT*

---

- **Invert** check box, when selected (cleared by default), inverts the generated/expected test pattern meaning that every 0 will be changed for 1 and every 1 for 0. For example, the pattern 1100 will be sent as 0011. Patterns **PRBS15**, **PRBS23**, and **PRBS31** are defined inverted as per ITU standard but EXFO uses non-inverted patterns for Ethernet test applications and EoOTN. Not available with 4 Unframed 200GAUI-4 and 8 Unframed 400GAUI-8 with either PRBS13Q or SSPRQ patterns.
- **All Lanes** check box when selected allows setting the same TX and/or RX test pattern for all lanes; when cleared (default) allows setting a different test pattern for each lane: **TX Pattern** with **Invert** and **RX Pattern** with **Invert**). Available with unframed parallel interfaces. The **All Lanes** check box is forced selected for 4 Unframed 200GAUI-4 and 8 Unframed 400GAUI-8.

**Pattern Sync**, available for each lane when the **All Lanes** check box is cleared, indicates the status of the received signal pattern. Refer to *Status Bar* on page 36 for more information.

## Bit Error / Pattern Error

**Note:** *Bit Error* is available with all patterns at the exception of **Seed A** and **Seed B** for which **Pattern Error** is available.

- **Pass/Fail Verdict** enables and sets the bit/pattern error rate/count threshold prior to run the test. This allows for a simple pass/fail verdict, leaving no room for misinterpretation of the test results. To enable the pass/fail verdict, select either **Bit Error Count / Pattern Error Count** or **Bit Error Rate / Pattern Error Rate** (default is **Disabled**). Only **Bit Error Rate** and **Disabled** are available with 2 Unframed 50GAUI-2, 4 Unframed 200GAUI-4 (PRBS31Q), 8 Unframed 200GAUI-4, 8 Unframed 400GAUI-8 (PRBS31Q) and 16 Unframed 400GAUI-8/16. Not supported for 4 Unframed 200GAUI-4 and 8 Unframed 400GAUI-8 with either PRBS13Q or SSPRQ.
- **BER Threshold** allows entering maximum bit/pattern error count allowed before declaring a fail verdict: **0** (default) to **999999** for count; **1.0E-14** to **1.9E-01** for rate (the default value is **1.0E-12**; **2.4E-4** for unframed 200/400G).

## Service Disruption

**Note:** *Not available with: No Pattern Analysis (Live) check box selected; Seed A, Seed B, or PRBS31 Unscrambled patterns; multiple link interface; OTN BERT with EoOTN client.*

The absence of traffic exceeding the configured **No Traffic Time** triggers the service disruption measurement.

For a **Framed**, **Unframed**, or **Unframed with Sync** test, the service disruption event is closed when valid Ethernet frames are received for at least the **Debounce Time** without any service disruption event. Reaching the Test Period or stopping the test also closes the SDT event.

For an **Unframed (Interop)** test, the service disruption event is closed when either the Test Period of 5 minutes is reached or the test is stopped.

## Setup

### *EtherBERT and Unframed BERT*

---

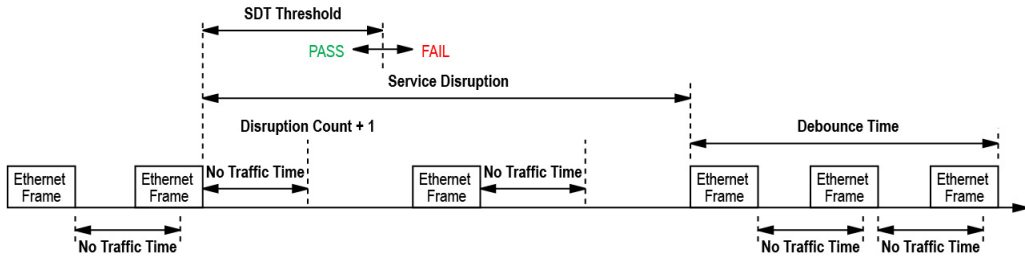

- **No Traffic Time (ms)** is the time acceptable between two Ethernet frames without any service disruption event: **0.005 ms to 1000 ms** (default is **1 ms**).
- **Debounce Time (ms)** allows setting the period without any service disruption event before stopping the current SDT measurement: **0** (default) to **500 ms**.
- **Disruption Monitoring** check box when selected (disabled by default) enables the disruption time measurements. However, the measurement will only start if the test is already started, or when the test will be started. Clearing the **Disruption Monitoring** check box or stopping the test, stops the measurement without clearing the results. Starting the test while the **Disruption Monitoring** check box is selected resets the results.
- **Pass/Fail Verdict** check box when selected (cleared by default) enables service disruption pass/fail verdict and allows setting the threshold value.
- **SDT Threshold** allows configuring the acceptable maximum service disruption time before failing the test: **0.005 to 299999.999 ms** (default is **50 ms**). The threshold value cannot be less than the **No Traffic Time** value.

## Shaping

- **TX Rate** allows the selection of the transmission rate in percentage of utilization (100 percent by default), Mbit/s, Gbit/s, Frame/s, or IFG. For Ethernet, the maximum percentage is 105 percent depending on the frame size selected.
- **Enable TX** check box is automatically selected when starting the test allowing stream generation. The **Enable TX** check box may also be selected or cleared while the test is running.

## Latency

**Note:** Available with Framed Layer 2 and higher. Dual port topology is only available for rates up to 10G. Not available with multiple link interface. Not available with **400ZR (DWDM Amplified) [478.75 Gbit/s]** rate.

- **Enable** check box when selected, cleared by default, enables latency measurements.
- **Mode**

**Note:** For 88200NGE and 890 modules, only **Round-Trip Latency** is supported.

**Round-Trip Latency** measurement provides the total delay measurement for both directions on a specific port.

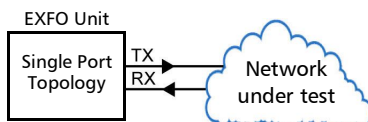

## Setup

### *EtherBERT and Unframed BERT*

---

**One-Way P<m> ↔ P<n>** provides the delay measurement of each direction independently between two separate ports of a single module. Only available when the rate and framing structure parameters are the same on both ports; changing any of these parameters automatically selects the **Round-Trip Latency** mode.

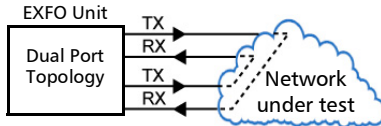

- **Pass/Fail Verdict** check box when selected enables the pass/fail verdict and allows setting the maximum latency threshold. This parameter is coupled on both ports for one-way measurement mode.
- **Unit** allows selecting the Latency unit: **ms** (default) or **μs**.
- **Round-Trip Threshold (ms)** is configurable from **5 μs** for 10Mbit/s, **1 μs** for 100Mbit/s and 10G WAN, or **100 ns** for all other rates up to **2 s** (default is **75 ms**).
- **One-Way P<m> -> P<n> Threshold** is configurable at the current P<m> RX port: from **5 μs** for 10Mbit/s, **1 μs** for 100Mbit/s and 10G WAN, or **100 ns** for all other rates up to **2 s** (default is **75 ms**).

## Ethernet Frame

- **Frame Size (Bytes)** allows selecting the frame type (**Fixed** (default) or **EMIX**) and the frame size (**48<sup>1</sup>** to **16000<sup>2</sup>**). Sending traffic with frame size >1518 in switched network may result in losing all frames.

The following table lists each component that may affect the minimum size value.

Component	Description
VLAN	4 bytes per VLAN (up to 3 VLAN for EtherBERT test application and only 1 VLAN for EoOTN client)
EoE Header	16 bytes
EoE VLAN	4 bytes
PBB-TE Header	18 bytes
B-VLAN	4 bytes
UDP	8 bytes
TCP	20 bytes
Ethernet Header	14 bytes
LLC and SNAP Headers	8 bytes
IPv4	20 bytes
IPv6	40 bytes
Latency	8 bytes

**EMIX** button is available when **EMIX** frame size is selected. The EMIX frame sequence is repeated continuously (refer to *EMIX* on page 958).

**Note:** *The following frame parameters are only available for OTN BERT test application with Ethernet client (EoOTN).*

1. The minimum of 48 bytes is only available for rates up to 10GE, for higher rates the minimum frame size is 64 bytes. The minimum frame size will be adjusted according to the frame structure and components selected.
2. The maximum frame size is limited to 10000 for 10/100/1000Mbps electrical interface.

## Setup

### *EtherBERT and Unframed BERT*

---

- **Source MAC Address** allows entering the source MAC address for the stream. The default setting is the module default and unique Source Media Access Control (MAC) address.
- **Destination MAC Address** allows entering the destination MAC address for the stream. The default setting is the MAC address of the port.
- **VLAN ID** check box, when selected (cleared by default), allows the configuration of the following VLAN parameters. Selecting the **VLAN ID** check box affects the **Frame Size** value.

**VLAN ID** allows selecting the VLAN ID: **0** through **4095** (default is **2**). Special VID values (IEEE Std 802.1Q-1998):

ID	Description
0	The null VLAN ID. Indicates that the tag header contains only user priority information; no VLAN identifier is present in the frame. This VID value must not be configured as a PVID, configured in any Filtering Database entry, or used in any Management operation.
1	The default PVID value used for classifying frames on ingress through a Bridge Port. The PVID value can be changed on a per-Port basis.
4095	Reserved for implementation use. This VID value shall not be configured as a PVID, configured in any Filtering Database entry, used in any Management operation, or transmitted in a tag header.

**Priority** allows selecting the VLAN priority: **0** (default) to **7**:

0	000 - Low Priority	4	100 - High Priority
1	001 - Low Priority	5	101 - High Priority
2	010 - Low Priority	6	110 - High Priority
3	011 - Low Priority	7	111 - High Priority

- **Type** indicates the supported VLAN Ethernet type which is **0x8100**.



## EtherSAM - Burst

**Note:** The **Burst** settings are only available for configuration when the **Burst Test** check box is selected (see page 258).

From the test menu, tap **Setup, Test Configurator**, tap on the test block, and on the **Burst** tab.

**Note:** The burst configuration parameters are defined globally for all services but **CBS, EBS, and Burst Max Rate** parameters are as per each service configuration.

### Burst Sequence

The graphic illustrates the configured burst sequence that contains in order, from left to right:

- **Refill Delay** represents the pre-burst recuperation time in percentage that is equal to the remaining percentage not used by the post-burst time (**Refill Delay Ratio**).
- **Burst Frames** represents the burst frame ratio in percentage that is equal to the subtraction of **100 % - Burst/IR Frame Ratio**.
- **Refill Delay** represents the post-burst recuperation time in percentage that is equal to the configured **Refill Delay Ratio**.
- **CIR or CIR+EIR Frames** represents the percentage of transmission at CIR or CIR+EIR rate. The **CIR or CIR+EIR Frames** percentage is equal to the configured **Burst/IR Frame Ratio**.
- The “. . .” next to the burst sequence indicates that the burst sequence is repeated the number of times specified in the **Number of Burst Sequence** field.

### Parameters

- **Number of Burst Sequence** is the number of times, **1** to **100** (default is **2**), the burst sequence will be repeated for the CBS and EBS tests.
- **Refill Delay Ratio (%)** is the percentage of time required to refill the CBS/EBS token buckets. The refill delay ratio is used for post-burst delay and the remaining percentage is applied to the pre-burst delay. The **Refill Delay Ratio** is configurable from **0** to **100** percent (**50** percent is the default as well as the standard's minimum recommended value).
- **Burst/IR Frame Ratio (%)** is the percentage of frames transmitted at **CIR** rate for the **CBS** test and the percentage of frames transmitted at **CIR+EIR** rate for the **EBS** test. The **Burst/IR Frame Ratio** is configurable from **10** to **90** percent (**90** percent is the default as well as the standard's recommended percentage value).

### Table

**Note:** *Test time values are only displayed for enabled services.*

- **Service No** indicates the service number.
- **Service Name** indicates the name of the service.
- **Direction**, available with **Dual Test Set** or **Dual Port** topology, indicates respectively results for local (**L**) and remote (**R**) directions, or port to port directions.
- **CBS Test Time (s)** indicates the total time required to perform all burst sequence iterations of the CBS test for this service.
- **EBS Test Time (s)** indicates the total time required to perform all burst sequence iterations of the EBS test for this service.
- **Total Burst Test Time (s)** indicates the total time required to perform all burst sequence iterations of both **CBS** and **EBS** tests for this service.

## EtherSAM - Global

From the test menu, tap **Setup, Test Configurator**, tap on the test block, and on the **Global** tab.

### Dual Test Set

- **Dual Test Set (DTS)** check box when selected (cleared by default) enables the **Dual Test Set** testing mode. Once **Dual Test Set** is enabled, use the **Discover Remote** button to select a remote unit. Not available in **Dual Port** topology.

**Note:** *It is also possible using the **Discover Remote** button to connect to a remote unit and automatically enable **Dual Test Set**. For more details, refer to Discover Remote on page 742.*

**Disconnected** indicates that there is no connection established with a remote unit.

**NAT LAN/WAN** and **WAN IP** indicate presence of NAT (Network Address Translation) router. The NAT router is automatically detected and graphically displayed with LAN/WAN indication as well as the WAN IP address when the unit is behind a NAT router.

**Note:** *When there is a NAT at the Remote site, it is required to create UDP/TCP port 62819 forwarding rule on this NAT router to allow DTS communication. In addition, when there is a NAT in both directions (L->R and R->L), it is also required to create port forwarding rules on the NAT router located at the Remote side for every service defined.*

- **Discover Remote** allows discovering remote unit supporting **Remote Loopback** and/or **Dual Test Set**. For more details, refer to *Discover Remote* on page 742.

### Subtests

- **Service Configuration Test** verifies if the network configuration is correct for each service before starting a long term test (Service Performance Test). To test the network configuration, an L2CP Handling test, a ramp test, and/or a burst test is/are executed for each configured service.
- **Subtest Duration** indicates the **Service Configuration Test** duration based on the configured Services, L2CP Handling, Ramp, and Burst settings.
- **L2CP Handling Test** check box when selected (cleared by default) verifies that L2CP frames are handled appropriately. Only available with Dual Test Set. Not supported at 200/400G rate.

Once the test is started, the configured quantity of L2CP frames for the service under test are transmitted at the configured frame rate. The test validates that the frames are received or not at the destination (remote unit). Then, based on the Expected L2CP Handling of each L2CP frame, a verdict is assessed for the service, per L2CP frame, and per direction.

The L2CP Handling test is performed when enabled for each enabled service.

- **Ramp Test** check box when selected (default) enables the ramp test:

In the first stage of the test, when **CIR** check box is selected (see *SLA Parameters* on page 385), the throughput is increased incrementally in steps until the CIR level is reached. During the first stage, the maximum Jitter, Latency, Frame Loss, and throughput are measured and are compared to the SLA thresholds to declare a pass/fail verdict.

In the second stage of the test, when the **CIR+EIR** check box is selected (see *SLA Parameters* on page 385), the throughput is increased to the **CIR+EIR** level to compare against expected maximum throughput threshold to declare a pass/fail verdict.

In the third stage of the test, when the **Traffic Policing** check box is selected (see *Test Parameters* on page 384), the throughput is increased one step over the **CIR+EIR** if selected otherwise over the **CIR** to compare against expected maximum throughput threshold to declare a pass/fail verdict.

The ramp test procedure is performed for each enabled service.

## Setup

*EtherSAM - Global*

---

- **Burst Test** check box when selected (cleared by default) verifies that the expected burst size can be transmitted at maximum burst rate with minimal loss. Not supported at 200/400G rate.

**CBS** (Committed Burst Size) check box when selected (see *SLA Parameters* on page 385), verifies the performance of a committed burst size at **CIR**'s average **TX** rate.

**EBS** (Excess Burst Size) check box when selected (see *SLA Parameters* on page 385), verifies the performance of an excess burst size at **CIR+EIR**'s average **TX** rate.

The maximum Jitter, Latency, Frame Loss, and throughput are measured. For **CBS**, the Jitter, Latency, and Frame Loss are compared to the SLA thresholds to declare a pass/fail verdict. For **EBS**, the throughput is compared to the SLA thresholds to declare a pass/fail verdict.

The burst test procedure is performed for each enabled service.

- **Service Performance Test** check box when selected (default) verifies that the **SLA** parameters (see *SLA Parameters* on page 385) are met over time by running multiple services simultaneously. The maximum Jitter, Latency, Frame Loss, and average throughput are measured and compared to the configured thresholds to declare pass/fail verdicts. The **Service Performance Test** is only performed for services that have their **CIR** check box selected.

**Subtest Duration** allows setting the duration time, in HH:MM:SS format, for the **Service Performance Test** (default is 10 minutes).

- **Global Test Duration Estimation** indicates the total estimate duration of the test.

## Global Options

- **Per Direction Configuration** check box when selected (default) specifies that the values can be configured independently for each direction (local to remote and remote to local) for **Dual Test Set** or for each port direction for **Dual Port**; for **Dual Port** using a different rate on each port, the check box is forced selected. When the **Per Direction Configuration** check box is cleared the configuration will be coupled and the values apply to both directions/ports. For **Dual Test Set** the **Per Direction Configuration** is only available when the communication with the remote unit is established.
- **Pass/Fail Verdict** check box when selected (default) enables the pass/fail verdict. A global pass/fail verdict is given for the EtherSAM test, **Service Configuration Test**, and **Service Performance Test** (for each service). The pass/fail verdict is based on the following criteria: **Frame Loss**, **Max Jitter**, **Round-Trip Latency**, and **Average - RX Rate**.
- **Latency Measurement Mode**, available with **Dual Test Set** for rates from 10M to 10GE, allows the selection of the latency measurement mode: **Round-Trip** (default) or **One-Way**.

Synchronization with 1PPS interface/reference is required to perform One-Way Latency measurement. One-Way Latency is only possible when both local and remote 1PPS signal clocks are valid. The following alarms are available with One-Way Latency measurement.

**LOPPS-L** and **LOPPS-R** (Loss Of Pulse Per Second - Local/Remote) are declared when either no pulse is received or when no pulse is received within 1 second  $\pm 6.6 \mu s$  after the previous pulse. LOPPS-R is only monitored once the DTS connection is established.

## Restore EtherSAM Defaults

Reverts the test application to its default factory settings.

# EtherSAM - L2CP

From the test menu, tap **Setup, Test Configurator**, tap on the test block, and on the **L2CP** tab.

- **Frame Rate** defines the rate of L2CP frames to be transmitted: **1 frame/s** or **10 frame/s** (default).
- **Frame Count** defines the quantity of each configured L2CP frame to be transmitted: **10** (default), **100**, **1000** frames.

## L2CP Frame Table

Lists predefined and user defined L2CP frames. Use the corresponding “...” button to edit each L2CP frame individually.

For predefined L2CP frames, only the **Name** and **Destination MAC Address** (frames having more than one allowed MAC Addresses) are configurable; the other parameters are fixed along with their L2CP type. For user defined frames, the following parameters are configurable at the exception of **Type** and **Subtype**:

- **Name**: Up to 20 characters are allowed. Default names are the type of the L2CP frame for predefined frames and **User 1/2/3/4 (01-80-C2)** and **User 5/6/7/8 (01-00-0C)** for user defined frames.
- **Type**: Indicates the type of the L2CP frame for predefined frames and **User (01-80-C2)** or **User (01-00-0C)** for user defined frames.
- **Frame Format**: **Ethernet II** (default), **LLC**, or **SNAP**.
- **Frame Size**: **64** bytes (default) to **1518** bytes. The frame size excludes the VLAN encapsulation.
- **Destination MAC Address**: For predefined L2CP frames allows selecting the **Destination MAC Address** for frames having more than one allowed MAC Addresses. For user defined allows selecting the **Destination MAC Address** from **01-80-C2-00-00-00** (default) to **01-80-C2-FF-FF-FF** for **User (01-80-C2)** and from **01-00-0C-00-00-00** (default) to **01-00-0C-FF-FF-FF** for **User (01-00-0C)**.



- **LLC** (available with LLC and SNAP frame formats)
  - **SSAP: 0x00 to 0xFF (0x42 by default)** for LLC frame format; fixed to **0xAA** for SNAP frame format.
  - **DSAP: 0x00 to 0xFF (0x42 by default)** for LLC frame format; fixed to **0xAA** for SNAP frame format.
  - **Control: 0x00 to 0xFF (0x03 by default)** for LLC frame format; fixed to **0x03** for SNAP frame format.

**Note:** *For LLC frame format, the following concatenated values of DSAP/SSAP/Control are not valid since they are reserved for SNAP frame format: 0xAAAA03 or 0xABAB03.*

- **OUI** (available with SNAP frame format): **0x000000** (default) to **0xFFFFFFFF**.
- **EtherType** (available with SNAP and Ethernet II frame formats): **0x0000 to 0xFFFF** for SNAP and **0x0600 to 0xFFFF** (excluding 0x8100, 0x88A8, 0x9100, 0x9200, 0x9300, 0x8847, and 0x8848) for Ethernet II. Default is **0x0600**.
- **Subtype**, only available for some predefined L2CP frames, indicates the subtype for the frame.
- **Custom Bytes** (16 bytes) **0x00000000000000000000000000000000** (default) to **0xFFFFFFFFFFFFFFFFFFFFFFFFFFFFFFFF**. Only available for user defined L2CP frames.

## Setup

### EtherSAM - L2CP

---

Predefined L2CP frame parameters:

Type	Frame Format	EtherType Subtype	LLC (DSAP + SSAP + Control)	OUI	Size (bytes)	Allowed Destination MAC Address
<b>LACP</b> (Link Aggregation Control Protocol)	Ethernet II	0x8809 0x01			128	01-80-C2-00-00-00 01-80-C2-00-00-02 01-80-C2-00-00-03
<b>LAMP</b> (Link Aggregation Marker Protocol)	Ethernet II	0x8809 0x02			128	01-80-C2-00-00-00 01-80-C2-00-00-02 01-80-C2-00-00-03
<b>Link - OAM</b> (802.3 OAM)	Ethernet II	0x8809 0x03			64	01-80-C2-00-00-02
<b>ESMC</b> (Ethernet Synchronization Messaging Channel)	Ethernet II	0x8809 0x0A			64	01-80-C2-00-00-02
<b>PTP</b> (Precision Time Protocol)	Ethernet II	0x88F7			64	01-80-C2-00-00-0E
<b>E-LMI</b> (Ethernet Local Management Interface)	Ethernet II	0x88EE				01-80-C2-00-00-07
<b>LLDP</b> (Link Layer Discovery Protocol)	Ethernet II	0x88CC			64	01-80-C2-00-00-00 01-80-C2-00-00-03 01-80-C2-00-00-0E
<b>VDP</b> (Virtual Station Interface Discovery and Configuration Protocol)	Ethernet II	0x8940 0x0001			64	01-80-C2-00-00-00
<b>PE-CSP</b> (Port-Extender Control and Status Protocol)	Ethernet II	0x8940 0x0002			64	01-80-C2-00-00-03
<b>802.1X</b> (Port-Based Network Access Control)	Ethernet II	0x888E			64	01-80-C2-00-00-00 01-80-C2-00-00-03 01-80-C2-00-00-0E

Type	Frame Format	EtherType Subtype	LLC (DSAP + SSAP + Control)	OUI	Size (bytes)	Allowed Destination MAC Address
<b>MAC-PAUSE</b> (802.3 MAC Control - PAUSE)	Ethernet II	0x8808 0x0001			64	01-80-C2-00-00-01
<b>MAC-PFC</b> (802.3 MAC Control - Priority Flow Control)	Ethernet II	0x8808 0x0101			64	01-80-C2-00-00-01
<b>MPMAC-Gate</b> (802.3 Multipoint MAC Control - Gate)	Ethernet II	0x8808 0x0002			64	01-80-C2-00-00-01
<b>MPMAC-Report</b> (802.3 Multipoint MAC Control - Report)	Ethernet II	0x8808 0x0003			64	01-80-C2-00-00-01
<b>MPMAC-Register-req</b> (802.3 Multipoint MAC Control - Register-req)	Ethernet II	0x8808 0x0004			64	01-80-C2-00-00-01
<b>MPMAC-Register</b> (802.3 Multipoint MAC Control - Register)	Ethernet II	0x8808 0x0005			64	01-80-C2-00-00-01
<b>MPMAC-Register-ack</b> (802.3 Multipoint MAC Control - Register-ack)	Ethernet II	0x8808 0x0006			64	01-80-C2-00-00-01
<b>MAC-Org-Spec-Ext</b> (802.3 MAC Control - Organisation Specific Extensions)	Ethernet II	0x8808 0xFFFF			64	01-80-C2-00-00-01
<b>STP</b> (Spanning Tree Protocol)	LLC		0x424203		64	01-80-C2-00-00-00 01-80-C2-00-00-08
<b>RSTP</b> (Rapid Spanning Tree Protocol)	LLC		0x424203		64	01-80-C2-00-00-00 01-80-C2-00-00-08
<b>MSTP</b> (Multiple Spanning Tree Protocol)	LLC		0x424203		64	01-80-C2-00-00-00 01-80-C2-00-00-08

## Setup

### EtherSAM - L2CP

Type	Frame Format	EtherType Subtype	LLC (DSAP + SSAP + Control)	OUI	Size (bytes)	Allowed Destination MAC Address
<b>SPB</b> (Shortest Path Bridge)	LLC		0xFEFE03		64	01-80-C2-00-00-2E 01-80-C2-00-00-2F
<b>MMRP</b> (Multiple MAC Registration Protocol)	Ethernet II	0x88F6			64	01-80-C2-00-00-20
<b>MVRP</b> (Multiple VLAN Registration Protocol)	Ethernet II	0x88F5			64	01-80-C2-00-00-21 01-80-C2-00-00-0D
<b>MSRP</b> (Multiple Stream Registration Protocol)	Ethernet II	0x22EA			64	01-80-C2-00-00-0E
<b>MIRP</b> (Multiple ISID Registration Protocol)	Ethernet II	0x8929			64	01-80-C2-00-00-00
<b>CDP</b> (Cisco Discovery Protocol)	SNAP	0x2000	0xAAAA03	0x00000C	64	01-00-0C-CC-CC-CC
<b>VTP</b> (VLAN Truncing Protocol)	SNAP	0x2003	0xAAAA03	0x00000C	64	01-00-0C-CC-CC-CC
<b>PAgP</b> (Port-Aggregation Protocol)	SNAP	0x0104	0xAAAA03	0x00000C	88	01-00-0C-CC-CC-CC
<b>UDLD</b> (Unidirectional Link Detection)	SNAP	0x0111	0xAAAA03	0x00000C	64	01-00-0C-CC-CC-CC
<b>DTP</b> (Dynamic Truncing Protocol)	SNAP	0x2004	0xAAAA03	0x00000C	64	01-00-0C-CC-CC-CC
<b>PVST+(LLC)</b> (Per VLAN Spanning Tree)	LLC		0x424203		64	01-00-0C-CC-CC-CD
<b>PVST+(SNAP)</b> (Per VLAN Spanning Tree)	SNAP	0x010B	0xAAAA03	0x00000C	68	01-00-0C-CC-CC-CD

Type	Frame Format	EtherType Subtype	LLC (DSAP + SSAP + Control)	OUI	Size (bytes)	Allowed Destination MAC Address
<b>STP-ULFAST</b> (Spanning Tree Protocol - Uplink Fast)	LLC		0x424203		64	01-00-0C-CD-CD-CD
<b>VLAN-BRDSTP</b> (VLAN Bridge Spanning Tree)	LLC		0x424203		64	01-00-0C-CD-CD-CE
<b>ISL</b> (Inter-Switch Link )	SNAP	0x0003	0xAAAA03	0x00000C	94	01-00-0C-00-00-00
<b>GMRP</b> (Generic MAC Registration Protocol)	LLC		0x424203		64	01-80-C2-00-00-20
<b>GVRP</b> (Generic VLAN Registration Protocol)	LLC				64	01-80-C2-00-00-21

# EtherSAM - Ramp

**Note:** The **Ramp** tab is only available for configuration when the **Ramp Test** check box is selected (see page 258).

From the test menu, tap **Setup, Test Configurator**, tap on the test block, and on the **Ramp** tab.

**Note:** The ramp configuration parameters are defined globally for all services but the presence of CIR+EIR, and Traffic Policing steps are as per each service configuration. CIR, CIR+EIR, and Traffic Policing steps are part of the step list as soon as they are enabled for at least one service even if that service is not enabled.

- **Dynamic Ramp** graph displays the percentage of each CIR level step in time.
- **Step Time** indicates the test duration for each ramp step: **5** (default) to **60** seconds.
- **Ramp Duration** indicates the total time required to perform all the ramp steps for each service.
- **Add Step** allows adding a new ramp step. Enter the CIR percentage from **1** to **99**. A maximum of 7 pre CIR steps can be added in the ramp configuration.
- **Delete Step** allows deleting a step from the ramp. Select the step from the list and tap on **Delete**.
- **Defaults** reverts the ramp configuration to its default factory settings.

## External Reference

**External Reference**, available with Time Error / Wander test application, allows configuring the external reference signal.

From the test menu, tap **Setup, Test Configurator**, and the **External Reference** block.

### Reference

- **Mode** allows selecting the clock source; forced to Internal GNSS for Time Error with an Ethernet interface.
  - **External Reference** (default): Clock signal from the EXT CLK port.
  - **Internal GNSS**: 1PPS clock signal provided by the Internal GNSS Receiver. Requires a GNSS antenna connected to the ANTENNA port (88260). The Internal GNSS receiver settings are configurable from *System - GNSS* on page 420.

### Ext Reference In / Reference In

Allows selecting the reference signal for TE/TIE measurements.

- **Signal** allows the selection of the reference interface: **2 MHz**, **10 MHz**, and **1PPS**. The reference signal is set to **1PPS** for a test using 1PPS interface/rate and for Internal GNSS clock mode.

**Ext Ref In / Ref In** on a green background indicates that a valid reference is received.

**LOS** on a red background indicates that the received signal is not valid.

- **Connector** indicates the connector used for the external reference signal: **RJ48C** or **BNC**.
- **Frequency (MHz)**, available with 2 MHz and 10 MHz, displays the frequency of the received reference signal.

## FC BERT

From the test menu, tap **Setup, Test Configurator** and tap on the **FC BERT** block.

### Pattern

- **Coupled RX to TX** check box, when selected (default), couples both the TX and RX signal with the same test pattern.
- **TX Pattern / RX Pattern** allows selecting the test pattern for each direction: **PRBS9, PRBS11, PRBS15, PRBS20, PRBS23, PRBS31** (default), and **User Pattern**. When **User Pattern** is selected, enter the payload pattern hexadecimal value.
- **Invert** check box, when selected (cleared by default), inverts the generated/expected test pattern meaning that every 0 will be changed for 1 and every 1 for 0. For example, the pattern 1100 will be sent as 0011.
- **Pattern Sync** icon indicates the status of the received signal pattern. Refer to *Status Bar* on page 36 for more information.

### Bit Error

- **Pass/Fail Verdict** enables and sets the bit error rate/count threshold prior to run the test. This allows for a simple pass/fail verdict, leaving no room for misinterpretation of the test results. To enable the pass/fail verdict, select either **Bit Error Count** or **Bit Error Rate** (default is **Disabled**).
- **BER Threshold** allows entering the maximum bit error count/rate allowed before declaring a fail verdict: **0** (default) to **999999** for count; **1.0E-14** to **1.9E-01** (default is **1.0E-12**) for rate.



## Service Disruption

**Note:** Only available on the FTBx-88260 module.

The absence of traffic exceeding the configured **No Traffic Time** triggers the service disruption measurement. The service disruption event is closed when valid FC frames are received for at least the **Debounce Time** without any service disruption event. Reaching the Test Period or stopping the test also closes the SDT event.

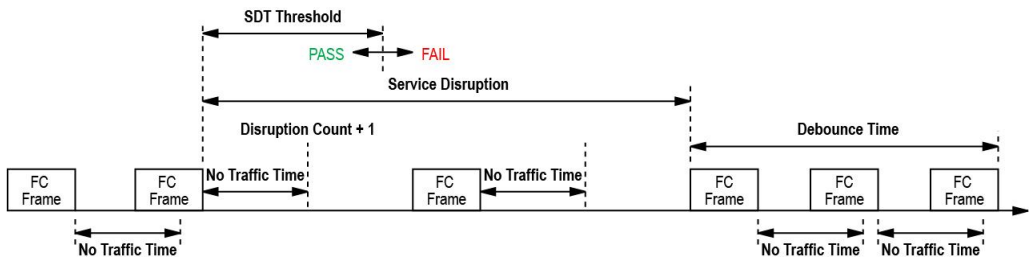

- **No Traffic Time (ms)** is the time acceptable between two FC frames without any service disruption event: **0.005 ms** to **1000 ms** (default is **1 ms**).
- **Debounce Time (ms)** allows setting the period without any service disruption event before stopping the current SDT measurement: **0** (default) to **500 ms**.
- **Disruption Monitoring** check box when selected (disabled by default) enables the disruption time measurements. However, the measurement will only start if the test is already started, or when the test will be started. Clearing the **Disruption Monitoring** check box or stopping the test, stops the measurement without clearing the results. Starting the test while the **Disruption Monitoring** check box is selected resets the results.

## Setup

### FC BERT

---

- **Pass/Fail Verdict** check box when selected (cleared by default) enables the service disruption pass/fail verdict and allows setting the threshold value.
- **SDT Threshold** allows configuring the acceptable maximum service disruption time before failing the test: **0.005 to 299999.999** ms (default is **50** ms). The threshold value cannot be less than the **No Traffic Time** value.

## FC Frame

**Frame Size (Bytes)** allows entering the frame size (in step of 4 bytes) for FC BERT test application: **40 to 2148** bytes (default). However the minimum frame size is 64 bytes when the **Latency Tags** check box is selected.

## Latency Tags Insertion

Round trip latency measures the average round trip latency (delay) between the time the data was transmitted and received.

- **Latency Tags** check box when selected enables latency measurements.
- **Pass/Fail Verdict** check box when selected (cleared by default) enables the service disruption pass/fail verdict and allows setting the threshold value.
- **Round-Trip Latency Threshold (ms)** allows the selection of the round trip latency: **0.015** (default) to **8000 ms**.

## Shaping

**TX Rate** allows the selection of the transmission rate in percentage (%) of utilization (100 percent by default), Mbit/s, Gbit/s, or MB/s.

## Fibre Channel

From the **Test** menu, tap **Setup, Test Configurator**, and the **Fibre Channel** block.

### World Wide Name (WWN)

The following WWN settings are only available when the **Login - Enable** check box is selected (see page 275).

- **Source** allows setting the 64-bit WWN address of the local fibre channel port: **00-00-00-00-00-00-00-00** to **FF-FF-FF-FF-FF-FF-FF-FF** (default is **20-00-00-03-01**[IEEE-MAC lsb (bits 23..0)]).
- **Destination** allows setting the 64-bit WWN address of the remote fibre channel port: **00-00-00-00-00-00-00-00** (default) to **FF-FF-FF-FF-FF-FF-FF-FF**. The destination WWN address is displayed and grayed-out for Point-to-Point topology after a successful login.

### Buffer to Buffer Flow Control

Buffer to Buffer (BB) Flow Control, also called Flow Control Management, manages the control of data traffic between the local and remote fibre channel ports based on the network, distance, and traffic congestion.

Each remote port advertises the buffer size (**BB\_Credit**) during the login.

- **Enable** check box when selected allows setting or use buffers to receive frames. The **Enable** check box is force selected when the **Login - Enable** check box is selected (see page 275).
- **Available BB\_Credit** is the number of frame buffers that the remote port has available to receive frames from the local port: **1 to 65535** (default is **10**). The **Available BB\_Credit** is not editable when the **Login - Enable** check box is selected but its value received from the remote interface through the login process is displayed. If the login fails, the **Available BB\_Credit** displays “-”.

## Login

After a link is established, it is possible to login to the Fibre Channel Network to send and receive data between a local and remote fibre channel port.

- **Enable** check box when selected (default) allows pressing the **Login** button to start the login process.
- **Advertised BB\_Credit** is the number of frame buffers the local port has available to receive frames from the remote port: **1** to **65535** (default is **10**). **Advertised BB\_Credit** is advertised to the remote port through the **Login** process. Changing the **Advertised BB\_Credit** requires to manually re-send a login using the **Login** button.
- **Login/Re-Login** button allows the initiation of the Login process with the selected **Advertised BB\_Credit**. Available when the **Login - Enable** check box is selected. The **Login** button initiates a log-in when not logged-in while the **Re-Login** re-initiates a log-in after changing the **BB\_Credit** and/or **WWN** when already logged-in. The capability to login is available only with Framed Layer 2 (FC-2) when a successful link has been established. There are two Login processes supported by Fibre Channel: **Port Login** (PLOGI) and **Fabric Login** (FLOGI).

It is possible to skip the **Login** procedure and use the **BB\_Credit** value. This is called **Implicit Login** and is only applicable for **Point-to-Point** topology. For **Point-to-Point** topology using implicit login, you must manually configure the **Available BB\_Credit** value for the remote port.

- **Discovered Topology** indicates the discovered topology.

**Fabric:** Ports are interconnected to a fabric switching network. A **Fabric** and **Port** login are required, and the **BB\_Credit** value is set based on the buffer capacity of the fabric switch.

**Point To Point:** Direct link between two ports.

- **Fabric Status** indicates the status of the Fabric switching network. The status is not available when the discovered topology is Point-to-Point.
  - **Logged-in** indicates that the login process has completed successfully.
  - **Failed** indicates that the login process is not completed successfully or an error has been detected.
  - **In Progress** indicates that the login process is running (not completed yet).
  - **Logged-out** (default) indicates that the system has not logged in yet or has received a valid Logout command from the remote port.
- **Port Status** indicates the state of the port login process.
  - **Logged-in** indicates that the login process has completed successfully.
  - **Failed** indicates that the login process is not completed successfully or an error has been detected.
  - **In Progress** indicates that the login process is running (not completed yet).
  - **Logged-out** (default) indicates that the system has not logged in yet, has received a valid Logout command from the remote port, or the Fabric status is either Failed, In Progress, or Logged-out.

## FlexE Group

From the test menu, tap **Setup, Test Configurator**, and on the **FlexE Group** protocol block.

**Note:** *Only one client is supported in the FlexE Group.*

- **FlexE Status** indicates the global FlexE group status: up (green arrow) or down (red arrow).
- **Calendar Mismatch** indicates if the received calendar differs from the one expected using the following colors: red for mismatch; green for match; otherwise it is gray.
- **FlexE Group Number** allows associating a number to the FlexE Group: **1** to **1048575**.
- **Calendar** allows selecting the calendar **A** or **B** that is used for mapping/demapping the FlexE clients into/from the FlexE group.
- **Calendar Granularity** allows selecting the calendar granularity: **5G** (default) or **25G**. When changing the granularity from 5G to 25G, it is possible that there are incompatibilities (sizes and/or boundaries) with existing clients, in this case these clients will be deleted.

## Table

- **Client ID** indicates the client identification number.
- **Size (Gbit/s)** indicates the size of the client.
- **Link** indicates the client link status: link up (green arrow) or link down (red arrow).
- **Qty of Clients** indicates the number of clients assigned to the FlexE group.
- **Assigned Capacity (Gbit/s)** indicates the sum of client size assigned to the FlexE group.

- **Unused Capacity (Gbit/s)** indicates the client size not assigned to the FlexE group.
- **Modify** (refer to *FlexE Calendar* on page 963)

## **Restore FlexE BERT Defaults**

Reverts the test application to its default factory settings.

# FlexO/OTN

From the test menu, tap **Setup, Test Configurator**, the **FlexO-OTUCn** protocol block, and **FlexO/OTN** tab.

**Note:** *Only one client is supported in the FlexO Group.*

## FlexO

- **FlexO Status** indicates the global FlexO group status: up (green arrow) or down (red arrow).
- **FlexO Group ID** indicates the FlexO group identification number.

## OTUCn

- **Client ID** indicates the client identification number.
- **Type** indicates the ODUk container (client).
- **Size (Gbit/s)** indicates the ODUk client size.
- **Edit ID** button allows editing the client identification number: **1** (default) to **40**.
- **OTUCn/ODUCn/ODUk** represents the mapping of the signal.
- **Payload Type** indicates the payload type which is **22**.
- **Qty of Clients** indicates the quantity of clients which is **1**.
- **Usage** indicates the number of tributary slot used and its corresponding rate in Gbit/s.



## Frequency

**Note:** *The Frequency tab is only available for parallel interfaces.*

From the test menu, tap **Setup, Test Configurator**, tap on the interface block, and on the **Frequency** tab.

- **Port**, available with FlexE BERT/FlexO BERT, allows selecting the physical port to be displayed.
- **FlexO Instance ID**, available with FlexO BERT, indicates the FlexO instance identifier per port.
- **FlexE PHY Number**, available with FlexE BERT, indicates the FlexE PHY number assigned to the port.
- **Link**, available with multiple link interface (ex: 2 x 100GE), allows selecting the link to be displayed.
- **Enable** check box when selected (default), available with multiple link interface, includes the selected link in the test. At least one of the links must remain enabled.

## TX Frequency

**Frequency (GHz)** indicates the frequency (actual frequency + Frequency offset) used for transmission.

**Note:** *Frequency offset is not available with: Multi-Channel OTN, multiple link interface, FlexE BERT/FlexO BERT, Time Error / Wander.*

- **Offset (ppm)** check box, when selected (cleared by default), enables the frequency offset generation. The frequency offset<sup>1</sup> range is  $\pm 120$  ppm for Ethernet test applications,  $\pm 50$  ppm for Transport Framed, and  $\pm 120$  ppm for Transport Unframed test applications.

---

1. The frequency offset range is guaranteed for a source signal at 0 ppm. In the event that the source signal already has an offset, then the output signal may exhibit an offset larger than the range specified.

## Setup

### Frequency

---

- **Fixed** (default): uses a fixed offset frequency value for generation. Use the “+” or “-” button to respectively increment or decrement the frequency offset value based on the defined **Step Size (ppm)**, or directly type the frequency offset value in the field.

**Step Size (ppm)**, available with **Fixed** frequency, allows setting the increment/decrement value (from 0.1 to either 50 or 120 depending on the test configuration) that will be used when changing the frequency offset with the “+” or “-” button.

- **Sweep** increases and decreases repetitively the frequency to cover the defined frequency offset range using a 1 ppm step at an average rate of up to 10 ppm/sec. Starting at offset 0 the min value is reached then repetitively increases to the maximum value then decreases to minimum value.

**Range (ppm)**, available with **Sweep** frequency offset mode, allows setting the range for frequency sweep generation.

## RX Frequency

**Note:** *The following frequency statistics are available for each lane.*

- **Frequency (GHz)** indicates the frequency of the input signal.

**Note:** *Frequency offset is not available with Time Error / Wander.*

- **Offset (ppm)** indicates the frequency offset between the standard rate specification and the rate at the input signal.

**Note:** *For both **Frequency** and **Offset** the following background colors are used.*

Background color	Description
Green	The frequency is in range.
Red	The frequency is out-of-range or LOC Lane.
Gray	Pending state.

**Note:** *In the **Test Configurator - Interface** block, **LO** and **HI** report respectively the current lowest and highest RX frequency offset values from any lane.*

- **Max. Negative Offset (ppm)** indicates the maximum negative frequency offset between the standard rate specification and the rate from the received signal.
- **Max. Positive Offset (ppm)** indicates the maximum positive frequency offset between the standard rate specification and the rate from the received signal.

**Note:** *Refer to Interface on page 911 for more information on standard rate specifications.*

## Setup

### Frequency - DCO BERT (Client)

---

## Frequency - DCO BERT (Client)

From the test menu, tap **Setup, Test Configurator**, the **Client** block, and on the **Frequency** tab.

### TX Frequency

**Frequency (GHz)** indicates the transmitted Ethernet client frequency (bit rate).

### RX Frequency

**Note:** *The following frequency statistics are available for each lane.*

- **Frequency (GHz)** indicates the received Ethernet client frequency (symbol rate).
- **Offset (ppm)** indicates the frequency offset between the nominal and the received Ethernet client frequencies.

**Note:** *For both **Frequency** and **Offset** the following background colors are used.*

Background color	Description
Green	The frequency is in range.
Red	The frequency is out-of-range or LOC Lane.
Gray	Pending state.

**Note:** *Refer to Interface on page 911 for more information on nominal frequencies.*

## FTFL/PT / PT

For **OTN BERT** and **OTN-SONET/SDH BERT**, from the test menu tap **Setup**, **Test Configurator**, the interface block, and the **FTFL/PT** tab.

For **Multi-Channel OTN**, from the test menu, tap **Setup**, **Test Configurator**,

- For the higher ODU layer: the interface block, and the **PT** tab.
- For the lower ODU layer: the **ODU Channels** test block, and the **PT** tab.

## ODUx Buttons

Tap on an **ODUx** button to select the multiplexed level. Not available with Multi-Channel OTN lower ODU level.

## FTFL

**FTFL** allows the configuration of the Forward and Backward ODU Fault Type Fault Location (FTFL) to be generated. Not available with Multi-Channel OTN.

- **Overwrite** check box when selected generates the defined FTFL. Only available with **Through Intrusive** topology and applies only to the ODU top layer.
- **Fault Indication** and **Code** allow the selection of the FTFL fault indicator message/code (byte 0 for forward, byte 128 for backward) to be generated.

Fault Indication	Code (Hex)
No fault	00 (default)
Signal fail	01
Signal Degrade	02
Reserved	03 <sup>a</sup>

- a. Selecting **Reserved** will use the hexadecimal code **03** but, all codes from **03** to **FF** are reserved for future international standardization.

## Setup

FTFL/PT / PT

---

**Note:** The **Code** field is automatically updated when the **Fault Indication** is changed and vice versa.

- **Operator Identifier** allows editing the Operator Identifier to be generated (bytes 1 to 9 for forward, bytes 129 to 137 for backward; 9 characters allowed; not defined by default).
- **Operator Specific** allows editing the Operator Specific to be generated (bytes 10 to 127 for forward, bytes 138 to 255 for backward; 118 characters allowed; not defined by default).

### PT / Global PT

Allows configuring the generated/expected payload type (PT). Changing the generated payload type does not alter the signal structure; it only modifies the OH value that is generated.

**Note:** *Global PT, available with Multi-Channel OTN, indicates that the PT settings apply to all channels.*

- **Overwrite** check box when selected generates the defined PT. Only available with Through Intrusive topology and applies only to the ODU top layer.
- **Payload Type and Code** allows the selection of the generated/expected payload signal type either by selecting the payload type from the list or by entering its code in hexadecimal (**00** to **FF**).

**Note:** *Codes not listed in the table are reserved for future standardization (Reserved For International Standardization).*

Payload type	Hex Code	MSB 1234	LSB 5678
Reserved for International Standardization <sup>a</sup>	00	0000	0000
Experimental mapping	01	0000	0001

<b>Payload type</b>	<b>Hex Code</b>	<b>MSB 1234</b>	<b>LSB 5678</b>
Asynchronous CBR mapping	02	0000	0010
Bit Synchronous CBR mapping	03	0000	0011
ATM mapping	04	0000	0100
GFP mapping	05	0000	0101
Virtual Concatenation Signal	06	0000	0110
PCS Codeword Transparent Ethernet	07	0000	0111
FC-1200 into ODU2e	08	0000	1000
GFP mapping into extended OPU2	09	0000	1001
OC-3/STM-1 into ODU0	0A	0000	1010
OC-12/STM-4 into ODU0	0B	0000	1011
FC-100 into ODU0	0C	0000	1100
FC-200 into ODU1	0D	0000	1101
FC-400 into ODUflex	0E	0000	1110
FC-800 into ODUflex	0F	0000	1111
Bit Stream with Octet Timing mapping	10	0001	0000
Bit Stream Without Octet Timing mapping	11	0001	0001
IB SDR mapping into ODUflex	12	0001	0010
IB DDR mapping into ODUflex	13	0001	0011
IB QDR mapping into ODUflex	14	0001	0100
SDI mapping into OPU0	15	0001	0101
(1.485/1.001) Gbit/s SDI mapping into OPU1	16	0001	0110
1.485 Gbit/s SDI mapping in to OPU1	17	0001	0111
(2.970/1.001) Gbit/s SDI mapping into OPUflex	18	0001	1000
2.970 Gbit/s SDI mapping into OPUflex	19	0001	1001
SBCON/ESCON mapping into OPU0	1A	0001	1010
DVB_ASI mapping into OPU0	1B	0001	1011
FC-1600 mapping into OPUflex	1C	0001	1100

## Setup

FTFL/PT / PT

---

Payload type	Hex Code	MSB 1234	LSB 5678
FlexE Client mapping into OPUflex	1D	0001	1101
FlexE aware (partial rate) mapping into OPUflex	1E	0001	1110
FC-3200 mapping into OPUflex	1F	0001	1111
ODU Multiplex with ODTUjk	20	0010	0000
ODU Multiplex with ODTUk.ts/ODTUjk	21	0010	0001
ODU multiplex with ODTUCn.ts	22	0010	0010
25GBASE-R mapping into OPUflex	30	0011	0000
200GBASE-R mapping into OPUflex	31	0011	0001
400GBASE-R mapping into OPUflex	32	0011	0010
Not Available <sup>b</sup>	55	0101	0101
Reserved Codes for Proprietary Use <sup>c</sup>	80	1000	0000
NULL Test Signal mapping	FD	1111	1101
PRBS Test Signal mapping	FE	1111	1110

- a. Selecting **Reserved for International Standardization** will use the hexadecimal code 00 but, all codes not listed in the previous table at the exception of those covered in notes b and c are reserved for future standardization.
- b. Selecting **Not Available** will use the hexadecimal code 55 but, 66 and FF are also Not Available payload types.
- c. Selecting **Reserved Proprietary** will use the hexadecimal code 80 but, all codes from 80 to 8F are reserved proprietary payload types.

**Note:** *The **Code** field is automatically updated when the **Payload Type** is changed and vice versa.*

- **OPU-PLM** check box when selected enables the OPU-PLM alarm analysis.



## GFP-F/GFP-T

**Note:** Only available with Ethernet **1GbE**, **10GbE**, or **Ethernet (flex/GFP-F)** client.

From the **Test** menu, tap **Setup**, **Test Configurator**, and tap on the **GFP-F/GFP-T** block.

**Note:** Refer to Generic Framing Procedure (GFP) on page 837 for more information on *Client Data* and *Client Management* frames.

- **CDF pFCS** (Client Data Frames payload Frame Check Sequence) enables the presence of the payload FCS for the client frames. This setting is only available with **Ethernet (flex/GFP-F)** client.
- **CMF pFCS** (Client Management Frames payload FCS) enables the presence of the payload FCS for the management frames. The **CMF pFCS** check box is automatically cleared when injecting FDI or RDI alarms.
- **EXI** (Extension Header Identifier) allows the selection of the type of GFP Extension Header. Choices are **Null** (0000) - (Default) and **Linear** (0001). EXI is only configurable with **Ethernet (flex/GFP-F)** client.
- **CID** (Channel Identifier) selects the communication channel used for the signal transmission for *both Client Data and Client Management frames*. Choices are from **0** (default) through **255**. CID is only available when EXI is set to **Linear**.

The status **Mismatch** is displayed next to the CID value when the TX and RX CID values differ.

- **Delta** indicates the GFP state machine synchronization parameter. Delta is set to 1.

## Interface

**Note:** With host/media loopback mode only **LINK** is available for a framed test and the **Interface** tab is not supported with an unframed test.

From the test menu, tap **Setup, Test Configurator**, the interface block, and the **Interface** tab.

**Port**, available with FlexE BERT/FlexO BERT, allows selecting the physical port to be displayed.

- **FlexO Instance ID**, available with FlexO BERT, indicates the FlexO instance identifier per port.
- **FlexE PHY Number**, available with FlexE BERT, allows configuring the FlexE PHY number assigned to the port:

Interface	FlexE PHY Number
400G	1 to 62
200G	1 to 126
100G	1 to 254
50G	1 to 126

- **Link**, available with multiple link interface (ex: 2 x 100GE), allows selecting the link to be displayed.
- **Enable** check box when selected (default), available with multiple link interface, includes the selected link in the test. At least one of the links must remain enabled.
- **FEC** check box, available with FlexO BERT, when selected (default) enables the FEC in TX/RX and allows detecting, reporting, and correcting up to 15 symbol errors (Correctable) per codeword. If there are over 15 symbol errors detected, they are reported as uncorrectable errors.

## LINK (Ethernet and Sync Test Applications)

- **LINK** indicates the port link status (at the PCS level for parallel interfaces): link up (green arrow), error or link down (red arrow), or awaiting incoming data to provide a status (gray arrow).

**Note:** Refer to: *Ethernet* on page 896; *Ethernet - PCS* on page 899; *Ethernet - PCS Lanes* on page 900; *RS-FEC (Ethernet)* on page 935; *PHY* on page 931 for more information on alarms.

- **RS-FEC** check box when selected (default), available with framed 25GE interface, enables the use of RS-FEC.
- **RS-FEC** check box when selected (default), available with framed 100GE interface, enables the use of the RS-FEC; ensure both ends of the circuit have the FEC enabled. The **RS-FEC** check box should be selected when using a 100GBASE-SR4, 100G-CWDM4, or 100G AOC transceiver but may be cleared for testing purposes. The **RS-FEC** check box is selected and dimmed for: 100GE (1 Lane), 100GE (2 Lanes), 100GE (4 Lanes) SR4/CWDM4 with Time Error / Wander. Not available when the **PHY Type** is set to **LR4/ER4**.
- **All Links** check box when selected, available with multiple link interface, applies the same settings on all enabled links.
- **RS-FEC (RX Only)** check box when selected (default), available with framed 50GE/200GE/400GE interface, enables the use of the RS-FEC in RX; when cleared, ignores RS-FEC parity symbols, detection of FEC errors, and no correction of message symbols are performed.
- **FEC Degraded SER** check box when selected, enables the monitoring of local/remote degraded SER alarms. Only available when **RS-FEC (RX Only)** check box is selected.
- **Thresholds** is available when **FEC Degraded SER** is enabled and allows setting the threshold values used to raise and clear the **Local Degraded SER Detected** alarm. Refer to *FEC Degraded SER Thresholds* on page 960.

## Setup

### Interface

---

- **Remote Fault Emulation** check box when selected, generates **Remote Fault** ordered sets when a **Link Fault** is received. Available for rates 10GE and up with EtherBERT (all framing at the exception of **Unframed (Interop)**), Traffic Gen & Mon (framed), and eCPRI (framed).
- **Auto-Negotiation** check box when selected (default), available with 10/100/1000M Electrical and 1GE Optical interfaces, indicates to the remote port which parameters to use. For 1GE Electrical interface and when using an active copper SFP, the **Auto-Negotiation** check box is selected and dimmed.

**Note:** *When the **Auto-Negotiation** check box is selected, the port **Speed**, **Duplex**, **Flow Control**, and **Local Clock** parameters can be set. Those settings are not applied immediately to the port, they are used only when the negotiation process is started and take effect only when the auto-negotiation succeeds. However current settings are applied immediately to the port when the **Auto-Negotiation** check box is cleared.*

- **Speed**, available with 10/100/1000M Electrical interface, allows the selection of the interface rate: **10M**, **100M**, **1GE**, or **Auto**. **Auto** is only available when the **Auto-Negotiation** check box is selected. The negotiated speed will be displayed next to the **Speed** field selection. The **10M** speed is not available with SyncE test application.
- **Duplex** is configurable for **10M** and **100M** electrical interfaces and choices depend on the test application: **Full Duplex** (default), **Half Duplex**, or **Auto** (available when the **Auto-Negotiation** check box is selected). For other rates the duplex is set to **Full Duplex**. **Half Duplex** is not available with an active copper SFP. The negotiated duplex will be displayed next to the **Duplex** field selection.
- **Flow Control** is configurable and choices depend on the test application: **Enable TX**, **Enable RX**, **Enable RX and TX**, **None** (default), or **Auto** (available when the **Auto-Negotiation** check box is selected). When the **Flow Control** is set to **None**, pause frames received are ignored.

- **Cable Mode**, available with 10/100/1000M Electrical interface, indicates the cable mode based on the test application configuration.  
**Manual** mode is selected when the **Auto-Negotiation** check box is cleared and allows selecting the type of cable: **MDI** (default) for straight through cable or **MDIX** for crossover cable.  
**Automatic** mode is selected when the **Auto-Negotiation** check box is selected and allows the unit to automatically detect the MDI or MDIX cable type.
- **Local Clock**, available with 1GE electrical interface, allows setting the source of the clock: **Master** (default), **Slave**<sup>1</sup>, or **Auto** (available when the **Auto-Negotiation** check box is selected). Not available with SyncE test application.

## **LINK (Fibre Channel)**

- **LINK** indicates the port link status: link up (green arrow), error or link down (red arrow), or awaiting incoming data to provide a status (gray arrow).
- **PSP (Link Protocol)** (Primitive Sequence Protocol) check box when selected (default) allows link management by activating the port.

## **LINK (CPRI)**

- **LINK** indicates the port link status: link up (green arrow), error or link down (red arrow), or awaiting incoming data to provide a status (gray arrow).
- **Scrambling** check box when selected (default), available with **Unframed** test, enables the scrambler. Only available with CPRI rates 4.9152 Gbit/s and higher.

---

1. **Slave** is the only available choice for Time Error / Wander test application.

## Setup

### Interface

---

- **Sequence** indicates the last Startup Sequence State: **Standby (A)**, **L1 Sync (B)**, **Protocol (C)**, **L2 C&M (D)**, **Vendor (E)**, **Operation (F)**, or **Passive (G)**. **Frame Sync** indicates the synchronization status: green for active, red for inactive, or gray for pending.
- **Protocol** defines how the CPRI Startup Sequence negotiates the protocol version.
  - **Auto** can use protocol **Version 1** and **Version 2** during the negotiation.
  - **Version 1** negotiates the protocol with **Scrambling** disabled for all supported CPRI rates with the exception of 10.1 and 24.3 Gbits/s for which the **Scrambling** is enabled.
  - **Version 2** negotiates the protocol with **Scrambling** enabled. Available with CPRI rates: 9.8, 6.1, and 4.9 Gbit/s.

**Protocol** table indicates either the last received (**Version 1** or **Version 2**) or negotiated (**Auto**) protocol version. A light-red background indicates a Protocol version mismatch between the received value and the expected generated value.

- **C&M Channel** defines the kind of channel that will be used by the startup sequence for negotiation. Only **Disabled** is available when **Vendor** is set to **Ericsson**.
  - **Auto** (default): Overhead byte #Z.66.0 can use any of the HDLC rates and Overhead byte #Z.194.0 can use any of the Ethernet Subchannel in the negotiation process.
  - **HDLC**: Only overhead byte #Z.66.0 is used with the configured HDLC Rate during the negotiation process. Ethernet #Z.194.0 byte is set to rr00 0000 as it is disabled.
  - **Ethernet**: Only overhead byte #Z.194.0 is used with the configured Ethernet Subchannel during the negotiation process. HDLC #Z.66.0 byte is set to rrrr r000 as it is disabled.

- **Disabled:** Both HDLC Rates and Ethernet Subchannel are disabled to simulate a Passive Link. Ethernet #Z.194.0 byte is set to rr00 0000 and HDLC #Z.66.0 byte is set to rrrr r000. Only available with **Base Station** emulation mode.

**C&M** table indicates either the received (**HDLC** or **Ethernet**) or negotiated (**Auto**) C&M for Ethernet subchannel and HDLC rates in Mbit/s. A red background indicates either a C&M type mismatch or HDLC Rate/Ethernet subchannel mismatch compared to the generated C&M channel. An arrow is displayed indicating which C&M Channel should normally be selected as per the standard rules.

- **Subchannel**, available with **Ethernet C&M Channel**, selects the Ethernet subchannel number: **20** to **63** where 63 is the lowest bit rate and 20 the highest.
- **Rate (Mbit/s)** is available with **HDLC** and **Ethernet C&M Channel**.

For **Ethernet**: Indicates the bit rate corresponding to the selected **Subchannel**.

For **HDLC**: Allows the selection of the HDLC bit rate. Choices depend on the selected CPRI interface rate. HDLC **Proprietary** is used to exercise a case where the Base Station is aware in advance of the HDLC rate to use. The proprietary rate are not described in the standard. If an HDLC Proprietary is received during the negotiation process while the **C&M Channel** is set to **Auto**, the negotiation completes but no actual bit rate is reported as it is unknown. Similarly, if an equipment vendor uses an invalid rate (as per the CPRI Standard) during the negotiation process, this rate is reported as **Unspecified (Code)** where **Code** is a decimal value representing an invalid rate based on the configured interface rate.

CPRI Rate (Gbit/s)	HDLC Rate (Mbit/s)
1.2	0.240, 0.480, 0.960 (default), Proprietary
2.4	0.240, 0.480, 0.960, 1.920 (default), Proprietary
3.1	0.240, 0.480, 0.960, 1.920, 2.400 (default), Proprietary

## Setup

### Interface

---

CPRI Rate (Gbit/s)	HDLC Rate (Mbit/s)
4.9	0.240, 0.480, 0.960, 1.920, 2.400, 3.840 (default), Proprietary
6.1	0.240, 0.480, 0.960, 1.920, 2.400, 4.800 (default), Proprietary
9.8, 10.1, 24.3	0.240, 0.480, 0.960, 1.920, 2.400, 7.680 (default), Proprietary

- **RS-FEC** check box when selected (default) enables the use of RS-FEC (only available with 24.3G).

### LINK (OBSAI Framed L2)

- **Sync** indicates the RX State Machine status: green for FRAME\_SYNC, gray for pending, or red for other states. The TX and RX State Machines are also displayed.
- **Force TX Idle** check box when selected forces the TX State Machine to Idle state and when cleared (default) allows the TX State Machine to operate normally.
- **Scrambling** check box when selected (default) enables the scrambler. Available with OBSAI 6.1 Gbit/s rate.

**TX Seed** is the start value of the scrambler training process: **0x01** (default) to **0x7F** limited to the Seed values defined in the standard.

**RX Seed** is the current seed value detected.

- **Frame Clock Burst Generation** check box when selected (default) enables the generation of the frame clock burst message. Available with base station emulation mode.



## RP3 Address (OBSAI Framed L2)

- **Source** identifies the source node of RP3 messages: **0000** to **1FFF**; default is **1234**. The RP3 address 1FFF corresponds to the empty message address that is dropped according to the standard.
- **Target** identifies the peer node that is receiving the RP3 messages: **0000** (default) to **1FFF**.
- **Peer Target** indicates the RP3 Peer Target Address; indicates a mismatch when displayed in red.
- **Address Mismatch** check box when selected, cleared by default, enables the monitoring of the mismatch between the **Source** and received **Peer Target** addresses.

## RP3 Address (OBSAI Framed L2)

- **Type** identifies the type of RP3 Data Message generated by the OBSAI node: **WCDMA/FDD** (00010) - (default), **LTE** (01110), **GSM/EDGE** (00100), and **802.16** (01100).
- **Msg Grp/Frame (N\_MG)** indicates the number of Message Group per Frame parameter.
- **Msg/Grp (M\_MG)** indicates the number of Message per Message Group parameter.
- **Idle/Grp (K\_MG)** indicates the number of Idle per Message Group parameter.

## ESMC

**Note:** Available with Time Error / Wander test application with Ethernet rates. Refer to Status Bar on page 36 for ESMC arrow status description.

- **Generated QL** allows selecting the QL message that will be generated. See page 497 for the list of QL message (default is **QL-DNU/DUS**).
- **ESMC Monitoring** check box when selected (cleared by default) validates the presence of ESMC messages in the received frames.
- **Received QL** indicates the received Quality Level monitored even when the test is not started. Available when the **ESMC Monitoring** check box is selected.

## WIS Button

**Note:** The **WIS** button is available with 10GE WAN interface.

- **J0 Trace** allows setting the trace value in 16 bytes format (default is **EXFO 10GigE**).
- **J1 Trace** allows setting the trace value in 16 bytes format allowing up to 15 bytes (a CRC-7 byte will be added in front for a total of 16 bytes). Default is **EXFO 10GigE**.

**Note:** Trace values should be 7-bit T.50 suitable characters. The **Padding** drop list from the message keyboard allows selecting **Null** or **Space** to fill up the trace message up to 15-byte value automatically. The **Ctrl Char.** button from the trace message keyboard, allows selecting the required character (see Keyboard Usage on page 48).

- **Path Signal Label (C2)** byte is allocated to indicate the content of the STS SPE, including the status of the mapped payload.

C2 (Hex.)	Description
00	Unequipped
01	Equipped - Non-Specific
1A <sup>a</sup>	10 Gbit/s Ethernet (IEEE 802.3)
FE	Test Signal, ITU-T 0.181

- a. Default value.

## Physical Interface

**Note:** For parallel interfaces, the following information is displayed for each optical lane. Not supported when **PHY Type** is set to **DAC**.

- **Optical Lane** indicates the optical lane number for parallel interfaces.

Optical Interface	Optical Lane Number
40GE (4 Lanes) [41.25 Gbit/s] 100GE (4 Lanes) [103.125 Gbit/s] 200GE (4 Lanes) [212.5 Gbit/s] 400GE (4 Lanes) [425 Gbit/s]	0 through 3
400GE (8 Lanes) [425 Gbit/s]	0 through 7

- **Laser** indicates the status of the laser: **ON** with the laser pictogram (emitting an optical laser signal) or **OFF**.
- **TX Power (dBm)** indicates, when supported, the transmit power level of the optical laser/lane in dBm.
- **Wavelength (nm)** indicates, when supported, the detected lane/laser wavelength.

## Setup

### Interface

---

- **RX Power (dBm)** indicates, when supported, the current received power level of the optical laser/lane in dBm.

Green: Power level in range.

Yellow: Power level out-of-range.

Red: Loss of signal or power level is close to damage.

Gray: Invalid operational range value or not available/supplied by the transceiver.

For parallel interfaces, **LO** and **HI** report respectively the current lowest and highest RX power levels from any lane. Not available with 50GE.

- **Min RX Power (dBm)** indicates, when supported, the minimum received power level of the optical laser/lane in dBm.
- **Max RX Power (dBm)** indicates, when supported, the maximum received power level of the optical laser/lane in dBm.
- **Laser ON/OFF** button, available with parallel interfaces, is used to activate the laser control per optical lane or for all lanes. Select the **Laser** check box to enable/disable the laser for each lane individually or select the **All Lanes** check box to enable/disable all optical lanes at once. Not available with 50GE.
- **Lasers OFF at Start-Up** check box when selected (cleared by default) automatically turns OFF the laser for serial interfaces or all lasers for parallel interfaces when starting the unit or when switching from one test application to another. However the laser remains ON, on a remote unit receiving a request for a DTS connection or a loopback command.
- **Modify Wavelength**, available with tunable SFP transceivers, refer to *Modify Wavelength (SFP)* on page 990.
- **Power Range (dBm)** indicates the transceiver operational RX power range.

## TX Frequency

**Note:** *The following TX Frequency information applies to serial interface only, refer to TX Frequency on page 280 for parallel interfaces. Not available when using an active copper SFP.*

- **Frequency (GHz)** indicates the frequency (actual frequency + Frequency offset) used for transmission.

**Note:** *Frequency offset is not available with OBSAI, CPRI in RRH emulation mode, RFC 6349 test application.*

- **Offset (ppm)** check box, when selected (cleared by default), allows setting the frequency offset that will be generated:  $\pm 120$  ppm for all Sync, Fibre Channel, and Ethernet rates at the exception of 10GE WAN which is  $\pm 50$  ppm; not supported for 10M electrical. Use the “+” or “-” button to respectively increment or decrement the frequency offset value based on the defined **Increment/Decrement Size**, or directly type the frequency offset value in the field.

**Step Size (ppm)** allows setting the increment/decrement value (from 0.1 to the maximum offset) that will be used when changing the frequency offset with the “+” or “-” button.

## RX Frequency

**Note:** *The following RX Frequency information applies to serial interface only, refer to RX Frequency on page 282 for parallel interfaces. Not available when using an active copper SFP.*

- **Frequency (GHz)** indicates the frequency of the input signal.
- **Offset (ppm)** indicates the frequency offset between the standard rate specification and the rate at the input signal.

## Setup

### Interface

---

**Note:** For both *Frequency* and *Offset* the following background colors are used.

Background color	Description
Green	The frequency is in range.
Red	The frequency is out-of-range or LOC Lane.
Gray	Pending state.

- **Max. Negative Offset (ppm)** indicates the maximum negative frequency offset between the standard rate specification and the rate from the received signal.
- **Max. Positive Offset (ppm)** indicates the maximum positive frequency offset between the standard rate specification and the rate from the received signal.

## Interface - DCO BERT

From the test menu, tap **Setup, Test Configurator**, the interface block, and on the **Interface** tab.

**Note:** *The **Local Degrade**, **Remote Degrade**, and **Remote PHY Fault** alarms are displayed; refer to *Interface (DCO BERT)* on page 914 for more information. The **FDD** and **FED** alarms are displayed when their corresponding check box is selected; refer to *Media RX FEC* on page 915 for more information.*

- **FED** check box when selected (cleared by default), available when supported by the DCO transceiver, enables the use of the **FEC Excessive Degrade** function.
- **FDD** check box when selected (cleared by default), available when supported by the DCO transceiver, enables the use of the **FEC Detected Degrade** function.
- **Thresholds** button is available when either the **FDD** or **FED** check box is selected (refer to *Thresholds - FED/FDD* on page 1002).

### Physical Interface

- **Laser** indicates the status of the laser: **ON** with the laser pictogram (emitting an optical laser signal) or **OFF**.
- **TX Power (dBm)** indicates the transmit power level of the optical laser/lane in dBm.
- **Wavelength (nm)** indicates the detected lane/laser wavelength.

## Setup

### Interface - DCO BERT

---

- **RX Power (dBm)** indicates the current received power level of the optical laser/lane in dBm.  
Green: Power level in range.  
Yellow: Power level out-of-range.  
Red: Loss of signal or power level is close to damage.  
Gray: Invalid operational range value or not available/supplied by the transceiver.
- **Lasers OFF at Start-Up** check box when selected, cleared by default, automatically turns OFF the laser for serial interfaces or all lasers for parallel interfaces when starting the unit or when switching from one test application to another. However the laser remains ON, on a remote unit receiving a request for a DTS connection or a loopback command.
- **Modify TX Power**, refer to *Modify TX Power - DCO BERT* on page 988.
- **Modify Wavelength**, refer to 0.
- **Power Range (dBm)** indicates the transceiver operational RX power range.



## TX Frequency

- **Frequency (GHz)** indicates the frequency (actual frequency + Frequency offset) used for transmission.
- **Offset (ppm)** check box, when selected (cleared by default), enables the frequency offset generation. The frequency offset range<sup>1</sup> is  $\pm 30$  ppm.
  - **Fixed** (default) uses a fixed offset frequency value for generation. Use the “+” or “-” button to respectively increment or decrement the frequency offset value based on the defined **Step Size (ppm)**, or directly type the frequency offset value in the field.

**Step Size (ppm)** allows setting the increment/decrement value (from 0.1 to the maximum offset) that will be used when changing the frequency offset with the “+” or “-” button.

- **Sweep** increases and decreases repetitively the frequency to cover the defined frequency offset range using a 1 ppm step at an average rate of up to 10 ppm/sec. Starting at offset 0 the min value is reached then repetitively increases to the maximum value then decreases to minimum value.

**Range (ppm)**, available with **Sweep** frequency offset mode, allows setting the range for frequency sweep generation (-20 to 20 ppm by default).

---

1. The frequency offset range is guaranteed for a source signal at 0 ppm. In the event that the source signal already has an offset, then the output signal may exhibit an offset larger than the range specified.

### Optical Metrics

When supported by the DCO transceiver, the following **Current** (live) metrics values are reported by the DCO transceiver:

- **CD (ps/nm)**, the Chromatic Dispersion, indicates the difference in propagation time between the different wavelengths.
- **CFO (MHz)**, the Carrier Frequency Offset, indicates the frequency offset between the carrier and the local oscillator.
- **DGD (ps)**, the Differential Group Delay, indicates the difference in propagation time between two polarizations.
- **OSNR (dB)**, the Optical Signal to Noise Ratio, indicates the ratio of service signal power to noise power within a valid bandwidth. It quantifies the degree of noise interference on the optical signal.
- **PDL (dB)**, the Polarization Dependent Loss, indicates the difference between the maximum and minimum values of the channel insertion loss or gain of the link due to a variation of the State of Polarization over all polarizations states.
- **SOPCR (krad/s)**, the State of Polarization Change Rate, indicates the rate of rotation of the two polarizations of the optical signal at the receiver.
- **SOPMD (ps<sup>2</sup>)**, the Second Order Polarization Mode Dispersion, indicates the derivative of the polarization dispersion vector with respect to the optical frequency.

## Labels

For SONET/SDH BERT and SONET/SDH - DS<sub>n</sub>/PDH BERT: From the test menu, tap **Setup, Test Configurator**, the interface block, and on the **Labels** tab.

For OTN-SONET/SDH BERT: From the test menu, tap **Setup, Test Configurator**, the protocol block, and on the **Labels** tab.

## Labels

**Note:** *Selecting a Label byte to be generated automatically update the corresponding OH byte and vice versa. Refer to OH - SONET/SDH on page 688 for more information. Check boxes are coupled with settings from Labels on page 472.*

- **STS Path (C2) / AU Path (C2):** The C2 byte is allocated to indicate the content of the STS SPE / VC, including the status of the mapped payloads.

**Generated** allows the selection of C2 byte (refer to C2 on page 696).

- **PLM-P/UNEQ-P / HP-PLM/HP-UNEQ** check box when selected (cleared by default) enables the Payload Mismatch and STS/AU UNEQ monitoring.

**Expected** allows the selection of the expected C2 byte value (refer to C2 on page 696).

## Setup

### Labels

---

- **VT Path (V5) / TU Path (V5):** The V5 byte is allocated to indicate the content of the VT/TU path, including the status of the mapped payloads.

**Generated** allows the selection of the V5 byte value (refer to V5 on page 699).

- **PLM-V/UNEQ-V / LP-PLM/LP-UNEQ** check box when selected (cleared by default) enables the Payload Mismatch and VT/TU UNEQ monitoring.

**Expected** allows the selection of the expected V5 byte value (refer to V5 on page 699).

## Link OAM

From the test menu, tap **Setup, Test Configurator**, and the **Link-OAM (802.3)** test block.

### OAM Mode

Allows the selection of the OAM mode:

- **Active** (default) initiates the OAM discovery and send OAMPDU loopback control; doesn't respond to variable request nor generate Link Event Notification.
- **Passive** doesn't initiate OAM discovery nor send OAMPDU loopback control.

### OAMPDU Destination MAC Address

Indicates and allows changing the default multicast OAM PDU destination MAC address: **01:80:C2:00:00:02**.

**Default** check box when cleared (default is selected), allows the configuration of the OAM PDU destination MAC address: **00:00:00:00:00:00** to **FF:FF:FF:FF:FF:FF**.

### Pass/Fail Verdict

**Pass/Fail Verdict** check box when selected (default) enables the use of the pass/fail verdict. A global fail verdict is declared when any of the following condition is met: **Link Down**, any Link OAM alarm, **Remote Alarms** (if enabled), or **Remote Loopback** (if enabled).

- **Remote Alarms** check box when selected (default) considers the following alarms to declare the pass/fail verdict: **Critical Event**, **Dying Gasp**, and **Link Fault**.
- **Remote Loopback** check box when selected (default) considers successful/unsuccessful remote loopback request to declare the pass/fail verdict.

## OAM Discovery Status

- **Local** reports the local OAM discovery status as follows:

Status	Description
Evaluating	OAM discovery is started.
Stable	OAM discovery is completed. Local OAM is satisfied with the remote OAM settings.
Unsatisfied	OAM discovery cannot complete successfully. Local OAM equipment is unsatisfied with the remote OAM settings.

- **Remote** reports the remote OAM discovery status as follows:

Status	Description
Evaluating	OAM discovery is started.
Stable	OAM discovery is completed. Remote OAM is satisfied with the local OAM settings.
Unsatisfied	OAM discovery cannot complete successfully. Remote OAM equipment is unsatisfied with the local OAM settings.

## Loopback



- **Local and Remote**
  - **Status** indicates the status of the local and remote loopback: **Enabled** represents a Looped-Up condition and **Disabled** a Looped-Down condition.
  - **Enable/Disable** button allows respectively Looping-Up (**Enable**) or Looping-Down (**Disable**).

## Local Details - iSAM

From the test menu, tap **Setup**, **Test Configurator**, and the **More** button from the **Local** block.

- **LINK** indicates the port link status (at the PCS level for parallel interfaces): link up (green arrow), error or link down (red arrow), or awaiting incoming data to provide a status (gray arrow).

**Note:** For 88260, a message is displayed when there is a warning or a problem with the transceiver system as described in the following table:

Icon	Displayed Message	Description
	Missing TA-...	No transceiver system detected
	Validating TA-...	Validation process is on-going
	Invalid TA-...	Validating process completed and incompatibility has been found

### ➤ Interface/Rate:

Unit	Interface/Rate	Connector
88708880	10GE LAN 1GE Optical 100M Optical	Port 1 - SFP + Port 2 - SFP +
	10/100/1000M Electrical	Port 1 - RJ45 Port 2 - SFP+ (RJ45) <sup>a</sup>

## Setup

### Local Details - iSAM

Unit	Interface/Rate	Connector
88200NGE	100GE (4 Lanes) [103.125 Gbit/s]	Port 1 - CFP4 Port 2 - QSFP (QSFP28)
	100GE (2 Lanes) [106.25 Gbit/s] 100GE (1 Lane) [106.25 Gbit/s]	Port 2 - QSFP
	40GE (4 Lanes) [41.25 Gbit/s]	Port 2 - QSFP (QSFP+)
	10GE LAN 1GE Optical 100M Optical	Port 1 - SFP+
	10/100/1000M Electrical	Port 1 - SFP+ (RJ45) <sup>b</sup>
88260	100GE (4 Lanes) [103.125 Gbit/s]	Port A1/A2/B1/B2 - QSFP28 Port A1/B1 - CFP4
	100GE (2 Lanes) [106.25 Gbit/s] 100GE (1 Lane) [106.25 Gbit/s]	Port A1/A2/B1/B2 - QSFP28
	40GE (4 Lanes) [41.25 Gbit/s]	Port A1/A2/B1/B2 - QSFP28
	10GE LAN 1GE Optical 100M Optical	Port A1/A2/B1/B2 - SFP28
	10/100/1000M Electrical	Port A1/A2/B1/B2 - SFP28 (RJ45) <sup>b</sup>

- a. Ethernet 10/100/1000M electrical is supported when using an active copper SFP.

➤ **Connector** allows the selection of the physical port (see the **Interface/Rate** table above).

➤ **PHY Type** allows selecting the transceiver PHY type:

For 100GE (4 Lanes): **LR4/ER4** (default), **SR4**, **CWDM4**, **CLR4**, **AOC**, or **Other**. The PHY type when set to any except **LR4/ER4**, provides access to RS-FEC configuration (see page 290).

For 100GE (1 Lane): **DR1/FR1/LR1** (default and dimmed); ensure the other end of the circuit has the FEC enabled.

For 100GE (2 Lanes): **SRBD** (default and dimmed); ensure the other end of the circuit has the FEC enabled.



- **RS-FEC** check box when selected (default), available with framed 100GE interface, enables the use of the RS-FEC; ensure both ends of the circuit have the FEC enabled. The **RS-FEC** check box should be selected when using a 100GBASE-SR4, 100G-CWDM4, or 100G AOC transceiver but may be cleared for testing purposes. For 100GE (1 Lane) and 100GE (2 Lanes) , the **RS-FEC** check box is selected and dimmed. Not available when the **PHY Type** is set to **LR4/ER4**.
- **Auto-Negotiation** check box when selected (default), available with 10/100/1000M Electrical and 1GE Optical interfaces, indicates to the remote port which parameters to use. For 1GE Electrical interface and when using an active copper SFP, the **Auto-Negotiation** check box is selected and dimmed.

**Note:** *When the **Auto-Negotiation** check box is selected, the port **Speed** can be set. This setting is not applied immediately to the port, it is used only when the negotiation process is started, and takes effect only when the auto-negotiation succeeds. However, the current setting is applied immediately to the port when the Auto-Negotiation check box is cleared.*

- **Speed**, available with 10/100/1000M Electrical interface, allows the selection of the interface rate: **10M**, **100M**, **1GE**, or **Auto**. **Auto** is only available when the **Auto-Negotiation** check box is selected. The negotiated speed will be displayed next to the **Speed** field selection.

**Note:** ***Full Duplex** is used and there is no **Flow Control** (pause frames received are ignored).*

- **Lasers OFF at Start-Up** check box when selected (cleared by default) automatically turns OFF the laser for serial interfaces or all lasers for parallel interfaces when starting the unit or when switching from one test application to another. However the laser remains ON, on a remote unit receiving a request for a DTS connection or a loopback command.

## Setup

### Local Details - iSAM

---

- **Wavelength (nm)** indicates, when supported, the detected wavelength.

**Modify** button, available with tunable transceivers, is used to configure the transceiver wavelength. Refer to *Modify Wavelength (SFP)* on page 990.

## MAC

- **MAC** indicates the default and unique Media Access Control (MAC) address given to the Ethernet port.
- **VLAN ID/Priority** check box when selected (cleared by default) enables C-VLAN with VLAN Ethernet type of 8100 and allows setting both VLAN ID and priority.

**VLAN ID** allows selecting the VLAN ID: **0** through **4095** (default is **2**). Special VID values (IEEE Std 802.1Q-1998):

ID	Description
0	The null VLAN ID. Indicates that the tag header contains only user priority information; no VLAN identifier is present in the frame. This VID value must not be configured as a PVID, configured in any Filtering Database entry, or used in any Management operation.
1	The default PVID value used for classifying frames on ingress through a Bridge Port. The PVID value can be changed on a per-Port basis.
4095	Reserved for implementation use. This VID value shall not be configured as a PVID, configured in any Filtering Database entry, used in any Management operation, or transmitted in a tag header.

**Priority** allows selecting the VLAN priority: **0** (default) to **7**:

0	000 - Low Priority	4	100 - High Priority
1	001 - Low Priority	5	101 - High Priority
2	010 - Low Priority	6	110 - High Priority
3	011 - Low Priority	7	111 - High Priority

## IP

- **IP Version** is set to **IPv4** and dimmed.
- **Automatic IP (DHCP)** check box when selected (cleared by default) allows obtaining an IP address dynamically from a DHCP (Dynamic Host Configuration Protocol) server.

**Note:** *IP Address, Subnet Mask, and Default Gateway are not configurable when the Automatic IP (DHCP) check box is selected.*

- **IP Address** allows entering the source IP address for the stream. The default setting is 10.10.x.y, where x and y are respectively the two least significant bytes of the port default MAC address.
- **Subnet Mask** allows entering the Subnet Mask (default is **255.255.0.0**).
- **Default Gateway** check box when selected (cleared by default) allows entering a default Gateway IP address (default is **0.0.0.0**).

## Remote Discovery ID

**Remote Discovery ID** is used to easily identify this module in case another module is performing a discovery scan. Up to 16 alpha-numeric characters are allowed.

# MAC/IP/UDP

**Note:** Only available with Framed Layer 2 and higher.

From the **Test** menu, tap **Setup, Test Configurator**, and...

For **RFC 2544** and **EtherBERT**, tap on the protocol block.

For **EtherSAM**, and **Traffic Gen & Mon**, tap on the protocol block, and on the **MAC/IP/UDP** tab.

For **FlexE BERT**, tap on the **Clients** block, and on the **MAC** tab.

For **eCPRI BERT**, tap on the **eCPRI FLOW** block, and on the **MAC** tab.

- **Link**, available with multiple link interface (ex: 2 x 100GE), allows selecting the link to be displayed.
- **Enable** check box when selected (default), available with multiple link interface, includes the selected link in the test. At least one of the links must remain enabled.
- **Client ID**, available with FlexE BERT, allows selecting the client identification to be displayed.
- **Size (Gbit/s)**, available with FlexE BERT, indicates the size of the client ID.
- **Stream selection**, available with Traffic Gen & Mon, allows the configuration of up to 16 streams individually by either using the left/right arrow or by tapping over the stream numbers area then on a specific number.
- **Service selection**, available with EtherSAM, allows the configuration of up to 10 services individually by either using the left/right arrow or by tapping over the service numbers area then on a specific number.

- **Couple with Interface** check box when selected (default) couples the following settings with the interface (see *Network* on page 328): **Frame Format**, **Network Layer**, and all **IP** and **VLAN**<sup>1</sup> settings. The **Source MAC Address** is always coupled. Not available when using **Provider Encapsulation**.
- **Discovery**, available with Traffic Gen & Mon for rates up to 10GE WAN, allows scanning the remote interface to discover packet signatures that can be used for stream configuration. Refer to *Remote Interface Discovery* on page 999.

## Modify Frame Structure

**Note:** Refer to *Modify Frame Structure* on page 978.

### Preamble/SFD

**Preamble/SFD** indicates that the frame structure contains the Preamble and SFD.

### EoE

**Note:** Available when **EoE** is selected as the **Provider Encapsulation** (see *Modify Frame Structure* on page 316).

- **Source EoE MAC Address** indicates and allows changing (when the **Factory Default** check box is cleared) the default EoE Media Access Control (MAC) address. The default setting is **0E:01:00:xx:xx:xx**.
- **Destination EoE MAC Address** allows entering the destination EoE MAC address for the stream. The default setting is **0E:01:00:00:00:01**.

---

1. VLAN is not coupled for EtherSAM.

## Setup

### MAC/IP/UDP

---

#### ➤ EoE VLAN

**Note:** Available when **EoE VLAN** is enabled; refer to **Modify Frame Structure** on page 316.

**VLAN ID** allows selecting the VLAN ID: **0** through **4095** (default is **2**). Special VID values (IEEE Std 802.1Q-1998):

ID	Description
0	The null VLAN ID. Indicates that the tag header contains only user priority information; no VLAN identifier is present in the frame. This VID value must not be configured as a PVID, configured in any Filtering Database entry, or used in any Management operation.
1	The default PVID value used for classifying frames on ingress through a Bridge Port. The PVID value can be changed on a per-Port basis.
4095	Reserved for implementation use. This VID value shall not be configured as a PVID, configured in any Filtering Database entry, used in any Management operation, or transmitted in a tag header.

**Priority** allows selecting the VLAN priority: **0** (default) to **7**:

0	000 - Low Priority	4	100 - High Priority
1	001 - Low Priority	5	101 - High Priority
2	010 - Low Priority	6	110 - High Priority
3	011 - Low Priority	7	111 - High Priority

**Type** allows selecting the EoE VLAN type: **0x8100**, **0x88A8**, **0x9100**, **0xA100** (default), **0x9200**, or **0x9300**.

**Drop Eligible** when set to **Yes** (DEI = 1), the transmitted frames will be dropped first on receipt when congestion occurs under test. Drop Eligible is not available when VLAN type is 0x8100. This setting is set to **No** by default.

- **TTL** allows selecting the Time To Live: **0** to **255** (default is **64**).
- **Etag** allows selecting the Extended Tag: **0** to **255** (default is **1**).

## PBB-TE

**Note:** Available when **PBB-TE** is selected as the **Provider Encapsulation** (see Modify Frame Structure on page 316).

- **Source B-MAC Address** indicates and allows changing (when the **Factory Default** check box is cleared) the default source Backbone MAC address: **00:03:01:xx:xx:xx**.
- **Destination B-MAC Address** allows entering the destination Backbone MAC address. The default setting is **00:00:00:00:00:00**.
- **B-VLAN** (EtherType: 0x88A8) is available when the **B-VLAN** check box is selected (see Modify Frame Structure on page 316).

**VLAN ID** allows selecting the VLAN ID: **0** through **4095** (default is **2**). Special VID values (IEEE Std 802.1Q-1998):

ID	Description
0	The null VLAN ID. Indicates that the tag header contains only user priority information; no VLAN identifier is present in the frame. This VID value must not be configured as a PVID, configured in any Filtering Database entry, or used in any Management operation.
1	The default PVID value used for classifying frames on ingress through a Bridge Port. The PVID value can be changed on a per-Port basis.
4095	Reserved for implementation use. This VID value shall not be configured as a PVID, configured in any Filtering Database entry, used in any Management operation, or transmitted in a tag header.

## Setup

MAC/IP/UDP

---

**Priority** allows selecting the VLAN priority: **0** (default) to **7**:

0	000 - Low Priority	4	100 - High Priority
1	001 - Low Priority	5	101 - High Priority
2	010 - Low Priority	6	110 - High Priority
3	011 - Low Priority	7	111 - High Priority

**Drop Eligible** when set to **Yes** (DEI = 1), the transmitted frames will be dropped first on receipt when congestion occurs under test. This parameter is set to **No** by default.

► **I-TAG** (EtherType: 0x88E7)

**SID** allows selecting the Service Instance Identifier: **0** through **16777215** (default is **256**).

**Priority** allows selecting the VLAN priority: **0** (default) to **7**:

0	000 - Low Priority	4	100 - High Priority
1	001 - Low Priority	5	101 - High Priority
2	010 - Low Priority	6	110 - High Priority
3	011 - Low Priority	7	111 - High Priority

**Drop Eligible** when set to **Yes** (DEI = 1), the transmitted frames will be dropped first on receipt when congestion occurs under test. This parameter is set to **No** by default.



## MAC

- **Source MAC Address** indicates the default and unique Media Access Control (MAC) address given to the Ethernet port. For multiple link interface, each link has its own MAC address. The MAC address is editable when: the **MAC Address - Factory Default** check box (either next to the **Source MAC Address** or from the **Network** tab) is cleared; using Provider Encapsulation; using multiple link interface.
- **Factory Default** check box when selected (default) indicates that the factory source MAC address is used. Available with DCO BERT.
- **Destination MAC Address** allows entering the destination MAC address for the stream. The default setting is the source MAC address. The destination MAC Address field is not accessible when the **Resolve MAC Address** check box is selected.
- **Resolve MAC Address** check box, when selected (default), sends a request to the network to retrieve the MAC address corresponding to the selected destination IP address. This setting is coupled with the **Resolve MAC Address** check box from *IP (IPv4) / IPv6* on page 324. Not available when the **Network Layer** is set to **None** (refer to *Modify Frame Structure* on page 316).
- **OAM Quick Ping** button automatically starts the quick Ping utility for the stream destination MAC address and provides either a successful or failed result. The quick Ping uses 3 attempts, a delay of 1 second, and a Timeout of 5 seconds.
- **EtherType** is set to the following values by default and is configurable from **0x0000** to **0xFFFF** when the **Network Layer** is set to **None**:
  - 0x0000** when **Network Layer** is set to **None**
  - 0x0800** for IPv4
  - 0x86DD** for IPv6
  - 0x8847** for MPLS
  - 0x88B7** when **Network Layer** is set to **None** with EtherBERT test
  - 0x8902** for S-OAM (available with EtherSAM)
  - 0xAEFE** for eCPRI Framed Layer 2 (no IP/UDP) and is not configurable

## Setup

### MAC/IP/UDP

---

**Note:** Depending on the **Layer Mode** (available with EtherSAM), some EtherType require to set the configuration parameters through the **Modify Frame Structure** pop-up instead of configuring its value from this field; in this case a pop-up message is displayed indicating the reason. The following EtherType are not supported for **Mixed** layer mode: 0x0001 to 0x05FF and 0x8870.

- **OUI**, available when the frame format **802.3 SNAP** is selected, allows the selection of the Organizationally Unique Identifier (OUI):
  - RFC1042** (0x000000) - (default)
  - User Defined**, available when **Network Layer** is set to **None**, allows entering the **OUI** value: **0x000000** (default) to **0xFFFFFFFF**.
- **Source Flooding** and **Destination Flooding** check boxes when selected (cleared by default) allows generation of frames using source/destination MAC addresses flooding as follows: The first frame is transmitted starting with the least significant bits of the source/destination MAC address covered by the range set to 0; each subsequent frame is transmitted by incrementing the least significant bits by 1; when the upper limit of the range is reached, the source/destination MAC address restarts over with the least significant bits covered by the range set to 0. Available with Traffic Gen & Mon when the **Network Layer** is set to **None** (see page 979).
- **Flood Range** is the range of the least significant bits used for the Source Flooding and/or Destination Flooding: **2 (1 bit)**, **4 (2 bits)**, **8 (3 bits)**, **16 (4 bits)**... up to **16777216 (24 bits)** (default). Available with Traffic Gen & Mon when the **Network Layer** is set to **None** (see page 979).

## VLAN

**Note:** *VLAN is only available when **VLAN Tag** is enabled; refer to Modify Frame Structure on page 316.*

For each VLAN tag enabled (C-VLAN/S-VLAN/E-VLAN) the following parameters are configurable.

- **VLAN ID** allows selecting the VLAN ID: **0** through **4095** (default is **2**). Special VID values (IEEE Std 802.1Q-1998):

ID	Description
0	The null VLAN ID. Indicates that the tag header contains only user priority information; no VLAN identifier is present in the frame. This VID value must not be configured as a PVID, configured in any Filtering Database entry, or used in any Management operation.
1	The default PVID value used for classifying frames on ingress through a Bridge Port. The PVID value can be changed on a per-Port basis.
4095	Reserved for implementation use. This VID value shall not be configured as a PVID, configured in any Filtering Database entry, used in any Management operation, or transmitted in a tag header.

- **Priority** allows selecting the VLAN priority: **0** (default) to **7**:

0	000 - Low Priority	4	100 - High Priority
1	001 - Low Priority	5	101 - High Priority
2	010 - Low Priority	6	110 - High Priority
3	011 - Low Priority	7	111 - High Priority

- **Type** allows selecting the VLAN Ethernet Type: **0x8100** (default for C-VLAN), **0x88A8** (default for S-VLAN), **0x9100** (default for E-VLAN), **0x9200**, or **0x9300**.
- **Drop Eligible** when set to **Yes** (DEI = 1), the transmitted frames will be dropped first on receipt when congestion occurs under test. Drop Eligible is not available when VLAN type is 0x8100. This setting is set to **No** by default.

### MPLS

**Note:** *MPLS is only available when **MPLS Label** is enabled; refer to Modify Frame Structure on page 316.*

- **Label** allows the selection of the MPLS TX labels: **0** to **1048575** (default is **16**). Refer to for the list of MPLS labels.
- **COS** allows the selection of the Class Of Service.
  - 0 (000 - Low)** (default)
  - 1 (001 - Low)**
  - 2 (010 - Low)**
  - 3 (011 - Low)**
  - 4 (100 - High)**
  - 5 (101 - High)**
  - 6 (110 - High)**
  - 7 (111 - High)**
- **TTL** allows selecting the Time to Live: **0** to **255** (default is **128**).

### S-OAM

*Only available with EtherSAM when the **S-OAM** check box is selected; refer to Modify Frame Structure on page 316.*

**MEG/MD Level** allows the selection of the Maintenance Entity Group Level / Maintenance Domain Level: **0** to **7** (default).

## IP (IPv4) / IPv6

For IPv4 only:

- **Automatic IP (DHCP)** check box when selected (cleared by default) allows obtaining an IP address dynamically from a DHCP (Dynamic Host Configuration Protocol) server.

**Note:** *Source IP Address, Subnet Mask, and Default Gateway are not configurable when the Automatic IP (DHCP) check box is selected.*

- **Source IP Address** allows entering the source IP address for the stream. The default setting is 10.10.x.y, where x and y are respectively the two least significant bytes of the port default MAC address. Not available when the **Automatic IP (DHCP)** check box is selected.
- **Destination IP Address** allows entering the destination IP address for the stream. The default setting is the source IP address.
- **Subnet Mask** allows entering the Subnet Mask (default is **255.255.0.0**).
- **Default Gateway** check box when selected (cleared by default) allows entering a default Gateway IP address (default is **0.0.0.0**).
- **TTL** allows selecting the Time to Live: **1** to **255** (default is **128**).
- **IP TOS/DS** allows entering either an hexadecimal value, **00** (default) to **FF**, or tap on the **TOS/DS Config** button to set each TOS or DS parameter individually (Refer to *TOS/DS Config* on page 1005). Changing the **IP TOS/DS** value will affect the **TOS/DS Config** settings and vice versa.

## Setup

### MAC/IP/UDP

---

For **IPv6** only; refer to *IPv6 Address Configuration* on page 967 for **Source Link-Local IPv6 Address**, **Source Global IPv6 Address**, and for additional settings.

- **IPv6 Destination Address** allows selecting the destination IP address for the stream that must start with **FE80**. The accepted range is from **0000:0000:0000:0000:0000:0000:0001** to **FFFF:FFFF:FFFF:FFFF:FFFF:FFFF:FFFF**. The default address is **2001::**. When the **Address** field is selected for editing using virtual keyboard, the **Previous IPs** button appears allowing the selection of a previously configured IP address.
- **Flow Label** is a number used to identify a series of related packets from a source to a destination: **0** (default) to **1048575**.
- **HOP Limit TTL** sets the Time To Live value: **1** to **255** (default is **128**).
- **Traffic Class (TOS/DS)** allows entering either a hexadecimal value, **00** (default) to **FF**, or tap on the **TOS/DS Config** button to set each TOS or DS parameter individually (Refer to *TOS/DS Config* on page 1005). Changing the **IP TOS/DS** value will affect the **TOS/DS Config** settings and vice versa.

For both IPv4 and IPv6:

- **Quick Ping** button automatically starts the quick Ping utility for the stream destination IP address and provides either a successful or failed result. The quick Ping uses 3 attempts, a Delay of 1 second, a Timeout of 2 seconds, and a Data Size of 32 Bytes. Refer to *Ping & Trace Route* on page 711 for more options.

- **Resolve MAC Address** check box, when selected (default), sends a request to the network to retrieve the MAC address corresponding to the selected destination IP address. This setting is coupled with the **Resolve MAC Address** check box from *MAC* on page 320. The Resolve MAC address status is displayed as follows:

Status	Description
--	The <b>Resolve MAC address</b> is not enabled.
<b>Resolving</b>	The MAC address is being resolved.
<b>Resolved</b>	The MAC address is resolved.
<b>Failed</b>	The MAC address cannot be resolved.

- **Source IP Multiplier** check box, when selected (cleared by default), allows changing the 7 LSB (Least Significant bit) of the source IP address as specified in the range: **1-128** (default) or **0-127**. Not available with eCPRI.

## UDP

- **Source Port** allows configuring the source UDP port number: **0** to **65535** (default is **49184**).
- **Destination Port** allows configuring the destination UDP port number: **0** to **65535** (default is **7 (echo)**).

## TCP

- **Source Port** allows configuring the source TCP port number: **0** to **65535** (default is **49184**).
- **Destination Port** allows configuring the destination TCP port number: **0** to **65535** (default is **7 (echo)**).

## Setup

MAC/IP/UDP

---

### eCPRI

**Message Type** allows selecting the message type to be generated: **IQ Data**, **Bit Sequence**, **Real-Time Control Data**, or **Generic Data Transfer**.

### Payload

For RFC 2544 and EtherBERT, indicates that the frame structure contains a Payload.

For Traffic Gen & Mon, allows the selection of both user defined header and pattern. Payload is not configurable when the **QoS Metrics Tags Insertion** check box is selected (see the **Global** tab).

- **User Defined Header** check box when selected (cleared by default) allows defining a 16-byte header.
- **Pattern** allows the selection of a pattern: **00** to **FF** (default is **CC**).

### FCS

FCS indicates that the frame structure contains an Ethernet FCS.



## Network

From the test menu tap **Setup**, **Test Configurator**, the interface block, and the **Network** tab.

**Note:** *For Through Mode test application, the Network tab is only available for the Primary Port but the configured parameters apply to both ports.*

- **Link**, available with multiple link interface (ex: 2 x 100GE), allows selecting the link to be displayed.
- **Enable** check box when selected (default), available with multiple link interface, includes the selected link in the test. At least one of the links must remain enabled.

## MAC

- **MAC Address** indicates and allows changing, when the **Factory Default** check box is cleared, the default and unique Media Access Control (MAC) address given to the Ethernet port.
- **Factory Default** check box when selected (default) indicates that the factory source MAC address is used.
- **Frame Format** (layer 2) allows selecting **Ethernet II** (default) or **802.3 SNAP** as the frame format. Only **Ethernet II** is available with 25G/50G/200G/400G, multiple link interface, and eCPRI.

## IP

- **IP Version** allows selecting **IPv4** (default) or **IPv6**<sup>1</sup>. **IP Version** is coupled for all links with multiple link interface.

For **IPv4** only:

- **Automatic IP (DHCP)** check box when selected (cleared by default) allows obtaining an IP address dynamically from a DHCP (Dynamic Host Configuration Protocol) server.

**Note:** *IP Address, Subnet Mask, and Default Gateway are not configurable when the **Automatic IP (DHCP)** check box is selected.*

- **IP Address** allows entering the IP address of the port. The default address is 10.10.x.y, where x and y are respectively the two least significant bytes of the port default MAC address.
- **Subnet Mask** allows entering the Subnet Mask (default is **255.255.0.0**).
- **Default Gateway** check box when selected (cleared by default) allows entering a default Gateway IP address (default is **0.0.0.0**).

For **IPv6** only; refer to *IPv6 Address Configuration* on page 967 (**Config...** button) for **Link-Local IPv6 Address, Global IPv6 Address, Default Gateway**, and for additional settings.

---

1. Not supported with: 25G, 50G, 100G on 88460 (RFC 2544 and Smart Loopback), eCPRI, TCP Throughput.

## VLAN

- **VLAN Tag** check box when selected (cleared by default) enables and allows setting up to 3 stacked VLANs. For each VLAN tag enabled (C-VLAN, S-VLAN, E-VLAN) the following parameters are configurable.
- **VLAN ID** allows selecting the VLAN ID: **0** through **4095** (default is **2**). Special VID values (IEEE Std 802.1Q-1998):

ID	Description
0	The null VLAN ID. Indicates that the tag header contains only user priority information; no VLAN identifier is present in the frame. This VID value must not be configured as a PVID, configured in any Filtering Database entry, or used in any Management operation.
1	The default PVID value used for classifying frames on ingress through a Bridge Port. The PVID value can be changed on a per-Port basis.
4095	Reserved for implementation use. This VID value shall not be configured as a PVID, configured in any Filtering Database entry, used in any Management operation, or transmitted in a tag header.

- **Priority** allows selecting the VLAN priority: **0** (default) to **7**:

0	000 - Low Priority	4	100 - High Priority
1	001 - Low Priority	5	101 - High Priority
2	010 - Low Priority	6	110 - High Priority
3	011 - Low Priority	7	111 - High Priority

- **Type** allows selecting the VLAN Ethernet Type: **0x8100** (default for C-VLAN), **0x88A8** (default for S-VLAN), **0x9100** (default for E-VLAN), **0x9200**, or **0x9300**.
- **Drop Eligible** when set to **Yes** (DEI = 1), the transmitted frames will be dropped first on receipt when congestion occurs under test. Drop Eligible is not available when VLAN type is 0x8100. This setting is set to **No** by default.

# Network / Network Details - iSAM

From the test menu, tap **Setup**, **Test Configurator**, and the **More** button from the **Network** block.

## Network Block

The **Network** block, available before clicking on the **More** button, allows configuring the basic network settings, click on **More** for all settings.

The total bandwidth (when the **Performance Test** is enabled) and the estimated test duration are displayed.

**NAT LAN/WAN** indicate presence of NAT (Network Address Translation) router. The NAT router is automatically detected and graphically displayed with LAN/WAN indication.

**Note:** *When there is a NAT at the remote site, it is required to create UDP/TCP port 62819 forwarding rule on this NAT router to allow DTS communication. In addition, when there is a NAT in both directions (L->R and R->L), it is required to create port forwarding rules on the NAT router located at the remote side for UDP port 7.*

## iSAM

- **Layer** is the layer used for all services. The layer is fixed to **L3/L4** when the **RFC 6349 Test on Service 1** is enabled.
  - **L2** (default) for Ethernet II.
  - **L3/L4** for Ethernet II, IP (IPv4), and respectively UDP for the Configuration and Performance subtests, and TCP for RFC-6349 subtest.
- **Classification** defines the traffic classification used in the provider network: **VLAN ID**, **VLAN Priority**, or **DSCP** (available with layer L3/L4).

**Note:** *At least one check box (**Configuration Test**, or **Performance Test**, or **RFC 6349 Test on Service 1**) has to be selected.*

- **Configuration Test** check box when selected (default) verifies if the network configuration is correct for each service before starting a long term test (**Performance Test**).

Set the **Configuration Test** duration in seconds per step enabled (**CIR** and **CIR+EIR**): 5 seconds (default) to 60 seconds.

- **Performance Test** check box when selected (default) verifies that the SLA parameters (FD, IFDV, and FLR) are met over time by running multiple services simultaneously. Results are measured and compared to the configured thresholds to declare the pass/fail verdicts. The **Περιορισμένη Τεστ** is only performed for services that have their **CIR** check box selected.

Set the **Performance Test** duration in hh:mm format: 1 minute to 24 hours (default is 10 minutes).

- **RFC 6349 Test on Service 1** check box when selected (cleared by default) verifies that the Ethernet service is able to properly carry TCP traffic; Service 1 is used to performed the RFC 6349 test. Enabling the **RFC 6349 Test on Service 1** automatically set the operation mode to DTS and the layer to **L3/L4**; direction is bidirectional, max MTU is 1500 bytes, multiple connections as well as Path MTU Discovery are enabled.

Duration: The field next to the **RFC 6349 Test on Service 1** check box is used to set the duration of the TCP Throughput phase per direction in hh:mm format: 1 minute (default) to 24 hours.

**Threshold (% of ideal)** allows entering the TCP Throughput as a percentage of the Ideal L4 Throughput that will be used to declare the pass/fail verdict for both directions: **0** to **100** %; default is **95** %.

## Setup

### Services

**Services** allows the selection of the number of services: **1** (default) to **4**.

The following parameters are configurable individually for each service:

- **Profile:** Two profiles are defined by default as well as **User Profile**. Profiles are user definable and up to 25 profiles can be predefined (see *Customizable Profiles* on page 338).

Profile	Parameter				
	Frame Type	Frame Size	VLAN Priority	DSCP	Performance Criteria
Priority	EMIX	64, 128, 512, 1024, and 1518 <sup>a</sup>	7	CS7 <sup>b</sup>	MEF Metro High
Best Effort			0	CS0 <sup>b</sup>	MEF Metro Low

- The minimum frame size value is adjusted according to the frame structure and components selected as shown in the table of **Frame Size** on page 335.
- ECN is not present and not configurable but is set to 00 (Not-ECT).

**Note:** *At least one check box (**CIR** or **CIR+EIR**) has to be selected. Thus, clearing the CIR check box while CIR+EIR check box is cleared, will automatically select the CIR+EIR check box and vice versa.*

**Note:** *For Dual Test Set, the CIR and CIR+EIR values are the same (Symmetric) for both **L->R** and **R->L** directions.*

- **CIR** (Mbit/s) (Committed Information Rate) check box when selected (default) sets the service rate guaranteed by the SLA (default is **1 Mbit/s**).
- **CIR+EIR** (Mbit/s) check box when selected (cleared by default) sets the best effort allowed traffic for the service. The EIR (Excess Information Rate) value is equal to the CIR+EIR value minus CIR (default is 1.5 Mbit/s). The threshold value is configurable from the defined CIR value for this service to the line rate minus the total CIR from all services.
- **Frame Type** allows the selection of the frame type and frame size(s):
  - **Fixed** allows setting a single frame size.
  - **EMIX** allows setting up to 8 EMIX frame sizes. The EMIX frame sequence is repeated until the test ends. Default are **64, 128, 512, 1024, and 1518**.  
**Quantity** allows selecting the number of EMIX frame sizes: 2 to 8 frames (default is **5**).

## Setup

### Network / Network Details - iSAM

---

#### ► Frame Size

Frame Type	Frame Size (bytes)
Fixed (default)	64 <sup>a</sup> (default) to 16000 <sup>b</sup>
EMIX	64 <sup>a</sup> to 16000 <sup>b</sup>

- The minimum value is adjusted according to the frame structure and components selected as shown in the following table.
- The maximum frame size is limited to 10000 for 10/100/1000Mbps electrical interface.

The following table lists each component that may affect the minimum size value.

Component	Description
C-VLAN	4 bytes
UDP	8 bytes
Ethernet Header	14 bytes
IPv4	20 bytes
Using DTS	4 bytes

**Note:** *Sending traffic with frame size > 1518 in switched network may result in losing these frames.*

**Classification** allows the selection of the value for the selected classification:

**VLAN ID** allows selecting the VLAN ID: **0** through **4095** (default is **2**).  
Special VID values (IEEE Std 802.1Q-1998):



ID	Description
0	The null VLAN ID. Indicates that the tag header contains only user priority information; no VLAN identifier is present in the frame. This VID value must not be configured as a PVID, configured in any Filtering Database entry, or used in any Management operation.
1	The default PVID value used for classifying frames on ingress through a Bridge Port. The PVID value can be changed on a per-Port basis.
4095	Reserved for implementation use. This VID value shall not be configured as a PVID, configured in any Filtering Database entry, used in any Management operation, or transmitted in a tag header.

**VLAN Priority** allows selecting the VLAN priority: **0** (default) to **7**:

0	000 - Low Priority	4	100 - High Priority
1	001 - Low Priority	5	101 - High Priority
2	010 - Low Priority	6	110 - High Priority
3	011 - Low Priority	7	111 - High Priority

**DSCP** allows selecting the DSCP Codepoints value (**000000 (CS0)** by default):

000000 (CS0)	110000 (CS6)	010100 (AF22)	100100 (AF42)
001000 (CS1)	111000 (CS7)	010110 (AF23)	100110 (AF43)
010000 (CS2)	001010 (AF11)	011010 (AF31)	101110 (EF)
011000 (CS3)	001100 (AF12)	011100 (AF32)	110011 (51)
100000 (CS4)	001110 (AF13)	011110 (AF33)	110110 (54)
101000 (CS5)	010010 (AF21)	100010 (AF41)	User Defined <sup>a</sup>

a. For **User Defined** enter the DSCP binary value.

**Performance Criteria** offers the following performance criteria by default:

Name	≤ FD (ms)	≤ IFDV (ms)	≤ FLR (%)
MEF Metro High	10	3	0.01

## Setup

### Network / Network Details - iSAM

---

Name	≤ FD (ms)	≤ IFDV (ms)	≤ FLR (%)
MEF Metro Med	20	8	0.01
MEF Metro Low	37	Disabled	0.1
MEF Regional High	25	8	0.01
MEF Regional Med	75	40	0.01
MEF Regional Low	125	Disabled	0.1
MEF Continental High	77	10	0.025
MEF Continental Med	115	40	0.025
MEF Continental Low	230	Disabled	0.1
MEF Global High	230	32	0.05
MEF Global Med	250	40	0.05
MEF Global Low	390	Disabled	0.1

**User Performance** allows the configuration of the following criteria per service: **FD (Latency)**, **IFDV (Jitter)**, and **FLR (Frame Loss)**.

**Note:** *The **Performance Criteria** list is user definable and up to 25 performance criteria can be created (see Customizable Performance Criteria on page 340).*

## Customizable Profiles

As previously mentioned, 2 profiles are available by default and up to 25 profiles can be predefined by editing the profile's text file (iSAMProfilesTemplate.ini) using a text editor like **Notepad**. The file is located under ProgramData\EXFO\ProtocolProducts\.

Example of profile's text file:

```
[Priority]
Frame Type = EMIX
Frame Size = 64, 128, 512, 1024, 1518
VLAN Priority = 7
DSCP = CS7
Performance Criteria = MEF Metro High

[Best Effort]
Frame Type = EMIX
Frame Size = 64, 128, 512, 1024, 1518
VLAN Priority = 0
DSCP = CS0
Performance Criteria = MEF Metro Low
```

## Setup

Each profile entry has the following parameters.

- **Profile Name:** 1 to 16 characters. All ASCII characters from 32 to 126 decimal are supported.
- **Frame Type:** Enter **Fixed** or **EMIX**. When the frame type is missing from a profile, **EMIX** is used.
- **Frame Size** (see **Frame Size on page 335** for possible values); when the frame size is missing from a profile, default value(s) is used:  
For **Fixed**: Enter a unique frame size.  
For **EMIX**: Enter 2 to 8 frame sizes with a comma between each entry.
- **VLAN Priority**<sup>1</sup> (optional): Enter the priority number.
- **DSCP**<sup>1</sup> (optional): Enter either the DSCP name or its binary value.
- **Performance Criteria**<sup>1</sup>: Enter the name of the performance criteria. When the **Performance Criteria** is missing from a profile or is not available from the user profile file, the **User Performance** criteria is used.

When a parameter is missing from a profile, the default value of the missing parameter is used.

The value of a parameter is validated to ensure it is within the supported range; otherwise the profile entry is unsupported.

If the profile file contain more than 25 profiles, only the first 25 valid profiles are retained.

---

1. See **Classification allows the selection of the value for the selected classification: on page 335** for possible values.

## Customizable Performance Criteria

As previously mentioned, factory performance criteria are available and up to 25 performance criteria can be defined by editing the performance criteria text file (iSAMPerformanceCriteriaTemplate.ini) using a text editor like **Notepad**. The file is located under ProgramData\EXFO\ProtocolProducts\.

Example of performance criteria's text file:

```
[MEF Metro High]
FD = 10
IFDV = 3
FLR = 0.01

[MEF Metro Med]
FD = 20
IFDV = 8
FLR = 0.01

[MEF Metro Low]
FD = 37
IFDV =
FLR = 0.1
```

Each profile entry has the following parameters:

- Performance Criteria Name: 1 to 16 characters. All ASCII characters from 32 to 126 decimal are supported.
- Frame Delay (FD) Threshold: 0.001 ms (0.005 ms for 10M) to 8000 ms.
- Inter-Frame Delay (IFDV) Threshold: 0.001 ms (0.005 ms for 10M) to 8000 ms.
- Frame Loss Ratio (FLR) Threshold: 0.00 % to 5.00 %.

If the threshold value for a parameter is not defined, it is considered as disabled (as in the example above for IFDV =).

The value of a parameter is validated to ensure it is within the supported range; otherwise the performance criteria entry is unsupported.

## ODU Channels - Global

From the test menu, tap **Setup, Test Configurator, ODU Channels**, and on the **Global** tab.

**Note:** *The ODU channels global configuration applies to all channels.*

### Pattern

The icon next to the **Pattern** label indicates the status of the received pattern signal. Refer to *Status Bar* on page 36 for more information.

- **No Pattern Analysis (Live)** check box when cleared (default), monitors the received traffic pattern. For live traffic, the **No Pattern Analysis (Live)** check box should be selected as the traffic is a live pattern thus there is no analysis of pattern loss and bit error.
- **Pattern** sets the test pattern that will be generated: **PRBS31** (default) or **NULL Client** (0000).
- **Invert** check box, when selected (cleared by default), inverts the generated/expected test pattern meaning that every 0 will be changed for 1 and every 1 for 0. For example, the pattern 1100 will be sent as 0011.

### Bit Error

- **Pass/Fail Verdict** enables and sets the bit error rate/count threshold prior to run the test. This allows for a simple pass/fail verdict, leaving no room for misinterpretation of the test results. To enable the pass/fail verdict, select either **Bit Error Count** or **Bit Error Rate** (default is **Disabled**).
- **BER Threshold** allows entering the maximum bit error count/rate allowed before declaring a fail verdict: **0** (default) to **999999** for count; **1.0E-14** to **1.9E-01** (default is **1.0E-12**) for rate.

## Service Disruption

The Service Disruption Time (SDT) corresponds to the duration associated to a defect that occurred in the network. For example a disruption that occurs during a network switching from the active channels to the backup channels or vice versa. The service disruption measurements are cleared when changing the criteria.

- **Disruption Monitoring** check box when selected (disabled by default) enables the disruption time measurements. However, the measurement will only start if the test is already started, or when the test will be started. Clearing the **Disruption Monitoring** check box or stopping the test, stops the measurement without clearing the results. Starting the test while the **Disruption Monitoring** check box is selected resets the results.
- **Defect** allows choosing on which layer and defect the service disruption time test will be performed. Choices depend on the selected test path.

Layer	Defect
ODUk	LOFLOM, AIS, OCI, LCK, BDI, BIP-8, BEI
OPUk	AIS, CSF

**Note:** *The Service Disruption Time measurement supports a parent defect approach where the SDT measurement is triggered when the selected defect or a higher defect in the signal structure hierarchy is detected.*

- **No Defect Time (ms)** allows selecting the period without any defects before stopping SDT measurement: **0.005 ms** to **2000 ms** (default is **300 ms**).

## Setup

### ODU Channels - Global

---

- **Pass/Fail Verdict** check box when selected (cleared by default) enables the service disruption pass/fail verdict and allows setting the threshold value.
- **SDT Threshold (ms)** allows configuring the acceptable maximum service disruption time before failing the test: **0.001** to **299999.999 ms** (default is **50 ms**).

## Channel Summary

The **Channel Summary** table indicates the ODU mapping type for each channel number.

- **Payload Type** indicates the mapped ODU payload type.
- **Quantity of Channels** indicates the number of channels part of the test.
- **Unused Capacity** indicates the number of tributary slot not used; either configured as background traffic or Unallocated.
- **Modify Trib Slots/Channels**, refer to *Modify Trib Slots/Channels (Multi-Channel OTN)* on page 984.

## Restore Multi-Channel OTN Defaults

Reverts the test application to its default factory settings.



## Path OAM

From the test menu, tap **Setup**, **Test Configurator** and tap on the **Clients** block and on the **Path OAM** tab.

- **Path OAM** check box when selected (cleared by default) enables the use of Path OAM configuration and monitoring including APS function.
- **OAM Responder** check box when selected (default) enables the path OAM responder to respond to the 2DMM messages.
- **Global Pass/Fail Verdict** check box when selected (default) enables the global Path OAM pass/fail verdict.
- **Path OAM on Client ID** allows selecting on which client ID the path OAM applies.

## Basic OAM

- **CC Function** check box when selected (default) allows generating and monitoring Basic OAM messages.
- **Period** allows selecting the transmission period of the Basic OAM Message: **16K**, **32K**, **64K** (default), **512K**.

## Bidirectional Delay Measurement

- **2DM Function** check box when selected (cleared by default) enables the bidirectional delay measurement function.
- **TX Enable** check box when selected (cleared by default) allows transmitting 2DMM messages once the test is started. When the delay measurement generation is not continuous, the **TX Enable** check box is automatically cleared once all messages have been transmitted.
- **Period** allows entering the transmission period of the 2DMM multi-block messages: **1 s**, **10 s** (default), or **1 min**.

## Setup

### Path OAM

---

- **Continuous** check box when selected (default) enables the continuous delay measurement generation.
- **Count** allows entering the quantity of 2DMM multi-block messages to be transmitted when not in **Continuous** mode: **1** to **1000** (default is **10**).

## Connectivity Verification

- **CV Function** check box when selected (cleared by default) allows generating and monitoring CV messages once the test is started.
- **Period** allows entering the transmission period of the CV multi-block message: **1 s**, **10 s** (default), or **1 min**.
- **SAPI** (Source Access Point Identifier) allows setting the generated SAPI message (**EXFO SAPI** by default) and the expected SAPI message (**EXFO SAPI** by default) when the Expected check box is selected. A maximum of 16 characters is allowed.
- **DAPI** (Destination Access Point Identifier) allows setting the generated DAPI message (**EXFO DAPI** by default) and the expected DAPI message (**EXFO DAPI** by default) when the Expected check box is selected. A maximum of 16 characters is allowed.
- **Expected** check box when selected (cleared by default) allows setting the expected SAPI and DAPI messages. When enabled, a mismatch detection is performed between the generated and expected messages.

## **CS Type**

- **CS Type Function** check box when selected (cleared by default) allows the generation and monitoring of CS Type messages once the test is started.
- **Period** allows entering the CS Type period: **1 s**, **10 s** (default), or **1 min**.
- **Type** allows selecting the CS Type to be generated: **Channel Not Loaded**, **Ethernet** (default), **SDH**, **FC**, or **CPRI**.
- **Expected** check box when selected (cleared by default) performs a mismatch detection between the generated and expected CS Type: **Channel Not Loaded**, **Ethernet** (default), **SDH**, **FC**, or **CPRI**.

## Setup

### Profile - DCO BERT

---

## Profile - DCO BERT

From the test menu, tap **Setup, Test Configurator**, the **Client** block, and the **Profile** tab.

### Ethernet Frame

- **Frame Size (Bytes)** allows selecting the frame type (**Fixed** (default) or **EMIX**) and the frame size (**64**<sup>1</sup> to **16000**<sup>2</sup>). Sending traffic with frame size > 1518 in switched network may result in losing all frames.

The following table lists each component that may affect the minimum size value.

Component	Description
VLAN	4 bytes per VLAN (up to 3 VLAN)
UDP	8 bytes
Ethernet Header	14 bytes
IPv4	20 bytes
IPv6	40 bytes

**EMIX** button is available when **EMIX** frame size is selected. The EMIX frame sequence is repeated continuously (refer to *EMIX* on page 958).

---

1. The minimum frame size will be adjusted according to the frame structure and components selected.  
2. The maximum frame size is limited to 10000 for 10/100/1000Mbps electrical interface.

## **Shaping**

- **TX Rate** allows the selection of the transmission rate in percentage of utilization (100 percent by default), Mbit/s, Gbit/s, Frame/s, or IFG. For Ethernet, the maximum percentage is 105 percent depending on the frame size selected.
- **Enable TX** check box is automatically selected when starting the test allowing stream generation. The **Enable TX** check box may also be selected or cleared while the test is running.

## Profile - FlexE BERT

From the test menu, tap **Setup**, **Test Configurator** and tap on the **Clients** block and on the **Profile** tab.

### Client ID and Size (Gbit/s)

- **Client ID** allows selecting the client identification to be displayed.
- **Size (Gbit/s)** indicates the size of the client.

### Ethernet Frame

**Frame Size (Bytes)** allows entering the frame size. The range is from **64** to either **2000** for multiple clients or **10000** for a single client.

### Shaping

- **TX Rate** allows the selection of the transmission rate in **Mbit/s** or **Gbit/s**.
- **Enable TX** check box when selected (default) generates streams for the selected client ID when the test is started while the **TX** button is enabled (refer to *Start/Stop | TX Button* on page 766). The **Enable TX** check box may also be selected or cleared while the test is running.

## Remote Details - iSAM

The remote block automatically scans the remote modules for **DTS** and **Remote Loopback** modes and allows the selection of the remote module that is used to loop back the traffic via **Smart Loopback** or EtherSAM in **Dual Test Set (DTS)** mode for simultaneous bidirectional results. If the connection with the remote module is not manually established, the remote connection process is automatically performed when starting the test.

From the test menu, tap **Setup, Test Configurator**, and the **More** button from the **Remote** block.

**Note:** *Not available with **Manual Loopback** remote operation mode.*

### For both DTS and Remote Loopback Operation Modes

#### ► Discovered Remotes

The modules are discovered dynamically and listed with their **Name**, **IP** address, **Status**, **Connection**, and **Preferred** information. **Name** and **Status** are only available for remote 88000 Series, and 85100G modules. Only modules from the same subnet are automatically discovered. To access a module from a different subnet, use the **Add** button.

## Setup

### Remote Details - iSAM

---

- **Preferred** check box when selected indicates that this module is part of the preferred module's list. Preferred remote modules will be considered first during the automatic connection process as follows:

Priority	Preferred or not	Status
1	Preferred	Available
2		Taken
3		Test in Progress
4	Non Preferred	Available
5		Taken
6		Test in Progress

- **Status**

Background Color	Status	Description
Green	Ready	Connected with the local unit
	Running	
Yellow	Taken	Connected with another unit
Red	Test in Progress	Test in progress with another unit
No color	Unreachable	Preferred remote does not reply
	Available	Not connected

- **Connection** indicates **Connected** when the local unit is connected to a remote module.
- **Add** button is used to add a preferred remote module to the preferred list. Enter the IP address of the remote module and tap **OK**. This is useful to access a module from a different subnet.



## For Remote Loopback Operation Mode

- **Loop-Up** button establishes the connection with the selected remote module and sets the remote module into **Smart Loopback** test application.

Following a successful loop-up, the IP address of the remote module will be used as the destination IP address for the test.

- **Overtake** button manually establishes the connection with the remote module and set the remote module into Smart Loopback test application. Available when the status is **Taken** or **Test in Progress** with another unit. A confirmation is required to overtake a module.
- **Loop-Down** button ends the connection between the local and the remote modules.

## For DTS Operation Mode

- **Connect** button manually establishes the connection with the selected remote module and sets the remote module into DTS EtherSAM test application.

Following a successful connection, the IP address of the remote module will be used as the destination IP address for the test.

- **Overtake** button manually establishes the connection with the remote module and set the remote module into DTS EtherSAM test application. Available when the status is **Taken** or **Test in Progress** with another unit. A confirmation is required to overtake a module.

Following a successful connection, the IP address of the remote module will be used as the destination IP address for the test.

- **Disconnect** button, available once the connection with the remote module is established, terminates the connection with the remote module. Available when the status is **Ready**.

## Setup

*Remote Details - iSAM*

---

### For Manual Loopback Operation Mode

- **MAC**, available with layer L2, allows entering the destination MAC address of the remote.
- **IP**, available with L3/L4, allows entering the destination IP address of the remote.
- Resolved MAC address status, available with L3/L4, indicates:
  - **Resolving** when the ARP process is resolving.
  - **Resolved** when the ARP process is resolved.
  - **Failed** when the ARP process failed.
- **Quick Ping**, available with layer L3/L4, tests if the destination IP address can be reached. A message displays if the ping attempt is **Successful** or **Failed**.

## RFC 2544 - Global

From the test menu, tap **Setup, Test Configurator**, tap on the **RFC 2544** block, and on the **Global** tab.

### Dual Test Set

- **Dual Test Set (DTS)** check box when selected (cleared by default) enables the **Dual Test Set** testing mode. Once **Dual Test Set** is enabled, use the **Discover Remote** button to select a remote unit. Not available in **Dual Port** topology.

**Note:** *It is also possible using the **Discover Remote** button to connect to a remote unit and automatically enable **Dual Test Set**. For more details, refer to Discover Remote on page 742.*

**Disconnected** indicates that there is no connection established with a remote unit.

**Connected** indicates that the connection is established with a remote unit.

- **Discover Remote** allows discovering remote unit supporting **Remote Loopback** and/or **Dual Test Set**. For more details, refer to *Discover Remote* on page 742.

### Global Options

- **Flow Direction** allows the selection of the traffic direction as follows:
  - **TX to RX** for **Single Port** topology.
  - **Port <m> to Port <n>**, **Port <n> to Port <m>**, and **Bidirectional** for **Dual Port** topology.
  - **Local to Remote**, **Remote to Local**, or **Bidirectional** for **Dual Test Set**.

## Setup

*RFC 2544 - Global*

---

- **Coupled**, available with **Bidirectional** flow direction, defines if the decision to increase or decrease the TX Rate of the next iteration is taken either independently per direction (**Coupled** check box is cleared) or commonly for both directions (**Coupled** check box is selected).
- **Rate Unit** determines the unit used to display the rate values: %, **Mbit/s**, or **Gbit/s**.
- **Pass/Fail Verdict** check box when selected (default) enables the use of the pass/fail verdict.

## Subtests / Estimated Time

- **Subtests** allows enabling the **Throughput**, **Back-to-Back**, **Frame Loss**, and **Latency** subtests individually.
- **Estimated Time (H:MM)** indicates the estimated time required to complete each subtest at best conditions. The total estimated time to complete all subtests is also displayed.

## Frame Distribution

- **Frame Distribution** allows selecting either **RFC 2544** (default) or **User Defined** distribution.
- **Quantity** is only available when **User Defined** is selected and allows selecting the number of frames, from **1** to **10** (**7** by default), in the distribution.

- **Frame Size (Bytes)** either gives predefined frame size distribution values (**RFC 2544**) or allows entering the frame size values (**User Defined**).

Distribution	Frame Size
RFC 2544	64 <sup>a</sup> , 128, 256, 512, 1024, 1280, and 1518
User Defined	64 <sup>a</sup> to 16000 <sup>b</sup>

- The minimum frame size will be adjusted according to the frame structure and components selected.
- The maximum frame size is limited to 10000 for 10/100/1000Mbps electrical interface.

The following table lists each component that may affect the minimum size value.

Component	Description
VLAN	4 bytes per VLAN tag (up to 3 VLAN tags)
LLC and SNAP Headers	8 bytes
IPv4	20 bytes
IPv6	40 bytes
Using DTS	4 bytes

## Restore RFC 2544 Defaults

Reverts the test application to its default factory settings.

# RFC 2544 - Subtests

From the test menu, tap **Setup, Test Configurator, RFC 2544** block, and on the **Subtests** tab.

Allows the configuration of each enabled subtest.

## Throughput

The objective of the **Throughput** test is to find the throughput of the device under test for which there is no frame loss. Starting at the specified maximum rate (**Max. Rate**), the rate converges towards the highest throughput without frame loss. The search is done with a halving/doubling method until a final value is reached. The test performs the number of trials defined (**Trials**). The throughput measurement is validated by the number of times specified (**Validations**) for the predefined duration (**Trial Duration**). The **Accuracy** and **Acceptable Errors** specify how precise the result must be. The test is performed for each defined frame size.

- **Max. Rate** is the maximum rate the test should begin with, in terms of a percentage of the line rate (%), **Mbit/s**, or **Gbit/s**. For **Dual Test Set** Max. Rate is configurable for both local (**L**) and remote (**R**) directions. For **Dual Port** topology, **Max. Rate** is configurable for both port directions.

Interface Speed	%	Max. Rate	
		Mbit/s	Gbit/s
10 Mbit/s	0.0050 to 100.0000 <sup>a</sup>	0.00001 to 10.000 <sup>a</sup>	Not Applicable
100 Mbit/s	0.0050 to 100.0000 <sup>a</sup>	0.0001 to 100.000 <sup>a</sup>	Not Applicable
1000 Mbit/s	0.0050 to 100.0000 <sup>a</sup>	0.001 to 1000.00 <sup>a</sup>	0.000001 to 1.000 <sup>a</sup>
10G LAN	0.0050 to 100.0000 <sup>a</sup>	0.01 to 10000.000 <sup>a</sup>	0.00001 to 10.000 <sup>a</sup>
10G WAN <sup>b</sup>	0.0005 to 92.8571 <sup>a</sup>	0.01 to 9285.71 <sup>a</sup>	0.00001 to 9.28571 <sup>a</sup>
25G	0.0050 to 100.0000 <sup>a</sup>	1.25 to 25000.00 <sup>a</sup>	0.00125 to 25.00000 <sup>a</sup>
40G	0.0050 to 100.0000 <sup>a</sup>	2.00 to 40000.0 <sup>a</sup>	0.00200 to 40.0000 <sup>a</sup>
100G	0.0050 to 100.0000 <sup>a</sup>	5.00 to 100000.0 <sup>a</sup>	0.00500 to 100.0000 <sup>a</sup>
200G	0.0050 to 100.0000 <sup>a</sup>	10.0 to 200000.0 <sup>a</sup>	0.0100 to 200.0000 <sup>a</sup>
400G	0.0050 to 100.0000 <sup>a</sup>	20.0 to 400000.0 <sup>a</sup>	0.0200 to 400.0000 <sup>a</sup>

- Default value.
- The maximum value for 10G WAN may be lower depending on the frame size. The maximum value will be adjusted for each frame size.

- **Trial Duration** is the time for each trial in minutes:seconds: **1** second (default) to **30** minutes.
- **Trials** is the number of times the test will be generated: **1** (default) to **50** trials.

## Setup

### RFC 2544 - Subtests

---

- **Accuracy** is the accuracy measurement in percentage of the line rate (%), **Mbit/s**, or in **Gbit/s**. The accuracy is not based on the configured **Maximum Rate** but on the Ethernet line rate:

Interface Speed	Max. Rate		
	%	Mbit/s	Gbit/s
10 Mbit/s	0.01 to 10.0 (default 1.0)	0.01 to 1.0 (default 0.10)	Not Applicable
100 Mbit/s	0.01 to 10.0 (default 1.0)	0.1 to 10.0 (default 1.0)	Not Applicable
1000 Mbit/s	0.01 to 10.0 (default 1.0)	1 to 100.0 (default 10)	0.001 to 0.100 (default 0.010)
10G LAN	0.01 to 10.0 (default 1.0)	10.0 to 1000.0 (default 100)	0.01 to 1.00 (default 0.10)
10G WAN	0.01 to 10.0 (default 1.0)	10.0 to 1000.0 (default 100.00)	0.01 to 1.00 (default 0.1)
25G	0.01 to 10.0 (default 1.0)	2.0 to 2500.0 (default 250.0)	0.002 to 2.50 (default 0.250)
40G	0.01 to 10.0 (default 1.0)	40.0 to 4000.0 (default 400.0)	0.04 to 4.00 (default 0.40)
100G	0.01 to 10.0 (default 1.0)	100.0 to 10000.0 (default 1000.0)	0.10 to 10.00 (default 1.0000)
200G	0.01 to 10.0 (default 1.00)	20 to 20000 (default 2000)	0.02 to 20.00 (default 2.00)
400G	0.01 to 10.0 (default 1.00)	40 to 40000 (default 4000)	0.04 to 40.00 (default 4.00)

**Note:** For Dual Test Set using different rates on local and remote, the accuracy on the remote will be set using the same percentage of its line rate as the local. For example, if the local interface is 1GE with an accuracy of 0.1 Gbit/s which correspond to an accuracy of 10% and the remote interface is 10GE, the 10% is applied to its line rate corresponding to an accuracy of 1 Gbit/s.

**Acceptable Errors** represents the number of acceptable errors for the test: **0** (default) to **10**.

**Validations** represents the number of times the result should be validated: **1** (default) to **50** times.



## Back-to-Back

The objective of the **Back-to-Back** test is to find the maximum number of frames that can be sent at maximum throughput without frame loss. A burst of frames (**Burst Time**) is sent with minimum inter-frame gaps to the device under test and the number of forwarded frames is counted. If the count of transmitted frames is equal to the number of forwarded frames, the length of the burst is increased and the test is rerun. If the number of forwarded frames is less than the number of transmitted frames, the length of the burst is reduced and the test is rerun. The Back-to-Back value is the number of frames in the longest burst that the Device Under Test (DUT) can handle without the loss of any frames. The test performs the number of defined trials (**Trials**). The **Accuracy** and **Acceptable Errors** settings specify how precise that result must be. The test is performed for each defined frame size.

- **Burst Time** is expressed in seconds: **1** (default) to **5** seconds.
- **Trials** is the number of times the test will be generated: **1** (default) to **50** trials.
- **Accuracy (Frames)** is the accuracy measurement value in frames: **1** (default) to **50** frames.
- **Acceptable Errors** represents the number of acceptable errors for the test: **0** (default) to **10**.
- **Bursts** represents the number of burst that will be generated: **1** (default) to **10**.

### Frame Loss

The objective of the **Frame Loss** test is to find the percentage of frames that are lost due to lack of resources. Starting at the specified maximum rate (**Max. Rate**), the test is performed for a specific frame size and for the specified duration (**Trial Duration**). The test is repeated by decreasing the rate by the specified granularity (**Granularity**), then the test is repeated again until there are two successive trials in which no frames are lost. The test is performed for the defined number of trials (**Trials**). The test is performed for each defined frame size.

- **Max. Rate** is the maximum rate the test should begin with, in terms of a percentage of the line rate (%), **Mbit/s**, or **Gbit/s**. The accepted values are as shown in the Max. Rate table on page 358. For **Dual Test Set** the **Max. Rate** is configurable for both local (**L**) and remote (**R**) directions. For **Dual Port** topology, **Max. Rate** is configurable for both port directions.
- **Trial Duration** is the time for each trial in minutes:seconds: **1** second (default) to **30** minutes.
- **Trials** is the number of times the test will be generated: **1** (default) to **50** trials.
- **Granularity** corresponds to the percentage interval between each throughput value used for the test: 1 % to 10 % (RFC) - (default). For example, 10 % granularity means that the test will be performed for 100 %, 90 %, 80 %... of the rate value.

## Latency

The objective of the **Latency** test is to measure the time required for the frame to go through the device under test and return back to source. Starting by sending a stream of frames for the predefined duration (**Trial Duration**) and throughput (**Max. Rate**) at a particular frame size, an identifying dependent tag is included in one frame. The time at which this frame is transmitted is recorded (*timestamp A*). When the tagged frame comes back, the time is recorded again (*timestamp B*) and the Latency result is:  $timestamp B - timestamp A$ . The test is repeated for the defined number of times (**Trials**) and the average result is calculated. The test is performed for each defined frame size.

- **Trial Duration** is the time for each trial in minutes:seconds: **1** second (default) to **2** minutes.
- **Trials** is the number of times the test will be generated: **1** (default) to **50** trials.
- **Copy From Throughput** check box, when selected (default), uses the Throughput subtest results max rate value for each corresponding frame size. When the check box is cleared, it is possible to set the **Max. Rate** by tapping on the **Config. per Frame Size** button.
- **Margin %**, available when **Copy From Throughput** check box is selected, decreases the max rate value(s) from the Throughput subtest by a value corresponding to the percentage of the line rate specified: **0** (default) to **10** percent.

## Setup

### RFC 2544 - Subtests

---

- **Measurement Mode**, available with **Dual Test Set**, allows the selection of the latency measurement mode for rates 10M to 10GE: **Round-Trip** (default) or **One-Way**. For other rates, the measurement mode is set to **Round-Trip**.

Synchronization with a 1PPS interface/reference is required to perform One-Way Latency measurement. One-Way Latency is only possible when both the local and remote 1PPS signal clocks are valid. The following alarms are available with One-Way Latency measurement mode.

**LOPPS-L** and **LOPPS-R** (Loss Of Pulse Per Second - Local/Remote) are declared when either no pulse is received or when no pulse is received within 1 second  $\pm 6.6 \mu s$  after the previous pulse. LOPPS-R is only monitored once the DTS connection is established.

- **Config. per Frame Size** is available when the **Copy From Throughput** check box is cleared and allows setting the **Max. Rate** for each frame size. For **Dual Test Set** the **Max. Rate** is configurable for both local (**L**) and remote (**R**) directions. For **Dual Port** topology, **Max. Rate** is configurable for both port directions.

**All Frames** check box when selected (cleared by default) allows entering the maximum rate that will be applied to all frame sizes.

## Thresholds

**Note:** Refer to *Thresholds - RFC 2544* on page 1003.

## RFC 6349

From the test menu, tap **Setup, Test Configurator**, and the RFC 6349 block.

### Connection

- **Operation Mode** allows the selection of the test operation mode: **Dual Test Set**, or **iPerf Compatible Server**. Once a Dual Test Set connection is established with a remote module, it is not possible to change the Operation Mode until the remote is disconnected. **iPerf Compatible Server** is not available for 40GE interface.

**Note:** For **iPerf Compatible Server**, only **Listening TCP Port** and **Max Nb of Connection Allowed** are available.

For **Dual Test Set** the connection is graphically displayed with its status as follows:

Operation Mode	Status	Description
Dual Test Set	Disconnected	No connection established with a remote module.
	NAT LAN/WAN, WAN IP	<p>Connection established with a remote module.</p> <p>NAT LAN/WAN and WAN IP indicate presence of NAT (Network Address Translation) router. The NAT router is automatically detected and graphically displayed with LAN/WAN indication as well as the WAN IP address when the Power Blazer is behind a NAT router.</p> <p>When there is a NAT at the Remote site, it is required to create the following rules on this NAT router:</p> <p>1- for UDP/TCP port 62819 to allow DTS communication.</p> <p>2- for the defined TCP port (see TCP Port on page 365).</p>

- **Discover Remote** button, available with **Dual Test Set**, allows discovering remote modules supporting **Direction** allows the selection of the traffic direction: **Local to Remote**, **Remote to Local**, and **Bidirectional** (default).

- **TCP Port** is the port used by the server located at the remote side: **1 to 65535** (excluding **62819** that is used for DTS connection), default is **50201**. The port forwarding rule for the defined TCP port must be created on the NAT router when the remote is behind a NAT.
- **Listening TCP Port**, available with iPerf Compatible Server, allows the selection of the port used by the server located at the remote side: **1 to 65535** (excluding **62819** that is used for DTS connection), default is **5001**.
- **Max Nb of Connection Allowed**, available for iPerf Compatible Server with 100GE interface, allows selecting the maximum number of connections the iPerf compatible server is allowed to accept: **16** (default) or **128**. Using a maximum of 16 connections allocates more memory per connection useful when the path delay is large and only few connections are used.

## Parameters

- **Multiple Connections** check box when selected (default) indicates that the applicable TCP Throughput phases are performed with multiple connections; otherwise TCP Throughput phases are performed within a single connection. For 40/100GE rate, this check box is selected and the **Window Size Target per Connection** can be used to set the target window.
- **Window Size Target per Connection**, available for 40/100GE rate, selects the target send window per connection: 1 MiB, 4 MiB, 8 MiB, 16 MiB (default), and 32 MiB.
- **CIR** is the Committed Information Rate per direction of the Ethernet Service under test: **1.0 Mbit/s** to Line Rate. The CIR is not used to actually transmit frames at this rate but to calculate a Bandwidth Delay Product (BDP) which in turn is used to set the maximum window size of the TCP connections.

**Rate Unit** determines the unit used to display the rate values: **Mbit/s** (default) or **Gbit/s**.

- **TOS/DS (IPv4)** allows entering an hexadecimal value, **00** (default) to **FF**. Changing the **IP TOS/DS** value will affect the **TOS/DS Config** settings and vice versa.
- **Window Boost - Enable** check box when selected (cleared by default) boosts the BDP value which affects the maximum window size of the TCP connections.

The Local-to-Remote and Remote-to-Local define respectively the BDP boost factor for each direction: **0.1** to **10.0** (default is **1.0**).

## MTU

- **Max MTU (bytes)** determines the Maximum Transfer Unit (MTU) to use when the client is generating TCP traffic toward the server: from **1080** to **9600** bytes (**1500** bytes by default).
- **Path MTU Discovery** check box when selected (default) allows performing a Packetization Layer Path MTU Discovery phase.

## Window Sweep

- **Window Sweep** check box when selected (default) allows performing the Window Sweep phase.
- **Duration (per step)** is the duration of the Window Sweep phase per direction and per Window tested: 30 seconds (default) to 5 minutes.

## TCP Throughput

- **Duration** is the duration of the TCP Throughput phase per direction: 1 minute (default) to 30 days.
- **Pass/Fail Verdict** check box when selected (default) enables the use of the pass/fail verdict.
- **Threshold (% of ideal)** allows entering the TCP Throughput as a percentage of the Ideal L4 Throughput that will be used to declare the pass/fail verdict for both directions: **0** to **100** %; default is **95** %.

### Advanced

#### Recommended Window Boost (only available with Dual Test Set)

- **Buffer Delay Weight** is a multiplier applied to the Buffer Delay value used in the Suggested Window Boost formula: **0** to **10** (default is **1**).
- **TCP Throughput Weight** is a multiplier applied to the TCP Throughput value used in the Suggested Window Boost formula: **0** (default) to **10**.

### Restore RFC 6349 Defaults

Reverts the configured parameters to their default values.



## S-OAM and MPLS-TP OAM

From the test menu, tap **Setup, Test Configurator**, and the **S-OAM (Y.1731/802.1ag/MEF)** or **MPLS-TP OAM (G.8113.1)** test block.

### OAM Mode

Allows the selection of the OAM mode.

OAM Type	OAM Mode
S-OAM	Y.1731 (default) supports both Connectivity Fault Management and Performance Monitoring which includes all S-OAM functions supported by this module.
	802.1ag supports Connectivity Fault Management including only the Continuity Check, Loopback, Link Trace, and RDI functions.
	MEF supports both Connectivity Fault Management and Performance Monitoring which includes all S-OAM functions supported by this module.
MPLS-TP OAM	G.8113.1 (default) supports both Connectivity Fault Management and Performance Monitoring which includes all MPLS-TP OAM functions supported by this module.

### S-OAM and MPLS-TP OAM Responder

**S-OAM Responder** or **MPLS-TP OAM Responder** check box when selected (default) allows responding to LBM, LTM, DMM, LMM, and SLM valid messages (test running or not). LTM and SLM are only available with Ethernet OAM. Traffic statistics are also monitored (refer to *Responder* on page 625).

For S-OAM: A valid message must have its source MAC address matching the Peer MEP MAC address, destination MAC address matching either the unit port Unicast MAC address or a Multicast class 1 address, VLANs matching the unit port VLANs, and MEG/MD Level matching the local MEG/MD Level. Refer to *Unicast/Multicast Addresses for Ethernet OAM* on page 867 for more information.

## Setup

### S-OAM and MPLS-TP OAM

---

For MPLS-TP OAM: A valid message must have its: destination MAC address matching either the unit MAC address, FF:FF:FF:FF:FF:FF, or 01:00:5E:90:00:00; VLANs matching the unit port VLANs; MPL Labels matching the local MPLS Label Stack configuration, including GAL; MEG Level matches the local MEG Level. For the Loopback function, a valid message must also have its: MEP ID of the target MEP ID TLV matching the Local MEP ID or ID Sub-Type is 0x00 (Discovery); and MEP ID and MEG ID of the requesting MEP ID TVL, if present, matching respectively the Peer MEP ID and the Local MEG ID.

Respond to... message	Respond with... message
LBM	LBR
LTM <sup>a</sup>	LTR
DMM	DMR
LMM	LMR
SLM <sup>a</sup>	SLR

- a. Only available with Ethernet OAM.

## Pass/Fail Verdict

**Pass/Fail Verdict** check box when selected (default) enables the use of the pass/fail verdict. A global fail verdict is declared when any of the following condition is met: **Link Down** alarm, **Loss Continuity** alarm, or any fail verdict for **Frame Delay**, **Frame Loss**, **Synthetic Loss** (Only applicable to Ethernet OAM), **Frame Delay Failure**, **Frame Loss Failure**, **Synthetic Loss Failure** (Only applicable to Ethernet OAM), **Loopback Failure**, or **Test Failure**.

## Thresholds

**Note:** Refer to Thresholds (S-OAM) on page 1004.

## Next HOP Router (G.8113.1)

- **MAC Address**, available when **Resolve MAC** check box is cleared, allows entering the Next HOP Router MAC address: 00:00:00:00:00:00 to FF:FF:FF:FF:FF:FF, default is 01:00:5E:90:00:00. The MAC Address 01:00:5E:90:00:00 is reserved for point-to-point link and can be used when the unicast address is unknown (as per RFC-7213).
- **Resolve MAC** check box, when selected (cleared by default), sends a request to the network to retrieve the MAC address corresponding to the selected IP address.
- **IP Address**, available when **Resolve MAC** check box is selected, allows entering the Next HOP Router IP address: 0.0.0.0 to 255.255.255.255 for IPv4; default is the source IP address; ::1 to FFFF:FFFF:FFFF:FFFF:FFFF:FFFF:FFFF:FFFF for IPv6, default is 2001::.

## Local Parameters

- **MEG ID** (Y.1731 and G.8113.1), the Maintenance Entity Group Level identification, allows defining a 13-bytes MEG ID value/message to be generated (default value is **EXFO MEG ID**). Values should be ASCII suitable characters including the *ITU T.50 Characters* on page 50.

**Padding** allows the selection of the character (**Null** or **Space**) to be used for remaining byte values.

- **MAID** (802.1ag and MEF) is a 45 bytes Maintenance Association Identification that is divided into two parameters:
  - **Domain ID** is an optional domain identification text field (0 byte (Domain ID not present), up to 44 bytes minus the **MA Name** field length) set to **EXFO Domain ID** by default.
  - **MA Name** (Short MA Name) is a Maintenance Association Name text field set to **EXFO MA Name** by default. The length of the **MA Name** field is from 1 to either 44 bytes minus the **Domain ID** field length when Domain ID is present or 45 bytes when not present.

## Setup

### *S-OAM and MPLS-TP OAM*

---

- **MEG Level** (Y.1731, MEF, and G.8113.1) is the Maintenance Entity Group Level configurable from **0** to **7** (default).
- **MD Level** (802.1ag) is the Maintenance Domain Level and is configurable from **0** to **7** (default).
- **MEP ID** is the Maintenance Entity Group End Point Identification configurable from **0x0001** (default) to **0x1FFF**.

### **Peer MEP Parameters**

- **MAC Address**, available with S-OAM Mode, allows entering the unique Media Access Control (MAC) address of the peer MEP (default is **00:00:00:00:00:00**).
- **MEP ID** is the Maintenance Entity Group End Point Identification configurable from **0x0001** (default) to **0x1FFF**.
- **OAM Quick Ping** verifies the bidirectional connectivity with the peer MEP. The **Successful** message is reported when at least one of three attempts has been successful otherwise **Failed** is reported.

### **Continuity Check**

- **CC Function** check box when selected (default) allows transmitting and monitoring CCM frames.

The following parameters are only configurable when the **CC Function** check box is cleared.

- **Address Type**, available with S-OAM Mode, defines the destination address type of the CCM frames: **Unicast** or **Multicast** (default).
- **Priority**, available with S-OAM Mode or when VLAN is enabled (see *VLAN* on page 330), allows selecting the VLAN user priority: **0** to **7** (default).

- **Drop Eligible**, available with S-OAM Mode or when VLAN is enabled (see *VLAN* on page 330), is set to **No** (no frames will be dropped when congestion occurs) and is not configurable.
- **Period** determines the transmission period of the CCM frame: **3.33 ms**, **10 ms**, **100 ms** (default), **1 s**, **10 s**, **1 min**, or **10 min**.

## MPLS-TP Label Stack (G.8113.1)

### ➤ MPLS-TP Mode

**PW** (Pseudo-Wire) (default) provides an emulation of a point-to-point connection over a packet-switching network. The PW begins and ends at the LER or PE (Provider Edge).

**LSP** (Label Switch Path) is a path through a MPLS network, it begins and ends at LER or LSR.

**Section** is a segment between two adjacent LER/LSR.

- **Label 2** check box when selected enables the MPLS Label 2. The Label 2 check box is configurable for PW and LSP (cleared by default) and is forced cleared for Section.
- **Label 1** check box when selected enables the MPLS Label 1. The **Label 1** check box is forced selected for PW and LSP and forced cleared for Section.
- **GAL** check box when selected enables the Generic Associated Channel Label. The GAL check box is forced selected for LSP and Section and is configurable for PW (selected by default).
- **Label** is configurable for **Label 1** and **Label 2**: **16** to **1048575**, default is **16**. Label is not configurable for GAL and is set to **13**.
- **TC** sets the Traffic Class: **0** (default) to **7**.
- **TTL** sets the Time To Live: **1** to **255**, default is **128**.

### Test Function

**Note:** *Test Function* parameters are not configurable when the **TX Enable** check box is selected.

- **Function** allows the selection of the test function to be performed.
  - **Loopback** (default) function is used to verify the bidirectional connectivity to a peer MEP (**Continuous** check box cleared) and to verify its capability to sustain close to line rate traffic (diagnostic test; **Continuous** check box selected).
  - **Test** function is used to generate a test signal and/or verify the integrity of received test signal from the peer MEP.
  - **Frame Delay** function is used to measure the round trip delay with the peer MEP.
  - **Frame Loss** function is used to measure the frame loss with the peer MEP in both directions from a single end point.
  - **Synthetic Loss** function is used to measure the frame loss with the peer MEP in both directions from a single end point using synthetic frames.
- **TX Enable** check box when selected (cleared by default) allows transmission of frames. However the transmission will only begin when the test is started or if the test is already running. When the **Continuous** check box is cleared, the **TX Enable** check box is automatically cleared once all frames have been transmitted.
- **Address Type**, available with S-OAM Mode, defines the destination address type of the frame: **Unicast** (default) or **Multicast**. Availability of address types depend on selected **S-OAM Mode** and **Test Function**.
- **Continuous** check box when selected (default) specifies that the frame generation is continuous. The **Continuous** check box is cleared for Multicast address type.

- **Requesting MEP ID TLV** (G.8113.1) check box when selected (default) determines if the Requesting MEP ID TLV is present in the LBM frame. The **Requesting MEP ID TLV** check box is cleared and not selectable when the **Continuous** check box is selected.
- **Priority**, available with S-OAM Mode or when VLAN is enabled (see *VLAN* on page 330), allows selecting the VLAN user priority: **0** (default) to **7**.
- **Drop Eligible**, available with S-OAM Mode or when VLAN is enabled (see *VLAN* on page 330), when set to **Yes** (DEI = 1), the transmitted frames will be dropped first on receipt when congestion occurs under test. Drop Eligible is only configurable with **Unicast** address type, otherwise is set to **No** (Default). Drop Eligible is set to **No** for **Frame Delay**, **Frame Loss**, and **Synthetic Loss** functions.
- **Period** determines the transmission period of frames which is set to **100 ms**. **Period** is not applicable for Multicast address type or when the **Continuous** check box is selected.
- **TX Rate (%)** is the transmission rate of the LBM frame: **0.0001** to **95 %** for 10M, **99.5 %** for 100M, **99.95 %** for 1G, **99.995 %** for 10G LAN, and **92.8521 %** for 10G WAN. Only available with Loopback test function when the **Continuous** check box is selected.

## Setup

### S-OAM and MPLS-TP OAM

---

- **Frame Size** allows entering the frame size. The frame size range for Ethernet II frame format is as follows:
  - S-OAM Mode: 64 to 1518<sup>1</sup>. The minimum frame size is adjusted according to the frame structure and parameters selected. For Frame Loss function, the frame size is not configurable and set to the minimum value.
  - MPLS-TP OAM Mode: Minimum and maximum values are as follows. The minimum frame size is adjusted according to the frame structure and parameters selected.

Test Function	MPLS-TP Mode		
	PW	LSP	Section
Loopback	68 <sup>a</sup> to 16000 <sup>1</sup>	72 to 16000 <sup>1</sup>	68 to 16000 <sup>1</sup>
Test	68 to 1522	68 to 1522	64 to 1518
Frame Delay	68 <sup>ab</sup> to 1522	72 <sup>b</sup> to 1522	68 <sup>b</sup> to 1518
Frame Loss <sup>c</sup>	68	68	64

- a. Add 4 bytes when the **GAL** check box is selected.
- b. Add 2 bytes when **Test ID** is selected as **TLV Type**.
- c. The frame size is not configurable and set to the minimum value.

The following table lists each parameter that may affect the minimum and maximum<sup>1</sup> frame size value.

Parameter	Number of bytes to be added	Apply to
802.3 SNAP	8 bytes	Y.1731, MEF, G.8113.1
VLAN	4 bytes per VLAN (up to 3 VLAN)	

---

1. For the Loopback function the maximum frame size is 16000 bytes for all rates at the exception of 10/100/1000 Mbps electrical interface which is 10000 bytes.



Parameter	Number of bytes to be added	Apply to
Label 2	4 bytes	G.8113.1
Continuous	18 bytes for <b>Data</b> TLV Type 21 bytes for <b>Test</b> TLV Type	
Requesting MEP ID TLV	56 bytes	

**Note:** Sending traffic with frame size >1518 in switched network may result in losing all frames.

- **Frame Count** is the quantity of frames to be transmitted: **1 to 1000** at the exception of **Frame Loss** function which is **2 to 1000** (default is **10**); set to **1** for Loopback function with Multicast address type; not applicable when the **Continuous** check box is selected at the exception of **Synthetic Loss** function.
- **TLV Type** defines the TLV Type included in the frame: **Data** (Default), **Test (Loopback (Y.1731 and G.8113.1) and Test functions)**, and **Test ID (Frame Delay function)**; is set to **Test** for the **Test** function; set to **Data** for **Synthetic Loss** function; not available for **Frame Loss** function.
- **Payload**, available with **Data** TLV Type, defines the repeating byte pattern used to fill the payload of the **Data** TLV: **0x00 to 0xFF** (default is **0xCC**).
- **Test Pattern**, available with **Test** TLV Type, defines the test pattern used to fill the **Test** TLV: **PRBS31** (default), **NULL**.
- **Test ID**, available with **Test ID** TLV or **Synthetic Loss** function, defines the test ID: **0x00000000 to 0xFFFFFFFF** (default is **0x00000001**).

## Restore Carrier Ethernet OAM Defaults

Reverts the Carrier Ethernet OAM test application to its default factory settings.

# Services - Global

From the **Test** menu, tap **Setup, Test Configurator**, tap on the services block, the **Global** tab, and on the **General** button.

## General Button

The following parameters are displayed and configurable per service.

- Check boxes:
  - The first check box (top-left) allows enabling sequentially service(s) within the limit of the link capacity when the **Service Performance Test** is enabled or enabling all services when the **Service Performance Test** is disabled.
  - The check boxes next to the service numbers allow enabling each service individually.

When the **Service Performance Test** is enabled, up to 10 services can be enabled one after the other, as long as the **Total TX Rate** (bandwidth) is not reached (**Committed**). For example, if the first service is using the full bandwidth available, then no other service can be enabled. If the first enabled service uses half bandwidth, then at least another service can be enabled using up to half bandwidth. Thus, to enable a second service, first set the CIR value within the non-used bandwidth (**Available**), then enable it.

When the **Service Performance Test** is disabled, up to 10 services can be enabled one after the other; the total TX rate is not limited.

- **Service Name** indicates the name of each service. Tap on the **Service Name** button to modify the name of each service. See *Services - Profile* on page 381 for more information.
- **Direction**, available with **Dual Test Set** or **Dual Port** topology, indicates respectively results for local (**L**) and remote (**R**) directions, or for both port directions.

- **Frame Size** indicates the frame size of each service. Tap on the **Frame Size** button to modify the frame size of each service.
- **Framing** indicates the framing of each service. Tap on the **Framing** button to modify the **Frame Format**, **Network Layer**, **Transport Layer**, **VLAN**, **S-OAM MEG/MD Level**, and **MPLS** when applicable (see **Modify Frame Structure** from the *MAC/IP/UDP* on page 315).
- **VLAN (ID/Priority)** indicates the ID and Priority of each VLAN level for each service. Tap on the **VLAN** button to modify the VLAN settings (see **VLAN** from the *MAC/IP/UDP* on page 315).
- **Addressing** indicates the source and destination IP or MAC addresses for each services. Tap on the **Addressing** button to modify the addressing (see **MAC** and **IP** from the *MAC/IP/UDP* on page 315).

**Batch** button allows bulk configuration for services addressing. Select the check box of each configuration parameter that needs to be copied and set its parameters. From **Apply To**, select all services the copy applies to and tap on the **Copy From** to proceed.

## SLA Button

The SLA parameters are displayed and configurable per service. Click on the desired column button to access the configuration settings.

See *General Button* on page 377 for more information on check boxes, **Direction**, and **Service Name**.

See *SLA Parameters* on page 385 for more information on **CIR**, **CIR+EIR**, **CBS**, **EBS**, **Max Jitter**, **Max Latency**, and **Frame Loss Rate**.

### Total TX Rate

**Note:** Only available when the **Service Performance Test** check box is selected (see EtherSAM - Global on page 258). For **Dual Test Set**, the total TX rates are displayed for both **Local** and **Remote** directions.

- **Committed** displays the total enabled TX rate (bandwidth) that will be generated by the selected service(s).
- **Available** displays the total TX rate (bandwidth) available for traffic generation.

### Global Options

- **Rate Unit** choices are % (default), **Mbit/s**, and **Gbit/s**.

**Latency Unit** allows selecting either **ms** (default) or **μs** as the reference unit for **Latency** and **Jitter**.

### Copy Service Button

**Copy Service** button allows copying the services configuration to one or several services.

- **Copy Service** allow selecting the services number from which the configuration will be copied from.
- **To the following Services** allows selecting all services that will inherit the configuration from the selected service. An orange background represents a selected service. A service that is already enabled cannot be selected for copy.
- **Copy** allows confirming the service configuration copy for all selected services.

## Services - L2CP

The EtherSAM test application supports the configuration of up to 10 different services individually. All parameters are configurable per service.

From the **Test** menu, tap **Setup, Test Configurator**, tap on the services block, and on the **L2CP** tab.

### Service Selection and L2CP Handling Test

- **Service Name** indicates the name to the selected service. Select the service to be configured by either using the left/right arrow or by tapping over the service numbers area then tapping on a specific service number. An orange background indicates the selected service while a green background indicates the services that are enabled.
- **L2CP Handling Test** check box when selected (default) enables the L2CP Handling test for the selected service.

### Table

The following parameters are displayed and/or configurable per service.

- **Check boxes:**
  - The first check box (top-left) allows enabling/disabling all L2CP frames at once.
  - The check box in front of each L2CP name allows enabling/disabling each L2CP frame individually; enabled by default for predefined frames and disabled for user defined frames.
- **Name** indicates the name of each L2CP frame.
- **Destination MAC address** indicates the L2CP frame destination MAC address.
- **Expected L2CP Handling** selects the expected L2CP handling for each L2CP frame: **Pass Through** (default) or **Discard/Peer**.

# Services - Profile

The EtherSAM test application supports the configuration of up to 10 different services individually. All parameters are configurable per service.

From the **Test** menu, tap **Setup**, **Test Configurator**, tap on the services block, and on the **Profile** tab.

## Service Selection and Activation

Select the service to be configured by either using the left/right arrow or by tapping over the service numbers area then tapping on a specific service number. An orange background indicates the selected service while a green background indicates the services that are enabled.

- **Service** associates a name to the selected service number. Up to 16 characters are allowed. Default service names are **Service 1** to **Service 10**.
- **Enable** check box when selected (cleared by default) enables the selected service. However, the service will be generated only when the test is started. For **Dual Test Set**, services can only be enabled once the connection with the remote unit is established.

When the **Service Performance Test** is enabled, up to 10 services can be enabled one after the other, as long as the **Total TX Rate** (bandwidth) is not reached (**Committed**). For example, if the first service is using the full bandwidth available, then no other service can be enabled. If the first enabled service uses half bandwidth, then at least another service can be enabled using up to half bandwidth. Thus, to enable a second service, first set the CIR value within the non-used bandwidth (**Available**), then enable it.

When the **Service Performance Test** is disabled, up to 10 services can be enabled one after the other; the total TX rate is not limited.

## Total TX Rate

**Note:** Only available when the **Service Performance Test** check box is selected (see EtherSAM - Global on page 258).

Indicates the total transmit rate of all services enabled for transmission. Unit selection is available from the *SLA Parameters* on page 385.

## Profile

- **Profile** button allows selecting the emulation profile. The selected service profile icon, name, and configuration (when applicable) is displayed next to the **Profile** button. Refer to *Profile (Services)* on page 996.
- **Frame Size (Bytes)** indicates the frame size for **Voice** and **Video** profiles and allows changing the frame size for **Data** profile:

Profile and Codec	Type	Frame Size (bytes)	
		IPv4	IPv6
Voice Codec: - VoIP G.711 - VoIP G.723.1 - VoIP G.729	Fixed	138 82 78	158 102 98
Video Codec: All	Fixed	1374	1394
Data	Fixed (default)	64 <sup>a</sup> (default) to 16000 <sup>b</sup>	
	Random	64 <sup>a</sup> to 1518 <sup>c</sup>	
	EMIX	64 <sup>a</sup> to 16000 <sup>b</sup>	

- a. The minimum value is adjusted according to the frame structure and components selected as shown in the following table.
- b. The maximum frame size is limited to 10000 for 10/100/1000Mbps electrical interface.
- c. The maximum frame size value is adjusted for each enabled VLAN (+4 bytes per VLAN).

## Setup

### Services - Profile

---

The following table lists each component that may affect the minimum frame size value.

Component	Description
VLAN	4 bytes per VLAN (up to 2 VLAN)
MPLS	4 bytes per label (up to two labels)
UDP	8 bytes
TCP	20 bytes
Ethernet Header	14 bytes
LLC and SNAP Headers	8 bytes
IPv4	20 bytes
IPv6	40 bytes
Using DTS	4 bytes

**Note:** *Sending traffic with frame size > 1518 in switched network may results in losing these frames.*

- **EMIX** button is available when EMIX frame size is selected. The EMIX frame sequence is repeated continuously (refer to *EMIX* on page 958).



## Test Parameters

**Note:** *Unit selection is available from the SLA Parameters on page 385.*

For **Dual Test Set**, parameters are configurable for both local (**L**) and remote (**R**) directions.

For **Dual Port** topology, parameters are configurable for both port directions.

- **Traffic Policing** check box when selected (default) allows stressing the rate limiting of the network by sending traffic at higher rate than committed by the SLA.
- **Burst Max Rate** allows setting the rate that is used for the CBS and EBS burst tests. Only available when the **Burst Test** is enabled (see *EtherSAM - Global* on page 258).

**Note:** *Changing a criteria value (CIR, CIR+EIR, Ramp Traffic Policing, or Burst Max Rate) may affect the other criteria values in order to comply to the following rules:*

*$CIR \leq CIR+EIR \leq Ramp\ Traffic\ Policing\ Rate \leq Line\ Rate$*

*$CIR \leq CIR+EIR \leq Burst\ Max\ Rate \leq Line\ Rate$*

*However, make sure that the criteria values comply to the following rule with an adequate margin, as per ITU-T Y.1564 standard, for a burst test to be valid:*

*$CIR < CIR+EIR < Burst\ Max\ Rate \leq Line\ Rate$*

## Setup

### Services - Profile

---

## SLA Parameters

The Service-Level Agreement (SLA) parameters allow enabling and defining the pass/fail verdict thresholds for the service.

For **Dual Test Set**, parameters are configurable for both local (**L**) and remote (**R**) directions at the exception of Max Round-Trip Latency for which the value is unique.

For **Dual Port** topology, parameters are configurable for both port directions.

### Information Rate

- Unit choices are % (default), **Mbit/s**, or **Gbit/s**. This unit is also used for **Total TX Rate** and for **Test Parameters (Traffic Policing and Burst Max Rate)**.

**Note:** *At least one check box (**CIR** or **CIR+EIR**) has to be selected. Thus, clearing the **CIR** check box while **CIR+EIR** check box is cleared, will automatically select the **CIR+EIR** check box and vice versa.*

- **CIR** (Committed Information Rate) check box when selected (default) sets the service rate guaranteed by the SLA. The threshold value is configurable from **0.0001**<sup>1</sup> to **100** percent (default is **50** percent). CIR and preceding steps are not performed for services that have the CIR check box cleared.
- **CIR+EIR** check box when selected (cleared by default) sets the best effort allowed traffic for the service. The EIR (Excess Information Rate) value is equal to the CIR+EIR value minus CIR. The threshold value is configurable from **0.0001**<sup>1</sup> to **100** percent (default is **75** percent).

**Burst Size** settings are only available when the **Burst Test** is enabled (see *EtherSAM - Global* on page 258).

- Burst Size unit choices are **Bytes** (default) or **ms**.

---

1. The minimum rate is 1Mbit/s when the **Frame Size** is **Random**.

- **CBS** check box when selected (default) sets the maximum committed burst size to which services' frames will be sent and be CIR-compliant (default is **12144** bytes). The CBS minimum and maximum values are affected by the **CIR**, **Burst Max Rate**, and **Frame Size** values. CBS is only available when CIR check box is selected.
- **EBS** check box when selected (cleared by default) sets the maximum excess burst size to which services' frames will be sent and be CIR+EIR compliant (default is **12144** bytes). The EBS minimum and maximum values are affected by the **CIR+EIR**, **Burst Max Rate**, and **Frame Size values**. EBS is only available when **CIR+EIR** check box is selected.

### Performance Criteria

- **Max Jitter** allows setting the maximum jitter value allowed for the service.
- **Max Round-Trip Latency** allows setting the maximum round-trip latency value allowed for the service. For **Dual Test Set**, only available with **Round-Trip Latency Measurement Mode** (see *Global Options* on page 262). Not available in **Dual Port** topology.
- **Max Latency**, available for **Dual Test Set** with **One-Way Latency Measurement Mode** (see *Global Options* on page 262) and Dual Port topology, allows setting the maximum one-way latency allowed for the service.
- **Frame Loss Rate** allows setting the maximum rate of Frame Loss allowed for the service.

**Note:** For Dual Test Set, the Frame Loss Rate is changed to percentage when the remote module does not support exponential notation. In this case a Frame Loss Rate Threshold lower than 1.0E-06 (0.0001 %) is considered as 0 %.

## Signal

From the test menu, tap **Setup, Test Configurator**, the interface block, and the **Signal** tab.

### Physical Interface

**Note:** *The following settings are available with optical signal. For parallel interfaces, the following information is displayed for each optical lane.*

- **Optical Lane** indicates the optical lane number for parallel interfaces.

Optical Interface	Optical Lane Number
OTU3 (4 Lanes) [43.018 Gbit/s]	0 through 3
OTU3e1 (4 Lanes) [44.571 Gbit/s]	
OTU3e2 (4 Lanes) [44.583 Gbit/s]	
OTU4 (4 Lanes) [111.81 Gbit/s]	

- **Laser** indicates the status of the laser: **ON** with the laser pictogram (emitting an optical laser signal) or **OFF**.
- **TX Power (dBm)** indicates, when supported, the transmit power level of the optical laser/lane in dBm.
- **Wavelength (nm)** indicates, when supported, the detected lane/laser wavelength.
- **RX Power (dBm)** indicates, when supported, the current received power level of the optical laser/lane in dBm.

Green: Power level in range.

Yellow: Power level out-of-range.

Red: Loss of signal or power level is close to damage.

Gray: Invalid operational range value or not available/supplied by the transceiver.

- **Min RX Power (dBm)** indicates, when supported, the minimum received power level of the optical laser/lane in dBm.
- **Max RX Power (dBm)** indicates, when supported, the maximum received power level of the optical laser/lane in dBm.
- **Laser ON/OFF** button, available with parallel interfaces, is used to activate the laser control per optical lane or for all lanes. Select the **Laser** check box to enable/disable the laser for each lane individually or select the **All Lanes** check box to enable/disable all optical lanes at once. Not available with 50GE.
- **Lasers OFF at Start-Up** check box when selected (cleared by default) automatically turns OFF the laser for serial interfaces or all lasers for parallel interfaces when starting the unit or when switching from one test application to another. However the laser remains ON, on a remote unit receiving a request for a DTS connection or a loopback command.
- **Power Range (dBm)** indicates the transceiver operational RX power range.

## Setup

### Signal

---

**Note:** The following settings are available with electrical signal and their availability depend on the signal itself and its mapping.

- **LBO (Line Build Out)** allows meeting the interface requirements over the full range of cable lengths.

Signal	LBO
DS1	Preamplification values: <b>DSX-1 (0-133 ft)<sup>a</sup></b> , <b>DSX-1 (133-266 ft)</b> , <b>DSX-1 (266-399 ft)</b> , <b>DSX-1 (399-533 ft)</b> , <b>DSX-1 (533-655 ft)</b> , Cable simulation (CSU Emulation mode) values: <b>CSU (0.0 dB)</b> , <b>CSU (-7.5 dB)</b> , <b>CSU (-15.0 dB)</b> , <b>CSU (-22.5 dB)</b> .
DS3	<b>0 to 225 ft range<sup>a</sup></b> , <b>225 to 450 ft range</b> , and <b>Cable Simulation 900 ft</b> .
E1/E3/E4	Not available
STS-1e/STM-0e	<b>0 to 225 ft range<sup>a</sup></b> , <b>225 to 450 ft range</b> , and <b>Cable Simulation 900 ft</b> .
STS-3e/STM-1e	<b>0 to 225 ft range</b> .

a. Default value

### ➤ Line Coding

Signal	Line Coding
DS1	<b>AMI and B8ZS<sup>a</sup></b>
DS3	<b>B3ZS</b>
E1	<b>AMI and HDB3<sup>a</sup></b>
E3	<b>HDB3</b>
E4	<b>CMI</b>
STS-1e/STM-0e	<b>B3ZS</b>
STS-3e/STM-1e	<b>CMI</b>

a. Default value.

### ➤ RX Termination

Signal	Termination
DS1/E1	Term <sup>a</sup> , Mon, and Bridge.
DS3/E3/E4/STS-1e/STM-0e/STS-3e/STM-1e	Term <sup>a</sup> , and Mon

a. Default value.

- **Power** indicates the received signal level in dBdsx for DS<sub>n</sub> or dBm for PDH and SONET/SDH.
- **Amplitude** indicates the received signal amplitude as well as its MIN, and MAX received values.

### TX Frequency

**Note:** *The following TX Frequency information applies to serial interface only, refer to TX Frequency on page 280 for parallel interfaces.*

- **Frequency (GHz)** indicates the frequency (actual frequency + Frequency offset) used for transmission.
- **Offset (ppm)** check box, when selected (cleared by default), allows setting the frequency offset that will be generated. Use the “+” or “-” button to respectively increment or decrement the frequency offset value based on the defined **Increment/Decrement Size**, or directly type the frequency offset value in the field. Possible offsets are:

Interface	Frequency Offset <sup>a</sup>	Nominal Frequency
DS1	±140 ppm	1544000 bit/s
E1	± 70 ppm	2048000 bit/s

## Setup

### Signal

---

Interface	Frequency Offset <sup>a</sup>	Nominal Frequency
E3	± 50 ppm	34368000 bit/s
DS3		44736000 bit/s
STS-1e/STM-0e		51840000 bit/s
E4		139264000 bit/s
STS-3e/STM-1e		155520000 bit/s
OC-1/STM-0	± 50 ppm	51840000 bit/s
OC-3/STM-1		155520000 bit/s
OC-12/STM-4		622080000 bit/s
OC-48/STM-16		2488320000 bit/s
OC-192/STM-64		9953280000 bit/s
OTU1	± 50 ppm	2666057143 bit/s
OTU2	± 50 ppm (Framed) ± 120 ppm (Unframed)	10709225316 bit/s
OTU1e	± 120 ppm	11049107143 bit/s
OTU2e		11095727848 bit/s
OTU1f		11270089286 bit/s
OTU2f		11317642405 bit/s

- a. The frequency offset range is guaranteed for a source signal at 0 ppm. In the event that the source signal already has an offset, then the output signal may exhibit an offset larger than the range specified.

**Note:** Frequency offset is not available when **Through** mode is selected.

**Step Size (ppm)** allows setting the increment/decrement value (from 0.1 to the maximum offset) that will be used when changing the frequency offset with the “+” or “-” button.



## RX Frequency

**Note:** The following RX Frequency information applies to serial interface only, refer to RX Frequency on page 282 for parallel interfaces.

- **Frequency (GHz)** indicates the frequency of the input signal.
- **TX Power (dBm)** indicates, when supported, the transmit power level of the optical laser/lane in dBm.

**Note:** For both **Frequency** and **Offset** the following background colors are used.

Background color	Description
Green	The frequency is in range.
Red	The frequency is out-of-range or LOC Lane.
Gray	Pending state.

- **Max. Negative Offset (ppm)** indicates the maximum negative frequency offset between the standard rate specification and the rate from the received signal.
- **Max. Positive Offset (ppm)** indicates the maximum positive frequency offset between the standard rate specification and the rate from the received signal.

**Note:** Refer to Interface on page 911 for more information on standard rate specifications.

## **Signal Configuration**

- For OTN, see *Signal - Signal Configuration - OTN* on page 398 for more information.
- For SONET/SDH, see *Signal - Signal Configuration - SONET/SDH* on page 401 for more information.
- For DS<sub>n</sub>/PDH, see *Signal - Signal Configuration - DS<sub>n</sub>/PDH* on page 394 for more information.

## Signal - Signal Configuration - DS<sub>n</sub>/PDH

For **SONET/SDH - DS<sub>n</sub>/PDH BERT**, from the test menu, tap **Setup**, **Test Configurator**, and the protocol block. Only **Framing** setting and the **Loopback** button are available.

For **DS<sub>n</sub>/PDH BERT** and **NI/CSU Emulation**, from the test menu, tap **Setup**, **Test Configurator**, and the interface block.

### Signal Configuration

- **Framing** allows the selection of the framing used for transmission:

DS1	DS3	E1	E3/E4
Unframed SF ESF <sup>a</sup> SLC-96	Unframed C-Bit Parity <sup>a</sup> M13	Unframed PCM30 <sup>a</sup> PCM30 CRC-4 PCM31 PCM31 CRC-4	Unframed Framed <sup>a</sup>

a. Default value

- **Background**, for multiplex test, allows the selection of the default timeslot background traffic: **AIS** (default) or **All Zeros**. The following diagram shows a test defined with DS<sub>n</sub>/PDH traffic where the background traffic is also inserted for the unused timeslots in a test data path. The insertion is similar to the low order path SONET/SDH terminated signal where the background traffic format inserted uses the same rate as the one defined in the test data path.

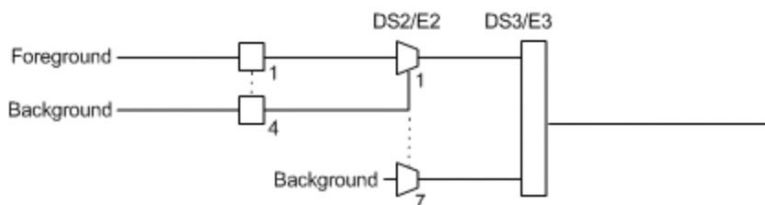

## Setup

### Signal - Signal Configuration - DSn/PDH

---

- **Channel**, for multiplex text case, allows the selection of the channel number of the mapped signal.
- **DS0/E0** check box when selected, cleared by default, activates the DS0/E0 testing. DS0/E0 configuration is not available when the framing is set to **Unframed**. Once selected, a summary of the payload content is displayed indicating the number of timeslot set to Pattern and Idle/Tone. The Modify DS0/E0 button is also displayed.
- **TX Signaling** check box when selected (cleared by default) allows generation of the signaling bits for either the 24 - DS0 channels or 30 - E0 channels (PCM-30 and PCM30 CRC-4). Only available when the **DS0/E0** check box is selected.
- **Modify DS0/E0** button is available when the **DS0/E0** check box is selected. Refer to *Modify DS0/E0* on page 975.
- **Loopback** (refer to *DS1 Loopback* on page 956)

For **NI/CSU Emulation** test the DS1 Loopback feature generates a code that is interpreted by the DUT. The DUT interprets the command and implements the loopback.

- **Mode** selects the loopback control mode: **Manual** or **Auto-Response**.
- **Type**, for **Manual** mode, selects the type of loopback code that will be applied: **Line** or **Payload**. Payload is not available when the framing is **Unframed**.

**Type**, for **Auto-Response**, selects the type of loopback code on which the unit will respond: **In-Band** or **Out-of-Band**. **Out-of-Band** is only available when the interface framing is set to ESF. The **Loop UP** and **Loop Down** values are automatically updated to the **In-Band** or **Out-of-Band** type selection.

- **Status** indicates either **Loopback Active** with a green loopback icon or **No Loopback** with a gray loopback icon.

- **Loop Code** selects the type of loopback that will be used to overwrite the traffic that will be generated.

In-Band loop code	Loop-UP Code	Loop-Down Code
CSU (10000/100)	10000	100
NIU FAC1 (1100/1110)	1100	1110
NIU FAC2 (11000/11100)	11000	11100
NIU FAC3 (100000/100)	100000	100
Loop Code 1 to 10	Refer to <i>Modify Loop Codes</i> allows the configuration of 10 DS1 loop code pairs. Configure each loop code Name, Loop-Up and Loop-Down values. The name field allows up to 16 characters. Loop-Up and Loop-Down range is from 3 to 16 bits (000 to 1111111111111111). The default DS1 loop codes correspond to the DS1 In-Band loop codes (Loop-Up=10000, and Loop-Down=100). on page 397.	

Out-of-Band loop code	Loop-UP Code	Loop-Down Code
Line	00001110 11111111	00111000 11111111
Payload	00010100 11111111	00110010 11111111
Reserved For Network Use	00010010 11111111	00100100 11111111
ISDN Line (NT2)	00101110 11111111	00100100 11111111
CI/CSU Line(NT1)	00100000 11111111	00100100 11111111

- **Force Release** button, available with **Auto-Response** mode when a loopback is active, allows releasing a loopback condition initiated from the network.
- **Activate** button, available with **Manual** mode when no loopback is active, allows sending a loopback condition.
- **Release** button, available with **Manual** mode when a loopback is active, allows releasing the loopback condition.

## Setup

### *Signal - Signal Configuration - DSn/PDH*

---

- **Loop Up** indicates the selected loop up code.
- **Loop Down** indicates the selected loop down code.
- **Modify Loop Codes** allows the configuration of 10 DS1 loop code pairs. Configure each loop code **Name**, **Loop-Up** and **Loop-Down** values. The name field allows up to 16 characters. **Loop-Up** and **Loop-Down** range is from 3 to 16 bits (**000** to **1111111111111111**). The default DS1 loop codes correspond to the DS1 In-Band loop codes (Loop-Up=**10000**, and Loop-Down=**100**).

## Signal - Signal Configuration - OTN

**Note:** The following signal configuration parameters are available from the interface block.

From the test menu, tap **Setup, Test Configurator**, the interface block, and on the **Signal** tab.

### Signal Configuration

➤ OTU<n>

**Note:** At least one of the two check boxes, **FEC** or **Scrambler**, must be selected in order to prevent potential alarms caused by a lack of bit transition on the optical signal. For example to disable **FEC**, first select the **Scrambler** check box then clear the **FEC** check box.

- **FEC** check box when selected (default) enables the FEC in TX/RX and allows detecting, reporting, and correcting up to 8 symbol errors (Correctable) per codeword. If there are over 8 symbol errors detected, they are reported as uncorrectable errors.
- **FEC-CORR Alarming** check box when cleared (selected by default) does not report the **FEC-CORR** error status (current/history), seconds, and does not affect the global test verdict. Only available when **FEC** is enabled.
- **Scrambler** check box when selected (default) provides enough “0” and “1” transitions on the optical signal for clock recovery.

**Note:** When the **Scrambler** check box is cleared, the receiver circuitry is forced to operate in a condition which is outside of the specified OTN operating conditions, potentially causing alarms/errors. This configuration can be used for special analysis in a lab environment.

## Setup

### Signal - Signal Configuration - OTN

---

➤ **ODU<n>**

**Note:** Only the higher ODU layer is available with Multi-Channel OTN.

- **OPU Trib Port**, available for each OPU level of a mapped signal, indicates the OPU tributary port used for the test. Tap the **Modify Trib Slots/Port** button to change the OPU tributary port (refer to *Modify Tributary Slots/Port* on page 982). Not available with Multi-Channel OTN.
- **OPU Trib Slots**, available for each OPU level of a mapped signal, indicates the OPU tributary slots used for the test. Tap the **Modify Tributary Slots/Port** button to change the OPU tributary slots (refer to *Modify Tributary Slots/Port* on page 982). Not available with Multi-Channel OTN.
- **TCM** indicates each Tandem Connection enabled; **No TCM** indicates that no TCM is enabled. To enable TCM, tap the **Config TCM** button (refer to *Config TCM* on page 954; not available with Multi-Channel OTN).



- **Background Traffic**, available for a multiplex signal, is used to generate traffic on the timeslots that are not part of the foreground test traffic. Choices are **Unallocated** (available with PT21 only), **AIS**, **Null Client**, and **PRBS31** (default). The background traffic is configurable for each mux type when the multiplex signal contains both PT20 and PT21 mux types.

Higher Layer	Tributary	Background Traffic <sup>a</sup>
ODU4	ODU3, ODU2, ODU1, ODU0, ODU2e, ODU1e, ODUflex	1.25 Gbit/s <sup>b</sup> or Unallocated
ODU3	ODU2	Fixed structure: ODU2 Non fixed structure: ODU1
	ODU1	ODU1
	ODU0, ODUflex	1.25 Gbit/s <sup>b</sup> or Unallocated
ODU2	ODU1	ODU1
	ODU0, ODUflex	1.25 Gbit/s <sup>b</sup> or Unallocated
ODU1	ODU0	ODU0

- a. Uses the selected AIS, Null Client, or PRBS31 background traffic unless Unallocated is selected which corresponds to undefined traffic.
- b. Per tributary slot.

- **Modify Tributary Slots/Port** (refer to *Modify Tributary Slots/Port* on page 982)
- **Config TCM** (refer to *Config TCM* on page 954)

## Setup

Signal - Signal Configuration - SONET/SDH

---

# Signal - Signal Configuration - SONET/SDH

For OTN-SONET/SDH BERT, from the test menu, tap **Setup**, **Test Configurator**, the protocol block, and the **Signal** tab.

For SONET/SDH BERT, from the test menu, tap **Setup**, **Test Configurator**, the interface block, and the **Signal** tab.

## Signal Configuration

### ➤ OC/STM Signal

- **Synchronization Status Message (S1)**: Bits 5 through 8 of the S1 byte are used to convey synchronization status of the NE. Not available with **Through** topology.

Bits 5 to 8	Description	
	SONET	SDH
0000 <sup>a</sup>	Synchronized - Traceability Unknown (STU)	Quality Unknown
0001	Stratum 1 Traceable (ST1)	Reserved
0010	Reserved	ITU G.811 (PRC)
0011	Reserved	Reserved
0100	Transit Node Clock Traceable (TNC)	SSU-A
0101	Reserved	Reserved
0110	Reserved	Reserved
0111	Stratum 2 Traceable (ST2)	Reserved
1000	Reserved	SSU-B
1001	Reserved	Reserved
1010	Stratum 3 Traceable (ST3)	Reserved
1011	Reserved	ITU-T G.813 Option 1 (SEC)
1100	SONET Minimum Clock Traceable (SMC)	Reserved
1101	Stratum 3E Traceable (ST3E)	Reserved
1110	Provisionable by the Network Operator (PNO)	Reserved
1111	Don't Use for Synchronization (DUS)	Do not use for synchronization

- a. Default message.

- **REI-L Computation Method / MS-REI Computation Method** (OC-192/STM-64 only): Allows selecting the default method used to calculate the REI-L/MS-REI error for OC-192 and STM-64 signals. Choices are **M1 Only** (default) and **M0 M1 (M0 and M1)**.
- **STS/AU and VT/TU Mappings**
  - **Timeslot** (SONET) allows the selection of the STS timeslot number. Refer to *SONET Numbering Convention* on page 859 for more information.
  - **Number** (SDH) allows the selection of the AU channel number. Refer to *SDH Numbering Convention* on page 860 for more information.
  - **TCM** check box when selected (cleared by default) allows Tandem Connection Monitoring (TCM).
  - **TC-UNEQ-P / TC-UNEQ-V / HPTC-UNEQ / LPTC-UNEQ** check boxes when selected (cleared by default) allows the monitoring of the corresponding Tandem Connection - Unequipped alarm. Only available when the **TCM** check box is selected.
  - **Overwrite Fixed Stuff** (STS-1 only) check box when selected (default) fills up the bytes of the STS-1 SPE's columns 30 and 59 with the selected pattern from the tab *BERT and Unframed BERT* on page 209.

## Setup

### Signal - Signal Configuration - SONET/SDH

---

- **Background** allows the selection of the high order path background traffic: **AIS**, **Equipped** (PRBS23) (default), or **Unequipped**.

**STS/AU Path (SONET/SDH HOP):** The following diagram shows a test case data path that is terminated right after SONET/SDH high order path. High order background traffic is automatically adapted to the rate (STS-1, AU-3, or AU-4) signal level for the paths that are not defined in the test case. In the situation where the traffic pattern is replaced by GFP the background traffic remains the same for the STS-1/AU-3/AU-4 that are not involved in the test case data path. In the situation where contiguous concatenation or virtual concatenation is used, the background traffic continues to be applied on the remaining timeslots not involved in the test case data path.

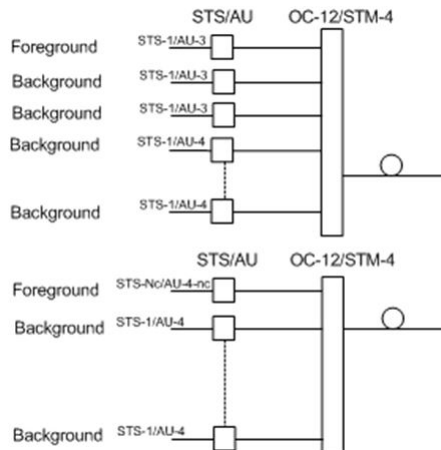

**VT/TU Path (SONET/SDH LOP):** The following diagram shows a test case data path that is terminated at the SONET/SDH low order path. The remaining STS-1 or AU-3 timeslot not involved in the test case are filled with background traffic of STS-1 or AU-3 level depending on the interface being SONET or SDH. At the low order path level, the data path not involved in the data path defined in the test case are filled with a background traffic equivalent to the VT Group (VTG) or Tributary Unit Group (TUG) type defined by the traffic selected in the data path. Further, the remaining VTG or TUG within the high order path, selected in the test case, are respectively filled with traffic of equivalent rate for SONET and SDH data paths.

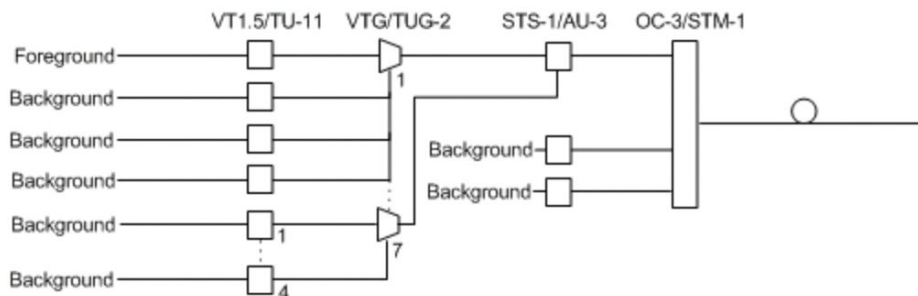

## Smart Loopback

**Note:** *The Smart Loopback block is only displayed when the **Transparent (Pseudo-Physical)** check box is cleared (see **Loopback Mode on page 182**).*

From the test menu, tap **Setup, Test Configurator**, and the Smart Loopback block.

### Loopback

- **Mode** determines at which layer the Smart Loopback address/port swapping operation will be.
  - **Ethernet** swaps the MAC addresses of received packets having their **Destination MAC** address matching the MAC address of the loopback port.
  - **Ethernet (All Unicast)** swaps the MAC addresses of received packets having Unicast **Destination MAC** address.
  - **IP**, for Ethernet Layer 3 and 4, swaps the MAC and IP addresses of received packets having their **Destination IP** address matching the IP address of the loopback port. For Ethernet Layer 2, swaps the **MAC addresses** for packets having their **Destination MAC** address matching the MAC address of the loopback port.

- **UDP/TCP** (default), for Ethernet Layer 4, swaps the UDP or TCP ports and the MAC and IP addresses of received packets having their **Destination IP** address matching the IP address of the loopback port. For Ethernet Layer 3, swaps the MAC and IP addresses for packets having their **Destination IP** address matching the IP address of the loopback port. For Ethernet Layer 2, swaps the **MAC addresses** for packets having their **Destination MAC** address matching the MAC address of the loopback port.
- **Matching & Swapping** indicates the Loopback parameters that will be used based on the Loopback Mode selected.

## S-OAM Responder

The S-OAM Responder check box when selected (default) allows responding to LBM, LTM, DMM, LMM, and SLM valid messages (test running or not). Traffic statistics are also monitored (refer to *Responder* on page 625).

Respond to... message	Respond with... message
LBM	LBR
LTM	LTR
DMM	DMR
LMM	LMR
SLM	SLR

# Streams - Global

From the **Test** menu, tap **Setup, Test Configurator**, the protocol block, and the **Global** tab.

The following parameters are displayed and configurable per stream.

➤ Check boxes:

The first check box (top-left) allows enabling stream(s) sequentially within the limit of the link capacity.

The check boxes next to the stream numbers allow enabling each stream individually within the limit of the link capacity.

- **Stream Name**<sup>1</sup> indicates the name of each stream. Tap on the **Stream Name** button to modify the name of each stream.
- **Frame Size**<sup>1</sup> indicates the frame size of each stream. Tap on the **Frame Size** button to modify the frame size of each stream.
- **TX Rate**<sup>1</sup> indicates the transmission rate for each stream. Tap on the **TX Rate** button to modify the transmission rate (see page 412).
- **Framing** indicates the framing of each service. Tap on the **Framing** button to modify the **Frame Format, Network Layer, Transport Layer, VLAN, and MPLS** when applicable (see **Modify Frame Structure** from the *MAC/IP/UDP* on page 315).
- **VLAN** indicates the ID and Priority of each VLAN level for each stream. Tap on the **VLAN** button to modify the VLAN settings (see **VLAN** from the *MAC/IP/UDP* tab).
- **Addressing MAC/IP** indicates the source and destination MAC/IP addresses for each stream. Tap on the **Addressing MAC/IP** button to modify the customer addressing (see **MAC** and **IP** from the *MAC/IP/UDP* tab). When using **Provider Encapsulation**, the source and destination addresses displayed are respectively EoE MAC for EoE and B-MAC for PBB-TE.

---

1. See the Profile tab for more information.



**Batch** button allows bulk configuration for stream addressing. Select the check box of each configuration parameter that needs to be copied and set its parameters. From **Apply To**, select all streams the copy applies to and tap on the **Copy From** to proceed.

The following parameters are global for all streams.

- **Total TX Rate** indicates the percentage of the total line utilization which is the TX rate sum of all enabled streams.
- **Link Capacity** indicates the total rate available for traffic generation.
- **Global Options:**
  - **Rate Unit** choices are % (default), **Mbit/s**, **Gbit/s**, **frame/s**, and **IFG**.
  - **Latency Unit** allows selecting either **ms** (default) or **μs** as the reference unit for **Latency** and **Jitter**.
  - **QoS Metrics Tags Insertion** check box when selected (default) automatically adds a stream analysis tag containing Jitter, Latency, Throughput, and sequence tags in all frames that is generated.
- **Copy Stream** button allows copying the stream configuration to one or several streams.

Select the stream number the configuration will be copied from.

From **To the following Streams**, select all streams that will inherit the configuration from the selected stream. An orange background represents a selected stream. A stream that is already enabled (Enable TX) cannot be selected for copy.

Tap **Copy** to confirm the stream configuration for all selected streams.

- **Restore Default** button reverts the current test application to its default factory settings.

## Setup

### Streams - Profile

---

## Streams - Profile

The Traffic Gen & Mon test application supports the configuration of up to 16 different streams individually.

From the **Test** menu, tap **Setup**, **Test Configurator**, the protocol block, and the **Profile** tab.

**Note:** *All parameters are configurable per stream.*

### Stream Selection and Activation

Select the stream to be configured by either using the left/right arrow or by tapping over the stream numbers area then tapping on a specific stream number. An orange background indicates the selected stream while a green background indicates the streams that are enabled.

- **Stream** associates a name to the selected stream number. Default stream names are **Stream 1** to **Stream n**.
- **Enable** check box when selected (cleared by default) enables the selected stream. However, the stream will be generated only when the test is started while the global **Enable TX** check box is selected from the **Global** tab.

## Profile

- **Profile** button allows the selection and configuration of either **Voice**, **Video**, or **Data** (default) emulation profile. The selected profile icon and its Codec for Voice and Video are displayed next to the **Profile** button. Refer to *Profile (Stream)* on page 995.
- **Frame Size (Bytes)** indicates the frame size for **Voice** and **Video** profiles and allows changing the frame size for **Data** profile:

Profile and Codec	Type	Frame Size (bytes)	
		IPv4	IPv6
Voice Codec: - VoIP G.711 - VoIP G.723.1 - VoIP G.729	Fixed	138 82 78	158 102 98
Video Codec: All	Fixed	1374	1394
Data	Fixed (default)	48 <sup>a</sup> to 16000 <sup>b</sup>	
	Random	64 <sup>a</sup> to 1518 <sup>c</sup>	
	EMIX	48 <sup>a</sup> to 16000 <sup>b</sup>	
	Sweep	48 <sup>a</sup> to 16000 <sup>b</sup>	

- a. The minimum value is adjusted according to the frame structure and components selected as shown in the following table. The minimum of 48 bytes is only available for rates up to 10GE, for higher rates the minimum frame size is 64 bytes.
- b. The maximum frame size is limited to 10000 for 10/100/1000Mbps electrical interface.
- c. The maximum frame size value is adjusted for each enabled VLAN (+4 bytes per VLAN).

## Setup

### Streams - Profile

---

The following table lists each component that may affect the minimum frame size value.

Component	Description
VLAN	4 bytes per VLAN (up to 2 VLAN)
MPLS	4 bytes per label (up to two labels)
EoE Header	16 bytes
EoE VLAN	4 bytes
PBB-TE Header	18 bytes
B-VLAN	4 bytes
LLC and SNAP Headers	8 bytes
UDP	8 bytes
Ethernet Header	14 bytes
IPv4	20 bytes
IPv6	40 bytes

**Note:** Only *Fixed frame size* is available when using **Provider Encapsulation**.

- **Sweep** button is available when **Sweep** frame size is selected. The first frame is generated starting with the minimum number of bytes defined, then each subsequent frame is incremented by 1 byte until the maximum number of bytes is reached and start over with minimum.
- **EMIX** button is available when **EMIX** frame size is selected. The EMIX frame sequence is repeated continuously (refer to *EMIX* on page 958).

## Shaping

- **TX Mode** allows the selection of the transmission mode for the selected stream when **Data** profile is selected. The TX Mode is forced to **Continuous** for Voice and Video profiles and when using **Provider Encapsulation**.

**Continuous** (default) transfers the selected frame continuously according to the selected percentage of bandwidth.

**n-Frame** transfers the selected number of frames.

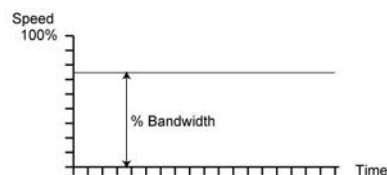

**Burst** transfers the selected frame at maximum bandwidth for the selected **Burst Duty Cycle** over the **Period**.

**n-Burst** transfers the selected number of Burst.

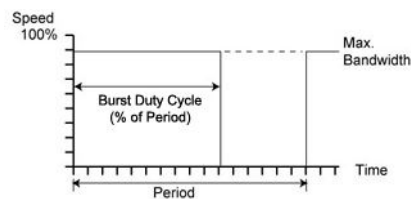

**Ramp<sup>a</sup>** transfers the selected bandwidth in a stair shape according to the selected step time, number of steps, and maximum bandwidth.

**n-Ramp<sup>a</sup>** transfers the selected number of Ramp.

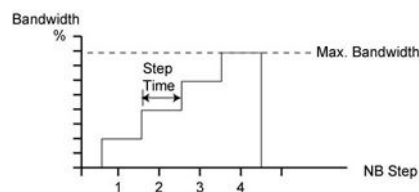

- a. Not supported with 200GE and 400GE.

- **TX Rate / Max TX Rate** indicates the transmission rate for Voice and Video profiles, and allows entering the transmission rate for Data profile. The available stream transmission rate will be calculated according to the selected TX Mode. The default setting is 100 percent for all interfaces at the exception of 10Gig-E WAN which is 92.8571 percent (depending on the frame format).

Unit choices are: **%** (default), **Mbit/s**, **Gbit/s**, **frame/s**, **IFG**. However **frame/s** and **IFG** are not available for **Random** and **Sweep** frame sizes.

## Setup

### Streams - Profile

---

- **Customer Frame TX Rate**, available when using **Provider Encapsulation**, indicates the customer frame TX rate based on the **TX Rate** defined.
- **Frame Count** is only available with n-Frame Transmit Mode. Enter the frame count number: **1** (default) to **267857142857**.
- **Shaping** button, refer to *Shaping* on page 1000.
- **Total TX Rate** indicates the percentage of the total line utilization which is the sum of all TX rate enabled streams.

**Note:** *The Individual stream can be enabled/disabled even when the test is started and running. The streams can be enabled one after the other, up to 16, as long as the maximum rate is not reached. For example, if the first stream is using the full rate available, then no other stream can be enabled. However, if the first enabled stream uses half rate, then at least another stream can be enabled using up to half rate. Thus, to enable a second stream, first set the TX rate value within the non-used rate, then enable it. A stream cannot be enabled if its MAC address is not valid (it can be either not resolved or wrongly entered).*

- **Link Capacity** indicates the total rate available for traffic generation.

## QoS Metrics

**Note:** *QoS Metrics settings apply to all streams.*

- **Global Pass/Fail Verdict** check box when selected (default) enables the pass/fail verdict for all streams.
- **Global Thresholds Type** button
  - **Throughput** allows selecting if the verdict is based on the **Current Throughput** (default) or **Average Throughput**.
  - **Frame Loss** allows selecting if the verdict is based on a frame loss **Count** (default) or **Rate**.
  - **Out-of-Sequence** allows selecting if the verdict is based on an Out-of-Sequence **Count** (default) or **Rate**.
- **Throughput (%)** check box when selected enables the throughput pass/fail verdict and allows setting the minimum and maximum threshold values.
- **Customer Frame Throughput**. available when using **Provider Encapsulation**, displays the calculated customer frame throughput minimum and maximum thresholds based on the throughput values.
- **Frame Loss Count/Rate** check box when selected enables the Frame Loss pass/fail verdict and allows setting the threshold of frame that are lost.

For **Count**, enter the maximum count of frame that are lost before declaring a fail verdict: **0** (default) to **999999999**.

For **Rate**, enter the maximum rate of frame that are lost before declaring a fail verdict: **1.0E-14** (default) to **1.0E00**.

## Setup

### *Streams - Profile*

---

- **Out-of-Sequence Count/Rate** check box when selected enables the Out-of-Sequence pass/fail verdict and allows setting the threshold of frames that are Out-of-Sequence.

For **Count**, enter the maximum count of frames that are Out-of-Sequence before declaring a fail verdict: **0** (default) to **999999999**.

For **Rate**, enter the maximum rate of frames that are Out-of-Sequence before declaring a fail verdict: **1.0E-14** (default) to **1.0E00**.

- **Jitter** check box when selected enables the Jitter verdict and allows setting the maximum Jitter before declaring a fail verdict.
- **Latency** check box when selected enables the Latency verdict and allows setting the maximum Latency before declaring a fail verdict.



## SyncE

From the test menu, tap **Setup, Test Configurator**, and the **SyncE** test block.

### ESMC Monitoring

- **ESMC** (Ethernet Synchronization Message Channel) is a live value monitored even when the test is not started. The arrow next to the **ESMC** label indicates that ESMC valid information frames are received or not.
  - A green arrow indicates that at least one ESMC valid information frame, containing a valid FCS, was received within a second in the last 5-second interval.
  - A red arrow indicates that no ESMC valid information frames were received for more than 5 seconds.
  - A gray arrow indicates awaiting incoming data to provide a status.
- **Received QL** indicates the last Quality Level received (monitored even when the test is not started).
- **QL Mismatch Monitoring** check box when selected (default) enables the Quality Level mismatch monitoring. The quality level characterizes the clock quality in terms of network synchronization.
- **Expected QL** available when the **QL Mismatch Monitoring** check box is selected, allows the selection of the Expected Quality Level value. See page 500 for more information.
- **Pass/Fail Verdict** check box when selected (default) enables the use of the pass/fail verdict. The global pass/fail verdict is based on the following criteria: **ESMC Rate Threshold** (when enabled), **QL Mismatch Monitoring** (when enabled), **ESMC Loss**, or **Link Down**.
- **ESMC Rate Threshold** check box when selected (default) enables the ESMC rate threshold monitoring which will declare a Fail verdict when the ESMC frame rate is outside the range of 0.8 to 10.2 frames/s.

### ESMC Generation

- **Generated QL** check box when selected (default) enables the generation of the selected QL message. See page 497 for the list of QL message (default is **QL-EEC2/ST3**). For 1GE Electrical interface using **Local Clock** set to **Slave**, **Generated QL** is dimmed with its check box selected and set to **QL-DNU/DUS**.
- **QL Rate (frame/s)** defines the frame rate at which the ESMC transmit the QL message value: **1** (default), **5**, or **10** frames per second. For 1GE Electrical interface using **Local Clock** set to **Slave**, the **QL Rate** is dimmed and set to **1** frame/s.

### Restore SyncE Defaults

Reverts the test application to its default factory settings.

## System - General

From the **Test** menu, tap **Setup**, and **System**.

For 88260: From the **Test** menu, tap **Setup**, **System**, and **General**.

### Factory Default

- **Restore Default** button restores the factory default settings for all test applications.
- **Restore Default at Start-Up** check box when cleared (default), reloads the last configuration settings when the application is launched; when selected, the factory settings are restored.

### Remote Control

**User Information** allows a user to leave a message to other users connected on the same module. Up to 80 characters are allowed.

**Time Zone** allows the selection of the time zone source.

- **Local** (default) uses and displays the time from the FTBx-88000 Series module or from the PC for a Remote ToolBox session.
- **Test Equipment**, available for a Remote ToolBox session, uses and displays the time from the FTBx-88000 Series module.

### Notification Control

**Transceiver Transaction Fault** check box when selected (cleared by default) displays a transceiver transaction fault message in the **Test Configurator** page (see *Test Configurator Overview* on page 125) when either the module is unable to discover the transceiver device or experiences abnormal communication conditions such as: register access is blocked, read/write errors are detected, transceiver is present but unresponsive, etc. A transceiver fault message remains displayed until either the **Transceiver Transaction Fault** check box is cleared, the transceiver is removed, or when switching the test application.

## Setup

### *System - General*

---

Whether the **Transceiver Transaction Fault** check box is selected or cleared, a log file is generated/updated when a transceiver transaction fault occurs. The log file contains the information about the transceiver and the related fail condition(s); up to 5000 entries are allowed; a log full indication is recorded if the limit is reached. The file name is **TransactionFault.log** and is located in the **Users\Public\Public Documents\<product>\Logs** folder. The content of the file can be cleared manually by opening the file, erasing its content, and saving the file. The file can also be deleted from disk and will be automatically regenerated when a new transceiver transaction fault occurs.

## System - GNSS

From the test menu, tap **Setup**, **System**, and **GNSS**.

### Configuration

- **Band** allows selecting the band used by the GNSS receiver:  
For TA-SYNC-PREMIUM: **L1** or **L1 + L2** (default).  
For TA-SYNC: **L1** (default) and dimmed.
- **Constellation** allows selecting the constellation:
  - GPS Galileo, GLONASS, Beidou**<sup>1</sup> (Default for TA-SYNC-PREMIUM)
  - GPS, Galileo, GLONASS**
  - GPS, Galileo, BeiDou** (Default for TA-SYNC)
  - GPS GLONASS, Beidou**<sup>1</sup>
  - Galileo, GLONASS, Beidou**<sup>1</sup>
  - GPS, Galileo**
  - GPS, BeiDou**
  - GPS, GLONASS**
  - Galileo, BeiDou**
  - Galileo, GLONASS**
  - BeiDou, GLONASS**
  - GPS**
  - Galileo**
  - BeiDou**
  - GLONASS**
- **QZSS** check box when selected (default) determines that the QZSS constellation is used. **QZSS** is only available when GPS is part of the selected constellation(s).

---

1. Available with TA-SYNC-PREMIUM.

## Setup

### System - GNSS

---

➤ **Time Source / Variant**

- **Time Source** allows selecting the time source based on the selected constellation(s):

**UTC** (Default)

**GPS**

**Galileo**

**BeiDou**

**GLONASS**

- **Variant** allows selecting the UTC Variant based on the selected constellation(s):

**Auto** (Default): Automatic selection

**USNO**: Unites States Naval Observatory

**SU**: Soviet Union

**NTSC**: National Time Service Center

**Europe**: European Laboratory

- **Position Mode** allows selecting how the position is acquired:

- **Survey-In** (Default): Once selected, starts the Survey-In process until the actual position accuracy is within the desired accuracy; the process last for at least 2 minutes.

- **Manual** allows configuring the antenna coordinates manually.

- **Restart**, available with Survey-In, performs a cold start of the GNSS receiver then, once booted, the Survey-In process starts automatically and runs until the desired accuracy is met. It is recommended to select the desired test application before restarting the GNSS receiver.

- **Desired Accuracy**, available with Survey-In, allows selecting the required position accuracy:

**Very High** (default): 1 meter

**High**: 3 meters

**Medium**: 10 meters

**Low**: 30 meters

- **Cable Delay** allows selecting the signal propagation delay of the antenna and its cable: **0** to **32767 ns** (default is **25 ns**).

## Antenna Coordinates

The antenna coordinates, available with Manual position mode, allows selecting the coordinates:

**Latitude:** **-90** to **90** degrees (default is **0**)

**Longitude:** **-180** to **180** degrees (default is **0**)

**Altitude:** **-500** to **9999** meters (default is **0**)

## Statuses

- **GNSS** reports the GNSS global status as **Ready** when the GNSS status is in **Fixed Mode** and the GNSS Time Lock status is **Locked**; otherwise **Not Ready** is reported. When the status is **Ready**, the 1PPS signal can be used as the clock synchronization for the test by selecting **Internal GNSS** as clock mode and **1PPS** as reference (see *Clock* on page 231). The 1PPS signal is aligned with the Time Source and Variant when applicable.
- **Status** reports the current GNSS status:
  - **Acquiring:** Indicates that no position has been acquired yet or the GNSS receiver reports an invalid Fix.
  - **Survey-In**, available with Survey-In position mode, indicates that the Survey-In process is running.
  - **Fixed Mode** indicates operating in timing mode and the GNSS receiver reports a valid Fix.
- **Time Lock** reports **Locked** when the time is known and confirmed, and when using UTC time source that the UTC Variant is known; otherwise **Not Locked** is reported.

## Setup

### System - GNSS

---

- **UTC Variant** is reported when using an UTC time source:
  - --: UTC Variant not known yet
  - **USNO**: Unites States Naval Observatory
  - **SU**: Soviet Union
  - **NTSC**: National Time Service Center
  - **Europe**: European Laboratory
- **Jamming** reports position and jamming/interference status.
  - **OK**: Position OK and no jamming/interference detected
  - **Warning**: Position OK and jamming/interference detected
  - **Critical**: No Position and jamming/interference detected
  - **Unknown**: Unknown (disabled/uninitialized or antenna disconnected)
- **# of Sat used** (Number of Satellites used) reports the number of satellites that are used by the GNSS receiver to determine the actual position and time.
- **Coordinates** reports the latitude, longitude, and altitude coordinates determined by the Survey-In process. The coordinates are updated as soon as the first position is obtained, then throughout the survey-in process until it completes.

## Satellites Histogram

Reports each satellite seen by the GNSS receiver.

- X axis reports satellite ID: **G..** for GPS, **E..** for Galileo, **B..** for BeiDou, **R..** for GLONASS, or **Q..** for QZSS.
- Y axis reports satellite power: RX Power (C/No, in dBHz)
- Color: Green for used satellites and gray for those not used.



## Transceiver System (TA/TA4)

Gives the transceiver system insertion counter and information on the inserted transceiver system. Only available on 88260 and 88460 modules.

From the **Test** menu:

- For iOptics, tap **Setup, Test Configurator**, tap **More...** from the **Device Under Test** block, and on the **Transceiver System** tab.
- For other tests, tap **Setup, Test Configurator**, tap on the interface block and on the transceiver system (**TA/TA4-...**) tab.
- For TA-Sync, tap either:
  - **Setup, Test Configurator**, tap on the clock block and on the **TA-Sync** tab. This tab is not displayed when Ext Clock Out is set to **None**.
  - **Setup, System** and on the **TA-Sync** tab.

### Port / Port A/B

**Note:** *Port A/B on 88260 indicates on which port the transceiver system is inserted.*

- **Transceiver System Insertion Counter** indicates the number of time a transceiver system has been inserted into this FTBx module port.
- **Transceiver System Parameters** are as follows:
  - **ID** indicates the name of the transceiver system.
  - **Serial Number** indicates the serial number of the transceiver system.
  - **Revision** indicates the hardware revision of the transceiver system.

## Setup

### *Transceiver System (TA/TA4)*

---

- **Battery**<sup>1</sup> indicates the status level of the battery: **Good**, **Low**, or **Depleted**.
- **Optical Module Insertion Counter**<sup>1</sup> indicates the number of time an optical transceiver has been inserted into this transceiver system port.

---

1. Not available with TA-SYNC.

## TCP Throughput

From the test menu, tap **Setup, Test Configurator**, and tap on the test block.

### TCP Mode

Since two units are required to perform a TCP Throughput test, one unit must be the source (**Local**) unit and the other one the destination (**Remote**). Set the TCP Mode on both units: **Local** (default) or **Remote**.

### TCP Connection Configuration

- **Remote IP Address**, available with **Local** TCP mode, allows entering the IP address of the remote unit.
- **Quick Ping** button automatically starts the quick Ping utility for the remote IP address and provides either a successful or failed result. The quick Ping uses 3 attempts, a Delay of 1 second, a Timeout of 2 seconds, and a Data Size of 32 Bytes. Refer to *Ping & Trace Route* on page 711 for more options.
- **Accept Connection from IP**, available with **Remote** TCP mode, allows entering the IP address of the local unit. The IP address **0.0.0.0** (default) listens to any TCP stream.
- **IP TOS/DS**, available with **Local** TCP mode, is configurable from **0x00** (default) to **0xFF**.
- **TCP Port**, available with **Local** and **Remote** TCP modes, allows the selection of the TCP port number: **0** to **65535** (default is **50201**). For the local unit, the specified TCP port will be used for the TCP initialization algorithm with the remote unit. The following TCP segments sent by the local unit will use the TCP port number replied by the remote unit.

## TCP Throughput Configuration

**Note:** *TCP Throughput Configuration is only available on the local unit.*

- **Initial Window Size**<sup>1</sup> is the window size that is used when the test is started: **1024** Bytes to **65536** KBytes (default is **2** KBytes). The Initial Window Size value must be between the **Minimum Window Size** and the **Maximum Window Size** values.
- **Minimum Window Size**<sup>1</sup> is the minimum window size used for the test: **1024** Bytes to **65536** KBytes (default is **1** KBytes).
- **Maximum Window Size**<sup>1</sup> is the maximum window size used for the test: **1024** Bytes to **65536** KBytes (default is **64** MBytes).
- **Rate Unit** allows selecting the unit that will be used to set the Throughput Pass/Fail Verdict Threshold and throughput results: % (default) or **MBit/s**.
- **Throughput Pass/Fail Verdict** check box when selected (default) enables the throughput verdict.
- **Threshold** allows setting the pass/fail verdict threshold value: **0** to **100** % (default).

## Restore TCP Throughput Defaults

Reverts the TCP Throughput test application to its default factory settings.

---

1. The entered value will be rounded to the closest multiple of 1024 Bytes. Unit choices are Bytes, KBytes (default), and MBytes.

## Test Sequence - iOptics

From the test menu, tap **Setup**, and **Test Configurator**.

- **Control Pin Check** check box when selected (default) stimulates the **TX\_DISABLE** pin for SFPs or the **Reset** pin for other transceivers. Clear this check box to bypass this test for transceiver not supporting the control pin.
- **Power Threshold (W)**<sup>1</sup> indicates the power consumption threshold based on the power level/class detected including uncertainty from the selected transceiver to declare the pass/fail verdict. Not available on 8870 and 8880 modules.  
**Power Consumption - Pass/Fail Verdict**<sup>1</sup> check box when selected (default) enables the power consumption pass/fail verdict based on the **Power Threshold** value. In the case where the Power Class needs to be disregarded, clear this check box to avoid reporting a fail verdict.
- **Temp. Threshold (°C)**<sup>1</sup> allows selecting the temperature threshold to declare the pass/fail verdict: **0** to **75 °C** (default is **70 °C**).
- **TX Power Range (dBm)**<sup>1</sup> indicates, when supported, the optical device TX operational range to declare the pass/fail verdict.
- **RX Power Range (dBm)**<sup>1</sup> indicates the optical device RX operational range to declare the pass/fail verdict.
- **BERT Duration** is the time duration of the bit error test:  
**1 minute** (default), **2, 3, 4, 5**, or **30 minutes**.
- **BERT Threshold** indicates the bit error test threshold (set to **0**) to declare the pass/fail verdict.
- **Skew Threshold (Bits)**, available with parallel interfaces, indicates the skew threshold that is automatically set based on the rate to declare the pass/fail verdict.

---

1. Not available when PHY Type is set to DAC.

## Setup

### Time Error / Wander

---

## Time Error / Wander

From the test menu, tap **Setup**, **Test Configurator**, and either the **Time Error** or **Wander** test block.

### Test

- **Sampling Rate**, available with Wander measurement mode, allows selecting the time interval error measurement sampling rate: **30 samples/s** (default), **20 samples/s**, **10 samples/s**, **5 samples/s**, and **1 sample/s**. For time error measurement the sampling rate is fixed to 1 sample/s.

For both Time Error and Wander measurements:

- **Maximum Test Duration** displays the maximum test duration based on the selected sampling rate.
- **Mask** allows selecting the MTIE/TDEV ITU mask for Time Error / Time Interval Error pass/fail validation.

Mask	MTIE	TDEV
None (default)	-	-
G.811- Primary Reference Clock (PRC)	X	X
G.812- Type I Node Clock (SSU) - Constant Temperature	X	X
G.812- Type I Node Clock (SSU) - Variable Temperature	X	-
G.812- Type II and III Node Clock (SSU) - Constant Temperature	X	X
G.813- Option 1 SDH Equipment Clock (SEC) - Constant Temperature	X	X
G.813- Option 1 SDH Equipment Clock (SEC) - Variable Temperature	X	-
G.813- Option 2 SDH Equipment Clock (SEC) - Constant Temperature	X	X
G.823- Primary Reference Clock (PRC)	X	X
G.823- Synchronization Supply Unit (SSU)	X	X
G.823- SDH Equipment Clock (SEC)	X	X
G.823- PDH Synchronization Interface	X	X
G.824- 1544 kbit/s Reference Interface	X	X
G.824- 1544 kbit/s Reference Interface for Option 2 SEC	-	X

Mask	MTIE	TDEV
G.8261- CES Case 1 - 2048 kbit/s (MRTIE)	X	-
G.8261- CES Case 1 - 1544 kbit/s	X	-
G.8261- CES Case 2A - 2048 kbit/s (MRTIE)	X	-
G.8261- EEC Option 1 - SyncE Interface	X	X
G.8261- EEC Option 2 - SyncE Interface	-	X
G.8261.1- PEC-Slave Frequency Case 3	X	-
G.8262- EEC Option 1- SyncE - Constant Temperature	X	X
G.8262- EEC Option 1- SyncE - Variable Temperature	X	-
G.8262- EEC Option 2- SyncE - Constant Temperature	X	X
G.8263- PEC-Slave Frequency - Constant Temperature	X	-
G.8263- PEC-Slave Frequency - Variable Temperature	X	-
G.8271.1- Dynamic Time Error	X	-

- **Duration** check box when selected (cleared by default) allows selecting/entering the test duration: **15 minutes**, **1/2/4/6/12/24/72 hours**, or **User Defined** (1 second up to 30 days depending on the selected **Sampling Rate**); with the G.8275.2 profile, the duration should be more than 200 seconds in order to obtain TE values.

**Note:** *Once the test completes (after the duration is reached or when manually stopped), MTIE calculation may take some time depending on the test duration and sampling rate used.*

For Time Error measurements:

- **cTE Averaging Period (s)**, available with either G.8275.1 profile or 1PPS interface, defines the averaging period used to calculate the constant Time Error (cTE) value over a specific period of time: **Elapsed time** (default), **100 s**, **500 s**, **1000 s**, **10000 s**.
- **dTE<sub>H</sub> Observation Period (s)**, available with either G.8275.1 profile or 1PPS interface, defines the observation period used for qualifying the Time Error after High-Pass filtering 0.1 Hz: **100 s**, **500 s**, **1000 s**, **10000 s** (default).

## Setup

### Time Error / Wander

---

- **Cable Delay Compensation (ns)**, available with 1PPS interface, allows manual compensation of external cable delay asymmetry: **-1000 ns to 1000 ns (0 ns by default)**.

The cable delay asymmetry is caused by the difference between the length of the cable feeding the reference signal and the one feeding the signal under test.

In the case where the cable length of the signal under test is longer than the reference signal, a negative value is needed to compensate for the asymmetry. For example to compensate for a cable delay of -10 ns, enter this measured value as the **Cable Delay Compensation (ns)**:  $-10 - (-10) = 0 \text{ ns}$ .

In the case where the cable length of the signal under test is shorter than the reference signal, a positive value is needed to compensate for the asymmetry. For example to compensate for a cable delay of 10 ns, enter this measured value as the **Cable Delay Compensation (ns)**:  $10 - (10) = 0 \text{ ns}$ .

- **Window Step Size**, available with G.8275.2 profile, allows selecting the window step size based on a 200 seconds window: **1** (default), **2**, **5**, **10**, **15**, or **20** seconds.
- **Pkt sel cTE Averaging Period (s)**, available with G.8275.2 profile, defines the averaging period used to calculate the packet selected constant time error value over a specific period of time: **Elapse time** (default), **100 s**, **500 s**, **1000 s**, **10000 s**.

## Verdict

For both Time Error and Wander measurements:

- **MTIE** check box when selected (default) reports the Maximum Time Interval Error (**MTIE**) verdict. Available when **MTIE** is supported by the selected **Mask**.



- **TDEV** check box when selected (default) reports the Time Deviation (**TDEV**) verdict. Available when **TDEV** is supported by the selected **Mask**.

For Time Error measurement with either G.8275.1 profile or 1PPS interface:

- **Max Absolute TE (ns)** check box when selected (default) allows selecting the maximum absolute time error threshold value: **50 ns** to **2000 ns** (default is **1100 ns**).
- **Max dTE<sub>H</sub> pk-pk (ns)** check box when selected (default) allows selecting the maximum dynamic time error (after High-Pass filtering 0.1 Hz) peak-to-peak threshold value: **20 ns** to **400 ns** (default is **200 ns**).
- **Max cTE (ns)** check box when selected (default) allows selecting the maximum constant time error threshold value: (+/-) **15 ns** to **600 ns** (default is **600 ns**).

For Time Error measurement with G.8275.2 profile:

- **Max Abs pkt sel TE (ns)** check box when selected (default) allows selecting the maximum absolute packet selected time error threshold value: **50 ns** to **2000 ns** (default is **1100 ns**).
- **Pk-pk pkt sel TE (ns)** check box when selected (default) allows selecting the peak-to-peak packet selected time error threshold value: **50 ns** to **2000 ns** (default is **1100 ns**).
- **Max pkt sel cTE (ns)** check box when selected (default) allows selecting the maximum packet selected constant time error threshold value: **15 ns** to **600 ns** (default is **600 ns**).

## Restore Time Error / Wander Defaults

Reverts the test application to its default factory settings.

## Timer

Allows starting and/or stopping automatically the test at a given time or for a specific duration.

From the **Test** menu, tap **Setup**, and **Timer**.

**Note:** *For RFC 6349 the Timer is only available with operation modes **Dual Test Set** (local unit).*

## Timer

**Note:** *For RFC 2544 and RFC 6349, only **Start Time** and the **ARM** button are available.*

- **Duration:** Selects the test duration based on the test start time. The test start time can be either the time the user starts the test or the time the test is automatically started when the start time is enabled. The **Duration** check box has to be selected to be included in the test timer. Choices are **15 minutes** (default), **1, 2, 4, 6, 12, 24, 72 hours, 7 days**, and **User Defined**.

When **User Defined** is selected, the field next to it becomes available to enter the test duration using the format: dd:hh:mm:ss.

**Note:** *Duration cannot be enabled while stop time is enabled. When the test is started while duration is enabled, the stop time is calculated and the **Stop Time** field is updated to indicate the time the test will stop.*

- **Start Time** selects the time the test will automatically start. The **Start Time** check box has to be selected to be included in the test timer.

**Note:** *A valid start time has to be subsequent to the current time.*

- **Stop Time** selects the time the test will automatically stop. The **Stop Time** check box has to be selected to be included in the test timer.

**Note:** *A valid stop time has to be subsequent to the current time or to the start time, when enabled. The stop time must not exceed 30 days based on the start time. The stop time cannot be enabled while **Duration** is enabled.*

- **ARM** button, available when the **Start Time** check box is selected (cleared by default), enables the start test timer. Not available while the test is running. It is not possible to start the test case when the start time is armed.

**Note:** *An icon is displayed in the global test status area indicating that the timer is enabled. **Armed** is displayed when the test start time is armed while the test is not started. Refer to Global Indicator on page 40 for more information.*

### Traces - OTN

For OTN BERT and OTN-SONET/SDH BERT: From the test menu tap **Setup, Test Configurator**, tap on the interface block, and on the **Traces** tab.

For Multi-Channel OTN: From the test menu, tap **Setup, Test Configurator**, tap on either:

- the interface block, and the **Traces** tab to configure the higher ODU layer.
- the test block (**ODU Channels**), and the **Traces** tab to configure the lower ODU layer. Traces settings apply to all channels unless otherwise indicated.

**Note:** Configuration is coupled with settings from *Traces - OTN* on page 608.

### OTU<sub>x</sub>, ODU<sub>x</sub>, and TCM<sub>x</sub> Buttons

Tap on either OTU<sub>x</sub> or an ODU<sub>x</sub> button. For ODU<sub>x</sub> when TCM is enabled (see *Modify TCM* on page 400), tap on a TCM<sub>x</sub> button to select a TCM level. TCM is not available with Multi-Channel OTN.

### SM TTI Traces / PM TTI Traces / ODU<sub>x</sub> TCM TTI Traces

**Note:** The TTI Traces are configurable for SM (OTU<sub>x</sub>), PM (ODU<sub>x</sub>), and TCM (ODU<sub>x</sub> when TCM is enabled; see *Config TCM* on page 400).

**Note:** For Multi-Channel OTN lower ODU layer, expected traces apply to all channels but may be overwritten individually per channel from *Traces - OTN* on page 608; In this case the  icon appears next to the expected message indicating that at least one channel uses a different message.

- **Overwrite** check box when selected generates the defined messages. Only available with **Through Intrusive** topology and applies only to the OTU and ODU top layers.

- **SAPI** (Source Access Point Identifier) allows entering the SAPI message to be generated (TTI bytes 0 to 15). The expected SAPI message is available when the **SAPI OTU-TIM / SAPI ODU-TIM** check box is selected. A maximum of 16<sup>1</sup> characters is allowed.

TTI Traces	Default Message <sup>a</sup>
SM	EXFO OTU SAPI
PM	EXFO ODU SAPI <sup>b</sup>
TCM <sup>c</sup>	EXFO TCMi SAPI

- a. The default message contains a NULL (all 0's) character preceding it. NULL (all 0's) characters are automatically appended to the message for bytes that are not defined.
- b. The channel number is automatically appended to the message.
- c. Not available with Multi-Channel OTN.

- **DAPI** (Destination Access point Identifier) allows entering the DAPI message to be generated (TTI bytes 16 to 31). The expected DAPI message is available when the **DAPI OTU-TIM / DAPI ODU-TIM** check box is selected. A maximum of 16<sup>1</sup> characters is allowed.

TTI Traces	Default Message <sup>a</sup>
SM	EXFO OTU DAPI
PM	EXFO ODU DAPI <sup>b</sup>
TCM <sup>c</sup>	EXFO TCMi DAPI

- a. The default message contains a NULL (all 0's) character preceding it. NULL (all 0's) characters are automatically appended to the message for bytes that are not defined.
- b. The channel number is automatically appended to the message.
- c. Not available with Multi-Channel OTN.

---

1. For Multi-Channel OTN lower ODU layer, a maximum of 13 characters are allowed since the channel number is automatically appended to the message.

## Setup

### Traces - OTN

---

- **Operator Specific** allows entering the Operator Specific message to be generated (TTI bytes 32 to 63). A maximum of 32 characters are allowed.

For OTN BERT and OTN-SONET/SDH BERT:

TTI Traces	Default Message <sup>a</sup>
SM	EXFO OTU OPERATOR SPECIFIC
PM	EXFO ODU OPERATOR SPECIFIC
TCM	EXFO TCMi OPERATOR SPECIFIC

- a. NULL (all 0's) characters are automatically appended to the message for bytes that are not defined.

For Multi-Channel OTN:

TTI Traces	Default Message <sup>a</sup>
SM	XFO OTU OPERATOR SPECIFIC
PM	XFO ODU OPERATOR SPECIFIC

- a. NULL (all 0's) characters are automatically appended to the message for bytes that are not defined.

- **SAPI OTU-TIM / SAPI ODU-TIM / SAPI TCM-TIM** check box, when selected (cleared by default), allows editing the expected Source Access Point Identifier and also enables OTU/ODU/TCM-TIM alarm monitoring.
- **DAPI OTU-TIM / DAPI ODU-TIM / DAPI TCM-TIM** check box, when selected (cleared by default), allows editing the expected Destination Access Point Identifier and also enables the OTU/ODU-TIM alarm monitoring.

## Traces - SONET/SDH

For SONET/SDH BERT and SONET/SDH - DS<sub>n</sub>/PDH BERT: From the test menu, tap **Setup, Test Configurator**, the interface block, and on the **Traces** tab.

For OTN-SONET/SDH BERT: From the test menu, tap **Setup, Test Configurator**, the protocol block, and on the **Traces** tab.

### Traces

**Note:** *Selecting a Trace byte to be generated will automatically update the corresponding OH byte. Refer to OH - SONET/SDH on page 688 for more information. Configuration is coupled with settings from Traces - SONET/SDH on page 611.*

- **Section (J0) / RS (J0), STS Path (J1) / AU Path (J1) / TU-3 Path (J1), VT Path (J2) / TU Path (J2)**

**Format** allows the selections of the J0/J1/J2 format: **1 Byte** (default), **16 Bytes**, or **64 Bytes**.

**Generated**, available when the 16 bytes or 64 bytes format is selected, allows entering the J0/J1/J2 trace value/message to be generated.

Format (bytes)	Default Traces	J0/J1/J2
1	01 <sup>a</sup>	J0/J1/J2
16	EXFO SONET/SDH	J0/J1/J2
64	EXFO SONET/SDH Analyzer Section/RS trace test message	J0
	EXFO SONET/SDH Analyzer high order path trace test message	J1 (STS/AU)
	EXFO SONET/SDH Analyzer low order path trace test message	J1 (TU-3)/J2

- a. Hexadecimal value. Refer to *OH - SONET/SDH* on page 688 to change this value.

## Setup

Traces - SONET/SDH

---

**Note:** 16-bytes selection allows typing up to 15 bytes (a CRC-7 byte will be added in front for a total of 16 bytes). 64-bytes selection allows typing up to 62-bytes (<C<sub>R</sub>> and <L<sub>F</sub>> bytes will be added at the end for a total of 64-bytes). Traces values should be ASCII suitable characters including the ITU T.50 Characters on page 50.

- **TIM-S / RS-TIM, TIM-P / HP-TIM, TIM-V / LP-TIM** check box when selected (cleared by default) enables the corresponding Trace Identifier Mismatch for the expected message defined.

**Format** allows the selection of the expected format:

**16 Bytes** (default), or **64 Bytes**.

**Expected** allows entering the expected J0 trace message.

## TCM Access Point Identifier

**Note:** Available when **TCM** is enabled from the Signal - Signal Configuration - SONET/SDH on page 401.

- **STS Path (N1) / AU Path (N1)**, and **VT Path (Z6) / TU-Path (N2) / TU-Path (N1)** for (TU-3) allows entering the N1/N2/Z6 value/message to be generated.
- **TC-TIM-P / HPTC-TIM / TC-TIM-V / LPTC-TIM** check box when selected (cleared by default) enables the corresponding TCM Access Point Identifier and allows the configuration of the expected message.



## Traces/PT - FlexO

From the test menu, tap **Setup, Test Configurator**, the **FlexO-OTUCn** protocol block, and the **Traces/PT** tab.

### OTUCn / ODUcN / ODUk

Tap on either the OTU or an ODU button.

### SM TTI Traces / PM TTI Traces / Global PM TTI Traces

**Note:** *The TTI Traces are configurable for SM (OTUCn), PM (ODUCn), and Global PM (ODUk).*

**Note:** *The expected message settings are coupled with the **Expected Message** from Traces/PT - FlexO on page 613. For ODUk, the  icon appears next to the expected message indicating that the **Expected Message** has been changed from Traces/PT - FlexO on page 613.*

- **SAPI** (Source Access Point Identifier) allows entering the SAPI message to be generated (TTI bytes 0 to 15). The expected SAPI message is available when the **SAPI OTU-TIM / SAPI ODU-TIM** check box is selected. A maximum of 16 characters are allowed; 13 characters for lower ODU layer since the channel number is automatically appended to the message.

TTI Traces	Default Message <sup>a</sup>
SM	EXFO OTU SAPI
PM	XFO ODU SAPI <sup>b</sup>

- a. The default message contains a NULL (all 0's) character preceding it. NULL (all 0's) characters are automatically appended to the message for bytes that are not defined.
- b. For ODUk, the client ID is automatically appended to the generated/expected message.

## Setup

### Traces/PT - FlexO

---

- **DAPI** (Destination Access point Identifier) allows entering the DAPI message to be generated (TTI bytes 16 to 31). The expected DAPI message is available when the **DAPI OTU-TIM / DAPI ODU-TIM** check box is selected. A maximum of 16 characters is allowed; 13 characters for lower ODU layer since the channel number is automatically appended to the message.

TTI Traces	Default Message <sup>a</sup>
SM	EXFO OTU DAPI
PM	XFO ODU DAPI <sup>b</sup>

- The default message contains a NULL (all 0's) character preceding it. NULL (all 0's) characters are automatically appended to the message for bytes that are not defined.
- For ODUk, the client ID is automatically appended to the message.

- **Operator Specific** allows entering the Operator Specific message to be generated (TTI bytes 32 to 63). A maximum of 32 characters are allowed.

TTI Traces	Default Message <sup>a</sup>
SM	EXFO OTU OPERATOR SPECIFIC
PM	XFO ODU OPERATOR SPECIFIC

- NULL (all 0's) characters are automatically appended to the message for bytes that are not defined.

- **SAPI OTU-TIM / SAPI ODU-TIM** check box, when selected (cleared by default), allows editing the expected Source Access Point Identifier and also enables OTU/ODU-TIM alarm monitoring.
- **DAPI OTU-TIM / DAPI ODU-TIM** check box, when selected (cleared by default), allows editing the expected Destination Access Point Identifier and also enables the OTU/ODU-TIM alarm monitoring.

## PT / Global PT

**Note:** *Global PT indicates that the PT settings apply to all Client ID.*

**Note:** *Changing the payload type (PT) does not alter the signal structure; it only modifies the OH value that is generated.*

- **Payload Type and Code** allows the selection of the generated/expected payload signal type either by selecting the payload type from the list or by entering its code in hexadecimal (**00** to **FF**).

**Note:** *Codes not listed in the table are reserved for future standardization (Reserved For International Standardization).*

Payload type	Hex Code	MSB 1234	LSB 5678
Reserved for International Standardization <sup>a</sup>	00	0000	0000
Experimental mapping	01	0000	0001
Asynchronous CBR mapping	02	0000	0010
Bit Synchronous CBR mapping	03	0000	0011
ATM mapping	04	0000	0100
GFP mapping	05	0000	0101
Virtual Concatenation Signal	06	0000	0110
PCS Codeword Transparent Ethernet	07	0000	0111
FC-1200 into ODU2e	08	0000	1000

## Setup

Traces/PT - FlexO

---

<b>Payload type</b>	<b>Hex Code</b>	<b>MSB 1234</b>	<b>LSB 5678</b>
GFP mapping into extended OPU2	09	0000	1001
OC-3/STM-1 into ODU0	0A	0000	1010
OC-12/STM-4 into ODU0	0B	0000	1011
FC-100 into ODU0	0C	0000	1100
FC-200 into ODU1	0D	0000	1101
FC-400 into ODUflex	0E	0000	1110
FC-800 into ODUflex	0F	0000	1111
Bit Stream with Octet Timing mapping	10	0001	0000
Bit Stream Without Octet Timing mapping	11	0001	0001
IB SDR mapping into ODUflex	12	0001	0010
IB DDR mapping into ODUflex	13	0001	0011
IB QDR mapping into ODUflex	14	0001	0100
SDI mapping into OPU0	15	0001	0101
(1.485/1.001) Gbit/s SDI mapping into OPU1	16	0001	0110
1.485 Gbit/s SDI mapping in to OPU1	17	0001	0111
(2.970/1.001) Gbit/s SDI mapping into OPUflex	18	0001	1000
2.970 Gbit/s SDI mapping into OPUflex	19	0001	1001
SBCON/ESCON mapping into OPU0	1A	0001	1010
DVB_ASI mapping into OPU0	1B	0001	1011
FC-1600 mapping into OPUflex	1C	0001	1100
FlexE Client mapping into OPUflex	1D	0001	1101
FlexE aware (partial rate) mapping into OPUflex	1E	0001	1110
FC-3200 mapping into OPUflex	1F	0001	1111
ODU Multiplex with ODTUjk	20	0010	0000
ODU Multiplex with ODTUk.ts/ODTUjk	21	0010	0001
ODU multiplex with ODTUCn.ts	22	0010	0010
25GBASE-R mapping into OPUflex	30	0011	0000

Payload type	Hex Code	MSB 1234	LSB 5678
200GBASE-R mapping into OPUflex	31	0011	0001
400GBASE-R mapping into OPUflex	32	0011	0010
Not Available <sup>b</sup>	55	0101	0101
Reserved Codes for Proprietary Use <sup>c</sup>	80	1000	0000
NULL Test Signal mapping	FD	1111	1101
PRBS Test Signal mapping	FE	1111	1110

- Selecting **Reserved for International Standardization** will use the hexadecimal code 00 but, all codes not listed in the previous table at the exception of those covered in notes b and c are reserved for future standardization.
- Selecting **Not Available** will use the hexadecimal code 55 but, 66 and FF are also Not Available payload types.
- Selecting **Reserved Proprietary** will use the hexadecimal code 80 but, all codes from 80 to 8F are reserved proprietary payload types.

**Note:** *The Code field is automatically updated when the Payload Type is changed and vice versa.*

- **OPU-PLM** check box when selected enables the OPU-PLM alarm analysis.



# 9 Test Results

The Test Results menu offers the following structure:

## Intelligent Apps

Test Applications	Page or Pop Up	Page
iOptics	Logger	477
	Summary	566
iSAM	Logger	477
	Summary	569

## Transport

Test Application	Page, Sub-Page, or Pop Up	Page
DCO BERT	Alarms/Errors	456
	Logger	477
	Measurements	480
	Summary	538
	Traffic - Ethernet	616
DSn/PDH BERT	Alarms/Errors	456
	Logger	477
	Performance Monitoring	488
	Summary	520
FlexO BERT	Alarms/Errors	456
	Logger	477
	Summary	564
	Traces/PT	613

## Test Results

---

Test Application	Page, Sub-Page, or Pop Up	Page
Multi-Channel OTN	PT	466
	Logger	477
	SDT	508
	Summary	575
	Traces	608
NI/CSU Emulation	Logger	477
	Summary	577
OTN BERT	Alarms/Errors	456
	FTFL/PT	466
	GFP-F/GFP-T	468
	Logger	477
	OTL-SDT	486
	Performance Monitoring	488
	Summary	520
	Traces	608
	Traffic - Ethernet	616
OTN-SONET/SDH BERT	Alarms/Errors	456
	FTFL/PT	466
	Labels	472
	Logger	477
	OTL-SDT	486
	Performance Monitoring	488
	Summary	520
	Traces	608 611



<b>Test Application</b>	<b>Page, Sub-Page, or Pop Up</b>	<b>Page</b>
SONET/SDH BERT	Alarms/Errors	456
	Labels	472
	Logger	477
	Performance Monitoring	488
	Summary	520
	Traces	611
SONET/SDH - DS <sub>n</sub> /PDH BERT	Alarms/Errors	456
	Labels	472
	Logger	477
	Performance Monitoring	488
	Summary	520
	Traces	611

### Ethernet

Test Application	Page, Sub-Page, or Pop Up	Page
Cable Test	Summary	527
Carrier Ethernet OAM	Alarms/Errors	456
	Link OAM	473
	Logger	477
	MPLS-TP OAM	503
	S-OAM	503
	Summary	573 586
	Traffic - MPLS-TP OAM	624
	Traffic - S-OAM	624
	Traffic - Ethernet	624
	WIS	627
EtherBERT	Alarms/Errors	456
	FEC Statistics	465
	Logger	477
	Summary	545
	Traffic - Ethernet	616
	WIS	627

<b>Test Application</b>	<b>Page, Sub-Page, or Pop Up</b>	<b>Page</b>
EtherSAM (Y.1564)	Alarms/Errors	456
	FEC Statistics	465
	Logger	477
	Service Configuration - Burst	510
	Service Configuration - L2CP	511
	Service Configuration - Ramp	513
	Service Performance	488
	Summary	549
	Traffic - Ethernet	624
	WIS	627
FlexE BERT	Alarms/Errors	456
	FEC Statistics	465
	Logger	477
	Summary	556
	Client Summary	559
	Traffic - Ethernet	624
	Traffic - Path OAM	622
RFC 2544	Alarms/Errors	456
	FEC Statistics	465
	Graph	471
	Logger	477
	Summary	578
	Traffic - Ethernet	624
	Traffic - Flow Control	619
	WIS	627

## Test Results

---

Test Application	Page, Sub-Page, or Pop Up	Page
RFC 6349	Alarms/Errors	456
	Logger	477
	Summary	581
	Traffic - Ethernet	624
	Traffic - Flow Control	619
	Window Sweep	626
Smart Loopback	Alarms/Errors	456
	FEC Statistics	465
	Summary	585
	Traffic - Ethernet	624
	Traffic - MPLS-TP OAM	624
	Traffic - S-OAM	624
	WIS	627
TCP Throughput	Alarms/Errors	456
	Logger	477
	Summary	594
	Traffic - Ethernet	624
	Traffic - Flow Control	619
Through Mode	Alarms/Errors	456
	Logger	477
	Summary	597
	Traffic - Ethernet	624
	Traffic - Flow Control	619
	Traffic - Graph	621
	Traffic - MPLS	485

<b>Test Application</b>	<b>Page, Sub-Page, or Pop Up</b>	<b>Page</b>
Traffic Gen & Mon	Alarms/Errors	456
	FEC Statistics	465
	Logger	477
	Streams - Customer Frame Throughput	519
	Streams - Frame Loss / Out-of-Sequence	517
	Streams - Jitter	517
	Streams - Latency	518
	Streams - MPLS	485
	Streams - Throughput	519
	Summary	599
	Traffic - Ethernet	624
	Traffic - Flow Control	619
	Traffic - Graph	621
	WIS	627

**Sync**

<b>Test Application</b>	<b>Page or Pop Up</b>	<b>Page</b>
1588 PTP	Alarms/Errors	456
	Logger	477
	PTP Stats	495
	Quality Level	497
	Summary	524
	Traffic - Ethernet	624

## Test Results

---

Test Application	Page or Pop Up	Page
SyncE	Alarms/Errors	456
	Logger	477
	Quality Level	500
	Summary	591
	Traffic - Ethernet	624
Time Error / Wander	Alarms/Errors	456
	Analysis - MTIE/TDEV	461
	Analysis - Time Error / Time Interval Error	463
	Logger	477
	PTP Stats	495
	Summary	602

## Fibre Channel

Test Application	Page or Pop Up	Page
FC BERT	Alarms/Errors	456
	Logger	477
	Summary	552

## Wireless

Test Application	Page or Pop Up	Page
CPRI/OBSAI BERT	Alarms/Errors <sup>a</sup>	456
	Logger	477
	Messages (OBSAI)	483
	Summary	533

<b>Test Application</b>	<b>Page or Pop Up</b>	<b>Page</b>
eCPRI BERT	Alarms/Errors	456
	Logger	477
	Messages <sup>a</sup>	483
	Summary	540
	Traffic - Ethernet <sup>a</sup>	624

a. Not available when the framing is unframed.

## Test Results

### Alarms/Errors Overview

---

## Alarms/Errors Overview

**Note:** Refer to Alarms/Errors on page 869 for the complete list of alarms/errors and their availability.

Current and history alarms/errors are displayed using different background colors as defined in the following table.

Background color	Alarm/Error	Description
Gray	Current	No test result available or the results have no impact on the test verdict.
	History	
Green	Current	No alarm/error has occurred in the last second.
	History	No alarm/error has occurred during the test.
Red	Current	An alarm/error occurred in the last second.
	History	
Amber	History	At least one alarm/error has occurred during the test.

When an alarm/error label is dimmed, it indicates that the alarm/error is not monitored or not supported.

- **Seconds** gives the total number of seconds in which one or more alarm/error occurred.
- **Count** gives the number of occurrences of a specific error. The count is displayed using integer value; exponential value (for example: 1.00000E10) is used when the count is bigger than the field display capacity.
- **Rate** calculates and displays the error rate. The rate is expressed using the exponential format with two decimal digits (example: 1.23E-04).



**Note:** When an alarms/errors group displays a magnifying icon, tapping on it gives more information on alarm/error like *Second, Count, and Rate*.



## Pass/Fail Verdict

**Note:** *The verdict is not displayed when disabled or unavailable.*

The Pass/Fail verdict is represented by the following icons:

Icon	Verdict	Description
	PASS	Result value meet the configured threshold criterion.
	FAIL	Result value does not meet the configured threshold criterion.

## Statistic Values

- **Current** indicates the average measurements in the last second.
- **Last** indicates the result of the last measurement.
- **Minimum** indicates the minimum value recorded.
- **Maximum** indicates the maximum value recorded.
- **Average** indicates the average value.

## Buttons / Selectors

- **<Port #>**, available with **Dual Port** topology, allows selecting the port to be displayed.
- **Global/<Port #>**, available with **Dual Port** topology, allows selecting to display a brief summary for both ports (**Global**) or for a specific port.
- **Link**, available with multiple link interface (ex: 2 x 100GE), allows selecting the link to be displayed; only enabled links are available.
- **Channel**, available with **Multi-Channel OTN** for ODUk level, allows selecting the channel to be displayed.

## Test Results

### Alarms/Errors Overview

---

- **Port**, available with FlexE BERT/FlexO BERT, allows selecting the physical port to be displayed.
- **FlexE PHY Number**, available with FlexE BERT, indicates the FlexE PHY number assigned to the port.
- **FlexO Instance ID**, available with FlexO BERT, indicates the FlexO instance identifier per port.
- **Client ID**, available with FlexE BERT, allows selecting the client identification to be displayed.
- **Client ID**, available with FlexO BERT, indicates the client identification.
- **Size (Gbit/s)**, available with FlexE BERT, indicates the size of the client ID.

## Alarms/Errors

From the **Test** menu, tap **Results**, and the **Alarms/Errors** tab. Depending on the test structure, the Alarms/Errors page may be split in different tabs such as OTN, GFP-T/GFP-F, PHY, Group, Client, and Ethernet; tap on the desired tab when required.

**Note:** Refer to Alarms/Errors on page 869 for the complete list of alarms/errors and their availability.

Alarms/errors blocks containing the magnifier (+) icon in its title, opens a zoomed view giving more details like alarms/errors for each lane (parallel interface), errors in seconds, count, and rate.

When there is not enough room on the page to display the error in seconds, count, and rate, the error is displayed in **Seconds** per default. To select another unit, tap on the unit's button and select either **Seconds** (default), **Count**, or **Rate**.

**Total**, available with certain errors (parallel interface), indicates the total of all lanes when **Count** or **Rate** unit is selected.

## Inject Button

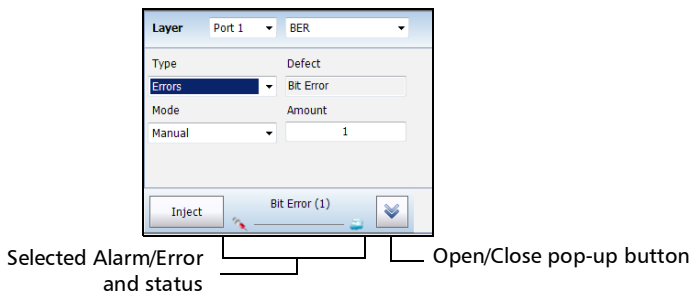

- **Inject** generates the selected alarm/error.

The selected alarm/error details and status are displayed next to the **Inject** button.

The open/close pop-up button allows expanding (up arrow) or collapsing (down arrow) the pop-up for setting the alarm/error injection parameters.

- **Layer** allows selecting on which layer is the alarm/error to be generated. Choices depend on the test application and its interface. For Multi-Channel OTN using mix-mapping, **ODUk** and **OPUk** represent ODU and OPU levels of the selected channel(s).

For **Dual Port** topology, select the port used for alarm/error injection.

For multiple link interface, select the link used for alarm/error injection; only enabled links are available.

- **Channel**, available with Multi-Channel OTN, allows selecting the channel number that will be used for injection. The **All** button allows selecting all defined channels.
- **Type** allows selecting the type of injection: **Alarms** or **Errors**.
- **Defect** allows selecting the alarm/error defect to be generated. Choices depend on the selected **Layer** and **Type**. Refer to *Alarms/Errors* on page 456 for more information.

## Test Results

### Alarms/Errors Overview

---

- **Mode** allows selecting the injection mode for error type; injection mode is set to **Continuous** for alarm injection. Only **Manual** mode is available with **100GE - 4 Unframed CAUI-4** and **OTU4 - 4 Unframed Physical Lanes** on 88220NGE; the **Amount** is fixed to 1; **Pattern Loss** injection is not possible.
- **Manual** generates the selected errors according to the defect and the amount selected.
- **Rate** generates the selected error at the rate specified.
- **Max Rate** generates the selected error at its theoretical maximum rate.
- **Continuous** generates the selected alarm continuously.
- **Amount**, available with **Manual** mode, allows entering the amount of error to be generated: **1** (default) through **50** or **100** (depending on the selected error).
- **Rate**, available with **Rate** mode, allows selecting the error injection rate. The rate must be within the minimum and maximum values specified.
- **Max Rate**, available with **Max Rate** mode, allows generating the error to its theoretical maximum rate.
- **Period**, available with GFP layer, allows setting the alarm period associated with the client management frames: **10 ms** to **1200 ms** (default is **100 ms**).
- **User-Defined UPI**, available with GFP layer, allows entering the Client Management Frame UPI value when **GFP-User-Defined CMF** alarm is selected.

UPI	Description for PTI = 100
0000 0000 and 1111 1111	Reserved
0000 0001	Client Signal Fail (Loss of Client Signal)

UPI	Description for PTI = 100
0000 0010	Client Signal Fail (Loss of Client Character Synchronization)
0000 0011 through 1111 1110	Reserved for future use

- **Lane**, available with parallel interfaces, allows selecting the physical lane that will be used for injection. Available for **Interface**, **OTL**, **FEC** (FlexO), **FOICx.y**, and **PCS** layers only.

The following settings are available with **FlexE BERT**:

- **FlexE** allows selecting the **PHY**, **Group**, or **Client** level used for injection.
- **Client ID** allows selecting the client ID used for injection.
- **PHY/Instance** allows selecting the PHY/Instance number that will be used for injection.

The following settings are available with **FlexO BERT**:

- **Category** allows selecting either **PHY**, **FlexO**, **OTN**, or **Client Payload** level used for injection.
- **Port** available for FlexO PHY level allows selecting the physical port number.
- **Client ID** indicates the client ID used for injection.
- **Instance** available at FlexO level allows enabling the FlexO instance number(s) used for injection.
- **OTUC** available at OTN level allows enabling the OTUC number(s) used for injection.

## Test Results

### Alarms/Errors Overview

---

The following settings are available with **Carrier Ethernet OAM**:

- **Address Type** defines the destination address type of the frame: **Unicast** or **Multicast** (default).
- **Priority** allows selecting the VLAN user priority: **0** (default) to **7**. Available when VLAN is enabled (refer to *VLAN* on page 330 for more information).
- **Drop Eligible** is set to **No** (no frames will be dropped when congestion occurs) and is not configurable. Available when VLAN is enabled (refer to *VLAN* on page 330).
- **MEG Level** (Y.1731 and MEF) is the Maintenance Entity Group Level configurable from **0** to **7** (default).
- **MD Level** (802.1ag) is the Maintenance Domain Level and is configurable from **0** to **7** (default).
- **Period** determines the transmission period of frames: **1 s** (default) and **1 min**. Not available with C-DCI.
- **Amount**, only available with C-DCI alarm, is set to **1**.

**Note:** *The **RDI** alarm is available when the **CC Function** is enabled and is using the parameters from the **CC Function** (refer to page 371).*

## Analysis - MTIE/TDEV

From the test menu, tap **Results**, **Analysis**, and the **MTIE/TDEV** tab.

**Note:** With the G.8275.2 profile, the TE values are only available 200 seconds after the test is started as the calculation method requires a sample selection window of 200 seconds.

- **MTIE/TDEV (ns)** graphically displays the MTIE/TDEV values in function of the **Observation Interval (s)**. The MTIE and TDEV masks are also displayed when supported by the selected standard. MTIE values and mask are displayed in pink. TDEV values and mask are displayed in blue.
- **Mask** allows the selection of an ITU mask used to validate MTIE/TDEV statistics.

Mask	MTIE	TDEV
None (default)	-	-
G.811- Primary Reference Clock (PRC)	X	X
G.812- Type I Node Clock (SSU) - Constant Temperature	X	X
G.812- Type I Node Clock (SSU) - Variable Temperature	X	-
G.812- Type II and III Node Clock (SSU) - Constant Temperature	X	X
G.813- Option 1 SDH Equipment Clock (SEC) - Constant Temperature	X	X
G.813- Option 1 SDH Equipment Clock (SEC) - Variable Temperature	X	-
G.813- Option 2 SDH Equipment Clock (SEC) - Constant Temperature	X	X
G.823- Primary Reference Clock (PRC)	X	X
G.823- Synchronization Supply Unit (SSU)	X	X
G.823- SDH Equipment Clock (SEC)	X	X
G.823- PDH Synchronization Interface	X	X
G.824- 1544 kbit/s Reference Interface	X	X
G.824- 1544 kbit/s Reference Interface for Option 2 SEC	-	X
G.8261- CES Case 1 - 2048 kbit/s (MRTIE)	X	-
G.8261- CES Case 1 - 1544 kbit/s	X	-
G.8261- CES Case 2A - 2048 kbit/s (MRTIE)	X	-
G.8261- EEC Option 1 - SyncE Interface	X	X

## Test Results

### Analysis - MTIE/TDEV

---

Mask	MTIE	TDEV
G.8261- EEC Option 2 - SyncE Interface	-	X
G.8261.1- PEC-Slave Frequency Case 3	X	-
G.8262- EEC Option 1- SyncE - Constant Temperature	X	X
G.8262- EEC Option 1- SyncE - Variable Temperature	X	-
G.8262- EEC Option 2- SyncE - Constant Temperature	X	X
G.8263- PEC-Slave Frequency - Constant Temperature	X	-
G.8263- PEC-Slave Frequency - Variable Temperature	X	-
G.8271.1- Dynamic Time Error	X	-

- **Remove Offset** check box when selected, subtracts the estimated frequency offset from the Time Error/Time Interval Error data used to calculate the MTIE/TDEV. It is preferable to set this setting before starting the test since changing this setting while the test is running will require some time for MTIE/TDEV recalculation.
- **MTIE** check box when selected (default) reports MTIE values on the graph. The MTIE pass/fail verdict is displayed when enabled.
- **TDEV** check box when selected (default) reports TDEV values on the graph. The TDEV pass/fail verdict is displayed when enabled.
- **Cursor** check box when selected (default), allows the selection of a specific observation interval value and returns the MTIE/TDEV values and the corresponding mask when enabled. Use the left and/or right arrow buttons to move the cursor position on the graph.
  - **Obs. Interval (s)** indicates the observation interval value at the cursor position on the graph.
  - **MTIE (ns)** indicates the MTIE value and the corresponding mask at the cursor position on the graph.
  - **TDEV (ns)** indicates the TDEV value and the corresponding mask at the cursor position on the graph.



## Analysis - Time Error / Time Interval Error

From the test menu, tap **Results, Analysis**, and either the **Time Error** or **Time Interval Error** tab.

**Note:** *With the G.8275.2 profile, the TE values are only available 200 seconds after the test is started as the calculation method requires a sample selection window of 200 seconds.*

### Time Error / Time Interval Error Graph

- **Time Error**, available with Time Error measurement mode, graphically displays the time error values as a function of time.
- **Time Interval Error**, available with Wander measurement mode, graphically displays the time interval error values as a function of time.

**Note:** *A refresh is required to update the graph (see Refresh below).*

**Note:** *It is possible to zoom/un-zoom on Time Error / Time Interval Error (Y axis): Using the touch screen, use the pinch-to-zoom to zoom/un-zoom. Using a mouse, click and drag (highest to lowest value to zoom and lowest to highest value to un-zoom).*

### Offset

- **Remove Offset** check box when selected displays a second TE/TIE trace on which the frequency offset has been removed.
- **Freq. Offset (ppm)** indicates an estimated frequency offset of the signal under test since the beginning of the test.

## Test Results

*Analysis - Time Error / Time Interval Error*

---

### Zoom

Allows zooming to a desired time region (X axis).

- **Time (Start/End)** allows selecting the starting and ending time for the zoom.
- **Display full range on Test Stop** check box when selected (default) displays the full test duration on the **Time** axis when the test stops.

### Refresh

Refreshes the page with the latest setting and collected data.

### Save TE Data / Save TIE Data

Saves the TE/TIE data into CSV file format.

- **Folder Path** allows the selection of the file destination drive and folder. Use the **Browse** button to change the file location. The default file location is:  
For Wander measurement mode:  
Users\<<User>\Documents\88000-PowerBlazer\Wander  
For Time Error measurement mode:  
Users\<<User>\Documents\88000-PowerBlazer\TimeError
- **File Name** allows the selection of the file name. The default file name is either **Wander** or **TimeError** followed by the date and time.

## FEC Statistics

**Note:** Only available with 50G/200/400G interfaces.

From the test menu tap **Results** and the **FEC Statistics** tab.

### Symbol Error per Correctable Codeword

- **Number of Symbols** indicates the number of symbols corrected in a codeword: 1 to 15.
- **Codeword Count:** corrected codeword count for each **Number of Symbols** category.
- **%:** the number of correctable codeword for each number of symbols category divided by the total count of correctable codeword. A bar graph is displayed in background as a relative way to compare the percentage of correctable codeword count per number of symbols category.

### Other Statistics

- **Error-free Codeword** indicates error-free codeword count. The percentage value correspond to the number of error-free codeword count divided by the codeword count (all categories i.e. correctable, uncorrectable, and error-free).
- **Uncorrectable Codeword** indicates uncorrectable codeword count. The percentage value correspond to the number of uncorrectable codeword count divided by the codeword count (all categories i.e. correctable, uncorrectable, and error-free).

### FTFL/PT / PT

For **OTN BERT** and **OTN-SONET/SDH BERT**: From the test menu tap **Results**, and the **FTFL/PT** tab.

For **Multi-Channel OTN**: From the test menu, tap **Results**, and the **PT** tab. **Channel**, available with **Multi-Channel OTN** for ODUk level, allows selecting the channel to be displayed.

### ODUx/ODUk Buttons

Tap on an **ODUx/ODUk** button to select the multiplexed level. For Multi-Channel OTN, the ODUk level displayed will be the one corresponding to the selected channel.

### FTFL

Indicates the Forward and Backward ODU Fault Type Fault Location. Not available with Multi-Channel OTN.

- **Fault Indication** and **Code** respectively displays the FTFL fault indicator message and its code in hexadecimal format (byte 0 for forward, byte 128 for backward).

Fault Indication	Code
No fault	00 (default)
Signal fail	01
Signal Degrade	02
Reserved	03

- **Operator Identifier** displays the received operator identifier (bytes 1 to 9 for forward, byte 129 to 137 for backward).
- **Operator Specific** displays the received operator specific (bytes 10 to 127 for forward, byte 138 to 255 for backward).

**PT**

- **Payload Type and Code** displays the received payload signal type and its code in hexadecimal format. The expected payload signal type can be selected from the list or by entering its hexadecimal code. Refer to *PT / Global PT* on page 285 for the list.
- **OPU-PLM** check box when selected enables the OPU-PLM alarm analysis. For Multi-Channel OTN lower ODU layer, the OPU-PLM check box is only configurable from the test setup.
- **Copy RX / Global Copy RX**<sup>1</sup> uses the received payload type as the expected payload type. For **Multi-Channel OTN** lower ODU layer, use the arrow button next to the **Copy RX** or **Global Copy RX** to switch from one button to the other; **Global Copy RX** uses the current channel received payload type as the expected payload type for all channels while **Copy RX** only affects the selected channel.

---

1. Only available for Multi-Channel OTN lower ODU layer.

## Test Results

GFP-F/GFP-T

---

### GFP-F/GFP-T

**Note:** This tab is only available with OTN BERT test application with **1GbE**, **10GbE**, or **Ethernet (flex/GFP-F)** client.

From the **Test** menu, tap **Results**, and the **GFP-F/GFP-T** tab.

#### Transport Layer

- **Bandwidth Usage (%)** indicates the transmitted/received transport layer bandwidth in the last second, excluding the Idle bytes.
- **Mapping Efficiency (%)** indicates the transmitted/received transport layer mapping efficiency (Client Payload Bytes divided by Client Data Bytes multiplied by 100) in the last second.

#### Frame Type

**Note:** For **Ethernet (flex/GFP-F)** client with **EXI** set to **Linear**, the **RX count/rate** is configurable to either **RX** (default) or **RX CID Filtered** by tapping on the table **RX** label. **RX CID Filtered** only includes frames that match the expected **CID** (refer to **CID** on page 288).

- **Client Data** indicates the transmitted/received client data frames without uncorrectable cHEC, tHEC, and eHEC errors. Possible rate units are **Frames** (default), **Bytes**, or **Payload Bytes** per second.
- **Client Management** indicates the transmitted/received client management frames without uncorrectable cHEC, tHEC, and eHEC, and pFCS errors. Possible rate units are **Frames** (default), or **Bytes** per second.
- **Idle** indicates the transmitted/received idle frames. Possible rate units are **Frames** (default), or **Bytes** per second.

- **Reserved PTI** indicates the received client data and management frames with a payload type identifier different of 000 and 100 without uncorrectable cHEC, tHEC, and eHEC, and pFCS errors. Possible rate units are **Frames** (default), or **Bytes** per second.
- **Reserved PLI** indicates the number of reserved control frames (PLI=1, 2, or 3 while in Synchronization state) received.
- **Invalid** indicates the number of received frames corresponding to at least one of the following conditions:
  - EXI=0000 while PFI=1 and PLI <8
  - EXI=0001 while PFI=0 and PLI <8
  - EXI=0001 while PFI=1 and PLI<12
- **Discarded** indicates the number of received frames with uncorrectable tHEC, eHEC errors, or Invalid Frames.
- **Total** indicates the received frames including Idle, Client Data, Client Management, and frames with a reserved PTI. Possible rate units are **Frames** (default), or **Bytes** per second.

## RX Mismatch

- **PFI** (Payload Frame Check Sequence Identifier) indicates the number of frames with PFI field not matching the expected PFI.
- **EXI** (Extension Header Identifier) indicates the number of frames with EXI field not matching the expected EXI.
- **UPI** (User Payload Identifier) indicates the number of frames UPI field not matching the expected UPI.
- **CID** (Channel Identifier), only available when EXI is set to **Linear**, indicates the number of frames CID field not matching the expected CID.

**Note:** For expected values, refer to GFP-F/GFP-T on page 288 for more information.

## Test Results

GFP-F/GFP-T

---

### Superblock

**Note:** *Superblock is only available with GFP-T.*

- **Valid** indicates the transmitted/received superblocks without any uncorrectable error.
- **Invalid** indicates the transmitted/received superblocks with uncorrectable error.
- **Total** indicates the total transmitted/received valid and invalid superblocks.



## Graph - RFC 2544

Displays the graph showing the **Throughput**, **Back-to-Back**, **Frame Loss**, and **Latency** measurements. For **Dual Test Set** the graph shows results from **Local to Remote** and **Remote to Local** using distinctive colors. For **Dual Port** topology the graph shows results of both port directions.

From the **Test** menu, tap **Results**, and the **Graphs** tab.

- **All** button allows viewing the graphs of all subtests simultaneously.
- **Throughput**, **Back-to-Back**, **Frame Loss**, and **Latency** buttons allow viewing an enlarged graph view of the selected subtest.
- **Displayed Results** allows selecting the displayed results mode, either **Minimum**, **Maximum** (default), **Average**, or **Current**.
- **Step**, available with Frame Loss, allows selecting the result step (100 percent by default) to be displayed.

The X axis shows the frame sizes while the Y axis shows the subtest results.

- **Frame Size (Bytes)** and **Step (%)**, available with Frame Loss, allows selecting either **Frame Size** (default) or **Step** as the X axis criterion.

## Labels

From the test menu, tap **Results**, and **Labels**.

### Labels

**Note:** *Check boxes are coupled with settings from Labels on page 306.*

- **STS Path (C2) / AU Path (C2):** The C2 byte is allocated to indicate the content of the STS SPE / VC, including the status of the mapped payloads.

**Received** displays the received C2 byte (refer to C2 on page 696).

- **PLM-P/UNEQ-P / HP-PLM/HP-UNEQ** check box when selected (cleared by default) enables the Payload Mismatch and STS/AU UNEQ monitoring.

**Expected** allows the selection of the expected C2 byte value (refer to C2 on page 696).

- **VT Path (V5) / TU Path (V5):** The V5 byte is allocated to indicate the content of the VT/TU path, including the status of the mapped payloads.

**Received** displays the received V5 byte (refer to V5 on page 699).

- **PLM-V/UNEQ-V / LP-PLM/LP-UNEQ** check box when selected (cleared by default) enables the Payload Mismatch and VT/TU UNEQ monitoring.

**Expected** allows the selection of the expected V5 byte value (refer to V5 on page 699).

## Link OAM

From the **Test** menu, tap **Results**, and the **Link OAM** tab.

### Remote MAC Address

Indicates the remote OAM link partner MAC address.

### Remote OAM Information

- **OAM Version** indicates the protocol version supported by the DTE.
- **Revision** indicates the revision of the Information TLV.
- **Multiplexer Action** reports the Multiplexer Action:
  - Forward** indicates that the device is forwarding non-OAMPDUs to the lower sublayer.
  - Discard** indicates that the device is discarding non-OAMPDUs.
- **Parser Action** reports the Parser Action:
  - Forward** indicates that the device is forwarding non-OAMPDUs to the higher sublayer.
  - Loopback** indicates that the device is looping back non-OAMPDUs to the lower sublayer.
  - Discard** indicates that the device is discarding non-OAMPDUs.
- **OAM Mode** reports the OAM mode:
  - Active** indicates that the DTE is configured in **Active** mode.
  - Passive** indicates that the DTE is configured in **Passive** mode.
- **OUI** reports the 24-bit IEEE Organizationally Unique Identifier field identifying the vendor.
- **Maximum OAMPDU Size** reports the maximum OAMPDU size in bytes, supported by the DTE.

## Test Results

### Link OAM

---

- **Vendor Specific Information** reports the 32-bit **Vendor Specific Information** field identifying the vendor's product model and version.
- **Unidirectional** reports unidirectional support capability:
  - Supported** indicates that the DTE is capable of sending OAMPDUs when the receive path is non-operational.
  - Unsupported** indicates that the DTE is not capable of sending OAMPDUs when the receive path is non-operational.
- **Remote Loopback** reports OAM remote loopback support capability:
  - Supported** indicates that the DTE is capable of OAM remote loopback mode.
  - Unsupported** indicates that the DTE is not capable of OAM remote loopback mode.
- **Variable Retrieval** reports variable retrieval capability:
  - Supported** indicates that the DTE supports sending Variable Response OAMPDUs.
  - Unsupported** indicates that the DTE does not support sending Variable Response OAMPDUs.
- **Link Events** reports link event capability:
  - Supported** indicates that the DTE supports interpreting Link Events.
  - Unsupported** indicates that the DTE does not support interpreting Link Events.

## Remote Error Event Statistics

- **Date Stamp**<sup>1</sup> indicates the date the last Event Notification OAMPDU frame was received.
- **Time Stamp**<sup>1</sup> indicates the time the last Event Notification OAMPDU event was received by the test equipment.
- **Window**

<b>Symbol Period</b>	Errored symbol Window in second
<b>Frame</b>	Errored frame event Window in second
<b>Frame Period</b>	Errored frame period Window - duration period in number of 64 bytes frames
<b>Frame Seconds</b>	Errored frame seconds summary Window

- **Threshold**

<b>Symbol Period</b>	Errored symbol threshold in second
<b>Frame</b>	Errored frame event threshold in second
<b>Frame Period</b>	Errored frame period threshold in second
<b>Frame Seconds</b>	Errored frame seconds summary threshold in second

- **Error Count**

<b>Symbol Period</b>	The number of symbol errors in Window
<b>Frame</b>	The number of frame event errors in Window
<b>Frame Period</b>	The number of frame period errors in Window
<b>Frame Seconds</b>	The number of frame seconds summary errors in Window

1. **Date Stamp** and **Time Stamp** parameters differ from the 802.3 standard definitions.

## Test Results

### Link OAM

---

#### ➤ Error Running Total

Symbol Period	The number of symbol errors since the last reset
Frame	The number of frame event errors since the last reset
Frame Period	The number of frame period errors since the last reset
Frame Seconds	The number of frame seconds summary errors since the last reset

#### ➤ Event Running Total

Symbol Period	The number of symbol events since the last reset
Frame	The number of frame events since the last reset
Frame Period	The number of frame period events since the last reset
Frame Seconds	The number of frame seconds events since the last reset

## Inject Errored Frames

Generates 5 consecutive packets with FCS errors within a 1 second period.

## Logger

The Logger page displays color-coded events and pass/fail verdict.

From the **Test** menu, tap **Results**, and the **Logger** tab.

**Note:** *For RFC 6349 the Logger is only available with operation modes **Dual Test Set** (local unit).*

## Sort By

Select the sorting order of the event logger entries:

- **ID** (default) displays the event logger entries in numeric ascending order based on the **ID** column of the event logger table.
- **Event** displays the event Logger entries in alphanumeric ascending order based on the **Event** column of the event logger table.

## Time Mode

- **Relative** displays the time/duration fields based on the time elapse since the beginning of the test or since the last test reset. The format of the time is Dd HH:MM:SS.
- **Absolute** (default) displays the time/duration fields based on the date and time the event occurred/ended. The time format depends on the platform time settings.

For 24 hours, the time format is MM/DD HH:MM:SS.

For 12 hours, the time format is MM/DD HH:MM:SS <AM or PM>.

## Test Results

### Logger

---

### Closure Format

- **Duration** (default): Indicates the number of seconds within which the event occurred. Test events like **Test Started** and **Test Stopped** will have no duration.
- **End Time**: Indicates at what time the event has been completed or cleared.

### Save to CSV

Allows saving the logger content to a CSV file format.

### Table

The logger table provides the following event logger information.

- **ID**: Indicates the event identification number. The events are sequentially numbered.
- **Start Time**: Indicates when the event has been started or detected.
- **Event**: Provides the event type and threshold crossing information.
- **Duration or End Time**, depending on the **Closure Format** selected, indicates either the duration or at what time the event has been completed or cleared.
- **Details**: Provides contextual information including the pass/fail verdict.

The following table displays the nature of information reported by type of event:

Type of Event	Nature of Information
Test Started	Start Date
Test Stopped	Pass/Fail Verdict
Alarm Events	Count value
Error Events	Current Count and Total Count



Type of Event	Nature of Information
SDT Events	Service Disruption Time
Threshold Crossing Event	Value at the end of the test

**Note:** *The Logger table can display up to 5000 event entries. Once the Logger table reports 5000 event entries, a log full indicator appears and no further entries are possible. However, the events in the Pending state will be updated if the test is still running.*

The Event Logger information will be cleared when:

- the test is reset or started.
- stopping the current test and.
- the unit is restarted.

**Note:** *An entry event remains in the Pending state as long as the event is not completed and it is highlighted on a yellow background color.*

**Note:** *The Threshold Crossing events are displayed in red text color.*

# Measurements - DCO BERT

From the test menu, tap **Results** and the **Measurements** tab.

## RX Power

- **RX Power (dBm)** indicates the received optical power level of the transceiver. The **Current**, **Minimum**, and **Maximum** values are displayed. The **Current** field displays **LOS** when no optical power is received.

Green: Power level in range.

Yellow: Power level out-of-range.

Red: Loss of signal or power level is close to damage.

Gray: Invalid operational range value or not available/supplied by the transceiver.

- **Power Range (dBm)** indicates the transceiver operational RX power range.

## Optical Metrics

When supported by the DCO transceiver, the **Current**, **Average**, **Minimum**, and **Maximum** optical metrics values are reported by the transceiver. The displayed **Average**, **Minimum**, and **Maximum** values are computed since the beginning of the test.

- **CD (ps/nm)**, the Chromatic Dispersion, indicates the difference in propagation time between the different wavelengths.
- **CFO (MHz)**, the Carrier Frequency Offset, indicates the frequency offset between the carrier and the local oscillator.
- **DGD (ps)**, the Differential Group Delay, indicates the difference in propagation time between two polarizations.
- **OSNR (dB)**, the Optical Signal to Noise Ratio, indicates the ratio of service signal power to noise power within a valid bandwidth. It quantifies the degree of noise interference on the optical signal.

- **PDL (dB)**, the Polarization Dependent Loss, indicates the difference between the maximum and minimum values of the channel insertion loss or gain of the link due to a variation of the State of Polarization over all polarizations states.
- **SOPCR (krad/s)**, the State of Polarization Change Rate, indicates the rate of rotation of the two polarizations of the optical signal at the receiver.
- **SOPMD (ps<sup>2</sup>)**, the Second Order Polarization Mode Dispersion, indicates the derivative of the polarization dispersion vector with respect to the optical frequency.

## Client RX Frequency

**Note:** *The following frequency statistics are available for each lane.*

- **Frequency (GHz)** indicates the received Ethernet client frequency (symbol rate).
- **Offset (ppm)** indicates the frequency offset between the nominal and the received Ethernet client frequencies.

**Note:** *For both **Frequency** and **Offset** the following background colors are used.*

Background color	Description
Green	The frequency is in range.
Red	The frequency is out-of-range or LOC Lane.
Gray	Pending state.

## Test Results

### *Measurements - DCO BERT*

---

- **Max. Negative Offset (ppm)** indicates the maximum negative frequency offset between the nominal and the received Ethernet client frequencies.
- **Max. Positive Offset (ppm)** indicates the maximum positive frequency offset between the nominal and the received Ethernet client frequencies.

**Note:** *Refer to Interface on page 911 for more information on nominal frequencies.*

## Messages

From the **Test** menu, tap **Results**, and the **Messages** tab.

**Note:** For *Dual Port* topology select the port to be displayed.

### Message Type

For OBSAI: The count of each OBSAI message type is reported.

Message Type	TX Count	RX Count
Control	-	X
Measurement	-	X
WCDMA/FDD	X	X
WCDMA/TDD	-	X
GSM/EDGE	X	X
TETRA	-	X
CDMA2000	-	X
WLAN	-	X
Loopback	-	X
Frame Clock Burst	X (BTS only)	X (RRH only)
Ethernet	-	X
RTT Message	X	X
802.16	X	X
Virtual HW Reset	-	X
LTE	X	X
Generic Packet	-	X
Multi-hop RTT Message	-	X
Others	-	X

## Test Results

### Messages

---

For eCPRI: The count of each eCPRI message type is reported.

Message Type	TX Count	RX Count	Loss Count	OOS Count
<b>IQ Data</b>	X	X	X	X
<b>Bit Sequence</b>	X	X	X	X
<b>Real-Time Control Data</b>	X	X	X	X
<b>Generic Data Transfer</b>	X	X	X	X
<b>Remote Memory Access</b>	-	X	-	-
<b>One-Way Delay Measurement</b>	X	X	-	-
<b>Remote Reset</b>	-	X	-	-
<b>Event Indication</b>	-	X	-	-
<b>Reserved</b>	-	X	-	-
<b>Vendor Specific</b>	-	X	-	-
<b>Total</b>	X	X	X	X

## RX Frame Clock Burst Details

When a valid Frame Clock Burst (FCB) message is received, its **SFN** and **c1** values are reported. Only available with OBSAI.

- **SFN** (System Frame Number): The master frame number received with an FCB message.
- **c1**: Arrival time of the FCB message Reference Point 1 (RP1) versus master frame start.

## MPLS

For **Traffic Gen and Mon**, from the test menu, tap **Results, Streams**, and the **MPLS** tab.

For **Through Mode**, from the test menu, tap **Results, Traffic**, and the **MPLS** tab.

**Note:** For *Dual Port* topology select the port to be displayed.

### Label 1 and Label 2

The number of MPLS frames transmitted (TX) and received (RX) are displayed for both **Label 1** and **Label 2** for each **Stream**. Not available for **Through Mode** test application.

### Total TX/RX MPLS

- **Line Utilization** indicates the percentage of MPLS line rate utilization in TX and RX.
- **Ethernet BW (%)** (Ethernet Bandwidth) indicates the MPLS data rate in TX and RX.
- **Frame Rate (frames/s)** indicates the number of transmitted (TX) and received (RX) MPLS frames.
- **Frame Count** indicates the count of transmitted (TX) and received (RX) MPLS EtherType (0x8847 or 0x8848) frames regardless if FCS is good or not.

## OTL-SDT

**Note:** Only available for parallel interfaces when an OTL defect, at the exception of LOL, is selected for Service Disruption Time (refer to Service Disruption on page 212).

From the test menu, tap **Results**, and the **OTL-SDT** tab.

## Service Disruption

**Note:** Service Disruption results are only available when **Disruption Monitoring** is enabled (refer to BERT and Unframed BERT on page 209).

Service Disruption is the time during which there is a disruption of service due to the absence of traffic or to the detection of defects per lane.

### Disruption Time

- **Defect** indicates on which layer and defect the service disruption time test is performed.
- **Lane** indicates the lane number.
- **Longest (ms)** indicates the longest measured disruption time per lane.
- **Shortest (ms)** indicates the shortest measured disruption time per lane.
- **Last (ms)** indicates the length of the last measured disruption time per lane.
- **Average (ms)** indicates the average duration of all measured disruption times per lane.
- **Total (ms)** indicates the total duration of all measured disruption times per lane.
- **Count** indicates the number of disruption events detected since the beginning of the SDT test per lane.



- **Longest Disruption** indicates the longest measured disruption time.
- **Lanes with Disruption** indicates the number of lanes with service disruption.

**Note:** *When a disruption event is equal to or longer than the test period which is fixed to 5 minutes, then the measured disruption time is equal to the test period.*

## Test Results

### Performance Monitoring

---

## Performance Monitoring

**Note:** This tab is only available with Transport test applications with Pattern client. Monitored performance parameters are reported, non-monitored values are left blank.

The Performance Monitoring tab gives error performance events and parameters for the circuit under test.

From the **Test** menu, tap **Results**, and the **Performance Monitoring** tab.

Each button on top of the window represents a level of the analyzed signal for which the Performance Monitoring (PM) is available. Each button also displays the PM standard(s) available for this level. Tap a signal level button to get its PM results.

Analyzed Signal	Standard's availability						
	G.821	G.826 ISM	G.828 ISM	G.829 ISM	M.2100 ISM	M.2100 OOSM	M.2101 ISM
DS3/DS1/E4/E3/E2/E1		X			X		
Section/RS				X			
Line/MS				X			X
VTn/STS-n/AU-n/ TU-n			X				X
BERT	X					X	

**Note:** G.821 and M.2100 OOSM are only available when **No Pattern Analysis (Live)** check box is cleared.

## Near-End

- **EFS** (Error Free Second) (**G.821**, **G.826**, **G.828**, and **G.829**): Gives the number of seconds within which no error occurred.
- **EC** (Error Count) (**G.821** only): Gives the number of bit errors.
- **EB** (Errored Block) (**G.826**, **G.828**, and **G.829**): Gives the count of blocks in which one or more bits are in error.
- **ES** (Errored Second)

For **G.821**, and **M.2100 OOSM**: Gives the number of seconds within which one or more bit error occurred, or during which Loss Of Signal (LOS) or AIS is detected.

For **G.826**, **G.828**, **G.829**, **M.2100 ISM**, and **M.2101**: Gives the number of seconds within which one or more anomalies (FAS (DSn/PDH), EB, etc.) occurred, or at least one defect occurred.

- **SES** (Severely Errored Second)

For **G.821**, and **M.2100 OOSM**: Gives the number of seconds within which a bit error ratio is  $\geq 10^{-3}$ , or during which one defect (LOS/AIS) is detected.

For **G.826**, **G.828**, **G.829** and **M.2101**: Gives the number of seconds within which anomalies (FAS (DSn/PDH), EB, etc.) are  $\geq X$  percent or at least one defect occurred. X=30 percent for DSn/PDH signals; see the following table for SONET/SDH signals SES threshold.

	<b>OC-1 STS-1e STM-0 STM-0e</b>	<b>OC-3 STS-3e STM-1 STM-1e</b>	<b>OC-12 STM-4</b>	<b>OC-48 STM-16</b>	<b>OC-192 STM-64</b>	<b>OC-768 STM-256</b>
Path	30 %	30 %	30 %	30 %	30 %	30 %
Line/MS	15 %	15 %	25 %	30 %	30 %	30 %
Section/RS	10 %	30 %	30 %	30 %	30 %	30 %

## Test Results

### Performance Monitoring

---

For **M.2100 ISM**: Gives the count of the seconds within which anomalies (frame bit errors, CRC block errors, etc.) are  $\geq Y$  or at least one defect occurred. Y depends on the type of DSn/PDH signal as described in the following table.

Signal	SES Threshold
DS1 (SF)	8 frame bit errors (Near-End)
DS1 (ESF)	320 CRC-6 block errors (Near-End) 320 CRC-6 block errors (Far-End, if FDL enabled)
E1 (Framed without CRC-4)	28 frame bit errors (Near-End)
E1 (Framed with CRC-4)	805 CRC-4 block errors (Near-End) 805 E-bit errors (Far-End)
DS3 (M13)	2444 P-bit errors (Near-End) or 5 F-bit errors (Near-End)
DS3 (C-bit Parity)	2444 P-bit errors (Near-End) or 5 F-bit errors (Near-End) 2444 FEBE errors (Far-End)
E2 (Framed)	41 frame bit errors (Near-End)
E3 (Framed)	52 frame bit errors (Near-End)
E4 (Framed)	69 frame bit errors (Near-End)

- **BBE (Background Block Error) (G.826, G.828, G.829, and M.2101)**: Gives the count of Errored Block not occurring as part of a SES.

- **UAS (Unavailable Second):** Gives the count of the seconds corresponding to the periods of unavailable time that begins at the onset of 10 consecutive SES events, including these 10 seconds. A period of available time shall begin at the onset of 10 consecutive non-SES events, including these 10 seconds.

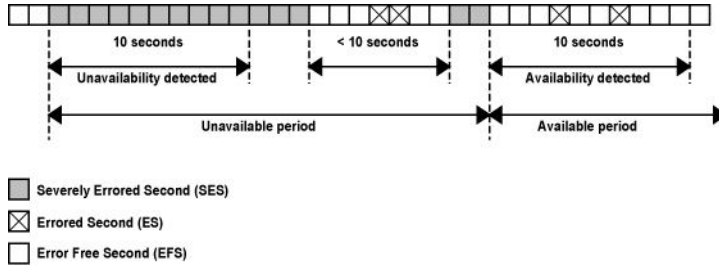

- **ESR (Errored Second Ratio) (G.821, G.826, G.828, and G.829):** Gives the ratio of the number of ES in available time (AS) during a fixed measurement interval.

$$ESR = ES \div AS$$

- **SESR (Severely Errored Second Ratio) (G.821, G.826, G.828, and G.829):** Gives the ratio of the number of SES in available time (AS) during a fixed measurement interval.

$$SESR = SES \div AS$$

- **BBER (Background Block Error Ratio) (G.826, G.828, G.829, and M.2101):** Gives the ratio of BBE in available time (AS) to total blocks in available time during a fixed measurement interval. The count of total blocks excludes all blocks during SESs.

- **DM (Degraded Minutes) (G.821 only):** A Degraded Minute is the number of minutes in which the estimated error rate exceeds  $10^{-6}$  but does not exceed  $10^{-3}$ . DM is determined by collecting all of the Available Seconds, removing any SES grouping the result in 60-second long groups and counting a 60-second long group as degraded if the cumulative errors during the seconds present in the group exceed  $10^{-6}$ .

## Test Results

### Performance Monitoring

---

- **SEP** (Severely Errored Period) (**G.828** only): A sequence between 3 to 9 consecutive SES. The sequence is terminated by a second which is not a SES.
- **SEPI** (Severely Errored Period Intensity) (**G.828** only): Gives the count of SEP events in available time, divided by the total available time in seconds.

## Far-End

- **EFS** (Error Free Second): Gives the count of the seconds within which no error occurred or when a defect is detected on the near-end.
- **EC** (Error Count) (**G.821** only): Gives the number of bit errors.
- **EB** (Errored Block) (**G.826**, **G.828**, and **G.829**): Gives the count of blocks in which one or more bits are in error.
- **ES** (Errored Second): For **G.826**, **G.828**, **G.829**, **M.2100 ISM**, and **M.2101**: Gives the count of the seconds within which one or more anomalies (FAS (DSn/PDH), EB, etc.) occurred or at least one defect occurred.
- **SES** (Severely Errored Second)

**For G.826, G.828, G.829 and M.2101:** Gives the number of seconds within which anomalies (FAS (DSn/PDH), EB, etc.) are  $\geq X$  percent or at least one defect occurred.  $X=30$  percent for DSn/PDH signals; see the following table for SONET/SDH signals SES threshold.

	<b>OC-1 STS-1e STM-0 STM-0e</b>	<b>OC-3 STS-3e STM-1 STM-1e</b>	<b>OC-12 STM-4</b>	<b>OC-48 STM-16</b>	<b>OC-192 STM-64</b>	<b>OC-768 STM-256</b>
Path	30 %	30 %	30 %	30 %	30 %	30 %
Line/MS	15 %	15 %	25 %	30 %	30 %	30 %
Section/RS	10 %	30 %	30 %	30 %	30 %	30 %

For M.2100 ISM: Gives the count of the seconds within which anomalies (frame bit errors, CRC block errors, etc.) are  $\geq Y$  or at least one defect occurred. Y depends on the type of DS<sub>n</sub>/PDH signal as described in the following table.

<b>Signal</b>	<b>SES Threshold</b>
DS1 (SF)	8 frame bit errors (Near-End)
DS1 (ESF)	320 CRC-6 block errors (Near-End) 320 CRC-6 block errors (Far-End, if FDL enabled)
E1 (Framed without CRC-4)	28 frame bit errors (Near-End)
E1 (Framed with CRC-4)	805 CRC-4 block errors (Near-End) 805 E-bit errors (Far-End)
DS3 (M13)	2444 P-bit errors (Near-End) or 5 F-bit errors (Near-End)
DS3 (C-bit Parity)	2444 P-bit errors (Near-End) or 5 F-bit errors (Near-End) 2444 FEBE errors (Far-End)
E2 (Framed)	41 frame bit errors (Near-End)
E3 (Framed)	52 frame bit errors (Near-End)
E4 (Framed)	69 frame bit errors (Near-End)

- **BBE** (Background Block Error) (G.828 and G.829 Line): Gives the count of Errored Blocks not occurring as part of an SES.

## Test Results

### Performance Monitoring

---

- **UAS (Unavailable Second):** Gives the count of the seconds corresponding to the period of unavailable time that begins at the onset of 10 consecutive SES events, including these 10 seconds. A period of available time shall begin at the onset of 10 consecutive non-SES events, including these 10 seconds.

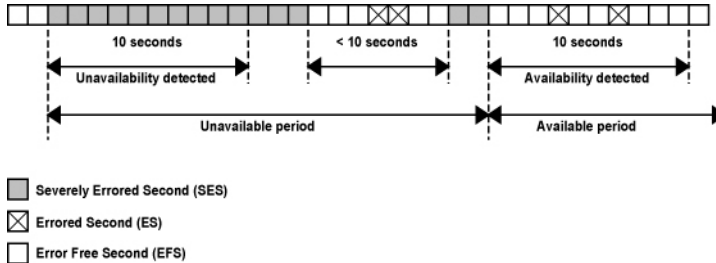

- **ESR (Errored Second Ratio):** Gives the ratio of the number of ES in available time to total seconds in available time during a fixed measurement interval.

$$\text{ESR} = \text{ES} \div \text{AS}$$

- **SESR (Severely Errored Second Ratio):** Gives the ratio of the number of SES in available time to total seconds in available time during a fixed measurement interval.

$$\text{SESR} = \text{SES} \div \text{AS}$$

- **BBER (Background Block Error Ratio):** Gives the ratio of BBE in available time to total blocks in available time during a fixed measurement interval. The count of total blocks excludes all blocks during SESs.



## PTP Stats

From the test menu, tap **Results**, and the **PTP Stats** tab.

### PDV

**Note:** Available for Time Error measurement with 8275.1/8275.2 profile.

**PDV** indicates the difference between the delay of a packet (difference between timestamp at receiving end and the original timestamp at the transmitter) and the minimum packet delay value for the specified interval. **Current, Average, Minimum, Maximum, and Standard Deviation** measurement values are displayed for both directions: **Forward (BC -> Client)** for **Sync** messages and **Reverse (Client -> BC)** for **Delay Req** messages. The **Standard Deviation** is the measure of the dispersion of messages from its mean. The pass/fail verdict is also displayed beside the maximum value when enabled.

### Round-Trip Delay

**Note:** Available for Time Error measurement with 8275.1/8275.2 profile.

**Delay** (ns) indicates the time required for a bit to travel from the transmitter back to its receiver. **Current, Average, Minimum, and Maximum** values are displayed.

### Count/Rate / Message Count/Rate

Gives the transmitted/received count and average rate for each PTP message, and the total count for all messages.

## Test Results

### PTP Stats

---

#### PTP Message:

TX	RX
Signaling Announce Req <sup>a</sup>	Signaling Announce Grant <sup>a</sup>
Signaling Sync Req <sup>a</sup>	Signaling Sync Grant <sup>a</sup>
Signaling Delay Resp Req <sup>a</sup>	Signaling Delay Resp Grant <sup>a</sup>
Delay Req	Delay Resp
	Sync
	Follow Up
	Announce

- a. The rate value corresponds to an average rate because these messages are only transmitted/received when negotiating or renewing the lease with the Grand Master clock. If the connection with the Grand Master Clock was already established when the test is started, the 0 value is displayed. However, the value becomes available with the next lease renewal which happens every 150 seconds. Available with G.8265.1 and G.8275.2 profiles.

**Note:** *In the case where messages are lost while the Receipt Timeout is set to a large value (slow communication), the last valid recorded rate value will be preceded with < to indicate that the reception rate is not stable. This applies to **Delay Resp**, **Announce**, **Sync**, and **Follow Up**.*

**Note:** *When the rate is above 150 messages/s, > 150 is displayed.*

## IPDV

**Note:** *Available with 1588 PTP test application.*

**IPDV** (Inter Packet Delay Variation) is available for **Sync** and **Delay Req** messages and is measured for all valid in-sequence messages (see *Delay Measurement* on page 526). **Current**, **Average**, **Minimum**, **Maximum**, and **Standard Deviation** measurement values are displayed. The **Standard Deviation** is the measure of the dispersion of messages from its mean. When a value is below 1 $\mu$  second, < 1 $\mu$ s is displayed. The pass/fail verdict is also displayed beside the maximum value when enabled.

## Quality Level - 1588 PTP

The quality level characterizes the clock quality in terms of network synchronization.

From the test menu, tap **Results**, and the **Quality Level** tab.

- **Last QL Received** indicates the last Quality Level value received. The pass/fail verdict is also displayed when both **QL Mismatch Monitoring** and **Pass/Fail Verdict** check boxes are selected.
- **Last Change** indicates the date and time of the **Last QL Received** has changed.
- **QL Mismatch Monitoring** when selected (default) enables the quality level mismatch monitoring.

## Test Results

Quality Level - 1588 PTP

- **Expected QL** allows the selection of the expected quality level value. Available when the **QL Mismatch Monitoring** check box is selected.

Profile ITU	Quality Level value	PTP Clock Class	Description
G.8265.1	QL-PRS	80	Primary Reference Source Traceable (G.811)
	QL-STU/UNK	82	Synchronized - Traceability Unknown
	QL-PRC (default)	84	Primary Reference Clock Traceable (G.811)
	QL-ST2	86	Traceable to Stratum 2 (G.812 Type II)
	QL-INV3	88	Quality Level Invalid 3
	QL-SSU-A/TNC	90	Type I or V slave clock (G.812) Traceable to Transit Node Clock (G.812 Type V)
	QL-INV5	92	Quality Level Invalid 5
	QL-INV6	94	Quality Level Invalid 6
	QL-SSU-B	96	Type VI slave clock (G.812)
	QL-INV9	98	Quality Level Invalid 9
	QL-ST3E	100	Traceable to Stratum 3E (G.812 Type III)
	QL-EEC2/ST3	102	Ethernet Equipment Clock Option 2 Traceable to Stratum 3 (G.812 Type IV)
	QL-EEC1/SEC	104	Ethernet Equipment Clock Option 1 Synchronous Equipment Clock (G.813 or G.8262, Option 1)
	QL-SMC	106	Traceable to SONET Minimum Clock (G.813 or G.8262, Option 2)
	QL-PROV	108	Provisionable by the Network Operator (PNO)
G.8275.1	QL-PRC/PRS (default)	6, 7, 135, 140	Primary Reference Clock Traceable (G.811)
	QL-SSU-A/ST2	150	Type I or V slave clock (G.812) Traceable to Stratum 2 (G.812 Type II)
	QL-SSU-B/ST3E	160	Type VI slave clock (G.812) Traceable to Stratum 3E (G.812 Type III)

<b>Profile ITU</b>	<b>Quality Level value</b>	<b>PTP Clock Class</b>	<b>Description</b>
G.8275.2	QL-PRC/PRS (default)	6, 7, 135, 140	Primary Reference Clock Traceable (G.811)
	QL-SSU-A/ST2	150	Type I or V slave clock (G.812) Traceable to Stratum 2 (G.812 Type II)
	QL-SSU-B/ST3E	160	Type VI slave clock (G.812) Traceable to Stratum 3E (G.812 Type III)
	QL-SEC/EEC1/ST3/EEC2	165, 248, 255	Synchronous equipment clock (G.813 Option I) Ethernet equipment clock (G.8262 Option I) Traceable to Stratum 3E (G.812 Type IV or G.8262 Option II) Ethernet equipment clock (G.8262 Option II)

### **QL / PTP Clock Class / Count**

- **Count** gives the count for each QL code (PTP Clock Class) included in the announce message received.

**Other** includes all clock class codes (0 to 255) included in the announce message received other than the QL codes (see table above).

- **Total** indicates the total count of all QL code messages received.

# Quality Level - SyncE

The quality level characterizes the clock quality in terms of network synchronization.

From the test menu, tap **Results**, and the **Quality Level** tab.

- **Generated QL** indicates the Quality Level value that is generated.
  - Last Change** indicates the date and time of the Generated Quality Level value has changed. For 1GE Electrical interface using **Local Clock** set to **Slave**, the **Last Change** is not available.
- **Last QL Received** indicates the last Quality Level value received. The pass/fail verdict is also displayed when both **QL Mismatch Monitoring** and **Pass/Fail Verdict** check boxes are selected.
  - Last Change** indicates the date and time of the **Last QL Received** has changed.
- **QL Mismatch Monitoring** when selected (default) enables the quality level mismatch monitoring.

- **Expected QL** allows the selection of the expected quality level value. Available when the **QL Mismatch Monitoring** check box is selected.

Quality Level value	SSM	Description
QL-STU/UNK	0	Synchronized - Traceability Unknown
QL-PRS	1	Primary Reference Source Traceable (G.811)
QL-PRC	2	Primary Reference Clock Traceable (G.811)
QL-INV3	3	Quality Level Invalid 3
QL-SSU-A/TNC	4	Type I or V slave clock (G.812) Traceable to Transit Node Clock (G.812 Type V)
QL-INV5	5	Quality Level Invalid 5
QL-INV6	6	Quality Level Invalid 6
QL-ST2	7	Traceable to Stratum 2 (G.812 Type II)
QL-SSU-B	8	Type VI slave clock (G.812)
QL-INV9	9	Quality Level Invalid 9
QL-EEC2/ST3 (default)	10	Ethernet Equipment Clock Option 2 Traceable to Stratum 3 (G.812 Type IV)
QL-EEC1/SEC	11	Ethernet Equipment Clock Option 1 Synchronous Equipment Clock (G.813 or G.8262, Option 1)
QL-SMC	12	Traceable to SONET Minimum Clock (G.813 or G.8262, Option 2)
QL-ST3E	13	Traceable to Stratum 3E (G.812 Type III)
QL-PROV	14	Provisionable by the Network Operator (PNO)
QL-DNU/DUS	15	Do Not Use Do Not Use for Synchronization

- **QL Mismatch Frame Count** gives the total count of information and/or event frames received not matching the **Expected QL**. Only available when the **QL Mismatch Monitoring** check box is selected.

## Test Results

Quality Level - SyncE

---

### QL

#### TX

- **Information** gives the count of information frames generated for each **QL** as well as the total of all **QL** values. For 1GE Electrical interface using **Slave** as **Master-Slave Clock**, only the count for **QL-DNU/DUS** is reported.
- **Event** gives the count of event frames generated for each **QL** as well as the total of all **QL** values. Not available with 1GE Electrical using **Slave** as **Master-Slave Clock**.

#### RX

- **Information** gives the count of information frames received for each **QL** as well as the total of all **QL** values.
- **Event** gives the count of event frames received for each **QL** as well as the total of all **QL** values.



## S-OAM and MPLS-TP OAM

From the **Test** menu, tap **Results**, and the **S-OAM** or **MPLS-TP OAM** tab.

### Loopback

- **Status** displays the status of the test function (refer to page 589).
- **TX LBM** indicates the count of transmitted LBM frames.
- **RX LBR** indicates the count of valid LBR frames received. A valid frame for S-OAM has its source MAC address matching the Peer MEP MAC address, destination MAC address matching the unit port MAC address, and VLANs matching the unit port VLANs. A valid frame for MPLS-TP OAM has its destination MAC address matching either the unit MAC address, FF:FF:FF:FF:FF:FF, or 01:00:5E:90:00:00; VLANs matching the unit port VLANs; and MPLS Labels matching the local MPLS Label Stack configuration.
- **LBR Timeout**

For connectivity verification (Continuous check box cleared), indicates the count of LBR Timeout event which occurs if a reply (LBR frame with matching Transaction ID) to a transmitted LBM frame is not received within 5 seconds.

For diagnostic test (Continuous check box selected), indicates the difference between the transmitted LBM frames and the received LBR frames.
- **Invalid LBR**

For connectivity verification (Continuous check box cleared), indicates the count of LBR frames received from the peer MEP with incorrect MEG/MD Level or with an unexpected Transaction ID.

For diagnostic test (Continuous check box is selected), indicates the count of LBR frames received from the peer MEP with incorrect MEG/MD Level.

## Test Results

### *S-OAM and MPLS-TP OAM*

---

- **Invalid Payload** indicates the count of received LBR frames having either a TLV type different than the one transmitted, Bit error or wrong data value detected in the data payload of a Data TLV, Bit error, Pattern Loss, or Pattern Type mismatch of a Test TLV.
- **Successful** indicates the count of received LBR frames having no errors.
- **Failed** indicates the count of LBR frames declared as invalid.

## Test

- **Status** displays the status of the test function (refer to page 589).
- **TX TST** indicates the count of transmitted TST frames.
- **RX TST** indicates the count of valid TST frames received. A valid frame for S-OAM has its source MAC address matching the Peer MEP MAC address; destination MAC address matching either the unit port Unicast MAC address or a Multicast class 1 address<sup>1</sup>; and VLANs matching the unit port VLANs. A valid frame for MPLS-TP OAM has its destination MAC address matching either the unit MAC address, FF:FF:FF:FF:FF:FF, or 01:00:5E:90:00:00; VLANs matching the unit port VLANs; and MPLS Labels matching the local MPLS Label Stack configuration.
- **Invalid TST** indicates the count of TST frames received from the peer MEP with incorrect MEG/MD level.
- **Invalid Payload** indicates the count of received TST frames having either an unsupported pattern type, or bit error / pattern loss detected in the payload.
- **Successful** indicates the count of received TST frames having no errors.
- **Failed** indicates the count of TST frames declared as invalid.

---

1. Refer to *Unicast/Multicast Addresses for Ethernet OAM* on page 867 for more information.

## Frame Delay

- **Status** displays the status of the test function (refer to page 589).
- **TX DMM** indicates the count of transmitted DMM frames.
- **RX DMR** indicates the count of valid DMR frames received. A valid frame for S-OAM has its source MAC address matching the Peer MEP MAC address; destination MAC address matching the unit port MAC address; and VLANs matching the unit port VLANs. A valid frame for MPLS-TP OAM has its destination MAC address matching either the unit MAC address, FF:FF:FF:FF:FF:FF, or 01:00:5E:90:00:00; VLANs matching the unit port VLANs; and MPLS Labels matching the local MPLS Label Stack configuration..
- **Invalid DMR** indicates the count of received DMR frames from the peer MEP having an incorrect MEG/MD Level, an incorrect Test ID (when applicable), or with a valid MEG/MD Level and valid Test ID (when applicable) but with a Frame Delay outside the 0.001 to 8000.000 ms range.
- **Delay (ms): Current** indicates the average of frame delay measured in the last second. **Minimum**, **Maximum**, and **Average** indicates respectively the minimum, maximum, and average frame delays measured since the beginning of the test.
- **Successful** indicates the count of received DMR frames having no errors.
- **Failed** indicates the count of DMR frames declared as invalid.

## Test Results

### *S-OAM and MPLS-TP OAM*

---

#### **Frame Loss**

- **Status** displays the status of the test function (refer to page 589).
- **TX LMM** indicates the count of transmitted LMM frames.
- **RX LMR** indicates the count of valid LMR frames received. A valid frame for S-OAM has its source MAC address matching the Peer MEP MAC address; destination MAC address matching the unit port MAC address; and VLANs matching the unit port VLANs. A valid frame for MPLS-TP OAM has its destination MAC address matching either the unit MAC address, FF:FF:FF:FF:FF:FF, or 01:00:5E:90:00:00; VLANs matching the unit port VLANs; and MPLS Labels matching the local MPLS Label Stack configuration.
- **Invalid LMR** indicates the count of LMR frames received from the peer MEP with incorrect MEG/MD level.
- **Frame Loss** is calculated (count and %) for both Near-End and Far-End over all valid LMR frames received.
- **Successful** indicates the count of received LMR frames having no errors.
- **Failed** indicates the count of LMR frames declared as invalid.

## Synthetic Loss

**Note:** *Only available with Ethernet OAM.*

- **Status** displays the status of the test function (refer to page 589).
- **TX SLM** indicates the count of transmitted SLM frames.
- **RX SLR** indicates the count of valid SLR frames received. A valid frame has its source MAC address matching the Peer MEP MAC address; destination MAC address matching the unit port MAC address; and VLANs matching the unit port VLANs.
- **Invalid SLR** indicates the count of SLR frames received from the peer MEP with incorrect MEG/MD level, incorrect source MEP ID, or incorrect Test ID.
- **Synthetic Loss** is calculated (count and %) for both Near-End and Far-End over all frames received and is updated after each Synthetic Loss measurement period (after receiving the defined **Frame Count**, refer to page 376).
- **Successful** indicates the count of received SLR frames having no errors.
- **Failed** indicates the count of SLR frames declared as invalid.

# SDT - Multi-Channel OTN

From the **Test** menu, tap **Results** and the **SDT** tab.

**Note:** *The SDT tab is only available when **Disruption Monitoring** is enabled (refer to ODU Channels - Global on page 341).*

Service Disruption is the time during which there is a disruption of service due to the absence of traffic or to the detection of defects per channel.

- **Channels with Disruption** indicates the number of channels with service disruption.
- **Channels Monitored** indicates the number of channels monitored.
- **Channels Above Threshold**, available when pass/fail verdict is enabled, indicates the number of channels with a disruption time above the defined threshold.
- **Longest Disruption** indicates the duration of the longest measured disruption time and the channel number on which it occurred. The Pass/Fail verdict when enabled, is displayed next to duration value.
- **Last Disruption** indicates the duration of the last measured disruption time and the channel number on which it occurred.
- **SDT Threshold (ms)**, available when pass/fail verdict is enabled, allows entering the SDT threshold value that will be used to declare the pass/fail verdict: **0.001** to **299999.999 ms** (default is **50 ms**).

The following statistics are presented per channel:

- **Channel** indicates the channel number.
- **Longest (ms)** indicates the longest measured disruption time.
- **Shortest (ms)** indicates the shortest measured disruption time.
- **Last (ms)** indicates the duration of the last measured disruption time.
- **Average (ms)** indicates the average duration of all measured disruption times.

- **Total (ms)** indicates the total duration of all measured disruption times.
- **Count** indicates the number of disruption events detected since the beginning of the test.
- **PASS FAIL**, available when pass/fail verdict is enabled, indicates the SDT pass/fail verdict.
  
- **Time Mode** selects the format used to display the disruption time.
  - Relative** displays SDT events based on the time elapsed since the beginning of the test.
  - Absolute** (default) displays SDT events based on date and time.
- **Units** selects the unit used to display SDT statistics:  $\mu$ s, ms (default), s, or min.
- **Time Stamp** displays the time or date/time for each SDT channel; this apply to **Longest** and **Last** disruption time statistics. Choices are **None** (default), **Time**, and **Date/Time**. An extra line is added for each channel to display the time, and two lines to display the time and date.

**Note:** *When a disruption event is equal to or longer than the test period which is fixed to 5 minutes, then the measured disruption time is equal to the test period.*

## Service Configuration - Burst

From the **Test** menu, tap **Results**, **Service Configuration**, and the **Burst** tab.

### Service Name and Selection

**Service Name** indicates the name of the selected service.

Select the service to be displayed by either using the left/right arrow or by tapping over the service numbers area then tapping on a specific service number. An orange background indicates the selected service while a green background indicates the services that are enabled.

### Committed/Excess

- **Committed - Burst test** is the **CBS** subtest.
- **Excess - Burst test** is the **EBS** subtest.
- **Direction**, available with **Dual Test Set** or **Dual Port** topology, indicates respectively results for local (**L**) and remote (**R**) directions, or for both port directions.
- **Burst Size** indicates the size in bytes of the burst used for each subtest.
- **SLA Verified** indicates the committed SLA parameters that are used to declare the pass/fail verdict. See *Summary - EtherSAM* on page 549 for more information on **Frame Loss**, **Max Jitter**, **Round-Trip Latency**, **Max Latency**, and **Max RX Rate**.
- **Informational** parameters are for information purpose only, they are not included in the test pass/fail verdict. See *Summary - EtherSAM* on page 549 for more information on **Frame Loss Rate**, **Max Jitter**, **Max Latency**, and **Round-Trip Latency**.
- **Average RX Rate** indicates the measured average utilization throughput for the CBS subtest.



## Service Configuration - L2CP

From the **Test** menu, tap **Results**, **Service Configuration**, and the **L2CP** tab.

### Service Name and Selection

**Service Name** indicates the name of the selected service.

Select the service to be displayed by either using the left/right arrow or by tapping over the service numbers area then tapping on a specific service number. An orange background indicates the selected service while a green background indicates the services that are enabled.

### L2CP Statistics per Service

- **Name** indicates the name of each L2CP frame.
- **Dest. MAC** indicates the L2CP frame destination MAC address.
- **Expected L2CP Handling** indicates the expected L2CP handling: **Pass Through** or **Discard/Peer**.
- **Direction** indicates respectively results for local (**L**) and remote (**R**) directions.
- **TX Frames** indicates the count of L2CP frames transmitted per direction.
- **RX Frames** indicates the count of L2CP frames received per direction.

## Test Results

### Service Configuration - L2CP

---

The L2CP frame verdict is as follows per direction:

Verdict	Description
PASS	If the Expected L2CP Handling is <b>Pass Through</b> and the L2CP TX frames have been received at destination with a maximum of 1 frame lost.
	If the Expected L2CP Handling is <b>Peer/Discard</b> and none of the transmitted L2CP frames have been received at destination.
FAIL	If the Expected L2CP Handling is <b>Pass Through</b> and none or some but not all (more than 1 frame lost) of the transmitted L2CP frames have been received at destination.
	If the Expected L2CP Handling is <b>Peer/Discard</b> and at least one of the transmitted L2CP frames have been received at destination.

L2CP service verdict is as follows per direction:

Verdict	Description
PASS	All L2CP frame verdicts (same direction) are pass.
FAIL	At least one L2CP verdict (same direction) is fail.

L2CP global verdict is as follows:

Verdict	Description
PASS	All L2CP service verdicts are pass.
FAIL	At least one L2CP service verdict is fail.

## Service Configuration - Ramp

From the **Test** menu, tap **Results**, **Service Configuration**, and the **Ramp** tab.

### Service Name and Selection

**Service Name** indicates the name of the selected service. Select the service to be displayed by either using the left/right arrow or by tapping over the service numbers area then tapping on a specific service number. An orange background indicates the selected service while a green background indicates the services that are enabled.

### Committed/Excess Steps

- **Committed Steps** indicate the pre CIR and CIR steps specified in the ramp configuration.
- **Excess Steps** indicate the **CIR+EIR** and **Traffic Policing** steps specified in the ramp configuration.
- **Direction**, available with **Dual Test Set** or **Dual Port** topology, indicates respectively results for local (**L**) and remote (**R**) directions, or for both port directions.
- **TX Rate** indicates the transmission rate.
- **SLA Verified** indicates the committed SLA parameters that are used to declare the pass/fail verdict. See *Summary - EtherSAM* on page 549 for more information on **Frame Loss Rate**, **Max Jitter**, **Round-Trip Latency**, and **Max RX Rate**.

## Test Results

### *Service Configuration - Ramp*

---

- **Informational** parameters are for information purpose only, they are not included in the test pass/fail verdict. See *Summary - EtherSAM* on page 549 for more information on **Frame Loss**, **Max Jitter**, and **Round-Trip Latency**.
- **Average RX Rate** indicates the measured average utilization throughput for each step.

## Service Performance

From the **Test** menu, tap **Results**, and the **Service Performance** tab.

### Service Name and Selection

**Service Name** indicates the name of the selected service.

Select the service to be displayed by either using the left/right arrow or by tapping over the service numbers area then tapping on a specific service number. An orange background indicates the selected service while a green background indicates the services that are enabled.

### SLA Parameters

The configured **CIR**, **Max Jitter**, **Frame Loss Rate** and **Max Latency/Max Round-Trip Latency** SLA parameters are displayed. Refer to *Services - Profile* on page 381 for more information. For **Dual Test Set** or **Dual Port** topology, parameters are displayed respectively for both local (**L**) and remote (**R**) directions, or for both port directions.

### Metrics

**Current**, **Average**, **Minimum**, **Maximum**, and **Estimate (Jitter)** measured values for each metric are reported. **Direction**, available with **Dual Test Set** or **Dual Port** topology indicates respectively results for local (**L**) and remote (**R**) directions, both port directions, and Round-Trip for Latency when in Round-Trip Latency Measurement Mode (see *Global Options* on page 262). For **Dual Test Set**, results for remote to local are obtained at the end of each step.

- **RX Rate** indicates the measured utilization throughput.
- **Jitter** indicates the measured delay variation.
- **Latency** indicates the measured round-trip latency (delay).

**Note:** For the **Current** value, 0 is displayed when no RX rate has been measured in the last second.

## Test Results

### Service Performance

---

**Note:** For the **Current** value, **Not measurable** is displayed when no delay has been measured in the last second.

## Errors

For **Dual Test Set**, errors “” are reported for both local (**L**) and remote (**R**) directions. For **Dual Port** topology, errors are reported for both port directions.

- **Frame Loss** indicates that a sequence number is missing in the received frames. The pass/fail verdict when enabled reports only the verdict when it is fail. **Seconds, Count, and Rate values are reported.**
- **Out-of-Sequence** indicates that the received frame sequence number is either smaller than the expected frame sequence number or is a duplicate number. The Out-Of-Sequence will not be considered in the global verdict. **Seconds, Count, and Rate values are reported.**

## RX Frame Count

The **RX Frame Count** indicates the number of frames received matching the selected service ID. For **Dual Test Set**, the count is reported for both local (**L**) and remote (**R**) directions. For **Dual Port** topology, the count is reported for both port directions.

## Streams - Frame Loss / Out-of-Sequence

From the **Test** menu, tap **Results**, **Streams**, and the **Frame Loss / Out-Of-Sequence** tab.

**Note:** For *Dual Port* topology select the port to be displayed.

- **Stream** indicates the stream identification number.
- **Thresholds** button allows setting the pass/fail thresholds (refer to *QoS Metrics* on page 414).
- **Frame Loss:** See *QoS Metrics* on page 934.
- **Out-Of-Sequence:** See *QoS Metrics* on page 934.

## Streams - Jitter

From the **Test** menu, tap **Results**, **Streams**, and the **Jitter** tab.

**Note:** For *Dual Port* topology select the port to be displayed.

- **Stream:** Indicates the stream identification number.
- **Jitter** is measured for each stream on all valid frames (in-sequence frames, valid Jitter tag, and no FCS error) received. **Current**, **Average**, **Minimum**, **Maximum**, and **Estimate** delay values are reported.

**Note:** For the **Current** value, **Not measurable** is displayed when no delay has been measured in the last second.

- **Thresholds** button allows setting the pass/fail thresholds (refer to *QoS Metrics* on page 414).

## Test Results

### *Streams - Latency*

---

## Streams - Latency

From the **Test** menu, tap **Results**, **Streams**, and the **Latency** tab.

**Note:** For **Dual Port** topology select the port to be displayed.

- **Stream:** Indicates the stream identification number.
- **Latency** is measured for each stream on all valid frames (valid Latency tag, expected originator identifier value, and no FCS error) received. **Current**, **Average**, **Minimum**, and **Maximum** round-trip latency (delay) are reported.

**Note:** *Latency statistics are only available in loopback test topology.*

**Note:** For the **Current** value, **Not measurable** is displayed when no delay has been measured in the last second.

- **Thresholds** button allows setting the pass/fail thresholds (refer to *QoS Metrics* on page 414).



## Streams - Throughput / Customer Frame Throughput

From the **Test** menu, tap **Results**, **Streams**, and the **Throughput** or the **Customer Frame Throughput** tab.

**Note:** For *Dual Port* topology select the port to be displayed.

- **Stream** indicates the stream identification number.
- **TX Rate** indicates the transmission rate.
- **RX Rate** is measured for each stream on all valid frames (valid Throughput tag with no FCS error). **Current**, **Average**, **Minimum**, and **Maximum** throughput results are reported. Refer to *Unit* on page 408 for unit selection.

**Note:** A **Current** value of **0** indicates that no RX rate has been measured in the last second.

- **Total** indicates the total TX and current measured RX throughput of all valid frames (valid Throughput tag with no FCS error).
- **Thresholds** button allows setting the pass/fail thresholds (refer to *QoS Metrics* on page 414). Not available on **Customer Frame Throughput** tab.

## Test Results

Summary - OTN/SONET/SDH/DSn/PDH

---

# Summary - OTN/SONET/SDH/DSn/PDH

**Note:** Available with OTN BERT, SONET/SDH BERT, OTN-SONET/SDH BERT, DS<sub>n</sub>/PDH BERT, and SONET/SDH - DS<sub>n</sub>/PDH BERT.

From the **Test** menu, tap **Results**, and the **Summary** tab.

- **Global**/**<Port #>**, available with **Dual Port** topology, allows selecting to display a brief summary for both ports (**Global**) or for a specific port.
- **Test Status** displays the current status of the test. The global test pass/fail verdict is displayed next to the **Test Status** field when enabled.

--: Idle state, the test is not running or results are not available.

**In Progress:** The test is running.

**Completed:** The test is completed, stopped at the planned time, or manually stopped when there is no set timer.

**Aborted:** The test is interrupted; stopped before the set timer.

- **Start Time** indicates the date and time the test was started. The date and time reset every time the test is restarted or reset.
- **Test Recovery**, when displayed, indicates that the test has automatically recovered from a power failure. The number of occurrences is also displayed next to the **Test Recovery** field. Refer to *Power Failure Recovery* on page 767.
- **Logger Full**, when displayed, indicates that the logger is full. Refer to *Logger* on page 477.

## BER and Multi-Pattern BER

**Note:** See BER on page 889 for a description of each alarm/error.

**Note:** For Multi-Pattern, alarms/errors are available for each pattern. An arrow in front of a specific pattern indicates the pattern that is currently generated/analyzed. **All** represents the sum of alarms/errors as well as the consolidated rate for all patterns.

- **Receiving Live Traffic - RX Pattern Analysis Disabled** when displayed, indicates that the **No Pattern Analysis (Live)** check box is selected and in this case no other information/statistics are available.
- **BER Threshold** is available when **Pass/Fail Verdict** is enabled<sup>1</sup>. For Multi-Channel OTN, this setting is global and applies to all Channels.
- **Restart Sequence** button, available with multi-pattern, clears results and restarts the multi-pattern sequence with the first enabled pattern in the list. This is the only way to restart the multi-pattern sequence and to allow synchronization between two test sets.

For back-to-back testing using two test sets, create a multi-pattern test on both units, tap the **Restart Sequence** button on each unit within 5 seconds apart. Once synchronized, start the test on each unit.

---

1. Refer to *BERT and Unframed BERT* on page 209 or *EtherBERT and Unframed BERT* on page 247.

## Test Results

Summary - OTN/SONET/SDH/DSn/PDH

---

- **Bit/Pattern Error Rate/Count** graphically displays a meter representing either the bit/pattern error rate or the bit/pattern error count depending on the Pass/Fail Verdict selection<sup>1</sup>.

When the verdict is enabled<sup>1</sup>, the values under the threshold are presented in green while the values above are in red.

When the verdict is disabled, the bit/pattern error rate is displayed in blue.

The arrow pointer indicates the current received bit/pattern error rate/count.

The Pass/Fail verdict is displayed just on top of the meter when enabled<sup>1</sup>.

- **Bit/Pattern Error, Amount/Rate, and Inject:** The bit/pattern error injection and settings are coupled with the *Inject Button* on page 457. For Transport test applications, not available in Through modes or with Multi-Pattern.

## Service Disruption

**Note:** *Service Disruption results are only available when **Disruption Monitoring** is enabled (refer to BERT and Unframed BERT on page 209). When Service Disruption is disabled, the message **Service disruption monitoring disabled** is displayed.*

Service Disruption is the time during which there is a disruption of service due to the detection of defects.

---

1. Refer to *BERT and Unframed BERT* on page 209 or *EtherBERT and Unframed BERT* on page 247.

➤ **Disruption Time**

**Note:** *For OTL defects, at the exception of LOL, the disruption time is displayed for the lane having the longest disruption time. See OTL-SDT on page 486 for results per lanes.*

**Longest** indicates the longest measured disruption time.

**Shortest** indicates the shortest measured disruption time.

**Last** indicates the length of the last measured disruption time.

**Average** indicates the average duration of all measured disruption times.

**Total** indicates the total duration of all measured disruption times.

- **Defect** indicates on which layer and defect the service disruption time test is performed. For OTL defect (parallel interface) also indicates within parenthesis the lane number having the longest disruption time.
- **Disruption Count:** Indicates the number of disruption events detected since the beginning of the SDT test.

**Note:** *When a disruption event is equal to or longer than the test period which is fixed to 5 minutes, then the measured disruption time is equal to the test period.*

- **SDT Threshold (ms)** allows configuring the acceptable maximum service disruption time before failing the test: **0.001 to 299999.999 ms** (default is **50 ms**). Refer to *Service Disruption* on page 212.

## **GFP Frames**

GFP Frames are available for OTN BERT with Ethernet 1 GbE, 10 GbE or Ethernet (flex/GFP-F) client (see *GFP-F/GFP-T* on page 468).

### Summary - 1588 PTP

From the test menu, tap **Results**, and the **Summary** tab.

- **Test Status** displays the current status of the test. The global test pass/fail verdict is displayed next to the **Test Status** field when enabled.

--: Idle state, the test is not running or results are not available.

**In Progress:** The test is running.

**Completed:** The test is completed, stopped at the planned time, or manually stopped when there is no set timer.

**Aborted:** The test is interrupted; stopped before the set timer.

- For G.8265.1: **[Message type] Request Denied, Session Canceled, or No Reply** is displayed next to **Aborted** when applicable.
- For G.8275.1: **Sync Message Rate Changed** is displayed next to **Aborted** when applicable.
- **Start Time** indicates the date and time the test was started. The date and time reset every time the test is restarted or reset.
- **Test Recovery**, when displayed, indicates that the test has automatically recovered from a power failure. The number of occurrences is also displayed next to the **Test Recovery** field. Refer to *Power Failure Recovery* on page 767.
- **Logger Full**, when displayed, indicates that the logger is full. Refer to *Logger* on page 477.

- **Negotiation Status** is displayed during the Unicast negotiation process which is initiated when either the test is started or the **Connect** button is activated. Only available with **Unicast** mode.

<b>Negotiation Status</b>	<b>Description</b>	<b>Background Color<sup>a</sup></b>
<b>Request Granted</b>	All the Signaling request types have been granted.	Green
[Message type] <b>Request Denied</b>	The Signaling grant message has not been granted.	Red
<b>Session Canceled</b>	The Grand Master has canceled the Unicast session.	Red
<b>No Reply</b>	No message is received from the Grand Master following transmission of 3 Signaling requests for a message type.  Make sure that both IP address and Domain (refer to <i>1588 PTP</i> on page 201) of the Grand Master Clock are valid as well as the IP address of the unit's port used to connect on the network (refer to <i>Network</i> on page 328).	Red
<b>Pending</b>	Unicast negotiation has started and no message has been received from the Grand Master.	Gray
<b>Inactive</b>	The Unicast negotiation is not active.	Gray

a. The gray background color is also used for a Link Down.

- **GM Info / BC Info:** Refer to *Grand Master Information / Boundary Clock Information* on page 965.

## Test Results

Summary - 1588 PTP

---

### Delay Measurement

- **Sync IPDV** meter displays the average of the inter packet delay variation of consecutive Sync messages in the last second. The value and the pass/fail verdict is also displayed when enabled.
- **Delay Req IPDV** meter displays the average of the inter packet delay variation of consecutive Delay Req messages in the last second. The value and the pass/fail verdict is also displayed when enabled.

**Note:** When a value is below  $1\mu$  second, “<  $1\mu$ s” is displayed.

**Note:** When the **Pass/Fail Verdict** is enabled, the green region is delimited from 0 to the IPDV Threshold (refer to Alarm Timeout/Threshold / Alarm Threshold on page 205) corresponding to a pass verdict. The red region beyond the threshold corresponds to a fail verdict. There is neither green nor red region when the Pass/Fail verdict is disabled.

### Quality Level

- **Last QL Received** indicates the last Quality Level value received. The pass/fail verdict is also displayed when both **QL Mismatch Monitoring** and **Pass/Fail Verdict** check boxes are selected.
- **Last Change** indicates the date and time of the **Last QL Received** has changed.

### Total PTP Messages

Gives respectively the total count of transmitted (TX) and received (RX) PTP messages.



## Summary - Cable Test

From the **Test** menu, tap **Results**, and the **Summary** tab.

- **Test Status** displays the current status of the test. The global test pass/fail verdict is displayed next to the **Test Status** field when enabled. The Pass/Fail verdict is based on the following criteria: **The worst pair's Wire Map, Prop. Delay, Delay Skew, and Length.**

--: Idle state, the test is not running or results are not available.

**In Progress:** The test is running.

**Completed:** The test is completed or manually stopped.

- **Start Time** indicates the date and time the test was started. The date and time reset every time the test is restarted or reset.

## Cable

**Note:** *When no value is available, "--" is displayed.*

- **Wire Map** indicates the Wire Map result for the pair having the worst Wire Map. The distance to fault is also displayed when a fault is identified. The Pass/Fail verdict is also displayed, when enabled.
- **Prop. Delay (ns)** indicates the propagation delay value for the pair having the longest propagation delay. The Pass/Fail verdict is also displayed when enabled.

## Test Results

### Summary - Cable Test

---

- **Delay Skew (ns)** indicates the delay skew value for the pair having the worst delay skew. The Pass/Fail verdict is also displayed when enabled. The Delay Skew result is only available for 1000BASE-T interface when the link is up.
- **Length (m/ft)** indicates the length for the pair having the worst cable length value. The Pass/Fail verdict is also displayed when enabled.

## Pairs

**Note:** When no value is available, "--" is displayed.

- **Pair** indicates the pair number.
- **Pins** indicates the pair's pin numbers and color of each wire corresponding to the selected wiring standard.

W-BL	White-Blue
BL	Blue
W-O	White-Orange
O	Orange
W-G	White-Green
G	Green
W-BR	White-Brown
BR	Brown

- **Wire Map Test Result** gives the wire map test result for each pair. When the link is up: The wire map result for each pair is given as seen by the module to get a link up. This means that the wire map result may not correspond to the type of cable tested depending on the cable(s) used and/or the configuration of the cable mode (MDI, MDIX, or auto-detection) on both the module and the far end equipment. For example, two crossed pair cables end to end used between the module and a far end equipment may give a straight pair (MDI) wire map result.

<b>MDI</b>	Straight pair.
<b>MDIX</b>	Crossed pair.
<b>MDI (-)</b>	For 1 Gbit/s, straight pair with swapped wires within pair.
<b>MDIX (-)</b>	For 1 Gbit/s, crossed pair with pair A swapped with pair B and/or pair C swapped with pair D.
<b>Noise</b>	Excessive noise on a pair most likely caused by a link partner running in 10/100 Mbit/s forced mode. In this case, no propagation delay or length is reported and there is no comparison with any threshold.

**Note:** *For 1 Gbit/s, both MDI and MDIX can be reported simultaneously since crossed pairs detection is performed independently for pairs A-B and C-D.*

## Test Results

### Summary - Cable Test

---

When the link is down:

Short	Short-circuit between Tip and Ring wires of a pair or Tip or ring wire of a pair is connected with an alien wire grounded.
Open	No cable plugged in, remote end open, or either one or two wires of a pair are not connected.
Short-between-pairs	Short between one or two wires of a pair with one or two wires of another pair. Short between more than two pairs, including one or two wires for each pair.
Noise	Excessive noise on a pair most likely caused by a link partner running in 10/100 Mbit/s forced mode. In this case, no distance is reported and there is no comparison with any threshold.
Unknown	No fault has been identified but the link is down. To maximize the cable test result, it is preferable to have the far end equipment powered up.

If the determined **Wire Map** is either **MDI**, **MDIX**, **MDI (-)**, **MDIX (-)**, or **Noise** (Link up), the test is declared as **PASS**. If the determined Wire Map is either **Short**, **Short-between-pair**, **Open**, **Noise** (Link down), or **Unknown**, the test is declared as **FAIL**.

**Note:** Refer to Ethernet Cables on page 818 for cable pinout.

- **Distance To Fault (m/ft)** gives the distance to fault from the near end for each pair, unless the problem is due to excessive noise. Noise may be due to electrical noise causing communication error.
- **Prop. Delay (ns)** indicates the propagation delay of a signal through each pair.
- **Length (m/ft)** indicates the cable length of each pair.

## PoE

**Note:** Only available on 8870/8880.

### Detection/Classification

- **Power Presence** indicates on which cable pairs (refer to **Wiring Standard** on page 227) the power is received and the polarity of each pair. Result is presented as follows:

Power Presence	Description
Pos: <pair>; Neg: <pair>	PSE applies power on 2 pairs.
Pos: <pair>, <pair>; Neg: <pair>, <pair>	PSE applies power on all pairs.
No power detected	No power over Ethernet was detected.

- **PSE Type** indicates the detected PSE type.
- **Granted Power Class** indicates the power class provided by the PSE:

Granted power Class	Description
0	Class 0 (13.0W)
1	Class 1 (3.8W)
2	Class 2 (6.5W)
3	Class 3 (13.0W)
4	Class 4 (25.5W)
None	The PSE denied power.

The Pass/Fail verdict is also displayed when enabled.

## Test Results

### Summary - Cable Test

---

#### Operation

**Note:** *The following results are only reported when the classification succeeded.*

- **Unloaded Voltage (V)** indicates the measured voltage when no load is applied. A value less than 5 is reported as **<5.0** and a value greater than 59 is reported as **>59.0**.
- **Loaded Voltage (V)** indicates the measured voltage by applying a load corresponding to the configured power class. A value less than 5 is reported as **<5.0** and a value greater than 59 is reported as **>59.0**. The Pass/Fail verdict is also displayed when enabled.
- **Current (mA)** indicates the current which is calculated based on the measured **Loaded Voltage** and the applied load.
- **Power (W)** indicates the power in watt which is calculated based on the measured **Loaded Voltage** and **Current**.

## Summary - CPRI/OBSAI BERT

From the test menu, tap **Results**, and the **Summary** tab.

- **Global**/**<Port #>**, available with **Dual Port** topology, allows selecting to display a brief summary for both ports (**Global**) or for a specific port.
- **Test Status** displays the current status of the test. The global test pass/fail verdict is displayed next to the **Test Status** field when enabled.

--: Idle state, the test is not running or results are not available.

**In Progress:** The test is running.

**Completed:** The test is completed, stopped at the planned time, or manually stopped when there is no set timer.

**Aborted:** The test is interrupted; stopped before the set timer.

- **Start Time** indicates the date and time the test was started. The date and time reset every time the test is restarted or reset.
- **Test Recovery**, when displayed, indicates that the test has automatically recovered from a power failure. The number of occurrences is also displayed next to the **Test Recovery** field. Refer to *Power Failure Recovery* on page 767.
- **Logger Full**, when displayed, indicates that the logger is full. Refer to *Logger* on page 477.

## Test Results

Summary - CPRI/OBSAI BERT

---

### Interface

**Note:** Only available with CPRI/OBSAI Unframed.

➤ **Alarms**

LOS indicates that there is no input signal.

➤ **Errors**

CV (Code Violation) indicates that invalid 10B code word are received.

### BER

**Note:** See BER on page 889 for a description of each alarm/error. For Pass/Fail Verdict, refer to BERT and Unframed BERT - CPRI/OBSAI on page 216.

➤ **Receiving Live Traffic - RX Pattern Analysis Disabled** when displayed, indicates that the **No Pattern Analysis (Live)** check box is selected and in this case no other information/statistics are available.

➤ **BER Threshold** is available when **Pass/Fail Verdict** is enabled.

➤ **Bit Error Rate/Count** graphically displays a meter representing either the bit error rate or the bit error count depending on the Pass/Fail Verdict selection.

When the verdict is enabled, the values under the threshold are presented in green while the values above are in red. The Pass/Fail verdict is displayed just on top of the meter when enabled. When the verdict is disabled, the bit/pattern error rate is displayed in blue.

The arrow pointer indicates the current received bit/pattern error rate/count.

➤ **Bit Error, Amount/Rate, and Inject:** The bit error injection and settings are coupled with the *Inject Button* on page 457.



## Service Disruption

**Note:** *Service Disruption results are only available when **Disruption Monitoring** is enabled (refer to EtherBERT and Unframed BERT on page 247). When Service Disruption is disabled, the message **Service disruption monitoring disabled** is displayed.*

Service Disruption is the time during which there is a disruption of service due to the detection of defects.

➤ **Disruption Time**

**Longest** indicates the longest measured disruption time.

**Shortest** indicates the shortest measured disruption time.

**Last** indicates the length of the last measured disruption time.

**Average** indicates the average duration of all measured disruption times.

**Total** indicates the total duration of all measured disruption times.

- **Disruption Count:** Indicates the number of disruption events detected since the beginning of the SDT test.

**Note:** *When a disruption event is equal to or longer than the test period which is fixed to 5 minutes, then the measured disruption time is equal to the test period.*

- **SDT Threshold:** See *Service Disruption* on page 250.

## Test Results

Summary - CPRI/OBSAI BERT

---

### CPRI

**Note:** Available with CPRI Framed L2.

- **Sequence** indicates the last Sequence State parameter: **Standby (A)**, **L1 Sync (B)**, **Protocol (C)**, **L2 C&M (D)**, **Vendor (E)**, **Operation (F)**, and **Passive (G)**. The pass/fail verdict is also displayed when enabled.
- **Frame Sync** indicates that the startup sequence synchronization status as per L1 Sync Status parameter: active (green) or inactive (red).
- **Protocol** indicates either the last received (**Version 1** or **Version 2**) or negotiated (**Auto**) protocol version. A red background indicates a Protocol version mismatch.
- **C&M** indicates either the received (HDLC or Ethernet) or negotiated (Auto) C&M for Ethernet subchannel and HDLC rates in Mbit/s. A red background indicates either a C&M type mismatch or HDLC Rate/Ethernet subchannel mismatch. An arrow is displayed indicating which C&M Channel, Ethernet or HDLC, is selected following the negotiation process.
- **Code Word (CW)** for rates up to 9.8G indicates the transmitted and received Code Word count.
- **66B Block** for rate 10.1G indicates the transmitted and received 66B Block count.
- **Hyperframe** indicates the transmitted and received hyperframe count.
- **L1 Reset**, available when **Remote Radio Head** emulation mode is selected, indicates the number of times a request to reset the RRH interface was received.

## **OBSAI**

**Note:** *Available with OBSAI Framed L2.*

- **Sync** indicates the RX State Machine status: green for FRAME\_SYNC, red for other states, or gray for pending. The TX and RX State Machines are also displayed.

The pass/fail verdict is displayed when enabled.

- **Code Word** reports the count of code words transmitted and received.
- **Message Group** reports the count of message groups transmitted and received.
- **Frame** reports the count of frames transmitted and received.
- **RP3 Peer Target Address** indicates the RP3 Peer Target Address; indicates a mismatch when displayed in red.

### Summary - DCO BERT

From the test menu, tap **Results**, and the **Summary** tab.

- **Test Status** displays the current status of the test. The global test pass/fail verdict is displayed next to the **Test Status** field when enabled.

--: Idle state, the test is not running or results are not available.

**In Progress:** The test is running.

**Completed:** The test is completed, stopped at the planned time, or manually stopped when there is no set timer.

**Aborted:** The test is interrupted; stopped before the set timer.

- **Start Time** indicates the date and time the test was started. The date and time reset every time the test is restarted or reset.
- **Test Recovery**, when displayed, indicates that the test has automatically recovered from a power failure. The number of occurrences is also displayed next to the **Test Recovery** field. Refer to *Power Failure Recovery* on page 767.
- **Logger Full**, when displayed, indicates that the logger is full. Refer to *Logger* on page 477.

## BER

**Note:** See BER on page 889 for a description of each alarm/error. For Pass/Fail Verdict, refer to BERT - DCO BERT on page 223.

- **Receiving Live Traffic - RX Pattern Analysis Disabled** when displayed, indicates that the **No Pattern Analysis (Live)** check box is selected and in this case no other information/statistics are available.
- **BER Threshold** allows entering the maximum bit error count/rate allowed before declaring a fail verdict: **0** (default) to **999999** for count; **1.0E-14** to **1.9E-01** (default is **1.0E-12**) for rate. Only available when the **Pass/Fail Verdict** is enabled.
- **BER Threshold** allows entering the maximum bit error count/rate allowed before declaring a fail verdict: **0** (default) to **999999** for count; **1.0E-14** to **1.9E-01** (default is **1.0E-12**) for rate.
- **Bit Error Rate / Bit Error Count** graphically displays a meter representing either the bit error rate or the bit error count depending on the pass/fail verdict selection.

When the verdict is enabled, the values under the threshold are presented in green while the values above are in red.

When the verdict is disabled, the bit error is displayed in blue.

The arrow pointer indicates the current received bit error rate/count.

The Pass/Fail verdict icon is displayed just on top of the meter when enabled.

- **Bit Error, Amount/Rate, and Inject:** The bit error injection and settings are coupled with the *Inject Button* on page 457.

## Test Results

### Summary - eCPRI BERT

---

## Summary - eCPRI BERT

From the test menu, tap **Results**, and the **Summary** tab.

- **Global**/**<Port #>**, available with **Dual Port** topology, allows selecting to display a brief summary for both ports (**Global**) or for a specific port.
- **Test Status** displays the current status of the test. The global test pass/fail verdict is displayed next to the **Test Status** field when enabled.

--: Idle state, the test is not running or results are not available.

**In Progress:** The test is running.

**Completed:** The test is completed, stopped at the planned time, or manually stopped when there is no set timer.

**Aborted:** The test is interrupted; stopped before the set timer.

- **LOPPS-L:** For One-Way Latency mode, the test is interrupted due to a failure of synchronization with the 1PPS clock (LOPPS-L).
- **Not Ready-R:** The test is interrupted because the Measurement Role of the peer is either Mismatch-R or Inactive-R. Check the eCPRI Flow at each end of the eCPRI circuit to determine the fault.
- **Start Time** indicates the date and time the test was started. The date and time reset every time the test is restarted or reset.
- **Test Recovery**, when displayed, indicates that the test has automatically recovered from a power failure. The number of occurrences is also displayed next to the **Test Recovery** field. Refer to *Power Failure Recovery* on page 767.
- **Logger Full**, when displayed, indicates that the logger is full. Refer to *Logger* on page 477.

## BER

**Note:** See BER on page 889 for a description of each alarm/error. For Pass/Fail Verdict, refer to BERT and Unframed BERT - eCPRI on page 220.

- **Receiving Live Traffic - RX Pattern Analysis Disabled** when displayed, indicates that the **No Pattern Analysis (Live)** check box is selected and in this case no other information/statistics are available.
- **BER Threshold** is available when **Pass/Fail Verdict** is enabled.
- **Bit Error Rate/Count** graphically displays a meter representing either the bit error rate or the bit error count depending on the Pass/Fail Verdict selection.

When the verdict is enabled, the values under the threshold are presented in green while the values above are in red.

When the verdict is disabled, the bit/pattern error rate is displayed in blue.

The arrow pointer indicates the current received bit/pattern error rate/count.

The Pass/Fail verdict is displayed just on top of the meter when enabled.

- **Bit Error, Amount/Rate, and Inject:** The bit error injection and settings are coupled with the *Inject Button* on page 457.

## Test Results

Summary - eCPRI BERT

---

### Service Disruption

**Note:** *Service disruption results are only available when **Disruption Monitoring** is enabled; when disabled the message **Service disruption monitoring disabled** is displayed. Refer to Service Disruption on page 221).*

- **Disruption Time** is the time during which there is a disruption of service due to the absence of traffic. The service disruption event lasts until valid Ethernet frames are received for at least the **Debounce Time** without any service disruption event. The following measured disruption time values are reported: **Longest**, **Shortest**, **Last**, **Average**, and **Total**. **Total** indicates the total duration of all measured disruption times.
- **Disruption Count** indicates the number of disruption events detected since the beginning of the SDT test.

**Note:** *When a disruption event is equal to or longer than the test period which is fixed to 5 minutes, then the measured disruption time is equal to the test period.*

- **SDT Threshold** allows configuring the acceptable maximum service disruption time before failing the test: **0.005** to **299999.999** ms (default is **50** ms). The threshold value cannot be less than the **No Traffic Time** value.

### QoS Metrics

**Note:** *QoS Metrics results are only available when at least one **QoS Measurements** criterion is enabled (refer to QoS Measurements on page 244), otherwise the **QoS Metrics Monitoring Disabled** message is displayed.*

Displays a summary of the QoS metrics and verdict when enabled. When there is no mention of **Current** or **Maximum**, the values reported are the current ones.



The following detailed QoS Metrics are available by clicking on the QoS Metrics magnifying icon:

- Port direction buttons are available for dual port topology in **One-Way P<m> ↔ P<n>** measurement mode.
- Local/Remote direction buttons are available for single/dual port topology in **One-Way** measurement mode.

**Note:** *Throughput (including RX Frame Count, TX Rate, and TX Frame Count), Jitter, Latency, and Frame Loos/Out-of-Sequence are available when enabled (see QoS Thresholds) but their availability depend on the selected measurement mode, measurement role, and direction.*

- **Throughput, Jitter, and Latency** meters display respectively the measured Throughput, Jitter, and Latency.

**Note:** *The green region defined by the configured threshold corresponds to a **PASS** verdict while the red regions corresponds to a **FAIL** verdict. The Pass/Fail verdict is only displayed when enabled (see QoS Thresholds on page 246).*

- **Jitter** is the delay variation measured<sup>1</sup> on all valid frames<sup>2</sup> received. **Current, Average, Minimum, Maximum, and Estimate** delay values are reported in  $\mu s$  per direction when applicable.
- **Latency** is measured<sup>1</sup> on all valid frames<sup>2</sup> received. **Current, Average, Minimum, and Maximum** latency (delay) are reported.

For **One-Way** and **One-Way P<m> ↔ P<n>** measurement modes, indicates the measured one-way latency (delay) in  $\mu s$  per direction when applicable (available on the sender side).

For Round-Trip measurement mode, indicates the measured round-trip latency (delay) in  $\mu s$  (available on the sender side).

---

1. For the **Current** value, **Not measurable** is displayed when no delay has been measured in the last second.

2. Frames with One-Way Delay (OWD) messages and no FCS and UDP Checksum errors.

## Test Results

### Summary - eCPRI BERT

---

- **Throughput** is the RX rate value measured on all valid frames (no FCS and UDP Checksum errors). **Current, Average, Minimum,** and **Maximum** throughput results are reported. A **Current** value of **0** indicates that no throughput has been measured in the last second.
- **RX Frame Count** indicates the number of frame received matching the stream.
- **TX Rate** indicates the transmitted throughput rate.
- **TX Frame Count** indicates the number of transmitted frames matching the stream.
- **Thresholds** allows configuring the QoS thresholds:
  - **Latency** check box when selected (default) enables the latency pass/fail verdict and allows setting the maximum threshold delay per direction when applicable.
  - **Jitter** check box when selected (default) enables the jitter pass/fail verdict and allows setting the maximum threshold value per direction when applicable.
  - **Frame Loss Rate** check box when selected (default) enables the Frame Loss pass/fail verdict and allows setting the frame loss rate for the port: 0.0E-00 to 5.0E-02 (default is 1.0E-07). However entering a value of 0.0E-00 or below 1.0E-14 is treated as a pass/fail verdict based on loss count instead of rate.
  - **Throughput** check box when selected (default) enables the throughput pass/fail verdict and allows setting the minimum and maximum threshold values for the port.
- **Frame Loss:** See *QoS Metrics* on page 934. When testing with protection switching, it is recommended to use **Generic Data Transfer** as the **Message Type** (refer to *eCPRI* on page 327).
- **Out-of-Sequence:** See *QoS Metrics* on page 934.

## Summary - EtherBERT

From the test menu, tap **Results**, and the **Summary** tab.

- **Global**/**<Port #>**, available with **Dual Port** topology, allows selecting to display a brief summary for both ports (**Global**) or for a specific port.
- **Link**, available with multiple link interface (ex: 2 x 100GE), allows selecting the link to be displayed; only enabled links are available.
- **Test Status** displays the current status of the test. The global test pass/fail verdict is displayed next to the **Test Status** field when enabled.

--: Idle state, the test is not running or results are not available.

**In Progress**: The test is running.

**Completed**: The test is completed, stopped at the planned time, or manually stopped when there is no set timer.

**Aborted**: The test is interrupted; stopped before the set timer.

- **Start Time** indicates the date and time the test was started. The date and time reset every time the test is restarted or reset.
- **Test Recovery**, when displayed, indicates that the test has automatically recovered from a power failure. The number of occurrences is also displayed next to the **Test Recovery** field. Refer to *Power Failure Recovery* on page 767.
- **Logger Full**, when displayed, indicates that the logger is full. Refer to *Logger* on page 477.

## Test Results

Summary - EtherBERT

---

### BER

**Note:** See BER on page 889 for a description of each alarm/error. For Pass/Fail Verdict, refer to EtherBERT and Unframed BERT on page 247.

- **Receiving Live Traffic - RX Pattern Analysis Disabled** when displayed, indicates that the **No Pattern Analysis (Live)** check box is selected and in this case no other information/statistics are available.
- **BER Threshold** allows entering maximum bit/pattern error count allowed before declaring a fail verdict: **0** (default) to **999999** for count; **1.0E-14** to **1.9E-01** for rate (the default value is **1.0E-12**; **2.4E-4** for unframed 200/400G). Only available when the **Pass/Fail Verdict** is enabled.
- **Bit Error Rate / Pattern Error Rate / Bit Error Count / Pattern Error Count** graphically displays a meter representing either the bit/pattern error rate or the bit/pattern error count depending on the pass/fail verdict selection.

When the verdict is enabled, the values under the threshold are presented in green while the values above are in red.

When the verdict is disabled, the bit/pattern error rate is displayed in blue.

The arrow pointer indicates the current received bit/pattern error rate/count.

The Pass/Fail verdict icon is displayed just on top of the meter when enabled.

- **Bit Error / Pattern Error, Amount/Rate, and Inject:** The bit error injection and settings are coupled with the *Inject Button* on page 457.

## Service Disruption

**Note:** *Service disruption results are only available when **Disruption Monitoring** is enabled; when disabled the message **Service disruption monitoring disabled** is displayed. Refer to Service Disruption on page 250.*

- **Disruption Time** is the time during which there is a disruption of service due to the absence of traffic. The service disruption event lasts until valid Ethernet frames are received for at least the **Debounce Time** without any service disruption event. The following measured disruption time values are reported: **Longest Shortest, Last, Average,** and **Total**. **Total** indicates the total duration of all measured disruption times.

**Note:** *When a disruption event is equal to or longer than the test period which is fixed to 5 minutes, then the measured disruption time is equal to the test period.*

- **Disruption Count** indicates the number of disruption events detected since the beginning of the SDT test.
- **SDT Threshold** allows configuring the acceptable maximum service disruption time before failing the test: **0.005** to **299999.999** ms (default is **50** ms). The threshold value cannot be less than the **No Traffic Time** value.

## Test Results

Summary - EtherBERT

---

### Latency

**Note:** Latency results are only available when **Latency** is enabled (refer to Latency on page 252) with Framed Layer 2 and higher. When **Latency** is disabled, the message **Latency Measurement Disabled** is displayed. For Dual port topology, available for rates up to 10G, the measured latency and threshold configuration are available per port/direction. Not available with multiple link interface.

- **Round-Trip** latency (delay) is measured on all valid frames received and the **Current**, **Average**, **Minimum**, and **Maximum** values are reported.

**Round-Trip Threshold (ms)** is configurable from **5  $\mu$ s** for 10Mbit/s, **1  $\mu$ s** for 100Mbit/s and 10G WAN, or **100 ns** for all other rates up to **2 s** (default is **75 ms**).

- **One-Way P<m>  $\leftrightarrow$  P<n>** latency (delay) is measured on all valid frames received and the **Current**, **Average**, **Minimum**, and **Maximum** values are reported per port/direction:

**P<m> -> P<n>**: Latency measurement at P<m> RX port.

**P<n> -> P<m>**: Latency measurement at P<n> RX port.

**One-Way P<m> -> P<n> Threshold** is configurable at the current P<m> RX port: from **5  $\mu$ s** for 10Mbit/s, **1  $\mu$ s** for 100Mbit/s and 10G WAN, or **100 ns** for all other rates up to **2 s** (default is **75 ms**).

- **Unit** allows selecting the Latency unit: **ms** (default) or  **$\mu$ s**.

## Summary - EtherSAM

From the **Test** menu, tap **Results**, and the **Summary** tab.

**Note:** For *Dual Test Set*, only *Start Time* is displayed on the remote module.

- **Service Configuration/Performance Test** indicates the actual test status as follows:

Test Status	Description
"--"	Test has not started.
<b>Disabled</b>	Test/subtests is/are disabled.
<b>Running</b>	Test/subtest is currently running.
<b>Data Transfer</b>	Test/subtest is running but no test traffic is being transmitted.
<b>Completed, &lt;Verdict&gt;</b>	Test/subtest has completed with the test pass/fail verdict. A fail verdict is declared when a <b>Link Down</b> or <b>LOS</b> is detected, or when any SLA parameter fails.
<b>Aborted, &lt;reason&gt;</b>	Test/subtest has been aborted either manually (Stop) or automatically from an alarm and the reason why the test has been aborted is also displayed as follows: <b>Link down alarm, LOS alarm, Timeout during execution, DTS connection failed, Loss of remote connection (DTS), LOPPS-L Alarm<sup>a</sup>, LOPPS-R Alarm<sup>a</sup>, LOPPS-L / LOPPS-R Alarm<sup>a</sup>, Unresolved addresses, No test enabled, No L2CP Frame Enabled, Invalid Burst Configuration, CIR disabled for all services, Excessive Refill Time<sup>b</sup>, Stopped, NAT detection failed</b>

- a. Available for **Dual Test Set** in **One-Way Latency** measurement mode.
- b. An excessive refill occurs when the pre-burst and/or post-burst duration last for more than 2 seconds.

- **Start Time** indicates the date and time the test was started. The date and time reset every time the test is restarted.
- **Remote unit in use and locked for Dual Test Set** indicates that this module is used for **Dual Test Set** as the remote module.

## Test Results

Summary - EtherSAM

---

- **Remote unit in Dual Test Set Mode** indicates that this module is set as remote but the DTS Connection is not established.
- **Service Configuration/Performance Test:** Tap **Service Configuration Test** or **Service Performance Test** button to view the result summary of the corresponding test.
  - **Service** indicates the service's number and name. For **Service Configuration Test**, the number/name is highlighted in red per service when VLAN mismatch occurred; in **Dual Test Set** or **Dual Port** topology, the direction is also highlighted; in Dual Test Set, the **R -> L** direction label is gray when **VLAN Preservation** is not supported by the remote module.
  - **Direction**, available with **Dual Test Set** or **Dual Port** topology, indicates respectively results for both local (**L**) and remote (**R**) directions, or both port directions.
  - **L2CP**, available when both **L2CP Handling Test** and pass/fail verdict are enabled, indicates the L2CP handling test pass/fail verdict.
  - **Service Performance Test** column displays the pass/fail verdict icon indicating if the service complies to the configured SLA parameters.
  - **Service Configuration Test** column displays the pass/fail verdict icon indicating if the service complies to the configured SLA parameters.



### **Committed**

- **Frame Loss Rate** indicates the rate of frames that are lost. The reported value is the maximum rate of Frame Loss from all burst sequences and ramp steps excluding the **CIR+EIR**, **EBS**, and **Traffic Policing** steps. Frame Loss is displayed as a percentage value when the remote module does not support exponential notation.
- **Max. Jitter** indicates the maximum measured delay variation.
- **Max Latency** indicates the maximum measured round-trip latency (delay). For Dual Test Set the local to remote and remote to local values are reported for One-Way Latency Measurement Mode while a single round-trip value is reported for Round-Trip Latency Measurement Mode (see *Global Options* on page 262).
- **Avg RX Rate**, for **Service Performance Test**, indicates the measured average utilization throughput.

### **Excess**

- Max RX Rate**, for **Service Configuration Test**, indicates the measured maximum utilization throughput.
- **VLAN Preservation** indicates if any VLAN mismatch (including VLAN level, VLAN ID, Priority, and Drop Eligible) occurred during any step of a Ramp or Burst tests as follows:
  - Grey: Undefined
  - Green: No Mismatch detected
  - Red: Mismatch detected

### Summary - FC BERT

From the test menu, tap **Results**, and the **Summary** tab.

- **Test Status** displays the current status of the test. The global test pass/fail verdict is displayed next to the **Test Status** field when enabled. The pass/fail verdict is only displayed once the test is stopped. The verdict is Pass when all verdicts are Pass, the verdict is Fail as soon as one of the verdict is Fail. Refer to *Bit Error* on page 217 and *Latency Tags Insertion* on page 273 for more information.

--: Idle state, the test is not running or results are not available.

**In Progress:** The test is running.

**Completed:** The test is completed, stopped at the planned time, or manually stopped when there is no set timer.

- **Start Time** indicates the date and time the test was started. The date and time reset every time the test is restarted or reset.
- **Test Recovery**, when displayed, indicates that the test has automatically recovered from a power failure. The number of occurrences is also displayed next to the **Test Recovery** field. Refer to *Power Failure Recovery* on page 767.
- **Logger Full**, when displayed, indicates that the logger is full. Refer to *Logger* on page 477.

## **BER**

**Note:** See BER on page 889 for a description of each alarm/error.

- **BER Threshold** is available when **Pass/Fail Verdict** is enabled (refer to page 217).
- **Bit Error Rate/Count** graphically displays a meter representing either the bit error rate or the bit error count depending on the Pass/Fail Verdict selection (refer to page 217).

When the verdict is enabled, the values under the threshold are presented in green while the values above are in red.

When the verdict is disabled, the bit error rate is displayed in blue.

The arrow pointer indicates the current received bit error rate/count.

The Pass/Fail verdict is displayed just on top of the meter when enabled.

- **Bit Error and Rate/Amount**
  - **Manual** allows entering the amount of manual error to be generated: **1** (default) through **50**.
  - **Rate** allows the selection of the injection rate for the selected error.
  - **Max Rate** generates the selected error to its theoretical maximum rate.
- **Inject** generates, if the test is running, the amount of bit error configured.

## Test Results

Summary - FC BERT

---

### Service Disruption

**Note:** Only available on the FTBx-88260 module. Service disruption results are only available when **Disruption Monitoring** is enabled; when disabled the message **Service disruption monitoring disabled** is displayed. Refer to Service Disruption on page 272).

- **Disruption Time** is the time during which there is a disruption of service due to the absence of traffic. The service disruption event lasts until valid FC frames are received for at least the **Debounce Time** without any service disruption event. The following measured disruption time values are reported: **Longest Shortest, Last, Average,** and **Total**. **Total** indicates the total duration of all measured disruption times.
- **Disruption Count** indicates the number of disruption events detected since the beginning of the SDT test.

**Note:** When a disruption event is equal to or longer than the test period which is fixed to 5 minutes, then the measured disruption time is equal to the test period.

- **SDT Threshold** allows configuring the acceptable maximum service disruption time before failing the test: **0.005** to **299999.999** ms (default is **50** ms). The threshold value cannot be less than the **No Traffic Time** value.

## Round-Trip Latency

- **Round Trip Latency (ms)** is measured for each local and remote port.  
**Current, Average, Minimum, and Maximum** indicates respectively the current, average, minimum, and the maximum round trip latency from the local to the remote port in the last one second. The pass/fail verdict is also displayed for the maximum round trip latency.  
**Samples** indicates the number of samples used for the round trip latency.
- **Estimated BB\_Credit** indicates the estimated number of packets that can be transmitted on the optical line at the same time.
- **Round-Trip Latency Threshold (ms)** sets the round trip latency threshold: **0.015 to 8000 ms** (default is **15**). This setting is only available when both **Latency Tags** and **Pass/Fail Verdict** check boxes are selected (refer to *Latency Tags Insertion* on page 273).

## Traffic

- **Line Utilization (%)** indicates the current percentage of the transmitting/receiving line rate utilization.
- **Frame Rate (frame/s)** indicates the current transmitted/received number of frames (including frame with error and aborted frames) in frame per second.
- **Byte Count** indicates the total number of transmitted/received bytes including the frame delimiters.
- **Frame Count** indicates the total number of transmitted/received frames including link service control frames.

## Test Results

Summary - FlexE BERT

---

### Summary - FlexE BERT

From the test menu, tap **Results**, and the **Summary** tab.

- **Test Status** displays the current status of the test.

--: Idle state, the test is not running or results are not available.

**In Progress:** The test is running.

**Completed:** The test is completed, stopped at the planned time, or manually stopped when there is no set timer.

**Aborted:** The test is interrupted; stopped before the set timer.

- **Start Time** indicates the date and time the test was started. The date and time reset every time the test is restarted or reset.
- **Test Recovery**, when displayed, indicates that the test has automatically recovered from a power failure. The number of occurrences is also displayed next to the **Test Recovery** field. Refer to *Power Failure Recovery* on page 767.
- **Logger Full**, when displayed, indicates that the logger is full. Refer to *Logger* on page 477.

### FlexE Group

Indicates respectively for each PHY/Instance, its number, port number, link status and skew (available with multiple PHY; refer to page 666). For FlexE group global alarms, refer to FlexE Group on page 904.

## FlexE Clients

**Note:** *The first row of the table reports statistics for the Pattern FlexE Clients while the subsequent rows report statistics for the other FlexE Clients.*

- The Pass/Fail verdict is displayed when enabled. For Pattern FlexE Client, a fail verdict is declared if any Bit Error, Pattern Loss, Ethernet alarm, or FCS error occurs. For FlexE Clients, a fail verdict is declared if any Ethernet alarm or FCS error occurs.

**Client ID** indicates the client identification number and allows displaying the client's summary page for the Pattern FlexE Client (see *Summary - Client Summary - FlexE BERT* on page 559).

- **Size (Gbit/s)** indicates the size of the client.
- **Link Alarm** indicates respectively, from left to right, the history and current client link status (Link Down).
- **TX Rate** indicates the transmission rate.
- **RX Rate** indicates the received rate.
- **RX Frame Count** indicates the total number of received valid and invalid frames.
- **Bit Error Rate** indicates the bit error rate. Only available for the Pattern FlexE Client.
- **Bit Error Count** indicates the bit error count. Only available for the Pattern FlexE Client.

## Test Results

### *Summary - FlexE BERT*

---

#### **Path OAM Client**

- The Pass/Fail verdict is displayed when enabled. A fail verdict is declared when any of the following alarms/errors occurs excluding CRC4: FlexE Client Link Down error, Basic OAM alarms/errors, CV alarms, or CS Type alarms.
- **Client ID** indicates the client identification number and allows displaying the Path OAM for the client (see *Summary - Path OAM - FlexE BERT* on page 560).
- **CC Status** indicates the Basic OAM CC Status: Green - no alarm; Red - alarm active; Gray - pending state.
- **CV Status** indicates the Connectivity Verification Status: Green - no alarm; Red - alarm active; Gray - pending state.
- **CS Type Status** indicates the CS Type Status: Green - no alarm; Red - alarm active; Gray - pending state.
- **Max Delay** indicates the Delay Measurement maximum value.



## Summary - Client Summary - FlexE BERT

**Note:** Available from Summary - FlexE BERT on page 556 - FlexE Clients. For **Test Status, Start Time, Test Recovery, and Logger Full** see Summary - FlexE BERT on page 556.

### BER

**Note:** See BER on page 889 for a description of each alarm/error.

- **Receiving Live Traffic - RX Pattern Analysis Disabled** when displayed, indicates that the **No Pattern Analysis (Live)** check box is selected and in this case no other information/statistics are available.
- **BER Threshold** allows entering the maximum bit error count/rate allowed before declaring a fail verdict: **0** (default) to **999999** for count; **1.0E-14** to **1.9E-01** (default is **1.0E-12**) for rate.
- **Bit Error Rate / Bit Error Count** graphically displays a meter representing either the bit error rate or the bit error count depending on the pass/fail verdict selection.

When the verdict is enabled, the values under the threshold are presented in green while the values above are in red.

When the verdict is disabled, the bit error is displayed in blue.

The arrow pointer indicates the current received bit error rate/count.

The Pass/Fail verdict icon is displayed just on top of the meter when enabled.

- **Bit Error, Amount/Rate, and Inject:** The bit error injection and settings are coupled with the *Inject Button* on page 457.

## Test Results

*Summary - Path OAM - FlexE BERT*

---

# Summary - Path OAM - FlexE BERT

**Note:** *Available from Summary - FlexE BERT on page 556 - Path OAM Client. For **Test Status**, **Start Time**, **Test Recovery**, and **Logger Full** see Summary - FlexE BERT on page 556.*

## Basic OAM

**Note:** *Only Basic OAM messages with valid CRC4 are monitored. For alarms/errors refer to Path OAM on page 930.*

### ➤ CC Status

- --: No results; function disabled or did not run yet.
- **Loss of Continuity:** Loss of Continuity alarm is active.
- **Unexpected Period:** Unexpected Period alarm is active.
- **Receiving BAS Messages:** Basic OAM messages are being received without alarms.
- **TX BAS** indicates the count of transmitted Basic OAM messages.
- **RX BAS** indicates the count of received Basic OAM messages.

## CS Type

**Note:** *Only CS Type messages with valid CRC4 are monitored.*

- **Status**
  - --: CS Type Function is disabled or CS Type messages have either never been received or more than 1.5 minutes have elapsed since the last CS Type message received.
  - **CS Type Mismatch** indicates mismatch between the expected and received CS Type.
  - **Normal:** CS Type messages are being received without alarms.
- **TX CSM** indicates the count of transmitted client signal messages.
- **RX CSM** indicates the count of received client signal messages.
- **CS Type** displays the received CS Type message and allows selecting the expected CS Type message: **Channel Not Loaded, Ethernet** (default), **SDH, FC**, or **CPRI**. The received message is highlighted in red when there is a mismatch.

## Test Results

Summary - Path OAM - FlexE BERT

---

### Delay Measurement

**Note:** Available when the **2DM Function** check box is selected. Only frames with valid CRC4 and containing the ascending sequence 0 to 5 are monitored.

#### ► Status

► --: No results; function is either disabled or did not run yet, or an alarm is preventing 2DMM messages to be transmitted.

► **In Progress:** Delay test is in progress; 2DMM frames are being transmitted and 2DMR frames are being monitored.

► **Completed:** Delay test is completed:

A Delay test with continuous transmission is manually stopped.

Delay test with continuous transmission is automatically stopped by a test timer.

All messages of a delay test with non-continuous transmission have been transmitted.

► **Aborted:** Delay test is aborted; this applies for non-continuous transmission when the test is stopped before all the frames are transmitted.

► **TX 2DMM** indicates the count of 2DMM messages transmitted.

► **RX 2DMR** indicates the count of 2DMR messages received.

► **Delay** indicates the delay measurement value in ms; **Last**, **Minimum**, **Maximum**, and **Average** values are reported.

The meter displays the currently measured delay in ms.

## Connectivity Verification

**Note:** Only CV multi-block messages with valid CRC4 and containing the ascending sequence 0 to 7 are monitored.

### ➤ Status

- --: CV Function is disabled or CV messages have either never been received or more than 1.5 minutes have elapsed since the last CV message received.
- **SAPI Mismatch:** SAPI Mismatch alarm is active.
- **DAPI Mismatch:** DAPI Mismatch alarm is active.
- **SAPI/DAPI Mismatch:** SAPI Mismatch and DAPI Mismatch alarms are active.
- **Normal:** CV messages are being received without alarms.
- **TX CVM** indicates the count of transmitted CV Messages.
- **RX CVM** indicates the count of received CV Messages.
- **SAPI** displays the received SAPI message and allows configuring the expected message when the **Expected** check box is selected from setup: **EXFO SAPI** by default. A maximum of 16 characters is allowed. The default message contains a NULL (all 0's) character preceding it and NULL (all 0's) characters are automatically appended to the message for bytes that are not defined.
- **DAPI** displays the received DAPI message and allows configuring the expected message when the **Expected** check box is selected from setup: **EXFO DAPI** by default. A maximum of 16 characters is allowed. The default message contains a NULL (all 0's) character preceding it and NULL (all 0's) characters are automatically appended to the message for bytes that are not defined.

## Test Results

Summary - FlexO BERT

---

### Summary - FlexO BERT

From the test menu, tap **Results**, and the **Summary** tab.

- **Client ID** indicates the client identification number.
- **Type** indicates the ODUk container (client).
- **Test Status** displays the current status of the test.
  - **--**: Idle state, the test is not running or results are not available.
  - **In Progress**: The test is running.
  - **Completed**: The test is completed, stopped at the planned time, or manually stopped when there is no set timer.
- **Start Time** indicates the date and time the test was started. The date and time reset every time the test is restarted or reset.
- **Test Recovery**, when displayed, indicates that the test has automatically recovered from a power failure. The number of occurrences is also displayed next to the **Test Recovery** field. Refer to *Power Failure Recovery* on page 767.
- **Logger Full**, when displayed, indicates that the logger is full. Refer to *Logger* on page 477.

### FlexO Group

Displays for each instance, its number, port number, skew (available with multiple instances on multiple ports), FlexO alarms (see *FlexO Group* on page 905), and OTUCn alarms (see *OTUCn* on page 926).

## BER

**Note:** See BER on page 889 for a description of each alarm/error.

- **Receiving Live Traffic - RX Pattern Analysis Disabled** when displayed, indicates that the **No Pattern Analysis (Live)** check box is selected and in this case no other information/statistics are available.
- **BER Threshold:** Refer to **Pass/Fail Verdict - BER Threshold** from setup.
- **Bit Error Rate / Bit Error Count** graphically displays a meter representing either the bit error rate or the bit error count depending on the pass/fail verdict selection.

When the verdict is enabled, the values under the threshold are presented in green while the values above are in red.

When the verdict is disabled, the bit error is displayed in blue.

The arrow pointer indicates the current received bit error rate/count.

The Pass/Fail verdict icon is displayed just on top of the meter when enabled.

- **Bit Error, Amount/Rate, and Inject:** The bit error injection and settings are coupled with the *Inject Button* on page 457.

## Test Results

### Summary - iOptics

---

## Summary - iOptics

From the test menu, tap **Results**, and the **Summary** tab.

**Start Time** indicates the date and time the test was started. The date and time reset every time the test is restarted.

**Calibrating:** When necessary for power consumption monitoring, the **Calibrating** progress message is displayed. If at any point during this process or during a sub-test execution an unexpected condition is detected, an abort message is displayed as follows:

Test Status	Description
Aborted, <reason>	Sub-test sequence has been aborted and a reason is displayed: <b>Missing Transceiver System, Invalid Transceiver System, Missing Device Under Test, Invalid Device Under Test, Link Down, Laser Off, LOS, Device under Test Ovrlid (overload), Device Pulled, Failed, or User Stopped.</b>

## Sub-Test Sequence

The progress status and pass/fail verdict are displayed for each sub-test sequence as follows:

Test Status	Description
"--"	Sub-test is not running or results are not available.
Running <details>	Sub-test is running and progress details are displayed.
Completed, Pass/Fail	Sub-test is completed with Pass or Fail verdict.
Aborted, Fail	Sub-test sequence has been aborted with a fail verdict.



- **I/O Interface Quick Check**
  - Validates the operation of the MDIO/I2C interface by sending specific commands to the transceiver.
  - Validates the information provided by a status pin and stimulates a control pin of the transceiver when the **Control Pin Check** check box is selected.
- **Optical TX Power Test (dBm)** reports the minimum and maximum optical TX power values; in-range values are displayed in green while out-of-range are in red. Not available with an **AOC** and **Host/Media Loopback** mode.
- **Optical RX Power Test (dBm)** reports the minimum and maximum optical RX power values; in-range values are displayed in green while out-of-range are in red. Not available with **Host/Media Loopback** mode.
- **Bit Error Test** reports the bit error count; a count value smaller or equal to the BER threshold is displayed in green while a bigger value is in red.
- **Excessive Skew Test** reports the highest skew value monitored during the sub-test; a value smaller than the threshold is displayed in green while a value crossing the threshold is in red. Only available for parallel interfaces with the exception of transceivers using RS-FEC (100GBASE-SR4, 100GBASE-SR4 AOC, 100GE-CWDM4, 100GE-CLR4).

## Test Results

### Summary - iOptics

---

## Monitoring

- **Power Consumption** graphically displays a meter representing the transceiver power consumption in Watt. Not available on 8870 and 8880 modules.

The **Current (A)** and **Power (W)** values (**Actual** and **Maximum**) for 3.3V source are displayed.

- **Temperature** graphically displays a meter representing the transceiver temperature in °C.

The current (**Actual**) and maximum temperature values are also displayed.

**Note:** *The green region is delimited from 0 to the Threshold corresponding to a **PASS** verdict. The red region beyond the threshold corresponds to a **FAIL** verdict.*

## Summary - iSAM

From the test menu, tap **Results**, and the **Summary** tab.

- **Start Time** indicates the date and time the test was started. The date and time reset every time the test is restarted.

### Service Configuration Test and Service Performance Test

- **RFC 6349 Results** button allows displaying summary results for **RFC 6349 Test** when results don't fit on one page.
- The actual test status is displayed as follows:

Test Status	Description
"--"	Test has not started.
<b>Disabled</b>	Test/subtests is/are disabled.
<b>Running</b>	Test/subtest is currently running.
<b>Data Transfer</b>	Test/subtest is running but no test traffic is being transmitted.
<b>Completed, &lt;Verdict&gt;</b>	Test/subtest has completed with the test pass/fail verdict. A fail verdict is declared when a Link Down or LOS is detected, or when any SLA parameter fails.
<b>Aborted, &lt;reason&gt;</b>	Test/subtest has been aborted either manually (Stop) or automatically from an alarm and the reason why the test has been aborted is also displayed as follows: <b>Link down alarm, LOS alarm, Timeout during execution, DTS connection failed, Loss of remote connection (DTS), Unresolved addresses, Stopped, NAT detection failed</b>

## Test Results

### Summary - iSAM

---

For **Dual Test Set** the following values are reported for both local to remote (**L->R**) and remote to local (**R->L**).

- **Service** indicates the service's number and name.  
The pass/fail verdict icon is displayed next to the service name indicating if the service complies to the configured SLA parameters.
- **TX CIR (Mbit/s)** indicates the transmitted Committed Information Rate.
- **FD (ms) (RTT<sup>1</sup>) (Latency)** indicates the maximum measured round-trip latency (Frame Delay). The pass/fail verdict is also displayed.
- **IFDV (ms) (Jitter)** indicates the maximum measured Inter Frame Delay Variation. The pass/fail verdict is also displayed.
- **FLR (%) (Frame Loss)** indicates the maximum percentage of frames that are lost (Frame Loss Ratio) from the CIR step. The pass/fail verdict is also displayed.
- **RX Rate (Mbit/s)** indicates either the measured maximum utilization throughput for **Service Configuration Test** or the measured average utilization throughput for **Service Performance Test**. The pass/fail verdict is also displayed.
- **Total RX Rate**, available for **Service Performance Test**, indicates the average utilization throughput for all services (both directions are displayed for **Dual Test Set**).

---

1. RTT is only displayed for Dual Test Set.

## RFC 6349 Test

- **Configuration/Performance Results** button allows displaying summary results for **Service Configuration Test** and **Service Performance Test** when results don't fit on one page.
- **Test Status** indicates the actual test status as follows:

Test Status	Description
"--"	Test has not started.
In Progress	The test is running.
Completed, <Verdict>	Test has completed and the test pass/fail verdict is displayed when enabled. A fail verdict is declared if any of the following conditions occurs: Link Down, LOS, TCP Throughput verdict failed, or an abort condition (Timeout, DTS connection lost, unresolved address, user stopped, configuration synchronization error, invalid MTU).
Aborted, <reason>	Test has been aborted either manually (Stop) or automatically from an alarm and the reason is displayed as follows: <b>Link down alarm, LOS alarm, Timeout during execution, DTS connection failed, Invalid Configuration, Unresolved addresses, Invalid MTU, User Stopped, TCP Timeout, TCP Connection failed, NAT detection failed</b>

- **MTU (bytes)** is the validated Maximum Transfer Unit.
- **Minimum RTT (ms)** is the minimum time between the first bit of a segment sent and the last bit of the corresponding acknowledge.
- **TCP Throughput**
  - **Service** indicates the service's number and name. The pass/fail verdict icon is displayed next to the service name. A fail verdict is declared if any of the following conditions occurs: Link Down, LOS, TCP Throughput verdict failed, or an abort condition (Timeout, DTS connection lost, unresolved address, user stopped, configuration synchronization error, invalid MTU).
  - **L->R** and **R->L** indicates respectively the direction from local to remote and remote to local.

## Test Results

### Summary - iSAM

---

- **Window** indicates the total Max Window (1 KiB = 1024 bytes) followed by the number of connections and KiB per connection in parenthesis as follows: (n conn.@ n KiB).
- **Ideal L4** indicates the ideal TCP throughput metric.
- **Actual L4** indicates the average of actual TCP Throughput metric. The pass/fail verdict icon is displayed next to the this metric. A value greater or equal to the defined threshold gives a pass verdict.
- **TCP Efficiency (%)** indicates the TCP Efficiency metric based on transmitted and retransmitted bytes.
- **Buffer Delay (%)** indicates the Buffer Delay percentage metric which represents the increase in RTT during a TCP Throughput test versus the **Minimum RTT**.

## Summary - Link OAM

From the **Test** menu, tap **Results**, and the **Summary** tab.

- **Test Status** displays the current status of the test. The global test pass/fail verdict is displayed next to the **Test Status** field when enabled.

--: Idle state, the test is not running or results are not available.

**In Progress:** The test is running.

**Completed:** The test is completed, stopped at the planned time, or manually stopped when there is no set timer.

**Aborted:** The test is interrupted; stopped before the set timer.

- **Start Time** indicates the date and time the test was started. The date and time reset every time the test is restarted or reset.
- **Test Recovery**, when displayed, indicates that the test has automatically recovered from a power failure. The number of occurrences is also displayed next to the **Test Recovery** field. Refer to *Power Failure Recovery* on page 767.
- **Logger Full**, when displayed, indicates that the logger is full. Refer to *Logger* on page 477.

## Alarms

- **Link OAM** indicates that no OAM Information PDUs were received for 5 seconds.
- **Critical Event:** Indicates that the OAM link partner has sent a critical event notification (bit 2 of the Flags field is set to 1).

## Test Results

### Summary - Link OAM

---

- **Dying Gasp:** Indicates that the OAM link partner has sent an unrecoverable local failure notification (bit 1 of the Flags field is set to 1).
- **Link Fault:** Indicates that the OAM link partner has sent a link fault notification (bit 0 of the Flags field is set to 1).

## Loopback

- **Local** indicates the **Status** of the local loopback (**Enabled** or **Disabled**) and allows enabling or disabling it.
- **Remote**<sup>1</sup> indicates the **Status** of the remote loopback (**Enabled** or **Disabled**), the number of **Successful** remote loopback requests, the number of **Fail** remote loopback requests, and allows enabling or disabling it.

## OAMPDU Frame Count

- Indicates the number of transmitted and received OAMPDU frames of the following types:
  - **Information**
  - **Loopback Control**
  - **Event Notification** (received only)
- **Total** indicates the total number of transmitted and received OAMPDU frames.

---

1. Statistics are influenced by both the protocol (Parser Action is set to "01") and physical loopback. The Fail and Successful counters will be affected by successive enable/disable loopback requests when sending a loopback request to a remote module running Link OAM test since it does not provide physical loopback.



## Summary - Multi-Channel OTN

From the test menu, tap **Results**, and the **Summary** tab.

- Τεστ Στατους displays the current status of the test.
  - --: Idle state, the test is not running or results are not available.
  - **In Progress**: The test is running.
  - **Completed**: The test is completed, stopped at the planned time, or manually stopped when there is no set timer.
- **Start Time** indicates the date and time the test was started. The date and time reset every time the test is restarted or reset.
- **Test Recovery**, when displayed, indicates that the test has automatically recovered from a power failure. The number of occurrences is also displayed next to the **Test Recovery** field. Refer to *Power Failure Recovery* on page 767.
- **Logger Full**, when displayed, indicates that the logger is full. Refer to *Logger* on page 477.

### Alarms/Errors, Traces, and Payload Type

The results displayed are for the first channel by default. Tap on one of the button described on the next page to select the results to be displayed. The selected button has an amber background.

When a channel button is selected:

- The channel number is displayed indicating the selected channel.
- A channel selector becomes available when zooming a result block allowing to select a specific channel.

## Test Results

Summary - Multi-Channel OTN

### Interface / OTL / OTU4, ODU4, and Channel Buttons

**Note:** Refer to Alarms/Errors on page 456 for more information on alarms/errors and alarms/errors injection.

- **Interface / OTL / OTU4** displays alarms/errors for **Interface** (see page 911), **Clock** (see page 890), **OTL** (see page 924), and **OTU4** (see page 927) as well as the received **SM TTI Traces** (see page 608).
- **ODU4** displays alarms/error at **ODU4** (see page 919) and **OPU4** (see page 923) levels as well as the received **PM TTI Traces** (see page 608) and received **Payload Type** (see page 466).
- **1, 2, up to 80**, depending on the OTN multiplexing, displays alarms/error for a specific channel including: **ODU<sub>x</sub>** (see page 919), **OPU<sub>x</sub>** (see page 923), **ODTU4.1 - GMP** (see page 911), **BERT** (see page 521), **SDT** (see page 522), received **PM TTI Traces** (see page 608), and received **Payload Type** (see page 466).

Buttons use different background colors representing current and history alarms/errors. An orange background indicates the selected button.

Background color	Alarm/ Error <sup>a</sup>	Description
Gray	Current	No test result available.
	History	
Green	Current	No alarm/error has occurred in the last second.
	History	No alarm/error has occurred during the test.
Red	Current	An alarm/error occurred in the last second.
	History	
Amber	History	At least one alarm/error has occurred during the test.

- a. History background color is presented on the left side of the button while Current background color is covering the rest of the button.

## Summary - NI/CSU Emulation

From the **Test** menu, tap **Results**, and the **Summary** tab.

- **Test Status** displays the current status of the test. The global test pass/fail verdict is displayed next to the **Test Status** field when enabled. The Pass/Fail verdict is based on the following criteria: The worst pair's **Wire Map**, **Prop. Delay**, **Delay Skew**, and **Length**.

--: Idle state, the test is not running or results are not available.

**In Progress:** The test is running.

**Completed:** The test is completed, stopped at the planned time, or manually stopped when there is no set timer.

- **Start Time** indicates the date and time the test was started. The date and time reset every time the test is restarted or reset.

### Auto-Response/Manual Loopback Status

Indicates the status of the loopback:

- **Loopback Active**
- **No Loopback.**

### Interface

See *Interface* on page 911 for more information on Interface alarms/errors.

### DS1

See *DS1* on page 892 for more information on DS1 alarms/errors.

## Test Results

*Summary - RFC 2544*

---

### Summary - RFC 2544

From the **Test** menu, tap **Results**, and the **Summary** tab.

- **Start Time** indicates the date and time the test was started. The date and time reset every time the test is restarted or reset. For **Dual Test Set**, this is the only information available on the remote unit.
- **Test Recovery**, when displayed, indicates that the test has automatically recovered from a power failure. The number of occurrences is also displayed next to the **Test Recovery** field. Refer to *Power Failure Recovery* on page 767.
- **Logger Full**, when displayed, indicates that the logger is full. Refer to *Logger* on page 477.
- **Remote unit in Dual Test Set Mode** indicates that this unit is set as remote but the DTS Connection is not established.
- **Remote unit in use and locked for Dual Test Set** indicates that this unit is used for **Dual Test Set** as the remote unit.

## Throughput, Back-to-Back, Frame Loss, and Latency Subtests

- **Throughput, Back-to-Back, Frame Loss, and Latency**

For each subtest, its status (-- (Idle), **In Progress**, **Completed**, or **Aborted** - (reason)) and duration are displayed.
- **TX Frames<sup>1</sup>** and **RX Frames<sup>1</sup>** display the transmitted and received frame counts of the subtest in progress. For **Dual Test Set**, frame counts are available for both local (**L**) and remote (**R**) directions. For Dual Port topology, frame counts are available for both port directions.
- **Trial #<sup>1</sup>** displays the current trial iteration of the subtest in progress when applicable.
- **Val. #<sup>1</sup>** displays the current validation iteration of the subtest in progress when applicable.
- **Step<sup>1</sup>** displays the current step of the subtest in progress when applicable.
- **Displayed Results:** Select the displayed result mode: **Current**, **Minimum** (default), **Maximum**, or **Average**.
- **Throughput/Back-to-Back/Frame Loss/Latency** table.

Each frame size used for the test is displayed with its subtest statistics. Statistics values are displayed based on the **Displayed Results** setting.

“--” indicates that the result is not available because the test has not run yet. While testing, one of the following messages is displayed for each frame size: **Initializing**, **Learning**, **Testing**, **Waiting**, **Not measurable**, **Aborted**, **Link is Down**, or **MAC not resolved**.

**Dir.** (Direction), available with **Dual Test Set** or **Dual Port** topology, indicates respectively results for both local (**L**) and remote (**R**) directions, or for both port directions.

---

1. Only displayed once the test is started.

## Test Results

Summary - RFC 2544

---

- **Unit:** Select the subtest result unit:
  - For Throughput: **Mbit/s**, **Gbit/s**, **frame/s**, and %.
  - For Back-to-Back: **Mbit/s**, **Gbit/s**, **frame/burst**, and %.
  - Frame Loss: %.
  - Latency: **ms** and **μs**.
  
- **Layer:** For Throughput and Back-to-Back subtests, select the subtest layers used to calculate the throughput.
  - All** (default): Layer 1,2,3 contains the Idle, Preamble, Start of Frame Delimiter, MAC address, IP address, and data.
  - Ethernet:** Layer 2,3 contains the MAC layer, IP layer, and data.
  - IP:** Layer 3 contains the IP layer, and data.
  
- **Step:** For Frame Loss subtest, selects the step (%) of the testing rate to be displayed.
  
- **Mode:** For Latency subtest, selects the propagation time mode.
  - Cut Through** (default) allows the calculation of the propagation time of a bit (Bit Latency).
  - S. & F.** (Store and Forward) allows the calculation of the propagation time of a frame (Frame Latency).

## Summary - RFC 6349

From the test menu, tap **Results**, and the **Summary** tab.

**Note:** For *Dual Test Set* on the remote unit only the following are available: *Test Status, Start Time, Test Recovery, Remote unit in Dual Test Set Mode, and Remote unit in use and locked for Dual Test Set.*

**Note:** For *iPerf Compatible Server* operation mode only the following are available: *Test Status, Start Time, Test Recovery, Active Connections, and Connection Details.*

- **Test Status** displays the current status of the test. The global test pass/fail verdict is displayed next to the **Test Status** field when enabled. A fail verdict is declared if any of the following conditions occurs: Link Down, LOS, TCP Throughput verdict failed, or any abort condition.
- --: Idle state, the test is not running or results are not available.

For **Dual Test Set**:

- **In Progress:** The test is running.
- **Completed:** The test is completed, stopped at the planned time, or manually stopped when there is no set timer.

## Test Results

Summary - RFC 6349

---

For **Dual Test Set** (local unit):

- **Data Transfer:** The test is running but no traffic is being transmitted because the local and remote units are exchanging data.
- **Aborted:** The test is interrupted; stopped before the set timer. An abort condition is reported: **Link Down Alarm, LOS Alarm, DTS Connection failed, No Communication with Remote, Remote is busy, Unexpected response from Remote, Timeout during execution, Invalid Configuration, Unresolved addresses, Invalid MTU, User stopped, TCP Timeout, TCP Connection failed, NAT detection failed**

For **iPerf Compatible Server**:

- **Listening:** The test is running but the server does not have any active connections.
- **Connected:** The test is running and the server has at least one active connection.
- **Completed:** The test is manually stopped.
- **Start Time** indicates the date and time the test was started. The date and time reset every time the test is restarted or reset. This is the only information available on the remote unit.
- **Test Recovery**, when displayed, indicates that the test has automatically recovered from a power failure. The number of occurrences is also displayed next to the **Test Recovery** field. Refer to *Power Failure Recovery* on page 767.
- **Logger Full**, when displayed, indicates that the logger is full. Refer to *Logger* on page 477.
- **Remote unit in use and locked for Dual Test Set** indicates that this unit is used for **Dual Test Set** as the remote unit.
- **Remote unit in Dual Test Set Mode** indicates that this unit is set as remote but the DTS Connection is not established.



- **MTU (bytes)** indicates the validated Maximum Transfer Unit.
- **Minimum RTT (ms)** indicates the minimum time between the first bit of a segment sent and the last bit of the corresponding acknowledge.
- **Active Connections**, available with iPerf Compatible Server, displays the number of active TCP connections reported by the iPerf compatible server.
- **Connection Details**, available for iPerf Compatible Server, displays the list of each client IP address and their number of TCP connections.

## Window Sweep

- **L->R** and **R->L** indicates respectively the direction from local to remote and remote to local.
- **Actual L4** indicates for each step the average TCP throughput metric. **Boost** appearing next to the **BDP** step label indicates that **Window Boost** factor is applied.

## TCP Throughput

- **L->R** and **R->L** indicates respectively the direction from local to remote and remote to local.
- **Window** indicates the total maximum send window in KiB (1 KiB = 1024 bytes) followed by the number of connections and KiB per connection in parenthesis as follows: (n conn. @ n KiB). **Boost** appearing next to the **Window** label indicates that **Window Boost** factor is applied.
- **Ideal L4** indicates the ideal TCP throughput metric.
- **Actual L4** indicates the average of actual TCP Throughput metric. The pass/fail verdict icon is displayed next to the this metric when enabled. A value greater or equal to the defined threshold gives a pass verdict.
- **TCP Efficiency (%)** indicates the TCP Efficiency metric based on transmitted and retransmitted bytes.

## Test Results

Summary - RFC 6349

---

- **Buffer Delay (%)** indicates the Buffer Delay percentage metric which represents the increase in RTT during a TCP Throughput test versus the **Minimum RTT**.
- **Threshold (% of ideal)** allows entering the TCP Throughput as a percentage of the defined CIR that will be used to declare the pass/fail verdict for both directions: **0** to **100 %**; default is **95 %**. The calculated throughput based on the selected threshold is displayed for both directions.
- **Recommended Window Boost** suggests the window boost factor value(s) to apply per direction when the **Actual L4** metric fails. The recommendation is provided when:
  - **Buffer Delay** percentage value is positive.
  - **Window Boost - Enable** check box is cleared (refer to page 366).
  - **TCP Efficiency** is acceptable.

**Apply and Start** applies the recommended window boost factor for direction(s) that failed and start the test. A boost factor of 1 is applied for a direction that didn't fail. The window boost factor values and the **Window Boost - Enable** check box are updated accordingly in test setup (refer to page 366).

## Summary - Smart Loopback

From the **Test** menu, tap **Results**, and the **Summary** tab.

- **Test Status** displays the current status of the test. The global test pass/fail verdict is displayed next to the **Test Status** field when enabled.

--: Idle state, the test is not running or results are not available.

**In Progress:** The test is running.

**Completed:** The test is completed, stopped at the planned time, or manually stopped when there is no set timer.

**Aborted:** The test is interrupted; stopped before the set timer.

- **Start Time** indicates the date and time the test was started. The date and time reset every time the test is restarted or reset.
- **Test Recovery**, when displayed, indicates that the test has automatically recovered from a power failure. The number of occurrences is also displayed next to the **Test Recovery** field. Refer to *Power Failure Recovery* on page 767.
- **Logger Full**, when displayed, indicates that the logger is full. Refer to *Logger* on page 477.

## Traffic

**Note:** See *Traffic - Ethernet* on page 616 for more information.

## Test Results

### Summary - S-OAM and MPLS-TP OAM

---

## Summary - S-OAM and MPLS-TP OAM

From the **Test** menu, tap **Results**, and the **Summary** tab.

- **Test Status** displays the current status of the test. The global test pass/fail verdict is displayed next to the **Test Status** field when enabled.

--: Idle state, the test is not running or results are not available.

**In Progress:** The test is running.

**Completed:** The test is completed, stopped at the planned time, or manually stopped when there is no set timer.

**Aborted:** The test is interrupted; stopped before the set timer.

- **Start Time** indicates the date and time the test was started. The date and time reset every time the test is restarted or reset.
- **Test Recovery**, when displayed, indicates that the test has automatically recovered from a power failure. The number of occurrences is also displayed next to the **Test Recovery** field. Refer to *Power Failure Recovery* on page 767.
- **Logger Full**, when displayed, indicates that the logger is full. Refer to *Logger* on page 477.

## Continuity Check (Peer MEP)

- **Status** displays the status of the continuity check with the peer MEP.

Status	Description
Loss Continuity	Loss of Continuity alarm is active.
Mismerge	Mismerge alarm is active.
Unexpected MEG Level	Unexpected MEG Level alarm is active.
Unexpected MEP	Unexpected MEP alarm is active.
Unexpected Period	Unexpected Period alarm is active.
Unexpected MD Level	Unexpected MD Level alarm is active.
Receiving CCMs	CCM frames from the peer MEP are received without alarms.

- **TX CCM** indicates the count of transmitted CCM frames.
- **RX CCM** indicates the count of valid CCM frames received. A valid frame for S-OAM has its source MAC address matching the Peer MEP MAC address; destination MAC address matching either the unit port Unicast MAC address or a Multicast class 1 address (refer to 867); and VLANs matching the unit port VLANs. A valid frame for MPLS-TP OAM has its destination MAC address matching either the unit MAC address, FF:FF:FF:FF:FF:FF, or 01:00:5E:90:00:00; VLANs matching the unit port VLANs; and MPL Labels matching the local MPLS Label Stack configuration.

## Test Results

### Summary - S-OAM and MPLS-TP OAM

---

- **CCM** indicates the content of the last received CCM frame including **MEG ID** (Y.1731 and G.8113.1), **Domain ID** (802.1ag and MEF), **MA Name** (802.1ag and MEF), **MEG Level** (Y.1731, MEF, and G.8113.1), **MD Level** (802.1ag), **MEP ID**, and **Period**.

For unsupported **Domain ID**, **MA Name**, and **MEG ID**, the **Unexpected Format** message is displayed.

	<b>Supported Format</b>
<b>Domain ID</b>	1 (No Maintenance Domain Name present) 4 (Character String)
<b>MA Name</b>	2 (Character String)
<b>MEG ID</b>	32 (ICC based format) 33 (CC and ICC based format)

## Loopback / Test / Frame Delay / Frame Loss / Synthetic Loss

**Note:** *Either Loopback, Test, Frame Delay, Frame Loss, or Synthetic Loss (available with Ethernet OAM) statistics are displayed according with the selected test function (refer to Test Function on page 373).*

➤ **Status** displays the status of the test function.

For **Loopback, Frame Delay, Frame Loss, and Synthetic Loss** (available with Ethernet OAM) functions:

Status	Description
Idle	No Results (function did not run yet).
In Progress	Test is in progress. Frames are being transmitted and monitored.
Completed	Test is completed: The test with continuous transmission is manually stopped and replies have been received or timed out. The test with continuous transmission is automatically stopped by a test timer and replies have been received or timed out. All frames of the test with non-continuous transmission have been transmitted and replies have been received or timed out.
Aborted	Test is aborted. The test with non-continuous transmission is stopped before all the frames are transmitted.

For **Test** function:

Status	Description
Idle	No Results (function did not run yet).
In Progress	Test is in progress. RX TST frames are being monitored.
Completed	Test is completed. The test is stopped or function is disabled after being In Progress state.

## Test Results

*Summary - S-OAM and MPLS-TP OAM*

---

- **RX Line Utilization** meter and value, available with **Loopback** function, indicate the line rate utilization percentage (only LBR frames are considered) received in the last second.
- **TST RX Rate** meter and value, available with **Test** function, indicate the quantity of TST frames received in the last second.
- **Frame Delay** meter and value, available with **Frame Delay** function, indicate the average of the measured frame delays in the last second.
- **Frame Loss Ratio** meter, available with **Frame Loss** function, indicates for both Near-End and Far-End the last measured frame loss ratio in the last second.
- **Synthetic Loss Ratio** meter, available with **Synthetic Loss** function which is available with Ethernet OAM, indicates for both Near-End and Far-End the last measured Synthetic Loss ratio in the last second.

**Note:** *Refer to S-OAM and MPLS-TP OAM on page 503 for more alarms/errors/statistics information.*

## Summary

Refer to *S-OAM and MPLS-TP OAM* on page 503 for more information on alarms.

## Thresholds

Refer to *Thresholds* on page 369 for more information.



## Summary - SyncE

From the test menu, tap **Results**, and the **Summary** tab.

- **Test Status** displays the current status of the test. The global test pass/fail verdict is displayed next to the **Test Status** field when enabled.

--: Idle state, the test is not running or results are not available.

**In Progress:** The test is running.

**Completed:** The test is completed, stopped at the planned time, or manually stopped when there is no set timer.

**Aborted:** The test is interrupted; stopped before the set timer.

- **Start Time** indicates the date and time the test was started. The date and time reset every time the test is restarted or reset.
- **Test Recovery**, when displayed, indicates that the test has automatically recovered from a power failure. The number of occurrences is also displayed next to the **Test Recovery** field. Refer to *Power Failure Recovery* on page 767.
- **Logger Full**, when displayed, indicates that the logger is full. Refer to *Logger* on page 477.

## Test Results

Summary - SyncE

---

### ESMC

Indicates the current (meter and value), average, minimum, and maximum ESMC frame rate (including information and event frames) received in frame/s. A fail verdict is also displayed beside the minimum and/or maximum values when the ESMC frame rate is outside the range while the Pass/Fail Verdict is enabled.

**ESMC RX Rate** meter displays the current ESMC frame rate (including information and event frames) in frame/s averaged over the last 11 frames received. The pass/fail verdict is also displayed when enabled.

**Note:** *When the **Pass/Fail Verdict** and **ESMC Rate Threshold** check boxes are selected (see page 416), the green region is delimited from 0.8 to 10.2 frames/s corresponding to a **PASS** verdict. The red regions above and beyond the threshold correspond to a **FAIL** verdict. There is neither green nor red region when the Pass/Fail verdict is disabled.*

## **RX**

- **Last QL Message** indicates the last Quality Level value received. The pass/fail verdict is also displayed when both **QL Mismatch Monitoring** and **Pass/Fail Verdict** check boxes are selected.

**Last Change** indicates the date and time of the Last QL Message has changed.

- **Information/Event Count** gives respectively the count of information and event frames generated for all Quality Level values.
- **QL Mismatch Frame Count** gives the total count of information and/or event frames received not matching the expected Quality Level. Only available when the **QL Mismatch Monitoring** check box is selected.
- **Frequency/Offset** indicates respectively the frequency and the offset between the standard rate specification and the rate of the input signal.
- **Max. (-/+ ) Offset (ppm)** indicates respectively the minimum and maximum offset between the standard rate specification and the largest/smallest rate recorded from the received signal.

## **TX**

- **QL Message** indicates the Quality Level value that is generated.

**Last Change** indicates the date and time of the QL Message value has changed. For 1GE Electrical interface using **Local Clock** set to **Slave**, the **Last Change** is not available.

- **Information/Event Count** gives respectively the count of information and event frames generated for all Quality Level values. **Event Count** is not available with 1GE Electrical interface using remote local clock.

## Summary - TCP Throughput

From the test menu, tap **Results**, and the **Summary** tab.

- **Test Status** displays the current status of the test.

--: Idle state, the test is not running or results are not available.

**In Progress:** The test is running.

**Completed:** The test is completed, stopped at the planned time, or manually stopped when there is no set timer.

**Aborted:** The test is interrupted; stopped before the set timer. An abort condition is reported: **TCP Session Closed** or **Remote IP Not Found**.

- **Start Time** indicates the date and time the test was started. The date and time reset every time the test is restarted or reset.
- **Test Recovery**, when displayed, indicates that the test has automatically recovered from a power failure. The number of occurrences is also displayed next to the **Test Recovery** field. Refer to *Power Failure Recovery* on page 767.
- **Logger Full**, when displayed, indicates that the logger is full. Refer to *Logger* on page 477.

## TCP Throughput

- **TCP Connection Status** indicates the actual TCP connection status.

Test Status	Description
"--"	The test is not running or results are not available.
In Progress	The TCP initialization algorithm is in progress.
Waiting	Indicates on the remote unit that the test is started but the TCP initialization algorithm is not initiated by the local unit.
Established	The TCP session has been successfully established between the local and remote units.
Closed	The session is closed. Either no TCP initialization algorithm has been received, the remote unit has received and completed the request to close the TCP session, or no data has been received at the remote unit for 30 seconds.
Closing	The TCP protocol is closing down the connection.
Remote IP not found	The local unit didn't received an answer to the ARP request sent to the IP address of the remote unit.

- **Transmitted Frames** indicates the total of frames transmitted by the local unit excluding the re-transmitted frames.
- **Re-transmitted Frames** indicates the total of frames that have been re-transmitted by the local unit.
- **Efficiency (%)** indicates the percentage of bytes that were not retransmitted.
- **Window Size Unit** allows selecting the unit used for **Window Size: Bytes, KBytes, or MBytes** (default).
- **Throughput Threshold** allows setting the pass/fail verdict threshold value: **0 to 100 %** (default). This setting is available when the **Throughput Pass/Fail Verdict** check box is selected (refer to *TCP Throughput* on page 426).
- **Throughput** meter displays the last second TCP Throughput measurement.

## Test Results

### *Summary - TCP Throughput*

---

- **TCP Throughput** displays respectively the last, minimum, maximum, and average TCP Throughput measurement.
- **Window Size** displays respectively the last, minimum, and maximum TCP window size.
- **Round Trip Latency (ms)** displays respectively the last, minimum, maximum, and average round trip time gathered from the TCP Throughput test.

## Ethernet Traffic

**Note:** See Traffic - Ethernet on page 616 for more information.

## Summary - Through Mode

From the **Test** menu, tap **Results**, and the **Summary** tab.

- **Test Status** displays the current status of the test. The global test pass/fail verdict is displayed next to the **Test Status** field when enabled.

--: Idle state, the test is not running or results are not available.

**In Progress:** The test is running.

**Completed:** The test is completed, stopped at the planned time, or manually stopped when there is no set timer.

**Aborted:** The test is interrupted; stopped before the set timer.

- **Start Time** indicates the date and time the test was started. The date and time reset every time the test is restarted or reset.
- **Test Recovery**, when displayed, indicates that the test has automatically recovered from a power failure. The number of occurrences is also displayed next to the **Test Recovery** field. Refer to *Power Failure Recovery* on page 767.
- **Logger Full**, when displayed, indicates that the logger is full. Refer to *Logger* on page 477.

## Traffic / Traffic Ethernet

**Note:** See *Traffic - Ethernet* on page 616 for more information.

## Test Results

### Summary - Through Mode

---

## RX Frequency

**Note:** *RX Frequency is available on both ports for rates up to 10G LAN. Not available for a port using an active copper SFP.*

- **Frequency (GHz)** indicates the frequency of the input signal.
- **Offset (ppm)** indicates the frequency offset between the standard rate specification and the rate at the input signal.

**Note:** *For both **Frequency** and **Offset** the following background colors are used.*

Background color	Description
Green	The frequency is in range.
Red	The frequency is out-of-range or LOC Lane. LOC is also displayed.
Gray	Pending state.



## Summary - Traffic Gen & Mon

From the **Test** menu, tap **Results**, and the **Summary** tab.

- <Port #>, available with **Dual Port** topology, allows selecting the port to be displayed.
- **Test Status** displays the current status of the test. The global test pass/fail verdict is displayed next to the **Test Status** field when enabled.

--: Idle state, the test is not running or results are not available.

**In Progress:** The test is running.

**Completed:** The test is completed, stopped at the planned time, or manually stopped when there is no set timer.

**Aborted:** The test is interrupted; stopped before the set timer.

- **Start Time** indicates the date and time the test was started. The date and time reset every time the test is restarted or reset.
- **Test Recovery**, when displayed, indicates that the test has automatically recovered from a power failure. The number of occurrences is also displayed next to the **Test Recovery** field. Refer to *Power Failure Recovery* on page 767.
- **Logger Full**, when displayed, indicates that the logger is full. Refer to *Logger* on page 477.

## Test Results

*Summary - Traffic Gen & Mon*

---

### Stream

- **Stream** indicates the stream number and provides stream detailed statistics when tapping on its button (see *Summary - Stream - Traffic Gen & Mon* on page 601).

The following statistics are available for each stream.

- **Current Throughput:** See *Streams - Throughput / Customer Frame Throughput* on page 519.
- **Frame Loss Rate:** See *Streams - Frame Loss / Out-of-Sequence* on page 517.
- **Jitter:** See *Streams - Jitter* on page 517.
- **Latency:** See *Streams - Latency* on page 518.
- **Out-of-Sequence:** See *Streams - Frame Loss / Out-of-Sequence* on page 517.

## Summary - Stream - Traffic Gen & Mon

**Note:** Available from Summary - Traffic Gen & Mon - Stream. For **Test Status**, **Start Time**, **Test Recovery**, and **Logger Full** see Summary - Traffic Gen & Mon on page 599 .

- **Latency Unit** allows selecting either **ms** (default) or **μs** as the reference unit for **Latency** and **Jitter**.
- **Stream Selection:** Select a stream by either using the left/right arrow or by tapping over the stream numbers area then tapping on a specific stream number. An orange background indicates the selected stream.
- **Throughput**, **Jitter**, and **Latency** meters display respectively the measured Throughput, Jitter, and Latency for the selected stream.

**Note:** The green region defined by the configured threshold corresponds to a **PASS** verdict while the red regions corresponds to a **FAIL** verdict. The verdict is only displayed when enabled (see QoS Metrics on page 414).

- **Jitter:** See *Streams - Jitter* on page 517.
- **Latency:** See *Streams - Latency* on page 518.
- **RX Rate:** See *Streams - Throughput / Customer Frame Throughput* on page 519.
- **RX Frame Count** indicates the number of frame received matching the selected stream.
- **TX Rate:** See *Streams - Throughput / Customer Frame Throughput* on page 519.
- **TX Frame Count** indicates the number of transmitted frames matching the selected stream.
- **Frame Loss** and **Out-of-Sequence:** See *Streams - Frame Loss / Out-of-Sequence* on page 517.

## Test Results

Summary - Time Error / Wander

---

### Summary - Time Error / Wander

From the test menu, tap **Results**, and the **Summary** tab.

**Note:** *With the G.8275.2 profile, the TE values are only available 200 seconds after the test is started as the calculation method requires a sample selection window of 200 seconds.*

- **Test Status** displays the current status of the test. The global test pass/fail verdict is displayed next to the **Test Status** field when enabled.

--: Idle state, the test is not running or results are not available.

**In Progress:** The test is running.

**Completed:** The test is completed, stopped at the planned time, or manually stopped when there is no set timer.

**Aborted:** The test has been aborted either manually (Stop) or automatically from an alarm/error:

- Any signal/interface alarm.
- **REF-FAULT** (reference signal alarm)
- For G.8275.1 profile: **Domain Mismatch, Loss Sync, Loss Announce**
- **Start Time** indicates the date and time the test was started. The date and time reset every time the test is restarted or reset.
- **Test Recovery**, when displayed, indicates that the test has automatically recovered from a power failure. The number of occurrences is also displayed next to the **Test Recovery** field. Refer to *Power Failure Recovery* on page 767.
- **Logger Full**, when displayed, indicates that the logger is full. Refer to *Logger* on page 477.

## **Time Error / Time Interval Error Metrics**

- **MTIE** label and the pass/fail verdict icon are displayed when enabled and the test is running.
- **TDEV** label and the pass/fail verdict icon are displayed when enabled and the test is running.

For Time Error measurement with either G.8275.1 profile or 1PPS interface:

**Note:** *The following metrics are collected using 0.1 Hz Low-Pass filtering.*

- **TE (ns)** indicates the last time error value collected in the last second.
- **Max TE (ns)** indicates the maximum time error value collected since the beginning of the test.
- **Min TE (ns)** indicates the minimum time error value collected since the beginning of the test.
- **Max Absolute TE (ns)** indicates the maximum absolute time error value collected since the beginning of the test. The pass/fail verdict is also displayed when enabled.
- **dTE<sub>H</sub> pk-pk (ns)** indicates the dynamic time error peak-to-peak over a defined observation period (refer to **dTE<sub>H</sub> Observation Period** on page 430). The first value is only available after the initial observation period has elapsed, the value is then updated every second.
- **Max dTE<sub>H</sub> pk-pk (ns)** indicates maximum dynamic time error peak-to-peak since the beginning of the test. The pass/fail verdict is also displayed when enabled.

## Test Results

### Summary - Time Error / Wander

---

**Note:** *The following metrics are collected without any filtering.*

- **cTE (ns)** indicates the constant time error which is an average value of time error over the defined period as follows (refer to **cTE Averaging Period** on page 430):
  - since the beginning of the test when the **cTE Averaging Period** is set to **Elapsed Time**.
  - for the averaging period defined when the **cTE Averaging Period** is set to a value other than the **Elapsed Time**. The first value is only available after the initial average period has elapsed, the value is then updated every second.

**Note:** *When cTE Averaging Period (s) is set to Elapsed time, the Last cTE (ns) value is displayed, otherwise Max cTE (ns) is displayed.*

- **Last cTE (ns)** indicates the last cTE value collected. The pass/fail verdict is also displayed when enabled.
- **Max cTE (ns)** indicates the maximum cTE value collected since the beginning of the test. The pass/fail verdict is also displayed when enabled.

For Time Error measurement with G.8275.2 profile:

**Note:** *The following metrics are collected using 0.1 Hz Low-Pass filtering.*

- **Pkt sel TE (ns)** indicates the last packet selected time error value collected in the last second.
- **Max pkt sel TE (ns)** indicates the maximum packet selected time error value collected since the beginning of the test.
- **Min pkt sel TE (ns)** indicates the minimum packet selected time error value collected since the beginning of the test.

- **Max Abs TE (ns)** the maximum absolute packet selected time error value collected since the beginning of the test. The pass/fail verdict is also displayed when enabled.

**Pk-pk pkt sel TE (ns)** indicates the peak-to-peak packet selected time error value collected since the beginning of the test (the difference between **Min pkt sel TE** and **Max pkt sel TE** values).

## Test Results

### Summary - Time Error / Wander

---

**Note:** *The following metrics are collected without any filtering.*

- **Pkt sel cTE (ns)** indicates the packet selected constant time error which is an average value of time error over the defined period as follows (refer to **Pkt cTE Averaging Period** on page 429):
  - since the beginning of the test when the **Pkt cTE Averaging Period** is set to **Elapse Time**.
  - for the averaging period defined when the **Pkt cTE Averaging Period** is set to a value other than the **Elapse Time**. The first value is only available after the initial average period has elapsed (in addition to the sample selection window of 200 seconds), the value is then updated every  $x$  second based on the selected **Window Step Size**.
- **Max pkt sel cTE (ns)** indicates the maximum packet selected constant time error value collected since the beginning of the test. The pass/fail verdict is also displayed when enabled.

For Time Error measurement with either G.8275.1 or G.8275.2 profile:

- **PDV** indicates the difference between the delay of a packet (difference between timestamp at receiving end and the original timestamp at the transmitter) and the minimum packet delay value for the specified interval. **PDV (ns)** and **PDV Max (ns)** values are reported for both **Forward (BC -> Client)** and **Reverse (Client -> BC)** directions.

## Time Interval Error Metrics

The following metrics are available for Wander measurement.

- **TIE (ns)** indicates the Time Interval Error value collected in the last second.
- **Max TIE (ns)** indicates the Maximum Time Interval Error value collected since the beginning of the test.



- **Min TIE (ns)** indicates the Minimum Time Interval Error value collected since the beginning of the test.
- **Max TIE pk-pk (ns)** indicates the maximum Time Interval Error peak-to-peak since the beginning of the test.

## **Time Error / Time Interval Error Graph**

Dynamically displays the graph of either TE or TIE values as a function of time. The dynamic view is a sliding window displaying the last 27000 samples collected.

Zooming the graph:

- Using the touch screen: Tap two points on the graph and drag them to enlarge the view.
- Using a mouse: click and drag the region to be zoomed.

**Note:** *When the graph is zoomed, a magnifying glass button is displayed at its top-right corner for un-zooming it.*

## **Settings**

- **Sampling Rate** indicates the sampling rate value.
- **Samples** indicates the number of samples collected since the beginning of the test.
- **TE Scale / TIE Scale** allows the selection of the Y-axis scale: **Auto** (default), **800  $\mu$ s**, **200  $\mu$ s**, **2  $\mu$ s**, **400 ns**, **100 ns**.
- **Time Scale** allows the selection of the X-axis scale: **Seconds** (default), **dd HH:MM:SS**.

## Test Results

Traces - OTN

---

### Traces - OTN

From the test menu, tap **Results, Traces**, and if available the **OTN** sub-tab.

**Channel**, available with **Multi-Channel OTN** for ODUk level, allows selecting the channel to be displayed.

**Note:** *Configuration is coupled with settings from Traces - OTN on page 435.*

### OTUx, ODUx, ODUk, and TCMx Buttons

Tap on either OTUx or an ODUx button. For ODUx when TCM is enabled (see Modify TCM on page 400), tap on a TCMx button to select a TCM level. TCM is not available with Multi-Channel OTN.

### SM TTI Traces / PM TTI Traces / ODUx TCM TTI Traces

**Note:** *The TTI Traces are available for SM (OTUx), PM (ODUx), and TCM (ODUx when TCM is enabled; see **Config TCM** on page 400).*

- **SAPI** (Source Access Point Identifier) indicates the received SAPI message (TTI bytes 0 to 15). The expected SAPI message is available when the **SAPI OTU-TIM / SAPI ODU-TIM** check box is selected. A maximum of 16<sup>1</sup> characters is allowed.

TTI Traces	Default Message <sup>a</sup>
SM	EXFO OTU SAPI
PM	EXFO ODU SAPI <sup>b</sup>
TCM <sup>c</sup>	EXFO TCMi SAPI

- a. The default message contains a NULL (all 0's) character preceding it. NULL (all 0's) characters are automatically appended to the message for bytes that are not defined.
- b. The channel number is automatically appended to the message.
- c. Not available with Multi-Channel OTN.

- **DAPI** (Destination Access point Identifier) indicates the received DAPI message (TTI bytes 16 to 31). The expected DAPI message is available when the **DAPI OTU-TIM / DAPI ODU-TIM** check box is selected. A maximum of 16<sup>1</sup> characters is allowed.

TTI Traces	Default Message <sup>a</sup>
SM	EXFO OTU DAPI
PM	EXFO ODU DAPI <sup>b</sup>
TCM <sup>c</sup>	EXFO TCMi DAPI

- a. The default message contains a NULL (all 0's) character preceding it. NULL (all 0's) characters are automatically appended to the message for bytes that are not defined.
- b. The channel number is automatically appended to the message.
- c. Not available with Multi-Channel OTN.

---

1. For Multi-Channel OTN lower ODU layer, a maximum of 13 characters are allowed since the channel number is automatically appended to the message.

## Test Results

### Traces - OTN

---

- **Operator Specific** indicates the received Operator Specific message (TTI bytes 32 to 63).
- **SAPI OTU-TIM / SAPI ODU-TIM / SAPI TCM-TIM** check box, when selected (cleared by default), allows editing the expected Source Access Point Identifier and also enables OTU/ODU/TCM-TIM alarm monitoring. For Multi-Channel OTN lower ODU layer, these check boxes are only available from the test setup.
- **DAPI OTU-TIM / DAPI ODU-TIM / DAPI TCM-TIM** check box, when selected (cleared by default), allows editing the expected Destination Access Point Identifier and also enables the OTU/ODU-TIM alarm monitoring. For Multi-Channel OTN lower ODU layer, these check boxes are only available from the test setup.
- **Copy RX / Global Copy RX**<sup>1</sup> allows using the received SAPI/DAPI message as the expected one. For Multi-Channel OTN lower ODU layer, use the arrow button next to the **Copy RX** or **Global Copy RX** to switch from one button to the other. **Global Copy RX** allows using the current channel received SAPI/DAPI message as the expected one for all channels while **Copy RX** only affects the selected channel.

---

1. Only available for the lower ODU layer for Multi-Channel OTN and FlexO BERT.

## Traces - SONET/SDH

From the test menu, tap **Results, Traces**, and if available the **SONET/SDH** sub-tab.

**Note:** *Selecting a Trace byte to be generated will automatically update the corresponding OH byte. Refer to OH - SONET/SDH on page 688 for more information. Configuration is coupled with settings from Traces - SONET/SDH on page 438.*

### Traces

- **Section (J0) / RS (J0), STS Path (J1) / AU Path (J1) / TU-3 Path (J1), VT Path (J2) / TU Path (J2)** displays the received J0/J1/J2 value in 16 or 64-bytes format. The <crc7> represents the CRC-7 for a 16-bytes format. The last two bytes of a 64-bytes format, <C<sub>R</sub>> and <L<sub>F</sub>>, represent respectively a carriage return and a line feed.
- **TIM-S / RS-TIM, TIM-P / HP-TIM, TIM-V / LP-TIM** check box when selected (cleared by default) enables the corresponding Trace Identifier Mismatch for the expected message defined.

**Format** allows the selection of the expected format:

**16 Bytes** (default), or **64 Bytes**.

**Expected** allows entering the expected J0 trace message.

**Copy RX** allows using the received SAPI/DAPI message as the expected one.

## Test Results

Traces - SONET/SDH

---

### TCM Access Point Identifier

**Note:** Available when **TCM** is enabled (refer to page 401).

- **STS Path (N1) / AU Path (N1)**, and **VT Path (Z6) / TU-Path (N2) / TU-Path (N1)** for (TU-3) displays the received N1/N2/Z6 value/message.
- **TC-TIM-P / HPTC-TIM / TC-TIM-V / LPTC-TIM** check box when selected (cleared by default) enables the corresponding TCM Access Point Identifier and allows the configuration of the expected message.

**Copy RX** allows using the received SAPI/DAPI message as the expected one.

## Traces/PT - FlexO

From the test menu, tap **Results**, and **Traces/PT**.

**Client ID** indicates the client ID for ODUk level.

### OTUCn, ODUCn, and ODUk Buttons

Tap on either an OTU or ODU button.

### SM TTI Traces / PM TTI Traces / Global PM TTI Traces

**Note:** *The TTI Traces are configurable for SM (OTUx), PM (ODUx), and PM (ODUk). The following settings are coupled with the Expected Message from Traces/PT - FlexO on page 440.*

- **SAPI** (Source Access Point Identifier) indicates the received SAPI message (TTI bytes 0 to 15). The expected SAPI message is available when the **SAPI OTU-TIM / SAPI ODU-TIM** check box is selected. A maximum of 16 characters are allowed; 13 characters for lower ODU layer since the channel number is automatically appended to the message.

TTI Traces	Default Message <sup>a</sup>
SM	EXFO OTU SAPI
PM	XFO ODU SAPI <sup>b</sup>

- a. The default message contains a NULL (all 0's) character preceding it. NULL (all 0's) characters are automatically appended to the message for bytes that are not defined.
- b. For ODUk, the client ID is automatically appended to the generated/expected message.

## Test Results

Traces/PT - FlexO

---

- **DAPI** (Destination Access point Identifier) indicates the received SAPI message (TTI bytes 16 to 31). The expected DAPI message is available when the **DAPI OTU-TIM / DAPI ODU-TIM** check box is selected. A maximum of 16 characters is allowed; 13 characters for lower ODU layer since the channel number is automatically appended to the message.

TTI Traces	Default Message <sup>a</sup>
SM	EXFO OTU DAPI
PM	XFO ODU DAPI <sup>b</sup>

- The default message contains a NULL (all 0's) character preceding it. NULL (all 0's) characters are automatically appended to the message for bytes that are not defined.
  - For ODUk, the client ID is automatically appended to the message.
- **Operator Specific** indicates the received Operator Specific message (TTI bytes 32 to 63).
  - **SAPI OTU-TIM / SAPI ODU-TIM** check box, when selected (cleared by default), allows editing the expected Source Access Point Identifier and also enables OTU/ODU-TIM alarm monitoring. For the lower ODU layer these check boxes are only configurable from the test setup.
  - **DAPI OTU-TIM / DAPI ODU-TIM** check box, when selected (cleared by default), allows editing the expected Destination Access Point Identifier and also enables the OTU/ODU-TIM alarm monitoring. For the lower ODU layer these check boxes are only configurable from the test setup.



- **Copy RX / Global Copy RX**<sup>1</sup> allows using the received SAPI/DAPI message as the expected one. For lower ODU layer, use the arrow button next to the **Copy RX** or **Global Copy RX** to switch from one button to the other. However since there is only one client, both **Global Copy RX** and **Copy RX** use the received SAPI/DAPI message as the expected one.

## **PT**

- **Payload Type and Code** displays the received payload signal type and its code in hexadecimal format. The expected payload signal type can be selected from the list or by entering its hexadecimal code.

**Note:** *Refer to PT / Global PT on page 442 for the list.*

- **OPU-PLM** check box when selected enables the OPU-PLM alarm analysis. For the lower ODU layer these check boxes are only configurable from the test setup.

**Copy RX** allows using the received payload type as the expected one.

---

1. **Global Copy RX** is only available for the lower ODU layer.

## Test Results

### Traffic - Ethernet

---

## Traffic - Ethernet

From the test menu, tap **Results**, **Traffic**, and when applicable the **Ethernet** tab.

**Note:** For *Through Mode* test application, the traffic statistics are displayed for both port directions.

- <Port #>, available with **Dual Port** topology, allows selecting the port to be displayed.
- **Link**, available with multiple link interface (ex: 2 x 100GE), allows selecting the link to be displayed; only enabled links are available.
- **Client ID**, available with FlexE BERT, allows selecting the client identification to be displayed.
- **Size (Gbit/s)**, available with FlexE BERT, indicates the size of the client ID.

## Traffic

- **Line Utilization (%)** indicates the current percentage of the transmitting/receiving line rate utilization.
- **Ethernet BW (Mbit/s)** indicates the current transmitting/receiving data rate expressed in Mbit/s.
- **Frame Rate (frame/s)** indicates the current transmitted/received number of frames (including bad frames, Broadcast frames and Multicast frames) in frame per second.
- **Frame Count** indicates the total number of transmitted/received valid and invalid frames.

## Frame Type

Displays the TX and RX count of the following frame types.

- **Multicast** indicates the number of multicast frames transmitted/received without FCS errors. Broadcast frames are not counted as multicast frames.
- **Broadcast** indicates the number of broadcast frames transmitted/received without FCS errors.
- **Unicast** indicates the number of unicast frames transmitted/received without FCS errors.
- **Non-Unicast** indicates the number of multicast and broadcast frames transmitted/received without FCS errors.
- **Total** indicates the total number of all frames transmitted/received without FCS error.

## Frame Size

Displays the RX count of each received frame size (valid and invalid), and the percentage (%) ratio of each received frame size based on the total count of frames. The percentage (%) ratio is not available for Through Mode test application.

- **< 64/80/82**: frames with less than 64 bytes; 80 bytes for EoE; 82 bytes for PBB-TE.
- **64/80/82**: frames equal to 64 bytes; 80 bytes for EoE; 82 bytes for PBB-TE.
- **65/81/83 - 127**: frames from 65 to 127 bytes; 81 to 127 bytes for EoE; 83 to 127 bytes for PBB-TE.
- **128 - 255**: frames from 128 to 255 bytes.
- **256 - 511**: frames from 256 to 511 bytes.
- **512 - 1023**: frames from 512 to 1023 bytes.

## Test Results

### Traffic - Ethernet

---

- **1024 - 1518/1534/1536:**
  - **1024 - 1518:** frames from 1024 to 1518 (no VLAN), 1522 (1 VLAN tag), 1526 (2 VLAN tags), or 1530 (3 VLAN tags) bytes.
  - **1024 - 1534:** for EoE, frames from 1024 to 1534; add 4 bytes to 1534 for each VLAN layer enabled in the encapsulated Ethernet payload and 4 bytes for EoE VLAN when enabled.
  - **1024 - 1536:** for PBB-TE, frames from 1024 to 1536; add 4 bytes to 1536 for each VLAN layer enabled in the encapsulated Ethernet payload and 4 bytes for B-VLAN when enabled.
- **> 1518/1534/1536:**
  - **> 1518:** frames with more than 1518 (no VLAN), 1522 (1 VLAN tag), 1526 (2 VLAN tags), or 1530 (3 VLAN tags) bytes.
  - **> 1534:** for EoE: frame with more than 1534; add 4 bytes to 1534 for each VLAN layer enabled in the encapsulated Ethernet payload and 4 bytes for EoE VLAN when enabled.
  - **> 1536:** for PBB-TE, frame with more than 1536; add 4 bytes to 1536 for each VLAN layer enabled in the encapsulated Ethernet payload and 4 bytes for B-VLAN when enabled.
- **Total** indicates the total count of all received frames (valid and invalid).

## Traffic - Flow Control

**Note:** *Not available with 200/400GE.*

From the test menu, tap **Results**, **Traffic**, and the **Flow Control** tab.

**Note:** *For Dual Port topology select the port to be displayed.*

### Frame Count - RX

- **Pause Frames** indicates the number of received valid flow-control frames. Frames that have a type/length field equal to 0x8808 will be counted as a pause frame.
- **Abort Frame** indicates the number of received pause frames with a Quanta equal to zero; cancelling the pause frames.
- **Total Frame** indicates the total number of pause time received from the link partner.

### Pause Time

Indicates respectively the total, last, maximum, and minimum pause time received from the link partner in **Quanta** (default) or **Microsecond** ( $\mu s$ ).

## Test Results

### Traffic - Flow Control

---

## Pause Injection

**Note:** *Pause injection is only available for Traffic Gen & Mon test application.*

- **Packet Pause Time:** Enter the pause time value to be transmitted in **Quanta** or **Microsecond** (default is **100** Quanta).

Interface	Range	
	Quanta	$\mu$ s
10 Mbit/s	0 to 65535	0 to 3355392
100 Mbit/s	0 to 65535	0 to 335539.2
1000 Mbit/s	0 to 65535	0 to 33553.92
10 Gbit/s	0 to 65535	0 to 3355.392
40 Gbit/s	0 to 65535	0 to 838.848
100 Gbit/s	0 to 65535	0 to 335.5392

**Note:** *When entering a value in  $\mu$ s it will be rounded to the closest multiple of 0.0512  $\mu$ s for 10 Mbit/s, 5.12  $\mu$ s for 100 Mbit/s, 0.512 $\mu$ s for 1000 Mbit/s, 0.0512  $\mu$ s for 10 Gbit/s, 0.0128  $\mu$ s for 40 Gbit/s, and 0.00512  $\mu$ s for 100 Gbit/s.*

- **Inject** button allows generating the defined packet pause time.
- **Destination MAC Address** check box, when selected (cleared by default), enables and allows setting the destination MAC address. The default destination MAC address is the control protocol multicast address: **01:80:C2:00:00:01**.

## Traffic - Graph

From the test menu, tap **Results**, **Traffic**, and the **Graph** tab.

**Note:** *For Dual Port topology select the port to be displayed.*

The graph displays the received line utilization. The X axis shows the time in seconds while the Y axis shows the percentage utilization.

## Test Results

### Traffic - Path OAM

---

## Traffic - Path OAM

**Note:** Available when **Path OAM** is enabled, refer to Path OAM on page 344.

From the test menu, tap **Results**, **Traffic**, and the **Path OAM** tab.

Reports the counts of the following messages transmitted and received. Total count is reported for TX and RX.

- **2DMM** (Two-way Delay Measurement Message) reports 2DMM messages transmitted.
- **2DMR** (Two-way Delay Measurement Response) reports 2DMR messages received having a valid CRC4 and the multi-block containing the ascending sequence numbers 0 to 5.
- **APS** (Automatic Protection Switching) reports the APS messages having a valid CRC4. Only available when **Path OAM APS** is enabled (refer to *Path OAM APS* on page 708).
- **BAS** (Basic OAM Message) reports Basic OAM messages having a valid CRC4.
- **CSM** (Client Signal Message) reports the CSM messages having a valid CRC4.
- **CVM** (Connectivity Verification Multi-block) reports CVM messages having a valid CRC4 and the multi-block containing the ascending sequence numbers 0 to 7.

## Responder

**Note:** Available when the **OAM Responder** check box is selected (refer to Path OAM on page 344).

Reports the counts of the following messages transmitted and received.



- **2DMM** (Two-way Delay Measurement Message) reports the count of 2DMM messages received having a valid CRC4 and the multi-block containing the ascending sequence numbers 0 to 1.
- **2DMR** (Two-way Delay Measurement Response) reports the count of 2DMR messages transmitted.

## Test Results

*Traffic - OAM, S-OAM, and MPLS-TP OAM*

---

# Traffic - OAM, S-OAM, and MPLS-TP OAM

From the test menu, tap **Results**, **Traffic**, and the **OAM**, **S-OAM**, or **MPLS-TP OAM** tab.

## Traffic Monitoring

**Note:** *Only available with Carrier Ethernet OAM test application.*

- In TX, reports counts of CCM, LBM, LTM, DMM, LMM, SLM, TST, AIS, LCK, and CSF frames transmitted. LTM and SLM are only available with Ethernet OAM. Total count is reported as well as unicast and/or multicast frame counts when applicable.
- In RX, reports counts of CCM, LBR, LTR, DMR, LMR, SLR, TST AIS, LCK, and CSF frames (LTR and SLR are only available with Ethernet OAM) received regardless of the sender as long as the following criteria are met:
  - **S-OAM:** The destination MAC address matches either the local MEP Unicast MAC address or a Multicast class 1 or class 2 address; and the VLANs matches the unit port VLANs. Refer to *Unicast/Multicast Addresses for Ethernet OAM* on page 867 for more information.
  - **MPLS-TP OAM:** The destination MAC address matches either the unit MAC address, FF:FF:FF:FF:FF:FF, or 01:00:5E:90:00:00; the VLANs matches the unit port VLANs; and MPL Labels matches the local MPLS Label Stack configuration. For AIS, LCK, and CSF, valid messages must also have the MEG Level matching the Local MEG Level.

Total count is reported as well as unicast and/or multicast frame counts when applicable.

## Responder

**Note:** Available when the **S-OAM Responder** or **MPLS-TP OAM Responder** check box is selected (refer to S-OAM and MPLS-TP OAM Responder on page 368).

For **Carrier Ethernet OAM** test application:

- In TX, reports counts of LBR, LTR, DMR, LMR, and SLR total frames transmitted. LTR and SLR are only available with Ethernet OAM.
- In RX, reports counts of valid LBM, LTM, DMM, LMM, and SLM unicast, multicast, and total frames received. LTM and SLM are only available with Ethernet OAM. A valid messages must have its:

**S-OAM:** source MAC address matching the Peer MEP MAC address; destination MAC address matching either the unit port Unicast MAC address or a Multicast class 1 or class 2 address; VLANs matching the unit port VLANs, and MEG/MD Level matching the local MEG/MD Level. Refer to *Unicast/Multicast Addresses for Ethernet OAM* on page 867 for more information.

**MPLS-TP OAM:** destination MAC address matching either the unit MAC address, FF:FF:FF:FF:FF:FF, or 01:00:5E:90:00:00; VLANs matching the unit port VLANs; and MPL Labels matching the local MPLS Label Stack configuration.

For **Smart Loopback** test application:

- In TX, reports counts of LBR, LTR, DMR, LMR, and SLR total frames transmitted.
- In RX, reports counts of valid LBM, LTM, DMM, LMM, and SLM total frames received. A valid messages must have its destination MAC address matching either the unit port Unicast MAC address or a Multicast class 1 or class 2 address. Refer to *Unicast/Multicast Addresses for Ethernet OAM* on page 867 for more information.

## Test Results

### *Window Sweep*

---

## Window Sweep

**Note:** *Only available for RFC 6349 with operation modes **Dual Test Set** (local unit).*

Displays the graph showing the Ideal L4 and Actual L TCP Throughput measured for each Window Sweep step. The number of connections and KiB per connection is also displayed in parenthesis as follows:  
(n conn.@ n KiB)

From the test menu, tap **Results**, and the **Window Sweep** tab.

## WIS

From the **Test** menu, tap **Results**, and the **WIS** tab.

### Traces/Label

- **J0 Trace** displays the **J0 Trace** value in 16-bytes format.
- **J1 Trace** displays the **J1 Trace** value in 16-bytes format.
- **Path Signal Label (C2)** displays the content of the STS SPE including the status of the mapped payload.



# 10 Test Functions

The Test Functions menu offers the following structure:

## Transport

Test Application	Page, Sub-Page, or Pop Up	Page
DCO BERT	<rate> Advanced - <transceiver> Control	634
	<rate> Advanced - Pre-Emphasis/RX EQ	641
	<rate> Advanced - PAM-4 Histogram	643
DSn/PDH BERT	FDL - Bit-Oriented Message	652
	FDL - Performance Report Message	656
	FEAC	659
	RTD	726
	Signaling Bits	734
	Spare Bits	736
FlexO BERT	-	-
Multi-Channel OTN	<rate> Advanced - <transceiver> Control	634
	GMP	668
NI/CSU Emulation	FDL - Bit-Oriented Message	652
	FDL - Performance Report Message	656
OTN BERT	<rate> Advanced - <transceiver> Control	634
	<rate> Advanced - Lanes Mapping & Skew	637
	Client Offset	649
	GMP	668
	OH BERT	669
	OH - GFP-F/GFP-T	677
	OH - OTN	682
	RTD	726

## Test Functions

---

Test Application	Page, Sub-Page, or Pop Up	Page
OTN-SONET/SDH BERT	<rate> Advanced - <transceiver> Control	634
	<rate> Advanced - Lanes Mapping & Skew	637
	APS	644
	GMP	668
	OH BERT	669
	OH - OTN	682
	OH - SONET/SDH	688
	Pointer Adjustment	716
	RTD	726
SONET/SDH BERT	APS	644
	OH	688
	Pointer Adjustment	716
	RTD	726
SONET/SDH - DS <sub>n</sub> /PDH BERT	APS	644
	OH	688
	Pointer Adjustment	716
	RTD	726
	Signaling Bits	734
	Spare Bits	736



## Ethernet

Test Application	Page, Sub-Page, or Pop Up	Page
Cable Test	Ping & Trace Route	711
Carrier Ethernet OAM	Filters	663
	Packet Capture	702
	Ping & Trace Route	711
	S-OAM Link Trace	732
EtherBERT	<rate> Advanced - <transceiver> Control	634
	<rate> Advanced - Lanes Mapping & Skew	637
	<rate> Advanced - Pre-Emphasis/RX EQ	641
	<rate> Advanced - PAM-4 Histogram	643
	Filters	663
	Packet Capture	702
	Ping & Trace Route	711
EtherSAM (Y.1564)	<rate> Advanced - <transceiver> Control	634
	<rate> Advanced - Lanes Mapping & Skew	637
	<rate> Advanced - Pre-Emphasis/RX EQ	641
	<rate> Advanced - PAM-4 Histogram	643
	Ping & Trace Route	711
FlexE BERT	<rate> Advanced - <transceiver> Control	634
	<rate> Advanced - Pre-Emphasis/RX EQ	641
	<rate> Advanced - PAM-4 Histogram	643
	FlexE Advanced	666
	OH	672
	Path OAM APS	708

## Test Functions

---

Test Application	Page, Sub-Page, or Pop Up	Page
RFC 2544	<rate> Advanced - <transceiver> Control	634
	<rate> Advanced - Lanes Mapping & Skew	637
	<rate> Advanced - Pre-Emphasis/RX EQ	641
	<rate> Advanced - PAM-4 Histogram	643
	Ping & Trace Route	711
RFC 6349	<rate> Advanced - <transceiver> Control	634
	<rate> Advanced - Lanes Mapping & Skew	637
	Ping & Trace Route	711
Smart Loopback	<rate> Advanced - <transceiver> Control	634
	<rate> Advanced - Lanes Mapping & Skew	637
	<rate> Advanced - Pre-Emphasis/RX EQ	641
	<rate> Advanced - PAM-4 Histogram	643
	Ping & Trace Route	711
TCP Throughput	Ping & Trace Route	711
Through Mode	Filters	663
	Packet Capture	702
Traffic Gen & Mon	<rate> Advanced - <transceiver> Control	634
	<rate> Advanced - Lanes Mapping & Skew	637
	<rate> Advanced - Pre-Emphasis/RX EQ	641
	<rate> Advanced - PAM-4 Histogram	643
	BFD	647
	Filters	663
	Packet Capture	702
	Ping & Trace Route	711
	Traffic Scan	738

## Sync

Test Application	Page or Pop Up	Page
1588 PTP	Filters	663
	Packet Capture	702
	Ping & Trace Route	711
SyncE	Filters	663
	Packet Capture	702
	Ping & Trace Route	711
Time Error / Wander	-	-

## Wireless

Test Application	Page or Pop Up	Page
CPRI/OBSAI BERT	<rate> Advanced - <transceiver> Control <sup>a</sup>	634
	RTD (Unframed)	726
	RTD (Framed L2) <sup>a</sup>	729
	RTT <sup>b</sup>	729
eCPRI BERT	<rate> Advanced - <transceiver> Control	634
	Filters <sup>c, d</sup>	663
	Packet Capture <sup>c, d</sup>	702
	Ping & Trace Route <sup>c</sup>	711

- a. Only available with CPRI BERT.
- b. Only available with OBSAI BERT.
- c. Only available with Framed Layer 2/3/4.
- d. Only supported in single port topology.

## Test Functions

<rate> Advanced - <transceiver> Control

---

### <rate> Advanced - <transceiver> Control

**Note:** Where <rate> is the rate selected for the test and <transceiver> is the selected connector.

From the **Test** menu, tap **Functions**, <rate> **Advanced**, and the <transceiver> **Control** tab.

- **Port**, available with FlexE BERT, allows selecting the physical port to be displayed.
- **FlexE PHY Number**, available with FlexE BERT, indicates the FlexE PHY number assigned to the port.
- <transceiver> **Reference Clock (MHz)** allows selecting the reference clock that will be used by the transceiver. Available with CFP4/CFP8 transceiver.

Interface/Rate	1/160 Host Lane Rate (default - recommended)	1/40 Host Lane Rate
OTU4	174.7031 MHz	698.8123 MHz
100GE	161.1328 MHz	644.5313 MHz
400GE	156.25 MHz	625.0 MHz

- <transceiver> **Power Class** indicates the power class of the inserted transceiver module. Available with CFP4/CFP8/OSFP/QSFP+/QSFP28/QSFP56-DD transceiver.

### <transceiver> Control Pins

Allows the following transceiver control pin settings. Refer to the CFP MSA standard for more information. Available with CFP4/CFP8/OSFP/QSFP+/QSFP28/QSFP56-DD transceiver.

**Note:** To apply any control, first select its check box then clear it; the control is applied only when the selected check box is cleared.

- **TX Disable**<sup>1</sup> check box (cleared by default).
- **Module Low Power Mode**<sup>2</sup> check box (cleared by default).
- **Module Reset** check box (cleared by default).
- **Module Power Shutdown** check box (cleared by default).

### <transceiver> Status Pins

Gives the following transceiver’s pin status (refer to the CFP/QSFP MSA standard for more information). Available with CFP4/CFP8/OSFP/QSFP+/QSFP28/QSFP56-DD transceiver.

Transceiver	Pin status
CFP4 CFP8	Module Absent, RX Loss of Signal, Global Alarm
OSFP QSFP+/ QSFP28/ QSFP56-DD/ QSFP56	Module Absent

### <transceiver> MDIO/I2C Access Interface

Available with MDIO transceivers (CFP4/CFP8) and I2C transceivers (OSFP/QSFP+/QSFP28/QSFP56-DD/SFP28/SFP+/SFP). SFP28/SFP+/SFP is only available with EtherBERT on 88260/88460.

- **MDIO/I2C - Bulk Read**

1. Not supported with OSFP/QSFP+/QSFP28/QSFP56/QSFP56-DD.

2. Not supported with QSFP56-DD.

## Test Functions

<rate> Advanced - <transceiver> Control

---

- **Device Address**, available with SFP28/SFP+/SFP, allows selecting the 2-wire serial interface address: **0xA0** (default) and **0xA2**.
  - **Page Select**, available with I2C, allows selecting the I2C address page: **0x00** (default) to **0xFF**. Not available when the **Device Address** selection is **0xA0**.
  - **MDIO/I2C Start Address** allows selecting the MDIO/I2C start address: **0x0000** (default) to **0xFFFF** (MDIO) / **0x00FF** (I2C).
  - **MDIO/I2C End Address** allows selecting the **MDIO/I2C** end address: **0x0000** to **0xFFFF**; default is **0x00FF**.
  - **Bulk Read** button (refer to *Bulk Read* on page 953)
  - **MDIO/I2C - Bulk Write** button (refer to *Bulk Write* on page 953)
  - **MDIO/I2C - Read/Write**
    - **MDIO/I2C Address** allows selecting the MDIO/I2C address: **0x0000** (default) to **0xFFFF** (MDIO) / **0x00FF** (I2C).
    - **MDIO/I2C Data** allows either selecting (write) or reading the MDIO/I2C data: **0x0000** (default) to **0xFFFF** (MDIO) / **0x00FF** (I2C).
- Read** button reads the data of the specified **MDIO/I2C Address**.
- Write** button writes the specified **MDIO/I2C DATA** value to the specified **MDIO/I2C Address**.

## <transceiver> TX Status

Indicates the transceiver transmission status for each optical lane.  
Available with CFP4/CFP8 transceiver.

## **<rate> Advanced - Lanes Mapping & Skew**

**Note:** *Only available with parallel interfaces. Not available: at 100G when the **RS-FEC** check box is selected; with multiple link interface.*

From the test menu, tap **Functions, 40/100/200/400G Advanced**, and the **Lanes Mapping & Skew** tab.

### **TX**

- **PCS/Logical Lane**, for Ethernet test applications, indicates the PCS (Ethernet test applications) or Logical (Transport Test applications) lane markers. To change the PCS/Logical lane order, see *Default/Random/Manual Mapping* on page 639.
- **Skew (Bits)** indicates the TX relative delay in bit time for each PCS/Logical lane. To change the skew values, see *Reset / Manual Skew* on page 640.

### **Lane / Physical Lane**

Indicates the lane numbers as follows:

<b>Rate</b>	<b>Lane Number</b>
400GE (4/8 Lanes)	400GAUI-8
200GE (4 Lanes)	200GAUI-4
100GE (4 Lanes)	CAUI-4
OTU4 (4 Lanes)	OTL4.4

## Test Functions

<rate> *Advanced - Lanes Mapping & Skew*

---

### RX

- **Skew (bits)** indicates the delay in bit time between the earliest PCS/Logical lane and the current lane for the one to zero transition of the alignment marker sync bits. The received skew accuracy is  $\pm 100$  bits.
- **PCS/Logical Lane** indicates received PCS/Logical Lane markers.

**Note:** *If a PCS/Logical Lane marker is detected more than once, a red background is used to highlight all occurrences of this PCS/Logical Lane marker. **Duplicate** is also displayed on a red background.*

### PCS/Logical Lane

Allows ordering the PCS/Logical Lane markers in either **Ascending** (1,2,3...) or **Coupled to RX**.

### Alarms

For a description of each alarm, refer to *OTL* on page 924 for Transport and *Ethernet - PCS Lanes* on page 900 for Ethernet.

### Errors

For a description of each error, refer to *OTL* on page 924 for Transport and *Ethernet - PCS Lanes* on page 900 for Ethernet.

The error values are displayed in seconds by default. Tapping on the unit allows selecting either **Seconds**, **Count**, or **Rate**.

**Total** indicates the total of all lanes when **Count** or **Rate** unit is selected.



## Default/Random/Manual Mapping

Allows changing the lane mapping that will be used for the test. Not available with 100 GbE client in OTU4.

- **Default Mapping** sets the TX mapping to the default numerical order value which corresponds to the ascending lane order.
- **Random Mapping** sets the TX mapping in a random order. Each time the button is tapped, random alignment markers are assigned to each lane.
- **Manual Mapping** allows setting the TX mapping manually.

- **Lane Marker and Assigned Status:**

The **Lane Marker** buttons allow assigning the corresponding lane marker to the selected PCS/Logical or xGAUI-y/CAUI/XLAUI/Physical Lane mapping (the one pointed by the arrow). Lane marker buttons are numbered from **0** to **15** for 400G, **0** to **7** for 200G, **0** to **19** for OTU4/100G, and **0** to **3** for OTU3/OTU3e1/OTU3e2/40G.

The **Assigned Status** column displays a check mark when the lane marker is assigned.

- **PCS/Logical Lane** and **xGAUI-y/CAUI/XLAUI/Physical Lane** columns indicate the target PCS/Logical to xGAUI-y/CAUI/XLAUI/Physical mapping.
- **Clear All** clears the lane assignments.
- **OK** accepts the new lane mapping. The **OK** button is only available when all target PCS/Logical Lane fields are assigned including duplicates.

**Note:** *A lane marker can be assigned more than once. If this is the case, a red background is used to highlight all occurrences of this lane marker.*

## Test Functions

<rate> *Advanced - Lanes Mapping & Skew*

---

### Reset / Manual Skew

Allows the selection of a relative delay in bit time that will be introduced for each PCS/Logical lane.

**Note:** *Not available with 100 GbE client in OTU4.*

- **Reset Skew** sets all TX skew values to 0 bit time.
- **Manual Skew** allows setting the skew value for each PCS/Logical lane manually. Refer to *Manual Skew (PCS/Logical Lane)* on page 972.

### Laser ON/OFF

Allows activating the laser control per optical lane or for all lanes. Refer to *Laser ON/OFF* on page 971.

### Skew Alarm Threshold (bits)

Allows setting the threshold value that will be used to declare the **Exc. Skew** alarm (refer to *Ethernet - PCS Lanes* on page 900).

**Default** button restores the default alarm threshold value.

## <rate> Advanced - Pre-Emphasis/RX EQ

**Note:** Only available with 200/400GE/multiple link interface (2x200GE, 4x100GE, 8x50GE) when using OSFP/QSFP56/QSFP56-DD transceiver.

From the test menu, tap **Functions, 200G/400G Advanced**, and the **Pre-Emphasis/RX EQ** tab.

### TX

- **PAM-4 Lane** indicates the lane numbers.
- **Pre Cursor** is configurable from -1000 to 1000.
- **Main Cursor** is configurable from -1000 to 1000.
- **Post Cursor** is configurable from -1000 to 1000.
- **Lower Eye** is configurable from 500 to 1500.
- **Upper Eye** is configurable from 1500 to 2500.
- **Swing** is configurable from 60% to 120% in step of 10%.
- **Restore TX Defaults:** Reverts the TX pre-emphasis to their default values.

### RX

- **CTLE** allows selecting the continuous time linear equalization: **0 to 9.0 dB** (64 possible values).
- **DSP Mode** allows selecting the digital signal processor mode:

DSP Mode	Description
FFE+SLC	Feed-Forward Equalizer + PAM-4 Slicer
FFE+DFE	Feed-Forward Equalizer + Decision Feedback Equalizer

## Test Functions

<rate> Advanced - Pre-Emphasis/RX EQ

---

DSP Mode	Description
FFE+DFE+RC	Feed-Forward Equalizer + Decision Feedback Equalizer + PAM-4 Reflection Cancellor
FFE+SLC+LDEQ	Feed-Forward Equalizer + PAM-4 Slicer + PAM-4 Level Dependent Equalizer
FFE+SLC+RC	Feed-Forward Equalizer + PAM-4 Slicer + PAM-4 Reflection Cancellor
FFE+SLC+RC+LDEQ	Feed-Forward Equalizer + PAM-4 Slicer + PAM-4 Reflection Cancellor + PAM-4 Level Dependent Equalizer

- **VGA Tracking** check box when selected (default) enables the tracking of the voltage gain amplifier.
- **Restore RX Defaults** reverts the RX CTLE, DSP Mode, and VGA Tracking to their default values.

## TX/RX

**Gray Encoding** check box when selected (default) enables the gray encoding.

## <rate> Advanced - PAM-4 Histogram

**Note:** Only available with 200/400GE/multiple link interface (2x200GE, 4x100GE, 8x50GE) when using OSFP/QSFP56/QSFP56-DD transceiver.

From the **Test** menu, tap **Functions, 200/400G Advanced**, and the **PAM-4 Histogram** tab.

The PAM-4 Histogram graph displays for the selected lane the number of hits at each 160 amplitude levels (PAM-4 Symbol 0 to PAM-4 Symbol 3) once the acquire process is completed.

➤ **Scale**

Allows selecting the scale for the histogram hits (Y-axis): **Linear** (default) or **Log** (logarithmic).

➤ **PAM-4 Lane**

Allows selecting the PAM-4 lane that will be used for the histogram acquisition. The lane displayed on an amber background indicates the selected lane while the ones on a green background indicate that valid histograms have been acquired.

➤ **Acquire**

Enables the PAM-4 histogram acquisition process for the selected lane. The green LED is on when the acquisition is enabled.

To acquire the PAM-4 histogram for other lane(s), select another lane either by tapping on its number or using the arrow while the acquisition is still enabled. Repeat for all required lanes.

**Note:** Reactivating the acquisition clears all previously acquired histograms.

## Test Functions

APS

---

### APS

From the **Test** menu, tap **Functions**, and the **APS** tab.

#### TX/RX

- **Switching Mode**, available for both TX and RX, selects the switching mode: **Linear** (default) or **Ring**.
- **K1**

**Request:** Bits 1 through 4 of the K1 byte.

Bits 1 to 4	Request	
	Linear mode	Ring mode
0000	No Request <sup>a</sup>	No Request (default) <sup>a</sup>
0001	Do Not Revert	Reverse Request - Ring
0010	Reverse Request	Reverse Request - Span
0011	Unused	Exerciser - Ring
0100	Exerciser	Exerciser - Span
0101	Unused	Wait-to-Restore
0110	Wait-to-Restore	Manual Switch - Ring
0111	Unused	Manual Switch - Span
1000	Manual Switch	Signal Degrade - Ring
1001	Unused	Signal Degrade - Span
1010	Signal Degrade - Low Priority	Signal Degrade (Protection)
1011	Signal Degrade - High Priority	Signal Fail - Ring
1100	Signal Fail - Low Priority	Signal Fail - Span
1101	Signal Fail - High Priority	Force Switch - Ring
1110	Force Switch	Force Switch -Span
1111	Lockout of Protection	Lockout of Protection - Span/SF - P

a. Default value.

**Channel (Linear switching mode) or  
Destination Node ID (Ring switching mode):**  
Bits 5 through 8 of the K1 byte.

Bits 5 to 8	Channel ID (Linear mode)	Destination Node ID (Ring mode)	Bits 5 to 8	Channel ID (Linear mode)	Destination Node ID (Ring mode)
0000	0 - Null <sup>a</sup>	0 <sup>a</sup>	1000	8	8
0001	1	1	1001	9	9
0010	2	2	1010	10	10
0011	3	3	1011	11	11
0100	4	4	1100	12	12
0101	5	5	1101	13	13
0110	6	6	1110	14	14
0111	7	7	1111	15 - Extra Traffic	15

a. Default value.

➤ K2

**Protected Channel (Linear switching mode) or  
Source Node ID (Ring switching mode):**  
Bits 1 through 4 of the K2 byte.

Bits 1 to 4	Protected Channel (Linear mode)	Source Node ID (Ring mode)	Bits 1 to 4	Protected Channel (Linear mode)	Source Node ID (Ring mode)
0000	0 - Null <sup>a</sup>	0 <sup>a</sup>	1000	8	8
0001	1	1	1001	9	9
0010	2	2	1010	10	10
0011	3	3	1011	11	11
0100	4	4	1100	12	12
0101	5	5	1101	13	13
0110	6	6	1110	14	14
0111	7	7	1111	15 - Extra Traffic	15

a. Default value.

## Test Functions

APS

---

**Architecture (Linear switching mode) or Bridge Request (Ring switching mode):**  
Bit 5 of the K2 byte. The default setting is **1+1** for Linear switching mode and **Short Path Request** for Ring switching mode.

Bit 5	Architecture (Linear mode)	Bridge Request (Ring mode)
0	1+1 <sup>a</sup>	Short Path <sup>a</sup>
1	1:n	Long Path

- a. Default value.

**Operation Mode:** Bits 6 through 8 of the K2 byte.

Bits 6 to 8	Linear mode	Ring mode
000	Reserved <sup>a</sup>	Idle <sup>a</sup>
001	Reserved	Bridged
010	Reserved	Bridged and Switched
011	Reserved	Extra Traffic - Protection
100	Unidirectional	Reserved
101	Bidirectional	Reserved
110	RDI-L <sup>b</sup> /MS-RDI <sup>c</sup>	RDI-L <sup>b</sup> /MS-RDI <sup>c</sup>
111	AIS-L <sup>b</sup> /MS-AIS <sup>c</sup>	AIS-L <sup>b</sup> /MS-AIS <sup>c</sup>

- a. Default value.  
b. Operation mode for SONET.  
c. Operation mode for SDH.



## BFD (Bidirectional Forwarding Detection)

**Note:** Only available with IPv4 Network Layer (refer to IP on page 328) in single port topology for rates up to 100GE (excluding 25GE/50GE).

From the **Test** menu, tap **Functions**, and the **BFD** tab.

### Bidirectional Forwarding Detection

- **Local IP Address** displays the configured interface **Source IP Address** (refer to IP on page 328).
- **Remote IP Address** allows configuring the destination IP Address.
- **IP TOS/DS** allows entering the type of service: **00** (default) to **FF**.
- **Desired Min TX Interval** defines the minimum interval the local module would like to use when transmitting BFD control packets: **100** ms (default) to **1** s.
- **Required Min RX Interval** defines the minimum interval between received BFD control packets the local module requires: **100** ms (default) to **1** s.
- **Detect Multiplier** is a value that is multiplied by the negotiated transmit interval giving the detection time for the receiving system. Choices are **1** to **255** (**3** by default).
- **Session State** indicates the local session state: **Down**, **Init**, **Up**.
- **Diagnostic** indicates the reason of the last local session state change.
- **Connect** starts/stops the BFD process.

## Test Functions

### *BFD (Bidirectional Forwarding Detection)*

---

#### Statistics

- **Packets Transmitted** indicates the number of sent BFD control packets.
- **Packets Received** indicates the number of received BFD control packets.

#### Neighbor Status

- **Session State** reports the remote session state: **Admin Down**, **Down**, **Init**, or **Up**.
- **Diagnostic** reports the reason of the remote last session state change.
- **Desired Min TX Interval** reports the remote desired minimum TX interval.
- **Required Min RX Interval** reports the remote required minimum RX interval.
- **Detect Multiplier** reports the remote **Detect Multiplier** value.

## Client Offset

**Note:** Available with OTN BERT test application with **1GbE** client and **Pattern** client with **ODUflex** multiplexing.

From the **Test** menu, tap **Functions**, and the **Client Offset** tab.

### TX Frequency

**Note:** TX Frequency is not available in **Through / Through Intrusive** topology.

- **Frequency (GHz)** indicates the frequency (nominal frequency + port frequency offset + client frequency offset) used for transmission.
- **Offset (ppm)** check box, when selected (cleared by default), allows setting the client frequency offset that will be generated. Use the “+” or “-” button to respectively increment or decrement the client frequency offset value based on the defined **Increment/Decrement Size**, or directly type the frequency offset value in the field.
- **Increment/Decrement Size (ppm)** allows setting the increment/decrement value (from 0.1 to either 115) that will be used when changing the frequency offset using the “+” or “-” button.

Client	Nominal Frequency	Offset <sup>a</sup>
1GbE	1250000000 bps	± 115 ppm
Pattern in ODUflex	Nominal bit rate configured (refer to <i>Nominal Bit Rate</i> on page 983).	± 115 ppm <sup>b</sup>

- a. The Client frequency offset range is guaranteed for a clock source signal at 0 ppm offset. In the event that the clock source signal already has an offset, the output signal may exhibit an offset larger than the range specified. For example, if the clock source signal has an offset of +20 ppm (configured on the Signal interface), the Client frequency offset could be up to 135 ppm (115 ppm + 20 ppm).
- b. The Client offset function does not allow the generation of a signal with a rate above 100 % of the TX rate. For example, if the TX Rate is set to 100 %, the allowed offset range will be -115 ppm to 0 ppm.

## Test Functions

### Client Offset

---

## RX Frequency

- **Frequency (GHz)** indicates the frequency of the input signal.

Client	Measurement range
1GbE	1250000000 ±120 ppm
Pattern in ODUflex	Expected Frequency ±120 ppm (see page 651)

- **Offset (ppm)** indicates the frequency offset between the standard rate specification and the rate at the input signal.

**Note:** For both **Frequency** and **Offset** a background color is used to indicate if the received client signal rate meets the standard rate specifications. Not available with Pattern in ODUflex when the **Frequency Offset Analysis** check box is cleared.

Background color	Description
Green	The frequency is in range.
Red	The frequency is out-of-range or there is a LOC Lane condition. <b>LOC</b> is also displayed.
Gray	Pending state.

Client	Standard Rate Specification
1GbE	1250000000 ±12500 bps (±100 ppm)
Pattern in ODUflex	Expected Frequency ±100 ppm (see page 651)

- **Max. Negative Offset (ppm)** indicates the maximum negative frequency offset between the standard rate specification and the rate from the received signal.

- **Max. Positive Offset (ppm)** indicates the maximum positive frequency offset between the standard rate specification and the rate from the received signal.

**Note:** *The following parameters are only available with ODUflex mapped to pattern.*

- **Frequency Offset Analysis** check box, when selected, enables the frequency offset measurements. This setting is enabled by default for **Coupled** topology, and disabled for **Through / Through Intrusive** topology.
- **Expected Frequency (GHz)** is available when the **Frequency Offset Analysis** check box is selected.

For **Coupled** topology, the frequency is set to the configured **TX Rate** (refer to either *EtherBERT and Unframed BERT* on page 247 or *BERT and Unframed BERT* on page 209).

For **Through / Through Intrusive** topology, enter the expected frequency in GHz.

## Test Functions

### FDL - Bit-Oriented Message

---

## FDL - Bit-Oriented Message

Allows setting and configuring the Bit-Oriented Messages (BOM) of the Extended Super-Frame (ESF).

**Note:** *FDL is only available for DSI interface with ESF framing. For Dual RX test, FDL is only available for the DSI TX/RX port 1.*

From the **Test** menu, tap **Functions**, **FDL**, and the **Bit-Oriented Message** tab.

## Generated Messages

### ► Priority

**Codeword:** The Bit-Oriented Message codewords are priority messages sent over the Data-Link. These messages are mostly used for networking operation and maintenance. A Bit-Oriented Message consists of 8 consecutive ones followed by a byte starting and ending by zeros.

Codeword	Pattern
RAI	00000000 11111111
Loopback Retention and Acknowledge	00101010 11111111
RAI-CI	00111110 11111111

**Injects** generates the selected codeword priority message.

### ► Command/Response

**Amount** allows the selection of the number of message to be generated. Choices are **1** to **15**. The default value is **10**.

**Inject** manually generates the selected amount of messages.

### Codeword

Command/Response Codeword	Pattern	Command/Response Codeword	Pattern
Line Loopback Activate	00001110 11111111	Protection Switch Line 22	01101100 11111111
Line Loopback Deactivate	00111000 11111111	Protection Switch Line 23	01101110 11111111
Payload Loopback Activate	00010100 11111111	Protection Switch Line 24	01110000 11111111
Payload Loopback Deactivate	00110010 11111111	Protection Switch Line 25	01110010 11111111
Reserved for Network Use	00010010 11111111 <sup>a</sup>	Protection Switch Line 26	01110100 11111111
Universal Loopback (Deactivate)	00100100 11111111	Protection Switch Line 27	01110110 11111111
ISDN Line Loopback (NT2)	00101110 11111111	Protection Switch Acknowledge	00011000 11111111
CI/CSU Line Loopback (NT1)	00100000 11111111	Protection Switch Release	00100110 11111111
For network use	00011100 11111111 <sup>b</sup>	Do Not use for Synchronization	00110000 11111111
Protection Switch Line 1 b	01000010 11111111	Stratum 2 Traceable	00001100 11111111
Protection Switch Line 2	01000100 11111111	SONET Minimum Clock Traceable	00100010 11111111
Protection Switch Line 3	01000110 11111111	Stratum 4 Traceable	00101000 11111111
Protection Switch Line 4	01001000 11111111	Stratum 1 Traceable	00000100 11111111
Protection Switch Line 5	01001010 11111111	Synchronization Traceability Unknown	00001000 11111111
Protection Switch Line 6	01001100 11111111	Stratum 3 Traceable	00010000 11111111
Protection Switch Line 7	01001110 11111111	Reserved for Network Synchronization	01000000 11111111
Protection Switch Line 8	01010000 11111111	Transmit Node Clock (TNC)	01111000 11111111
Protection Switch Line 9	01010010 11111111	Stratum 3E Traceable	01111100 11111111
Protection Switch Line 10	01010100 11111111	Under study for maintenance	00101100 11111111
Protection Switch Line 11	01010110 11111111	Under study for maintenance	00110100 11111111
Protection Switch Line 12	01011000 11111111	Reserved for network use	00010110 11111111
Protection Switch Line 13	01011010 11111111	Reserved for network use	00011010 11111111
Protection Switch Line 14	01011100 11111111	Reserved for network use	00011110 11111111
Protection Switch Line 15	01011110 11111111	Reserved for network use	00111010 11111111
Protection Switch Line 16	01100000 11111111	Reserved for customer	00000110 11111111
Protection Switch Line 17	01100010 11111111	Reserved for customer	00001010 11111111
Protection Switch Line 18	01100100 11111111	Reserved for customer	00000010 11111111
Protection Switch Line 19	01100110 11111111	Reserved for customer	00110110 11111111
Protection Switch Line 20	01101000 11111111	Reserved for customer	00111100 11111111
Protection Switch Line 21	01101010 11111111	Reserved for customer	01111010 11111111

- a. Loopback Activate.
- b. Indication of NT1 power off.

### Receive Messages

- **Link Activity** indicates the activity of the following parameters during the last second of measurement.
  - **Idle** indicates that only idle codes have been detected in the last second.
  - **Priority** indicates that at least one valid priority message has been detected in the last second.
  - **C/R** (Command/Response) indicates that a least one valid command and response has been detected in the last second.
  - **Unassigned** indicates that at least one unassigned message has been detected in the last second. Therefore, since an unassigned message is part of a Command/Response codewords, the Command/Response LED will also be red.
  - **PRM** indicates that at least one PRM has been detected in the last second.
- **Priority:** The Bit-Oriented Messages are priority messages send over the Data-Link. These messages are mostly used for networking operation and maintenance. A Bit-Oriented Message consists of 8 consecutive 1s followed by a byte starting and ending by zeros.

**Current** indicates the priority message detected in the last second. If no priority message has been detected, "--" is displayed.

**Previous** indicates the last priority message detected excluding the current message. If no priority message has been detected since the beginning of the test, "--" is displayed.

**Note:** See *Priority on page 652* for the list of possible priority codeword messages.



➤ **Command/Response**

**Current** indicates the command/response message detected in the last second. If no priority message has been detected, "--" is displayed.

**Previous** indicates the last command/response message detected excluding the current message. If no command/response message has been detected since the beginning of the test, "--" is displayed.

**Note:** See *Command/Response on page 652* for the list of possible *Command/Response codeword messages*.

## Test Functions

### FDL - Performance Report Message

---

## FDL - Performance Report Message

**Note:** FDL PRM is only available for DS1 interface with ESF framing. For Dual RX test, FDL is only available for the DS1 TX/RX port 1. For NI/CSU Emulation, only available in the RX direction.

From the **Test** menu, tap **Results**, tap the **FDL**, and **Performance Report Message** tab.

### Generated Messages

- **Circuit** allows the selection of the circuit type: **CI to Network** (default) or **Network to CI**.
- **ANSI T1-403** check box when selected allows the generation of a compliant ANSI T1.403 PRM Message.
- **Injection**
  - Single** sends the selected PRM Message(s) manually.
  - Continuous** generates the selected PRM Message(s) continuously.
- **Event Count** indicates the number of PRM messages sent.
- **PRM Bit Events** allows the activation of the following PRM bit events. All PRM bit events are disabled by default.

G1: CRC = 1	FE: Frame sync. bit error $\geq 1$
G2: $1 < \text{CRC} \leq 5$	LV: Line code violation event $\geq 1$
G3: $5 < \text{CRC} \leq 10$	LB: Payload loopback activated
G4: $10 < \text{CRC} \leq 100$	SL: Slip $\geq 1$
G5: $100 < \text{CRC} \leq 319$	R Bit (Reserved - Default value is 0)
G6: CRC $\geq 320$	U1: Bit
SE: Severely errored framing $\geq 1$	U2: Bit

## Received Messages

- **Event Counts** lists received PRM bit event counts. See **PRM Bit Events** below.
- **Report Content** lists received performance information. See **Performance Information** below.
- **Circuit** indicates the selected circuit type: **CI to Network** or **Network to CI**.
- **Valid Event Count** indicates the number of valid PRM messages received.
- **Link Activity**, see page 654 for more information.
- **PRM Bit Events** table, available when the **Event Counts** button is selected, reports the count of the detected valid PRM bit events.

G1: CRC = 1	SE: Severely errored framing $\geq 1$
G2: $1 < \text{CRC} \leq 5$	FE: Frame sync. bit error $\geq 1$
G3: $5 < \text{CRC} \leq 10$	LV: Line Code Violation $\geq 1$
G4: $10 < \text{CRC} \leq 100$	LB: Payload loopback activated
G5: $100 < \text{CRC} \leq 319$	SL: Slip $\geq 1$
G6: CRC $\geq 320$	

## Test Functions

### *FDL - Performance Report Message*

---

- ▶ **Performance Information** table, available when the **Report Content** button is selected, reports the time t0, t0-1, t0-2, and t0-3 for each PRM.

#### **Time**

- ▶ **T0** represents the valid PRM message received in the last second of measurement (bytes 5 and 6).
- ▶ **T0-1** represents the message one PRM ago (bytes 7 and 8).
- ▶ **T0-2** represents the message two PRM ago (bytes 9 and 10).
- ▶ **T0-3** represents the message three PRM ago (bytes 11 and 12).

#### **PRM**

**G3:**  $5 < \text{CRC Error Event} \leq 10$

**LV:** Line Code Violation Event  $\geq 1$

**G4:**  $10 < \text{CRC Error Event} \leq 100$

**U1:** Under study for synchronization

**U2:** Under study for synchronization

**G5:**  $100 < \text{CRC Error Event} \leq 319$

**SL:** Controlled Slip Event  $\geq 1$

**G6:** CRC Error Event  $\geq 320$

**FE:** Frame Sync. Bit Error Event  $\geq 1$

**SE:** Severely-Errored Framing Event  $\geq 1$

**LB:** Payload Loopback Activated

**G1:** CRC Error Event = 1

**R:** Reserved

**G2:**  $1 < \text{CRC Error Event} \leq 5$

**Nm** and **Nl:** One-second report modulo 4 counter.

## FEAC

The Far-End Alarm and Control signal (FEAC) provides Communication Channel capability over a DS3 in a network applications using C-bit Parity configuration (see page 395).

From the test menu, tap **Functions**, and the **FEAC** tab.

### Generated Messages

Allows configuring and sending alarms/status information and control signals (loopback commands) to other network elements.

➤ **Alarm/Status and Unassigned**

- **Codeword** allows the selection of the codeword alarm/status to be generated either manually or continuously.

The FEAC message format is a 16 bit codeword (0xxxxxx0 11111111) with the rightmost bit transmitted first. The 0xxxxxx0 represents the message codeword.

Codeword		
DS3 Equipment Failure SA (00110010)	Single DS1 LOS (00111100)	User Defined (00100000)
DS3 Loss of Signal (LOS) (00011100)	DS1 Equipment Failure NSA (00000110)	User Defined (00100010)
DS3 Out-of-Frame (00000000)	User Defined (00000010)	User Defined (00101000)
DS3 AIS Received (00101100)	User Defined (00000100)	User Defined (00101110)
DS3 Idle Signal Received (00110100)	User Defined (00001000)	User Defined (00110000)
DS3 Equipment Failure NSA (00011110)	User Defined (00001100)	User Defined (00111110)
DS3 NUI Loop Up (00010010)	User Defined (00010000)	User Defined (01000000)
DS3 NUI Loop Down (00100100)	User Defined (00010100)	User Defined (01111010)
Common Equipment Failure NSA (00111010)	User Defined (00010110)	User Defined (01111100)
Multiple DS1 LOS (00101010)	User Defined (00011000)	User Defined (01111110)
DS1 Equipment Failure SA (00001010)	User Defined (00011010)	

- **Mode** is the alarm/status injection mode: **Manual** or **Continuous**.

## Test Functions

### FEAC

---

- **Amount** is the amount of codeword to be generated: **1 to 15** (default is **10**).
- **Inject** generates error(s) according to the Codeword and mode selected.
- **Loopback Commands**
  - **Control**

**Codeword** is the loopback control codeword to be generated: **Line Loopback Activate (00001110)** - (Default) or **Line Loopback Deactivate (00111000)**.

**Amount** is the number of **Control Codeword** to be generated: **1 to 15** (default is **10**).
  - **Channel**

**Codeword** is the channel codeword to be generated.

Channel Codeword		
DS3 Line (00110110)	DS1 Line-No10 (01010100)	DS1 Line-No20 (01101000)
DS1 Line-No1 (01000010)	DS1 Line-No11 (01010110)	DS1 Line-No21 (01101010)
DS1 Line-No2 (01000100)	DS1 Line-No12 (01011000)	DS1 Line-No22 (01101100)
DS1 Line-No3 (01000110)	DS1 Line-No13 (01011010)	DS1 Line-No23 (01101110)
DS1 Line-No4 (01001000)	DS1 Line-No14 (01011100)	DS1 Line-No24 (01110000)
DS1 Line-No5 (01001010)	DS1 Line-No15 (01011110)	DS1 Line-No25 (01110010)
DS1 Line-No6 (01001100)	DS1 Line-No16 (01100000)	DS1 Line-No26 (01110100)
DS1 Line-No7 (01001110)	DS1 Line-No17 (01100010)	DS1 Line-No27 (01110110)
DS1 Line-No8 (01010000)	DS1 Line-No18 (01100100)	DS1 Line-No28 (01111000)
DS1 Line-No9 (01010010)	DS1 Line-No19 (01100110)	DS1 Line-All (00100110)

- Amount** is the number of Channel Codeword to be generated: **1 to 15** (Default is **10**).
- **Inject** generates the defined loopback command.

## Received Messages

Displays current and previous alarms/status and loopback commands as well as the link activity for the received DS3 signal.

- **Link Activity**
  - **None (All 1's):** An all ones pattern (11111111 11111111) has been detected in the last second.
  - **Alarm/Status:** An Alarm/Status codeword has been detected in the last second. An Alarm/Status is only detected when receiving at least 10 consecutive occurrences of a specific codeword.
  - **Loopback:** A Loopback command message has been detected in the last second. A valid loopback command is detected only when receiving 10 consecutive occurrences of a specific **Loopback Command** immediately followed by 10 occurrences of a specific **Channel Codeword**.
  - **Unassigned:** An unassigned message has been detected in the last second. An Unassigned message is only detected when receiving at least 10 consecutive occurrences of a specific unassigned codeword. An **Alarm/Status** codeword is also reported since **Unassigned** is part of the **Alarm/Status** group.
- **Alarm/Status and Unassigned** displays the current and previously received **Codeword** messages.
  - **Current** indicates the last valid message, if any, received in the last second of measurement.
  - **Previous** indicates the message, if any, that was received just before the current measurement.

## Test Functions

FEAC

---

- **Loopback Commands**
  - **Current** displays the valid message received in the last second of measurement. A valid message is detected only when receiving 10 consecutive occurrences of a specific **Loopback Command** immediately followed by 10 occurrences of a specific **Channel Codeword**.
  - **Previous** displays the last valid message received excluding the actual **Current** message.



## Filters

**Filters** allows gathering statistics according to the programmed filters. Filters provide the capability to analyze a specific stream's behavior in order to monitor a single protocol's behavior, perform SLA verification, or precisely troubleshoot unwanted behavior. Up to 10 filters having up to four operands each can be defined and enabled.

**Note:** *Not available with: eCPRI dual port topology; multiple link interface.*

From the test menu, tap **Functions**, and the **Filters** tab.

- <Port #> button, when available, allows selecting the port to be displayed. For **Dual Port** topology both ports are available. For the **Through Mode** test application, filters apply only to the **Primary Port**.
- **Filter** allows the selection of the filter number (1 to 10). The filter criteria, if defined, will be displayed. A filter used (enabled) for data capture will not be configurable and the message **Filter in use for data capture** is displayed.
- **Enable** check box when selected enables the currently selected filter. The filter has to be configured first before enabling it. If the filter configuration contains errors, it will not be possible to enable it. A filter can be enabled or disabled even when the test is running. It is not possible to modify or disable a filter that is already in use for capture until either another filter or **Interface** (see *Capture Source* on page 702) is assigned to capture.
- **Enabled Time** indicates the time during which the filter is enabled.
- **Assign to Capture** assigns the selected filter for packet capture (see *Packet Capture* on page 702).

## Filter Configuration

The filter configuration section allows configuring the filter criteria for the selected filter. The configuration is only possible when the **Enable** check box is cleared.

## Filter Configuration

- “(“ and “)”“, the open and close parenthesis controls the precedence of operands when more than two operands are used. Only one level of parenthesis is supported. When no parenthesis are used, a logical AND has precedence over a logical OR.
- **Not** check box when selected, adds the logical negation (not equal) operator for the operand filter defined at its right.
- **Filter** specifies the filter to be used (**None** by default).

Category	Filter
Ethernet	MAC Destination Address, MAC Source Address, EtherType <sup>a</sup> , C-VLAN ID, S-VLAN ID, E-VLAN ID, C-VLAN Priority, S-VLAN Priority, E-VLAN Priority, Frame Format
IPv4	IPv4 Destination Address, IPv4 Source Address, IPv4 TOS, IPv4 Precedence, IPv4 Protocol, IPv4 DiffServ
IPv6	IPv6 Destination Address, IPv6 Source Address, IPv6 Flow Label, IPv6 Next Header <sup>b</sup> , IPv6 Traffic Class, IPv6 Precedence, IPv6 DiffServ
Higher Layer	TCP Destination Port <sup>c</sup> , TCP Source Port <sup>c</sup> , UDP Destination Port, UDP Source Port
MPLS <sup>d</sup>	MPLS Label 1, MPLS Label 2, MPLS COS 1, MPLS COS 2

- Applies only to the last EtherType occurrence when VLAN is used.
- Applies only to the last next header occurrence when extension headers are used.
- Available with 10M to 10G interface rates only.
- Available when the corresponding software option is enabled.

- **Value** is the value associated to the selected filter.

- **Mask** allows masking the defined filter value. A bit mask of 1 indicates that the corresponding bit in the value is compared for the match. A bit mask of 0 indicates that the corresponding bit in the value is ignored.

For binary values, enter the mask value in binary format.

For decimal and MAC address values, enter the mask value in hexadecimal format.

For IP address field, enter the mask in decimal format.

- **Oper.** specifies the logical operator (AND or OR) used between two operands.

## **Filter Statistics**

Indicates throughput statistics of the frame matching the configured filter's criteria.

- **Line Utilization** indicates the percentage of line rate utilization.
- **Ethernet BW** (Bandwidth) indicates the receiving data rate expressed in Mbit/s.
- **Frame Rate** indicates the receiving number of frames (including bad frames) in frame/s.
- **Frame Count** indicates the number of frame matching the configured filter's criteria.
- **Error Count** indicates respectively the number of frames matching the configured filter's criteria having **IP Checksum**, **UDP Checksum**, **TCP Checksum**, **FCS**, **Jabber**, **Oversize**, **Runt**, or **Undersize** errors. Refer to *Ethernet* on page 896 and *IP/UDP/TCP* on page 915 for more information on errors.

# FlexE Advanced

From the test menu, tap **Functions**, and the **FlexE Advanced** tab.

## TX

- **PHY** indicates the TX PHY number assigned to the port.
- **Skew (ns)** indicates the TX relative delay in nanoseconds for each PHY. To change the skew values, see *Manual Skew (PHY)* on page 973.

## Port

**Port** indicates the module's port number.

## RX

- **Skew (ns)** indicates the delay in nanoseconds between the earliest PHY and the current PHY for the one to zero transition of the alignment marker sync bits. The received skew accuracy is  $\pm 100$  bits.
- **PHY** indicates the received PHY number.

## Alarms / Errors

For a description of each alarm/error, refer to *PHY* on page 931.

The error values are displayed in seconds by default. Tapping on the unit allows selecting either **Seconds**, **Count**, or **Rate**.

## **Reset Skew / Manual Skew**

Allows the selection of a relative delay in nanoseconds that will be introduced for each PHY.

- **Reset Skew** sets all TX skew values to 0 ns.
- **Manual Skew** allows setting the skew value for each PHY manually. Refer to *Manual Skew (PHY)* on page 973.

## **PHY Skew Alarm Threshold (ns)**

- **PHY Skew Alarm Threshold (ns)** allows setting the threshold value that will be used to declare the **Excessive PHY Skew** alarm: **50 ns** to **1000 ns** (default is **300 ns**).
- **Default** restores the default alarm threshold value.

## GMP

**Note:** Available with Transport test applications with either payload type 21 (PT21) or one of the following clients: **1GbE**, **40GbE**, **100GbE**, **Ethernet (flex/GFP-F)**, or **SONET/SDH (through ODU0)**.

From the **Test** menu, tap **Functions**, and the **GMP** tab.

- **Channel** available with Multi-Channel OTN allows the selection of the channel number.

### Generic Mapping Procedure

- **TX Cm** indicates the minimum and maximum Cm value transmitted during the test.
- **TX CnD** indicates the minimum and maximum CnD value transmitted during the test.
- **RX Cm** indicates the minimum and maximum Cm value captured during the test.
- **RX CnD** indicates the minimum and maximum CnD value captured during the test.

## OH BERT

The OH BERT validates the integrity of some overhead bytes on the top layer of an OTN test signal. The OH bytes are bundled as group for test purposes.

From the **Test** menu, tap **Functions**, and the **OH BERT** tab.

**Note:** *Only supported with Coupled topology.*

### OH BERT

The **OH BERT** check box when selected (cleared by default), enabled the OH BERT/SYNC generation and monitoring.

### Mode

Allows selecting the test operating mode:

- **BERT** (default) is a typical BER test that is executed on the selected group of OH bytes, a PRBS15 test pattern is mapped in each individual OH group for BER evaluation.
- **SYNC** is a special test which validates that the content of each selected OH group is carried by the same OTUk frame throughout its transfer over the network.

### Invert PRBS15 Pattern

**Invert PRBS15 Pattern** check box, when selected (cleared by default), inverts the test pattern meaning that every 0 will be changed for 1 and every 1 for 0. For example, the pattern 1100 will be sent as 0011. Available with BERT mode only.

### OTUx and ODUx

Overhead group check boxes:

Layer	Overhead Group	Number of Bytes	OH Bytes Coordinate	
			Row	Column
OTU	GCC0	2	1	11,12
	RES	2	1	13,14
ODU	GCC1	2	4	1, 2
	GCC2	2	4	3, 4
	APS/PCC	4	4	5-8
	PM&TCM	1	2	3
	TCM ACT	1	2	4
	FTFL <sup>a</sup>	1	2	14
	EXP	2	3	13, 14
	RES	8	2 4	1,2 9-14
	TCM1 <sup>b</sup>	3	3	7, 8, 9
	TCM2 <sup>b</sup>	3	3	4, 5, 6
	TCM3 <sup>b</sup>	3	3	1, 2, 3
	TCM4 <sup>b</sup>	3	2	11, 12, 13
	TCM5 <sup>b</sup>	3	2	8, 9, 10
TCM6 <sup>b</sup>	3	2	5, 6, 7	

- a. Only configurable when the test is not running. Once enabled, the FTFL configuration and alarm generation and monitoring in the main test are not available for the top ODU layer.
- b. Only configurable when not enabled in the test and when the test is not running.



The current and history status for enabled overhead group is as follows:

Status	Mode	
	BERT	SYNC
Green	No alarms/errors.	Overhead group bytes are synchronized.
Red	Alarms/errors condition detected.	Un-synchronized overhead group bytes condition detected.
Gray	Pending state	

### **BERT**

- Overhead group selector: Allows selection of the overhead group on which Pattern Loss condition and the Bit error statistics will be reported. Only enabled overhead group from OTUx/ODUx are listed.
- **Pattern Loss** indicates that the PRBS15 sequence synchronization is lost.
- **Bit Error** indicates that bit errors are detected on the selected overhead group bytes.

### **Bit Error**

- Overhead group selector: Allows selection of the overhead group on which bit error will be injected. Only enabled overhead group from OTUx/ODUx are listed; All selects all enabled overhead group.
- **Inject** generates bit errors on the selected overhead group bytes.

### **Reset**

Clears all OTUx/ODUx status as well as **Pattern Loss** and **Bit Error** statistics.

### OH - FlexE

Allows respectively modifying the FlexE overhead information to be transmitted (**TX**) or viewing (**RX**) the overhead information received.

From the test menu, tap **Functions**, **OH**, then either the **TX** or **RX** tab.

- **FlexE PHY Number** allows selecting the FlexE PHY to be displayed.
- **FlexE PHY / Instance Number** allows selecting for which FlexE PHY/Instance the information is displayed.
- **Frame** allows selecting for which frame the OH bytes is displayed: **0** to **31** for 100G instance; **0** to **15** for 50G interface.
- **Default FlexE OH** returns all TX overhead bytes to their factory default values.

### FlexE OH Frame Summary

#### Block 1

- **SH** (Sync Header), bit 0-1, is set to **10**.
- **Type**, bit 0-7, is set to **0x4B**.

**Note:** *Bits 8-11 (C, OMF, RPF/Res, and SC/Res) are reserved bits (Res) set to 0 for unequipped instances.*

- **C** (Calendar), bit 8, indicates the calendar in use: **A** or **B**. The calendar can be changed from the setup **FlexE Group** page.
- **OMF** (Overhead Multiframe Indicator), bit 9, is set to **0** for the first sixteen overhead frames of the overhead multiframe and to **1** for the remaining sixteen frames.
- **RPF/Res** (Remote PHY Fault / Reserved), bit 10 for the first instance of the PHY, informs the far-end shim of a locally detected failure of the PHY. The bit value can be changed by injecting the **Remote PHY Fault** alarm from the results **Alarms/Errors** page. For other instances RPF is replaced by a reserved bit.

- **SC/Res** (Synchronization Configuration / Reserved), bit 11 for the first instance of the PHY, indicates when set to **1** (default is **0**) that the group supports a synchronization messaging channel. For other instances SC is replaced by a reserved bit set to **0** (default) and can be overwritten.
- **Group** (FlexE Group), bit 12-31, indicates the FlexE Group number. The group number can be changed from the setup **FlexE Group** page for equipped instances. For an unequipped instance the FlexE Group number is 0 and is not configurable.
- **O** (O Code), bits 32-35, is set to **05** identifying a FlexE overhead.
- **0 00 00 00** (000\_0000 Code), bit 36-63, indicates the 000\_0000 Code.

**Note:** *Block 2 to 8 are replaced by **Unequipped** when the selected instance is unequipped.*

### Block 2

- **SH** (Sync Header), bit 0-1, is set to **01**.
- **C** (Calendar), bit 0, indicates the calendar in use: **A** or **B**. The calendar can be changed from the setup **FlexE Group** page.
- **FlexE Map** reports the FlexE Map bits over the frames. For 100G instance there are 256 bits over 32 frames; bits 1 to 254 contain the mapping information; bits 0 and 255 are reserved. For 50G instance there are 128 bits over 16 frames; bits 1 to 126 contain the mapping information; bits 0 and 127 are reserved.

The table on the left displays the FlexE Map hexadecimal and binary values for each frame. Select a frame to display its bit mapping on the **FlexE Map [frame#]** table.

The **FlexE Map [frame#]** table displays the FlexE PHY/Instance Map bit mapping for the selected frame. The first row indicates the position of the bits which are 1 to 8; the second row the binary value of each bit; the third row the PHY/Instance Map bit numbers for the selected frame.

## Test Functions

### *OH - FlexE*

---

- **Instance Number**, bit 9-16, indicates the FlexE PHY/Instance number.
- **Reserved**, bit 17-63, are for future FlexE implementation and are configurable: **00** to **7F** for the first 7 bits; **00** to **FF** for the remaining bytes.

### **Block 3**

- **SH** (Sync Header), bit 0-1, is set to **01**.
- **C** (Calendar), bit 0, indicates the calendar in use: **A** or **B**. The calendar can be changed from the setup **FlexE Group** page.

### ➤ **Client Calendar / Reserved**

**Client Calendar**, bit 1-32 available for frame 0 to 19 for 100G instance and 0 to 9 for 50G instance, indicates the client ID associated to both calendar A (bit 1-16) and calendar B (bit 17-32) for each frame. **U** indicates an unassigned calendar.

**Reserved**, bit 1-32 available for frame 20 to 31 for 100G instance and 10 to 15 for 50G instance, are for future FlexE implementation and are configurable per byte: **00** (default) to **FF**.

- **CR** (Calendar Switch Request), bit 33, is configurable as **A** or **B** calendar. The default value corresponds to the selected calendar (**C** bit).
- **CA** (Calendar Switch Acknowledge), bit 34, is configurable as **A** or **B** calendar. The default value corresponds to the selected calendar (**C** bit).
- **Reserved**, bit 35-47, are for future FlexE implementation and are configurable: **00** to **1F** for the first 5 bits; **00** to **FF** for the remaining bytes.
- **CRC-16** (Cyclic Redundancy Check-16), bits 48-63, indicates the calculated CRC over D1, D2, and D3 bytes of the ordered set in overhead block 1, all eight octets after the sync header of overhead block 2, and the first six octets after the sync header of overhead block 3.

**Block 4/5**

- **SH** (Sync Header), bit 0-1, is configurable as **01** or **10** (default).
- **Management Channel - Section**, bit 0-63, are configurable per byte from **00** to **FF** (default is **1E** for the first byte and **00** for the remaining bytes). Available with the first instance.

**Note:** *The combination of the **SH** and **Management Channel - Section** byte default values corresponds to an Idle Control Block.*

- **Reserved**, bit 0-63, are configurable per byte: **00** (default) to **FF**. Available with the second and subsequent instances.

**Block 6**

- **SH** (Sync Header), bit 0-1, is configurable as **01** or **10** (default).
- **Management Channel - Shim To Shim**, bit 0-63, are configurable per byte: **00** to **FF** (default is **1E** for the first byte and **00** for the remaining bytes). Available with the first instance when SC bit is set to 0.
- **Management Channel - Synchronization Channel**, bit 0-63, are configurable per byte from **00** to **FF** (default is **1E** for the first byte and **00** for the remaining bytes). Available with the first instance when SC bit is set to 1.

**Note:** *The combination of the **SH** and **Management Channel - Shim To Shim / Management Channel - Synchronizaton Channel** byte default values corresponds to an Idle Control Block.*

- **Reserved**, bit 0-63, are configurable per byte: **00** (default) to **FF**. Available with the second and subsequent instances.

## Test Functions

*OH - FlexE*

---

### Block 7/8

- **SH** (Sync Header), bit 0-1, is configurable as **01** or **10** (default).
- **Management Channel - Shim To Shim**, bit 0-63, are configurable per byte: **00** to **FF** (default is **1E** for the first byte and **00** for the remaining bytes). Available with the first instance when SC bit is set to 0.

**Note:** *The combination of the **SH** and **Management Channel - Shim To Shim** byte default values corresponds to an Idle Control Block.*

- **Reserved**, bit 0-63, are configurable per byte: **00** (default) to **FF**. Available with the second and subsequent instances.

## OH - GFP-F/GFP-T

**Note:** Available with OTN BERT test application with **1GbE (GFP-T)**, **10GbE (GFP-F)**, or **Ethernet (flex/GFP-F)** client.

From the **Test** menu, tap **Functions**, **OH** tab, and **GFP-F/GFP-T** sub tab.

➤ **Core Header**

**PLI** and **cHEC** are not configurable.

➤ **Type Header**

The following settings are available for **Client Data** and **Client Management** frame types.

- **PTI** (Payload Type Identifier) allows overwriting the Payload Type Identifier.

PTI	Description
000	Client Data Frame
100	Client Management Frame
001, 010, 011, 101, 110, and 111	Reserved

- **PFI** (Payload Frame Check Sequence Identifier) allows overwriting the Payload FCS Indicator.

PFI	Description
0	FCS Absent
1	FCS Present

## Test Functions

OH - GFP-F/GFP-T

- **EXI** (Extension Header Identifier) allows overwriting the Extension Header Identifier.

EXI	Description
0000	Null Extension Header
0001	Linear Frame
0010	Ring Frame
0011 to 1111	Reserved

- **UPI** (User Payload Identifier) allows overwriting the User Payload Identifier.

UPI	Description for PTI = 000	Description for PTI = 100
0000 0000 1111 1111	Reserved and not available	Reserved
0000 0001	Frame-Mapped Ethernet	Client Signal Fail (Loss of Client Signal)
0000 0010	Mapped PPP Frame	Client Signal Fail (Loss of Character Synchronization)
0000 0011	Transparent Fibre Channel	Client Defect Clear Indication (DCI)
0000 0100	Transparent FICON	Client Forward Defect Indication (FDI)
0000 0101	Transparent ESCON	Client Reverse Defect Indication (RDI)
0000 0110	Transparent GbE	
0000 0111	Reserved for future use	
0000 1000	Frame-Mapped Multiple Access Protocol over SDH (MAPOS)	
0000 1001	Transparent DVB ASI	
0000 1010	Framed-Mapped IEEE 802.17 Resilient Packet Ring	
0000 1011	Frame-Mapped Fibre Channel FC-BBW	
0000 1100	Asynchronous Transparent Fibre Channel	
0000 1101	Framed MPLS Unicast	
0000 1110	Framed MPLS Multicast	
0000 1111	Framed IS-IS	
0001 0000	Framed IPv4	
0001 0001	Framed IPv6	



<b>UPI</b>	<b>Description for PTI = 000</b>	<b>Description for PTI = 100</b>
0001 0010	Framed DVD-ASI	
0001 0011	Framed 64B/66B Ethernet	
0001 0100	Framed 64B/66B Ethernet Ordered Set	
0001 0101 through 1110 1111	Reserved for future standardization	
1111 0000 through 1111 1110	Reserved for proprietary use	
0000 0110 through 1101 1111		Reserved for future use
1110 0000 through 1111 1110		Reserved for proprietary use

- **Extension Header: CID and Spare** are only available when EXI is set to **Linear** (refer to **EXI** on page 288) and are available for **Client Data** and **Client Management** frame types.
  - **CID** (Channel IDentifier) allows overwriting the communication channel used for the signal transmission set from CID on page 288. Choices are from **00000000** through **11111111** (0 to 255). The default setting is 00000000.
  - **Spare** allows setting the extension header Spare field. Choices are from **00000000** through **11111111** (0 to 255).

## **Default all OH**

Returns all TX overhead bytes to their factory default values.

### RX

**Note:** *The following **Core Header**, **Type Header**, and **Extension Header** parameters are available for **Client Data**, **Client Management**, and **Reserved PTI** frames. The details of the selected OH field is displayed in the **OH Details** section on the bottom-right of the screen.*

#### ➤ Core Header

- **PLI** (Payload Length Indicator) indicates the number of octets in the GFP payload area.
- **cHEC** (Core Header Error Control) indicates the CRC-16 error control code that protects the integrity of the contents of the core header by enabling both single-bit error correction and Multi-bit error detection.
- **Type Header:** See **Type Header on page 677** for **PTI**, **PFI**, **EXI**, and **UPI** possible values.
  - **PTI** (Payload Type Identifier) indicates the type of GFP client frame.
  - **PFI** (Payload Frame Check Sequence Indicator) displays the Payload FCS Indicator.
  - **EXI** (Extension Header Identifier) indicates the Extension Header Identifier.
  - **UPI** (User Payload Identifier) indicates the User Payload Identifier.
  - **tHEC** (Type Header Error Control) indicates the CRC-16 error control code that protects the integrity of the contents of the type field by enabling both single-bit error correction and multi-bit error detection.

- **Extension Header: CID, Spare, and eHEC** are only available when EXI is set to **Linear** (refer to EXI on page 288).
  - **CID** (Channel IDentifier) indicates the communication channel used by the signal. Possible values are 00000000 through 11111111 (0 to 255).
  - **Spare** indicates the extension header Spare field. Possible values are 00000000 through 11111111 (0 to 255).
  - **eHEC** (Type Header Error Control) indicates the CRC-16 error control code that protects the integrity of the contents of the extension header by enabling both single-bit error correction (optional) and multi-bit error detection.

## **OH Details**

Displays the details of the selected OH byte. The first column indicates the selected OH byte. The second column indicates respectively from top to bottom the bit numbers used, the byte value in binary, and the interpretation of the byte when applicable.

### OH - OTN

For **OTN BERT**, from the **Test** menu, tap **Functions**, and the **OH** tab.

For **OTN-SONET/SDH BERT**, from the **Test** menu, tap **Functions**, **OH**, and the **OTN** sub tab.

Allows respectively modifying the overhead information to be transmitted or viewing the overhead information received.

### OTU<sub>x</sub>/ODU<sub>x</sub> and ODU<sub>x</sub> Buttons

Tap on either the **OTU<sub>x</sub>/ODU<sub>x</sub>** or the **ODU<sub>x</sub>** button to select the OH level.

### Default OTN OH

Returns all TX overhead bytes to their factory default values.

### TX/RX

Overhead bytes are organized using rows and columns structure as per G.709 standard.

Row 1

- **OA1** and **OA2**, columns 1-6, OTU FAS: All the Frame Alignment Signal **OA1** bytes and **OA2** bytes are individually configurable from **00** to **FF**. The default values are **F6** for all **OA1** bytes and **28** for all **OA2** bytes.
- **MFAS**, column 7, OTU MFAS: The Multi-Frame Alignment Signal byte is not configurable.
- **SM**, columns 8-10, OTU OH: The Section Monitoring contains the following bytes.

The first SM byte (column 8) contains the TTI multiframe byte that is only configurable from *Traces - OTN* on page 435.

The second SM byte (column 9) contains the BIP-8 byte that is automatically generated for each frame. This byte is not configurable.

The third SM byte (column 10) contains the following sub-fields. This byte is configurable from **00** (default) to **FF**.

Bit 1-4	Bit 5	Bit 6	Bit 7-8
BEI/BIAE	BDI	IAE	RES

- **GCC0**, columns 11-12, OTU OH: The two General Communication Channel-0 bytes are configurable from **00** (default) to **FF**. Not configurable when GCC0 check box is selected from *OH BERT* on page 669.
- **RES**, columns 13-14, OTU OH: The two Reserved (RES) bytes are configurable from **00** (default) to **FF**.
- **JC4** or **RES**<sup>1</sup>

**JC4**, column 15, OPU OH: Bits 1-3 set to all-0s, and bits 4-8 are controlled by GMP function. This byte is not configurable.

**RES**, column 15, OPU OH: The Reserved (RES) byte is configurable from **00** (default) to **FF**.
- **JC1** or **JC**<sup>1</sup>

**JC1**, column 16, OPU OH: Controlled by GMP function. This byte is not configurable.

**JC**, column 16, OPU OH:  
 Bits 1-6, Reserved (RES), are configurable from binary **000000** (default) to **111111**.  
 Bits 7-8, Justification Control (JC), are configurable from binary **00** (default) to **11**. Not available with ODU mux. Changing the JC value will corrupt the payload.

---

1. Depending on the test MUX/Mapping.

## Test Functions

### OH - OTN

---

Row 2

- **RES**, columns 1-2, ODU OH: The two Reserved (RES) bytes are configurable from **00** (default for each byte) to **FF**.
- **PM & TCM**, column 3, ODU OH: The Path Monitoring and Tandem Connection Monitoring byte is configurable from **00** (default) to **FF**.
- **TCM ACT**, column 4, ODU OH: The Tandem Connection Monitoring Activation is configurable from **00** (default) to **FF**.
- **TCM6/TCM5/TCM4**, column 5-13, ODU OH: The Tandem Connection Monitoring overhead contains the following bytes.

The first TCM<sub>i</sub> byte contains the TTI multiframe byte and is only configurable from *Traces - OTN* on page 435.

The second TCM<sub>i</sub> byte contains the BIP-8 byte and is automatically generated for each frame. This byte is not configurable.

The third TCM<sub>i</sub> byte contains the following sub-fields. This byte is configurable from **00** to **FF**. The default value is **00** when TCM<sub>i</sub> is disabled, and **01** when enabled.

Bit 1-4	Bit 5	Bit 6-8
BEI/BIAE	BDI	STAT

- **FTFL**, column 14, ODU OH: The Fault Type Fault Location multiframe byte is only configurable from *FTFL/PT / PT* on page 284.
- **JC5** or **RES**<sup>1</sup>
  - JC5**, column 15, OPU OH: Bits 1-3 set to all-0s, and bits 4-8 are controlled by GMP function. This byte is not configurable.
  - RES**, column 15, OPU OH: The Reserved (RES) byte is configurable from **00** (default) to **FF**.

---

1. Depending on the test MUX/Mapping.

➤ **JC2 or JC<sup>1</sup>**

**JC2**, column 16, OPU OH: Controlled by GMP function. This byte is not configurable.

**JC**, column 16, OPU OH:

Bits 1-6, Reserved (RES), are configurable from binary **000000** (default) to **111111**.

Bits 7-8, Justification Control (JC), are configurable from binary **00** (default) to **11**. Not available with ODU mux. Changing the JC value will corrupt the payload.

Row 3

➤ **TCM3/TCM2/TCM1**, columns 1-9, ODU OH: See *TCM6/TCM5/TCM4* on page 684 for more information.

➤ **PM**, column 10-12, ODU OH: The Path Monitoring overhead contains the following bytes.

The first PM byte (column 10) contains the TTI byte that is not configurable.

The second PM byte (column 11) contains the BIP-8 byte and is automatically generated for each frame. This byte is not configurable.

The third PM byte (column 12) contains the following sub-fields. This byte is configurable from **00** to **FF**. The default value is **01**.

Bit 1-4	Bit 5	Bit 6-8
BEI	BDI	STAT

➤ **EXP**, column 13-14, ODU OH: The two Experimental overhead bytes are configurable form **00** (default for each byte) to **FF**.

1. Depending on the test MUX/Mapping.

## Test Functions

*OH - OTN*

---

➤ **JC6 or RES<sup>1</sup>**

**JC6**, column 15, OPU OH: Bits 1-3 set to all-0s, and bits 4-8 are controlled by GMP function. This byte is not configurable.

**RES**, column 15, ODU OH: The Reserved (RES) bytes are configurable from **00** (default) to **FF**.

➤ **JC3 or JC<sup>1</sup>**

**JC3**, column 16, OPU OH: Controlled by GMP function. This byte is not configurable.

**JC**, column 16, OPU OH:

Bits 1-6, Reserved (RES), are configurable from binary **000000** (default) to **111111**.

Bits 7-8, Justification Control (JC), are configurable from binary **00** (default) to **11**. Not available with ODU mux. Changing the JC value will corrupt the payload.

Row 4

➤ **GCC1**, column 1-2, ODU OH: The two General Communication Channel-1 bytes are configurable from **00** (default for each byte) to **FF**. Not configurable when GCC1 check box is selected from *OH BERT* on page 669.

➤ **GCC2**, column 3-4, ODU OH: The two General Communication Channel-2 bytes are configurable from **00** (default for each byte) to **FF**. Not configurable when GCC2 check box is selected from *OH BERT* on page 669.

➤ **APS/PCC**, column 5-8, ODU OH: The Automatic Protection Switching / Protection Communication Channel overhead bytes are defined in the ITU-T G.709 standard. These bytes are configurable from **00** (default) to **FF**.

➤ **RES**, column 9-14, ODU OH: The six Reserved (RES) bytes are configurable from **00** (default for each byte) to **FF**.

---

1. Depending on the test MUX/Mapping.



- **PSI**, column 15, OPU/ODU OH: Tap the PSI field to configure (TX) or display (RX) the Payload Structure Identifier.
  - TX: Select any TX byte from the list and its content is displayed below the list. Tap the **Edit** button to change its value.
  - RX: Select any RX byte from the list and its content is displayed below the list.
  - **Foreground Signal Label**: This is a legend representing the status of the MSI for each PSI#, either **MSI TX** (black), **Expected MSI RX** (green), or **MSI Mismatch** (red).
  - The **Link TX/RX Scrolling** check box when selected (cleared by default), allows synchronizing both TX and RX table allowing to see the same TX and RX PSI byte numbers when scrolling from either TX or RX table.
- **OMFI or NJO**

**OMFI**, column 16, OPU OH: OPU Multi-Frame Identifier is only available for OPU4 of a mapped signal. This byte is not configurable.

**NJO**, column 16, ODU OH: The Negative Justification Opportunity byte is not configurable. Available either for non-concatenated signal or on the LO of a concatenated signal.

## **RX**

- **RX OH Byte Details** displays the content of the selected OH RX byte. Tap on any OH RX byte to see its content
- **Legend TX/RX** indicates the path level for all OH bytes.

## OH - SONET/SDH

The SONET/SDH OH page allows modifying (TX) the overhead information to be transmitted and viewing (RX) the overhead information received.

For **SONET/SDH BERT**, from the **Test** menu, tap **Functions**, and the **OH** tab.

For **OTN-SONET/SDH BERT**, from the **Test** menu, tap **Functions**, **OH**, and the **SONET/SDH** sub tab.

Tap on any overhead byte in TX to modify its value.

Tap on any overhead byte in RX to see its detailed content/value.

**Note:** *A byte in TX that has no value displayed or is grayed out, is not configurable from the OH tab.*

### TX and RX Buttons (SDH)

Tap on the TX or RX button to respectively access the overhead bytes in transmission or receive mode.

### STS-1 Timeslot/STM-1 Channel

Allows selecting the timeslot number for the Transport OH bytes. The STS/AU/TU-3 overhead bytes are always for the timeslot selected in the test configuration. Furthermore when modifying the Transport OH bytes H1 SS bits, the modification applies to all timeslots when the test topology is **Coupled**. Choices are **1** (default) to **192** (SONET) / **64** (SDH) depending on the OC-N/STM-N interface selected.

## Transport OH - Section/RS

- **A1 and A2:** Framing. The value should be hexadecimal **F6** for A1 and **28** for A2. They must appear in every STS-1/STM-1 frame of a composite signal.

SONET: Provide frame alignment of each STS-1 frame within a composite signal (STS-1 to STS-n).

SDH: Indicate the beginning of the STM-N frame.

- **J0/Z0**

- **J0:** The J0 (Trace) byte is used to trace the origin of an STS-1/STM-1 frame as it travels across the SONET/SDH network. This byte is only defined for the first STS-1/STM-1 frame of a composite signal.

Available when the Trace format is set to 1 Byte (refer to *Traces - SONET/SDH* on page 438).

- **Z0:** Growth.

SONET: The Z0 byte was used to uniquely identify the STS in question. This byte has to be defined in every STS-1 to STS-n frame of a composite signal. This byte is only defined for the STS-1 #2 to STS-1 #N of a OC-N signal.

SDH: These bytes are reserved for future international standardization. They are located at positions S[1,6N+2] to S[1,7N] of an STM-N signal (N > 1).

- **B1:** BIP-8 (Bit-Interleaved Parity) byte provides section error monitoring. This byte is only defined for the first STS-1/STM-1 frame of a composite signal. The byte is calculated by performing a routine even-parity check over all bits of the previous STS-N/STM-N frame of a composite signal.
- **E1:** Orderwire. Provides a 64 Kbit/s voice channel for communication between two STEs (Section Terminating Equipment). This byte is only defined for the first STS-1/STM-1 frame of a composite signal.

## Test Functions

### *OH - SONET/SDH*

---

- **F1:** User/User Channel. This byte is reserved for user purposes. This byte is only defined for the first STS-1/STM-1 frame of a composite signal.
- **D1, D2, and D3:** Data Communications Channel (DCC). Provides a 192 Kbit/s data communication between two STEs for operation functions such as OAM&P. These bytes are only defined for the first STS-1/STM-1 frame of a composite signal.

## Transport OH - Line/MS

- **H1 and H2:** Pointer.

SONET: H1 and H2 bytes are combined to form a pointer indicating where the path overhead begins within each SPE.

SDH: H1 and H2 bytes are combined to form a pointer indicating where the VC (Virtual Container) frame begins within each SPE.

Bits 5 and 6 of the H1 byte represent the SS bits and are configurable as follows:

SS Bits	Description
00	SONET
01	Undefined
10	SDH
11	Undefined

- **H3:** Pointer Action. H3 is an extra byte used to compensate for the SPE timing variation. The H1 and H2 pointer tell the receiver when the H3 pointer is used.

SONET: This byte must be defined in every STS-1 to STS-n frame of a composite signal.

SDH: This byte must be defined in every STM-1 of an STM-N signal in the event of negative justification, otherwise it is not defined.

- **B2: BIP-8**

SONET: The BIP-8 (Bit-Interleaved Parity) byte provides line error monitoring. This byte is only defined for the first STS-1/STM-1 frame of a composite signal. The byte is calculated by performing a routine even-parity check over all bits of the LOH and the STS-1 frame capacity of the previous frame of a composite signal (STS-1 to STS-n). Note that the SOH is not used to calculate the parity check.

SDH: The MS BIP-N\*24 (Bit-Interleaved Parity) byte provides line error monitoring. The byte is calculated by performing a routine even-parity check over all bits of the MSOH and the STM-N frame of the previous STM-N frame. Note that the RSOH is not used to calculate the parity check.
- **K1 and K2: Automatic Protection Switching (APS):** The K1 and K2 bytes communicate APS between two LTE. These bytes are only defined for the first STS-1/STM-1 frame of a composite signal.
- **D4 through D12: Data Communications Channel (DCC):** The D4 through D12 bytes provide a 576 Kbit/s data communications channel between two LTEs for administration, monitoring and other communications. These bytes are only defined for the first STS-1/STM-1 frame of a composite signal.
- **S1/Z1 (SONET)**

**S1:** Synchronization Status: The S1 byte is used to carry the synchronization status of the SONET device. This byte is only defined for the first STS-1/STM-1 frame of a composite signal.

**Z1:** Growth. This byte is located in the second STS-1 through STS-n frame of a composite signal (STS-1 #2, STS-1 #3, up to STS-1 #N of a OC-N (N>3) signal).
- **S1 (SDH):** Synchronization Status. Bits 5 to 8 of the S1 byte are used to carry the synchronization messages of the SDH device. This byte is only defined for the first STS-1/STM-1 frame of a composite signal.

## Test Functions

OH - SONET/SDH

---

➤ **M0 or M1/Z2 (SONET)**

**M0:** REI-L: The M1 byte is used for line Remote Error Indication (REI-L)

- For STS-1e and OC-1: The M0 byte located in the STS-1 indicates BIP violations.

<b>M0, bits 234 5678</b>	<b>Indicates</b>
000 0000	0 BIP violation
000 0001	1 BIP violation
:	:
000 1000	8 BIP violations
000 1001 to 1111 1111	0 BIP violation

- For OC-192: The M0 bytes located in the STS-1 #4 indicates BIP violations when combined with the M1 byte (see M1 byte below for more information).

**M1:** REI-L. The M1 byte is used for line Remote Error Indication (REI-L).

- For STS-3e and OC-3: The M1 byte located in the STS-1 #3 indicates BIP violations.

<b>M1, bits 234 5678</b>	<b>Indicates</b>
000 0000	0 BIP violation
000 0001	1 BIP violation
:	:
001 1000	24 BIP violations
001 1001 to 1111 1111	0 BIP violation

- For OC-12: The M1 byte located in the STS-1 #7 indicates BIP violations.

<b>M1, bits 234 5678</b>	<b>Indicates</b>
000 0000	0 BIP violation
000 0001	1 BIP violation
:	:
110 0000	96 BIP violations
110 0001 to 1111 1111	0 BIP violation

- For OC-48: The M1 byte located in the STS-1 #7 indicates BIP violations.

<b>M1</b>	<b>Indicates</b>
0000 0000	0 BIP violation
0000 0001	1 BIP violation
:	:
1111 1111	255 BIP violations

- For OC-192: Either the M1 byte located in the STS-1 #7, or the combination of the M0 and M1 bytes indicates BIP violations (refer to *REI-L Computation Method* on page 402).

For **M1 Only** computation method:

<b>M1</b>	<b>Indicates</b>
0000 0000	0 BIP violation
0000 0001	1 BIP violation
:	:
1111 1111	255 BIP violations

## Test Functions

OH - SONET/SDH

---

For **M0** and **M1** computation method:

<b>M0 Located in STS-1 #4</b>	<b>M1 Located in STS-1 #7</b>	<b>Indicates</b>
0000 0000	0000 0000	0 BIP violation
0000 0000	0000 0001	1 BIP violation
:	:	:
0000 0110	0000 0000	1536 BIP violations
0000 0110 to 1111 1111	0000 0001 to 1111 1111	0 BIP violation

**Z2:** Growth. Available with OC-3, OC-12, and OC-48 signal, this byte is located in STS-1 #1 up to STS-1 #48 except for timeslots used by M0 and M1.

**Undefined "--"** for all other timeslots not covered by M0, M1, and Z2.

➤ **M0 or M1 (SDH)**

**M0:** MS-REI. STM-1 channel #1 of a STM-0e and STM-0 signal; channel #2 of an STM-64 signal.

**M1:** MS-REI. STM-1 channel #1 of a STM-1e and STM-1 signal; channel #3 of an STM-N signal (N > 1).

**Undefined "--"** for all other channels not covered by M0, and M1.

➤ **E2:** Orderwire. Provides a 64 Kbit/s voice channel for communication between LTEs. This byte is only defined for the first STS-1/STM-1 frame of a composite signal.



### **STS/AU/TU-3**

- **J1:** Trace. Available when the Trace format is set to 1 Byte (refer to *Traces - SONET/SDH* on page 438).

SONET: The J1 Trace byte provides a 16 or 64 byte fixed string to verify connection between path transmitting equipment and path receiving equipment.

SDH: The higher-order (AU)/low-order (TU) VC-N path trace byte provides a 64 byte fixed string to verify connection between path transmitting equipment and path receiving equipment.

- **B3:** BIP-8. The BIP-8 (Bit-Interleaved Parity) byte provides path error monitoring. The byte is calculated by performing an even-parity check over all bits of the previous SPE.

## Test Functions

OH - SONET/SDH

- **C2: Signal Label.** Entering a C2 byte value will automatically update the Path Signal Label (C2) selection and vice versa. Refer to *STS/AU Path (C2)* on page 306 for more information.

C2 (Hex.)	Description	
	SONET	SDH
00 <sup>a</sup>	Unequipped	UNEQ or supervisory-UNEQ
01	Equipped - Non-Specific	RES (Equipped - Non-Specific)
02	Floating VT Mode (Default)	TUG Structure
03	Locked VT Mode	Locked TU-n
04	Async Mapping for DS3	Async Mapping of 34M/45M in C-3
05	Mapping under development	Experimental Mapping
12	Async Mapping for 140M (DS4NA)	Async Mapping of 140M in C-4
13	Mapping for ATM	ATM Mapping
14	Mapping for DQDB	MAN DQDB
15	Async Mapping for FDDI	FDDI [3]-[11] Mapping
16	Mapping of HDLC over SONET	Mapping of HDLC/PPP
17	SDL with self-sync scrambler	RES (SDL self-synch scrambler)
18	Mapping of HDLC/LAPS	Mapping of HDLC/LAPS
19	SDL with a set-reset scrambler	RES (SDL set-reset scrambler)
1A	10 Gbit/s Ethernet (IEEE 802.3)	10 Gbit/s Ethernet (IEEE 802.3)
1B	GFP	GFP
1C	Not supported	Mapping 10 Gbit/s FC
20	Not supported	Async Mapping of ODUk
CF	RES (Obsolete HDLC/PPP framed)	RES (obsolete HDLC/PPP framed)
E1 <sup>a</sup> to FC <sup>a</sup>	STS-1 w/1 VTx PD, STS-1 w/2 VTx PD, ... STS-1 w/28 VTx or STS-n/nc PD	Not supported
FE	Test Signal, ITU-T 0.181	Test Signal, ITU-T 0.181
FF <sup>a</sup>	STS SPE AIS (TCM)	VC-AIS (TCM)

- a. These values cannot be selected as Expected Path Signal Label.

- **G1:** Path Status. The G1 byte provides a method to communicate the far-end path status back to the path originating equipment.

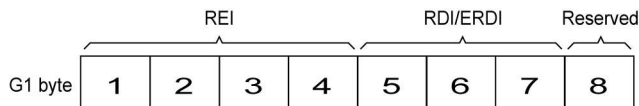

REI:

Bits 1 to 4 of G1	Description
0000	No error
0001	1 error
0010	2 errors
:	:
1000	8 errors
1001 to 1111	No error

RDI/ERDI:

Bits 5, 6, 7 of G1	Description
000, 001, 011	No defect
100, 111	RDI
010	ERDI-PD
101	ERDI-SD
110	ERDI-CD

- **F2:** User Channel. The User Channel provides a 64 Kbit/s channel for communication between two PTEs. This byte is only defined for the first STS-1/STM-1 frame of a composite signal.
- **H4:** Multiframe Indicator. The H4 byte provides a multiframe phase indication of a VT/TU payload.

## Test Functions

*OH - SONET/SDH*

---

- **Z3 and Z4:**  
SONET only: Growth.
- **F3:**  
SDH only: User Channel. The Path User Channel provides a channel for communication purposes between path elements and is payload dependent.
- **K3:**  
SDH only: Automatic Protection Switching (APS). Bits 1 to 4 of the K3 byte are used for APS signaling. K3 bits 5 to 8 are reserved for future use.
- **N1:**  
SONET: The N1 byte (formerly referred to as the Z5 byte) is allocated for Tandem Connection Maintenance (TCM) and the Path Data Channel.  
  
SDH: (Network operator byte) The N1 byte is allocated to provide a Higher-Order Tandem Connection Monitoring (HO-TCM) function.

## VT/TU

### ➤ V5 VT/TU Path Overhead

The V5 byte is allocated to indicate the content of the VT/TU path, including the status of the mapped payloads. It provides the same functions for VT/VC paths that the B3, C2, and G1 bytes provide for STS/STM paths.

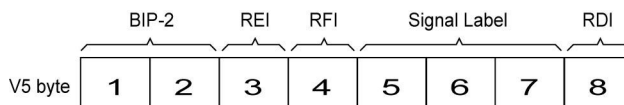

- **BIP-2** is not configurable.
- **REI, RFI, and RDI:** Choices are **0** (disabled), and **1** (enabled).
- Signal Label

Bits 5, 6, 7 of V5	Description	
	SONET	SDH
000 <sup>a</sup>	Unequipped	Unequipped or supervisory-unequipped
001	Reserved (Equipped - Non-specific)	
010	Asynchronous	
011	Bit Synchronous	
100	Byte Synchronous	
101	Extended Signal Label	
110	Test Signal, ITU-T 0.181 specific mapping	
111 <sup>a</sup>	VT SPE AIS (TCM)	VC-AIS (TCM)

a. These bytes cannot be selected in receive mode.

## Test Functions

### OH - SONET/SDH

---

If the signal label in V5 (bits 5, 6, and 7) is 101 the contents of the extended signal label is valid and contains in a 32 bit multiframe as shown below. See Z7/K4 Structure shown below.

#### Z7/K4 Structure

1	2	3	4	5	6	7	8	9	10	11	12	13	14	15	16	17	18	19	20	21	22	23	24	25	26	27	28	29	30	31	32			
Multiframe Alignment Signal											Extended Signal Label							0	R	R	R	R	R	R	R	R	R	R	R	R	R	R	R	R
Frame Count				Sequence Indicator																														

R = Reserved

- **J2 Trace.** Available when the Trace format is set to 1 Byte (refer to *Traces - SONET/SDH* on page 438).

SONET: VT Path Trace: The J2 Trace byte provides a 16 or 64 bytes fixed string allowing the receiving VT PTE to verify its continued connection to the intended transmitting VT PTE.

SDH: Path Trace: The J2 byte is used to repetitively transmit a Lower-Order Access Path Identifier so that a path receiving terminal can verify its continued connection to the intended transmitter.

- **Z6/N2**

**Z6 (SONET):** VT Tandem Connection Monitoring or VT Path Growth. The Z6 byte is allocated for future growth.

**N2 (SDH):** (Network operator byte) Tandem Connection Monitoring for the VC2, VC-12, and VC-11 level.

➤ **Z7 /K4** : Extended signal label

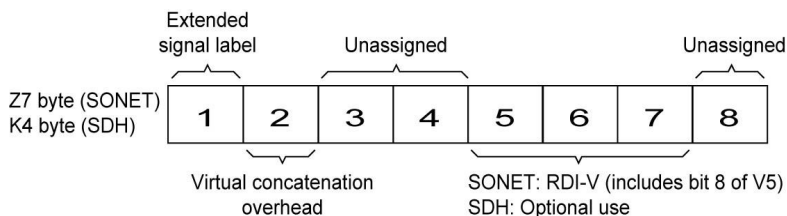

Bits	Description	
	Z7 (SONET)	K4 (SDH)
1	Extended signal label. Bits 12 to 19 of the 32 bit frame multiframe (see <b>Z7/K4 Structure on page 700</b> ) contain the extended signal label.	
2	Virtual concatenation. Bits 1 to 5 of the 32 bit frame multiframe (see <b>Z7/K4 Structure on page 700</b> ) contain the LO virtual concatenation frame count while bits 6 to 11 contain the LO virtual concatenation sequence indicator.	
3 - 4	unassigned and reserved for APS signaling for protection at the lower order path level.	
5 - 7	These bits in combination with bit 8 of V5 are allocated for RDI -V/ERDI-V signal	Optional use.
8	unassigned and reserved for a lower order path data link.	

## Default all OH

Returns all TX overhead bytes to their factory default values.

## Packet Capture

Capture is used to analyze all or filtered data traffic and save complete or truncated frames into a buffer. It allows observing network truncated data precisely, or understanding errors and unwanted behavior.

**Note:** *Not available with 200/400G and eCPRI dual port topology.*

From the test menu, tap **Functions**, and the **Packet Capture** tab.

- <Port #> button, when available, allows selecting the port to be displayed. For **Dual Port** topology both ports are available. For the **Through Mode** test application, packet capture applies only to the **Primary Port**.

## Capture Source

Specifies what kind of data to be captured.

- **Interface** captures all received frames and saves them in the capture buffer.
- **Filter #** captures only frames that match the selected filter and saves them in the capture buffer. Select the filter number from the list. Only enabled filters are available, see *Filters* on page 663. The selected filter will be reserved for data capture and will not be available for filter configuration.



## Frame Length

Specifies the length of the frame that will be saved in the capture buffer.

- **Complete** captures the entire frames.
- **Truncated** captures only the first specified number of bytes per frame. Use either the Bytes field to manually enter the number of bytes per frame or tap on the **Truncation Calculator** button for automatic bytes per frame calculation.

**Bytes** allows the selection of the number of bytes that will be saved in the capture buffer for each frame captured: 14 (default) to 1536 bytes.

**Truncation Calculator** allows determining easily at what byte to truncate the frame captured by selecting the desired frame header components.

- **Header Layer** specifies the header layer level: **Layer 2 (Ethernet)**, **Layer 3 (IP)**, or **Layer 4 (TCP/UDP)**.
- **IP Version** specifies the IP version: **IPv4** or **IPv6**.
- **Encapsulation** parameters are optional and not selected by default.

**VLAN** check box when selected enables VLAN and allows selecting the number of VLANs: 1, 2, or 3.

**MPLS** check box when selected enables MPLS and allows selecting the number of labels: 1 or 2.

**EoE** check box, when selected, enables EoE.

**PBB-TE** check box, when selected, enables PBB-TE.

- **Additional Payload (bytes)** allows selecting optionally the number of additional payload bytes (1 to 1400 bytes).
- **Total Number of Bytes** indicates the number of bytes for the selected frame parameters. This value will be used as the truncated frame length (**Truncated** field).

### Trigger

- **Trigger Type** defines the trigger source criterion that will be used to automatically start/stop the capture when a received frame matches the filter and trigger criteria.
  - **Manual** automatically starts the frame capture when the Capture button is on (green LED) and the test is started (refer to *Start/Stop | TX Button* on page 766).
  - **On Error** starts the frame capture when the selected error occurs.
    - FCS**
    - Jabber**
    - Oversize** (available when **Oversize Monitoring** is enabled)
    - Runt**
    - Undersize**
    - IP Checksum**
    - UDP Checksum**
    - TCP Checksum**
    - Any Type** (any of the above errors).
  - **Field Match** starts the frame capture when the configured field match is encountered. Use the **Configuration** button to select the field match criteria (see **Filter Configuration** from the **Filters** tab).
    - Cfg. Status** indicates the status of the configured field match configuration: **Valid** or **Invalid**. A valid status is required to be able to start the capture.

- **Trigger Position** selects the triggered frame position within the buffer.
  - **Post-Trigger** for a trigger frame located at the beginning of the buffer. The buffer will contain the triggered frame with the following frames.
  - **Mid-Trigger** for a trigger frame located at the middle of the buffer. The buffer will contain the triggered frame with the preceding and following frames.
  - **Pre-Trigger** for a trigger frame located at the end of the buffer. The buffer will contain the triggered frame with the preceding frames.

## Status and Controls

- **Capture Status** indicates the status of the data capture:
  - “--” indicates that the capture is not started and has not run yet.
  - Armed...** indicates the the capture is started but waiting for the trigger event.
  - Capturing...** indicates that the capture is in progress. For Post-Trigger and Mid-Trigger mode, the trigger event has been captured and the buffer is filling up.
  - Completed** indicates that the capture is completed.
- **Frame Count** indicates the number of frames captured that matches the selected filter criteria. However, for Mid-trigger and Pre-Trigger, the frame counter will only be available when the capture is completed.
- **Buffer Usage** indicates the percentage of the buffer capacity used.
- **Triggered Error** is available when trigger on error is selected and indicates the error that activated the trigger.
- **Triggered Frame - Details** gives details on the triggered frame. Refer to *Triggered Frame Details* on page 1006.

## Test Functions

### Packet Capture

---

- **Capture** button allows starting/stopping the data capture. The test must be running (refer to *Start/Stop | TX Button* on page 766) in order to start capturing and recording data into the buffer. The Capture button is not available when the trigger on field match is selected while its trigger parameters are not valid.

No data will be recorded in the buffer if no frame matches the filter and the trigger criteria during the data capture.

The data capture stops automatically once the buffer is full. The maximum buffer capacity is 64 KBytes or a maximum of 2078 frames for rates up to 10GE and 512 KBytes or a maximum of 8192 frames for rate 40GE/100GE.

When the capture stops or is manually stopped, the following message is displayed: **Capture completed. Press Export to save captured data (the test must be stopped)**. To avoid losing the captured data, the data must be exported and saved into a file before restarting the test or creating a new test.

- **Export**, available when the test application is stopped, allows exporting the data captured into a .pcap file format and viewing the file using Wireshark.
  - **Save In** allows selecting the folder to save the capture file (by default:  
Users\\Documents\88000-PowerBlazer\CaptureData).
  - **View File After Generation** check box when selected (cleared by default) allows displaying the report once it is generated using the Wireshark application.

- **Generate & Save** allows generating and saving the capture data. The name of the captured file is automatically selected and contains the date and time of the capture. Capture file bigger than 100Mbytes will be split into multiple files. Tapping on the **Cancel** button stops the capture generation. The captured data already processed will be saved.

**Note:** *The export process may take several minutes.*

Once generated, the capture file will be automatically opened in Wireshark when the **View File After Generation** check box is selected. The capture file report may also be manually opened within Wireshark typically using Windows Explorer.

# Path OAM APS

**Note:** Available when **Path OAM** is enabled, refer to Path OAM on page 344.

From the test menu, tap **Functions** and the **Path OAM APS** tab.

- **Path OAM APS** check box when selected (cleared by default) enables the generation and monitoring of APS messages when the test is running.
- **Request/State Interpretation** allows selecting the standard used for request/state interpretation: **G.873.1** (default) or **G8331**.
- **Path OAM on Client ID** indicates on which client ID the path OAM applies.

## TX/RX

- **Request/State:** Bits 1 to 4 of the APS data byte 0. Reserved request/state values are not available for transmission.

Bits 1 to 4	Request/State	
	G.873.1	G8331
1111	Lockout of protection (LoP)	Lockout of protection (LO)
1110	Forced switch (FS)	Signal Fail on Protection (SF-P)
1101	Reserved	Forced Switch (FS)
1100	Signal fail (SF)	Reserved
1011	Reserved	Signal Fail on Working (SF-W)
1010	Signal degrade (SD)	Reserved
1001	Reserved	Signal Degrade (SD)
1000	Manual switch (MS)	Reserved
0111	Reserved	Manual Switch (MS)
0110	Wait-to-restore (WTR)	Reserved
0101	Reserved	Wait-to-Restore (WTR)

Bits 1 to 4	Request/State	
	G.873.1	G8331
0100	Exercise (EXER)	Exercise (EXER)
0011	Reserved	Reserved
0010	Reverse request (RR)	Reverse Request (RR)
0001	Do not revert (DNR)	Do Not Revert (DNR)
0000	No request (NR) (Default)	No Request (NR) (Default)

- **Requested Signal:** Bits 1 to 8 of the APS data byte 1: **0 Null Signal** (Default), **1, 2, ..., 254, 255 Extra Traffic Signal**.
- **Bridged Signal:** Bits 1 to 8 of the APS data byte 2: **0 Null Signal** (Default), **1, 2, ..., 254, 255 Extra Traffic Signal**.
- **Reserved:** Bits 1 to 8 of the APS data byte 3: **0** (default) to **255**.
- **Protection Type:** Bits 5 to 8 of the APS data byte 0.

Protection Type	Bit		Description
	#	Value	
A	5	0	No APS Channel (Default)
		1	APS Channel
B	6	0	1+1 (permanent bridge) (Default)
		1	1:n (no permanent bridge)
D	7	0	Unidirectional switching (Default)
		1	Bidirectional switching
R	8	0	Non-revertive operation (Default)
		1	Revertive operation

## Test Functions

### *Path OAM APS*

---

## **RX**

- **APS**
  - **TX Count** reports the count of transmitted APS messages.
  - **RX Count** report the count of received APS messages having a valid CRC4.

## **Apply Changes**

Use the **Apply Changes** button to apply any changes made to the APS TX configuration once the test is started/running, otherwise all changes apply automatically when the test is started. Only available when **Path OAM APS** is enabled and the test is started.



## Ping & Trace Route

From the **Test** menu, tap **Functions**, and the **Ping & Trace Route** tab.

**Note:** For *Dual Port* topology select the port to be displayed.

**Link**, available with multiple link interface (ex: 2 x 100GE), allows selecting the link to be displayed.

### Source IP Address

Displays or allows the selection of either the interface source IP address or a stream IP address depending on the test and its configuration. Refer to *Network* on page 328, *MAC/IP/UDP* on page 315, or *Smart Loopback* on page 405.

### Destination IP Address

Enter the **Destination IP Address** of the network device to be detected. The destination IP address is configurable only with **IPv4 Network Layer** (refer to *Modify Structure* on page 132). The accepted range for IPv4 is **0.0.0.0** (default) to **255.255.255.255**.

The default setting for IPv6 is **2001:0000:0000:0000:0000:0000:0000:0000** or is set automatically to the IP address of the target module from the Remote Loopback mode. The destination IP address is configured only when **Ethernet/IPv6/UDP** is selected. The **IPv6 Address** can either be the **Link-Local IPv6 Address** or the **Global IPv6 Address**. The acceptable range for IPv6 is from **000:0000:0000:0000:0000:0000:0000:0001** to **FFFF:FFFF:FFFF:FFFF:FFFF:FFFF:FFFF:FFFF**.

### Stream

**Stream** is available with EtherSAM and Traffic Gen & Mon and allows selecting a stream/service to use its source and destination IP addresses for the Ping and Trace Route tests.

## Use Stream

**Use Stream**, available with test application using stream/services, allows using the source and destination IP of the defined or selected stream/services.

## Ping

- **Data Size (Bytes)**: Enter the data size that will be sent to the network device to be detected. Choices are **0 to 1452 bytes; 32 bytes** by default.
- **TTL for IPv4 and Hop Limit (TTL) for IPv6**: Enter the maximum number of hops the packet can go through. Choices are **1 to 255; 128** by default.
- **IP TOS/DS for IPv4 and Traffic Class (TOS/DS) for IPv6**: Enter the type of service. Choices are **00** (default) to **FF**.
- **Flow Label (IPv6)** value acceptable range is from **0** (default) to **1048575**.
- **Timeout (ms)**: Enter the maximum time allowed between an ICMP echo and response. Choices are **200 ms to 10000 s; 4000 ms** by default.
- **Delay (ms)**: Enter the delay between each attempt (PING). Choices are **100 to 10000 ms; 1000 ms** by default.
- **Attempts**: Select **n-Attempts** to specify the number of ping requests to send following a ping activation or select **Continuous** to ping continuously until manually stopped. If **n-Attempts** is selected, enter the number of ping attempts from **1 to 1000**. The default setting is **n-Attempts** with **4** attempts.
- **Ping** button starts the ping tool with the specified settings.

## Trace Route

- **Max Hop Count:** Enter the maximum network device the packet is allowed to go through. Choices are **1** to **255**; **128** by default.
- **Timeout (ms):** Enter the maximum time allowed between an ICMP echo and response at each hop. Choices are **200 ms** to **10000 ms**; **4000 ms** by default.
- **Trace Route** button starts the trace route tool with the specified settings.

## Results

To succeed, a ping command shall be acknowledged by the network device within a given delay (**Timeout**). Typically a ping command can fail for the following reasons:

- The IP address is unavailable or unknown.
- The time allowed to perform the ping command is too short.
- The remote device is not supporting ICMP messaging.

To succeed, a trace route command shall be acknowledged by the network device within a given delay (**Timeout**). Typically a trace route command can fail for the following reasons:

- The IP address is unavailable or unknown.
- The time allowed to perform the trace route command is too short.
- The remote device is not supporting ICMP messaging.

The ping and trace route results are displayed with the following columns:

- **No.:** Indicates the attempt number.

## Test Functions

### *Ping & Trace Route*

---

► **Status:** Indicates the status of the attempt as follows:

Status	Description
<b>Successful</b>	Valid ICMP echo reply received.
<b>User Aborted</b>	When a user has manually stopped the ping/trace route function before the end of attempts.
<b>Time Out</b>	When an ICMP echo reply was not received within the defined timeout.
<b>Destination Invalid</b>	With reserved IP addresses: For IPv4: 0.0.0.0, 127.0.0.0, and all addresses above 240.0.0.0 (Class E and above). For IPv6: 0::/8 (reserved/unspecified), 0::1/128 (Loopback), FF00::/8 (Multicast).
<b>TTL Expired (ping test)</b>	When the number of TTL was insufficient to reach the destination host.
<b>Hop Reached (trace route test)</b>	When a Time Exceeded message is received from a host while executing the trace route function.
<b>Destination Unreachable</b>	For IPv4: When the IP address is unreachable (no default gateway for an IP address, not in the same subnet, or an ICMP Unreachable message is received). For IPv6: When the IP address is unreachable (no default gateway for an IP address, not in the same subnet, or address resolution failed or an ICMP Destination Unreachable message is received).
<b>Data Corrupted</b>	Parameter problem message is received or data corruption is found for IPv4.
<b>Discarded</b>	Congestion has been detected and the request cannot be transmitted.
<b>Packet Too Big</b>	Packet Too Big message is received in response to a packet that the router cannot forward because the packet is larger than the MTU of the outgoing link. It is only applicable for the <b>IPv6 version</b> .
<b>Undefined</b>	For any other errors in ping/trace route that do not fall into one of the above description.

➤ **Replied Details**

For ping, indicates the IP address of the replier, the buffer size of the ICMP echo response, the time of response in milliseconds, and the TTL of the ICMP echo response.

For trace route, indicates the IP address of the replier, and the time of response in milliseconds.

**Statistics**

➤ **Packets Transmitted** indicates the number of sent packets.

➤ **Packets Received** indicates the number of received packets.

The following statistics are only available for the ping test.

➤ **Percentage Lost (%)** indicates the percentage of packets lost.

➤ **Min Round Trip Time (ms)** indicates the minimum time recorded for a ping request to be answered.

➤ **Max Round Trip Time (ms)** indicates the maximum time recorded for a ping request to be answered.

➤ **Avg. Round Trip Time (ms)** indicates the average time required for a ping request to be answered.

## Pointer Adjustment

From the **Test** menu, tap **Functions**, and the **Pointer Adjustment** tab.

### TX Pointer Adjustment

**Note:** *Only available in Coupled topology.*

The pointer adjustment supports two modes of operation: **Manual** and **Sequence**. Both modes offer the generation of pointer events even when the test is not started.

### TX Pointer Adjustment - Manual Button

#### Step

##### ➤ Value

For STS/AU: Select the number of positive (Increment) or negative (Decrement) pointer adjustments to include into the STS-n (SONET) or AU-n (SDH): **1** (default) to **1000**. For multiple pointer adjustments, the pointer adjustment rate is 1 adjustment at every 4 frames.

For VT/TU: Select the number of positive (Increment) or negative (Decrement) pointer adjustment to include into the VTn (SONET) or TU-n (SDH): **1** (default) to **1000**. For multiple pointer adjustments, the pointer adjustment rate is 1 adjustment at every 4 multiframes.

- **Increment** button sends the positive pointer adjustment defined.
- **Decrement** button sends the negative pointer adjustment defined.
- **Pointer Value** indicates the current pointer value.

**Jump**

- **New Pointer** allows selecting a new pointer value:

For STS/AU: **0** (default) to **782**

For VT/TU:

Path	Range
VT1.5	0 to 103
VT2	0 to 139
TU-3	0 to 764
TU-11	0 to 103
TU-12	0 to 139

- **Inject** button sends the new pointer value.
- **New Data Flag** (NDF) check box when selected inserts a New Data Flag with the pointer adjustment when the Inject button is tapped.

For STS/AU: When NDF is enabled, bits 1 to 4 of the pointer word (H1 and H2 bytes) are set to **1001** when executing a pointer jump.

For VT/TU: When NDF is enabled, bits 1 to 4 of the pointer word (V1 and V2 bytes) are set to **1001** when executing a pointer jump.

## Test Functions

### Pointer Adjustment

---

## TX Pointer Adjustment - Sequence Button

**Note:** The pointer sequence is only supported on one test layer; either on VT/TU layer or on STS/AU when the test doesn't contain VT/TU mapping. The field next to the **Sequence** operation mode button indicates the path level used for the sequence pointer adjustment.

- **Sequence: T.105-03/GR-253** allows the selection of the pointer sequence pattern based on the **T.105-03/GR-253** standard.

Pointer Sequence Pattern	Available with
Single pointers of opposite polarity	AU-x, TU-3, TU-11, TU-12
Regular pointers plus one double pointer	AU-x, TU-3, TU-11, TU-12
Regular pointers with one missing pointer	AU-x, TU-3, TU-11, TU-12
Double pointers of opposite polarity	AU-x, TU-3, TU-11, TU-12
Single pointer adjustment	STS-x, VT1.5, VT2, AU-x, TU-3, TU-11, TU-12
Burst pointer adjustment	STS-x, VT1.5, VT2, AU-x, TU-3, TU-11, TU-12
Phase transient	STS-x, VT1.5, VT2, AU-x, TU-3, TU-11, TU-12
Periodic pointer adjustment 87-3 pattern	STS-x, AU-x, TU-3
Periodic 87-3 with Add	STS-x, AU-x, TU-3
Periodic 87-3 with Cancel	STS-x, AU-x, TU-3
Periodic pointer adjustment continuous	STS-x, VT1.5, VT2, AU-x, TU-3, TU-11, TU-12
Periodic pointer adjustment continuous with Add	STS-x, VT1.5, VT2, AU-x, TU-3, TU-11, TU-12
Periodic pointer adjustment continuous with Cancel	STS-x, VT1.5, VT2, AU-x, TU-3, TU-11, TU-12
Periodic pointer adjustment 26-1 pattern	VT1.5, TU-11
Periodic 26-1 with Add	VT1.5, TU-11
Periodic 26-1 with Cancel	VT1.5, TU-11



➤ **Initialization / Cool Down / Sequence**

The following time line examples show the initialization, cool down, and the pointer sequence according to the selected sequence and parameters.

**Example 1: Periodic 87-3 with Cancel**

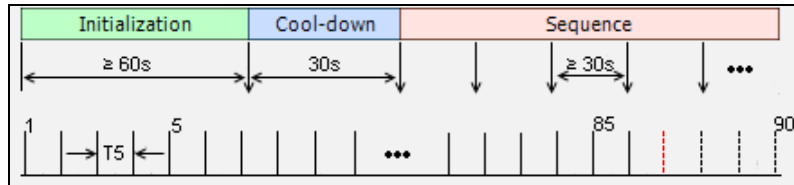

**Example 2: Regular pointers plus one double pointer**



Legend:

	Description
	When located at the end (right) of the sequence, indicates a continuous repetition of the pointer sequence. When located within the sequence, indicates a repetition of pointers.
	Regular pointer event or sequence.
	Cancel event.
	Special event like an extra cancel event (for example in <b>Periodic 87-3 with Cancel</b> ) or a missing event from the <b>Regular pointers with one missing pointer</b> sequence.
	Special event like add, double pointer, etc.
	Indicates that the sequence is periodic with special event.

## Test Functions

### Pointer Adjustment

- **T1 to T6** are configurable duration parameters. The range of the duration parameters as well as their availability versus pointer sequence are described in the following table.

Pointer Sequence Pattern	Parameter	Duration range
Single pointers of opposite polarity	T1	10 to 30 s (default 10 s)
Regular pointers plus one double pointer	T2	AU/TU-3: 7.5 ms to 30 s (default 0.333 s) TU-11/12: 0.2 s to 30 s (default 0.75 s)
	T3	AU/TU-3: 0.5 ms TU-11/12: 2 ms
Regular pointers with one missing pointer	T2	AU/TU-3: 7.5 ms to 30 s (default 0.333 s) TU-11/12: 0.2 s to 30 s (default 0.75 s)
Double pointers of opposite polarity	T1	10 to 30 s (default 10 s)
	T3	STS-x/AU-x/TU-3: 0.5 ms to 1 s (default 0.5 ms) VT-x/TU-11/12: 2 ms to 1 s (default 2 ms)
Single pointer adjustment	T6	30 to 60 s (default 30 s)
Burst pointer adjustment	T4	STS-x/AU-x/TU-3: 0.5 ms VT-x/TU-11/12: 2ms
	T6	30 to 60 s (default 30 s)
Phase transient	T6	30 to 60 s (default 30 s)
Periodic pointer adjustment 87-3 pattern	T5	7.5 ms to 10 s (default 0.333 s)
Periodic 87-3 with Add	T4	0.5 ms
	T5	7.5 ms to 10 s (default 0.333 s)
Periodic 87-3 with Cancel	T5	7.5 ms to 10 s (default 0.333 s)
Periodic pointer adjustment continuous	T5	STS-x/AU-x/TU-3: 7.5 ms to 10 s (default 0.333 s) VT-x/TU-11/12: 0.2 s to 10s (default 1 s)
Periodic pointer adjustment continuous with Add	T4	STS-x/AU-x/TU-3: 0.5 ms VT-x/TU-11/12: 2 ms
	T5	STS-x/AU-x/TU-3: 7.5 ms to 10 s (default 0.333 s) VT-x/TU-11/12: 0.2 s to 10 s (default 1 s)
Periodic pointer adjustment continuous with Cancel	T5	STS-x/AU-x/TU-3: 7.5 ms to 10 s (default 0.333 s) VT-x/TU-11/12: 0.2 s to 10 s (default 1 s)
Periodic pointer adjustment 26-1 pattern	T5	0.2 s to 10 s (default 1 s)
Periodic 26-1 with Add	T4	2 ms
	T5	0.2 s to 10 s (default 1 s)
Periodic 26-1 with Cancel	T5	0.2 s to 10 s (default 1 s)

- **T1 (s)** represents the interval between two pointer events.

Example of **Single pointer of opposite polarity** sequence.

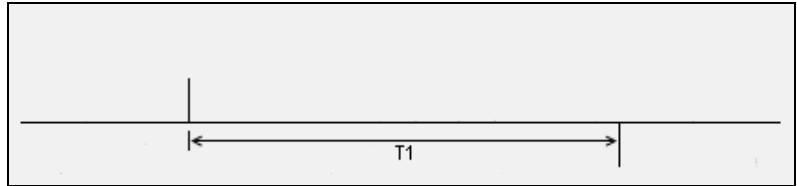

- **T2 (s)** represents the interval between successions of pointer events.

Example of **Regular pointers with one missing pointer** sequence.



- **T3 (ms)** represents the interval between back to back pointer events.

Example of **Regular pointers plus one double pointer** sequence.



## Test Functions

### Pointer Adjustment

- **T4 (ms)** represents the interval between back to back pointer events in periodic pointer sequence.

Example of **Burst pointer adjustment** sequence.

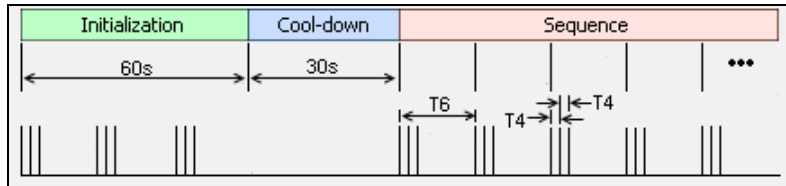

- **T5 (s)** represents the interval between successions of pointer events in a Periodic pointer sequence.

Example of **Periodic 87-3 with Cancel** sequence.

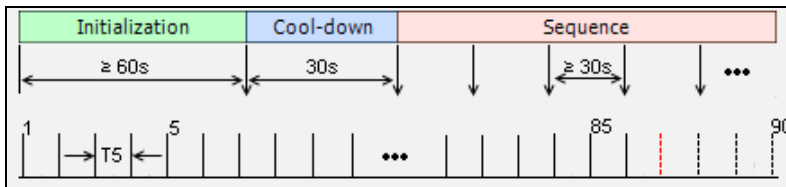

- **T6 (s)** represents the interval between successions of pointer events.

Example of **Phase transient** sequence.

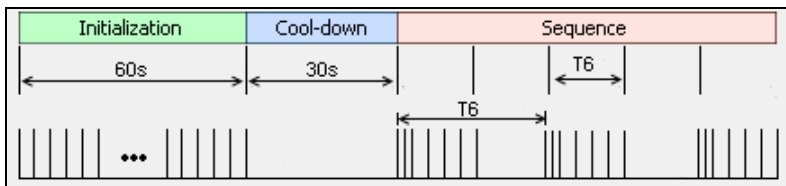

- **Increment/Decrement** allows determining if the pointer sequence will increment (positive) or decrement (negative) the pointer values.
- **Periodic** check box when selected, generates the pointer sequence continuously. The pointer sequence is generated only once when the **Periodic** check box is cleared. The capability to clear the **Periodic** check box is only available for the following pointer sequences:
  - Single pointers of opposite polarity
  - Regular pointers plus one double pointer
  - Regular pointers with one missing pointer
  - Double pointers of opposite polarity
- **Init-Cool** check box when selected, generates pointer action with three phases: initialization, Cool-down, and pointer sequence. Only the pointer sequence is generated when the **Init-Cool** check box is cleared.
- **Status** indicates the pointer event activity status.
  - **Initialization** indicates that the pointer sequence test is started and is running the initialization phase.
  - **Cool-down** indicates that the pointer sequence test is started and is running the cool down phase.
  - **Sequence** indicates that the pointer sequence test is started and is running the sequence phase; this phase runs until the Sequence is turn off.
  - **Static pointer** indicates that the pointer sequence is not started. The signal generator transmits a fix pointer value.
- **Pointer Value** indicates the current pointer value. Available even if the test is not started or if the sequence is not enabled.

## Test Functions

### Pointer Adjustment

- **Sequence** button when enabled, generates pointer events on a regular basis. The initialization and cool down sequence are described below for each pointer sequence pattern.

Pointer Sequence Pattern	Initialization	Cool down
Single pointers of opposite polarity	Basic sequence <sup>ab</sup> Duration ≥ 60 sec	Basic sequence <sup>ab</sup> Duration = 30 sec
Regular pointers plus one double pointer	Add sequence Duration ≥ 60 sec	Add sequence Duration = 30 sec
Regular pointers with one missing pointer	Cancel sequence Duration ≥ 60 sec	Cancel sequence Duration = 30 sec
Double pointers of opposite polarity	Basic sequence <sup>ab</sup> Duration ≥ 60 sec	Basic sequence <sup>ab</sup> Duration = 30 sec
Single pointer adjustment	One pointer event per second Duration = 60 sec	No pointer event Duration = 30 sec
Burst pointer adjustment		
Phase transient		
Periodic pointer adjustment 87-3 pattern	Basic sequence <sup>a</sup> Duration ≥ 60 sec	Basic sequence <sup>a</sup> Duration = 30 sec
Periodic 87-3 with Add		Add sequence Duration = 30 sec
Periodic 87-3 with Cancel		Cancel sequence Duration = 30 sec
Periodic pointer adjustment continuous	Basic sequence <sup>a</sup> Duration = 60 sec	Basic sequence <sup>a</sup> Duration = 30 sec
Periodic pointer adjustment continuous with Add		Add sequence Duration = 30 sec
Periodic pointer adjustment continuous with Cancel		Cancel sequence Duration = 30 sec
Periodic pointer adjustment 26-1 pattern	Basic sequence <sup>a</sup> Duration ≥ 60 sec	Basic sequence <sup>a</sup> Duration = 30 sec
Periodic 26-1 with Add		Add sequence Duration = 30 sec
Periodic 26-1 with Cancel		Cancel sequence Duration = 30 sec

- The basic sequence corresponds to the pointer event pattern defined in the standard without any Add or extra Cancel event.
- Only available when the **Periodic** check box is selected.

## RX Pointer Adjustment

### ➤ Pointer Value

For STS/AU: Displays the value for the pointer, H1 and H2, indicating the offset in bytes between the pointer and the first byte of the STS-n (SONET) or AU-n (SDH).

For VT/TU: Displays the value of the pointer, V1 and V2, indicating the offset in bytes between the pointer and the first byte of the VTn (SONET) or TU-n (SDH) of the high order path. However, TU-3 considered a low order path, uses the H1, H2, H3 bytes for its location.

- **Cumulative Offset** indicates the difference between the pointer increment and the pointer decrement. A pointer jump will reset this value to **0**.
- **Ptr. Incr.** (Pointer Increment) gives statistics on positive pointer adjustment detected.
- **Ptr. Decr.** (Pointer Decrement) gives statistics on negative pointer adjustment detected.
- **NDF** (New Data Flag) gives statistics on pointer jumps containing a New Data Flag.

For STS/AU: Bits 1 to 4 of the pointer word (H1 and H2) detected are **1001**.

For VT/TU: Bits 1 to 4 of the pointer word (V1 and V2) detected are **1001**.

- **No NDF** (No New Data Flag) gives statistics on normal pointer jumps containing no NDF.

For STS/AU: Bit 1 to 4 of the pointer word (H1 and H2) detected are **0110**.

For VT/TU: Bit 1 to 4 of the pointer word (V1 and V2) detected are **0110**.

## RTD

**Note:** *Available with Pattern client. Not available in Decoupled, Through, or Through Intrusive mode.*

Round Trip Delay (RTD) measurements are needed to quantify the time it takes for a signal to cross the network and come back. Usually, transport delay is due to two factors: long configured paths and transit times through the network elements along the path. Therefore, RTD measurements are significant in systems that require two-way interactive communication, such as voice telephony, or data systems where the round-trip time directly affects the throughput rate.

From the **Test** menu, tap **Functions**, and the **RTD** tab.

**Note:** *To do a Round Trip Delay test, the remote NE should be configured to provide a loopback.*

**Note:** *Be aware that RTD requires error free operation conditions to provide reliable results. Therefore, RTD results could be affected by error injection or error introduced by the network.*

## Mode

Allows the selection of the round trip delay test mode. Choices are **Single** (default) and **Continuous**.

- **Single** allows testing the round trip delay once.
- **Continuous** allows testing the round trip delay continuously in a repetitive manner (one RTD measurement every 2 seconds).



## Measure Delay Button

Allows enabling the round trip delay measurement.

For **Single** mode, the test is performed once and stops (the **Measure Delay** button turns off by itself). The **Measure Delay** button is only available when the test is running.

For **Continuous** mode, the test is performed continuously until the RTD test or the test case itself is stopped. However, the measurement will only start if the test is running or when it will be started. The **Measure Delay** button turns off by itself when the auto-calibration fails.

**Note:** *The Round Trip Delay (RTD) auto-calibration generates some bit errors when turning on the RTD measurement while the test is running or when starting the test while the **Measure Delay** button is enabled. A far end testing equipment will detect those bit errors.*

## Status

Indicates the test status of the RTD test. The status is only available when the test case is running.

- **Ready** indicates that the last calibration sequence has been successful and the test is now ready to perform RTD measurement.
- **Running** indicates that the RTD test is running.
- **Cancelled** indicates that the RTD test has been stopped before its completion.
- **Calibration Failed** indicates that the test calibration failed due to at least one of the following conditions:
  - Internal errors.
  - Presence of high number of bit errors.

Therefore the RTD statistics becomes unavailable since the test does not allow RTD testing.

## Test Functions

### RTD

---

- **Disabled:** Indicates that the RTD feature is disabled.
- **--:** Indicates that the RTD measurement is not ready.

### Reset

Resets the RTD results and measurement counts.

### Delay

Indicates the time required for a bit to travel from the transmitter back to its receiver after crossing a far-end loopback.

- **Last** indicates the result of the last Round Trip Delay measurement.
- **Minimum** indicates the minimum Round Trip Delay recorded.
- **Maximum** indicates the maximum Round Trip Delay recorded.
- **Average** indicates the average Round Trip Delay value.
- **Unit** measurement selections are **ms** (default) and **μs**.

### Count

Indicates the total number of successful and failed measurements.

**Successful:** A measurement is declared successful when the RTD is smaller or equal to 2 seconds.

**Failed:** A measurement is declared failed when the RTD is > 2 seconds.

## RTD/RTT (CPRI/OBSAI Framed L2)

**Note:** Only available with CPRI/OBSAI Framed L2 in **Base Station** emulation mode.

Round Trip Delay (RTD for CPRI) and Round Trip Time (RTT for OBSAI) measurements are needed to quantify the time it takes for a signal to cross the remote radio head and come back.

**Note:** Be aware that RTD/RTT requires error free operation conditions to provide reliable results. Therefore, RTD/RTT results could be affected by error injection or error introduced by the network.

From the **Test** menu, tap **Functions**, and the **RTD/RTT** tab.

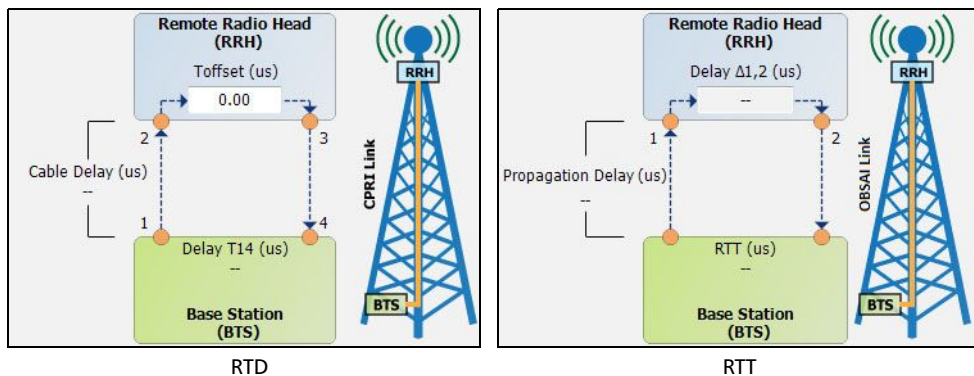

**Note:** For **Dual Port** topology select the port to be displayed.

## Test Functions

*RTD/RTT (CPRI/OBSAI Framed L2)*

---

### Round Trip Delay (CPRI)

Indicates the time required for a bit to travel from one point to another.

- **Delay T14** indicates the round trip delay measurement from the Base Station going through the Remote Radio Head (including **Toffset**) and back to the Base Station. The **Delay T14** appearing on the diagram corresponds to the average value.
- **Cable Delay** indicates the cable delay measured from the Base Station to the Remote Radio Head (RRH) or vice-versa assuming that the cabling in both directions are the same. The **Cable Delay** appearing on the diagram corresponds to the average value.
- **Last** indicates the result of the last delay measurement.
- **Minimum** indicates the minimum delay recorded.
- **Maximum** indicates the maximum delay recorded.
- **Average** indicates the average delay value.
- **Unit** measurement selections are **μs** (default) and **ns**.
- **Toffset** allows the configuration of the internal delay introduced by the electronic components in the Radio Equipment (RE): 0 μs (default) to 66.67 μs.

**Note:** *A warning icon appears next to the **Toffset** value when this value is larger than the **Delay T14** value measured indicating that the **Toffset** configured value maybe invalid thus corrupting the **Cable Delay** values reported.*

## Round Trip Time (OBSAI)

Indicates the time required for a bit to travel from one point to another.

- **RTT** indicates the round trip time measurement from the Base Station going through the Remote Radio Head (including **Delay  $\Delta_{1,2}$** ) and back to the Base Station. The **RTT** appearing on the diagram corresponds to the average value.
- **Propagation Delay** indicates the propagation delay measured from the Base Station to the Remote Radio Head (RRH) or vice-versa assuming that the cabling in both directions are in the same cable bundle. The **Propagation Delay** appearing on the diagram corresponds to the average value.
- **Last** indicates the result of the last time/delay measurement.
- **Minimum** indicates the minimum time/delay recorded.
- **Maximum** indicates the maximum time/delay recorded.
- **Average** indicates the average time/delay value.
- **Unit** measurement selections are  **$\mu\text{s}$**  (default) and **ns**.
- **Delay  $\Delta_{1,2}$**  reports the internal delay introduced by the electronic components in the Remote Radio Head (RRH).

## S-OAM Link Trace

From the **Test** menu, tap **Functions**, and the **S-OAM Link Trace** tab.

### Link Trace

- **Priority**<sup>1</sup> allows selecting the VLAN user priority: **0** (default) to **7**. Refer to *VLAN* on page 330 for more information.
- **Drop Eligible**<sup>1</sup> is set to **No** (no frames will be dropped when congestion occurs) and is not configurable.
- **TTL** sets the Time To Live value: **1** to **255** (default is **128**).
- **Link Trace** button when ON (OFF by default) starts the link trace process. The **Link Trace** button turn OFF automatically once the link trace process is completed.

### Result

The table reports the following information for each valid LTR frames received in response to the last LTM frame sent: **TTL**, **MEP/MIP MAC Address**, **Forward**, and **Term MEP**.

- **Last Link Trace Status** displays the last link trace status.

Status	Description
Pending	No Results
Successful	Last Link Trace was successful
Failed – LTR Timeout	Last Link Trace failed due to a LTR Timeout
Failed – Invalid LTR	Last Link Trace failed due to an Invalid LTR

- **TX LTM** indicates the count of transmitted LTM frames.

---

1. Available when VLAN is enabled (see *VLAN* on page 330).

- **RX LTR** indicates the count of received LTR frames having their destination MAC address matching the unit port MAC address, and VLANs matching the unit port VLANs.
- **LTR Timeout** indicates the count of LTR Timeout event which occurs if a reply (LTR) from the Peer MEP is not received within 5 seconds.
- **Invalid LTR** indicates the count of LTR frames received with incorrect MEG/MD Level or Transaction ID.

## Test Functions

### Signaling Bits

---

## Signaling Bits

Allows generation and monitoring of the signaling bits. Only available for DS<sub>n</sub>/PDH BERT framed test with DS0/E0 enabled.

From the **Test** menu, tap **Functions** and the **Signaling Bits** tab.

**Note:** *Two signaling bits (AB) are available for SF or SLC-96 framing while four signaling bits (ABCD) are available for ESF.*

## TX Signaling

**Note:** *Only available when TX Signaling is enabled (refer to TX Signaling check box when selected (cleared by default) allows generation of the signaling bits for either the 24 - DS0 channels or 30 - E0 channels (PCM-30 and PCM30 CRC-4). Only available when the DS0/E0 check box is selected. on page 395). For E0 the TX signaling always displays the ABCD bits.*

- **Signaling Mode**, available with DS0, is configurable to **2/4/16 States** for ESF or **2/4 States** for SF/ SLC-96; default is **4 States**.

Signaling Mode Framing	2-States		4-States		16-States
	SF/SLC-96	ESF	SF/SLC-96	ESF	ESF
Signaling Bits	00 11 <sup>a</sup>	0000 1111 <sup>a</sup>	00 to 11 <sup>a</sup>	0000 0101 1010 1111 <sup>a</sup>	0000 to 1111 <sup>a</sup>

- a. Default value.



- **Channel/AB/ABCD** table: Allows the configuration of signaling bits of either the 24 - DS0 channels or 30 - E0 channels.

**Note:** *Channel numbers for E0 refer to telephone channel numbers. Timeslots 1 to 15 and 17 to 31 are assigned to telephone channels numbered from 1 to 30 as per G.704.*

### **RX Signaling**

**Channel/AB/ABCD** table: The monitoring of signaling bits of either the 24 - DS0 channels or 30 - E0 channels is performed when the test is running.

### Spare Bits

**Note:** *Spare Bits* are not available when the framing is set to **Unframed**.

From the **Test** menu, tap **Functions**, tap the **Spare Bits** tab.

#### TX

Tap a spare bits field to set its value.

**Note:** *All spare bits are reserved for national use and should be set to 1 when not used.*

➤ E4

**G.751 Bit 14, 15, 16:** Choices are **000** to **111** (default).

➤ E3

**G.751 Bit 12:** Choices are **0** and **1** (default).

➤ E1

- **S<sub>i0</sub>** is located in the bit 1 of the frame containing the frame alignment signal (FAS). Choices are **0** and **1** (default).
- **S<sub>i1</sub>** is located in the bit 1 of the frame not containing the frame alignment signal (FAS). Choices are **0** and **1** (default).
- **S<sub>a4</sub>** to **S<sub>a8</sub>** are located in bit 4 to 8 of frame number 1, 3, 5, and 7 of sub-multiframe 1 and 2. Choices are **0** and **1** (default) or **0000** to **1111** (default) depending on the selected framing.
- **TS16 Frame 0 Bit 5, 7, 8** are located in bit 5, 7, and 8 from Timeslot 16 of frame 0 of a E1 signal. Choices are **000** to **111** (default).

**RX**

## ➤ E4

**G.751 Bit 14, 15, 16** are reserved for national use.

## ➤ E3

**G.751 Bit 12** is reserved for national use.

## ➤ E2

**G.742 Bit 12** represents Bit 12 from Timeslot 1, 2, 3, and 4 respectively.

## ➤ E1

➤ **S<sub>i0</sub>** is located in the bit 1 of the frame containing the frame alignment signal (FAS).

➤ **S<sub>i1</sub>** is located in the bit 1 of the frame not containing the frame alignment signal (FAS).

➤ **S<sub>a4</sub> to S<sub>a8</sub>** are located in bit 4 to 8 of frame number 1, 3, 5, and 7 of sub-multiframe 1 and 2. Possible values are either **0** and **1** or **0000** to **1111** depending on the framing.

➤ **TS16 Frame 0 Bit 5, 7, 8** are located in bit 5, 7, and 8 from Timeslot 16 of frame 0 of a E1 signal.

## Test Functions

### Traffic Scan

---

## Traffic Scan

The traffic scan tool provides the capability to discover and monitor VLAN traffic flows on the network.

**Note:** *Not available with dual port test and when **Provider Encapsulation** is used. Not available with 25/50/200/400GE.*

From the **Test** menu, tap **Functions**, and the **Traffic Scan** tab.

### Level

Allows the selection of the criteria that will be used to filter the incoming VLAN traffic flows. The default setting is **All**. Choices are:

Level	Description
All	Monitors untagged frames and up to 3 levels of stacked VLAN frames
Untagged	Monitors untagged frames only (no VLAN)
C-VLAN	Discovers/monitors only frames where the outer VLAN is a C-VLAN (TPID of 0x8100)
S-VLAN	Discovers/monitors only frames where the outer VLAN is a S-VLAN (TPID of 0x8100, 0x88A8, 0x9100, 0x9200, or 0x9300)
E-VLAN	Discovers/monitors only frames where the outer VLAN is a E-VLAN (TPID of 0x8100, 0x88A8, 0x9100, 0x9200, or 0x9300)

## Rate Layer

Allows the selection of the rate unit used for **Link Rate** and **Rate** statistics.

- **Line Utilization** is used to express the real line rate including the Preamble, SFD, and IFG.
- **Ethernet BW** (Bandwidth) is used to express the Ethernet bandwidth rate excluding the Preamble, SFD, and IFG.

## Discovered

Indicates the number of different traffic flows monitored based on the scan criteria.

## Link Rate (Mbit/s)

Indicates the network link rate based on the received frames with a valid FCS regardless if the frame matches or not the traffic flows, and regardless if the traffic flow was ignored due to the limit reached (see *Limit Reached*). The rate is expressed either in **Line Utilization** or **Ethernet Bandwidth** depending on the **Rate Layer** selected.

## Limit Reached

Up to 128 different traffic flows can be monitored, the **Limit Reached** text appears with a red background next to the **Discovered** field when the limit is reached.

## Scan

Starts/stops the traffic scan test.

## Monitored Frames Table

Statistics are gathered for each different traffic flow matching the scan criteria. Each different monitored traffic flow creates a separate entry in the scan table. When the limit is reached, new traffic flows are not considered in the table but the existing traffic flows are still monitored.

The level of VLAN (untagged, E-VLAN, S-VLAN, C-VLAN), and values of VLAN ID, Priority, and TPID are used to identify a traffic flow. Any difference in one of these values will create a separated entry in the table. PBB-TE frames are ignored.

**Note:** *Scan statistics are cleared when restarting the scan.*

➤ **E-VLAN / S-VLAN / C-VLAN**

- **ID** indicates the VLAN ID of the received traffic flow.
- **Priority** indicates the VLAN Priority of the received traffic flow.

**Note:** *The TPID indicating the Tag Protocol Identifier of the received traffic flow is reported in the test report.*

➤ **Statistics**

- **Frame Count** indicates for each traffic flow, the number of frames matching the selected scan criteria.

**Total** indicates the total number of frames matching the selected scan criteria.

- **Rate (Mbit/s)** indicates for each traffic flow, the rate of frames matching the selected scan criteria. The rate is expressed either in **Line Utilization** or **Ethernet Bandwidth** (see *Rate Layer*).

**Total** indicates the total rate of frames matching the selected scan criteria.

# 11 Test Control

This chapter describes the test control buttons available on the right navigation bar of the application.

Button	For more information, see:
Discover Remote	Discover Remote <i>on page 742</i>
Inject	Inject Button <i>on page 747</i>
Laser	Laser Button <i>on page 747</i>
Lpbk Tool	Lpbk Tool Button (Loopback Tool) <i>on page 748</i>
Report	Report Button <i>on page 755</i>
Reset	Reset Button <i>on page 761</i>
Save/Load	Save/Load Button <i>on page 762</i>
Start/Stop TX	Start/Stop TX Button <i>on page 766</i>

## More/Less Button

The **More/Less** button appears when there is not enough room to display all available test control buttons. The **More** button expands the control buttons area to display all control buttons while the **Less** button closes the expanded area. The pin button can be used to keep open the expanded area.

# Discover Remote

The Discover Remote function allows performing Ethernet tests in conjunction with a second test set (unit) by either scanning and connecting to any available EXFO Datacom remote unit or connecting to a third party remote device in loopback mode. The remote unit is used to loop back the traffic; for an EXFO unit it could be via Smart Loopback or **Dual Test Set (DTS)** for simultaneous bidirectional RFC 2544, RFC 6349, or EtherSAM results.

**Note:** *Only available with single-port **EtherSAM**, **EtherBERT**, **RFC 2544**, **RFC 6349**, and **Traffic Gen & Mon** test applications. Not available with host/media loopback. Not available with multiple link interface.*

## Remote Mofule Type

Allows selecting the loopback type for EtherSAM, EtherBERT, RFC 2544, and Traffic Gen & Mon test applications. For other test applications, this setting is forced to **EXFO**.

- **EXFO** (default), see *Remote Modules Discovery (EXFO)*
- **Third-Party Loopback**, see *Remote Modules Discovery (3rd Party Loopback)* on page 745

## Remote Modules Discovery (EXFO)

- **Target** defines how to perform the scan to discover remote units.
  - **Subnet** indicates to perform the scan based on the current subnet.
  - **Specific IP** indicates to perform the scan for a specific remote unit IP address. Enter the IP address of the target unit.
    - Quick Ping** tests if the destination IP address can be reached. A message displays if the ping attempt is **Successful** or **Failed**.
- **Scan** button scans the subnet or a specific IP (see **Target**) to discover remote EXFO compatible unit(s).



The discovered units are listed in the table with their **IP Address**, **Remote ID**, **Capabilities**, and **Status** information. **Remote ID**, **Capabilities**, and **Status** are only available for remote 88000 Series, and 85100G units.

- **Capabilities** indicates the loopback capabilities of the remote unit using the following test application icons<sup>1</sup>: Smart Loopback, RFC 2544, RFC 6349, and/or EtherSAM.
- **Status** indicates the status of the remote unit.

Status	Description
<b>Idle</b> -<test application> <sup>a</sup>	The specified test application is selected but not running.
<b>Busy</b> -<test application> <sup>b</sup>	The specified test application is running.
<b>Not Responding</b>	No response from the specified IP address (only possible when <b>Target</b> is set to <b>Specific IP</b> ).

- a. Possible test applications: EtherSAM, RFC 2544, RFC 6349, EtherBERT, Traffic Gen & Mon, Smart Loopback, Through Mode, TCP Throughput, Carrier Ethernet OAM, Cable Test, 1588 PTP, SyncE or eCPRI.
- b. Possible test applications: EtherSAM, RFC 2544, RFC 6349, EtherBERT, Traffic Gen & Mon, Smart Loopback, TCP Throughput, Carrier Ethernet OAM, 1588 PTP, SyncE or eCPRI.

1. A yellow exclamation symbol on the application icon indicates that there is a software incompatibility between the local and remote units. In this case the connection with the remote is not possible, a software upgrade is required on the remote unit to fix the incompatibility.

## Test Control

### Discover Remote

---

- **Loop Up and Loop Down** buttons (Not available with RFC 6349 test application)
  - **Loop Up** establishes the connection with the selected remote unit and sets the remote unit into **Smart Loopback** test application.

If a remote unit is in any busy status, a user confirmation is required to proceed with the Loop Up command.

Following a successful loop up, the IP address of the remote unit will be used as the destination IP address for the test.

Once the connection is established with the remote unit, the local unit can be set for EtherSAM, RFC 2544, EtherBERT, or Traffic Gen & Mon testing.
  - **Loop Down** ends the connection between the local and the remote units.
- **Connect and Disconnect** buttons are only available with RFC 2544, RFC 6349, and EtherSAM test applications.
  - **Connect** establishes the connection with the selected remote unit and sets the remote unit into either DTS RFC 2544, DTS RFC 6349, or DTS EtherSAM test application, depending on the active test on the local unit.

If a remote unit is in any busy status, a user confirmation is required to proceed with the Loop Up command.

If a remote unit is incompatible, indicated by a yellow exclamation symbol on the application icon, the connection is not established and a message is displayed indicating that a software upgrade is required on the remote unit.

Following a successful connection, the IP address of the remote unit will be used as the destination IP address for the test.
  - **Disconnect** ends the connection between the local and the remote units.

## Remote Modules Discovery (3rd Party Loopback)

- **Use Stream Destination from Test Application** check box when selected (default), it uses the stream destination configuration parameters from the test application to communicate with the third-party loopback unit. Only available with single-stream test applications.
- **Loop Layer** allows selecting the layer of loop messages: **L2: Ethernet**, **L3: IP**, or **L4: UDP/TCP**.
- **Destination MAC Address**<sup>1</sup> (L2) allows specifying the stream destination MAC address.
- **Destination IP Address**<sup>1</sup> (L3/L4), allows specifying the stream destination IP address.
- **Quick Ping** tests if the destination IP address can be reached. A message displays if the ping attempt is **Successful** or **Failed**.
- **Destination Port**<sup>1</sup> (L4) allows selecting the stream destination UDP port.
- **Remote Module ID** indicates the unit ID of the remote unit.
- **Remote Status** indicates the status of the remote unit.

---

1. Not configurable when the **User Stream Destination from Test Application** check box is selected.

## Test Control

### *Discover Remote*

---

#### ➤ **Loop Up / Loop Down**

- **Loop Up** establishes the connection with the selected remote unit and the loopback mode is set and initiated on the remote unit.

The interface IP address is used as the source address for the test and the stream/service address has to be coupled with the interface (refer to **Couple with Interface** on page 315). For Layer 4, the UDP source port is using the one configured on the first stream/service. For EtherSAM, since the VLAN is not coupled, make sure to use the same VLAN configuration for the interface and all enabled services.

Following a successful loop up, the MAC and IP addresses of the remote unit will be used as the destination addresses for the test.

When the connection is established with the remote unit, the test should be started locally. A message is displayed if the remote unit cannot be reached.

- **Loop Down** ends the connection between the local and the remote units.

## **Local Module Identification**

**Module ID** is used to easily identify this unit in case another unit is performing a discovery scan. Up to 16 alpha-numeric characters are allowed.



## Inject Button

Injects alarms/errors based on settings from the *Inject Button* on page 457.

## Laser Button

The **Laser** button enables or disables the laser for optical interfaces. For **Dual Port** topology, enables or disables the laser for both optical interfaces (ports). However, when an active copper SFP is used on a port, the laser is always on for this port.

**Note:** *Not available with host/media loopback.*

Laser Button	Border Color	Description
	Black	Laser is off.
	Red	Laser is on.

## Test Control

### *Lpbk Tool Button (Loopback Tool)*

---

## Lpbk Tool Button (Loopback Tool)

The Loopback Tool provides the capability of looping back the Ethernet frames/packets that are received on the loopback tool port.

Pressing the **Lpbk Tool** button opens the Loopback Tool pop-up and powers up the port unused by the main test application (it does not start looping back the frames yet). The Loopback Tool starts looping back the Ethernet frames/packets that are received when pressing on the **Loopback** button from the **Loopback Tool** tab.

**Note:** *The **Lpbk Tool** button is available when the main test application is any single port Ethernet test application (up to 10G rate) with the exception of Through mode. Not available on 88200NGE.*

**Note:** *The Loopback Tool is independent from the main test **Start/Stop**, **Reset** and **Test Timer**.*

**Note:** *Enabling/disabling the Laser control affects both the main test application and the Loopback Tool when applicable (if both test and tool are using an optical port).*

## Loopback Tool tab

The **Loopback Tool** tab allows the configuration of the loopback parameters and displays the traffic statistics as well as the S-OAM Responder statistics.

Press the **Lpbk Tool** button and select the **Loopback Tool** tab.

- **Status:** The status field displays the current status of the Loopback test.
  - **-- (Idle):** Loopback Tool is not looping back frames and results are not available.
  - **In Progress:** Loopback Tool is looping back frames.
  - **Completed:** Loopback Tool is not looping back frames but results are available. The test **Status** indicates **Completed** when the loopback tool has been stopped.
- **Start Time:** The time when the Loopback Tool was started.
- **Transparent (Pseudo-Physical)** check box when selected (cleared by default), determines that the Loopback tool operates as a physical loopback by transmitting all received frames unaltered and without discrimination.

**In transparent mode, the Network tab and the S-OAM Responder statistics are not available.**

**Note:** *The **Transparent** mode is intended to be used for point-to-point topology, not for switched or routed networks. Use the **Transparent** mode with caution because all received frames are looped back without discrimination.*

## Test Control

### *Lpbk Tool Button (Loopback Tool)*

---

- **Loopback Mode** determines at which layer the address/port swapping is limited.
  - **Ethernet** swaps the MAC addresses of received packets having their **Destination MAC** address matching the MAC address of the loopback port.
  - **Ethernet (All Unicast)** swaps the MAC addresses of received packets having Unicast **Destination MAC** address.
  - **IP**, for Ethernet Layer 3 and 4, swaps the MAC and IP addresses of received packets having their **Destination IP** address matching the IP address of the loopback port. For Ethernet Layer 2, swaps the **MAC addresses** for packets having their **Destination MAC** address matching the MAC address of the loopback port.
  - **UDP/TCP** (default), for Ethernet Layer 4, swaps the UDP or TCP ports and the MAC and IP addresses of received packets having their **Destination IP** address matching the IP address of the loopback port. For Ethernet Layer 3, swaps the MAC and IP addresses for packets having their **Destination IP** address matching the IP address of the loopback port. For Ethernet Layer 2, swaps the **MAC addresses** for packets having their **Destination MAC** address matching the MAC address of the loopback port.
- **Traffic**
  - **Line Utilization (%)** indicates the current percentage of the transmitting/receiving line rate utilization.
  - **Ethernet BW (Mbit/s)** indicates the current transmitting/receiving data rate expressed in Mbit/s.
  - **Frame Rate (frame/s)** indicates the current transmitted/received number of frames (including bad frames, Broadcast frames and Multicast frames) in frame per second.
  - **Frame Count** indicates the total number of transmitted/received valid and invalid frames.



- **S-OAM Responder** check box when selected (default) allows responding to LBM, LTM, DMM, LMM, and SLM valid messages (**Lpbk Tool** must be started, see **Loopback** button below). Traffic statistics are also monitored (refer to *Responder* on page 625).

<b>Responds to... message</b>	<b>Responds with... message</b>
LBM	LBR
LTM	LTR
DMM	DMR
LMM	LMR
SLM	SLR

**Responder - TX Count** reports respectively the count of LBR, LTR, DMR, LMR, SLR, and the total of frames transmitted.

**Responder - RX Count** reports counts of valid LBM, LTM, DMM, LMM, SLM, and the total of frames received. A valid messages must have its destination MAC address matching either the unit port Unicast MAC address or a Multicast class 1 address<sup>1</sup>.

- **Loopback** button starts/stops looping back the frames/packets that are received. The default value is disabled.

---

1. Refer to *Unicast/Multicast Addresses for Ethernet OAM* on page 867 for more information.

### Interface Tab

#### Physical Interface

- **Interface/Rate** allows the selection of the loopback tool interface rate: **10/100/1000M Electrical** (default), **100M Optical**, **1GE Optical**, or **10GE LAN**.
- **Connector** displays the unused module's port (on the same transceiver system when applicable) for the selected interface/rate. Ethernet 10/100/1000M electrical is supported on optical connector when using an active copper SFP.
- **Clock Mode**: Displays the clock mode
- **Internal**: Internal clock of the unit (STRATUM 3).
- **Recovered**: Line clock from the input port signal involved in the tool.
- **Wavelength (nm)** indicates, when supported, the detected wavelength.
- **RX Power (dBm)** indicates the current received power level of the optical laser in dBm.  
Green: Power level in range.  
Yellow: Power level out-of-range.  
Red: Loss of signal or power level is close to damage.  
Gray: Invalid operational range value or not available/supplied by the transceiver.
- **Power Range (dBm)** indicates, when supported, the received power level range of the optical laser in dBm.
- **RX Frequency (MHz/GHz)** indicates the frequency of the input signal. When no frequency reading is possible, "--" is displayed. Not available when using an active copper SFP.

**LINK**

- **Auto-Negotiation** check box when selected, enables the link auto-negotiation and allows setting the port **Speed**, **Duplex**, **Flow Control**, and **Local Clock** parameters. Those settings are not applied immediately to the port, they are used only when the negotiation process is started and take effect only when the auto-negotiation succeeds. However current settings are applied immediately to the port when the **Auto-Negotiation** check box is cleared. The **Auto-Negotiation** check box is automatically selected for 1GE Electrical interface and is not configurable. Available with **10/100/1000M Electrical** interface.
- **Speed**, available with **10/100/1000M Electrical** interface, allows the selection of the interface rate: **10M**, **100M**, **1GE**, or **Auto**<sup>1</sup>. The negotiated speed will be displayed next to the **Speed** field selection.
- **Duplex** choices for **10M** and **100M** electrical interfaces are **Full Duplex** (default), **Half Duplex**, and **Auto**<sup>1</sup>. For other rates the Duplex is set to **Full Duplex**. The negotiated duplex will be displayed next to the **Duplex** field selection.
- **Flow Control** choices are **TX**, **RX**, **RX and TX**, **None** (default), and **Auto**<sup>1</sup>. When the **Flow Control** is set to **None**, pause frames received are ignored.
- **Cable Mode** is available with **10/100/1000M Electrical** interface.
- **Manual** mode is selected when the **Auto-Negotiation** check box is cleared and allows selecting the type of cable: **MDI** (default) for straight through cable or **MDIX** for crossover cable.

---

1. **Auto** is only available when the **Auto-Negotiation** check box is selected.

## Test Control

*Lpbk Tool Button (Loopback Tool)*

---

- **Automatic** mode is selected when the **Auto-Negotiation** check box is selected and allows detecting automatically the MDI or MDIX cable type.
- **Local Clock** is only available with 1GE electrical interface and allows setting the provenance of the clock: **Master** (default), or **Slave**, or **Auto**<sup>1</sup>.

## Network tab

Refer to *Network* on page 328 for more information.

## SFP/SFP+ tab

Refer to *CFP/OSFP/QSFP/SFP* on page 229 for more information.

---

1. **Auto** is only available when the **Auto-Negotiation** check box is selected.

## Report Button

The report contains all information about the current test including its setup and results.

**Note:** *Nothing prevents the configuration and alarm/error injection setup while the test has been stopped; thus, the report should be saved/printed before changing any test parameters to avoid printing discrepancy between the configuration and results.*

The **Report** button is available when the test is running or stopped, but the report generation is only possible when the test is stopped. It is possible to save, open, import, export, and delete test report(s).

### File Location

➤ **Public Documents:**

Users\Public\Documents\88000-PowerBlazer\Reports

➤ **My Documents:**

Users\

➤ **Others**, use **Browse** to select a specific file location that will be displayed under **Others**.

➤ **Removable Drives** is only available when there is a removable disk/key connected to the platform USB port.

### Config/Save Tab

The **Config/Save** tab allows configuring the report parameters and generating/saving the report.

Tap the **Report** button and the **Config/Save** tab.

- **Job Information** parameters, not mandatory, are used to identify the source of the report. Enter the following job information if required: **Job ID**, **Contractor Name**, **Customer Name**, **Operator Name**, **Circuit ID**, and **Comment**. Up to 30 characters are allowed for each parameter at the exception of **Comment** for which 256 characters are allowed.

**Note:** *When the **EXFO Connect Server** check box is selected in **EXFO Connect Client**, the **Operator Name** is not editable but can be selected from the **EXFO Connect** operator list using the **Change** button.*

**Restore Default** reverts all **Job Information** parameters back to the default values.

- **Report Headlines and Content** parameters are used to identify the report and are not mandatory. Up to 30 characters are allowed for each parameter.
  - **Report Header** could be the company name.
  - **Report Title** could be the name of the product, name of test, test number, etc.

- **Optional Content** allows choosing the optional content that can be part of the report:
  - All** (default) includes all optional content to the report. For JSON format, **All** is selected and dimmed.
  - None** excluded all optional content from the report.
  - Custom** allows selecting the optional content to be part of the report.
- **Choose Content**, available when the **Optional Content** is set to **Custom**, allows selecting what will be part of the custom content.

## Test Control

### Report Button

---

#### ► Save Report

- **Auto-Generate Report** check box, when selected (cleared by default), automatically generates the report once the test ends or is manually stopped. When enabled, the report is also automatically generated when controlling the unit remotely using SCPI commands but the module application (GUI) must be running on the platform in order to work.
- **Auto-Generate File Name** check box, when selected (default), automatically generates the report file name which contains the name of the test, the date (YY.MM.DD), and time (HH.MM.SS). Clear the **Auto-Generate File Name** check box to enter a specific file name.  
**File Name** is the name of the report to be generated.
- **Save To** is the file location where the report file will be saved (see *File Location* on page 755).
- **Display Report after Saving** check box when selected (default) automatically displays the report once it is generated.

**Note:** *Once generated, the report can be opened from the Open Tab on page 759.*

- **Turn on Report Generation Prompt** check box when selected (default) displays a pop-up every time a test case is stopped or completed to ask if a report generation is desired.
- **Format** is the file format for the report: **PDF** (default), **HTML** and **JSON** (only available with iOptics and EtherBERT).



- **Logo** check box when selected (default) allows including a logo to the report. Select the logo picture that will be displayed on the report. Not supported with JSON report format.

To select another logo, first add a new logo by either copying the logo picture file to the following folder or by using the Import/Export (see page 760) then select the new logo from the list.

**Documents\88000-PowerBlazer\Reports\Images**

Supported picture file formats are jpg, gif, bmp, and png.

- **Save Report** button generates and saves the report on the selected media (**Save to**).

## Open Tab

Report files can be opened from this page.

Tap the **Report** button and the **Open** tab.

### ***To open a saved report:***

- 1.** Select the file location (see *File Location* on page 755).
- 2.** Select the report file from the list.
- 3.** Tap the **Open** button.

### Import/Export Tab

Allows transferring and deleting report files from an external USB media. Also allows importing images that can be used as the Logo for reports.

Tap the **Report** button and select the **Import/Export** tab.

#### **To import/export a report or image:**

1. Select either **Report** or **Image** as **File Type**.
2. Select the file location (see *File Location* on page 755).
3. From the **Copy To** drop list, select where the file(s) will be copied.
4. Select the file(s) to be copied by selecting its corresponding check box or tap the **(Un)Select All** button to select or unselect all files in the list.
5. Tap the **Copy** button.
6. A confirmation is displayed, tap **OK**.

#### **To delete a report or image:**

1. Select either **Report** or **Image** as **File Type**.
2. Select the file location (see *File Location* on page 755).
3. Select the file(s) to be deleted by selecting its corresponding check box or tap the **(Un)Select All** button to select or unselect all files.
4. Tap the **Delete** button.
5. Tap **YES** to confirm the deletion.

## **Reset Button**

Tap the **Reset** button to clear results, statistics, and logger content. The **Reset** button is only available when the test is running.

**Note:** *The **Reset** button is not available for EtherSAM, RFC 2544, RFC 6349, Cable Test, and Smart Loopback test applications.*

### Save/Load Button

The **Save/Load** button allows saving, loading, importing, exporting, and deleting configuration file(s).

**Note:** *Save/Load is only possible when the test is stopped.*

#### File location

- **My Documents** offers two file locations: use **Favorites** for most commonly used configuration files or **Configurations** for others.

Users\<<User>\Documents\88000-PowerBlazer\Configuration

Users\<<User>\Documents\88000-PowerBlazer\Configuration\Favorites

- **Public Documents** offers two file locations: use **Favorites** for most commonly used configuration files or **Configurations** for others.

Users\Public\Documents\88000-PowerBlazer\Configuration

Users\Public\Documents\88000-PowerBlazer\Configuration\Favorites

- **Others** offers two file locations: use **Factory Defined** for factory defined configuration files or select **Browse** to create a user defined file location.
- **Removable Drives** is only available when there is a removable disk/key connected to the platform USB port.

## **Save/Load Tab**

Tap the **Save/Load** button and the **Save/Load** tab.

The save function stores the configuration of the module including all test settings to a file.

### **To save a configuration:**

- 1.** Select the file location (see *File location* on page 762).
- 2.** Tap on the **Save** button.
- 3.** Type the name of the configuration file to be saved and a description (**Config Summary**) if needed.
- 4.** Select the **Add to Favorites** check box to save the configuration file in the **Favorites** list.
- 5.** Tap **OK**.

The load function opens and applies the test configuration from a previously saved configuration file.

### **To load a configuration:**

- 1.** Select the file location (see *File location* on page 762).
- 2.** Select the file from the list.
- 3.** Select or clear the **Overwrite report settings** check box as required. The **Overwrite report settings** check box when selected (default) replaces the current report settings by those from the configuration that is loaded.
- 4.** Tap the **Load** button.

**Note:** *Configuration file has a limited backward compatibility. (Typically the backward compatibility period is one year or three software releases.)*

## Test Control

### *Save/Load Button*

---

#### **To rename a configuration file:**

1. Select the file location (see *File location* on page 762).
2. Select the file from the list.
3. Tap the **Rename** button.
4. Change the name of the configuration file.
5. Select the **Add to Favorites** check box to save the configuration file in the **Favorites** list.
6. Tap **OK**.

#### **To delete a configuration file:**

1. Select the file location (see *File location* on page 762).
2. Select the file from the list.
3. Tap the **Delete** button.
4. Tap **Yes** to confirm the deletion.

#### **To add a configuration file to the Favorites list:**

1. Select **Configuration** from either **My Documents** or **Public Documents**.
2. Select the file from the list.
3. Tap the **Add to Favorites** button. The file will be moved into the **Configurations** folder of its corresponding location (either **My Documents** or **Public Documents**).

#### **To remove a configuration file from the Favorites list:**

1. Select **Favorites** from either **My Documents** or **Public Documents**.
2. Select the file from the list.
3. Tap the **Remove from Favorites** button. The file will be moved into the **Configurations** folder of its corresponding location (either **My Documents** or **Public Documents**).

## **Import/Export Tab**

Configuration files can be transferred to and from an external USB media as well as deleted.

Tap the **Save/Load** button and the **Import/Export** tab.

### **To import/export a test configuration:**

- 1.** Select the source file location (see *File location* on page 762).
- 2.** From the **Copy To** drop list, select a destination file location.
- 3.** Select the file(s) to be copied by selecting its corresponding check box or tap the **(Un)Select All** button to select or unselect all files in the list.
- 4.** Tap the **Copy** button.
- 5.** A confirmation is displayed, tap **OK**.

### **To delete a test configuration:**

- 1.** Select the file location (see *File location* on page 762).
- 2.** Select the file(s) to be deleted by selecting its corresponding check box or tap the **(Un)Select All** button to select or unselect all files in the list.
- 3.** Tap the **Delete** button.
- 4.** Tap **YES** to confirm the deletion.

### Start/Stop | TX Button

The **Start/Stop | TX** button allows starting or stopping manually any test as well as enabling traffic generation.

**To start the test:**

Tap the **Start** button to start the test. **Start** is available when the test is not running.

**To stop the test:**

Tap the **Stop** button to stop the test; the traffic generation also stops if it was enabled (TX button). **Stop** is available when the test is running.

By default, a message is displayed when the test stops asking to generate a report. To disable this feature, see *Turn on Report Generation* on page 759. Nothing prevents the configuration and alarm/error injection setup while the test has been stopped; thus, if a report is required, it should be saved before changing any test parameters to avoid discrepancy between the configuration and results. See *Report Button* on page 755 to generate and save a report.

**To enable traffic generation:**

Tap the **TX** button to enable traffic generation; the test is also started if it was not running.

Test Application	Descripton
Traffic Gen & Mon	Enables traffic generation for all enabled streams. Some conditions, such as ARP not resolved, link down, etc., may prevent the stream to be transmitted.
FlexE BERT	Enables traffic generation for all enabled clients (refer to Enable TX from <i>Profile - FlexE BERT</i> on page 349).
eCPRI BERT	Enables traffic generation.

**Note:** While the test is running the **TX** button is available to enable/disable traffic generation.



## 12 Power Failure Recovery

The automatic power failure recovery is used to select, configure, and restart<sup>1</sup> the test that was running before the power failure; a test that was not running will be selected and configured but not started. To provide this level of protection, the configuration of the current test is automatically saved; the logger, injections, and configuration are periodically saved.

A power failure occurs when the AC power is down (LTB-8 and FTB) while the unit's battery (FTB) has not sufficient power to keep the unit running. Pressing the platform power button for 5 seconds performs a power down reset and is also considered as a power failure condition. The Windows **Hibernate** or **Sleep** mode is also considered as a power failure condition.

When the power returns, the automatic power failure recovery restarts the platform, the module application, then selects, configures, and starts the test if it was running before the power failure.

**Note:** *If the automatic power failure recovery is not used, restarting the module after a power failure automatically selects, configures, and starts the test if it was running before the power failure.*

---

1. Not applicable for iSAM, EtherSAM, RFC 2544, RFC 6349, TCP Throughput, and Cable Test applications; these tests must be started manually.

# Enabling Power Failure Recovery

**To enable the automatic power failure recovery:**

1. Enable launching the application when starting the platform (refer to the platform user guide for more information):

From ToolBox X, tap on the **System Settings** button, the **Startup Applications** button, and select the corresponding module's check box.

2. moduleEnable the platform automatic power on feature (refer to the platform user guide for more information):

**2a.** From ToolBox X, tap on the **System Settings** button and the **ToolBox X** button.

**2b.** Select the **Power on the unit when AC outlet is connected or after power outage** check box.

3. Make sure that Windows does not require a user name and password. The platform is set to require user name and password by default. To disable Windows user name and password:

**3a.** From ToolBox X, tap on the **System Settings** button and the **Automatic Logon** button.

**3b.** Clear the **User must enter a user name and password to use this computer** check box and enter the password to confirm.

**Note:** *The power failure recovery is not used when the application closes normally.*

## **When Using the Test Timer**

Refer to *Timer* on page 433 for more information on test timer.

The test that was running will be re-created and started after a power failure if conditions described above are met in addition with the following test time conditions:

- The start time has not expired during the power failure.
- The stop time or the duration has not expired during the power failure.



# 13 Maintenance

To help ensure long, trouble-free operation:

- Always inspect fiber-optic connectors before using them and clean them if necessary.
- Keep the unit free of dust.
- Clean the unit casing and front panel with a cloth slightly dampened with water.
- Store unit at room temperature in a clean and dry area. Keep the unit out of direct sunlight.
- Avoid high humidity or significant temperature fluctuations.
- Avoid unnecessary shocks and vibrations.
- If any liquids are spilled on or into the unit, turn off the power immediately, disconnect from any external power source, remove the batteries and let the unit dry completely.



## WARNING

The use of controls, adjustments and procedures, namely for operation and maintenance, other than those specified herein may result in hazardous radiation exposure or impair the protection provided by this unit.

## Maintenance

### *Cleaning LC/MPO-n Connectors*

---

## Cleaning LC/MPO-n Connectors

Under normal circumstances the cleaning of the LC/MPO-n connector is not required. However if the connector shows signs of debris or contamination, cleaning may be required.

### ***To clean a LC/MPO-n connector***

- 1.** Use a clean dry air (CDA) or a air gun to blow out the dust or contamination.
- 2.** Re-inspect the connector. For MPO-n optical connector, re-inspect the connector under magnification to make sure that it is clean.
- 3.** If the connector is still not clean, use a commercial cleaner recommended by the transceiver manufacturer.

**Note:** *Refer to the transceiver manufacturer for more detailed cleaning recommendations and instructions.*

## Battery Safety Information

The TA/TA4... transceiver systems contain a battery for the insertion counter. If the battery status is low, contact your nearest authorized EXFO service center for its replacement.



### **WARNING**

**Do not throw batteries into fire or water and do not short-circuit the batteries' electrical contacts. Do not disassemble.**

## **Recalibrating the Unit**

EXFO manufacturing and service center calibrations are based on the ISO/IEC 17025 standard (*General Requirements for the Competence of Testing and Calibration Laboratories*). This standard states that calibration documents must not contain a calibration interval and that the user is responsible for determining the re-calibration date according to the actual use of the instrument.

The validity of specifications depends on operating conditions. For example, the calibration validity period can be longer or shorter depending on the intensity of use, environmental conditions and unit maintenance, as well as the specific requirements for your application. All of these elements must be taken into consideration when determining the appropriate calibration interval of this particular EXFO unit.

Under normal use, the recommended interval for your module is: 2 years.

For newly delivered units, EXFO has determined that the storage of this product for up to six months between calibration and shipment does not affect its performance (EXFO Policy PL-03).

## Maintenance

### *Recycling and Disposal*

---

To help you with calibration follow-up, EXFO provides a special calibration label that complies with the ISO/IEC 17025 standard and indicates the unit calibration date and provides space to indicate the due date. Unless you have already established a specific calibration interval based on your own empirical data and requirements, EXFO would recommend that the next calibration date be established according to the following equation:

**Next calibration date = Date of first usage (if less than six months after the calibration date) + Recommended calibration period (2 years)**

To ensure that your unit conforms to the published specifications, calibration may be carried out at an EXFO service center or, depending on the product, at one of EXFO's certified service centers. Calibrations at EXFO are performed using standards traceable to national metrology institutes.

**Note:** *You may have purchased a FlexCare plan that covers calibrations. See the Service and Repairs section of this user documentation for more information on how to contact the service centers and to see if your plan qualifies.*

## Recycling and Disposal



This symbol on the product means that you should recycle or dispose of your product (including electric and electronic accessories) properly, in accordance with local regulations. Do not dispose of it in ordinary garbage receptacles.

For complete recycling/disposal information, visit the EXFO Web site at [www.exfo.com/recycle](http://www.exfo.com/recycle).



# 14 Troubleshooting

## Solving Common Problems

Before calling EXFO's technical support, please read the following common problems that can occur and their respective solution.

Problem	Possible Cause	Solution
Optical Laser LED is off and the connector is not generating the signal.	The <b>Laser On</b> option is disabled.	Ensure that the <b>Laser</b> button is enabled (On).
	There is a configuration mismatch between the inserted transceiver and the rate selected for the test case.	Ensure that the transceiver is supporting the rate used for the test case.
	The transceiver is not compatible with the module.	Ensure to use a compatible transceiver. Refer to <i>Modify Structure</i> on page 132 and <i>Specifications</i> on page 783.
Unable to edit the <b>Operator Name</b> in <b>Generate Report</b> page.	This is the expected behavior when the <b>EXFO Connect Server</b> check box is selected in <b>EXFO Connect Client</b> , since the <b>Operator Name</b> is selected from the EXFO Connect operator name list.	To edit the <b>Operator Name</b> : - Clear the <b>EXFO Connect Server</b> check box from <b>EXFO Connect Client</b> . - Close and restart the module application.
Transceiver System (TA4) not detected.	TA4 is not inserted properly.	Remove the TA4 from the 88460 module, and carefully follow the insertion procedure described on page 16.
Unable to connect to a remote module in Dual Test Set with RFC 6349, there is a yellow exclamation symbol on the RFC 6349 application icon.	The local and remote units have incompatible software versions.	Upgrade the remote unit. Note that with the new software version, the <b>EXFO Worx Interop</b> operation mode is no longer supported.

## Troubleshooting

*Contacting the Technical Support Group*

---

### Contacting the Technical Support Group

To obtain after-sales service or technical support for this product, contact EXFO at one of the following numbers. The Technical Support Group is available to take your calls from Monday to Friday, 8:00 a.m. to 7:00 p.m. (Eastern Time in North America).

#### Technical Support Group

400 Godin Avenue  
Quebec (Quebec) G1M 2K2  
CANADA

1 866 683-0155 (USA and Canada)  
Tel.: 1 418 683-5498  
Fax: 1 418 683-9224  
support@exfo.com

For detailed information about technical support, and for a list of other worldwide locations, visit the EXFO Web site at [www.exfo.com](http://www.exfo.com).

If you have comments or suggestions about this user documentation, you can send them to [customer.feedback.manual@exfo.com](mailto:customer.feedback.manual@exfo.com).

To accelerate the process, please have information such as the name and the serial number (see the product identification label), as well as a description of your problem, close at hand.

## Transportation

Maintain a temperature range within specifications when transporting the unit. Transportation damage can occur from improper handling. The following steps are recommended to minimize the possibility of damage:

- Pack the unit in its original packing material when shipping.
- Avoid high humidity or large temperature fluctuations.
- Keep the unit out of direct sunlight.
- Avoid unnecessary shocks and vibrations.

# 15 Warranty

## General Information

EXFO Inc. (EXFO) warrants this equipment against defects in material and workmanship for a period of one year from the date of original shipment. EXFO also warrants that this equipment will meet applicable specifications under normal use.

During the warranty period, EXFO will, at its discretion, repair, replace, or issue credit for any defective product, as well as verify and adjust the product free of charge should the equipment need to be repaired or if the original calibration is erroneous. If the equipment is sent back for verification of calibration during the warranty period and found to meet all published specifications, EXFO will charge standard calibration fees.



### IMPORTANT

The warranty can become null and void if:

- unit has been tampered with, repaired, or worked upon by unauthorized individuals or non-EXFO personnel.
- warranty sticker has been removed.
- case screws, other than those specified in this guide, have been removed.
- case has been opened, other than as explained in this guide.
- unit serial number has been altered, erased, or removed.
- unit has been misused, neglected, or damaged by accident.

THIS WARRANTY IS IN LIEU OF ALL OTHER WARRANTIES EXPRESSED, IMPLIED, OR STATUTORY, INCLUDING, BUT NOT LIMITED TO, THE IMPLIED WARRANTIES OF MERCHANTABILITY AND FITNESS FOR A PARTICULAR PURPOSE. IN NO EVENT SHALL EXFO BE LIABLE FOR SPECIAL, INCIDENTAL, OR CONSEQUENTIAL DAMAGES.

## **Warranty**

### *Gray Market and Gray Market Products*

---

## **Gray Market and Gray Market Products**

Gray market is a market where products are traded through distribution channels that are legal but remain unofficial, unauthorized, or unintended by the original manufacturer. Intermediaries using such channels to distribute products are considered to be part of the gray market (hereafter unauthorized intermediary).

EXFO considers that a product originates from the gray market (hereafter gray market product) in the following situations:

- A product is sold by an unauthorized intermediary.
- A product is designed and destined for a particular market and sold on a second market.
- A product is resold, despite being reported lost or stolen.

When products are purchased on the gray market, rather than through an authorized EXFO distribution channel, EXFO is unable to guarantee the source and quality of those products nor the local safety regulations and certifications (CE, UL, etc.).

EXFO will not honor warranty, install, maintain, repair, calibrate, provide technical support nor make any support contracts available for gray market products.

For complete information, refer to EXFO's policy regarding gray market products at

[www.exfo.com/en/how-to-buy/sales-terms-conditions/gray-market/](http://www.exfo.com/en/how-to-buy/sales-terms-conditions/gray-market/)

## Liability

EXFO shall not be liable for damages resulting from the use of the product, nor shall be responsible for any failure in the performance of other items to which the product is connected or the operation of any system of which the product may be a part.

EXFO shall not be liable for damages resulting from improper usage or unauthorized modification of the product, its accompanying accessories and software.

## Exclusions

EXFO reserves the right to make changes in the design or construction of any of its products at any time without incurring obligation to make any changes whatsoever on units purchased. Accessories, including but not limited to fuses, pilot lamps, batteries and universal interfaces (EUI) used with EXFO products are not covered by this warranty.

This warranty excludes failure resulting from: improper use or installation, normal wear and tear, accident, abuse, neglect, fire, water, lightning or other acts of nature, causes external to the product or other factors beyond the control of EXFO.



### **IMPORTANT**

In the case of products equipped with optical connectors, EXFO will charge a fee for replacing connectors that were damaged due to misuse or bad cleaning.

## Certification

EXFO certifies that this equipment met its published specifications at the time of shipment from the factory.

## Service and Repairs

EXFO commits to providing product service and repair for five years following the date of purchase.

**To send any equipment for service or repair:**

1. Call one of EXFO's authorized service centers (see *EXFO Service Centers Worldwide* on page 781). Support personnel will determine if the equipment requires service, repair, or calibration.
2. If equipment must be returned to EXFO or an authorized service center, support personnel will issue a Return Merchandise Authorization (RMA) number and provide an address for return.
3. If possible, back up your data before sending the unit for repair.
4. Pack the equipment in its original shipping material. Be sure to include a statement or report fully detailing the defect and the conditions under which it was observed.
5. Return the equipment, prepaid, to the address given to you by support personnel. Be sure to write the RMA number on the shipping slip. *EXFO will refuse and return any package that does not bear an RMA number.*

**Note:** *A test setup fee will apply to any returned unit that, after test, is found to meet the applicable specifications.*

After repair, the equipment will be returned with a repair report. If the equipment is not under warranty, you will be invoiced for the cost appearing on this report. EXFO will pay return-to-customer shipping costs for equipment under warranty. Shipping insurance is at your expense.

Routine recalibration is not included in any of the warranty plans. Since calibrations/verifications are not covered by the basic or extended warranties, you may elect to purchase FlexCare Calibration/Verification Packages for a definite period of time. Contact an authorized service center (see *EXFO Service Centers Worldwide* on page 781).

## **EXFO Service Centers Worldwide**

If your product requires servicing, contact your nearest authorized service center.

### **EXFO Headquarters Service Center**

400 Godin Avenue  
Quebec (Quebec) G1M 2K2  
CANADA

1 866 683-0155 (USA and Canada)  
Tel.: 1 418 683-5498  
Fax: 1 418 683-9224  
support@exfo.com

### **EXFO Europe Service Center**

Winchester House, School Lane  
Chandlers Ford, Hampshire S053 4DG  
ENGLAND

Tel.: +44 2380 246800  
Fax: +44 2380 246801  
support.europe@exfo.com

### **EXFO Telecom Equipment (Shenzhen) Ltd.**

3rd Floor, Building C,  
FuNing Hi-Tech Industrial Park, No. 71-3,  
Xintian Avenue,  
Fuhai, Bao'An District,  
Shenzhen, China, 518103

Tel: +86 (755) 2955 3100  
Fax: +86 (755) 2955 3101  
support.asia@exfo.com

To view EXFO's network of partner-operated Certified Service Centers nearest you, please consult EXFO's corporate website for the complete list of service partners:

<http://www.exfo.com/support/services/instrument-services/exfo-service-centers>.





# A **Specifications**



## **IMPORTANT**

The following technical specifications can change without notice. The information presented in this section is provided as a reference only. To obtain this product's most recent technical specifications, visit the EXFO Web site at [www.exfo.com](http://www.exfo.com).



## **CAUTION**

The operation and storage temperatures, as well as the altitude, and humidity of some modules may differ from those specified for your platform. In this case, always ensure that you comply with the most restrictive conditions (either from this section or in the platform user guide).

## Specifications

### General Specifications

---

## General Specifications

Specification	8870/8880/ 88200NGE	88260	88460
Temperature	Operating: 0 °C to 40 °C (32 °F to 104 °F) Storing: -40 °C to 70 °C (-40 °F to 158 °F)		
Relative humidity	0 % to 95 %, non-condensing		
Maximum operation altitude	5000 m (16000 ft)		
Pollution degree	3		
Measurement category	Not rated for measurement categories II, III, or IV		

## Transceiver System

Specification	TA-QSFP28	TA4-CFP8	TA4-QSFP-DD
Temperature	Operating: 0 °C to 40 °C (32 °F to 104 °F) Storing: -40 °C to 70 °C (-40 °F to 158 °F)		
Relative humidity	0 % to 95 %, non-condensing		
Maximum operation altitude	5000 m (16000 ft)		
Pollution degree	3		
Measurement category	Not rated for measurement categories II, III, or IV		

# **B** *Glossary*

## **Acronym List**

10B_ERR	10B_Error
200GAUI-4	200 Gbit/s Attachment Unit Interface - 4 physical lanes
2DM	Two-way Delay Measurement
2DMM	Two-way Delay Measurement Message
2DMR	Two-way Delay Measurement Response
400GAUI-16	400 Gbit/s Attachment Unit Interface - 16 physical lanes
400GAUI-8	400 Gbit/s Attachment Unit Interface - 8 physical lanes
?	Help

### A

AC	Alternating Current
ACH	Associated Channel Header
ACT	Activity
AIS	Alarm Indication Signal
AMI	Alternate Mark Inversion
AOC	Active Optical Cable
APS	Automatic Protection Switching
ATM	Asynchronous Transfer Mode
AU-n	Administrative Unit-n
AUI	Attachment Unit Interface

### B

B-VLAN	Backbone Virtual Local Area Network
B8ZS	Bipolar with 8 Zero Substitution
BAS	Basic OAM

## Glossary

### Acronym List

---

BB	Buffer to Buffer
BBE	Background Block Error
BBER	Background Block Error Ratio
BDI	Backward Defect Indication
BDP	Bandwidth Delay Product
BEI	Backward Error Indication
BER	Bit Error Rate
BERT	Bit Error Rate Test
BIAE	Backward Incoming Alignment Error
BIP	Bit-Interleaved Parity
bit/s	Bit per second
BSD	Backward Signal Degrade
BSF	Backward Signal Fail

## C

C	Current
C-DCI	Client - Defect Clear Indication
C-FDI	Client - Forward Defect Indication
C-LOS	Client - Loss Of Signal
C-RDI	Client - Remote Defect Indication
C-VLAN	Client/Customer Virtual Local Area Network
CA	Calendar Switch Acknowledge
CAUI	100 Gbit/s Attachment Unit Interface
CAGE	Commerce And Government Entities
CBR	Constant Bit Rate
CBS	Committed Burst Size
CC	Continuity Check
CCM	Continuity Check Message

CD	Chromatic Dispersion
CE	Congestion Encountered
CD	Connectivity Defect
CDF	Client Data Frames
CE	European Conformity
CFO	Carrier Frequency Offset
cHEC	core Header Error Check
CID	Channel IDentifier
CIR	Committed Information Rate
CLK	Clock
CMF	Client Management Frames
CORR	Correctable
COS	Class Of Service
CPRI	Common Public Radio Interface
CR	Calendar Switch Request
CRC	Cyclic Redundancy Check
CRC-x	Cyclic Redundancy Check on x bits
CRITIC	Critical
CS	Client Signal
CS_LF	Client Signal Local Fault
CS_FPI	Client Signal Low Power Indication
CS_RF	Client Signal Remote Fault
CSF	Client Signal Fail
CSM	Client Signal Message
CSV	Comma Separated Value
cTE	constant Time Error
CTLE	Continuous Time Linear Equalization
CV	Code Violation

## Glossary

### Acronym List

---

CV	Connectivity Verification
CVM	Connectivity Verification Message
CW	Code Word

## D

DA	Destination MAC Address
DAC	Direct Attached Copper
DAPI	Destination Access Point Identifier
dBm	Decibel - milliwatts
DCC	Data Communications Channel
DCI	Defect Clear Indication
DCO	Digital Coherent Optics
DFE	Decision Feedback Equalizer
DGD	Differential Group Delay
DM	Degraded Minutes
DMM	Delay Measurement Message
DMR	Delay Measurement Reply
DNR	Do not revert
DS0	Digital Signal-level 0 (64 Kbit/s)
DS1	Digital Signal-level 1 (1.544 Mbit/s)
DS3	Digital Signal-level 3 (44.736 Mbit/s)
DSn	Digital Signal-level n
DSP	Digital signal processor
DST	Destination
DTE	Data Terminal Equipment
dTE <sub>H</sub>	dynamic Time Error High
DUS	Don't Use for Synchronization
DUT	Device Under Test

E

E-VLAN	Extended Virtual Local Area Network
E0	European standard for digital transmission-level 0 (64 Kbit/s).
E1	European standard for digital transmission-level 1 (2.048 Mbit/s).
E2	European standard for digital transmission-level 2 (8.448 Mbit/s).
E3	European standard for digital transmission-level 3 (34.368 Mbit/s).
E4	European standard for digital transmission-level 4 (139.264 Mbit/s).
EB	Errored Block
EBS	Excess Burst Size
EC	Error Count
ECN	Explicit Congestion Notification
ECT	ECN Capable Transport
EEC	Ethernet Equipment Clock
EFS	Error Free Second
eHEC	extension Header Error Check
EIR	Excess Information Rate
EoE	Ethernet over Ethernet
EoOTN	Ethernet over OTN
ERDI	Enhanced RDI
ES	Errored Second
ESMC	Ethernet Synchronization Message Channel
ESF	Extended Superframe
ESR	Errored Second Ratio
ETag	Extended Tag
EUI	EXFO Universal Interfaces
EXER	Exercise
EXI	Extension Header Identifier

## Glossary

### Acronym List

---

EXM	Extension Header Mismatch
EXT CLK	External Clock

## F

FAS	Frame Alignment Signal
FC	Fibre Channel
FCC	Federal Communications Commission
FCB	Frame Clock Burst
FCS	Frame Check Sequence
FD	Frame Delay
FDD	FEC Detected Degrade
FDI	Forward Defect Indication
FEC	Forward Error Correction
FEC-COR-BITS	FEC Correctable Bits
FEC-COR-CW	FEC Correctable Codeword
FEC-SYMB	FEC Symbol
FEC-UNCOR-CW	FEC Uncorrectable Codeword
FEC-UNCOR-FR	FEC Uncorrectable Frames
FED	FEC Excessive Degrade
FFE	Feed-Forward Equalizer
FlexE	Flex Ethernet
FlexO	Flexible Optical Transport Network
FLOGI	Fabric Login
FLR	Frame Loss Ratio
FOIC	FlexO Interface
fps	Frame Per Second
FS	Forced switch



FSD	Forward Signal Degrade
FSF	Forward Signal Fail

**G**

GAL	Generic Associated Channel Label
GE	Gigabit Ethernet
Gbit/s	Gigabit per second
GCC	General Communication Channel
GFP	Generic Framing Procedure
GFP-F	GFP - Framed
GFP-T	GFP - Transparent
GHz	Giga Hertz
GIDM	Group ID Mismatch
GM	Grand Master
GMP	Generic Mapping Procedure
GMP OOS	GMP Out of Synchronization
GNSS	Global Navigation Satellite System
GPS	Global Positioning System
GUA	Global IPv6 Address
GUI	Graphical User Interface

**H**

H	History
HDB3	High Density Bipolar 3 Code
HDMI	High Definition Multimedia Interface
HDTV	High Definition Television
Hi-BER	High-Bit Error Ratio

## Glossary

### Acronym List

---

Hi-BER1027B	High-Bit Error Ratio 1027 Blocks
HP-	High Order Path -
Hz	Hertz

### I

IAE	Incoming Alignment Error
IAIS	Incoming Alarm Indication Signal
ID	Identification
IEC	International Electrotechnical Commission
IEC	Incoming Error Count
IEEE	Institute of Electrical & Electronics Engineers
IFDV	Inter-Frame Delay Variation
IIDM	Instance ID Mismatch
IN	Input
IP	Internet Protocol
IPDV	Inter Packet Delay Variation
IPTV	Internet Protocol Television
IPG	Interframe Gap
IPv4	Internet Protocol version 4
IPv6	Internet Protocol version 6
ISM	In-Service Monitoring

### J

JC	Justification Control
----	-----------------------

L

-L	Line
L Deg SER Det	Local Degraded SER Detected
L Deg SER Rcd	Local Degraded SER Received
L2CP	Layer 2 Control Protocol
LAN	Local Area Network
LBM	Loopback Message
LBR	Loopback Reply
LCD	Loss of Code-Group Delineation
LCK	Locked
LED	Light-Emitting Diode
LER	Label Edge Router
lb	Pound
LBO	Line Build Out
LDEQ	PAM-4 Level Dependent Equalizer
LFD	Loss of Frame Delineation
LLA	Link-Local IPv6 Address
LLC	Logical Link Control
LLM	Logical Lane Marker
LMM	Loss Measurement Message
LMR	Loss Measurement Reply
LOA	Loss Of Alignment
LOAML	Loss of Alignment Marker Lock
LOAML1027B	Loss of Alignment Marker Lock 1027 Blocks
LOBL	Loss of Block Lock
LOBL1027B	Loss of Block Lock 1027 Blocks
LOC	Loss Of Clock
LOC Lane	Loss Of Clock Lane

## Glossary

### Acronym List

---

LOCS CSF	Loss of Client Signal - Client Signal Fail
LOCCS CSF	Loss of Client Character Synchronization - Client Signal Fail
LOCWS	Loss of CW Synchronization
LOF	Loss Of Frame
LOFLOM	Loss of Frame Loss Of Multiframe
LOL	Loss of Lane Alignment
LOM	Loss Of Multiframe
LOOMFI	Loss of OPU Multi-Frame Identifier
LOP	Loss Of Pointer
LoP	Lockout of protection
LOPPS-L	Loss Of Pulse Per Second - Local
LOPPS-R	Loss Of Pulse Per Second - Remote
LOR	Loss Of Recovery
LOS	Loss Of Signal
LSB	Least-Significant Bit
LSP	Label Switch Path
LSR	Label Switching Router
LSS	Loss of Sequence Synchronization
LTC	Loss of Tandem Connection
LTM	Link Trace Message
LTR	Link Trace Reply

## M

m	Minute
m	Meter
MA	Maintenance Association
MAC	Media Access Control
MAID	Maintenance Association Identification

MAPM	MAP Mismatch
Mbit/s	Megabit per second
MD	Maintenance Domain
MDI	Media Dependant Interface (straight through Ethernet cable)
MDIO	Management Data Input/Output
MDIX	Media Dependant Interface Crossover (crossover Ethernet cable)
ME	Maintenance Entity
MEG	ME Group
MEG ID	MEG Identification
MEP	MEG End Point
MFAS	Multiframe Alignment Signal
MHz	Megahertz
MIP	MEG Intermediate Point
MPD	Mean Path Delay
MPLS	Multiprotocol Label Switching
MS	Multiplex Section
MS	Manual switch
MSA	Multisource Agreement
MSB	Most-Significant Bit
MSEQV	Marker Sequence Violation
msg/s	Message per second
MSIM	Multiplex Structure Identifier Mismatch
MTIE	Maximum Time Interval Error
MTU	Maximum Transfer Unit

## Glossary

### Acronym List

---

#### N

NAT	Network Address Translation
NATO	North Atlantic Treaty Organization
nAUI	200GAUI-4, 400GAUI-8/16, CAUI, or XLAUI
NDF	New Data Flag
NE	Network Element
NID	Network Interface Device
NJO	Negative Justification Opportunity
nm	Nanometer
NR	No request
NTSC	National Time Service Center

#### O

OAM	Operation, Administration, and Maintenance
OBSAI	Open Base Station Architecture Initiative
OC-	Optical Carrier-
OCI	Open Connection Indication
ODI	Outgoing Defect Indication
ODU	Optical Data Unit
OEI	Outgoing Error Indication
OH	Overhead
OLA	Out-of-Lane-Alignment
OMF	Overhead Multiframe Indicator
OMFI	OPU Multi-Frame Identifier
OOMFI	Out of OPU Multi-Frame Identifier
OOF	Out-Of-Frame
OOM	Out-Of-Multiframe
OOR	Out-Of-Recovery

OOS	Generic Mapping Procedure Out Of Synchronization
OOS	Out-Of-Sequence
OOSM	Out-Of-Service Monitoring
OPU	Optical Payload Unit
OSNR	Optical Signal to Noise Ratio
OTL	Optical channel Transport Lane
OTN	Optical Transport Network
OTU	Optical Transport Unit
OUI	Organizationally Unique Identifier
OUT	OUTput

**P**

-P	Path
PBB-TE	Provider Backbone Bridges with Traffic Engineering
PC	Personal Computer
PCD	Path Connectivity Defect
PCP	Priority Code Point
PCS	Physical Coding Sublayer
PD	Payload Defect
PDI	Payload Defect Indication
PDL	Polarization Dependent Loss
PDU	Protocol Data Unit
PE	Provider Edge
pFCS	payload Frame Check Sequence
PFI	Payload Frame Check Sequence Identifier
PHY	Physical Layer Device
PLI	Payload Length Indicator
PLM	Payload Label Mismatch

## Glossary

### Acronym List

---

PLOGI	Port Login
PM	Performance Monitoring
PNO	Provisionable by the Network Operator
POS	Position Field
POSV	Position Field Violation
PPD	Path Payload Defect
ppm or PPM	parts per million
PRBS	Pseudo Random Bit Sequence
PRS	Primary Reference Source/Clock
PRC	Primary Reference Source/Clock
PSD	Path Server Defect
PSI	Payload Structure Identifier
PTI	Payload Type Identifier
PTP	Precision Time Protocol
Ptr. Incr.	Pointer Increment
Ptr. Decr.	Pointer Decrement
PTSF	Packet Timing Signal Fail
PW	Pseudo-Wire

### Q

QL	Quality Level
QoS	Quality of Service
QSFP	Quad Small Form Factor Pluggable
QZSS	Quasi-Zenith Satellites System

### R

R Deg SER	Remote Degraded SER
-----------	---------------------



RC	PAM-4 Reflection Canceller
RDI	Reverse Defect Indication
RDI	Remote Defect Indication
REI	Remote Error Indicator
RES	Reserved
RFI	Remote Failure Indication
RMA	Return Merchandise Authorization
RPF	Remote PHY Fault
RPn	Reference Point n
RR	Reverse request
RS-	Regenerator Section
RTD	Round Trip Delay
RTT	Round Trip Time
RX	Receive
Rx LOF	Rx Loss Of Frame
Rx LOM	Rx Loss Of Multi frame
Rx Demod LOL	Rx Demodulator Loss Of Lock
Rx CDC LOL	Rx Chromatic Dispersion Compensation
Rx LOA	Rx Loss Of Alignment
Rx OOA	Rx Out Of Alignment
Rx Deskew LOL	Rx Deskew Loss Of Lock
Rx FIFO	Rx FIFO Error

**S**

s	second
-S	Section
S-OAM	Service - OAM
S-VLAN	Service Virtual Local Area Network

## Glossary

### Acronym List

---

SA	Source MAC Address
SAPI	Source Access Point Identifier
SB	Superblock
SC	Synchronization Configuration
SD	Server Defect
SD	Signal degrade
SDH	Synchronous Digital Hierarchy
SDT	Service Disruption Time
SDTV	Standard Digital Television
SEF	Severely Errored Framing
SEP	Severely Errored Period
SEQV	Sequence Violation
SES	Severely Errored Second
SESR	Severely Errored Second Ratio
SF	Superframe
SF	Signal fail
SFN	System Frame Number
SFP	Small Form Factor Pluggable
SH	Sync Header
SI	International System
SID	Service Instance Identifier
SLA	Service-Level Agreement
SLC	PAM-4 Slicer
SLM	Synthetic Loss Message
SLR	Synthetic Loss Reply
SM	Section Monitoring
SMA	Sub-Miniature A Connector
SMC	SONET Minimum Clock Traceable

SNAP	Sub Network Access Point
SOF	Start Of Frame
SONET	Synchronous Transport Signal
SOPCR	State of Polarization Change Rate
SOPMD	Second Order Polarization Mode Dispersion
SP	Service Provider
SPE	Synchronous Payload Envelope
SR4	Short Reach (4 Lanes)
SRC	Source
SSM	Synchronization Status Messaging
ST1	Stratum 1 Traceable
ST2	Stratum 2 Traceable
ST3	Stratum 3 Traceable
ST3E	Stratum 3E Traceable
STM	Synchronous Transport Module
STS	Synchronous Transport Signal
STU	Synchronized - Traceability Unknown
SU	Soviet Union
SYMB	Symbol
SW	Software

**T**

TAI	International Atomic Time
TC	Traffic Class
TCM	Tandem Connection Monitoring
TCP	Transport Control Protocol
TDEV	Time Deviation
TE	Time Error

## Glossary

### Acronym List

---

tHEC	type Header Error Check
THz	Terahertz
TIE	Time Interval Error
TIM	Trace Identifier Mismatch
TLV	Type, Length, and Value
TNC	Transit Node Clock Traceable
TOS	Type Of Service
TST	Test PDU
TTI	Trail Trace Identifier
TTL	Time To Live
TU	Tributary Unit
TUG	Tributary Unit Group
TX	Transmit
Tx CMU LOL	Tx Clock Monitor Unit Loss Of Lock
Tx Deskew LOL	Tx Deskew Loss Of Lock
Tx FIFO	Tx FIFO Error
Tx LOA	Tx Loss Of Alignment
Tx OOA	Tx Out Of Alignment
Tx RefClk LOL	Tx Reference Clock Loss Of Lock

## U

UAS	Unavailable Second
UDP	User Data Protocol
UNCORR	Uncorrectable
UNEQ	Unequipped
UPI	User Payload Identifier
UPM	User Payload Mismatch
$\mu$ s	microsecond

USA	United States of America
USNO	United States Naval Observatory
UTC	Coordinated Universal Time
UTP	Unshielded Twisted Pairs

V

V	VT
VC	Virtual Container
VGA	Voltage Gain Amplifier
VIOL	Violation
VLAN	Virtual Local Area Network
VoIP	Voice over Internet Protocol
VT	Virtual Tributary
VTG	VT Group

W

WAN	Wide Area Network
WIS	WAN Interface Sublayer
WTR	Wait-to-restore
WWN	World Wide Name

X

XLAUI	40 Gbit/s Attachment Unit Interface
-------	-------------------------------------

## 10G Ethernet Client

The OTN Overclocked technology provides the capability to transparently transport 10G base-R Ethernet signals into OPU2 as specified in ITU-T. Two optical rates are provided:

- 11.0957 Gbits/s, +/- 100 ppm, designated OTU2e
- 11.0491 Gbits/s, +/- 100 ppm, designated OTU1e

The OTU2e uses the mapping scheme of CBR10G into OPU2 as defined in G.709. The client signal, 10GE LAN and the OPU fixed stuff bytes are accommodated into an OPU-like signal designated OPU2e. This signal is then wrapped in an ODU2e and then in an OTU2e signal.

The OTU1e uses the mapping scheme of CBR2G5 into OPU1 as defined in G.709. The client signal, 10GE LAN is accommodated into an OPU-like signal designated OPU1e (note that the fixed stuff bytes are not left free) this is why the 10GE signal can be transported at a lower rate than OTU2e. This signal is then wrapped in an ODU1e and then in an OTU1e signal.

The transparent transport of the 10G base-R means that the full 10G Ethernet data rate i.e. 10.3125 Gbit/s is transported over OTN. This means that the following information is transported:

- PCS 64B/66B coded information
- IPG (inter-frame filler), MAC FCS, Preamble and SFD (start of frame delimiter) and Ordered Sets (Remote Fault indication)

The OTN clocking is derived from the Ethernet client signal which is +/- 100 ppm, this is outside the clock tolerance allocated by the G.709 standard which translates in unspecified jitter performance thus limiting the application to Point to Point data path.

The following figure presents a typical network application.

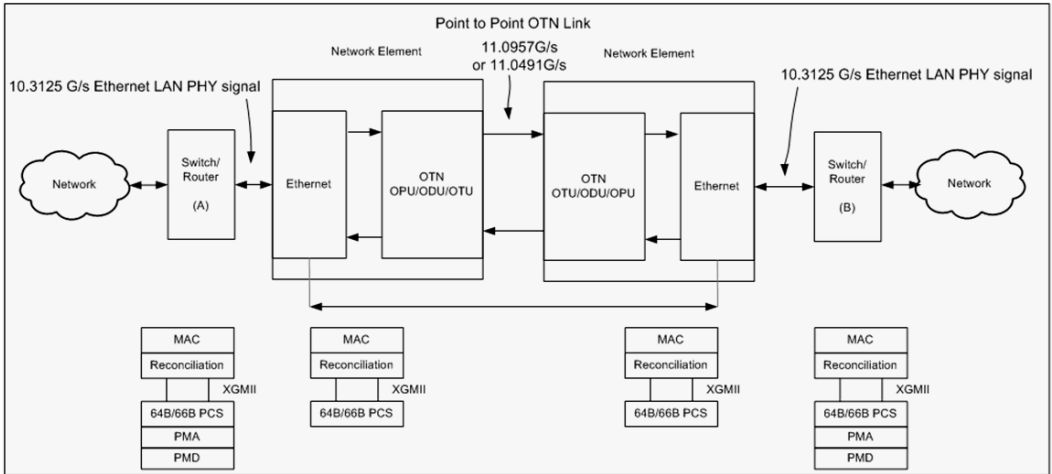

## Glossary

### 10G Ethernet Client

The following figure presents a typical test application.

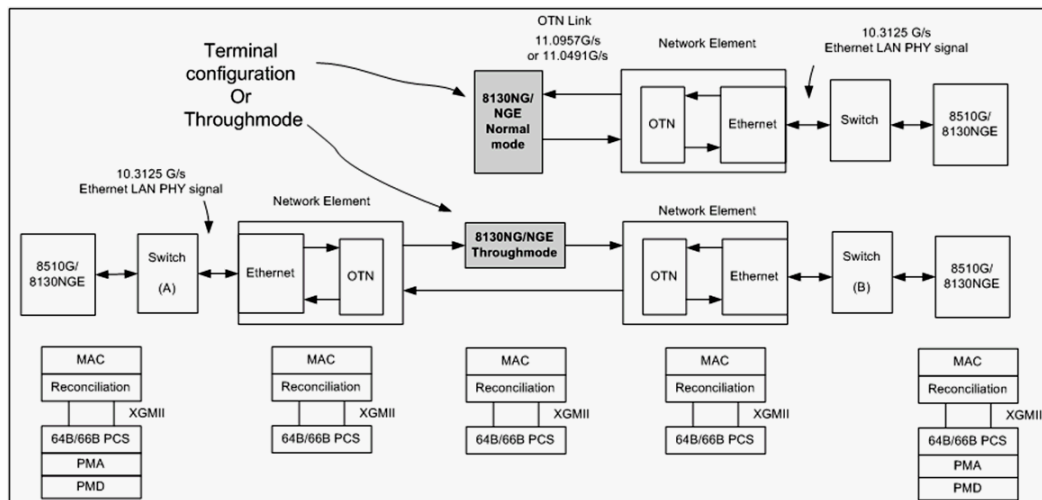

The Ethernet layer provides the equivalent functionality of the BERT Framed Layer 2 Test application supported on EXFO's Datacom product family with the particularity that there is no Ethernet Physical port as such. The Ethernet frame has its Ethertype field set to 0x88B7.



## 1588 PTP

The goal of the IEEE 1588 Precision Time Protocol (PTP) is to provide Network Synchronization using a packet based distribution mechanism.

Depending on the system application the Network Synchronization may require phase and frequency synchronization. 1588 PTP has the capability to deliver both by allowing a Client clock to track a Master clock in phase (time of day) and in frequency.

The protocol is based on exchange of time stamps between the Master clock and the Client clock. Two methods have been defined in the 1588 PTP standard:

- **Delay Request-Response** mechanism uses message Sync, Delay Request, Delay Response, and Follow Up (if required).

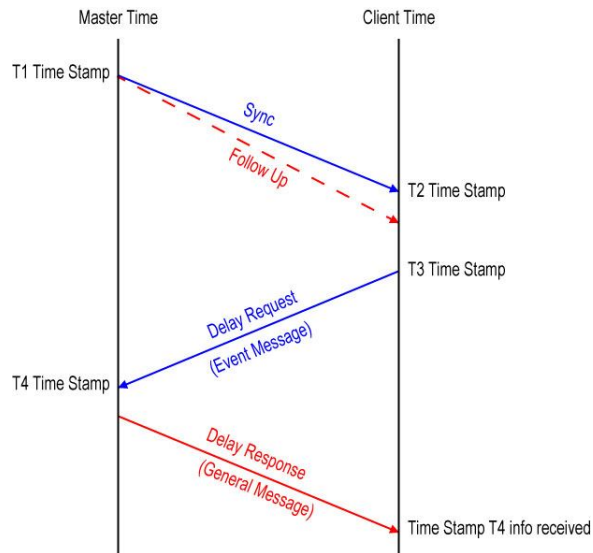

- **Peer Delay** mechanism uses message Pdelay Request, Pdelay Response, and if required Pdelay Response Follow Up. This mechanism is restricted to topologies where each peer-to-peer port communicates PTP messages with, at most, one other such port. Peer Delay is not supported by the Telecom Profile.

In order to minimize traffic on the network, PTP can operate in different modes:

- **Two-way** operation uses Sync/Follow Up, Delay Request, and Delay Response messages.
- **One-way** operation uses only the Sync/Follow Up messages. This mode of operation is used to synchronize a Client clock in frequency only. The Master clock and Client clock phases are not aligned.
- **Two-step** clock mode uses the optional Follow Up message to carry the T1 time stamp.
- **One-step** clock mode uses the Sync message to carry the T1 time stamp; no Follow Up message is transmitted by the Master clock, therefore less traffic on the network.

Client clock synchronization is achieved with a 2-part process:

- Part 1: Path delay measurement using bidirectional messages  
Mean path delay measurement (MPD) =  $((T2-T1) + (T4-T3)) / 2$
- Part 2: Clock phase offset correction  
Offset =  $(T2-T1) - MPD$

The offset information is used by the Client clock to adjust the frequency of its oscillator in order to keep the phase offset close to zero.

The 1588 PTP supports the following Master/Client communication; however **Unicast** is used for the Telecom Profile.

- **Multicast:** A Master clock sends its Sync/Follow Up and Delay Response in a multicast mode. A Client can collect information from many Master clocks and select the Master clock that is best suited for its application.
- **Unicast:** A dedicated communication link is established between the Master and the Client clock. This mode of operation requires a negotiation which is initiated by the Client clock.

The 1588 PTP messages can be mapped on the following protocols; however UDP IPv4 is used for the Telecom Profile.

- UDP/IPv4
- UDP/IPv6
- Ethernet

## **1588 PTP Profiles**

The purpose of a PTP profile is to allow organizations to specify particular selections of attribute values and optional features of PTP that, when using the same transport protocol, inter-work and achieve a performance that meets the requirements of a given application.

### Telecom Profile G.8265.1

The Telecom Profile G.8265.1 is designed for frequency synchronization in Telecom network applications. The main attributes of this profile are:

- Unicast communication with the Grand Master
- UDP/IPv4 or UDP/IPv6 network layer

With the Telecom Profile, the Client Clock initiates the communication to the Master Clock by making a request for service that consists of sending Signaling messages containing a REQUEST UNICAST TRANSMISSION TLV to the IP address of the Master Clock.

If the Master Clock has sufficient capacity to handle the Client Clock request, it responds with a signaling message containing a GRANT UNICAST TRANSMISSION TLV.

The REQUEST UNICAST TRANSMISSION TLV contains several parameters:

- **messageType** is the type of service being requested: Announce, Sync, or Delay Response.
- **durationField** is the duration of the requested service: 300 seconds by default and configurable from 60 to 1000 seconds.
- **logInterMessagePeriod**: transmission rate of the requested messages.

If the Master Clock denies the request, e.g. because it has no remaining capacity, it will send back a GRANT UNICAST TRANSMISSION TLV with the durationField set to zero.

In the event of being denied service by a Master Clock, or receiving no response to the service request, a Client Clock should wait a minimum of one second before issuing a new Unicast request to that Master Clock.

As Unicast service is only granted for a limited time, the Client Clock must re-request service periodically, before the expiration of the current grant. The Client Clock should reissue the request sufficiently far in advance of the expiration to allow the request to be repeated at least twice if no grant is received. This parameter is called Unicast renewal interval.

The following diagram shows the sequence of message exchange between a Client Clock and a Master Clock. First, the Client request Unicast Announce message service. When this is granted and the first Announce message is received, the Client can check the QL value conveyed in the clockClass field of the message. From there the Client Clock can request service for Sync and Delay Request messages. Service requests are reissued at the end of the Announce duration interval to ensure continuity of service.

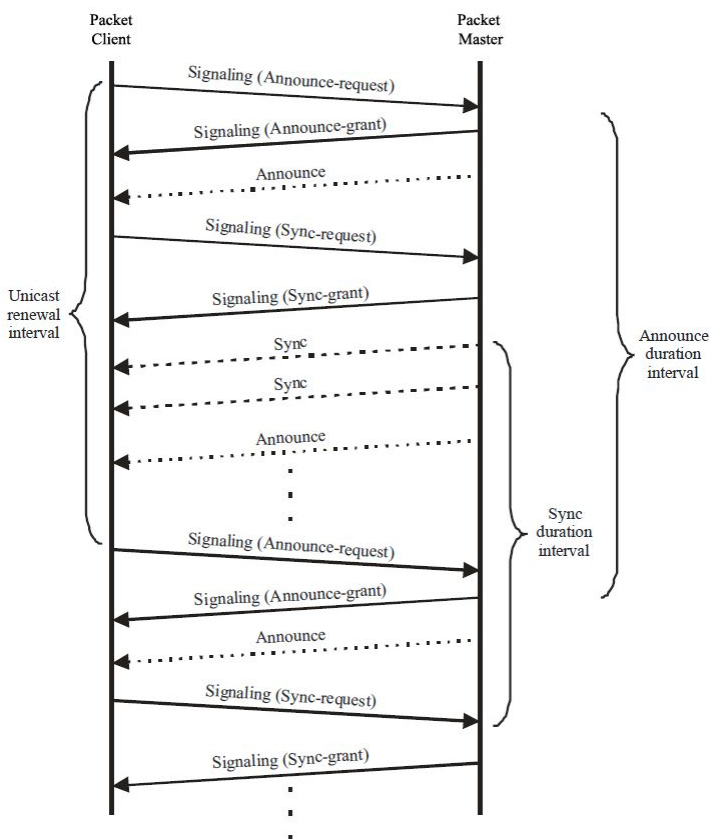

### Telecom Profile G.8275.1

The Telecom Profile G.8275.1 is designed for time/phase synchronization in telecom network applications. The main attribute of this profile are:

- Full timing support from the network, i.e. all network nodes are boundary clocks
- Slave clocks synchronize with its respective upstream Boundary Clock
- 1588 messages are mapped on Ethernet Multicast

A very important distinction that has to be made compared with G.8265.1 is the mandatory use of Boundary Clocks with G.8275.1. With G.8265.1, network nodes such as Ethernet Switches or Routers were not required to be PTP aware. With G.8275.1, all network nodes needs to be PTP aware. This means that regular Ethernet Switches or Routers cannot be used. Switches/Routers are required to include the Boundary Clock functionality.

### Telecom Profile G.8275.2

The Telecom Profile G.8275.2 is designed for time/phase synchronization in telecom network applications. The main attribute of this profile are:

- Partial timing support from the network, i.e. some network nodes are Boundary Clocks among PTP unaware network nodes
- Unicast communication with respective upstream Boundary Clock
- UDP/IPv4 or UDP/IPv6 network layer

The main difference compared with G.8275.1 is that the Boundary Clocks are positioned at strategic locations in the network. With G.8275.2, a mix of PTP Unaware and PTP Aware network nodes can be deployed on the transport path. This means that Switches/Routers with or without Boundary Clock functionality can be used. G.8275.2 mainly addresses for operators who don't want to swap out all their existing equipment by a Boundary Clock embedded in every network element to meet the stringent time error requirements for 4G/5G field deployment.

## CPRI

### Overview

Traditional mobile installations are bulky (use thick coaxial cables) and require a lot of power to operate (there is a huge power loss in the coaxial cabling which often requires the use of Tower Mounted Amplifiers) as outlined in the following figure.

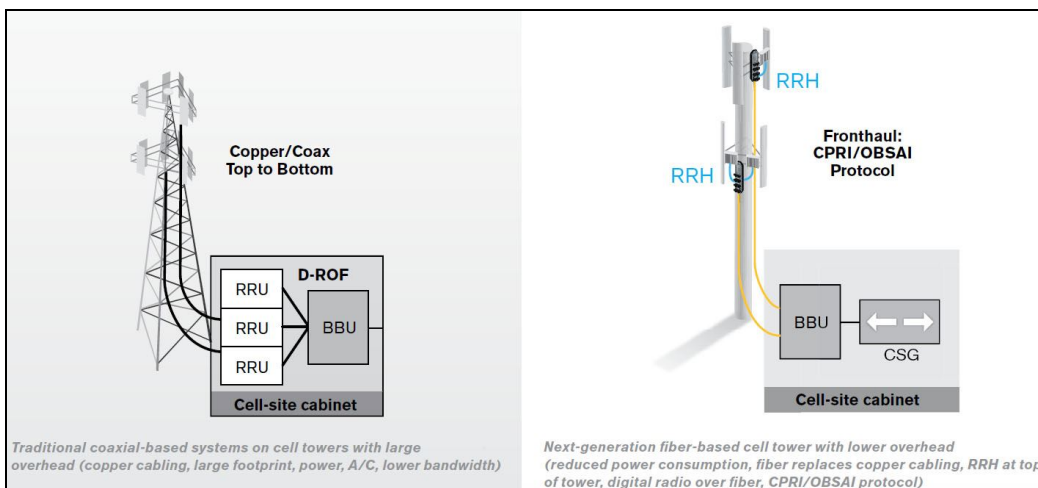

Pressures on the Mobile Network Operators (MNO) to reduce their capital, operational cost, and increase coverage are at the heart of a revolution in the mobile network. To address the situation, a concept of decomposition of the radio base station has been developed where the radio basic functions and its ability to transmit and receive radio modulated signals are separated. In such a distributed environment a protocol is required to maintain synchronization and management capabilities as well as transporting the user traffic between the simplified Base Transceiver Station (BTS) and its Remote Radio Head (RRH).

## Glossary

### *CPRI*

---

This protocol called Common Public Radio Interface (CPRI) separates a traditional radio base station configuration into two separate elements: Radio Equipment Control (REC) and the Radio Equipment (RE). The REC processes the baseband radio digital information and performs the control of the Radio Equipment. The RE converts the digital radio information into radio frequency signals transported over the air interface (antenna). The REC and RE are interconnected by a point-to-point link. This link carries the CPRI protocol and is known in the industry as the fronthaul as opposed to the backhaul that is the WAN bringing the network traffic to the base station.

The CPRI link can be extended over several kilometers as it uses fiber optics, in fact it can be deployed up to 40 km although most field installations at the moment of this writing are below 10 km.

The CPRI standard covers the physical and data link layers only. This specific focus provides additional development freedom to the various vendors to implement proprietary functions at upper layers.



## Functional Description

As mentioned earlier, CPRI remotely locates the RE from the REC. This means that the RE must be controlled, managed and synchronized from the REC in addition to transporting the User information (Voice and user application data) and all that on the same digital link. As such, CPRI is composed of 3 communication flows multiplexed into a single serial signal transmitted in the same optical fiber as illustrated in the following figure.

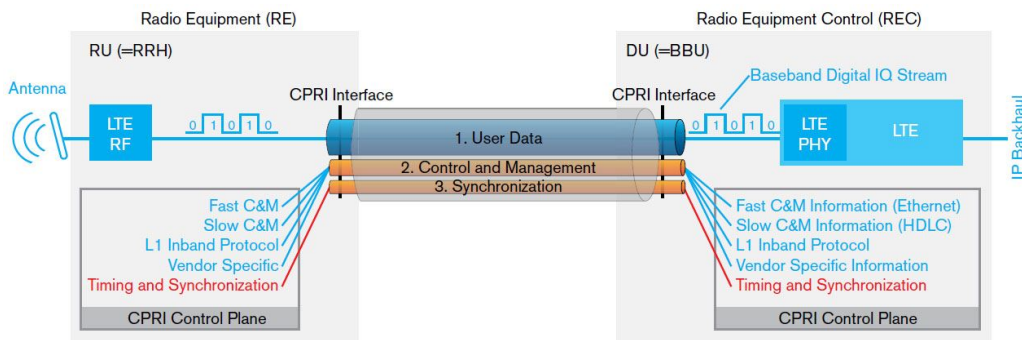

An electrical link is also available from CPRI but it is typically used for base station shelf interconnection. Since a state machine drives the link parameters (rates, protocol, and C&M channel) alignment, a BTS (defined as Master in the standard) and RRH (defined as Slave in the standard) interfaces are defined where the Master initiates the negotiation procedure necessary to achieve this alignment.

- **Synchronization:** Provides precise frequency and frame timing alignment from BTS to RRH to ensure accurate frequency and timing of the RF signal transmission and reception on the Air Interface. In essence, it provides the reference frequency for the RE.
- **Control & Management (C&M):** Management of the link between the REC and RE as well as control over radio functions such as alarms and power.
- **User:** Also known as IQ Data, represents the voice and data information that is exchanged by end-User Equipment (UE)

## CPRI Model

The CPRI Model revolves around the 3 communication flows described above. CPRI defines only the Layer 1 and Layer 2 associated to these communication flows as outlined in the following figure.

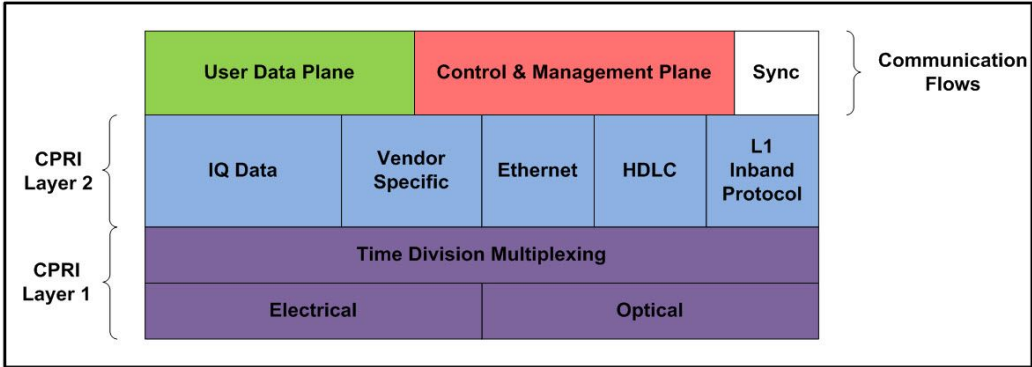

The User Data Plane contains mostly voice/data traffic in the form of IQ Data samples. IQ Data digitally encodes the change in amplitude/phase of a user device modulated signal sampled at the RE antenna.

The Control & Management Plane maintains the CPRI link itself and provides the facility to manage the operation of the RE radio functions. It is done through the L1 Inband Protocol which provides a bit oriented channel defined to support link specific alarms (R-LOS, R-LOF, ...). Also, the Ethernet/HDLC channel offer two OAM&P channel alternatives which are respectively high and low bandwidth with rates configurable based on the CPRI line interface rate. These carry proprietary information between the REC and RE. Some Vendor Specific overhead is also available.

Finally, the Synchronization flow ensures frequency stability and offers the overhead necessary for frame alignment between the REC and RE to ensure hitless channel or frequency hopping. All these flows are time division multiplexed onto one optical fiber for CPRI field deployments such as Distributed Antenna Systems (DAS).

## Physical Interface

CPRI offers 8 options in terms of interface rates. Rates below 10G uses 8B/10B line coding as per CPRI V6.0 while rates above 10G use 64B/66B coding. Depending on the rates used, scrambling is optional. Depending on the CPRI signal structure (Framed or Unframed) the scrambling is either manually configured or negotiated.

Option	Rate	Line Coding	Protocol Version (Scrambling)
1	614.4 Mbit/s	8B/10B	Version 1: No scrambling
2	1.2288 Gbit/s		
3	2.4576 Gbit/s		
4	3.0720 Gbit/s		
5	4.9152 Gbit/s		Version 1: No scrambling Version 2: Scrambling (Scrambling is optional)
6	6.1444 Gbit/s		
7	9.8304 Gbit/s		
8	10.1376 Gbit/s	64B/66B	Version 1: Scrambling

## Ethernet Cables

Minimum Category 3 cable is required for 10Base-T connection while Category 5 cable is required for 100Base-TX and 1000Base-T connections.

Maximum cable length (between two nodes) for 10Base-T, 100Base-TX, or 1000Base-T connection is 328 feet (100 meters).

➤ **Straight Through Cable (10/100 Mbit/s)**

An Unshielded Twisted Pair (UTP) straight through cable is required to connect a 10Base-T/100Base-TX module port to a layer 1 or 2 device (ex: HUB, switch).

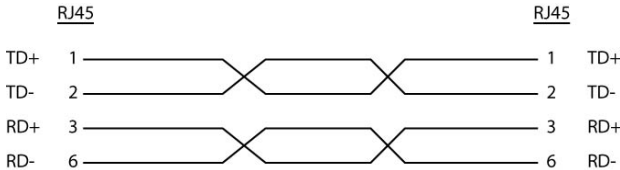

➤ **Crossover Cable (10/100 Mbit/s)**

An Unshielded Twisted Pair (UTP) crossover cable is required to connect the 10Base-T/100Base-TX module port to a layer 3 device (ex: router).

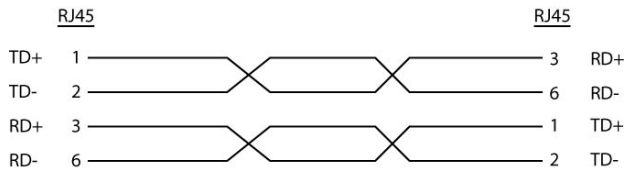

➤ **Straight Through Cable (1000 Mbit/s)**

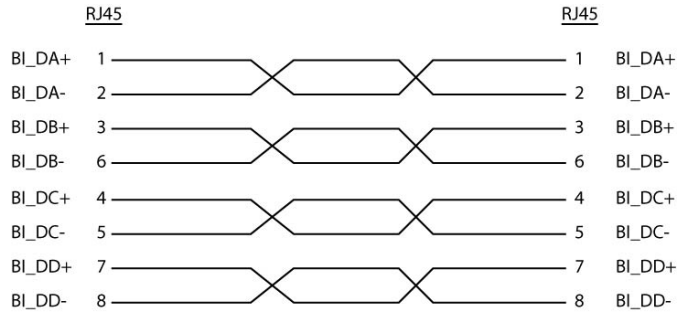

➤ **Crossover Cable (1000 Mbit/s)**

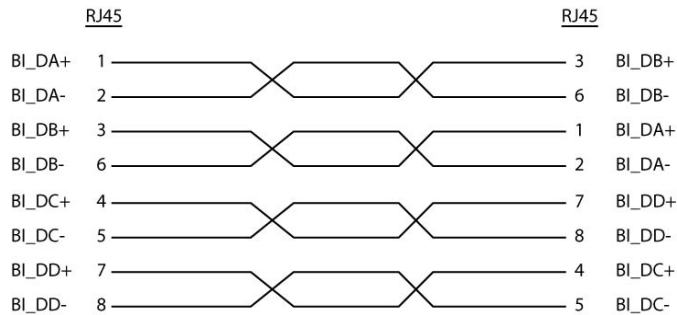

# G.709 Optical Transport Network (OTN)

## Overview

The optical transport network (OTN) combines the benefits of SONET/SDH technology with the bandwidth expansion capabilities offered by dense wavelength-division multiplexing (DWDM) technology.

The OTN consists of the following layers:

- Optical Transport Section (OTS)
- Optical Multiplex Section (OMS)
- Optical Channel (OCh)
- Optical channel Transport Lane (OTL)
- Optical Transport Unit (OTU)
- Optical Data Unit (ODU)
- Optical Channel Payload Unit (OPU)

Each of these layers and their functions are distributed along the network and activated when they reach their termination points, which are illustrated in the following figure.

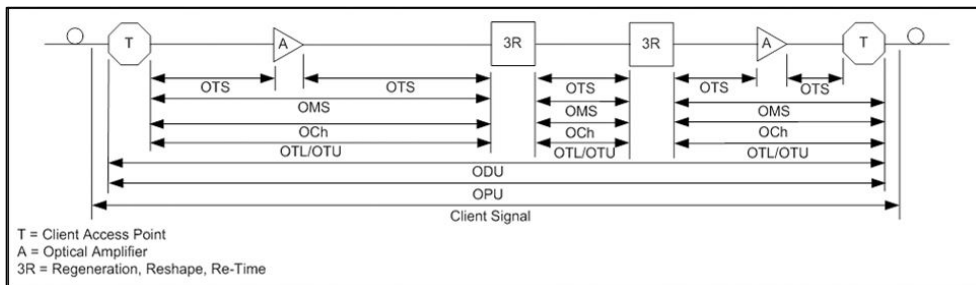

OTN Layer Termination Points

The termination of the OTS, OMS and OCh layers is performed at the optical level of the OTN. It is at the termination of the OTU layer that further functionality can be added. This layer is the digital layer—also known as the “digital wrapper”—and offers specific overhead to manage the OTN’s digital functions. The OTU also introduces a new dimension to optical networking by adding forward error correction (FEC) to the network elements, allowing operators to limit the number of required regenerators used in the network which, in turn, lowers its cost.

FEC allows an increase in the optical link budget by providing a new method to correct errors, thereby reducing the impact of network noise and other optical phenomena experienced by the client signal traveling through the network.

The OTU also encapsulates two additional layers—the ODU and the OPU—which provide access to the payload (SONET, SDH, etc.). These layers are normally terminated at the same location.

## Glossary

### G.709 Optical Transport Network (OTN)

---

The OTU, ODU (including the ODU tandem connection) and OPU layers can all be analyzed and monitored. As per ITU G.709, current test solutions offer these possibilities using the following line rates:

- OTU1 ( $255/238 \times 2.488\ 320$  Gbit/s  $\approx 2.666057143$  Gbit/s) also referred to as 2.7 Gbit/s
- OTU2 ( $255/237 \times 9.953280$  Gbit/s  $\approx 10.709225316$  Gbit/s) also referred to as 10.7 Gbit/s
- OTU3 ( $255/236 \times 39.813120$  Gbit/s  $\approx 43.018413559$  Gbit/s) also referred to as 43 Gbit/s
- OTU4 ( $255/227 \times 99.532\ 800$  Gbit/s  $\approx 111.809973568$  Gbit/s) also referred to as 112 Gbit/s.

The following non standard rates are also defined:

- OTU1e ( $255/238 \times 10.3125$  Gbit/s  $\approx 11.0491071429$  Gbit/s)
- OTU2e ( $255/237 \times 10.3125$  Gbit/s  $\approx 11.0957278481$  Gbit/s)
- OTU3e1 ( $255/236 \times 4 \times 10.3125$  Gbit/s  $\approx 44.570974576$  Gbit/s)
- OTU3e2 ( $243/217 \times 16 \times 2.488320$  Gbit/s  $\approx 44.583355576$  Gbit/s)

The following non standard rates are not covered by the ITU standard but they are the equivalent function associated to Fiber Channel rates:

- OTU1f ( $255/238 \times 10.51875$  Gbit/s  $\approx 11.2700892857143$  Gbit/s)
- OTU2f ( $255/237 \times 10.51875$  Gbit/s  $\approx 11.3176424050633$  Gbit/s)

Each line rate is adapted to service different client signals:

- OC-48/STM-16 is transported via OTU1
- OC-192/STM-64 is transported via OTU2
- OC-768/STM-256 is transported via OTU3
- Null Client (All 0s) is transported via OTUk (k = 1, 2, 1e, 2e, 1f, 2f, 3, 3e1, 3e2, 4)
- PRBS31 is transported via OTUk (k = 1, 2, 1e, 2e, 1f, 2f, 3, 3e1, 3e2, 4)



In order to map client signals via ITU G.709, they are encapsulated using the structure illustrated in the following figure.

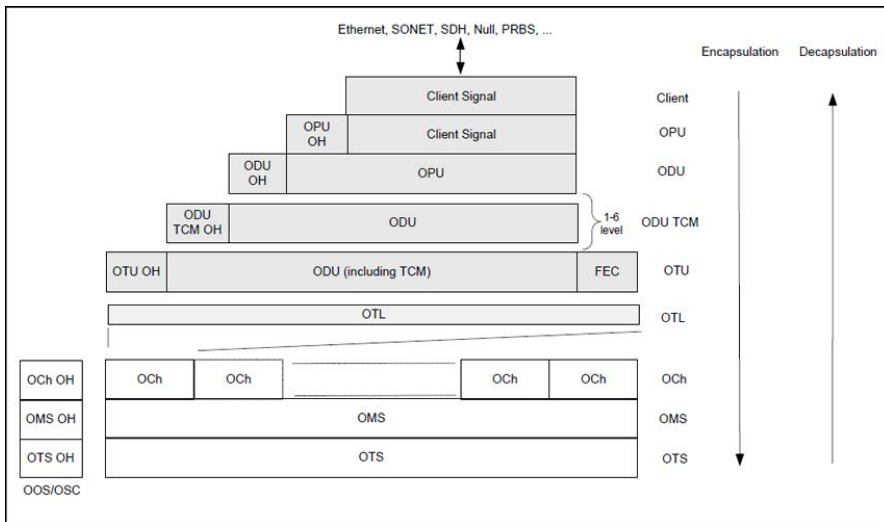

**Basic OTN Transport Structure**

## Glossary

### G.709 Optical Transport Network (OTN)

---

As depicted above, to create an OTU frame, a client signal rate is first adapted at the OPU layer. The adaptation consists of adjusting the client signal rate to the OPU rate. Its overhead contains information to support the adaptation of the client signal. Once adapted, the OPU is mapped into the ODU. The ODU maps the OPU and adds the overhead necessary to ensure end-to-end supervision and tandem connection monitoring (up to six levels). Finally, the ODU is mapped into an OTU, which provides framing as well as section monitoring and FEC.

Following the OTN structure presented in figure *Basic OTN Transport Structure* on page 823, OTUks ( $k = 1, 2, 3$ ) are transported using the OCh; each unit is assigned a specific wavelength of the ITU grid. Several channels can be mapped into the OMS and then transported via the OTS layer. The OCh, OMS and OTS layers each have their own overhead for management purposes at the optical level. The overhead of these optical layers is transported outside of the ITU grid in an out-of-band channel called the optical supervisory channel (OSC).

When the OTU frame structure is complete (OPU, ODU and OTU), ITU G.709 provides OAM&P functions that are supported by the overhead.

## OTU Frame Structure and Overhead

As shown in the figure below, the OTU frame is broken down into the following components:

- Framing
- OTL, OTU, ODU, OPU overhead
- OTU FEC

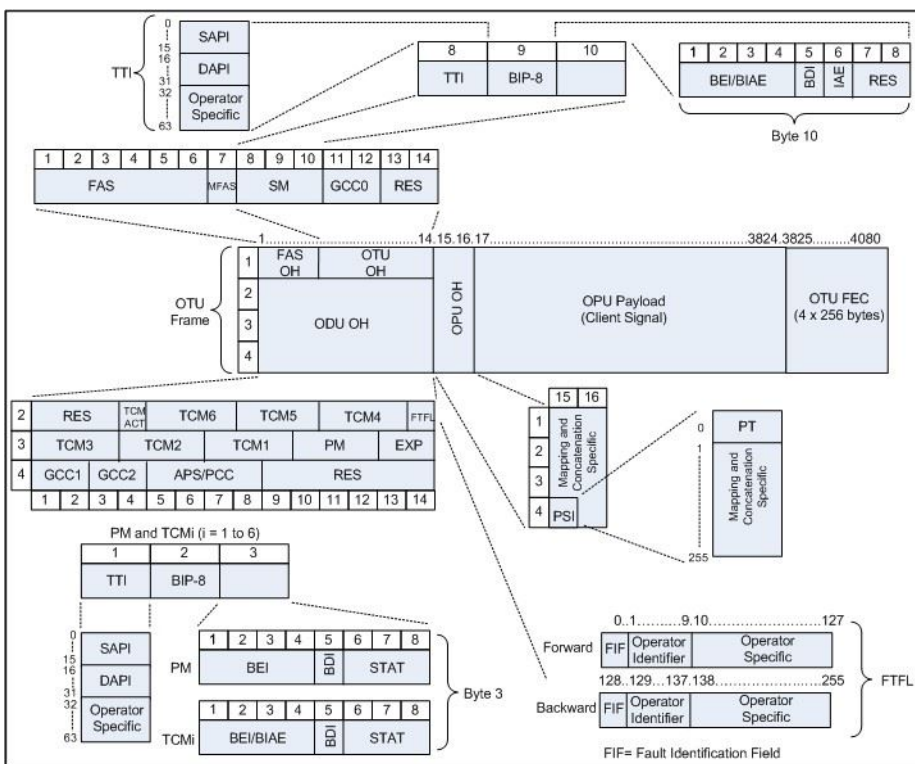

OTU Frame Description

## Glossary

### G.709 Optical Transport Network (OTN)

---

#### ► Framing

The OTU framing is divided into two portions: FAS and MFAS.

The frame alignment signal (FAS) uses the first six bytes and, similarly to SONET/SDH, it is used to provide framing for the entire signal. In order to provide enough 1/0 transitions for synchronization, scrambling is used over the entire OTU frame, except for the FAS bytes.

The multiframe alignment signal (MFAS) byte is used to extend command and management functions over several frames. The MFAS counts from 0 to 255, providing a 256 multiframe structure.

#### ► Overhead

Each portion of the OTU frame has its own specific overhead functions. They are displayed in figure *OTU Frame Description* on page 825, and are briefly described below. Further details can be found about these overhead fields in the ITU G.709 standard.

#### ► Optical channel Transport Lane (OTL)

The Optical channel Transport Lane (OTL) is an adaptation layer whose purpose is to re-use the modules developed for Ethernet 40GBASE-R and 100GBASE-LR4. These modules have a four-lane WDM interface to and from a transmit/receive pair of G.652 optical fibers, and connect to the host board via a 4-lane (OTL3.4) or 10-lane (OTL4.10) electrical interface.

The OTL layer is responsible for mapping the serial OTU signal onto a parallel path designated lanes. In the case of OTU4 the signal is distributed over 20 logical lanes and for OTU3 the signal is distributed over 4 logical lanes.

➤ **Optical Transport Unit (OTU)**

The OTU overhead is comprised of the SM, GCC0 and RES bytes.

The section monitoring (SM) bytes are used for the trail trace identifier (TTI), parity (BIP-8) and the backward error indicator (BEI), or backward incoming alignment error (BIAE), backward defect indicator (BDI), and incoming alignment error (IAE). The TTI is distributed over the multiframe and is 64 bytes in length. It is repeated four times over the multiframe.

General communication channel 0 (GCC0) is a clear channel used for transmission of information between OTU termination points.

The reserved (RES) bytes are currently undefined in the standard.

## Glossary

### G.709 Optical Transport Network (OTN)

---

#### ► Optical Data Unit (ODU)

The ODU overhead is broken into several fields: RES, PM, TCMi, TCM ACT, FTFL, EXP, GCC1/GCC2 and APS/PCC.

The reserved (RES) bytes are undefined and are set aside for future applications.

The path monitoring (PM) field is similar to the SM field described above. It contains the TTI, BIP-8, BEI, BDI and Status (STAT) field.

There are six tandem connection monitoring (TCMi) fields, which contain the BEI/BIAE, BDI and STAT fields. The STAT field is used in the PM and TCMi fields to provide an indication of the presence or absence of maintenance signals.

The tandem connection monitoring activation/deactivation (TCM ACT) field is currently undefined in the standards.

The fault type and fault location reporting communication channel (FTFL) is a message spread over a 256-byte multiframe that provides the ability to send forward and backward path-level fault indications.

The experimental (EXP) field is a field that is not subject to standards and is available for network operator applications.

General communication channels 1 and 2 (GCC1/GCC2) fields are very similar to the GCC0 field except that each channel is available in the ODU.

The automatic protection switching and protection communication channel (APS/PCC) supports up to eight levels of nested APS/PCC signals, which are associated to a dedicated-connection monitoring level depending on the value of the multiframe.

➤ **Optical Payload Unit (OPU)**

The primary overhead field associated to the OPU is the Payload Structure Identifier (PSI). This is a 256 bytes multi-frame where its first byte is defined as the Payload Type (PT). The remaining 255 bytes are currently reserved.

The other fields in the OPU overhead are dependent on the mapping and concatenation capabilities associated to the OPU. For an asynchronous mapping (the client signal and OPU clock are different) Justification Control (JC) bytes are available to compensate for clock rate differences, two methods are supported Asynchronous Mapping Procedure (AMP) and Generic Mapping Procedure (GMP). For a purely Bit-Synchronous Mapping Procedure (BMP) (client source and OPU clock are the same), the JC bytes become reserved (set to 0). Concatenation bytes are also available as described in ITU G.709.

# Glossary

## Tandem Connection Monitoring (TCM)

TCM enables the user and its signal carriers to monitor the quality of the traffic that is transported between segments or connections in the network. SONET/SDH allowed a single level of TCM to be configured, while ITU G.709 allows six levels of tandem connection monitoring to be configured. The assignment of monitored connections is currently a manual process that involves an understanding between the different parties. There are various types of monitored connection topologies: cascaded, nested and overlapping. Examples of these topologies are provided in the following figure.

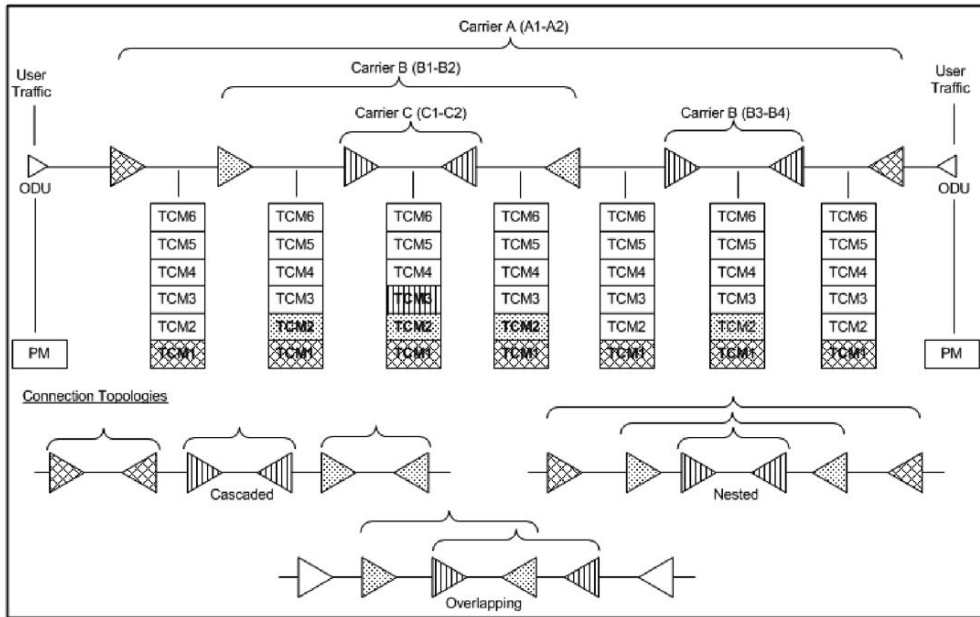



Each of the six TCMi fields in the ODU overhead is assigned to a monitored connection. There can be from zero to six connections that can be configured for each connection. In the figure *Tandem Connection Monitoring* on page 830, there are three different connections that are actually monitored. Carrier C, due to its location, can monitor three TCM levels as the ODU passes through its portion of the network.

In addition to monitoring maintenance signals, using the STAT field associated with each TCM level, the TCM connection also monitors the BIP-8 and BEI errors for each connection level. Maintenance signals are used to advertise upstream maintenance conditions affecting the traffic and errors provide an indication of the quality of service offered at each segment of the network, which provides a valuable tool for the user and carrier to isolate faulty sections of the network.

## **Forward Error Correction (FEC)**

The ITU G.709 standard supports forward error correction (FEC) in the OTU frame and is the last part added to the frame before the frame is scrambled. FEC provides a method to significantly reduce the number of transmitted errors due to noise, as well as other optical phenomena that occur at high transmission speeds. This enables providers to support longer spans in between optical repeaters.

An OTU frame is divided into four rows. Each row is broken down into 16 sub-rows comprised of 255 bytes each, as shown in figure *Forward Error Correction* on page 832. A sub-row is composed of interleaved bytes. The interleave is executed so that the first sub-row contains the first overhead (OH) byte, the first payload byte and the first FEC byte, and so on for the remaining sub-rows of each row in the frame. The first FEC byte starts at position 240 for all sub-rows.

# Glossary

## G.709 Optical Transport Network (OTN)

The FEC uses a Reed-Solomon RS (255/239) coding technique. This means that 239 bytes are required to compute a 16-byte parity check. The FEC can correct up to eight (bytes) errors per sub-row (codeword) or detect up to 16 byte errors without correcting any. Combined with the byte interleave capability included in ITU G.709 implementation, the FEC is more resilient in regards to error burst, where up to 128 consecutive bytes can be corrected per OTU frame row.

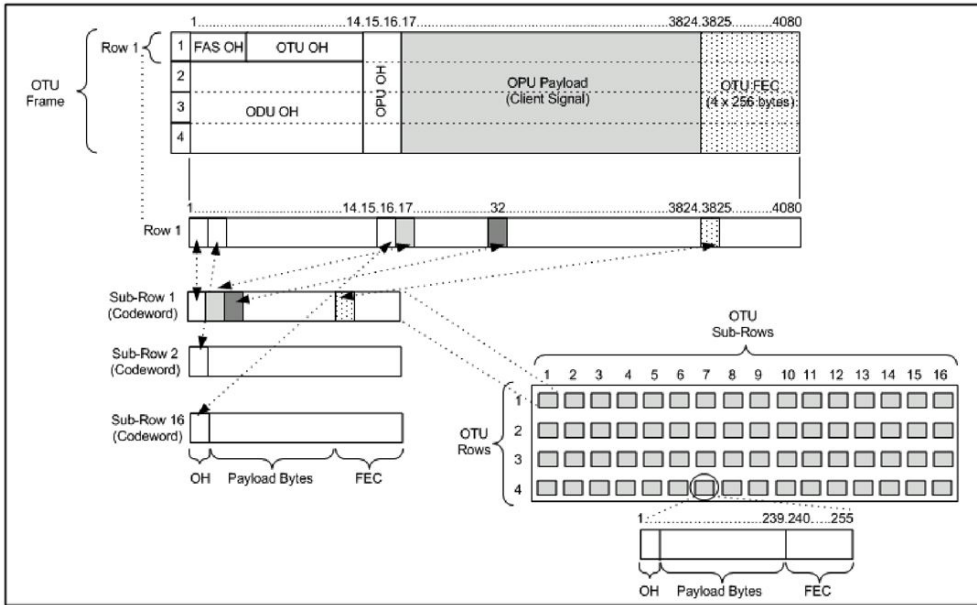

Forward Error Correction

## ODU Multiplexing

The ODU multiplexer is a function that allows the multiplexing of ODU tributary signals into higher OTN signal rates. The G.709 standard supports 2 types of ODU multiplexer which can be classified as follows:

- Legacy architecture is based on multi-stage architecture to bring an ODUk client to a higher OTN interface rate. This multiplexer is identified by Payload Type 20 (PT 20).
- New architecture uses a single stage architecture to bring an ODUk client to any higher OTN interface rate. This method supports the ODUflex client signal. The multiplexer is identified by Payload Type 21 (PT 21).

**Note:** *Refer to the OTN BERT on page 58 or OTN-SONET/SDH BERT on page 61 for the ODU multiplexing capabilities.*

The multiplexing strategy is based on the concept of tributary slots, which is similar in concept to the SONET timeslot. The multiplexing of 4 ODU1 in one ODU2 is made by distributing the ODU1 structure in a repetitive sequence of 4 ODU2 Tributary slots, a similar strategy is used for ODU3 multiplexing where the repetitive sequence is made of 16 ODU3 tributary slots, refer to G.709 standard for detailed information.

## Glossary

### *G.709 Optical Transport Network (OTN)*

---

The main attributes of the ODU multiplexer functionality are as follows:

- The Asynchronous Mapping Procedure (AMP) is used for multiplexing the tributary signals; this method uses a modified Justification Control mechanism which has 2 positive Justification Control bytes and one negative Justification Control byte.
- The new multiplex method also supports the Generic Mapping Procedure as the Justification Control mechanism is still using the OPU OH JC bytes.
- The Multiplex Structure Identifier (MSI) provides information that is specific to each type of multiplexer provided.
- Can handle multiplex signals with frequency offset of +/- 20 ppm on every layer for the legacy architecture while the new architecture (using GMP) can handle frequency offset of +/-100 ppm.

## ODUflex

ODUflex provides the capability to carry client payload of variable size with a container size of 1.244 Gbit/s granularity. An ODUflex (L) signal can be transported once multiplexed in an ODUk (H) signal, the multiplexer in this case handles tributary slots of 1.244 Gbit/s and has a Payload Type 21. The ODUflex function can be used to transport 2 signal categories mapped in ODTUk.ts using GMP:

➤ Ethernet in ODUflex over GFP-F signal

The Ethernet packets are mapped in GFP-F as specified in G.7041, the packets are processed as follows:

- The Start of Frame Delineation bytes are terminated
- Inter Frame Gaps bytes are terminated
- PCS coding is terminated
- GFP overhead bytes added

Since the PCS coding is terminated, it is not possible to transport the Ethernet Link status transparently but it is accommodated by the Forward Defect Indication (FDI) and Remote Defect Indication (RDI) alarms over GFP. The RDI is used to carry the Remote Fault alarm while the FDI is used to carry the Local Fault.

GFP-F provides rate adaptation between the incoming Ethernet signal and the outgoing OPUflex transport signal. This brings the fact that GMP is operated at a fixed Cm value close to the maximum server capacity.

➤ CBR over ODUflex signal

ODUflex can transport Constant Bit Rate signal (bulk filled Test pattern) as Client of the ODUflex CBR function. This CBR function needs a Pattern generator that can operate at a data rate specified by the user, the range of the available data rates is qualified by the Bandwidth management function.

## Glossary

*G.709 Optical Transport Network (OTN)*

---

### OTN Signal Rates

Rate	Signal
2.666057143 Gbit/s	OTU1
10.709225316 Gbit/s	OTU2
11.0491 Gbit/s	OTU1e
11.0957 Gbit/s	OTU2e
11.2701 Gbit/s	OTU1f
11.3176 Gbit/s	OTU2f
43.018413559 Gbit/s	OTU3
44.571 Gbit/s	OTU3e1
44.583 Gbit/s	OTU3e2
111.81	OTU4

## Generic Framing Procedure (GFP)

Generic framing procedure (GFP), defined in ITU recommendation G.7041/Y.1303, is a framing mechanism to transport packet-based client signals, such as Ethernet, Fibre Channel, ESCON, FICON, over fixed-data-rate optical channels. As such, GFP provides a single, flexible mechanism to map these client signals into SONET/SDH and OTN networks, as shown in figure below.

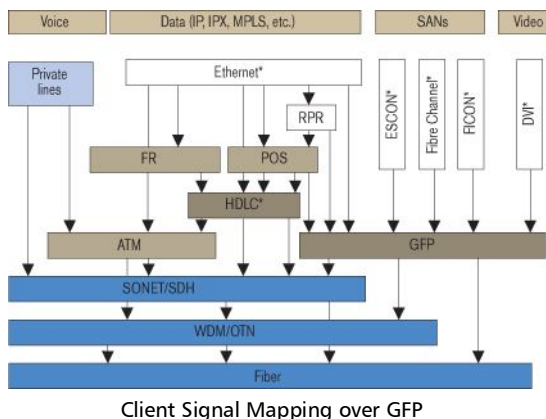

Prior to the introduction of GFP, several methods had been used to transport packet services over SONET/SDH networks. The first method was Asynchronous Transfer Mode (ATM) Adaptation Layer 5 (AAL 5) over SONET/SDH. ATM is a very efficient switching and multiplexing technology, whose transfer rates scale with SONET/SDH rates. However, ATM does not make the most efficient use of bandwidth because the payload data is separated into groups of 48 bytes, called cells, with an additional 5-byte header of software overhead. It became immediately apparent that almost 10 % of the bandwidth would be lost. In addition, certain types of data required even more ATM overhead.

## **Glossary**

### *Generic Framing Procedure (GFP)*

---

Other methods have focused on using point-to-point protocol (PPP). The IP traffic coming to an Ethernet port is encapsulated over a PPP link and multiple ports can be encapsulated over multilink PPP (ML-PPP) links. By using an HDLC framing, the PPP traffic is transported over the SONET/SDH payload. These methods have been standardized within the IETF through the following Requests for Comments (RFC): RFC 1662, RFC 1990 and RFC 2615. The ITU-T expanded this work by specifying the use of LAPS (very similar protocol to PPP/HDLC) and specifying IP over LAPS in X.85/Y.1321 and Ethernet over LAPS in X.86/Y.1323. All these methods for encapsulating traffic suffer from the weaknesses of HDLC framing; i.e., limited protection from frame corruption and the introduction of variable packet sizes because of its trailer.

GFP has been standardized to better optimize the transport of Ethernet and other data services over SONET/SDH networks, taking into account both the pros and cons of ATM and PPP/HDLC and leveraging two new emerging SONET/SDH capabilities, VCAT and LCAS, that will be discussed later in this document.



## GFP Mapping

Two types of mapping are currently available for GFP: framed-mapped (GFP-F) and transparent-mapped (GFP-T), whose mappings keep the same basic frame structure, as will be shown in the next sections. The decision on which mode to use is dependent on the underlying service to be transported.

- **Frame-Mapped GFP (GFP-F):** mapping mechanism in which one client signal frame is received and mapped in its entirety into one GFP frame. Therefore, with this adaptation mode, the GFP-F frame size is variable as it is directly related to the incoming client payload. In fact, with GFP-F, the entire client frame must be buffered in order to determine its length. GFP-F is usually used to support Layer 2 frames like Ethernet MAC that are tolerant to some latency. The ITU G.7041 defines the following frame-mapped user payloads supported through GFP-F:
  - Frame-Mapped Ethernet
  - Frame-Mapped PPP
  - Frame-Mapped Multiple Access Protocol over SDH (MAPOS)
  - Frame-Mapped IEEE 802.17 Resilient Packet Ring
  - Frame-Mapped Fibre Channel FC-BBW
- **Transparent-Mapped GFP (GFP-T):** mapping mechanism that facilitates the transport of 8B/10B block-coded client signals like Gigabit Ethernet (GbE), Fibre Channel, ESCON, FICON, and DVB-ASI. With GFP-T, individual characters of a client signal are decoded from the client signal and then mapped into fixed-size GFP frames (64B/65B coded superblocks). This approach avoids the buffering of an entire client frame before it can be mapped into a GFP frame, which reduces latency and in turn makes it ideally suited for SAN applications that require very low transmission latency.

# Glossary

## Generic Framing Procedure (GFP)

The figure *GFP-T vs GFP-F Features* below provides a functional comparison between GFP-F and GFP-T, while figure *GFP-T vs. GFP-F Frames* below provides a comparison of the GFP frames for both modes.

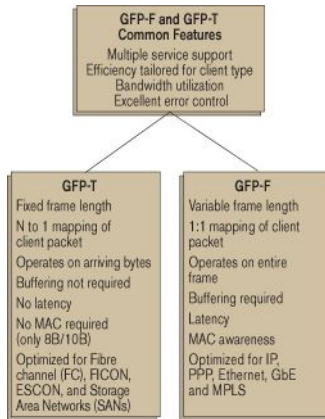

GFP-T vs GFP-F Features

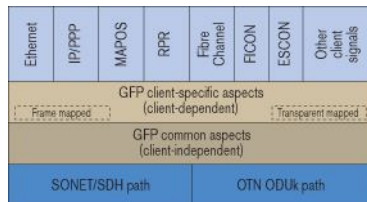

GFP-T vs. GFP-F Frames

Functionally, GFP consists of both common and client-specific aspects. Common GFP aspects apply to all GFP-adapted traffic (i.e., both GFP-F and GFP-T) and cover functions such as packet data unit (PDU) delineation, data link synchronization and scrambling, client PDU multiplexing, and client-independent performance monitoring. Client-specific aspects of GFP cover issues such as mapping of the client PDU into the GFP payload, client-specific performance monitoring, as well as operations, administration, and maintenance (OA&M). This is illustrated in figure *Client Signal Mapping over GFP* on page 837.

## GFP Frame Structure

As illustrated in figure below, Two basic GFP frame types have been defined: GFP client frames and GFP control frames. GFP client frames are categorized into two types: client data frames (CDFs) and client management frames (CMFs). CDFs are used to transport the client data, while CMFs are used to transport information associated with the management of the client signal or GFP connection.

As for GFP control frames, at this time, only one category has been defined by the standard so far; i.e., GFP idle frames.

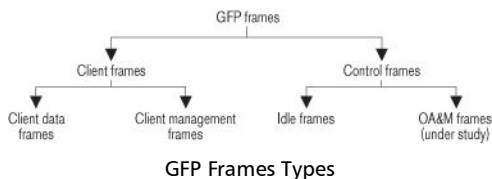

# Glossary

## Generic Framing Procedure (GFP)

The GFP generic frame structure is presented in figure below.

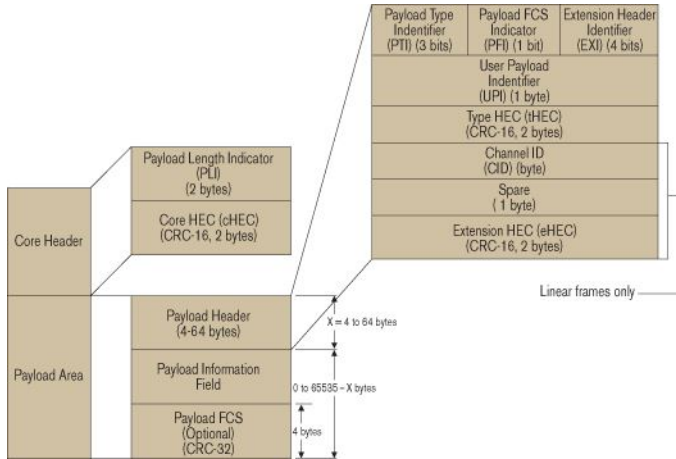

GFP Generic Frame Structure

Each GFP frame type consists of three main components: the core header, the payload header, and the payload information field.

The core and payload headers form the GFP header, whereas the payload information field represents the customer traffic carrying the data services. The payload header carries information about the payload type (i.e., Ethernet, Fibre Channel, etc.) that it is carrying, while the core header carries information about the size of the GFP frame itself.

Each header contains a header error correction (HEC) calculation, allowing for the correction of single errors; that is, any errors that occur in the core header or in the payload header can potentially be corrected by the HEC, through the network element. This creates a very robust mapping scheme, which ensures that GFP frames can get transported across a network without customer traffic loss.

➤ **Core Header**

The GFP core header consists of a two-octet length field, specifying the length of the GFP frame's payload area in octets, and a two-octet field containing a CRC-16 error-check code.

- **Payload Length Indicator (PLI):** The PLI is a two-byte field indicating the size in bytes of the GFP payload area. It indicates the beginning of the next GFP frame in the incoming bit-stream as an offset from the last byte in the current GFP core header. PLI values in the range of 0 to 3 are reserved for GFP internal use and are referred to as GFP control frames. All other frames are referred to as GFP client frames.
- **Core HEC (cHEC):** The cHEC is a two-byte field containing a cyclic redundancy check (CRC-16) sequence that protects the integrity of the core header. The cHEC sequence is computed over the core header bytes using standard CRC-16. The CRC-16 enables both single-bit error correction and multibit error detection.

➤ **Payload Header**

The payload header is a variable-length area, 4 to 64 octets long, intended to support data-link management procedures specific to the transported client signal. The payload header contains two mandatory fields, the Type field and Type Header Error Correction (tHEC) field. The payload header also supports an additional variable number of subfields referred to, as a group, as the extension header.

- **Payload Type Identifier (PTI):** A three-bit subfield that identifies the type of GFP client frame. The following table lists the currently defined user frames.

PTI	Description
000	Client Data Frame
100	Client Management Frame
Others	Reserved

## Glossary

### Generic Framing Procedure (GFP)

---

- **Payload FCS Indicator (PFI):** A one-bit subfield indicating the presence (1) or absence (0) of the payload FCS field. The following table lists the currently defined PFI values.

PFI	Description
0	FCS Absent
1	FCS Present

- **Extension Header Identifier (EXI):** A four-bit subfield identifying the type of GFP extension header. Three kinds of extension headers are currently defined:

EXI	Description	Function
0000	Null Extension Header	Indicates that no extension header is present.
0001	Linear Extension Header	A two-octet extension header that supports sharing of the GFP payload across multiple clients in a point-to-point configuration. The linear extension header consists of an eight-bit channel ID (CID) field, used to indicate one of 256 communication channels (i.e. clients) at a GFP termination point, and an eight-bit spare field reserved for future use.
0010	Ring Extension Header	The use of this field is under consideration. Similar to linear, the current proposal being considered is to allow the sharing of the GFP payload across multiple clients; however, this would only apply to ring configurations.
0011 to 1111	Reserved	

- **User Payload Identifier (UPI):** An eight-bit field identifying the type of payload conveyed in the GFP payload information field:

UPI	Client Data	Client Management
0000 0000 1111 1111	Reserved and not available	Reserved
0000 0001	Mapped Ethernet Frame	Client Signal Fail (Loss of Client Signal)

<b>UPI</b>	<b>Client Data</b>	<b>Client Management</b>
0000 0010	Mapped PPP Frame	Client Signal Fail (Loss of Character Synchronization)
0000 0011	Transparent Fibre Channel	Client Defect Clear Indication (DCI)
0000 0100	Transparent FICON	Client Forward Defect Indication (FDI)
0000 0101	Transparent ESCON	Client Reverse Defect Indication (RDI)
0000 0110	Transparent GbE	
0000 0111	Reserved for future use	
0000 1000	Frame-Mapped IEEE 802.17 Resilient Packet Ring	
0000 1011	Frame-Mapped Fibre Channel FC-BBW	
0000 1100	Asynchronous Transparent Fibre Channel	
0000 1101	Framed MPLS Unicast	
0000 1110	Framed MPLS Multicast	
0000 1111	Framed IS-IS	
0001 0000	Framed IPv4	
0001 0001	Framed IPv6	
0001 0010	Framed DVD-ASI	
0001 0011	Framed 64B/66B Ethernet	
0001 0100	Framed 64B/66B Ethernet Ordered Set	
0001 0101 through 1110 1111	Reserved for future standardization	
1111 0000 through 1111 1110	Reserved for proprietary use	
0000 0110 through 1101 1111		Reserved for future use
1110 0000 through 1111 1110		Reserved for proprietary use

# Glossary

## Generic Framing Procedure (GFP)

- **Type HEC (tHEC) Field:** A two-octet field that contains a CRC-16 sequence to protect the integrity of the type field. The tHEC sequence is computed over the core header bytes using standard CRC-16. As with the cHEC, CRC-16 enables both single-bit error correction and multibit error detection.
- **Channel Identifier (CID):** A one-byte field that is only available when the EXI field is configured to Linear. The CID byte is used to indicate one of 256 communication channels at a GFP termination point.
- **Spare:** A one-byte field that is only available when the EXI field is configured to Linear. This field is reserved for future use.
- **Extension HEC (eHEC):** A two-byte field that contains a CRC-16 check sequence that protects the integrity of the contents of the extension. CRC-16 enables both single-bit correction and multibit error detection.

The figure below explains how (in GFP-F) the transmitter encapsulates one entire frame of the client data.

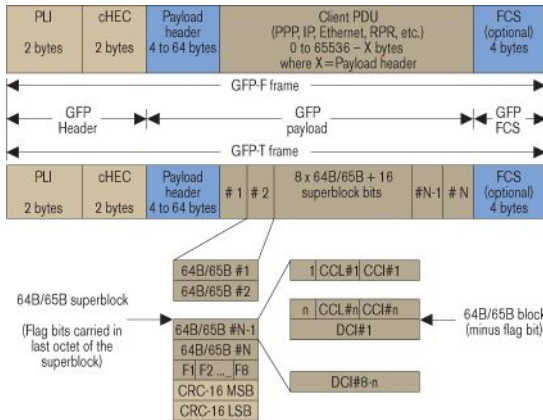

GFP-F vs. GFP-T Frame Structure



► **Payload Information Field**

The payload area (also referred to as payload information field) contains the framed client signal. This variable-length field may include from 0 to 65,535 – X octets, where X is the size of the payload header (including the extension header, if present) and the payload FCS field (if present).

Figure *GFP-T vs. GFP-F Frames* on page 840 shows the GFP-T and GFP-F frame structures. As shown, Both GFP-T and GFP-F frame types share a common core header, payload header, and payload FCS (optional), and they differ in the way in which the client is mapped into this payload area.

► **Payload FCS (pFCS)**

This is an optional four-octet-long frame-check sequence. It contains a CRC-32 check sequence that is designed to validate the entire content of the payload area. The FCS field presence is signalled by the PFI bit located in the Type field of the payload header. The FCS does not correct any errors; it just indicates the presence of error(s).

In GFP-F, the transmitter encapsulates one entire frame of the client data into one GFP frame. In this case, the basic frame structure of a GFP client frame is used, including the required payload header.

In GFP-T, however, rather than buffering an entire client-data frame, the individual characters of the client signal are demapped from the client block codes and then mapped into periodic fixed-length GFP frames. The transparent GFP client frame uses the same structure as the frame-mapped GFP, including the required payload header.

# Glossary

## Generic Framing Procedure (GFP)

### GFP Summary

GFP has been standardized to better optimize the transport of Ethernet and other data services over SONET, taking into account both the pros and cons of ATM and PPP/HDLC framing mechanisms. As described in this section, GFP represents a robust mapping mechanism that allows for the mapping of multiple client-data types into SONET/SDH payload (SPEs). This technology has been embraced by network equipment and service providers as it provides an efficient way of providing interoperable data-services transport over the existing SONET/SDH install base. The versatility provided by GFP allows SONET/SDH networks to offer transport services for a multiple of services, as shown in figure below.

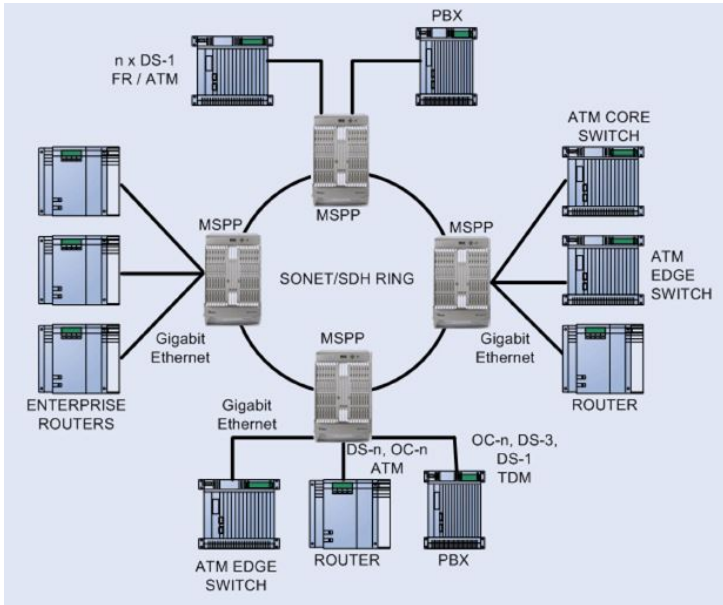

Multiservice SONET/SDH Network

## MPLS Labels

The MPLS labels are listed in the following table.

<b>Label</b>	<b>Description</b>
0	IPv4 explicit null
1	Router alert
2	IPv6 explicit null
3	Implicit null
14	OAM alert
4 to 13, and 15	Unassigned
16 to 1048575	Label ID

## OBSAI

### Overview

Traditional mobile installations are bulky (use thick coaxial cables) and require a lot of power to operate (there is a huge power loss in the coaxial cabling which often requires the use of Tower Mounted Amplifiers) as outlined in the following figure.

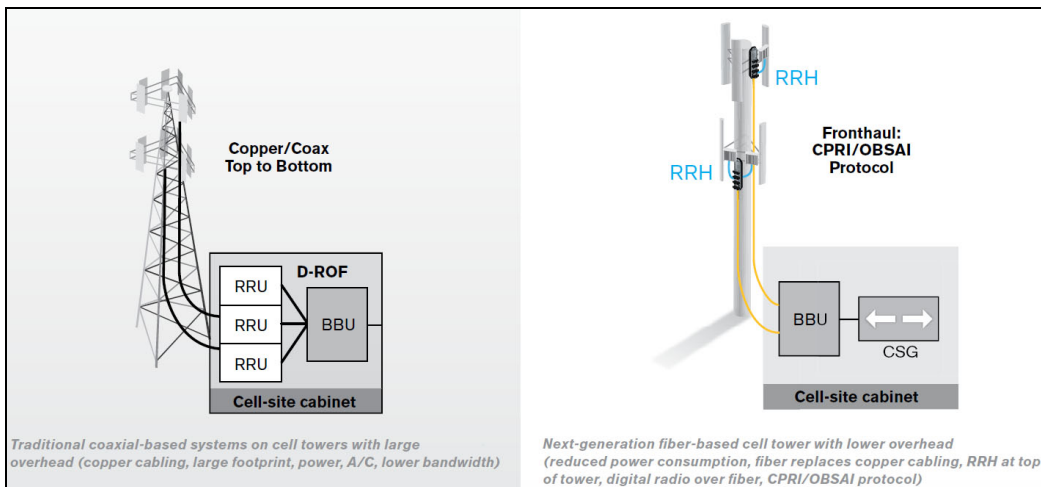

Pressures on the Mobile Network Operators (MNO) to reduce their capital, operational cost, and increase coverage are at the heart of a revolution in the mobile network. To address the situation, a concept of decomposition of the radio base station has been developed where the radio basic functions and its ability to transmit and receive radio modulated signals are separated. In such a distributed environment, a protocol is required to maintain synchronization and management capabilities as well as transporting the user traffic between the simplified Base Transceiver Station (BTS) and its Remote Radio Head (RRH).

This protocol called Open Base Station Architecture Initiative (OBSAI) separates a traditional radio base station configuration into two separate elements: Base Transceiver Station (BTS) and Remote Radio Head (RRH). The BTS processes the digital baseband radio information and performs the control of the RRH. The RRH converts the digital radio information into radio frequency signals transported over the air interface (antenna). The BTS and RRH are interconnected by a point-to-point link. This link carries the OBSAI protocol and is known in the industry as the fronthaul as opposed to the backhaul that is the WAN bringing the network traffic to the base station.

The OBSAI link can be extended over several kilometers as it uses fiber optics. In fact it can be deployed up to 40 km although most field installations at the moment of this writing are below 10 km.

The OBSAI BTS System Reference Document defines multiple Reference Points. The Reference Point 3 Specification mainly defines the physical to the application layers providing an opportunity for larger interoperability between vendors. However, field experience suggests that the interoperability is pretty much limited to the physical and data link layers.

## OBSAI RP3-01 System Architecture

OBSAI remotely locates the RRH from the BTS. This means that the RRH must be controlled, managed and synchronized from the BTS in addition to transporting the User information (Voice and user application data) and all that on the same digital link, the RP3-01. As such, an OBSAI interface is composed of 3 communication flows sent in the same optical fiber in the form of continuous messages as illustrated in the following diagram.

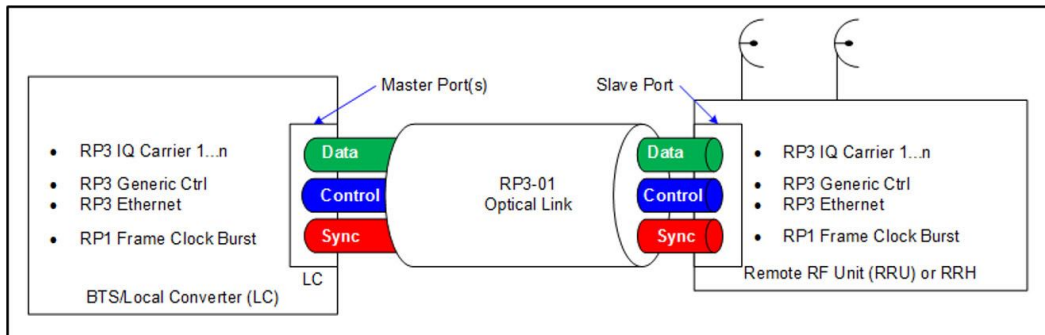

The OBSAI link parameter alignment setup is driven by two paired TX and RX state machines; one pair located on the BTS acts as a Master and the other located at the RRH acts as a Slave. The Master initiates the negotiation procedure necessary to achieve this alignment.

- **Data:** User Data Messages (IQ Data) which represents the voice and data information that is exchanged by End-User Equipment
- **Control:** Call Processing/OAM&P messages (Generic Ctrl and RP3 Ethernet messages)
- **Synchronization:** Frame synchronization messages

## OBSAI Protocol Stack

The OBSAI RP3 Protocol Stack revolves around the 4 layers: Physical Layer, Data Link Layer, Transport Layer and Application Layer as outlined in the following diagram.

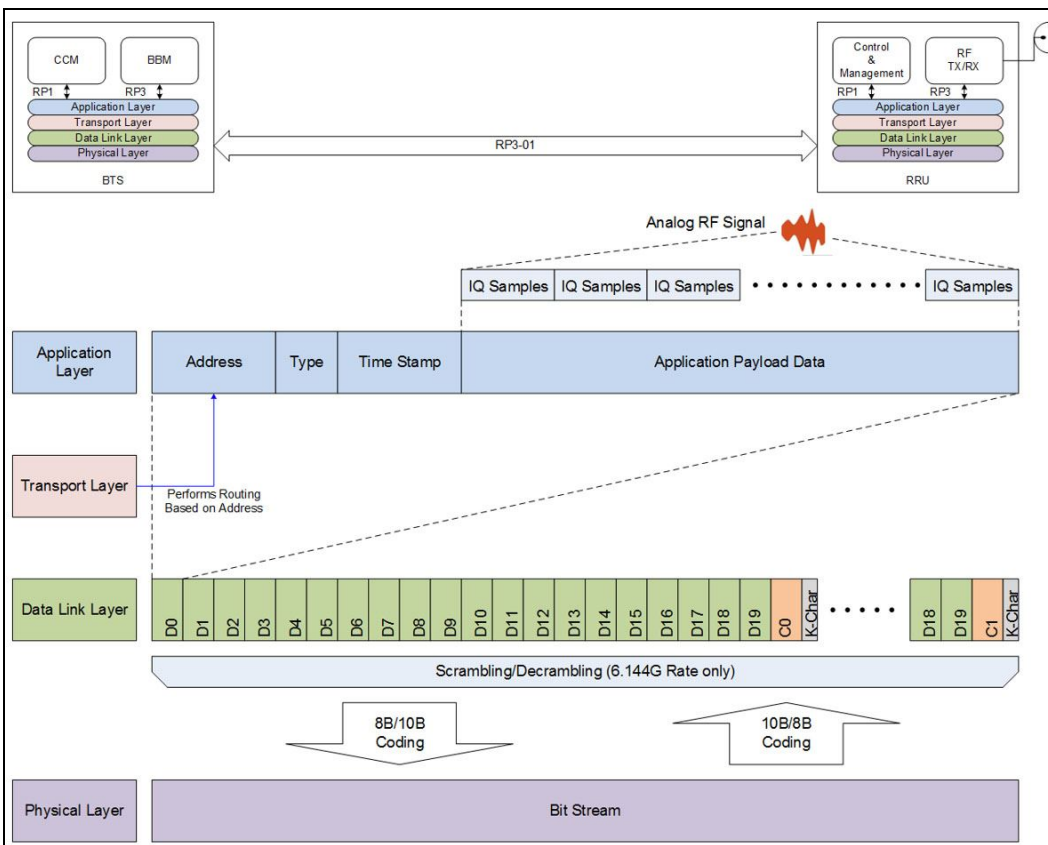

## Glossary

### OBSAI

---

- Application Layer: Provides message sampling and mapping based on payload type (ex: WCDMA/FDD, LTE, GSM/EDGE and 802.16 also known as Wi-Max).
- Transport Layer: End-to-End delivery message including routing based on RP3 Address defined in the messages.
- Data Link Layer:
  - Message framing and link synchronization.
  - Scrambling/Descrambling (6.144G only).
- Physical Layer:
  - 8B/10B Coding/Decoding (or 10B/8B Coding).
  - Create serial bit stream.
  - Transmit/Receive bit stream on the interface..

## Physical Interface

OBSAI offers 4 rates based on a multiple of 768 Mbit/s. All OBSAI rates use 8B/10B line coding. Scrambling is mandatory for the 6.1Gbit/s rate. When using OBSAI with Framed L2, the line rate and scrambling are normally negotiated following the operation of the TX and RX state machines at the BTS and RRH nodes.

Multiple (i)	Rate	Line Coding	Scrambling
1x	768 Mbit/s	8B/10B	None
2x	1.536 Gbit/s		
4x	3.072 Gbit/s		
8x	6.144 Gbit/s		Configurable (enabled by default)



## SONET/DSn/SDH/PDH

### SONET/DSn/SDH/PDH Nomenclature

The GUI will use the International or European nomenclature based on the SONET and SDH software options installed on the module.

Software option	Nomenclature
SONET only	International
SDH only	European
SONET and SDH	International

### Signal Rates

Rate	SONET/DSn	SDH/PDH	
		International	European
1.544 Mbit/s	DS1	-	1.5M
2.048 Mbit/s	-	E1	2M
8.448 Mbit/s	-	E2	8M
34.368 Mbit/s	-	E3	34M
44.736 Mbit/s	DS3	-	45M
51.84 Mbit/s	OC-1	STM-0	52M
139.264 Mbit/s	-	E4	140M
155.52 Mbit/s	OC-3	STM-1	STM-1
622.08 Mbit/s	OC-12	STM-4	STM-4
2.48832 Gbit/s	OC-48	STM-16	STM-16
9.95328 Gbit/s	OC-192	STM-64	STM-64
39.81312 Gbit/s	OC-768	STM-256	STM-256

## Glossary

*SONET/DSn/SDH/PDH*

---

### SONET/SDH High and Low Order Path Nomenclature

Path Type	SDH	SONET
High Order	AU-3	STS-1
	AU-4	STS-3c
	AU-4-4c	STS-12c
	AU-4-16c	STS-48c
	AU-4-64c	STS-192c
	AU-4-256c	STS-768c
Low Order	TUG-3	-
	TUG-2	VTG
	TU-11	VT1.5
	TU-12	VT2
	TU-3	-

## SONET/SDH Alarms and Errors Nomenclature

Layer	SONET	SDH
Physical	BPV/CV	CV
Section / Regenerator Section	LOF-S	RS-LOF
	SEF	RS-OOF
	TIM-S	RS-TIM
	FAS-S	RS-FAS
	B1	B1
Line / Multiplex Section	AIS-L	MS-AIS
	RDI-L	MS-RDI
	B2	B2
	REI-L	MS-REI
High Order Path	AIS-P	AU-AIS
	LOP-P	AU-LOP
	H4-LOM	H4-LOM
	PDI-P	-
	RDI-P	HP-RDI
	ERDI-PCD	ERDI-CD
	ERDI-PPD	ERDI-PD
	ERDI-PSD	ERDI-SD
	PLM-P	HP-PLM
	UNEQ-P	HP-UNEQ
	TIM-P	HP-TIM
	B3	B3
	REI-P	HP-REI

## Glossary

*SONET/DSn/SDH/PDH*

---

Layer	SONET	SDH
Low Order Path	AIS-V	TU-AIS
	LOP-V	TU-LOP
	RDI-V	LP-RDI
	ERDI-VCD	ERDI-CD
	ERDI-VPD	ERDI-PD
	ERDI-VSD	ERDI-SD
	RFI-V	LP-RFI
	UNEQ-V	LP-UNEQ
	TIM-V	LP-TIM
	PLM-V	LP-PLM
	BIP-2	BIP-2
	REI-V	LP-REI

## SONET Numbering Convention

The module supports the Timeslot (default) and hierarchical two-level numbering conventions as per GR-253.

Hierarchical Notation:

The module supports numbering SONET high order path STS-1s and STS-3c using the two-level “STS-3#,STS-1#” convention in an OC-N. For example: STS-1 [2,3].

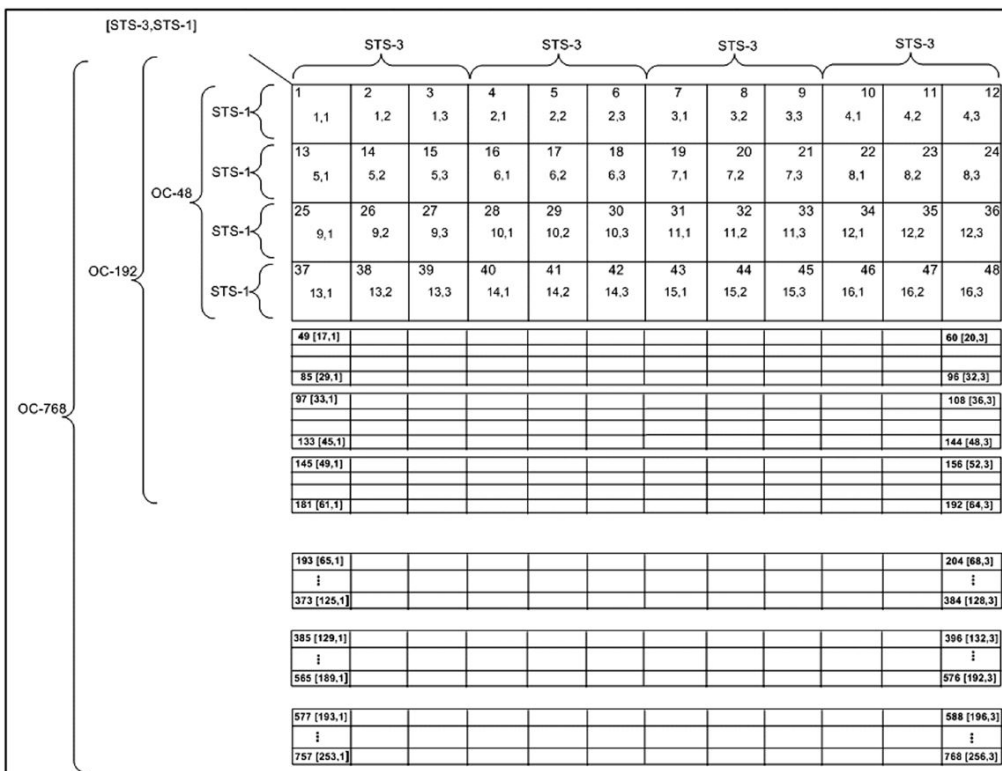

## Glossary

SONET/DSn/SDH/PDH

The module supports numbering SONET low order path using the two-level “VTGroup#,VT#” convention for numbering VTs within an STS-1. For example: VT1.5 [1,3], VT2 [3,2], VT6 [6,1].

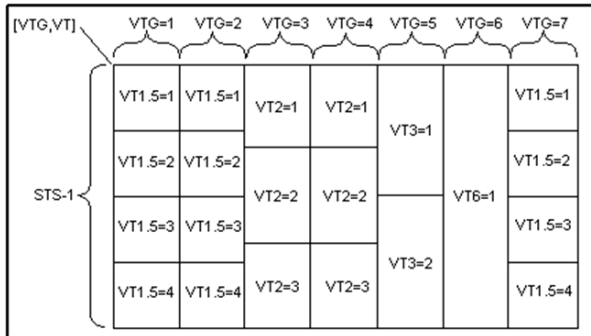

The module supports numbering SONET high order path STS-nc within an OC-N using the two-level “STS-3#,STS-1#”. For example: STS-12c [5,1].

## SDH Numbering Convention

As per ITU G.707, the high order paths are defined using a 2 to 5 level convention E,D,C,B,A depending on the rate of the STM-n used.

- E: the AUG-64 are numbered 1 to 4
- D: the AUG-16 are numbered 1 to 4
- C: the AUG-4 are numbered 1 to 4
- B: the AUG-1 are numbered 1 to 4
- A: the AU-3 are numbered 1 to 3

Naming is as follows for each of the following rates:

- [E,D,C,B,A] for STM-256
- [D,C,B,A] for STM-64
- [C,B,A] for STM-16
- [B,A] for STM-4
- [0] for AU-4 in STM-1
- [A] for AU-3 in STM-1
- [A] for the AU-3 in STM-0e, A=0.

		B=1			B=2			B=3			B=4					
E=1	D=1	C=1	1	2	3	4	5	6	7	8	9	10	11	12		
			A=1	A=2	A=3	A=1	A=2	A=3	A=1	A=2	A=3	A=1	A=2	A=3		
		C=2	13	14	15	16	17	18	19	20	21	22	23	24		
			A=1	A=2	A=3	A=1	A=2	A=3	A=1	A=2	A=3	A=1	A=2	A=3		
		C=3	25	26	27	28	29	30	31	32	33	34	35	36		
			A=1	A=2	A=3	A=1	A=2	A=3	A=1	A=2	A=3	A=1	A=2	A=3		
		C=4	37	38	39	40	41	42	43	44	45	46	47	48		
			A=1	A=2	A=3	A=1	A=2	A=3	A=1	A=2	A=3	A=1	A=2	A=3		
	D=2		[1,2,1,1]												[1,2,1,4,3]	
			[1,2,4,1,1]												[1,2,4,4,3]	
		D=3		[1,3,1,1,1]												[1,3,1,4,3]
				[1,3,4,1,1]												[1,3,4,4,3]
D=4		[1,4,1,1,1]												[1,4,1,4,3]		
		[1,4,4,1,1]												[1,4,4,4,3]		
E=2		[2,1,1,1,1]												[2,1,1,4,3]		
		⋮												⋮		
		[2,4,4,1,1]												[2,4,4,4,3]		
E=3		[3,1,1,1,1]												[3,1,1,4,3]		
		⋮												⋮		
		[3,4,4,1,1]												[3,4,4,4,3]		
E=4		[4,1,1,1,1]												[4,1,1,4,3]		
		⋮												⋮		
		[4,4,4,1,1]												[4,4,4,4,3]		

## Glossary

*SONET/DSn/SDH/PDH*

---

The low order paths are defined using a 2 or 3 level convention K,L,M depending on the rate of the AU-4 or AU-3 used to multiplex the low order signals.

- K: the TUG-3 are numbered 1 to 3
- L: the TUG-2 are numbered within the TUG-3 0 or from 1 to 7
- M: the TU-2, TU-12, TU-11 are numbered within the TUG-2 1, 1 to 3, 1 to 4 respectively

Examples for AU-4 (3 level convention)

TU-3: [K,0,0]

TU-2: [K,L,0]

TU-12:[K,L,M] where M = 1 to 3

TU-11:[K,L,M] where M = 1 to 4

Example for AU-3 (2 level convention)

TU-2: [L,0]

TU-12: [L,M] M is numbered 1 to 3

TU-11: [L,M] M is numbered 1 to 4



The GUI Grid indicates the TUG-2 [x] and TUG-3 [x] values.

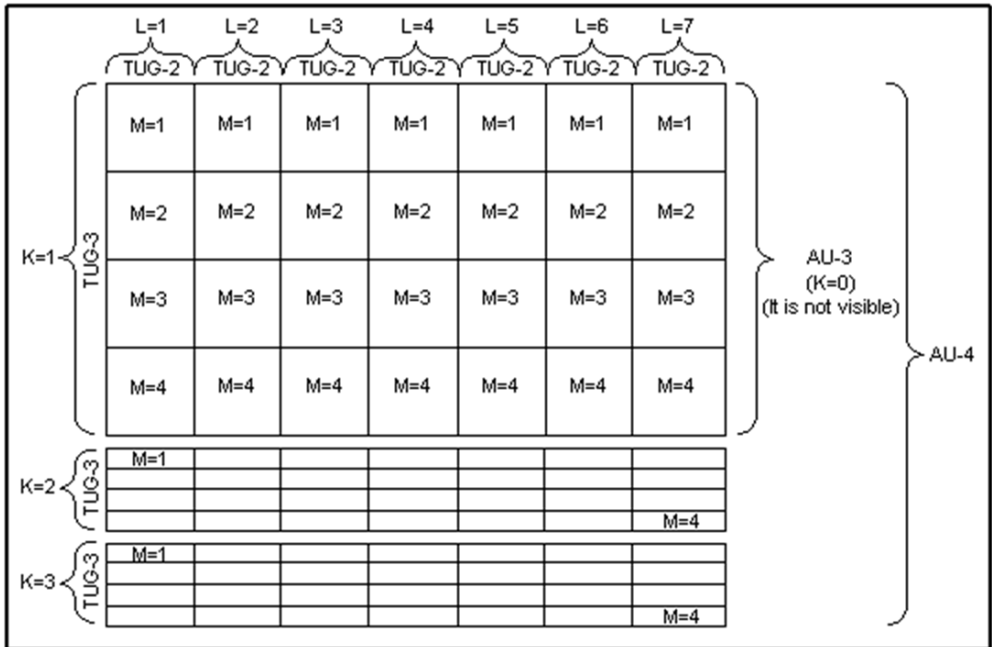

### **DSn/PDH Numbering Convention**

The DS1 numbering in DS3 shall be numbered with respect to the DS2 muxing [DS2,DS1]. For example a DS3 has 7 DS2 and a DS2 has 4 DS1, so an example would be for a DS1 number [3,2]. The DS3 shall have a single number to represent its position. That is [1] all the time whether it is used in an STS-1 or it is the DS3 electrical interface.

The PDH do not have special grouping of the E1, E2, E3 or E4. This means that the PDH has a single number. For example E1 number 2 shall be number [2].

The E1 in DS3 via G.747 numbering uses the naming [DS2,E1]. However in the grid the label shall adapt itself to DS2 [x] or 6.3M [x] (where x = 1 to 7) with respect to the interface standard used: European or International.

## SyncE

Synchronous Ethernet or SyncE enables a traceable network timing reference frequency to be distributed node-by-node across a chain of Ethernet devices (SyncE compliant devices only). The network timing reference is typically hierarchically traceable to a Primary Reference Source/Clock (PRS/PRC) in a unidirectional flow. Any node in the chain not compliant to SyncE automatically terminates the synchronization propagation but this does not impact the flow of traffic.

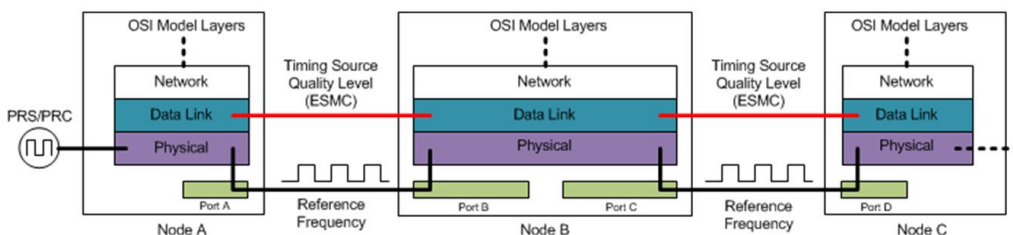

The Physical Layer carries the clock frequency and the Data Link layer carries the Quality Level (QL) associated to the transported frequency via Synchronization Status Messaging (SSM) embedded in the Ethernet Synchronization Message Channel (ESMC). The QL is transported via Information and Event PDUs typically transmitted at a rate of 1 frame per second but this rate can vary between 1 to 10 messages per second to respect the slow protocol rules. The Information PDU is used as heart-beat for the channel while one Event PDU is transmitted asynchronously to the Information PDU upon change of the QL value. Following this change, the Information PDU is also adjusted to match the new QL.

# Glossary

## SyncE

In order for an Ethernet interface to be considered Synchronous Ethernet compliant it needs to be upgraded as shown in the following diagram. In addition to supporting the ESMC channel, this upgrade consists in allowing the recovered clock from the CDR to be propagated to a function called the Ethernet Equipment Clock (EEC).

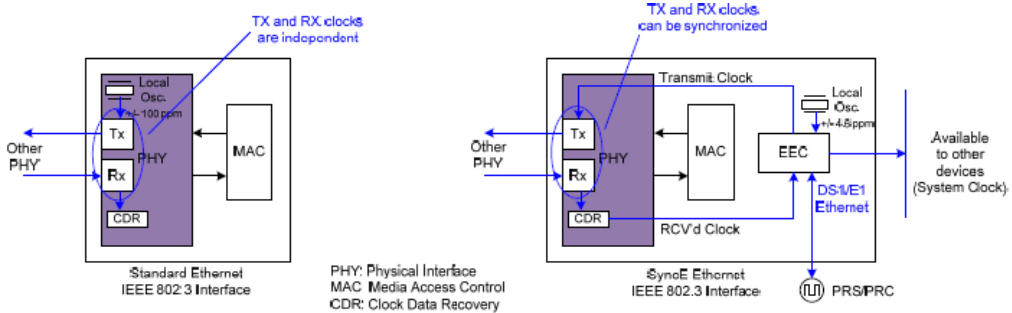

The EEC is present in a network element (NE) to determine which port should be used to distribute the frequency to other port(s) in the NE as well as what QL value to transmit over the ESMC to other network element in the network synchronization chain. The actual selection decision is based on the QL value received from the various port(s) in the NE. If none are valid the EEC is equipped with a better oscillator than a standard Ethernet interface to provide synchronization (Holdover mode). Typically the highest QL value is selected among the nominated sources within the network element.

## Unicast/Multicast Addresses for Ethernet OAM

Unicast or multicast address can be used for most of S-OAM functions.

- Unicast addresses a unique destination address of the MEP.
- Multicast Class 1 addresses all MEPs in the MEG. The address value is 01-80-C2-00-00-3x, where x represents the MEG/MD Level.
- Multicast Class 2 addresses all MIPs and MEPs in the MEG. The address value is 01-80-C2-00-00-3y, where y represents the MEG/MD Level + 8.

The following table specifies which address type is used for each frame type.

Frame Type	Unicast	Multicast		Frame Type	Unicast	Multicast	
		Class 1	Class 2			Class 1	Class 2
CCM	X	X		LMM	X	X	
LBM	X	X		LMR	X		
LBR	X			SLM	X	X	
LTM			X	SLR	X		
LTR	X			AIS	X	X	
TST	X	X		CSF	X	X	
DMM	X	X		LCK	X	X	
DMR	X						



# C Alarms/Errors

**Note:** For a complete list of alarms/errors per layer and their TX/RX availability see TX/RX Alarms/Errors per Layer on page 874.

## Quick Access to Alarms/Errors per Layer

*BER | Clock | Clock | CPRI | DCO - TX | DCO - RX | DS1 | DS3 | E1 | E2/E3/E4 | Electrical Interface (DCO BERT) | Ethernet | Ethernet - PCS | Ethernet - PCS Lanes | FEC (FlexO) | FEC (OTN) | Fibre Channel (including RS-FEC) | FlexE Group | FOICx.y | GFP | GMP (ODTU4.x - GMP) | Interface | Interface (DCO BERT) | IP/UDP | IP/UDP/TCP | Media RX FEC | OBSAI | ODUcN | ODUx and ODUk (ODUflex) | ODUx-TCM | OPUCn | OPUx and OPUk (OPUflex) | OTL | OTUC Frame | OTUCn | OTUx | Path OAM | PHY | PHYs/Instances | PTP | QoS Metrics | Reference Signal | RS-FEC (CPRI) | RS-FEC (Ethernet) | S-OAM / MPLS-TP OAM | Section/Line / RS/MS | STS-x/AU-x | SyncE | TCM (SONET/SDH) | Transcoding | VT/TU | WIS*

## Alarms/Errors Layer per Test Application

The following table lists the alarm/error layers availability per test application and interface/rate.

### ► Transport

Test Application	Interface	Alarms/Errors Layer
DCO BERT	All	<i>BER   DCO - TX   DCO - RX   Electrical Interface (DCO BERT)   Ethernet   Ethernet - PCS   Interface (DCO BERT)   IP/UDP   Media RX FEC</i>
FlexO BERT	100G	<i>BER   FEC (FlexO)   FEC Lanes   FlexO Group   OTUC Frame   FOICx.y   Interface   ODUcN   ODUx and ODUk (ODUflex)   OPUCn   OPUx and OPUk (OPUflex)   OTUC Frame   OTUCn   OTUx</i>
OTN BERT	All	<i>BER   Clock   Ethernet   FEC (OTN)   GFP   GMP (ODTU4.x - GMP)   Interface   ODUx and ODUk (ODUflex)   ODUx-TCM   OPUx and OPUk (OPUflex)   OTUx</i>
	OTU3	<i>Transcoding   OTL</i>
	OTU4	<i>OTL</i>

## Alarms/Errors

Test Application	Interface	Alarms/Errors Layer
Multi-Channel OTN	OTU4	<i>BER   Clock   Interface   ODUx and ODUk (ODUflex)   OPUx and OPUk (OPUflex)   OTL   OTUx</i>
SONET/SDH BERT	All	<i>BER   Clock   Interface   Section/Line / RS/MS   STS-x/AU-x   TCM (SONET/SDH)   VT/TU</i>
OTN-SONET/SDH BERT	All	<i>BER   Clock   FEC (OTN)   GMP (ODTU4.x - GMP)   Interface   ODUx and ODUk (ODUflex)   ODUx-TCM   OPUx and OPUk (OPUflex)   OTUx   Section/Line / RS/MS   STS-x/AU-x</i>
	OTU3, OTU4	<i>OTL</i>
DSn/PDH BERT	All	<i>BER   DS1   DS3   E1   E2/E3/E4   Interface</i>
SONET/SDH - DSn/PDH BERT	All	<i>BER   DS1   DS3   E1   E2/E3/E4   Interface   Section/Line / RS/MS   STS-x/AU-x   TCM (SONET/SDH)   VT/TU</i>
NI/CSU Emulation	DS1	<i>Interface   DS1   DS3</i>

### ➤ Ethernet

Test Application	Interface	Alarms/Errors Layer
Carrier Ethernet OAM	All	<i>Clock   Ethernet   Interface   S-OAM / MPLS-TP OAM</i>
	10GE WAN	<i>WIS</i>
EtherBERT	All	<i>BER   Clock   Ethernet   Interface   IP/UDP/TCP</i>
	10GE WAN	<i>WIS</i>
	25GE	<i>RS-FEC</i>
	50GE, 100GE	<i>Ethernet - PCS   Ethernet - PCS Lanes   FEC Lanes   RS-FEC</i>
	200GE, 400GE	<i>Ethernet - PCS   Ethernet - PCS Lanes</i>



Test Application	Interface	Alarms/Errors Layer
EtherSAM (Y.1564)	All	<i>Clock   Ethernet   Interface   IP/UDP/TCP</i>
	10GE WAN	<i>WIS</i>
	25GE	<i>RS-FEC</i>
	100GE	<i>Ethernet - PCS   Ethernet - PCS Lanes   FEC Lanes   RS-FEC</i>
	400GE	<i>Ethernet - PCS   Ethernet - PCS Lanes</i>
FlexE BERT	100GE	<i>BER   Ethernet   Ethernet - PCS   Ethernet - PCS Lanes   FEC Lanes   FlexE Group   Interface   Path OAM   PHY   PHYs/Instances   RS-FEC</i>
RFC 2544	All	<i>Clock   Ethernet   Interface   IP/UDP/TCP</i>
	10GE WAN	<i>WIS</i>
	25GE	<i>RS-FEC</i>
	100GE	<i>Ethernet - PCS   Ethernet - PCS Lanes   FEC Lanes   RS-FEC</i>
	400GE	<i>Ethernet - PCS   Ethernet - PCS Lanes</i>
RFC 6349	All	<i>Clock   Ethernet   Interface   IP/UDP/TCP</i>
	10GE WAN	<i>WIS</i>
	100GE	<i>Ethernet - PCS   Ethernet - PCS Lanes   FEC Lanes   RS-FEC</i>
Smart Loopback	All	<i>Clock   Ethernet   Interface   IP/UDP/TCP</i>
	10GE WAN	<i>WIS</i>
	25GE	<i>RS-FEC</i>
	100GE	<i>Ethernet - PCS   Ethernet - PCS Lanes   FEC Lanes   RS-FEC</i>
	400GE	<i>Ethernet - PCS   Ethernet - PCS Lanes</i>
TCP Throughput	All	<i>Clock   Ethernet   Interface   IP/UDP/TCP</i>
Through Mode	All	<i>Clock   Ethernet   Interface   IP/UDP/TCP</i>
	10GE WAN	<i>WIS</i>
	100GE	<i>Ethernet - PCS   Ethernet - PCS Lanes   FEC Lanes   RS-FEC</i>

## Alarms/Errors

Test Application	Interface	Alarms/Errors Layer
Traffic Gen & Mon	All	<i>Clock   Ethernet   Interface   IP/UDP/TCP   QoS Metrics</i>
	10GE WAN	<i>WIS</i>
	25GE	<i>RS-FEC</i>
	100GE	<i>Ethernet - PCS   Ethernet - PCS Lanes   FEC Lanes   RS-FEC</i>
	400GE	<i>Ethernet - PCS   Ethernet - PCS Lanes</i>

### ➤ Sync

Test Application	Interface	Alarms/Errors Layer
1588 PTP	All	<i>Ethernet   Interface   IP/UDP/TCP   PTP</i>
SyncE	All	<i>Ethernet   Interface   IP/UDP/TCP   SyncE</i>
Time Error / Wander	All	<i>Ethernet   Interface   PTP   Reference Signal   SyncE</i>
	100GE	<i>Ethernet - PCS   Ethernet - PCS Lanes   FEC Lanes   RS-FEC</i>

### ➤ Fibre Channel

Test Application	Interface	Alarms/Errors Layer
FC BERT	All	<i>BER   Clock   Fibre Channel (including RS-FEC)   Interface</i>

➤ **Wireless**

<b>Test Application</b>	<b>Interface</b>	<b>Alarms/Errors Layer</b>
CPRI/OBSAI BERT	All	<i>BER   Clock   Interface</i>
	CPRI rates	<i>CPRI</i>
	CPRI 24.3G	<i>RS-FEC (CPRI)</i>
	OBSAI rates	<i>OBSAI</i>
eCPRI BERT	10G	<i>BER   Clock   Ethernet   Interface   QoS Metrics</i>
	25G	<i>RS-FEC</i>

### TX/RX Alarms/Errors per Layer

The following table lists the Injection (TX) and Reception (RX) alarms/errors availability per layer.

Layer	Alarms/Errors		TX/RX	Page
BER	Alarms	No Traffic	RX	889
		Pattern Loss	TX/RX	
		Client Frequency	RX	
	Errors	Bit Error	TX/RX	889
		Frame Loss	RX	
		Mismatch '0'	RX	
		Mismatch '1'	RX	
		Out-of-Seq.	RX	
	Pattern Error	TX/RX		
Clock	Alarms	LOC	TX <sup>a</sup>	890
		LOPPS-L and LOPPS-R	RX	
CPRI	Alarms	Link Down	RX	890
		LOF	TX/RX	
		RAI	TX/RX	
		R-LOF	TX/RX	
		R-LOS	TX/RX	
		SDI	TX/RX	
	Errors	FAS	TX/RX	891
DCO - TX	Alarms	Tx LOA	TX <sup>a</sup>	891
		Tx OOA	TX <sup>a</sup>	
		Tx CMU LOL	TX <sup>a</sup>	
		Tx RefClk LOL	TX <sup>a</sup>	
		Tx Deskew LOL	TX <sup>a</sup>	
		Tx FIFO	TX <sup>a</sup>	

Layer	Alarms/Errors		TX/RX	Page
DCO - RX	Alarms	Rx LOF	RX	891
		Rx LOM	RX	
		Rx Demod LOL	RX	
		Rx CDC LOL	RX	
		Rx LOA	RX	
		Rx OOA	RX	
		Rx Deskew LOL	RX	
		Rx FIFO	RX	
DS1	Alarms	AIS	TX/RX	892
		OOF	TX/RX	
		RAI	TX/RX	
	Errors	CRC-6	TX/RX	892
Framing Bit		TX/RX		
DS3	Alarms	AIS	TX/RX	893
		Idle	TX/RX	
		OOF	TX/RX	
		RDI	TX/RX	
	Errors	CP-Bit	TX/RX	893
		F-Bit	TX/RX	
		FEBE	TX/RX	
		P-Bit	TX/RX	
E1	Alarms	AIS	TX/RX	894
		LOF	TX/RX	
		LOMF	TX/RX	
		RAI	TX/RX	
		RAI MF	TX/RX	
		TS16 AIS	TX/RX	
	Errors	CRC-4	RX	895
		E-Bit	RX	
		FAS	TX/RX	
E2/E3/E4	Alarms	AIS	TX/RX	895
		AIS	TX/RX	
		RAI	TX/RX	
	Errors	FAS	TX/RX	895

## Alarms/Errors

Layer	Alarms/Errors		TX/RX	Page
Electrical Interface	Alarms	Frequency	RX	911
		LOC Lane	RX	
Ethernet	Alarms	Hi-BER	RX	896
		Client Frequency	RX	
		Link Down	TX/RX	
		Local Fault	TX	
		Local Fault Det	RX	
		Local Fault Rcd	RX	
		No Traffic	RX	
		Remote Fault	TX/RX	
	Errors	Alignment	RX	897
		66B Block	TX/RX	
		Block	TX/RX	
		Collision	RX	
		Exc. Coll.	RX	
		False Carrier	RX	
		FCS	TX/RX	
		Idle	RX	
		Jabber	RX	
		Late Coll.	RX	
		Oversize	RX	
		Runt	RX	
Symbol	TX/RX			
Undersize	RX			
Ethernet - PCS	Alarms	Inv. Mapping	RX	899
		LOA	RX	
		L Deg SER Det	RX	
		L Deg SER Rcd	TX/RX	
		R Deg SER	RX	
	Errors	66B Block	TX/RX	900
		FEC-COR-CW	TX/RX	
		FEC-UNCOR-CW	TX/RX	

Layer	Alarms/Errors		TX/RX	Page
Ethernet - PCS Lanes	<b>Alarms</b>	Exc. Skew	RX	900
		LOAML	RX	
		LOBL	RX	
	<b>Errors</b>	Block	TX/RX	901
		FEC-SYMB	TX	
		Inv. Marker	TX/RX	
		PCS BIP-8	TX/RX	
		Pre-FEC-Bit	RX	
	Pre-FEC-SYMB	RX		
FEC (FlexO)	<b>Errors</b>	FEC-COR-CW	TX/RX	902
		FEC-SYMB	TX	
		FEC-UNCOR-CW	TX/RX	
		Pre-FEC-SYMB	RX	
FEC (OTN)	<b>Errors</b>	FEC-CORR-BIT	TX/RX	902
		FEC-CORR-CW	TX/RX	
		FEC-CORR-SYM	TX/RX	
		FEC-STRESS	TX/RX	
		FEC-UNCORR-CW	TX/RX	
FEC Lanes (see RS-FEC (Ethernet))	<b>Alarms</b>	FEC-LOAML	RX	935
		FEC Exc. Skew (50GE)	RX	
	<b>Errors</b>	Pre-FEC-SYMB	RX	936
		<b>FEC Inv. Marker (50GE)</b>	TX/RX	
		<b>Pre-FEC-Bit (50GE)</b>	RX	

## Alarms/Errors

Layer	Alarms/Errors		TX/RX	Page
Fibre Channel (including RS-FEC)	<b>Alarms</b>	Link Down	RX	903
		Local Fault Detected	RX	
		Local Fault Received	RX	
		LOCWS	RX	
		Remote Fault	RX	
	<b>Errors</b>	Block	RX	903
		66B Block	RX	
		FCS	TX/RX	
		FEC-CORR-CW	TX/RX	
		FEC-SYMB	TX	
		FEC-UNCOR-CW	TX/RX	
		Oversize	RX	
		Pre-FEC-SYMB	RX	
		Symbol	RX	
Undersize	RX			
FlexE Group	<b>Alarms</b>	Calendar Mismatch	RX	904
		FlexE Group Down	RX	
		Illegal Client	RX	
		Inconsistent Calendar	RX	
FlexO Group	<b>Alarms</b>	Excessive Instance SKew	RX	906
		GIDM	TX/RX	
		Group Down	RX	
		IIDM	TX/RX	
		LOM	TX/RX	
		MAPM	TX/RX	
		OOM	TX/RX	
		RPF	TX/RX	
	<b>Errors</b>	MFAS	TX/RX	905
		OH CRC	TX/RX	
FOICx.y	<b>Alarms</b>	Exc. Skew	RX	906
		LOA	RX	
		LOAML	RX	
	<b>Errors</b>	Inv. Marker	TX/RX	907



Layer	Alarms/Errors		TX/RX	Page
GFP	Alarms	GFP-DCI	TX/RX	907
		GFP-EXM	RX	
		GFP-FDI	TX/RX	
		GFP-LFD	TX/RX	
		GFP-LOCCS	TX/RX	
		GFP-LOCS	TX/RX	
		GFP-RDI	TX/RX	
		GFP-Reserved CMF	RX	
		GFP-UPM	RX	
		GFP-UserDefined CMF	TX/RX	
	Errors	GFP-10B_ER	TX/RX	909
		GFP-cHEC-CORR	TX/RX	
		GFP-cHEC-UNCORR	TX/RX	
		GFP-eHEC-CORR	TX/RX	
		GFP-eHEC-UNCORR	TX/RX	
		GFP-pFCS	TX/RX	
		GFP-SB-CORR	RX	
		GFP-SB-CORR (Post)	TX	
		GFP-SB-CORR (Pre)	TX	
		GFP-SB-UNCORR	TX/RX	
GFP-tHEC-CORR	TX/RX			
GFP-tHEC-UNCORR	TX/RX			
GMP (ODTU4.x - GMP)	Alarms	OOS	RX	911
	Errors	Cm-CRC-8	RX	911
		CnD-CRC-5	RX	
		Cm-CRC-6	RX	
		CnD-CRC-9	RX	

## Alarms/Errors

Layer	Alarms/Errors		TX/RX	Page
Interface	<b>Alarms</b>	Frequency	RX	911
		LOC Lane	RX	
		LOS	TX/RX	
	<b>Errors</b>	66B Block	TX/RX	913
		BPV	TX/RX	
		CV	TX/RX	
		EXZ	TX/RX	
		K30.7	TX/RX	
	Sync Header	TX/RX		
Interface (DCO)	<b>Alarms</b>	Local Degrade	TX/RX	914
		LOS	TX/RX	
		Remote Degrade	TX/RX	
		Remote PHY Fault	RX	
IP/UDP	<b>Errors</b>	IP Chksum	RX	915
		UDP Chksum	RX	
IP/UDP/TCP	<b>Errors</b>	IP Chksum	RX	915
		TCP Chksum	RX	
		UDP Chksum	RX	
Media RX FEC (DCO)	<b>Alarms</b>	FDD	RX	915
		FED	RX	
	<b>Errors</b>	FEC-COR-BITS	RX	916
		FEC-UNCOR-FR	RX	
MPLS-TP OAM (see S-OAM / MPLS-TP OAM)	<b>Alarms</b>	AIS	TX/RX	937
		C-DCI	TX	
		C-FDI	TX/RX	
		C-LOS	TX/RX	
		C-RDI	TX/RX	
		LCK	TX/RX	
		Loss Continuity	RX	
		Mismerge	RX	
		RDI	TX/RX	
		Unexp MEG/MD Lvl	RX	
		Unexp MEP	RX	
		Unexp Period	RX	

Layer	Alarms/Errors		TX/RX	Page
OBSAI	Alarms	Link Down	RX	916
		LOF	TX/RX	
		RP3 Address Mismatch	RX	
	Errors	CRC	RX	916
		FAS	TX/RX	
ODUCn	Alarms	AIS	TX/RX	917
		BDI	TX/RX	
		LCK	TX/RX	
		TIM	RX	
	Errors	BEI	TX/RX	917
		BIP-8	TX/RX	
ODUk (ODUflex) (see ODUx and ODUk (ODUflex))	Alarms	AIS	TX/RX	919
		BDI	TX/RX	
		LCK	TX/RX	
		LOFLOM	TX/RX	
		OCI	TX/RX	
		TIM	RX	
	Errors	BEI	TX/RX	920
		BIP-8	TX/RX	
ODUx (see ODUx and ODUk (ODUflex))	Alarms	AIS	TX/RX	919
		BDI	TX/RX	
		BSD	TX/RX	
		BSF	TX/RX	
		FSD	TX/RX	
		FSF	TX/RX	
		LCK	TX/RX	
		LOFLOM	TX/RX	
		OCI	TX/RX	
		TIM	RX	
		Errors	BEI	
	BIP-8		TX/RX	

## Alarms/Errors

Layer	Alarms/Errors		TX/RX	Page
ODUx-TCM	<b>Alarms</b>	BDI	TX/RX	921
		BIAE	TX/RX	
		IAE	TX/RX	
		LTC	TX/RX	
		TIM	RX	
	<b>Errors</b>	BEI	TX/RX	922
	BIP-8	TX/RX		
OPUCn	<b>Alarms</b>	LOOMFI	TX/RX	922
		MSIM	TX/RX	
		OOMFI	TX/RX	
		PLM	RX	
	<b>Errors</b>	OMFI	TX/RX	923
OPUk (OPUflex) (see OPUx and OPUk (OPUflex))	<b>Alarms</b>	AIS	TX/RX	923
		CSF	TX/RX	
		PLM	RX	
<b>Errors</b>	OMFI	TX/RX	924	
OPUx (see OPUx and OPUk (OPUflex))	<b>Alarms</b>	AIS	TX/RX	923
		CSF	TX/RX	
		LOOMFI	TX/RX	
		MSIM	TX/RX	
		OOMFI	TX/RX	
	PLM	RX		
<b>Errors</b>	OMFI	TX/RX	923	
OTL	<b>Alarms</b>	Exc. Skew	RX	924
		LOF	TX/RX	
		LOL	TX/RX	
		LOR	TX/RX	
		OOF	TX/RX	
		OOR	TX/RX	
	<b>Errors</b>	FAS	TX/RX	925
		Inv. Marker	TX/RX	

Layer	Alarms/Errors		TX/RX	Page
OTUx	Alarms	AIS	TX/RX	927
		BDI	TX/RX	
		BIAE	TX/RX	
		IAE	TX/RX	
		LOF	TX/RX	
		LOM	TX/RX	
		OOF	TX/RX	
		OOM	TX/RX	
		TIM	RX	
	Errors	BEI	TX/RX	929
		BIP-8	TX/RX	
		FAS	TX/RX	
		FEC-CORR-BIT	TX/RX	
		FEC-CORR-CW	TX/RX	
		FEC-CORR-SYM	TX/RX	
		FEC-STRESS	TX	
		FEC-UNCORR-CW	TX/RX	
		MFAS	TX/RX	
		OTUC Frame	Alarms	
OOF	TX/RX			
Errors	FAS		TX/RX	925
	MFAS		TX/RX	
OTUCn	Alarms	AIS	TX/RX	926
		BDI	TX/RX	
		BIAE	TX/RX	
		IAE	TX/RX	
		TIM	RX	
	Errors	BEI	TX/RX	927
		BIP-8	TX/RX	

## Alarms/Errors

Layer	Alarms/Errors		TX/RX	Page
Path OAM	<b>Alarms</b>	BAS Unexp. Period	RX	930
		CS_LF	TX/RX	
		CS_LPI	TX/RX	
		CS_RF	TX/RX	
		CS Type Mismatch	RX	
		DAPI Mismatch	RX	
		Loss Continuity	TX/RX	
		RDI	TX/RX	
		SAPI Mismatch	RX	
	<b>Errors</b>	BIP-8	TX/RX	931
		CRC4	TX/RX	
		REI	TX/RX	
	PHY	<b>Alarms</b>	Hi-BER	RX
Link Down			TX/RX	
LOA			RX	
L Deg SER Det			RX	
L Deg SER Rcd			TX/RX	
R Deg SER			TX/RX	
<b>Errors</b>		66B Block	RX	932
		FEC-COR-CW	TX/RX	
		FEC-UNCOR-CW	TX/RX	
PHYs/Instances	<b>Alarms</b>	Excessive PHY Skew	RX	932
		FlexE Group Number Mismatch	RX	
		Loss of OH Frame Lock	TX/RX	
		Loss of OH MF Lock	TX/RX	
		Loss of PHY Number Lock	RX	
		Remote PHY Fault	TX/RX	
	<b>Errors</b>	OH CRC	TX/RX	933
	PTP	<b>Alarms</b>	Domain Mismatch	RX
Loss Announce			RX	
Loss Sync			RX	
QL Mismatch			RX	
Unusable			RX	

Layer	Alarms/Errors		TX/RX	Page
QoS Metrics	Errors	Frame Loss	RX	934
		Out-of-Seq.	RX	
Reference Signal	Alarms	REF-FAULT	RX	935
RS-FEC (CPRI)	Errors	FEC-COR-CW	TX/RX	935
		FEC-UNCOR-CW	TX/RX	
		FEC-SYMB	TX	
		Pre-FEC-SYMB	RX	
RS-FEC (Ethernet) (for Fibre Channel, see page 903)	Alarms	FEC-LOA	RX	935
		FEC-LOAML	RX	
		FEC Degraded SER (50GE)	RX	
	Errors	FEC-COR-BITS (100GE (1 Lane))	RX	936
		FEC-COR-CW (25GE/50GE)	TX/RX	
		FEC-COR-CW (100GE (4 Lanes))	RX	
		FEC Inv. Marker (25GE/50GE)	TX/RX	
		FEC-SYMB (25GE/50GE)	TX	
		FEC-UNCOR-CW (25GE/50GE)	TX/RX	
		FEC-UNCOR-CW (100GE)	RX	
Pre-FEC-Bit (50GE)	RX			
Pre-FEC-SYMB (25GE/50GE)	RX			
OAM (see S-OAM / MPLS-TP OAM)	Alarms	AIS	TX/RX	937
		C-DCI	TX	
		C-FDI	TX/RX	
		C-LOS	TX/RX	
		C-RDI	TX/RX	
		LCK	TX/RX	
		Loss Continuity	RX	
		Mismerge	RX	
		RDI	TX/RX	
		Unexp MEG/MD Lvl	RX	
		Unexp MEP	RX	
		Unexp PeriodERDI-PCD	RX	

## Alarms/Errors

Layer	Alarms/Errors		TX/RX	Page
Section/Line / RS/MS	<b>Alarms</b>	AIS / MS	TX/RX	939
		LOF-S / RS-LOF	TX/RX	
		RDI-L / MS-RDI	TX/RX	
		SEF / RS-OOF	TX/RX	
		TIM-S / RS-TIM	RX	
	<b>Errors</b>	B1	TX/RX	940
		B2	TX/RX	
		FAS-S / RS-FAS	TX/RX	
		REI-L / MS-REI	TX/RX	
STS-x/AU-x	<b>Alarms</b>	AIS-P / AU-AIS	TX/RX	941
		ERDI-PCD / ERDI-CD	TX/RX	
		ERDI-PPD / ERDI-PD	TX/RX	
		ERDI-PSD / ERDI-SD	TX/RX	
		H4-LOM	TX/RX	
		LOP-P / AU-LOP	TX/RX	
		PDI-P	TX/RX	
		PLM-P / HP-PLM	RX	
		RDI-P / HP-RDI	TX/RX	
		TIM-P / HP-TIM	RX	
		UNEQ-P / HP-UNEQ	TX/RX	
	<b>Errors</b>	B3	TX/RX	942
		REI-P / HP-REI	TX/RX	
SyncE	<b>Alarms</b>	ESMC Loss	RX	943
		QL Mismatch	RX	



Layer	Alarms/Errors		TX/RX	Page
TCM (SONET/SDH)	Alarms	TC-IAIS-P / HPTC-IAIS	TX/RX	943
		TC-IAIS-V / LPTC-IAIS	TX/RX	
		TC-LTC-P / TC-LTC-V / HPTC-LTC / LPTC-LTC	TX/RX	
		TC-ODI-P / TC-ODI-V / HPTC-ODI / LPTC-ODI	TX/RX	
		TC-RDI-P / TC-RDI-V / HPTC-RDI / LPTC-RDI	TX/RX	
		TC-TIM-P / TC-TIM-V / HPTC-TIM / LPTC-TIM	RX	
		TC-UNEQ-P / HPTC-UNEQ	TX/RX	
		TC-UNEQ-V / LPTC-UNEQ	TX/RX	
	Errors	TC-IEC-P / HPTC-IEC	TX/RX	944
		TC-OEI-P / TC-OEI-V / HPTC-OEI / LPTC-OEI	TX/RX	
		TC-REI-P / TC-REI-V / HPTC-REI / LPTC-REI	TX/RX	
		TC-VIOL-P / HPTC-VIOL	RX	
		TC-VIOL-V / LPTC-VIOL	RX	
	Transcoding	Alarms	Hi-BER1027B	RX
LOAML1027B			RX	
LOBL1027B			RX	
Errors		Inv. Flag	TX/RX	946
		MSEQV	TX/RX	
		POSV	RX	
		SEQV	RX	
VT/TU	Alarms	AIS-V / TU-AIS	TX/RX	947
		ERDI-VCD	TX/RX	
		ERDI-VPD / LP-ERDI-PD	TX/RX	
		ERDI-VSD / LP-ERDI-SD	TX/RX	
		LOP-V / TU-LOP	TX/RX	
		PLM-V / LP-PLM	RX	
		RDI-V / LP-RDI	TX/RX	
		RFI-V / LP-RFI	TX/RX	
		TIM-V / LP-TIM	RX	
		UNEQ-V / LP-UNEQ	TX/RX	
	Errors	BIP-2	RX	949
		REI-V / LP-REI	RX	

## Alarms/Errors

Layer	Alarms/Errors		TX/RX	Page
WIS	Alarms	AIS-L	RX	949
		AIS-P	RX	
		ERDI-PCD	RX	
		ERDI-PPD	RX	
		ERDI-PSD	RX	
		LCD-P	RX	
		LOF	RX	
		LOP-P	RX	
		PLM-P	RX	
		RDI-L	RX	
		RDI-P	RX	
		SEF	RX	
		UNEQ-P	RX	
		WIS Link Down	RX	
	Errors	B1	RX	951
		B2	RX	
		B3	RX	
		REI-L	RX	
		REI-P	RX	

- a. TX alarm, no injection.

## BER

### Alarms

- **No Traffic** indicates that no pattern traffic has been received in the last second. Available with EtherBERT, eCPRI BERT, FC BERT, and OTN BERT with EoOTN client. Not available when **Disruption Monitoring** is enabled.
- **Pattern Loss** (Ethernet) indicates that more than 20 percent of bit errors are received or the reference sequence can be unambiguously identified as out of phase. However, for OTU4 - **4 Unframed Physical Lanes** and 100GE - **4 Unframed CAUI-4**, bit error rate is greater than  $2.5 \times 10^{-3}$ .
- **Pattern Loss** (Fibre Channel) indicates that bit error is detected on four consecutive words.
- **Client Frequency**, available for ODUflex with Pattern client, indicates that the received client signal rate doesn't meet the nominal bit rate configured  $\pm 100$  ppm (refer to *Nominal Bit Rate*).

### Errors

- **Bit Error** indicates that there are logic errors in the bit stream (i.e., zeros that should be ones and vice versa). Only the count and rate values are reported for unframed test 40GE/OTU3 and up.
- **Mismatch '0'** indicates that there is a bit error on a binary '0' (for example ones that should be zeros) found in the test pattern only. Available with EtherBERT and OTN BERT with EoOTN client; not available with 100GE - **4 Unframed CAUI-4** and OTU4 - **4 Unframed Physical Lanes** on 88200NGE.

## Alarms/Errors

### Clock

---

- **Mismatch '1'** indicates that there is a bit error on a binary '1' (for example zeros that should be ones) found in the test pattern only. Available with EtherBERT and OTN BERT with EoOTN client; not available with 100GE - **4 Unframed CAUI-4** and OTU4 - **4 Unframed Physical Lanes** on 88200NGE.
- **Pattern Error**, available with **Seed A** or **Seed B** pattern, indicates a block mismatch.

## Clock

### Alarms

- **LOC** (Loss Of Clock) indicates that the unit is unable to synchronize with the selected **Clock Mode**. No valid clock is generated/extracted to/from the EXT CLK port.
- **LOPPS-L** and **LOPPS-R** (Loss Of Pulse Per Second - Local/Remote) indicates that either no pulse is received or no pulse is received within 1 second  $\pm 6.6 \mu s$  after the previous pulse. **LOPPS-R** is only monitored once the DTS connection is established. Available in **One-Way Latency** measurement mode for **Dual Test Set** and eCPRI BERT (LOPPS-L).

## CPRI

**Note:** *CPRI alarms/errors are only available for Framed L2.*

### Alarms

- **Link Down** indicates that the start-up sequence is not in F (Operation) or G (Passive) link state.
- **LOF** (Loss Of Frame) indicates that the hyperframe alignment cannot be achieved or is lost.
- **RAI** (Remote Alarm Indication) indicates that bit 1 of the Z.130.0 byte is set to 1.

- **R-LOF** (Remote - Loss Of Frame) indicates that bit 4 of the Z.130.0 byte is set to 1.
- **R-LOS** (Remote - Loss Of Signal) indicates that bit 3 of the Z.130.0 byte is set to 1.
- **SDI** (Service Access Point Defect Indication) indicates that bit 2 of the Z.130.0 byte is set to 1.

### **Errors**

- **FAS** (Frame Alignment Signal): For rates up to 9.8G, indicates error detected in the start of hyperframe (byte different of **K28.5** while not in LOF). For rate 10.1G, indicates error detected in the sync control word of hyperframe (byte different of **/S/** while not in LOF).

## **DCO - TX**

### **Alarms**

- **Tx CMU LOL** indicates Tx Clock Monitor Unit Loss Of Lock.
- **Tx Deskew LOL** indicates Tx Deskew Loss Of Lock.
- **Tx FIFO** indicates Tx First In, First Out error.
- **Tx LOA** indicates Tx Loss Of Alignment.
- **Tx OOA** indicates Tx Out Of Alignment.
- **Tx RefClk LOL** indicates Tx Reference Clock Loss Of Lock.

## **DCO - RX**

### **Alarms**

- **Rx CDC LOL** indicates Rx Chromatic Dispersion Compensation.
- **Rx Demod LOL** indicates Rx Demodulator Loss Of Lock.

## Alarms/Errors

DS1

---

- **Rx Deskew LOL** indicates Rx Deskew Loss Of Lock.
- **Rx FIFO** indicates Rx First In, First Out error.
- **Rx LOA** indicates Rx Loss Of Alignment.
- **Rx LOF** indicates Rx Loss Of Frame.
- **Rx LOM** indicates Rx Loss Of Multi frame.
- **Rx OOA** indicates Rx Out Of Alignment.

## DS1

**Note:** *For Time Error / Wander test application only **AIS** and **OOF** alarms are supported.*

### Alarms

- **AIS** (Alarm Indication Signal) indicates that an unframed all-ones signal is received.
- **OOF** (Out-Of-Frame) indicates that four consecutive frame bit errors are detected.
- **RAI** (Yellow) (Remote Alarm Indication) for ESF framing, indicates that eight “ones” followed by eight “zeros” pattern is received continuously in the data link (FDL).
- **RAI** (Yellow) (Remote Alarm Indication) for SF framing, indicates that bit 2 in each timeslot contains “0”.

### Errors

- **CRC-6** (Cyclical Redundancy Check), available with ESF framing, indicates that one or more bit errors have been detected in a block of data through cyclical redundancy check.
- **Framing Bit** indicates that an incorrect value appeared in a bit position reserved for framing.

## DS3

### Alarms

- **AIS** (Alarm Indication Signal) indicates that the M-frame contains zeros (0) for C-bits, ones (1) for X-bits, 1010... repeating sequence with a one (1) immediately following any of the control bit positions for the information bits.
- **Idle** (DS3 Idle) indicates that subframe 3 of the M-frame contains zeros (0) for the three C-bits, ones (1) for X-bits, 1100... repeating sequence with the first two bits following each control bit set to 11 for the information bits.
- **OOF** (Out-Of-Frame) indicates that four consecutive frame bit errors are detected.
- **RDI** (Remote Defect Indicator) indicates that both X-bits of the M-Frame are set to "0".

### Errors

- **CP-Bit** (Control-Bit) indicates that the three C-bits reserved to control bit stuffing are different of "111" and "000".
- **F-Bit** (Framing-Bit) indicates that the frame alignment pattern received is different of "1001".
- **FEBE** (Far-End Block Error) indicates that the three FEBE bits reserved for framing or parity error detection contain the "000" pattern.
- **P-Bit** (Parity-Bit) indicates that the P-Bits does not match the parity of all the information bits following the first X-Bit of the previous DS3 frame.

# E1

**Note:** *For Time Error / Wander test application only **AIS** and **LOF** alarms are supported.*

## Alarms

**Note:** *Only AIS is available when the framing is set to **Unframed**.*

- **AIS** (Alarm Indication Signal) indicates that two or less ZEROs are received in each of two consecutive double frame periods (512 bits).
- **LOF** (Loss Of Frame) indicates that three consecutive incorrect frame alignment signals is received.
- **LOMF** (Loss Of MultiFrame) indicates that two consecutive multiframes alignment signals (bits 1 through 4 of TS16 of frame 0) is received with an error.
- **RAI** (Yellow) (Remote Alarm Indication) indicates that bit 3 in timeslot 0 is set to “1”.
- **RAI MF** (Remote Alarm Indication Multi-Frame) indicates that bit 6 of timeslot 16 of frame 0 is set to “1”.
- **TS16 AIS** (TimeSlot 16 Alarm Indication Signal) indicates that three or less ZEROs are received in each Timeslot 16 of two consecutive multiframes.



## Errors

- **CRC-4** (Cyclical Redundancy Check) indicates that one or more bit errors are detected in a block of data through cyclical redundancy check.
- **E-Bit** (CRC-4 Error Signal), available with **PCM30 CRC-4** or **PCM31 CRC-4** framing, indicates that bit 1 of sub-multiframe (SMF) II in frame 13 and/or 15 is set to 0 indicating a sub-multiframe error.
- **FAS** (Frame Alignment Signal), available with **PCM30 CRC-4** or **PCM31 CRC-4** framing, indicates that bits 2 to 8 of the frame containing the FAS differ from 0011011.

## E2/E3/E4

### Alarms

**Note:** Only AIS is available when the framing is set to **Unframed**.

- **AIS** (Alarm Indication Signal) indicates that an unframed all-ones signal is received.
- **LOF** (Loss Of Frame) indicates that four consecutive incorrect frame alignment signals is received.
- **RAI** (Remote Alarm Indication) indicates that bit 11 of a framed E2 is set to “1”.

### Errors

- **FAS** (Frame Alignment Signal) indicates that bits 1 to 10 of the first frame differ from 1111010000.

## Electrical Interface (DCO BERT)

**Note:** Available with DCO BERT, see Interface on page 911.

# Ethernet

## Alarms

**Note:** For *LOA*, *Inv. Mapping*, *L Deg SER Det*, *L Deg SER Rcd*, and *R Deg SER* alarms see Ethernet - PCS on page 899.

- **Client Frequency**, available with EoOTN 1GbE client, indicates that the received client signal rate doesn't meet the standard rate specification of  $1250000000 \pm 150000$  bps ( $\pm 120$  ppm).
- **Hi-BER** (High-Bit Error Ratio) indicates that the bit error ratio is  $> 10^{-4}$  on a fixed time period; 2 ms for 25GE, 1250  $\mu$ s for 40GE, 1 ms for 50GE, and 500  $\mu$ s for 100GE. Available with 25/40/50/100GE interface, and EoOTN 100 GbE client.
- **Link Down** indicates: For 10/25/40/50/200/400GE that there is a local or a remote fault condition. For 100/1000 Mbit/s that there is no bits/clock sync (PMA/PMD Link down), including LOS. For 10 Mbit/s that no data or no Normal Link Pulse (NLP) are received.
- **Local Fault Det** (Local Fault Detected) indicates that at least one of the following events is detected: Loss of bit synchronization, Loss of Block synchronization, Link down, or High BER. Available with Ethernet 10/25/40/50/100/200/400 Gbit/s interface, Ethernet (flex/GFP-F) client, and EoOTN 10/40/100 GbE client. Remote Fault is also available with EoOTN 1GbE client.
- **Local Fault Rcd** (Local Fault Received) indicates that the received data path contains the **Local Fault** signal. Available with Ethernet 10/25/40/50/100/200/400 Gbit/s interface, Ethernet (flex/GFP-F) client, and EoOTN 10/40/100 GbE client. Remote Fault is also available with EoOTN 1GbE client.

- **No Traffic**, available with FlexE, indicates that no pattern traffic has been received in the last second.
- **Remote Fault** indicates that the received data path contains the **Remote Fault** status. Available with Ethernet 10/25/40/50/100/200/400 Gbit/s interface, Ethernet (flex/GFP-F) client, and EoOTN 10/40/100 GbE client. Remote Fault is also available with EoOTN 1GbE client.

## Errors

- **Alignment**, available with 10/100 Mbit/s interface, indicates that frames without an integral number of octets in length are received.
- **Block**, available with 10G LAN/WAN interface, indicates that error block is received in frames.
- **Collision** indicates the number of collisions on the link. Available with **Half Duplex** mode for electrical interface 10 Mbit/s and 100 Mbit/s.
- **Exc. Coll.**, available with 10/100 Mbit/s electrical interface in **Half Duplex** mode, indicates the number of frames that were sent 16 times unsuccessfully due to consecutive collisions.
- **False Carrier** indicates that data is being received with invalid start of frame. Available with Ethernet 100/1000 Mbit/s interface, and EoOTN 1GbE client.
- **FCS** (Frame Check Sequence) indicates that frames with an invalid FCS are received.
- **FEC-COR-BITS** (FEC Correctable Bits) indicates FEC Bit containing errors that were corrected. Available with DCO BERT; not available with 100G Ethernet (CAUI-4 w/o FEC) client.
- **FEC-UNCOR-FR** (FEC Uncorrectable Frames) indicates that FEC uncorrectable frame error is detected on the Ethernet client signal. Available with DCO BERT; not available with 100G Ethernet (CAUI-4 w/o FEC) client..

## Alarms/Errors

### Ethernet

---

- **Idle** indicate tha an error is detected between the end of a frame and the beginning of the next frame. Available with Ethernet 100/1000 Mbit/s interface, and EoOTN 1GbE client.
- **Jabber** indicates that frames larger than 1518 bytes with an invalid FCS are received (add 4 bytes for each VLAN layer enabled); 1534 bytes for EoE (add 4 bytes for each VLAN layer enabled in the encapsulated Ethernet payload and 4 bytes for EoE VLAN when enabled); 1536 bytes for PBB-TE (add 4 bytes for each VLAN layer enabled in the encapsulated Ethernet payload and 4 bytes for B-VLAN when enabled).
- **Late Coll.**, available with 10/100 Mbit/s electrical interface in **Half Duplex** mode, indicates the number of collisions that have occurred after a 64 bytes transmission.
- **Oversize** indicates frames larger than: 1518 bytes with a valid FCS (add 4 bytes for each VLAN layer enabled); 1534 bytes for EoE (add 4 bytes for each VLAN layer enabled in the encapsulated Ethernet payload and 4 bytes for EoE VLAN when enabled); 1536 bytes for PBB-TE (add 4 bytes for each VLAN layer enabled in the encapsulated Ethernet payload and 4 bytes for B-VLAN when enabled). Available when the **Oversize Monitoring** check box is selected.  
  
**Oversize Monitoring** check box when selected (cleared by default) allows monitoring the **Oversize** frame errors.
- **Runt** indicates frames smaller than 64 bytes with an invalid FCS; 80 bytes for EoE; 82 bytes for PBB-TE.
- **Symbol** indicates that an invalid code-group is detected in the code. Available with Ethernet 100/1000 Mbit/s interface, and EoOTN 1GbE client.
- **Undersize** indicates frames smaller than 64 bytes with a valid FCS; 80 bytes for EoE; 82 bytes for PBB-TE.

## Ethernet - PCS

**Note:** Available with parallel interfaces only: 40/50/100/200/400 Gbit/s Ethernet and OTN with 40/100GbE Ethernet client. Available under the **PCS** sub tab for Through Mode test providing alarms/errors for both ports.

### Alarms

- **Inv. Mapping** (Invalid Mapping), available with 40/100GE, indicates errors in the mapping attributed to either a mapping value appearing more than once or a non valid mapping value (out of range).
- **LOA** (Loss Of Alignment), available with 40/50/100/200/400GE, indicates that two or more logical lanes have the same logical lane marker value, or one or more logical lane marker recovery processes are in the OOR state, or if the differential delay between two logical lanes exceeds the configured alarm threshold compensable delay.
- **L Deg SER Det** (Local Degraded SER Detected), available with 200GE/400GE when **FEC Degraded SER** is enabled, indicates that a local FEC degraded SER condition is detected.
- **L Deg SER Rcd** (Local Degraded SER Received), available with 200GE/400GE when **FEC Degraded SER** is enabled, indicates that a Local degraded SER signal is detected.
- **R Deg SER** (Remote Degraded SER), available with 200GE/400GE when **FEC Degraded SER** is enabled, indicates that a remote degraded SER signal is detected.

## Errors

- **66B Block**, available with 50/200/400GE (not available with FlexE BERT), indicates that an invalid 64b/66b block code is received. An invalid 64b/66b block is declared when the synchronization field has a value of 00 or 11.
- **FEC-COR-CW** (FEC Correctable Codeword), available with 200GE/400GE, indicates that FEC correctable codeword error is detected on the Ethernet signal. The **FEC-COR-CW** does not raise an error, only the count and rate values are reported. Available when RS-FEC is enabled.
- **FEC-UNCOR-CW** (FEC Uncorrectable Codeword), available with 200GE/400GE, indicates that FEC uncorrectable codeword error is detected on the Ethernet signal. Available when RS-FEC is enabled.

## Ethernet - PCS Lanes

**Note:** Available with parallel interfaces only: 40/100/200/400 Gbit/s Ethernet and OTN with 40/100 GbE Ethernet client. Available under the **PCS** sub tab for Through Mode test providing alarms/errors for both ports.

- **Skew Alarm Threshold (bits)**, available with Ethernet test application, allows setting the threshold value that will be used to declare a skew alarm. Not available at 100G when the RS-FEC check box is selected. **Default** restores the default skew alarm threshold value.

Rate	Range	Default Value
400G 200G	0 to 10550	4781
100G	0 to 2047	928
40G	0 to 4095	1856

## Alarms

**Note:** For *LOA* and *Inv. Mapping* alarms see Ethernet - PCS on page 899.

- **Exc. Skew** (Excessive Skew) indicates that the skew exceeds the defined threshold. Not available with 100GE (1 Lane)/100GE (2 Lanes)/4 x 100GE interface.
- **LOAML** (Loss of Alignment Marker Lock) indicates that in lock mode, four consecutive marker values are received that do not match the alignment marker that the lane is currently locked to. The LOAML alarm is cleared when the PCS Lane is declared Lock and two valid alignment markers 16384 blocks (66b) apart are received.
- **LOBL** (Loss of Block Lock), available with 40/100G, indicates that in lock mode, 65 invalid sync fields (00 or 11) within a 1024 sync window are received. A PCS Lane Lock alarm is cleared when receiving 64 consecutive valid 66b sync field (01 or 10) in a row.

## Errors

- **Block** indicates that invalid 64b/66b block code are received. An invalid 64b/66b block is declared when the synchronization field has a value of 00 or 11. Available with Ethernet test applications and 100 GbE over OTU4. Injection is not available at 100GE when RS-FEC is enabled.
- **Inv. Marker** (Invalid Marker) indicates that there are errors in the 66-bit block alignment marker. Injection is not available when RS-FEC is enabled.
- **OTN BIP-8**, available with 40GE over OTU3, indicates for each lane that at the OTN egress, the calculated 8-bit error contains at least one bit set to "1".

## Alarms/Errors

### FEC (FlexO)

---

- **PCS BIP-8** indicates that there are PCS lane bit-interleave parity errors. A routine even-parity check is performed over all bits of a PCS lane, from and including the previous alignment marker, but not including the current alignment marker.
- **PCS BIP-8 Mask**, available with 40GE over OTU3, indicates that at the OTN ingress, the calculated 8-bit error mask contains at least one bit set to “1”.
- **Pre-FEC-Bit**, available with 200/400G when **RS-FEC (RX Only)** is enabled, indicates the number of bits corrected by the FEC. Receiving uncorrectable codeword may affect the Pre-FEC-Bit error rate.
- **Pre-FEC-SYMB**, available with 200/400G when **RS-FEC (RX Only)** is enabled, indicates that FEC symbol errors are detected. The **Pre-FEC-SYMB** does not raise an error, only the count and rate values are reported. Receiving uncorrectable codeword may affect the Pre-FEC-SYMB error rate.

## FEC (FlexO)

### Errors

**FEC-COR-CW** (FEC Correctable Codeword) indicates FEC Codeword containing errors that were corrected.

- **FEC-UNCOR-CW** (FEC Uncorrectable Codeword) indicates FEC Codeword containing errors that were not corrected.
- **Pre-FEC-SYMB** (Pre-FEC Symbol) indicates FEC symbol errors are corrected and counted once for each 10-bit symbol.



## FEC (OTN)

### Errors

- **FEC-CORR-BIT** (FEC Correctable Bit) indicates FEC Bit containing errors that were corrected.
- **FEC-CORR-CW** (FEC Correctable Codeword) indicates FEC Codeword containing errors that were corrected.
- **FEC-CORR-SYM** (FEC Correctable Symbol) indicates FEC Symbol containing errors that were corrected.
- **FEC-UNCORR-CW** (FEC Uncorrectable Codeword) indicates FEC Codeword containing errors that were not corrected.

## Fibre Channel (including RS-FEC)

### Alarms

- **Link Down** indicates that the Fibre Channel connection is down meaning that there is a local or a remote fault condition.
- **Local Fault Detected**, available with FC 10X, indicates that at least one of the following events is detected: **LOS**, **Loss of bit synchronization**, **Loss of Block synchronization**, **Link down**, or **High BER** (High BER is true when the bit error ratio  $> 10^{-4}$  on a fixed 125  $\mu$ s time period).
- **Local Fault Received**, available with FC 10X, indicates that the received data path contains the Local Fault signal.
- **LOCWS** (Loss of CW Synchronization), available with FC 32X, indicates that the codeword\_sync is false.
- **Remote Fault**, available with FC 10X, indicates that a Remote Fault event is detected.

#### Errors

- **66B Block**, available with FC 32X, indicates the number of frames received with an errored block condition; excluding frames in LOCWS.
- **Block**, available with FC 10X/16X, indicates the number of frames received with an errored block condition.
- **FCS** (Frame Check Sequence) indicates that frames with an invalid FCS are received/generated.
- **FEC-CORR-CW**, available with FC 32X, indicates FEC codeword containing errors that were corrected; excluding frames in LOCWS.
- **FEC-UNCOR-CW**, available with FC 32X, indicates FEC codeword containing error that were not corrected; excluding frames in LOCWS.
- **Oversize** indicates the number of received FL-2 frames larger than 2148 bytes with a valid FCS.  
**Pre-FEC-SYMB** (Pre-FEC Symbol), available with FC 32X, indicates that FEC symbol errors are corrected and counted once for each 10-bit symbol; excluding frames in LOCWS.
- **Symbol**, available with FC 1X/2X/4X/8X, indicates that invalid code-group is detected in the code.
- **Undersize** indicates FL-2 frames smaller than 36 bytes with a valid FCS.

## FlexE Group

#### Alarms

- **Calendar Mismatch** indicates that received calendar is different of the one transmitted, including unequipped instances.
- **FlexE Group Down** indicates that at least one PHY link of the group is down or any of the FlexE group alarm is present.

- **Illegal Client** indicates that FlexE client size on the received calendar is not supported.
- **Inconsistent Calendar** indicates inconsistency among the PHY maps, PHY numbers, unequipped instances, or FlexE group numbers received on the different PHYs.

## FlexO Group

**Instance Skew Alarm Threshold (ns)**, available with multiple instances on multiple ports, allows setting the threshold value that will be used to declare a skew alarm: **50** to **1000** ns (**300** ns by default). **Default** restores the default alarm threshold value.

## Alarms

- **Excessive Instance Skew** indicates that the current skew is above the configured **Instance Skew Alarm** threshold. Available with multiple instances on multiple ports. The Excessive Instance Skew condition corresponds to a Loss of lane alignment defect (LOL) as mentioned in the standard.
- **GIDM** (Group ID Mismatch) indicates that received GID of any of the group member PHYs, with good CRC, does not match the expected GID parameter.

## Alarms/Errors

### *FlexO Group*

---

- **Group Down** indicates that at least one instance of the group is in LOS, at least one OTUC is in LOFLOM, or any FlexO Group alarm at the exception of Remote PHY Fault.
- **IIDM** (Instance ID Mismatch) indicates that the received IID, with good CRC, does not match the expected IID parameter.
- **LOM** (Loss Of Multiframe) indicates that OOM is present for at least 3 ms.
- **MAPM** (MAP Mismatch) indicates that either the received MAP value (with good CRC) does not match the value of the transmitted MAP, any values of the received IID does not have the corresponding bit set in the transmitted MAP, or the received IID values are not unique.
- **OOM** (Out-Of-Multiframe) indicates that MFAS are in error for at least 5 consecutive FlexO frames.
- **RPF** (Remote PHY Fault) indicates that the RPF bit is set in the OH.

### **Errors**

- **MFAS** (Multiframe Alignment Signal) indicates that the received OH MFAS does not match the expected MFAS value.
- **OH CRC** indicates an invalid CRC in the OH received.

## FOICx.y

- **Skew Alarm Threshold (ns)**, coupled for all ports in the FlexO group, allows setting the threshold value that will be used to declare a skew alarm: **0** to **1000** ns (**180** ns by default). **Default** restores the default alarm threshold value.

## Alarms

- **Exc. Skew** (Excessive Skew) indicates that the skew exceeds the defined threshold.
- **LOA** (Loss Of Alignment) indicates that two or more logical lanes have the same logical lane marker value, or one or more logical lane marker recovery processes are in the OOR state, or if the differential delay between two logical lanes exceeds the configured alarm threshold compensable delay.
- **LOAML** (Loss of Alignment Marker Lock) indicates that in lock mode, five consecutive marker values are received that do not match the alignment marker that the lane is currently locked to. The **LOAML** alarm is cleared when FOIC Lane is declared Lock and two valid alignment markers are received.

## Errors

- **Inv. Marker** (Invalid Marker) indicates that there are errors in the 66-bit block alignment marker.

## GFP

**Note:** Available from the GFP-F/GFP-T sub-tab.

### Alarms

- **GFP-DCI** (GFP - Defect Clear Indication) indicates that CMF frame is received with an UPI set to “0000 0011”. In TX, generates a client DCI by setting the UPI field to “0000 0011”.
- **GFP-EXM** (GFP - Extension Header Mismatch) indicates that the EXI received is different from the expected EXI (refer to EXI on page 288) without uncorrectable cHEC, tHEC, eHEC, and no pFCS errors.
- **GFP-FDI** (GFP - Forward Defect Indication), available with GFP-F, indicates that CMF frame is received with an UPI set to “0000 0100”. In TX, generates a client FDI by setting the UPI field to “0000 0100”. Note that the configuration of the CMF pFCS check box (see *GFP-F/GFP-T* on page 288) is temporarily cleared and the UPI value changed when the GFP-FDI alarm is selected. The CMF pFCS check box state and the UPI value returns to their previous state/value when another alarm (other than GFP-FDI or GFP-RDI) is selected.
- **GFP-LFD** (GFP - Loss of Frame Delineation) indicates that the GFP engine is out of synchronization. In TX, generates a sufficient number of cHEC uncorrectable errors to avoid synchronization.
- **GFP-LOCCS** (CSF-Loss of Client Character Synchronization) indicates that CMP frame is received with an UPI set to “0000 0010”. In TX, generates a LOCCS by setting the UPI field to “0000 0010”.
- **GFP-LOCS** (GFP - CSF-Loss of Client Signal) indicates that CMF frame is received while UPI is set to “0000 0001”. In TX, generates a LOCS by setting the UPI field to “0000 0001”.
- **GFP-RDI** (GFP - Reverse Defect Indication), available with GFP-F, indicates that CMF frame is received with an UPI set to “0000 0101”. In TX, generates a client RDI by setting the UPI field to “0000 0101”. Note that the configuration of the CMF pFCS check box (see *GFP-F/GFP-T* on

page 288) is temporarily cleared and the UPI value changed when the GFP-RDI alarm is selected. The CMF pFCS check box state and the UPI value returns to their previous state/value when another alarm (other than GFP-FDI or GFP-RDI) is selected.

- **GFP-Reserved CMF** (Client Management Frame) indicates MF alarms other than the ones described above.

**Reserved CMF Monitoring** check box, when selected, allows monitoring the **GFP-Reserved CMF** alarms.

- **GFP-UPM** (GFP - User Payload Mismatch) indicates that the UPI received is different from the expected Client Data UPI without uncorrectable cHEC, tHEC, eHEC, and no pFCS errors. The *GFP-F/GFP-T* on page 288 displays the expected UPI value based on the test structure. Refer to page 844 for more information on UPI values.
- **GFP-UserDefined CMF** generates a CMF (Client Management Frame) with a user defined UPI.

## Errors

- **GFP-10B\_ER** (GFP - 10B\_Error), available with GFP-T, indicates that a 10B\_ERR code has been detected in the payload of the superblock. In TX, generates a 10B\_ERR code over the payload of the superblock as defined in ITU G.7041.
- **GFP-cHEC-CORR** (GFP - core Header Error Check - Correctable) indicates that only one bit error has been detected on Core header (PLI and cHEC). In TX, generates a “Walking 1” pattern to hit all applicable bits covered by the cHEC and PLI.
- **GFP-cHEC-UNCORR** (GFP - core Header Error Check - Uncorrectable) indicates that two or more bit errors have been detected on Core header (cHEC and PLI). In TX, generates a “Walking 11” pattern to hit all consecutive 2 bits applicable to the bits covered by the cHEC and PLI.

- **GFP-eHEC-CORR** (GFP - extension Header Error Check - Correctable), available with GFP-F when EXI is set to **Linear**, indicates that only one bit error has been detected in the Extension header (eHEC, CID and Spare). In TX (requires client data frame generation), generates a “Walking 1” pattern to hit all applicable bits covered by the eHEC, CID and Spare.
- **GFP-eHEC-UNCORR** (GFP - extension Header Error Check - Uncorrectable), available with GFP-F when EXI is set to **Linear**, indicates that two or more bit errors have been detected in the Extension header (eHEC, CID and Spare). In TX (requires client data frame generation), generates a “Walking 11” pattern to hit all consecutive 2 bits applicable to the bits covered by the eHEC, CID and Spare.
- **GFP-pFCS** (GFP - payload Frame Check Sequence) indicates that at least one bit error has been detected in the payload. In TX (requires client data frame generation), generates a “Walking 1” pattern to hit all 32 bits of the pFCS only. Only available with **Ethernet (flex/GFP-F)** client when the **CDF pFCS** check box is selected (refer to *GFP-F/GFP-T* on page 288).
- **GFP-SB-CORR** (GFP - Superblock Correctable), available with GFP-T, indicates that bit error has been detected in the CRC-16 word of the superblock. A received SB Correctable (Pre) error counts as one error while SB Correctable (Post) counts as two errors. In TX:
  - GFP-SB-CORR (Pre)** generates a “Walking 1” pattern to include a single bit error in the CRC-16 word of the superblock.
  - GFP-SB-CORR (Post)** generates in the payload of the superblock, a “Walking 1” pattern to include two separate errors in one superblock separated by 43 bits.
- **GFP-SB-UNCORR** (GFP - Superblock Uncorrectable), available with GFP-T, indicates that two or more bit errors have been detected in the CRC-16 word of the superblock. Note that if two errors are spaced by



exactly 43 bits, they will not be reported as uncorrectable. In TX, generates a “Walking 11” pattern to include two consecutive errors in the CRC-16 word of the superblock.

- **GFP-tHEC-CORR** (GFP - type Header Error Check - Correctable) indicates that only one bit error has been detected in the Type header (tHEC, PTI, PFI, EXI, and UPI). In TX (requires client data frame generation), generates a “Walking 1” pattern to hit all applicable bits covered by the tHEC, PTI, PFI, EXI, and UPI.
- **GFP-tHEC-UNCORR** (GFP - type Header Error Check - Uncorrectable) indicates that two or more bit errors have been detected in the Type header (tHEC, PTI, PFI, EXI, and UPI). In TX (requires client data frame generation), generates a “Walking 11” pattern to hit all consecutive 2 bits applicable to the bits covered by the tHEC, PTI, PFI, EXI and UPI.

## **GMP (ODTU4.x - GMP)**

**Note:** *GMP is only available with EoOTN client (ODU0 with PT21) and is displayed under ODUx alarms/errors group. **GMP** is labelled as **ODTU4.1 - GMP** with Multi-Channel OTN and **ODTUC4.80 - GMP** with FlexO BERT.*

### **Alarms**

- **OOS** (GMP - Out Of Synchronization) Indicates that the GMP RX cannot synchronize with the GMP TX.

### **Errors**

- **Cm-CRC-8** indicates that there is a Cm-CRC-8 mismatch between the received value and the locally computed value.
- **CnD-CRC-5** indicates that there is a CnD-CRC-5 mismatch between the received value and the locally computed value.

## Alarms/Errors

### Interface

---

- **Cm-CRC-6** indicates that there is a Cm-CRC-6 mismatch between the received value and the locally computed value. Available with FlexO.
- **CnD-CRC-9** indicates that there is a CnD-CRC-9 mismatch between the received value and the locally computed value. Available with FlexO.

## Interface

### Alarms

- **Frequency** indicates that the received signal frequency meets the standard specifications (green) or not (red). Not available when using an active copper SFP.

For Ethernet **100/1000M Electrical, 100M Optical, 1GE Optical, 10GE LAN/WAN, 25GE**, or Fibre Channel **1X/2X/4X/8X/10X/16X/32X** interface/rate, the frequency range is  $\pm 100$  ppm. Not supported for 10M electrical.

For parallel interfaces (available for each Physical Lane):

Rate	Physical Lane	Frequency
40GE	XLAUI	10.3125 GHz $\pm$ 100 ppm
50GE	50GAUI-2	26.5625 GHz $\pm$ 100 ppm
100GE	CAUI-4	25.78125 GHz $\pm$ 100 ppm
200GE	200GAUI-4	26.5625 GHz $\pm$ 100 ppm
400GE	400GAUI-8 400GAUI-16	26.5625 GHz $\pm$ 100 ppm
400ZR	400GAUI-8	26.5625 GHz $\pm$ 100 ppm
400ZR+	400GAUI-8	26.5625 GHz $\pm$ 100 ppm
100ZR+	100GAUI-2 CAUI-4	26.5625 GHz $\pm$ 100 ppm 25.78125 GHz $\pm$ 100 ppm
100G FlexO-1-RS	4x28G	27.952 GHz $\pm$ 20 ppm
OTU3	4x10G	10.7546 GHz $\pm$ 20 ppm
OTU3e1	4x10G	11.1427 GHz $\pm$ 20 ppm
OTU3e2	4x10G	11.1458 GHz $\pm$ 20 ppm
OTU4	4x25G	27.952 GHz $\pm$ 20 ppm

For serial interfaces:

Interface	Standard Rate Specification
DS1	1544000 $\pm$ 36.6 ppm
E1	2048000 $\pm$ 54.6 ppm
E3	34368000 $\pm$ 24.6 ppm
DS3	44736000 $\pm$ 24.6 ppm
STS-1e/STM-0e, OC-1/STM-0	51840000 $\pm$ 20 ppm
E4	139264000 $\pm$ 19.6 ppm
STS-3e/STM-1e, OC-3/STM-1	155520000 $\pm$ 20 ppm
OC-12/STM-4	622080000 $\pm$ 20 ppm
OC-48/STM-16	2488320000 $\pm$ 20 ppm
OTU1	2666057143 $\pm$ 20 ppm
OC-192/STM-64	9953280000 $\pm$ 20 ppm
OTU2	10709225316 $\pm$ 20 ppm
OTU1e	11049107143 $\pm$ 100 ppm
OTU2e	11095727848 $\pm$ 100 ppm
OTU1f	11270089286 $\pm$ 100 ppm
OTU2f	11317642405 $\pm$ 100 ppm

- **LOC Lane** (Loss Of Clock Lane), available for each Lane for parallel interfaces, indicates that the unit is unable to lock on the Physical / CAUI / CAUI-4 / XLAUI / 50GAUI-2 / 100GAUI-2 / 200GAUI-4 / 400GAUI-8/16 link interface.

## Alarms/Errors

### Interface

---

- **LOS** (Loss Of Signal) indicates absence of an input signal or an all-zeros pattern is received. Available for each Optical Lane for parallel interfaces. Not supported when **PHY Type** is set to **DAC** or with host/media loopback.

For CPRI Framed L2:

Rates up to 9.8G: Absence of an input signal or at least 16 8B/10B code violations occur in one hyperframe.

Rate 10.1G and 24.3G (RS-FEC disabled): Absence of an input signal or the `hi_ber` variable is set to true.

For rate 24.3G (RS-FEC enabled): Absence of an input signal or the `codeword_sync` variable is set to false.

For Time Error / Wander 1PPS interface: Either no pulse is received or no pulse is received within 1 second  $\pm 100$  ms after the previous pulse.

## Errors

- **66B Block** indicates sync header violations or /E character is received. Available with CPRI 10.1G and 24.3G (with RS-FEC).
- **BPV** (Bipolar Violation) indicates that pulses of the same consecutive polarity were detected, in violation with the bipolar signal format. Available with DS1, DS3, and STS-1e.
- **CV** (Code Violation) for E1, E3, E4, STM-0e, STM-1e, and STS-3e, indicates that pulses of the same consecutive polarity were detected, in violation with the bipolar signal format.
- **CV** (Code Violation) for CPRI (up to 9.8G) /OBSAI, indicates that invalid 10B code word are received.
- **EXZ** (Excessive Zeros) for **DS1** with **AMI Line Coding**, indicates that more than 15 consecutive bit periods with no pulses have been received.

- **EXZ** (Excessive Zeros) for **DS1** with **B8ZS Line Coding**, indicates that more than 7 consecutive bit periods with no pulses have been received.
- **EXZ** (Excessive Zeros) for **DS3**, indicates that more than 2 consecutive bit periods with no pulses have been received.
- **K30.7** indicates that code word with Error\_Propagation/V ordered\_set are received. Available with CPRI (up to 9.8G)/OBSAI Framed L2.
- **Sync Header** indicates sync header violations. Available with CPRI 10.1G and 24.3G (RS-FEC disabled).

## Interface (DCO BERT)

### Alarms

- **LOS** (Loss Of Signal) indicates that the optical signal power is below the threshold or an all-zeros pattern is received over a period of time.
- **Local Degrade** indication is present in the STAT OH byte of the 400ZR/ZR+ frame. Injection is not supported with 100G Ethernet clients.
- **Remote Degrade** indication is present in the STAT OH byte of the 400ZR/ZR+ frame. Injection is not supported with 100G Ethernet clients.
- **Remote PHY Fault** indication is present in the STAT OH byte of the 400ZR frame.

### IP/UDP

- **IP Chksum** (IP Checksum) indicates that received IP datagrams have invalid IP header checksum. Only available for IPv4.
- **UDP Chksum** (UDP Checksum) indicates that received UDP segments have invalid UDP checksum.

## IP/UDP/TCP

### Errors

- **IP Chksum** (IP Checksum) indicates that received IP datagrams have invalid IP header checksum. Only available for IPv4.
- **TCP Chksum** (TCP Checksum) indicates that received TCP segments have invalid TCP checksum.
- **UDP Chksum** (UDP Checksum) indicates that received UDP segments have invalid UDP checksum.

## Media RX FEC

### Alarms

- **FDD** (FEC Detected Degrade), available when the **FDD** check box is selected, indicates that the BER is greater to the **FDD** activate threshold. The **FDD** alarm is clear when the BER is below to the deactivate threshold.
- **FED** (FEC Excessive Degrade), available when the **FED** check box is selected, indicates that the BER is greater to the **FED** activate threshold. The **FED** alarm is clear when the BER is below to the deactivate threshold.

### Errors

- **FEC-COR-BITS** (FEC Correctable Bits) indicates FEC Bit containing errors that were corrected.
- **FEC-UNCOR-FR** (FEC Uncorrectable Frames) indicates that FEC uncorrectable frame error is detected on the signal.

## OBSAI

**Note:** *OBSAI alarms/errors are only available for Framed L2.*

### Alarms

- **Link Down** indicates that the RX state machine is not FRAME\_SYNC.
- **LOF** (Loss Of Frame) indicates that the RX state machine is in either WAIT\_FOR\_K28.7\_IDLE or SCR\_CAP state.
- **RP3 Address Mismatch** indicates that the RP3 Target Address does not match the local RP3 Source Address. Available when **Address Mismatch** is enabled (refer to page 296).

### Errors

- **CRC** (Cyclic Redundancy Check) indicates a message received with an invalid CRC.
- **FAS** (Frame Alignment Signal) indicates error detected in message group terminating character (byte different of K28.5) or master frame terminating character (byte different of K28.7).

## ODUCn

**Note:** *For OPUCn alarms/errors see page 922.*

### Alarms

- **AIS** (Alarm Indication Signal) indicates that the STAT information in the PM byte 3, bits 6 to 8 of ODUc #1 is “111” for at least 15 consecutive frames. In TX, generates an all "1"s pattern in the entire ODUc signal, excluding the frame alignment overhead (FA OH), and OTUC overhead (OTUC OH).

## Alarms/Errors

ODUCn

---

- **BDI** (Backward Defect indication) indicates that the BDI bit in the PM overhead field (byte 3, bit 5) of ODUc #1 is “1” for at least 15 consecutive frames. In TX, generates a “1” in the BDI (byte 3, bit 5) of the PM overhead field of the ODUc #1 continuously.
- **LCK** (Lock) indicates that the STAT information in the PM byte 3, bits 6 to 8 of ODUc #1 is “101” for at least 15 consecutive frames. In TX, generates a repeating "01010101" pattern in the entire ODUc signal, excluding the frame alignment overhead (FA OH) and OTUC overhead (OTUC OH).
- **TIM** (Trace Identification Mismatch) indicates that the received SAPI and/or DAPI do not math the expected SAPI and/or DAPI. This alarm is only available when the **SAPI ODU-TIM** and/or **DAPI ODU-TIM** check boxes are selected from *PT / Global PT* on page 442.

## Errors

- **BEI** (Backward Error Indication) indicates that there is interleaved block in error detected by the corresponding ODU path monitoring sink using the BIP-8 code.

ODU BEI bits (1234)	BIP violations	ODU BEI bits (1234)	BIP violations
0000	0	0101	5
0001	1	0110	6
0010	2	0111	7
0011	3	1000	8
0100	4	1001 to 1111	0

- **BIP-8** (Bit Interleave Parity-8) indicates that there is a PM BIP-8 mismatch between the received value and locally computed value (0 to 8).



## ODUx and ODUk (ODUflex)

**Note:** For OPUx and OPUk (OPUflex) alarms see page 923. For GMP alarms/errors see page 911.

### Alarms

- **AIS** (Alarm Indication Signal) indicates that the STAT information in the PM byte 3, bits 6 to 8 is “111” for at least 3 consecutive frames. In TX, generates an all “1”s pattern in the entire ODUk signal, excluding the frame alignment overhead (FA OH), OTUk overhead (OTUk OH) and ODUk FTFL.
- **BDI** (Backward Defect indication) indicates that the BDI bit in the PM overhead field (byte 3, bit 5) is “1” for at least 5 consecutive frames. In TX, generates a “1” in the BDI (byte 3, bit 5) of the PM overhead field continuously.
- **BSD** (Backward Signal Degrade) indicates that the FTFL byte 128 is “00000010”. In TX, generates a “00000010” pattern in the FTFL Byte 128 continuously.
- **BSF** (Backward Signal Fail) indicates that the FTFL byte 128 is “00000001”. In TX, generates a “00000001” pattern in the FTFL Byte 128 continuously.
- **FSD** (Forward Signal Degrade) indicates that the FTFL byte 0 is “00000010”. In TX, generates a “00000010” pattern in the FTFL Byte 0 continuously.
- **FSF** (Forward Signal Fail) indicates that the FTFL byte 0 is “00000001”. In TX, generates a “00000001” pattern in the FTFL Byte 0 continuously.
- **LCK** (Lock) indicates that the STAT information in the PM byte 3, bits 6 to 8 is “101” for at least 3 consecutive frames. In TX, generates a repeating “01010101” pattern in the entire ODUk signal, excluding the frame alignment overhead (FA OH) and OTUk overhead (OTUk OH).

## Alarms/Errors

### ODUx and ODUk (ODUflex)

---

- **LOFLOM** (Loss of Frame Loss Of Multiframe), available for mapped ODU client signal (designated as LO in the standard), indicates that OOF is present for at least 3 ms. In TX, generates error continuously in FAS and MFAS of a multiplexed test case.
- **OCI** (Open Connection Indication) indicates that STAT information in the PM byte 3, bits 6 to 8 is "110" for at least 3 consecutive frames. In TX, generates a repeating "01100110" pattern in the entire ODUk signal, excluding the frame alignment overhead (FA OH) and OTUk overhead (OTUk OH).
- **TIM** (Trace Identification Mismatch) indicates that the received SAPI and/or DAPI do not math the expected SAPI and/or DAPI. This alarm is only available when the **SAPI ODU-TIM** and/or **DAPI ODU-TIM** check boxes are selected from *PT / Global PT* on page 285.

## Errors

- **BEI** (Backward Error Indication) indicates that there is interleaved block in error detected by the corresponding ODU path monitoring sink using the BIP-8 code.

ODU BEI bits (1234)	BIP violations	ODU BEI bits (1234)	BIP violations
0000	0	0101	5
0001	1	0110	6
0010	2	0111	7
0011	3	1000	8
0100	4	1001 to 1111	0

- **BIP-8** (Bit Interleave Parity-8) indicates that there is a PM BIP-8 mismatch between the received value and locally computed value (0 to 8).

## ODUx-TCM

### Alarms

- **BDI** (Backward Defect Indication) indicates that the BDI bit in the TCM overhead field Byte 3, bit 5 is “1” for at least 5 consecutive frames. In TX, generates a "1" in the BDI bit of the TCM overhead field (byte 3, bit 5) continuously.
- **BIAE** (Backward Incoming Alignment Error) indicates that the BEI/BIAE bits in the TCM overhead field Byte 3, bits 1 to 4 are “1011” for at least 3 consecutive frames. In TX, generates "1011" in the BEI/BIAE bits of the TCM overhead (byte 3, bits 1 to 4) continuously.
- **IAE** (Incoming Alignment Error) indicates that the STAT information in the TCM is “010” for at least 3 consecutive frames. In TX, generates "1" in the IAE bit of the TCM overhead (byte 3, bit 6) continuously.
- **LTC** (Loss of Tandem Connection) indicates that the STAT information in the TCM Byte 3, bits 6, 7, and 8 are “000” for at least 3 consecutive frames. In TX, generates "000" in the STAT field of TCM overhead (byte 3, bits 6 to 8) continuously.
- **TIM** (Trace Identification Mismatch) indicates that the SAPI and/or DAPI do not math the expected SAPI and/or DAPI. This alarm is only available when the **SAPI TCM-TIM** and/or **DAPI TCM-TIM** check boxes are selected from *PT / Global PT* on page 285.

## Alarms/Errors

OPUCn

---

### Errors

- **BEI** (Backward Error Indication) indicates that there is interleaved block in error detected by the corresponding ODU tandem connection monitoring sink using the BIP-8 code.

ODU TCM BEI bits (1234)	BIP violations	ODU BEI bits (1234)	BIP violations
0000	0	0101	5
0001	1	0110	6
0010	2	0111	7
0011	3	1000	8
0100	4	1001 to 1111	0

- **BIP-8** (Bit Interleave Parity-8) indicates that there is a TCM BIP-8 mismatch between the received value and locally computed value (0 to 8).

## OPUCn

**Note:** OPUCn is displayed under ODUCn alarms/errors group.

### Alarms

- **LOOMFI** (Loss of OPU Multi-Frame Identifier) indicates that OOMFI is present for at least 3 ms.
- **MSIM** (Multiplex Structure Identifier Mismatch) indicates that the RX Payload Structure Identifier (PSI) information does not match the expected HO Multiplex Structure Identifier defined. In TX, corrupts the content of the PSI bytes associated to the ODUk.

**MSIM Monitoring** check box when selected (default) monitors the **MSIM** alarm.

- **OOMFI** (Out of OPU Multi-Frame Identifier) indicates that OPU Multi-frame Identifier number are in error for at least 5 consecutive OTUC frames.
- **PLM** (Payload Mismatch) indicates that the Payload Structure Identifier (PSI) field does not match the expected PT for at least 3 consecutive frames. Available when the OPU-PLM check box is selected.

## **Errors**

- **OMFI** (OPU Multi-Frame Identifier) indicates that an invalid OMFI word sequence is detected.

## **OPUx and OPUk (OPUflex)**

**Note:** *OPUx is displayed under ODUx alarms/errors group. OPUk (OPUflex) is displayed under ODUk alarms/errors group.*

## **Alarms**

- **AIS** (Alarm Indication Signal), available on the OPU client signal (designated as LO in the standard), indicates that a PRBS11 pattern is received causing a failure of the client signal. In TX, generates a PRBS11 pattern.
- **CSF** (Client Signal Fail), available on the OPU client signal (designated as LO in the standard), indicates that Bit 1 of the OPUk PSI[2] byte is set to “1” causing a failure of the client signal mapped into the OPUk of the OTN signal. In TX, sets the bit 1 of the OPUk PSI[2] byte to “1”.
- **LOOMFI** (Loss of OPU Multi-Frame Identifier) indicates that OOMFI is present for at least 3 ms. Available for OPU4 of a mapped signal.
- **MSIM** (Multiplex Structure Identifier Mismatch), available for the high order path of a multiplexed test case, indicates that the RX Payload Structure Identifier (PSI) information do not match the expected HO Multiplex Structure Identifier defined. In TX, corrupts the content of the PSI as follows: For PT20: Bytes 2 and 3 for ODU0 in ODU1, bytes 2 to 5

## Alarms/Errors

### OTL

---

for ODU1 in ODU2, and bytes 2 to 17 for ODU2 in ODU3. Not applicable for ODU4. For PT21: Bytes 2 to 9 for ODU1 in ODU2, bytes 2 to 33 for ODU2 in ODU3, and bytes 2 to 81 for ODU3 in ODU4. Not applicable for ODU0.

**MSIM Monitoring** check box when selected (default) monitors the **MSIM** alarm.

- **OOMFI** (Out of OPU Multi-Frame Identifier), available for OPU4 of a mapped signal, indicates that the OPU Multi-frame Identifier number are in error for at least 5 consecutive OTU frames.
- **PLM** (Payload Mismatch) indicates that the Payload Structure Identifier (PSI) field does not match the expected PT for at least 3 consecutive frames. Available when OPU-PLM check box is selected.

### Errors

- **OMFI** (OPU Multi-Frame Identifier), available for OPU4 of a mapped signal, indicates that an invalid OMFI word sequence is detected.

## OTL

### Alarms

- **Exc. Skew** (Excessive Skew) indicates that the skew exceeds the defined threshold.
- **LOF** (Loss of Frame) indicates that OOF is present for at least 3 ms.
- **LOL** (Loss of Lane Alignment) indicates that the multilane alignment process is in the out-of-alignment (OLA) state for 3 ms.
- **LOR** (Loss Of Recovery) indicates that OOR persists at least 3 ms.

- **OOF** (Out-Of-Frame) indicates that any byte of the FAS (bytes 3, 4, and 5) is in error for at least 5 consecutive frames.
- **OOR** (Out-Of-Recovery) indicates that while in In-recovery (IR) state, in five consecutive 16320 byte periods each of the received logical lane marker (LLM) is different from the accepted LLM value.

### **Errors**

- **FAS** (Frame Alignment Signal) indicates that FAS bits are in error.
- **Inv. Marker** (Invalid Marker) indicates that errors are detected in the 66-bit block alignment marker.

## **OTUC Frame**

**Note:** *Available with FlexO BERT.*

### **Alarms**

- **LOFLOM** (Loss of Frame Loss Of Multiframe) indicates that OOF is present for at least 3 ms. In TX, generates error continuously in FAS and MFAS.
- **OOF** (Out-Of-Frame) indicates that FAS (bytes 3, 4, and 5) are in error for at least 5 consecutive OTUC frames or MFAS does not match the expected value for at least 5 consecutive OTUC frames. In TX, generates error in all FAS bits for 5 consecutive OTUC frames.

### **Errors**

- **FAS** (Frame Alignment Signal) indicates that the received FAS does not match the expected value.
- **MFAS** (Multiframe Alignment Signal) indicates that the received MFAS does not match the expected value.

# OTUCn

**Note:** Available with FlexO BERT.

## Alarms

- **AIS** (Alarm Indication Signal) indicates that the STAT bits in the SM overhead field (byte 3, bits 6 to 8) of the OTUC #1 are “111” for at least 15 consecutive frames. In TX, generates all ones over each OTUC of the signal excluding the OH framing (FAS and MFAS).
- **BDI** (Backward Defect Indication) indicates that the BDI bit in the SM overhead field (byte 3, bit 5) of the OTUC #1 is “1” for at least 15 consecutive frames. In TX, generates “1” for the BDI bit in the SM overhead field (byte 3, bit 5) of the OTUC #1 continuously.
- **BIAE** (Backward Incoming Alignment Error) indicates that the BEI/BIAE bits in the SM overhead field (byte 3, bits 1 to 4) are “1011” for at least 3 consecutive frames. In TX, generates “1011” for the BEI/BIAE bits in the SM overhead field (byte 3, bits 1 to 4) of OTUC continuously.
- **IAE** (Incoming Alignment Error) indicates that the STAT bits in the SM overhead field (byte 3, bits 6 to 8) of the OTUC #1 are “010” for at least 15 consecutive frames. In TX, generates “010” for the STAT bits in the SM overhead field (byte 3, bits 6 to 8) of the OTUC #1 continuously.
- **TIM** (Trace Identifier Mismatch) indicates that the expected SM SAPI and/or SM DAPI do not match the received SM SAPI and/or DAPI for at least 3 consecutive TTI. This alarm is only available when the **SAPI OTU-TIM** and/or **DAPI OTU-TIM** check boxes are selected from page 440.



## Errors

- **BEI** (Backward Error Indication) indicates that SM BEI errors are received from the DUT (value 0 to 8).

OTU BEI bits (1234)	BIP violations	ODUk BEI bits (1234)	BIP violations
0000	0	0101	5
0001	1	0110	6
0010	2	0111	7
0011	3	1000	8
0100	4	1001 to 1111	0

- **BIP-8** (Bit Interleave Parity-8) indicates that there is a SM BIP-8 mismatch between the received value and locally computed value (0 to 8).

## OTU<sub>x</sub>

**Note:** Available for OTU4, OTU3, OTU3e1, OTU3e2, OTU2f, OTU1f, OTU2e, OTU1e, OTU2, and OTU1.

## Alarms

- **AIS** (Alarm Indication Signal), available with serial interfaces, indicates that polynomial number 11 (PN-11) is over all OTU frame bits including FAS and MFAS for at least 3 consecutive 8192 bit-interval. In TX, generates polynomial number 11 (PN-11) over all OTU frame bits including FAS and MFAS continuously.
- **BDI** (Backward Defect Indication) indicates that the BDI bit in the SM overhead field (byte 3, bit 5) is “1” for at least 5 consecutive OTU frames. In TX, generates “1” for the BDI bit in the SM overhead field (byte 3, bit 5) continuously.

## Alarms/Errors

### OTU<sub>x</sub>

---

- **BIAE** (Backward Incoming Alignment Error) indicates that the BEI/BIAE bits in the SM overhead field (byte 3, bits 1 to 4) are “1011” for at least 3 consecutive frames. In TX, generates “1011” for the BEI/BIAE bits in the SM overhead field (byte 3, bits 1 to 4) continuously.
- **IAE** (Incoming Alignment Error) indicates that the IAE bit in the SM overhead field (byte 3, bit 6) is “1” for at least 5 consecutive OTU frames. In TX, generates “1” for the IAE bit in the SM overhead field (byte 3, bit 6) continuously.
- **LOF** (Loss of Frame) indicates that OOF is present for at least 3 ms. In TX, generates error in all FAS bits continuously.
- **LOM** (Loss Of Multiframe) indicates that OOM is present for at least 3 ms. In TX, generates error in MFAS bits continuously.
- **OOF** (Out-Of-Frame) indicates that FAS (bytes 3, 4, and 5) are in error for at least 5 consecutive OTU frames. In TX, generates error in all FAS bits for 5 consecutive OTU frames.
- **OOM** (Out-Of-Multiframe) indicates that MFAS are in error for at least 5 consecutive OTU frames. In TX, generates error in multiframe number for 5 consecutive OTU frames.
- **TIM** (Trace Identifier Mismatch) indicates that the expected SM SAPI and/or SM DAPI do not match the received SM SAPI and/or DAPI for at least 3 consecutive TTI. This alarm is only available when the **SAPI OTU-TIM** and/or **DAPI OTU-TIM** check boxes are selected.

## Errors

- **BEI** (Backward Error Indication) indicates that there is a SM BIP-8 mismatch between the received value and locally computed value (0 to 8).

OTU BEI bits (1234)	BIP violations	ODUk BEI bits (1234)	BIP violations
0000	0	0101	5
0001	1	0110	6
0010	2	0111	7
0011	3	1000	8
0100	4	1001 to 1111	0

- **BIP-8** (Bit Interleave Parity-8) indicates that SM BEI errors are received from the DUT (value 0 to 8).
- **FAS** (Frame Alignment Signal) indicates that the FAS bits are in error.
- **FEC-CORR-BIT** (FEC - Correctable - Bit) indicates that statistics on bits (BIT) are corrected by the FEC. In TX, generates 1 symbol (byte) containing 1 bit in error.
- **FEC-CORR-CW** (FEC - Correctable - Codeword) indicates that statistics on codewords (CW) are corrected by the FEC. In TX, generates 8 symbols (bytes) containing 8 bits in error each, in each codeword.
- **FEC-CORR-SYM** (FEC - Correctable - Symbol) indicates that statistics on symbols (SYMB) are corrected by the FEC. In TX, generates 1 symbol (byte) containing 8 bits in error.
- **FEC-STRESS** (Forward Error Correction - Stress) generates correctable errors composed of a random number of symbol errors (less or equal to 8) containing a random number of bits distributed all over the OTU frame.

## Alarms/Errors

### Path OAM

---

- **FEC-UNCORR-CW** (FEC - Uncorrectable - Codeword) indicates statistics on the detected codewords (CW) having uncorrectable errors. In TX, generates 16 symbol (bytes) containing 8 bits in error each, in each codeword.
- **MFAS** (Multiframe Alignment Signal) indicates that the MFAS bits are in error.

## Path OAM

### Alarms

- **BAS Unexp. Period** indicates that the period field value of the received Basic OAM message is different than the one configured.
- **CS\_LF** (Client Signal Local Fault) indicates that a Basic OAM message is received with the CS\_LF field set.
- **CS\_LPI** (Client Signal Low Power Indication) indicates that a Basic OAM message is received with the CS\_LPI field set.  
**CS\_LPI Monitoring** check box, when selected (cleared by default), allows monitoring the **CS\_LPI** alarms.
- **CS\_RF** (Client Signal Remote Fault) indicates that a Basic OAM message is received with the CS\_RF field set.
- **CS Type Mismatch** indicates a mismatch between the received and the expected CS Type.
- **DAPI Mismatch** indicates a mismatch between the received and the expected DAPI message.
- **Loss Continuity** indicates that no Basic OAM messages are received for at least 3.5 times the configured Basic OAM transmission period.
- **RDI** (Remote Defect Indication) indicates that a Basic OAM message is received with the RDI field set.

- **SAPI Mismatch** indicates a mismatch between the received and the expected SAPI message.
- **Signal Failure** indicates that the BIP-8 error rate is above the Signal Failure threshold configured.

## Errors

- **BIP-8** (Bit Interleaved Parity - 8) indicates a BIP-8 mismatch between the received value and the locally computed value.
- **CRC4** indicates a message block having invalid CRC4 value.
- **REI** (Remote Error Indication) indicates that REI are received from path peer.

## PHY

**Note:** Available with FlexE BERT from the Alarms/Errors **PHY** tab.

## Alarms

- **Hi-BER** (High-Bit Error Ratio), available with 100GE interface, indicates that the bit error ratio is  $> 10^{-4}$  on a fixed time period of 500  $\mu$ s.
- **Link Down** indicates that there are alarms at the PCS level.
- **LOA** (Loss Of Alignment), available with 200GE/400GE, indicates that two or more logical lanes have the same logical lane marker value, or one or more logical lane marker recovery processes are in the OOR state, or if the differential delay between two logical lanes exceeds the configured alarm threshold compensable delay.
- **L Deg SER Det** (Local Degraded SER Detected), available with 200GE/400GE when **FEC Degraded SER** is enabled, indicates that a local FEC degraded SER condition is detected.

## Alarms/Errors

### PHYs/Instances

---

- **L Deg SER Rcd** (Local Degraded SER Received), available with 200GE/400GE when **FEC Degraded SER** is enabled, indicates that a Local degraded SER signal is detected.
- **R Deg SER** (Remote Degraded SER), available with 200GE/400GE when **FEC Degraded SER** is enabled, indicates that a remote degraded SER signal is detected.

### Errors

- **FEC-COR-CW** (FEC Correctable Codeword), available with 200GE/400GE, indicates that FEC correctable codeword error is detected on the Ethernet signal. The **FEC-COR-CW** does not raise an error, only the count and rate values are reported. Available when RS-FEC is enabled.
- **FEC-UNCOR-CW** (FEC Uncorrectable Codeword), available with 200GE/400GE, indicates that FEC uncorrectable codeword error is detected on the Ethernet signal. Available when RS-FEC is enabled.

## PHYs/Instances

**Note:** Available with FlexE BERT from the Alarms/Errors **Group** tab.

- **PHY Skew Alarm Threshold (ns)**, available with multiple PHY, allows setting the threshold value that will be used to declare an excessive PHY skew alarm: **50 ns** to **1000 ns**, default is **300 ns**. The **Default** button restores the default PHY skew alarm threshold value.

### Alarms

- **Excessive PHY Skew**, available with multiple PHY, indicates that the skew is above the configured **PHY Skew Alarm Threshold**.
- **FlexE Group Number Mismatch** indicates that the received FlexE group number is different of the one configured. Not applicable when the group number is set to 0.

- **Loss of OH Frame Lock** indicates that the received SH control block or the “O” code doesn’t match the expected position for 5 occurrences.
- **Loss of OH MF Lock** indicates that the OMF bit changes from 0 to 1 or 1 to 0 in consecutive OH frames with good CRC.
- **Loss of PHY Number Lock** indicates that the received PHY number value is different than the locked one for two consecutive OH frames with good CRC. A PHY number lock condition occurs when the same PHY number value is received in two consecutive OH frames with good CRC.
- **Remote PHY Fault** indicates that the RPF bit is set in the OH.

## Errors

- **OH CRC** indicates an invalid CRC in the OH received.

## PTP

### Alarms

- **Domain Mismatch**, available with G.8275.1 profile, indicates that none of the received Domain values match the configured value (refer to page 202).
- **Loss Announce** indicates that the Slave Clock does not receive Announce messages within their expected arrival time for a duration exceeding the configured **Receipt Timeout** (refer to *Alarm Timeout/Threshold / Alarm Threshold* on page 205).
- **Loss Sync** indicates that the Slave Clock does not receive packet timing signal messages (Sync, Follow Up, Delay Resp) within their expected arrival time for a duration exceeding the configured **Receipt Timeout** (refer to *Alarm Timeout/Threshold / Alarm Threshold* on page 205).

- **QL Mismatch** indicates that the received QL value does not match the Expected QL. The **QL Mismatch** alarm is only reported when at least one Announce message has already been received (**Last QL Received**) and that the **QL Mismatch Monitoring** check box is selected. Only supported with the 1588 PTP test application.
- **Unusable**, available for the 1588 PTP test application with G.8265.1/G.8275.2 profile, indicates that either the maximum Sync IPDV value or the maximum Delay Req IPDV value in the last second exceeds the configured **IPDV Threshold** (refer to *Alarm Timeout/Threshold / Alarm Threshold* on page 205).
- **Unusable**, available for Time Error measurement with G.8275.2 profile, indicates that either the maximum Sync IPDV value or the maximum Delay Req IPDV value in the last second exceeds the configured **Unusable** alarm threshold (refer to *Alarm Timeout/Threshold / Alarm Threshold* on page 205).

## QoS Metrics

**Note:** Available with Traffic Gen & Mon and eCPRI BERT test applications.

### Errors

- **Frame Loss** indicates that a sequence number is missing in the received frames.
- **Out-of-Seq.** (Out-of-Sequence) indicates that the received frame sequence number is either smaller than the expected frame sequence number or is a duplicate number.



## Reference Signal

### Alarms

- **REF-FAULT** indicates that an impairment is detected on the reference signal. When an impairment is detected on the reference signal the test automatically stops.

## RS-FEC (CPRI)

### Errors

- **FEC-COR-CW** (FEC Correctable Codeword) indicates that FEC Codeword containing errors were corrected.
- **FEC-UNCOR-CW** (FEC Uncorrectable Codeword) indicates that FEC Codeword containing errors were not corrected.
- **Pre-FEC-SYMB** (Pre-FEC Symbol) indicates that FEC symbol errors are corrected and counted once for each 10-bit symbol.

## RS-FEC (Ethernet)

### Alarms

#### RS-FEC

- **FEC-LOA** (FEC-Loss Of Alignment) indicates that the deskew process is not complete meaning that not all lanes are synchronized (Alignment Marker locked) and aligned. Not available with 100GE (1 Lane)/100GE (2 Lanes) interface.
- **FEC Degraded SER** indicates that a FEC degraded SER condition is detected. Available with 50GE when **FEC Degraded SER** is enabled.

## Alarms/Errors

### RS-FEC (Ethernet)

---

#### FEC Lanes

- **FEC-LOAML** (FEC-Loss Of Alignment Marker Lock) indicates that the location of the alignment marker payload sequence for a given lane on the PMA service interface is not detected. Not available with 100GE (1 Lane)/100GE (2 Lanes) interface.
- **FEC Exc. Skew** (Excessive Skew), available with 50GE, indicates that the skew exceeds the defined threshold.
- **Skew Alarm Threshold (bits)**, available with 50GE, allows setting the threshold value that will be used to declare a skew alarm: **0** to **10550** (default is **4781**). **Default** restore the default skew alarm threshold value.

#### Errors

##### RS-FEC

- **FEC-COR-BITS** (FEC Correctable Bits), available with 100GE (1 Lane), indicates that FEC Bits containing errors were corrected.
- **FEC-COR-CW** (FEC Correctable Codeword) indicates that FEC Codeword containing errors were corrected.
- **FEC-UNCOR-CW** (FEC Uncorrectable Codeword) indicates that FEC Codeword containing errors and were not corrected.
- **Inv-CW-Marker** (Invalid Codeword Marker), available with 25GE, indicates that the received Codeword marker is invalid.

##### FEC Lanes

- **Pre-FEC-SYMB** (Pre-FEC Symbol) indicates that FEC symbol errors are corrected and counted once for each 10-bit symbol.
- **FEC Inv. Marker** (FEC Invalid Marker), available with 50GE, indicates that there are errors in the 66-bit block alignment marker.
- **Pre-FEC-Bit**, available with 50GE, indicates the number of bits corrected by the FEC. Receiving uncorrectable codeword may affect the Pre-FEC-Bit error rate.

## S-OAM / MPLS-TP OAM

### Alarms

**Note:** *The following alarms are available when the **CC Function** check box is selected (refer to page 371).*

- **Loss Continuity** indicates that no CCM frames with same or lower MEG/MD Level were received from the peer MEP within an interval equal to 3.5 times the configured CCM transmission period. The alarm is cleared when at least 3 CCM frames with same or lower MEG/MD Level from the peer MEP are received within an interval equal to 3.5 times the configured CCM transmission period.
- **Mismerge** indicates that a CCM frame was received from the peer MEP with same MEG/MD Level but with incorrect MEG ID/MAID value or format. The MAID, composed of a Domain ID and a Short MA Name strings, is incorrect if one or both strings are not as expected. The alarm is cleared when no CCM frames with same MEG/MD Level but with incorrect MEG ID/MAID value or format are received within an interval equal to 3.5 times the configured CCM transmission period.
- **RDI (Remote Defect Indication)** indicates that the RDI flag bit of a valid CCM frames is set to 1. A valid CCM frame has its source MAC address matching the Peer MEP MAC address, the destination MAC address matching either the unit port Unicast MAC address or a Multicast class 1 address (refer to page 867), and VLANs matching the unit port VLANs.
- **Unexp MEG/MD Lvl (Unexpected MEG/MD Level)** indicates that a CCM frame was received from the peer MEP with lower MEG/MD Level. The alarm is cleared when no CCM frames with lower MEG/MD Level are received within an interval equal to 3.5 times the configured CCM transmission period.

## Alarms/Errors

### S-OAM / MPLS-TP OAM

---

- **Unexp MEP** (Unexpected MEP) indicates that a CCM frame was received from the peer MEP with same MEG/MD Level, correct MEG ID/MAID, and correct source MAC Address (corresponds to the peer MEP) but with unexpected MEP ID. The alarm is cleared when no CCM frames with same MEG/MD Level, correct MEG ID/MAID, correct source MAC Address (corresponds to the peer MEP) but with an unexpected MEP ID are received within an interval equal to 3.5 times the configured CCM transmission period.
- **Unexp Period** (Unexpected Period) indicates that a CCM frame is received from the peer MEP with same MEG/MD Level, correct MEG ID/MAID, and correct MEP ID but with a period field value different than the one configured. The alarm is cleared when no CCM frames with same MEG/MD Level, correct MEG ID/MAID, and correct MEP ID but with incorrect period field value are received within an interval equal to 3.5 times the configured CCM transmission period.

**Note:** *The following alarms are available with G.8113.1, Y.1731 and MEF modes.*

- **AIS** (Alarm Indication Signal) indicates that a valid AIS frame is received. A valid frame has its destination MAC address matching either the unit port Unicast MAC address or a Multicast class 1 address (refer to page 867), VLANs matching the unit port VLANs, and MEG level matching the local MEG level. The alarm is cleared when during an interval equal to 3.5 times the AIS transmission period indicated in the last received AIS frame, no AIS frames are received.
- **C-DCI** (Client Signal Fail - Defect Clear Indication) generates a CSF frame with CSF type equal to **011**.
- **C-FDI** (Client Signal Fail - Forward Defect Indication) indicates that a CSF frame is received with CSF type equal to **001**. The alarm is cleared when no CSF (C-FDI) frames are received during an interval equal to 3.5 times the CSF transmission period indicated in the last received CSF (C-FDI) frame, or when a CSF frame is received with Client Defect Clear Indication (C-DCI) information (CSF Type 011).

- **C-LOS** (Client Signal Fail - Loss Of Signal) A CSF frame is received with CSF type equal to **000**. The alarm is cleared when no CSF (C-LOS) frames are received during an interval equal to 3.5 times the CSF transmission period indicated in the last received CSF (C-LOS) frame, or when a CSF frame is received with Client Defect Clear Indication (C-DCI) information (CSF Type 011).
- **C-RDI** (Client Signal Fail - Remote Defect Indication) indicates that a CSF frame is received with CSF type equal to **010**. The alarm is cleared when no CSF (C-RDI) frames are received during an interval equal to 3.5 times the CSF transmission period indicated in the last received CSF (C-RDI) frame, or when a CSF frame is received with Client Defect Clear Indication (C-DCI) information (CSF Type 011).
- **LCK** (Locked) indicates that a valid LCK frame is received. A valid frame has its destination MAC address matching either the unit port Unicast MAC address or a Multicast class 1 address (refer to page 867), VLANs matching the unit port VLANs, and MEG level matching the local MEG level. The alarm is cleared when during an interval equal to 3.5 times the LCK transmission period indicated in the last received LCK frame, no LCK frames are received.

## **Section/Line / RS/MS**

### **Alarms**

- **AIS-L / MS-AIS** (Alarm Indication Signal) indicates that bits 6, 7 and 8 of the K2 byte contain the “111” pattern in five consecutive frames. In TX, generates a SONET/SDH signal that contains a valid Section Overhead (SOH) / Regenerator Section Overhead (RSOH) and an all-ones pattern on the SPE.
- **LOF-S / RS-LOF** (Loss Of Frame) indicates that an SEF (SONET)/RS-OOF (SDH) defect on the incoming optical signal persists for at least 3 milliseconds. In TX, generates non-valid framing bytes (A1 and A2).

## Alarms/Errors

Section/Line / RS/MS

---

- **RDI-L / MS-RDI** (Remote Defect Indication) indicates that bits 6, 7, and 8 of the K2 byte contain the “110” pattern in five consecutive frames. In TX, generates a “110” pattern for the bits 6, 7 and 8 of the K2 byte.
- **SEF / RS-OOF** (Severely Errored Framing / Out-Of-Frame) indicates that a minimum of four consecutive errored framing patterns are received. In TX, generates four consecutive errored framing patterns.
- **TIM-S / RS-TIM** (Trace Identifier Mismatch) indicates that the received J0 Trace doesn't match the expected message value. Only available when Enable TIM-S/RS-TIM check box is selected (refer to *Traces - SONET/SDH* on page 438).

## Errors

- **B1** (BIP-8, Bit-Interleave Parity - 8 bits) indicates a Section (SONET) / Regeneration Section (SDH) parity error by performing a routine even-parity check over all frames of the previous STS-n/STM-n signal (located in the first STS-1/STM-1 of an STS-n/STM-n signal).
- **B2** (BIP-8, Bit-Interleave Parity - 8 bits): For SONET indicates a Line parity error by performing an even-parity check over all bits of the LOH and SPE of the previous frame (located in every STS-1 of an STS-n signal). For SDH indicates a Multiplex Section parity error by performing an even-parity check over all bits (except those in the RSOH bytes) of the previous frame of a STM-N signal.
- **FAS-S / RS-FAS** (Frame Alignment Signal) indicates that at least one A1 or A2 byte of the FAS word is in error.
- **REI-L / MS-REI** (Remote Error Indicator) indicates that the M0, M1, or the combination of both M0 and M1 bytes indicate that one or more BIP violations have been detected. Refer to **M0 or M1/Z2 (SONET)** on page 692 for more information. For OC-192, also refer to *REI-L Computation Method* on page 402.

## STS-x/AU-x

### Alarms

- **AIS-P / AU-AIS** (Alarm Indication Signal) indicates that the H1 and H2 bytes contain an all-ones pattern in three consecutive frames or more. In TX, generates an all-ones pattern over H1, H2, H3, and SPE.
- **ERDI-PCD / ERDI-CD** (ERDI - Connectivity Defect) indicates that bits 5, 6, and 7 of the G1 byte contain the “110” pattern in five consecutive frames. In TX, generates a “110” pattern for bits 5, 6, and 7 of the G1 byte.
- **ERDI-PPD / ERDI-PD** (ERDI - Payload Defect) indicates that bits 5, 6, and 7 of the G1 byte contain the “010” pattern in five consecutive frames. In TX, generates a “010” pattern for bits 5, 6, and 7 of the G1 byte.
- **ERDI-PSD / ERDI-SD** (ERDI - Server Defect) indicates that bits 5, 6, and 7 of the G1 byte contain the “101” pattern in five consecutive frames. In TX, generates a “101” pattern for bits 5, 6, and 7 of the G1 byte.
- **H4-LOM** (H4 - Loss Of Multiframe), for VT/TU structured optical frames, indicates that the system loss track of the H4 byte multiframe indicator sequence. In TX, generates a wrong H4 byte multiframe indicator sequence.
- **LOP-P / AU-LOP** (Loss Of Pointer) indicates that a valid pointer is not found in N consecutive frames (where  $8 \leq N \leq 10$ ), or that N consecutive NDFs (“1001” pattern) are detected (non-concatenated payloads). In TX, generates a non-valid pointer.
- **PDI-P** (Payload Defect Indication), for VT-structured STS-1 SPE, indicates that there is a LOP-V, AIS-V, DS3 AIS, DS3 LOS, or DS3 OOF defect on any VT or DS3 payload that it embeds into the STS SPE that it is originating; for non-VT-structured STS-1 or STS-Nc SPE, the C2 byte contains the hexadecimal FC code. In TX, for VT-structured STS-1 SPE,

## Alarms/Errors

STS-x/AU-x

---

generates a VT-structured STS-1 SPE with payload defect; for non-VT-structured STS-1 or STS-Nc SPE, inserts the hexadecimal FC code in the C2 byte.

- **PLM-P / HP-PLM** (Payload Label Mismatch) indicates that five consecutive frames have mismatched STS/VC signal labels (C2 byte). Only available when PLM-P/UNEQ-P / HP-PLM/HP-UNEQ is enabled (refer to *Labels* on page 306).
- **RDI-P / HP-RDI** (Remote Defect Indication) indicates that bits 5, 6, and 7 of the G1 byte contain the “100” or “111” pattern in five consecutive frames. In TX, generates a “100” pattern for bits 5, 6 and 7 of the G1 byte.
- **TIM-P / HP-TIM** (Trace Identifier Mismatch) indicates that J1 Trace doesn't match the expected message value. Only available when TIM-P/HP-TIM is enabled (refer to *Traces - SONET/SDH* on page 438).
- **UNEQ-P / HP-UNEQ** (Unequipped) indicates that the C2 byte contains “00 H” in five consecutive frames. Only available when PLM-P/UNEQ-P / HP-PLM/HP-UNEQ is enabled (refer to *Labels* on page 306). In TX, generates an all-zeros pattern over POH and SPE.

## Errors

- **B3** (BIP-8, Bit-Interleave Parity - 8 bits) indicates a high order path parity error by performing an even-parity check over all bits of the previous SPE (SONET) / VC-N (SDH).
- **REI-P / HP-REI** (Remote Error Indicator) indicates that bits 1 through 4 of the G1 byte contain one pattern from the following binary range: “0001” through “1000” (1 to 8) (located in every STS-1/STM-1 of an STS-n/STM-n signal).



## SyncE

### Alarms

**Note:** For Time Error / Wander test application only **ESMC Loss** alarm is supported.

- **ESMC Loss** indicates that no ESMC valid information frames were received for more than 5 seconds.
- **QL Mismatch** indicates that received QL does not match the Expected QL value configured. Available when the **QL Mismatch Monitoring** check box is selected.

## TCM (SONET/SDH)

**Note:** TCM is displayed for rates up to OC-192/STM-64 under the STS-x/AU-x or VT/TU alarms/errors group when TCM is enabled.

### Alarms

- **TC-IAIS-P / HPTC-IAIS** (Incoming Alarm Indication Signal) indicates that bits 1 through 4 of the N1 byte are set to “1110”.
- **TC-IAIS-V / LPTC-IAIS** (Incoming Alarm Indication Signal) indicates that bit 4 of the Z6/N2 byte is set to “1”.
- **TC-LTC-P / TC-LTC-V / HPTC-LTC / LPTC-LTC** (Loss of Tandem Connection) indicates that a wrong FAS multiframe is received/generated.
- **TC-ODI-P / TC-ODI-V / HPTC-ODI / LPTC-ODI** (Outgoing Defect Indication), for SONET indicates that bit 7 of the N1/Z6 byte frame 74 is set to “1”; for SDH indicates that bit 7 of the N1/N2 byte multiframe 74 is set to “1”.

## Alarms/Errors

TCM (SONET/SDH)

- **TC-RDI-P / TC-RDI-V / HPTC-RDI / LPTC-RDI** (Remote Defect Indication), for SOENT indicates that bit 8 of the N1/Z6 byte frame 73 is set to “1”; for SDH indicates that bit 8 of the N1/N2 byte multiframe 73 is set to “1”.
- **TC-TIM-P / TC-TIM-V / HPTC-TIM / LPTC-TIM** (Trace Identifier Mismatch) indicates that the received message differs from the defined expected message. The TC-TIM is also declared when receiving invalid ASCII characters or when errors are detected with CRC-7.
- **TC-UNEQ-P / HPTC-UNEQ** (Unequipped) indicates that an all “0”s pattern is received/generated in the higher order path signal label byte (C2), the TCM byte (N1) and the path trace byte (J1), and a valid BIP-8 bytes (B3).

**TC-UNEQ-V / LPTC-UNEQ** (Unequipped / LPTC - Unequipped) indicates that an all “0”s pattern is received/generated in the lower order path signal label (bit 5, 6, 7 of byte V5), the TCM byte (Z6/N2) and the path trace byte (J2), and a valid BIP-2 (bits 1, 2 of V5 byte).

## Errors

**TC-IEC-P / HPTC-IEC** (Incoming Error Count) indicates the number of B3 parity violations detected at the TC Source for STS-1 SPE/VC-3 and above (bits 1 to 4 of the N1 byte).

Number of BIP-8 violations	Bit				Number of BIP-8 violations	Bit			
	1	2	3	4		1	2	3	4
0	0	0	0	0	8	1	0	0	0
1	0	0	0	1	0	1	0	0	1
2	0	0	1	0	0	1	0	1	0
3	0	0	1	1	0	1	0	1	1
4	0	1	0	0	0	1	1	0	0

Number of BIP-8 violations	Bit				Number of BIP-8 violations	Bit			
	1	2	3	4		1	2	3	4
5	0	1	0	1	0	1	1	0	1
6	0	1	1	0	0 (IAIS)	1	1	1	0
7	0	1	1	1	0	1	1	1	1

**TC-OEI-P / TC-OEI-V / HPTC-OEI / LPTC-OEI** (Outgoing Error Indication) indicates errored blocks of the outgoing VTn/VC-n (bit 6 of the N1 or Z6/N2 byte). In TX, bit 6 of the N1 or Z6/N2 byte is set to 1.

**TC-REI-P / TC-REI-V / HPTC-REI / LPTC-REI** (Remote Error Indication) indicates errored blocks caused within the Tandem Connection (bit 5 of the N1 or Z6/N2 byte). In TX, bit 5 of N1 or Z6/N2 byte is set to 1.

**TC-VIOL-P / HPTC-VIOL** (Violations) indicates the number of B3 parity violation within the tandem connection for STS-1 SPE/VC-3 and above.

**TC-VIOL-V / LPTC-VIOL** (Violations) indicates the number of violation within the tandem connection for VT6 SPE/VC-2 and below.

# Transcoding

**Note:** Only available with OTU3 BERT test application with 40 GbE client.

## Alarms

- **Hi-BER1027B** (High-Bit Error Ratio 1027 Blocks) indicates that the bit error ratio is  $> 10^{-4}$  on a fixed 250  $\mu$ s time period.
- **LOAML1027B** (Loss of Alignment Marker Lock 1027 Blocks) indicates that in lock mode, four consecutive marker values are received that do not match the alignment marker that the lane is currently locked to. The LOAML alarm is cleared when the PCS Lane is declared Lock and two valid alignment markers 16384 blocks (66b) apart are received.
- **LOBL1027B** (Loss of Block Lock 1027 Blocks) indicates that sixteen 1027-bit blocks with invalid 3-bit patterns are received before sixty-four valid blocks.

## Errors

- **Inv. Flag** (Invalid Flag) indicates that a 1027-bit block with invalid 3-bit pattern is received.
- **MSEQV** (Marker Sequence Violation) indicates that unexpected marker sequence is detected.
- **POSV** (POS Violation) indicates that two or more POS (Position Field) have the same POS values or they are not in ascending order.
- **SEQV** (Sequence Violation) indicates that unexpected sequence is detected.

## VT/TU

### Alarms

- **AIS-V / TU-AIS** (Alarm Indication Signal) indicates that V1 and V2 bytes for the VT/TU path contain an all-ones pattern in three (SONET) / five (SDH) consecutive superframes. In TX, generates an all-ones pattern for the V1 and V2 bytes of the VT/TU path and payload.
- **ERDI-VCD** (Enhanced Remote Defect Indication - Connectivity Defect) indicates that bits 5, 6, and 7 of the Z7 (SONET) / K4 (SDH) byte contain the “110” pattern, and bit 8 of the V5 byte contain “1”, in five consecutive VT/LP superframes. In TX, generates a “110” pattern for bits 5, 6, and 7 of the Z7 (SONET) / K4 (SDH) byte, and “1” for bit 8 of the V5 byte.
- **ERDI-VPD / LP-ERDI-PD** (Enhanced Remote Defect Indication - Payload Defect) indicates that bits 5, 6, and 7 of the Z7 (SONET) / K4 (SDH) byte contain the “010” pattern, and bit 8 of the V5 byte contain “0”, in five consecutive VT/LP superframes. In TX, generates a “010” pattern for bits 5, 6, and 7 of the Z7 (SONET) / K4 (SDH) byte, and “0” for bit 8 of the V5 byte.
- **ERDI-VSD / LP-ERDI-SD** (ERDI - Server Defect) indicates that bits 5, 6, and 7 of the Z7 (SONET) / K4 (SDH) byte contain the “101” pattern, and bit 8 of the V5 byte contain “1”, in five consecutive VT/LP superframes. In TX, generates a “101” pattern for bits 5, 6, and 7 of the Z7 (SONET) / K4 (SDH) byte, and “1” for bit 8 of the V5 byte.
- **LOP-V / TU-LOP** (Loss Of Pointer) indicates that a valid pointer is not found in N consecutive superframes (where  $8 \leq N \leq 10$ ), or if N consecutive NDFs (“1001” pattern). In TX, generates a non-valid pointer.

- **PLM-V / LP-PLM** (Payload Label Mismatch) indicates that five consecutive superframes with mismatched VT/LP Signal (bits 5 through 7 of the V5 byte are “000”, “001” or “111”). Only available when the **PLM-V/UNEQ-V / LP-PLM/LP-UNEQ** check box is selected (refer to page *Labels* on page 306).
- **RDI-V / LP-RDI** (Remote Defect Indication) indicates that bit 8 of the V5 byte contains “1” in five consecutive VT/TU superframes while bits 6 and 7 of the Z7 (SONET) / K4 (SDH) byte contain the “00” or “11” pattern. In TX, generates “1” for the bit 8 of the V5 byte and a “00” pattern for bits 6 and 7 of the Z7 (SONET) / K4 (SDH) byte.
- **RFI-V / LP-RFI** (Remote Failure Indication) indicates that bit 4 of the V5 byte contains “1” in five consecutive superframes. In TX, generates “1” for the bit 4 of the V5 byte. Available with VC-11 only. Available with VC-11 only.
- **TIM-V / LP-TIM** (Trace Identifier Mismatch), for SONET indicates that the J2 Trace doesn’t match the expected message value; for SDH indicates that tone of the sampled LP trace strings match the expected message value. Only available when the **TIM-V/LP-TIM** check box is selected (refer to page *Traces - SONET/SDH* on page 438).
- **UNEQ-V / LP-UNEQ** (Unequipped) indicates that bit 5 through 7 of the V5 byte contain “000” for five consecutive superframes. Only available when the **PLM-V/UNEQ-V / LP-PLM/LP-UNEQ** check box is selected (refer to page *Labels* on page 306). In TX, generates samples of unequipped VT/LP signal label (bits 5 through 7 of V5 byte are set to “000”).

## Errors

- **BIP-2** (Bit-Interleave Parity - 2 bits), for SONET, indicates a parity error by performing a routine even-parity check over all VT1.5 bytes of the previous frame of a composite signal (VT1.5/VT2/VT6); for SDH, indicates a Low Order Path parity error by performing a routine even-parity check over all bytes of the previous VC frame.
- **REI-V / LP-REI** (Remote Error Indicator) is declared when bit 3 of the V5 byte is set to “1”.

## WIS

### Alarms

- **AIS-L** (Alarm Indication Signal - Line) indicates that bits 6, 7 and 8 of the K2 byte contain the “111” pattern in five consecutive frames.
- **AIS-P** (Alarm Indication Signal - Path) indicates that the H1 and H2 bytes for a STS path contain an all-ones pattern in three consecutive frames or more.
- **ERDI-PCD** (Enhanced RDI - Path Connectivity Defect) indicates that bits 5, 6 and 7 of the G1 byte contain the “110” pattern in five to ten consecutive frames.
- **ERDI-PSD** (Enhanced RDI - Path Server Defect) indicates that bits 5, 6 and 7 of the G1 byte contain the “101” pattern in five to ten consecutive frames.
- **ERDI-PPD** (Enhanced RDI - Path Payload Defect) indicates that bits 5, 6 and 7 of the G1 byte contain the “010” pattern in five to ten consecutive frames.
- **LCD-P** (Loss of Code-Group Delineation - Path) indicates that the signal synchronization has been lost and the valid code-groups are no longer being delineated from the received payload stream being passed to the PCS.

## Alarms/Errors

WIS

---

- **LOF** (Loss Of Frame) indicates that a Severely Error Framing (SEF) defect on the incoming SONET signal persists for at least 3 milliseconds.
- **LOP-P** (Loss Of Pointer - Path), for non-concatenated payloads, indicates that a valid pointer is not found in N consecutive frames (where  $8 = N = 10$ ), or N consecutive NDFs ("1001" pattern) are detected.
- **PLM-P** (Payload Label Mismatch - Path) indicates that five consecutive frames have mismatched STS signal labels.
- **PLM-P/UNEQ-P** (Payload Label Mismatch - Path / Unequipped - Path) check box when selected (cleared by default) enables the Signal Label Mismatch for the expected message defined as well as **UNEQ-P** monitoring.
- **RDI-L** (Remote Defect Indication - Line) indicates that bits 6, 7, and 8 of the K2 byte contain the "110" pattern in five consecutive frames.
- **RDI-P** (Remote Defect Indication - Path) indicates that bits 5, 6 and 7 of the G1 byte contain the "100" or "111" pattern in ten consecutive frames.
- **SEF** (Severely Errored Framing) indicates a minimum of four consecutive errored framing patterns.
- **UNEQ-P** (Unequipped - Path) indicates that the C2 byte contains "00 H" in five consecutive frames.
- **WIS Link Down** indicates that at least one of the following errors is present: AIS-P, LOF, PLM-P, SEF, LOP, or AIS-L.



## Errors

- **B1** (BIP-8, Bit-Interleave Parity - 8 bits) indicates a Section parity error by performing a routine even-parity check over all Section bits of the previous frame of a composite signal (located in the first STS-1 of an STS-n signal).
- **B2** (BIP-1536, Bit-Interleave Parity - 1536 bits) indicates a Line parity error by performing a routine even-parity check over all Line bits of the LOH and STS-1 frame capacity of the previous frame of a composite signal (located in every STS-1 of an STS-n signal).
- **B3** (BIP-8, Bit-Interleave Parity - 8 bits) indicates a Path parity error by performing a routine even-parity check over all Path bits of the previous SPE excluding the LOH and SOH.
- **REI-L** (Remote Error Indicator - Line) indicates that bits 5 through 8 of the M0 byte contain one pattern from the following binary range: "0001" through "1000" (1 to 8) (located in the first STS-1 of an STS-n signal).
- **REI-P** (Remote Error Indicator - Path) indicates that bits 1 through 4 of the G1 byte contain one pattern from the following binary range: "0001" through "1000" (1 to 8) (located in every STS-1 of an STS-n signal).



# D Pop-Up

## Add Channel (Multi-Channel OTN)

- **Channel ID** is the channel ID to be added. Subsequent channel ID are selected then assigned, skipping channel ID already assigned, when adding more than one channel at once.
- **ODU Type** is the ODU mapping type: **ODU0**, **ODU1**, **ODU2**, or **ODU3**. It is possible to have different ODU types when the OTN-MIX-MAPPING software option is enabled; otherwise all channels must have the same ODU type.
- **Quantity** is the number of channel to be added.

## Bulk Read

**Bulk Read** button reads and displays the data based on the specified MDIO range (MDIO/I2C Start Address to MDIO/I2C End Address).

**Save to CSV** button allows saving the read MDIO/I2C's addresses and data to a CSV file.

**Note:** *The bulk read size is limited to 1024 addresses.*

## Bulk Write

**Bulk Write** allows configuring and writing MDIO/I2C data values for up to 20 addresses.

- **Page Select**, available for I2C, allows selecting the I2C address page: **0x00** (default) to **0xFF**.
- **Address** and **Data** allows defining up to 20 MDIO/I2C addresses and their data values: **0x0000** (default) to **0xFFFF** for MDIO and **0x00** (default) to **0xFF** for I2C.

## Pop-Up

### Config TCM

---

- **Bulk Write** button writes the MDIO/I2C data values for each MDIO/I2C address defined.
- **Default** button resets the MDIO/I2C page select, addresses, and data values to their default values.

## Config TCM

**Config TCM** allows enabling each TCM level (1 to 6) individually. All ODUx of a mapped signal are also available. All TCM check boxes are cleared by default (disabled). Refer to *Traces - OTN* on page 435 for more information. Not available with Multi-Channel OTN.

## Configure Per Frame Size

**Config. per Frame Size** is available when the **Copy From Throughput** check box is cleared and allows setting the **Max. Rate** for each frame size. For **Dual Test Set** the **Max. Rate** is configurable for both local (**L**) and remote (**R**) directions. For **Dual Port** topology, **Max. Rate** is configurable for both port directions.

**All Frames** check box when selected (cleared by default) allows entering the maximum rate that will be applied to all frame sizes.

## Copy Service

- **Copy Service** allow selecting the services number from which the configuration will be copied from.
- **To the following Services** allows selecting all services that will inherit the configuration from the selected service. An orange background represents a selected service. A service that is already enabled cannot be selected for copy.

- **Copy** allows confirming the service configuration copy for all selected services.

## **Copy Stream**

Select the stream number the configuration will be copied from.

From **To the following Streams**, select all streams that will inherit the configuration from the selected stream. An orange background represents a selected stream. A stream that is already enabled (Enable TX) cannot be selected for copy.

Tap **Copy** to confirm the stream configuration for all selected streams.

## **DS1 Loopback**

The Loopback feature generates a code that is interpreted by the DUT. The DUT interprets the command and implements the loopback.

- **Loop Code** allows selecting the type of loopback that will be used to overwrite the traffic that will be generated. Choices are listed in the following table in addition with 10 predefined Loop Codes (see **Modify Loop Codes** *allows the configuration of 10 DS1 loop code pairs. Configure each loop code Name, Loop-Up and Loop-Down values. The name field allows up to 16 characters. Loop-Up and Loop-Down range is from 3 to 16 bits (000 to 1111111111111111).* The default DS1 loop codes correspond to the DS1 In-Band loop codes (Loop-Up=10000, and Loop-Down=100). on page 957).

Loopback Type	Command	
	Loop-Up	Loop-Down
CSU (10000/100)	10000 (default)	100
NIU FAC1 (1100/1110)	1100	1110
NIU FAC2 (11000/11100)	11000	11100
NIU FAC3 (100000/100)	100000	100

- **Loop-Up** injects the selected loop up code. The loop code will be generated continuously for a maximum of 10 seconds or until the loopback is confirmed. After 10 seconds, if the loopback has failed, a Loop-Down command is sent. A pop-up window appears indicating the loop code injection progress and result. The text box next to the **Loop-Up** button indicates the selected loop up code.

- **Loop-Down** injects the selected loop down code. The loop code will be generated continuously for a maximum of 10 seconds or until the loopback is confirmed. After 10 seconds, if the loopback has failed, a Loop-Down command is sent. A pop-up window appears indicating the loop code injection progress and result. The text box next to the **Loop-Down** button indicates the selected loop down code.
- **Modify Loop Codes** allows the configuration of 10 DS1 loop code pairs. Configure each loop code **Name**, **Loop-Up** and **Loop-Down** values. The name field allows up to 16 characters. **Loop-Up** and **Loop-Down** range is from 3 to 16 bits (**000** to **1111111111111111**). The default DS1 loop codes correspond to the DS1 In-Band loop codes (Loop-Up=**10000**, and Loop-Down=**100**).

## EMIX

- **Quantity** allows selecting 2 to 8 frame size values.
- **EMIX Frame Sizes** allows setting the EMIX frame sizes: 48<sup>1</sup> to 16000<sup>2</sup>.

The following table lists each component, when supported by the test application, that may affect the minimum frame size value.

Component	Description
VLAN	4 bytes per VLAN
MPLS	4 bytes per label (up to two labels)
EoE Header	16 bytes
EoE VLAN	4 bytes
PBB-TE Header	18 bytes
B-VLAN	4 bytes
LLC and SNAP Headers	8 bytes
UDP	8 bytes
TCP	20 bytes
Ethernet Header	14 bytes
IPv4	20 bytes
IPv6	40 bytes
Latency	8 bytes
Using DTS	4 bytes

- **Restore Default** button reverts the quantity and EMIX frame sizes to their default values.

1. The minimum value is adjusted according to the frame structure and components selected as shown in the following table. The minimum of 48 bytes is only available for rates up to 10GE, for higher rates the minimum frame size is 64 bytes. For EtherSAM the minimum frame size is 64 bytes.

2. The maximum frame size is limited to 10000 for 10/100/1000Mbps electrical interface.



## Export Capture

**Export**, available when the test application is stopped, allows exporting the data captured into a .pcap file format and viewing the file using Wireshark.

- **Save In** allows selecting the folder to save the capture file (by default: Users\<User>\Documents\88000-PowerBlazer\CaptureData).
- **View File After Generation** check box when selected (cleared by default) allows displaying the report once it is generated using the Wireshark application.
- **Generate & Save** allows generating and saving the capture data. The name of the captured file is automatically selected and contains the date and time of the capture. Capture file bigger than 100Mbytes will be split into multiple files. Tapping on the **Cancel** button stops the capture generation. The captured data already processed will be saved.

**Note:** *The export process may take several minutes.*

Once generated, the capture file will be automatically opened in Wireshark when the **View File After Generation** check box is selected. The capture file report may also be manually opened within Wireshark typically using Windows Explorer.

## **FEC Degraded SER Thresholds**

The alarm is raised when the number of symbol errors is higher than the **Activate Threshold (Symbols)** defined. The alarm is cleared when the number of symbol errors is lower than the **Deactivate Threshold (Symbols)** defined.

- **Interval (CW)** defines the number of codewords (interval) used by the FEC decoder to count the number of symbol errors detected.
- **Activate Threshold (Symbols)** defines the number of detected symbols required to declare the **Local Degraded SER Detected** alarm.
- **Deactivate Threshold (Symbols)** defines the number of detected symbols required to clear the **Local Degraded SER Detected** alarm.

## Filter Configuration

- “(“ and “)”“, the open and close parenthesis controls the precedence of operands when more than two operands are used. Only one level of parenthesis is supported. When no parenthesis are used, a logical AND has precedence over a logical OR.
- **Not** check box when selected, adds the logical negation (not equal) operator for the operand filter defined at its right.
- **Filter** specifies the filter to be used (**None** by default).

Category	Filter
Ethernet	MAC Destination Address, MAC Source Address, EtherType <sup>a</sup> , C-VLAN ID, S-VLAN ID, E-VLAN ID, C-VLAN Priority, S-VLAN Priority, E-VLAN Priority, Frame Format
IPv4	IPv4 Destination Address, IPv4 Source Address, IPv4 TOS, IPv4 Precedence, IPv4 Protocol, IPv4 DiffServ
IPv6	IPv6 Destination Address, IPv6 Source Address, IPv6 Flow Label, IPv6 Next Header <sup>b</sup> , IPv6 Traffic Class, IPv6 Precedence, IPv6 DiffServ
Higher Layer	TCP Destination Port <sup>c</sup> , TCP Source Port <sup>c</sup> , UDP Destination Port, UDP Source Port
MPLS <sup>d</sup>	MPLS Label 1, MPLS Label 2, MPLS COS 1, MPLS COS 2

- a. Applies only to the last EtherType occurrence when VLAN is used.
- b. Applies only to the last next header occurrence when extension headers are used.
- c. Available with 10M to 10G interface rates only.
- d. Available when the corresponding software option is enabled.

- **Value** is the value associated to the selected filter.

## Pop-Up

### *Filter Configuration*

---

- **Mask** allows masking the defined filter value. A bit mask of 1 indicates that the corresponding bit in the value is compared for the match. A bit mask of 0 indicates that the corresponding bit in the value is ignored.

For binary values, enter the mask value in binary format.

For decimal and MAC address values, enter the mask value in hexadecimal format.

For IP address field, enter the mask in decimal format.

- **Oper.** specifies the logical operator (AND or OR) used between two operands.

## FlexE Calendar

- **Client ID** allows selecting the client identification to be displayed.
- **Size (Gbit/s)** indicates the size of the client.

### Client Assignment Status

- **Table**
  - ID** indicates the client identification number.
  - Size (Gbit/s)** indicates the size of the client.
  - Status** indicates the client assignment status: **Assigned** or *n/total* (*n* is the number of assigned block over the *total* for this client).
- **Edit ID** edits of the client identification number (**1** to **65534**).
- **Add Client** adds a new client by selecting its **Client ID**, **Size (Gbit/s)**, and the **Quantity** of clients.

Unit	Interface	Size (Gbit/s)	Quantity
88260	100G	5, 10, 25, 40, 50, 100, 150, 200	Up to 8 clients
	50G	5, 10, 25, 40, 50, 100	Up to 16 clients
88460	400G	5, 10, 25, 40, 50, 100, 150, 200, 250, 300, 350, 400	Up to 40 clients
	200G	5, 10, 25, 40, 50, 100, 150, 200	
	100G	5, 10, 25, 40, 50, 100, 150, 200, 250, 300, 350, 400	

- **Delete Client** removes the selected client from the FlexE group.
- **Delete All** removes all clients from the FlexE group.

## **Assign / Unassign / Mode**

**Assign**, based on the selected **Mode** and **Calendar Granularity**, assigns slot(s) to client(s). Depending on the **Calendar Granularity**, the assignment is either done slot by slot for 5G or per group of 5 slots for 25G (Slots 0 to 4, 5 to 9, etc.).

- **Unassign**, based on the selected **Mode** and **Calendar Granularity**, unassigns slot(s) from client(s).
- **Mode**
  - **Slot** applies to either a single slot or a group of 5 slots depending on the **Calendar Granularity** selected.
  - **Client** applies to all slots for a specific client. After selecting a first slot of a client having more than one slot, subsequent tributary slots are automatically assigned/unassigned.
  - **All Clients** applies to all slots of a client and then all clients in order. After selecting the first slot for a client having more than one slot, subsequent slots are automatically assigned/unassigned.

### ***To assign or unassign slots:***

- 1.** Select a client from the **Client Assignment Status** table.
- 2.** Select **Assign** or **Unassign**.
- 3.** From the PHYn (Port n) slot matrix on the right, select the slot(s); slots are assigned/unassigned according to the selected **Mode**.

## **PHY *n* / Instance *n* (Port *n*)**

A PHY/Instance (Port) grid is presented for each enabled port displaying and allowing edition (see **Assign / Unassign / Mode** above) of the client assignment per slot of 5 Gbit/s or per group of 5 slots depending on the selected calendar granularity. Assigned clients are identified by their client ID number. Unassigned clients are identified by the U letter.

## Grand Master Information / Boundary Clock Information

**Note:** *Only available when Grand Master Information / Boundary Clock Information is available.*

The decoded clock information are displayed as follows:

For G.8265.1 only:

- **Identity** reports the 8-byte identification code of the Grand Master Clock.

For G.8275.1 only:

- **Log Message Interval (Announce)** reports the mean time interval between successive Announce messages.
- **Log Message Interval (Sync)** reports the mean time interval between successive Sync messages.

For G.8275.1 and G.8275.2:

- **Port Identity** reports the identity type of the PTP port.
- **GM Identity** reports the clock identity of the Grand Master Clock.
- **Priority 1** reports the priority 1 attribute of the Grand Master Clock.
- **Priority 2** reports the priority 2 attribute of the Grand Master Clock.
- **UTC Offset** reports the current difference between the TAI and UTC timescale values collected from the Announce message.
- **Steps Removed** reports the number of communication paths crossed between the local clock and the Grand master Clock.

## Pop-Up

### *Grand Master Information / Boundary Clock Information*

---

For G.8265.1, G.8275.1 and G.8275.2:

- **Clock Class** reports the description and code of the Grand Master Clock Class.

Code	Description
0-5, 8-12, 15-51, 53-57, 59-67, 123-132, 171-186, 188-192, 194-215, 233-247, 249-254	Reserved
6	Sync to primary reference
7, 14	Holdover
13	Sync to application-specific reference
52, 58, 187, 193	Degraded
68 to 79, 81-109 (odd values), 11-122, 133-170, 216-232	Alternate PTP profiles
80-110 (even values) <sup>a</sup>	Quality Level (QL-xxx <sup>a</sup> )
248	Default
255	Slave only

a. Refer to QL table on page 206 for the list of Quality Level values that will be used as the description.

- **Clock Mode** reports the description of the Grand Master Clock Mode: **Two-step** or **One-step**.
- **Clock Accuracy** reports the accuracy of the clock.
- **Time Source** reports the source of time used by the Grand Master Clock.



## IPv6 Address Configuration

### IP

- **Link-Local IPv6 Address** (LLA) is used for local communication between on-link neighbors and for Neighbor Discovery process.
  - **Mode**
    - Stateless Auto** (default) allows automatic generation of the IPv6 address based on the MAC address.
    - Static** allows entering the IP Address.
  - **Address**, available with **Static** mode, allows selecting the Link-Local IPv6 Address. The accepted range is from **FE80:0000:0000:0000:0000:0000:0000** to **FE80:0000:0000:0000:FFFF:FFFF:FFFF:FFFF**. The default address is **FE80::[Interface ID]**, where **[Interface ID]** is generated from the source MAC address. When the **Address** field is selected for editing using virtual keyboard, the **Previous IPs** button appears allowing the selection of a previously configured IP address.
- **Global IPv6 Address** (GUA) is used to communicate with on-link neighbors and for global communication with hosts outside the subnet.
  - **Mode**
    - None** disables the **Global IPv6 Address** and **Default Gateway**.
    - Stateless Auto** (default) allows automatic generation of the IPv6 address based on the Link-Local address interface ID and the prefix obtained from the router advertisements. If no Interface ID has been obtained for the **Link-Local IPv6 Address**, the global address will not be generated.
    - Static** allows entering the IP address.

- **Address**, available with **Static** mode, allows selecting the **Global IPv6 Address**. The accepted range is from **0000:0000:0000:0000::[Interface ID]** to **FFFF:FFFF:FFFF:FFFF::[Interface ID]**. The default address is **2001:0000:0000:0000::[Interface ID]**, where **[Interface ID]** is generated from the source MAC address. When the **Address** field is selected for editing using virtual keyboard, the **Previous IPs** button appears allowing the selection of a previously configured IP address.

- **Interface ID Coupled**, available when the **Source Global IPv6 Address** mode is **Static**, allows coupling the interface ID of the Global address to the Link-Local source address.

**Enabled** (default): Only the 64 bit (MSB) prefix ID in the IPv6 address is configurable, and the 64 bit (LSB) Interface ID is not configurable (read-only).

**Disabled**: The 64 bit (MSB) Prefix ID and 64 bit (LSB) Interface ID in the IPv6 address are configurable.

- **Prefix Mask**, available with **Static** mode, allows specifying a prefix that defines the subnet. The accepted range is **0000:0000:0000:0000:0000:0000:0000:0000** to **FFFF:FFFF:FFFF:FFFF:0000:0000:0000:0000**.

For example:

**Global IPv6 Address**: 2001:0DB8:0001:0002:02AA:00FF:FE11:1111

**Prefix Mask**: FFFF:FFFF:FFFF:0000:0000:0000:0000:0000

Corresponding Prefix: 2001:0DB8:0001.

- **Default Gateway** allows the configuration of the default gateway address to forward packets outside the subnet.
  - **Mode**
    - Automatic** (default) allows automatic selection of the default gateway.
    - Static** allows entering the default gateway IP address.
  - **Address**, available with **Static** mode, allows entering the IP address of the Default Gateway. The accepted range is from **0000:0000:0000:0000:0000:0000:0000:0000** to **FE80:0000:0000:0000:FFFF:FFFF:FFFF:FFFF**. The default address is **FE80:0000:0000:0000:0000:0000:0000:0000**.

## **L2CP**

For predefined L2CP frames, only the **Name** and **Destination MAC Address** (frames having more than one allowed MAC Addresses) are configurable; the other parameters are fixed along with their L2CP type. For user defined frames, the following parameters are configurable at the exception of **Type** and **Subtype**:

- **Name:** Up to 20 characters are allowed. Default names are the type of the L2CP frame for predefined frames and **User 1/2/3/4 (01-80-C2)** and **User 5/6/7/8 (01-00-0C)** for user defined frames.
- **Type:** Indicates the type of the L2CP frame for predefined frames and **User (01-80-C2)** or **User (01-00-0C)** for user defined frames.
- **Frame Format:** **Ethernet II** (default), **LLC**, or **SNAP**.
- **Frame Size:** **64** bytes (default) to **1518** bytes. The frame size excludes the VLAN encapsulation.
- **Destination MAC Address:** For predefined L2CP frames allows selecting the **Destination MAC Address** for frames having more than one allowed MAC Addresses. For user defined allows selecting the **Destination MAC Address** from **01-80-C2-00-00-00** (default) to **01-80-C2-FF-FF-FF** for **User (01-80-C2)** and from **01-00-0C-00-00-00** (default) to **01-00-0C-FF-FF-FF** for **User (01-00-0C)**.
- **LLC** (available with LLC and SNAP frame formats)
  - **SSAP:** **0x00** to **0xFF** (**0x42** by default) for LLC frame format; fixed to **0xAA** for SNAP frame format.
  - **DSAP:** **0x00** to **0xFF** (**0x42** by default) for LLC frame format; fixed to **0xAA** for SNAP frame format.
  - **Control:** **0x00** to **0xFF** (**0x03** by default) for LLC frame format; fixed to **0x03** for SNAP frame format.

**Note:** For LLC frame format, the following concatenated values of DSAP/SSAP/Control are not valid since they are reserved for SNAP frame format: 0xAAAA03 or 0xABAB03.

- **OUI** (available with SNAP frame format): **0x000000** (default) to **0xFFFFFFFF**.
- **EtherType** (available with SNAP and Ethernet II frame formats): **0x0000** to **0xFFFF** for SNAP and **0x0600** to **0xFFFF** (excluding 0x8100, 0x88A8, 0x9100, 0x9200, 0x9300, 0x8847, and 0x8848) for Ethernet II. Default is **0x0600**.
- **Subtype**, only available for some predefined L2CP frames, indicates the subtype for the frame.
- **Custom Bytes** (16 bytes) **0x00000000000000000000000000000000** (default) to **0xFFFFFFFFFFFFFFFFFFFFFFFFFFFFFFFF**. Only available for user defined L2CP frames.

## Laser ON/OFF

**Laser ON/OFF** button, available with parallel interfaces, is used to activate the laser control per optical lane or for all lanes. Select the **Laser** check box to enable/disable the laser for each lane individually or select the **All Lanes** check box to enable/disable all optical lanes at once. Not available with 50GE.

### Manual Skew (PCS/Logical Lane)

- **All Lanes**, when selected, applies the change(s) to all PCS/Logical Lane at once.
- **Skew Inc/Dec Size (bits)** allows setting the increment/decrement value that will be used when changing the TX Skew (bits) values using the “+” and “-” buttons. Range is from **0** to **10550** for 200/400G, **0** to **2047** for 100G/OTU4 and **0** to **4095** for 40G/OTU3/OTU3e1/OTU3e2.
- **PCS/Logical Lane** indicates the PCS/Logical Lane numbers and **All** which represents the value for all PCS/Logical Lane when the **All Lanes** check box is selected.
- **Skew (bits)** allows setting the skew value for each lane. Enter directly the skew value in the field or use the “+” and “-” buttons to respectively increment or decrement the skew value using the defined **Skew Inc/Dec Size** value. Tapping and holding the “+” or “-” button allows reaching the desired value faster using the defined **Skew Inc/Dec Size** value. Range is from **0** to **10550** for 200/400G, **0** to **2047** for 100G/OTU4 and **0** to **4095** for 40G/OTU3/OTU3e1/OTU3e2.

## Manual Skew (PHY)

➤ **PHY TX Skew**

**PHY/Port** indicates the PHY/Port numbers and **All** which represents the value for all PHY/Port when the **All PHY** check box is selected.

**Skew (ns)** allows setting the skew value for each PHY. Enter directly the skew value in the field or use the “+” and “-” buttons to respectively increment or decrement the skew value using the defined **Skew Inc/Dec Size** value. Tapping and holding the “+” or “-” button allows reaching the desired value faster using the defined **Skew Inc/Dec Size** value. Range is from **0** to **10000** ns.

➤ **All PHY**, when selected, applies the change(s) to all PHYs at once.

➤ **Skew Inc/Dec Size (ns)** allows setting the increment/decrement value that will be used when changing the Skew (ns) values using the “+” and “-” buttons. Range is from **0** to **10000** ns.

## Default/Random/Manual Mapping

Allows changing the lane mapping that will be used for the test. Not available with 100 GbE client in OTU4.

- **Default Mapping** sets the TX mapping to the default numerical order value which corresponds to the ascending lane order.
- **Random Mapping** sets the TX mapping in a random order. Each time the button is tapped, random alignment markers are assigned to each lane.
- **Manual Mapping** allows setting the TX mapping manually.

- **Lane Marker and Assigned Status:**

The **Lane Marker** buttons allow assigning the corresponding lane marker to the selected PCS/Logical or xGAUI-y/CAUI/XLAUI/Physical Lane mapping (the one pointed by the arrow). Lane marker buttons are numbered from **0** to **15** for 400G, **0** to **7** for 200G, **0** to **19** for OTU4/100G, and **0** to **3** for OTU3/OTU3e1/OTU3e2/40G.

The **Assigned Status** column displays a check mark when the lane marker is assigned.

- **PCS/Logical Lane** and **xGAUI-y/CAUI/XLAUI/Physical Lane** columns indicate the target PCS/Logical to xGAUI-y/CAUI/XLAUI/Physical mapping.
- **Clear All** clears the lane assignments.
- **OK** accepts the new lane mapping. The **OK** button is only available when all target PCS/Logical Lane fields are assigned including duplicates.

**Note:** *A lane marker can be assigned more than once. If this is the case, a red background is used to highlight all occurrences of this lane marker.*



## Modify DS0/E0

**Note:** For DS0, the framing structure has 24 timeslots. For E0, the framing structures PCM-30 and PCM30 CRC-4 have 30 channel timeslots (1 to 15 and 17 to 31) while PCM-31 and PCM-31 CRC-4 have 31 channel timeslots (1 to 31).

- **DS0/E0 Size** sets the channel timeslot data rate for the pattern payload content to either **56K** or **64K** (default); forced to respectively **56K** for DS0 and **64K** for E0 when **TX Signaling** is enabled. A timeslot data rate of 56 Kbit/s uses 7 bits while 64 Kbit/s uses 8 bits to carry the payload information.
- **Zero Code Suppression** allows the selection of the Zero Code Suppression (ZCS) method used to replace the all-zero bytes of the Idle and Tone payload contents. The ZCS mechanism is a global parameter meaning that all channel timeslots configured with Tone/Idle data, use the same ZCS method. Choices are:

ZCS	Description	Availability
None <sup>a</sup>	No Zero Code Suppression	DS0 and E0
Jammed Bit 8	Every 8th (LSB) bit is forced to 1.	DS0 and E0
GTE	Bit 8 of an all zero channel byte is replaced by 1, except in signaling frames where bit 7 is forced to 1.	DS0
Bell	Bit 7 of an all zero channel byte is replaced by 1.	DS0

a. Default value.

**Note:** Bit 8 is the Least-Significant Bit (LSB) and bit 1 is the Most-Significant Bit (MSB).

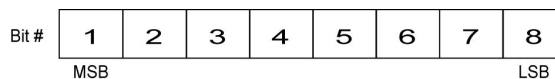

## Pop-Up

Modify DS0/E0

---

- **Payload Content** allows the selection of the payload content that will be applied to all TX timeslots when tapping the **Set All** button: **Pattern**, **Idle**, or **Tone**.

**Set All** applies the selected payload content to all TX timeslots.

- **TX**

- **Pattern/Idle/Tone** button: Tap once or several times on each timeslot until the desired payload content appears: **Pattern** (default), **Idle**, or **Tone**. For E0, timeslots 0 and 16 (PCM30 and PCM30 CRC4) are not configurable; timeslot 0 generates the FAS/NFAS framing; timeslot 16 generates a static MFAS frame when TX Signaling is disabled and generates a frame with Signaling capability when TX Signaling is enabled.

**Pattern:** The pattern used is the one selected from *Pattern* on page 209.

- **Tone (Hz)** allows the selection of a tone for digital milliwatt testing. The signal output power, when converted to analog, is 0 dBm. Choices are **1000 Hz** and **1004 Hz** (default). The selected tone applies to all timeslots set to **Tone**.
- **Idle** uses the Idle code byte from the Idle field: **00** to **FF** (default is **7F**). The selected Idle code applies to all timeslots set to Idle.

**Binary** check box allows either displaying the **Idle** code value in binary (when selected) or in hexadecimal (default).

**Note:** *The timeslots set to **Idle** or **Tone** can be changed from **Idle** to **Tone** and vice versa even when the test is running; their values can also be changed.*

➤ **RX**

- **Apply Channel TX to RX**, available for decoupled test, allows applying the RX payload content based on the TX settings. **None** will be used when TX is set to either **Idle** or **Tone**. For E0 the timeslots 0 and 16 (PCM30 and PCM30 CRC4) are not configurable. Timeslot 0 processes the FAS/NFAS while timeslot 16 processes the Signaling frame.

**Note:** *The RX timeslot selection is only configurable in a **Decoupled** topology when the **Apply Channel TX to RX** check box is cleared. A warning is displayed when the number of Pattern timeslot does not match between TX and RX. This is to ensure pattern continuity between the TX and RX interface in a MUX/DEMUX test even if used through a cross-connect device.*

- **Pattern/None** button: Select the payload content by tapping once or several times on each timeslot until the desired content appears: **Pattern** or **None**.

**Pattern** (default) uses the pattern from the received signal.

**None** does not use the pattern.

## Modify Frame Structure

Allows modifying the structure of the frame.

### Global Options

- **S-OAM** check box when selected, available with EtherSAM for rates up to 10G WAN, enables EtherSAM over service OAM at Layer 2 on all services. The EtherSAM uses LBM and LBR messages of the S-OAM protocol to perform the test. A device having the capability to loopback LBM messages (via LBR) is required at the remote. Not available in Dual Test Set and Dual Port topology.
- **Layer Mode** sets the frame layer mode for all services (available with EtherSAM when the **S-OAM** check box is cleared):

**Mixed** (default) allows configuring the frame layer per service: L2, L3, or L4.

**L2 Only** configures all services to Layer 2 only (no IP, no MPLS).

- **Provider Encapsulation** is available and configurable with single port **Traffic Gen & Mon** (not supported on FTBx-88460) and available but fixed to **None** for **EtherBERT** Framed Layer 2. Available for rates 10GE, 40GE, and 100GE.

**None:** No encapsulation.

**EoE:** Ethernet over Ethernet encapsulation.

Destination EoE MAC Address	Source EoE MAC Address	EoE VLAN 0xA100 (4 bytes)	EoE TPID (EtherType) 0xE0E0 (2 bytes)	TTL (1 byte)	ETag (1 byte)	Customer Frame starting with Destination Address without FCS	FCS (4 bytes)
-----------------------------------	------------------------------	---------------------------------	--	-----------------	------------------	---	------------------

**PBB-TE:** Provider Backbone Bridges with Traffic Engineering encapsulation.

Backbone Destination MAC Address (6 bytes)	Backbone Source MAC Address (6 bytes)	B-VLAN 0x88A8 (4 bytes)	EtherType 0x88E7 (2 bytes)	I-TAG (4 bytes)	Customer Frame starting with Destination Address without FCS	FCS (4 bytes)
---	--	-------------------------------	----------------------------------	--------------------	---	------------------

- **IP Version** allows selecting **IPv4** (default) or **IPv6**<sup>1</sup>. For EtherSAM and Traffic Gen & Mon, the IP version applies to both the interface and all streams/services.

## Framing

**Note:** *The framing for EtherSAM in a NAT environment is limited to Ethernet II, IPv4, and UDP.*

- **Frame Format** (layer 2) allows selecting **Ethernet II** (default) or **802.3 SNAP** as the frame format. Only **Ethernet II** is available with 25G/50G/200G/400G, multiple link interface, and eCPRI.
- **Network Layer** (layer 3) sets the network traffic type: **IPv4/IPv6** (default), or **None**. Not available with EtherSAM when the **S-OAM** check box selected or when the **Layer Mode** is set to **L2 Only**. Not available when using **Provider Encapsulation**. Not configurable and set to **None** for 40GE/100GE dual port topology.

---

1. Not supported with: 25G, 50G.

## Pop-Up

### Modify Frame Structure

---

- **Transport Layer** allows the selection of the transport layer; disabled when the **Network Layer** is set to **None**. Not available with EtherSAM when the **S-OAM** check box selected or when the **Layer Mode** is set to **L2 Only**. Not available when using **Provider Encapsulation**. Not configurable and set to **None** for 40GE/100GE dual port topology.

Test Application	Transport Layer
EtherSAM	None, UDP (default), TCP <sup>a</sup>
RFC 2544 eCPRI BERT DCO BERT	UDP
EtherBERT	UDP (default), TCP <sup>a</sup>
Traffic Gen & Mon	None, UDP (default), TCP <sup>a</sup>

- Only available for 10M to 10G.

## VLAN

**VLAN Tag** check box when selected (cleared by default) enables up to 3 stacked VLAN; up to 2 staked VLAN when using **Provider Encapsulation**. See *VLAN* on page 322 for additional *VLAN settings*.

## MPLS

**MPLS Label** check box when selected (cleared by default) enables 1 or 2 MPLS labels allowing management and test frames to be transmitted and received. Only available with EtherSAM and Traffic Gen & Mon test applications for rates up to 10GE and 100GE. Not available when using **Provider Encapsulation**. Not available with EtherSAM when the **S-OAM** check box is selected or when **Layer Mode** is set to **L2 Only**.

## **EoE**

**EoE VLAN** check box when selected (cleared by default) enables the EoE VLAN tag. Available when **EoE** is selected as **Provider Encapsulation**.

## **PBB-TE**

**B-VLAN** check box when selected (cleared by default) enables the B-VLAN tag. Available when **PBB-TE** is selected as **Provider Encapsulation**.

## Modify Tributary Slots/Port

**Note:** Tributary slots must be selected starting with the higher layer down to the lower and all required tributary slots must be selected to access the next level. **Clear All**, **Select All**, and **Default** buttons may be used to facilitate the selection.

- **Payload Type** indicates the payload type 20 or 21 for each mapped OPU level. Not available with Multi-Channel OTN.

For...	Mapped into...	Tributary slot selection
ODU3	OPU4	31
ODU2e ODU1e	OPU4	8
ODU2	OPU4 OPU3	8 4 (PT20), 8 (PT21)
ODU1	OPU4 OPU3 OPU2	2 1 (PT20), 2 (PT21) 1 (PT20), 2 (PT21)
ODU0	OPU4 OPU3 OPU2 OPU1	1 1 1 1
ODUflex	OPU4 OPU3 OPU2	up to 80 up to 32 up to 8
ODUflex/GFP-F	OPU4 OPU3 OPU2	up to 8 up to 8 up to 8

- **Fixed Structure** check box when selected (default) for OPU3, the selection of a tributary slot will automatically select four tributary slots from the same column, which constitute the foreground traffic. When the **Fixed Structure** check box is cleared, select the four tributary slots individually.



- **Tributary Port**, configurable when the **Fixed Structure** check box is cleared, allows selecting the **Tributary Port** number that will be associated to the selected tributary slots. When the **Fixed Structure** check box is selected, the **Tributary Port** is automatically assigned to either the selected slot number or for OPU3 to the first slot number in the column.
- **Nominal Bit Rate (Gbit/s)** available with ODUflex and ODUflex/GFP-F indicates the TX frequency based on the number of tributary slots selected. Note that for ODUflex with pattern Client, the **Nominal Bit Rate** may be affected by the **TX Rate** when not set to 100 % (see **TX Rate** on page 209).
- **Number of Trib Slots** indicates the number of tributary slots selected.

## Modify Trib Slots/Channels (Multi-Channel OTN)

- **Channel ID** selects a channel number highlighting the tributary slots composing this channel. Alternatively, selecting a channel from the table on the right (**TX**, **RX**, or **TX = RX** tab) also selects a channel number.
- **Tributary Port** indicates the tributary port number associated to the channel number.
- **Payload Type** indicates the payload type for the mapped OPU.
- **RX, TX, or TX = RX** tab (table on the right) displays the tributary slot assignments per channel for either RX, TX, or both RX and TX (TX=RX) and allows selecting tributary slots to be assigned/unassigned; see **Assign/Unassign/Mode** for more information.

Each tributary slot displays its number (left top corner) and channel number (middle); the channel number is replaced by **B** or **U** indicating respectively if the tributary slot carries background traffic or is configured as Unallocated.

- The following table indicates the number of tributary slots per channel:

For...	Mapped into...	Tributary slot per channel
ODU3	OPU4	31
ODU2	OPU4	8
ODU1	OPU4	2
ODU0	OPU4	1

The table provides a status for each channel using visual indication as follows:

<b>Background Color</b>	<b>Description</b>
White	Tributary slot using background traffic ( <b>B</b> ) or Unallocated ( <b>U</b> ).
Orange	Tributary slot(s) assigned for the selected channel.
Gray	Tributary slot(s) assigned.

- **TX = RX** check box, when selected, allows using the same tributary slot configuration for both TX and RX.
- **RX Structure Match** is a live status indicating if the tributary slot/channel configuration is matching the received signal. Only configured channels are considered during the validation. **RX Structure Match** is displayed using different background colors as follows:

<b>Background Color</b>	<b>Description</b>
Green	Configured structure is matching the received signal.
Red	Configured structure is not matching the MSI received signal or could contain an unsupported mapping (for example Unallocated).
Gray	Impaired signal is preventing RX structure decoding (for example when a LOS alarm is detected).

## Pop-Up

### *Modify Trib Slots/Channels (Multi-Channel OTN)*

---

#### ➤ **Channel Assignment Status**

The table provides a list of each channel ID, its ODU type, and the TX/RX assignment status. TX/RX indicates either **Assigned** when all tributary slot are selected for this channel or the number of assigned tributary slot over the total number of tributary slots for this channel. TX/RX status must be **Assigned** for all channels in order to complete the tributary slots/channels configuration. Channel are sorted by their ascending ID by default, it is possible to sort ascending/descending and by **Type**, **RX**, or **TX** column by clicking in the desired column title.

**Note:** *ODU0 type mapping is selected by default for all channels when the test is created. To change the ODU type mapping, use the **Del Ch** or **Delete All** button then use the **Add Ch** button to select another ODU type.*

- **Edit Ch ID** button selects a new channel ID from available list.
- **Add Ch** button allows adding new channels. See *Add Channel (Multi-Channel OTN)* on page 953.
- **Del Ch** button removes the selected channel.
- **Delete All** button removes all channels.

➤ **Assign / Unassign / Mode**

**To assign or unassign tributary slots:**

1. From the **Channel Assignment Status** table, select a channel.
2. Select either **Assign** or **Unassign**.
3. From the tributary slot matrix on the right, select a tributary slot; tributary slots are assigned/unassigned as follows according to the selected **Mode**:

<b>Mode</b>	<b>Description</b>
Tributary Slot	Assigns/unassigns a single tributary slot.
Channel	Assigns/unassigns all tributary slots for a specific channel. After selecting a first tributary slot, subsequent tributary slots are automatically assigned/unassigned if the channel contains more than one tributary slot.
All Channels	Assigns/unassigns all tributary slots to/from a channel and this is repeated for all channels. After selecting the first tributary slot, subsequent tributary slots are automatically assigned/unassigned if the channel contains more than one tributary slot. This is repeated for all channels in order.

- **Copy RX MSI** allows automatic configuration of the Channel to Trib Slot that matches the system under test configuration. A warning message is displayed when the RX test structure is either:

**Unsupported:** An unsupported ODU channel is received (for example Unallocated). The unsupported ODU channels are configured as background traffic.

**Invalid:** Impaired signal is preventing RX structure decoding (for example when a LOS alarm is detected). The RX MSI structure cannot be copied.

## Modify TX Power - DCO BERT

### Configuration

- **Use Advertised Capabilities** check box when selected (default) limits the **User Config** choices to the transceiver's advertised capabilities, otherwise all choices are available.

**Configuration mismatch with capabilities** is displayed when the **Use Advertised Capabilities** check box is cleared and the **User Config - Target TX Power** value is outside the advertised supported range. In this case the  icon appears in front of the **Target TX Power** field.

**Transceiver Initializing...** is displayed when the transceiver is initializing.

**Programmable TX Power not supported** is displayed when the transceiver does not support programmable TX power.

- **Target TX Power - User Config** allows configuring the transmit output power when supported by the DCO transceiver: **-40 to 0** (default) when the **Use Advertised Capabilities** check box is cleared; within the transceiver's advertised minimum and maximum (default) values when the **Use Advertised Capabilities** check box is selected.
- **Target TX Power - Transceiver Config** indicates the transmit output power when supported by the DCO transceiver.
- **Apply** allows applying the configured values to the transceiver.
- **Copy** retrieves the transceiver's target TX power value to use as the **Target TX Power** configuration.

### Current TX Power

**Current TX Power (dBm)** indicates the live transceiver's TX power.

## **Tuning Status (Laser/TX Power)**

**Tuning Status (Laser/TX Power)** indicates the transceiver tuning progress status: -- (pending), **In Progress**, **Completed**.

## **Advertised Capabilities**

**Programmable TX Power** indicates if the transceiver is supporting the TX power programming capability: **Yes** or **No**. When supported, the transceiver's **Minimum TX Power (dBm)** and **Maximum TX Power (dBm)** values are reported.

## **Modify Wavelength (SFP)**

**Modify Wavelength**, available with tunable transceivers when the **TunableOptics** software option is enabled, is used to configure the transceiver wavelength.

- **Wavelength** (nm) indicates the actual wavelength value selected. Use the scroll box and/or the -/+ buttons to select the wavelength. The minimum and maximum wavelength values are displayed.
- **Channel Number** indicates the actual ITU channel number based on ITU Grid.
- **Frequency** (THz) indicates the actual Frequency based on ITU Grid
- **Channel Spacing** (GHz) indicates the difference in frequency between two adjacent channel detected from the transceiver device.
- **Restore Previous** restores the current value present in the transceiver device.



## Modify Wavelength - DCO BERT

**Note:** *Not available with unamplified interface.*

### Config Tab

- **Configuration:** The **User Config** column allows configuring the transceiver parameters while the **Transceiver Config** columns displays the actual transceiver configuration parameters.
- **Use Advertised Capabilities** check box when selected (default) limits the **User Config** choices to the transceiver's advertised capabilities, otherwise all choices are available.

**Configuration mismatch with capabilities** is displayed when the **Use Advertised Capabilities** check box is cleared and any **User Config** values is outside the advertised supported range. In this case the  icon appears in front of the field value that is out of range.

**Transceiver Initializing...** is displayed when the transceiver is initializing.

**Wavelength Tuning not supported** is displayed when the transceiver does not support wavelength tuning.

- **Grid** allows selecting the grid for configuration: **100 GHz** (default), **75 GHz**, **50 GHz**, **33 GHz**, **25 GHz**, **12.5 GHz**, **6.25 GHz**, and **3.125 GHz**.

## Pop-Up

### Modify Wavelength - DCO BERT

---

- **Channel** allows selecting the channel number depending on selected **Grid** and inserted transceiver. The range is limited to the minimum and maximum values shown in the following table even if the transceiver's advertised capabilities exceed the range.

Channel	Grid in GHz							
	100	75	50	33	25	12.5	6.25	3.125
Minimum	-86	-342	-172	-258	-344	-688	-1376	-2752
Maximum	30	120	60	90	120	240	480	960

- **Channel Frequency (THz)** allows selecting the channel frequency: **184.5 to 196.1** THz.
- **Fine Tuning** check box when selected, cleared by default, enables the capability to fine tune the transceiver by setting the offset. Only available when fine tuning is supported by the transceiver.

**Offset (GHz)**, available when the **Fine Tuning** check box is selected, allows setting the laser frequency offset. The range is limited to the minimum and maximum values shown in the following table even if the transceiver's advertised capabilities exceed the range.

Offset (GHz)	Grid (GHz)							
	100	75	50	33	25	12.5	6.25	3.125
Minimum	-32.768	-32.768	-32.768	-32.768	-24.999	-12.499	-6.249	-3.124
Maximum	32.768	32.768	32.768	32.768	24.999	12.499	6.249	3.124

- **Laser Frequency (THz)** displays the laser frequency based on the configured **Laser Frequency** and **Fine Tuning - Offset**.
- **Laser Wavelength (nm)** displays the laser wavelength based on the **Laser Frequency**.

- **Apply**, applies the **User Config** settings into the transceiver (**Transceiver Config**).
- **Copy** allows copying the **Transceiver Config** settings to the **User Config**.
- **Current Laser Frequency** (THz) indicates the current laser frequency reported by the DCO transceiver.
- **Current Laser Wavelength** (nm) indicates the current laser wavelength.
- **Tuning Status (Laser/TX Power)** indicates the transceiver tuning progress status: -- (pending), **In Progress**, **Completed**.

## Info Tab

**Advertised Capabilities** reports the following capabilities advertised by the transceiver:

- **Laser Tuning Supported** indicates if the laser tuning is supported.
- **Grid Capabilities**
  - **Grid** displays the list of grid: **100 GHz, 75 GHz, 50 GHz, 33 GHz, 25 GHz, 12.5 GHz, 6.25 GHz, and 3.125 GHz**.

The following parameters are reported for each grid:

- **Supported** indicates if the grid is supported.
- **Lowest Channel Number** indicates the lowest channel supported.
- **Highest Channel Number** indicates the highest channel supported.
- **Lowest Frequency** (THz) indicates the lowest frequency supported.
- **Highest Frequency** (THz) indicates the highest frequency supported.

## Pop-Up

*Modify Wavelength - DCO BERT*

---

- **Fine Tuning Capabilities**
  - **Supported** indicates if the fine tuning is supported.
  - **Lowest Offset** (GHz) indicates the fine tuning lowest offset.
  - **Highest Offset** (GHz) indicates the fine tuning highest offset.
  - **Resolution** (GHz) indicates the fine tuning resolution.

## Profile (Stream)

Allows the selection and configuration of either **Voice**, **Video**, or **Data** (default) emulation profile. Only **Data** is available when using **Provider Encapsulation**.

### Voice

- **Voice Codec** allows the selection of the codec used by the voice profile: **VoIP G.711** (default), **VoIP G.723.1**, or **VoIP G.729**.
- **Number of Calls** allows the selection of the number of calls that will be generated for the selected stream. The minimum (default value) is **1** for 10M to 1G, **5** for 10G /25G, and **10** for 40G/ 50G/100G.
- **Rate** indicates the rate corresponding to the selected codec and the number of calls.

### Video

- **Video Codec** allows the selection of the codec used by the video profile: **SDTV (MPEG-2)** - (default), **HDTV (MPEG-2)**, or **HDTV (MPEG-4)**.
- **Number of Channels** allows the selection of the number of channels (**1** by default) that will be generated for the selected stream.
- **Rate** indicates the rate corresponding to the selected coded and the number of channels.

## **Profile (Services)**

Allows the selection and configuration of either **Voice**, **Video**, or **Data** (default) emulation profile.

### **Voice**

- **Voice Codec** choices are **VoIP G.711** (default), **VoIP G.723.1**, and **VoIP G.729**.
- **Number of Calls** allows the selection of the equivalent number of calls that will be generated for the selected stream (default is **1**).
- **CIR** indicates the committed information rate in Mbps based on the number of calls selected.

### **Video**

- **Video Codec** choices are **SDTV (MPEG-2)** - (default), **HDTV (MPEG-2)**, and **HDTV (MPEG-4)**. Only **SDTV (MPEG-2)** is available with the 10 Mbps interface.
- **Number of Channels** is the equivalent number of channels that will be generated for the selected service (default is **1**).
- **CIR** indicates the committed information rate in Mbps based on the number of channels selected.

**Note:** *The **CIR** value will be calculated on the basis of the selected service profile and the value entered in the **Number of Calls** or **Number of Channels** field.*

## QoS Metrics (eCPRI BERT)

- Port direction buttons are available for dual port topology in **One-Way P<m> ↔ P<n>** measurement mode.
- Local/Remote direction buttons are available for single/dual port topology in **One-Way** measurement mode.

**Note:** *Throughput (including RX Frame Count, TX Rate, and TX Frame Count), Jitter, Latency, and Frame Loos/Out-of-Sequence are available when enabled (see QoS Thresholds) but their availability depend on the selected measurement mode, measurement role, and direction.*

- **Throughput, Jitter, and Latency** meters display respectively the measured Throughput, Jitter, and Latency.

**Note:** *The green region defined by the configured threshold corresponds to a **PASS** verdict while the red regions corresponds to a **FAIL** verdict. The Pass/Fail verdict is only displayed when enabled (see QoS Thresholds on page 246).*

- **Jitter** is the delay variation measured<sup>1</sup> on all valid frames<sup>2</sup> received. **Current, Average, Minimum, Maximum, and Estimate** delay values are reported in  $\mu\text{s}$  per direction when applicable.
- **Latency** is measured<sup>1</sup> on all valid frames<sup>2</sup> received. **Current, Average, Minimum, and Maximum** latency (delay) are reported.

For **One-Way** and **One-Way P<m> ↔ P<n>** measurement modes, indicates the measured one-way latency (delay) in  $\mu\text{s}$  per direction when applicable (available on the sender side).

For Round-Trip measurement mode, indicates the measured round-trip latency (delay) in  $\mu\text{s}$  (available on the sender side).

---

1. For the **Current** value, **Not measurable** is displayed when no delay has been measured in the last second.

2. Frames with One-Way Delay (OWD) messages and no FCS and UDP Checksum errors.

## Pop-Up

### QoS Metrics (eCPRI BERT)

---

- **Throughput** is the RX rate value measured on all valid frames (no FCS and UDP Checksum errors). **Current, Average, Minimum,** and **Maximum** throughput results are reported. A **Current** value of **0** indicates that no throughput has been measured in the last second.
- **RX Frame Count** indicates the number of frame received matching the stream.
- **TX Rate** indicates the transmitted throughput rate.
- **TX Frame Count** indicates the number of transmitted frames matching the stream.
- **Thresholds** allows configuring the QoS thresholds:
  - **Latency** check box when selected (default) enables the latency pass/fail verdict and allows setting the maximum threshold delay per direction when applicable.
  - **Jitter** check box when selected (default) enables the jitter pass/fail verdict and allows setting the maximum threshold value per direction when applicable.
  - **Frame Loss Rate** check box when selected (default) enables the Frame Loss pass/fail verdict and allows setting the frame loss rate for the port: 0.0E-00 to 5.0E-02 (default is 1.0E-07). However entering a value of 0.0E-00 or below 1.0E-14 is treated as a pass/fail verdict based on loss count instead of rate.
  - **Throughput** check box when selected (default) enables the throughput pass/fail verdict and allows setting the minimum and maximum threshold values for the port.
- **Frame Loss:** See *QoS Metrics* on page 934. When testing with protection switching, it is recommended to use **Generic Data Transfer** as the **Message Type** (refer to *eCPRI* on page 327).
- **Out-of-Sequence:** See *QoS Metrics* on page 934.



## Remote Interface Discovery

**Note:** Available with Traffic Gen & Mon for rates up to 10GE WAN.

### Discover

The **Discover** button activates, disabled by default, the interface discovery process. The discovery process automatically stops when the test is started or when the maximum of 16 signatures is reached.

### Remote Interfaces

Lists every unique signature having good FCS and valid IP checksum. Any difference in either MAC source address, VLAN parameters, or IP source address is considered as a unique signature. Up to 16 signatures can be discovered.

#### ➤ Signature

**Number** indicates the identification number given to the discovered signature.

The check box of a signature, when selected, indicates the signature's parameters that will be used for the current stream when clicking on the **Apply To Stream** button. Only one signature can be selected.

Signatures having a different IP version than the test configuration will not be available for selection.

- **Layer 2** indicates the Layer 2 parameters if applicable: **MAC Address**, **E-VLAN**, **S-VLAN**, **C-VLAN**.
- **Layer 3** indicates the Layer 3 parameter if applicable: **IP Address**.
- **Signature Advanced Details** (... button) opens a pop-up displaying the details of the current signature: **Number**, **Source MAC Address**, **Source IP Address**, **E-VLAN ID**, **S-VLAN ID**, **C-VLAN ID**, **Priority**, **Type**.

## **Apply To Stream**

Applies the selected signature parameters to the current stream and updates the stream configuration accordingly.

## **Shaping**

### **For Burst and n-Burst TX modes.**

- **Burst Duty Cycle (%)** represents the burst duration within the burst period: **1** to **100** percent (default is **50** percent).
- **Period** represents the burst pattern duration: **1** to **8000** milliseconds (default is **1000** ms).  
Unit choices are **ms** (default) and **s**.
- **Burst Count**, available with n-Burst TX Mode, represents the number of times the burst will be repeated: **1** (default) to **255**.

### **For Ramp and n-Ramp TX modes.**

- **Ramp Nb. of Steps** represents the number of steps within the ramp: **2** to **100** (default is **10**).
- **Step Time** represents the duration of each step: **100** to **8000** milliseconds (default is **1000** ms).  
Unit choices are **ms** (default) and **s**.
- **Ramp Cycle Count**, available with n-Ramp TX mode only, represents the number of times the ramp will be repeated: **1** (default) to **255**.

## Thresholds (eCPRI QoS)

- **Latency** check box when selected (default) enables the latency pass/fail verdict and allows setting the maximum threshold delay per direction when applicable.
- **Jitter** check box when selected (default) enables the jitter pass/fail verdict and allows setting the maximum threshold value per direction when applicable.
- **Frame Loss Rate** check box when selected (default) enables the Frame Loss pass/fail verdict and allows setting the frame loss rate for the port: 0.0E-00 to 5.0E-02 (default is 1.0E-07). However entering a value of 0.0E-00 or below 1.0E-14 is treated as a pass/fail verdict based on loss count instead of rate.
- **Throughput** check box when selected (default) enables the throughput pass/fail verdict and allows setting the minimum and maximum threshold values for the port.

## Thresholds - FED/FDD

**Note:** Available with DCO BERT when either the **FED** or **FDD** check box is selected from the interface block - **DCO** tab.

Allows setting the threshold activate/deactivate values used to respectively declare or clear the **FED** or **FDD** alarm.

**FED Activate Threshold (BER)** sets the threshold activate value used to declare the **FED** alarm: **1.00E-15** to **1.00E0** bit error rate (default is **1.22E-2** for 400ZR and **2.00E-2** for 400ZR+ / 100ZR+).

**FED Deactivate Threshold (BER)** sets the threshold deactivate value used to clear the **FED** alarm: **1.00E-15** to **1.00E0** bit error rate (default is **1.20E-2** for 400ZR and **1.98E-2** for 400ZR+ / 100ZR+).

**FDD Activate Threshold (BER)** sets the threshold activate value used to declare the **FED** alarm: **1.00E-15** to **1.00E0** bit error rate (default is **6.10E-3** for 400ZR and **1.00E-2** for 400ZR+ / 100ZR+).

**FDD Deactivate Threshold (BER)** sets the threshold deactivate value used to clear the **FED** alarm: **1.00E-15** to **1.00E0** bit error rate (default is **6.00E-3** for 400ZR and **9.90E-3** for 400ZR+ / 100ZR+).

**Note:** The activate value must be greater or equal to the deactivate value.

**Note:** When both the **FED** and **FDD** check boxes are selected, the **FED** threshold values must be greater or equal to the **FDD** threshold values.

## Thresholds - RFC 2544

**Note:** For *Dual Test Set*, thresholds are configurable for **Local to Remote** and **Remote to Local** directions at the exception of **Round-Trip Latency Threshold** for which the value is unique. For **Dual Port** topology, thresholds are configurable for both port directions.

- **Throughput Threshold** sets the threshold value used to declare a pass/fail verdict for all frame sizes when applicable. The verdict is PASS when the received/measured value is greater or equal to the threshold value. The range is as follows:

Interface Speed	%	Threshold <sup>a</sup>	
		Mbit/s	Gbit/s
10 Mbit/s	0.0 to 100.0 <sup>b</sup>	0.0 - 10.0 <sup>b</sup>	Not Applicable
100 Mbit/s	0.0 to 100.0 <sup>b</sup>	0.0 - 100.0 <sup>b</sup>	Not Applicable
1000 Mbit/s	0.0 to 100.0 <sup>b</sup>	0.0 - 1000.0 <sup>b</sup>	0.0 - 1.0 <sup>b</sup>
10G LAN	0.0 to 100.0 <sup>b</sup>	0.0 - 10000.0 <sup>b</sup>	0.0 - 10.0 <sup>b</sup>
10G WAN <sup>c</sup>	0.0 to 92.857 <sup>b</sup>	0.0 - 9285.7 <sup>b</sup>	0.0 - 9.2857 <sup>b</sup>
25G	0.0 to 100 <sup>b</sup>	0.0 - 25000 <sup>b</sup>	0.0 - 25 <sup>b</sup>
40G	0.0 to 100.0 <sup>b</sup>	0.0 - 40000.0 <sup>b</sup>	0.0 - 40.0 <sup>b</sup>
100G	0.0 to 100.0 <sup>b</sup>	0.0 - 100000.0 <sup>b</sup>	0.0 - 100.0 <sup>b</sup>
200G	0.0 to 100.0 <sup>b</sup>	0.0 - 200000.0 <sup>b</sup>	0.0 - 200.0 <sup>b</sup>
400G	0.0 to 100.0 <sup>b</sup>	0.0 - 400000.0 <sup>b</sup>	0.0 - 400.0 <sup>b</sup>

- a. The maximum threshold value is adjusted with the Throughput **Max. Rate** selected.
- b. Default value.
- c. The maximum value for 10G WAN may be lower depending on the frame size. The maximum value will be adjusted for each frame size.

- **Back-to-Back Threshold** sets the threshold value in percentage of frames per burst to declare a pass/fail verdict for all frames sizes when applicable. The verdict is PASS when the received/measured value is greater or equal to the threshold value.

## Pop-Up

### Thresholds (S-OAM)

---

- **Frame Loss Threshold (%)** sets the threshold value of frame loss for all frame sizes when applicable. The verdict is PASS when the received/measured value is lower or equal to the threshold value.
- **Latency Threshold**, available when **Dual Test Set** is not enabled, sets the threshold value as the maximum delay for all frame sizes when applicable.
- **Round-Trip Latency Threshold**, available with **Dual Test Set** in **Round-Trip** measurement mode (see *Latency* on page 362), sets the threshold value as the maximum delay for all frame sizes when applicable.
- **One-Way Latency Threshold**, available with **Dual Test Set** in **One-Way** measurement mode (see *Latency* on page 362), sets the maximum one-way latency value allowed for all frame sizes.
- **Latency Unit** allows selecting either **ms** (default) or **μs** as the reference unit for **Latency**.

## Thresholds (S-OAM)

Available with G.8113.1, Y.1731 and MEF OAM Modes when Pass/Fail verdict is enabled. The verdict is PASS when the measured value is lower or equal to the threshold value.

- **Frame Delay Threshold (ms)** allows setting the threshold value of frame delay: **0.001** to **8000** ms (default is **50** ms).
- **Frame Loss Threshold (%)** allows setting the threshold value of frame loss: **0.001** to **100** % (default is **10** %).
- **Synthetic Loss Threshold (%)**, available with Ethernet OAM (Y.1731 and MEF), allows setting the threshold value of Synthetic Loss: **0.001** to **100** % (default is **10** %).

## **TOS/DS Config**

### **TOS/DS**

- **TOS/DS** allows selecting either Type Of Service (TOS) or Differentiated Services (DS).
- **Binary/Hex** allows displaying, once this pop-up is closed, the IP TOS/DOS value either in binary or hexadecimal.

### **Type Of Service (TOS)**

- **Precedence:**
  - 000 (Routine)** (Default)
  - 001 (Priority)**
  - 010 (Immediate)**
  - 011 (Flash)**
  - 100 (Flash Override)**
  - 101 (CRITIC/ECP)**
  - 110 (Internet Control)**
  - 111 (Network Control)**
- **Delay** allows the selection of the delay level: **Normal** (default) or **Low**.
- **Throughput** allows the selection of the throughput level: **Normal** (default) or **High**.
- **Reliability** allows the selection of the reliability level: **Normal** (default) or **High**.
- **Monetary Cost** allows the selection of the monetary cost level: **Normal** (default) or **Low**.
- **Reserved Bit** allows the selection of the reserved bit value: **0** (default) or **1**.

## Differentiated Services (DS)

➤ **DSCP Codepoints:**

**000000 (CS0)** (default), **001000 (CS1)**, **010000 (CS2)**, **011000 (CS3)**, **100000 (CS4)**, **101000 (CS5)**, **110000 (CS6)**, **111000 (CS7)**, **001010 (AF11)**, **001100 (AF12)**, **001110 (AF13)**, **010010 (AF21)**, **010100 (AF22)**, **010110 (AF23)**, **011010 (AF31)**, **011100 (AF32)**, **011110 (AF33)**, **100010 (AF41)**, **100100 (AF42)**, **100110 (AF43)**, **101100 (VOICE-ADMIT)**, **101110 (EF)**, **110011 (51)**, **110110 (54)**, or **User Defined**.

**User Defined Codes**, available when **User Defined** is selected from the **DSCP Codepoints**, allows entering a user defined code from hexadecimal **00** (default) to **3F** once the **TOS/DS Config** pop-up is closed.

- **ECN** allows the selection of the Explicit Congestion Notification code: **00 (Not-ECT)** (default), **01 (ECT-1)**, **10 (ECT 0)**, or **11 (CE)**.

## Triggered Frame Details

The triggered frame corresponds to the first received frame that matches the filter and the trigger settings.

- **Frame Number** indicates the triggered frame position in the buffer.
- The table displays the framing MAC/IP/UDP/TCP source and destination addresses.



## Truncation Calculator

**Truncation Calculator** allows determining easily at what byte to truncate the frame captured by selecting the desired frame header components.

- **Header Layer** specifies the header layer level: **Layer 2 (Ethernet)**, **Layer 3 (IP)**, or **Layer 4 (TCP/UDP)**.
- **IP Version** specifies the IP version: **IPv4** or **IPv6**.
- **Encapsulation** parameters are optional and not selected by default.

**VLAN** check box when selected enables VLAN and allows selecting the number of VLANs: 1, 2, or 3.

**MPLS** check box when selected enables MPLS and allows selecting the number of labels: 1 or 2.

**EoE** check box, when selected, enables EoE.

**PBB-TE** check box, when selected, enables PBB-TE.

- **Additional Payload (bytes)** allows selecting optionally the number of additional payload bytes (1 to 1400 bytes).
- **Total Number of Bytes** indicates the number of bytes for the selected frame parameters. This value will be used as the truncated frame length (**Truncated** field).



# E Remote ToolBox

## Overview

The **Remote ToolBox** application allows remotely controlling a module installed on a platform using a remote PC. Remote users are connected to the platform using an Ethernet connection.

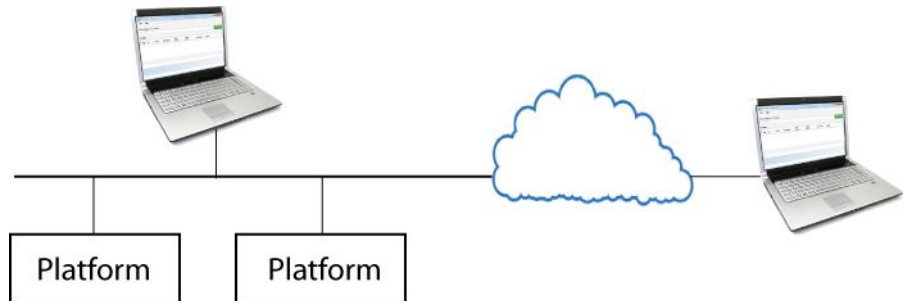

**Note:** *The remote control feature has to be enabled for the module on its specific slot on the platform. Refer to the Controlling Modules Remotely section from the platform user guide for more information.*

The **Remote ToolBox** allows starting one or several module application(s). Once a module application is started, the application is independent and does not require the **Remote ToolBox** anymore. Thus, the **Remote ToolBox** application can be closed or can be disconnected from the platform using the **Disconnect** button without affecting the running remote module applications.

## Remote ToolBox

### Overview

---

A remote module application offers the same level of control as if the module is locally controlled with the following behaviors.

➤ Multi-user behaviors:

Up to five connections including the local and/or remote sessions are allowed per module. Beyond five connections, the performance to service the connections may decrease.

Each user is able to individually navigate through the module application without affecting the other users. However, any changes to the operation of the test (**Start, Stop, Reset**, etc.) or to any test parameter will be applied to all users.

➤ File location behaviors:

The save, load, report, and data capture functions are associated with the location of the session initiated; for Remote ToolBox it will be on the local PC. The files are not duplicated on the platform platform.

➤ The **Save/Load** configurations are saved in the following folder:  
Document\88000-PowerBlazer\Configuration

➤ The **Reports** are saved in the following folder:  
Document\88000-PowerBlazer\Reports

If a report is being generated, no user will be able to start the test case until the report generation is completed.

➤ The **Data Capture** files are saved in the following folder:  
Document\88000-PowerBlazer\CaptureData

If a capture file is being generated, all users will be able to stop the capture but only the user that initiates the capture will be able to see the captured data file after generation.

## Remote ToolBox Installation

### Requirements

The following system requirements must be met before installing the **Remote ToolBox** software.

- 10 or 10/100 Mbit/s network interface card.
- Windows XP/Vista/7/8/10 operating system.

**Note:** *Some Windows applications such as PDF reader, Excel, etc. may be required to open the generated reports.*

### Installation

Download the **Remote ToolBox** application from **EXFO STORE** at [www.exfo.com](http://www.exfo.com). Run the **Setup.exe** application and follow the on-screen instructions to complete the installation.

A shortcut of the **EXFO Remote ToolBox** will be created on the PC desktop.

# Starting and Using the Remote ToolBox Application

Start the **Remote ToolBox** application, either by using the desktop **EXFO Remote ToolBox** shortcut, or by clicking on the **EXFO Remote ToolBox** application from **All Programs - EXFO**.

## File Menu

The **File-Exit** menu allows quitting the **Remote ToolBox** application.

## Help Menu

The **Help** menu displays the help information about the **Remote ToolBox** application.

## Server Address or Host Name

Allows entering the platform IP address or the Host Name. The IP address format is IPv4 (xxx.xxx.xxx.xxx) where xxx are values from 0 to 255. For example: 192.168.1.1.

To find the IP address of the platform, refer to the platform user guide.

## Connect/Disconnect Button

- **Connect** establishes the connection with the platform specified by the selected IP address or the Host Name.
- **Disconnect**, closes the connection with the selected platform allowing to establish a connection with another platform.

## Modules

Once connected to the platform, lists the modules installed on the platform regardless of the remote control feature being enabled or not. The following information is displayed for each module.

- **Type** displays the module's icon.
- **Slot** indicates the platform slot number where the module is inserted.
- **Module** indicates the name of the module.
- **Description** displays the description given to the module. Refer to the platform user guide for more information.
- **Serial Number** indicates the serial number of the module.
- **Remote Control** indicates if the remote control feature is enabled for this module. Refer to the *Controlling Modules Remotely* section from the platform user guide for more information.
- **Standalone** indicates if the standalone feature is possible for this module. Refer to the *Controlling Modules Remotely* section from platform platform user guide for more information.
- **Version** indicates the software version of the module application.

### Applications for...

**Note:** *The application icon is only available if the selected module has its **Remote Control** enabled and is only displayed if the module is supported by the **Remote ToolBox** application.*

Click on the icon to start the application.

The application is automatically started when the same version of the application is installed on the local PC.

The application is downloaded from the platform and installed on the local PC when either the application is not installed or the versions are different. Once installed, the application is automatically started. While downloading the application, the **Cancel** button allows cancelling the download and the installation process.

**Note:** *Multiple versions of a module application may be installed on the same PC. Use the Windows - Control Panel - Add/Remove tool to remove non-required versions from the PC.*





## Index

---

Apply .....	993	Backplane .....	232, 237, 238
Apply Channel TX to RX .....	977	Backplane Clock .....	237
Apply To Stream .....	1000	Back-to-Back .....	360, 579
APS .....	622, 644	Back-to-Back button .....	471
APS RX Count .....	710	Band .....	420
APS TX Count .....	710	Bandwidth Usage .....	468
APS/PCC .....	686	BAS Unexp. Period .....	930
Architecture .....	646	Base Station .....	139
ARM .....	434	Basic OAM .....	344, 560
Armed .....	705	Batch button .....	378, 408
Arrow buttons .....	47	Battery .....	425
Arrows .....	130	battery	
Assign .....	987	safety .....	772
Assign to Capture .....	663	Battery/AC Icons .....	39
Assigned Capacity .....	277	BBE .....	490, 493
Attempts .....	712	BBER .....	491, 494
AU Path (C2) .....	306, 472	BDI .....	917, 919, 921, 926, 927
AU Path (J1) .....	438, 611	BEI .....	917, 920, 922, 927, 929
AU Path (N1) .....	439, 612	Bell .....	975
AU-AIS .....	941	BER .....	889
AU-LOP .....	941	BER Threshold .. 211, 217, 221, 224, 226, 250,	
Auto .....	293	271, 341, 539, 546, 553, 559	
Automatic .....	292, 969	BERT .....	209, 216, 220, 223, 225, 347
Automatic IP (DHCP) .....	314, 324, 329	BERT Duration .....	428
Auto-Negotiation .....	291, 312, 753	BERT Threshold .....	428
Auto-Response Loopback Status .....	577	BFD .....	647
AU-x .....	941	BIAE .....	921, 926, 928
Available .....	379	Bidirectional .....	241, 354
Available BB_Credit .....	274	Bidirectional Delay Measurement .....	344
Average .....	455	Binary .....	976
Average RX Rate .....	510	Binary/Hex .....	1005
Average TX Rate .....	514	BIP-2 .....	949
Avg RX Rate .....	551	BIP-8 .....	918, 920, 922, 927, 929, 931
Avg. Round Trip Time .....	715	Bit Error .. 217, 221, 224, 226, 250, 271, 553,	
		889	
		Bit Error Count .. 522, 534, 539, 541, 546, 557,	
		559, 565	
		Bit Error Rate .. 522, 534, 539, 541, 546, 557,	
		559, 565	
		Bit Error Test .....	567
		Bit-Oriented Message .....	652
		Block .....	897, 901, 903

## B

B1 .....	689, 940, 951
B2 .....	691, 940, 951
B3 .....	695, 942, 951
Background .....	394, 403
Background Traffic .....	400

BPV .....	913
BRIDGE .....	233
Bridge Request .....	646
Bridged Signal .....	709
Broadcast .....	617
BSD .....	919
BSF .....	919
Buffer Delay .....	572, 584
Buffer to Buffer Flow Control .....	274
Buffer Usage .....	705
Bulk Read .....	953
Bulk Write .....	953, 954
Burst .....	412, 510
Burst Count .....	1000
Burst Duty Cycle .....	1000
Burst Frames .....	256
Burst Max Rate .....	384
Burst Sequence .....	256
Burst Size .....	385, 510
Burst Test .....	261
Burst Time .....	360
Burst/IR Frame Ratio .....	257
Bursts .....	360
Burt .....	256
B-VLAN .....	318
<b>C</b>	
C/R .....	654
C&M .....	294, 536
C&M Channel .....	293
c1 .....	484
C2 .....	306, 472, 696
cable .....	818
Cable Delay .....	422, 730
Cable Delay Compensation (ns) .....	431
Cable Mode .....	292, 753
Cable Test .....	91, 227
Calendar .....	277
Calendar Granularity .....	277
Calendar Mismatch .....	277, 904
Calibrating .....	566
Calibration Failed .....	727
Cancelled .....	727
Capture button .....	706
Capture Source .....	702
Capture Status .....	705
Capturing... .....	705
Carrier Ethernet OAM .....	89
Category .....	459
CAUI-4 Lane .....	637
caution	
of personal hazard .....	4
of product hazard .....	4
CBS .....	261, 386
CBS Test Time .....	257
CC Function .....	344, 371
CC Status .....	560
C-CDI .....	938
CCM .....	588, 624
CD .....	305, 480
CDF pFCS .....	288
C-FDI .....	938
Cfg. Status .....	704
CFO .....	305, 480
CFP .....	229
CFP4 .....	21, 27
CFP4 Control .....	634
CFP4 Power Class .....	634
CFP4 Reference Clock .....	634
CFP4 TX Status .....	636
CFP8 .....	25
CFP8 Reference Clock .....	634
CFP8 Status Pins .....	635
CFP8 TX Status .....	636
Channel .....	641, 645, 660, 987, 992
Channel Assignment Status .....	986
Channel Frequency .....	992
Channel ID .....	953, 984
channel identifier .....	846
Channel Number .....	990
Channel Spacing .....	990
Channel Summary .....	343
Channels Monitored .....	508

## Index

---

cHEC .....	680	Committed - Burst Test .....	510
cHEC-CORR .....	909	Committed Steps .....	513
cHEC-UNCORR .....	909	Complete .....	703
CID .....	288, 469, 679, 681	Completed .....	705
CIR .....	334, 365, 385, 996	Config TCM .....	400, 954
CIR or CIR+ EIR Frames .....	256	Config/Save .....	756
CIR+EIR .....	334, 385	Configuration .....	991
Circuit .....	656, 657	Configuration mismatch capabilities .....	988, 991
Classification .....	331, 335	Configuration/Performance Results .....	569, 571
cleaning		Connect .....	203, 352, 744
front panel .....	771	Connect button .....	1012
Cleaning Optical Connectors .....	772	Connected .....	354, 582
Client 140, 141, 160, 161, 168, 173, 185, 189, 964		Connectivity Verification .....	345, 563
Client Assignment Status .....	963	Connector 134, 135, 136, 138, 140, 141, 143, 147, 156, 157, 159, 161, 162, 164, 170, 177, 179, 182, 184, 188, 191, 192, 196, 199, 233, 270, 311, 752	
Client Data .....	468	Constellation .....	420
Client Frequency .....	889, 896	Continuity Check .....	371
Client ID .. 277, 279, 315, 349, 456, 459, 557, 558, 564, 613, 616, 963		Continuity Check (Peer MEP) .....	587
Client Management .....	468	Continuous .....	373, 412, 726
Client Offset .....	649	Control .....	660
Client RX Frequency .....	481	Control Pins .....	634
Clients - Path OAM .....	344, 708	conventions, safety .....	4
Clients - Profile .....	349	Coordinates .....	423
Clock .....	231, 270, 890	Copy .....	379, 955, 993
Clock Accuracy .....	966	Copy From Throughput .....	362
Clock block .....	131	Copy RX .....	467, 610, 615
Clock Class .....	966	Copy Service .....	379, 954
Clock Mode .....	231, 238, 752, 966	Copy Services button .....	379
Clock Out .....	237	Copy Stream button .....	408
Clock Synchronization .....	231	Core Header .....	677
C-LOS .....	939	core header .....	843
Cm CRC-8 .....	911	Count .....	454, 728
CMF .....	908	Couple with Interface .....	316
CMF pFCS .....	288	Coupled .. 142, 160, 161, 168, 174, 185, 189, 355	
CnD CRC-5 .....	911	Coupled RX to TX ... 209, 216, 220, 223, 225, 248, 271	
Code .....	285, 442, 467, 615	CP-Bit .....	893
Code Word .....	536	CPRI .....	217, 250, 536, 537, 813, 890, 916
Codeword .....	465, 652, 659, 660	CPRI/OBSAI BERT .....	96
Collision .....	897		
Command/Response .....	655		
Committed .....	379		

CRC	916	Date and Time	39
CRC-4	895	Date Stamp	475
CRC-6	892	DCI	907
C-RDI	939	DCO (Interface)	302
Critical Event	573	Deactivate Threshold (Symbols)	960
CS Type	346, 561	Debounce Time	221, 251, 272
CS Type Mismatch	930	Decoupled	142, 185, 189
CS_LF	930	Default	954
CS_LPI	930	Default all OH	679, 701
CS_RF	930	Default FlexE OH	672
CSF	624, 923	Default Gateway	314, 324, 329, 969
cTE (ns)	604, 606	Default Mapping	639, 974
cTE Averaging Period (s)	430	Default OTN OH	682
CTLE	641	Defaults	269
Cumulative Offset	725	Defect	212, 342, 457, 486, 523
Current	455, 532	Del Ch	986
Current Laser Frequency	993	Delay	495, 712, 728, 1005
Current Laser Wavelength	993	Delay (ms)	505
Current Throughput	600	Delay 1,2	731
Current TX Power	988	Delay Measurement	526, 562
Cursor	462	Delay Mode	203
Custom Bytes	264, 971	Delay Req IPDV	526
Customer Frame TX Rate	413	Delay Skew	528
customer service	780	Delay Skew Threshold	228
Cut Through	580	Delay T14	730
CV	534, 913	Delay-Request	205
CV Function	345	Delete All	963, 986
<b>D</b>			
D1	690	Delete Client	963
D2	690	Delete Step	269
D3	690	Delta	288
D4 through D12	691	Desired Accuracy	421
DAPI	436, 441, 563, 609, 614	Dest. MAC	511
DAPI Mismatch	930	Destination	274
DAPI ODU-TIM	437, 442, 610, 614	Destination B-MAC Address	318
DAPI OTU-TIM	437, 442, 610, 614	Destination EoE MAC Address	316
DAPI TCM-TIM	437, 610	Destination Flooding	321
Data	995	Destination IP Address	324, 711, 745
Data Size	712	Destination MAC Address	255, 263, 320, 620, 745, 970
Data Transfer	582	Destination MAC address	380
		Destination Node ID	645
		Destination Port	326, 745

## Index

---

Details .....	478	dTEH pk-pk (ns) .....	603
Detection/Classification .....	531	Dual RX .....	142
Device Address .....	635	Dual Test Set .....	258, 354
Device Under Test block .....	125	DUPLEX .....	33
DGD .....	305, 480	Duplex .....	291
Differentiated Services .....	1006	Duration .....	366, 430, 433, 478
Direction 257, 364, 377, 510, 511, 513, 550, 571, 579, 583		Dying Gasp .....	574
Disabled .....	294, 728	Dynamic Ramp .....	269
Discarded .....	469		
Disconnect .....	352, 744	<b>E</b>	
Disconnect button .....	1012	E0 check box .....	395
Disconnected .....	258, 354, 364	E1 .....	689
Discover .....	999	E2 .....	694
Discover Remote .....	258, 354	EB .....	489, 492
Discovered Topology .....	275	E-Bit .....	895
Discovery .....	316	EBS .....	261, 386
Displayed Results .....	471, 579	EBS Test Time .....	257
Disruption Count .....	523, 535, 542, 547, 554	EC .....	489, 492
Disruption Monitoring ... 213, 218, 222, 251, 272, 342		eCPRI BERT .....	98
Disruption Time 486, 523, 535, 542, 547, 554		Edit Ch ID .....	986
Distance To Fault .....	530	Edit ID .....	279, 963
DM .....	491	Efficiency .....	595
DMM .....	624, 625, 751	EFS .....	492
DMR .....	623, 625, 751	eHEC .....	681
Domain .....	202	eHEC-CORR .....	909
Domain ID .....	370	Embedded DSn .....	189
Domain Mismatch .....	933	Embedded PDH .....	189
Drop Eligible .. 317, 319, 322, 330, 372, 374, 460, 732		Embedded SONET/SDH .....	172
DS0 check box .....	395	EMIX .....	254, 334, 347, 383, 411
DS0/E0 Size .....	975	EMIX Frame Sizes .....	958
DS1 .....	577	Emulation Mode .....	139
DS3 .....	893	Enable .....	215, 381, 409, 663
DSCP .....	336	Latency .....	252
DSCP Codepoints .....	1006	Enable TX .....	252, 348, 349
DSn/PDH BERT .....	69	Enabled Time .....	663
DSn/PDH Multiplexing .....	141	Encapsulation .....	703, 1007
DSP Mode .....	641	End Time .....	478
DSX-MON .....	233	EOE .....	316, 703, 981, 1007
dTEH Observation Period (s) .....	430	EOE VLAN .....	317
		equipment returns .....	780
		ERDI-CD .....	941



## Index

---

FC BERT .....	95, 271	Fine Tuning .....	992
FC Frame .....	273	Fixed .....	281, 304, 334
FCS .....	327, 897, 903	Fixed Structure .....	982
FD .....	337, 570	FlexE .....	459
FDD .....	302, 915	FlexE Clients .....	557
FDD Activate Threshold (BER) .....	1002	FlexE Group .....	277, 556
FDD Deactivate Threshold (BER) .....	1002	FlexE Group Down .....	904
FDI .....	907	FlexE Group Number .....	277
FEAC .....	659	FlexE Group Number Mismatch .....	932
FEBE .....	893	FlexE OH Frame Summary .....	672
FEC .....	289, 398, 831	FlexE PHY Number .. 229, 280, 289, 456, 634, 672	
FEC (RX Only) .....	290	FlexE Status .....	277
FEC Degraded SER .....	935	FlexO BERT .....	57
FEC Exc. Skew .....	936	FlexO Group ID .....	279
FEC Inv. Marker .....	936	FlexO Instance ID .....	229, 280, 289, 456
FEC Statistics .....	465	FlexO Status .....	279
FEC-COR-BITS .....	936	FlexO-OUTCn .....	279
FEC-COR-CW .....	900, 902, 932, 935, 936	Flood Range .....	321
FEC-CORR Alarming .....	398	Flow Control .....	291, 753
FEC-CORR-BIT .....	902, 929	Traffic .....	619
FEC-CORR-BITS .....	897, 916	Flow Direction .....	354
FEC-CORR-CW .....	902, 903, 929	Flow Label .....	202, 325
FEC-CORR-SYM .....	902, 929	FLR .....	337, 570
FEC-LOA .....	935	Force Release .....	396
FEC-LOAML .....	936	Force TX Idle .....	295
FEC-STRESS .....	929	Foreground Signal Label .....	687
FEC-UNCOR-CW 900, 902, 903, 932, 935, 936		Format .....	438, 439, 611
FEC-UNCOR-FR .....	897, 916	Frame .....	537, 672
FEC-UNCORR-CW .....	902, 930	Frame Clock Burst Generation .....	295
FED .....	302, 915	Frame Count ... 376, 413, 485, 555, 616, 665, 705, 750	
FED Activate Threshold (BER) .....	1002	Frame Count - RX .....	619
FED Deactivate Threshold (BER) .....	1002	Frame Delay .....	373, 505, 590
Fibre Channel .....	274	Frame Delay Threshold .....	1004
Field Match .....	704	Frame Distribution .....	355
File .....	1012	Frame Format .....	263, 328, 970, 979
Filter .....	664, 702, 961	Frame Length .....	703
Mask .....	665, 962	Frame Loss 373, 414, 506, 516, 517, 551, 570, 579, 934	
Operator .....	665, 962	Frame Loss / Out-of-Sequence	
Value .....	664, 961	Stream .....	517
Filter Configuration .....	663, 664, 961		
Filter Statistics .....	665		
Filters .....	663, 666		



Frame Loss button .....	471
Frame Loss Configuration .....	361
Frame Loss Rate .....	246, 386, 544, 600, 998, 1001
Frame Loss Ratio .....	590
Frame Loss Threshold .....	1004
Frame Number .....	1006
Frame Rate .....	485, 555, 616, 665, 750
Frame Size .....	243, 254, 263, 273, 335, 347, 349, 356, 375, 378, 407, 411, 471, 617, 970
Frame Sync .....	536
Frame Type .....	334, 468, 617
Framed .....	164
Framed L2 .....	138
Framed Layer 1 .....	148
Framed Layer 2 .....	144, 148
Framed Layer 3/4 .....	144
frame-mapped GFP .....	839
Framing ..	138, 144, 148, 161, 164, 184, 202, 234, 235, 378, 394, 407
Framing Bit .....	892
Freq. Offset .....	463
Frequency .....	234, 236, 270, 280, 282, 283, 300, 392, 481, 598, 650, 911, 990
Frequency Offset Analysis .....	651
Frequency/Offset .....	593
front panel, cleaning .....	771
FSD .....	919
FSF .....	919
FTFL .....	284, 466, 684
FTFL/PT .....	466
Function .....	373
Functions .....	42
<b>G</b>	
G.709 OTN .....	820
G.742 Bit 12 .....	737
G.751 Bit 12 .....	736, 737
G.751 Bit 14, 15, 16 .....	736, 737
G.8113.1 .....	368
G1 .....	697
GAL .....	372
GCC BERT .....	669
GCC0 .....	683
GCC1 .....	686
GCC2 .....	686
Generate & Save .....	707, 959
Generated Messages .....	652, 656, 659
Generated QL .....	297, 417, 500
Generic Framing Procedure .....	837
GFP .....	837
GFP frame structure .....	841
GFP mapping .....	839
GFP-10B_ERR .....	909
GFP-CHEC-CORR .....	909
GFP-CHEC-UNCORR .....	909
GFP-DCI .....	907
GFP-eHEC-CORR .....	909
GFP-eHEC-UNCORR .....	909
GFP-EXM .....	907
GFP-F .....	288, 468
GFP-F/GFP-T .....	677
GFP-FDI .....	907
GFP-LFD .....	907
GFP-LOCCS .....	907
GFP-LOCS .....	908
GFP-pFCS .....	910
GFP-RDI .....	908
GFP-Reserved CMF .....	908
GFP-SB-CORR .....	910
GFP-SB-CORR (Post) .....	910
GFP-SB-CORR (Pre) .....	910
GFP-SB-UNCORR .....	910
GFP-T .....	288
GFP-tHEC-CORR .....	910
GFP-tHEC-UNCORR .....	910
GFP-UPM .....	908
GFP-UserDefined CMF .....	908
GIDM .....	905
Global	
EtherSAM .....	258
RFC 2544 .....	354

# Index

---

Services .....	377
Streams .....	407
Global alarm .....	41
Global Copy RX .....	467, 610, 615
Global indicator .....	40
Global IPv6 Address .....	967
Global Options .....	262, 354, 379, 408
Global Pass/Fail Verdict .....	246, 414
Global PM TTI Traces .....	613
Global Test Duration Estimation .....	261
Global Thresholds Type .....	414
Global Verdict .....	41
GM Identity .....	965
GM Info .....	204, 525
GM IP Address .....	202, 203
GMP .....	668
GNSS .....	422
Granted Power Class .....	531
Granularity .....	361
Graph	
RFC 2544 .....	471
Traffic .....	621
Gray Encoding .....	642
Grid .....	991, 993
Group Down .....	905
Group Size .....	159
GTE .....	975

## H

H1 .....	690
H2 .....	690
H3 .....	690
H4 .....	697
H4-LOM .....	941
HDLC .....	293
Header Layer .....	703, 1007
Help .....	1012
Help button .....	43
Hi-BER .....	896, 931
Hi-BER1027B .....	946
Highest Channel Number .....	993

Highest Frequency .....	993
Highest Offset .....	994
HOP Limit TTL .....	325
Host Name .....	1012
Host/Media Loopback .....	147, 242
HP-PLM .....	942
HP-RDI .....	942
HP-REI .....	942
HPTC-IAIS .....	943
HPTC-IEC .....	944
HPTC-LTC .....	943
HPTC-ODI .....	943
HPTC-OEI .....	945
HPTC-RDI .....	944
HPTC-REI .....	945
HPTC-TIM .....	439, 612, 944
HPTC-UNEQ .....	402, 944
HPTC-VIOL .....	945
HP-TIM .....	439, 611, 942
HP-UNEQ .....	942
Hyperframe .....	536

## I

I/O Interface Quick Check .....	567
I2C - Bulk Read .....	635
I2C - Bulk Write .....	636
I2C - Read/Write .....	636
I2C Access Interface .....	635
I2C Address .....	636
I2C Data .....	636
I2C End Address .....	636
I2C Start Address .....	636
IAE .....	921, 926, 928
ID .....	424, 478
Ideal L4 .....	572, 583
identification label .....	776
Identity .....	965
Idle .....	468, 654, 898, 976
Idle/Grp (K_MG) .....	296
IFDV .....	337, 570
IIDM .....	905

Illegal Client .....	904	Invalid SLR .....	507
Import/Export tab .....	765	Invalid TST .....	504
Inconsistent Calendar .....	904	Inv-CW-Marker .....	936
Increment/Decrement Size .....	649	Invert 211, 216, 220, 223, 225, 249, 271, 341	
Individual Pattern Duration .....	215	Invert PRBS15 Pattern .....	669
Information .....	502	iOptics .....	53
Information Count .....	593	IP .....	324, 353, 405, 750
Information Rate .....	385	IP Address .....	314, 329, 370
Informational .....	510, 514	IP Checksum .....	915
Initial Window Size .....	427	IP TOS/DS .....	203, 324, 325, 426, 647, 712
Inject .....	457, 553, 620, 652, 660, 717	IP Version .....	314, 329, 703, 979, 1007
Inject button .....	457	IPDV .....	496
Injection .....	656	IPDV Threshold .....	206
Injects .....	652	IPv4 .....	324, 329
Inserting and Removing Transceiver System 13		IPv6 .....	325, 329
FTBx-88260 .....	13	IPv6 Destination Address .....	325
FTBx-88460 .....	16	iSAM .....	55
Instance Skew Alarm Threshold .....	905	I-TAG .....	319
Interface . 137, 140, 143, 145, 154, 193, 239,		ITU G.8275.1 .....	201
289, 310, 428, 577, 702		ITU G.8275.2 .....	201
Interface block .....	131		
Interface ID Coupled .....	968	<b>J</b>	
Interface Type .....	232, 234	J0 .....	689
Interface/Rate . 134, 135, 136, 141, 157, 158,		J0 Trace .....	297, 627
160, 161, 162, 163, 170, 175, 178,		J1 .....	695
180, 183, 187, 191, 192, 195, 197,		J1 Trace .....	297, 627
310, 752		J2 .....	700
Internal .....	231, 238, 752	Jabber .....	898
Internal 1/160 .....	235	jammed bit 8 .....	975
Internal 1/40 .....	235	Jamming .....	423
Internal 1/8 .....	235	JC .....	683, 685, 686
Internal GNSS .....	231, 270	JC1 .....	683
Interval (CW) .....	960	JC2 .....	685
Inv. Flag .....	946	JC3 .....	686
Inv. Mapping .....	899	JC4 .....	683
Inv. Marker .....	901, 907, 925	JC5 .....	684
Invalid .....	469, 470	JC6 .....	686
Invalid DMR .....	505	Jitter .....	415, 515, 517, 543, 570, 600, 997
Invalid LBR .....	503	Streams .....	517
Invalid LMR .....	506	Job Information .....	756
Invalid LTR .....	733		
Invalid Payload .....	504		

## Index

---

### K

K1 .....	644, 691
K2 .....	645, 691
K3 .....	698
K30.7 .....	914
K4 .....	701
Keyboard usage .....	48

### L

L Deg SER Det .....	899, 931
L Deg SER Rcd .....	899, 932
L1 Reset .....	536
L2 .....	331
L2 Only .....	978
L2CP .....	511, 550
EtherSAM .....	263
Services .....	380
L2CP Handling Test .....	259, 380
L3/L4 .....	331
Label .....	372, 627
Label 1 .....	372, 485
Label 2 .....	372, 485
label, identification .....	776
Labels .....	306, 472, 480
Lane .....	459
Lanes Mapping & Skew .....	637
Lanes with Disruption .....	487, 508
LASER .....	33
Laser .....	298, 302, 387
Laser Frequency .....	992
Laser OFF at Start-Up .....	242, 299, 303, 312, 388
Laser On .....	775
Laser ON/OFF .....	299, 388, 640, 971
Laser Tuning Support .....	993
Laser Wavelength .....	992
Last .....	455
Last Change .....	593
Last cTE (ns) .....	604
Last Disruption .....	508
Last Link Trace Status .....	732
Last QL Message .....	593

Last QL Received .....	497, 500, 526
Late Coll. ....	898
Latency ...	415, 515, 518, 543, 548, 570, 579, 600, 997
Streams .....	518
Latency button .....	471
Latency Configuration .....	362
Latency Measurement Mode .....	262
Latency Tag .....	273
Latency Tags Insertion .....	273
Layer .....	331, 457, 580
Layer 2 .....	999
Layer 3 .....	999
Layer Mode .....	978
LBL Tx FIFO .....	891
LBL Tx LOA .....	891
LBL Tx OOA .....	891
LBL Tx RefClk LOL .....	891
LBM .....	624, 625, 751
LBO .....	235, 389
LBR .....	623, 625, 751
LBR Timeout .....	503
LCD-P .....	949
LCK .....	624, 917, 919, 939
Lease Duration .....	205
LED .....	33
Blue .....	33
Legend TX/RX .....	687
Length .....	528, 530
Length Threshold .....	228
Length Unit .....	227
LFD .....	907
Line .....	939
Line Coding .....	233, 235, 389
Line Utilization .....	485, 555, 616, 665, 750
LINK .....	223, 247, 290, 310
Link .....	277
Link Activity .....	654, 657, 661
Link Alarm .....	557
Link Capacity .....	408
Link Down .....	890, 896, 903, 916, 931
Link Events .....	474

Link Fault .....	574	Logical Lane .....	637, 638, 666
Link OAM .....	308, 573	Login .....	275
Link Trace .....	732	Logo .....	759
Link TX/RX Scrolling .....	687	LOL .....	924
LINK/RX .....	33	LOM .....	905, 928
Link-Local IPv6 Address .....	967	LOMF .....	894
Listening .....	582	Longest Disruption .....	487, 508
LLC .....	264, 970	LOOMFI .....	922, 923
LLC Control .....	264, 970	Loop Down .....	744, 746
LLC DSAP .....	264, 970	Loop Layer .....	745
LLC SSAP .....	264, 970	Loop UP .....	744, 746
LMM .....	624, 625, 751	Loop UP/Down .....	746
LMR .....	623, 625, 751	Loopback .....	373, 395, 405, 503, 661, 751
LOA .....	906	Loopback Commands .....	660, 662
Loaded Voltage .....	532	Loopback Mode .....	750
LOAML .....	901, 906	Loop-Down .....	352, 397, 957
LOAML1027B .....	946	Loop-Up .....	352, 397, 956
LOBL1027B .....	946	LOP-P .....	941, 950
LOC .....	237, 890	LOPPS-L .....	233, 262, 890
LOC Lane .....	913	LOPPS-R .....	262, 890
Local .....	418	LOP-V .....	947
Local block .....	126	LOR .....	924
Local Clock .....	292, 754	LOS .....	233, 534, 913, 914
Local Fault Det .....	896	Loss Announce .....	933
Local Fault Detected .....	903	Loss Continuity .....	930, 937
Local Fault Rcd .....	896	Loss of OH Frame Lock .....	933
Local Fault Received .....	903	Loss of OH MF Lock .....	933
Local Module Identification .....	746	Loss of PHY Number Lock .....	933
Local Parameters .....	370	Loss Sync .....	933
Local to Remote .....	354	Lower Eye .....	641
LOCCS .....	907	Lowest Channel Number .....	993
LOCS .....	908	Lowest Frequency .....	993
LOCWS .....	903	Lowest Offset .....	994
LOF .....	890, 894, 895, 916, 924, 928, 950	LP-ERDI-CD .....	947
LOFLOM .....	920, 925	LP-ERDI-PD .....	947
LOF-S .....	939	LP-ERDI-SD .....	947
Log Message Interval (Announce) .....	965	LP-PLM .....	307, 472, 948
Log Message Interval (Sync) .....	965	LP-RDI .....	948
Logger .....	477	LP-REI .....	949
Logger Full .....	520, 524, 533, 538, 540, 545, 552, 556, 564, 573, 575, 578, 582, 585, 586, 591, 594, 597, 599, 602	LP-RFI .....	948
		LPTC- .....	945
		LPTC-IAIS .....	943



Message Rate .....	204	RFC 2544 .....	175
Message Type .....	327, 483, 484	RFC 6349 .....	178
Messages .....	483	Smart Loopback .....	180
Metrics .....	515	SONET/SDH BERT .....	183
MFAS .....	682, 906, 925, 930	SONET/SDH-DSn/PDH BERT .....	187
Mid-Trigger .....	705	SyncE .....	191
Min pkt sel TE (ns) .....	604	TCP Throughput .....	192
Min Round Trip Time .....	715	Through Mode .....	193
Min RX Power .....	299, 388	Time Error / Wander .....	195
Min TE (ns) .....	603	Traffic Gen & Mon .....	197
Min TIE (ns) .....	607	Modify Structure button .	132, 135, 136, 140, 141, 145, 154, 157, 158, 160, 161, 162, 163, 170, 175, 178, 180, 183, 187, 193, 197
Minimum .....	455	Modify Trib Slots/Channels .....	343, 984
Minimum RTT .....	571, 583	Modify Trib Slots/Port .....	400, 982
Minimum Window Size .....	427	Modify Wavelength .....	242, 990
Mismatch .....	288	Modules .....	1013
Mismatch '0' .....	889	MON .....	233
Mismatch '1' .....	890	Monetary Cost .....	1005
Mismerge .....	937	More .....	242
Mixed .....	978	MPLS .....	323, 485, 703, 1007
Mode 202, 252, 270, 405, 458, 659, 726, 987		MPLS Label .....	980
Modify .....	278, 313	MPLS-TP Label Stack .....	372
Modify DS0 .....	395	MPLS-TP Mode .....	372
Modify E0 .....	395	MPLS-TP OAM .....	136, 368, 473, 503, 937
Modify Frame Structure .....	978	Traffic .....	624
Modify Loop Codes .....	397, 957	MPLS-TP OAM Responder .....	369
Modify Structure .....	129	MS .....	939
1588 PTP .....	134	MS-AIS .....	939
Cable Test .....	135	MSEQ Violation .....	946
Carrier Ethernet OAM .....	136	Msg Grp/Frame (N_MG) .....	296
CPRI/OBSAI BERT .....	137	Msg/Grp (M_MG) .....	296
DCO BERT .....	140	MSIM .....	922, 924
DSn/PDH BERT .....	141	MSIM Monitoring .....	922, 924
eCPRI BERT .....	143	MS-RDI .....	940
EtherBERT .....	145	MS-REI .....	940
EthersAM (Y.1564) .....	154	MS-REI Computation Method .....	402
FC BERT .....	157	MTIE .....	462
FlexE BERT .....	158	MTIE/TDEV .....	461
FlexO BERT .....	160	MTU .....	571, 583
Multi-Channel OTN .....	161	Multicast .....	617
NI/CSU Emulation .....	162		
OTN BERT .....	163		
OTN-SONET/SDH BERT .....	170		

## Index

---

Multicast MAC ..... 202  
Multi-Channel OTN ..... 56  
Multi-Pattern Configuration ..... 215  
Multiple Connections ..... 365  
Multiplexer Action ..... 473

### N

N1 ..... 698  
N2 ..... 700  
Name ..... 263, 380, 511, 970  
NAT LAN/WAN ..... 258, 331  
n-Burst ..... 412  
NDF ..... 725  
Near-End ..... 489  
Negotiation Status ..... 203, 525  
Network ..... 328, 331  
Network block ..... 126  
Network Details ..... 331, 350  
Network Layer ..... 979  
New Data Flag ..... 717  
New Pointer ..... 717  
Next HOP Router ..... 370  
n-Frame ..... 412  
NI/CSU Emulation ..... 74  
NJ0 ..... 687  
No Defect Time ..... 213, 218, 342  
No NDF ..... 725  
No Pattern Analysis (Live) 209, 216, 220, 223,  
225, 248, 341  
No Traffic ..... 889, 897  
No Traffic Time ..... 221, 251, 272  
Nominal Bit Rate ..... 983  
None ..... 975, 977  
None (All 1's) ..... 661  
Non-Unicast ..... 617  
Not ..... 664, 961  
n-Ramp ..... 412  
Number ..... 402  
Number of Burst Sequence ..... 257  
Number of Calls ..... 995, 996  
Number of Channels ..... 995, 996

Number of samples ..... 607  
Number of Symbols ..... 465  
Number of Trib Slots ..... 983

### O

OA1 ..... 682  
OA2 ..... 682  
OAM Mode ..... 308, 368, 473  
OAM Quick Ping ..... 320, 371  
OAM Responder ..... 344  
OAM Version ..... 473  
Obs. Interval ..... 462  
OBSAI ..... 850  
OCI ..... 920  
ODU ..... 828  
ODU Channels ..... 341  
ODU Multiplexing ..... 833  
ODU Type ..... 953  
ODUCn ..... 917  
ODUflex ..... 835  
ODUx ..... 919  
ODUx TCM TTI Traces ..... 435  
ODUx-TCM ..... 921  
Offset 234, 280, 282, 283, 300, 304, 390, 481,  
598, 649, 650, 992  
OH BERT ..... 669  
OH CRC ..... 906, 933  
OH Details ..... 681  
OH TX/RX (FlexE) ..... 672  
OMFI ..... 687, 923, 924  
On Error ..... 704  
One-step ..... 966  
One-Way ..... 548  
One-Way Latency Threshold ..... 1004  
One-Way P P ..... 253  
One-Way P -> P Threshold ..... 253, 548  
OOF ..... 892, 893, 925, 928  
OOM ..... 906, 928  
OOMFI ..... 923, 924  
OOR ..... 925  
OOS ..... 911



- Operation ..... 532  
 Operation Mode ..... 364, 646  
 Operator  
     Filter ..... 665, 962  
 Operator Identifier ..... 285, 466  
 Operator Specific 285, 437, 441, 466, 610, 614  
 Optical Lane ..... 298, 387  
 Optical Metrics ..... 305, 480  
 Optical Module Insertion Counter ..... 425  
 Optical RX Power Test ..... 567  
 Optical TX Power Test ..... 567  
 OPU ..... 829  
 OPU Tributary Port ..... 399  
 OPU Tributary Slots ..... 399  
 OPUCn ..... 922  
 OPU-PLM ..... 287, 444, 467, 615  
 OPUx ..... 923  
 OSFP ..... 229  
 OSNR ..... 305, 480  
 OTL ..... 826, 924  
 OTL4.4 Physical Lane ..... 637  
 OTL-SDT ..... 486  
 OTN ..... 682  
 OTN BERT ..... 58  
 OTN BIP-8 ..... 901  
 OTN Multiplexing ..... 160, 167, 171  
 OTN Traces/PT ..... 440  
 OTN-SONET/SDH BERT ..... 61  
 OTU ..... 827  
 OTU frame structure ..... 825  
 OTU overhead ..... 825  
 OTUC Frame ..... 925  
 OTUCn ..... 926  
 OTUx ..... 927  
 OUI ..... 264, 321, 473, 971  
 Out-of-Seq. .... 934  
 Out-of-Sequence .... 414, 415, 516, 517, 600  
 Oversize ..... 898, 903  
 Oversize Monitoring ..... 898  
 Overtake ..... 352  
 Overwrite ..... 284, 285, 435  
 Overwrite Fixed Stuff ..... 402
- P**
- Packet Capture ..... 702  
 Packet Pause Time ..... 620  
 Packets Received ..... 648, 715  
 Packets Transmitted ..... 648, 715  
 Page Select ..... 636, 953  
 Pair ..... 528  
 PAM-4 Histogram ..... 643  
 PAM-4 Lane ..... 643  
 Parameters ..... 242, 257  
 Parser Action ..... 473  
 PASS ..... 41, 455  
 Pass/Fail Verdict 208, 211, 214, 217, 219, 221,  
     222, 224, 226, 228, 250, 251, 253,  
     262, 271, 273, 341, 343, 355, 366,  
     369, 416  
     FAIL ..... 455  
     PASS ..... 455  
 Path OAM ..... 344, 560, 708  
     Traffic ..... 622, 708  
 Path OAM APS ..... 708  
 Path OAM Client ..... 558  
 Path OAM on Client ID ..... 344, 708  
 Path Signal Label (C2) ..... 298, 627  
 Path/Mapping  
     DSn/PDH BERT ..... 70  
     OTN BERT ..... 56, 58  
     OTN-SONET/SDH BERT ..... 62  
     SONET/SDH - DSn/PDH BERT ..... 72  
     SONET/SDH BERT ..... 65  
 Pattern ..... 209, 215, 216, 220, 225, 341, 977  
 Pattern Error ... 250, 522, 534, 539, 541, 546,  
     559, 565, 890  
 Pattern Error Count 522, 534, 539, 541, 546,  
     559, 565  
 Pattern Error Rate ... 522, 534, 539, 541, 546,  
     559, 565  
 Pattern Loss ..... 889  
 Pattern on Client ID ..... 225  
 Pattern Sync ..... 211, 249, 271  
 Pause Frames ..... 619

## Index

---

Payload .....	327, 376	Pins .....	528
Payload Content .....	976	Pk-pk pkt sel TE (ns) .....	605
payload FCS .....	847	Pkt sel cTE Averaging Period (s) .....	431
payload FCS indicator .....	844	Pkt sel TE (ns) .....	604
payload header .....	843	PLI .....	680
payload information field .....	847	PLM .....	923, 924
Payload Type .. 279, 285, 343, 442, 467, 615, 984		PLM-P .....	942, 950
payload type identifier .....	843	PLM-P/UNEQ-P .....	950
PBB-TE .....	318, 703, 981, 1007	PLM-V .....	307, 472, 948
P-Bit .....	893	PM .....	685
PCS BIP-8 .....	901	PM & TCM .....	684
PCS BIP-8 Mask .....	901	PM TTI Traces .....	435, 440, 613
PCS Lane .....	637, 638, 666	PoE .....	227, 531
PDI-P .....	942	PoE Loaded Voltage Thresholds .....	228
PDL .....	305, 481	Point To Point .....	275
PDV .....	206	Pointer Adjustment .....	716
Peer MEP Parameters .....	371	Pointer Value .....	716, 725
Peer Target RP3 Address .....	296	Port .....	229, 280, 289, 456, 459, 634, 666
Per Direction Configuration .....	262	Port #1 to Port #2 .....	354
Percentage Lost .....	715	Port #2 to Port #1 .....	354
Performance Criteria .....	336, 386	Port A .....	22
Performance Information .....	658	Port A1 .....	22
Performance Monitoring .....	488	Port A2 .....	22, 23
Performance Report Message .....	656	Port B .....	22
Performance Test .....	332	Port B1 .....	22
Period .... 344, 345, 372, 374, 458, 460, 1000		Port B2 .....	22
pFCS .....	910	Port Identity .....	965
PFI .....	469, 677, 680	Port Status .....	276
PHY .....	459, 666, 931	Port1 - QSFP28 .....	159, 160
PHY n / Instance n (Port n) .....	964	Port2 - QSFP28 .....	159, 160
PHY Skew Alarm Threshold .....	667	Port3 - QSFP28 .....	159, 160
PHY TX Skew .....	973	Port4 - QSFP28 .....	159, 160
PHY Type 143, 147, 156, 158, 177, 179, 181, 194, 196, 199, 311		POS Violation .....	946
PHY/Port .....	973	Position Mode .....	421
Physical clock port .....	131	Post Cursor .....	641
Physical Connection .....	130	Post-Trigger .....	705
Physical Interface .....	298, 302, 387	Power .....	532
Physical interface port .....	130	Power Class .....	228
Ping & Trace Route .....	711	Power Consumption .....	428, 568
Ping button .....	712	Power Presence .....	531
		Power Range .....	299, 303, 388, 480, 752
		Power Threshold .....	428

Pre Cursor .....	641
Preamble/SFD .....	316
Precedence .....	1005
Pre-Emphasis/RX EQ .....	641
Pre-FEC-Bit .....	902, 936
Pre-FEC-SYMB .....	902, 904, 935, 936
Prefix Mask .....	968
Pre-Trigger .....	705
Primary Port / Secondary Port .....	193
Priority .....	371, 374, 460, 652, 654, 732
Priority 1 .....	965
Priority 2 .....	965
PRM .....	654, 658
PRM Bit Events .....	656, 657
product	
identification label .....	776
specifications .....	3, 783
Profile .....	201, 333, 349, 382, 995
eCPRI .....	243
Services .....	381
Streams .....	409
Programmable TX Power not supported .....	988, 991
Programmable TX Power Supported .....	989
Prop. Delay .....	527, 530
Prop. Delay Threshold .....	228
Propagation Delay .....	731
Protected Channel .....	645
Protection Type .....	709
Protocol .....	293, 536
Protocol block .....	131
PSE Type .....	531
PSI .....	687
PSP (Link Protocol) .....	292
PTI .....	677, 680
PTP .....	201, 933
PTP Message .....	495
PTP Stats .....	495
Ptr. Decr. .....	725
Ptr. Incr. .....	725
PW .....	372

---

**Q**

QL Message .....	593
QL Mismatch .....	934, 943
QL Mismatch Frame Count .....	501, 593
QL Mismatch Monitoring .....	206, 416, 497, 500
QL Rate .....	417
QoS Metrics .....	414, 934
QoS Metrics Tags Insertion .....	408
QSFP .....	21, 24, 27, 229
QSFP Control .....	634
QSFP Power Class .....	634
QSFP28 .....	29
QSFP56-DD .....	25
Qty of Clients .....	277, 279
Quality Level .....	206, 497, 500, 526
Quantity .....	355, 953
Quantity of Channels .....	343
Quick Ping .....	202, 325, 426, 745
QZSS .....	420

**R**

R Deg SER .....	899, 932
RAI .....	892, 894, 895
RAI MF .....	894
Ramp .....	412
EtherSAM .....	269
Service Configuration .....	513
Ramp Cycle Count .....	1000
Ramp Duration .....	269
Ramp Nb. of Steps .....	1000
Ramp Test .....	260
Random Mapping .....	639, 974
Range .....	281, 304
Rate .....	241, 294, 454, 458, 553, 995
Rate Unit .....	355, 365, 379, 408, 427
rates .....	836, 855
RDI .....	893, 908, 930, 937
RDI-L .....	940, 950
RDI-P .....	942, 950
RDI-V .....	948
Read .....	636

## Index

---

Ready .....	727	Remote unit in use and locked for DTS ...	549, 578, 582
Receipt Timeout .....	205	Remove Offset .....	463
Receive Messages .....	654, 661	Renewal Interval .....	205
Received QL .....	297, 416	Replied Details .....	715
Receiving Live Traffic 521, 534, 539, 541, 546, 559, 565		Report Content .....	657
Recovered .....	231, 238	Request .....	644
REF OUT .....	21, 24, 27, 29	Request/State .....	708
Reference Signal .....	935	Request/State Interpretation .....	708
REF-FAULT .....	935	Requested Signal .....	709
Refill .....	256	Requesting MEP ID TLV .....	374
Refill Delay .....	256	RES .....	683, 684, 686
Refill Delay Ratio .....	257	Reserved .....	709
Refresh .....	464	Reserved Bit .....	1005
regulatory information .....	xiv	Reserved CMF .....	908
REI-L .....	940, 951	Reserved PLI .....	469
REI-L Computation Method .....	402	Reserved PTI .....	469
REI-P .....	942, 951	Reset .....	728
REI-V .....	949	Reset button .....	761
Relative .....	477	Reset Skew .....	640, 667
Release .....	396	Resolution .....	994
Reliability .....	1005	Resolve MAC .....	370
Re-Login .....	275	Resolve MAC Address .....	320, 326, 353
Remote block .....	126	Responder .....	625
Remote Control .....	418	Restore Carrier Ethernet OAM Defaults ...	376
Remote Discovery ID .....	314	Restore Default .....	418, 958
Remote Fault .....	897, 903	Restore Default at Start-Up .....	418
Remote Fault Emulation .....	291	Restore OTN BERT Defaults .....	247
Remote Interface Discovery .....	999	Restore Previous .....	990
Remote IP Address .....	426	Restore RFC 6349 Defaults .....	367
Remote Loopback .....	474	Restore RX Defaults .....	642
Remote Module ID .....	745	Restore TCP Throughput Defaults .....	427
Remote Module Type .....	742	Restore TX Defaults .....	641
Remote Modules Discovery .....	742, 745	Results .....	42, 713
Remote PHY Fault .....	914, 933	Re-transmitted Frames .....	595
Remote Radio Head .....	139	return merchandise authorization (RMA)	780
Remote Status .....	245, 745	Revision .....	473
Remote to Local .....	354	RFC 2544 .....	77
Remote ToolBox .....	1009	Global .....	354
Installation .....	1011	RFC 6349 .....	79, 364
Starting and using .....	1012	RFC 6349 Results .....	569, 571
Remote unit in DTS Mode .....	550, 578, 582	RFC 6349 Test on Service 1 .....	332



## Index

---

Save to CSV .....	953	Service Performance Test button .....	550
Save/Load button .....	762	Service Performance Test Status .....	549, 569
Save/Load tab .....	763	Services .....	333
SB-CORR .....	910	SES .....	489, 492
SB-CORR (Post) .....	910	SESR .....	491, 494
SB-CORR (Pre) .....	910	Set All .....	976
SB-UNCORR .....	910	Setup .....	42
Scale .....	643	SFN .....	484
Scrambler .....	398	SFP .....	229
Scrambling .....	292, 295	SFP+ .....	21, 27
SDI .....	891	Shaping .....	252, 348, 349, 412, 413
SDT Threshold 214, 219, 222, 251, 273, 343, 508, 523, 535, 542, 547, 554		shipping to EXFO .....	780
Secondary Port .....	193	Si0 .....	736, 737
Seconds .....	454	Si1 .....	736, 737
Section .....	372, 939	SID .....	319
Section (J0) .....	438, 611	Signal .....	270, 387
SEF .....	940, 950	Signal Auto-Detect .....	200
Send diagnostics .....	43	Signal Configuration .....	393
SEP .....	492	DSn/PDH .....	394
SEPI .....	492	OTN .....	398
SEQ Violation .....	946	SONET/SDH .....	401
Sequence .....	293, 536	Signal Failure .....	931
Serial Number .....	424	signal rates .....	836, 855
Server Address .....	1012	Signaling Bits .....	734
Service .....	381, 550, 570, 571	Signaling Mode .....	734
service and repairs .....	780	Signature .....	999
service centers .....	781	Signature Advanced Details .....	999
Service Configuration		Single .....	726
Ramp .....	513	Size .....	279
Service Configuration Test .....	259, 332, 550	Size (Gbit/s) 277, 315, 349, 456, 557, 616, 963	
Service Configuration Test button .....	550	Skew .....	637, 638, 666, 973
Service Configuration Test Status .....	549, 569	Skew Alarm Threshold .....	640, 900, 906, 932, 936
Service Disruption .. 212, 218, 342, 486, 508, 522, 535, 542, 547, 554		Skew Inc/Dec Size .....	973
Service Duration .....	205	Skew Threshold .....	428
Service Name .....	257, 377, 380	SLA button .....	378
Service Name and Selection .. 510, 511, 513, 515		SLA Parameters .....	385, 515
Service No .....	257	SLA Verified .....	510, 513
Service Performance .....	515	SLM .....	624, 625, 751
Service Performance Test .....	261, 550	Slot .....	964
		SLR .....	623, 625, 751
		SM .....	682

- 
- SM TTI Traces ..... 435, 440, 613
  - Smart Loopback ..... 85, 405
  - SMB ..... 33
  - S-OAM ..... 323, 368, 473, 503, 937, 978
    - Traffic ..... 624
  - S-OAM Link Trace ..... 732
  - S-OAM Responder ..... 368, 406, 751
  - Software options ..... 44
  - SONET/SDH ..... 688
  - SONET/SDH - DS<sub>n</sub>/PDH BERT ..... 71
  - SONET/SDH BERT ..... 64
  - SONET/SDH Multiplexing ..... 173, 184, 188
  - SOPCR ..... 305, 481
  - SOPMD ..... 305, 481
  - Sort By ..... 477
  - Source ..... 235, 274
  - Source B-MAC Address ..... 318
  - Source EoE MAC Address ..... 316
  - Source Flooding ..... 321
  - Source IP Address ..... 324, 711
  - Source IP Multiplier ..... 326
  - Source MAC Address ..... 255, 320
  - Source Node ID ..... 645
  - Source Port ..... 326
  - Source RP3 Address ..... 296
  - Spare ..... 679, 681, 846
  - Spare Bits ..... 736
  - Special VID values .. 255, 313, 317, 318, 322, 330, 335
  - Specific IP ..... 742
  - specifications, product ..... 3, 783
  - Speed ..... 291, 312, 753
  - SRBD 143, 147, 156, 158, 177, 179, 181, 194, 199, 311
  - Start button ..... 766
  - Start Time 433, 520, 524, 527, 533, 538, 540, 545, 549, 552, 556, 564, 566, 569, 573, 575, 577, 578, 582, 585, 586, 591, 594, 597, 599, 602, 749
  - Stateless Auto ..... 967
  - Static ..... 967, 969
  - Status 520, 524, 527, 533, 538, 540, 545, 552, 573, 577, 585, 586, 587, 589, 591, 597, 599, 602, 714, 727, 749, 963
  - Status Bar ..... 36
    - Alarm/Error Injection ..... 39
    - Clock synchronization ..... 38
    - Connected ..... 38
    - Disconnected ..... 38
    - ESMC ..... 36, 37
    - Interface/Signal ..... 36
    - Laser ..... 38
    - LINK ..... 36
    - Loopback ..... 38
    - Loopback mode ..... 39
    - OH ..... 39
    - P1, P2 ..... 36
    - P1, P2, P3, P4 ..... 36
    - Pattern ..... 38
    - Power level ..... 37
    - Remote PC connection ..... 39
    - Test icon ..... 36
    - TX/RX, TX, RX ..... 36
  - Status Pins ..... 635
  - Step ..... 471, 579, 580, 716
  - Step Size ..... 281, 300, 304, 391
  - Step Time ..... 269, 1000
  - Steps Removed ..... 965
  - STM-1 Channel ..... 688
  - Stop button ..... 766
  - Stop Time ..... 434
  - storage requirements ..... 771
  - Stream ..... 409, 517, 518, 519, 543, 600, 711
  - Stream Name ..... 407
  - Stream Selection and Activation ..... 409
  - STS Path (C2) ..... 306, 472
  - STS Path (J1) ..... 438, 611
  - STS Path (N1) ..... 439, 612
  - STS-1 Timeslot ..... 688
  - STS-x ..... 941
  - Subchannel ..... 294
  - Subnet ..... 742
  - Subnet Mask ..... 314, 324, 329





- 
- TC-TIM-V ..... 439, 612, 944
  - TC-UNEQ-P ..... 402, 944
  - TC-UNEQ-V ..... 402, 944
  - TC-VIOL-P ..... 945
  - TC-VIOL-V ..... 945
  - TDEV ..... 462
  - TE (ns) ..... 603
  - TE Scale ..... 607
  - technical specifications ..... 3, 783
  - technical support ..... 776
  - Temp. Threshold ..... 428
  - Temperature ..... 568
  - temperature for storage ..... 771
  - TERM ..... 233
  - Termination ..... 233
  - Test ..... 373, 504
  - Test Applications ..... 51
  - Test Block ..... 131
  - Test Configurator ..... 115
    - Ethernet Test Applications ..... 127
    - Fibre Channel Test Application ..... 128
    - Intelligent Apps ..... 125
    - Overview ..... 125
    - Packet Sync Test Applications ..... 128
    - Transport Test Applications ..... 127
    - Wireless Test Applications ..... 128
  - Test Control ..... 42
  - Test Equipment ..... 418
  - Test Function ..... 373
  - Test ID ..... 376
  - Test Menu ..... 42
  - Test Parameters ..... 384
  - Test Pattern ..... 376
  - Test Recovery ..... 520, 524, 533, 538, 540, 545, 552, 556, 564, 573, 575, 578, 582, 585, 586, 591, 594, 597, 599, 602
  - Test Sequence block ..... 125
  - Test Setup ..... 51
  - Test Status ..... 556, 564, 571, 575, 581, 594
  - Test Timer ..... 42
  - tHEC ..... 680
  - tHEC-CORR ..... 910
  - tHEC-UNCORR ..... 910
  - Threshold ..... 427, 475
  - Threshold (% of ideal) ..... 332, 366
  - Thresholds ..... 290, 517, 518, 519, 960, 1004
  - Through ..... 142, 169, 174, 186, 190
  - Through Intrusive ..... 169, 174
  - Through Mode ..... 87
  - Throughput ..... 246, 357, 414, 544, 579, 998, 1001, 1005
    - Streams ..... 519
  - Throughput button ..... 471
  - Throughput meter ..... 595
  - Throughput Pass/Fail Verdict ..... 427
  - Throughput Threshold ..... 595
  - TIE (ns) ..... 606
  - TIE Scale ..... 607
  - TIM ..... 917, 920, 921, 926, 928
  - Time ..... 478, 658
  - Time Error ..... 195, 463
  - Time Error / Wander ..... 429
  - Time Interval Error ..... 463
  - Time Lock ..... 422
  - Time Mode ..... 477, 509
  - Time Source ..... 421, 966
  - Time Stamp ..... 475, 509
  - Time Zone ..... 418
  - Timeout ..... 712, 713
  - Timer ..... 42, 115, 433
  - Timeslot ..... 402
  - TIM-P ..... 439, 611, 942
  - TIM-S ..... 439, 611, 940
  - TIM-V ..... 439, 611, 948
  - Title Bar ..... 39
  - TLV Type ..... 376
  - To the following Services ..... 379, 954
  - Toffset ..... 730
  - Tone ..... 976
  - Topology ..... 129, 137, 139, 142, 143, 144, 153, 156, 160, 161, 168, 174, 177, 185, 189, 199
  - TOS/DS ..... 366, 1005
  - TOS/DS Config ..... 203

## Index

---

Total .....	469, 470	Truncation Calculator .....	703, 1007
Total Burst Test Time .....	257	TS16 AIS .....	894
Total Frame .....	619	TS16 Frame 0 Bit 5, 7, 8 .....	736, 737
Total Number of Bytes .....	703, 1007	TST .....	624
Total PTP Messages .....	526	TST RX Rate .....	590
Total TX Rate .....	379, 408, 413	TTI Traces	
Total TX/RX MPLS .....	485	PM .....	440
Trace Route .....	713	SM .....	440
Traces .....	627	TCM .....	440
OTN .....	435, 508, 608, 613	TTL .....	317, 323, 324, 325, 372, 712, 732
SONET/SDH .....	438, 611	TU .....	947
Traffic .....	555, 616	TU Path .....	404
Traffic Class (TOS/DS) .....	324, 325	TU Path (J2) .....	438, 611
Traffic Ethernet .....	585, 597	TU Path (V5) .....	307, 472
Traffic Gen & Mon .....	83	TU-3 Path (J1) .....	438, 611
Traffic Monitoring .....	624	TU-AIS .....	947
Traffic Policing .....	384	TU-LOP .....	947
Traffic Scan .....	738	Tuning Status .....	989, 993
Transaction Fault .....	419	TU-Path (N1) .....	439, 612
Transceiver Config .....	991	TU-Path (N2) .....	439, 612
Transceiver Initializing... ..	988, 991	Two-step .....	966
Transceiver System Insertion Counter .....	424	TX .....	984
Transceiver System Parameters .....	424	TX = RX .....	984
Transcoding .....	946	TX 2DMM .....	562
Transmitted Frames .....	595	TX BAS .....	560
Transparent .....	182, 749	TX button .....	688, 766
Transparent (Pseudo-Physical) .....	182, 749	TX CCM .....	587
transparent-mapped GFP .....	839	TX CIR .....	570
Transport Layer .....	468, 980	TX Cm .....	668
transportation requirements .....	771, 776	Tx CMU LOL .....	891
Trial .....	579	TX CnD .....	668
Trial Duration .....	358, 361, 362	Tx Deskew LOL .....	891
Trials .....	358, 360, 361, 362	TX DMM .....	505
Tributary Port .....	983, 984	TX Enable .....	344, 373
Tributary Slot .....	987	TX Frames .....	511, 579
Tributary Synchronization .....	238	TX Frequency ... ..	280, 283, 300, 304, 390, 649
Trigger Position .....	705	TX LBM .....	503
Trigger Type .....	704	TX LMM .....	506
Triggered Error .....	705	TX LTM .....	732
Triggered Frame - Details .....	705	TX MCLK .....	235
Triggered Frame Details .....	1006	TX Mode .....	412
Truncated .....	703		

TX Pattern	209, 216, 220, 223, 225, 248, 271, 341
TX Poniter Adjustment	716
TX Power	298, 302, 387, 392
TX Power Range	428
TX Rate	209, 243, 252, 273, 348, 349, 374, 407, 412, 513, 519, 544, 557, 998
TX Seed	295
TX Signaling	395, 734
TX SLM	507
TX to RX	354
TX TST	504
Type	255, 263, 279, 296, 317, 322, 330, 395, 457, 564, 970
Type Header	677
type HEC field	846
Type Of Service	1005
<b>U</b>	
UAS	491, 494
UDP	326, 406
UDP Checksum	915
UDP/TCP	750
Unassign	987
Unassigned	654, 661
Uncorrectable Codeword	465
Undersize	898, 904
UNEQ-P	942, 950
UNEQ-V	307, 472, 948
Unexp MEP	938
Unexp Period	938
Unexp. MD Lvl	937
Unexp. MEG Lvl	937
Unframed	138, 144, 149
Unframed (Interop)	148
Unframed BERT	209, 216, 220, 223, 247, 347
Unframed with Sync	149
Unicast	617
Unidirectional	474
Unit	580
Unloaded Voltage	532
Unusable	206, 934
Unused Capacity	278, 343
UPI	469, 678
UPM	908
Upper Eye	641
Usage	279
Use Advertised Capabilities	988, 991
Use Stream	712
Use with QSFP28 to SFP28 Adapter	240
User Config	991
User Defined Codes	1006
User Defined UPI	458
User Information	418
user payload identifier	844
User Performance	337
User Stream Destination from Test Application	745
UserDefined CMF	908
UTC Offset	965
UTC Variant	423
<b>V</b>	
V5	699
Val.	579
Valid	470
Valid Event Count	657
Validations	359
Value	716
Filter	664, 961
Variable Retrieval	474
Variant	421
Vendor	138
Vendor Specific Information	474
Verdict	41
--	41
FAIL	41, 455
PASS	41, 455
Version 1	293
Version 2	293
VGA Tracking	642
VID	255, 313, 317, 318, 322, 330, 335

## Index

---

Video ..... 995  
Video Codec ..... 995, 996  
View File After Generation ..... 706, 959  
VLAN ..... 322, 407, 703, 1007  
VLAN (ID/Priority) ..... 378  
VLAN ID ... 255, 313, 317, 318, 322, 330, 335  
VLAN ID/Priority ..... 313  
VLAN Priority .. 255, 313, 317, 319, 322, 330,  
336  
VLAN Tag ..... 316, 330, 980  
Voice ..... 995  
Voice Codec ..... 995, 996  
VT ..... 947  
VT Path ..... 404  
VT Path (J2) ..... 438, 611  
VT Path (V5) ..... 307, 472  
VT Path (Z6) ..... 439, 612

## W

WAN IP ..... 258  
Wander ..... 94, 195  
warranty  
    certification ..... 779  
    exclusions ..... 779  
    general ..... 777  
    liability ..... 779  
    null and void ..... 777  
Wavelength ..... 298, 302, 313, 387, 752, 990  
Window ..... 475, 583  
Window (KiB) ..... 572  
Window Boost Factor ..... 366  
Window Size ..... 596  
Window Size Target per Connection ..... 365  
Window Sweep ..... 583, 626  
Windows Size Unit ..... 595  
Wire Map ..... 527  
Wire Map Test Result ..... 529  
Wiring Standard ..... 227  
WIS ..... 627, 949  
WIS button ..... 297  
WIS Link Down ..... 950

World Wide Name ..... 274  
Write ..... 636

## Y

Y.1731 ..... 368

## Z

Z0 ..... 689  
Z1 ..... 691  
Z2 ..... 694  
Z3 ..... 698  
Z4 ..... 698  
Z5 ..... 698  
Z6 ..... 700  
Z7 ..... 701  
Zero Code Suppression ..... 975  
Zoom ..... 464

CHINESE REGULATION ON RESTRICTION OF HAZARDOUS SUBSTANCES (RoHS)  
中国关于有害物质限制的规定

NAMES AND CONTENTS OF THE TOXIC OR HAZARDOUS SUBSTANCES OR ELEMENTS  
CONTAINED IN THIS EXFO PRODUCT  
包含在本 EXFO 产品中的有毒有害物质或元素的名称及含量

Part Name 部件名称	Lead 铅 (Pb)	Mercury 汞 (Hg)	Cadmium 镉 (Cd)	Hexavalent Chromium 六价铬 (Cr(VI))	Polybrominated biphenyls 多溴联苯 (PBB)	Polybrominated diphenyl ethers 多溴二苯醚 (PBDE)
Enclosure 外壳	O	O	O	O	O	O
Electronic and electrical sub-assembly 电子和电气组件	X	O	X	O	X	X
Optical sub-assembly <sup>a</sup> 光学组件 <sup>a</sup>	X	O	O	O	O	O
Mechanical sub-assembly <sup>a</sup> 机械组件 <sup>a</sup>	O	O	O	O	O	O

Note:

注:

This table is prepared in accordance with the provisions of SJ/T 11364.

本表依据 SJ/T 11364 的规定编制。

O: Indicates that said hazardous substance contained in all of the homogeneous materials for this part is below the limit requirement of GB/T 26572.

O: 表示该有害物质在该部件所有均质材料中的含量均在 GB/T 26572 标准规定的限量要求以下。

X: indicates that said hazardous substance contained in at least one of the homogeneous materials used for this part is above the limit requirement of GB/T 26572. Due to the limitations in current technologies, parts with the "X" mark cannot eliminate hazardous substances.

X: 表示该有害物质至少在该部件的某一均质材料中的含量超出 GB/T 26572 标准规定的限量要求。



标记 "X" 的部件, 皆因全球技术发展水平限制而无法实现有害物质的替代。

a. If applicable.

如果适用。

MARKING REQUIREMENTS

标注要求

Product 产品	Environmental protection use period (years) 环境保护使用期限 (年)	Logo 标志
This EXFO product 本 EXFO 产品	10	
Battery <sup>a</sup> 电池	5	

a. If applicable.  
如果适用。

P/N: 23.0.0.1

[www.EXFO.com](http://www.EXFO.com) · [info@EXFO.com](mailto:info@EXFO.com)

**CORPORATE HEADQUARTERS** 400 Godin Avenue

Quebec (Quebec) G1M 2K2 CANADA  
Tel.: 1 418 683-0211 · Fax: 1 418 683-2170

**TOLL-FREE** (USA and Canada)

1 800 663-3936

© 2022 EXFO Inc. All rights reserved.  
Printed in Canada (2022-05)

