



MTS Acumen[®] Electrodynamic Test Systems

Delivering quieter, simpler and faster ways to get better data

be certain.



Low
Maintenance



Industry-leading
Performance



Small
Footprint



Reduced Cost
of Ownership



Operational
Simplicity



Energy
Efficient



Quiet
Operation



Oil Free



MTS Acumen[®]

Electrodynamic Test System

Engineered for Your Industry

The MTS Acumen portfolio accommodates a wide range of material and component testing

MTS Acumen electrodynamic test systems deliver the capabilities researchers and test engineers need to perform high-fidelity dynamic and static tests that are vital to improving the efficiency, reliability and performance of materials and components.

Combining the extensive functionality MTS solutions are known for with a user-centric design, MTS Acumen systems give test professionals a fast, easy way to establish or expand in-house capacity. These compact systems are easy to install, operate and maintain. They leverage more than three decades of MTS electrodynamic expertise, offering a solution that demonstrates our commitment to providing high-quality systems for the full spectrum of materials testing.

Biomedical

- » Medical devices
- » Orthopaedics
- » Dental
- » Tissue
- » Vascular
- » Medical packaging
- » Fluid baths and accessories allow for in-vivo conditions

Materials Test Types

- » Fatigue and fracture
- » Component strength and durability
- » FDA regulatory tests
- » Tension
- » Compression
- » Flex / bend
- » Dynamic Mechanical Analysis (DMA)

Microelectronics

- » Semiconductor research
- » Printed circuit boards
- » Flex circuiting
- » Switches / buttons
- » Tactile feel
- » Fine wires and connectors
- » Solder fatigue testing

Aerospace

- » Lightweighting
- » Composites
- » Adhesives
- » High-temperature engine materials
- » Additive manufactured components

Automotive

- » Vibration isolation
- » Composites
- » Tire / rubber
- » Adhesives
- » Fasteners
- » Lightweighting

Consumer Products

- » Quality control and quality assurance
- » End-of-line testing
- » Durability
- » Additive manufacturing
- » Packaging



MTS Acumen Electrodynamic Test Systems

Available in force capacities up to 12 kN with options for torsion testing of components



Acumen 12
12 kN



Acumen 3
3 kN



Acumen 1
1 kN

Comprehensive Testing Capabilities

MTS provides hardware, software and application expertise to support any testing requirements

Fatigue & Fracture

- » High-cycle fatigue to 100 Hz
- » From pre-cracking to fatigue crack growth
- » Low-cycle fatigue for high-temperature applications
- » File playback and spectrum loading to simulate automotive, aerospace and biomedical duty cycles
- » Fracture mode failure evaluation of full ductile-to-brittle material spectrum

Production Line Quality Control (QC)

- » Hardware and software configurations for in-line inspection and pass/fail quality control testing
- » Measure stiffness and other dynamic properties of viscoelastic materials, like the vibration isolation functionality used in automotive elastomer-based engine mounts
- » Smaller footprint than oil-based systems

DMA / Dynamic Characterization

- » Standard and high-force DMA, from -140C to 350C
- » Temperature and frequency sweeps
- » Assess dynamic properties as a function of fatigue
- » Tension, compression, bending, shear, and fully-reversed double cantilever
- » Modulus characterization down to 0.2 N peak-to-peak
- » Master Curves for product life evaluation

Tension / Compression

- » Ultimate strength of materials and components
- » Determine strain rate sensitivity
- » Controlled buckling failure
- » Creep and stress relaxation
- » Hold and pulse tests of products with buttons and switches
- » Pull and shear tests (common for adhesives and films)

Torsion

- » Unprecedented versatility (speed, angular displacement, number of cycles, continuous rotation, etc.)
- » Accessory versatility accommodates bone screws, fine wire, electronics, pill bottles, laminate shearing, biological tissue, etc.

Low-force Testing

- » Microscale testing (milli-Newtons)
- » Combined low-force and low-torque testing
- » Low-torque testing of very small components
- » Tactile-feel load measurement in displacement control
- » Simulate a physiological pressure range (80-120 mmHg)

Equipped with a Bionix® EnviroBath, MTS Acumen test systems enable efficient, accurate testing of biomedical and general material specimens in fluids heated to body temperature.



Accessories for Dynamic & Static Testing

A sample of the many accessories available for Acumen systems

Grips & Fixtures



Scissors Action Grip



Thumb Screw Grips



Spring Action Grip



645 Pneumatic Grips



Shear Fixtures



Tension/Compression Grips



Cam-action Tensile Grips



Bend Fixtures



Compression Platens

Environmental



Environmental Chambers

Bionix EnviroBath

Accessories



Alignment Fixture



XY table



Pinned Attachment Kit
(threaded also available)

Load/Strain Measurement



661 Load Cell

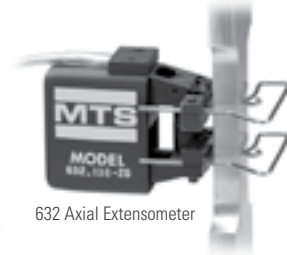

632 Axial Extensometer



634 Axial Extensometer

Test Productivity

Industry leading MTS TestSuite™ software simplifies test setup and data collection, display, and analysis



Customized test templates or guided test setup

- » Easy – Standard test templates
- » Flexible – Fast tailoring of standard templates
- » Powerful – Detailed implementation of specific testing techniques

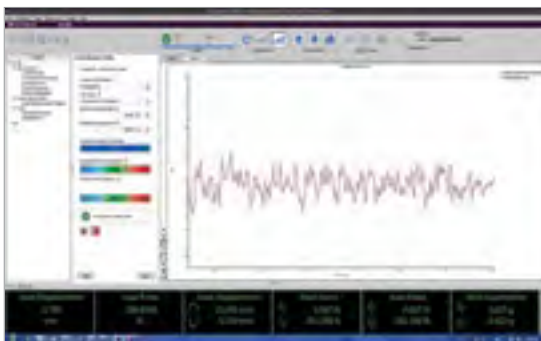

Auto-tuning capability

- » Increased usability without compromising capabilities
- » Auto-tuning allows software to measure and enter specimen parameters
- » No need to enter stiffness values
- » Raw control loop parameter access for advanced users
- » Axial and torsional auto-tuning



Generating & distributing data

- » Full-function oscilloscope and meters to show real-time display of parameters (velocity, hysteresis, cyclic data)
- » Real-time display of calculated results; no need for test to finish and perform post-test analysis
- » Quick save of displayed data for real-time evaluation of long-term tests
- » Choose from a variety of application programs tailored to specific tests and standards

Ease of Use

Simple installation, setup, test monitoring and modification



Color-coded system status display

- » Verify system status at a glance and from a distance
- » Immediately know if your test is running
 - Green:** Test or program in progress
 - Blue:** Test ready to run but system has not been started
 - White:** Standby mode optimizes conditions for test setup
 - Red:** System disabled until safety interlocks are cleared

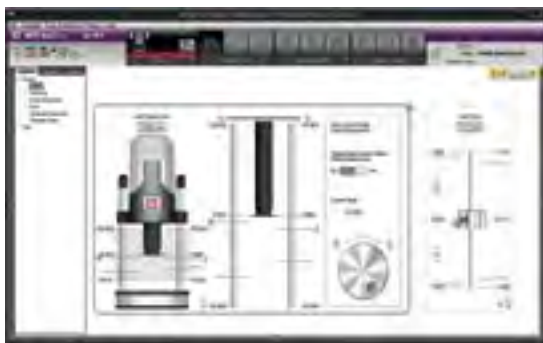

Virtual graphical display

- » Visual display of limits instead of clicking open a menu
- » Protect your specimen, protect your system
- » Instantly view and respond to errors and safety interlocks
- » Critical parameters quickly adjusted to meet test requirements



Intuitive system installation

- » Powered by a standard single phase electrical outlet
- » Bundled and color-coded cables help ensure error-free attachment and a clear test space

Technical Highlights

Features of the Acumen platform focus on testing flexibility and safety

Test setup designed with safeguards

- » System control mode during test setup and tuning is stable, helping prevent pretest sample or system damage
- » Test limit settings are accomplished easily and quickly with mouse-controlled adjustments to visually simple graphics
- » Visual directional control graphics ensure error-free test parameter settings and modifications
- » Guided and automated test setup processes facilitate creating new or modifying existing test protocols

Controlled stop feature enhances system stability

- » Establishes the desired end-of-test specimen condition eliminating excessive or undesirable specimen damage
- » Enables quick recovery and return to intended test conditions
- » Ensures actuator remains safely controlled and predictable when test limits are reached
- » Safe and reliable limit actions increase confidence and efficiency during test setup

Mounting hardware & sensor options provide convenience & flexibility

- » Easily and quickly transition the system load cell between the base and the actuator
- » Standard T-Slot base with common functionality across frames
- » Common threaded interface with pilot features on the load cell, actuator, and base plate all provide reliable and consistent alignment
- » Optional threaded attachment kits for leveraging a wide array of MTS and customer grips and fixtures
- » Several system and tandem load cell options and also an optional high performance Advanced Dynamic Response (ADR) sensor for very low-force testing of dynamic loads (as low as 0.2 N peak-to-peak)

Auto-tune methodology - uniquely MTS

- » Accurate electrodynamic system tuning, accomplished with patent-pending software algorithms for comprehensive specimen characterization
- » All system control modes are tuned simultaneously in one simple step, for both axial & torsional testing
- » Verification feature measures quality of tuning
- » Tuning options for even the most challenging samples

System-level engineering delivers added precision & accuracy

- » Sturdy design increases system stiffness
- » Acceleration compensation techniques deliver unparalleled closed loop performance
- » High resolution linear encoder for precise crosshead measurements
- » Alignment fixtures are available
- » Engineered options for complex Dynamic Mechanical Analysis (DMA) testing through glass transition, including Master Curves



Acumen 12

Scalable Controllers & Remote Monitoring Solutions

Best-in-class multi-station control and remote monitoring solutions for labs with multiple systems

- » Industry-leading control performance enabled by lowest latency
- » Advanced control algorithms and compensators achieve unparalleled testing accuracy
- » Mezzanine card-based design enables future expandability
- » Four chassis sizes provide the right level of scalability
- » Versatile and easy to reconfigure as your testing needs change
- » Independent safety interlock chains for each station ensure the right response to limit trips
- » Large selection of modules to support a wide variety of sensors and equipment
- » Support for Transducer Electronic Data Sheets (TEDS)

** MTS Echo® Intelligent Lab offers cloud-based or local network solutions to monitor test status and equipment health*



Torsion Testing

Acumen systems offer higher speeds, higher torque and more continuous rotation

Applications

- » Biomechanics studies of orthopaedic systems and implants
- » Torsional strength and stiffness characterization of bone screws and small scale medical devices, fine wires, fibers, etc,
- » Wound healing (bone) studies that define an exercise and drug regimen to expedite healing outcome
- » Complex medical packaging evaluation, including childproof pill bottles that are designed to be easier for seniors to open
- » Torsional shear performance of adhesives
- » Support and validate FEA or materials models that have torsional elements



Bone Screw Testing

Multi-Sample Fatigue Fixture

Monitor fracture of multiple endovascular samples simultaneously

The MTS MSF15 Fixture is designed for use with MTS Acumen Electrodynamic Test Systems to provide a cost-effective high-cycle fatigue testing solution for fatigue life curve development.

Features

- » 15 test sites per fixture +25% more samples in one test (vs. 12)
- » 50 mm test space clearance at each test site
- » Adjustable test height for larger/smaller samples
- » Individual station load sensing & break detection with choice of load cell capacities such as 45 N (5 kg)
- » Individual mean strain adjustment to balance all samples to the same initial strain level
- » Proprietary design simplifies alignment for each test site
- » Easy to load design allows the user to set up each test site at an easy to reach location then lower the fixture into the preconditioned bath
- » The 37 C (+/-2C) Transparent Bath allows simple video verification for each test site during the test



Endovascular Device Testing

Lab Productivity

MTS offers the products, engineering support and application expertise to maximize lab efficiency



Optimize your test system readiness

- » Hardware and software maintenance programs
- » Spares programs, extended warranties
- » Accredited calibration services & system alignment
- » Remote test monitoring with MTS Echo® products
- » Predictive maintenance programs
- » Lab facility efficiency audits



Maximize your testing efficiency

- » Hardware and software training classes at MTS offices or at your facility
- » Material and application consulting
- » Advanced test design software training
- » Custom test template design services
- » Local service engineers
- » Lab process efficiency audits

Tailor your lab's data management requirements

- MTS' solutions are designed to fit seamlessly into the overall laboratory LIMS ecosystem, and MTS consultants are available to customize data integration.
- » Customize your test system data output
 - » Automate data flow between the test machine & LIMS systems or material databases
 - » Leverage MTS system consultants for system integration challenges

Specifications

Load Frame Specifications ¹	Diagram Detail	MODEL		
		Acumen 1	Acumen 3	Acumen 3 A/T
Dynamic force²		1250 N (281 lbf)	3000 N (670 lbf)	3000 N (670 lbf)
Static force²		850 N (191 lbf)	2000 N (450 lbf)	2000 N (450 lbf)
Dynamic torque rating		–	–	±30 Nm (265 in-lb)
Static torque rating		–	–	±21 Nm (185 in-lb)
Actuator dynamic stroke		70 mm (2.75 in)	70 mm (2.75 in)	70 mm (2.75 in)
Angular displacement		–	–	±135° ±20 revolutions 0.001 rpm - 100 rpm continuous rotation to 350 rpm
Dynamic performance		≤100 Hz	≤100 Hz	≤100 Hz
Minimum test space height³	A	26 mm (1.02 in)	26 mm (1.02 in)	0 mm (0.00 in)
Maximum test space height⁴	A	603 mm (23.74 in)	819 mm (32.24 in)	603 mm (23.74 in)
Working height⁵	B	133 mm (5.24 in)	133 mm (5.24 in)	133 mm (5.24 in)
Test space width (measured between columns)	C	375 mm (14.76 in)	460 mm (18.11 in)	460 mm (18.11 in)
Base plate design		T-Slot (industry standard: 8 mm)	T-Slot (industry standard: 8 mm)	T-Slot (industry standard: 8 mm)
Column diameter	D	63.5 mm (2.5 in)	63.5 mm (2.5 in)	63.5 mm (2.5 in)
Frame footprint width	E	550 mm (21.62 in)	634 mm (24.96 in)	634 mm (24.96 in)
Frame footprint depth⁶	F	485 mm (19.09 in)	501 mm (19.72 in)	501 mm (19.72 in)
Overall width_s (with frame-mounted controller)	G	679 mm (26.73 in)	764 mm (30.08 in)	764 mm (30.08 in)
Overall height⁷	H	1511 mm (59.49 in)	1726 mm (67.95 in)	1726 mm (67.95 in)
Weight		159 kg (350 lb)	188 kg (415 lb)	230 kg (507 lb)
Noise level - typical⁸		47 dbA	47 dbA	47 dbA
Noise level - maximum⁸		69 dbA	69 dbA	69 dbA
Mounting		Tabletop: Vertical	Tabletop: Vertical	Tabletop: Vertical
Standard load cell		1.5 kN Accel Comp	3 kN Accel Comp	3 kN Accel Comp
Operating temperature		+5C° to +40C°	+5C° to +40C°	+5C° to +40C°
Cooling		Automated forced air	Automated forced air	Automated forced air
Electrical requirements⁹	Voltage - VAC Frequency - Hz Current - Amps Phase	100-120 (200-240) 50-60 7 (4) Single	200-240 50-60 10 Single	200-240 50-60 20 Single

Acumen 1 Axial Dynamic Performance

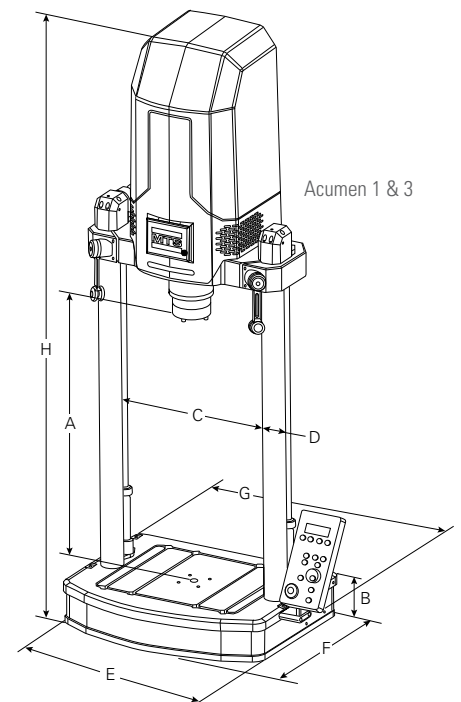
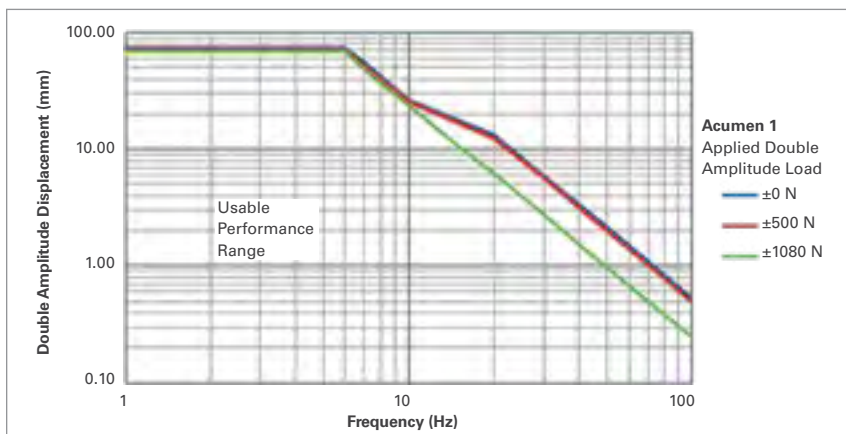

Load Frame Specifications ¹	Diagram Detail	MODEL	
		Acumen 12	Acumen 12 A/T
Dynamic force²		12000 N (2697 lbf)	12000 N (2697 lbf)
Static force²		8500 N (1910 lbf)	8500 N (1910 lbf)
Dynamic torque rating		–	±120 Nm (1056 in-lb)
Static torque rating		–	±84.8 Nm (746 in-lb)
Actuator dynamic stroke		70 mm (2.75 in)	70 mm (2.75 in)
Angular displacement		–	±135° ±20 revolutions 0.001 rpm - 100 rpm continuous rotation to 100 rpm
Dynamic performance		≤100 Hz	≤100 Hz
Minimum test space height³	A	55 mm (2.17 in)	0 mm (0.00 in)
Maximum test space height⁴	A	985 mm (38.8 in)	810 mm (31.9 in)
Working height⁵	B	815 mm (32.1 in)	815 mm (32.1 in)
Test space width (measured between columns)	C	460 mm (18.11 in)	460 mm (18.11 in)
Base plate design		T-Slot (industry standard: 14 mm)	T-Slot (industry standard: 14 mm)
Column diameter	D	76.2 mm (3 in)	76.2 mm (3 in)
Frame footprint width	E	651 mm (25.6 in)	651 mm (25.6 in)
Frame footprint depth⁶	F	817 mm (32.2 in)	817 mm (32.2 in)
Overall width⁶ (with frame-mounted controller)	G	805 mm (31.7 in)	805 mm (31.7 in)
Overall height⁷	H	2810 mm (110.7 in)	2810 mm (110.7 in)
Weight		953 kg (2100 lb)	1043 kg (2300 lb)
Noise level - typical⁸		62	62
Noise level - maximum⁸		78	78
Mounting		Floor: Vertical	Floor: Vertical
Standard load cell		12 kN Accel Comp	12 kN Accel Comp
Operating temperature		+5C° to +40C°	+5C° to +40C°
Cooling		Automated forced air & self contained water cooled	Automated forced air & self contained water cooled
Electrical requirements⁹	Voltage - VAC Frequency - Hz Current - Amps Phase	200-240 50 - 60 38 Single	200-240 50 - 60 38 Single

- Specifications subject to change without notice.
- Verifiable with MTS compression spring test. Performance may vary depending on test type, test set-up, frequency, specimen, environment and other factors.
- Assumes standard system load cell installed, crosshead fully lowered and actuator fully extended to end of the dynamic stroke.
- Assumes standard system load cell installed, crosshead fully raised and actuator fully retracted to end of the dynamic stroke.
- From table to top of work surface; without optional isolation pads.
- For systems with optional test area enclosure, add 98 mm (3.8 in.) to dimension F and 45 mm (1.8 in) to dimension G for overall system dimensions.
- Measured with crosshead fully raised, without optional isolation pad.
- Typical usage at 1 m, free field. Noise level varies depending upon test type, specimen, environment and other factors.
- Acumen 1 current rated at 100 (200) VAC. Acumen 3 current rated at 200 VAC.

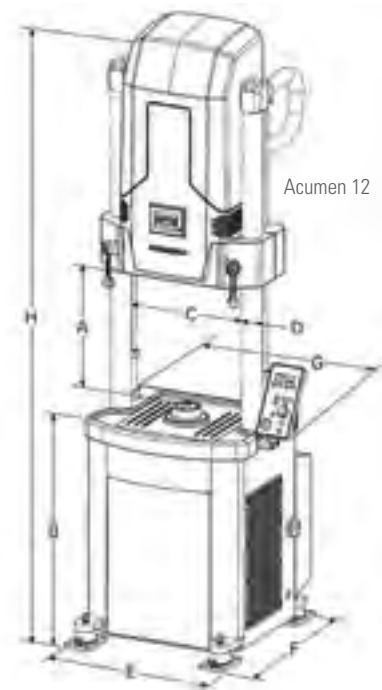

Performance Curves

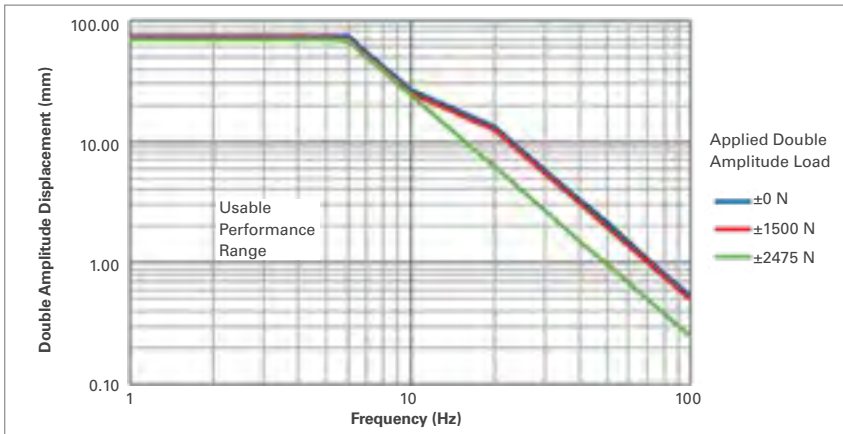

Acumen 3
Axial Dynamic Performance

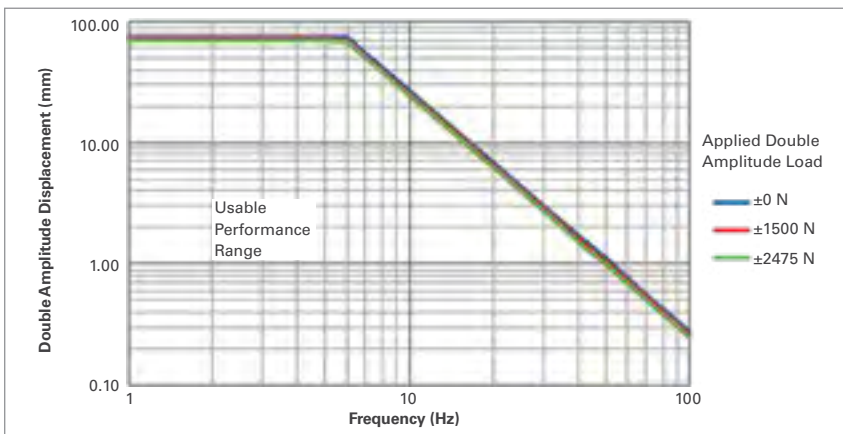

Acumen 3 A/T
Axial Dynamic Performance

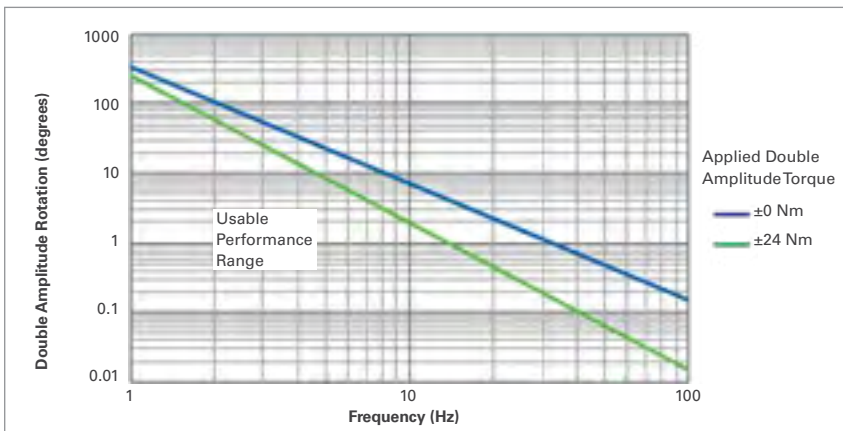

Acumen 3 A/T
Torsional Dynamic Performance

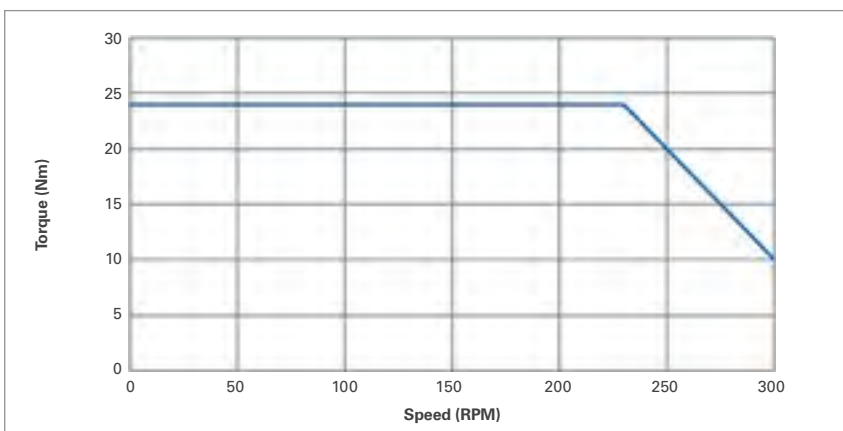

Acumen 3 A/T
Speed vs. Torque

Performance Curves

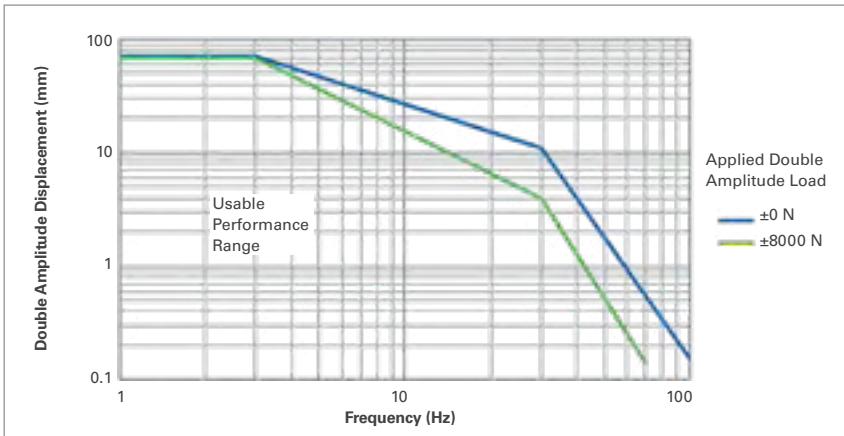

Acumen 12
Axial Dynamic Performance

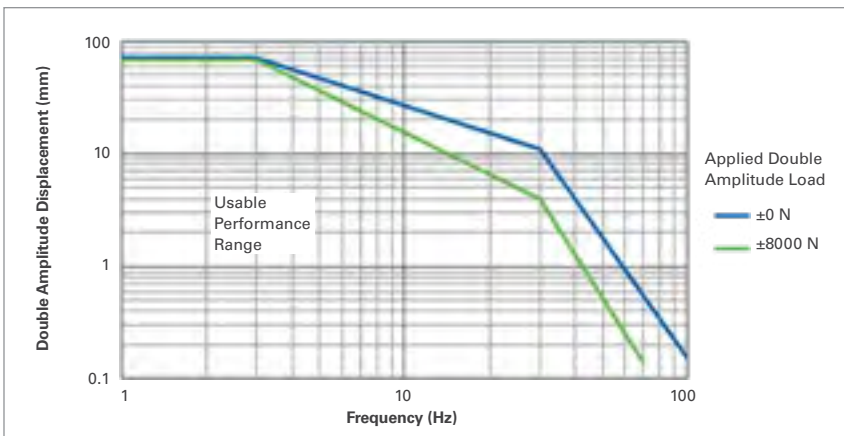

Acumen 12 A/T
Axial Dynamic Performance

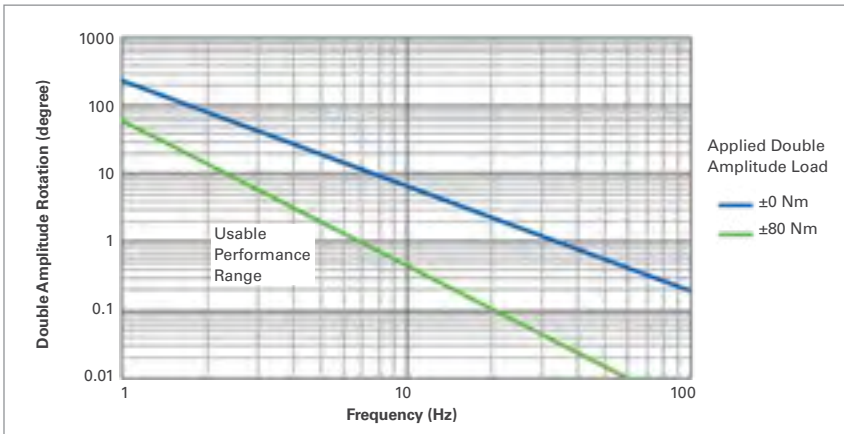

Acumen 12 A/T
Torsional Dynamic Performance

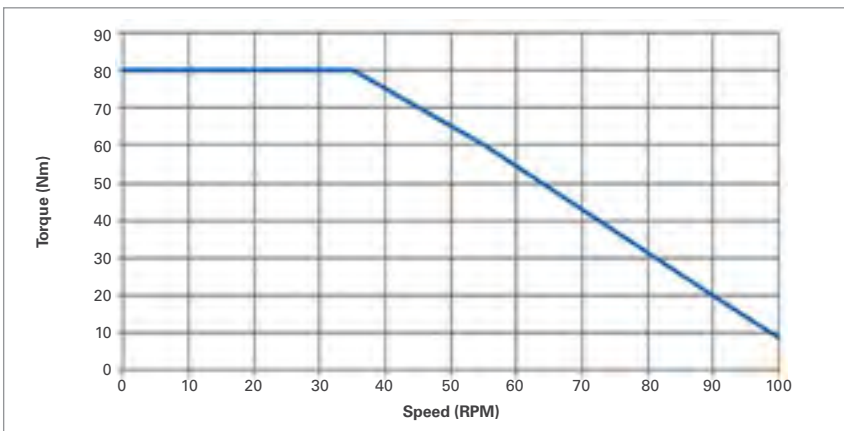

Acumen 12 A/T
Speed vs. Torque

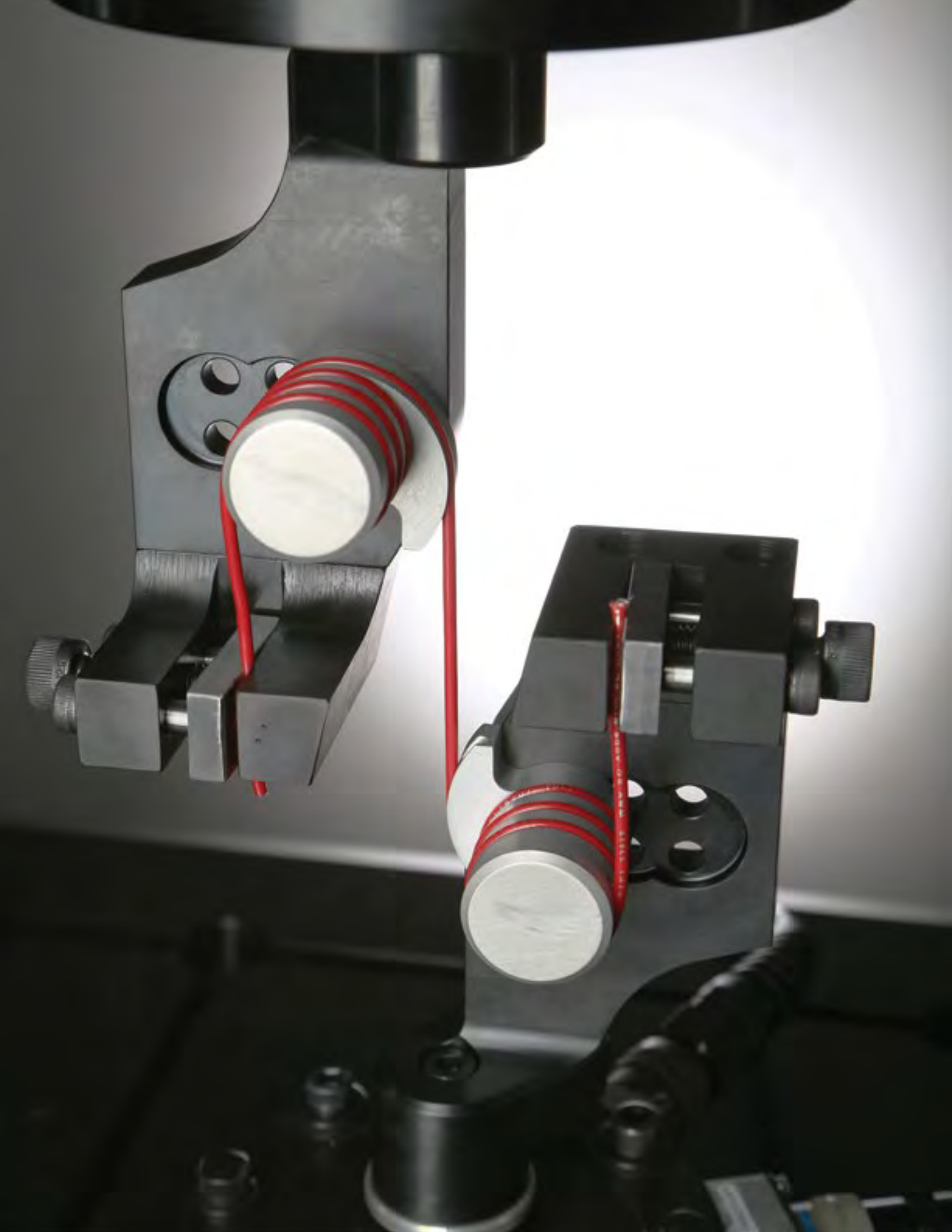

Common ASTM / ISO Standards

MTS supports testing to both industry and proprietary test standards

Bio / Medical Devices

- » ISO 14801 Dynamic Fatigue for Endosseous Dental Implants
- » ISO 6475 Implants for Surgery: Metallic Bone Screws
- » ASTM F1717 Spinal Implant Constructs in a Vertebrectomy Model
- » ASTM F2077 Test Methods for Intervertebral Body Fusion Devices
- » ISO 7206 / ASTM 1440 Uniaxial Endurance of Stemmed Femoral Components
- » ASTM F543 Torsional Testing of Metallic Medical Bone Screws
- » ASTM F1800 and ISO 14879 Fatigue Testing of Metal Tibial Tray Component for Total Knee Joint Replacements
- » ASTM F3140-17 Standard Test Method for Cyclic Fatigue Testing of Metal Tibial Tray Components of Unicondylar Knee Joint Replacements

DMA / Dynamic Characterization

- » ASTM D7028 Glass Transition Temperature (DMA Tg) of Polymer Matrix Composites by Dynamic Mechanical Analysis (DMA)
- » ASTM D5992 Dynamic Testing of Vulcanized Rubber (Elastomer) and Rubber-Like Materials
- » ASTM D5023 Dynamic Mechanical Properties (DMA) of Plastics in Flexure (Three-Point Bending)
- » ASTM D5024 Dynamic Mechanical Properties (DMA) of Plastics in Compression
- » ASTM D5026 Dynamic Mechanical Properties (DMA) of Plastics in Tension
- » ASTM D5418 Dynamic Mechanical Properties (DMA) of Plastics in Flexure (Dual Cantilever Beam)
- » ISO 6721-4 and -5 Dynamic Mechanical Properties (DMA) Tensile Vibration; Flexural Vibration

Fatigue & Fracture

- » ISO 1099 Metallic Materials - Fatigue Testing - Axial Force Controlled Method
- » ASTM 466-96 Conducting Force Controlled Constant Amplitude Axial Fatigue Tests
- » ASTM 468-90 Presentation of Constant Amplitude Test Results
- » ASTM E606, D3479, E466: Low-Cycle and High-Fatigue (Advanced and High Temperature)
- » ASTM E2368, EUR 22281 EN: Thermomechanical Fatigue (TMF)
- » ASTM E647 Fatigue Crack Growth (Clip gages and Direct Current Potential Drop (DCPD))
- » ASTM E399, E1290 and E1820: Fracture Toughness (K_{Ic}, Crack Tip Opening Displacement (CTOD), J_{Ic}-CTOD)
- » ASTM 399-17 Linear-Elastic Plane-Strain Fracture Toughness K_{Ic} of Metallic Materials

Tension / Compression

- » ISO 6892 Tensile Testing of Metallic Materials at Ambient Temperature
- » ASTM D412 Tensile Properties of Vulcanized Rubber and Thermoplastic Elastomers
- » ASTM D882 Tensile Properties of Thin Film/Plastic Sheet
- » ASTM 527-2 Tensile Properties of Moulding and Extrusion Plastics
- » ASTM 527-3 Tensile Properties of Plastic Films and Sheets

Torsion

- » ASTM F543 Torsional Testing of Metallic medical bone screws
- » ISO 7800 Metal Wire Torsion Testing
- » ASTM A938 Torsional Test of Wire
- » ASTM D1043 Torsion of Plastics Testing
- » ASTM D5279 Thermoset and Thermoplastic Dynamic Torsion Testing
- » ASTM F383 Static Bend and Torsion Testing of Intramedullary Rods
- » ISO 5835/6475/9268 Bone Screw Torsion Test Methods
- » ISO 80369-1 Axial-Torsion Luer Connector Testing

Regional Business Centers

THE AMERICAS

MTS Systems

14000 Technology Drive
Eden Prairie, MN 55344-2290
USA
Telephone: 952-937-4000
Toll Free: 800-328-2255
E-mail: info@mts.com
Internet: www.mts.com

EUROPE

MTS Systems France

BAT EXA 16
16/18 rue Eugène Dupuis
94046 Créteil Cedex
France
Telephone: +33-(0)1-58 43 90 00
E-mail: contact.france@mts.com

MTS Systems (Germany) GmbH

Hohentwielsteig 3
14163 Berlin
Germany
Telephone: +49-(0)30 81002-0
E-mail: euroinfo@mts.com

MTS Systems S.R.L. a socio unico

Strada Pianezza 289
10151 Torino
Italy
Telephone: +39-(0)11 45175 11 sel. pass.
E-mail: mtstorino@mts.com

MTS Systems Norden AB

Datavägen 37b
SE-436 32 Askim
Sweden
Telephone: +46-(0)31-68 69 99
E-mail: norden@mts.com

MTS Systems Limited

98 Church Street,
Hunslet,
Leeds
LS102AZ
United Kingdom
Telephone: +44 (0) 113 270 8011
E-mail: mtsuksales@mts.com

ASIA/PACIFIC

MTS Japan Ltd.

Raiden Bldg. 3F 3-22-6,
Ryogoku, Sumida-ku,
Tokyo 130- 0026
Japan
Telephone: +81 3 5638 0850
E-mail: mts-j-info@mts.com

MTS Korea, Inc.

4th F., ATEC Tower, 289,
Pankyo-ro, Bundang-gu
Seongnam-si
Gyeonggi-do 13488,
Korea
Telephone: +82-31-728-1600
E-mail: mtsk-info@mts.com

MTS Systems (China) Co., Ltd.

Floor 34, Building B,
New Caohejing International
Business Center,
No.391, Guiping Road,
Xuhui District
Shanghai 200233
P.R.China
Telephone: +021-24151000
Market: +021-24151111
Sales: +021-24151188
Service: +021-24151198
E-mail: MTSC-Info@mts.com

MTS Testing Solutions Pvt Ltd.

Unit No. 201 & 202, Second Floor
Donata Radiance,
Krishna Nagar Industrial Layout,
Koramangala, Bangalore - 560029
Karnataka, India
Telephone: +91 80 46254100
Email: mts.india@mts.com



MTS Systems

14000 Technology Drive
Eden Prairie, MN 55344-2290 USA

ISO 9001 Certified QMS
<http://www.mts.com>

Specifications subject to change without notice.

MTS, Acumen, Echo and FlexTest are registered trademarks and MTS TestSuite is a trademark of MTS Systems in the United States. These trademarks may be protected in other countries. RTM No. 211177.

All other trademarks are property of their respective owners.

©2021 MTS Systems
100-257-545e Acumen • Printed in U.S.A. • 09/21