

# HYDRONIC MANOMETER MODEL HM685

---

OWNER'S MANUAL

P/N 6006820, REVISION F  
MARCH 2022



# START SEEING THE BENEFITS OF REGISTERING TODAY!

---

Thank you for your TSI instrument purchase. Occasionally, TSI releases information on software updates, product enhancements and new products. By registering your instrument, TSI will be able to send this important information to you.

**<http://register.tsi.com>**

As part of the registration process, you will be asked for your comments on TSI products and services. TSI's customer feedback program gives customers like you a way to tell us how we are doing.



UNDERSTANDING, ACCELERATED

**TSI Incorporated** - Visit our website **[www.tsi.com](http://www.tsi.com)** for more information.

<b>USA</b>	<b>Tel:</b> +1 800 874 2811	<b>India</b>	<b>Tel:</b> +91 80 67877200
<b>UK</b>	<b>Tel:</b> +44 149 4 459200	<b>China</b>	<b>Tel:</b> +86 10 8219 7688
<b>France</b>	<b>Tel:</b> +33 1 41 19 21 99	<b>Singapore</b>	<b>Tel:</b> +65 6595 6388
<b>Germany</b>	<b>Tel:</b> +49 241 523030		

# HYDRONIC MANOMETER MODEL HM685

OWNER'S MANUAL

P/N 6006820, REVISION F  
MARCH 2022

**SHIP TO/MAIL TO:**

TSI Incorporated  
500 Cardigan Road  
Shoreview, MN 55126-3996  
USA

**U.S.**

**Technical Support:**

(800) 680-1220/(651) 490-2860

**Fax:**

(651) 490-3824

**E-mail address:**

[answers@tsi.com](mailto:answers@tsi.com)

**Website:**

<http://www.tsi.com>

**INTERNATIONAL**

**Technical Support:**

(001 651) 490-2811

**Fax:**

(001 651) 490-3824



# Manual History

The following is a manual history of the Hydronic Manometer Model HM685 Owner's Manual (P/N 6006820).

<b>Revision</b>	<b>Date</b>
A	May 2013
B	January 2014
C	June 2015
D	February 2016
E	February 2017
F	March 2022

# Warranty

**Part Number**  
**Copyright**  
**Address**  
**Fax No.**  
**E-mail Address**  
**Limitation of Warranty  
and Liability**  
(effective February 2015)

6006820 / Revision F / March 2022

©TSI Incorporated / 2013–2022 / All rights reserved.

TSI Incorporated / 500 Cardigan Road / Shoreview, MN 55126 / USA

651-490-3824

[answers@tsi.com](mailto:answers@tsi.com)

(For country-specific terms and conditions outside of the USA, please visit [www.tsi.com](http://www.tsi.com).)

Seller warrants the goods, excluding software, sold hereunder, under normal use and service as described in the operator's manual, to be free from defects in workmanship and material for twenty-four (24) months, or if less, the length of time specified in the operator's manual, from the date of shipment to the customer. This warranty period is inclusive of any statutory warranty. This limited warranty is subject to the following exclusions and exceptions:

- a. Hot-wire or hot-film sensors used with research anemometers, and certain other components when indicated in specifications, are warranted for 90 days from the date of shipment;
- b. Pumps are warranted for one year or 3000 hours; whichever comes first;
- c. Parts repaired or replaced as a result of repair services are warranted to be free from defects in workmanship and material, under normal use, for 90 days from the date of shipment;
- d. Seller does not provide any warranty on finished goods manufactured by others or on any fuses, batteries or other consumable materials. Only the original manufacturer's warranty applies;
- e. This warranty does not cover calibration requirements, and seller warrants only that the instrument or product is properly calibrated at the time of its manufacture. Instruments returned for calibration are not covered by this warranty;
- f. This warranty is **VOID** if the instrument is opened by anyone other than a factory authorized service center with the one exception where requirements set forth in the manual allow an operator to replace consumables or perform recommended cleaning;
- g. This warranty is **VOID** if the product has been misused, neglected, subjected to accidental or intentional damage, or is not properly installed, maintained, or cleaned according to the requirements of the manual. Unless specifically authorized in a separate writing by Seller, Seller makes no warranty with respect to, and shall have no liability in connection with, goods which are incorporated into other products or equipment, or which are modified by any person other than Seller.

The foregoing is **IN LIEU OF** all other warranties and is subject to the **LIMITATIONS** stated herein. **NO OTHER EXPRESS OR IMPLIED WARRANTY OF FITNESS FOR PARTICULAR PURPOSE OR MERCHANTABILITY IS MADE. WITH RESPECT TO SELLER'S BREACH OF THE IMPLIED WARRANTY AGAINST INFRINGEMENT, SAID WARRANTY IS LIMITED TO CLAIMS OF DIRECT INFRINGEMENT AND EXCLUDES CLAIMS OF CONTRIBUTORY OR INDUCED INFRINGEMENTS. BUYER'S EXCLUSIVE REMEDY SHALL BE THE RETURN OF THE PURCHASE PRICE DISCOUNTED FOR REASONABLE WEAR AND TEAR OR AT SELLER'S OPTION REPLACEMENT OF THE GOODS WITH NON-INFRINGEMENTS.**

TO THE EXTENT PERMITTED BY LAW, THE EXCLUSIVE REMEDY OF THE USER OR BUYER, AND THE LIMIT OF SELLER'S LIABILITY FOR ANY AND ALL LOSSES, INJURIES, OR DAMAGES CONCERNING THE GOODS (INCLUDING CLAIMS BASED ON CONTRACT, NEGLIGENCE, TORT, STRICT LIABILITY OR

OTHERWISE) SHALL BE THE RETURN OF GOODS TO SELLER AND THE REFUND OF THE PURCHASE PRICE, OR, AT THE OPTION OF SELLER, THE REPAIR OR REPLACEMENT OF THE GOODS. IN THE CASE OF SOFTWARE, SELLER WILL REPAIR OR REPLACE DEFECTIVE SOFTWARE OR IF UNABLE TO DO SO, WILL REFUND THE PURCHASE PRICE OF THE SOFTWARE. **IN NO EVENT SHALL SELLER BE LIABLE FOR LOST PROFITS, BUSINESS INTERRUPTION, OR ANY SPECIAL, INDIRECT, CONSEQUENTIAL OR INCIDENTAL DAMAGES.** SELLER SHALL NOT BE RESPONSIBLE FOR INSTALLATION, DISMANTLING OR REINSTALLATION COSTS OR CHARGES. No Action, regardless of form, may be brought against Seller more than 12 months after a cause of action has accrued. The goods returned under warranty to Seller's factory shall be at Buyer's risk of loss, and will be returned, if at all, at Seller's risk of loss.

Buyer and all users are deemed to have accepted this LIMITATION OF WARRANTY AND LIABILITY, which contains the complete and exclusive limited warranty of Seller. This LIMITATION OF WARRANTY AND LIABILITY may not be amended, modified or its terms waived, except by writing signed by an Officer of Seller.

#### **Trademarks**

TSI and the TSI logo are registered trademark of TSI Incorporated in the United States and may be protected under other country's trademark registrations. CompuDat is a trademark of TSI Incorporated. Microsoft, Excel, Windows, and Vista are registered trademarks of Microsoft Corporation.

# Contents

<b>Manual History</b> .....	<b>ii</b>
<b>Warranty</b> .....	<b>iii</b>
<b>About This Manual</b> .....	<b>ix</b>
Formatting and Typography .....	ix
Technical Assistance—Help! .....	ix
<b>Safety Information</b> .....	<b>xi</b>
Labels .....	xi
Description of Caution/Warning Symbols .....	xii
Caution .....	xii
Warning .....	xii
Caution or Warning Symbols .....	xii
<b>CHAPTER 1 Introduction</b> .....	<b>1-1</b>
Instrument Description .....	1-2
Unpacking .....	1-3
<b>CHAPTER 2 Getting Started</b> .....	<b>2-1</b>
Keypad .....	2-1
Powering the Instrument .....	2-2
Using the AC Adapter .....	2-2
Battery Installation .....	2-2
Battery Charging .....	2-4
Instrument Start-up .....	2-5
Zeroing the Manometer .....	2-5
Zeroing the Gauge Pressure Sensor .....	2-5
Zeroing the Differential Pressure Sensor .....	2-6
Connecting the Manometer to the Test Points .....	2-7
Attaching the Hoses to the Manometer .....	2-7
Bleeding the Entrained Air .....	2-7
Attaching the Hoses to the Test Points .....	2-8
Performing Pressure Measurements .....	2-8
Accessing the Pressure Measurement Screen .....	2-8
Pressure Measurement Screen .....	2-8
Continuous Pressure Measurements .....	2-9
Discrete Pressure Measurements .....	2-9
Performing Flow Measurements .....	2-10
Accessing the Flow Measurement Screen .....	2-10
Flow Measurement Screen .....	2-10
Continuous Flow Measurements .....	2-11
Discrete Flow Measurements .....	2-11
Performing Temperature Measurements .....	2-11
Connecting the Temperature Probe .....	2-11
Setting Units of Measure .....	2-12

Storing Discrete Measurements.....	2-12
Disconnecting the Manometer from the Test Points.....	2-13
<b>CHAPTER 3 Main Menu.....</b>	<b>3-1</b>
Zero Gauge Pressure.....	3-1
Flow Setup .....	3-2
Select Cv/Kv Factor .....	3-2
Select Factor Type.....	3-3
Enter Cv/Kv Value .....	3-3
Edit Cv/Kv Name .....	3-4
Temporary Adjustments to the Cv (Kv) Value .....	3-4
Select Fluid .....	3-5
<b>CHAPTER 4 Data Logging .....</b>	<b>4-1</b>
Menu .....	4-1
Log Mode .....	4-1
Log Settings .....	4-2
Choose Test .....	4-3
Name Test.....	4-3
View Data.....	4-4
Choose Test .....	4-4
View Stats.....	4-4
View Samples .....	4-4
Delete Data .....	4-5
% Memory .....	4-6
<b>CHAPTER 5 Calculations Menu .....</b>	<b>5-1</b>
Brake Power.....	5-1
Inputs .....	5-2
Heat Flow .....	5-4
Inputs .....	5-4
Calculating Cv/Kv.....	5-6
Inputs .....	5-7
Output .....	5-8
Pump Law Impeller Diameter.....	5-8
Inputs .....	5-9
Output .....	5-10
Pump Law Delta P .....	5-10
Inputs .....	5-11
Output .....	5-12
Pump Law Brake Power.....	5-12
Inputs .....	5-12
Output .....	5-13
<b>CHAPTER 6 Settings Menu.....</b>	<b>6-1</b>
Beeper.....	6-2
Select Units .....	6-2
Differential Pressure and Gauge Pressure .....	6-3
Flow.....	6-3
Temperature.....	6-4
Time Constant.....	6-4
Contrast.....	6-5



Set Time .....	6-5
Set Date .....	6-6
Time Format .....	6-6
Date Format .....	6-7
Number Format .....	6-7
Backlight.....	6-8
Auto Off .....	6-8
<b>CHAPTER 7 Calibration .....</b>	<b>7-1</b>
Calibration Differential Pressure and Calibration Gauge Pressure.....	7-2
Calibration Temperature 1 and 2 .....	7-3
Restore Factory Calibration .....	7-3
<b>CHAPTER 8 Maintenance and Troubleshooting .....</b>	<b>8-1</b>
Routine Maintenance .....	8-1
Draining the Hoses .....	8-1
Draining the Manometer Valve .....	8-1
In-Line Flow Restrictor .....	8-2
Cleaning the In-line Flow Restrictors .....	8-2
Cleaning the Instrument Housing .....	8-3
Calibration .....	8-3
Troubleshooting .....	8-3
Technical Contacts.....	8-5
<b>CHAPTER 9 USB Downloading to a Computer .....</b>	<b>9-1</b>
Installing the USB Software .....	9-1
Connecting the Manometer to the Computer.....	9-2
First Time Connection.....	9-2
Software Interface .....	9-6
HM685 Data Download Steps .....	9-7
HM680 Download Instructions.....	9-9
Downloading Data.....	9-10
<b>APPENDIX A Specifications .....</b>	<b>A-1</b>
<b>APPENDIX B Compliance .....</b>	<b>B-1</b>

*(This page intentionally left blank)*

# About This Manual

This manual explains how to set up, operate, and maintain the TSI® Incorporated Hydronic Manometer Model HM685. Please read it thoroughly before using the instrument.

---

## Formatting and Typography

- Step-by-step instructions are numbered: 1, 2, 3, etc., set flush-left against the inside margin.
- References to keys on the manometer and the instrument's displayed readout are represented in bold typeface. In addition to the different typeface, displayed messages appear in quotes.

---

## Technical Assistance—Help!

For technical assistance or questions about the instrument or this manual, or if the HM685 Hydronic Manometer needs repair or recalibration, call Technical Support at (651) 490-2860 or (800) 680-1220.

*(This page intentionally left blank)*

# Safety Information

**Carefully read each of the following safety warnings prior to using the HM685 Hydronic Manometer.**


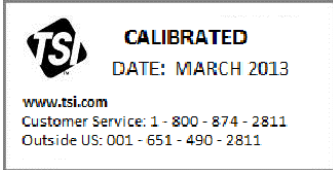

This section gives instructions to promote safe and proper handling of the HM685 Hydronic Manometer.

## IMPORTANT

There are no user-serviceable parts inside the instrument. Refer all repair and maintenance to a qualified factory-authorized technician. All maintenance and repair information in this manual is included for use by a qualified factory-authorized technician.

## Labels

Identification and calibration labels are attached to the outside of the hydronic manometer housing.

<p>1. Serial number label (back panel )</p>	
<p>2. Calibration label (back panel)</p>	
<p>3. European symbol for non-disposable item. Item must be recycled.</p>	

# Description of Caution/Warning Symbols

Appropriate caution/warning statements are used throughout the manual and on the instrument that require you to take cautionary measures when working with the instrument.

## Caution



### CAUTION

Failure to follow the procedures prescribed in this manual might result in irreparable equipment damage. Important information about the operation and maintenance of this instrument is included in this manual.

## Warning



### WARNING

Warning means that unsafe use of the instrument could result in serious injury to you or cause damage to the instrument. Follow the procedures prescribed.

## Caution or Warning Symbols

The following symbols may accompany cautions and warnings to indicate the nature and consequences of hazards:

	Warns that uninsulated voltage within the instrument may have sufficient magnitude to cause electric shock. Therefore, it is dangerous to make contact with any part inside the instrument.
	Warns that the instrument is susceptible to electro-static dissipation (ESD) and ESD protection procedures should be followed to avoid damage.
	Indicates the connector is connected to earth ground and cabinet ground.

**Carefully read each of the following safety warnings prior to using the HM685 Hydronic Manometer.**



### WARNINGS

- **NEVER** use the HM685 Hydronic Manometer or accessories on potable water systems or other systems which may be used to convey fluids for human or animal consumption.
- **NEVER** charge non-rechargeable batteries by setting battery-type selection switch to NiMH when using alkaline or other non-rechargeable batteries. Fire, explosions, or other hazards may result.



## CAUTIONS

- **NEVER** use the HM685 Hydronic Manometer to measure the pressure of volatile, flammable, or otherwise hazardous fluids or gasses. The instrument is not designed to be intrinsically safe, nor is it designed for use with caustic or corrosive chemicals.
- **NEVER** connect the HM685 Hydronic Manometer or accessories to systems which exceed the instrument's maximum pressure specification (300 psi; 2068 kPa).
- Observe proper safety precautions and wear appropriate personal protective equipment, including gloves and eyewear, when working on high pressure or high temperature systems. Ruptured or leaking lines pose a potential risk of serious personal injury.
- When using the HM685 Hydronic Manometer, verify all hose connections are secure prior to taking pressure measurements. Loose connections may result in the discharge of pressurized water or air, posing a potential risk of serious personal injury.
- Exercise caution when disconnecting the HM685 Hydronic Manometer from a pressurized system. Water or air discharged under pressure poses a potential risk of severe injury.
- Exercise caution in using the HM685 Hydronic Manometer near electrical equipment. Water spray associated with purging or disconnecting hoses presents a potential risk of damage to such equipment.
- Thoroughly drain and dry the HM685 Hydronic Manometer hoses and internal piping after each use. This will help in limiting the potential for growth of hazardous microorganisms.
- **NEVER** plug into the instrument any power supply other than the one provided with the instrument.
- **ALWAYS** make certain that the battery switch is in the correct position for the type of battery being used (Alkaline/NiMH). Failure to do so may result in Fire, Explosions or other hazard.
- **NEVER** use Alkaline and NiMH batteries together on the same instrument.
- **ALWAYS** use the hoses with the provided Flow Restrictor connected in line with the shut-off valves to prevent "Water Hammer." Water Hammer is a fast moving shock wave of pressure caused by sudden changes in the system such as a valve being opened or closed or a pump being turned on or off.

*(This page intentionally left blank)*



# CHAPTER 1

## Introduction

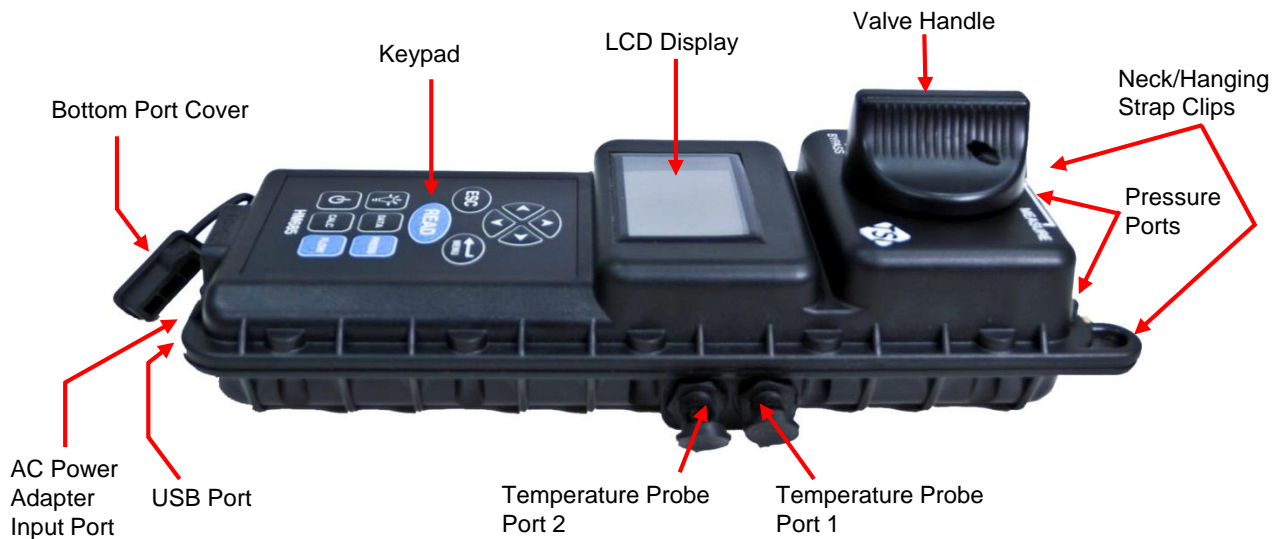
The HM685 Hydronic Manometer is an easy-to-use instrument designed for the accurate measurement of pressure and calculation of flow in non-potable water and air systems. Features of the manometer include the following:

- Single-function keys for ease of use
- Simultaneous measurement and display of High-side gauge and Differential pressure
- Direct calculation and display of Low-side gauge pressure
- Direct calculation and display of flow
- Data logging with calculated statistics
- Output port for downloading stored data to a computer
- User-selectable units of measure
- User-selectable time constant
- Easy-to-read, LCD with backlight
- Power supplied via AC adapter or batteries (alkaline or rechargeable NiMH)
- Internal NiMH battery charging
- Automatic power shutoff
- Splash-proof case
- Rugged carrying case for storage of meter, hoses, accessories, tools, and paperwork
- Two Temperature ports for simultaneous low and high side temperature measurements

# Instrument Description

The HM685 Hydronic Manometer includes:

- Meter
- 4-inch temperature probe
- Hard carrying case
- (2) 6-foot (1.8 m) hoses with shut-off valves & filters
- (2) P/T gauge adapter probes
- (2) B&G readout probes
- (2) ¼" Flare male x ¼" male NPT fittings
- (2) Female ¼" NPT to Male ¼" ISO Parallel Pipe Threads
- (2) Female ¼" NPT to Male ¼" ISO Tapered Pipe Threads
- AC adapter
- (4) NiMH batteries
- Carrying strap
- Owner's manual
- NIST traceable certificate



**Figure 1-1**  
HM685 Meter Description

---

# Unpacking

As unpacking the instrument and accessories, check the components against the packing list. If any parts are missing or damaged, notify TSI immediately. Tables 1-1 and 1-2 list standard and optional components for the HM685 Hydronic Manometer.

**Table 1-1**  
Standard Components

Item	Part No.
4 in. (10 cm) long, 0.125 in. (3.175 mm) dia. Temperature probe	801290
Carrying case	1319409
Blue and red hose kit with shut-off valves and flow restrictor	6006813
P/T gauge adapter probes (2)	632360004
B&G readout probes (2)	632360010
AC adapter	6009857
4 AA-size NiMH battery	1208048
Battery holder	1801206
Carrying strap	2913011
Owner's manual	6006820
USB Cable	1303754
CompuDat CD	1083575
Pocket screw driver	3012054

**Table 1-2**  
Optional Components

Item	Part No.
Accessory fittings kit (USA only)	HMFIT
4 in. (10 cm) long, 0.125 in. (3.175 mm) dia. Temperature probe	801290
External battery charger with (4) AA NiMH batteries (USA only)	801093

Please register your HM685 promptly through our website at <http://register.tsi.com>. Registration of your product allows us to notify you of product updates.




*(This page intentionally left blank)*

# CHAPTER 2

## Getting Started

### Keypad

Each key and its function are described below.

▲▼	The ▲ and ▼ keys are used to navigate through menus or to select an item to change. When entering text, these keys change the highlighted letter/number.
◀▶	The ◀ and ▶ keys are used to change the selected item. When entering text, these keys move the cursor to the desired location in a left/right or up/down direction.
ESC	The <b>ESC</b> key returns to the previous screen or to cancel an operation without saving changes.
↵	The <b>ENTER</b> key selects a menu item or accepts changes made within a menu item and returns to the previous screen. From either the Pressure or Flow Measurement screens, pressing the <b>ENTER</b> key accesses the Main Menu.
READ	Pressing the <b>READ</b> key initiates taking a time-averaged reading based on Log Mode and Log Settings. After taking the reading, the values are stored to memory (current Test ID) and displayed on screen for a period of four (4) seconds or until the <b>READ</b> key has been pressed again. The <b>READ</b> key also updates the calculations with current readings in the <b>CALCULATIONS</b> Menu. See <a href="#">Chapter 4</a> for more details on Data Logging and adjusting the log mode, sample interval and log settings.
	<p>Press the <b>BACKLIGHT</b> key to turn the display's backlighting on or off.</p> <div style="border: 1px solid black; background-color: #0070C0; color: white; text-align: center; padding: 2px;"><b>NOTE</b></div> <p>Backlighting has a significant impact on battery life. Use backlighting only when working in areas where you cannot read the display with existing light.</p>
DATA	Press the <b>DATA</b> key from either the Pressure or Flow Measurement screens to access the Data Logging Menu.
PRESS	Press the <b>PRESS</b> key from the Flow Measurement screen to access the Pressure Measurement screen.
	Press the  key to turn the HM685 Hydronic Manometer on or off.

<b>CALC</b>	Pressing the <b>CALC</b> key from either the Pressure or Flow Measurement screens provides access to the Calculations Menu.
<b>FLOW</b>	Pressing the <b>FLOW</b> key from the Pressure Measurement screen provides access to the Flow Measurement screen.

## Powering the Instrument

The HM685 Hydronic Manometer is equipped to power either by four (4) AA-size batteries (alkaline or rechargeable NiMH) or the AC adapter.

### Using the AC Adapter

The AC adapter allows the HM685 Hydronic Manometer to power from a standard AC wall outlet. When using the AC adapter, the batteries (if installed) are bypassed. The AC adapter also charges the NiMH type batteries (if installed) in the unit.

#### NOTE

With the battery-type selection switch set to NiMH, the manometer will initiate charging the batteries whenever the AC adapter is connected.



#### CAUTIONS

- **Only use TSI P/N 6009857, the AC adapter supplied with the instrument, when powering the HM685 Hydronic Manometer externally. DO NOT** connect the AC adapter or car adapter provided with the battery optional charger (801093) or any other AC adapter to the HM675/685. Using any other power cable or power supply may cause damage to the device and void the warranty.
- **NEVER** plug into the instrument any power supply other than the one provided with the instrument.



#### WARNING

**NEVER** charge non-rechargeable batteries by setting battery-type selection switch to NiMH with alkaline or other non-rechargeable batteries. Fire, explosions, or other hazards may result.

### Battery Installation

To install/replace the batteries:

1. Turn the manometer off and locate the battery cover on the back of the unit.
2. Loosen the screw on the battery compartment cover and lift to remove.
3. Remove the battery holder. Tapping the backside of the meter against your hand may assist in removing the battery holder.

4. Remove the old batteries and replace with fresh batteries (alkaline or rechargeable NiMH). Ensure that the batteries are correctly oriented within the battery holder.
5. Set the battery-type selection switch to indicate the type of batteries to be used (alkaline or rechargeable NiMH).



**Figure 2-1**  
Location of Battery-Type Selection Switch



### **WARNING**

**DO NOT** use Lithium batteries in this instrument. Fire, explosions, or other hazards may result.



### **CAUTIONS**

- **NEVER** use Alkaline and NiMH batteries together on the same instrument.
- **ALWAYS** make certain that the battery switch is in the correct position for the type of battery being used (Alkaline/NiMH). Failure to do so may result in Fire, Explosions, or other hazard.

6. Reinstall the battery holder. Ensure the battery holder orientation is such that its terminals make contact with the spring contacts within the battery compartment.
7. Replace the battery compartment cover.

## NOTES

- The NiMH batteries included with the instrument may require recharging prior to first use.
- Fully charged batteries should enable the instrument to operate for a period of at least twelve (12) hours
- Setting the battery-type selection switch properly will prevent unwanted charging of non-rechargeable alkaline batteries and provide charging of NiMH batteries when the AC adapter is connected.
- A battery charge life remaining indicator is shown on the display whenever the manometer is powered by batteries, and turned on.
- When using NiMH batteries, the indicator of battery charge life remaining will not be accurate due to their inherent non-linear voltage drop with power use.
- Due to the danger of battery leakage, remove batteries from the battery compartment prior to storage.
- **NEVER** mix battery types.
- For maximum battery life, ensure backlight is “off” when not needed.

## Battery Charging



### WARNING

**DO NOT** use Lithium batteries in this instrument. Fire, explosions, or other hazards may result.



### CAUTIONS

- **NEVER** plug into the instrument any power supply other than the one provided with the instrument.
- **ALWAYS** make certain that the battery switch is in the correct position for the type of battery being used (Alkaline/NiMH). Failure to do so may result in Fire, Explosions or other hazard.
- **NEVER** use Alkaline and NiMH batteries together on the same instrument.

The HM685 Hydronic Manometer allows for internal charging of AA-size type NiMH (only) batteries. Charging of the batteries is initiated as follows:

1. Turn the manometer off and locate the battery cover on the back of the unit.
2. Loosen the screw on the battery compartment cover and lift to remove.
3. Remove the battery holder. Tapping the backside of the meter against your hand may help in removing the battery holder.
4. Verify the batteries installed are rechargeable type NiMH.
5. Set the battery-type selection switch to NiMH.



6. Reinstall the battery holder. Ensure the battery holder orientation is such that its terminals make contact with the spring contacts within the battery compartment.
7. Replace the battery compartment cover.
8. Plug in the AC adapter.

#### NOTES

- Full charge of the batteries is achieved within four (4) hours.
- Fully charged batteries should enable the instrument to operate for a period of at least twelve (12) hours.
- The manometer is fully operational while charging batteries.
- **NEVER** attempt to charge battery types other than AA-size rechargeable NiMH.
- For maximum battery life, ensure the backlight is “off” when not needed.
- **NEVER** mix battery types.
- NiMH batteries should only be charged at room temperature. Starting with batteries that are too cold or too warm can cause the charge cycle to terminate early.

---

## Instrument Start-up

Upon turning the HM685 Hydronic Manometer on, the meter engages in a brief self-check while displaying the serial number, model number, and revision of the instrument being used. While completing the self-check, you are given the option to zero the gauge pressure sensor or skip the zero process prior to proceeding to the Pressure Measurement Screen.

---

## Zeroing the Manometer

The HM685 Hydronic Manometer is equipped with both a gauge and differential pressure sensor, allowing for simultaneous measurement and display of High-side gauge and Differential pressure. The gauge and differential pressure sensors are zeroed independently of one another.

### Zeroing the Gauge Pressure Sensor

To ensure the most accurate gauge pressure (**High P**) measurements, the HM685 gauge pressure sensor should be zeroed prior to taking readings on each new system. When not in the instrument start-up sequence, the gauge pressure sensor is zeroed as follows:

1. Enter the Main Menu by pressing the **ENTER (↵)** key.
2. Select **Zero Gauge Pressure**.

3. Follow the on-screen instruction to complete the gauge pressure sensor zeroing process.
4. Allow the manometer to stand undisturbed for five (5) seconds until the zero gauge pressure sensor function has completed.

#### NOTES

- Zeroing the gauge pressure sensor requires you to disconnect the High pressure (red) hose; as such it is often most convenient to zero the gauge pressure sensor as part of the start-up sequence (i.e., before hoses have been connected).
- The zero offset of the gauge pressure sensor is sensitive to temperature changes. If moving the manometer between areas of extreme temperature difference, it is best to allow the meter to settle to the new temperature prior to zeroing.

## Zeroing the Differential Pressure Sensor

To ensure the most accurate differential pressure (**dP**) measurements and calculated flow (**Flow**) values, the HM685 differential pressure sensor should be zeroed prior to taking readings on each new system. The differential pressure sensor is zeroed as follows:

1. Go to the **Measurement Screen**.
2. Turn the valve handle on the manometer to the **BYPASS** position.
3. The instrument will automatically zero the differential pressure sensor. Follow the on-screen instructions and return the knob to **MEASURE** once this is done.

#### NOTES

- Any pressures applied to the hoses will not affect the **dP** zeroing function. This feature allows for successful zeroing of the differential pressure sensor while maintaining connections to the system under test.
- Zeroing of the differential pressure sensor is initiated any time the valve handle has been turned to the **BYPASS** position while in the Pressure or Flow Measurement screens. This feature allows for successful zeroing of the differential pressure sensor while entrained air is being purged from the hoses.
- The zero offset of the differential pressure sensor is sensitive to temperature changes. If moving the manometer between areas with extreme temperature difference, it is best to allow the meter to settle to the new temperature prior to zeroing.

---

# Connecting the Manometer to the Test Points

## Attaching the Hoses to the Manometer

1. Connect the straight female flare fitting on the High pressure (red) hose to the male fitting on the top of the manometer marked with a plus (+) sign.
2. Connect the straight female flare fitting on the Low pressure (blue) hose to the male fitting on the top of the manometer marked with a minus(-) sign.

## Bleeding the Entrained Air

To ensure the most accurate pressure measurements, all entrained air within the hoses should be purged as follows:

1. Turn the shut-off ball valve on both the High and Low pressure hoses to the closed position.
2. Turn the valve handle on the manometer to the **MEASURE** position.
3. Using an appropriate fitting, connect the open end of the High pressure (red) hose to the test point with the higher line pressure.
4. Attach the appropriate fitting to the open end of the Low pressure (blue) hose.
5. To ensure all the air is bled from the hoses, hold the open end of the Low pressure (blue) hose in an upright position over a suitable receptacle or near a drain.
6. Turn the shut-off ball valve on both the High and Low pressure hoses to the open position.
7. Turn the valve handle on the manometer to the **BYPASS** position to allow the liquid flow to displace the entrained air.

### NOTE

Zeroing of the differential pressure sensor is initiated any time the valve handle has been turned to the **BYPASS** position while in the Pressure or Flow Measurement screens. This feature allows for successful zeroing of the differential pressure sensor while entrained air is being purged from the hoses.

8. Once the liquid is flowing steadily from the Low pressure (blue) hose, turn the valve handle on the manometer to the **MEASURE** position.

### NOTE

The time to fully prime the hose with fluid may take up to one minute depending on the line pressure. Higher line pressure will reduce the bleed time.

## Attaching the Hoses to the Test Points

1. As indicated previously, use an appropriate fitting to connect the open end of the High pressure (red) hose to the test point with the higher line pressure.
2. Using an appropriate fitting, connect the open end of the Low pressure (blue) hose to the test point with the lower line pressure.

### NOTE

If the hoses are connected in the inverse orientation (i.e., High pressure (red) hose to the lower line pressure), the displayed High-side gauge pressure (**High P**) will be less than the Low-side gauge pressure (**Low P**), and the Differential pressure (**dP**) and resulting calculated flow (**Flow**) will be negative.

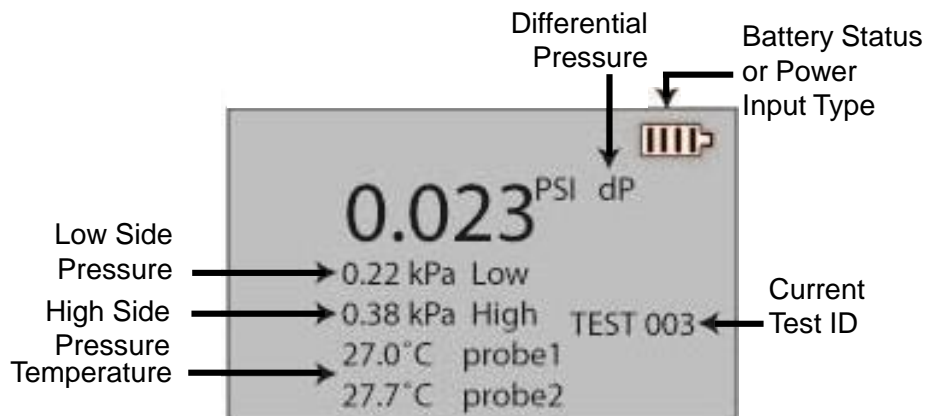
## Performing Pressure Measurements

The HM685 Hydronic Manometer allows for simultaneous measurement and display of the High-side gauge and Differential pressure. The calculated Low-side gauge pressure is also displayed. While in the Pressure Measurement screen, the manometer makes and displays continuous pressure measurements, and allows for data storage to the memory.

### Accessing the Pressure Measurement Screen

The Pressure Measurement screen is accessed by pressing the **PRESS** key from the Flow Measurement screen, or by pressing the **ESC** key from any of the primary menus (Main Menu, Data Logging Menu, and Calculations Menu) when that menu was accessed from the Pressure Measurement screen.

### Pressure Measurement Screen



\*Shown with two optional accessory temperature probes attached.

<b>High-Side Gauge Pressure</b>	The High-side gauge pressure measurement is indicated as <b>High</b> on the manometer display. The gauge pressure readings can be positive or negative values in the range of -20 to 300 psi (-138 to 2068 kPa).
<b>Low-Side Gauge Pressure</b>	The Low-side gauge pressure reading is indicated as <b>Low</b> on the manometer display. It represents a calculated value determined from the measured High-side gauge and Differential pressure as follows:  <b>Low P = High P – dP</b>
<b>Differential Pressure</b>	The Differential pressure measurement is indicated as <b>dP</b> on the manometer display. The differential pressure readings can be positive or negative values in the range of ±300 psi (±2068 kPa).

## Continuous Pressure Measurements

The HM685 Hydronic Manometer continuously measures and displays pressure readings whenever the manometer is in the Pressure Measurement or Flow Measurement screen, with the exception of when the **READ** key is pressed. When the **READ** key is pressed, the displayed readings are averaged measurements taken over the sampling period as defined by the Log Mode and Log Settings. The display is updated once per second.

## Discrete Pressure Measurements

Taking a discrete pressure measurement allows for measurement and display of a single time-averaged reading taken over the sampling period as defined by the Log Mode and Log Settings. Discrete pressure measurement values are displayed on-screen for a period of 4 seconds and then returns to continuous measurement mode. See [Chapter 4, Data Logging](#), for more details on setup.

1. Press the **READ** key.
2. Allow the manometer to stand undisturbed until the reading is complete.

# Performing Flow Measurements

The HM685 Hydronic Manometer allows for continuous calculation and display of flow. While in the Flow Measurement screen, the manometer makes and displays continuous pressure measurements, calculates and displays continuous flow readings, and allows for discrete data storage to the memory.

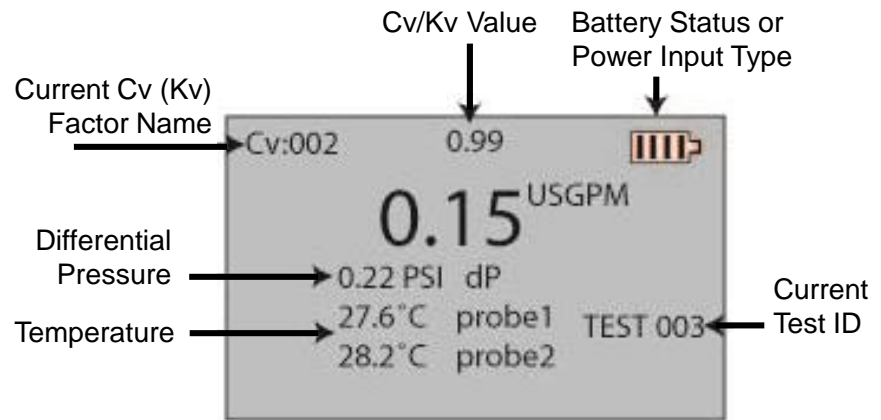
**NOTE**

The **Cv (Kv)** value of the measured valve must be known in order to obtain meaningful flow readings.

## Accessing the Flow Measurement Screen

The Flow Measurement screen is accessed by pressing the **FLOW** key from the Pressure Measurement screen.

## Flow Measurement Screen



\*Shown with two optional accessory temperature probes attached.

<b>Flow</b>	The flow reading is indicated as Flow on the manometer display. It represents a calculated value determined from the measured Differential pressure and user entered values for the valve flow coefficient (Cv or Kv) and fluid specific gravity.
<b>Cv/Kv</b>	<p>The valve flow coefficient is indicated as Cv (Kv) on the manometer display.</p> <p style="text-align: center;"><b>NOTES</b></p> <ul style="list-style-type: none"> <li>• The <b>Cv (Kv)</b> value of the measured valve must be known in order to obtain meaningful flow readings.</li> <li>• 100 different <b>Cv (Kv)</b> names and values can be stored in the instrument (Reference <a href="#">Chapter 3, Flow Setup</a>).</li> <li>• The <b>Cv (Kv)</b> value can be temporarily edited within the Flow Measurement screen by pressing the ▲ or ▼ key to enter an edit mode. Use the ▲ or ▼ keys to change the value. Press <b>ESC</b> to leave the edit mode. See <a href="#">Chapter 3, Flow Setup, Temporary Adjustments to the Cv (Kv) Value</a>.</li> </ul>

## Continuous Flow Measurements

The HM685 Hydronic Manometer continuously measures and displays flow readings whenever the manometer is in the Flow Measurement screen, with the exception of when the **READ** key is pressed. When the **READ** key is pressed, the displayed readings are averaged measurements taken over the sampling period as defined by the Log Mode and Log Settings. The display is updated once per second. See [Chapter 4, Data Logging](#), for more details on setup.

## Discrete Flow Measurements

Taking a flow measurement allows for measurement and display of a single time-averaged reading taken over the sampling period as defined by the Log Mode and Log Settings. Discrete pressure or flow measurement values are displayed on-screen for a period of 4 seconds and then returns to continuous measurement mode. See [Chapter 4, Data Logging](#), for more details on setup.

1. Press the **READ** key.
2. Allow the manometer to stand undisturbed until the reading is complete.

---

# Performing Temperature Measurements

The HM685 Hydronic Manometer accessory temperature probe is a 1/8" diameter, stainless steel sheathed immersion probe designed for measurement of water line temperatures. When using the accessory temperature probe, the HM685 Hydronic Manometer is equipped to make and display continuous temperature measurements in both the Pressure and Flow Measurement screens. Two temperature probes can be connected to the instrument to measure upstream and downstream temperature simultaneously.

## Connecting the Temperature Probe

Connect the keyed 3-pin plug of the accessory temperature probe to the mating connector located on the right-hand side of the manometer.

### NOTE

A locking nut is provided on the accessory temperature probe plug to allow for a more secure attachment when connecting to the manometer.

---

## Setting Units of Measure

The units of measure for gauge pressure, differential pressure, flow, and temperature are adjusted within the Setting Menu. See [Chapter 6, Settings Menu](#) for more details. Available unit settings are as follows:

<b>Gauge Pressure</b>	psi, inH <sub>2</sub> O, ftH <sub>2</sub> O, inHg, kPa, mH <sub>2</sub> O, mmHg, and bar
<b>Differential Pressure</b>	psi, inH <sub>2</sub> O, ftH <sub>2</sub> O, inHg, kPa, mH <sub>2</sub> O, mmHg, and bar
<b>Flow</b>	USGPM, UKGPM, l/s, l/m, m <sup>3</sup> /h
<b>Temperature</b>	°F or °C

---

## Storing Discrete Measurements

Taking a discrete measurement allows for measurement, display, and storage of a single time-averaged reading taken over the sampling period. Discrete measurement values are stored to the memory (current Test ID) and displayed on-screen for a period of four (4) seconds. See [Chapter 4, Data Logging](#) for more details on data logging and adjusting the log mode, sample interval, and log settings.

1. Press the **READ** key (from the Pressure or Flow Measurement screen).
2. Allow the manometer to stand undisturbed until the reading is complete (time of completion is dependent on the time constant setting).

### NOTE

Discrete measurements stored from the Pressure Measurement screen will not contain flow data.



---

# Disconnecting the Manometer from the Test Points



## CAUTIONS

- Exercise caution when disconnecting the HM685 Hydronic Manometer from a pressurized system. Water or air discharged under pressure poses a potential risk of severe injury.
- Exercise caution in using the HM685 Hydronic Manometer near electrical equipment. Water spray associated with purging or disconnecting hoses presents a potential risk of damage to such equipment.
- Thoroughly drain and dry the HM685 Hydronic Manometer hoses and internal piping after each use. This will help in limiting the potential for growth of hazardous microorganisms.

The following provides a guideline for disconnecting the manometer from the test points once measurements have been completed.

1. Turn the shut-off ball valve on both the High and Low pressure hoses to the closed position.
2. Disconnect the High pressure (red) hose from the higher line pressure test point.
3. Disconnect the Low pressure (blue) hose from the lower line pressure test point.

## NOTE


If additional measurements at another location/system containing the same fluid are to be made, it is not necessary to proceed to step 4 and drain the fluid entrained within the hoses at this time. The fluid remaining within the hoses will help minimize the time necessary to bleed entrained air prior to making subsequent measurements.

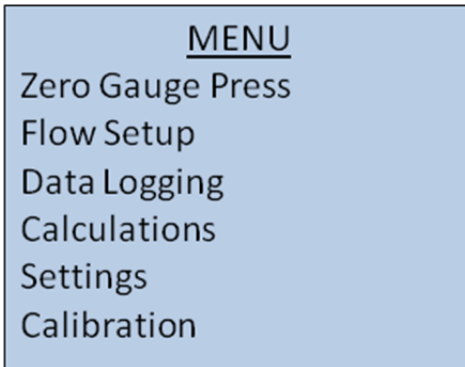
4. Place the open end of the Low pressure (blue) hose in a suitable receptacle or near a drain.
5. Turn the valve handle on the manometer to the **BYPASS** position.
6. Turn the shut-off ball valve on the Low pressure (blue) hose to the open position to discharge the pressurized fluid out of the open end of the Low pressure (blue) hose.
7. Elevate the High pressure (red) hose and turn its shut-off ball valve to the open position to allow for draining of the remaining entrained fluid.

*(This page intentionally left blank)*

## CHAPTER 3

# Main Menu

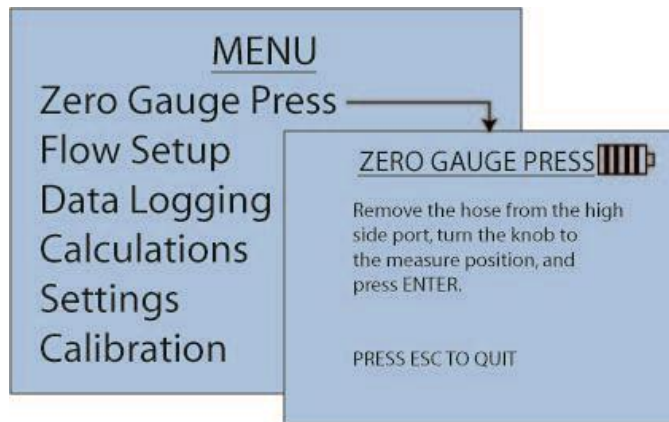
The Main Menu is accessed by pressing the **ENTER**  key from either the Pressure or Flow Measurement screens.



---

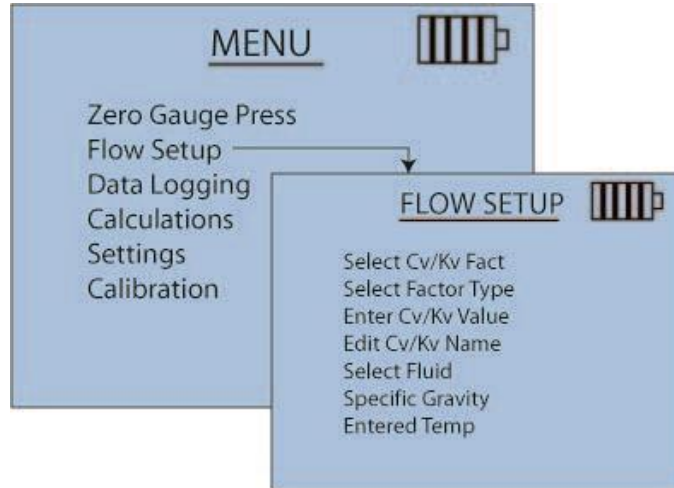
## Zero Gauge Pressure

Zero Gauge Pressure zeros the manometer's gauge pressure sensor. Refer to [Zeroing the Manometer](#) in the Getting Started chapter for instructions.



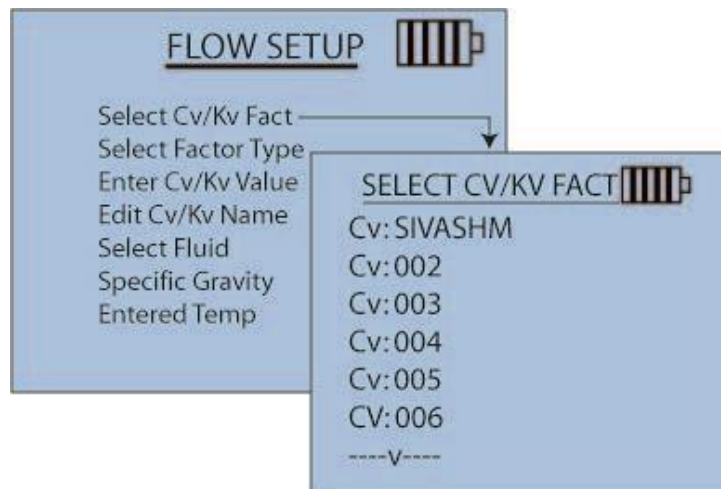
# Flow Setup

Use Flow Setup to set values for key factors that impact measured flow values.

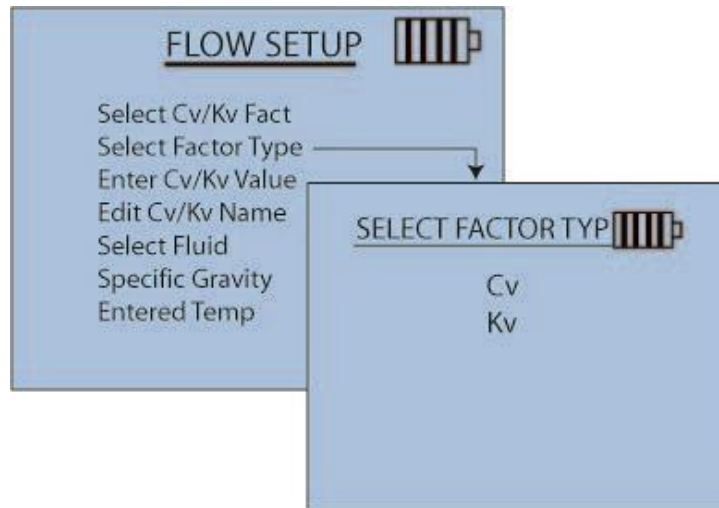


## Select Cv/Kv Factor

Allows input up to 100 valve flow coefficients (Cv/Kv factors) to calculate flow from differential pressure. These are typically coefficients provided by the balancing valve manufacturers and can be dependent on the type of valve and the valve setting in the case of variable valves. Within **Flow Setup** 100 user-programmed valve flow coefficients (**Cv** or **Kv**) that are stored within the instrument are selectable. The most recent selected **Cv** (**Kv**) factor is the default when entering the Flow Measurement screen.

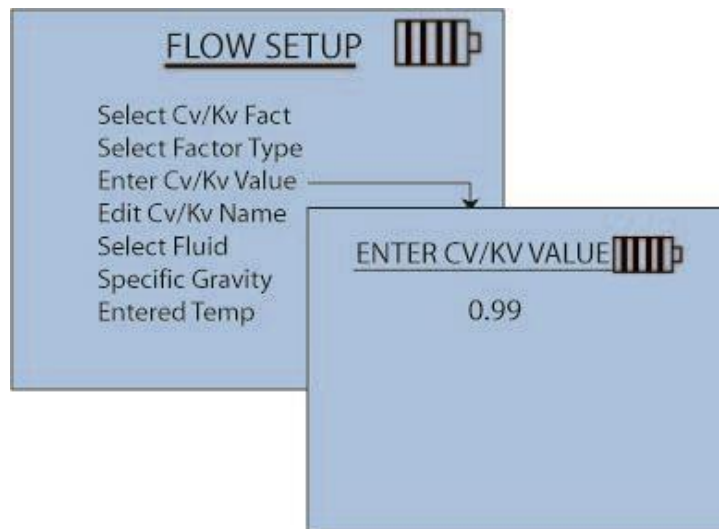


## Select Factor Type



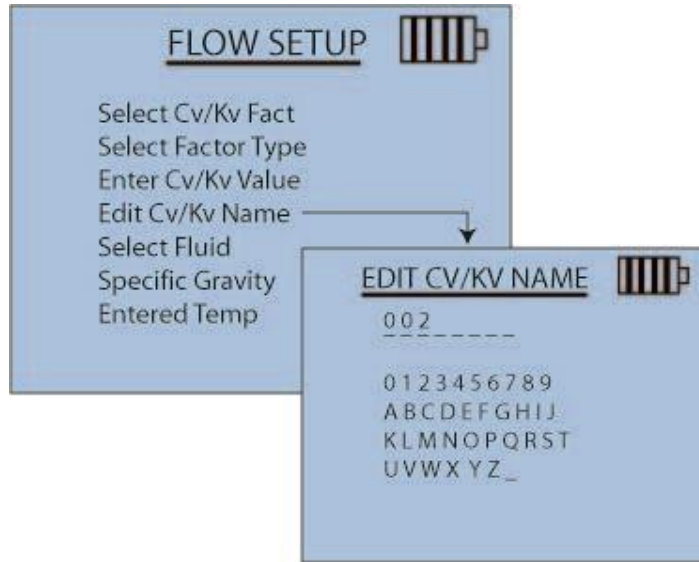
## Enter Cv/Kv Value

A known Cv/Kv Value is required of the measured valve to obtain accurate flow readings.



## Edit Cv/Kv Name

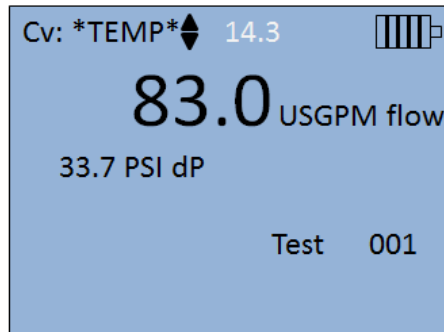
Up to 100 different Cv/Kv names and values can be stored. Edit the name of the selected **Cv (Kv)** factor.



## Temporary Adjustments to the Cv (Kv) Value

The Cv (Kv) value can be temporarily changed without going into the Flow Setup menu. When the Flow Measurement screen is showing, press the up or down arrow key to enter a mode where the Cv (Kv) value can be edited. This edit mode is indicated by:

- The factor name changes to “\*TEMP\*”
- An up/down arrow appears in front of the value to be edited



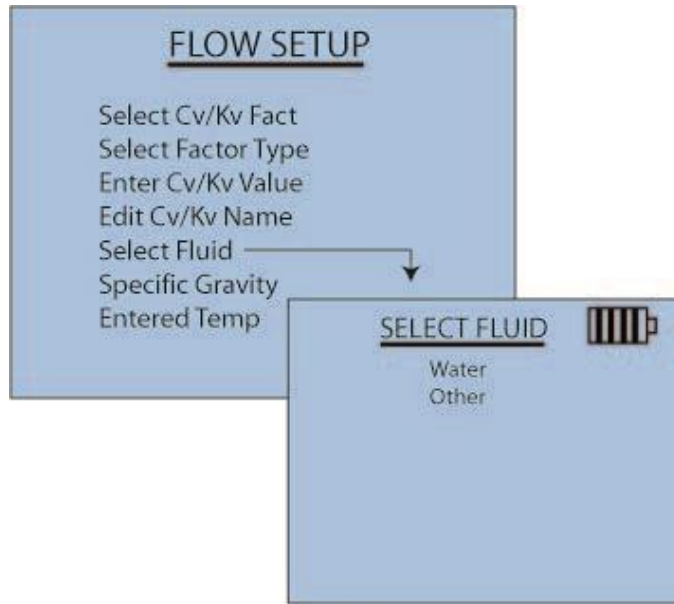
Once you are in the edit mode, press and hold the up or down arrow keys to change the Cv (Kv) value. The new, temporary value will automatically be used to calculate flow and is stored when logging data. It does not change any of the 100 stored Cv (Kv) values.

To leave the edit mode and resume using your originally selected Cv (Kv) value, press the **ESC** key. The edit mode is also canceled whenever you enter the Flow Setup menu.

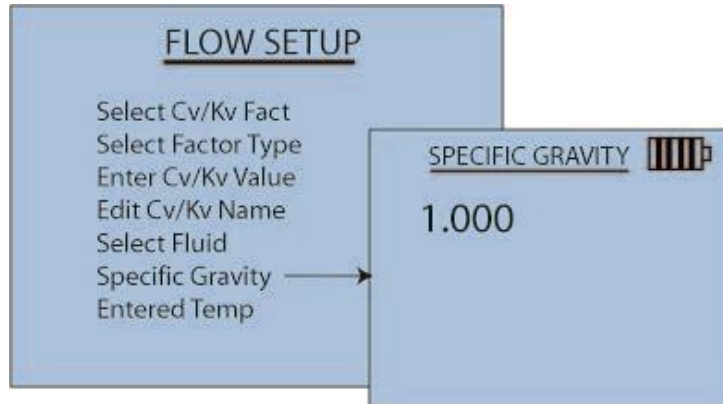
## Select Fluid

Defines the fluid for the manometer to account for the fluid's specific gravity when calculating flow. The fluid type of the system being measured is Water or Other.

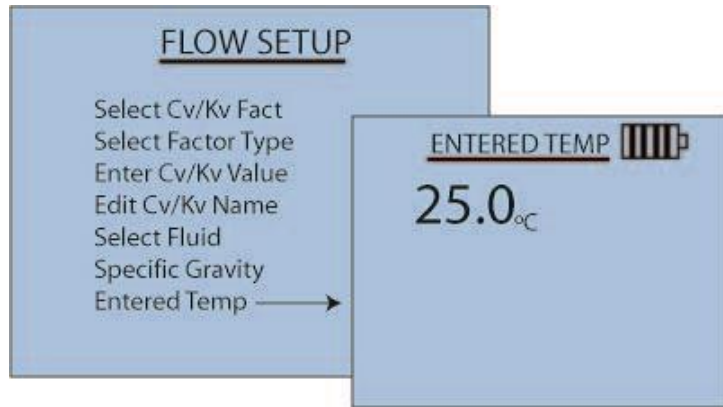
<b>Water</b>	<p>Select <b>Water</b> to automatically determine the specific gravity based upon the measured temperature of the fluid (<b>T<sub>probe</sub></b>).</p> <p style="text-align: center;"><b>NOTE</b></p> <p>If the accessory temperature probe is not connected, you will have the option of manually entering the fluid temperature (<b>T<sub>entered</sub></b>).</p>
<b>Other</b>	<p>Select <b>Other</b> to prompt for entry of the fluid's specific gravity.</p> <p style="text-align: center;"><b>NOTE</b></p> <p>When <b>Other</b> is selected as the fluid type, the entered value for specific gravity will not be compensated with changes in temperature.</p>



### Specific Gravity



### Entered Temperature





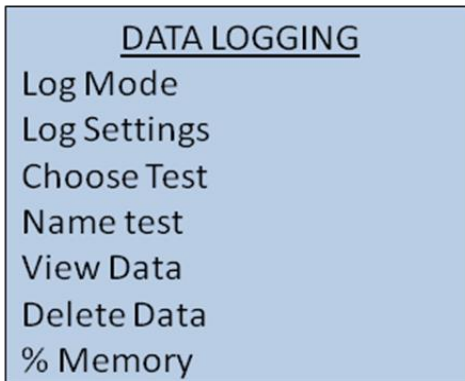
# CHAPTER 4

## Data Logging

---

### Menu

Access the Data Logging Menu by pressing the **DATA** key from either the Pressure or Flow Measurement screens or from the Main Menu.

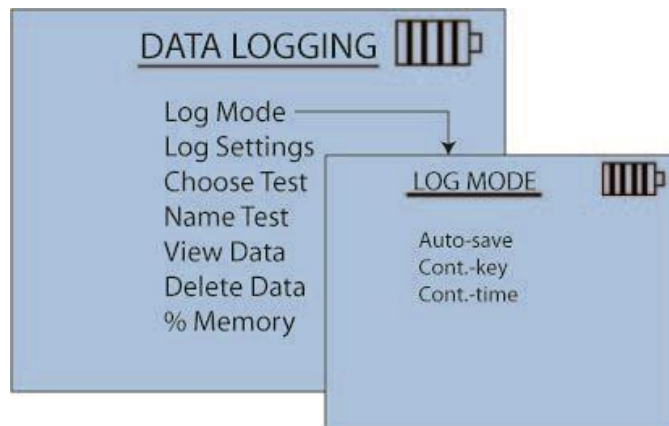


---

### Log Mode

The HM685 is programmable to store measurement to memory in the following logging formats:

- Auto-save
- Cont-key
- Cont-time



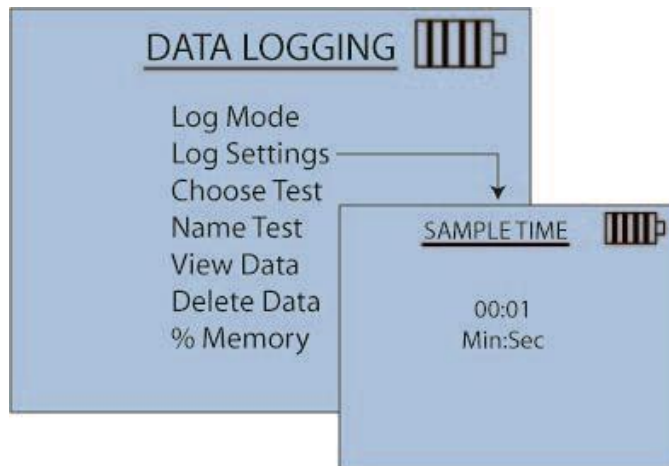
<b>Auto-Save Logging</b>	In Auto-save mode, user samples are automatically logged to memory at the end of the sampling period. To start logging, press the <b>Read</b> key.
<b>Cont-.key Logging</b>	In Cont-key Logging mode, logging starts by press the <b>Read</b> key. The instrument continues logging until the <b>Esc</b> key is pressed.
<b>Cont.-time Logging</b>	In Cont-time mode, readings start by pressing the <b>Read</b> key. The instrument continues taking samples until the time set in "Sample Time" elapses or the <b>Esc</b> key is pressed.

## Log Settings

Log Settings defines the frequency period with which the manometer will log sample readings. When the Log Mode is set to Cont-Time, this setting is also used to define the length of the test in hh:mm:ss.

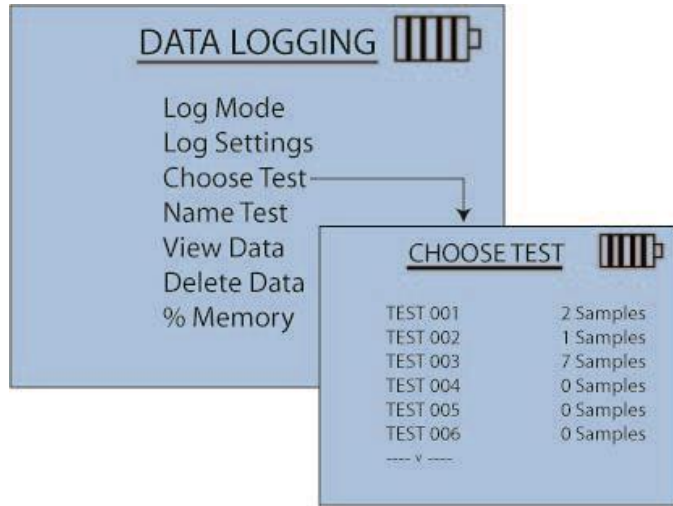
### NOTE

**It is recommended** that the logging interval must be set at a time period that is greater than or equal to the current setting of the time constant.



## Choose Test

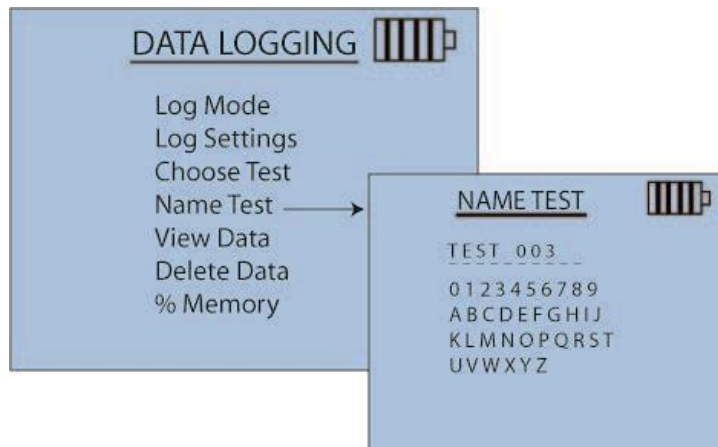
Use the Choose Test screen to choose the Test where the samples (readings) will be stored.



---

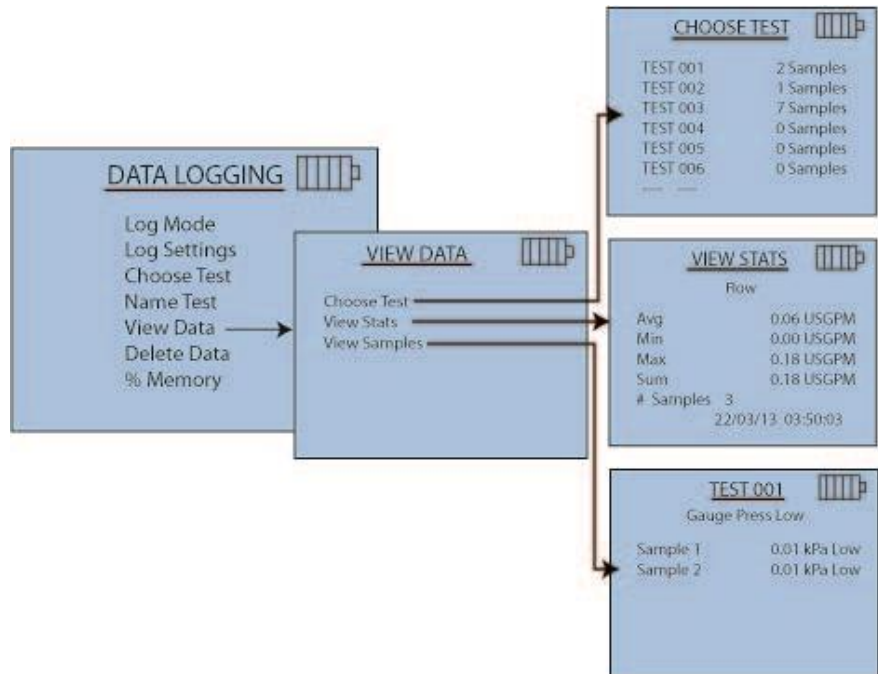
## Name Test

Name Test screen allows customizing the Test ID name of the selected test using 10 characters maximum. Use the arrow keys to move the cursor to a desired location, press **Enter** to accept. This feature can be used to logically name measurement locations for future analysis or report generation; e.g., Conference Room 1, Break Room, Machine Shop, etc.



# View Data

The View Data screen allows you to choose the data you want to review.



## Choose Test

Select any of the 100 available Test IDs within the instrument. All new data stored is saved to the most recently selected Test ID.

## View Stats

Displays statistics (average, minimum, and maximum) of a selected Test ID and the number of samples and date/time the samples were taken.

- **AVG** (average of all values stored in TEST ID.)
- **MIN** (lowest value stored in TEST ID)
- **MAX** (highest value stored in TEST ID)
- **SUM** (sum of all values stored in TEST ID)

**NOTE: SUM IS ONLY PRESENTED FOR FLOW READINGS.**

## View Samples

Displays the total number of readings to be stored as part of the continuous unattended data logging.

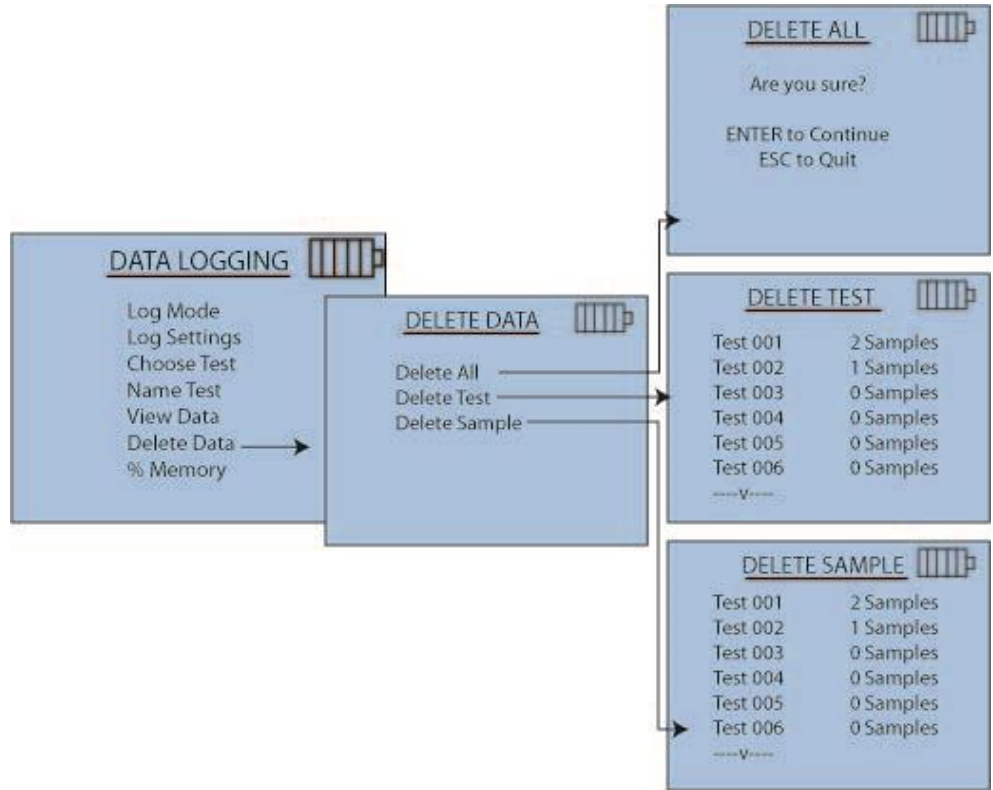
### NOTE

The instrument can store a maximum of 4000 different samples. These samples can be distributed over one or all of the available Test IDs.

# Delete Data

Delete discrete samples, an entire Test ID, or all data stored to the instrument at this menu.

**NOTE:** Deleted data cannot be retrieved.

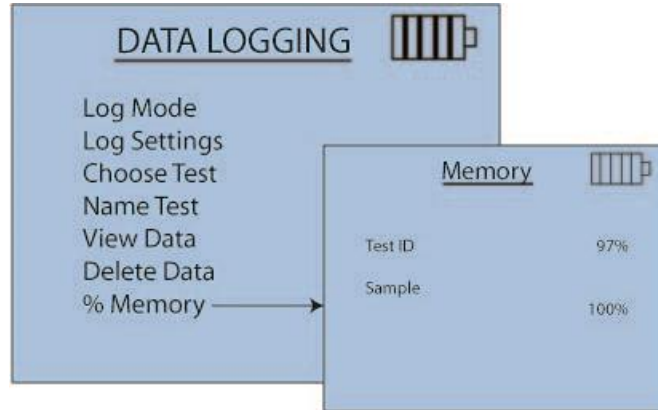


<b>Delete All</b>	Delete all samples stored to the instrument, as well as restoring the factory set default names to each of the Test IDs.
<b>Delete Test</b>	Delete all samples within the current Test ID as well as restoring its factory set default name.
<b>Delete Sample</b>	Delete discrete samples within the current Test ID. The ▲ and ▼ keys toggle between the individual data samples.
	<b>NOTE</b>
	Test ID statistics automatically recalculate upon deletion of an individual stored sample.

---

# % Memory

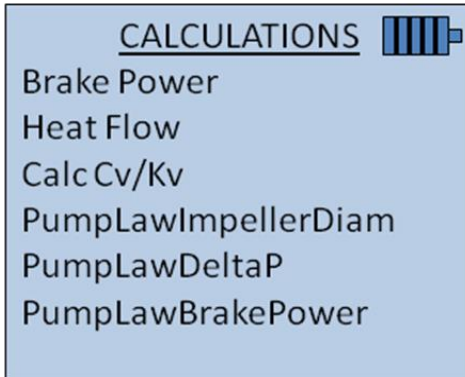
% Memory displays the total memory available. Delete All, under Delete Data, clears memory and resets to 100 percent.



## CHAPTER 5

# Calculations Menu

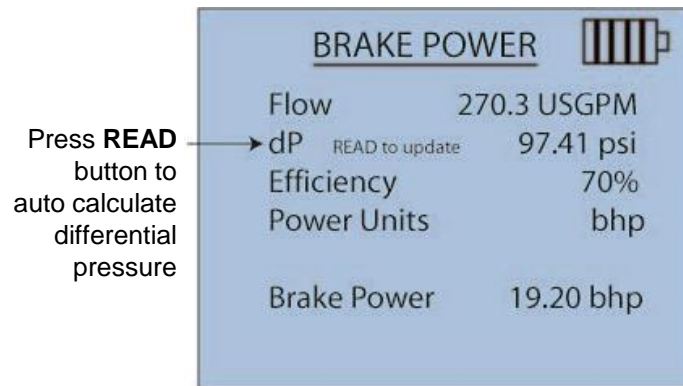
The HM685 Hydronic Manometer is capable of performing a variety of calculations useful in evaluating hydronic system performance. The Calculations Menu is accessed by pressing the **CALC** key from either the Pressure or Flow Measurement screens.



---

## Brake Power

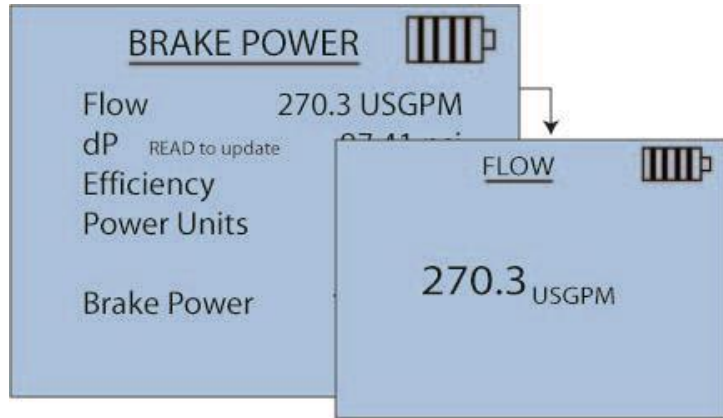
This Calculations Menu option determines pump brake power.



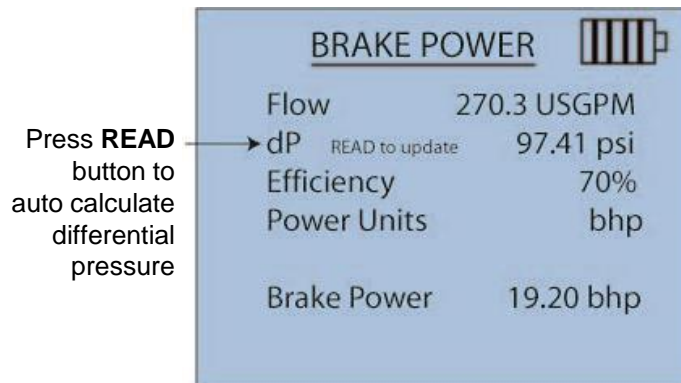
## Inputs

The following inputs are necessary for calculating brake power. Use the ▲ and ▼ keys to select the parameter, and the ◀ and ▶ keys to change the value of the highlighted field. Units for the inputs are driven by what was last set in the Pressure and Flow Measurement screens.

<b>Flow</b>	The pump flow rate.
-------------	---------------------



<b>dP</b>	The pressure drop measured across the pump.
	<b>NOTE</b>
	The pressure drop across the pump can be entered as a real-time measurement. With the value for differential pressure highlighted, press the <b>READ</b> key. The field will begin updating with measured values of differential pressure. Press the <b>READ</b> key again to discontinue real-time updates.





<b>Efficiency</b>	<p>The pump efficiency (as a percent).</p> <div style="border: 1px solid black; background-color: #0056b3; color: white; padding: 2px; text-align: center; font-weight: bold;">NOTES</div> <ul style="list-style-type: none"> <li>The pump efficiency should be provided by the manufacturer.</li> <li>If the pump efficiency is not known, allowing for an efficiency factor of 70 % is a good rule-of-thumb.</li> </ul>
-------------------	---

**BRAKE POWER**

Flow 270.3 USGPM

dP READ to update 97.41 psi

Efficiency 70%

Power Units bhp

Brake Power 19.20 bhp

**EFFICIENCY**

70%

<b>Power Units</b>	<p>The calculated pump brake power (<b>BP</b>) automatically updates as the input parameters are changed. Using the ▲ and ▼ keys to scroll, and the ◀ and ▶ keys to change the selected field, the unit of measure for brake power can be adjusted.</p> <p>Available units for brake power are: bhp, W, and kW.</p>
--------------------	---

**BRAKE POWER**

Flow 270.3 USGPM

dP READ to update 97.41 psi

Efficiency 70%

Power Units bhp

Brake Power 19.20 bhp

**POWER UNITS**


bhp

W

kW

# Heat Flow

This Calculations Menu option allows for determination of heat flow.

HEAT FLOW		
Upstream Temperature	→ T1 READ to update	73.6°F
Downstream Temperature	→ T2 READ to update	70.2°F
	FLOW READ to update	57.54 USGPM
	Specific Heat	1.20 Btu/lbF
	Specific Gravity	1.00
	Heat Flow Units	Btu/hr
	Heat Flow	117546 Btu/hr

Press **READ** button to auto calculate T1 and T2

## Inputs

The following inputs are necessary for calculating heat flow. Use the ▲ and ▼ keys to select the parameter to be updated, and the ◀ and ▶ keys to change the value of the highlighted field. Units for the inputs are driven by what was last set in the Pressure and Flow Measurement screens (with the exception of specific heat).

<p><b>T1</b></p>	<p>The upstream fluid temperature of the device being measured.</p> <div style="border: 1px solid black; background-color: #0070C0; color: white; text-align: center; padding: 2px;"><b>NOTE</b></div> <p>The upstream temperature can be entered as a real-time measurement if the accessory temperature probe is connected. With the value for the upstream temperature highlighted, press the <b>READ</b> key. The field will begin updating with measured values of temperature. Press the <b>READ</b> key again to discontinue real-time updates.</p>
<p><b>T2</b></p>	<p>The downstream fluid temperature of the device being measured.</p> <div style="border: 1px solid black; background-color: #0070C0; color: white; text-align: center; padding: 2px;"><b>NOTE</b></div> <p>The downstream temperature can be entered as a real-time measurement if the accessory temperature probe is connected. With the value for the downstream temperature highlighted, press the <b>READ</b> key. The field will begin updating with measured values of temperature. Press the <b>READ</b> key again to discontinue real-time updates.</p>

<b>Flow</b>	<p>The flow rate through the device.</p> <p style="text-align: center;"><b>NOTE</b></p> <p>The flow rate through the device can be entered as a real-time measurement. With the value for flow highlighted, press the <b>READ</b> key. The field will begin updating with calculated values of flow. Press the <b>READ</b> key again to discontinue real-time updates.</p>
<b>Specific Heat</b>	<p>The specific heat of the system fluid.</p> <p style="text-align: center;"><b>NOTE</b></p> <p>The unit of measure for specific heat is driven by that selected for heat flow as follows:</p> <ul style="list-style-type: none"> <li>• Heat flow in Btu/hr → specific heat in Btu/lb·°F</li> <li>• Heat flow in W or kW → specific heat in kJ/kg·°C</li> </ul> <p>The default specific heat is that of water: 1.00 Btu/lb·°F (4.19 kJ/kg·°C)</p>

HEAT FLOW

T1 READ to update 73.6 °F

T2 READ to update 70.2 °F

FLOW READ to update 57.54 USGPM

Specific Heat 1.20 Btu/lbF →

Specific Gravity 1.00

Heat Flow Units Btu/hr

Heat Flow 117546 Btu/hr

SPECIFIC HEAT

1.00

Btu/lbF

**Specific Gravity**

HEAT FLOW

T1 READ to update 73.6 °F

T2 READ to update 70.2 °F

FLOW READ to update 57.54 USGPM

Specific Heat 1.20 Btu/lbF

Specific Gravity 1.00 →

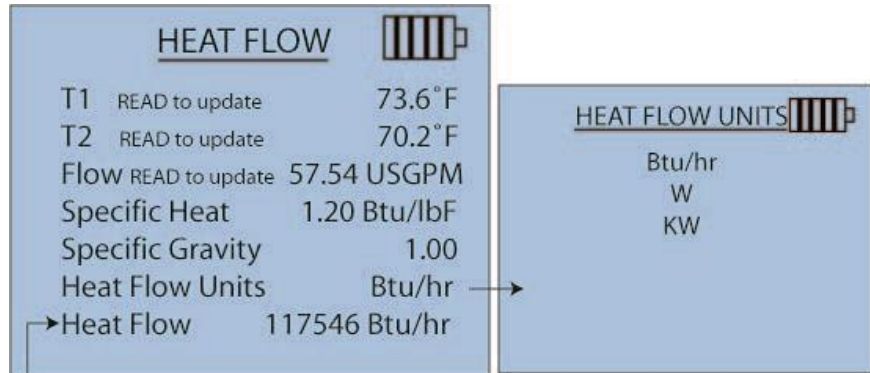
Heat Flow Units Btu/hr

Heat Flow 117546 Btu/hr

SPECIFIC GRAVITY

1.000

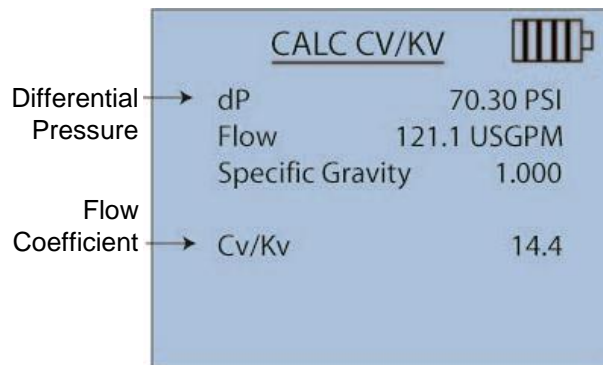
<p><b>Heat Flow Units</b></p>	<p>Heat Flow measurement can display in Btu/hr, W, or KW units.</p> <p>The calculated heat flow (HF) automatically updates as the input parameters are changed. Using the ▲ and ▼ keys to scroll, and the ◀ and ▶ keys to change the selected field, the unit of measure for heat flow can be adjusted.</p> <p>Available units for heat flow are: Btu/hr, W, and kW.</p>
-------------------------------	--



Heat Flow auto adjusts when units change

## Calculating Cv/Kv

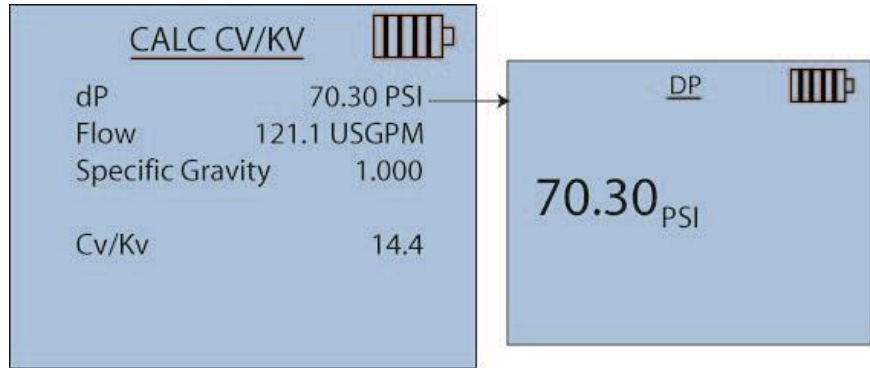
This Calculations Menu option allows for determination of a valve flow coefficient (**Cv** or **Kv**).



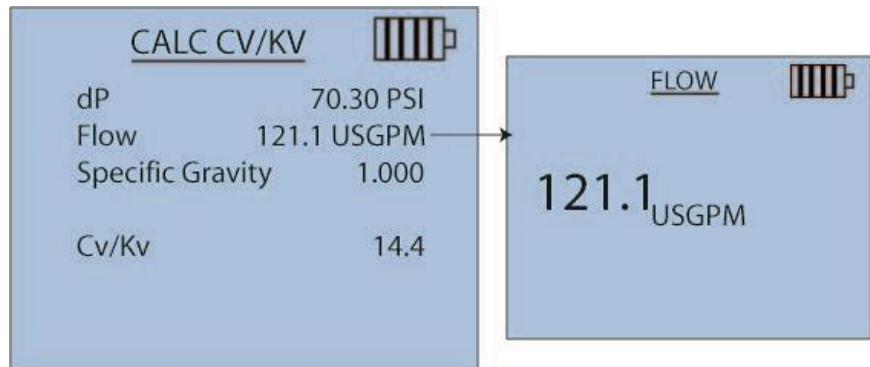
## Inputs

The following inputs are necessary for calculating the flow coefficient. Use the ▲ and ▼ keys to select the parameter to be updated, and the ◀ and ▶ keys to change the value of the highlighted field. Units for the inputs are driven by what was last set in the Pressure and Flow Measurement screens.

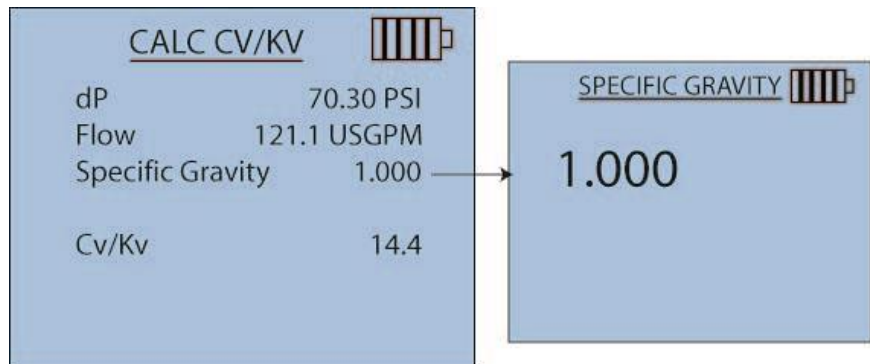
<b>Differential Pressure (dP)</b>	The pressure drop across the valve.
-----------------------------------	-------------------------------------



<b>Flow</b>	The flow rate through the valve.
-------------	----------------------------------



<b>Specific Gravity</b>	The specific gravity of the system fluid.
-------------------------	---



## Output

The calculated valve flow coefficient (**Cv** or **Kv**) automatically updates as the input parameters are changed.


### NOTE

Whether a **Cv** or **Kv** value is being calculated is dependent on the type (**Cv** or **Kv**) set for the current selected valve flow coefficient (Reference [Chapter 3, Flow Setup](#)).

---

## Pump Law Impeller Diameter

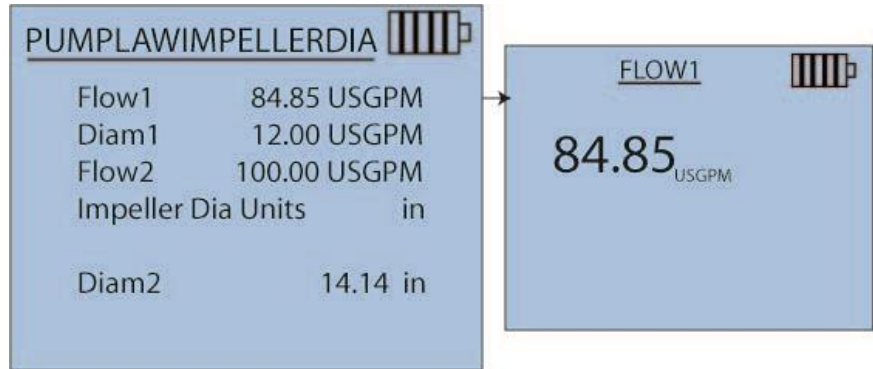
This Calculations Menu option allows for determination of required pump impeller size. The calculation is based upon the following affinity law: Flow varies directly as the change in impeller diameter.

PUMPLAWIMPELLERDIA 		
Actual Flow	→ Flow1	84.85 USGPM
Actual Impeller Diameter	→ Diam1	12.00 USGPM
Desired Flow	→ Flow2	100.00 USGPM
	Impeller Dia Units	in
Required Impeller Diameter	→ Diam2	14.14 in

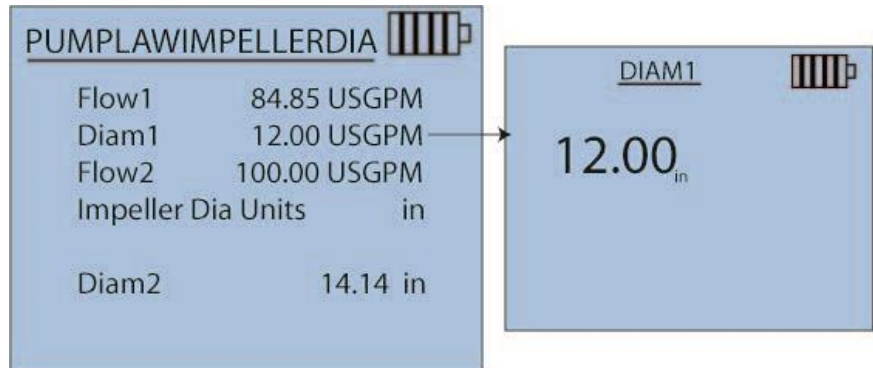
## Inputs

The following inputs are necessary for calculating the required impeller diameter. Use the ▲ and ▼ keys to select the parameter to be updated, and the ◀ and ▶ keys to change the value of the highlighted field. Units for the inputs are driven by what was last set in the Flow Measurement screen (with the exception of impeller diameter).

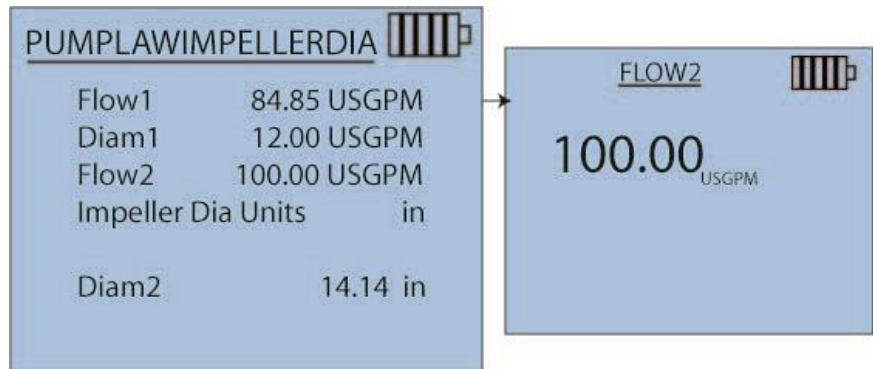
<b>Flow1</b>	The actual system flow rate.
--------------	------------------------------



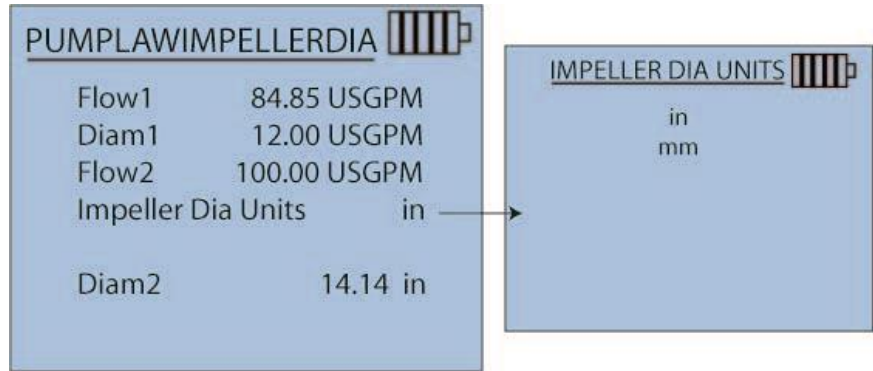
<b>Diam1</b>	The actual pump impeller diameter.
--------------	------------------------------------



<b>Flow2</b>	The desired system flow rate.
--------------	-------------------------------



<b>Impeller Dia Units</b>	The impeller diameter in inches or millimeters.
---------------------------	---



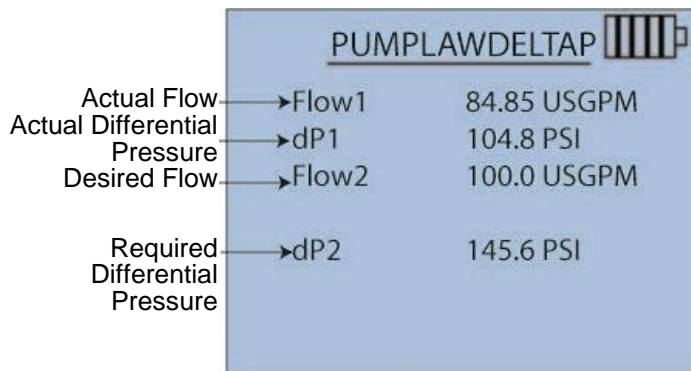
### Output

The calculated required impeller diameter (Diam2) to achieve the desired flow will automatically update as the input parameters are changed. Using the ▲ and ▼ keys to scroll, and the ◀ and ▶ keys to change the selected field, the unit of measure for impeller diameter may be adjusted. Available units for impeller diameter are: in, and mm.

---

## Pump Law Delta P

This Calculations Menu option allows for determination of required pump pressure drop. The calculation is based upon the following affinity law: Pump pressure drop varies as the square of flow.

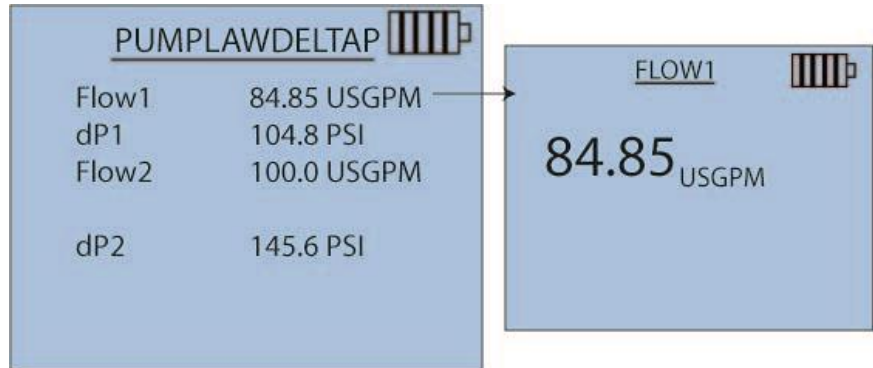




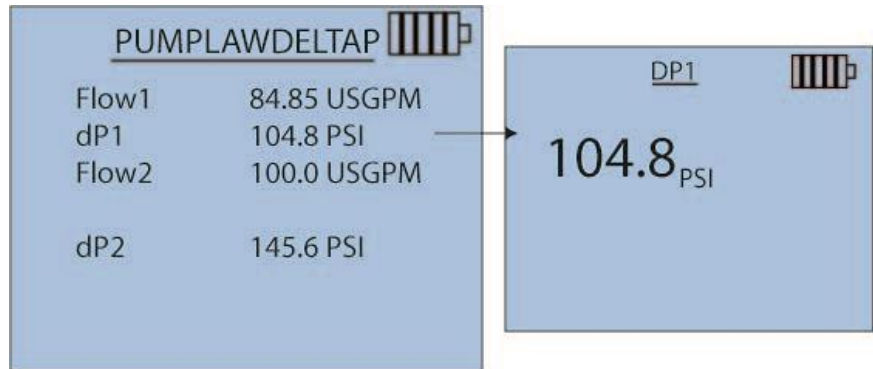
## Inputs

The following inputs are necessary for calculating the required pump pressure drop. Use the ▲ and ▼ keys to select the parameter to be updated, and the ◀ and ▶ keys to change the value of the highlighted field. Units for the inputs are driven by what was last set in the Pressure and Flow Measurement screens.

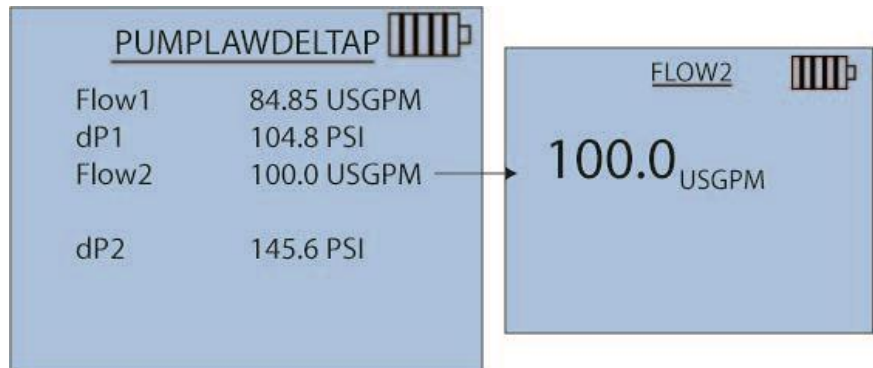
<b>Flow1</b>	The actual system flow rate.
--------------	------------------------------



<b>dP1</b>	The actual pump pressure drop.
------------	--------------------------------



<b>Flow2</b>	The desired system flow rate.
--------------	-------------------------------



## Output

The calculated required pump pressure drop (**dP2**) to achieve the desired flow will automatically update as the input parameters are changed. The units for pump pressure drop are driven by what was last set in the Pressure and Flow Measurement screens.

---

## Pump Law Brake Power

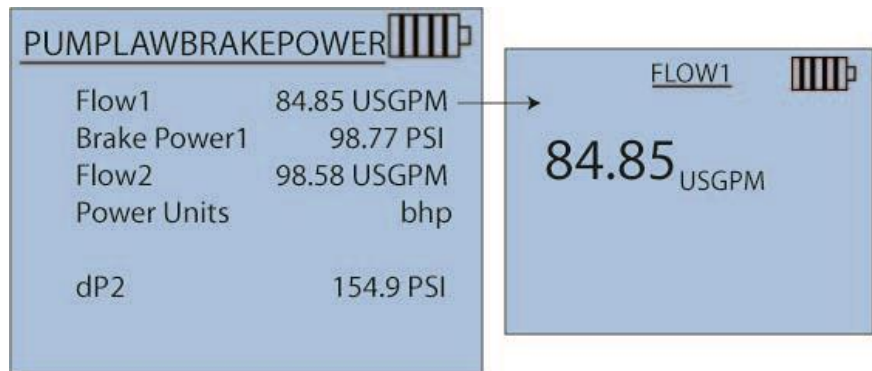
This Calculations Menu option allows for determination of required pump brake power. The calculation is based upon the following affinity law: Pump brake power varies as the cube of flow.

PUMPLAWBRAKEPOWER	
Actual Flow	→ Flow1 84.85 USGPM
Actual Pump Brake Power	→ Brake Power1 98.77 PSI
Desired Flow	→ Flow2 98.58 USGPM
Required Pump Brake Power	→ Power Units bhp
	dP2 154.9 PSI

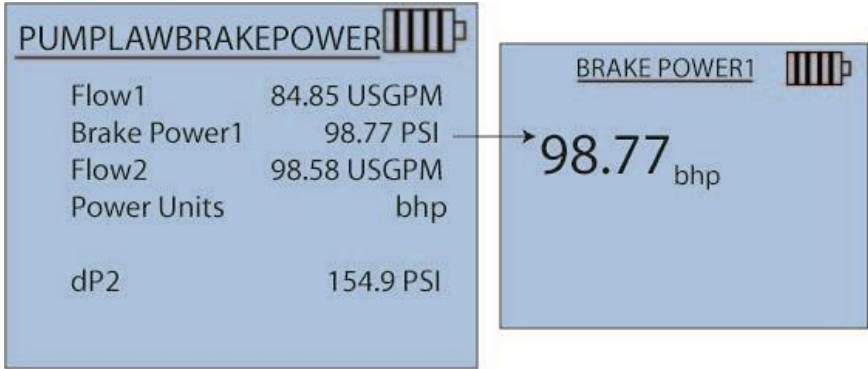
## Inputs

The following inputs are necessary for calculating the required pump brake power. Use the ▲ and ▼ keys to select the parameter to be updated, and the ◀ and ▶ keys to change the value of the highlighted field. Units for the inputs are driven by what was last set in the Pressure and Flow Measurement screens (with the exception of brake power).

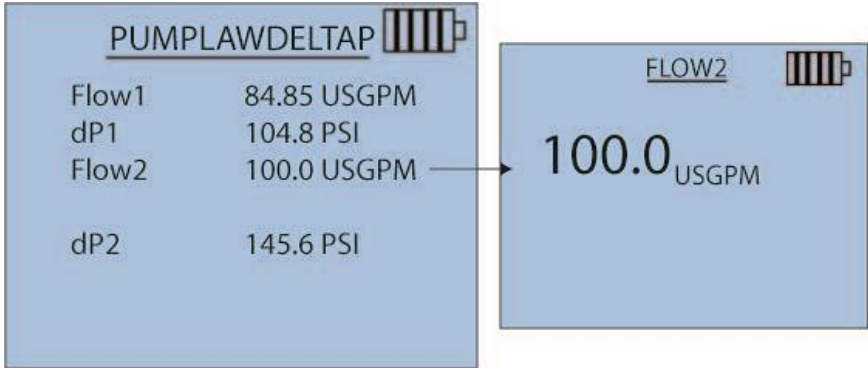
<b>Flow1</b>	The actual system flow rate.
--------------	------------------------------



<b>BP1</b>	The actual pump brake power.
------------	------------------------------



<b>Flow2</b>	The desired system flow rate.
--------------	-------------------------------



### Output

The calculated required pump brake power (**BP2**) to achieve the desired flow will automatically update as the input parameters are changed. Using the ▲ and ▼ keys to scroll, and the ◀ and ▶ keys to change the selected field, the unit of measure for pump brake power may be adjusted. Available units for pump brake power are: bhp, W and kW.

*(This page intentionally left blank)*

# CHAPTER 6

## Settings Menu

The Settings menu allows customization of the instrument display.

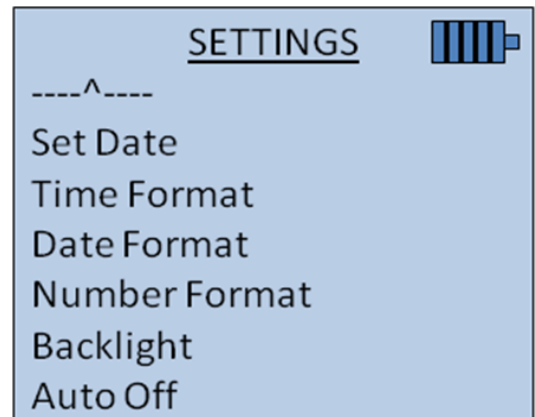
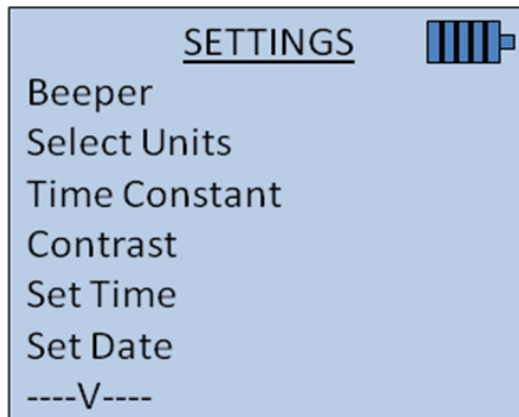
General settings include:

- [Beeper](#)
- [Select Units](#)
- [Differential Pressure and Gauge Pressure](#)
- [Flow](#)
- [Temperature](#)
- [Time Constant](#)
- [Contrast](#)
- [Set Time](#)
- [Set Date](#)
- [Time Format](#)
- [Date Format](#)
- [Number Format](#)
- [Backlight](#)
- [Auto Off](#)

Navigate to the Settings menu by pressing the **Enter** key at the Pressure or Flow display.

Use the arrow keys to select an option or to change the settings for each option.

Press the **Enter** key to accept the selected setting.

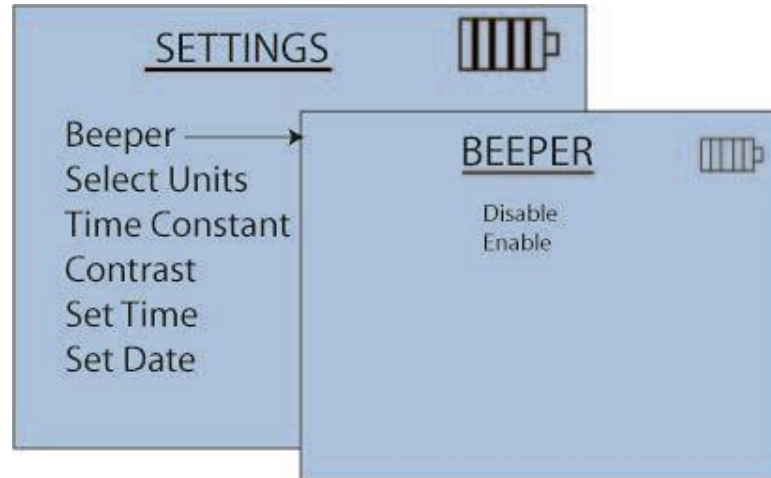


---

# Beeper

The Beeper setting changes the keypad press with an audible beep or silent.

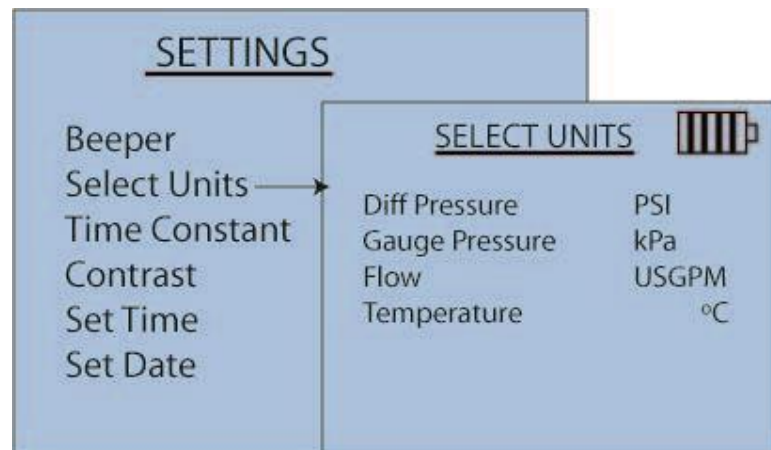
- Enable sets an audible beep
- Disable provides no audible beep



---

# Select Units

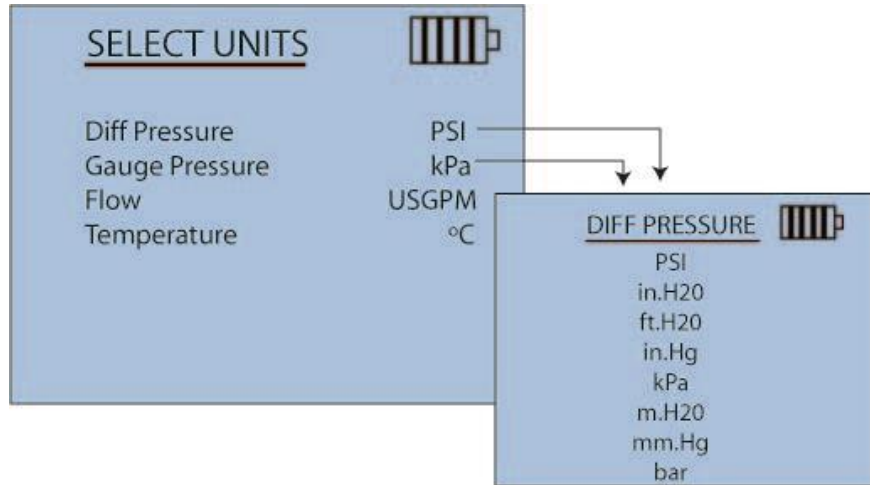
Select Units adjusts the format of the delimiter in both displayed and stored data for differential pressure, gauge pressure, flow, and temperature.



---

# Differential Pressure and Gauge Pressure

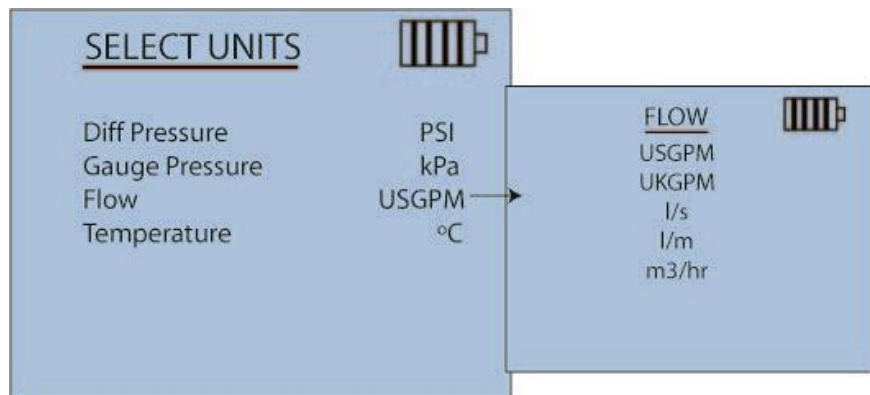
Highlight either differential pressure or gauge pressure and press the **Enter** key. Use the arrow keys to highlight the appropriate measurement and press the **Enter** key to accept.



---

# Flow

At the Select Units screen, highlight Flow and press the **Enter** key. Highlight the appropriate measurement and press the **Enter** key to accept.

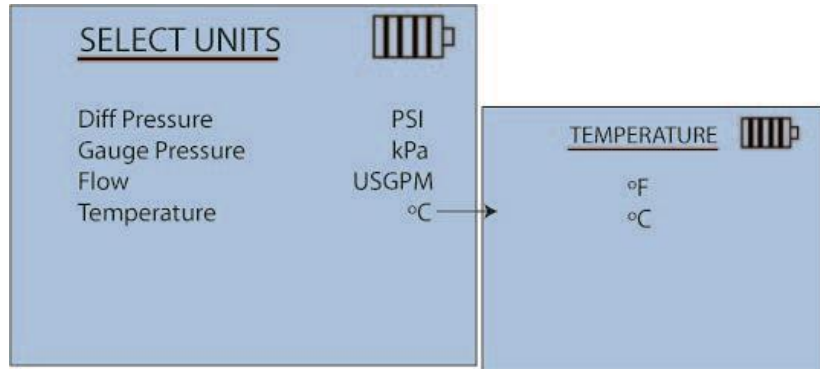


---

# Temperature

Temperature readings can display in °C or °F.

- At the Select Units menu, highlight Temperature and press the **Enter** key to select the desired setting.



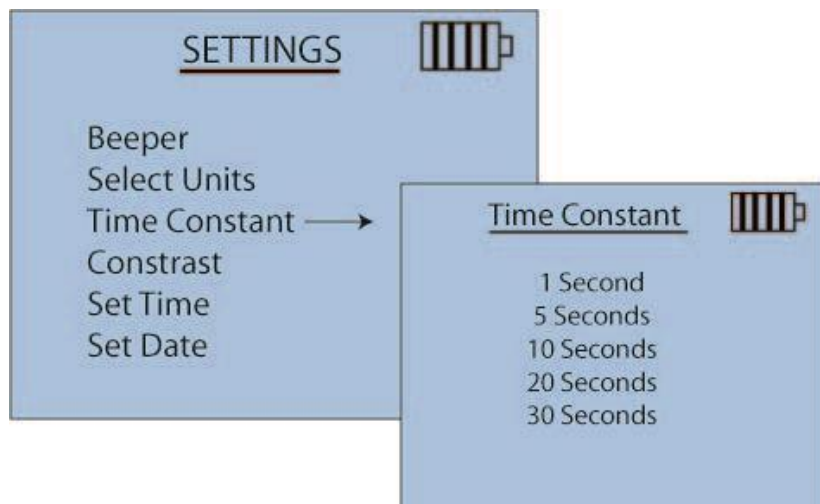
---

# Time Constant

The current value of the time constant is adjustable. Available settings include 1, 5, 10, 20, and 30 seconds.

## NOTES

- The time constant is the period over which the manometer averages measurements. Example: with the time constant equal to ten (10) seconds, the displayed reading represents the average of measurements taken over the previous ten (10) seconds.
- Increasing the time constant will serve to improve measurement stability, particularly when measuring systems with fluctuating pressures.

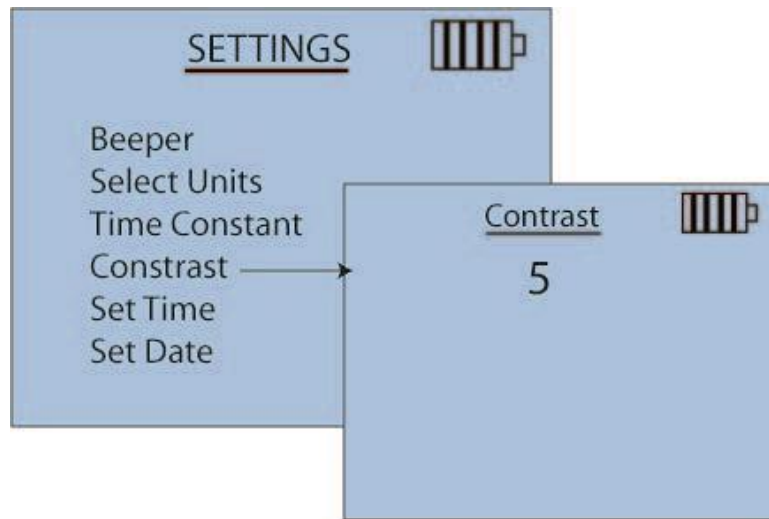




---

## Contrast

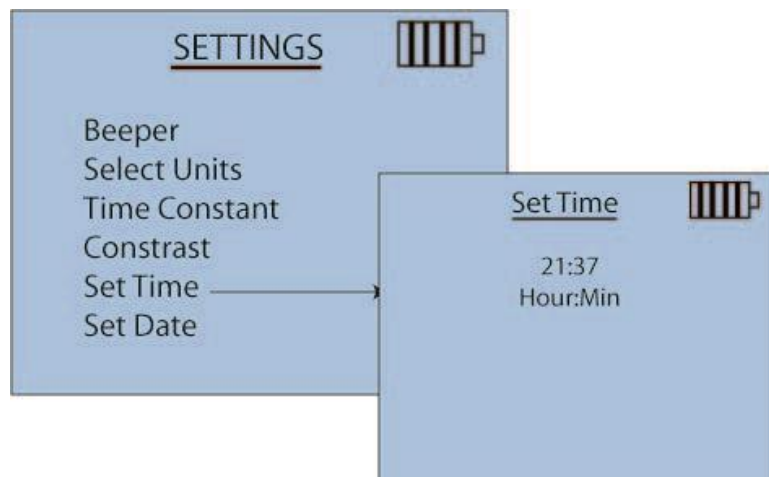
The Contrast menu allows contrast adjustment to the manometer display based on the surrounding lighting environment. Setting selections range from 0 to 10. The higher the settings number, the darker the contrast of the display. Use the up and down or left and right arrow keys to adjust contrast.



---

## Set Time

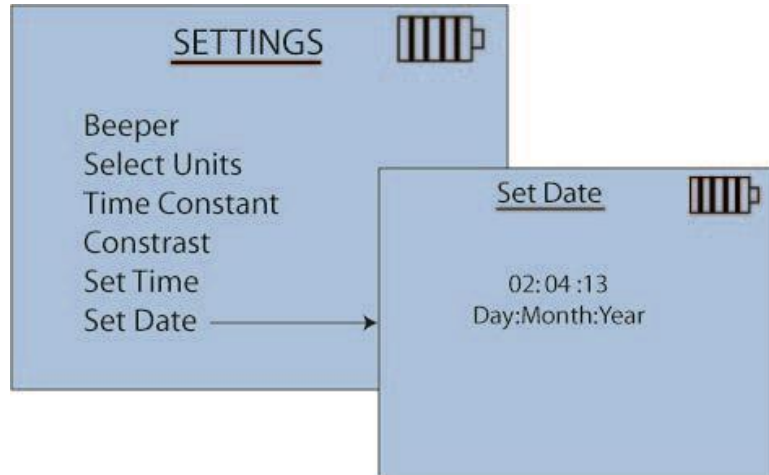
The Set Time menu sets the instrument's real-time clock. The digit selected to change will flash. Use the arrow keys to select the hour/minute digits and to adjust accordingly. Press the **Enter** key to confirm. The time format of 12 or 24 hour is set at the Time Format menu.



---

## Set Date

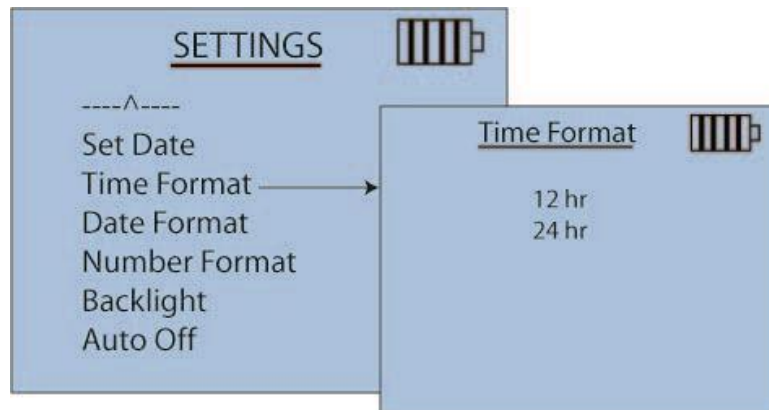
The date is programmed to the instrument at the Set Date menu. The digit selected to change will flash. Use the arrow keys to select the date, month, or year and to adjust the date accordingly. Press the **Enter** key to confirm.



---

## Time Format

The time format displays the time in a 12 or 24 hour format.

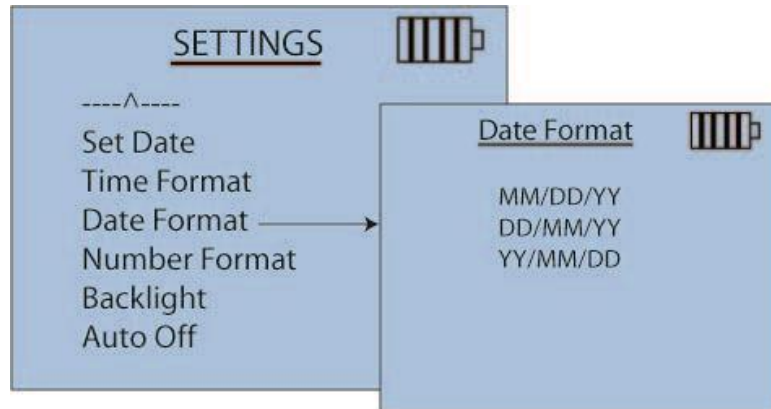


---

## Date Format

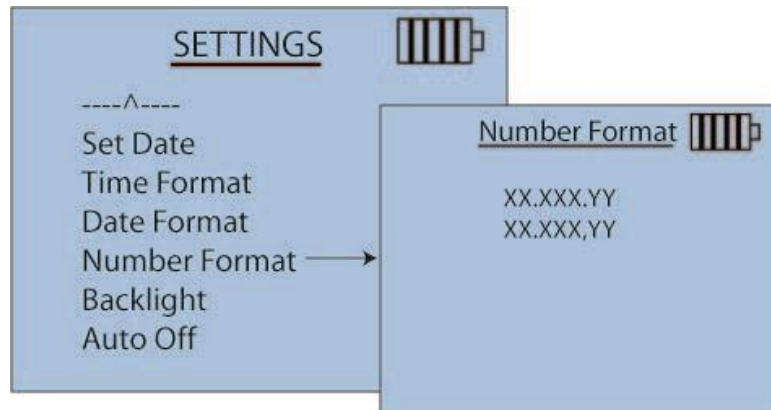
Three date settings are selectable based on your preference and include:

- Month/Date/Year
- Date/Month/Year
- Year/Month Date



---

## Number Format



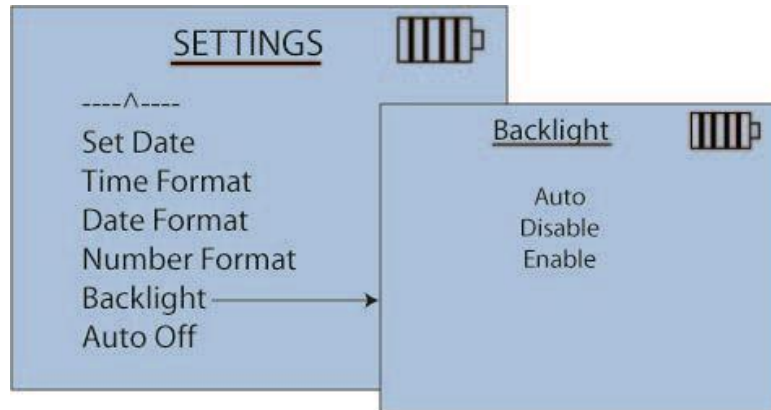
---

# Backlight

The Backlight feature illuminates the display in low light conditions.

Backlight options include:

- Auto (automatically turns on backlight in low-light condition)
- Disable (no backlighting)
- Enable (backlight is always on)



---

# Auto Off

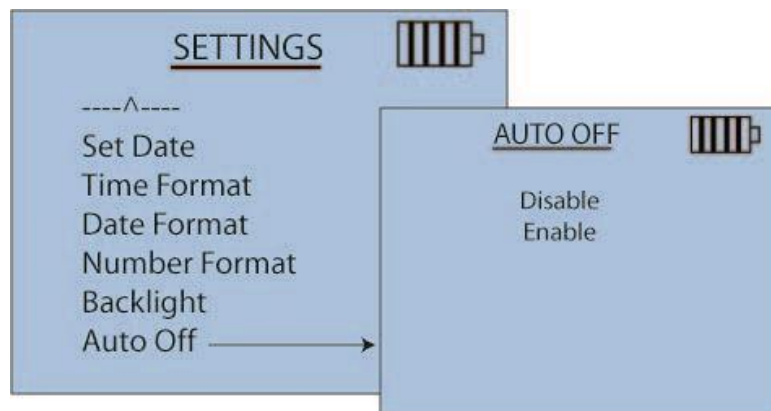
Automatic shutoff extends battery life by turning off the instrument if the keypad is inactive for a period of thirty (30) minutes.

Shutoff options include:

- **Disable** (instrument does not power off after inactivity)
- **Enable** (instrument powers off after 30 minute inactivity)

## NOTE

The automatic shutoff feature is disabled whenever data logging is active.



## CHAPTER 7

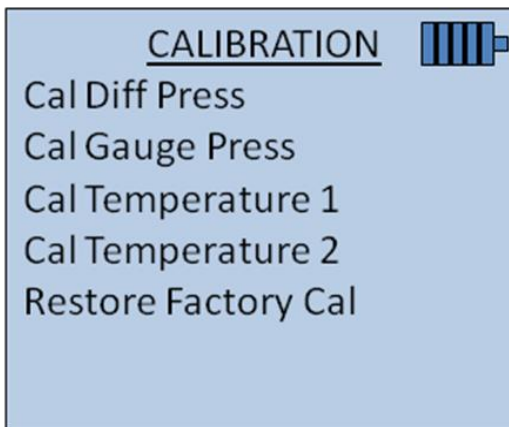
# Calibration

On the calibration screen, you can either adjust the factory calibration value so their measurements meet another standard or can restore factory calibration settings to the instrument in case you believe the calibration of the instrument has changed.

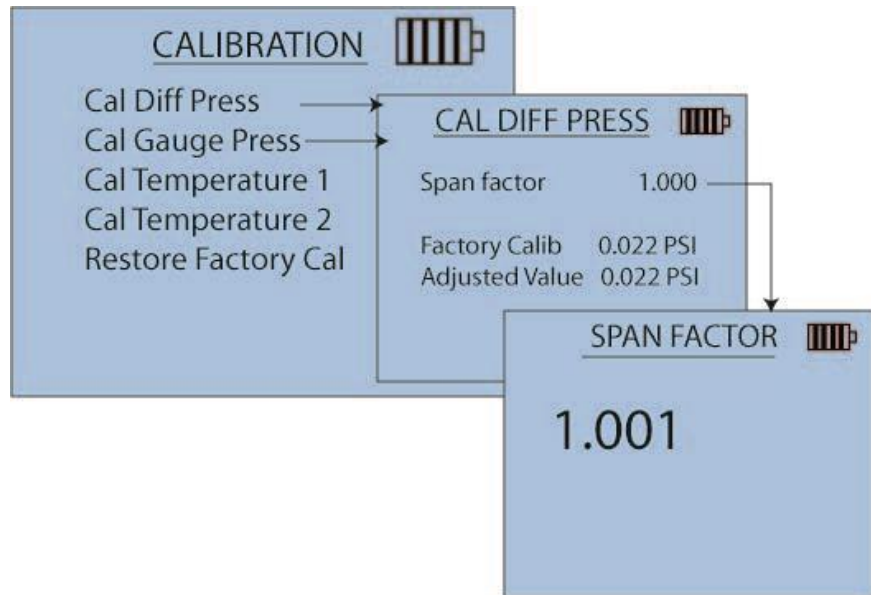
The following items can be seen in each section of the calibration screen.

1. The magnitude of user adjustment
2. The factory calibrated measurement value
3. The measurement value after performing the user adjustment.

This allows you to change measurement calibration by a specific amount and to change back to factory calibration if necessary.



# Calibration Differential Pressure and Calibration Gauge Pressure

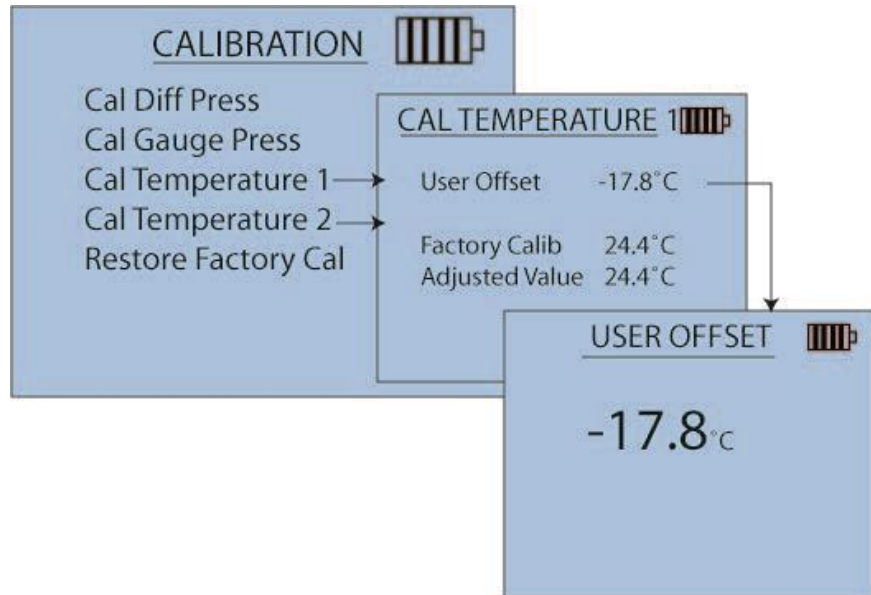


The Span Factor is used to adjust the pressure readings on the meter. It is multiplied by the factory calibrated pressure to yield the displayed pressure value.

**Example** - If you determine that differential pressure is reading 2.3% too low, you enter a Span Factor of 1.023 and afterward all differential pressure values will be multiplied by 1.023.

---

## Calibration Temperature 1 and 2



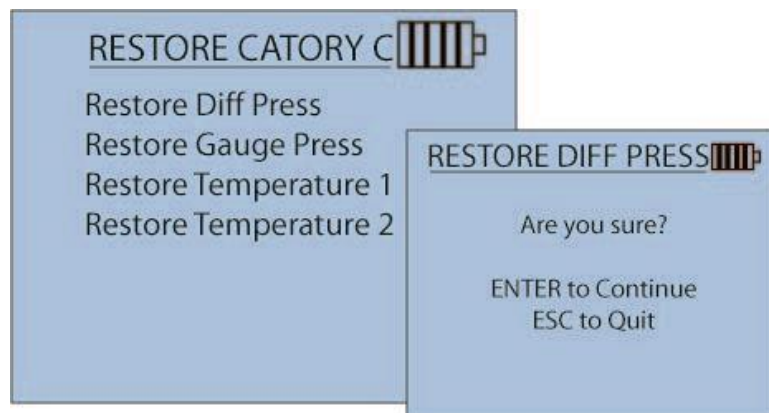
The temperature User Offset is added to temperature measurements to yield the displayed temperature value.

**Example** - If you determine that temperature probe 1 is reading 0.5°C too high, enter a User Offset of -0.5°C and afterward all temperature values from probe 1 will be shifted down by 0.5°C

---

## Restore Factory Calibration

Factory calibrations for differential pressure, gauge pressure, and temperatures can be restored using below menu options.



*(This page intentionally left blank)*



## CHAPTER 8

# Maintenance and Troubleshooting

The HM685 Hydronic Manometer has been designed to provide long-term field use with minimum required maintenance. As with any precision electronic device, proper care, maintenance, and handling will ensure its accurate and reliable operation.

### IMPORTANT

There are no user-serviceable parts inside this instrument. Opening the instrument case may void the warranty. TSI recommends that you return the HM685 Hydronic Manometer to the factory for any required maintenance or service not described in this manual.

---

## Routine Maintenance

The following guidelines should be followed whenever storing the HM685 Hydronic Manometer:

### Draining the Hoses

Fluid within the High (red) and Low (blue) pressure hoses should be properly drained whenever the instrument is being stored after use.

1. Disconnect the manometer hoses from the test points (*Reference Chapter 2, "Disconnecting the Manometer from the Test Points"*).
2. Disconnect the High (red) and Low (blue) pressure hoses from the manometer.
3. Turn the shut-off ball valve on both the High and Low pressure hoses to the open position.
4. Using a suitable high pressure air source, blow the entrained liquid from both hoses.

### Draining the Manometer Valve

Fluid within the manometer valve should be properly drained whenever the instrument is being stored after use.

1. Disconnect the High (red) and Low (blue) pressure hoses from the manometer.
2. Turn the valve handle on the manometer to the **BYPASS** position.
3. Hold the manometer with the pressure ports directed downward to allow liquid to drain from the unit.

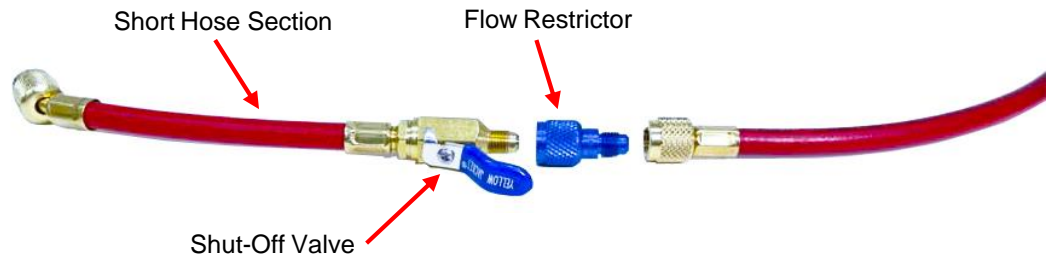
4. Turn the valve handle on the manometer to the **MEASURE** position.
5. Hold the manometer with the pressure ports directed downward to allow liquid to drain from the unit.

#### NOTE

The HM685 Hydronic Manometer should be stored with the valve handle in the **MEASURE** position.

### In-Line Flow Restrictor

The blue and red hose assemblies include flow restrictors. The flow restrictors must be used to prevent damage to the pressure sensors from unexpected water hammering or pressure spikes and also acts as a filter. **DO NOT** use the HM685 Hydronic Manometer without the flow restrictors installed in the hose assemblies or sensor damage or clogging will occur.



### Cleaning the In-line Flow Restrictors

These flow restrictors should be flushed periodically with clean water to minimize potential clogging.

1. Disconnect the hose from the manometer.
2. Turn the shut-off ball valve on the hose to the closed position.
3. Connect the straight female flare fitting (farthest from the hose shut-off valve) on the hose to a suitable water source.
4. Place the open end of the hose in a suitable receptacle or near a drain.
5. Turn the shut-off ball valve on the hose to the open position and allow water to flush through for several minutes.
6. Using a suitable high pressure air source, blow the entrained water from the hose.
7. Repeat with the second hose.

#### NOTE

If necessary, remove the flow restrictor for further cleaning or flushing. Reattach to hose assembly when complete.

## Cleaning the Instrument Housing

The HM685 Hydronic Manometer may be cleaned using a soft, damp, clean cloth.

### NOTE

Solvents or abrasive cleaners should never be used to clean the instrument housing, keypad, or display.

---

## Calibration

TSI® recommends that the HM685 Hydronic Manometer receive an annual calibration. TSI® will verify calibration of the instrument and re-issue a certificate of calibration with traceability to NIST. This “annual checkup” helps to ensure the specified accuracy of the instrument is maintained.

To calibrate the instrument, please ship TSI® the complete package that includes the meter and accessory temperature probe. Everything should be packed carefully within the carrying case and then inside a shipping box. The original shipping box and packaging (carton and foam) is preferred.


Before returning the Hydronic Manometer to TSI for service, visit our website at [tsi.com/service](https://www.tsi.com/service) or call TSI at 1-800-680-1220 (USA) or 001 (651) 490-2860 for specific return instructions. Customer Service will need the following information when you call:

- The instrument model number
- The instrument serial number
- A purchase order number (unless under warranty)
- A billing address
- A shipping address

---

## Troubleshooting

The following table lists the symptoms, possible causes, and recommended solutions for common problems encountered with the instrument. If your symptom is not listed, or if the recommended solutions do not address your problem, please contact the factory.

Symptom	Possible Causes	Corrective Action
No display	Unit not turned on. Low or dead batteries. Dirty battery contacts. AC adapter not connected.	Press On/OFF key. Replace or recharge the batteries. Clean the battery contacts. Plug in AC adapter.
 flashing on display	Low battery charge. Dirty battery contacts.	Replace or recharge the batteries. Clean the battery contacts.
"8888" flashing on display	The indicated measurement is out of range.	The allowable ranges for pressure and temperature measurements are shown on the specifications page.
"-----" on display	The temperature sensor is unplugged The pressure measurement is out of the meter's range.	Try one of the below two steps: 1. Plug in temperature probe. 2. Return the pressure measurement to the correct range
Instrument unresponsive to pressure	Hoses are clogged	Make sure hoses and flow restrictors are unclogged from any debris by following instructions on <a href="#">Cleaning the In-line Flow Restrictors</a> .

The following table lists error messages which can be displayed should the instrument detect a problem. Should any of these error messages recur repeatedly, the instrument should be returned to the factory for servicing.

Error Message	Possible Causes & Corrective Action
"Lithium Battery Low"	The battery which runs the real-time clock and saves data logging information is depleted and should be replaced. Please return the unit to factory to replace the battery.
"Reading Logged Data"	There was a problem with the logged data. You should download their logged data as soon as practical and then execute the "Delete All" command to re-initialize data logging. If the lithium battery is depleted, this could also cause an error reading logged data.
"Saved Measurement Params"	There was a problem with the measurement parameters read from memory. They should be checked to make sure they still represent your desired settings. Measurement parameters are Cv/Kv, selected fluid, time constant, and measurement units.
"Saved User Config"	There was a problem with the user configuration read from memory. It should be checked to make sure it still represents your desired settings. These are settings that do not impact measurements – contrast, logging mode, log sample intervals, backlight setting time & date format, decimal setting (commas or periods), beeper enable setting and auto power-down setting
"Saved Pressure Zero"	There was a problem with a pressure zero reading read from memory. Differential pressure and gauge pressure should both be re-zeroed.

---

# Technical Contacts

- If you have any difficulty installing the Hydronic Manometer, or if you have technical or application questions about this instrument, contact an applications engineer at one of the locations listed below.
- If the Hydronic Manometer fails, or if you are returning it for service, visit our website at <http://service.tsi.com> or contact TSI at:

**TSI Incorporated**

500 Cardigan Road  
Shoreview, MN 55126 USA

**Phone:** +1-800-680-1220 (USA) or +1 (651) 490-2860

**E-mail:** [technical.service@tsi.com](mailto:technical.service@tsi.com)

---

**TSI GmbH**

Neuköllner Strasse 4  
52068 Aachen  
GERMANY

**Telephone:** +49 241-52303-0

**E-mail:** [tsigmbh@tsi.com](mailto:tsigmbh@tsi.com)

---

**TSI Instruments Ltd.**

Stirling Road  
Cressex Business Park  
High Wycombe, Bucks  
HP12 3ST  
UNITED KINGDOM

**Telephone:** +44 (0) 149 4 459200

**E-mail:** [tsiuk@tsi.com](mailto:tsiuk@tsi.com)

*(This page intentionally left blank)*

## CHAPTER 9

# USB Downloading to a Computer

The HM685 Hydronic Manometer allows for downloading of stored data to a computer by using the included Windows®-based CompuDat™–USB downloading program and USB interface cable.

---

## Installing the USB Software

Successful installation of the CompuDat™–USB downloading software is completed as follows:

1. Insert the CompuDat–USB Software CD into the computer CD drive.
2. Allow the Autorun program to initiate the installation.

### NOTE

If the program fails to start automatically, run the file setup.exe located on the CD.

3. Follow the on-screen instruction to properly install the program.

### NOTES

- You must have administrative rights on the computer in order to successfully install the included USB downloading software.
- Restart the computer (as prompted) upon completing the installation prior to first running the USB downloading program.
- The CompuDat-USB 2.0 program is also compatible with the HM680 meter.

# Connecting the Manometer to the Computer

The HM685 Hydronic Manometer is connected to the computer using the provided USB interface cable. The meter must be powered on in order to properly establish communication.

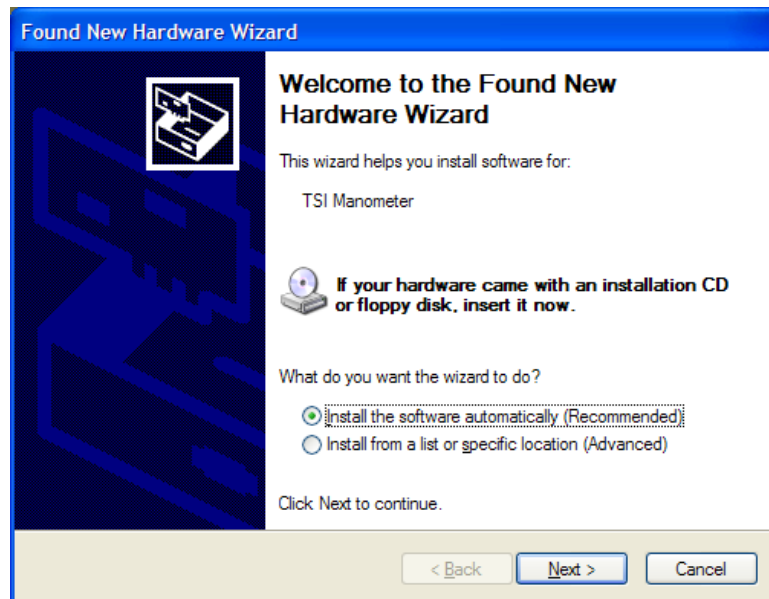
## First Time Connection

The *first* time the meter is connected to the computer, you will be prompted to complete the following New Hardware installation.

### NOTE

The screens shown here are from a Windows® XP (32-bit only) system installation. Windows® 7 (32- and 64-bit) system screens will differ. Windows® 7 screen images are also shown below.

1. Select **Automatic Install** and click **Next**.



**Figure 9-1**  
Found New Hardware Wizard





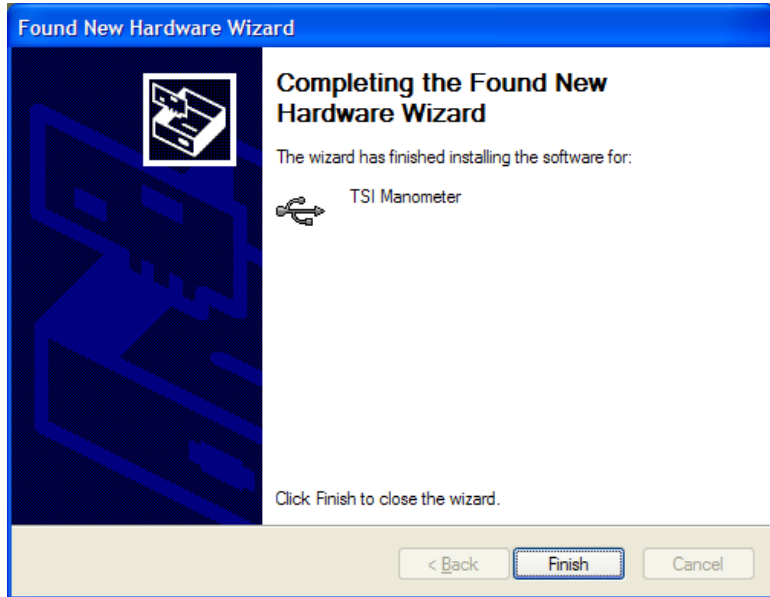
**Figure 9-2**  
Windows 7 Found New Hardware Wizard

2. Click **Continue Anyway** for Windows® XP system. Windows® 7 system will install the driver automatically.

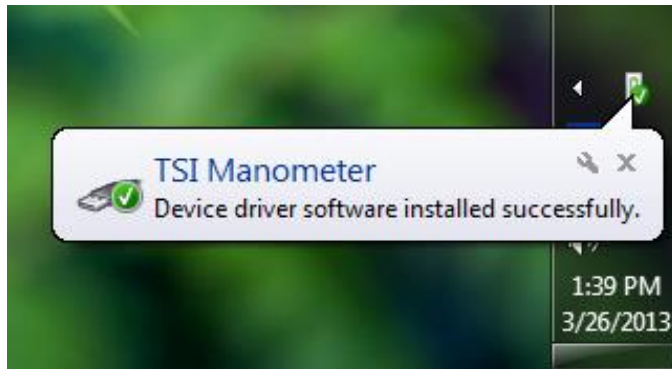


**Figure 9-3**  
Hardware Installation

3. Click **Finish** for Windows® XP system. No action needed for Windows® 7 system.

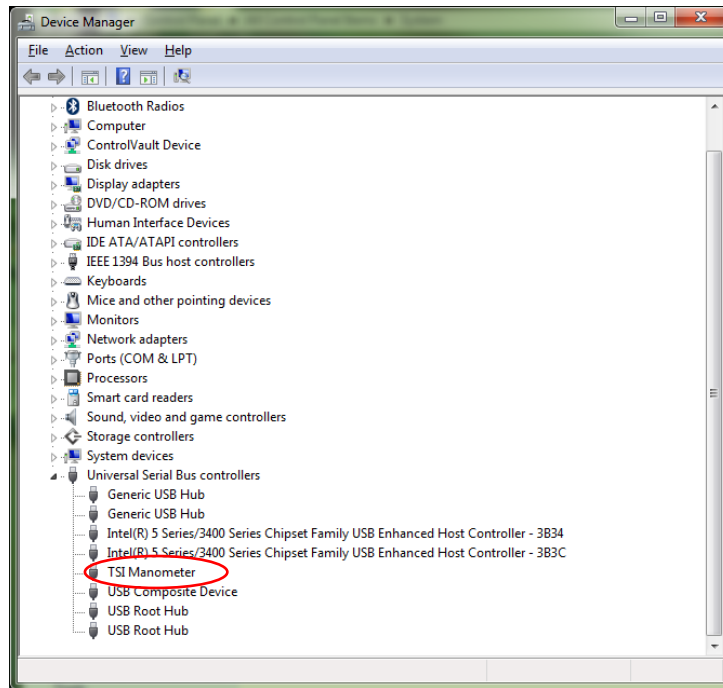


**Figure 9-4**  
Completing the Found New Hardware Wizard



**Figure 9-5**  
Windows® 7 Installation Notification

4. Verify that the meter driver has installed successfully by checking the device manager. Go to Device Manager using the following steps:
  - a. Click on the Windows **Start** button.
  - b. Go to **Control Panel**, then **Administrative Tools** then select **Computer Management**
  - c. Double-click on **Device Manager**.

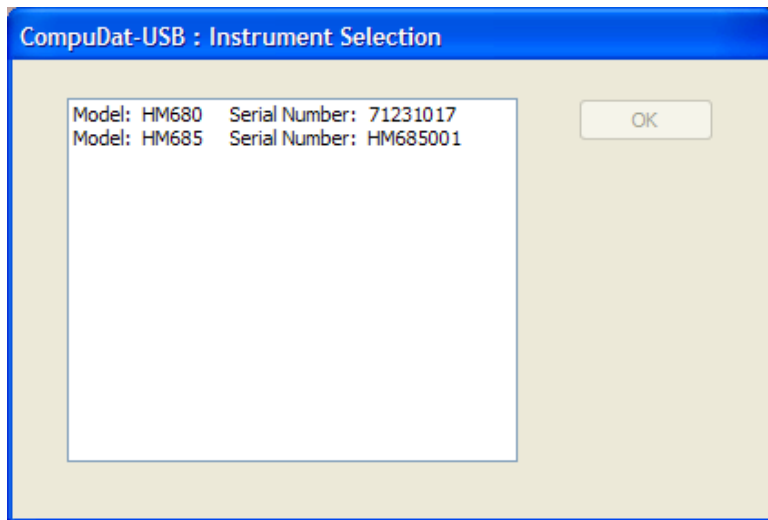


**Figure 9-6**  
Confirm Meter Software Installation

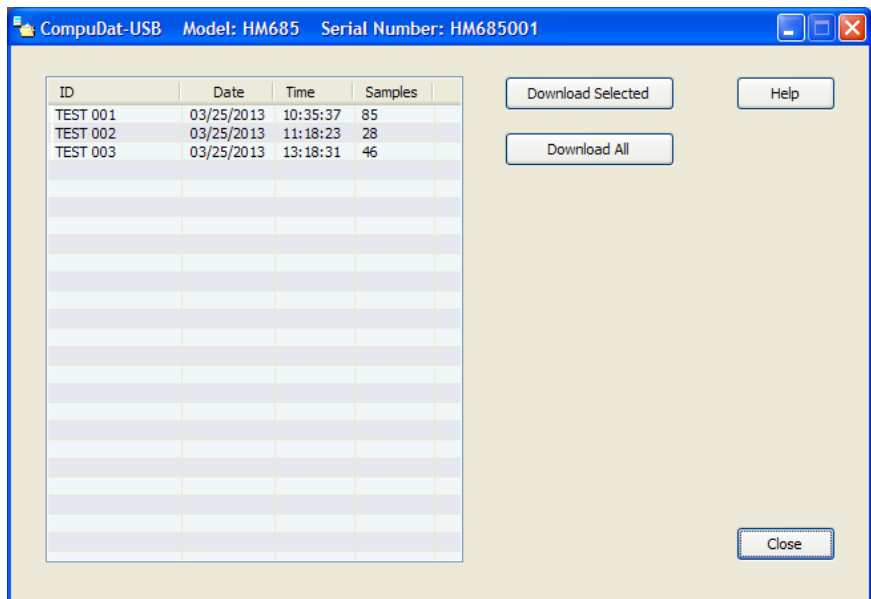
# Software Interface

With the HM685 meter connected to the computer, double-click on the **CompuDat-USB 2.0** icon on computer's desktop. All downloadable data stored to the instrument will be presented in a form similar to as follows:

When launching the software with more than one supported meter connected, the following screen appears. Select the meter from which you want to download data. If only one meter is connected, either the screen for HM680 files and folders or the screen for HM685 displays.



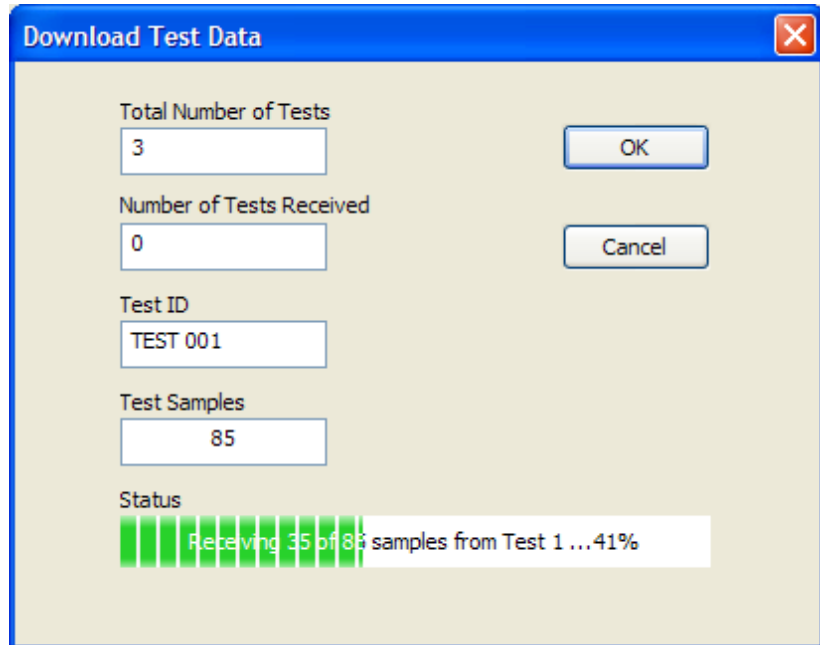
**Figure 9-7**  
Instrument Selection Screen



**Figure 9-8**  
HM685 Data Download Screen

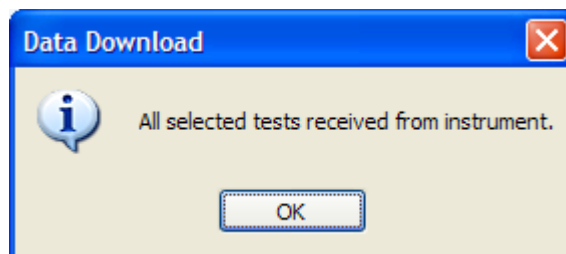
## HM685 Data Download Steps

1. Highlight the test (row) in test list or just left mouse click like Windows® operation to select the test/tests.
2. Select **tests** and click **Download Selected** button to download selected tests or click **Download All** button to download all tests.
3. The following screen is shown when downloading starts.



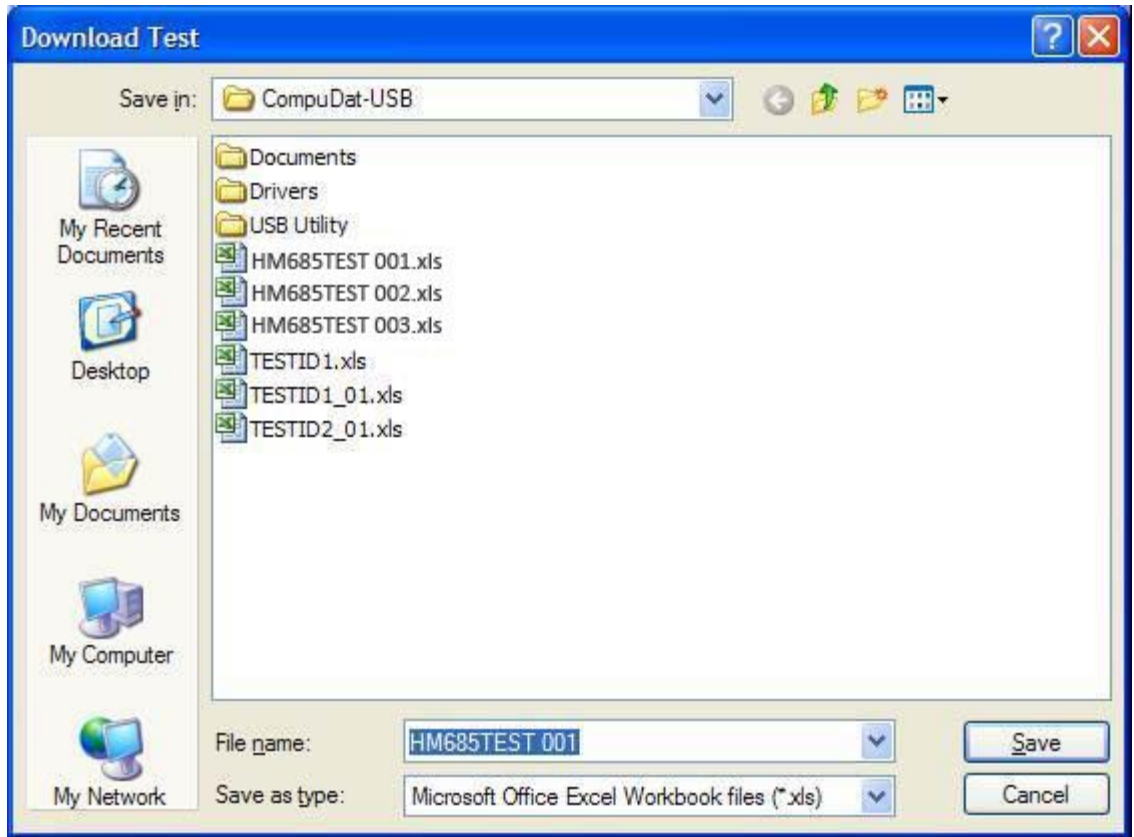
**Figure 9-9**  
HM685 Download Test Data Screen

4. When download finishes, a dialog similar to the following appears.



**Figure 9-10**  
HM685 Data Download Screen

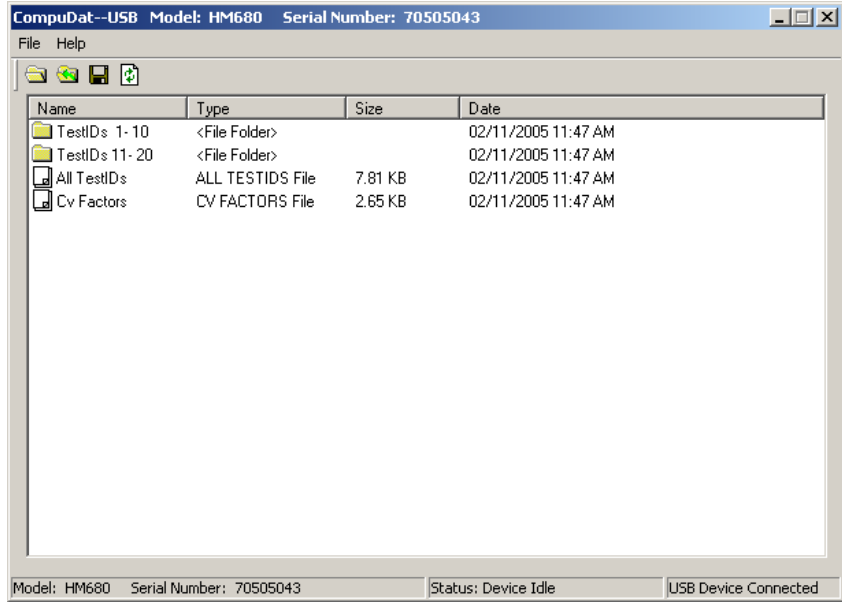
5. Click **OK** button and a dialog similar to the standard windows file save as dialog appears.
6. Change the filename or use default and click **Save** button.



**Figure 9-11**  
HM685 Download Test Screen

7. Test/tests will be saved to one file.

8. If HM680 is selected and **OK** is clicked, the screen shown below will display. Follow instructions for downloading data from HM680.



**Figure 9-12**  
HM680 USB Folders and Files

### HM680 Download Instructions

<b>All TestIDs</b>	The All TestIDs file contains all data stored to each of the instrument's 100 available Test IDs.
<b>Cv Factors</b>	The Cv Factors file contains all data associated with the instruments 100 available Cv/Kv valve coefficients.
<b>TestIDs Folder</b>	Each TestIDs folder contains files for each of the Test ID numbers indicated (example: the folder "TestIDs 1-10" will contain files of stored data for Test ID 1 through Test ID 10). TestIDs folders can be downloaded in their entirety or opened for access to individual Test ID files.

---

## Downloading Data

Downloading stored data is completed as follows:

1. Single-click the desired file/folder to highlight.
2. Click the **Save As** icon in the toolbar.

### NOTE

The **Save As** option may also be used from the file pull-down menu.

3. Choose the filename, file type, and directory to save data to.

### NOTES

- Double-clicking or using the **Open** menu option allows for automatically opening the selected file using an appropriate application (i.e., Microsoft® Excel® spreadsheet) upon having saved the file to the computer.
- TSI® recommends that you **DO NOT** save data files in the C:\Program Files directory when running on a Windows® 7 operating system in a multi-user environment.



# APPENDIX A

## Specifications

Model HM685 Hydronic Manometer specifications are as follows  
(specifications are subject to change without notice).

<b>Range</b>	
Differential Pressure .....	±300 psi (±2068 kPa)
Gauge Pressure .....	-20 to 300 psi (-138 to 2068 kPa) (-40 to 610 in. Hg)
Flow <sup>1</sup> .....	± 99,999 USGPM ( ±6309 l/s, ±22,712 m <sup>3</sup> /h)
Operating Temperature .....	40 to 113°F (5 to 45°C) electronics
Storage Temperature .....	-4 to 140°F (-20 to 60°C)
Temperature Probe .....	-40 to 250°F (-40 to 121°C)
Liquid Media .....	32 to 180°F (0 to 82°C)
<b>Resolution</b>	
Pressure (best) .....	0.001 psi (0.01 kPa) (0.01 in. Hg)
Flow (best) .....	0.0001 USGPM (0.00001 l/s)
Temperature .....	0.1°F (0.1°C)
<b>Accuracy</b>	
Pressure <sup>2</sup> .....	±1% of reading +.072 psi (0.5 kPa) (0.15 in.Hg)
Flow .....	per pressure accuracy + valve deviation
Temperature .....	±0.5% of reading +1.2°F (0.7°C)
<b>Units</b>	
Pressure .....	psi, in. H <sub>2</sub> O, ft H <sub>2</sub> O, kPa, mm Hg, in. Hg, m H <sub>2</sub> O, bar
Flow .....	USGPM, UKGPM, m <sup>3</sup> /h, l/s, l/m
Temperature .....	degrees F, degrees C
<b>Statistics</b> .....	min, max, average, sum up to 4000 readings
<b>Data Storage</b> .....	100 Test IDs, 4000 combined readings, time and date stamped
<b>Logging Interval</b> .....	user selectable (1 to 3600 seconds)
<b>Time Constant</b> .....	user selectable (1, 5 10, 20, and 30 seconds)
<b>Display</b> .....	LCD with backlight
<b>Dimensions</b> (meter only) .....	11.1 in. x 4.7 in. x 3.5 in. (28.2 cm x 11.9 cm x 8.8 cm)
<b>Pressure Connection</b> .....	¼" 37° Flare Fitting, Male
<b>Weight with Batteries</b> .....	2.65 lb. (1.20 kg)

<b>Power Requirements</b> .....	four AA-size cells, alkaline or rechargeable NiMH (included), or AC adapter (included) 9 VDC, 2 A, regulated
<b>Battery Life</b> <sup>3</sup> .....	minimum of 12 hours with backlight on minimum of 18 hours with backlight off
<b>Recharge Time</b> .....	4 hours (internal charger)
<b>Warranty</b> .....	2-year factory warranty

<sup>1</sup>The flow reading is a calculated value determined from the measured Differential pressure, user entered valve flow coefficient (Cv or Kv), and fluid specific gravity.

<sup>2</sup>Accuracy statement applies from -15 to 250 psi (-103 to 1724 kPa).

<sup>3</sup>The minimum battery life stated will occur after the NiMH batteries have been recharged 2 to 3 times after initial charge.

# APPENDIX B

## Compliance

<b>CE Marking</b>	EN61326 / EN 55011, Class B: Radiated Emissions EN61326 / EN 55011, Class B: Conducted Emissions EN61000-4-2: Electrostatic Discharge Immunity EN61000-4-3: Electromagnetic Field Immunity EN61000-4-4: Burst Immunity EN61000-4-5: Surge Immunity EN61000-4-6: Conducted PS Immunity EN61000-4-8: Rated Power-Frequency Field Immunity EN61000-4-11: Voltage Dips\Short Interruptions Immunity
<b>RoHS Marking</b>	Yes

*(This page intentionally left blank)*





**TSI Incorporated** – Visit our website [www.tsi.com](http://www.tsi.com) for more information.

<b>USA</b>	<b>Tel:</b> +1 800 874 2811	<b>India</b>	<b>Tel:</b> +91 80 67877200
<b>UK</b>	<b>Tel:</b> +44 149 4 459200	<b>China</b>	<b>Tel:</b> +86 10 8219 7688
<b>France</b>	<b>Tel:</b> +33 1 41 19 21 99	<b>Singapore</b>	<b>Tel:</b> +65 6595 6388
<b>Germany</b>	<b>Tel:</b> +49 241 523030		

P/N 6006820 Rev F

©2022 TSI Incorporated

Printed in U.S.A.

