

High Speed Programmable Microohmmeter MODEL 1750



Instruction Manual

PN# 1750-840
Publication Date: July 2011
REV. M

NOTE: This User's Manual was as current as possible when this product was manufactured. However, products are constantly being updated and improved. To ensure you have the latest documentation, refer to www.tegam.com.

TABLE OF CONTENTS

1 INSTRUMENT DESCRIPTION

- Instrument Description 1-1
- Feature Overview 1-1
- Accessories Sheet 1-4
- Performance Specifications 1-5
 - Accuracy 1-6
 - Measurement Times 1-7
- Reference Current Modes 1-9
- Miscellaneous Specifications 1-10
- Test Lead Requirements 1-12
- Broken Lead Detection 1-14

2 PREPARATION FOR USE

- Unpacking & Inspection 2-1
- Safety Information & Precautions 2-1
 - Terms in this Manual 2-1
 - Terms as Marked on Equipment 2-1
 - Symbols 2-2
 - Grounding the Equipment 2-2
 - Danger Arising from the Loss of Ground 2-2
 - Use the Proper Fuse 2-2
 - Do not Use in Explosive Environments 2-2
 - Do not Operate without Covers 2-3
 - Preventive Maintenance 2-3
 - Line Voltage Selection 2-4

3 QUICK START INSTRUCTIONS

- General 3-1
- Power the Unit 3-1
- Factory Settings 3-1
- Customizing Parameter Settings 3-2
- Test Lead Requirements 3-2
- Measuring Resistances Greater than 200kΩ 3-2

4 OPERATING INSTRUCTIONS

- Basic Operation 4-1
- Default Parameters 4-1
- Front Panel Description 4-2
- Rear Panel Description 4-3
- Display Modes 4-4
 - Resistance Mode 4-5
 - Figure 4.5 Over Range or Open Lead Condition 4-5
 - Open Lead Detection 4-5
 - Reading Hold 4-6
 - Absolute Comparator Mode 4-7
 - % Comparator Mode 4-8
- Navigating the Menus 4-9
 - Keypad Functionality 4-9
 - Figure 4.8 Menu 4-9
- Ranges 4-10

TABLE OF CONTENTS (continued)

- Trigger Modes..... 4-11
- Delay Time..... 4-11
- Display Mode..... 4-12
- Absolute Comparator Limits..... 4-12
- % Compare Limits..... 4-13
- Communication Interface..... 4-13
- Store Setup..... 4-14
- Recall Setup..... 4-14
- Line Frequency..... 4-14
- PIN Function..... 4-15
- Calibration..... 4-15
- Auto Correct..... 4-15
- The PIN Function..... 4-16
 - Enabling or Disabling the PIN Function..... 4-16
 - Changing a PIN Number..... 4-16
 - Disabling an Unknown PIN..... 4-16

5 PROGRAMMING & INTERFACING

- Interfacing to the 1750..... 5-1
- Front Panel..... 5-1
 - Figure 5.1 Lemo Connector..... 5-1
- Rear Panel..... 5-2
 - Trigger Input Connector..... 5-2
 - Trigger Out Connector..... 5-3
 - Using the Trigger Outputs..... 5-4
- Connector J8..... 5-5
- RS232 Communication..... 5-8
 - RS232 Settings..... 5-8
 - RS232 Interface Command Summary..... 5-9
 - RS232 Device Dependent Commands Supplementary Information..... 5-11
 - Table 5.4 –RS232 Status Command Summary..... 5-12
 - RS232 Hierarchy of Commands..... 5-13
- Power Up and Device Clear Defaults..... 5-13
 - Reading Via RS232 Interface..... 5-14
- IEEE-488.1 / GPIB Operation..... 5-15
 - GPIB Command Summary..... 5-16
 - GPIB Device Dependent Commands Supplementary Information..... 5-18
 - Serial Polling..... 5-19
 - Self Test..... 5-21
 - Hierarchy of GPIB Commands..... 5-21
 - Power Up and Device Clear Defaults..... 5-23
 - Reading from the IEEE-488 Bus..... 5-23
 - Sample Programs..... 5-24

6 SERVICE INFORMATION

- Cleaning..... 6-1
- Calibration Procedure..... 6-1
 - Calibration Verification Procedure..... 6-3
 - Performance Verification Procedure..... 6-4
- Internal Jumpers..... 6-5

TABLE OF CONTENTS (continued)

Calibration Enable Jumper	6-5
RS232/RS422 Configuration Jumper	6-5
Figure 6.1 Internal Jumpers.....	6-5
Repair Parts.....	6-6
Instructions for Fuse Replacement.....	6-6
Figure 6.2 Fuse and Filter Assemblies	6-6
Troubleshooting	6-7
No Display.....	6-7
Reading Drifts.....	6-7
Unstable Reading	6-7
Preparation for Repair or Calibration Service.....	6-8
Expedite Repair and Calibration Form	6-9
Warranty.....	6-10
Warranty Limitations	6-10
Statement of Calibration	6-10
Contact Information	6-10
Appendix A (for 1750/BAT)	
Instrument Description	A-1
Performance Specifications	A-2
Battery Removal/Replacement	A-4

SECTION 1

INSTRUMENT DESCRIPTION

The Model 1750 is a highly versatile, precision digital Microohmmeter designed to provide unmatched measurement speed and accuracy for production test and quality control applications up to 23 M Ω . The 1750 microohmmeter automatically rejects thermal and electromagnetic line noise to provide error free measurements for micro Ohm measurements down to 100 n Ω resolution. The 1750 also incorporates a single command set to make integration easy for IEEE-488, RS-422 and RS-232 applications.

FEATURE OVERVIEW

The 1750 microohmmeter is designed as a complete bundled solution for a wide variety of resistance measurement applications. Listed below are some of the features.

.02% Basic Accuracy with 4½ digit resolution

The 1750 microohmmeter is designed to perform resistance measurements with a .02% basic accuracy. The 4½ digit display produces readings from 100 n Ω resolution to 23 M Ω maximum resistance values.

Bipolar Test Signal Eliminates Thermal EMF errors

The unit is designed to eliminate junction EMFs by introducing a bipolar test signal, which when combined with digital signal processing, produce an accurate resistance measurement minus thermal offset errors.

Closed Box Calibration

Full digital calibration is performed within minutes without having to make any internal adjustments. A calibration enable/disable jumper is accessible by removing the top panel. All adjustments are made digitally.

Programmable Delay Mode

Settling times are programmable from 1-250 ms to allow measurements of devices with extended time constants.

Continuous and One-Shot Triggering

The 1750 microohmmeter provides two user-selectable, trigger modes, One-Shot and Continuous for greater flexibility and optimization of test processes.

Selectable Reference Currents from 100 nA – 1 A

For power sensitive applications such as fuses and resistors, multiple test current selections are available.

Percent or Absolute Comparator with HI-GO-LO contact and TTL outputs

The 1750 microohmmeter design makes it easy to integrate into new or existing designs. There are three comparator outputs which double as output bins 1, 2, and 3. The 1750 interface includes relay and TTL outputs for comparator and bin functions.

Rear Panel TTL & Relay outputs for PLCs and interfacing

In addition to GPIB and RS232 interfaces, the 1750 provides a variety of TTL and relay contact I/O's designed to make integrating the 1750 into a test stand as versatile as possible.

1 year calibration cycle (after initial 6-month calibration)

After the initial 6 month calibration, the recommended calibration interval for the 1750 is every twelve months.

10 Preset Storage Locations

Storage location 0 is reserved for recalling factory default settings. Locations 1-9 are user definable and may be programmed manually or via communication interfaces. These settings are stored in non-volatile RAM locations.

Fast Mode for high-speed measurement

Fast Modes allow speedy measurements of up to 100 reading per second. The time to first reading is approximately 12 ms, faster than any other Ohmmeter in the market. This is obtained by using a patent pending DSP technique developed by TEGAM.

½ Rack Width

Two 1750 microohmmeter units are able to be rack mounted, side-by-side, in a standard 19" rack without modification to the 1750 case.

Manual or Auto Ranging

User defined ranging allows AUTO range or 19 user-selectable ranges of resistance and test current. All ranges have a 15% over-ranging capability.

Auto- Correct Function

The auto- correct function compensates for time or temperature drift by reading high accuracy internal references and automatically calculating correction coefficients for all ranges. During this software correction process, the 1750 will delay one reading for 50 ms. The auto correct routine is performed at power up, after 30 seconds of operation, after 30 minutes of operation, and after every 65,536 “delayed trigger” readings, (approximately 2 hours).

High Noise Immunity

Built in line cycle integration in combination with shielded test leads produce exceptional noise rejection.

GPIB, RS232, or RS-422 Communication Interfaces

Standard GPIB, RS232, or RS422 user-selectable interfaces are standard communications for all 1750 units. A simple command sets ease the task of integration while the use of device dependent commands allows for specialized function execution.

ACCESSORIES SHEET



17501- Kelvin Klip™ Leads

Provides a solid four-terminal connection to components under test. These clips are particularly useful for manual resistance measurement.
Cable length – 3 ft.



17502- Spade Lug Adapter

Used for connections between the 1750 front panel LEMO and existing test fixtures.
Cable length – 3 ft.



KK100- Kelvin Klip™ Rebuild Kit

Kelvin Klip™ replacements for construction or repair of Kelvin Klip leads.



17505 - Male LEMO Connector & Strain Relief

For the repair or construction of 1750 test leads.



17503-Sorting Fixture

This sorting fixture allows for efficient four-wire measurement of leaded parts. The test fixture features spring action contacts for easy insertion and removal of test components.
Cable length – 3 ft.



GPIB (IEEE-488) Cables

- 1583-3** – 1-meter GPIB buss cable
- 1583-6** – 2-meter GPIB buss cable
- 1583-9** – 3-meter GPIB buss cable



CBL-3102-BNC-BNC Cable

BNC to BNC, RG 58/U, coaxial cable for use at the trigger inputs and outputs of the 1750. Cable length is a minimum of 1 meter (3.28 ft) long.



17504 – Kelvin Probes

These probes are excellent for making four-wire surface resistance measurements on films and other flat metallic surfaces. Each probe has two spring-loaded, replaceable tips that are easily removed and replaced.
Cable length – 3 ft.



CA-22-36 – RS-232 Straight Cable 9 pin

Male to Female DB9 straight cable used to connect the 1750 to a PC via RS-232.
Cable length – 3 ft.

PERFORMANCE SPECIFICATIONS

The advertised specifications of the model 1750 are valid under the following conditions:

1. The instrument must be calibrated using the methods and intervals as described in the calibration section of this user's manual.
2. The instrument must be in an environment, which does not exceed the limitations as defined under "Environmental" in the Miscellaneous Specifications in Section 1.
3. The unit is allowed to warm up for a period of at least 30 minutes before measurements are taken. A warm-up period of 60 minutes is recommended after exposure to or storage in a high humidity, (non-condensing), environment.
4. The Kelvin series lead resistances must not exceed the limitations as defined in Table 1.1 or Table 1.7.

Table 1.1 below is a summary of the ranges and resistances available with the model 1750. It also shows the full-scale voltage for each of the reference current ranges. The default ranges are printed in **BOLD**. Absolute maximum lead resistances for each of the reference current ranges are included on the bottom row. If these absolute maximum lead resistances are exceeded then significant error will be introduced into the measurement.

RANGE	RESOLUTION	REFERENCE CURRENT							
		1 A	100 mA	10 mA	1 mA	100 μ A	10 μ A	1 μ A	100 nA
2 m Ω	100 n Ω	2 mV							
20 m Ω	1 $\mu\Omega$	20 mV	2 mV						
200 m Ω	10 $\mu\Omega$	200 mV	20 mV						
2 Ω	100 $\mu\Omega$		200 mV	20 mV					
20 Ω	1 m Ω			200 mV	20 mV				
200 Ω	10 m Ω			2 V	200 mV	20 mV			
2 k Ω	100 m Ω				2 V	200 mV			
20 k Ω	1 Ω					2 V	200 mV		
200 k Ω	10 Ω						2 V		
2 M Ω	100 Ω							2 V	
20 M Ω	1 k Ω								2 V
Max. Lead Resistance		500 m Ω	5 Ω	50 Ω	100 Ω	100 Ω	100 Ω	100 Ω	100 Ω

Table 1.1: Full Scale Voltage as a Function of Reference Current

Table 1.2 summarizes the accuracy specifications for the model 1750, in the delayed mode.

RANGE	REFERENCE CURRENT							
	1 A	100 mA	10 mA	1 mA	100 μ A	10 μ A	1 μ A	100 nA
2 m Ω	.02%+5ct							
20 m Ω	.02%+4ct	.02%+5ct						
200 m Ω	.02%+2ct	.02%+4ct						
2 Ω		.02%+2ct	.02%+4ct					
20 Ω			.02%+2ct	.02%+4ct				
200 Ω			.02%+2ct	.02%+2ct	.02%+4ct			
2 k Ω				.02%+2ct	.02%+2ct			
20 k Ω					.02%+2ct	.02%+2ct		
200 k Ω						.02%+2ct		
2 M Ω							.04%+2ct	
20 M Ω								.04%+2ct

Table 1.2: Delayed Mode Accuracies with Respect to Reference Current
 (\pm) ACCURACY; 18-28 $^{\circ}$ C (64.4-82.4 $^{\circ}$ F); 1 YEAR (after initial 6 month cycle).

In the fast mode, the published accuracy for all reference current ranges is +/- (0.05% + 5 counts). These accuracies are displayed in Table 1.3. Fast Mode is not available for all ranges. If the unit is in Fast Mode and a range is selected that Fast Mode is not available, then the instrument will default to Delayed mode.

RANGE	REFERENCE CURRENT							
	1 A	100 mA	10 mA	1 mA	100 μ A	10 μ A	1 μ A	100 nA
2 m Ω	NA							
20 m Ω	NA	NA						
200 m Ω	.05%+5ct	NA						
2 Ω		.05%+5ct	NA					
20 Ω			.05%+5ct	NA				
200 Ω			.05%+5ct	.05%+5ct	NA			
2 k Ω				.05%+5ct	.05%+5ct			
20 k Ω					.05%+5ct	NA		
200 k Ω						NA		
2 M Ω							NA	
20 M Ω								NA

Table 1.3: Fast Mode Accuracy with Respect to Reference Current

RANGE	REFERENCE CURRENT							
	1 A	100 mA	10 mA	1 mA	100 μ A	10 μ A	1 μ A	100 nA
2 m Ω	.004%rdg +1 count							
20 m Ω	.004%rdg +5 counts	.004%rdg +1 count						
200 m Ω	.002%rdg +1 counts	.004%rdg +5 counts						
2 Ω		.002%rdg +1 counts	.004%rdg +5 counts					
20 Ω			.002%rdg +1 counts	.004%rdg +5 counts				
200 Ω			.002%rdg +1 counts	.002%rdg +1 counts	.004%rdg +5 counts			
2 k Ω				.002%rdg +1 counts	.002%rdg +1 count			
20 k Ω					.002%rdg +1 count	.002%rdg +1 counts		
200 k Ω						.002%rdg +1 counts		
2 M Ω							.008%rdg +5 counts	
20 M Ω								.008%rdg +5 counts

Table 1.4: Table of Temperature Coefficients
 +/- Temperature Coefficient / $^{\circ}$ C
 (0-18 $^{\circ}$ C & 28-50 $^{\circ}$ C; 32-64.4 $^{\circ}$ F & 82.4-122 $^{\circ}$ F)

	MEASUREMENT TIMES	READING RATE	TIME TO FIRST READING
FAST MODE	10ms	100 Readings/s	12 ms
DELAYED MODE			
DELAY=1 ms	36 ms	27 RDG/s	38 ms
DELAY=5 ms	45 ms	22 RDG/s	47 ms
DELAY=10 ms	55 ms	18 RDG/s	57 ms

Table 1.5: Measurement Times

Table 1.5 provides approximations of measurement times and reading rates for delayed and fast modes. Note that the time to first reading is longer than subsequent readings. Examples are provided for various delay settings. The Delayed Mode Measurement Time is calculated by the following equation:

$$\text{Delayed Mode Measurement} = 2 \times (\text{Line Period} + \text{Programmed Delay} + \text{Process Time})$$

Where the Line Period is $1/f$, $f = (50 \text{ or } 60 \text{ Hz})$ and the Programmed Delay Time may range from 1mS to 250 ms. The Process Time is the time required to process the read data and is equal to about 1.9 ms.

RANGE	REFERENCE CURRENT							
	1 A	100 mA	10 mA	1 mA	100 μ A	10 μ A	1 μ A	100 nA
2 m Ω	D							
20 m Ω	D	D						
200 m Ω	D, F	D						
2 Ω		D, F	D					
20 Ω			D, F	D				
200 Ω			D, F	D, F	D			
2 k Ω				D, F	D, F			
20 k Ω					D, F	D		
200 k Ω						D		
2 M Ω							D	
20 M Ω								D

Table 1.6: Table of Trigger Modes

In Table 1.6, the availability of Fast, (F), or Delayed, (D), Mode Triggering is illustrated. Delayed mode is available for each of the 19 resistance / reference current ranges. The Fast Triggering mode is limited to 8 of the ranges.

REFERENCE CURRENT MODES

There are several types of pulses available for making measurements. Below is a summary of characteristics for each type of trigger mode and the sequence of events that occur during an actual measurement.

Fast Continuous:

Readings are taken towards the end of each +REF/ 0A state. The test signal is an alternating reference current from + REF to 0A, with automatic thermal and noise rejection.

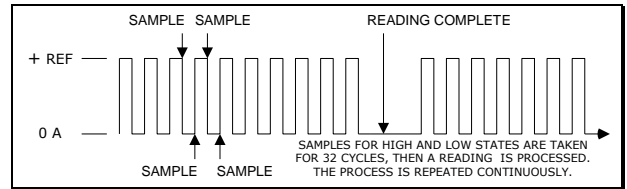

Fast One-Shot:

This mode must receive an external trigger and is a shortened version of the Fast Continuous mode. A total of 64 data samples are taken. 32 samples on + cycles and 32 samples on the 0 Ampere cycles. These samples are digitally processed to produce reading

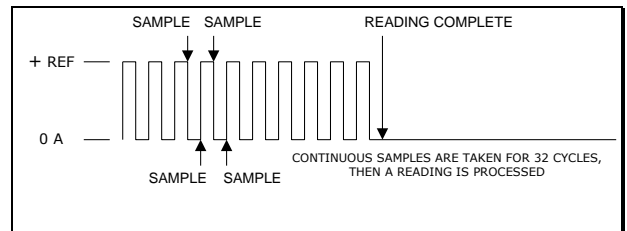

Delayed Continuous:

Continuous Alternating reference current from + REF to - REF. "A" represents the programmable delay time from 1 to 250 mS. "B" represents the line cycle time - 1/f (Sampled Input for Line Cycle Integration) "C" is the time required for broken lead detection to take place "D" is when the reading is processed and updated.

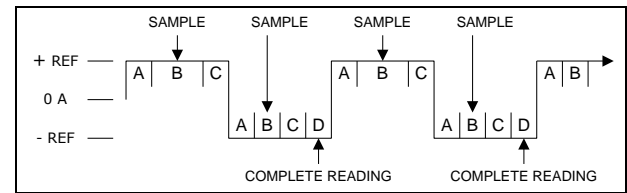

Delayed One-Shot

Alternating reference current from + REF to - REF. Triggering via GPIB, RS232 or rear trigger input will cause a single cycle of reference current.

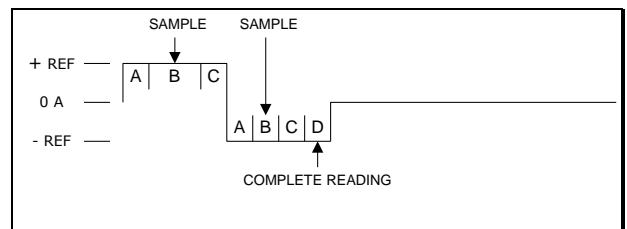

Delayed One-Shot

(Triggered Via Front Panel)

Alternating reference current from + REF to - REF. Triggering via the front panel. Once triggered, two reference cycles are released of which the latter pulse will be used to take the actual reading.

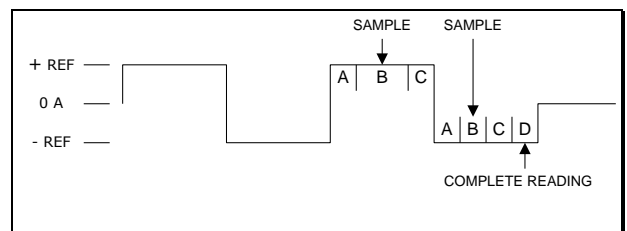

MISCELLANEOUS SPECIFICATIONS

Display Modes:

- Resistance; Absolute Comparator; % Comparator

Digital Interfaces:

- IEEE-488
- RS-232
- RS-422
- External Trigger Input, and Reading Done TTL Outputs. - BNC Connectors

Display:

- 4½ Digit alpha numeric readout; 2 X 16 Characters, Dot Matrix Display with backlight

Measurement Method:

- 4 terminal Kelvin connection to DUT.

Input Connector:

- Heavy Duty Type LEMO Connector for signal integrity and long life.

Input Protection:

- ± 15 V Continuous. ESD Protected Per IEC-801-2, Level 1.
- Maximum Common Mode Input Voltage is 42 V peak.

Overload Current:

- Delayed Mode: 100% Overshoot, <25 μ s
- Fast Mode: 200% Overshoot, < 30 μ s

Noise Rejection:

- 60 dB Typical at Line Frequency

Maximum Open Circuit Compliance Voltage, (Typical):

Closed circuit compliance voltages are much lower; see Table 1.1, Full Scale Voltage as a Function of Reference Current

- 18 Vp-p maximum (1 mA-1 A Test Current)
- 14 Vp-p maximum (100 nA-100 μ A Test Current)

*Environmental:

- Operating Temperature from 0 to 50 °C (32 to 122 °F), <80% RH; (Non-Condensing)
- Storage Temperature -35 to 60 °C (-31 to 140 °F), 90% RH (Non-Condensing)

EMC:

- CE Class A; EN 55011, IEC 801-2, IEC 801-3

MISCELLANEOUS SPECIFICATIONS (Continued)**1750 Dimensions:**

- Depth: 13.0" (33.0 cm)
- Width: 8.50" (21.6 cm)
- Height: 5.20" (13.2 cm)

Weight:

- 9.25 lbs (4.20 kg)

Rear Interface Relay Contact Specifications:

The relay contact I/Os are rated at 125 VAC @ 500 mA or 30 VDC @ 1 A.

Calibration:

Calibration of the 1750 is permitted via the front panel with no internal adjustments. Calibration requires the temporary placement of a jumper, P9 to the J9 position.

***AC Power Requirements:**

Input: <100 VA, 120/240 VAC \pm 10% and from 50/60 Hz.

***Fuse:**

- For 120 V Operation; use 0.8 A @ 250 V, 5X20 mm, fast acting, TEGAM PN#FU-800
- For 240 V Operation; use 0.5 A @ 250 V, 5X20 mm, fast acting, TEGAM PN#FU-500

Please see Appendix A for additional specifications that apply to the 1750/BAT unit.

***These specifications for the model 1750/BAT differ from the standard model 1750.**

TEST LEAD REQUIREMENTS

From the factory, the 1750 microohmmeter is equipped with the choice of either 17501 Kelvin Klips or 17502 Kelvin Spade Lugs. These are both 4-wire Kelvin input cables. Four-wire Kelvin-type cables must be used with the 1750 in order to obtain an accurate resistance measurement.

The Kelvin measurement technique allows for a much more accurate reading over the two wire method. This is because it eliminates lead resistance. This is done by designating two of the four conductors as source leads. These source leads provide the precision test current that will be referenced in making the resistance measurement. Since current is the same throughout a series circuit, the lead resistance of the test leads will not have any effect on the reference current.

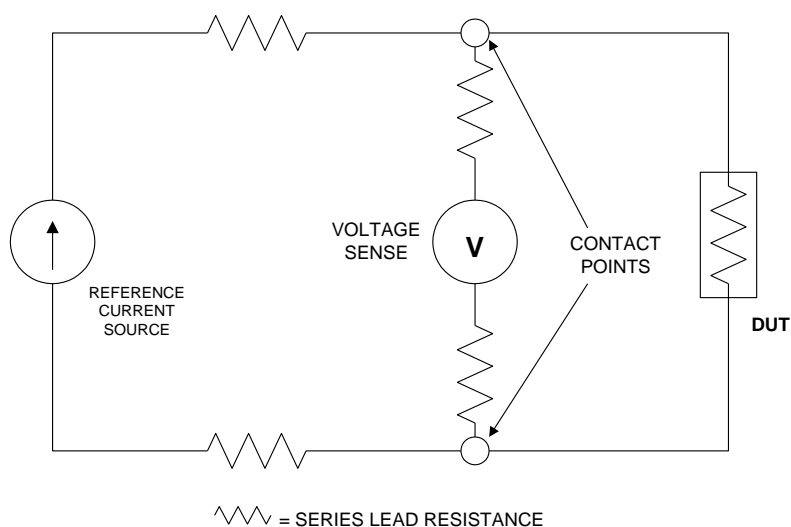

Figure 1.1: Electrical Representation of a typical Four-Wire Kelvin Measurement

The other two conductors are designated as voltage sense leads. These leads originate from high impedance, volt measurement circuit. When these leads are terminated at the points of contact, an exact resistance reading may be calculated by the 1750 microprocessor. The series lead resistance of the voltage sense leads is negligible with respect to the high impedance of the voltage measurement circuitry within the 1750 microohmmeter.

Four-wire Kelvin measurements are mainly used for low resistance measurements where lead resistance errors must be eliminated.

Even though the four-wire Kelvin measurement minimizes the effect that lead resistance has on the overall measurement, there is a maximum allowable lead resistance. If this value is exceeded, then the resulting measurement will be erroneous. The test current source dictates this limitation and lead resistance limits are based on the amount of reference current that is flowing. The table below summarizes these limitations.

REFERENCE CURRENT	1 A	100 mA	10 mA	1 mA	100 μ A	10 μ A	1 μ A	100 nA
MAXIMUM LEAD RESISTANCE	500 m Ω	5 Ω	50 Ω	100 Ω	100 Ω	100 Ω	100 Ω	100 Ω

Table 1.7: Maximum Allowable Lead Resistance (per lead).

To assure measurement accuracy, the above lead resistance limits should not be exceeded.

In order to make accurate measurements on resistances greater than 200 k Ω , it is highly recommended that the GROUND terminal, located on the rear panel, be connected to the DUT test fixture shield. The test fixture shield must surround the DUT.

Also, for resistance measurements greater than 200 k Ω , the programmable delay time should be set to a minimum of 100 ms to allow adequate settling of the reference current.

BROKEN LEAD DETECTION

A broken lead detection feature is enabled for ranges below 200 Ω when operating in either of the two Delayed trigger modes. This feature is a function of the firmware and detects an open circuit by monitoring the test current characteristics. The illustration below represents the Kelvin leads and the connection across a device under test. Note that there are three loops drawn with the arrows. Each of these arrows shows the continuity test that is effectively performed by firmware during each read cycle. If either the negative Kelvin loop, Positive Kelvin loop, or connection between the leads is broken, then a broken lead state will be detected and the message “*****” is displayed on the LCD.

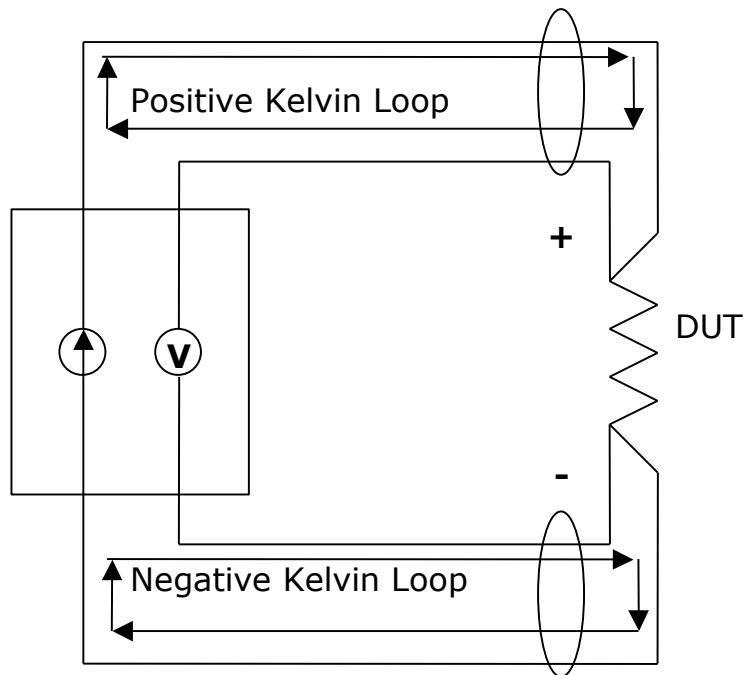

Fig 1.2: Continuity Test Paths for Broken Lead Detection

SECTION 2

PREPARATION FOR USE

UNPACKING & INSPECTION

Each 1750 microohmmeter is put through a series of electrical and mechanical inspections before shipment to the customer. Upon receipt of your instrument unpack all of the items from the shipping carton and inspect for any damage that may have occurred during transit. Report any damaged items to the shipping agent. Retain and use the original packing material for reshipment if necessary.

Upon Receipt, inspect the carton for the following items:

Model 1750 Precision Microohmmeter

Model 1750 User's Manual

Either one of the following: 17501 Kelvin Klips™ or 17502 Spade Lug Adapter



SAFETY INFORMATION & PRECAUTIONS

The following safety information applies to both operation and service personnel. Safety precautions and warnings may be found throughout this instruction manual and the equipment. These warnings may be in the form of a symbol or a written statement. Below is a summary of these precautions.

Terms in This Manual

CAUTION statements identify conditions or practices that could result in damage to the equipment or other property.

WARNING statements apply conditions or practices that could result in personal injury or loss of life.

Terms as Marked on Equipment

CAUTION indicates a personal injury hazard not immediately accessible as one reads the marking, or a hazard to property including the equipment itself.

DANGER indicates a personal injury hazard immediately accessible as one reads the marking.

**SAFETY INFORMATION & PRECAUTIONS** (Continued)**Symbols**

As Marked in This Manual:



This symbol denotes where precautionary information may be found.

As Marked on Equipment:



Attention – Please refer to the instruction manual.

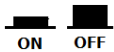

Power ON/OFF switch



Danger – High or hazardous Voltage



Earth Ground Terminal

Grounding the Equipment

This product is grounded through the grounding conductor of the power cord. To avoid electrical shock or other potential safety hazards, plug the power cord into a properly wired receptacle before using this instrument. The proper grounding of this instrument is essential for safety and optimizing instrument operation.

Danger Arising from Loss of Ground

If the connection to ground is lost or compromised, a floating potential could develop in the instrument. Under these conditions all accessible parts, including insulating parts such as keypads and buttons could develop a hazardous voltage and put the user at risk.

Use the Proper Fuse

To avoid fire hazard, use only the correct fuse type as specified for the AC power supply in the "Miscellaneous Specifications" or "Repair Parts" sections of this manual.

Refer fuse replacement to qualified service personnel.

Do Not Use in Explosive Environments

The 1750 microohmmeter is not designed for operation in explosive environments.

Do not Operate without Covers

This device should be operated with all panels and covers in place. Operation with missing panels or covers could result in personal injury.

Preventive Maintenance

Preventive maintenance performed on a regular basis will improve the reliability of this instrument. It may include cleaning (please refer to Section 6), visual inspection, or even monitoring the operating environment.

FOR QUALIFIED SERVICE PERSONNEL ONLY**SERVICING SAFETY SUMMARY****Do Not Service Alone**

Do not perform service or adjustment on this product unless another person capable of rendering first aid is present. Installation and maintenance procedures described in this manual are to be performed by qualified service personnel only.

Use Care When Servicing with Power On

Dangerous voltages may exist at several points in this product. To avoid personal injury or damage to this equipment, avoid touching exposed connections or components while the power is on. Assure that the power is off when removing panels, soldering, or replacing components.

Power Source

This product is intended to connect to a power source that will not apply more than 250 V_{RMS} between the supply conductors or between either supply conductor and ground. A protective ground connection by way of the grounding conductor in the power cord is essential for safe operation.



LINE VOLTAGE SELECTION

CAUTION: DO NOT APPLY POWER TO THE INSTRUMENT BEFORE READING THIS SECTION:

Unless otherwise specified, the Model 1750 microohmmeter is delivered from TEGAM with its power supply set for 120 V, 60 Hz operation. However, the 1750 design allows it to operate under 120/240 V @ 50/60 Hz operation. It is recommended that the line voltage, frequency setting and fuse type be verified before powering the unit.

The following procedure describes the steps necessary to change the 1750 power settings from factory default settings to 240 VAC @50 Hz.

1. Verify that there is no power connected to the unit. Remove the top cover.
2. Change the line selector switch on the power supply printed circuit board from 120 VAC to 240 VAC. The switch is located toward the rear panel of the 1750 on the top most PCB board. Refer to the figure below:
3. Replace the top cover and connect the 1750 to its power source. Power the unit by depressing the power switch located on the front panel.
4. Press the [MENU/CLEAR] key then press the 50/60 Hz key, (Key #1). Scroll the menu by pressing either the [▲] or [▼] keys. Once 50Hz is displayed on the LCD then press [ENTER]. The 1750 is now set for 240 VAC @ 50 Hz operation.

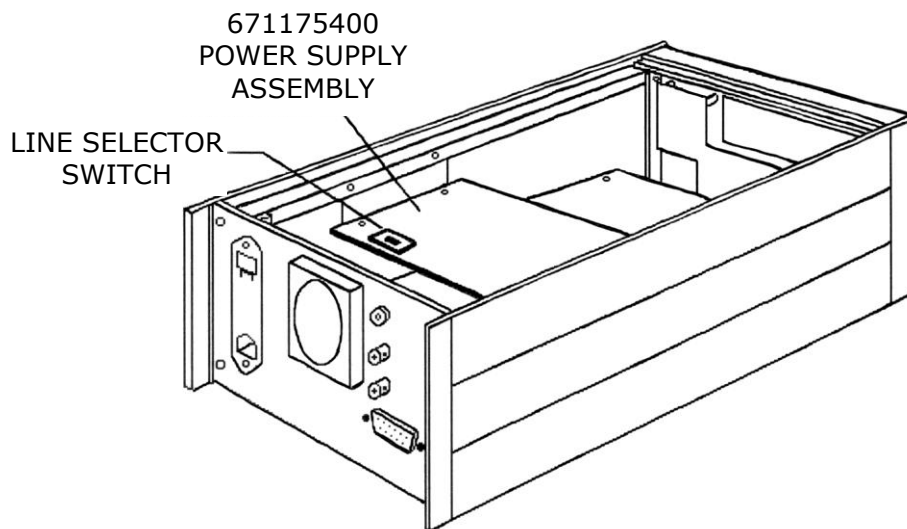

Fig 2.1: Line Voltage Selection Location

NOTE: The 1750 microohmmeter uses line cycle integration in order to prevent interference from affecting the instrument readings. For proper readings, the frequency setting of the instrument must match the line supply. You can change the frequency setting simply by following the instructions in step #4.

SECTION 3

QUICK START INSTRUCTIONS

GENERAL

The Model 1750 microohmmeter is a versatile product, which can be used in many different configurations. Depending on the application, there are configurations of the 1750 microohmmeter that will help optimize test conditions involving accuracy, measurement speed, and versatility. The best way to maximize the effectiveness of a product and test setup is by having a thorough understanding of the instrumentation and the test parameters, which can affect the readings.

The Quick Start section is designed to give the user a general instruction set for the speedy setup and measurement of resistance values. Whenever additional information is applicable, a reference will be made to other parts of this manual so that the user, at their discretion, can decide whether or not to pursue additional information.

POWER THE UNIT

The power supply of the Model 1750 is designed for 50-60 Hz operations and a voltage range of 108-132 & 216-264 VAC. Review the line voltage selection procedure on page 2-4 before proceeding.

Power the unit and allow at least 30 minutes for the unit to warm up. Make sure that the safety precautions on pages 2-2 and 2-3 have been reviewed and understood. Verify that the environmental conditions, listed on page 1-10 are met.

FACTORY SETTINGS

Before performing the actual resistance measurement, there are a number of test parameters, which must be defined. The factory settings can be used for most general resistance measurements.

The 1750 microohmmeter is shipped from the factory with instrument settings as follows: These settings can be recalled by sending a device clear command via RS232, RS422 or GPIB interface.

	Parameter	Setting		Parameter	Setting
1	Range	2 Ω @100 mA	8	Communication	*RS232
2	Trigger	Delay Continuous	9	Store Setup	-
3	Delay Time	111 ms	10	Recall Setup	-
4	Display Mode	Resistance	11	Line Frequency	60 Hertz
5	Compare Limits	19999; 00000	12	PIN Function	*Disabled
6	% Compare Limits	10.00%; 10.00%	13	Calibration	*Disabled
7	Nominal	10000			

* When a device clear command is sent via communications interface, this value does not change.

Table 3.1: Factory Default Settings

CUSTOMIZING PARAMETER SETTINGS

The 1750 factory settings are usually adequate to meet the needs of most manual, low inductance, resistance measurement applications. However, in high-speed, automated resistance measurement, it is often desirable to optimize the instruments settings to obtain the highest accuracy and throughput. For this reason, the Model 1750 offers 13 user-defined test parameters. In-depth information for any of these Setup options may be found in Section 4, Operating Instructions. Before changing any of these factory default settings, it is highly recommended that Section 4 is thoroughly reviewed and understood. Special attention should be directed toward allowing adequate settling times for high resistance measurement applications and defining the proper reference current in fuse testing applications.

The front keypad is setup for maximum functionality. Each key has multiple functions assigned to it. These functions are labeled according to their primary and secondary functions. To access the Setup options, simply press the [MENU] button on the front panel. The message " Menu Number?" will appear on the screen. From this display, you can access any of the 11 menu options labeled with teal text located below the key. Pressing any of these buttons will allow you to access the instrument's Sub-Menu for entering custom settings. You can modify instrument Sub-settings by either pressing the [▲] or [▼] scroll keys or by manually entering a numeric value.

See Section 4 for an in depth description of the keypad functionality and how to store and recall custom settings.

TEST LEAD REQUIREMENTS

The Model 1750 microohmmeter measures resistance by using the four-wire Kelvin technique. This type of measurement virtually eliminates lead resistance error. A set of Kelvin Klip™ leads or Spade Lug Adapters are supplied with the new instrument. In addition, optional sorting fixture or Kelvin Probes are available. These accessories are designed to function with the Model 1750 in all operating currents and ranges.

In certain applications, the need arises for a custom assembled test connection or fixture. When constructing a solution of this type, detail has to be directed towards the maximum allowable series lead resistance. There is a specific series lead resistance limit established for each current range. If these limits are exceeded, a significant amount of error may be introduced into the measurement. Detailed information on Kelvin-type measurements and lead resistance error may be found in Section 1 under the "Test Lead Requirements" section. See Table 1.7 for maximum allowable series lead resistances.

MEASURING RESISTANCES LARGER THAN 200KΩ

For stable resistance measurements on resistances greater than 200 kΩ, it is recommended that the GUARD terminal on the rear panel be connected to the DUT test fixture GROUND terminal. The actual resistance being measured should be shielded within a grounded test fixture.

If it is unknown whether the test circuit is inductive or capacitive in nature, the delay time should be set to a minimum of 100mS in order to allow adequate measurement settling time. This settling time should be increased as the measured resistance value is increased.

SECTION 4

OPERATING INSTRUCTIONS

BASIC OPERATION

The Model 1750 microohmmeter is a highly versatile product, designed for use in many different applications. There are ideal configurations of the 1750 microohmmeter for each type of application. These configurations optimize test conditions while enhancing accuracy, measurement speed, and versatility.

In order to maximize the effectiveness the 1750's operation the user should have a thorough understanding of the instruments operation.

This section is designed to give the user an in depth description of the numerous parameters and operating modes available from the Model 1750. The user will be exposed to additional topics that will enhance the integration of the Model 1750 into their application.

DEFAULT PARAMETERS

Each unit is delivered from the factory with predefined test parameters and modes. These predefined settings are intended for general-purpose resistance measurement and ease of use. Section 3, Quick Start Instructions, contains information on factory default settings.

FRONT PANEL DESCRIPTION

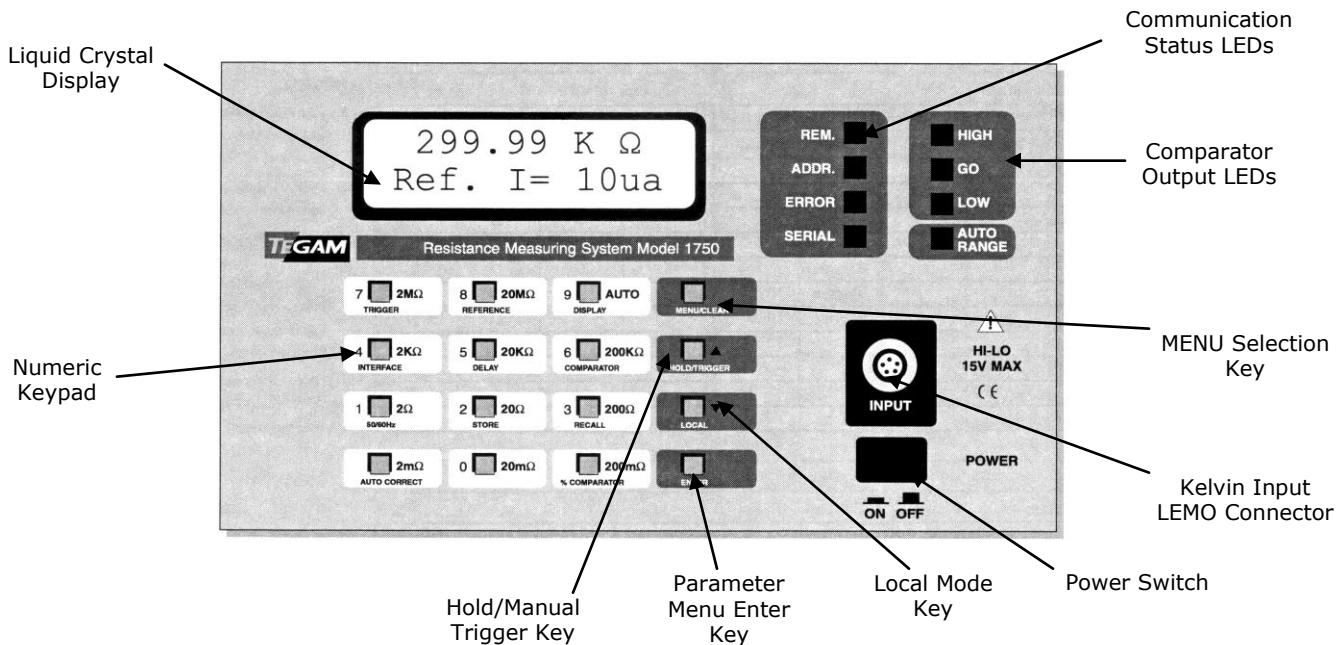

Figure 4.1: Front Panel Layout

Liquid Crystal Display - Indicates the resistance measurement, resistance range, comparator settings, communication type, and other operating conditions. See "Display Modes" in this Section for details of display operation.

Numeric Keypad - Numeric keypad includes 0-9 keys for entering values for menu items, delay times or comparator/bin limits.

Hold/Manual Trigger Key - This key allows the user to either HOLD the measurement when operating in Continuous Trigger Modes or to TRIGGER a reading in the One-Shot Modes. It also functions as the scroll up, [▲], key when the unit is in parameter mode.

Parameter Menu Enter Key - The [ENTER] key is used for inputting parameter settings for any of the menus or for storing numerical data.

Local Mode Key - Pressing this key permits the user to access front panel controls while the unit is operating in remote mode. The unit returns to remote mode from local mode after receiving a command from the GPIB or RS232 interface. The local key also functions as the scroll down, [▼], key when the menu mode is selected.

If the internal calibration jumper is enabled, pressing this button will switch the 1750 into debug mode. This feature is for factory use only.

Power Switch - Powers the 1750.

Kelvin Input LEMO Connector - Heavy Duty Input Connector for Kelvin Klips™, Spade Lug Adapter, Kelvin Probes or Test Fixture using 5 conductor, male LEMO.

Menu Scroll Keys - The scroll keys will allow the navigation of the Menu Screens by pressing either the [▲] or [▼] keys.

Menu Selection Key - Pressing this key will toggle the function of the numeric keypad for accessing and defining instrument parameters.

Comparator Output LEDs - LEDs indicate status of comparator after measurement cycle. LED status corresponds to comparator relay and TTL outputs on rear panel connector, J8.

Communication Status LEDs - Indicate the error and status of communications RS232, RS422 & GPIB.

REAR PANEL DESCRIPTION

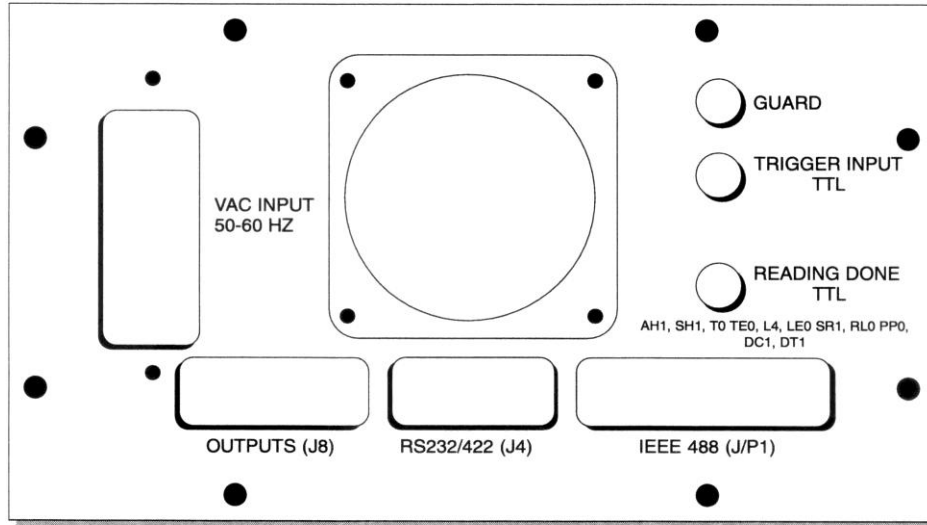

Figure 4.2: Rear Panel Layout

BNC Reading Done TTL Output – Open Collector TTL Output. Output is at +5V until a complete reading cycle has occurred. A negative going pulse occurs for about 4.25 ms then the output state returns to +5 V.

BNC Trigger TTL Input – A TTL low into this input will activate a trigger command. A trigger will also occur if the input is shorted to ground via relay or other contact for a minimum of 10 ms.

J8 – Relay and TTL I/O Connector – See Section 5, Interfacing to the PC for pin out details.

VAC Input – 120/240 V @ 50/60 Hz, power input. Line fuse is accessible through this input.

GPIO (IEE-488.2) Port - See Section 5, Interfacing to the PC for pin out details.

RS232 Port - See Section 5, Interfacing to the PC for pin out details.

RS422 Port - See Section 5, Interfacing to the PC for pin out details.

Guard Terminal – Banana connection to the 1750 test signal current source (common), typically used for reducing noise in high resistance, (>20 kΩ) measurements.

Cooling Fan – 20 CFM maximum airflow. Operation is 5 V @ 240 mA.

DISPLAY MODES

When the power key is depressed, AC power is applied to the 1750. During the power cycle, the 1750 operating system initiates and the display will show the product identification information. The 1750 digital software revisions appear below the product identification. This display will be visible for about two seconds and then the 1750 will resume operation under the same set-up parameters as when it was last turned off.

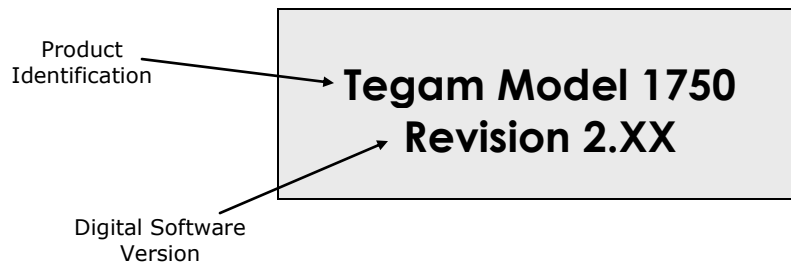

Figure 4.3: Initialization Display

After initialization, the 1750 microohmmeter will display one of three types of displays, Resistance, Absolute Comparator, or % Comparator. The particular display mode will be dependent upon the mode that the 1750 was operating in before the last power down. The following sections will describe each of the display modes and their respective display fields.

Resistance Mode

The 1750 factory default setting is the Resistance Mode. Below is a representation of the Resistance Mode display and a brief description of each of the display fields.

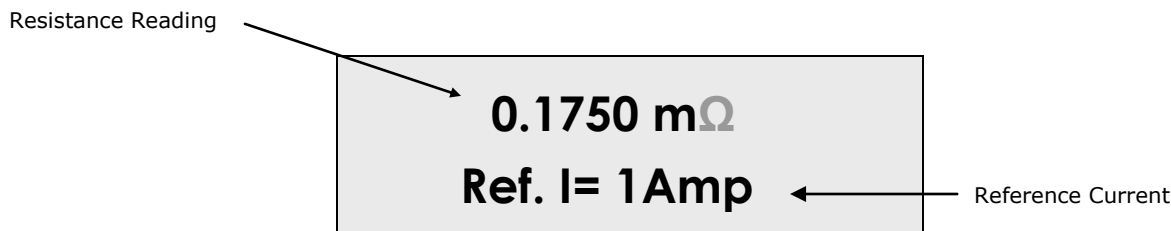

Figure 4.4: Resistance Mode

Resistance Reading

This field is reserved for display of the resistance measurement value or status. There are 4 ½ digits of resolution for all ranges of resistance and test currents. The reading is updated once every measurement cycle in the Continuous Trigger Mode. The actual cycle time of the continuous mode is dependent on whether the unit is in Delayed Continuous or Fast Continuous Mode. Refer to Section 1, for detailed timing diagrams and a formula for calculating total measurement times. When the 1750 is operating in the Delayed One-Shot or Fast One-Shot Mode, the resistance reading is updated one measurement cycle after a manual trigger is received. These actual measurement times may also be determined by referencing Section 1.

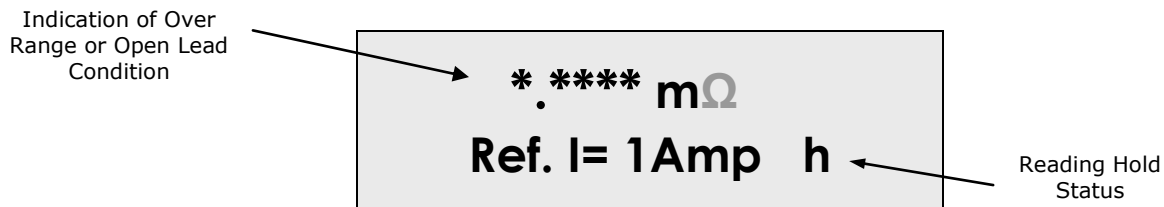

Figure 4.5: Over Range or Open Lead Condition

Open Lead Detection

The 1750 includes an Open Lead Detection feature, which is active in the 20 Ω, 2 Ω, 200 mΩ, 20 mΩ, and 2 mΩ ranges. It verifies the continuity of the test leads and contacts when the 1750 is operating in either of the two delayed trigger modes, (*Delayed Continuous or Delayed Trigger*). The Kelvin measurement technique requires that four wires be used in making a measurement. If any of these leads or a combination of these leads is open, then the instrument shall display “*.****”, which is the equivalent of an over range condition. For RS232 and GPIB operation, the unit will send a “2.9999” ASCII string, which is also the equivalent of an over range condition.

Reading Hold

When the [HOLD/TRIGGER] button is pressed, the most current reading may be latched and held on the LCD until the [HOLD/TRIGGER] button is pressed again. The status of the reading hold feature is indicated on the lower left hand corner of the LCD. An "h" indicates a hold condition. This feature is only functional in the Continuous Trigger Modes.

One Shot Trigger

When the 1750 microohmmeter is operated in the One-Shot Trigger Mode, an "S" will appear in place of the "h" in the LCD lower right hand corner. This symbol notates that the instrument is in the One Shot mode and requires external triggering from the front panel, communications interface or the BNC TTL trigger input on the rear panel.

Resistance Range and Reference Current

There are 19 possible resistance and reference current range combinations that the 1750 will operate under. The present reference current level is displayed on the bottom of the LCD. Once the user becomes more familiar with the display, the actual resistance and reference current combination can be determined by observing the placement of the decimal point on the reading and the indicated reference current level. When the 1750 is in *AUTO RANGE* mode, then the *AUTO RANGE* LED on the right hand side of the front panel will be illuminated.

Absolute Comparator Mode

In the Absolute Comparator Display Mode, the screen will look like the Resistance Display Mode except that the reference current indication is replaced by two additional fields of data. On the left side is the high limit, absolute value. On the right side is the absolute low, comparator limit.

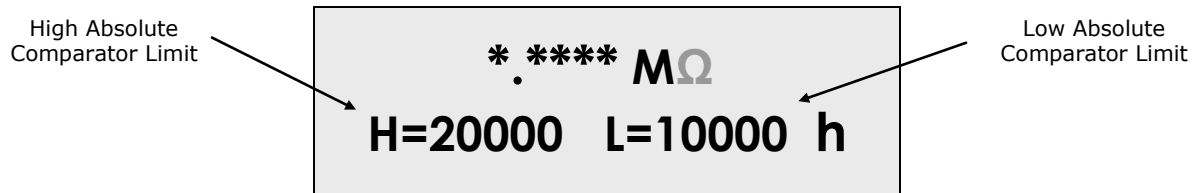

Figure 4.6: Absolute Comparator Mode

The above display indicates that the meter is in the 2 M Ω range. The high limit is set to 20,000 counts of full scale, which is 2 M Ω . The low limit is set to 10,000 counts, which is the equivalent to 1 M Ω in this scale. Note that the comparator limits are programmed in counts rather than Ohmic units. This means that the comparator resistance values are determined by both the active range and the user defined limit values.

High & Low Absolute Comparator Limit

Fields indicate the user-defined upper and lower limits for the absolute comparator function. If the measured resistance reading exceeds the high limit, and the comparator mode is active, then the corresponding "HI" state will transfer to the Comparator State LED. If the current reading falls on or between the HI and LO comparator limits, then the "GO" LED becomes illuminated. And finally, if the reading falls below the low limit then the "LO" comparator output is activated. The TTL and Relay comparator outputs in the rear panel follow the front panel comparator LED states. All comparator outputs are disabled when the 1750 is operating in the resistance mode.

% Comparator Mode

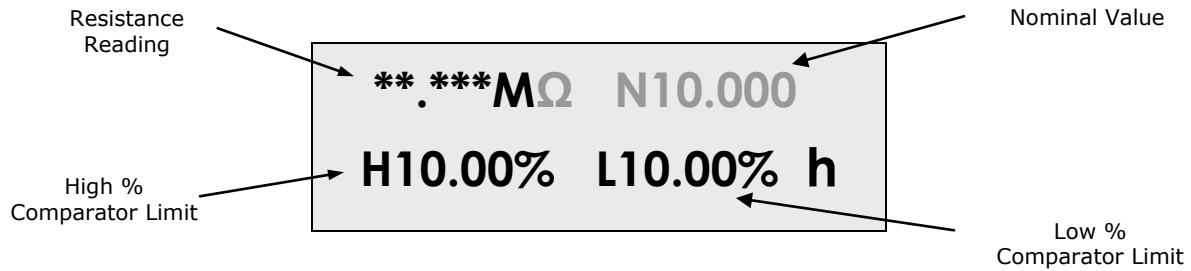

Figure 4.7: % Comparator Mode

High% & Low% Absolute Comparator Limit

The % Comparator Display Mode is similar to the Absolute Comparator Mode in that the user defines the upper and lower limits of the resistance measurement. However, these limits are defined in terms of a high and low percentage of a nominal value instead of an absolute value. The comparator state is indicated by the front panel LEDs and is transferred to the TTL and Relay outputs of the rear panel.

Nominal Resistance Value

In the upper right-hand corner of the display, the user-defined nominal value is displayed. High and low % comparator values are calculated by the 1750 from the user-defined nominal value. In the illustration above, the nominal value is set for 10 MΩ. The high limit is set for all readings above 11.0 MΩ, ($10 M + 1 M$) and the low limit is set for all readings below 9 MΩ ($10 M - 1 M$).

NAVIGATING THE MENUS

Keypad Functionality

Each button on the keypad has one primary function and up to two secondary functions. The table below summarizes the functions of each button on the front panel keypad. These buttons are highlighted in white on the 1750 front panel. Each key is labeled with its primary and secondary functions. The primary function of each button is a short cut to the instrument’s default resistance and reference current ranges. Secondary functions are enabled by pressing the [MENU] key. The 1750 secondary functions permit numeric data entry or the selection of instrument parameters.

Resistance Range Short Cut (Primary Function)	Numeric Function (Secondary Function)	MENU OPTION (Secondary Function)
2 mΩ @ 1A	-	AUTO CORRECT
20 mΩ @ 1A	-	PIN ACCESS
200 mΩ @ 1A	-	% COMPARATOR
2 Ω @ 100mA	1	50/60 Hz
20 Ω @ 10mA	2	STORE
200 Ω @ 10mA	3	RECALL
2 kΩ @ 1mA	4	INTERFACE
20 kΩ @ 100μA	5	DELAY
200 kΩ @ 10μA	6	COMPARATOR
2 MΩ @ 1μA	7	TRIGGER
20 MΩ @ 100nA	8	REFERENCE
AUTO	9	DISPLAY

Table 4.1: Summary of Keypad Functionality

From the main display, press the [MENU] key. The instrument display should look like the illustration below:

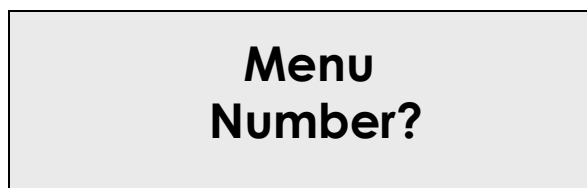

Figure 4.8: Menu

This message prompts the user to select one of the 12 buttons on the keypad. Pressing one of the keys allows access for modifying or enabling instrument parameters. Refer to the Keypad Functionality Table above and the following section in order to navigate the menu.

RANGES

From the main menu, the user can access any of the default instrument resistance range settings by pressing the corresponding range key. If AUTO range is selected, the meter will automatically select the best default resistance range setting for the resistance being measured. Only 11 of the total 20 ranges are available when using the shortcut keys or AUTO range.

In AUTO range mode, if the reading is at or below 10% of 20,000 counts, then the instrument will switch to the next lower range. If the measurement is at or above 101% of 20,000 counts, then the instrument will select the next higher range.

In manual mode, each range is capable of measuring from 0 to 22,999 counts before over ranging.

The diagram below maps all of the available resistance range settings. These settings are accessible by pressing the [MENU] key then the [REFERENCE] key. The ranges may be explored by repeatedly pressing the [REFERENCE] key or by scrolling the [▲] or [▼] keys until the desired range setting is displayed. Pressing the [ENTER] key will enable the range setting. Default range settings are shaded.

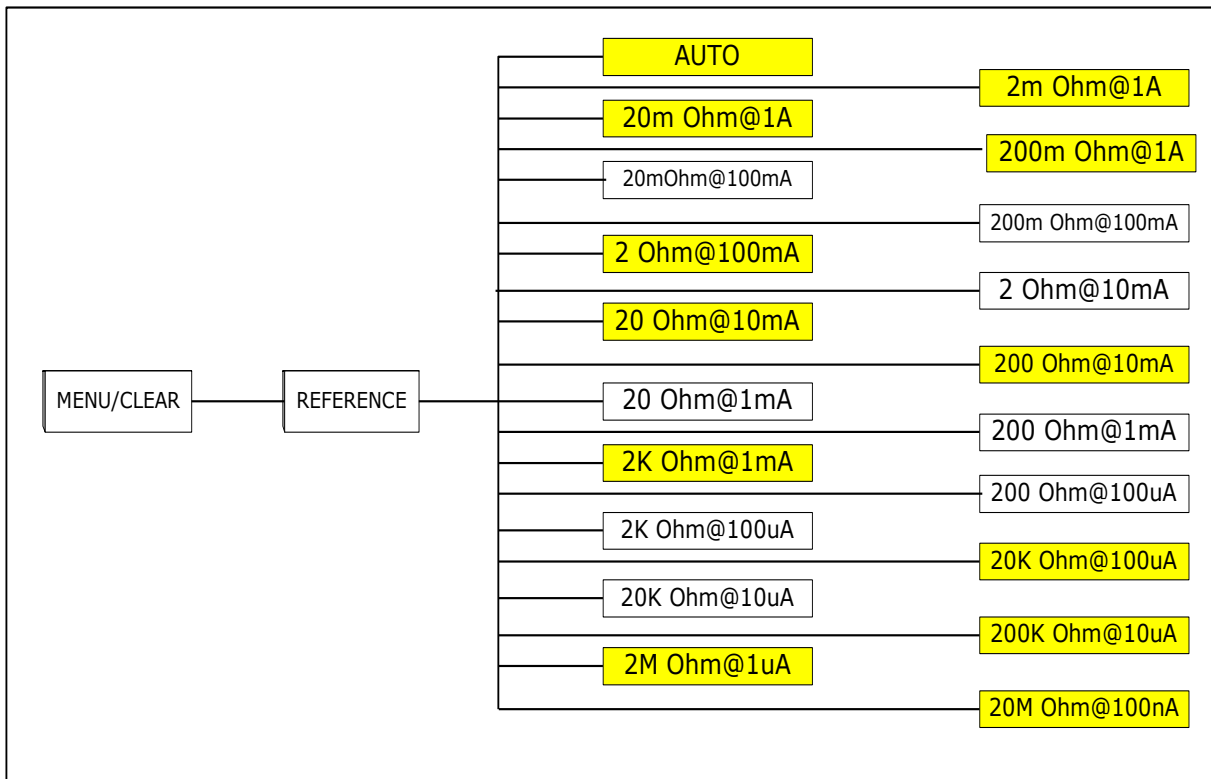

TRIGGER MODES

There are four selectable Trigger Modes: Fast Continuous, Fast One Shot, Delayed Continuous and Delayed One Shot.

The Fast modes are not as accurate as the Delayed modes but are able to generate an initial reading in about 12 ms. Note that Fast Mode is not available for all ranges. See Table 1.6 for a summary of which ranges apply.

Delayed Modes are generally more accurate than the Fast Modes and allow the user to program settling times. When the instrument is in the Delayed Mode, the broken wire function is also enabled for all ranges below 200 Ω.

Continuous Trigger Modes are controlled internally and produce a continuous reading on the display. One Shot trigger modes require external triggering for each measurement. This is done by shorting the BNC trigger input in the rear panel, software command via GPIB, RS232, or RS422, or manually pressing the [HOLD/TRIGGER] button on the front panel.

Press the [MENU/CLEAR] button > [TRIGGER] then select the desired trigger mode. Enable the selected trigger mode by pressing [ENTER].

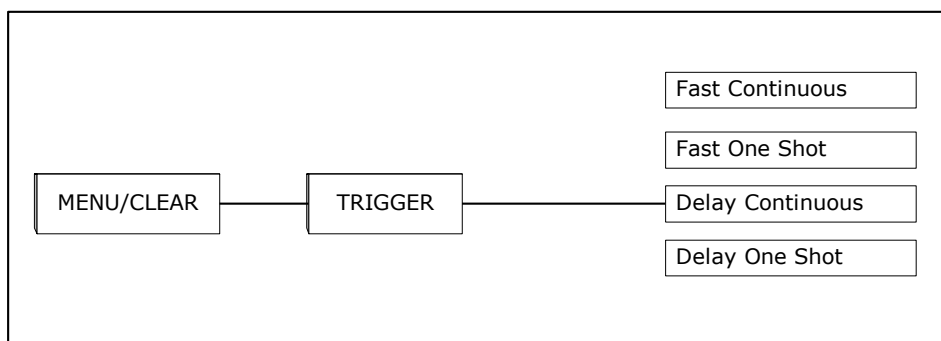

DELAY TIME

This parameter applies only when the instrument is in either Delayed One Shot or Delayed Continuous Modes. The Delayed Modes allow the user to program settling times from 1 to 250 ms. Simply type in a numerical value into the entry field and hit [ENTER] to save the new delay time.

Allowing a longer settling period allows the Delayed Modes to produce a more accurate reading. This is a commonly used feature for measuring high resistances or components with a slight inductive characteristic.

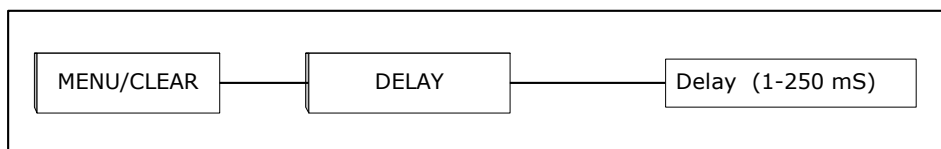

DISPLAY MODE

Three selectable options are available for the display type. These are Resistance, Comparator, and % Comparator.

Selecting either of the Comparator Display Modes will enable the Comparator LED's on the front Panel and their respective outputs on the rear panel.

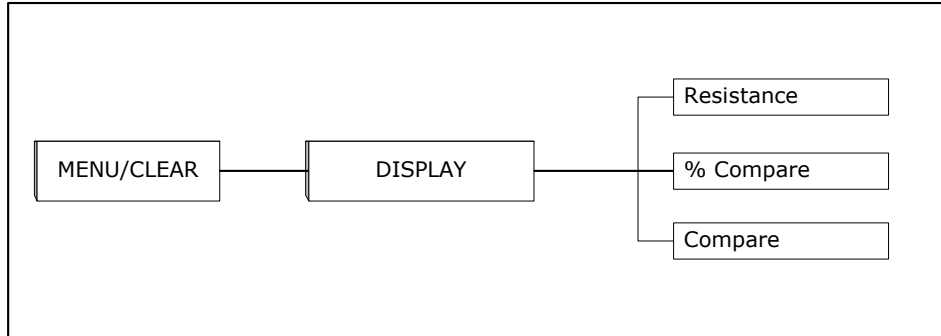

ABSOLUTE COMPARATOR LIMITS

Comparator limits are entered into the 1750 in counts. Because the 1750 is a 4½ digit meter, the maximum entered value would be 22999 counts. The lowest possible entry would be 00000. For the high limit, any value less than the high limit value may be entered for the low limit and any limit lower than the high limit may be entered as the lower limit.

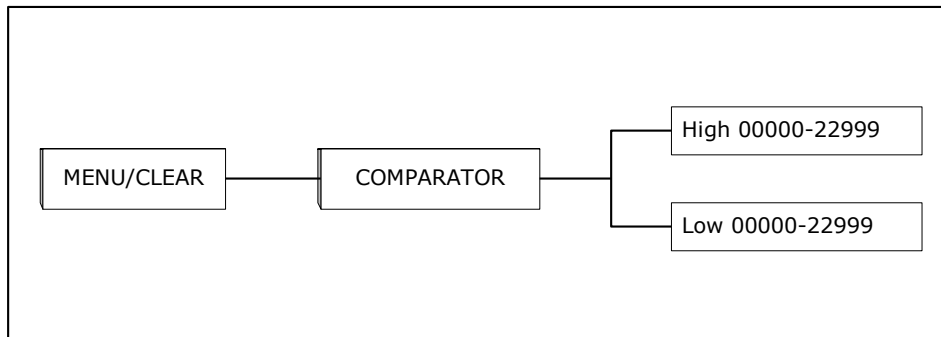

% COMPARATOR LIMITS

For the % comparator, there are three programmable parameters; Upper % Limit, Lower % Limit, and the Nominal Value. Values 00.00 through 99.99% may be entered for the upper and lower % comparator limits. The nominal value is entered from 00000 – 22999, in counts.

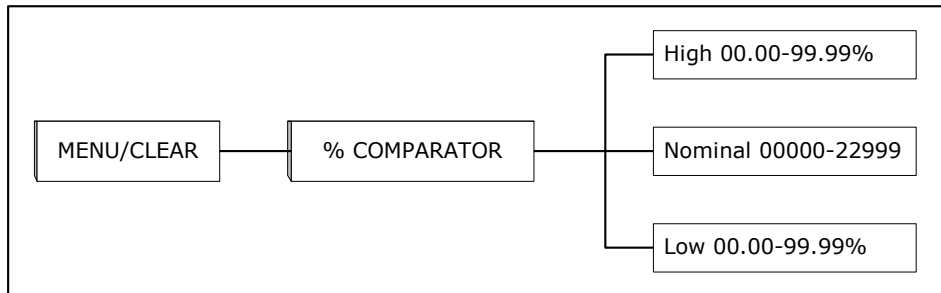

COMMUNICATION INTERFACE

GPIB, RS232 or RS422 communication is selected from this menu option. When the GPIB communication mode is selected (*by pressing the [ENTER] key once*), an additional screen will appear to allow a new GPIB address to be entered. Enter a new GPIB address by typing a number from 01 to 30 and pressing [ENTER]. The existing address may be retained by simply pressing [ENTER].

There are no user-defined settings available for the RS232 or RS422 communication modes.

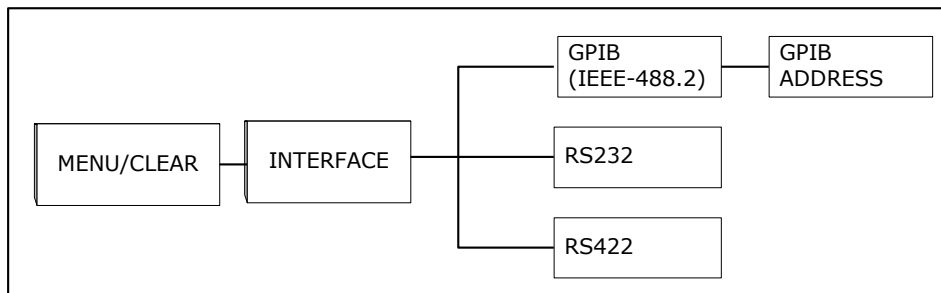

STORE SETUP

Accessing this menu will allow the user to store the current instrument settings into a memory location from 1-9. Comparator and GPIB settings are included.

**RECALL SETUP**

Recalls setups from 1-9.

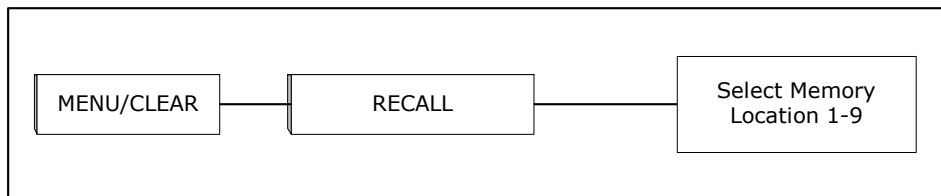
**LINE FREQUENCY**

In this menu, the user selects either 50 or 60 Hz operation for line cycle integration.

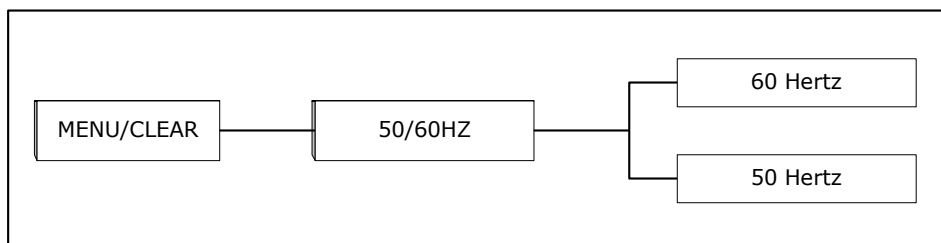

PIN FUNCTION

Enter the PIN # to either enable or disable the PIN lockout function. Refer to the section on PIN function located in this Section.

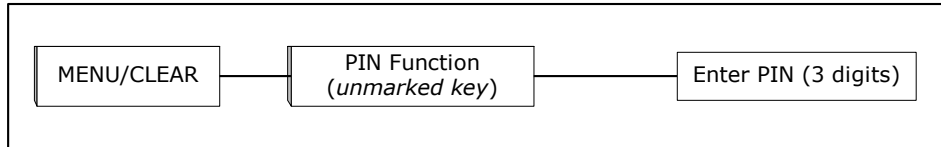

CALIBRATION

The Pin function must be disabled in order to access this menu. In addition, an internal calibration jumper must be in place to enable the calibration of this instrument. See section 6, on calibration for an in depth description of calibration functions procedures.

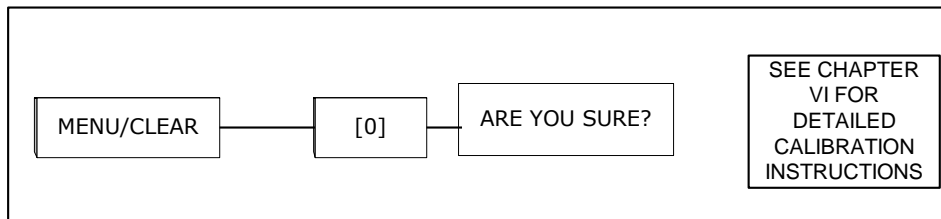

AUTO CORRECT

The 1750 microohmmeter has an auto-correction feature that allows internal compensation of the instrument for temperature changes in the operating environment. In earlier firmware revisions, the auto correction feature was user-selectable. Currently, all 1750 units have this feature enabled and the user cannot modify the feature.

This feature does NOT compensate for changes in resistance of the DUT due to ambient temperature changes.

THE PIN FUNCTION

Because the 1750 has a significant number of measurement parameters that are user defined and may have an impact on measurement accuracy, a lockout feature is supplied with each 1750. This lockout feature is referred to as a PIN function, which prevents unauthorized access to instrument settings critical to the operation of the 1750. It also prevents an operator from accidentally changing the instrument settings. The PIN function may be enabled or disabled by a user provided that the correct code is entered to gain access to the PIN menu. The instrument settings which are protected by the PIN function are as follows; Resistance Range, Trigger Mode, Delay Time, Communication Mode, Line Frequency, and access to the Calibration menu.

Enabling or Disabling the PIN Function

To enable the PIN function, follow the steps below:

- a) Press the [MENU/CLEAR] key then press the [0] key.
- b) You will be prompted to enter a three-digit PIN code. Enter the three-digit code and press enter. (Use the [MENU/CLEAR] key to erase numbers if necessary).

NOTE: The 1750 is shipped from the factory with a PIN of "555"

- c) If the PIN function is off, then you will be prompted "Turn PIN ON?" If the PIN function is ON, then you will be prompted "Turn PIN OFF?" To acknowledge turning the PIN function on or off, simply press the [ENTER] key. A Message will appear on the display to acknowledge the PIN functions new state before returning to the 1750s main display.
- d) If you choose not to change the state of the PIN function, then simply press the [MENU/CLEAR] key to prompt an error message. This will exit the PIN menu and return to the main display.

Changing a PIN Number

To change an existing PIN Number, follow the steps below:

- a) Press the [MENU/CLEAR] key then press the [0] key.
- b) You will be prompted to enter a three-digit PIN code. Enter the three-digit code and press enter. (Use the [MENU/CLEAR] key to erase numbers if necessary).
- c) If the PIN function is off, then you will be prompted "Turn PIN ON?" If the PIN function is ON, then you will be prompted "Turn PIN OFF?"
- d) Press the "0" key and the message, "Change PIN # ?" will appear on the screen.
- e) Press the [ENTER] key and a new screen appears. This screen will show the old PIN number.
- f) The PIN number is changed by keying in the new PIN numbers and pressing [ENTER]. You can escape this screen without changing the old PIN number by pressing [MENU/CLEAR] > [ENTER]. (Use the [MENU/CLEAR] key to erase numbers if necessary).

To Disable an Unknown PIN

In case an unknown PIN number needs to be disabled, a "back door" has been created to bypass the PIN function. To bypass the PIN function, simply enter the code, [9][9][9], as the PIN number. Upon

entering this code, you will be prompted to disable the PIN function. Pressing [ENTER] will unlock the PIN function.

NOTE: This "back door" will only allow the Pin function to be disabled. The only way to reactivate the PIN function is to enter the original PIN code. Contact TEGAM for support in reactivating the PIN number if it is permanently lost.

**SECTION 5
PROGRAMMING AND INTERFACING**

INTERFACING TO THE 1750

This section provides detailed information about the model 1750 electrical interfaces and their functionality. It will provide all of the necessary information required to integrate the 1750 easily into a working test stand. Only one communication interface may be used at a time. The 1750 is shipped from the factory with a default RS232 communications setting. To change the communications setting, refer to the menu navigation chart on page 4-13.

The command sets for the RS232, RS422 and GPIB communication are virtually identical. However, because of the minor differences, this section separates RS232 and RS422 from GPIB to simplify the description of operating principles.

FRONT PANEL

The Model 1750 uses a four-wire, Kelvin type connection to make resistance measurements. This Kelvin connection is located on the instruments front panel. There are five connections used on this connector. Two source leads, which send the bipolar test current through the DUT, two voltage sense leads that detect the voltage drop across the DUT, and a shield connection for protection against external electrical interference. The orientation of the front panel LEMO connector is illustrated below:

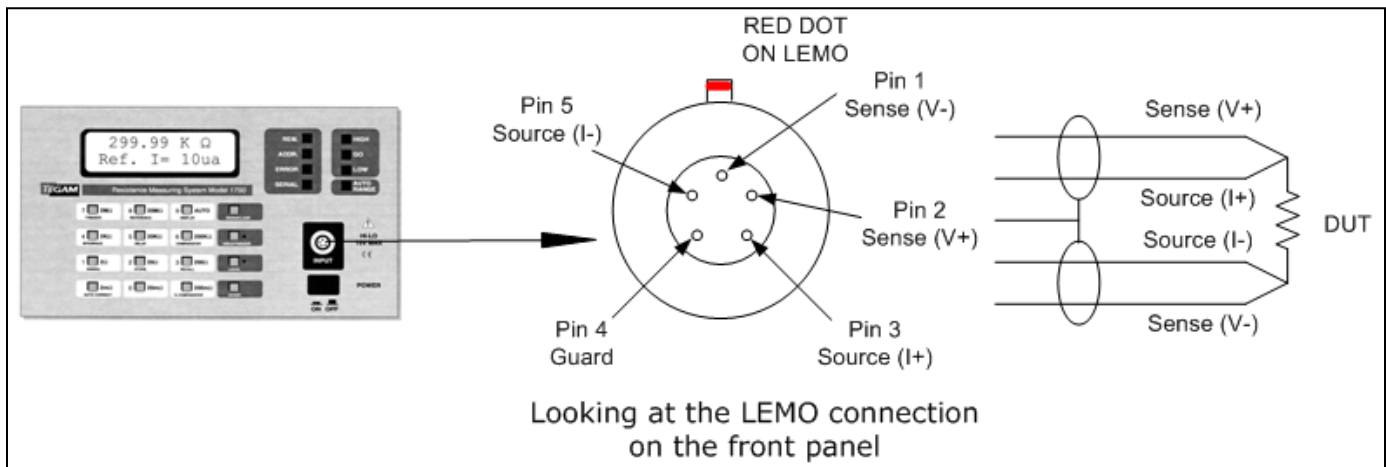

Figure 5.1: Lemo Connector

NOTE: When constructing custom test leads for a test fixture etc., the maximum allowable lead resistance limits must not be exceeded. Refer to Table 1.7 in Section 1 for a summary of maximum lead resistance limits for each of the reference current ranges. Use shielded cable, grounded on one end only, to minimize external interference. Also, take special care in assuring proper contact to the DUT when taking measurements.

REAR PANEL

RS232, RS422 and GPIB communication ports are standard features of the Model 1750. These ports are located in the rear panel of the unit. In addition to the RS232, RS422 and GPIB connectors, there are two BNC connectors used for external control of the unit and a comparator output connector. These input/output connectors have been added to simplify integration to PLCs and other control devices. Below is an in depth description of these I/O connections and how they may be used with PLCs or other test & measurement equipment.

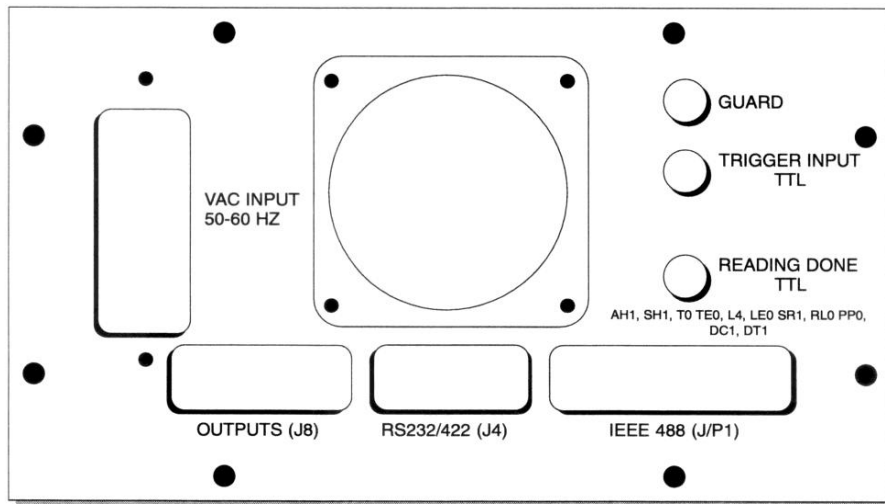

Figure 5.2: Rear Panel

Trigger Input Connector

The first BNC connector is a *Trigger Input*, which requires a low TTL state to become active. Shorting the center conductor of this BNC connector to ground, via relay contacts, is also an effective triggering mechanism. The minimum period for the trigger pulse should be 10 ms for both TTL and relay contact-type triggering. This minimum time allows the microprocessor to detect a low state while conducting its routine monitoring of this input. The trigger input is periodically scanned after each read cycle. Thus, the trigger input’s scan interval is dictated by the measurement mode and settings of the model 1750. Please refer to the section titled Reference Current Modes in Section 1, for illustrations of various modes and how to determine their approximate measurement times.

Trigger Out Connector

The second BNC connector provides a TTL level, *Done Pulse*. The *Reading Done* outputs' normal state is +5 V. Once the 1750 completes a measurement cycle, the state of the output goes to a low state for approximately 4.5 ms, and then returns to +5 V. Its state is updated after each read cycle. Below is an illustration that displays the functions of the TTL input and output. There is also a table of electrical specifications for these outputs.

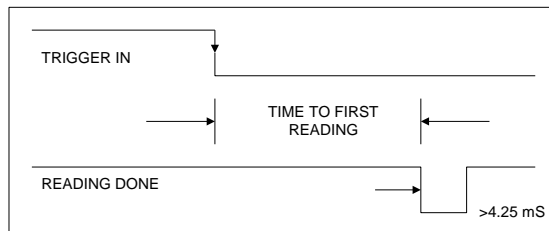

Trigger Input and Reading Done TTL Outputs.
(BNC Connectors)

Connector	Description	High State	Low State
Trigger Input	BNC connector, active low	MIN: >3.5 VDC MAX: <5.3 VDC	< 0.8 VDC
Trigger Output (Reading Done)	BNC connector, >4.25 ms, active low pulse	> 4.2 VDC 0.8 mA source	<0.4 VDC 1.6 mA sink

Table 5.1: Trigger I/O Electrical Requirements ($V_{DD} = 5.0$ VDC)

Using the Trigger Outputs

The Trigger I/Os are interfaced directly to the data lines of the 1750 microprocessor. The 1750 may be triggered externally by providing a low TTL level with external circuitry or by shorting the center conductor of the trigger input to its shield for a minimum of 10 ms with a relay or other device.

The trigger output may be read by any TTL compatible circuitry that meets the signal level requirements as defined in Table 5.1. The Trigger output is normally in the high state until a read cycle has completed. At this time the 5 VDC signal will go low for a minimum of 4.25 ms, then it returns to a high state again until the next read cycle has completed.

If the Trigger output must be read by a PLC, it is recommended that a buffer be used to interface the 1750 trigger output to the PLC input. This can be done through optical isolation or through an open collector configuration. Since additional buffer circuitry may not be practical for some PLC applications, the following procedure provides a possible work around:

1. Using an external controller, (PC), send a command to the 1750 to initiate a reading cycle. The 1750 is assumed to be operating in either absolute or % comparator mode.
2. Upon the completion of the test cycle and acknowledging that the controller has received a new reading from the 1750, send a command to change the 1750 display mode to resistance mode. Changing the 1750 display mode from comparator mode to resistance mode will disable the comparator outputs and return their state to either normally open or normally closed outputs. These comparator outputs should be tied to the PLC inputs.
3. Create a ladder rung in the PLC that becomes true when all three comparator states become equal. When this condition is met, the PLC detects that the reading cycle has been completed confirming a reading complete condition.
4. Send a command to return the 1750 display mode back to one of the comparator modes. This will enable the comparator outputs and create a reading in process condition for the PLC.

CONNECTOR J8

Connector, J8 is used to provide contact outputs for the comparators, bins and other control outputs. A standard DB-15 connector is required. The pin designations are illustrated below:

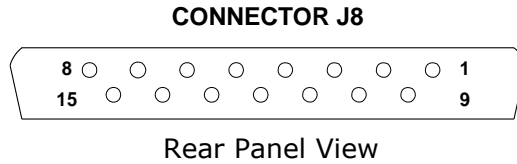
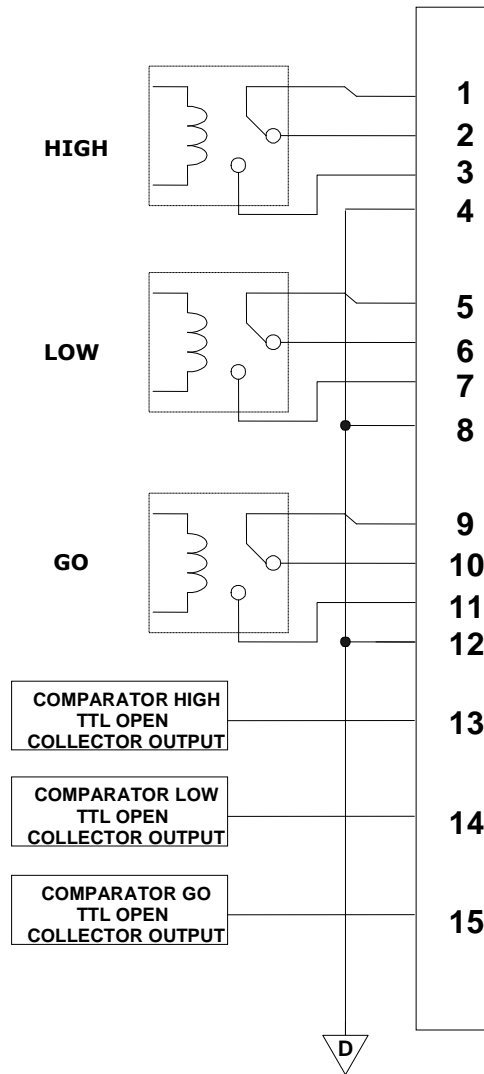

Figure 5.3: J8 Connections



There are a total of 15 pins in connector, J8. The connector contains relay and TTL I/O pins used for interfacing to PLCs and other control devices. The TTL outputs, 74LS03, are compatible with most TTL logic type devices. Their states are updated after each reading cycle.

The output relay contacts change their state as a function of the comparator/ binning outputs. There are normally open and normally closed contacts available for each of the comparator outputs. Their states are updated after each reading cycle. The contacts are rated at 125 VAC @ 500 mA or 30 VDC @ 1 A.

Below is a list of these pins and a brief description of what their functions are.

1. Comparator High Output – Contact - Common
2. Comparator Hi Output – Contact - Normally Closed
3. Comparator Hi Output – Contact - Normally Open
4. Digital Common
5. Comparator Low Output – Contact - Common.
6. Comparator Low Output – Contact - Normally Closed
7. Comparator Lo Output – Contact - Normally Open
8. Digital Common
9. Comparator Go Output – Contact - Common.
10. Comparator Go Output – Contact - Normally Closed
11. Comparator Go Output – Contact - Normally Open
12. Digital Common
13. Comparator High LS Open Collector, TTL Output, Pull Up Resistor Required
14. Comparator Low LS Open Collector, TTL Output, Pull Up Resistor Required
15. Comparator Go LS Open Collector, TTL Output, Pull Up Resistor Required

TTL Outputs	Description	High State	Low State
HIGH GO LOW	Open Collector TTL outputs Requires pull up resistor up to 28 VDC pull up voltage.	LOGIC HIGH= V (pull-up) - .8 VDC	LOGIC LOW= < 0.5 VDC 8 mA sink
Relay Outputs	Description	DC Contact Ratings	AC Contact Ratings
COMPARATOR RELAY OUTPUTS	Normally Open and Normally closed relay outputs for comparator state.	30 VDC @ 1 A	125 VAC @ 0.5 A

Table 5.2: Connector, J8 Electrical Requirements

Connector J8 Timing Diagrams

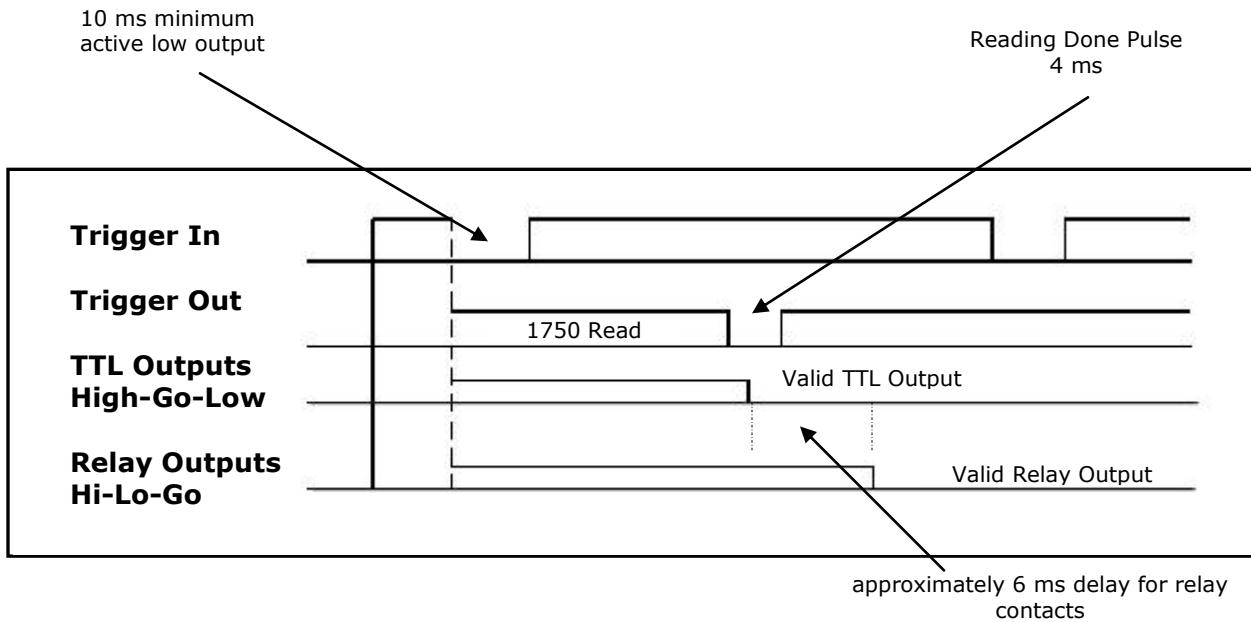

Timing Diagram for Relay Outputs

NOTES: Approximately 5.5 ms after a valid TTL output is generated, a valid output state may be read from the HI, LO, GO relay output contacts.

RS232 COMMUNICATION

- Pin 1 = Pin 4 = Pin 6
- Pin 2 = 1750 transmit
- Pin 3 = 1750 receive
- Pin 5 = ground
- Pin 7 = Pin 8
- Pin 9 = no connect

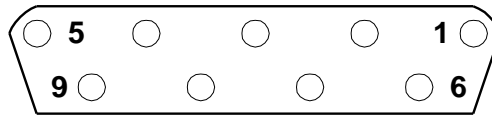

Rear Panel View

Figure 5.4: RS-232 Connector (J4)

Please refer to CA-22-36 in the accessory sheet.

RS232 Settings

The Model 1750 comes from the factory preset with the RS232 protocol. These settings are not user definable. A null modem connection is not required..

Handshake	None
Baud rate	9600 BPS
Data Bits	8
Start Bit	1
Stop Bits	2 (Unit will function with only one Stop Bit)
Parity	None

RS232 Interface Command Summary

Description	Command	Action
Enable Auto Correction Feature	Bn	Not user Selectable. Auto Correction is always enabled. Per latest firmware revision.
Recall Stored Setup	Cn	Recall Setup, "n" Where n=0 through 9
Delay	Dnnn	Set Delay Time in ms; n= 001 – 250 [Default=111]
Enter Command	E	Commands Model 1750 to Transmit; This command will also trigger the 1750.
Set Line Cycle Integration Frequency	F0 F1	Set 1750 to 60 Hz Integration [Default] Set 1750 to 50 Hz Integration
Get Trigger	G	Command a group execute trigger, (GET) on the serial interface.
Clear Device	I	Commands the device to clear all errors and reinitialize the unit to factory default settings. See page 3-1.
Comparator Limits	L0,nnnn L1,nnnn L2,nnnn L3,nnnn L4,nnnn	Set high comparator limit value where n=00000-22999 Set low comparator limit value where n=00000-22998 Set nominal value in % comparator where n=00000-22999 Set high % limit in % comparator where nnnn=00.00-99.99 Set low % limit in % comparator where nnnn=00.00-99.99
Display Mode	P0 P1 P2	Display Resistance Mode [Default] Display Comparator Mode Display % Comparator Mode
Perform Self Test	Q1	Perform Self test (Requires "x" then "E" to report results)
Range	R0 R1 R2 R3 R4 R5 R6 R7 R8 R9 R10 R11 R12 R13 R14 R15 R16 R17 R18 R19	Auto Range [Default] 2 mΩ range @ 1 Amp Test Current 20 mΩ range @ 1 Amp Test Current 20 mΩ range @ 100 mA Test Current 200 mΩ range @ 1 Amp Test Current 200 mΩ range @ 100 mA Test Current 2 Ω range @ 100 mA Test Current 2 Ω range @ 10 mA Test Current 20 Ω range @ 10 mA Test Current 20 Ω range @ 1 mA Test Current 200 Ω range @ 10 mA Test Current 200 Ω range @ 1 mA Test Current 200 Ω range @ 100 uA Test Current 2 kΩ range @ 1 mA Test Current 2 kΩ range @ 100 uA Test Current 20 kΩ range @ 100 uA Test Current 20 kΩ range @ 10 uA Test Current 200 kΩ range @ 10 uA Test Current 2 MΩ range @ 1 uA Test Current 20 MΩ range @ 100 nA Test Current

Description	Command	Action
Save Setup	Sn	Saves Current Setup to a specified location, where n=1-9
Set Trigger Type	T0 T1 T2 T3 T4 T5 T6 T7	Fast Continuous on Talk or Front Panel Operation Fast One Shot on Talk or Front Panel Operation Delay Continuous on Talk or Front Panel Operation [Default] Delay One Shot on Talk or Front Panel Operation Fast Continuous on GET Fast One Shot on GET Delay Continuous on GET Delay One Shot on GET
Status	U0 U1 U2 U3 U4 U5 U6 U7	Send machine State Send Error Status Send Firmware Revision Level Send High Comparator Limit Value Send Low Comparator Limit Value Send Nominal Value Send High % Comparator Value Send Low % Comparator Value
Execute	X	Force Execution of preceding Command
Message Terminator	Y0 Y1 Y2 Y3	Append <CR><LF> as terminators Append <LF><CR> as terminators Append <CR> as terminators Append <LF> as terminators

Table 5.3: RS232 Interface Command Summary

RS232 Device Dependent Commands Supplementary Information

Functional information is provided for the RS232 device dependent commands that require additional information for use. The RS232 connector, J4, is a DB9 type and is compatible with most 9-pin RS232 cables. The information below is to be used with the RS232 command summary table to gain a complete understanding of the command functions.

To acquire a reading requires three events to take place.

- 1) The trigger type must be selected and armed;
- 2) The previous trigger must be stopped and a new trigger must be instructed;
- 3) A new value must be returned after the 1750 completes a reading. Below is a breakdown of the trigger modes and commands via GPIB interface.

Step #1 does not have to be done with all readings once the correct trigger mode is programmed. The stopping of triggers applies only to continuous modes. One Shot modes are stopped automatically.

T0, T1, T2, and T3 [Trigger on E]

- a) Issue a T0, T1, T2, or T3 to select or arm the trigger. Sending an "E" will stop the old trigger and provide a new trigger to begin the next acquisition.
- b) It will also return a reading after it has been completed by the 1750. One "E" command will perform two separate actions.

T4, T5, T6, and T7 [Trigger on GET]

- a) Issue a T4, T5, T6, or T7 to select and arm the new trigger. Issuing the GET command will stop the old trigger and provide a new trigger to begin the next acquisition.
- b) Sending an "E" will return a reading after it has been completed by the 1750.

Returned ASCII Values:

- a) "1.2345 mOhm" – A resistance reading will be returned to the PC in this format.
- b) "2.9999 or 29.999" – This returned value indicates that there is an over range condition.
This value may also indicate an open wire condition for ranges below 200 Ω .

Range – R0, R1, R2, R3, R4, R5, R6, R7, R8, R9, R10, R11, R12, R13, R14, 15, R16, R17, R18, R19.

Delay – Dnnn – where nnn=0-250 ms

Frequency – F0, F1

Trigger – T0, T1, T2, T3, T4, T5, T6, T7

Display Mode – P0, P1, P2

Terminators – Y0, Y1, Y2, Y3, Y4; CR= carriage return, LF= line feed

Save Setup – Sn – where n=1-9

Recall Setup – Cn – where n=0-9

Limits – L0, L1, L2, L3, L4

Status – U0, U1, U2, U3, U4, U5, U6, U7

Immediate Commands – I, G, T, E, X, There are a total of 5 immediate commands used via RS232.

“**I**” – Initializes the 1750 and executes a device clear. When the I command is used the 1750 returns to its original factory default settings.

“**G**” – This command gives the unit a trigger to allow the unit to initiate a reading. For example, if the unit had been previously set for “T4”, Fast Continuous on “G” command, that is, “T4X” the instrument will begin to take readings after a “GX” command follows.

“**E**” – Return the generated message from the 1750 output buffer to the controller. This is because the RS232 interface is not set up for full duplex communications, (handshaking) like the GPIB interface.

“**X**” – Force execution of preceding commands

Self-Test – Q1X – The Q1 command instructs the 1750 to perform a self-test and the trailing X instructs the instrument to execute the self-test. If the 1750 passes the Self-Test then the message “SelfTest PASS” is stored in the output buffer so that the next read instruction will call the message. If the user is communicating with the instrument with a serial emulator such as Windows HyperTerminal, an “E” command is also needed to return the self test results to the computer.

Status Commands – Reading the instrument status is usually performed after executing one or more device dependent commands. The status request function, UnX, (where n=0-7) will generate the respective responses to the RS232 output buffer of the 1750. The “E” command will return the status message to the controller. If no status query was entered prior to the “E” command, then the latest reading of the 1750 will be received by the controller.

Query	Command	Return Value (example)	Description Additional Notes
Machine Status	U0XE	COD111F0M63P0R05S0T0B0Y0	Active Device Dependent Command Settings
Error Status	U1XE	Error#, where #: No errors = 000 self test fail = 008 illegal command = 016 conflict = 032 illegal command option = 064	Any time that an error occurs in a program line, all of the commands in that line up to the next “X” are disregarded. To clear an error send U1X then send the command to read per your command string. Both actions are required in order to clear the error bit in the control byte.
Revision Level	U2XE	Tegam 1750 D02.20 Apr 26,2000	Returns the software revision level of the 1750
High Limit	U3XE	10000	Returns the high comparator limit in counts
Low Limit	U4XE	00500	Returns the low comparator limit in counts
Nominal	U5XE	12345	Returns the nominal % comparator value in counts
% High Limit	U6XE	10.00	Returns the high % comparator limit in %
% Low Limit	U7XE	10.00	Returns the low % comparator limit in counts.
Self Test Response	Q1XE	“Self test PASS”	Verification of self-test successful – no reported errors.

Table 5.4: RS232 Status Command Summary

RS232 Hierarchy of Commands

The 1750 microprocessor is programmed to evaluate the RS232 command set on a priority basis up to the command delimiter "X" as follows:

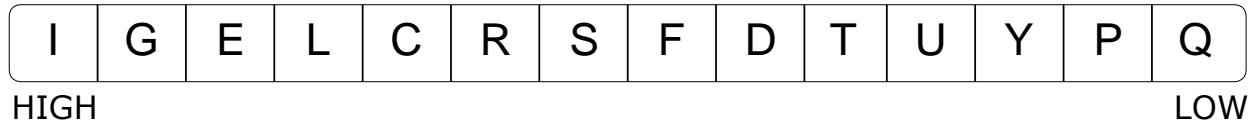

The "L" (limits), command is the only command that can have a conflicts error associated with it. If the user attempts to set an upper limit on the comparator that is less than the lower limit or a lower limit that exceeds the upper comparator limit a conflict error is generated. If a conflict error condition is generated, the limits are not changed.

The "C" (recall setup), command supersedes all programming, (except for immediate commands), up to the next "X" (execute), command. All commands following the "C" command will be ignored since the "C" command is defining a totally new machine state. For example, in the command line, "C2R5X", C2 calls for memory location #2 to be restored into the 1750. The command R5 will be ignored since the C2 command already defines a new range.

To force a user defined priority sequence, separate the commands with the command line delimiter, X. For example, to change Delay time and then the range send the following: "D123XR2X". This will set the Delay time to 123 mS then set the instrument to Resistance Range #2.

If an "E", command is sent to the 1750, it will return a reading to the controller in the form of ASCII characters. The reading will be in the form of a numeric 4 ½ digit value followed by a SI unit prefix, (n, u, m, k, or M), and Ohm units. This returned reading is completed by a termination sequence as defined by the active "Yn" state, where n=0-4. Below are some examples of possible returned vales for readings.

Over range Readings:	"Over Range" "2.9999 or 29.999"
Broken Lead Condition: (Ranges below 200 Ω)	"Open Wire" "2.9999 or 29.999"
Typical Reading Example:	"1.2345 mOhm"

POWER UP AND DEVICE CLEAR DEFAULTS

When the 1750 is first powered up the machine state reinitializes to the last settings it had before its last power down. To restore the unit to factory defaults an initialize command; "I" must be executed. See Table 3.1 for a summary of these default settings.

Reading via RS232 Interface

This is a basic example for setting the 1750 to the 20 k Ω range and taking a reading. Windows supplies HyperTerminal as a standard accessory and may be used for executing simple RS232 functions.

Set the 1750 resistance range by sending the ASCII string, "R15X", where "R15" is the command for setting the resistance range and "X" is the message delimiter.

Send the ASCII character "E" to instruct the 1750 to return a value to the PC. A reading will be returned followed by a carriage return, <CR> and a line feed, <LF>.

IEEE-488.1 OPERATION

The Model 1750 may operate in either GPIB or RS232 communication interface. From the factory, the 1750 is configured for GPIB communication at address 12. To change the GPIB address, select [MENU]>[INTERFACE]>[GPIB]>[ENTER]. You will be prompted to enter a new GPIB address. Type in the new GPIB address and press [ENTER]. The new GPIB setting is now activated.

Below is an illustration of the rear panel GPIB connector and a definition of the pin assignments can be found in the table below.

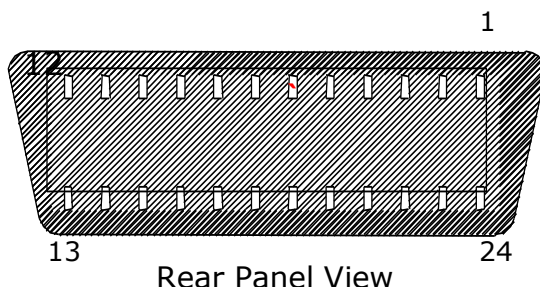

Figure 5.5: GPIB Connector

Pin	Signal	Function	Pin	Signal	Function
1	DIO1	Data input/ output bit 1	13	DIO5	Data input/ output bit 5
2	DIO2	Data input/ output bit 2	14	DIO6	Data input/ output bit 6
3	DIO3	Data input/ output bit 3	15	DIO7	Data input/ output bit 7
4	DIO4	Data input/ output bit 4	16	DIO8	Data input/ output bit 8
5	EOI	End or identity	17	REN	Remote Enable
6	DAV	Data Valid	18	SHIELD	Ground (DAV)
7	NRFD	Not Ready for Data	19	SHIELD	Ground (NRFD)
8	NDAC	Not Data Accepted	20	SHIELD	Ground (NDAC)
9	IFC	Interface Clear	21	SHIELD	Ground (IFC)
10	SRQ	Service request	22	SHIELD	Ground (SRQ)
11	ATN	Attention	23	SHIELD	Ground (ATN)
12	SHIELD	Chassis Ground	24	SIGNAL GND	Signal Ground

Table 5.5: Pin Outs for GPIB Rear Connector

GPIB Command Summary

Below is a summary of the GPIB commands that may be used while programming the 1750. It is recommended that the user have some familiarity with the IEEE-488 specification before continuing with this section. Programming for the Model 1750 is performed by using Device Dependent Commands from the buss to the instrument. These commands are a combination of a letter and a number. Upper and lower case letters are permitted. In order to send a Device Dependent Command to the instrument, the command string must be followed by a message delimiter, such as "X" and a terminator sequence. The table below is a summary of individual commands.

Description	Command	Action
Enable Auto Correct Feature	Bn	Not user Selectable. Auto Correction is always enabled. Per latest firmware revision.
Recall Stored Setup	Cn	Recall Setup, "n" Where n=0 through 9
Delay	Dnnn	Set Delay Time in ms; n= 001 – 250 [Default=111]
Set Line Cycle Integration Frequency	F0	Set 1750 to 60 Hz Integration [Default=111]
	F1	Set 1750 to 50 Hz Integration
Group Execute Trigger [GET]	[<i>IBGET</i> for <i>National Instruments</i>]	Triggers the device to take a reading. The reading is not returned to the bus.
Clear Device	[<i>IBCLEAR</i> for <i>National Instruments</i>]	Commands the device to clear all errors and reinitialize the unit to factory default settings. See page 3-2.
Comparator Limits	L0,nnnnn	Set high comparator limit value where n=00000-22999
	L1,nnnnn	Set low comparator limit value where n=00000-22998
	L2,nnnnn	Set nominal value in % comparator where n=00000-22999
	L3,nnnn	Set high % limit in % comparator where nnnn=00.00 -99.99
	L4,nnnn	Set low % limit in % comparator where nnnn=00.00-99.99
Serial Poll Mask	Mnn	Mask Undesired Serial Poll bits where n=0-63 mask value.
Display Mode	P0	Display Resistance Mode [Default=111]
	P1	Display Comparator Mode
	P2	Display % Comparator Mode
Perform Self Test	Q1	Perform Self test (Requires "x" then "E" to report results)

Description	Command	Action
Range	R0	Auto Range
	R1	2 mΩ range @ 1 Amp Test Current
	R2	20 mΩ range @ 1 Amp Test Current
	R3	20 mΩ range @ 100 mA Test Current
	R4	200 mΩ range @ 1 Amp Test Current
	R5	200 mΩ range @ 100 mA Test Current
	R6	2 Ω range @ 100 mA Test Current
	R7	2 Ω range @ 10 mA Test Current
	R8	20 Ω range @ 10 mA Test Current
	R9	20 Ω range @ 1 mA Test Current
	R10	200 Ω range @ 10 mA Test Current
	R11	200 Ω range @ 1 mA Test Current
	R12	200 Ω range @ 100 uA Test Current
	R13	2 kΩ range @ 1 mA Test Current
	R14	2 kΩ range @ 100 uA Test Current
	R15	20 kΩ range @ 100 uA Test Current
	R16	20 kΩ range @ 10 uA Test Current
	R17	200 kΩ range @ 10 uA Test Current
	R18	2 MΩ range @ 1 uA Test Current
R19	20 MΩ range @ 100 nA Test Current	
Save Setup	Sn	Saves Current Setup to a specified location, where n=1-9
Set Trigger Type	T0	Fast Continuous on Talk or Front Panel Operation
	T1	Fast One Shot on Talk or Front Panel Operation
	T2	Delay Continuous on Talk or Front Panel Operation [Default]
	T3	Delay One Shot on Talk or Front Panel Operation
	T4	Fast Continuous on GET
	T5	Fast One Shot on GET
	T6	Delay Continuous on GET
	T7	Delay One Shot on GET
Status	U0	Send machine State
	U1	Send Error Status
	U2	Send Firmware Revision Level
	U3	Send High Comparator Limit Value
	U4	Send Low Comparator Limit Value
	U5	Send Nominal Value
	U6	Send High % Comparator Value
	U7	Send Low % Comparator Value
Execute	X	Force Execution of preceding Command
Message Terminator	Y0	Append <CR><LF>EOI as terminators
	Y1	Append <LF><CR>EOI as terminators
	Y2	Append <CR>EOI as terminators
	Y3	Append <LF>EOI as terminators

Table 5.6: GPIB Command Summary

GPIB Device Dependent Commands Supplementary Information

Functional information is provided for the GPIB device dependent commands that require additional information for use. The device dependent command such as "R0" requires a message delimiter such as "X" and a terminator sequence such as "<LF> EOI" before it is executed by the instrument. Up to 32 characters may be accepted by the input buffer before the "X" command must be executed. The information below is to be used with the GPIB command summary table to gain a complete understanding of the command functions.

To acquire a reading requires three events to take place.

- 1) The trigger type must be selected and armed;
- 2) The previous trigger must be stopped and a new trigger must be instructed;
- 3) A new value must be returned after the 1750 completes a reading. Below is a breakdown of the trigger modes and commands via GPIB interface.

Step #1 does not have to be done with all readings once the correct trigger mode is programmed. The stopping of triggers applies only to continuous modes. One Shot modes are stopped automatically.

T0, T1, T2, and T3 [Trigger on Talk]

- a) Issue a T0, T1, T2, or T3 to select or arm the trigger. An address to Talk on the bus will stop the old trigger and provide a new trigger to begin the next acquisition.
- b) It will also return a reading after it has been completed by the 1750. One Talk command will perform two separate actions.

T4, T5, T6, and T7 [Trigger on GET]

- a) Issue a T4, T5, T6, or T7 to select and arm the new trigger. Issuing the GET command on the bus will stop the old trigger and provide a new trigger to begin the next acquisition.
- b) An address to Talk on the bus will return a reading after it has been completed by the 1750.

Returned ASCII Values:

- a) "1.2345 mOhm" – A reading will be returned to the PC in this format.
- b) "2.9999 or 29.999" – This returned value indicates that there is an over range condition.
This value may also indicate an open wire condition for ranges below 200 Ω .

Range – R0, R1, R2, R3, R4, R5, R6, R7, R8, R9, R10, R11, R12, R13, R14, R15, R16, R17, R18, R19.

Delay – Dnnn – where nnn=0-250 ms

Frequency – F0, F1

Trigger – T0, T1, T2, T3, T4, T5, T6, T7

Display Mode – P0, P1, P2

Terminators – Y0, Y1, Y2, Y3, Y4; CR= carriage return, LF= line feed, and EOI = end of information
 NOTE: EOI is used only with GPIB.

Save Setup – Sn – where n=1-9

Recall Setup – Cn – where n=0-9

Limits – L0, L1, L2, L3, L4

Status – U0, U1, U2, U3, U4, U5, U6, U7

Serial Polling

Mnn – where “nn” is the decimal equivalent mask value.

Setting the SRQ Mask Bits allow the 1750 to signal the controller when a significant event occurs. The decimal values that are allowable for the Mask range from 0-63. This decimal value is converted to a binary masking byte, which is “AND”ed with the 1750 status byte. The resulting byte indicates whether an SRQ will be generated by the 1750. A true status is indicated by a binary 1 in the status byte. The assignment of bits for the 1750-status byte are as follows:

BIT7	BIT6	BIT5	BIT4	BIT3	BIT2	BIT1	BIT0
NOT USED	RSV	ERROR	READY FOR INPUT	SELF TEST COMPLETE	NOT USED	NOT USED	READING DONE

1750 Status (Control) Byte

Examples of mask settings and their respective results.

“M63” will allow SRQ’s for all of the 1750 status bits. Since a binary 63 is represented by 11111111, this value is “AND”ed with the status byte allowing all states to transfer to the controller to generate and SRQ.

“M32” will allow SRQ’s on Error States Only. This is bit #5. Since bit #5 is the only allowable bit allowed by the mask ONLY error states will generate an SRQ condition.

The error bit is the only status bit that is latched when it becomes true. All of the other status bits will be cleared after being read by the serial poll of the bus. The Error Bit will remain latched until a U1X command is sent to the 1750 and a status is returned to the controller.

After an SRQ is generated on the bus, serial polling the bus returns the serial poll byte. If the Model 1750 is the device generating the SRQ, the #6 bit, (64 binary value), is set in the serial poll byte along with the applicable status bits. The returned value will yield the value of the #6 bit, (64), plus the decimal value of the active status bits.

Examples of some commonly returned values from the bus:

"65" indicates that the 1750 caused an SRQ due to a reading done condition. Bit #6 is set in addition to bit #0. The decimal sum of these bits is equal to 65.

"72" indicates that the 1750 caused an SRQ due to a self-test done condition.

"80" indicates that the 1750 generated an SRQ indicating that it is ready for additional instruction.

"89" indicates the 1750 generated an SRQ due to ready, self-test, and reading done conditions.

"96" indicates an SRQ was generated by the 1750 due to an operational error.

"112" indicates that the 1750 caused an SRQ and is ready for additional instruction.

After an SRQ on the IEEE-488 bus, serial polling the bus produces a serial poll byte. If the 1750 did not cause the SRQ, (i.e., mask bit are cleared), the poll bits will still reflect the state of the 1750.

Examples of these returned values are:

"1" = Reading Done

"8" = Self test Done

"16" = Ready for more instructions. (all commands are executed)

"32" = Error condition occurred on the 1750

Self-test

Q1 – Perform an instrument self test routine and report the device’s status. If the device passes the self-test, a “Self Test Pass” message is put into the output buffer so that the next bus read will return this condition. This command will also update the serial poll byte and SRQ status.

Hierarchy of GPIB Commands

The 1750 microprocessor is programmed to evaluate the command set on a priority basis up to the command delimiter “X” as follows:

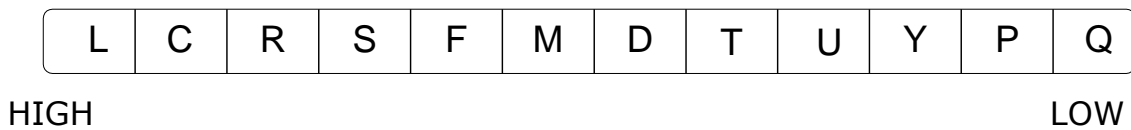

The “L” (limits), command is the only command that can have a conflicts error associated with it. If the user attempts to set an upper limit on the comparator that is less than the lower limit or a lower limit that exceeds the upper comparator limit a conflict error is generated. If a conflict error condition is generated, the limits are not changed.

The “C” (recall setup), command supersedes all programming up to the next “X” (execute), command. All commands following the “C” command will be ignored since the “C” command is defining a totally new machine state. For example, in the command line, “C2R5X”, C2 calls for memory location #2 to be restored into the 1750. The command R5 will be ignored since the C2 command already defines a resistance range. If the presets in location #2 are to be restored with the newly defined resistance range, R5, then the following line of code needs to be implemented, “C2XR5X”. This will recall setup location 2 with resistance range R5.

To force a user defined priority of commands, the commands should be separated by a command line delimiter, “X”. For example, to change the delay time *then* the resistance range, enter the following string of characters: D123XR2X.

Status Commands

Reading the instrument status is usually performed after executing one or more device dependent commands. The status request function, UnX, (where n=0-7) will return the respective responses to the IEEE-488 bus.

Query	Command	Return Value	Description
Machine Status	U0X	C0D111F0M63P0R05S0T0B0Y0	Active Device Dependent Command Settings
Error Status	U1X	Error#, where #: No errors = 000 self test fail = 008 illegal command = 016 conflict = 032 illegal command option = 064	Ant time that an error occurs in a program line, all of the commands in that line up to the next "X" are disregarded.
Revision Level	U2X	Tegam 1750 D02.20 Apr 26,2000	Returns the software revision level of the 1750
High Limit	U3X	10000	Returns the high comparator limit in counts
Low Limit	U4X	00500	Returns the low comparator limit in counts
Nominal	U5X	12345	Returns the nominal % comparator value in counts
% High Limit	U6X	10.00	Returns the high % comparator limit in %
% Low Limit	U7X	10.00	Returns the low % comparator limit in counts.
Self Test Response	Q1X	"Self test PASS"	Verification of self-test successful - no reported errors.

Table 5.7: GPIB Status Command Summary

Power Up and Device Clear Defaults

When the 1750 is first powered up the machine state reinitializes to the last settings it had before its last power down. When a device clear or selected device clear is executed from the bus, the machine state reinitializes to factory defaults. See Table 3-1 for a summary of these default settings.

Reading from the IEEE-488 bus

Below are some BASIC instructions for making a 1 k Ω measurement of a resistor via the interface bus. This will be executed by programming the 1750 to the 2 k Ω @ 1 mA range, fast one-shot trigger, and take a resistance reading.

Send the ASCII string, "R13T1X" to address 12

[OUTPUT 12; "R13T1X"

Where R13 = 2 k Ω @1 mA range

T1 = Set 1750 to Fast One-Shot Trigger

X = Message Delimiter

Retrieve the reading of ASCII string "1.0000 kOhm" with default terminators of <CR><LF>and EOI

ENTER 12

LINE INPUT A\$

PRINT A\$

Sample Programs

The examples below are written in HP Basic for Windows on a PC. The 1750 is set at GPIB address 12 and the GPIB card is set at location 700 in the PC.

- a) This example uses HP Basic for Windows on a PC. The 1750 address is 12 and the IEEE-488 interface card address is at 700 in the PC.

```

10  REMOTE 712
20  OUTPUT 712; "R13T1X"
30  ENTER 712; A$
40  PRINT A$
50  END
    
```

- b) This next example allows the user to enter commands from the PC keyboard and to view the readings on the computer CRT.

```

10  DIM B$ [50]           `dimension receive string
20  REMOTE 712           `set IEEE-488 to remote
30  INPUT A$             `ask for user keyboard command
40  OUTPUT 712; A$       `send keyboard command to 1750
50  ENTER 712; B$       `obtain a reading from the 1750
60  PRINT B$            `display the reading on the CRT
70  GOTO 30              `wait for the next keyboard command
    
```

- c) This next example allows the user to use the [GET], group execute trigger function of the IEEE-488 bus to trigger a reading.

```

10  DIM B$ [50]           `dimension receive string
20  REMOTE 712           `set IEEE-488 to remote
30  OUTPUT 712; "T7X"    `program the 1750 to one shot GET trigger
40  INPUT A$             `ask for user keyboard command
50  OUTPUT 712; A$       `send keyboard command to 1750
60  TRIGGER 712         `trigger the 1750 to take a reading
70  ENTER 712; B$       `obtain a reading from the 1750
80  PRINT B$            `display the reading on the CRT
90  GOTO 30              `wait for the next keyboard command
    
```

- d) This next example is a combination of examples a & b above, except that it will SRQ if an error occurs and display the 1750 status. It will then trigger the 1750 and wait for a reading done SRQ before taking a reading from the unit.

```
10 DIM B$ [50]           `dimension receive string
20 REMOTE 712            `set IEEE-488 to remote
30 OUTPUT 712; "T7M33X" `program the 1750 to one shot GET trigger AND SRQ on
                        `error or reading done state.
40 INPUT A$              `ask for user keyboard command
50 OUTPUT 712; A$        `send keyboard command to 1750
60 S=POLL (712)         `read serial poll byte for any errors
70 IF S>85 THEN GOTO 200 `test for an error SRQ
80 TRIGGER 712          `no errors, trigger the 1750 to take a reading
70 ENTER 712; B$        `obtain a reading from the 1750
80 PRINT B$             `display the reading on the CRT
90 S=POLL (712)         `read serial poll byte for any errors again
100 IF S<>65 THEN GOTO 90 `wait for the reading done SRQ
110 ENTER 712;B$        `retrieve the completed reading from the 1750
120 PRINT B$            `display the reading on the CRT
130 GOTO 40             `wait for the next keyboard command

200 OUTPUT 712; "U1X"   `ask for the error status byte
210 ENTER 712;B$        `retrieve the error status byte from the 1750
220 PRINT "Error=";B$   `display the status reading on the CRT
230 GOTO 40             `continue to wait for the next keyboard command
240 END
```

SECTION 6

SERVICE INFORMATION

CLEANING



UNPLUG THE POWER CABLE. AVOID THE USE OF CHEMICAL CLEANING AGENTS WHICH MIGHT DAMAGE THE PLASTICS USED IN THIS UNIT. DO NOT APPLY ANY SOLVENT CONTAINING KETONES, ESTERS OR HALOGENATED HYDROCARBONS. TO CLEAN, USE ONLY WATER SOLUBLE DETERGENTS, ETHYL, METHYL, OR ISOPROPYL ALCOHOL.

Exterior. Loose dust may be removed with a soft cloth or a dry brush. Water and mild detergent may be used; however, abrasive cleaners should not be used.

Interior. Use low-velocity compressed air to blow off the accumulated dust. Hardened dirt can be removed with a cotton-tipped swab, soft, dry cloth, or a cloth dampened with a mild detergent and water.

WARNING

TO AVOID PERSONAL INJURY FROM ELECTRIC SHOCK DO NOT REMOVE INSTRUMENT COVERS OR PERFORM ANY MAINTANCE OTHER THAN DESCRIBED IN THIS MANUAL.

CALIBRATION PROCEDURE

Scope: To achieve rated accuracy, the 1750 must be calibrated within 6 months of initial purchase or after being repaired. After the initial 6 months, the calibration interval may be extended to once every 12 months. The 1750 is digitally calibrated from the front panel. No internal adjustment is required. Use this procedure to verify and make necessary adjustments to qualify the Model 1750 for NIST traceable calibration.

Equipment: Full Scale Calibration Standard; 17501 Kelvin Klip™ Leads

Preparation: Power up the model 1750 and allow the unit to stabilize for 24 hours in a temperature and humidity controlled environment. The temperature and humidity must be 23 °C ±1.0 °C, (73.4 °F ±1.8 °F), and a 50% (±5%) relative humidity environment.

Procedure

1. Change the calibration jumper, P9 position from operate to calibration mode. See page 6-5, Internal Jumpers, for instructions on changing the jumper.
2. Depress the [MENU/CLEAR] key and select the Delayed Continuous Trigger Mode from the Trigger Menu. Set the Delay Time to 111 ms.

3. Press the [MENU/CLEAR] > [AUTO CORRECT] buttons. The following prompt will appear:

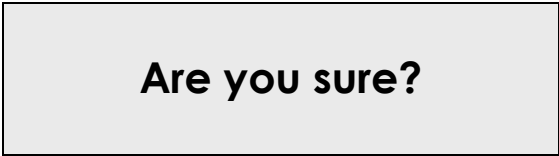

4. Press [ENTER]. You will see following prompt appear on the LCD:



5. The display will read "Apply 20M Std.". Connect the Kelvin Klip™ Leads to the 20 MΩ standard and press [ENTER]. See the table below for a summary of all the ranges.

*NOTE: If a standard needs to be reapplied, a message similar to "Apply 200*2 Std." will appear. This particular message refers to reapplying the 200 Ω standard.*

1	20 MΩ	5	20 kΩ-2	9	200 Ω - 2	13	2 Ω	17	20 mΩ
2	2 MΩ	6	2 kΩ	10	200 Ω - 3	14	2 Ω - 2	18	20 mΩ - 2
3	200 kΩ	7	2 kΩ - 2	11	20 Ω	15	200 mΩ	19	2 mΩ
4	20 kΩ	8	200 Ω	12	20 Ω - 2	16	200 mΩ - 2		

6. The instrument will make internal adjustments and automatically proceed to the next calibration step.

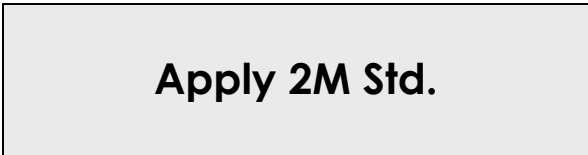

7. Connect the Kelvin Klip™ Leads to the 2 MΩ standard and press [ENTER]. Repeat this process until all standards have been used. When the calibration is complete, a calibration done message appears.

NOTE: If you wish to abort the calibration process at any time during the procedure, press the [0] key. This will exit the calibration sequence and will not modify any of the calibration constants.

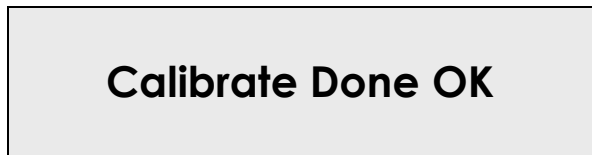

NOTE: All new calibration constants are written to the EEPROM when the "Calibrate Done OK" message is displayed. This notates the completion of the calibration process. Turn off the unit and disconnect the power cord. Remove the top cover and move jumper P9 back the operate position. Install the top cover and proceed to the Calibration Verification procedure.

Calibration Verification Procedure

Scope: The Calibration Verification procedure should be performed immediately after the calibration adjustment procedure. These specifications are tighter than the advertised 1750 specifications in order to insure a safe margin between the instrument's calibration adjustments and its advertised specifications.

Procedure

1. With the instrument Time Delay set to 111 ms when in the Delayed Continuous Mode (steps 2-12), manually select the 2 mΩ range by pressing the 2 mΩ range key. The instrument will need changed to Fast Continuous mode for steps 13-16.

NOTE: The Calibration Verification cannot be performed with the instrument in the AUTO range mode.

2. Connect the Kelvin Klips™ to the 2 mΩ standard securely and observe the subsequent reading. Record the resistance reading in the table below and verify that it falls within the specified allowable ranges.
3. Check either the PASS or FAIL box and proceed to the next calibration point. Repeat steps 1-3 until all ranges have been verified.
4. Should a range fail to meet calibration specifications, repeat the calibration procedure or call TEGAM for service.

#	Resistance Range	Specification (± counts)	Lower Allowable Limit	Read Value	Upper Allowable Limit	PASS √	FAIL √
1	AUTO RANGE IS NOT USED FOR VERIFICATION						
2	2 mΩ@1 A	± 3	1.9997		2.0003		
3	20 mΩ @ 1 A	± 3	19.997		20.003		
4	200 mΩ @ 1 A	± 2	199.98		200.02		
5	2 Ω @ 100 mA	± 2	1.9998		2.0002		
6	20 Ω @ 10 mA	± 2	19.998		20.002		
7	200 Ω @ 10 mA	± 2	199.98		200.02		
8	2 kΩ @ 1 mA	± 2	1.9998		2.0002		
9	20 kΩ @ 100 uA	± 2	19.998		20.002		
10	200 kΩ @ 10 uA	± 2	199.98		200.02		
11	2 MΩ @ 1 uA	± 4	1.9996		2.0004		
12	20 MΩ @ 100 nA	± 5	19.995		20.005		
13	200 mΩ Fast @ 1 A	± 11	199.89		200.11		
14	2 Ω Fast @ 100 mA	± 11	1.9989		2.0011		
15	20 Ω Fast @ 10 mA	± 11	19.989		20.011		
16	200 Ω Fast @ 10 mA	± 11	199.89		200.11		

Performance Verification

Scope: Performance Verification is intended to verify that the 1750 is measuring within its advertised specifications. This procedure may be performed in a controlled lab environment 22 to 24 °C (71.6 to 75.2 °F) with humidity between 45-55% in order to generate incoming data for the 1750 before an actual calibration is performed.

Equipment: Full Scale Calibration Standar; 17501 Kelvin Klip™ Leads

Preparation: Power up the Model 1750 and allow the unit to stabilize for a minimum of 30 minutes.

1. With the instrument Time Delay set to 111 ms when in the Delayed Continuous Mode (steps 2-12), manually select the 2 mΩ range by pressing the 2 mΩ range key. The instrument will need changed to Fast Continuous mode for steps 13-16.

NOTE: The Calibration Verification cannot be performed with the instrument in the AUTO range mode.

2. Connect the Kelvin Klips™ to the 2 mΩ standard securely and observe the subsequent reading. Record the resistance reading in the table below and verify that it falls within the specified allowable ranges.
3. Check either the PASS or FAIL box and proceed to the next calibration point. Repeat steps 1-3 until all ranges have been verified.
4. Should a range fail to meet calibration specifications, repeat the calibration procedure or call TEGAM for service.

#	Resistance Range	Specification (± counts)	Lower Allowable Limit	Read Value	Upper Allowable Limit	PASS √	FAIL √
1	AUTO RANGE IS NOT USED FOR VERIFICATION						
2	2 mΩ@1 A	± 9	1.9991		2.0009		
3	20 mΩ @ 1 A	± 8	19.992		20.008		
4	200 mΩ @ 1 A	± 6	199.94		200.06		
5	2 Ω @ 100 mA	± 6	1.9994		2.0006		
6	20 Ω @ 10 mA	±6	19.994		20.006		
7	200 Ω @ 10 mA	± 6	199.94		200.06		
8	2 kΩ @ 1 mA	±6	1.9994		2.0006		
9	20 kΩ @ 100 uA	± 6	19.994		20.006		
10	200 kΩ @ 10 uA	± 6	199.94		200.06		
11	2 MΩ @ 1 uA	± 10	1.9990		2.0010		
12	20 MΩ @ 100 nA	± 10	19.990		20.010		
13	200 mΩ Fast @ 1 A	± 15	199.85		200.15		
14	2 Ω Fast @ 100 mA	± 15	1.9985		2.0015		
15	20 Ω Fast @ 10 mA	± 15	19.985		20.015		
16	200 Ω Fast @ 10 mA	± 15	199.85		200.15		

INTERNAL JUMPERS

The Model 1750 has two internal user-changeable, jumpers, the calibration jumper, P9 and the RS232/RS422 configuration jumper. The unit is shipped from the factory with P9, in the operate position and configured for RS232. To change either of these configurations, follow the instructions below:

1. Remove all input cabling and line cords before opening unit.
2. Remove top cover Philip screws.
3. Slide the top cover backwards and off the unit.
4. Jumpers should be visible and can be modified.

Calibration Enable Jumper

To change the 1750 from operating mode to calibration mode, move jumper P9 from the normal, (operate) position to the calibrate position. After performing a calibration, be sure to return the jumper back to its normal position. Refer to Figure 6.1 for more details.

RS232/RS422 Configuration Jumper

To change the unit from RS232 operation to RS422 the communications printed circuit blocks must be swapped. From the factory the RS232 block is in SO2, which is designated as the active socket. The RS422 block is stored on SO1. Simply remove the RS232 block from the SO2 socket and replace it with the RS422 block. Place the RS232 block into SO2 for storage.

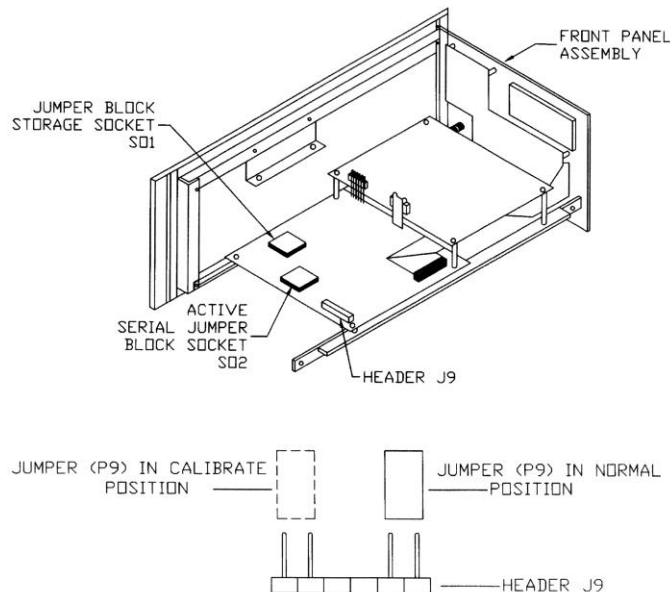

Figure: 6.1 Internal Jumpers

REPAIR PARTS

The Model 1750 has no user replaceable parts except for the accessories listed in Section 1 and the following items:

Periodically check the fan filter to be sure that it is not obstructed by dirt. If so, clean or replace the filter.

Replaceable Fan Filter

TEGAM P/N#378175000

Qualtech Electronics P/N#09250-F/45

Instructions for Fuse Replacement

Remove the line cord from the black input module. The fuses are located in the top compartment of this module. Remove the fuses by inserting a flat blade screwdriver into the tab and pulling the compartment from the module. There are two fuses in the compartment, one for the AC line and the other for AC neutral.

Fuse

For 120 V Operation; use 0.8 A @ 250 V, 5X20 mm, fast acting, TEGAM PN#FU-800

For 240 V Operation; use 0.5 A @ 250 V, 5X20 mm, fast acting, TEGAM PN#FU-500

Please refer to Appendix A for 1750/BAT fuse specifications.

If problems continue, please contact TEGAM for additional service information.

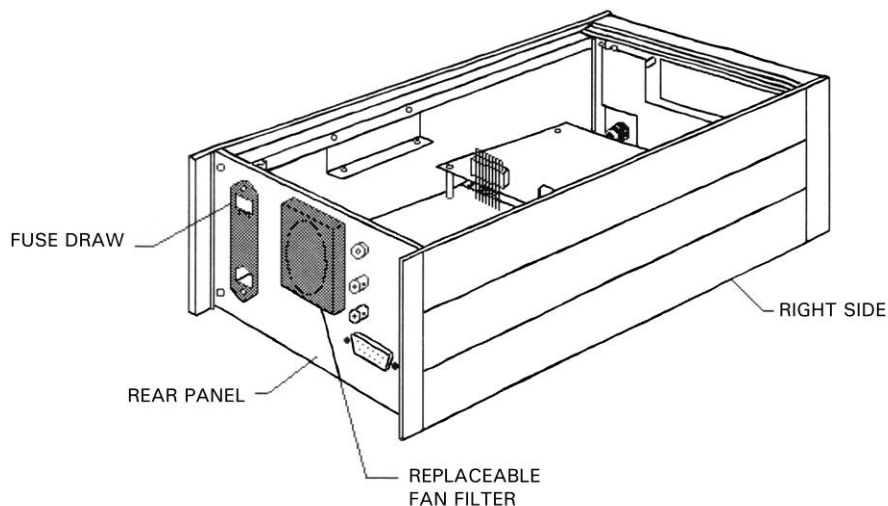

Figure: 6.2 Fuse and Filter Assemblies

TROUBLESHOOTING

The TEGAM Model 1750 has been designed to provide many years of trouble free performance. However, there are some instances where harsh operating environments or excessive physical strain may cause premature failure. Should a malfunction of the 1750 be discovered, it is recommended that certain steps be taken in order to assist our service department in identifying the cause of the malfunction and to provide the quickest possible turn around time for the repair cycle. Below is a summary of some commonly observed symptoms and some possible causes for them. These should be checked before sending the 1750 unit to TEGAM for repair.

No Display – The display is completely blank:

- Check the power supply. Make sure that the AC line is supplying power to the unit.
- Check the fuse located in the rear panel. If a blown fuse is identified, there is usually a reason for the fuse blowing, so the probability of another related problem is high. Send the unit in for service.

Reading Drifts – An accurate reading may be obtained but its value over a short period of time begins to climb or drop at a slow but noticeable rate.

- This is usually a sign of heating. It is very possible that the resistance of the test component is changing due to the 1750 test current. The resistance may drift upward or downward depending upon the temperature coefficient of the test component. Try testing at a lower current level or using a one shot trigger mode in order to reduce the amount of power being sent into the test component.
- Check the cooling fan operation to make sure that it is moving freely and there is no excessive bearing noise. Make sure the fan filter is clean and that air can move freely through the filter.

Unstable Reading – The reading bounces erratically with no apparent pattern. Depending on the measurement range and trigger mode, there is a certain allowable error for counts usually 2-5 counts. (See Section 1 for the exact specifications). Readings that bounce out of the specification ranges usually indicate a problem with noise.

- Make sure that the test leads or fixtures are manufactured by TEGAM. All accessories for the 1750 are specially designed to minimize the effects of external noise to the measurement signal.
- Check the Line Frequency option to make sure that the correct frequency is selected. The 1750 uses a special algorithm to eliminate noise created by line power.
- Verify that there are no sources of noise in close proximity to the 1750, test leads, power leads, or test fixture. The 1750 performs measurement in the nanovolt range and sources of noise such as CRTs, relays, and other switching devices are primary causes for erratic readings.
- Make sure that adequate settling time is permitted in order to receive a reading. Sometimes it takes time for the measurement to stabilize before data is read by the A/D.
- Make sure that the device being tested is not highly inductive. In some cases when involving motors, transformers, or excessive lengths of wire, the switching action of the test signal does not function well with high inductance. If there is an issue with a particular application, please call TEGAM and ask to speak with one of our applications engineers.

PREPARATION FOR CALIBRATION OR REPAIR SERVICE

Once you have verified that the cause for 1750 malfunction cannot be solved in the field and the need for repair and calibration service arises, contact TEGAM customer service to obtain an RMA, (Returned Material Authorization), number. You can contact TEGAM customer service via the TEGAM website, www.tegam.com or by calling 440.466.6100 (*All Locations*) OR 800.666.1010 (*United States Only*).

The RMA number is unique to your instrument and will help us identify your instrument and to address the particular service request by you which is assigned to that RMA number.

Of even importance, a detailed written description of the problem should be attached to the instrument. Many times repair turnaround is unnecessarily delayed due to a lack of repair instructions or of a detailed description of the problem.

This description should include information such as measurement range, and other instrument settings, type of components being tested, are the symptoms intermittent?, conditions that may cause the symptoms, has anything changed since the last time the instrument was used?, etc. Any detailed information provided to our technicians will assist them in identifying and correcting the problem in the quickest possible manner. Use a copy of the Repair and Calibration Service form provided on the next page.

Once this information is prepared and sent with the instrument to our service department, we will do our part in making sure that you receive the best possible customer service and turnaround time possible.

EXPEDITE REPAIR & CALIBRATION FORM

Use this form to provide additional repair information and service instructions. The Completion of this form and including it with your instrument will expedite the processing and repair process.

RMA#:		Instrument Model #:	
Serial Number:		Company:	
Technical Contact:		Phone Number:	
Additional Contact Info:			

Repair Instructions:

Evaluation Calibration Only Repair Only Repair & Calibration Z540 (Extra Charge)

Detailed Symptoms:

Include information such as measurement range, instrument settings, type of components being tested, is the problem intermittent? When is the problem most frequent?, Has anything changed with the application since the last time the instrument was used?, etc.

WARRANTY

TEGAM, Inc. warrants this product to be free from defects in material and workmanship for a period of one year from the date of shipment. During this warranty period, if a product proves to be defective, TEGAM Inc., at its option, will either repair the defective product without charge for parts and labor, or exchange any product that proves to be defective.

TEGAM, Inc. warrants the calibration of this product for a period of 6 months from date of shipment. During this period, TEGAM, Inc. will recalibrate any product, which does not conform to the published accuracy specifications.

In order to exercise this warranty, TEGAM, Inc., must be notified of the defective product before the expiration of the warranty period. The customer shall be responsible for packaging and shipping the product to the designated TEGAM service center with shipping charges prepaid. TEGAM Inc. shall pay for the return of the product to the customer if the shipment is to a location within the country in which the TEGAM service center is located. The customer shall be responsible for paying all shipping, duties, taxes, and additional costs if the product is transported to any other locations. Repaired products are warranted for the remaining balance of the original warranty, or 90 days, whichever period is longer.

Warranty Limitations

The TEGAM, Inc. warranty does not apply to defects resulting from unauthorized modification or misuse of the product or any part. This warranty does not apply to fuses, batteries, or damage to the instrument caused by battery leakage.

The foregoing warranty of TEGAM is in lieu of all other warranties, expressed or implied. TEGAM specifically disclaims any implied warranties of merchantability or fitness for a particular purpose. In no event will TEGAM be liable for special or consequential damages. Purchaser's sole and exclusive remedy in the event any item fails to comply with the foregoing express warranty of TEGAM shall be to return the item to TEGAM; shipping charges prepaid and at the option of TEGAM obtain a replacement item or a refund of the purchase price.

Statement of Calibration

This instrument has been inspected and tested in accordance with specifications published by TEGAM Inc. The accuracy and calibration of this instrument are traceable to the National Institute of Standards and Technology through equipment, which is calibrated at planned intervals by comparison to certified standards maintained in the laboratories of TEGAM Inc.

Contact Information:

TEGAM INC.
10 TEGAM WAY
GENEVA, OHIO 44041
CAGE Code: 49374

WEB: <http://www.tegam.com>



HIGH SPEED PROGRAMMABLE MICROOHMMETER (WITH BATTERY OPTION)

MODEL 1750/BAT



Appendix A

TABLE OF CONTENTS

Instrument Description	A-1
Performance Specifications	A-2
Battery Removal/Replacement	A-4

INSTRUMENT DESCRIPTION

The Model 1750/BAT is a battery powered model 1750 Microohmmeter. A rechargeable battery pack has been added to enhance the portability feature of the model 1750. Basic instrument operation remains unchanged, and the specifications listed in the 1750 instruction manual are valid. Additional specifications and support information for the new battery operated model is provided in this document.

This instrument will operate with either battery power or AC line power. (The battery does not have to be charged to operate with AC power.) The duration for battery-powered operation depends on the measurement range. It will operate 1 hour (minimum, continuous) at maximum current drain, or 4 hours under normal operating conditions. The unit will turn off automatically when the battery power drops below 12 VDC. The battery can be brought to full charge by leaving the instrument plugged in overnight, or for approximately 8 hours. The full charge point is 16.4 VDC.

PERFORMANCE SPECIFICATIONS

Battery Requirement:	16.4 V 5200 mAh Li-Ion
Power Requirements:	90 to 250 VAC, 50/60 Hz < 100 VA
Fuse:	2 x 3 A @ 250 V, 5X20 mm, Slow Blow, TEGAM PN#FU-505
Operating Time:	Dependent of range (refer to table 1). 1 to 4 Hours continuous operation.

RANGE	REFERENCE CURRENT							
	1 A	100 mA	10 mA	1 mA	100 μ A	10 μ A	1 μ A	100 nA
2 m Ω	1 Hour							
20 m Ω	1 Hour	4 Hours						
200 m Ω	1 Hour	4 Hours						
2 Ω		4 Hours	4 Hours					
20 Ω			4 Hours	4 Hours				
200 Ω			4 Hours	4 Hours	4 Hours			
2 k Ω				4 Hours	4 Hours			
20 k Ω					4 Hours	4 Hours		
200 k Ω						4 Hours		
2 M Ω							4 Hours	
20 M Ω								4 Hours

Table 1: Minimum Battery Operating Time (Continuous) with Respect to Range

Charging Time:	Approximately 8 hours for full charge.
Full Charge Level:	16.4 VDC
Environmental:	
Operating temperature	0 to 40 $^{\circ}$ C, <80% RH; (Non-Condensing)
Storage temperature	-20 to 60 $^{\circ}$ C, 90% RH (Non-Condensing)

A fully charged battery should power the 1750/BAT for approximately 4 hours continuously, with connection to an external resistor. Operation on any of the three lowest resistor ranges will reduce this to approximately 1 hour (refer to table 1). The battery may be discharged and recharged at least 100 completed cycles before requiring replacement.

There are two LEDs present on the battery board assembly, indicating the power and battery status. They are visible through the top cover.

Red LED indicates that the unit is plugged into an AC power line.

Green LED indicates the charging status of the battery. When this LED is ON and the instrument is plugged into an AC power line, the battery is fully charged. It has two charging modes.

Single Flash Mode – This mode shows low state of charge and that the battery is in the hard charge mode.

Double Flash Mode – This mode shows that the battery is trickle charging.

BATTERY REMOVAL/REPLACEMENT**FOR QUALIFIED SERVICE PERSONNEL ONLY****SERVICING SAFETY SUMMARY****Use Care When Servicing with Power On**

Dangerous voltages may exist at several points in this product. To avoid personal injury or damage to this equipment, avoid touching exposed connections or components while the power is on. Assure that the power is off when removing panels, soldering, or replacing components.

Power Source

This product is intended to connect to a power source that will not apply more than 250 V_{RMS} between the supply conductors or between either supply conductor and ground. A protective ground connection by way of the grounding conductor in the power cord is essential for safe operation.

WARNING

TO AVOID PERSONAL INJURY FROM ELECTRIC SHOCK, DO NOT REMOVE INSTRUMENT COVERS OR PERFORM ANY MAINTENANCE OTHER THAN DESCRIBED IN THIS MANUAL. INSTALLATION AND MAINTENANCE PROCEDURES DESCRIBED ARE TO BE PERFORMED BY QUALIFIED SERVICE PERSONNEL ONLY.

**CAUTION**

BATTERIES INSTALLED WITH THE WRONG POLARITY MAY SERIOUSLY DAMAGE THE INSTRUMENT AND DEGRADE THE LIFE OF THE BATTERY. OPERATOR SHOULD WEAR A GROUNDING WRIST WRAP WHILE PERFORMING THE BATTERY REPLACEMENT.

A user may replace the battery pack, in case the battery stops holding the charge. The battery replacement kit part number is 1750/BAT-910. This kit contains two battery packs connected in parallel with a custom connector, two tie wraps and a jumper.

Follow the step by step procedure provided below to replace the battery:

1. Turn instrument power OFF. Remove the AC power connection.
2. Remove the rear panel screws holding the top cover.
3. Slide the cover off toward the rear and set aside.

4. Install jumper J102. This ensures that the battery charge control circuit is in the shutdown state to facilitate the replacement procedure. Refer to figure 1 for the jumper position.
5. Cut the old tie wraps.
6. Remove connector P101 from J101.
7. Remove the old battery.
8. Install the new battery.
9. Tie the tie wraps.
10. Connect P101 to J101.
11. Remove jumper J102.
12. Reinstall the top cover and connect the 1750/BAT to its power source. Allow approximately 8 hours to charge the battery.

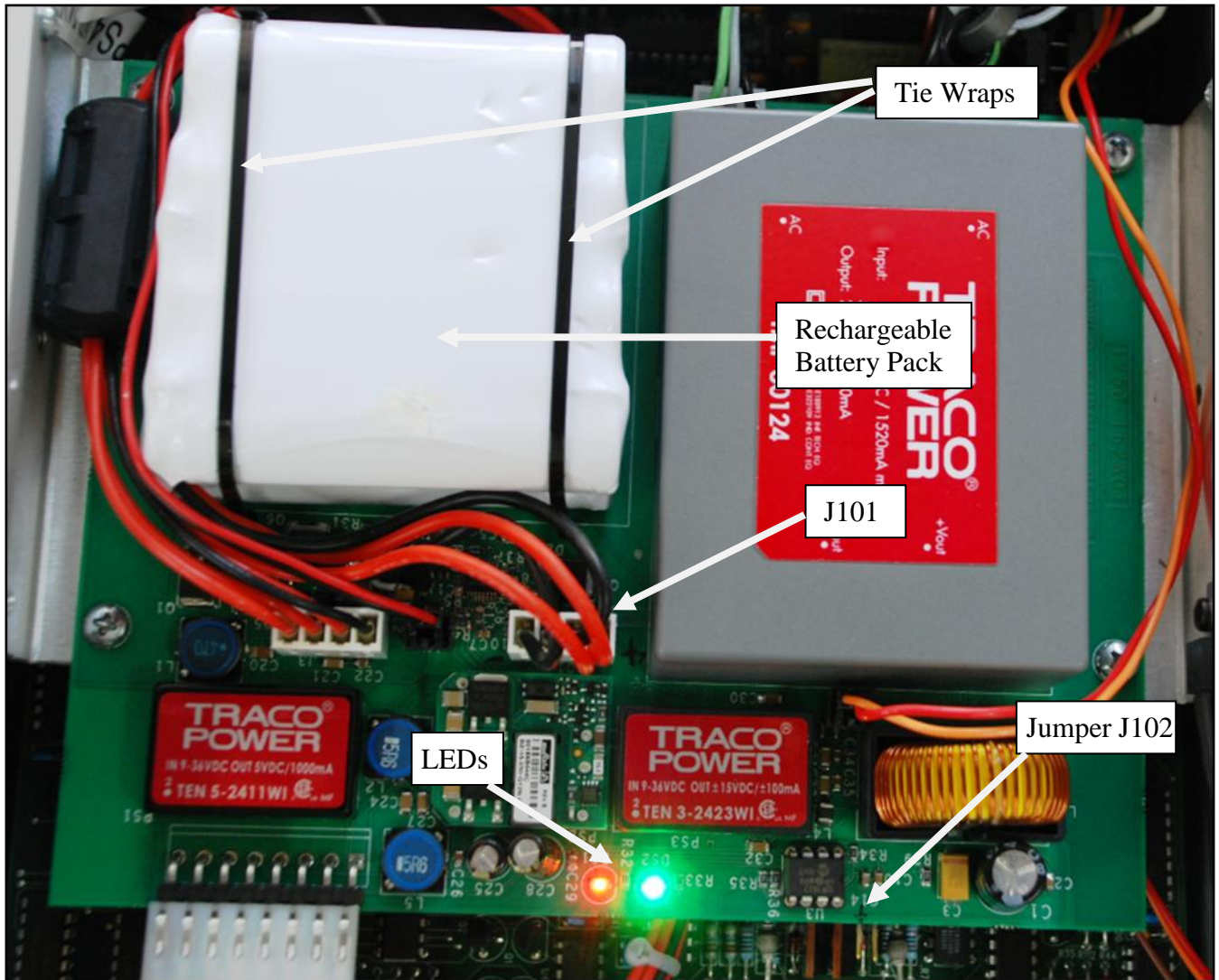

Figure 1: Rechargeable Battery Assembly

Contact Information:

TEGAM INC.
10 TEGAM WAY
GENEVA, OHIO 44041
CAGE Code: 49374

WEB: <http://www.tegam.com>

