



S904 and S904D Humidity & Temperature Calibrator User's Manual



Please fill out the form(s) below for each instrument that has been purchased.

Use this information when contacting Michell Instruments for service purposes.

Instrument	
Code	
Serial Number	
Invoice Date	
Location of Instrument	
Tag No	

Instrument	
Code	
Serial Number	
Invoice Date	
Location of Instrument	
Tag No	

Instrument	
Code	
Serial Number	
Invoice Date	
Location of Instrument	
Tag No	



S904

For Michell Instruments' contact information please go to
www.michell.com

© 2016 Michell Instruments

This document is the property of Michell Instruments Ltd. and may not be copied or otherwise reproduced, communicated in any way to third parties, nor stored in any Data Processing System without the express written authorization of Michell Instruments Ltd.

Contents

Safety	vi
Electrical Safety	vi
Toxic Materials	vi
Repair and Maintenance	vi
Calibration	vi
Safety Conformity	vi
Abbreviations	vii
Warnings	viii
1 INTRODUCTION	1
1.1 Description	1
1.1.1 Comparison of the S904 and S904D	2
1.2 System Components	3
1.2.1 S904	3
1.2.2 S904D	5
2 INSTALLATION	7
2.1 Installing the Relative Humidity and Temperature Control Probe.....	7
2.2 Filling the Water Reservoir	9
2.3 Draining the Water Reservoir.....	10
2.4 Desiccant	11
2.5 Power Supply	12
3 OPERATION	13
3.1 Preparation	13
3.1.1 Installing Relative Humidity Instruments for Calibration	13
3.2 Start-Up.....	14
3.3 Manual Control of Humidity and Temperature Setting.....	14
3.4 Typical Response Times for Various Step Changes.....	14
3.5 Maximum Humidity Levels That can be Generated by the S904 Series	15
3.6 25 pin D-sub Connector - S904.....	16
3.7 Automatic Control of Temperature and Humidity Set Points - S904	17
3.7.1 25 pin D-sub Connector - Rear Panel and Inside Chamber - S904D.....	18
3.7.2 S904D Example Wiring Diagrams	19
4 APPLICATION SOFTWARE - S904D	21
4.1 Connecting and Starting the S904D Software	21
4.2 LabVIEW® Software Menu Structure	22
4.2.1 Command - File	22
4.2.2 Command - Settings.....	23
4.2.3 Command - Tools.....	24
4.2.4 Command - Help	30
4.3 LabVIEW® Software User Interface	31
5 MAINTENANCE	40
5.1 Troubleshooting.....	40

Figures

Figure 1	S904	2
Figure 2	S904D	2
Figure 3	S904 - Front View.....	3
Figure 4	S904 - Back Panel	4
Figure 5	S904D Front panel.....	5
Figure 6	S904D - Back Panel	6
Figure 7	Control Probe Installation.....	7
Figure 8	Location of Control Probe Inside the Climate Chamber	8
Figure 9	Filling the Water Reservoir	9
Figure 10	Emptying the Water Reservoir	10
Figure 11	Desiccant Replacement.....	11
Figure 12	Level of Silica Gel Required	11
Figure 13	Probe Ports.....	13
Figure 14	Port Adapter Removal Tool	13
Figure 15	Port Adapters and Removal Tool	13
Figure 16	Humidity and Temperature Setting Switches.....	14
Figure 17	25 pin D-sub Connector Location.....	16
Figure 18	25 pin D-sub Connector	16
Figure 19	Switches.....	17
Figure 20	25 pin D-sub Connector	18
Figure 21	S904D Wiring Diagram Example 1	19
Figure 22	S904D Wiring Diagram Example 2	20

Tables

Table 1	Typical Response Times for Step Changes	14
---------	---	----

Appendices

Appendix A	Technical Specifications.....	42
Appendix B	EU Declaration	44
Appendix C	Quality, Recycling & Warranty Information.....	46
	C.1 Pressure Equipment Directive (PED) 97/23/EC	46
	C.2 Recycling Policy	46
	C.3 WEEE Compliance.....	46
	C.4 RoHS2 Compliance	47
	C.5 Warranty.....	47
	C.6 REACH Compliance	48
	C.7 Return Policy	48
	C.8 Calibration Facilities	49
	C.9 Manufacturing Quality	49
	C.10 FCC (EMC Requirements for North America)	49
Appendix D	Return Document & Decontamination Declaration	51

Safety

The manufacturer has designed this equipment to be safe when operated using the procedures detailed in this manual. The user must not use this equipment for any other purpose than that stated. Do not apply values greater than the maximum value stated.

This manual contains operating and safety instructions, which must be followed to ensure the safe operation and to maintain the equipment in a safe condition. The safety instructions are either warnings or cautions issued to protect the user and the equipment from injury or damage. Use qualified personnel and good engineering practice for all procedures in this manual.

Electrical Safety

The instrument is designed to be completely safe when used with options and accessories supplied by the manufacturer for use with the instrument.

Toxic Materials

The use of hazardous materials in the construction of this instrument has been minimized. During normal operation it is not possible for the user to come into contact with any hazardous substance which might be employed in the construction of the instrument. Care should, however, be exercised during maintenance and the disposal of certain parts.

Repair and Maintenance

The instrument must be maintained either by the manufacturer or an accredited service agent. Refer to www.michell.com for details of Michell Instruments' worldwide offices contact information.

Calibration

The internal reference probe (HT961T00) should be re-calibrated annually. The probe should be returned to the manufacturer, Michell Instruments, or one of their accredited service agents for re-calibration.

Safety Conformity

This product meets the essential protection requirements of the relevant EU directives. Further details of applied standards may be found in the product specification.

Abbreviations

The following abbreviations are used in this manual:

°C	degrees Celsius
°F	degrees Fahrenheit
AC	alternating current
DC	direct current
max	maximum
min	minimum
%	percentage
RH	relative humidity
RS232	serial data transmission standard
T	temperature
USB	Universal Serial Bus
V	Volts
mA	milli Ampere

Warnings

The following general warnings listed below are applicable to this instrument. They are repeated in the text in the appropriate locations.



Where this hazard warning symbol appears in the following sections it is used to indicate areas where potentially hazardous operations need to be carried out.



Where this symbol appears in the following sections it is used to indicate areas of potential risk of electric shock.

1 INTRODUCTION

1.1 Description

The S904 Series are completely stand-alone and transportable calibrators for humidity sensors, requiring no external services other than mains power. The calibrator is capable of humidity generation over the range of 10-90% RH, with temperature control from +10 to +50°C (+50 to +122°F). The calibration chamber features 5 interchangeable ports to accommodate virtually any brand, type or model of sensor. This calibrator is ideal for companies or organizations looking to calibrate large numbers of probes in a laboratory or field setting.

The environment within the insulated calibration chamber is temperature controlled using a 4-zone fan assisted Peltier arrangement for maximum stability, and minimum temperature gradient. The humidity of the circulating air is precisely regulated using a closed-loop control system that functions by proportionally mixing flows of dry and saturated air.

Two highly visible LED panels display the current humidity and temperature within the calibration chamber. The response time to a humidity or temperature step change is typically less than 10 minutes, so a simple 3-point calibration can be carried out in under an hour.

The S904 Series is easy to maintain. The desiccant changes color to indicate when it needs to be recharged and this is visible through a clear window on the front of the unit. Recharging the desiccant is simply a matter of heating it in a conventional oven at +130°C (266°F) for 3 hours. The water reservoir at the front of the unit shows the current saturator fill level, and makes it easy to top-up with distilled water when required. The only external service required is a single phase power supply.

There are two versions available:

- S904
- S904D

With the S904D version, the humidity and temperature set points of the chamber can be controlled with the supplied PC application software, enabling the operator to create completely automated calibration profiles for unattended laboratory operation. The software also gives the ability to monitor, chart and log data from the probes connected to the S904D or application software for later analysis. Alternatively, the set points can be controlled manually with the front panel controls - making the S904 Series ideal for field calibrations where a PC is not available.

1.1.1 Comparison of the S904 and S904D

The S904D has the Data Acquisition connector on the rear panel, and a blanking plate fitted to the front panel, as shown in *Figure 2*.

The S904D also features a USB, and an RS232 port on the rear panel, for communication with the LabVIEW® application software.

Front Panel

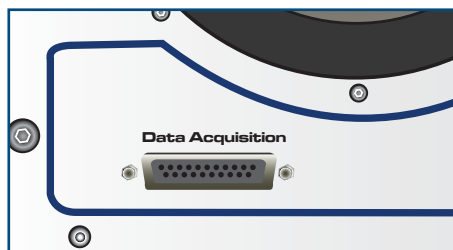

Figure 1 *S904*

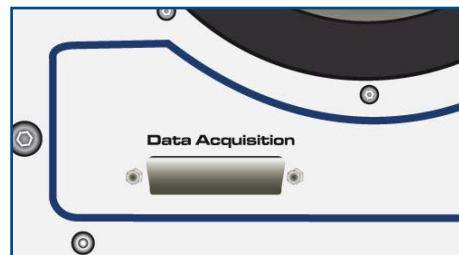

Figure 2 *S904D*

1.2 System Components

1.2.1 S904

Front Panel S904

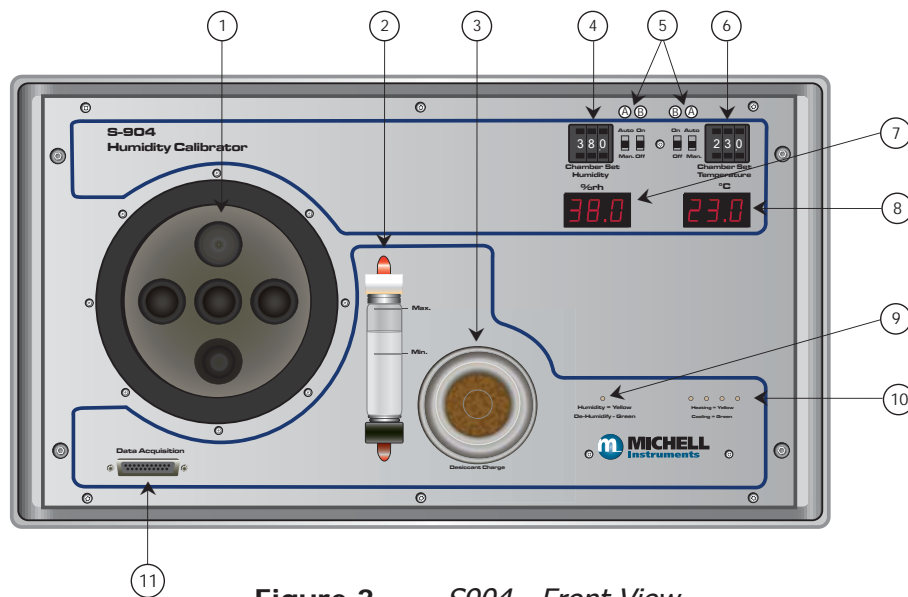

Figure 3 S904 - Front View

1. Chamber door
2. Water reservoir
3. Desiccant cell and indicator window
4. Relative humidity set point (% RH)
5. **A** Manual/Auto switches for relative humidity / temperature control
MAN - Setpoint is set by switch 4 (humidity) and switch 6 (temperature)
AUTO - Remote control of relative humidity / temperature set points (see Section 3.7).
6. Temperature setpoint (°C)
7. Humidity level indicator
8. Temperature level indicator
9. Humidity control indication LED
 Humidify (yellow)
 De-humidify (green)
10. 4-Zone chamber temperature control indication LEDs
 Heating (yellow)
 Cooling (green)
11. Data acquisition connector

Back Panel S904

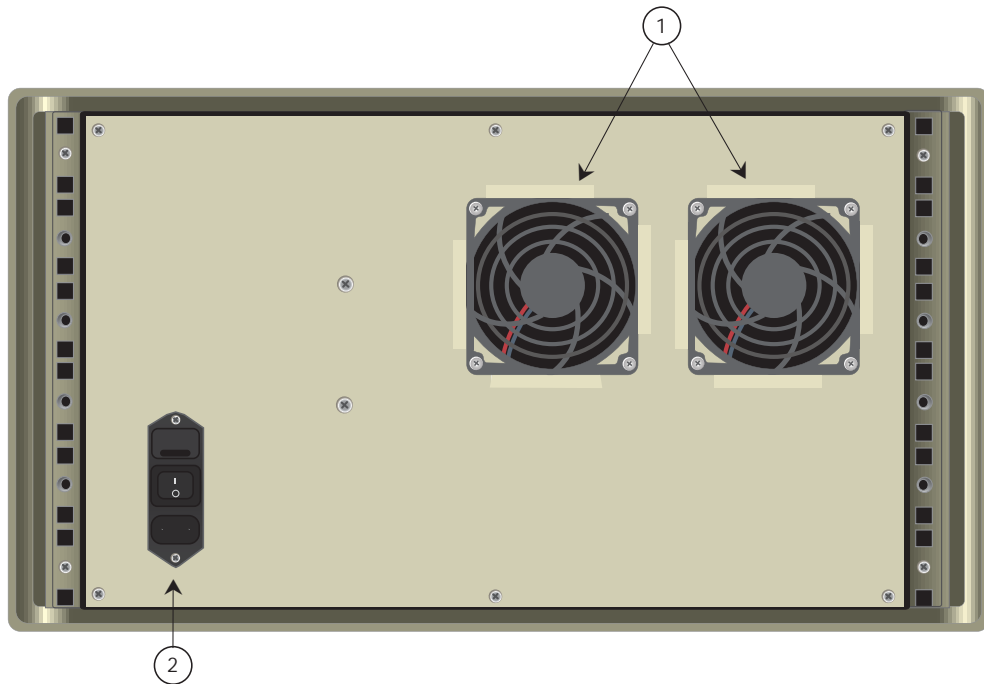

Figure 4 *S904 - Back Panel*

1. Ventilation fans
2. Electrical mains connector, on/off switch and power input fuse

Accessories

The S904 humidity and temperature generator is delivered with the following standard accessories:

- Bottle of distilled water
- Desiccant cell filled with silica gel
- HT961T00 control probe
- Chamber door (according to customer specification)
- IEC mains cable
- Calibration certificate for internal reference probe
- Certificate of conformity (graph)
- User's Manual

1.2.2 S904D

Front Panel S904D

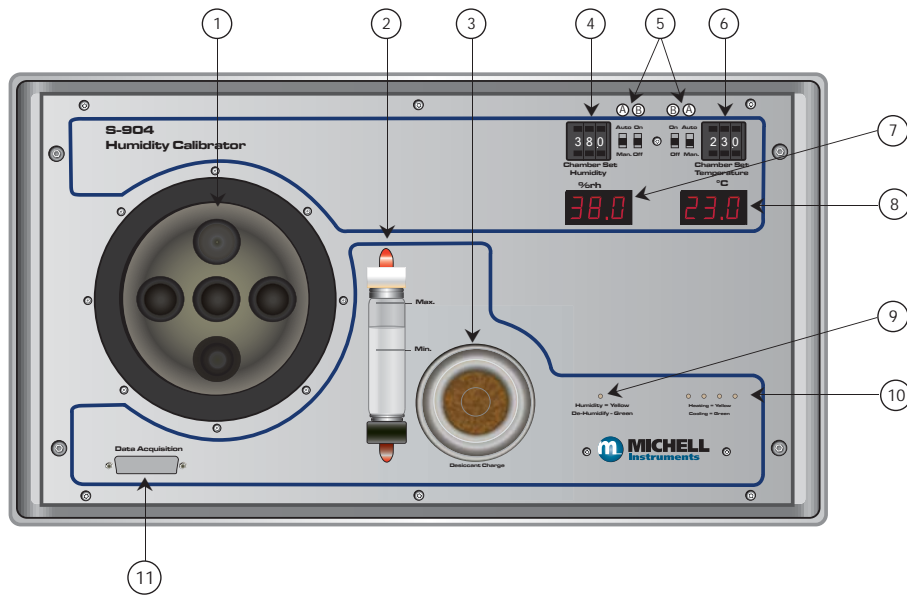

Figure 5 S904D Front panel

1. Chamber door
2. Water reservoir
3. Desiccant cell and indicator window
4. Relative humidity set point (% RH)
5. **A** Manual/Auto switches for relative humidity / temperature control
MAN - Setpoint is set by switch 4 (humidity) and switch 6 (temperature)
AUTO - Remote control of relative humidity / temperature set points (see Section 3.7).
6. Temperature setpoint (°C)
7. Humidity level indicator
8. Temperature level indicator
9. Humidity control indication LED
Humidify (yellow)
De-humidify (green)
10. 4-Zone chamber temperature control indication LEDs
Heating (yellow)
Cooling (green)
11. Blind plate

Back Panel S904D

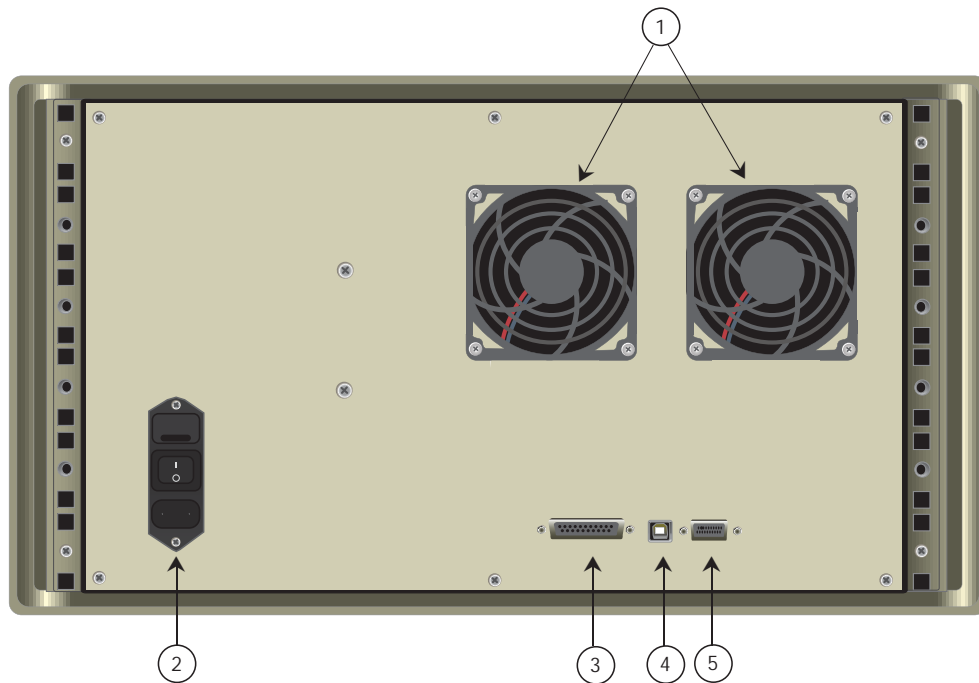

Figure 6 S904D - Back Panel

1. Ventilation fans
2. Electrical mains connector, on/off switch and power input fuse
3. Data acquisition connector
4. USB connection
5. RS232 connection

Accessories

The S904D humidity and temperature generator is delivered with the following standard accessories:

- Bottle of distilled water
- Desiccant cell filled with silica gel
- HT961T00 control probe
- Chamber door (according to customer specification)
- IEC mains cable
- Calibration certificate for internal reference probe
- Certificate of conformity (graph)
- User's Manual
- USB cable
- LabVIEW® software

2 INSTALLATION



Before using the S904 Series, make sure that Sections 2.1, 2.2 and 2.4 are read thoroughly.

The S904 Series' enclosure is designed for bench top mounting in a laboratory type environment. It must be positioned in a clean and level location with sufficient clearance at the rear of the enclosure for adequate ventilation.



The S904 Series is not designed to be fully portable. However it can easily be moved to any suitable location for use. Before moving ensure that any water in the reservoir is drained and the relative humidity control probe in the chamber is removed.

The S904 Series should NOT be moved while in operation.

2.1 Installing the Relative Humidity and Temperature Control Probe

The HT961T00 Relative Humidity and Temperature Control Probe is supplied as an accessory with the S904 Series. This control probe is removed during transportation.

To install the control probe remove the chamber door and plug in the probe as shown in *Figure 7*.

This internal control probe is delivered with its own calibration certificate.

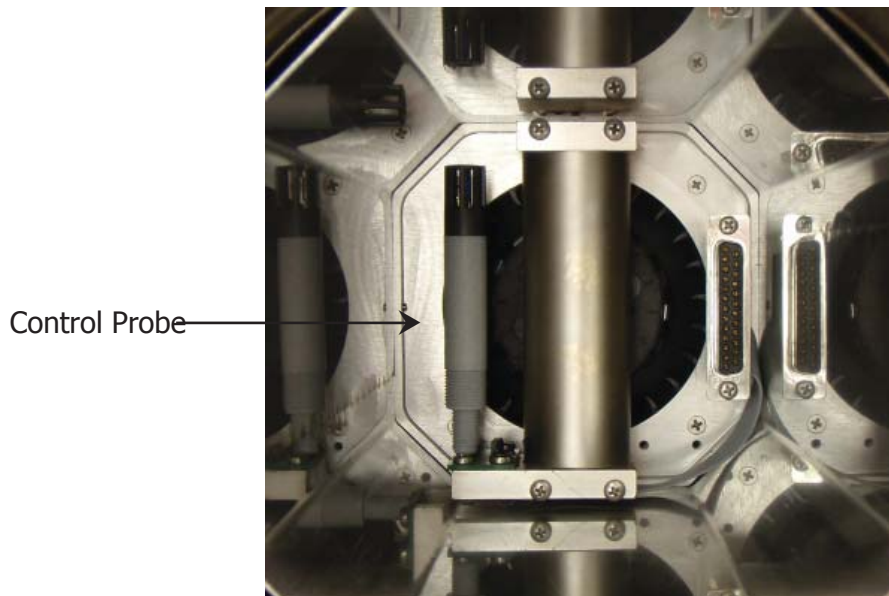

Figure 7 Control Probe Installation



The chamber control relative humidity and temperature probe must always be removed during transportation.

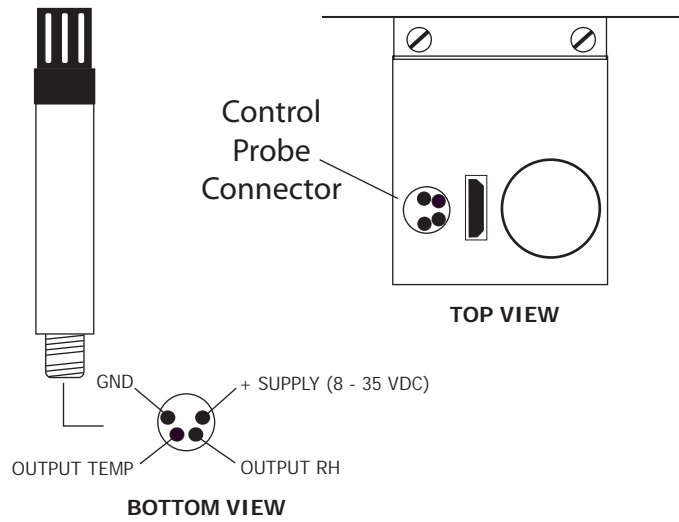

Figure 8 *Location of Control Probe Inside the Climate Chamber*

2.2 Filling the Water Reservoir

Before operation the water reservoir located on the front panel must be filled with distilled water (supplied with the instrument).



Do not use tap water or demineralized water!



Figure 9 *Filling the Water Reservoir*

Use the bottle supplied to fill the water reservoir.

1. Remove the red plastic cap from the top of the reservoir.
2. Carefully fill with clean distilled water to a level between the two indicator lines.
3. Replace the red cap on the water reservoir after filling.



Do NOT fill above the MAX indicated line as this may cause liquid to enter the humidity chamber and adversely affect the control process.

2.3 Draining the Water Reservoir

Drain the water reservoir before transporting, or if the system is accidentally overfilled.

To empty the water reservoir:

1. Remove the red caps from the bottom and top of the water reservoir.
2. Drain the water into a suitable container.
3. Tilt the instrument to empty the reservoir completely.
4. Re-fit the red cap after emptying.

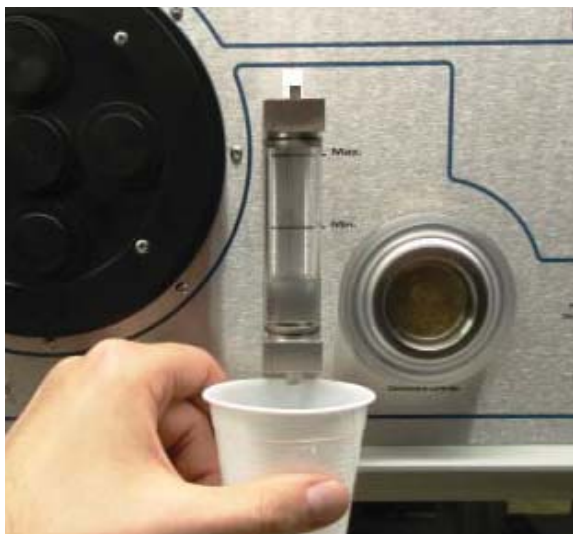

Figure 10 *Emptying the Water Reservoir*



It is essential to drain the water reservoir before transporting or when the system is not going to be used for a few weeks.

Do not re-use any of the drained water within the system.

2.4 Desiccant

The S904 Series has a container filled with a desiccant which is used to dry the air.

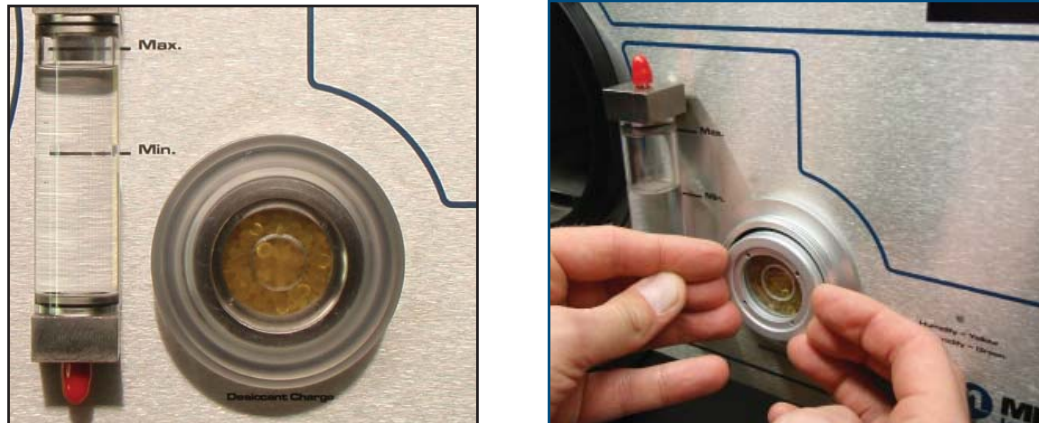

Figure 11 *Desiccant Replacement*

The desiccant container can be accessed by following these steps:

1. Remove the clear plastic screw cap on the front panel.
2. Pull out the desiccant container using the finger tips.
3. Fill with desiccant up to the thread as shown in *Figure 12* below.



Figure 12 *Level of Silica Gel Required*

The natural color of the desiccant (dry silica gel) should be orange, or blue (depending on type). As moisture is absorbed, the color will gradually change to transparent or pink (depending on type). When the desiccant has become transparent or pink - this is an indication that the instrument's ability to generate low humidity is reduced. It is recommended that the silica gel is replaced or regenerated at this time.

The desiccant can be regenerated by emptying it completely from the desiccant chamber and drying it in an oven for approximately 3 hours at a temperature of +130°C (266°F). After drying it in an oven, allow the desiccant to cool before refilling the desiccant chamber and refitting the chamber into the generator. Ensure that the screw lid is correctly fitted.

Frequency of desiccant regeneration or replacement is dependant entirely upon the length of time in operation. Typically, given a normal calibration profile and operation cycle, the S904 Series can continually generate accurate and stable chamber humidity for a period of several weeks before regeneration or replacement of the desiccant is necessary.

2.5 Power Supply

A single mains power supply between 100 to 240 V AC is required to operate the unit.

The power supply connection is a 3-pin IEC plug located on the rear panel of the instrument. The **ON/OFF** switch and the power input fuse are in the same location, adjacent to the power socket.

A 3-core power cable is provided.



The instrument must be connected to an electrical earth for safety purposes.

3 OPERATION

3.1 Preparation

3.1.1 Installing Relative Humidity Instruments for Calibration

Relative humidity probes can easily be installed into the humidity chamber through the ports in the door. The amount and size of the ports are supplied per customer specification.

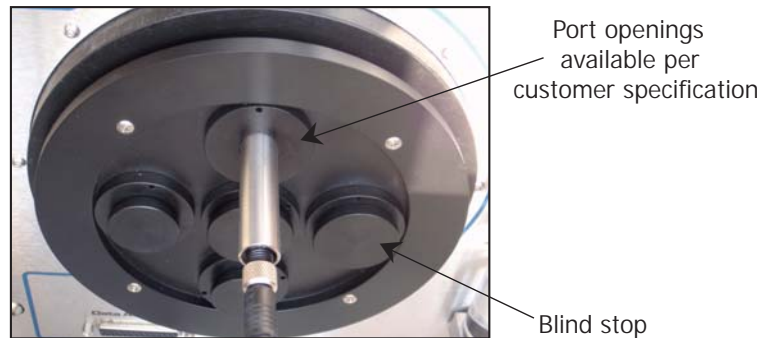

Figure 13 *Probe Ports*

NOTE: Ports which are not being used should be covered with a blind stop to exclude temperature and relative humidity influences from outside the chamber.

NOTE: If a door without ports (A000268) is used, the probes to be tested must be placed inside the measurement chamber. To ensure good air flow do not overfill the chamber with probes.

The port adapters can be changed using a port adapter removal tool (A000265) available from Michell Instruments.



Figure 14 *Port Adapter Removal Tool*

Insert the two pegs on the adapter tool into the corresponding holes on the port adapter and turn counter-clockwise to loosen and clockwise to tighten.

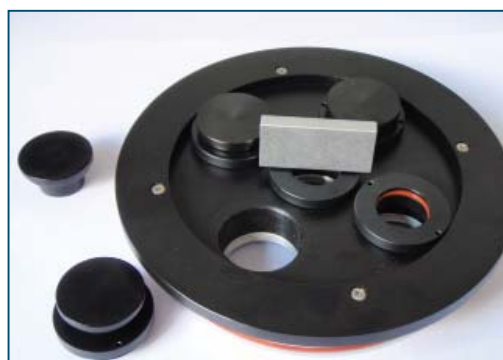

Figure 15 *Port Adapters and Removal Tool*

3.2 Start-Up

After installing the instruments for calibration, switch on the S904 Series by using the ON/OFF switch on the rear panel of the instrument.

3.3 Manual Control of Humidity and Temperature Setting

The desired percentage of relative humidity and temperature (in °C) can be manually set by using the humidity and temperature setting switches when the **AUTO/MAN** switches are in the **MAN** position. Humidity or temperature control can be enabled or disabled individually using the associated **ON/OFF** switch.

NOTE: Sufficient time must be allowed for the S904 Series to thermally stabilize before monitoring the humidity and temperature readings.

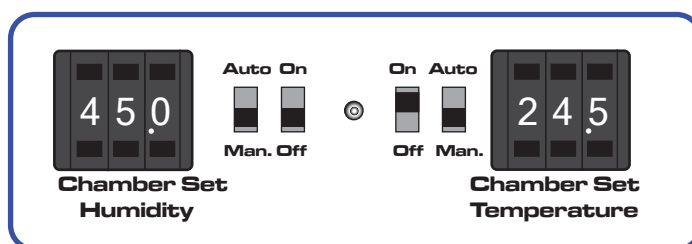

Figure 16 Humidity and Temperature Setting Switches

3.4 Typical Response Times for Various Step Changes

Typical response times for various step changes are shown in Table 1 below. T100 represents the total time taken to reach stability at the new setpoint.

T63 and T95 values represent the time taken to reach 63% and 95% respectively of the step change in relative humidity and/or temperature. (Start temperature = 23°C / Start RH = 50%)

Temperature	°C	RH %	T63	T95	T100
Step 1	15	20	≤12 mins	≤23 mins	≤26 mins
Step 2	15	50	≤2 mins	≤3 mins	≤5 mins
Step 3	15	80	≤3 mins	≤7 mins	≤9 mins
Step 4	25	20	≤3 mins	≤5 mins	≤14 mins
Step 5	25	80	≤3 mins	≤8 mins	≤10 mins

The time taken depends on the quality of the desiccant and the overall temperature of the S904 Series' calibration chamber

Table 1 Typical Response Times for Step Changes

The S904 Series can also be used with relative humidity generation only or with temperature generation only.

For example: If the calibration of the instruments is complete and new instruments need to be inserted, both switches can be set to **OFF**. This will cause the pump to switch off in order to save energy.

If only temperature calibration is needed, humidity generation can be switched off. **NOTE: In this instance, the pump will also stop.**

The minimum chamber temperature that can be reached is about 10°C (18°F) below ambient temperature. The maximum chamber temperature is limited to about +52°C (+125°F).

3.5 Maximum Humidity Levels That can be Generated by the S904 Series

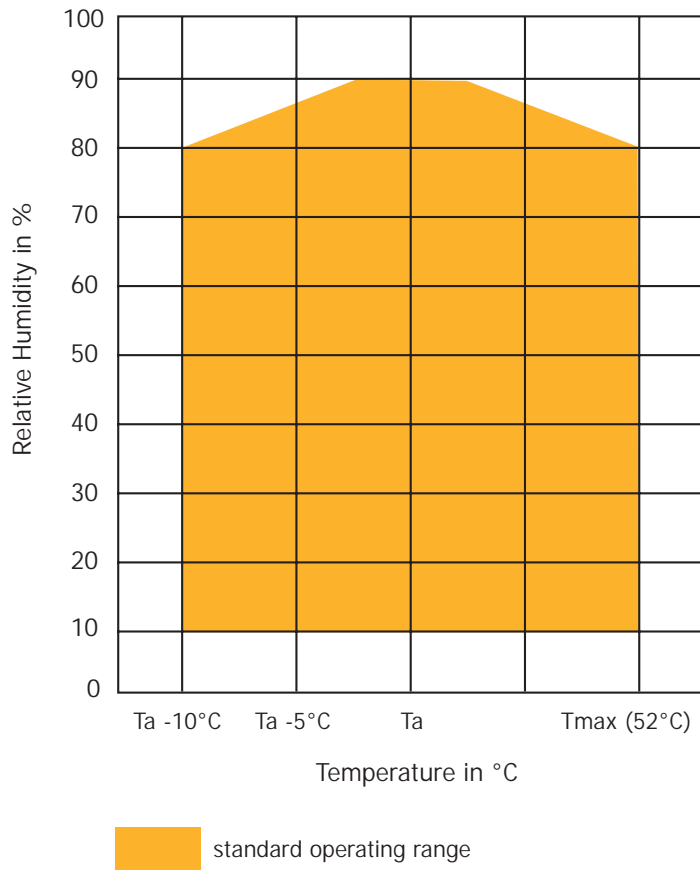

3.6 25 pin D-sub Connector - S904

These two connectors provide % RH and temperature outputs from the chamber control probe. 15 free pins wired from the internal chamber connector to the front panel connector can be used for any purpose.

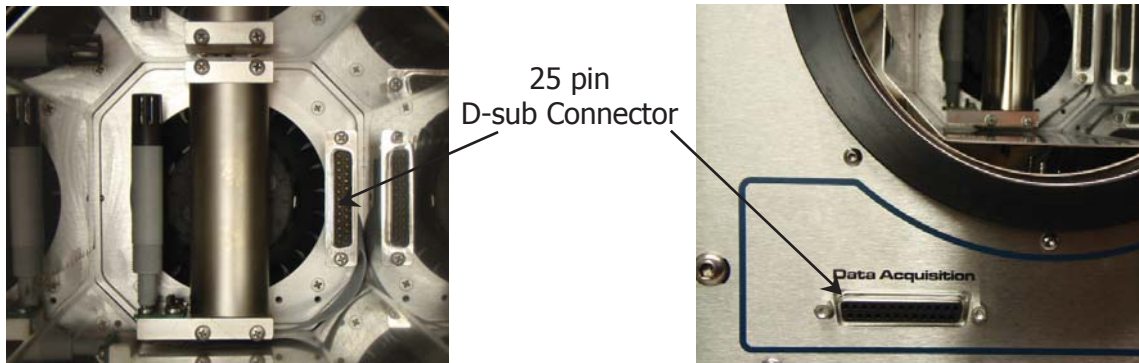

Figure 17 25 pin D-sub Connector Location

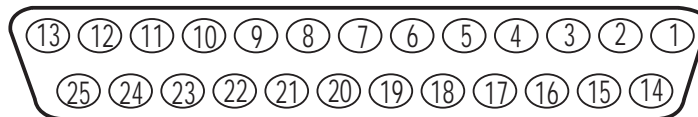

Figure 18 25 pin D-sub Connector

Pins	Function
1,2,3,4,5,6,7,8 & 14,15,16,17,18,19,20	Free (Unused)
21 (Front panel only)	Ground
9 (Front panel only)	Control probe output, Temperature 0 to 100°C, 0 to 10 V fixed output
22 (Front panel only)	Control probe output, % RH 0-100% RH, 0 to 10 V fixed output
24 (Front panel only)	External set point control enable input 0 V DC / Not connected = Manual control 5 V DC = Enable external set point control
10 (Front panel only)	Temperature setpoint control input 0 to 10 V, 0 to 100°C
23 (Front panel only)	% RH setpoint control input 0 to 10 V, 0-100% RH
11,12,13,25	Reserved – Do not use

Free (Unused)

These pins are wired from the 25-pin connector inside the chamber to straight through to the 25-pin connector on the front panel, and can be used for any purpose.

These pins have a maximum current rating of 100 mA, and a maximum voltage rating of 50 V, which must not be exceeded.

Ground

This pin is connected to the ground of the internal power supply.

Control Probe Outputs, Temperature and %RH

These are fixed 0 to 10 V outputs from the control probe inside the chamber, ranged from 0 to 100°C and 0-100% RH respectively.

External set point control

To enable external setpoint control, connect +5 V to this pin with respect to ground.

3.7 Automatic Control of Temperature and Humidity Set Points - S904

These instructions do not apply to the S904D.

To enable the S904 set points to be controlled using a voltage input:

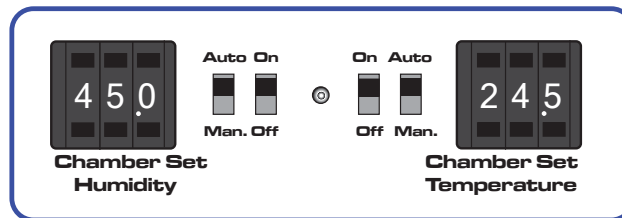

Figure 19 Switches

1. Put the **MAN/AUTO** switches into the **AUTO** position.
2. Put the **ON/OFF** switches into the **ON** position.
3. Connect +5 V to pin 24 with respect to ground (pin 21) to enable external control of the set points.

The unit is now ready to accept external inputs.

External inputs:

- %RH set point
Pin 23, Input: 0 to 10 V, Range: 0 to 100%
- Temperature set point
Pin 10, Input: 0 to 10 V, Range: 0 to 100°C

NOTE: Connections to the external inputs should be made with respect to ground on pin 21.

NOTE: The maximum temperature in the climate chamber that can be reached is 52°C, and the minimum is 10°C (18°F) below the ambient temperature.

3.7.1 25 pin D-sub Connector - Rear Panel and Inside Chamber - S904D

These two connectors provide 6 channels for data acquisition, a +14.5 V supply, ground connection and 9 free pins wired from the internal chamber connector to the rear panel connector that can be used for any purpose.

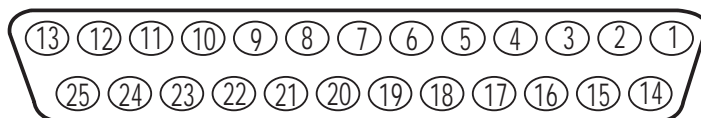

Figure 20 25 pin D-sub Connector

Pins	Function
1,2,3,4,5 & 14,15,16,17	Free (Unused)
9	Channel 1 Control probe output, Temperature 0 to 100°C, 0 to 10 V fixed output
22	Channel 2 Control probe output, % RH 0-100% RH, 0 to 10 V fixed output
24 (Front panel only)	External set point control enable input 0 V DC / Not connected = Manual control 5 V DC = Enable external set point control
8	Channel 3
20	Channel 4
7	Channel 5
19	Channel 6
6	Channel 7
18	Channel 8
25	+14.5 V supply
21	Ground
10,11,12,13,23,24	Reserved – Do not use

Free (Unused)

These pins are wired from the 25-pin connector inside the chamber to straight through to the 25-pin connector on the rear panel, and can be used for any purpose.

These pins have a maximum current rating of 100 mA, and a maximum voltage rating of 50 V, which must not be exceeded.

Channels 1-2

These channels are connected to the built-in RH probe and are always logged by the S904D Labview® Software.

Channels 3-8

These channels accept a 0 to 10 V input and can also be logged by the S904D Labview® Software.

14.5 V Supply - PIN 25

This pin is connected to the internal power supply of the S904D and can be used to provide power to probes inside the chamber.

NOTE: For safety purposes the power supply is fitted with a thermal cut-out that is connected to the rear panel 25-pin connector only. It is important that this thermal cut-out is not bypassed, or the instrument may be damaged in the event of a fault. Refer to Figures 21 and 22 for detailed drawings showing how to correctly wire the power supply.

Ground - PIN 21

This pin is connected to the ground of the internal power supply.

Reserved – Do not use - PINS 10, 11, 12, 13, 23, 24



Warning
Applying a current or voltage to the Reserved PINS may cause permanent, irreversible damage to the S904D electronics.

3.7.2 S904D Example Wiring Diagrams

The following diagram shows how to connect three %RH probes using the 25-pin D-sub connector inside the chamber, and powering the probes using the internal S904D power supply while logging their %RH and temperature outputs.

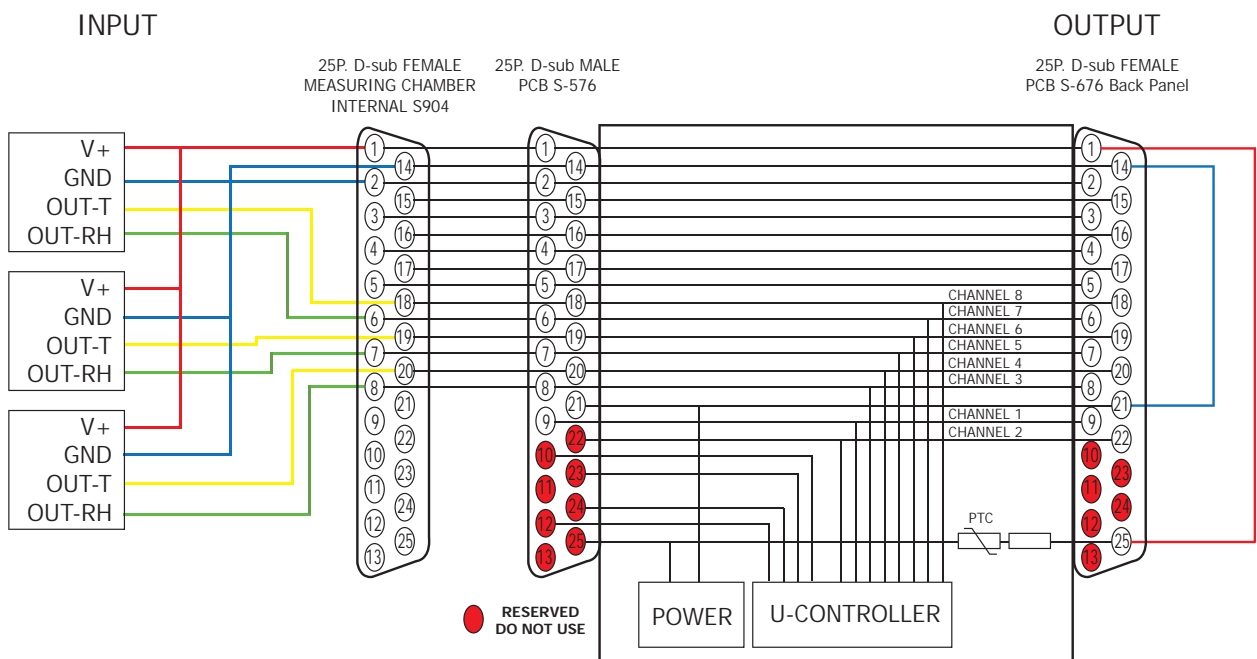

Figure 21 S904D Wiring Diagram Example 1

The following diagram shows how to connect three % RH probes using the 25-pin D-sub connector on the rear panel of the S904D, and powering the probes using the internal S904D power supply while logging their % RH and temperature outputs.

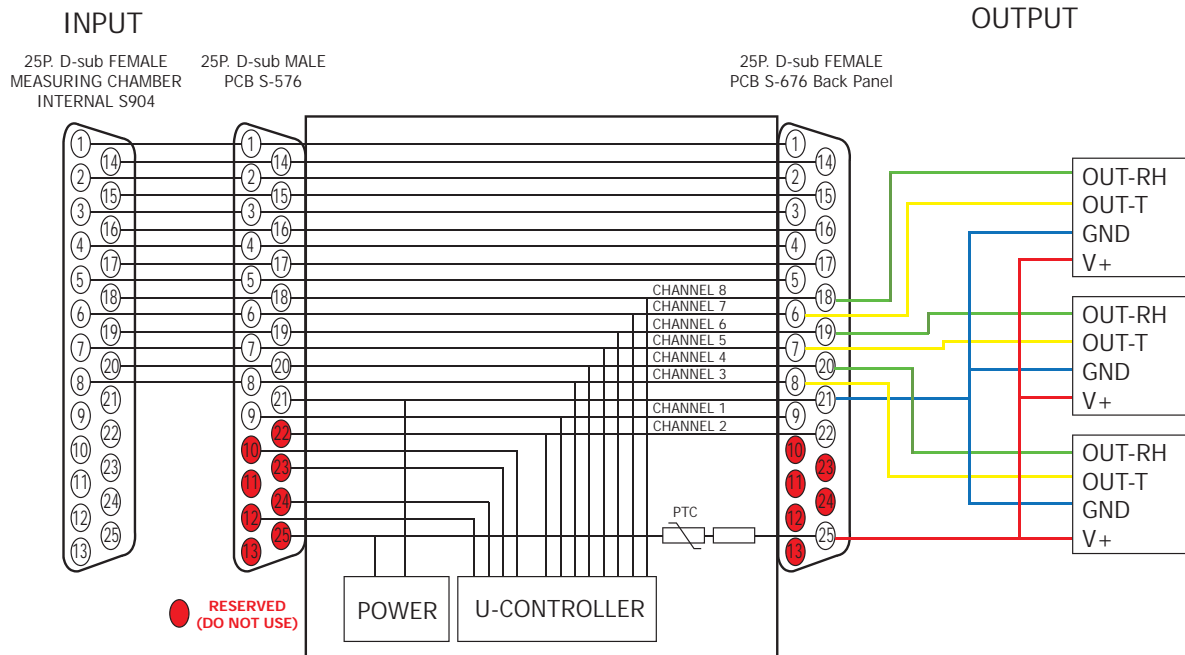

Figure 22 S904D Wiring Diagram Example 2

S904D Data Acquisition Resolution

The data acquisition is made for 0 to 10 V input. The AD converter (analog to digital) is 12 bit data acquisition, so there are 4096 steps. If a device is connected with a 0 to 5 V output the resolution goes down to 2048 steps and for an instrument with a 0 to 1 V output the resolution goes down to 409 steps.

For example: If an instrument under calibration has an output of 0 to 1 V and the temperature output range of the instrument is -40 to +60°C, (which is a total range of 100°C) then the resolution is 0.25°C. See the calculations below:

0 to 1 V	$\frac{100^{\circ}\text{C}}{409} = 0.25^{\circ}\text{C}$ resolution which will be recorded in the data logger
0 to 5 V	$\frac{100^{\circ}\text{C}}{2048} = 0.05^{\circ}\text{C}$ resolution which will be recorded in the data logger
0 to 10 V	$\frac{100^{\circ}\text{C}}{4096} = 0.02^{\circ}\text{C}$ resolution which will be recorded in the data logger

4 APPLICATION SOFTWARE - S904D

NOTE: See Installation Guide S904D on how to install the S904D software.

4.1 Connecting and Starting the S904D Software

Connect the S904D to the computer, by using the USB cable or through the RS232 port.

Start the LabVIEW® software, by clicking on S904D Control.exe (*standard location: C:\Program Files\Michell Instruments\S904D Control Program*).

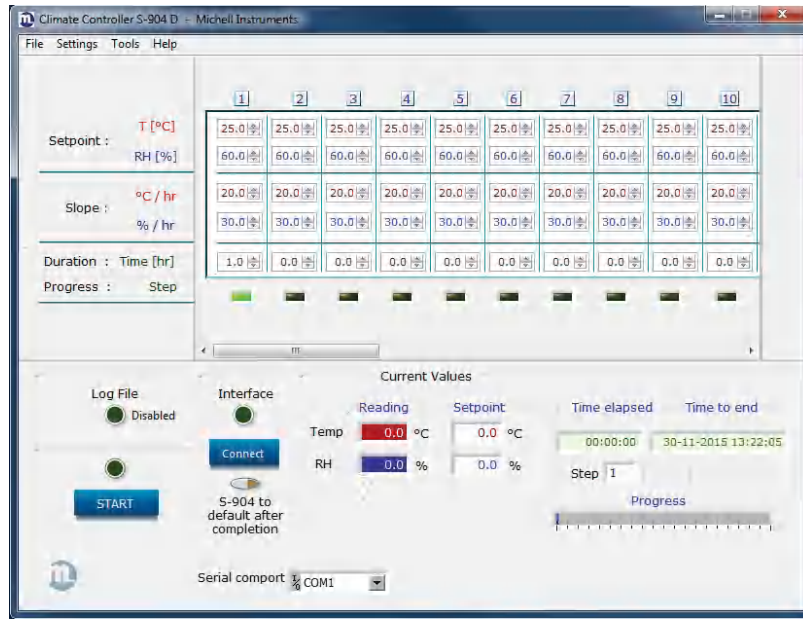

Select the used com. Port, and click on **Connect**.

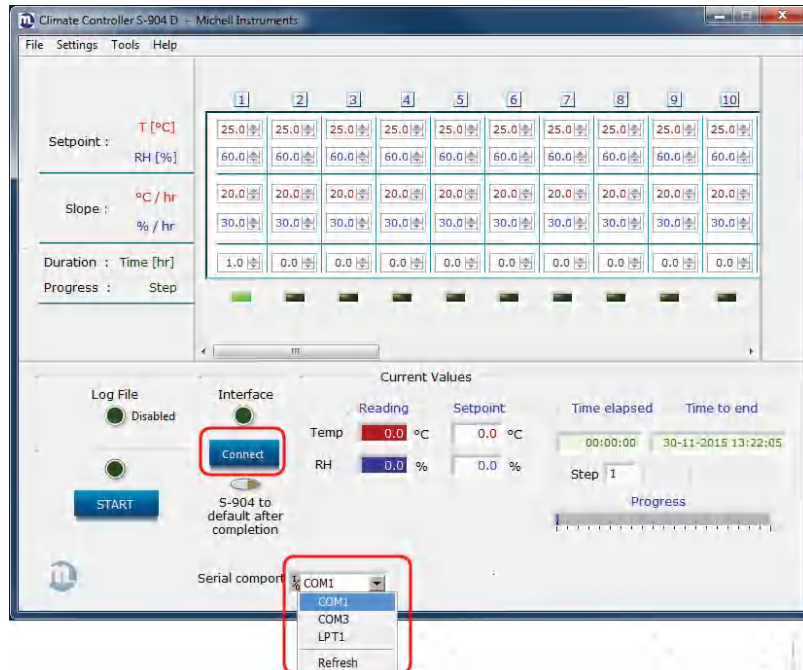

Click on **OK** to confirm.



Once the connection is established, the green **interface** light will come on.

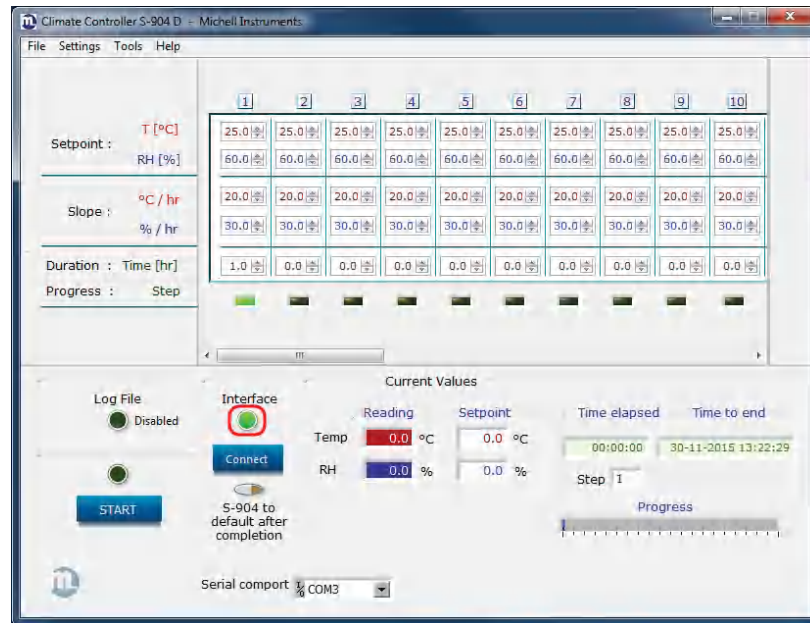

4.2 LabVIEW® Software Menu Structure

This section covers the navigation of the LabVIEW® software.

4.2.1 Command - File



Page Setup

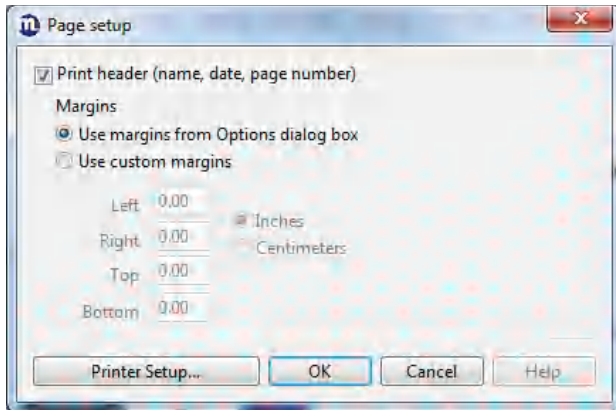

A print header containing the name, date and page number can be added to the file for printing.

The print margins can also be changed.

Print Window

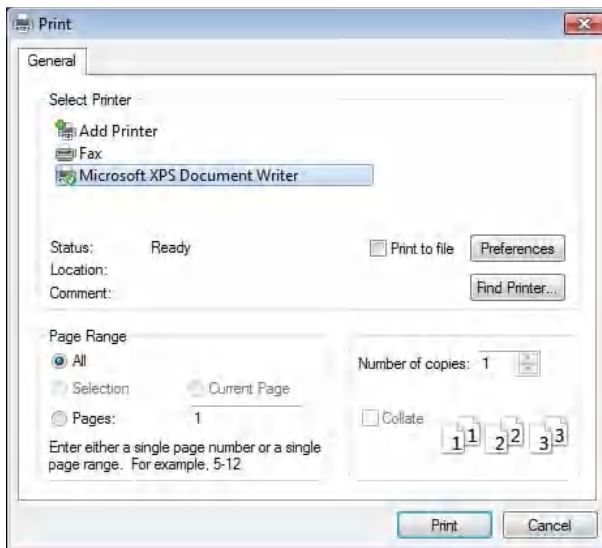

If required for reporting purposes a screen shot can be printed by clicking on **Print Window**.

Exit

To close the program click on **Exit**.

4.2.2 Command - Settings



Retrieve Control Settings

To load a (previously) saved setpoint settings file click on **Retrieve Control Settings**.

Save Control Settings

All setpoint settings can be saved by clicking on **Save Control Settings**. The file can then be saved under a unique name.

Reset Control Settings

By clicking on **Reset Control Settings**, the connection with the control sensor in the calibration chamber will be disconnected. All setpoint settings will be then be set back to factory settings.

4.2.3 Command - Tools



Logging

During the different conditions generated in the chamber, all data can be saved to the log file.

A maximum of 6 channels can be logged, plus the internal reference probe with temperature and relative humidity.

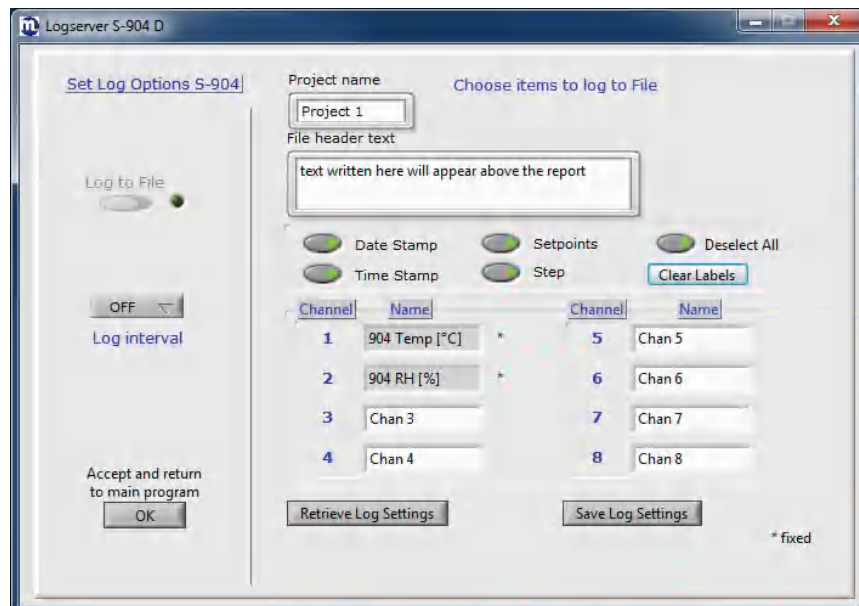
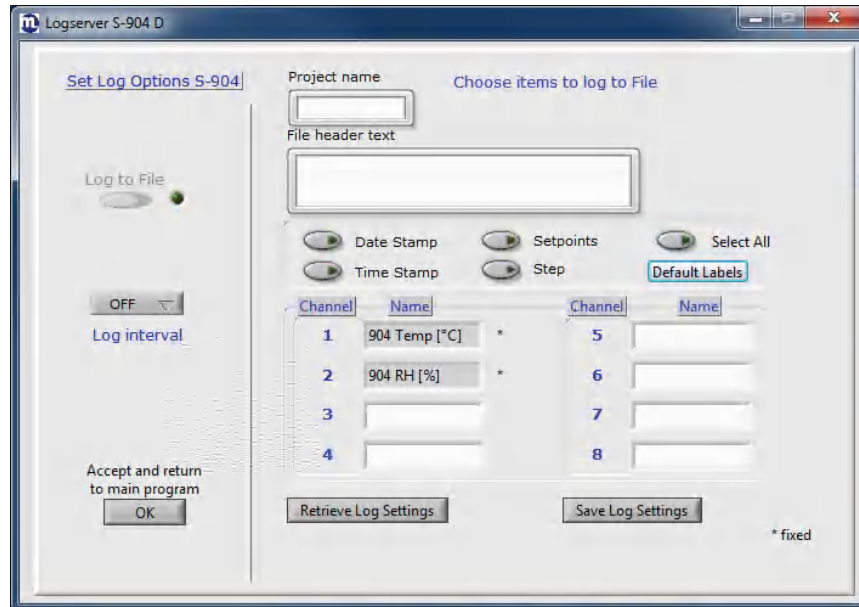

Project name

Type the name of the project.

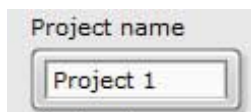

File header text

Text written here will appear above the report.

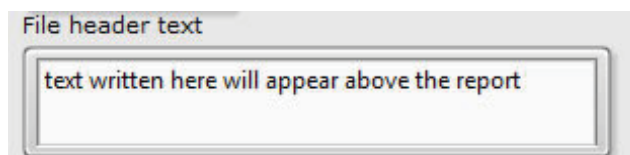

The following data can also be logged :



Date stamp

The date from the PC where the log file is saved to will be used.

Time stamp

The time from the PC where the log file is saved to will be used.

Setpoints

The temperature and humidity setpoint chosen by the user in LabVIEW®.

Step

A total of 32 setpoint steps can be chosen. All steps are numbered from 1 to 32. The actual step number (setpoint) can also be logged here.

Select / Deselect All

Date stamp, Time stamp, Set points and Step will / will not be logged.

Default / Clear Labels

Sets / clears the channel names to their defaults: Chan3, Chan4, Chan5, Chan6, Chan7, Chan8.

NOTE: Channels 1 and 2 are dedicated channels and cannot be changed.

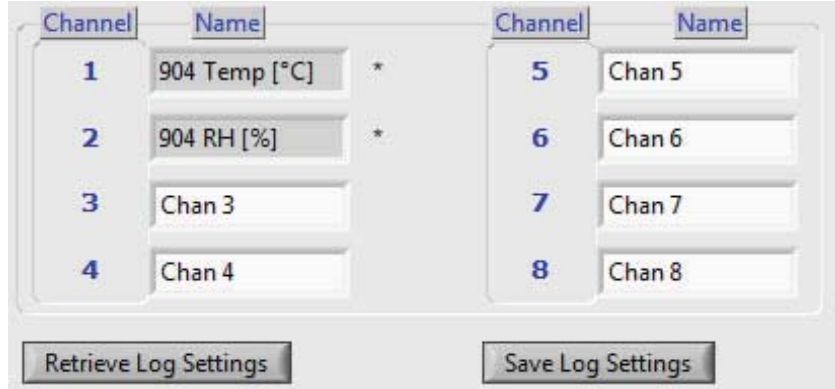

Save Log Settings

All log settings can be saved by clicking on **Save Log Settings**. The file can then be saved under a unique name.

Retrieve Control Settings

To load a (previously) saved log settings file click on **Retrieve Log Settings**.

Log interval

Click on **Log interval** - a new window appears. Select the logging frequency.

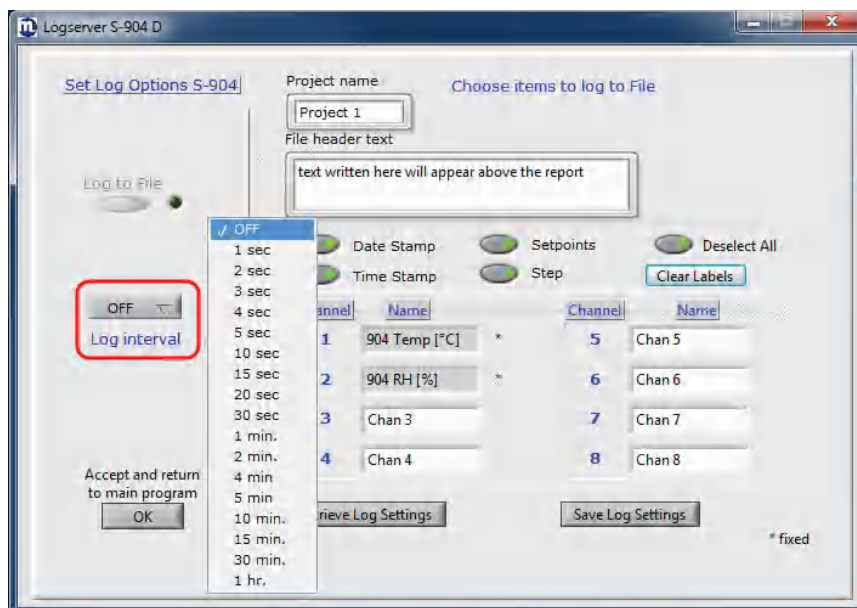

The **Log to File** button will now be enabled.

Log to File

Type the name for the log file. The name and path will be visible at the bottom of the log settings window.

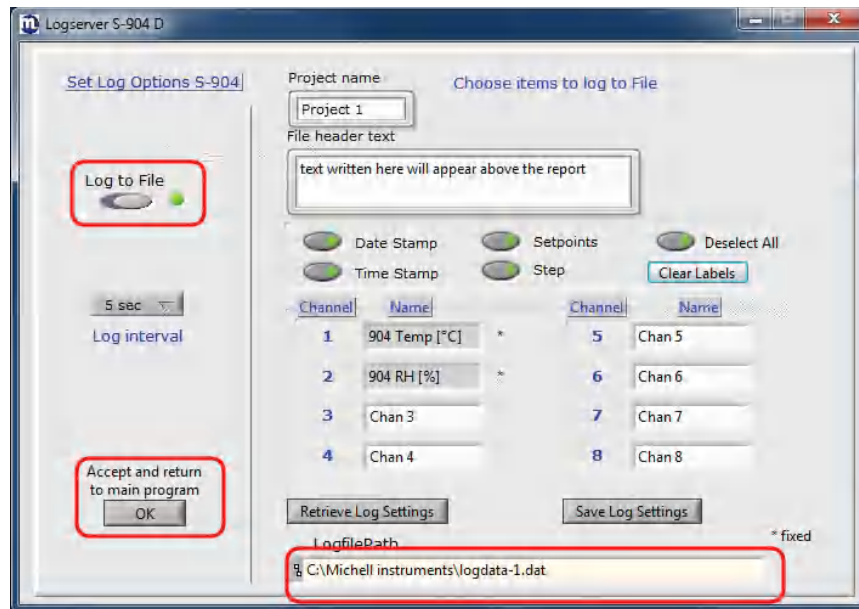

Accept and return to main program

Use this button to leave the log settings menu and return to the main program.

To accept all new settings, click on **OK**.

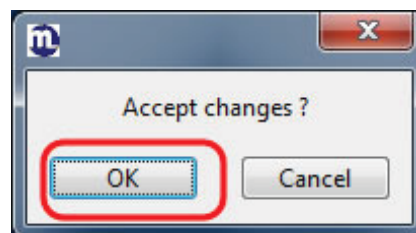

The green Log file light will come on.

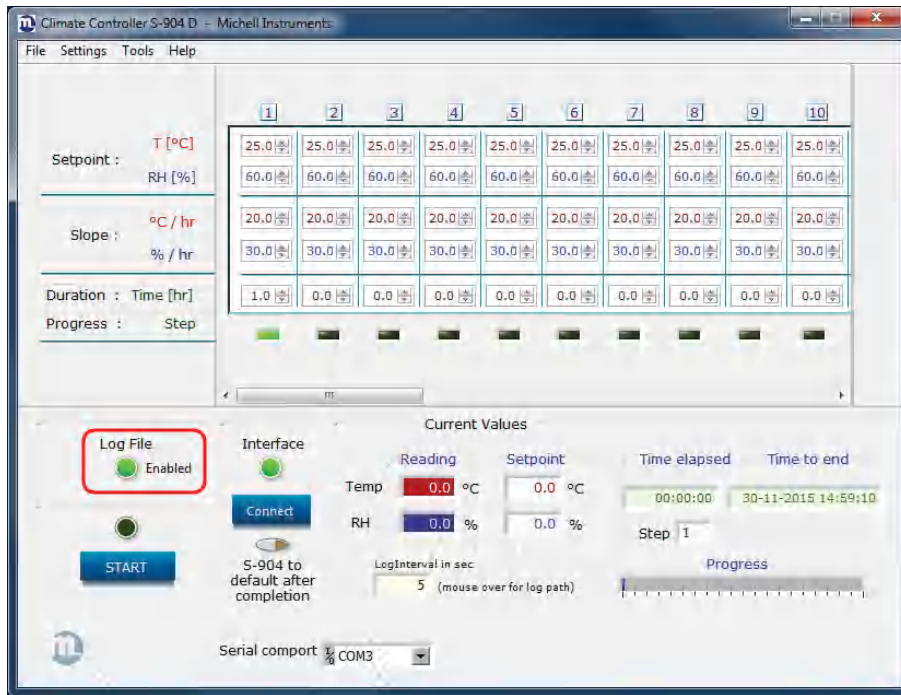

Monitor

Once the program is running it is possible to open a new window: **Process Monitor**. This window will display the status of humidity, temperature, setpoints and time.

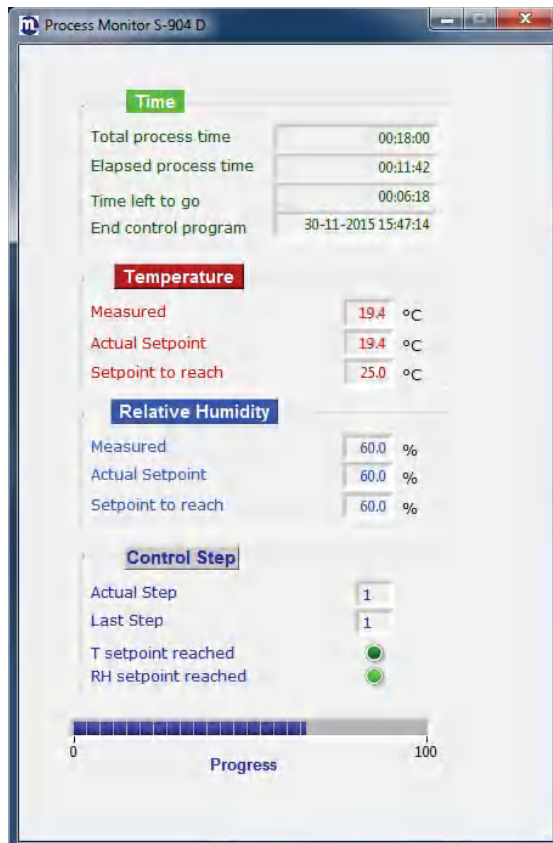

Graph

This option opens a new window showing the logged data in a graph.

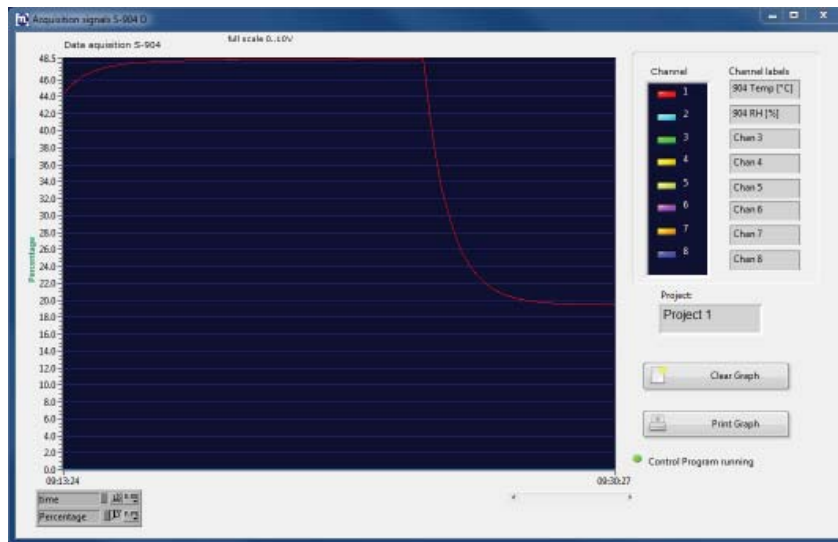

4.2.4 Command – Help

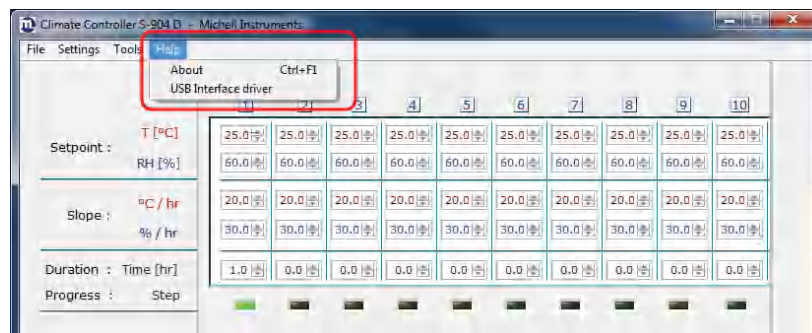

About

Click on **About** to find the software version number.



USB Interface driver

Click on the USB Interface driver to install the CP210x USB to UART Bridge Driver (see S904D Controller Installation Guide).

4.3 LabVIEW® Software User Interface

The user interface consists of several sections.

Up to 32 set points can be programmed by the user.

Only 10 are visible - use the scroll-bar to show the other 22.

Setpoint

Use the up and down arrows or type the desired set point value for temperature and/or humidity in the corresponding box.

Temperature range: 0.0 to 75.0°C
 Humidity range: 0.0 to 99.5%RH



Slope

Slope determines how fast the S904D will go from one setpoint to another setpoint.

Use the up and down arrows or type the desired value for the slope of temperature and/or humidity in the corresponding box.

Slope Temperature range: 0.0 to 99.9°C/hr
 Slope Humidity range: 0.0 to 999.9%RH/hr

A slope of 0 means the setpoint will not change.

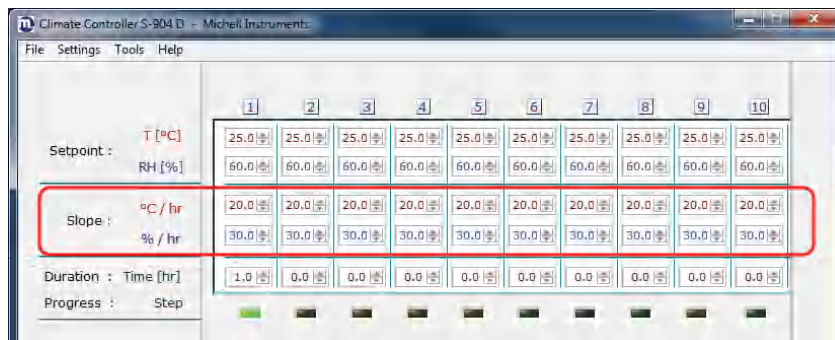

Duration



Duration represents the time that the control reserves for one pair of setpoints (RH +T). This time includes the Ramp time.

The control will proceed with the next program step if this time has elapsed. This is also true when a certain setpoint is not achieved. The program could otherwise be stalled by one extreme setpoint.

When the duration setpoint is set to 0 the LabVIEW® software will automatically go to the next setpoint.

The value that is selected is directly related to an hour.

For example: if the time chosen is 0.9 this is calculated as 0.9 x 60 minutes = 54 minutes.

See below for a quick reference chart.

Time Chosen	Minutes
0.1	6
0.2	12
0.3	18
0.4	24
0.5	30
0.6	36
0.7	42
0.8	48
0.9	54
1.0	60
1.1	66

Progress

A green light will show the actual setpoint.



Start

Press the start button to start the program and / or logging.

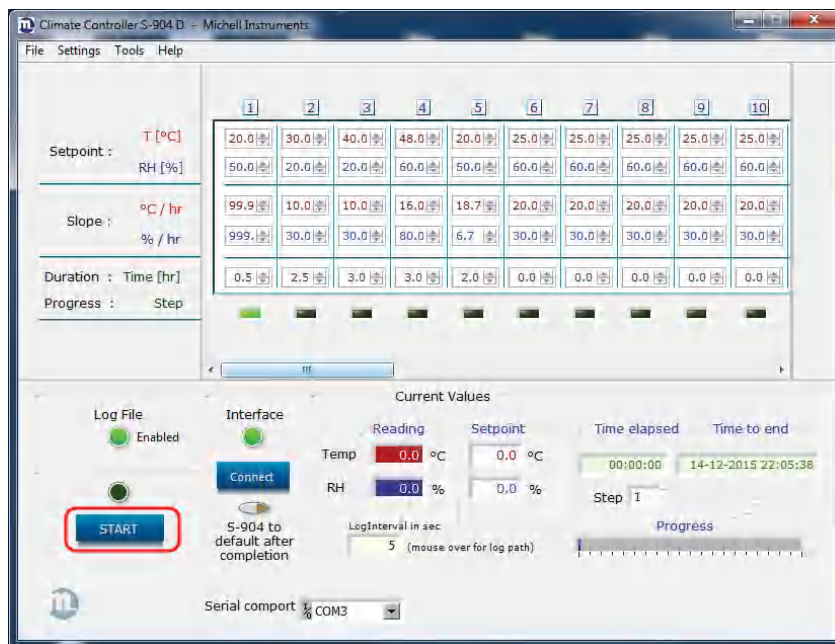

Click on **OK** to start the process.

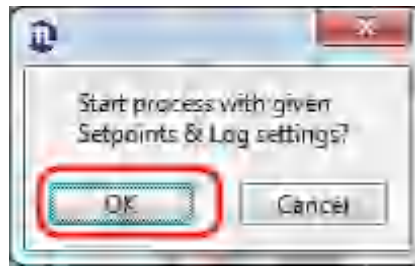

The process starts and the green light will come on.

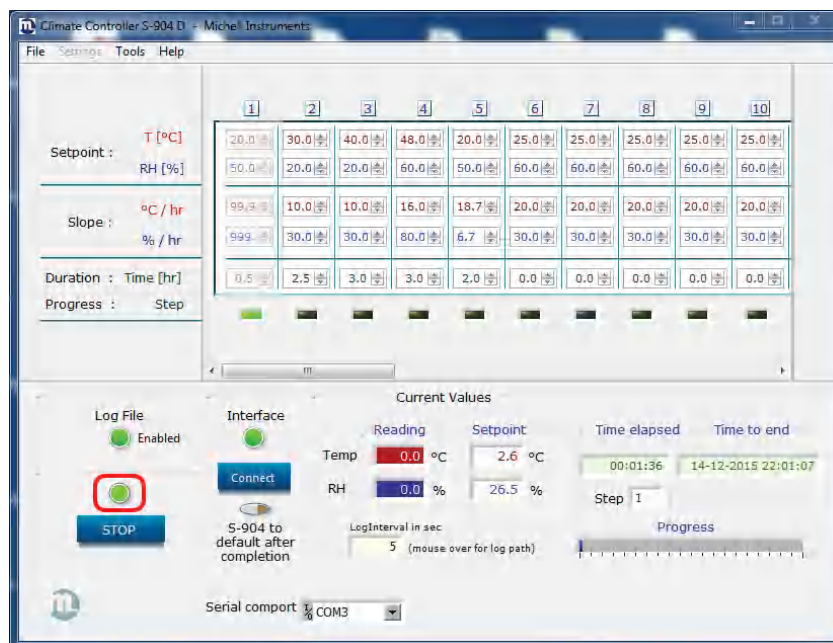

The program runs all setpoints sequentially. After the last setpoint the program stops.

Click on **OK** to finish.

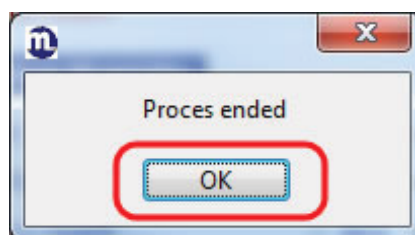

Log file

The log file is a comma separated file. When it is loaded into Excel it will look like this:

	A	B	C	D	E	F	G	H	I	J	K	L	M
1	Text written here will appear above the report												
2	Project: Project 1												
3	Date	Time	Step no	T set	RH set	904 Temp [°C]	904 RH [%]	Chan 3	Chan 4	Chan 5	Chan 6	Chan 7	Chan 8
4	14-12-2015	11:06:12	1	20	50	0	0	0	0	0	0	0	0
5	14-12-2015	11:06:16	1	20	50	0	0	0	0	0	0	0	0
6	14-12-2015	11:06:21	1	20	50	0	0	0	0	0	0	0	0
7	14-12-2015	11:06:26	1	20	50	0	0	0	0	0	0	0	0
8	14-12-2015	11:06:31	1	20	50	0	0	0	0	0	0	0	0
9	14-12-2015	11:06:36	1	20	50	0	0	0	0	0	0	0	0
10	14-12-2015	11:06:41	1	20	50	0	0	0	0	0	0	0	0
11	14-12-2015	11:06:46	1	20	50	0	0	0	0	0	0	0	0
12	14-12-2015	11:06:51	1	20	50	0	0	0	0	0	0	0	0
13	14-12-2015	11:06:56	1	20	50	0	0	0	0	0	0	0	0
14	14-12-2015	11:07:01	1	20	50	0	0	0	0	0	0	0	0
15	14-12-2015	11:07:06	1	20	50	0	0	0	0	0	0	0	0
16	14-12-2015	11:07:11	1	20	50	0	0	0	0	0	0	0	0
17	14-12-2015	11:07:16	1	20	50	0	0	0	0	0	0	0	0
18	14-12-2015	11:07:21	1	20	50	0	0	0	0	0	0	0	0
19	14-12-2015	11:07:26	1	20	50	0	0	0	0	0	0	0	0
20	14-12-2015	11:07:31	1	20	50	0	0	0	0	0	0	0	0
21	14-12-2015	11:07:36	1	20	50	0	0	0	0	0	0	0	0
22	14-12-2015	11:07:41	1	20	50	0	0	0	0	0	0	0	0

Actual Values

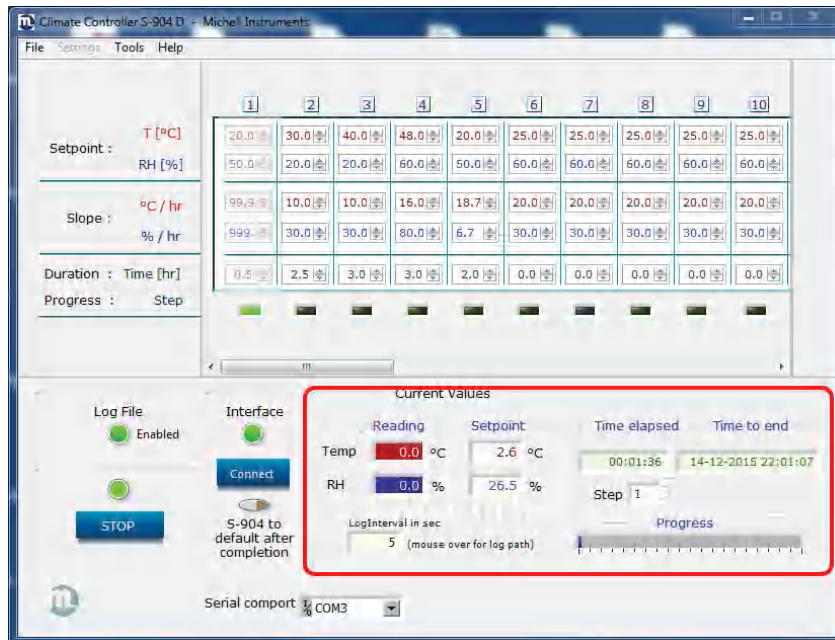

The overview with the momentary values shows:

Reading

The reading of the internal reference probe, temperature and relative humidity.

Setpoint

The actual setpoint.

Time elapsed / Time to end

The time elapsed so far and the estimated time to the end of all steps.

Step

The actual step (maximum of 32) that the software is in.

Progress

A bar showing the progress of the steps

S904 to default after completion

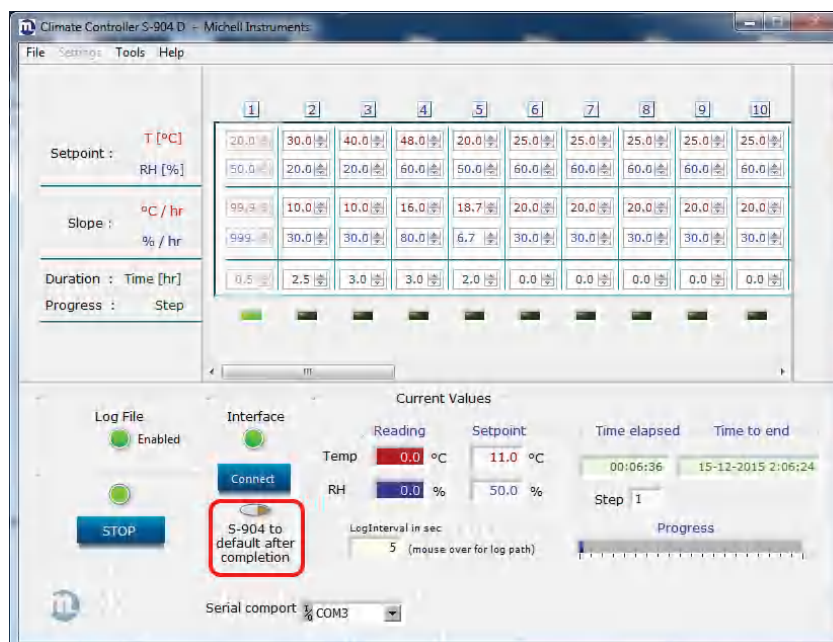

Normally when the S904D Control program is finished the logging stops and the last setpoints remain active until the S904D is switched off.

If, for example, the last setpoint was 10°C, the S904D remains cooling until it is switched off.

To avoid a long period of time between switching off the S904D and the end of the S904D control program there is a **default after completion** button.

Activation of this button creates an additional setpoint of $\pm 20^{\circ}\text{C}$ and 50%RH after the program is finished. (These values will not be logged).

This additional setpoint remains active until the S904D is switched off.

The orange light will come on.

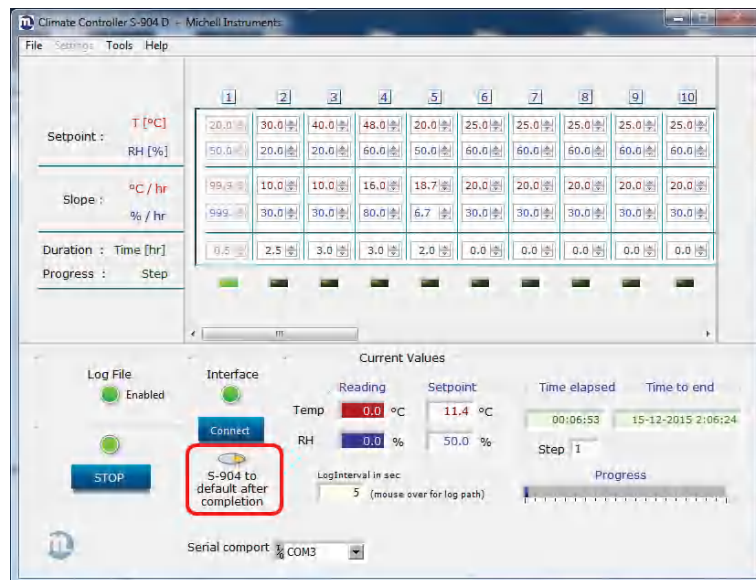

Example of a test program :

- 1 stabilize the chamber for 30 minutes at 20°C and 50%RH. (assuming the S904D starts at ambient temperature and humidity $\pm 20^{\circ}\text{C}/\pm 50\% \text{RH}$).
- 2 go in 1 hour to 30°C and 20%RH, and stabilize for 1.5 hours.
- 3 go in 1 hour to 40°C and 20%RH, and stabilize for 2 hours.
- 4 go in 0.5 hours to 48°C and 60%RH, and stabilize for 2.5 hours.
- 5 go in 1.5 hours to 20°C and 50%RH, and stabilize for 0.5 hours.
- 6 End.

Action needed :

- 1 Set temperature setpoint to 20.0°C, set humidity setpoint to 50%RH.
Set slope for temperature to 99.9
(the S904D will go to the T-setpoint as fast as possible).
Set slope for humidity to 999.9
(the S904D will go to the RH-setpoint as fast as possible).
Set duration time to 0.5 hour (stabilize for 30 minutes).

- 2 Set temperature setpoint to 30.0°C, set humidity setpoint to 20%RH.
Set slope for temperature to 10.0
(Ramp time = 1 hour, delta T=10°C => slope = 10°C/hr).
Set slope for humidity to 30.0
(Ramp time = 1 hour, delta RH=30%RH => slope = 30%RH/hr).
Set duration time to 2.5 hour
(1 hour Ramp time + 1.5 hours stabilize time).

(Ramp time is the time in which the S904D goes from one setpoint to another setpoint.)

- 3 Set temperature setpoint to 40.0°C, set humidity setpoint to 20%RH.
Set slope for temperature to 10.0
(Ramp time = 1 hour, delta T=10°C => slope = 10°C/hr).
Set slope for humidity to 30.0
(no Ramp time for humidity, use standard slope).
Set duration time to 3.0 hour
(1 hour Ramp time + 2 hours stabilize time).

- 4 Set temperature setpoint to 48.0°C, set humidity setpoint to 60%RH.
Set slope for temperature to 16.0
(Ramp time = 0.5 hour, delta T=8°C => slope = 16°C/hr).
Set slope for humidity to 80.0
(Ramp time = 0.5 hour, delta RH=40%RH => slope = 80%RH/hr).
Set duration time to 3.0 hour
(0.5 hour Ramp time + 2.5 hours stabilize time).

- 5 Set temperature setpoint to 20.0°C, set humidity setpoint to 50%RH.
Set slope for temperature to 18.7
(Ramp time = 1.5 hour, delta T=28°C => slope = 18.7°C/hr).
Set slope for humidity to 6.7
(Ramp time = 1.5 hour, delta RH=10%RH=> slope = 6.7%RH/hr).
Set duration time to 2.0 hour
(1.5 hour Ramp time + 0.5 hours stabilize time).

- 6 For setpoint 6 to 32:

Set temperature setpoint to 25.0°C, set humidity setpoint to 60%RH
(standard setpoints).
Set slope for temperature to 30.0
(no Ramp time, use standard slope).
Set slope for humidity to 30.0
(no Ramp time, use standard slope).
Set duration time to 0.0 hour
(= standard, this setpoint will be skipped).

	1	2	3	4	5	6	7	8	9	10
Setpoint : T [°C]	20.0	30.0	40.0	48.0	20.0	25.0	25.0	25.0	25.0	25.0
Setpoint : RH [%]	50.0	20.0	20.0	60.0	50.0	60.0	60.0	60.0	60.0	60.0
Slope : °C / hr	99.9	10.0	10.0	16.0	18.7	20.0	20.0	20.0	20.0	20.0
Slope : % / hr	99.9	30.0	30.0	80.0	6.7	30.0	30.0	30.0	30.0	30.0
Duration : Time [hr]	0.5	2.5	3.0	3.0	2.0	0.0	0.0	0.0	0.0	0.0
Progress : Step										

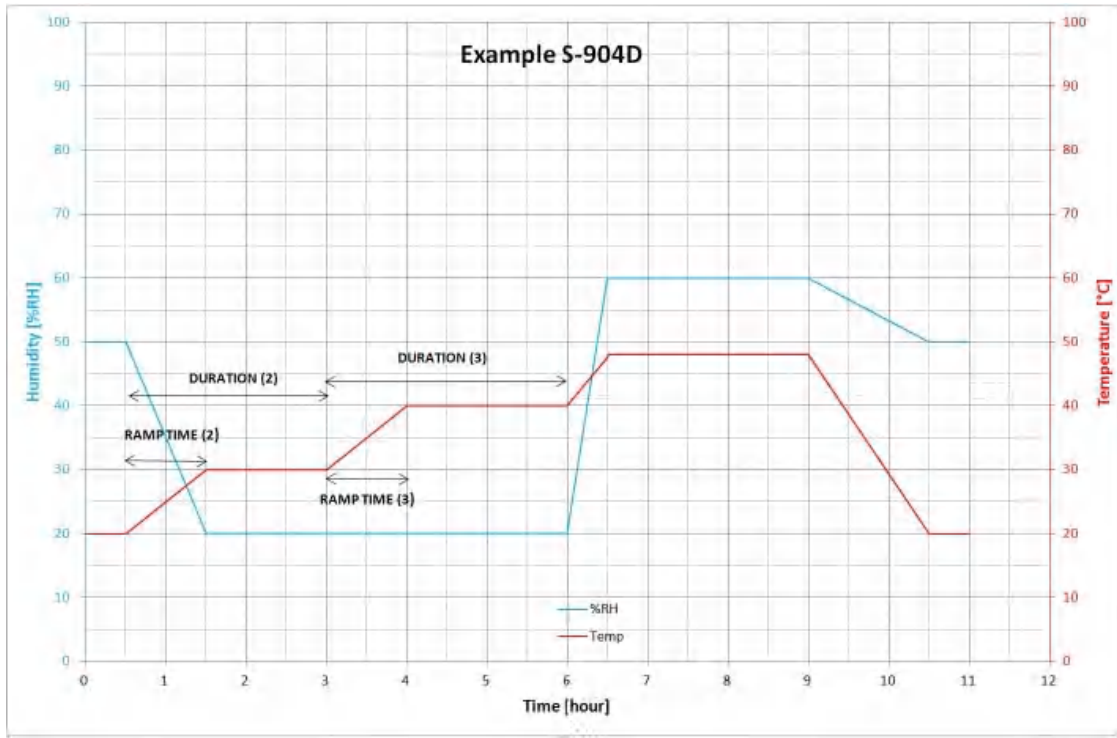

5 MAINTENANCE

5.1 Troubleshooting

Problem	Possible Solution
No drying	Change desiccant Water in chamber; dry the chamber
No humidifying	Water level too low
No drying and humidifying	Switch 1 is off (see below)
No heating or cooling	Switch 2 is off (see below)
No display	Fuse on back panel
No external control	Front panel switches set to AUTO ? Pin 24 of the front connector must be +5V

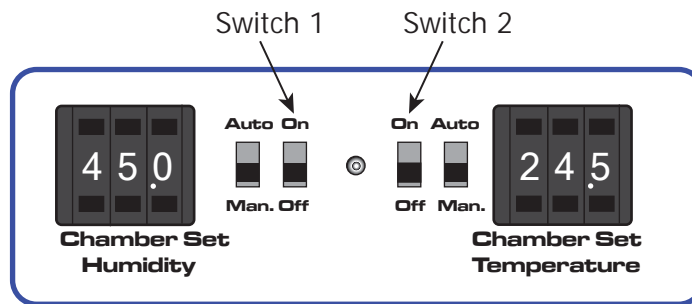

Appendix A

Technical Specifications

Appendix A Technical Specifications

Humidity	
Generator Range	10 - 90% RH
Accuracy Control Element	≤ ±1% RH (10 - 70% RH) ≤ ±1.5% RH (70 - 90% RH)
Stability	±0.2% RH (20 - 80% RH)
Temperature	
Generator Range	+10 to +50°C (+50 to +122°F) (lowest T set point = +10°C (+18°F) below ambient)
Accuracy	±0.1°C (±0.2°F)
Stability	±0.1°C (±0.2°F)
Chamber	
Ramp Rate From +20 to +40°C (+68 to +104°F) +40 to +20°C (+104 to +68°F)	1.5°C/minute (2.7°F/minute) 0.7°C/minute (1.2°F/minute)
Control element	Removable relative humidity sensor
General	
Probe Ports	up to 5 - sensor body diameters 5 - 25mm (0.2 - 0.98") accommodated by port adapters
Chamber Volume	2000cm ³ (122.1in ³)
Chamber Dimensions	105 x 105 x 160mm (4.13 x 4.13 x 6.3") (w x h x d)
Instrument Dimensions	520 x 290 x 420mm (20.5 x 11.4 x 16.5") (w x h x d)
Setpoint Resolution	0.1 for humidity and temperature
Displays	3 digit LED, 10mm (0.39") characters
Supply	100 to 240 V AC, 50/60 Hz, 100 VA
Weight	20kg (44lbs)

Appendix B

EU Declaration

Appendix B EU Declaration

EU Declaration of Conformity



Manufacturer: **Michell Instruments Benelux B.V.**
Krombraak 11
4906 CR Oosterhout
The Netherlands.



We declare under our sole responsibility that the product:

S904 Humidity Calibrator

complies with all the essential requirements of the EU directives listed below.

2014/30/EU	EMC Directive
2014/35/EU	Low Voltage Directive (LVD)
2011/65/EU	Restriction of Hazardous Substances Directive (RoHS2)

and has been designed to be in conformance with the relevant sections of the following standards or other normative documents.

EN61326-1:1997 Electrical equipment for measurement, control and laboratory use – EMC requirements – Class B (emissions) and Industrial Locations (immunity).
+A1:1998
+A2:2001

EN61010-1:2010 Safety Requirements for Electrical Equipment for Measurement, Control, and Laboratory Use - Part 1: General Requirements

A handwritten signature in black ink, appearing to be 'Peter Haakma', written over a horizontal line.

Peter Haakma, Managing Director Michell Instruments Benelux B.V.
 Date of Issue: October 2016

Appendix C

Quality, Recycling & Warranty Information

Appendix C Quality, Recycling & Warranty Information

C.1 Pressure Equipment Directive (PED) 97/23/EC

The above Directive has been implemented in United Kingdom Law by the Pressure Equipment Regulations 1999.

The Regulations require that all pressure equipment and assemblies within the scope of the Pressure Equipment Directive must be safe when placed on the market or put into service.

Michell Instruments' products have been assessed and, as referenced against the Classification Charts detailed in Annex II of the Directive, do not fall into the requirements for CE marking compliance with the Pressure Equipment Directive.

Article 3, paragraph 3 states that any product containing a pressurized fluid that does not qualify for compliance should, nevertheless, be constructed with Sound Engineering Practice (SEP).

Michell Instruments attests here that its products have been designed, manufactured & tested to assure safe operation, and in accordance with Sound Engineering Practices.

C.2 Recycling Policy



Michell Instruments is concerned with the protection of the environment. It is our commitment to reduce and eliminate from our operations, wherever possible, the use of substances which may be harmful to the environment. Similarly, we are increasingly using recyclable and/or recycled material in our business and products wherever it is practical to do so.

To protect natural resources and to promote material reuse, please separate batteries from other types of waste and recycle responsibly. If batteries are not properly disposed of, these substances can cause harm to human health and the environment.

The product that you have purchased may contain recyclable and/or recycled parts and we will be happy to provide you with information on these components if required. For further information please see the following sections.

C.3 WEEE Compliance

Directive 2012/19/EU 4 July 2012 on Waste Electronic and Electrical Equipment (WEEE)

The Waste Electronic and Electrical Equipment (WEEE) Directive places rules upon European manufacturers of electrical and electronic equipment. The directives' aim is to reduce the impact that electronic devices have on the environment.

Michell Instruments is in full compliance with the WEEE Directive and is registered with an approved recycler (Registration No. WEE/JB0235YW) and treats the requirement of the directive and the protection of the environment with the utmost importance. All Michell Instruments' products are appropriately marked indicating their requirement for recycling.

It may be required to return certain instruments for treatment at the end of their working life.

Feb 2013

C.4 RoHS2 Compliance

Directive 2011/65/EU of the European Parliament and of the Council of 8 June 2011

The Restriction of Hazardous Substances (RoHS) Directive places rules upon European manufacturers of electrical and electronic equipment. The directives' aim is to reduce the impact that electronic devices have on the environment.

According to the EC Directive 2002/95/EC, Michell Instruments' products qualify as Category 9, Control and Monitoring Equipment. Under the 2002/95/EC Directive, Category 9 products are exempt from compliance with the Directive.

However, the careful design of all Michell Instruments' products takes into consideration the requirements of the Directive and, wherever possible, compliance is achieved. All future products will be developed entirely using compliant materials. Furthermore, Michell Instruments is taking active steps to remove non-compliant materials and components from existing products wherever these may occur. Presently, none of the non-compliant materials are known to occur in Michell Instruments' products.

The new Directive 2011/65/EU (RoHS2) entered into force on 21 July 2011 and required all Member States to transpose the provisions into their respective national laws by 2 January 2013.

Under the provisions of the RoHS2 EU Directive 2011/65/EU (Article 3, [24]) defines 'Control and Monitoring Equipment' specifically as 'monitoring and control instruments designed exclusively for industrial or professional use'.

RoHS2 EU Directive 2011/65/EU states the closing date for compliance of any Control and Monitoring Equipment product sold into the EU market place as 22nd July 2017.

However, the careful design policy of all Michell Instruments' products continues to attain compliance in the shortest practical timescales and strives to ensure that less than 0.1% of total mass per product, of all non-compliant materials, appear within them. Michell Instruments continues to monitor suppliers and material sources to ensure that compliance of goods provided is maintained.

January 2013

C.5 Warranty

Unless otherwise agreed, the Supplier warrants that, as from the date of delivery for a period of 12 months, the goods and all their component parts, where applicable, are free from any defects in design, workmanship, construction or materials.

The Supplier warrants that the services undertaken shall be performed using reasonable skill and care, and be of a quality conforming to generally accepted industry standards and practices.

Except as expressly stated, all warranties whether express or implied, by operation of law or otherwise, are hereby excluded in relation to the goods and services to be provided by the Supplier.

All warranty services are provided on a return to base basis. Any transportation costs for the return of a warranty claim shall reside with the Customer.

C.6 REACH Compliance

Regulation (EC) No. 1907/2006

Registration, Evaluation, Authorisation and Restriction of Chemicals (REACH)

Michell Instruments is a manufacturer of moisture measurement and gas analysis instrumentation and is a 'downstream' user of chemicals, as described by the EU Council Directive 76/769/EEC. The products we supply are not raw chemical products (goods).

Under normal and reasonably foreseeable circumstances of application, the goods supplied to you shall not contain or release any prohibited chemicals. No listed SVHC (Substances of Very High Concern) appear within products manufactured by Michell Instruments. Therefore the 0.1% mass per product, or total usage of 1 tonne/year, will never be exceeded. For these reasons we are neither required by obligation for registration nor for the creation of material safety data sheets (MSDS) for our products.

Our continued review of the SVHC Candidate List and latest additions is to ensure we remain compliant.

Michell Instruments maintains a hazardous material register in which MSDS data sheets are collated, and we will check that our suppliers will comply to REACH requirements for all materials and substances we use in the processes of our manufacturing.

In the unlikely event that any chemicals of concern appear in our products in quantities greater than 0.1% of total mass per product we will immediately inform you by correspondence according to the REACH Article 33 requirements. Our current appraisal is, however, that we do not expect or foresee such an incidence.

January 2013

C.7 Return Policy

If a Michell Instruments' product malfunctions within the warranty period, the following procedure must be completed:

1. Notify a Michell Instruments' distributor, giving full details of the problem, the model variant and the serial number of the product.
2. If the nature of the problem indicates the need for factory service then the instrument should be returned to Michell Instruments, carriage prepaid, preferably in the original packaging, with a full description of the fault and the customer contact information.
3. Upon receipt, Michell Instruments will evaluate the product to determine the cause of the malfunction. Then, one of the following courses of action will be taken:
 - If the fault is covered under the terms of the warranty, the instrument will be repaired at no cost to the owner and returned.
 - If Michell Instruments determines that the fault is not covered under the terms of the warranty, or if the warranty has expired, an estimate for the cost of the repairs, at standard rates, will be provided. Upon receipt of the owner's approval to proceed, the product will be repaired and returned.

C.8 Calibration Facilities

Michell Instruments' calibration facilities are among the most sophisticated in the world and have been recognized for their excellence.

Traceability to the National Physical Laboratory (NPL) UK is achieved through our UKAS Accreditation (Number 0179). This covers dew point over the range -90 to +90°C (-130 to +194°F) and also Relative Humidity.

Dew-point calibrations are also traceable to the National Institute for Standards & Technology (NIST) USA over the range -75 to +20°C (-103 to +68°F).

NOTE: Standard traceable calibration certificates for instruments and sensors are not issued under our UKAS accreditation.

C.9 Manufacturing Quality

Michell Instruments is registered with the British Standards Institute for Quality Assurance to:

BS EN ISO 9001: 2008

Rigorous procedures are performed at every stage of production to ensure that the materials of construction, manufacturing, calibration and final test procedures meet the requirements laid down by our BSI approved Quality System.

Please contact Michell Instruments (www.michell.com) if the product does not arrive in perfect working order.

C.10 FCC (EMC Requirements for North America)

This device complies with part 15 of the FCC Rules. Operation is subject to the following two conditions:

1. This device may not cause harmful interference.
2. This device must accept any interference, including interference that may cause undesired operation.

This equipment has been tested and found to comply with the limits for a Class A digital device, pursuant to part 15 of the FCC Rules. These limits are designed to provide reasonable protection against harmful interference when the equipment is operated in a commercial environment. This equipment generates, uses, and can radiate radio frequency energy and, if not installed and used in accordance with the user manual, may cause harmful interference to radio communications. Operation of this equipment in a residential area is likely to cause harmful interference in which case the user will be required to correct the interference at his own expense. This product must be operated as per the operating instructions provided. Do not make any alterations or modifications to the product. Any unauthorized alterations or modifications made to this product may require you to stop operating the product.

Canadian Radio Interference Regulations

This Class A digital product complies with Canadian ICES-001. Règlement canadien sur les interférences radio. Ce produit numérique de classe A est conforme à la norme NMB-001.

Appendix D

Return Document & Decontamination Declaration

Appendix D Return Document & Decontamination Declaration

Decontamination Certificate

IMPORTANT NOTE: Please complete this form prior to this instrument, or any components, leaving your site and being returned to us, or, where applicable, prior to any work being carried out by a Michell engineer at your site.

Instrument			Serial Number	
Warranty Repair?	YES	NO	Original PO #	
Company Name			Contact Name	
Address				
Telephone #			E-mail address	
Reason for Return /Description of Fault:				
Has this equipment been exposed (internally or externally) to any of the following? Please circle (YES/NO) as applicable and provide details below				
Biohazards			YES	NO
Biological agents			YES	NO
Hazardous chemicals			YES	NO
Radioactive substances			YES	NO
Other hazards			YES	NO
Please provide details of any hazardous materials used with this equipment as indicated above (use continuation sheet if necessary)				
Your method of cleaning/decontamination				
Has the equipment been cleaned and decontaminated?			YES	NOT NECESSARY
Michell Instruments will not accept instruments that have been exposed to toxins, radio-activity or bio-hazardous materials. For most applications involving solvents, acidic, basic, flammable or toxic gases a simple purge with dry gas (dew point <-30°C) over 24 hours should be sufficient to decontaminate the unit prior to return. Work will not be carried out on any unit that does not have a completed decontamination declaration.				
Decontamination Declaration				
I declare that the information above is true and complete to the best of my knowledge, and it is safe for Michell personnel to service or repair the returned instrument.				
Name (Print)			Position	
Signature			Date	





<http://www.michell.com>