



Technical Specifications *

Accuracy:	< 2% of FS range under constant conditions
Analysis:	0-1%, 0-5%, 0-10%, 0-25% FS ranges; auto-ranging or fixed single range
Application:	Oxygen analysis in inert, hydrocarbon, helium, hydrogen, mixed and acid (CO ₂) gas streams
Approvals:	Certified for use in hazardous areas - see lower right UL: United States: UL 1203, UL 913, UL 508 Canada: CAN/CSA C22.2 No. 30-M1986, CAN/CSA C22.2 No. 157-92, CAN/CSA C22.2 No. 14-10 ATEX: Directive 94/9/EC
Area Classification:	Certified for use in hazardous areas - see lower right
Alarms:	Two user configurable alarms: magnetic coil relays rated 3A at 100 VAC, programmable alarm delays, alarm bypass for calibration and system fail alarm
Calibration:	Max interval—3 months. Air calibrate with clean source of certified span gas, compressed, or ambient (20.9% O ₂) air on 0-25% range.
Compensation:	Barometric pressure and temperature (ATEX) Temperature (UL)
Connections:	1/8" compression tube fittings
Controls:	Water resistant keypad; menu driven range selection, calibration and system functions
Display:	Graphical LCD 2.75" x 1.375"; resolution 0.001%; displays real time ambient temperature and pressure
Enclosure:	NEMA Type 3R for rain in outdoor applications (UL) NEMA 4X (ATEX)
Flow:	Not flow sensitive; recommended flow rate 1-2 SCFH
Linearity:	±1% of full scale
Pressure:	Inlet - regulate to 5-30 psig to deliver 1-2 SCFH flow; vent - atmospheric
Power:	12-28 VDC (UL, ATEX Certified) 110-220 VAC (ATEX Certified)
Response Time:	90% of final reading in 10 seconds
Sample System:	Sample flow meter; options available, see other side
Sensitivity:	< 0.5% of FS range
Sensor Model:	GPR-11-32 for non-acid (CO ₂) gas streams XLT-11-24 for gases containing > 0.5% CO ₂
Sensor Life:	GPR-11-32 32 months in air at 25°C and 1 atm XLT-11-24 24 months in air at 25°C and 1 atm
Signal Output:	4-20mA; optional Modbus RTU communication
Operating Range:	5°C to 45°C (GPR sensor); -10° to 45°C (XLT)
Warranty:	12 months analyzer; 12 months sensor
Wetted Parts:	Stainless steel

UL or ATEX Certified for Hazardous Areas



GPR-2800 AIS Oxygen Analyzer

**Full Featured Oxygen Analyzer with
→ Optional Modbus RTU Communication and
Modular Sample Systems**

Exia
CLASSIFIED
UL US
UL Certified
File E343386
Class I, Division 1, Groups C and D
T₄ T_{amb} -20°C to +50°C

ATEX Certified - Directive 94/9/EC
Examination Cert: INERIS 08ATEX0036
II 2 G
Ex d [ib] ib IIB T4
T_{amb} -20°C to +50°C
CE
0080

ISO 9001:2008 Certified
INTERTEK Certificate No. 485
INTERTEK
ISO 9001:2008

Optional Equipment

Sample conditioning systems (see back page) - Contact factory

* Specifications subject to change without notice

GPR-2800 AIS PPM Oxygen Transmitter



Shown with Optional A-3393-6 Sample System

Owner's Manual





Table of Contents

Introduction	1
Quality Control Certification	2
Safety	3
Features & Specifications	4
Operation	5
Maintenance	6
Spare Parts	7
Troubleshooting	8
Warranty	9
Material Safety Data Sheets	10
Drawings	A/R
Explosion Proofing Electrical Connections	Appendix A
Correlating readings – LCD display to 4-20mA signal output	Appendix B
H2S Scrubber, Sample System, Media MSDS	Appendix F
Maintenance H2S Scrubber & Coalescing Filter	Appendix G

The appendices referenced above are an integral part of the documentation, installation and maintenance of this analyzer to comply with all applicable directives. It is important that users review these documents before proceeding.

1. Introduction

Your new oxygen transmitter incorporates an advanced electrochemical sensor specific to oxygen along with state-of-the-art digital electronics designed to give you years of reliable precise oxygen measurements in a variety of industrial oxygen applications. More importantly, it has been constructed as intrinsically safe in accordance with ATEX Directives 94/9/EC for use in hazardous areas in zone 1 Group C and D.

T h e d e s i g n a l s o m e e t s	Analytical Industries Inc. dba Advanced Instruments Inc. 2855 Metropolitan Place, Pomona, CA 91767 USA GPR-1800AIS/2800AIS  0080 Serial No.: Year of Manufacture: INERIS 08ATEX0036  II 2 G Ex d [ib] ib IIB T4  T _{amb} -20 C to +50 C  WARNING: POTENTIAL ELECTROSTATIC CHARGING HAZARD – SEE INSTRUCTIONS
--	--

The transmitter also complies with NEC intrinsic safety standards for use in Class 1, Division 1, Group C, D hazardous areas. Please refer to Appendix A for information on making electrical connections that maintain the desired level of protection.

To obtain maximum performance from your new oxygen transmitter, please read and follow the guidelines provided in this Owner's Manual.

Every effort has been made to select the most reliable state of the art materials and components, to design the transmitter for superior performance and minimal cost of ownership. This transmitter was tested thoroughly by the manufacturer prior to shipment for best performance.

However, modern electronic devices do require service from time to time. The warranty included herein plus a staff of trained professional technicians to quickly service your transmitter is your assurance that we stand behind every transmitter sold.

The serial number of this transmitter may be found on the inside the transmitter enclosure. You should note the serial number in the space provided and retains this Owner's Manual as a permanent record of your purchase, for future reference and for warranty considerations.

Serial Number: _____

Advanced Instruments Inc. appreciates your business and pledges to make every effort to maintain the highest possible quality standards with respect to product design, manufacturing and service.

3. General Safety & Installation

This section summarizes the essential precautions applicable to the GPR-2500AIS Oxygen Transmitter. Additional precautions specific to individual transmitter are contained in the following sections of this manual. To operate the transmitter safely and obtain maximum performance follow the basic guidelines outlined in this Owner's Manual.



Caution: This symbol is used throughout the Owner's Manual to Caution and alert the user to recommended safety and/or operating guidelines.



Warning: This symbol is used throughout the Owner's Manual to Warn and alert the user of the presence of electrostatic discharge. Clean all non-metallic surfaces with a damp cloth only



Danger: This symbol is used throughout the Owner's Manual to identify sources of immediate Danger such as the presence of hazardous voltages.

Read Instructions: Before operating the transmitter read the instructions.

Retain Instructions: The safety precautions and operating instructions found in the Owner's Manual should be retained for future reference.

Heed Warnings: Follow all warnings on the transmitter, accessories (if any) and in this Owner's Manual.

Follow Instructions: Observe all precautions and operating instructions. Failure to do so may result in personal injury or damage to the transmitter.

Analyzer label



2. Quality Control Certification

Maintenance

Serviceability: Except for replacing the oxygen sensor, there are no parts inside the transmitter for the operator to service.

Only trained personnel with the authorization of their supervisor should conduct maintenance.

Oxygen Sensor: DO NOT open the sensor. The sensor contains a corrosive liquid electrolyte that could be harmful if touched or ingested, refer to the Material Safety Data Sheet contained in the Owner's Manual appendix. Avoid contact with any liquid or crystal type powder in or around the sensor or sensor housing, as either could be a form of electrolyte. Leaking sensors should be disposed of in accordance with local regulations.

Troubleshooting: Consult the guidelines in Section 8 for advice on the common operating errors before concluding that your transmitter is faulty. Do not attempt to service the transmitter beyond those means described in this Owner's Manual.

Do not attempt to make repairs by yourself as this will void the warranty as per Section 10 and may result in electrical shock, injury or damage. All other servicing should be referred to qualified service personnel.

Cleaning: The transmitter should be cleaned only as recommended by the manufacturer. Wipe off dust and dirt from the outside of the unit with a soft damp cloth then dry immediately. Do not use solvents or chemicals.

Nonuse Periods: If the transmitter is equipped with a range switch advance the switch to the OFF position and disconnect the power when the transmitter is left unused for a long period of time.

Installation

This analyzer has been constructed in compliance with

EN 60079-0 : 2006

EN 60079-1 : 2004

EN 60079-11 : 2007

It must be installed in accordance with

EN 60079-14

Gas Sample Stream: Ensure the gas stream composition of the application is consistent with the specifications and if in doubt, review the application and consult the factory before initiating the installation.

Note: In natural gas applications such as extraction and transmission, a low voltage current is applied to the pipeline itself to inhibit corrosion of the pipeline. As a result, electronic devices connected to the pipeline can be affected unless they are adequately grounded.

Contaminant Gases: A gas scrubber and flow indicator with integral metering valve are required upstream of the analyzer to remove any interfering gases such as oxides of sulfur and nitrogen or hydrogen sulfide that can interfere with measurement and cause reduction in the expected life of the sensor. Consult the factory for recommendations concerning the proper selection and installation of components.

Expected Sensor Life: With reference to the publish specification located at the last page of this manual, the expected life of all oxygen sensors is predicated on oxygen concentration (< 1000 ppm for PPM sensor or air for % sensor), temperature (77°F/25°C) and pressure (1 atmosphere) in “normal” applications. Deviations from standard conditions will affect the life of the sensor. As a rule of thumb sensor life is inversely proportional to changes in the pressure and temperature.

Accuracy & Calibration: Refer to section 5 Operation.

Materials: Assemble the necessary zero, sample and span gases and optional components such as valves, coalescing or particulate filters, and pumps as dictated by the application. Stainless steel tubing is essential for maintaining the integrity of the gas stream for low % or PPM O₂ level analysis.

Operating Temperature: The sample must be sufficiently cooled before it enters the analyzer and any optional components. A coiled 10 foot length of ¼” stainless steel tubing is sufficient for cooling sample gases as high as 1,800 °F to ambient. The recommended operating temperature is below 35 °C. However, the analyzer may be operated at temperature up to 45 °C on an intermittent basis but the user is expected to accept a reduction in expected sensor life –as a rule of thumb, for every degree °C increase in temperature (above 25 °C), the sensor life is reduced by approximately 2.5%.

Heat: Situate and store the analyzer away from direct sources of heat.

Liquid and Object Entry: The analyzer should not be immersed in any liquid. Care should be taken so that liquids are not spilled into and objects do not fall into the inside of the analyzer.

Handling: Do not use force when using the switches, knobs or other mechanical components. Before moving your analyzer be sure to disconnect the wiring/power cord and any cables connected to the output terminals of the analyzer.

Sample Pressure and Flow

All electrochemical oxygen sensors respond to partial pressure changes in oxygen. The sensors are equally capable of analyzing the oxygen content of a flowing sample gas stream or monitoring the oxygen concentration in ambient air (such as a confined space in a control room or an open area around a landfill or bio-pond). The following is applicable to analyzers equipped with fuel cell type oxygen sensors.

Analyzers designed for in-situ ambient or area monitoring has no real sample inlet and vent. The sensor is exposed directly to the sample gas and it is intended to operate at atmospheric pressure. The analyzer has a built-in pressure sensor and the sensor output is automatically compensated for any atmospheric pressure changes.

Inlet Pressure: For the analyzers designed to measure oxygen in a flowing gas stream, the inlet sample pressure must be regulated between 5-30 psig. Although the rating of the SS tubing and tube fittings/valves itself is considerably higher (more than 100 psig), a sample pressure of 5-30 psig is recommended for ease of control of sample flow.

The analyzer equipped with a sample system has designated SAMPLE and VENT ports. Connect SAMPLE gas to SAMPLE and the vent to the VENT ports only.



Caution: If the analyzer is equipped with an optional H₂S scrubber, sample inlet pressure must not exceed 30 psig.

Outlet Pressure: In applications where sample pressure is positive, the sample must be vented to an exhaust pipe at a pressure less than the inlet pressure so that the sample gas can flow through the sensor housing. Ideally, the sample must be vented to atmospheric pressure.

Note: The sensor may be used at a slight positive pressure (e.g., when sample is vented to a common exhaust where the pressure might be higher than 1 atmosphere). However, the pressure at the sensor must be maintained at all times including during the span calibration. This may be accomplished by using a back-pressure regulator at vent line of the analyzer. **Caution:** A sudden change in pressure at the sensor may result in the sensor electrolyte leakage.

Flow rates of 1-5 SCFH cause no appreciable change in the oxygen reading. However, flow rates above 5 SCFH may generate a slight backpressure on the sensor resulting in erroneous oxygen readings.

Caution: Do not place your finger over the vent (it pressurizes the sensor) to test the flow indicator when gas is flowing to the sensor. Removing your finger (the restriction) generates a vacuum on the sensor and may damage the sensor (voiding the sensor warranty).

Application Pressure - Positive: A flow indicator with integral metering valve positioned upstream of the sensor is recommended for controlling the sample flow rate between 1-5 SCFH. If a separate flow control valve and a flow indicator is used, position flow control valve upstream of the sensor and position a flow indicator downstream of the sensor. If necessary, a pressure regulator upstream of the flow control valve should be used to regulate the inlet pressure between 5-30 psig.



Caution: If the analyzer is equipped with a H₂S scrubber as part of an optional sample conditioning system, inlet pressure must not exceed 30 psig.

Application Pressure - Atmospheric or Slightly Negative: For % oxygen measurements, an optional external sample pump may be used upstream of the sensor to push the sample across the sensor and out to atmosphere. For PPM oxygen measurements, an optional external sampling pump should be positioned downstream of the sensor to draw the sample from the process, by the sensor and out to atmosphere. A flow meter is generally not necessary to obtain the recommended flow rate with most sampling pumps. However, if the sample pump can pull/push more than 5 SCFH, a flow control must be used to control the sample flow. The flow control valve must be positioned in such a way that it does not generate any vacuum on the sensor.



Caution: If the analyzer is equipped with a flow indicator with integral metering valve or a metering flow control valve upstream of the sensor and the pump is installed downstream of sensor- open the metering valve completely before turning the pump ON to avoid drawing a vacuum on the sensor and placing an undue burden on the pump.

If pump loading is a consideration, a second throttle valve on the pump's inlet side may be necessary to provide a bypass path so the sample flow rate is within the above parameters.

Moisture & Particulates: Installation of a suitable coalescing or particulate filter is required to remove condensation, moisture and/or particulates from the sample gas to prevent erroneous analysis readings and damage to the sensor or other optional components. Moisture and/or particulates do not necessarily damage the sensor. However, collection of moisture/particulate on the sensing surface can block or inhibit the diffusion of sample gas into the sensor resulting in a reduction of sensor signal output – and the appearance of a sensor failure. Consult the factory for recommendations concerning the proper selection and installation of optional components.

Moisture and/or particulates generally can be removed from the sensor by opening the sensor housing and either blowing on the sensing surface or gently wiping or brushing the sensing surface with damp cloth.

Mounting: The analyzer is approved for indoor as well as outdoor use. However, avoid mounting in an area where direct sun might heat up the analyzer beyond the recommended operating temperature range. If possible, install a small hood over the analyzer for rain water drain and to prevent over-heating of analyzer.

Gas Connections: The Inlet and outlet vent gas lines require 1/8" or 1/4" stainless steel compression type tube fittings. The sample inlet tubing must be metallic, preferably SS. The sample vent line may be of SS or hard plastic tubing with low gas permeability.

Power: Supply power to the analyzer only as rated by the specification or markings on the analyzer enclosure. The GPR-2800AIS is powered by 12-24 VDC or 100/230 VAC supply (check the QC certificate to ensure the power requirement of your analyzer). The wiring that connects the analyzer to the power source should be installed in accordance with recognized electrical standards. Ensure that the analyzer case is properly grounded and meets the requirements for area classification where the analyzer is installed. Never yank wiring to remove it from a terminal connection.

The maximum power the analyzer consumes is no more than 7 Watts.

4. Features & Specifications



Technical Specifications

Accuracy: < 1% of FS range under constant conditions

Analysis: 0-1%, 0-5%, 0-10% and 0-25% FS ranges; auto-ranging or manually lock on single range

Application: Oxygen analysis in inert, hydrocarbon, helium, hydrogen, mixed and acid (CO₂) gas streams

Approvals: EC TYPE EXAMINATION CERTIFICATE: INERIS 08ATEX0036

Area Classification: Meets recognized intrinsic safety standards for use in Zone 1, Class 1, Division 1, Group C and D hazardous areas

Alarms: Two user configurable alarms: magnetic coil relays rated 3A at 110 VAC, field programmable alarm time delays, alarm bypass for calibration and system fail alarm.

Calibration: Air or certified span gas of O₂ balance N₂ approx 80% of analysis range or one range above

Compensation: Barometric pressure and temperature

Connections: 1/4" compression tube fittings

Controls: Water resistant keypad; menu driven and field selectable range selection, calibration value and alarm functions

Display: Graphical LCD 2.75x1.375"; resolution 0.001%; displays real time ambient temperature and pressure

Enclosures: Aluminum ex-proof, fiberglass NEMA 4X, 16x9x6", 20 lbs

Flow Sensitivity: None between 0.5-5 SCFH, 1-2 SCFH recommended

Linearity: ±1% of full scale

Pressure: Inlet - regulate to 5-30 psig; vent - atmospheric

Power: 12-24VDC (suitable for solar power systems) or 100/230VAC

Response Time: 90% of final reading in 10 seconds

Sample System: Flow meter; shown with optional A-3393 H2S sample system 16x16" panel with coalescing filter, 3-way sample/span valve, H2S scrubber

Sensitivity: < 0.5% of FS range

Sensor Model: GPR-11-32 for inert gases
XLT-11-24 for gas streams with > 0.5% CO₂

Sensor Life: 24 months at 25°C and 1 atm

Signal Output: 4-20mA

Operating Range: Recommended -20° to 45°C (XLT sensor); -10° to 45°C (GPR sensor)

Warranty: 12 months analyzer; 12 months sensor

Wetted Parts: Stainless steel

Optional Equipment:

Expanded sample system to include pressure regulator w/gauge, continuous liquid drain system - consult factory for details.



GPR-2800 AIS

12-24 VDC or 100/230 VAC Powered Intrinsic Safety Oxygen Analyzer

ATEX Directive 94/9/EC
INERIS 08ATEX0036





ISO 9001:2000 QA System
INTERTEK Certificate No. 485

2855 Metropolitan Place, Pomona, CA 91767 USA • Tel: 909-392-6900, Fax: 909-392-3665, www.aill.com, e-mail: info@aill.com Rev 9/08

5. Operation

Principle of Operation

The GPR-2800AIS Oxygen Transmitter incorporates a variety of advanced galvanic fuel cell type oxygen sensors. These sensors are very specific to oxygen and generate an electrical signal proportional to the amount of oxygen present in a gas stream. The selection of A particular type of sensor depends on the composition of the sample gas stream. Consult the factory for recommendation.

The transmitter is configured in two sections. The signal processing electronics and sensor are housed in a general purpose NEMA 4X rated enclosure. The terminals for incoming power, signal output and intrinsic safety barriers are mounted on a PCB housed in an explosion proof enclosure.

The two sets of electronics are interconnected using an explosion proof Y-fitting, explosion proof packing fiber and sealing cement – see Appendix A. Once connected, the intrinsic safety barriers limit the amount of power that flows to and from the signal processing electronics effectively preventing an explosive condition. The analyzer design conforms to the ATEX directive for equipment as intrinsically safe and has been approved by an independent body:

The analyzer carries the following area classification



II 2 G

Ex d [ib] ib IIB T4

T_{amb} -20 °C to +50 °C



WARNING: POTENTIAL ELECTROSTATIC CHARGING HAZARD-SEE INSTRUCTION

The GPR-2800AIS also meets the intrinsic safety standards required for use in Class 1, Division 1, Group C, D hazardous areas.

Advanced Galvanic Sensor Technology

All galvanic type sensors function on the same principle and are specific to oxygen. They measure the partial pressure of oxygen from low PPM to 100% levels in inert gases, gaseous hydrocarbons, helium, hydrogen and mixed gases

Design Objectives

- Improve quality and reliability through a proprietary controlled manufacturing process . . .
- Comply with domestic and international quality standards
- Compact disposable dimensions
- No sensor maintenance
- Improve performance over replacement sensors - sensitivity, stability, response, recovery
- Longer operating and shelf life - translate into longer warranty period
- Low cost of ownership

% Oxygen Sensors

- Extend operating life to 10 years in air (20.9% O₂) . . .
24 months in continuous 100% O₂
- Extended operating range to -40° C/F to 50° C
- Excellent stability at elevated pressure . . .
Up to 10 atmospheres in hyperbaric chambers
- Superior compatibility with 0.5 - 100% CO₂ gas streams
24 month operating life in traditional dimensions
- Develop special sensor for fast response and long life
Large cathode with proprietary electrolytes and anodes

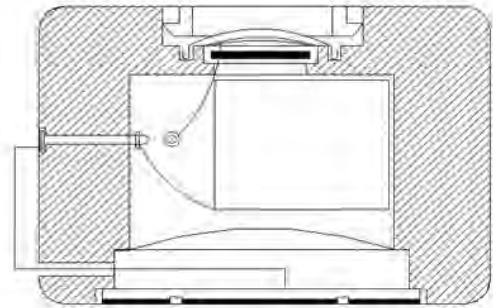

GPR/XLT 11 Series % Oxygen Sensor

Oxygen, the fuel for this electrochemical transducer, diffusing into the sensor, reacts electrochemically at the sensing electrode to produce an electrical current output proportional to the oxygen concentration in the gas phase. The sensor's signal output is linear over all measuring ranges and remains virtually constant over its useful life. The sensor requires no maintenance and is easily and safely replaced at the end of its useful life.

Proprietary advancements in design and chemistry add significant advantages to this extremely versatile oxygen sensing technology. Sensors for low % analysis recover from air to low % levels in seconds, exhibit longer life and reliable quality. The expected life of our new generation of percentage range sensors now range from 32 months to ten years with faster response times and greater stability. Another significant development involves expanding the operating temperature range for percentage range sensors from -30°C to 50°C. Contact factory for more specific information about your application.

The PPM sensors recover from an upset condition to low PPM level in a matter of few minutes. These sensors show excellent stability over its useful life.

Electronics

The signal generated by the sensor is processed by state of the art low power micro-processor based digital circuitry. The first stage amplifies the signal. The second stage eliminates the low frequency noise. The third stage employs a high frequency filter and compensates for signal output variations caused by ambient temperature changes. The result is a very stable signal. Sample oxygen is analyzed very accurately. Response time of 90% of full scale is less than 10 seconds (actual experience may vary due to the integrity of sample line connections, dead volume and flow rate selected) on all ranges under ambient monitoring conditions. Sensitivity is typically 0.5% of full scale of the low range. Oxygen readings may be recorded by an external device via the 4-20 mA or 1-5V signal output.

Sample System

The standard GPR-2800AIS is supplied without a sample conditioning system thereby giving users the option of adding their own or purchasing a factory designed sample conditioning system, see section 2 QC Certification for optional equipment ordered. Whatever the choice, the sample must be properly conditioned before introducing it to the sensor to ensure an accurate measurement.

The GPR-2800AIS is generally supplied with a minimum of a sample flow control valve and a flow meter. Users interested in adding their own sample conditioning system should consult the factory. Advanced Instruments Inc. offers a full range of sample handling, conditioning and expertise to meet your application requirements. Contact us at 909-392-6900 or e-mail us at info@aii1.com.

Calibration & Accuracy Overview

Single Point Calibration: As previously described the galvanic type oxygen sensor generates an electrical current proportional to the oxygen concentration in the sample gas. In the absence of oxygen the sensor exhibits an absolute zero, e.g. the sensor does not generate a current output in the absence of oxygen. Given these linearity and absolute zero properties, single point calibration is possible.

Pressure: Because sensors are sensitive to the partial pressure of oxygen in the sample gas, their output is a function of the number of molecules of oxygen 'per unit volume'. Readouts in percent are permissible only when the total pressure of the sample gas being analyzed remains constant. The pressure of the sample gas and that of the calibration gas must be the same.

Temperature: The rate at which oxygen molecules diffuse into the sensor is controlled by a Teflon membrane otherwise known as an 'oxygen diffusion limiting barrier' and all diffusion processes are temperature sensitive, the fact the sensor's electrical output will vary with temperature is normal. This variation is relatively constant (2.5% per °C). A temperature compensation circuit employing a thermistor and a network of resistors offsets this effect with an accuracy of $\pm 5\%$ or better over a wide operating temperature range e.g., 5-45 °C can be obtained thus the signal output remains virtually independent of ambient temperature. There is extremely low error in measurement if the calibration and sampling are performed at similar temperatures (within ± 5 °C. Conversely, a temperature variation of 10 °C may produce an error of < 2% of full scale.

Accuracy: In light of the above parameters, the overall accuracy of an analyzer is affected by two types of errors: 1) 'percent of reading errors', illustrated by Graph A below, is contributed by the temperature compensation circuit (tolerance in the thermistor value, variation in temperature coefficient of the thermistor, tolerances in resistors values and the accuracy in the measuring devices, e.g., LCD display and 2) 'percent of full scale errors', illustrated by Graph B, such as 1-2% offset errors in readout and calibration devices. Other errors are 'spanned out' during calibration, especially when analyzer is calibrated close to the top end of the measuring range.

Graph C illustrates these 'worse case' specifications that are typically used to develop an overall accuracy statement of < 1% of full scale at constant temperature or < 5% over the operating temperature range. The QC testing error is typically < 0.5% prior to shipment of analyzer from the factory.

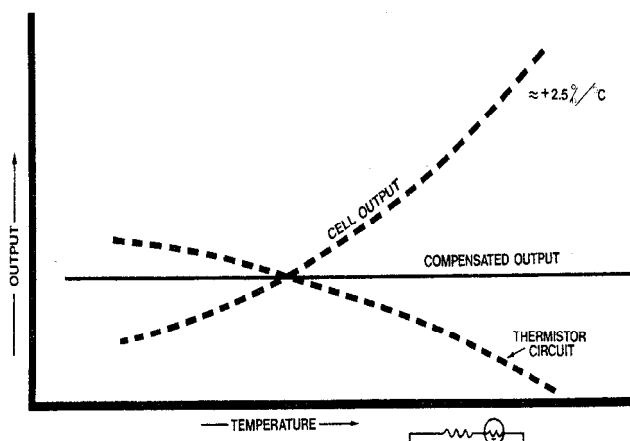

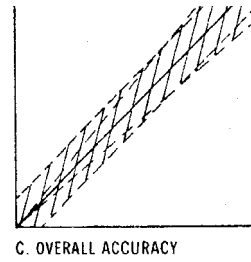
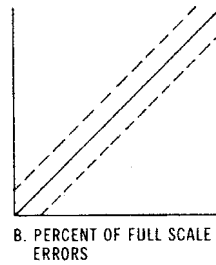
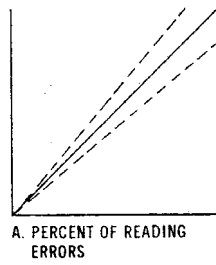

Example 1: As illustrated by Graph A, any error during a span adjustment at lower end of the scale, e.g., 20.9% (air) on a 100% full scale range, would be multiplied by a factor of 4.78 ($100/20.9$) when making measurements close to 100% O₂. Conversely, an error during a span adjustment close to the top end of the range, e.g., at 100% is reduced proportionately for measurements of oxygen concentrations near the bottom end of the range.

Graph B represents a constant error over the entire measuring range. This error is generally associated with the measuring e.g., LCD and or calibrating devices, e.g., current simulator or current/voltage measuring devices.

Mounting the Transmitter

The GPR-2800AIS analyzer consists of two interconnected enclosures (without the optional sample conditioning system and panel) and measures 8"H x 15-3/4"W x 7"D. This configuration is designed to be mounted directly to any flat vertical surface, wall or bulkhead plate by using eight (4) of the appropriate screws.

To facilitate servicing the interior of the transmitters, secure the back plate to a vertical surface approximately 5 feet from the floor or a level accessible to service personnel. This requires the user to supply four (4) additional proper size screws and anchors.



Caution: Do not remove or discard the gaskets from either the Ex enclosure or the fiberglass enclosure. Failure to reinstall either of the gaskets will void the NEMA 4 rating and the immunity to RFI/EMI.

The transmitters design provides immunity from RFI/EMI by maintaining a good conductive contact between the two halves of the enclosures via a conductive gasket (the smaller enclosure containing signal processing electronics) The surfaces contacting the conductive gasket are unpainted. Do not paint these areas. Painting will negate the RFI/EMI protection.

Note: If equipped with the optional H₂S sample conditioning system, the transmitter and sample system are mounted to a back panel 15-3/4"H x 15-3/4"W with four mounting holes. Mount the entire panel to any vertical flat surface.



GPR-2800 AIS shown with optional Sample conditioning system

Gas Connections

The GPR-2800AIS with its standard flow through configuration is designed for positive pressure samples and requires connections for incoming sample and outgoing vent lines. Zero and span inlet ports are offered as part of the optional sample systems. The user is responsible for calibration gases and other required components, see below.

Procedure

Caution: Do not change the factory setting until instructed to do in this manual.

1. If analyzer has no marking for sample inlet and sample vent, designate one of the bulkhead tube fittings as the VENT and the other as SAMPLE.
2. Regulate the sample pressure as described in "Pressure and Flow" section above.
3. Connect a 1/8" or 1/4" vent line to the compression fitting to be used for venting the sample.
4. Connect a 1/8" or 1/4" sample line to the compression fitting to be used to bring SAMPLE gas to the analyzer.
5. If equipped with optional SPAN and/or ZERO ports, connect the SPAN and the ZERO gas lines to the respective SPAN and ZERO ports of the analyzer
6. Set the SAMPLE, SPAN and the ZERO gas pressure between 5-30 psig..
7. Select sample gas and allow it to flow through the transmitters and set the flow rate to 1- 2 SCFH.

Note: If equipped with the optional H₂S sample conditioning system: Regulate the pressure so that it does not exceed 30 psig.

Flow rates of 1-5 SCFH cause no appreciable change in the oxygen reading. However, flow rates above 5 SCFH may generate a backpressure and cause erroneous oxygen readings due to fact that the smaller diameter of the integral sample system tubing cannot vent the sample gas quickly at higher flow rates. If the analyzer is not equipped with an integral flow control valve, a flow control metering valve with a flow indicator upstream of the sensor must be installed to control the flow rate of the sample gas. A flow rate of 1- 2 SCFH or 0.5-1 liter per minute is recommended for optimum performance.



Caution: Do not place your finger over the vent (it pressurizes the sensor) to test the flow indicator when gas is flowing to the sensor. Removing your finger (the restriction) generates a sudden vacuum on the sensor and may lead to electrolyte leakage thus causing damage to the sensor (will void sensor warranty).

Electrical Connections



Incoming power, alarm relays, and signal output connections are made to terminal blocks mounted on a PCB located in the explosion proof enclosure.

Do not supply voltage more than specified in this manual and noted near the power input terminal of the analyzer.

The PCB in the explosion proof enclosure contains a power limiting intrinsic safety barrier that limit the total power available at the PCB electronics mounted in the general purpose enclosure.

With proper insulation of the incoming power (see Appendix A), this configuration of the GPR-2800AIS conforms to the ATEX directives for equipments for use in hazardous area. The analyzer meets the following area classification:



II 2 G

Ex d [ib] ib IIB T4

T_{amb} -20 C to +50 C



Ex enclosure for power input, alarms and signal output

The GPR-2800AIS also meets the intrinsic safety standards required for use in Class 1, Division 1, Group C, D hazardous areas.

The A-1166A IS PCB in the Ex enclosure contains two fuses, one plug-in (brown color) rated at 50 mA and the second mounted on the PCB (after the DC voltage is regulated to a lower safe value, this fuse meets barrier network standard EN 50020).



Avoid electrostatic discharge – Clean all non-metallic surfaces with a damp cloth only.

Analyzer ground terminal must be connected to a ground

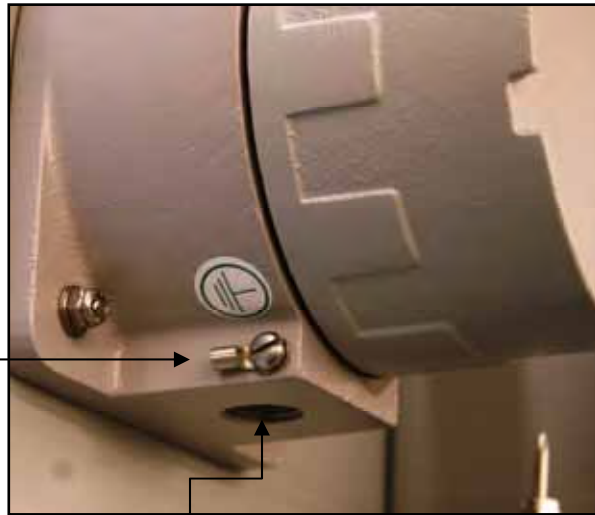

Run all cables through an ATEX approved conduit

Hazardous Area Installation

The GPR-2800AIS may be installed in a hazardous area with proper insulation of the incoming power, see Appendix A. A 12-28 VDC or 100/230 VAC power supply with a shielded power cable is recommended. The power cable to the Ex enclosure must be supplied through a conduit approved for use in hazardous area. Secure the wires to the power input terminal block by using the integral screws of the terminal block. Do not substitute terminal screws. With AC power, the power ground must be connected to the ground terminal.



CAUTION: Check the QC for the proper power requirement. Incorrect power will severely damage the analyzer

Output Connections

The analyzer has two adjustable alarms, one power fail alarm and 4-20 mA or 1-5 VDC output connections. **CAUTION:** The 4-20mA IC does not require external power. Supplying external power to the IC can seriously damage the analyzer.

The HI and LOW alarms are user configurable. The relays are rated at 5A at 250 V.

The power failure alarm is a dry contact that will close when power is turned OFF. This relay is rated at 5A at 250 V.

CUTION: Do not exceed the recommended rating of the relays. Excessive power through the relays can severely damage the analyzer.

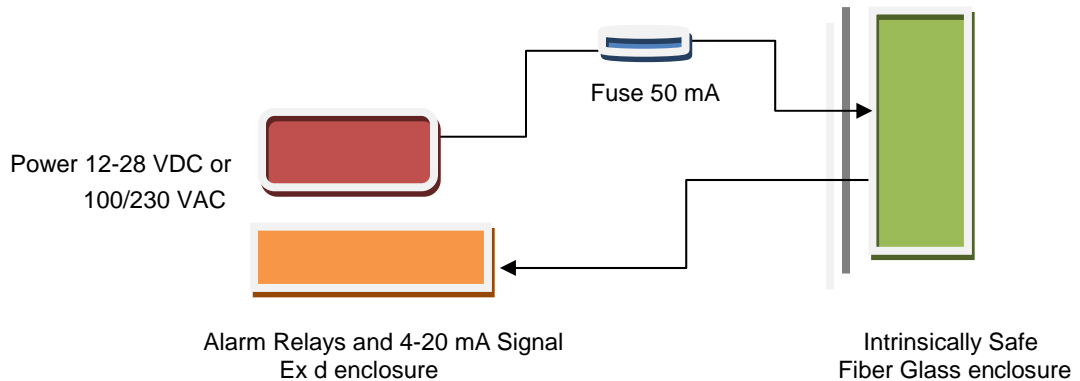

Procedure

Power requirements consist of a 12-28 VDC or 100/230 VAC power supply. Check the QC and analyzer cover plate for proper power requirement.

1. Unscrew the cone shaped cover from the lower enclosure.
2. Separate the shielding from the wires of the cable.
3. Ensure the positive and negative terminals of the power supply are connected to the appropriate terminals of the terminal block as marked. For AC power, connect primary, neutral and power ground to the respective terminals.
4. Connect the shielding of the cable to the ground screw inside the enclosure.
5. Replace the cover.

Note: The male and female power terminals snap together, making it difficult to detach them when connecting the shield to the ground. However, after connecting the shield, ensure that the male terminal is fully inserted and secured into the female terminal block.

Installing the Oxygen Sensor

The GPR-2800AIS Oxygen Transmitter is equipped with a SS sensor housing. This housing offers ease of replacement of sensor and at the same time prevents any leakage into the system. The two sections of the sensor are held together by a metal clamp secured in place by easily accessed bolt. The integrity of the sensor housing has been tested at the factory prior to shipment and is fully operational from the shipping container.



Caution: All transmitters must be calibrated once the installation has been completed and periodically thereafter as described below. Following the initial installation and calibration, allow the transmitters to stabilize for 12-24 hours and re-calibrate the transmitter with a certified span gas.



Caution: DO NOT dissect the oxygen sensor. The sensor contains a corrosive liquid electrolyte that could be harmful if touched or ingested, refer to the Material Safety Data Sheet contained in the Owner's Manual appendix. Avoid contact with any liquid or crystal type powder in or around the sensor or sensor housing, as either could be a form of electrolyte. Leaking sensors should be disposed off in a manner similar to that of a common battery in accordance with local regulations.



Avoid electrostatic discharge – Clean all surfaces with a damp cloth only.

Procedure

1. Remove the two (2) clamps securing the right side corners and open the door of the fiber glass enclosure.
2. Loosen the bolt at the bottom of the sensor housing by using 5/16 ranch provided.
3. Twist the upper section of the housing 90 degree and pull it up until it clears the bottom section of the sensor housing.
4. Remove the old sensor (if previously installed) from the sensor housing
5. Remove the oxygen sensor from the bag and remove the two red shorting taps from the two ring gold color contact plate of the sensor.
6. Insert the sensor into the upper section of the sensor housing with gold contact plate facing towards two gold contact pins of the sensor housing
7. By holding the sensor and the upper section of the sensor housing in your hand, allow 2-3 minutes for the analyzer to respond to the new sensor. The analyzer should display oxygen around 21% with factory default span setting (see below)
8. You may perform a quick air calibration to ensure that the analyzer accepts the air calibration confirming that the sensor output is within the recommended limits.
9. Place the sensor in the bottom section of the sensor housing with the two ring gold contact plate facing up. Place the upper section of the sensor housing over the sensor. Slightly push it down and twist 90 degree.
10. By using the 5/16 ranch, tighten the bolt securing the two section together.

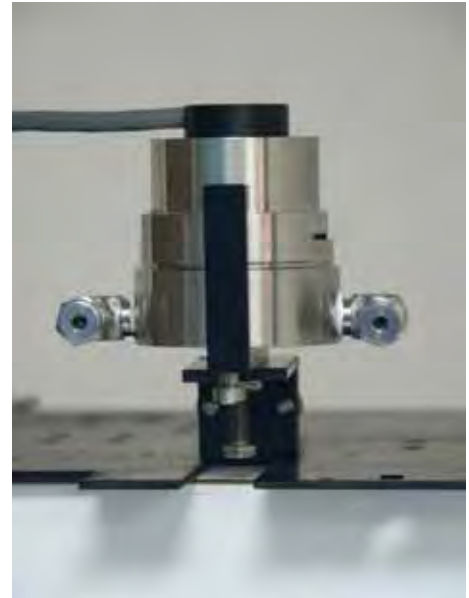

Span Gas Preparation

Note: The GPR-2800AIS can be calibrated by using ambient air. However, it can also be calibrated by using a certified span gas. Air calibration can be achieved right after installing the sensor in the housing. Subsequent calibration, where the sensor has been exposed to a sample gas, air calibration can be achieved by either removing the sensor from the sensor housing or by pushing the air through the sensor housing.



Caution: Do not contaminate the span gas cylinder when installing the pressure regulator on the span gas cylinder. Further, bleed the air filled regulator and span gas tubing before connecting the span gas to the analyzer and attempting the initial calibration.

Required Components

1. Certified span gas cylinder with an oxygen concentration, balance nitrogen, approximating 80% of the full scale of the measuring range or one range above the intended measuring range.
2. A pressure regulator to set the span gas pressure between 5 and 30 psig.
3. A flow meter to set the flow between 1-5 SCFH,
4. Suitable tube fittings and a 4-6 ft. length of 1/8" dia. metal tubing to connect the regulator to the flow meter inlet
5. Suitable tube fittings and a 4-6 ft. length of 1/8" dia. metal tubing to connect from the flow meter vent to tube fitting designated as SAMPLE IN or SPAN IN at the analyzer.

Procedure

1. With the span gas cylinder valve closed, install the pressure regulator on the cylinder.
2. Open the regulator's exit valve and partially open the pressure regulator's control knob.
3. Open slightly the cylinder valve.
4. Loosen the nut connecting the regulator to the cylinder and bleed the pressure regulator.
5. Retighten the nut connecting the regulator to the cylinder
6. Adjust the regulator exit valve and slowly bleed the pressure regulator.
7. Open the cylinder valve completely.
8. Set the pressure between 5-30 psig using the pressure regulator's control knob.

Caution: Do not exceed the recommended flow rate. Excessive flow rate could cause the backpressure on the sensor and may result in erroneous readings and damage the sensor

Establishing Power to Electronics

Once the two power input wires of the shielded cable are properly connected to the terminals inside the Ex enclosure as described above, connect the other end of the two wires to a suitable 12-24 VDC power supply such as a battery, PLC, DCS, etc.

The digital display responds instantaneously. When power is applied, the transmitter performs several self-diagnostic system status checks termed as "START-UP TEST" as illustrated below:

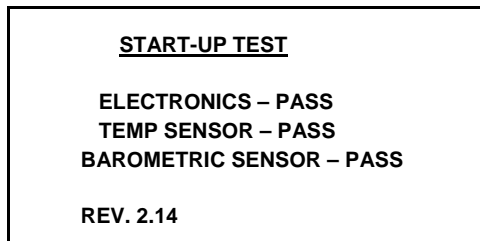

After self diagnostic tests, the analyzer turns itself into the sampling mode. And displays oxygen contents the sensor is exposed to, the analysis range, the ambient temperature and pressure, High and Low alarm set points.

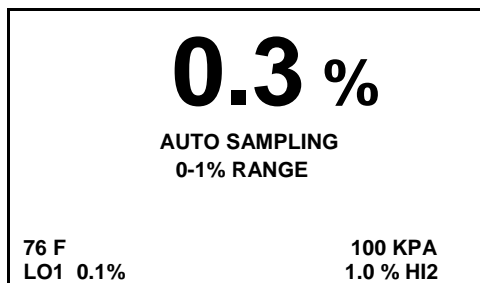

Menu Navigation

The four (4) pushbuttons located on the front of the transmitter control the micro-processor functions:

- Blue ENTER (select)
- Yellow UP ARROW
- Yellow DOWN ARROW
- Green MENU (escape)

Main Menu

To access the MAIN MENU, press the MENU (ESC) key and the following screen will appear.

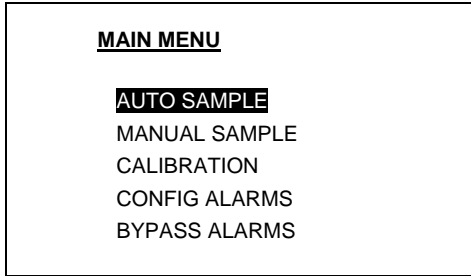

This screen shows various options available. You can use the UP and DOWN arrow key to move the cursor and highlight the desired function. After moving the cursor to the desired function, press ENTER to access that function.

Range Selection

The GPR-2800 AIS transmitter is equipped with four (4) standard measuring ranges (see specification) and provides users with a choice of sampling modes. By accessing the MAIN MENU, users may select either the AUTO SAMPLING (ranging) or MANUAL SAMPLING (to lock on a single range) mode.

Note: For calibration purposes, use of the AUTO SAMPLE mode is recommended. For example, calibration with ambient air (20.9% oxygen), the analyzer will automatically turn into 0-25% range. However, the user can also select the MANUAL SAMPLE mode for calibration but the span gas must not exceed the full scale of the manual range selected – for example, a span gas with an 8% oxygen concentration in nitrogen would dictate the use of the 0-10% full scale range for calibration.

Auto Sampling:

1. Access the MAIN MENU by pressing the MENU key.
2. Advance the reverse shade cursor using the ARROW keys to highlight AUTO SAMPLE.
3. Press the ENTER key to select the highlighted menu option.

The display returns to the sampling mode:

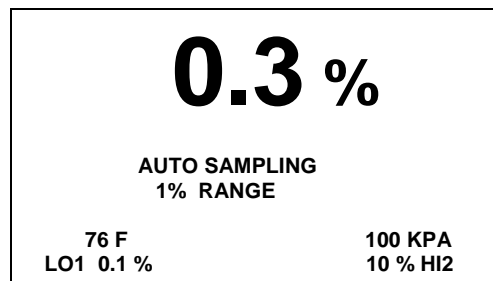
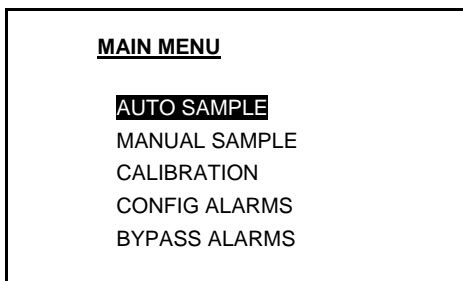

The display will shift to the next higher range when the oxygen reading exceeds 99.9% of the upper limit of the current range. The display will shift to the next lower range when the oxygen reading drops to 85% of the next lower range.

For example, if the transmitter is reading 1% on the 0-10% range and an upset occurs, the display will shift to the 0-25% range when the oxygen reading exceeds 9.9%. Conversely, once the upset condition is corrected, the display will shift back to the 0-10% range when the oxygen reading drops to 8.5%.

Manual Sampling:

1. Access the MAIN MENU by pressing the MENU key.
2. Advance the reverse shade cursor using the ARROW keys to highlight MANUAL SAMPLE.
3. Press the ENTER key to select the highlighted menu option.

The following display appears:

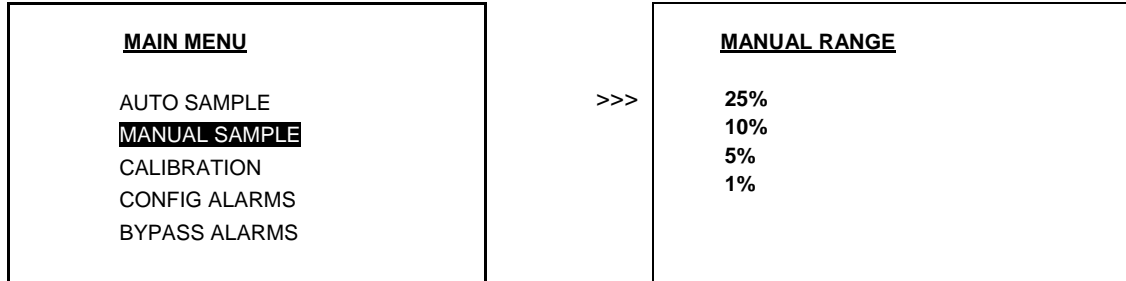

4. Advance the reverse shade cursor using the ARROW keys to highlight the desired MANUAL RANGE.
5. Press the ENTER key to select the highlighted menu option.

The following display appears with the range selected and oxygen concentration of the sample gas:

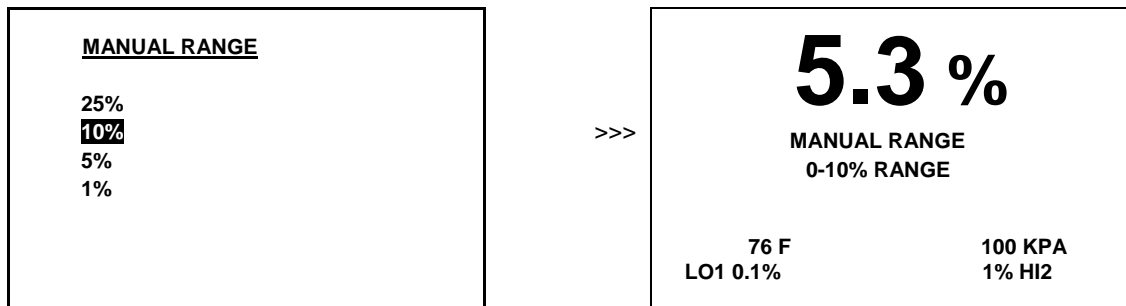

NOTE: If the oxygen value goes above the full scale range selected, display will not shift to the next higher range. Instead, when the oxygen reading exceeds 110% of the upper limit of the current range, an OVER RANGE warning will be displayed.

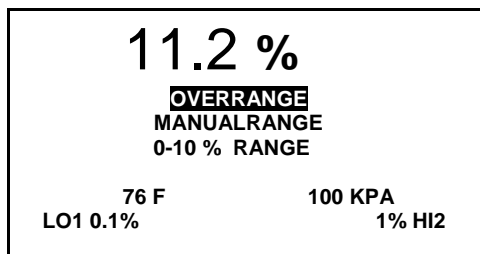

Once the OVER RANGE warning appears the user must advance the transmitter to the next higher range.

NOTE: With oxygen reading above 110% of the selected range, the mA signal output will increase but will freeze at a maximum value of 24 mA. After the oxygen reading falls below the full scale range, the mA signal will become normal.

Calibration of Transmitter

The electrochemical oxygen sensors generate an electrical current that is **linear** or proportional to the oxygen concentration in a sample gas. In the absence of oxygen the sensor exhibits an **absolute zero**, i.e., the sensor does not generate a current output in the absence of oxygen. Given the properties of linearity and an absolute zero, a single point calibration is possible.

As described below, zero calibration is recommended only when the application (or user) demands optimum accuracy of below 5% of the most sensitive or lowest range available on the analyzer. Span calibration, in one of the forms described below, is necessary to adjust the analyzer sensitivity for accurate measurements of oxygen. As a rule of thumb, zero calibration should be carried out after span calibration.

Zero Calibration

Despite the absolute zero inherent in the electrochemical oxygen sensors, the reality is that analyzers may display an oxygen reading even when sampling a zero gas (oxygen free gas) due to:

1. Contamination or questionable quality of the zero gas
2. Minor leakage in the sample line connections
3. Residual oxygen dissolved in the sensor's electrolyte
4. Tolerances of the electronic components

The maximum zero offset of every analyzer is checked prior to shipment. However, due to the fact that the factory sample system conditions differ from that of the user, no ZERO OFFSET adjustment is made at the factory

Span Calibration

Involves periodically, see Intervals section below, checking and/or adjusting the electronics to the sensor's signal output at a given oxygen standard. The frequency of calibration varies with the application, e.g., the degree of accuracy required by the application and the quality assurance protocol of the user. However, the interval between span calibrations should not exceed three (3) months.

Note: Regardless of the oxygen concentration of the standard used, the span calibration process takes approximately 10-15 minutes. However, the time required to bring a PPM analyzer back on-line after span calibration can vary, see Online Recovery Time below.

Considerations

When it comes to the calibration of oxygen analyzers utilizing an electrochemical oxygen sensor, circumstances vary widely from the ideal conditions that exist at the factory to a variety of differing circumstances users encounter in the field. The following describes the most common factors and reasons that influence the calibration procedures.

All electrochemical sensor based analyzers require periodic calibration, e.g. weekly intervals to a 3 month maximum, to ensure accuracy and ascertain the integrity of the sensor

For optimum accuracy, calibrate the analyzer at or close to the temperature and pressure of the sample gas

The priority users place on getting or keeping an analyzer online is “the” most significant factor involved in calibration and troubleshooting issues. The time it takes an analyzer to come down to a specific level after exposure to high O₂ concentrations or air is significantly different if a sensor is being installed than if the sensor had been in-service at low oxygen levels for more than 1 week.

Sensor	Calibration at Install	In-service Calibration
% Fuel Cell	Air to $0.1\% < 30$ Sec	Similar
	Air to $0.05\% < 2$ min	
	Air to $< 0.02\% < 10$ min	Less than 5 min

The above times assume the introduction of a zero gas (low level of oxygen in nitrogen) after span calibration.

For optimum accuracy, the O₂ concentration of a span gas should be approximate 50-90% of the full scale range of analysis or one range above the analysis range, e.g. 20.9% O₂ on the 0-25% range. Conversely, if the recommended span gas is not available and air calibration is not an option, a span gas of the same full scale range and near the anticipated analysis level (approximately 30-50% of full scale) is acceptable with the understanding that the accuracy will suffer slightly.

Use of span gas near 30% of the full scale range of measurements, at the higher end of the range has the effect of “expanding the error” as illustrated by Graph A in Example 1 in the Accuracy section above.

Prematurely initiating the SPAN CALIBRATION function (before the analyzer reading has stabilized) can result in erroneous readings as follows:

When purging an analyzer to lower ranges and calibrating with a span gas: If the oxygen reading reaches less than 2% of the intended calibration range, enter the value of the span gas. If the oxygen reading is greater than 2% of the calibration range, add the O₂ reading to the value of the span gas (the impact of the offset on accuracy is minor but the addition allows the oxygen sensor to continue to purge down and avoid negative readings after calibration).

When installing a new oxygen sensor and calibrating with air, allow 2-3 minutes for the sensor to equilibrate in ambient air from storage packaging. Failure to do so can introduce error in calibration.

Zero Calibration

Typical offset from a % analyzer is less than 0.02 %. Therefore, for most applications, a Zero calibration is not required. However, ZERO calibration feature has been provided to allow the user to precisely measure oxygen concentration at the very low levels (less than 0.05 %). As described below, accomplishing either objective places a degree of responsibility on the user.

Determining the true offset requires the user to wait (see Online Recovery Time section) until the analyzer reading is no longer trending downward (best evidenced by a constant horizontal trend on an external recording device).

The zero offset adjustment is limited to 50% of the most sensitive range of the analyzer. At factory, analyzer is QC tested to confirm that the maximum offset is less than 50% of the most sensitive range available. Should you observe a zero offset more than 50% of the lowest range, check sample system for any possible leaks, integrity of the zero gas and assure that the analyzer has been given enough time to stabilize on zero gas before initiating the “ZERO CALIBRATION”.

Caution: If adequate time is not allowed for the analyzer to establish the true baseline and a ZERO calibration is performed, the analyzer will in all probability display a negative reading in the sample mode after a certain period of time. If a negative reading is seen, perform ZERO calibration again.

Span Gas vs. Air Calibration

The analyzer can be calibrated by using ambient air (20.9% O₂) or a certified span gas. The only advantage of using a certified span gas for calibration is the fast recovery time to a low % level after calibration. For example, if the analyzer is calibrated by using 1% span gas, the analyzer will recover to within 0.01% of the original reading within five minutes. On the other hand, if the analyzer is calibrated with ambient air, it may take 5-10 minutes for the reading to get below within 0.01%

Zero Calibration Procedure

Zero calibration should be carried out after the span calibration has been performed. Normally, zero calibrations are performed when a new sensor is installed or changes are made in the sample system connections.

Before performing a ZERO calibration, it is highly recommended to perform a factory default zero. This will eliminate previous zero offset adjustment that might have been made. With factory default setting, if the zero offset does not exceed 50% of the lowest range, this indicates that the integrity of the sensor, the analyzer sample system and the sample line bringing in the sample gas is maintained.

1. Access the MAIN MENU by pressing the MENU key.
2. Advance the reverse shade cursor using the ARROW keys to highlight CALIBRATION.
3. Press the ENTER key to select the highlighted menu option.

The following displays appear:

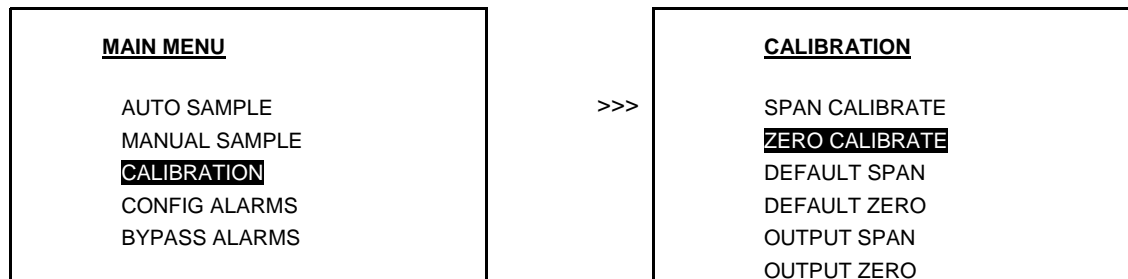

4. Advance the reverse shade cursor using the ARROW keys to highlight ZERO CALIBRATE.
5. Press the ENTER key to select the highlighted menu option.

The following displays appear:

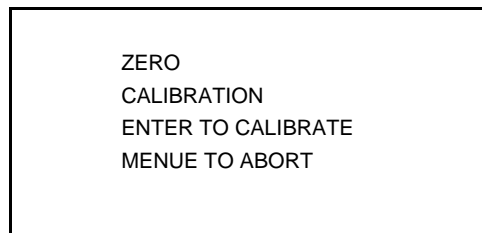

6. Press the ENTER key to calibrate or MENU key to abort and return to SAMPLING mode.
7. Allow approximately 60 seconds for the calibration process while the microprocessor determines whether the signal output or reading has stabilized within 50% of the full scale low range. If the offset is

less than 50% of the lowest range, by pressing ENTER, message PASSED CALIBRATION will appear and return to the Sample mode. On the other hand, if the offset is above 50%, pressing ENTER, message FAILED CALIBRATION will appear and the analyzer will return to Sample mode without completing the Zero calibration.

Both the Zero Calibrate and Span Calibrate functions result in the following displays:

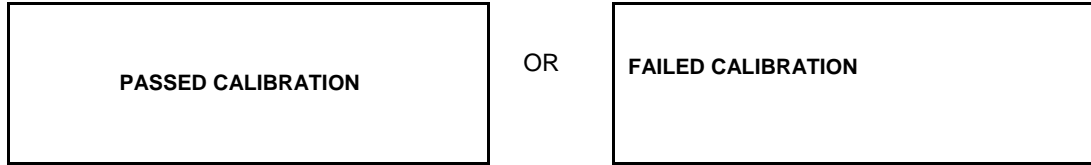

Default Zero Calibration

The feature will eliminate any previous zero calibration adjustment and display the actual signal output of the sensor at a specified oxygen concentration. For example, assuming a zero gas is introduced, the display above 0.00% will reflect an actual zero offset. This feature allows the user to ensure that the accumulative zero offset never exceeds 50% of the lowest range limit. To perform Default Zero,

1. Access the MAIN MENU by pressing the MENU key.
2. Advance the reverse shade cursor using the ARROW keys to highlight CALIBRATION.
3. Press the ENTER key to select the highlighted menu option.

The following displays appear:

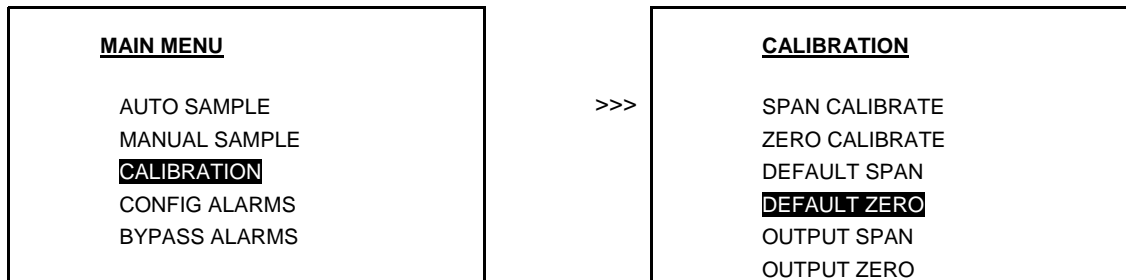

4. Advance the reverse shade cursor using the ARROW keys to highlight DEFAULT ZERO.
5. Press the ENTER key to select the highlighted menu option.

The following display appears and after 3 seconds the system returns to the SAMPLING mode:

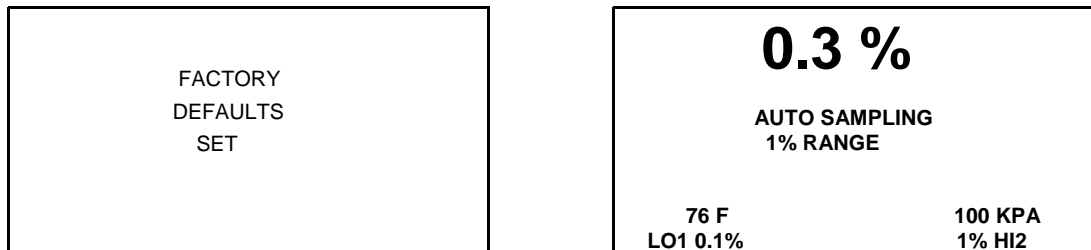

Analog Output with Zero O₂

In rare instances the 4-20mA signal output may not agree to the reading displayed on the LCD. This feature enables the user to adjust the 4mA signal output when the LCD displays 00.00.

Note Adjust the 20mA signal output with the OUTPUT SPAN option described below.

1. Access the MAIN MENU by pressing the MENU key.
2. Advance the reverse shade cursor using the ARROW keys to highlight CALIBRATION.
3. Press the ENTER key to select the highlighted menu option and the following displays appear:

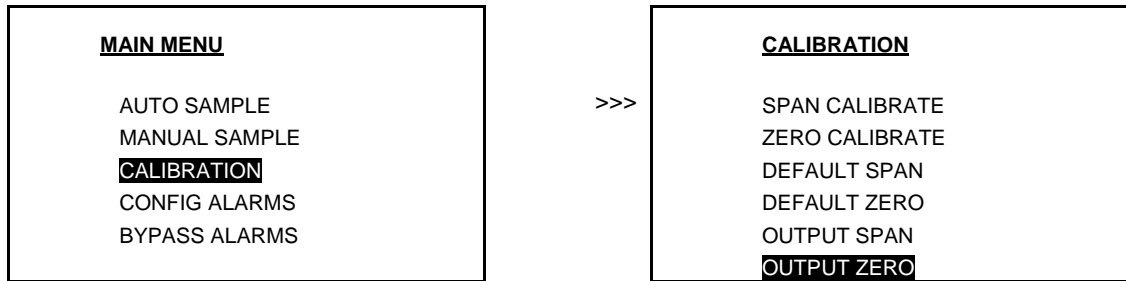

4. Advance the reverse shade cursor using the ARROW keys to highlight DEFAULT ZERO.
5. Press the ENTER key to select the highlighted menu option and the following display appears:

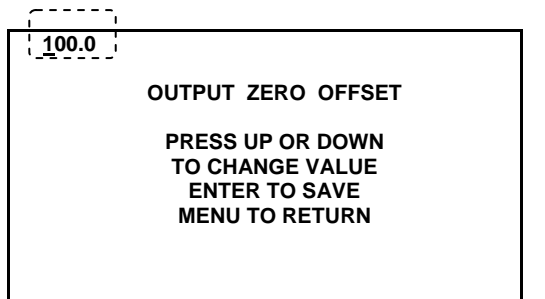

6. The default setting of 100 illustrates no adjustment to the analog output signal. Compute the adjustment value as described in Appendix B or consult the factory. The true adjustment value must be determined empirically by trial and error. Adjust the initial value to above 100 to increase the analog signal value or decrease it below 100 to decrease the analog signal.

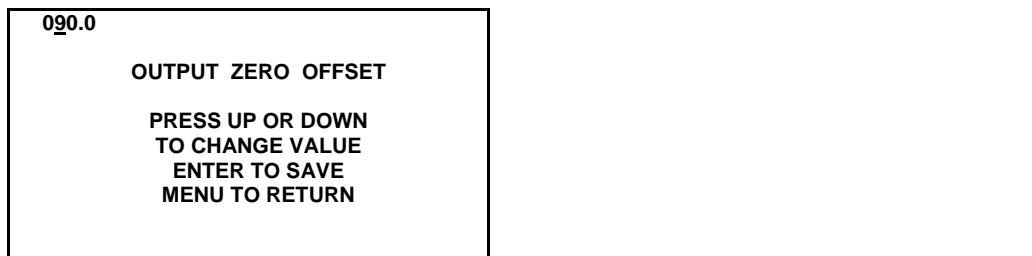

7. Press the ENTER key to advance the underline cursor right or press the MENU key to advance the underline cursor left to reach to the desired digit of the OUTPUT ZERO OFFSET value.
8. Press the ARROW keys to enter the OUTPUT ZERO OFFSET value.
9. Repeat the OUTPUT ZERO OFFSET routine until the output is 4 mA .

**Save the adjustment value by pressing the ENTER key or abort by pressing the MENU key.
After adjustment, the system returns to the SAMPLING mode.**

Span Calibration Procedure

This procedure assumes a span gas under positive pressure and is recommended for a transmitter without an optional sampling pump.

To assure an accurate calibration, the temperature and pressure of the span gas must closely match with the sample gas.

For calibration purposes, use of the AUTO SAMPLE mode is recommended. To perform Span calibration

1. Access the MAIN MENU by pressing the MENU key.
2. Advance the reverse shade cursor using the ARROW keys to highlight AUTO SAMPLE.
3. Press the ENTER key to select the highlighted menu option.

The following displays appear:

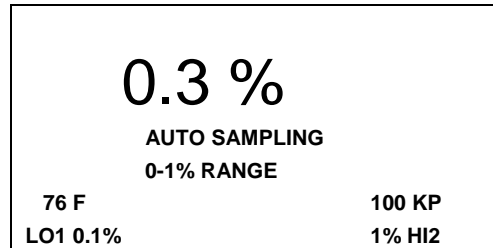
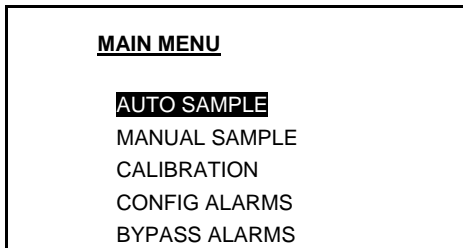

4. Return to the MAIN MENU by pressing the MENU key.
5. Advance the reverse shade cursor using the ARROW keys to highlight CALIBRATION.
6. Press the ENTER key to select the highlighted menu option.
7. Repeat to select SPAN CALIBRATE

The following displays appear:

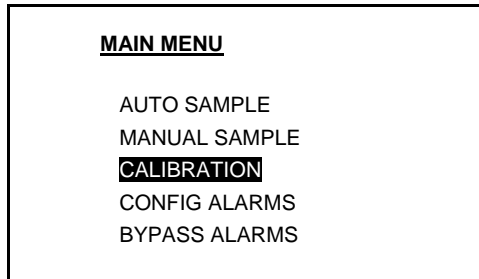

>>>

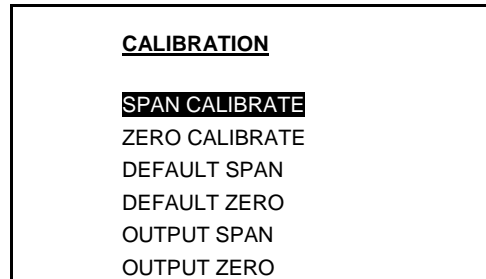

8. After selecting the SPAN CALIBRATION, enter appropriate span gas value.
9. Advance the reverse shade cursor using the ARROW keys to highlight the desired GAS CONCENTRATION.

Press the ENTER key to select the highlighted menu option.

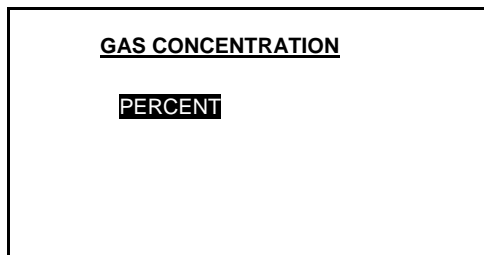

The following displays appear:

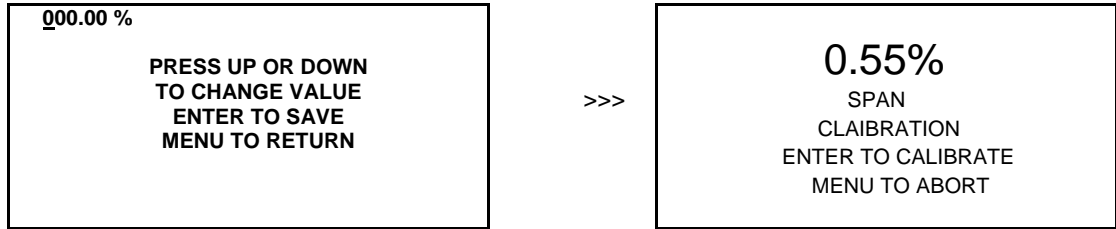

10. Press the ENTER key to advance the underline cursor right or press the MENU key to advance the underline cursor left to reach to the desired digit of the alarm value.
11. Repeat until the complete span value has been entered.
12. Press the ENTER key to accept SPAN CALIBRATION. After successful calibration, the analyzer will display a message "PASSED CALIBRATION" and return to the Sample mode.

NOTE: The analyzer is allowed to accept calibration only when O2 reading is within 50% of the span gas value. If the O2 reading is outside of this limit, by pressing ENTER to accept calibration will result in "FAILED CALIBRATION" and the analyzer will return to the Sample mode without completing Span calibration.

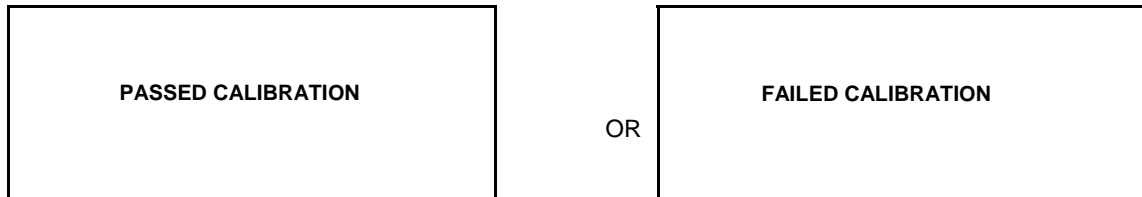

13. If the calibration is unsuccessful, return to the SAMPLING mode with span gas flowing through the transmitter, make sure the reading stabilizes, reaches within 30-50% (see below) of the span gas value (after factory default span setting) and repeat the calibration before concluding the equipment is defective.
14. Before disconnecting the span gas line and connecting the sample gas line (if the analyzer is not equipped with a SPAN/SAMPLE vale option), flow the sample gas for 1-2 minutes to purge the air inside the sample line.
15. Disconnect the span gas line and replace it with the sample gas line.

Default Span

With factory default span, previous calibration data stored in the memory is removed and the sensitivity of the analyzer is reset to the value based on the average output of the oxygen sensor at a specific oxygen concentration. For example, with factory default settings, when a span gas is introduced, the micro-processor will display oxygen reading within 30-50% of the span gas value, indicating that the sensor output is within the specified limits. This feature allows the user to check the sensor's signal output without removing it from the sensor housing.

1. Access the MAIN MENU by pressing the MENU key.
2. Advance the reverse shade cursor using the ARROW keys to highlight CALIBRATION.
3. Press the ENTER key to select the highlighted menu option.

The following display appears:

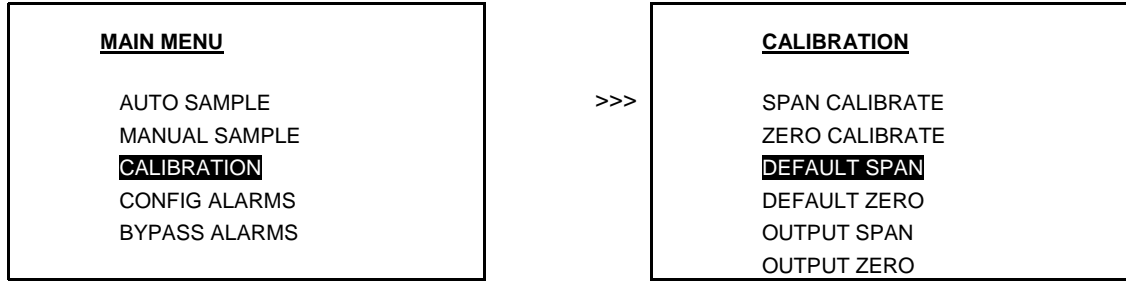

4. Advance the reverse shade cursor using the ARROW keys to highlight DEFAULT SPAN.
5. Press the ENTER key to select the highlighted menu option.

The following displays appear and after 3 seconds the system returns to the SAMPLING mode:

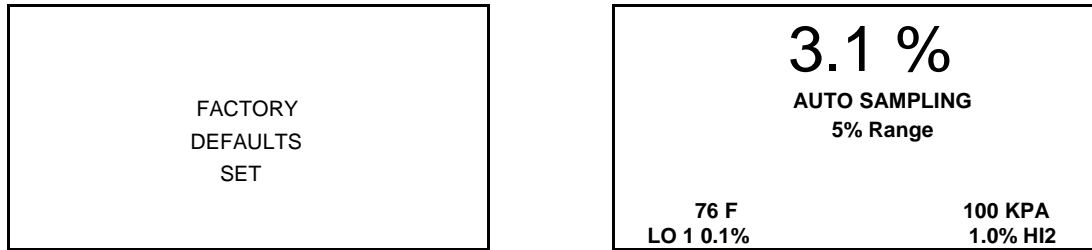

4-20 mA Output Adjustment

In rare instances the 4-20mA signal output may not agree to the reading displayed by the LCD. This feature enables the user to adjust the 20mA signal output should the LCD display not agree.

Note: Adjust the 4mA signal output with the OUTPUT ZERO option described above.

1. Access the MAIN MENU by pressing the MENU key.
2. Advance the reverse shade cursor using the ARROW keys to highlight CALIBRATION.
3. Press the ENTER key to select the highlighted menu option.

The following displays appear:

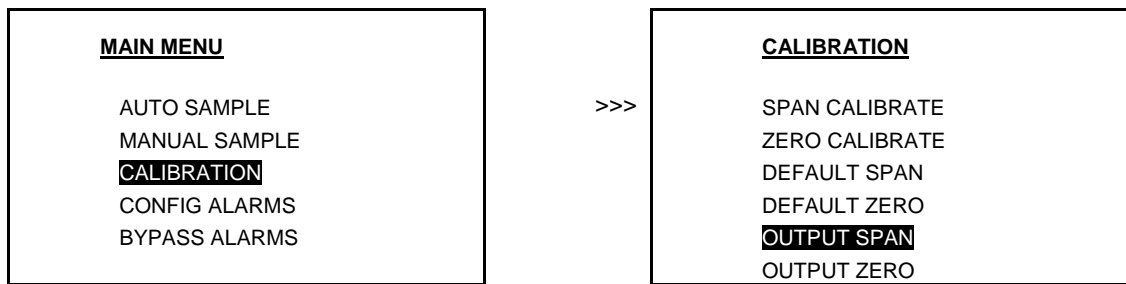

4. Advance the reverse shade cursor using the ARROW keys to highlight DEFAULT SPAN.
5. Press the ENTER key to select the highlighted menu option.

The following display appears

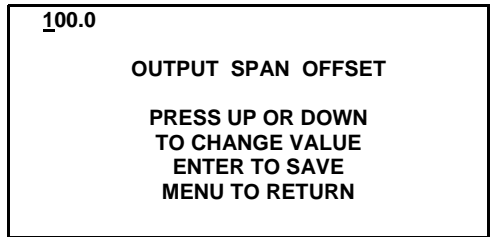

6. The default setting of 100 illustrates no adjustment to the analog output signal. Compute the adjustment value as described in Appendix B or consult the factory. The true adjustment value must be determined empirically by trial and error. Adjust the initial value to above 100 to increase the 20 mA analog signal value or decrease it below 100 to decrease the 20 mA analog signal.
7. Press the ENTER key to advance the underline cursor right or press the MENU key to advance the underline cursor left to reach to the desired digit of the OUTPUT SPAN OFFSET value.
8. Press the ARROW keys to enter the OUTPUT SPAN OFFSET value.
9. Repeat above steps until the complete OUTPUT SPAN OFFSET value has been entered.
10. Save the adjustment value by pressing the ENTER key or abort by pressing the MENU key. The system returns to the SAMPLING mode.

Sampling

GPR-2800 AIS Oxygen Transmitter requires a positive pressure to flow the sample gas across the sensor to measure the oxygen concentration in a sample gas. If not available see Pressure & Flow section.

Procedure

Following calibration, the transmitter returns to the SAMPLE mode.

1. Select the desired sampling mode - auto or if manual, the range that provides maximum resolution – as described above.
2. Use metal tubing to transport the sample gas to the transmitter.
3. The main consideration is to eliminate air leaks which can affect oxygen measurements above or below the 20.9% oxygen concentration in ambient air - ensure the sample gas tubing connections fit tightly into the sample input port.
4. For sample gases under positive pressure, the user must provide a means of controlling the inlet pressure between 5-30 psig and the flow of the sample gas between 1-5 SCFH, a flow rate of 1-2 SCHF is recommended
5. For sample gases under atmospheric or slightly negative pressure, an optional sampling pump is recommended to push the sample the sensor housing. Generally, when using a pump, no pressure regulation or flow control device is involved. However, a flow meter upstream of analyzer is recommended to ensure that the sample flow is adequate.
6. Assure the sample is adequately vented for optimum response and recovery – and safety.
7. Allow the oxygen reading to stabilize for approximately 10 minutes at each sample point.
8. **Note:** To avoid erroneous oxygen readings and damage to the sensor, do not place your finger over the vent (it pressurizes the sensor) to test the flow indicator when gas is flowing to the sensor. Removing your finger (the restriction) generates a vacuum on the sensor and may damage the sensor (voiding the sensor warranty).
9. Assure there are no restrictions in the sample or vent lines
10. Avoid drawing a vacuum that exceeds 14" of water column pressure – unless done gradually
11. Avoid excessive flow rates above 5 SCFH which may generate backpressure on the sensor.
12. Avoid sudden releases of backpressure that can severely damage the sensor.

13. Avoid the collection of particulates, liquids or condensation on the sensor that could block the diffusion of oxygen into the sensor.
14. If the transmitter is equipped with an optional integral sampling pump (positioned downstream of the sensor) and a flow control metering valve (positioned upstream of the sensor), completely open the flow control metering valve to avoid drawing a vacuum on the sensor and placing an undue burden on the pump

Setting Alarms

The analyzer is equipped with two programmable alarm relays. The two alarms set points are user adjustable and can be set either as LOW/HIGH, LOW/LOW or HIGH/HIGH.

Alarm delay option allows the user to ignore the alarm should a sudden short spike in the oxygen reading occurs.

The alarms bypass feature allows the user to bypass the alarm during trouble shooting/repair or test run. However, once the alarm bypass is selected, alarm will remain disabled even if the oxygen reading is over/under the alarm set point. The alarm will re-arm itself only after the fault condition has been reverted.

The alarms are automatically disabled during SPAN/ZERO calibration.

The relays are rated at 5A @ 250V.

CAUTION; When using these relays, do not exceed the recommended rating.

Power Failure Alarm

A relay contact that is normally energized (normally open) during operation, is closed if the power to the analyzer is turned OFF.

The relay is rated at 5A @ 250V.

CAUTION: When using this relay, do not exceed the recommended rating.

Standby

The transmitter has no special storage requirements.

The sensor should remain inside of the sensor housing and connected to the electronics during storage periods. Before turning the sample gas OFF, ensure that sample/bypass valve (if analyzer equipped) is at the BYPASS position. This will keep the sensor isolated from ambient air and would be ready to use again when required with very short down time.

NOTE: Under isolated conditions, some oxygen will diffuse into the sample system/sensor housing and the sensor out will slowly climb up but after 2-3 hours, it will reach a Plato, generally less than 400 PPM

Store the transmitter with the power OFF at a safe location and away from a direct heating source.

If storing for an extended period of time, protect the analyzer from dust, heat and moisture.

6. Maintenance

Generally, cleaning the electrical contacts inside of the upper section of the sensor housing or replacing filter element of the coalescing filter is the extent of the maintenance requirements of this transmitter.

Serviceability: Except for replacing the oxygen sensor, there are no parts inside the transmitter for the operator to service. Only trained personnel with the authorization of their supervisor should conduct maintenance.

7. Spare Parts

Recommended spare parts for the GPR-1500 IS Oxygen Transmitter:

Item No.	Description
GPR-11-32	Oxygen Sensor, for measuring O2 in inert gases
XLT-11-24	Oxygen Sensor, for measuring O2 in a gas mixture containing CO2

Other spare parts:

Item No.	Description
B-2762-A-2-14	Sensor Housing Upper Section
MTR-1011	Meter Digital Panel LCD Backlight
MTR-1014	Meter Digital Panel LCD Low Temperature
A-1161-AIS-2	PCB Assembly Main / Display
A-1166-AIS-2	PCB Assembly Power Supply

8. Troubleshooting

Symptom	Possible Cause	Recommended Action
Slow recovery	At installation, defective sensor	Replace sensor if recovery unacceptable or O ₂ reading fails to reach 10% of lowest range
	Air leak in sample system connection(s)	Leak test the entire sample system: Vary the flow rate, if the O ₂ reading changes inversely with the change in flow rate indicates an air leak - correct source of leak
	Abnormality in zero gas Damaged in service - prolonged exposure to air, electrolyte leak	Qualify zero gas (using portable transmitter) Replace sensor
	Sensor nearing end of life	Replace sensor
High O ₂ reading after installing or replacing sensor	Transmitter calibrated before sensor stabilized caused by:	Allow O ₂ reading to stabilize before making the span/calibration adjustment Continue purge with zero gas
	1) Prolonged exposure to ambient air, worse if sensor was un-shorted	Leak test the entire sample system (above) Qualify zero gas (using portable transmitter)
	2) Air leak in sample system connection(s)	
	3) Abnormality in zero gas	
High O ₂ reading Sampling	Flow rate exceeds limits	Correct pressure and flow rate
	Pressurized sensor	Remove restriction on vent line
	Improper sensor selection	Replace GPR/PSR sensor with XLT sensor when CO ₂ or acid gases are present

Symptom	Possible Cause	Recommended Action
Response time slow	Air leak, dead legs, distance of sample line, low flow rate, volume of optional filters and scrubbers	Leak test (above), reduce dead volume or increase flow rate
O ₂ reading doesn't agree to expected O ₂ values	Pressure and temperature of the sample is different than span gas Abnormality in gas	Calibrate the transmitter (calibrate at pressure and temperature of sample) Qualify the gas (use a portable analyzer as a second check)
Erratic O ₂ reading or No O ₂ reading	Change in sample pressure Dirty electrical contacts in upper section of sensor housing Corroded solder joints on sensor PCB from corrosive sample or electrolyte leakage from sensor Corroded spring loaded contact in upper section of sensor housing from liquid in sample or electrolyte leakage from sensor Liquid covering sensing area Improper sensor selection Presence of interference gases Unauthorized maintenance Sensor nearing end of life	Calibrate the transmitter (calibrate at pressure and temperature of sample) Clean contacts with alcohol (minimize exposure time of MS sensor to ambient air to extent possible) Replace sensor and return sensor to the factory for warranty determination Upper section of sensor housing: Clean contacts with water, wipe contacts with clean paper towel and flush system and sensor housing with dry gas Sensor: Replace if leaking and return it to the factory for warranty determination Wipe with lint free towel or flow dry sample or zero gas for 2-3 hours to flush out condensation Consult factory for recommendation. Replace sensor and install scrubber Consult factory. Replace sensor
Erratic O ₂ reading or Negative O ₂ reading	Pressurizing the sensor by flowing gas to the sensor with the vent restricted or SHUT OFF valve closed and	Zero the transmitter. If not successful replace the sensor

or
No O₂ reading
accompanied by
electrolyte leakage

suddenly removing the
restriction draws a vacuum
on the sensor

or
partially opened valves
upstream of the transmitter
when using a pump
downstream of the
transmitter to draw sample
from a process at
atmospheric pressure or
under a slight vacuum.
Placing a vacuum on the
sensor in excess 10" of water
column is strongly
discouraged.

Avoid drawing a vacuum on the sensor, a
pressurized sensor may not leak but still
produce negative readings.

A premature adjustment of
the ZERO OFFSET
potentiometer is a common
problem

From MAIN MENU select DEFAULT ZERO

9. Warranty

The design and manufacture of GPR Series oxygen transmitters/analyzers, monitors and oxygen sensors are performed under a certified Quality Assurance System that conforms to established standards and incorporates state of the art materials and components for superior performance and minimal cost of ownership. Prior to shipment every analyzer is thoroughly tested by the manufacturer and documented in the form of a Quality Control Certification that is included in the Owner's Manual accompanying every analyzer. When operated and maintained in accordance with the Owner's Manual, the units will provide many years of reliable service.

Coverage

Under normal operating conditions, the monitor, analyzers and sensor are warranted to be free of defects in materials and workmanship for the period specified in accordance with the most recent published specifications, said period begins with the date of shipment by the manufacturer. The manufacturer information and serial number of this analyzer are located on the rear of the analyzer. Advanced Instruments Inc. reserves the right in its sole discretion to invalidate this warranty if the serial number does not appear on the analyzer.

If your Advanced Instruments Inc. monitor, analyzer and/or oxygen sensor is determined to be defective with respect to material and/or workmanship, we will repair it or, at our option, replace it at no charge to you. If we choose to repair your purchase, we may use new or reconditioned replacement parts. If we choose to replace your Advanced Instruments Inc. analyzer, we may replace it with a new or reconditioned one of the same or upgraded design. This warranty applies to all monitors, analyzers and sensors purchased worldwide. It is the only one we will give and it sets forth all our responsibilities. There are no other express warranties. This warranty is limited to the first customer who submits a claim for a given serial number and/or the above warranty period. Under no circumstances will the warranty extend to more than one customer or beyond the warranty period.

Limitations

Advanced Instruments Inc. will not pay for: loss of time; inconvenience; loss of use of your Advanced Instruments Inc. analyzer or property damage caused by your Advanced Instruments Inc. analyzer or its failure to work; any special, incidental or consequential damages; or any damage resulting from alterations, misuse or abuse; lack of proper maintenance; unauthorized repair or modification of the analyzer; affixing of any attachment not provided with the analyzer or other failure to follow the Owner's Manual. Some states and provinces do not allow limitations on how an implied warranty lasts or the exclusion of incidental or consequential damages, these exclusions may not apply.

Exclusions

This warranty does not cover installation; defects resulting from accidents; damage while in transit to our service location; damage resulting from alterations, misuse or abuse; lack of proper maintenance; unauthorized repair or modification of the analyzer; affixing of any label or attachment not provided with the analyzer; fire, flood, or acts of God; or other failure to follow the Owner's Manual.

Service

Call Advanced Instruments Inc. at 909-392-6900 (or e-mail info@aii1.com) between 7:30 AM and 5:00 PM Pacific Time Monday thru Thursday or 8:00 AM to 12:00 pm on Friday. Trained technicians will assist you in diagnosing the problem and arrange to supply you with the required parts. You may obtain warranty service by returning you analyzer, postage prepaid to:

Advanced Instruments Inc.
2855 Metropolitan Place
Pomona, Ca 91767 USA

Be sure to pack the analyzer securely. Include your name, address, telephone number, and a description of the operating problem. After repairing or, at our option, replacing your Advanced Instruments Inc. analyzer, we will ship it to you at no cost for parts and labor.

10. MSDS – Material Safety Data Sheet

Product Identification

Product Name	Oxygen Sensor Series - PSR, GPR, All, XLT
Synonyms	Electrochemical Sensor, Galvanic Fuel Cell
Manufacturer	Advanced Instruments Inc., 2855 Metropolitan Place, Pomona, CA 91767 USA
Emergency Phone Number	909-392-6900
Preparation / Revision Date	January 1, 1995
Notes	Oxygen sensors are sealed, contain protective coverings and in normal conditions do not present a health hazard. Information applies to electrolyte unless otherwise noted.

Specific Generic Ingredients

Carcinogens at levels > 0.1%	None
Others at levels > 1.0%	Potassium Hydroxide or Acetic Acid, Lead
CAS Number	Potassium Hydroxide = KOH 1310-58-3 or Acetic Acid = 64-19-7, Lead = Pb 7439-92-1
Chemical (Synonym) and Family	Potassium Hydroxide (KOH) – Base or Acetic Acid (CH ₃ CO ₂ H) – Acid, Lead (Pb) – Metal

General Requirements

Use	Potassium Hydroxide or Acetic Acid - electrolyte, Lead - anode
Handling	Rubber or latex gloves, safety glasses
Storage	Indefinitely

Physical Properties

Boiling Point Range	KOH = 100 to 115° C or Acetic Acid = 100 to 117° C
Melting Point Range	KOH -10 to 0° C or Acetic Acid – NA, Lead 327° C
Freezing Point	KOH = -40 to -10° C or Acetic Acid = -40 to -10° C
Molecular Weight	KOH = 56 or Acetic Acid – NA, Lead = 207
Specific Gravity	KOH = 1.09 @ 20° C, Acetic Acid = 1.05 @ 20° C
Vapor Pressure	KOH = NA or Acetic Acid = 11.4 @ 20° C
Vapor Density	KOH – NA or Acetic Acid = 2.07
pH	KOH > 14 or Acetic Acid = 2-3
Solubility in H ₂ O	Complete
% Volatiles by Volume	None
Evaporation Rate	Similar to water
Appearance and Odor	Aqueous solutions: KOH = Colorless, odorless or Acetic Acid = Colorless, vinegar-like odor

Fire and Explosion Data

Flash and Fire Points	Not applicable
-----------------------	----------------

Flammable Limits	Not flammable
Extinguishing Method	Not applicable
Special Fire Fighting Procedures	Not applicable
Unusual Fire and Explosion Hazards	Not applicable

Reactivity Data

Stability	Stable
Conditions Contributing to Instability	None
Incompatibility	KOH = Avoid contact with strong acids or Acetic Acid = Avoid contact with strong bases
Hazardous Decomposition Products	KOH = None or Acetic Acid = Emits toxic fumes when heated
Conditions to Avoid	KOH = None or Acetic Acid = Heat

Spill or Leak

Steps if material is released	Sensor is packaged in a sealed plastic bag, check the sensor inside for electrolyte leakage. If the sensor leaks inside the plastic bag or inside an analyzer sensor housing do not remove it without rubber or latex gloves and safety glasses and a source of water. Flush or wipe all surfaces repeatedly with water or wet paper towel (fresh each time).
Disposal	In accordance with federal, state and local regulations.

Health Hazard Information

Primary Route(s) of Entry	Ingestion, eye and skin contact
Exposure Limits	Potassium Hydroxide - ACGIH TLV 2 mg/cubic meter or Acetic Acid - ACGIH TLV / OSHA PEL 10 % (TWA), Lead - OSHA PEL .05 mg/cubic meter
Ingestion	Electrolyte could be harmful or fatal if swallowed. KOH = Oral LD50 (RAT) = 2433 mg/kg or Acetic Acid = Oral LD50 (RAT) = 6620 mg/kg
Eye	Electrolyte is corrosive and eye contact could result in permanent loss of vision.
Skin	Electrolyte is corrosive and skin contact could result in a chemical burn.
Inhalation	Liquid inhalation is unlikely.
Symptoms	Eye contact - burning sensation. Skin contact - soapy slick feeling.
Medical Conditions Aggravated	None
Carcinogenic Reference Data	KOH and Acetic Acid = NTP Annual Report on Carcinogens - not listed; LARC Monographs - not listed; OSHA - not listed
Other	Lead is listed as a chemical known to the State of California to cause birth defects or other reproductive harm.

Special Protection Information

Ventilation Requirements	None
Eye	Safety glasses
Hand	Rubber or latex gloves
Respirator Type	Not applicable
Other Special Protection	None

Special Precautions

Precautions

Do not remove the sensor's protective Teflon and PCB coverings. Do not probe the sensor with sharp objects. Wash hands thoroughly after handling. Avoid contact with eyes, skin and clothing.

Empty sensor body may contain hazardous residue.

Transportation

Not applicable

Appendix A

Electrical connections require an approved explosion proof sealing fitting and packing around wires and cables (for incoming power for the analyzer electronics and 4-20mA signal output) coming into and out of the explosion proof enclosure that houses the power supply/signal output PCB.

Full compliance with hazardous area electrical code requires the user to supply glands, fittings and/or conduit commensurate with the level of protection or classification desired. To maintain the ATEX certification of this unit, the user must install ATEX approved components according to ATEX directives. To meet the NEC standard for use in Class 1, Division 1, Group C, D hazardous areas, the user must install the appropriate components according to NEC standards.



Note: The following instruction is supplied from information and data supplied by a reputable enclosure manufacturer which we believe is reliable and is given in good faith. Since the methods of application and conditions under which our products are put to use are beyond our control, we are not able to guarantee the application and/or use of same. The user assumes all risks and liability in connection with the application and use of our products.

Directions for use of Explosion Proof Packing Fiber (non-asbestos)

For use as packing at the hub of sealing fittings, tamp packing fiber between and around conductors where they enter fitting to prevent leakage of the liquid cement. Leave enough space in the fitting for length equivalent to the inside diameter of the conduit but, not less than 5/8”.



Caution: Avoid getting in eyes or breathing dust
Use barrier cream, gloves and long sleeve shirts if dust or fiber is irritating.
Prolonged contact may cause lung, eye or skin irritation.

Directions for use

Explosion Proof Sealing Cement: Tamp packing fiber between and around conductors where they enter the sealing fitting to prevent leakage of liquid cement. Make sure conductors are not in contact with each other or with the wall of fitting. Leave space in the fitting for a sealing length equivalent to the thread size of the conduit seal but not less than 5/8”

Fill the marked shipping container with clean cold water to the “water line” [35 ml to be precise].



Caution: Do not exceed the required amount of water.

Gradually pour cement from the plastic bag into the water and stir thoroughly for proper mixture. Fill fitting completely within five (5) minutes after mixing, then tamp with blunt stick to expel any air bubbles. Close up any opening in the fitting to insure integrity of the seal. Fittings requiring more than 10 oz. of cement must be filled from a single mixture of cement and water. **DO NOT POUR IN STAGES.** Allow cement at least 72 hours to cure. Water-mix sealing compound should not be poured or installed at temperature below 40F (4C). Maintain temperature at or above 40F for at least 72 hours after pouring. CSA certified when used with any CSA certified sealing fitting. Adaco No. 1 sealing cement must be used as a part of any Adalet UL listed fitting.



Caution: At least five threads must engage on all fill plugs.

Caution:

Prolonged breathing or ingestion may cause internal obstruction, seek medical care.

Do not get into eyes or on skin – if cement touches eyes or skin, flush with water for 15 minutes.

Large amounts on skin when hardening may cause skin burn.

Use adequate ventilation.

To reorder sealing cement kit, specify P/N ENCL-1071-KIT

Appendix B

Matching - LCD Display with 4-20mA Output

In rare instances the 4-20mA signal output may not agree with the reading displayed on the LCD. The Output Zero and Output Span features enable the user to adjust the 4mA and 20 mA signal output matching with the reading displayed by the LCD.

For optimum accuracy make two separate adjustments as follows:

1. OUTPUT ZERO feature: To adjust the 4mA signal output and requires zero gas.
2. OUTPUT SPAN feature: To adjust the 20mA signal output and requires span gas near full range.

Note: In the field or in the absence of the preferred gases, use the OUTPUT SPAN feature and adjust the 20mA signal output using the span gas available.

Procedure – regardless of type of adjustment:

1. When you select OUTPUT ZERO OR OUTPUT SPAN, the microprocessor defaults to 100% to start.
2. The “actual” 4-20mA signal output will be adjusted to the “theoretical” value of the LCD display.
3. Adjustment general rule:
 - a) If the actual 4-20mA value < the theoretical LCD value, the adjustment value will be > 100%.
 - b) If the actual 4-20mA value > the theoretical LCD value, the adjustment value will be < 100%.
4. Convert the “actual” reading of the LCD display to the “theoretical” 4-20mA as follows:
 - a) Divide the “actual” (% or percent) LCD reading by the value of the span gas available.
 - b) Multiply 16mA (20mA – 4mA) times the “result of a.”
 - c) Add 4mA plus the “result of b.” to obtain the “theoretical” 4-20mA signal output value.
5. Adjustment value: Divide the theoretical by the actual 4-20mA values and multiply by 100.
6. Enter the adjustment value via OUTPUT ZERO or OUTPUT SPAN routines described below.

Example: Analyzer reading is 60 % oxygen (100 % range) on 84 % span gas, 4-20mA signal output at PLC is 24mA

- Solution:
- a) Use OUTPUT SPAN feature to make the adjustment.
 - b) Adjustment will be < 100% (default value of OUTPUT SPAN feature).
 - c) 13.6mA is the “theoretical” 4-20mA converted from the “actual” reading of the LCD.
 $60\% \text{ divided by } 84\% = 0.71 \text{ or } 71\%$
 $16\text{mA multiplied by } 0.71 = 11.36\text{mA}$
 $4\text{mA plus } 11.36\text{mA} = 15.36\text{mA}$ “theoretical” 4-20mA signal output value
 - d) $15.36\text{mA divided by } 24\text{mA}$ the “actual” 4-20mA value = 64.0 adjustment value
 - e) Enter 64.0 via OUTPUT SPAN procedure below.

Adjust 4 mA with Zero O₂

Access the MAIN MENU by pressing the MENU key.

Advance the reverse shade cursor using the ARROW keys to highlight CALIBRATION.

Press the ENTER key to select the highlighted menu option.

The following displays appear:

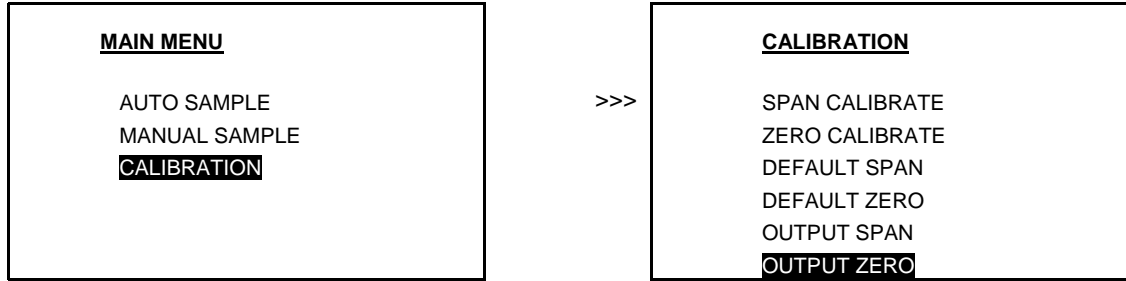

Advance the reverse shade cursor using the ARROW keys to highlight **DEFAULT ZERO**.

Press the ENTER key to select the highlighted menu option.

The following display appears:

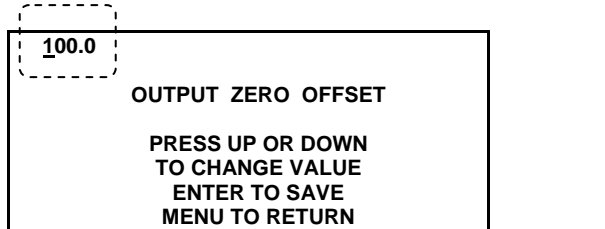

Enter the calculated adjustment value. *Note:* Once the initial adjustment is made and checked at the PLC it may be necessary to fine tune the initial adjustment by repeating. Any additional percent error must be added or subtracted from the initial adjustment value

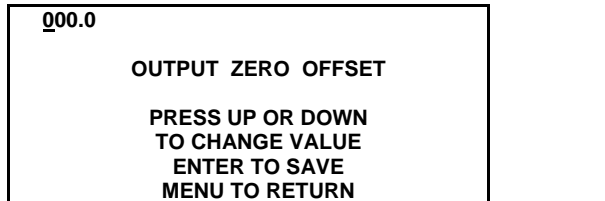

Press the ENTER key to advance the underline cursor right or press the MENU key to advance the underline cursor left to reach to the desired digit of the adjustment **OUTPUT ZERO OFFSET** value.

Press the ARROW keys to enter each the numerical value of each digit of the adjustment **OUTPUT ZERO OFFSET** value.

Repeat until the complete **OUTPUT ZERO OFFSET** value has been entered.

Save the adjustment value by pressing the ENTER key or abort by pressing the MENU key.

The system returns to the SAMPLING mode.

Adjust 20 mA at known O₂

Access the **MAIN MENU** by pressing the **MENU** key.

Advance the reverse shade cursor using the ARROW keys to highlight **CALIBRATION**.

Press the ENTER key to select the highlighted menu option.

The following displays appear:

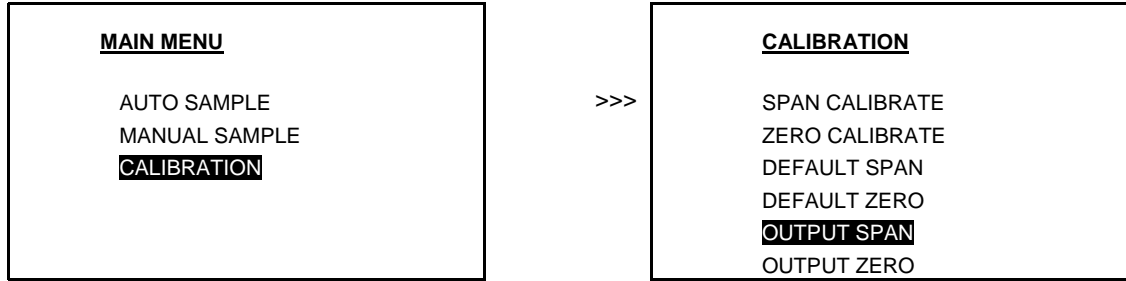

Advance the reverse shade cursor using the ARROW keys to highlight OUTPUT SPAN.

Press the ENTER key to select the highlighted menu option.

The following display appears:

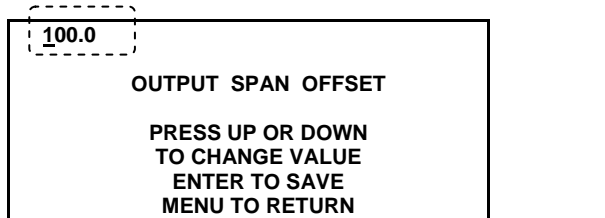

Enter the calculated adjustment value, refer to example described above.

Note: Once the initial adjustment is made and checked at the PLC it may be necessary to fine tune the initial adjustment by repeating. Any additional percent error must be added or subtracted from the initial adjustment value

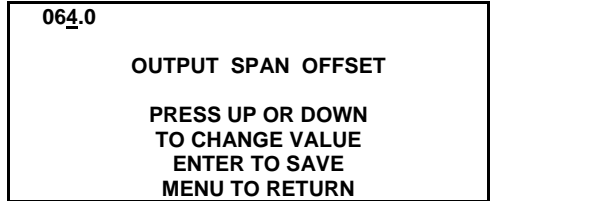

Press the ENTER key to advance the underline cursor right or press the MENU key to advance the underline cursor left to reach to the desired digit of the adjustment OUTPUT SPAN OFFSET value.

Press the ARROW keys to enter the numerical value of each digit of the OUTPUT SPAN OFFSET value.

Repeat until the complete OUTPUT SPAN OFFSET value has been entered.

Save the adjustment value by pressing the ENTER key or abort by pressing the MENU key.

The system returns to the SAMPLING mode.

Appendix F

H₂S Scrubbers & Sample Systems



B-2734-6 1x6"
 B-2734 1.5x12"
 B-3247 2.5x6"



B-3251 H₂S Scrubber System



GPR-1500 AIS with
 B-3247 H₂S Scrubber
 A-3393 H₂S Scrubber System

Advanced Instruments Inc. offers a complete line of efficient hydrogen sulfide (H₂S) scrubbers and sample conditioning systems for:

- Preparing a gas stream containing H₂S for oxygen analysis
- Zero gas generation for H₂S transmitters

The scrubber media selectively removes H₂S and other oxidizing gases from the gas stream that can interfere with the oxygen measurement. As an indication the scrubber is nearing the end of its useful life the media changes color from purple to orange to brown to white as it is consumed.

The information included herein is based on data sheets published by the manufacturer of the scrubbing media as follow: the media not only adsorbs gases but also chemically transforms them into harmless end products that remain trapped in the media. Unlike adsorption, chemisorption is an instantaneous and irreversible process that permanently removes unwanted gases from the environment. The potassium permanganate (KMnO₄), the purple colored media inside the scrubber, turns into manganese oxide and elemental sulfur salt which are stable non-leachable solids.

Scrubbers are available in refillable:

- 1.0" x 6" (P/N B-2734-6) plexi-glass container with SS connections
- 1.5" x 12" (P/N B-2734) plexi-glass container with SS connections
- 2.0" x 24" (P/N A-2839) stainless steel container with SS connections
- 2.5" x 6" (P/N B-3247) plexi-glass container with SS connections
- 2.5" x 24" (P/N B-3247-24) plexi-glass container with SS connections

They can be installed in-line or as part of a complete scrubber sample conditioning system. More elaborate custom designed scrubber sample conditioning systems can include dual scrubbers and valve system that can eliminate downtime. Operators simply switch the gas flow to the fresh scrubber while servicing the other one.

Specifications:

- Inlet connections: 1/4" SS tube fitting (refill port)
- Outlet connections: 1/4" SS tube fitting
- Pressure rating: 30 psig maximum
- Temperature: -20°C to 45°C (-4°F to 113°F)
- Application conditions: Free of moisture (may require coalescing filter)
- Materials of construction: Clear acrylic and/or stainless steel
- Scrubber life: Varies with flow rate, media volume, H₂S concentration

Dimensions Part No.	H ₂ S Concentration	Flow Rate	Service Life - Days
1.5" x 12" (P/N B-2734)	1.0% (10,000 ppm)	1/3 SCFH (150 sccm)	3.6
	0.1% (1,000 ppm)	same	36.8
	0.01% (100 ppm)	same	368.2
2.5" x 6" (P/N B-3247)	1.0% (10,000 ppm)	1/3 SCFH (150 sccm)	6.0
	0.1% (1,000 ppm)	same	59.6
	0.01% (100 ppm)	same	596.4

H₂S Sample System

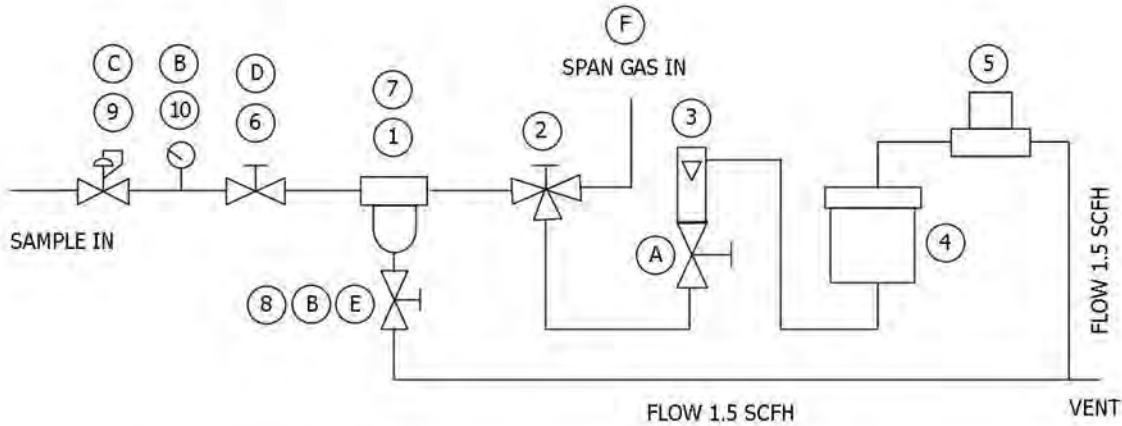

A-3393 STANDARD CONFIGURATION

- * B-3359 SAMPLE PANEL (NOT SHOWN)
- 1. FLTR-1002-2 FILTER COALESCING
- 2. VALV-1002 VALVE SS 3-WAY SAMPLE/SPAN
- 3. FMTR-1007-1 FLOW METER, INTEGRAL VALVE
- 4. B-3247-1 SCRUBBER H₂S CLEAR, POLYCARB 2.5" ID
- 5. B-3310-A-1S SENSOR HOUSING ASSEMBLY SS
- * FITN-1016 3x BULKHEAD UNION 1/8" TO 1/4" SAMPLE, SPAN, VENT CONNECTIONS

A-3393-2 CONTINUOUS DRAIN OPTION:

- ADD 6. VALV-1004 VALVE SS 2-WAY METERING
- REPLACE 7. FLTR-1024 FILTER COALESCING, FNPT DRAIN
- ADD 8. VALV-1033 VALVE PLASTIC 2-WAY DRAIN

A-3393-4 PRESSURE REGULATOR & GAUGE OPTION:

- REPLACE B-3358 SAMPLE PANEL (REPLACES B-3359)
- ADD 9. REG-1013 PRESSURE REGULATOR SS
- ADD 10. REG-1008 GAUGE

A-3393-6 PRESSURE REGULATOR & GAUGE WITH CONTINUOUS DRAIN OPTION:

COMBINE OPTIONS 4 & 2

CONTINUOUS DRAIN SET-UP:

- A. OPEN VALVE
- B. CLOSE VALVE
- C. SET REGULATOR, 20-30 PSIG
- D. OPEN VALVE TO 3 SCFH ON FLOW METER
- E. OPEN VALVE TO 1.5 SCFH ON FLOW METER
- F. SET VALVE ON FLOW METER TO 2 SCFH FOR SPAN GAS, AFTER SPAN, OPEN VALVE FOR SAMPLE

A-3393-1 NO H₂S SCRUBBER OPTION:

DELETE 4. B-3247-1 SCRUBBER H₂S CLEAR, POLYCARB 2.5" ID

A-3393-3 NO H₂S SCRUBBER WITH CONTINUOUS DRAIN OPTION:

COMBINE OPTIONS 1 & 2

A-3393-5 NO H₂S SCRUBBER WITH PRESSURE REGULATOR & GAUGE OPTION:

COMBINE OPTIONS 1 & 4

A-3393-7 NO H₂S SCRUBBER WITH PRESSURE REGULATOR & GAUGE WITH CONTINUOUS DRAIN OPTION:

COMBINE OPTIONS 1, 4 & 2

2/7/07 REV 1 - CHANGE STANDARD CONFIGURATION, ADD OPTIONS

Advanced Instruments Inc.

THIS DRAWING IS THE PROPERTY OF ADVANCED INSTRUMENTS INC. AND CONTAINS CONFIDENTIAL INFORMATION. IT IS TO BE REPRODUCED OR USED IN ANY MANNER WITHOUT WRITTEN PERMISSION.

TOLERANCES UNLESS OTHERWISE SPECIFIED: FRACTION 21/64", DECIMAL ±.005", ANGULAR ±1/2

DATE 2/7/07, SCALE NONE, DRAFTER BJP, ENGINEER, APPROVAL PSB, REV LEVEL

MATERIAL ITEM NO. DESCRIPTION SEE LIST

DESCRIPTION: GPR-1500 AIS/IS SAMPLE SYSTEM DRAWING NO. A-3393

Material Safety Data Sheet

May be used to comply with
 OSHA's Hazard Communication Standard,
 CFR 1910.1200. Standard must be
 consulted for specific requirements.

U.S. Department of Labor

Occupational Safety and Health Administration
 (Non-Mandatory Form)
 Form Approved
 OBM No. 1218-0072

IDENTITY (As used on Label and List)

UNISORB MARK 2

Note: Blank spaces are not permitted. If any item is not applicable, or no information is available, the space must be marked to indicate that.

Section I

Manufacturer's Name UNISORB CORPORATION	Emergency Telephone Number (713) 943-3753
Address (Number, Street, City, State, and ZIP Code) 1310 GENOA STREET	Telephone Number for Information (713) 943-3753
SOUTH HOUSTON, TX 77567	Date Prepared JANUARY 7, 2002
	Signature of Preparer (Optional)

Section II - Hazardous Ingredients/Identity Information

Hazardous Components (Specific Chemical Identity, Common Name(s))	OSHA PEL	ACGIH TLV	Other Limits Recommended	% (Optional)
Aluminum Oxide: Activated Alumina	15mg/m ³ (TWA)	10mg/m ³ (TWA)	None	
Potassium Permanganate: Potassium Salt	5mg/m ³ (TWA or Mn)	5mg/m ³ (TWA or Mn)	None	

Aluminum Oxide: CAS - 1344-28-1

Potassium Permanganate: CAS - 7722-64-7

Section III - Physical/Chemical Characteristics

Boiling Point	N/A	Specific Gravity	3.2
Vapor Pressure (mm Hg.)	N/A	Melting Point	2050 °C
Vapor Density (Air = 1)	N/A	Evaporation Rate	N/A

Solubility in Water
Insoluble

Appearance and Odor
Purple Spheres, No Odor

Section IV - Fire and Explosion Hazard Data

Flash Point (Method Used) Not Flammable	Flammable Limits None	LEL N/A	UEL N/A
--	--------------------------	------------	------------

Extinguishing Media
Foam, Carbon Dioxide, or Dry Chemical

Special Fire Fighting Procedures
Use Respiratory Protection

Unusual Fire and Explosion Hazards
None

Appendix G

Maintenance – H2S Scrubber

Servicing any of the H2S scrubbers will depend on several factors as illustrated in Appendix F and include: the (average) H2S concentration, volume of scrubber media and flow rate through the scrubber (often times maximizing the service life means longer system response time) see Appendix F.

Required equipment:

1. 2x 7/16" open end wrenches
2. 1x 9/16" open end wrench
3. 1x 1" open end or adjustable wrench

Procedure:

Separate the top connection to the scrubber using a 7/16" and the 9/16" open end wrenches on the two top nuts.

Hold the second nut with the 9/16" open end wrench.

With one of the 7/16" open end wrenches turn the top nut counter clockwise until the fitting disengages.

Separate the bottom connection to the scrubber using both 7/16" open end wrenches.

Hold the nut at the bottom of the scrubber with a 7/16" open end wrench.

With the other 7/16" open end wrench turn the nut below counter clockwise until the fitting disengages.

Carefully, remove the stainless tubing from the top and bottom of the scrubber.

Carefully pull the scrubber from its mounting clip which is attached to the back panel.

Once the scrubber is free, hold the scrubber with one hand and using the 1" open end or adjustable wrench with the other hand, turn the 1" nut counter clockwise and remove the 1" nut from the scrubber.

There is no need to remove the 7/16" fitting at the bottom of the scrubber.

With the 1" nut removed, empty the spent media through the opening.

Fill the scrubber with fresh media (should be rich purple in color).

Reverse the above steps to re-assemble and install the scrubber.

Maintenance – Coalescing Filter

Servicing the coalescing filter (P/N FLTR-1002-2) depends on the cleanliness and moisture content of the sample and maintenance intervals.

Required equipment:

Channel locks

Damp rag

Lubricant (a thin coat applied to the o-ring after cleaning helps ensure a tight seal and extend o-ring life)

Procedure:

Unscrew the clear polycarbonate bowl by turning it counter clockwise.

Note: It is probably stuck tight – use a damp rag to grip if removing by hand or to prevent damage to the bowl if using the channel locks.

The bowl seals to the head section with an o-ring, do not lose the o-ring.

The filter element screws into the head section, carefully turn it counter clockwise and remove it from the head.

Using the damp cloth, clean the inside of the bowl and the o-ring before reassembling – apply a very thin coat of lubricant to the o-ring.

Reverse the above steps to re-assemble the filter.