

XZR400 Series Oxygen Analyzers User's Manual



Please fill out the form(s) below for each instrument that has been purchased.

Use this information when contacting Michell Instruments for service purposes.

Product Name	
Order Code	
Serial Number	
Invoice Date	
Installation Location	
Tag Number	

Product Name	
Order Code	
Serial Number	
Invoice Date	
Installation Location	
Tag Number	

Product Name	
Order Code	
Serial Number	
Invoice Date	
Installation Location	
Tag Number	



For Michell Instruments' contact information please go to
www.michell.com

© 2020 Michell Instruments

This document is the property of Michell Instruments Ltd and may not be copied or otherwise reproduced, communicated in any way to third parties, nor stored in any Data Processing System without the express written authorization of Michell Instruments Ltd.

Contents

Safety	viii
Electrical Safety	viii
Pressure Safety	viii
Temperature Safety	viii
Toxic Materials	viii
Repair and Maintenance	viii
Calibration	viii
Safety Conformity	viii
Abbreviations	ix
Warnings	x
1 INTRODUCTION	1
1.1 Operating Principle	2
1.2 The MSRS Technology	3
2 INSTALLATION	6
2.1 Unpacking the Analyzer	6
2.2 General configuration	6
2.3 Dimensions – XZR400A1	7
2.3.1 Installing the XZR400A1	7
2.4 Dimensions – XZR400A2	8
2.4.1 Installing the XZR400A2	8
2.5 Dimensions – XZR400A3	9
2.6 Operating Requirements	10
2.6.1 Environmental Requirements	10
2.6.2 Electrical Requirements	10
2.6.3 Gas Requirements	10
2.6.4 Sampling System	10
2.7 Connections to the XZR400A1	11
2.7.1 Front Panel	11
2.7.2 Back Panel	11
2.7.3 Gas Inlet, Outlet and Bypass Gas Connections	12
2.7.4 Sample Path	13
2.7.5 Electrical Terminal Block	14
2.7.6 D-Sub DE9 plug	15
2.7.7 Automatic Calibration Control Connector	15
2.8 Connections to the XZR400A2	15
2.8.1 Gas Sample Inlet and Outlet Fittings	16
2.8.2 Electrical Terminal Block	18
2.8.3 Optional Connectors	18
2.9 Connections to the XZR400A3	19
2.9.1 Front Panel	19
2.9.2 Side Panel	20
2.9.3 Electrical Terminal Block	21
2.10 Gas Connection	21
3 OPERATION	23
3.1 General Operational Information	23
3.1.1 Signal Processing Path	24
3.1.2 Alarm Outputs	24
3.2 Powering-up the System	25
3.3 Warm-Up Period	26
3.4 Main Screen	28
3.5 Control Parameters Display	29

3.5.1	Configuration	30
3.5.2	Changing the Access Code	31
3.6	The Main (Expert) Menu	33
3.6.1	Analog 1	34
3.6.2	Alarms.....	35
3.6.3	System	37
3.6.3.1	Hour Tab	37
3.6.3.2	Misc Tab.....	38
3.6.4	Flow	39
4	CALIBRATION.....	40
4.1	Definitions	41
4.1.1	Manual Adjustment.....	42
4.1.2	Control Gas.....	45
5	MAINTENANCE	48
5.1	Troubleshooting Guide / Failure Analysis	48
6	AVAILABLE OPTIONS	52
6.1	Auto Adjustment	52
6.1.1	Purpose	52
6.1.2	Hardware configuration	52
6.1.3	Parameter setting for auto adjust	53
6.1.4	Main Tab.....	54
6.1.5	Level Tab.....	55
6.1.6	Process Tab	56
6.1.7	Automatic Adjustment Usage	57
6.2	Total Pressure Correction	57
6.2.1	Process Pressure Correction Input Connections.....	58
6.3	Digital Communications.....	59
6.3.1	RS232	59
6.3.2	RS485	59
6.4	XZR400A2 external pump options.....	60
6.5	Extended Operating Range (0...100%).....	60
6.6	Flow Fault Contact.....	61
6.6.1	Flow Fault Output Connections	61
6.7	Commutable Scale (Auto-Ranging)	61
6.8	Optional Moisture Sensor	62

Tables

Table 1	XZR400 Series MSRS Assembly.....	5
Table 2	RS232 Commands	74

Figures

Figure 1	Zirconia Sensor Operating Principle.....	3
Figure 2	MSRS Sensor.....	4
Figure 3	MSRS Dimensions.....	4
Figure 4	MSRS Wiring.....	4
Figure 5	XZR400 Series MSRS Assembly.....	5
Figure 6	Example configuration of the rack version analyzer.....	6
Figure 7	Dimensions – XZR400A1.....	7
Figure 8	Dimensions – XZR400A2.....	8
Figure 9	Dimensions – XZR400A3.....	9
Figure 10	Front Panel XZR400A1.....	11
Figure 11	Back Panel XZR400A1.....	11
Figure 13	Gas Circuit Diagram for Rack & Pump Version.....	12
Figure 12	Gas Circuit Diagram for Rack Version.....	12
Figure 14	Sample Path XZR400A1.....	13
Figure 15	Sample Path with Pump Fitted XZR400A1.....	14
Figure 16	Electrical Terminal Block XZR400A1.....	14
Figure 17	Connections XZR400A2.....	15
Figure 18	Gas Circuit Diagram for XZR400A2 & A3 models.....	16
Figure 19	XZR400A2 Sample Path.....	17
Figure 20	Electrical Terminal Block XZR400A2.....	18
Figure 21	Connections Front Panel – XZR400A3.....	19
Figure 22	Connections Side Panel – XZR400A3.....	20
Figure 23	Electrical Terminal Block XZR400A3.....	21
Figure 24	Start-up Screen.....	26
Figure 25	Oven Temperature Screen.....	26
Figure 26	Sample Flow Adjustment.....	27
Figure 27	Main Screen.....	28
Figure 28	Control Parameters Screen.....	29
Figure 29	Main Menu Access Screen.....	30
Figure 30	Main Menu Screen.....	30
Figure 31	Main Menu Screen.....	33
Figure 32	Analog Output Screen.....	34
Figure 33	Alarm Screen (Main).....	35
Figure 34	Alarm Screen (Alarm 1).....	36
Figure 35	Flow Correction Screen.....	39
Figure 36	Calibration Procedure with XZR400A1.....	40
Figure 37	Screen Page 3.2.....	42
Figure 38	Screen Page 3.2.1.....	42
Figure 39	Screen Page 3.2.2.....	43
Figure 40	Screen Page 3.2.3.....	44
Figure 41	Screen Page 3.2.8.....	44
Figure 42	Screen Page 3.2.4.....	45
Figure 43	Screen Page 3.2.5.....	45
Figure 44	Screen Page 3.2.6.....	46
Figure 45	Screen Page 3.2.7.....	46
Figure 46	Example of the required environment for the analyzer's auto adjustment.....	52
Figure 47	Auto Adjustment Screen.....	53
Figure 49	Comm Screen.....	59
Figure 50	Dimensions for XZR400A2 – J3 Option.....	60
Figure 52	Control Parameters Page.....	62
Figure 53	Main Menu.....	62
Figure 51	Main Page.....	62
Figure 54	DP Sensor Page.....	63
Figure 48	Pressure Correction Screen.....	64

Appendices

Appendix A	Technical Specifications.....	66
Appendix B	Modbus (RTU) over RS485	69
	B.1 Port Configuration.....	69
	B.2 Hardware Configuration	69
	B.3 Exception handling	70
	B.4 Composition of the STATUS word.....	70
	B.5 Modbus Register Map	71
Appendix C	RS232 Serial Output	73
	C.1 Port Configuration.....	73
	C.2 Hardware Configuration	73
	C.3 RS232 Command List.....	74
	C.4 RS232 Periodic Output	75
Appendix D	Quality, Recycling & Warranty Information.....	77
Appendix E	Analyzer Return Document & Decontamination Declaration	79

Safety

The manufacturer has designed this equipment to be safe when operated using the procedures detailed in this manual. The user must not use this equipment for any other purpose than that stated. Do not apply values greater than the maximum value stated.

This manual contains operating and safety instructions, which must be followed to ensure the safe operation and to maintain the equipment in a safe condition. The safety instructions are either warnings or cautions issued to protect the user and the equipment from injury or damage. Use qualified personnel and good engineering practice for all procedures in this manual.

Electrical Safety

The instrument is designed to be completely safe when used with options and accessories supplied by the manufacturer for use with the instrument. The input power supply voltage is 100...240 V AC ($\pm 10\%$), 50...60 Hz ($\pm 5\%$). Refer to labels on instrument or calibration certificate.

Pressure Safety

DO NOT permit pressures exceeding 2 barg (29 psig) to be applied to the instrument. This maximum pressure applies to all versions of the instrument.

Temperature Safety

During operation some parts of the instrument can be at very high temperatures.

Toxic Materials

The use of hazardous materials in the construction of this instrument has been minimized. During normal operation it is not possible for the user to come into contact with any hazardous substance which might be employed in the construction of the instrument. Care should, however, be exercised during maintenance and the disposal of certain parts. Long exposure or breathing of the calibration gases may be dangerous.

Repair and Maintenance

The instrument must be maintained either by the manufacturer or an accredited service agent. Refer to www.michell.com for details of Michell Instruments' worldwide offices contact information.

Calibration

The recommended calibration (or verification) interval for the analyzer is 1 to 3 months depending on the location and application in which the instrument is used.

Safety Conformity

This product carries the CE mark and meets the requirements of relevant European safety directives.

Abbreviations

The following abbreviations are used in this manual:

AC	alternating current
A	Ampere
barg	pressure unit (=100 kP or 0.987 atm) gauge
°C	degrees Celsius
°F	degrees Fahrenheit
l/h	liters per hour
l/min	liters per minute
mA	milliampere
min	minute
ppm	parts per million
psig	pound(s) per square inch (gauge)
RS232	Modbus RTU serial data transmission standard
RS485	Modbus RTU serial data transmission standard
T	temperature
V	Volts

Warnings

The following general warnings listed below are applicable to this instrument. They are repeated in the text in the appropriate locations.



Where this hazard warning symbol appears in the following sections, it is used to indicate areas where potentially hazardous operations need to be carried out.



Where this symbol appears in the following sections it is used to indicate areas of potential risk of electrical shock.



Where this hot surface warning appears in the following sections it is used to indicate areas where the surface may potentially be dangerously hot.

1 INTRODUCTION

The XZR400 Series Trace Oxygen Analyzer is designed to measure oxygen as an impurity in nitrogen, carbon dioxide, argon, helium or other inert gases. Analysis is both quick and stable, utilizing the Michell Metallic Sealed Reference Sensor (MSRS), with no requirement for reference air.

There are three versions of the XZR400 analyzer. All are trace oxygen analyzers designed to measure oxygen content in gas, between 0.01 ppm and 25% O₂ (250,000 ppm).

Michell Instruments can supply the analyzer so that it is suitable for use with enriched oxygen samples, including pure oxygen which may accidentally be introduced to the sample. This cleaning service must be ordered at the time of purchase as special components are required.

Extended operating ranges of 0...100% O₂ can be supplied but will require the analyzer to be cleaned for oxygen service.

Typical applications include:

Gas purity

Inerting or blanketing specific atmospheres

Combustion pre-mixing analysis

Respiratory or medical gas mixtures

Heat treatment

Three models of the XZR400 Series Oxygen Analyzer are available:

- A rack-mount (XZR400-RM) model XZR400A1
- A wall-mount (XZR400-WM) model XZR400A2
- A bench-mount (XZR-400-BM) model XZR400A3

NOTE: The rack-mount version can be supplied with a built-in Easidew sensor for measuring moisture in the range -100...+20 °C (-148...+68 °F).

Sample gases at pressures up to a maximum of 2 barg (29 psig) can be accepted.

The XZR400 Series includes the following front panel mounted items:

- Liquid crystal touchscreen display
- Flow (sample) adjustment valve
- Bypass control valve

1.1 Operating Principle

The analyzer operates on the zirconium oxide (zirconia) principle.

A sample of the gas to be measured is connected to the inlet port of the analyzer. The sample gas flows through stainless steel pipework into the oven where the zirconia oxygen sensor is located.

The sample flow should be set to between 1 and 3 l/hr using the electronic flowmeter, and sample and bypass needle valves on the front of the unit.

The sample gas circulates in the oven, which is heated to 634 °C – the optimum temperature for our zirconia oxygen sensor.

The MSRS generates a signal that is proportional to the logarithm of the ratio of the oxygen partial pressure in the sample to the oxygen partial pressure contained on the sealed reference side of the MSRS.

The analyzer provides the O₂ concentration on the screen and via the 4...20 mA output (optional on XZR400A3).

1.2 The MSRS Technology

The zirconium oxide sensors are often referred to as the 'high temperature' electrochemical sensors. The principle is based on the Nernst principle [W. H. Nernst (1864–1941)]. Zirconium oxide sensors use a solid state electrolyte and are stabilized with yttrium oxide. The zirconium oxide probe is plated on opposing sides with platinum which serves as the sensor electrodes. For a zirconium oxide sensor to operate properly, it must be heated to approximately 600 °C. At this temperature, on a molecular basis, the zirconia lattice becomes porous, allowing the movement of oxygen ions from a higher concentration of oxygen to a lower one, based on the partial pressure of oxygen. The movement of oxygen ions across the zirconium oxide produces a voltage between the two electrodes, the magnitude of which is based on the oxygen partial pressure differential created by the reference and sample gas.

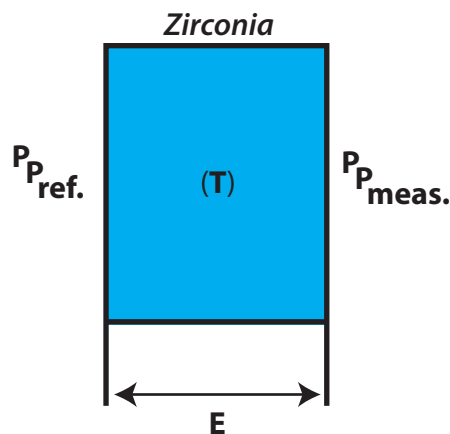

Figure 1 *Zirconia Sensor Operating Principle*

Within the oven the zirconium oxide MSRS is maintained at a temperature of 634 °C. The MSRS generates a signal that is proportional to the natural logarithm of the partial pressure of oxygen $p(O_2)$.

$$E = \frac{RT}{4F} \ln \frac{p(O_{2,meas})}{p(O_{2,ref})}$$

With a known reference electrode and a constant temperature it is possible to define the partial pressure of oxygen using the Nernst-equation (see above).

The conductivity of zirconium oxide increases exponentially with temperature. The oxide ion conductivity is optimized at temperatures above 600 °C.

The MSRS technology allows the design of miniaturized zirconium oxide-based oxygen sensors. The low mass and volume of the MSRS sensors have a positive effect on the response time, which is one of the best available on the market.

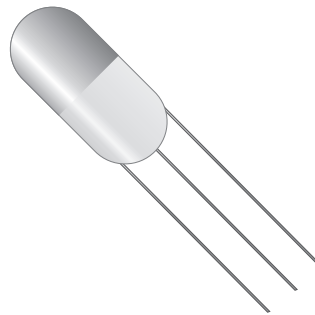

Figure 2 *MSRS Sensor*

Conventional zirconium oxide sensors require an air reference on one side of the sensor with the sample on the other. This provides a known constant on one side. The Michell MSRS does not require an air reference but instead utilizes a metal, and its oxide, sealed in the zirconium sheath. This allows the sensor operation to be irrespective of the ambient air quality and negates the requirement for a 'zero' calibration gas.



Figure 3 *MSRS Dimensions*

Temperature is a major component in the Nernst equation and can affect the accuracy of some sensors. Placing the thermocouple in contact with the small sensor body helps provide a very accurate temperature measurement. The complete design offers high accuracy and repeatability.

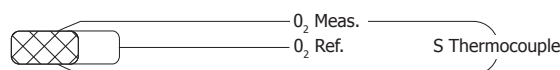

Figure 4 *MSRS Wiring*

Figure 5 shows the MSRS and its S thermocouple installed in a 4-hole aluminum tube. This configuration has the part number XZR400-SMP. Any reference to the MSRS sensor refers to this complete assembly which is considered solid state and non user-serviceable.

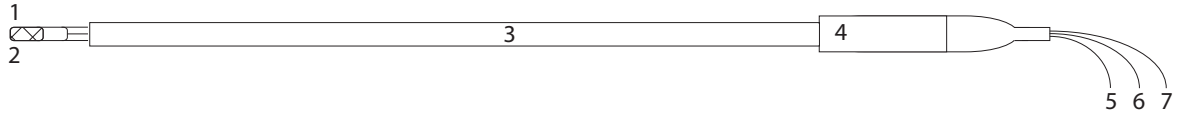

Figure 5 XZR400 Series MSRS Assembly

Item	Description	Wiring
1	MSRS	
2	S-type thermocouple	
3	4-hole alumina tube	
4	Stainless steel connector	
5	O ₂ reference wire	blue wire
6	Common (O ₂ meas. & -TC)	white wire
7	Positive thermocouple (+TC)	orange wire

Table 1 XZR400 Series MSRS Assembly

2 INSTALLATION



It is essential that the installation of the electrical and gas supplies to this analyzer be undertaken by qualified personnel.

2.1 Unpacking the Analyzer

It is recommended that the packaging is retained until after successful commissioning and start up of the unit. If you choose to dispose of the packaging materials, please ensure that they are recycled in accordance with local legislation.

Standard contents in the box:

- XZR400 Series Oxygen Analyzer
- Power cable (except XZR400A2 model)
- Test result sheet

2.2 General configuration

All variants of the XZR400 series can be connected to several types of recorders, alarms and personal computers. A typical installation may be similar to the example below:

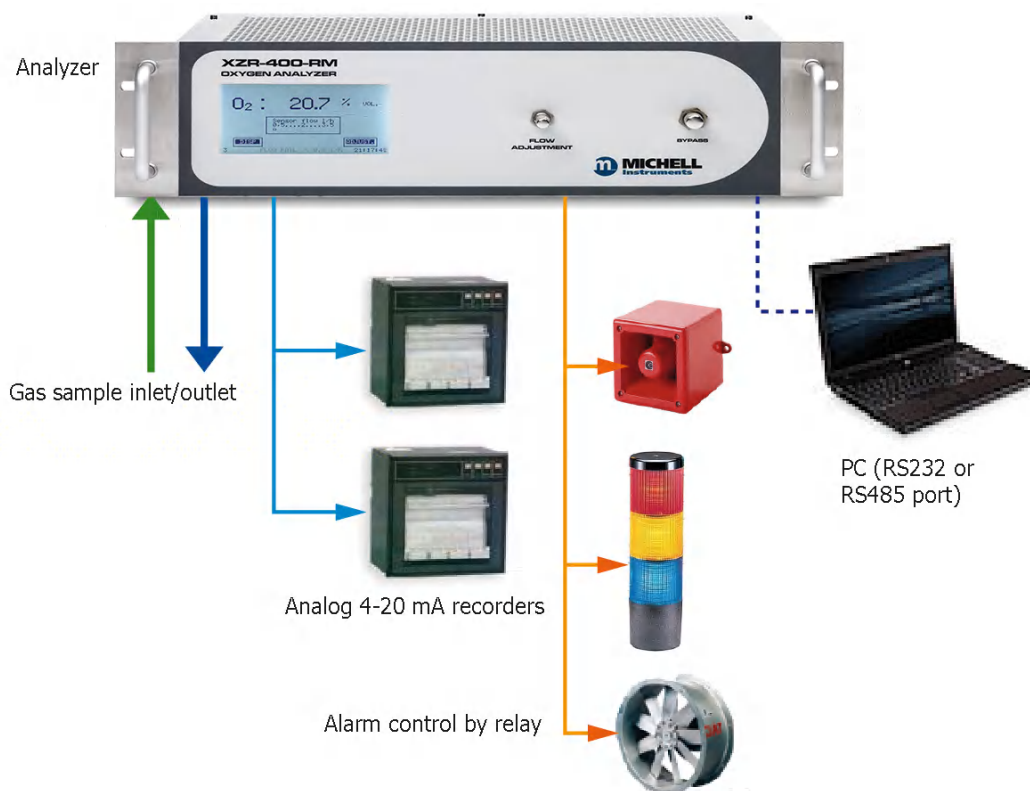

Figure 6 Example configuration of the rack version analyzer

2.3 Dimensions – XZR400A1

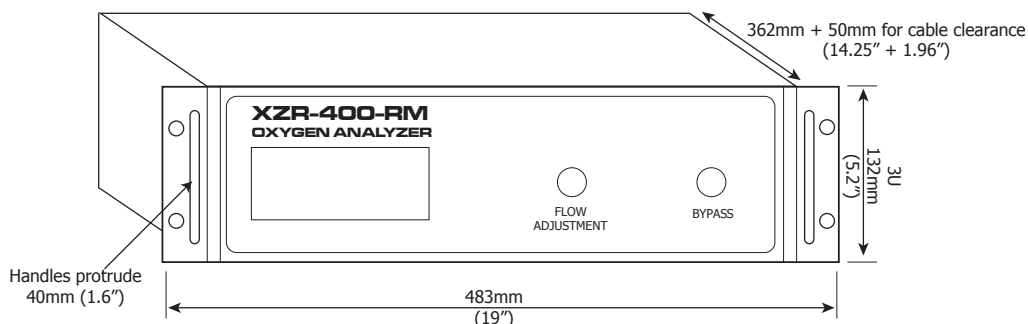

Figure 7 Dimensions – XZR400A1

2.3.1 Installing the XZR400A1

Choose your installation site carefully following the recommendations above. Once installed into the rack, there should be at least 2U clearance spaces from other equipment above and below the instrument. The instrument requires a minimum of 1000 mm (39.37") of clearance at the front of the unit for installation/removal and 800 mm (31.5") of clearance for access to rear connections.

To install, follow the steps below:

1. If necessary, remove any covers from the rack cabinet to gain access to the rear and side.
2. Slide the instrument into the rack and support its weight while the four fixing screws are inserted.
3. Ensure that the front panel of the instrument is flush and square with the front of the rack and tighten the fixing screws.

2.4 Dimensions – XZR400A2

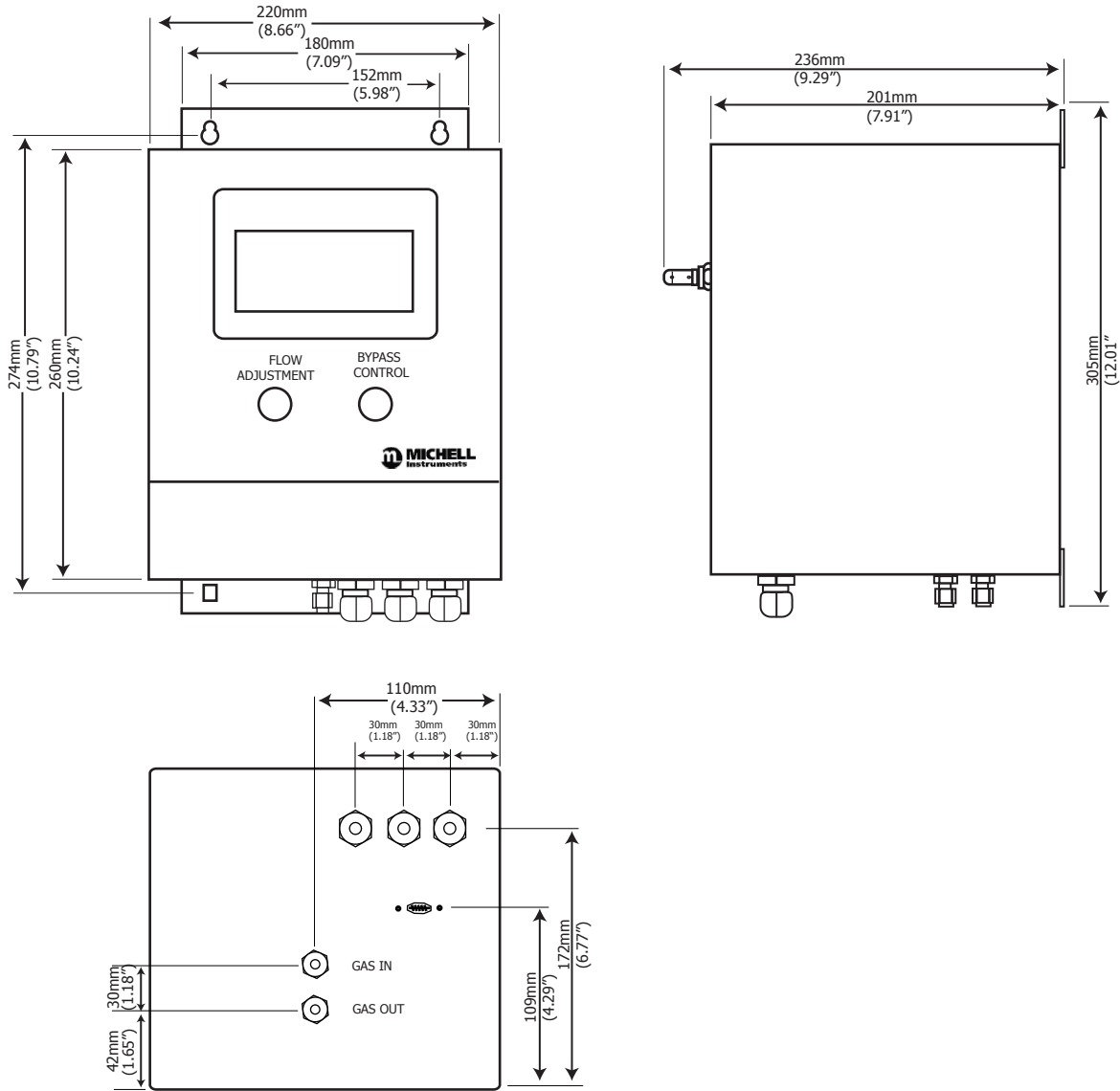

Figure 8 Dimensions – XZR400A2

2.4.1 Installing the XZR400A2

Choose your installation site carefully following the recommendations above. Also note, the instrument requires a minimum of 1000 mm (39.37") of clearance at the front of the unit for removal and 50 mm (1.97") of clearance on the right-hand side for heat dissipation.

Follow the steps below:

1. Identify a clean and flat surface on a wall or other vertical location e.g. an instrument panel that is suitable to hold the analyzer.
2. Prepare the mounting site by drilling 4 holes to accommodate 6 mm (0.24") screws, according to the dimensions in *Figure 8*.
3. Fix the analyzer vertically to the installation surface using suitable screws.

2.5 Dimensions – XZR400A3

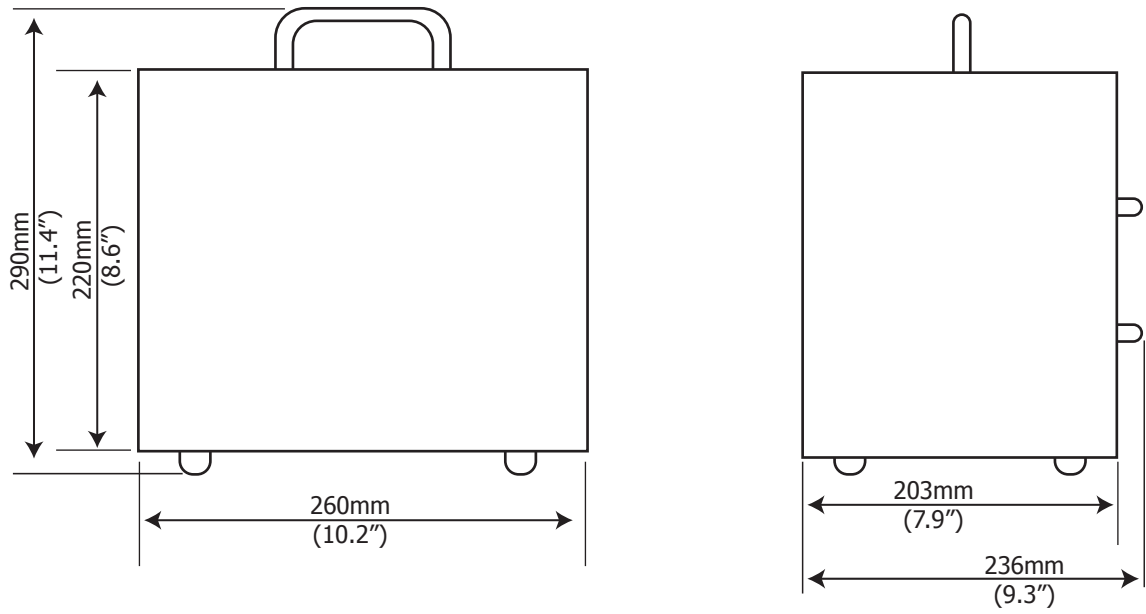

Figure 9 Dimensions – XZR400A3

2.6 Operating Requirements

2.6.1 Environmental Requirements

The XZR400 Series should be installed in a clean, dust-free environment. The recommended ambient temperature is 20...25 °C (68...77 °F) although the instrument will operate, within specification, inside the temperature band of 0...55 °C (32...131 °F). It must be installed indoors in a non-condensing atmosphere.

2.6.2 Electrical Requirements

The analyzer requires the following electrical supply:

100...240 V AC ($\pm 10\%$), 50...60 Hz ($\pm 5\%$)

There are 2 concentration alarm relays. The output contacts are normally open and potential free. The relay switching capability is 10 W max (up to 100 V or up to 0.5 A).

2.6.3 Gas Requirements

To ensure that the sample gas is properly conditioned a sampling system might be required.

Contact Michell Instruments if you wish to order a suitable sampling system.

The gas must be clean, dry and oil mist free. Maximum inlet pressure is 2 barg (29 psig). Particulates $> 3\mu\text{m}$ should be filtered out.



The analyzer is not suitable for samples with hydrocarbons present. These will combust on the cell and consume oxygen molecules.

2.6.4 Sampling System

Depending upon the application, a sampling system may be required to condition the sample for measurement or accommodate outdoor installations.

It is recommended that a stainless steel construction is used for all parts that will be in contact with the gas.

Install the sampling system as close as possible to the XZR400 Series analyzer to ensure the best possible measurement results.

NOTE: Michell Instruments can provide a suitable sampling system when delivering the analyzer. Contact a Michell Instruments' Application Engineer for more information.

2.7 Connections to the XZR400A1

2.7.1 Front Panel

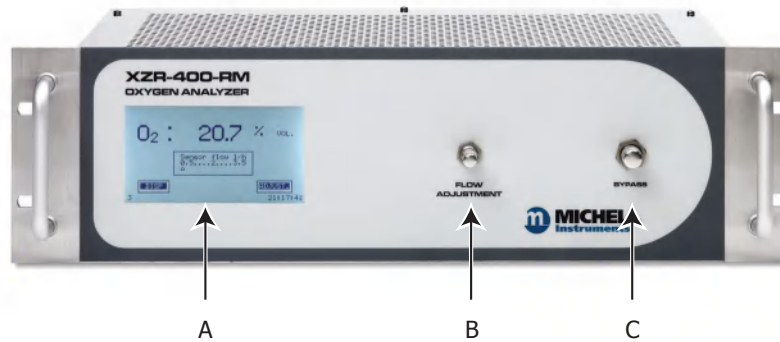

Item	Description
A	Touchscreen LCD
B	Flow adjustment needle valve
C	Bypass control needle valve

Figure 10 Front Panel XZR400A1

2.7.2 Back Panel

An electrical connection terminal is provided for signal and alarm connections.

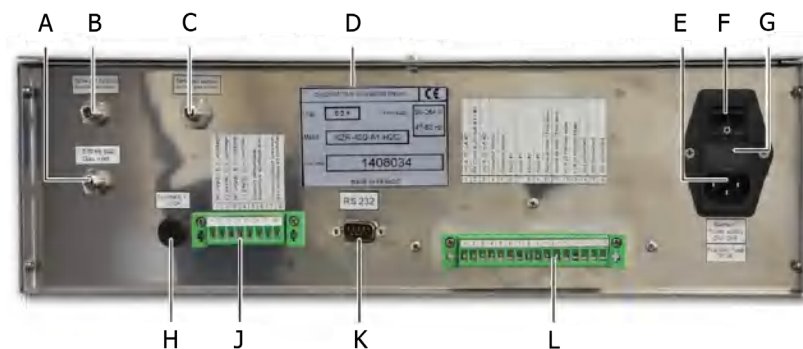

Item	Description
A	Sample inlet – 1/8" tube
B	Bypass outlet – 1/8" tube
C	Sample outlet – 1/8" tube
D	Order code & serial number label
E	Mains socket (100...240 V AC (±10%), 50...60 Hz (±5%))
F	On/Off switch
G	Housing for analyzer's 2 x electrical protection fuses (250 V AC, 6.3 Amp timed fuse)
H	Housing for solenoid valve's electrical protection fuses (250 V AC, 3.15 A) Only fitted on the rack with automatic calibration option
J	Optional connector for the automatic calibration option
K	Optional D-sub DE9 male plug (RS232 port)
L	Electrical connector

Figure 11 Back Panel XZR400A1

2.7.3 Gas Inlet, Outlet and Bypass Gas Connections

The gas path comprises 2 flow control valves (sensor flow and bypass flow), an electronic flow meter and a sensor. The gas connections are stainless steel Swagelok 1/8" couplings.



The sample must be safely vented at atmospheric pressure, otherwise the total pressure correction option is required.

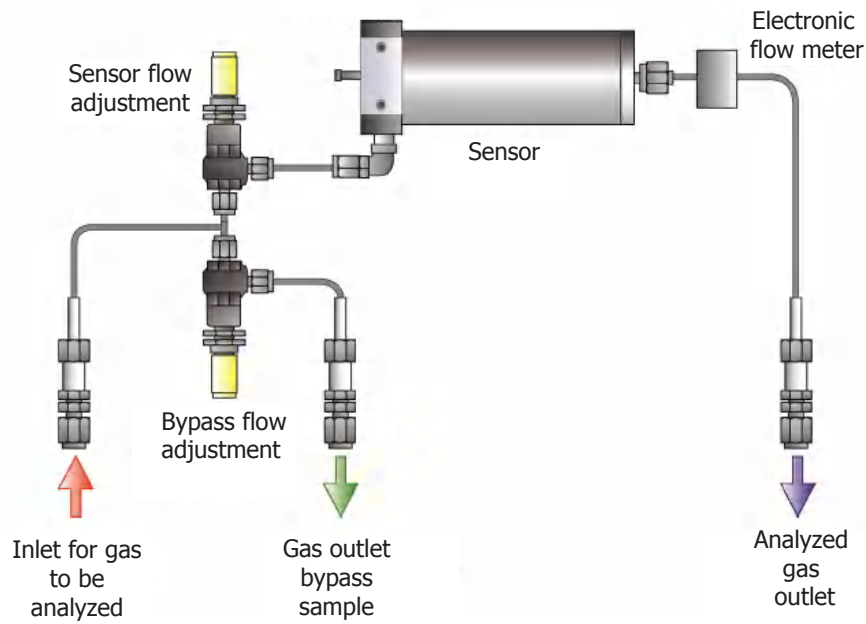

Figure 12 Gas Circuit Diagram for Rack Version

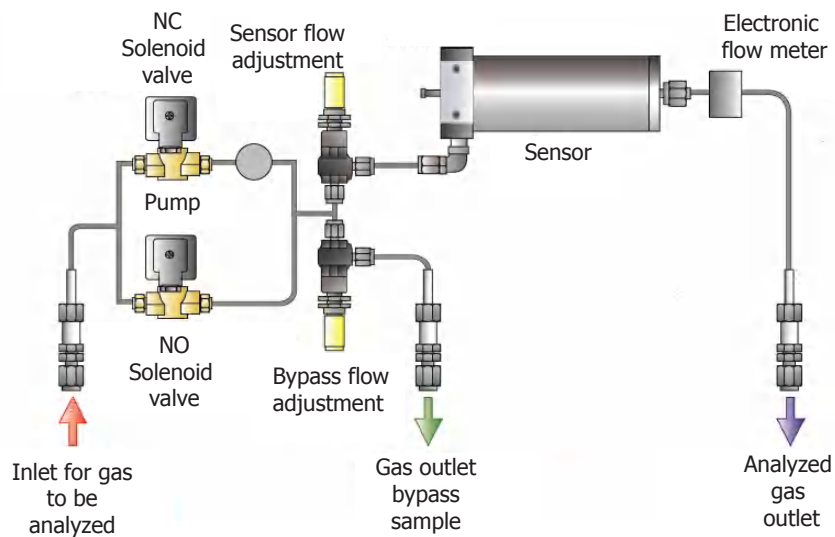

Figure 13 Gas Circuit Diagram for Rack & Pump Version

The MSRS sensor is placed inside an oven in which the gases to be analyzed are circulated. The oven consists of a gas inlet head and a outlet plate. 3 Viton O-rings ensure the sealing of this device (2 for the inlet and 1 for the outlet).

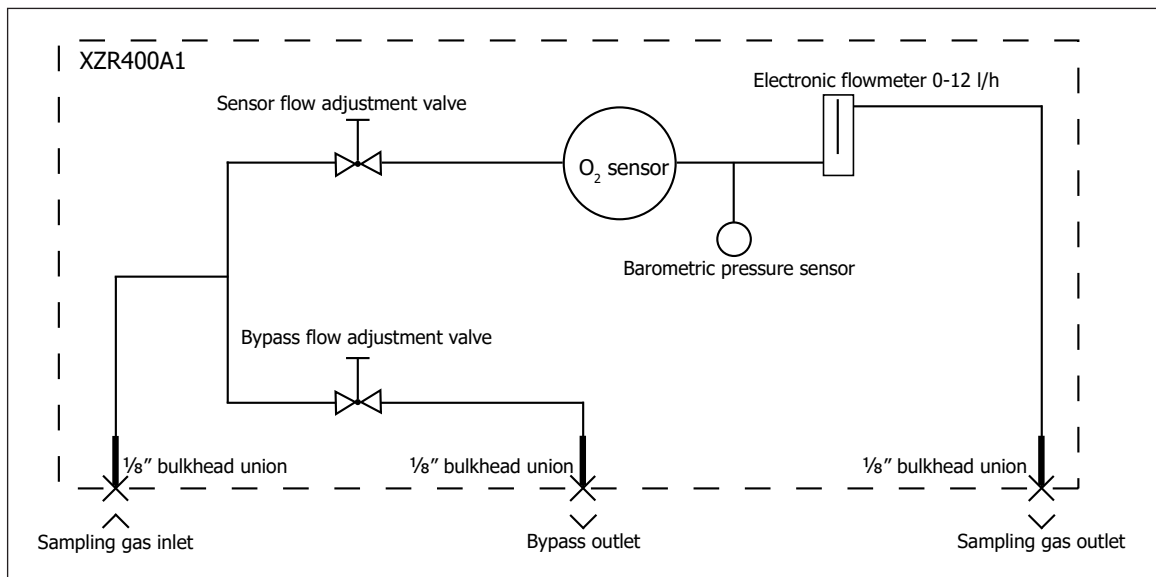

Figure 14 *Sample Path XZR400A1*

NOTE: The bypass valve must not be fully closed during measurement. Sample gas containing higher oxygen concentrations could be trapped in a dead leg formed by the closed valve and be slowly be flushed through the sensor. This is of particular concern post calibration (or after exposure to air) when sampling pure gases with very low (<10ppm) oxygen.

2.7.4 Sample Path

XZR400A1 WITH INTERNAL PUMP:

- 3 Swagelok 6 mm stainless steel bulkhead unions (1 gas inlet and 2 gas outlets) – on the rear panel
- 1 sampling pump (3 l/min)
- 2 electrovalves

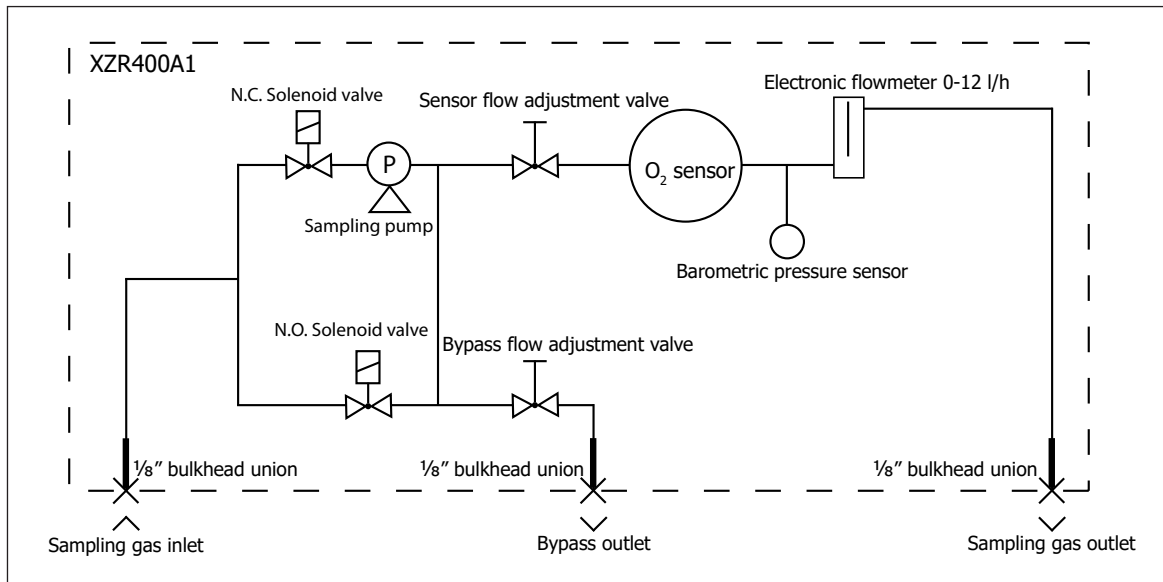
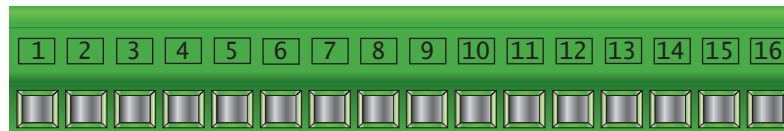

Figure 15 Sample Path with Pump Fitted XZR400A1

2.7.5 Electrical Terminal Block



Do not connect the RS485, 4...20 mA and alarm wire shield to earth.

Item	Function
1	Channel 1 mA output +
2	mA output 0 V
3	Channel 2 mA output +
4...5	Fault alarm 250 V AC, 2 A or 30 V DC, 2 A
6...7	Process Alarm 1 (250 V AC, 2 A or 30 V DC, 2 A). Function mode (Normally Open/ Normally Closed) and hysteresis can be configured. See Section 3.6.2.
8...9	Process Alarm 2 (250 V AC, 2A or 30 V DC, 2A). Function mode (Normally Open/ Normally Closed) and hysteresis can be configured. See Section 3.6.2.
10...11	Flow Alarm (Optional) (250 V AC, 2 A or 30 V DC, 2 A).
12	mA Input +. Option process pressure correction input.
13	mA Output 0 V. Option process pressure correction input.
14	RS485 Data +/A.
15	RS485 Data -/B.
16	RS485 0 V.

Figure 16 Electrical Terminal Block XZR400A1

2.7.6 D-Sub DE9 plug

This optional D-Sub DE9 type male plug (9 pin) is used to connect an RS232 port.

2.7.7 Automatic Calibration Control Connector

This optional connector allows the connection of terminals for automatic analyzer calibration. See Section 6.1, Auto Adjustment.

2.8 Connections to the XZR400A2

The connections are shown below.



Item	Description
A	Graphic touch screen – displays measurement and menus
B	Sample flow control valve
C	Bypass flow control valve
D	Removable plate for access to electrical terminal block and mains fuse
E	Three cable glands are provided for the electrical connections
F	Optional D-Sub DE9 male plug (RS485 or RS232 port)
G	Sample inlet 6 mm
H	Sample outlet 6 mm

Figure 17 Connections XZR400A2

2.8.1 Gas Sample Inlet and Outlet Fittings

The gas path consists of 2 flow control valves (sensor flow and bypass flow), a sensor and an electronic flowmeter. For the gas inlet and the outlet connections, Swagelok stainless steel 6 mm bulkhead unions are used.



The evacuation of the analyzed sample must be carried out at atmospheric pressure, otherwise the total pressure correction option is required.

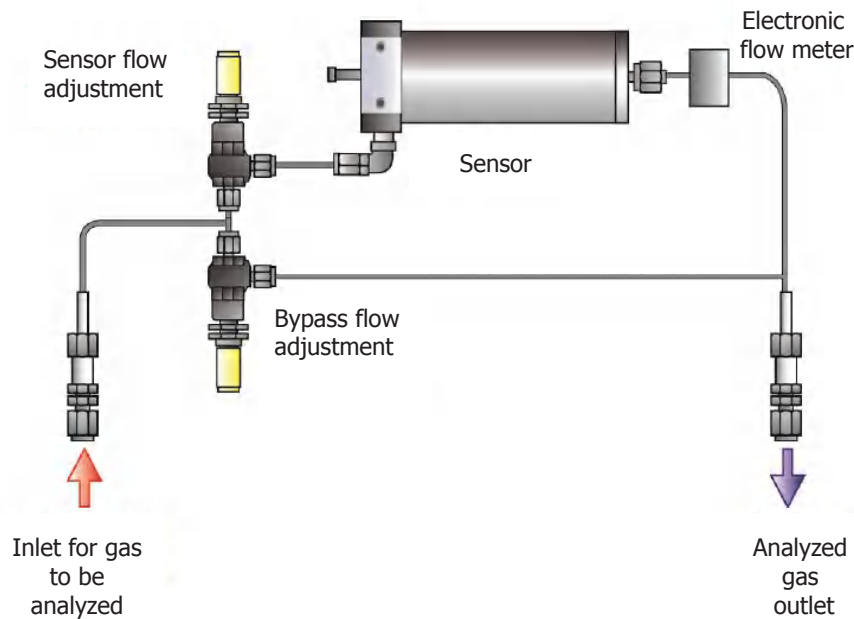

Figure 18 Gas Circuit Diagram for XZR400A2 & A3 models

The MSRS sensor is placed inside an oven in which the gases to be analyzed are circulated. The oven consists of a gas inlet head and a outlet plate. 3 Viton O-rings ensure the sealing of this device (2 for the inlet and 1 for the outlet).

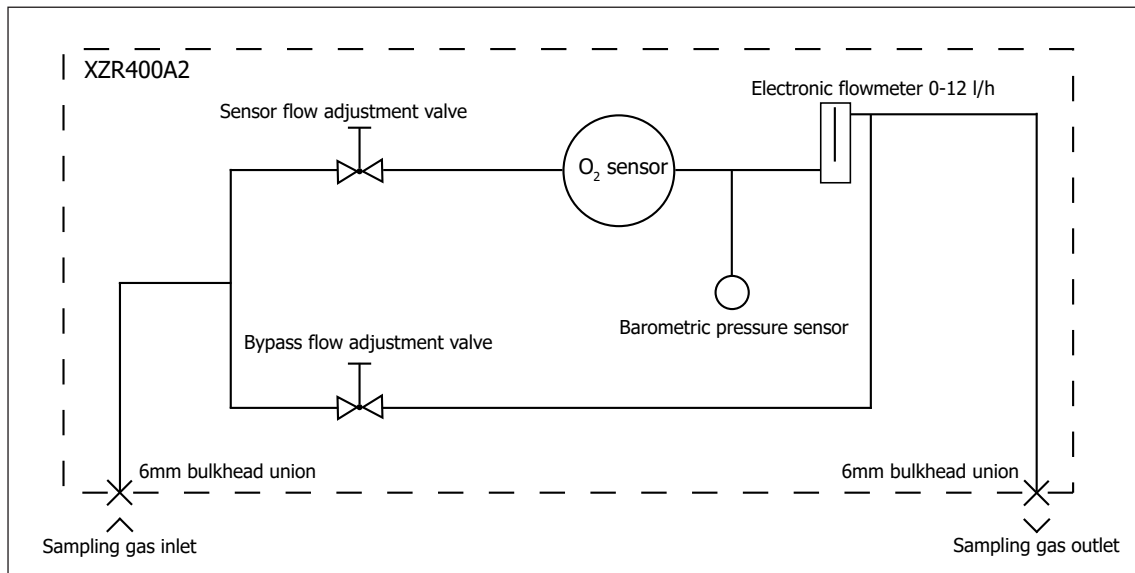

Figure 19 *XZR400A2 Sample Path*

NOTE: The bypass valve must not be fully closed during measurement. Sample gas containing higher oxygen concentrations could be trapped in a dead leg formed by the closed valve and be slowly be flushed through the sensor. This is of particular concern post calibration (or exposure to air) when sampling pure gases with very low (<10ppm) oxygen.

2.8.2 Electrical Terminal Block

The terminal block is located by removing the front panel cover.

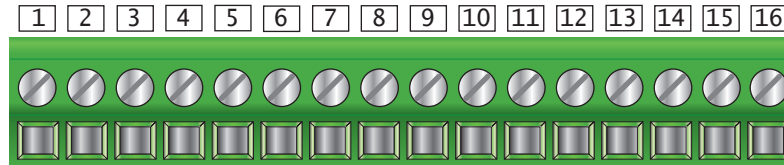

Figure 20 *Electrical Terminal Block XZR400A2*

Item	Function
1	Connection to the MSRS cell; system reserved (TC+ – orange).
2	Connection to the MSRS cell; system reserved (common – white).
3	Connection to the MSRS cell; system reserved (reference – blue).
4	Oven connection
5	Oven connection
6	Channel 1 mA output +. A second 4...20 mA output is available as an option.
7	mA output 0V
8...9	Flow Alarm (Optional) (250 V AC, 30 V DC or 2 A, 2 A). Normally Open.
10...11	Fault Alarm 250 V AC, 2 A or 30 V DC, 2 A). Function mode (Normally Open/ Normally Closed) and hysteresis can be configured. See Section 3.6.2.
12	Process Alarm 1 (250 V AC , 2 A or 30 V DC, 2 A). Function mode (Normally Open/Normally Closed) and hysteresis can be configured. See Section 3.6.2
13	Shared contact for alarms No. 1 and No. 2.
14	Process Alarm 2 (250 V AC , 5 A or 30 V DC, 5 A). Function mode (Normally Open/Normally Closed) and hysteresis can be configured. See Section 3.6.2.
15	Mains supply phase.
16	Mains supply neutral.

The equipment is protected by a T2 A – 250 V AC timed fuse (5 x 20 mm) located near the terminal block.

2.8.3 Optional Connectors

Dependent on what options are selected, there may be D-Sub DE9 and/or D-Sub DA15 female connectors on this unit. The available connections are described in Section 6.

2.9 Connections to the XZR400A3

2.9.1 Front Panel

The front panel features are shown below:



Item	Description
A	Carrying handle
B	Bypass flow control valve
C	Graphic touch screen – displays measurement and menus
D	Sample flow control valve
E	Access plate to the MSRS sensor

Figure 21 Connections Front Panel – XZR400A3

2.9.2 Side Panel

The side panel connections are shown below:

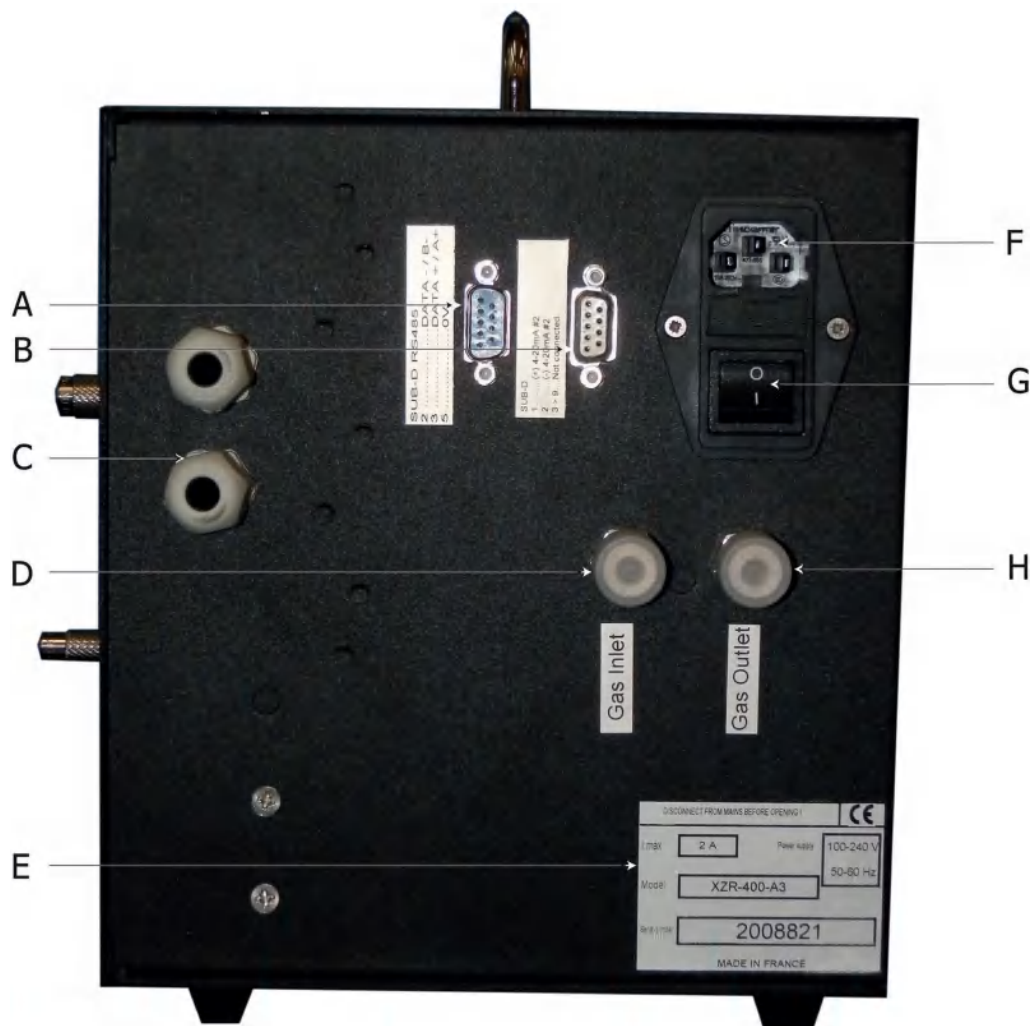

Item	Description
A	Optional Sub-D DE9 female connector; RS232 or RS485 output
B	Optional Sub-D DE9 female connector
C	Cable entries
D	Sample inlet – 6mm tube
E	Serial number & order code label
F	Mains socket (90-132/187-264 VA, automatic range switching, 50...60 Hz (±5%))
G	ON/OFF button
H	Outlet fitting for the gas sample to be analyzed (for 6 mm tube)

Figure 22 Connections Side Panel – XZR400A3

2.9.3 Electrical Terminal Block

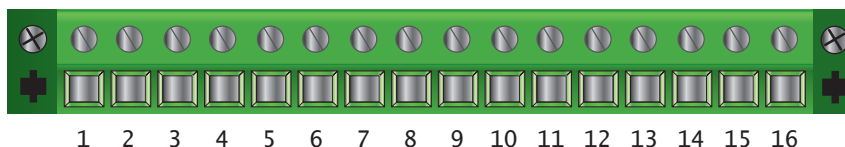

Item	Function
1	Connection to the MSRS cell; system reserved (TC+ – orange)
2	Connection to the MSRS cell; system reserved (common – white)
3	Connection to the MSRS cell; system reserved (reference – blue)
4–5	Oven connection, system reserved
6	Channel 1 mA output +. A second 4...20 mA output is available as an option.
7	mA output 0V
8–9	Fault Alarm (250 V AC, 30 V DC or 2 A, 2 A). Normally Open.
10–11	Process Alarm 1 (250 V AC, 2 A or 30 V DC, 2 A). Direction of action (Normally Open/Normally Closed).
12	Flow Alarm (Optional) (250 V AC, 2 A or 30 V DC, 2 A). Function mode (Normally Open/Normally Closed) and hysteresis can be configured. See Section 3.6.2.
13	Optional Shared contact for alarms No.1 and No. 2
14	Process Alarm 2 (250 V AC, 5 A or 30 V DC, 5 A). Function mode (Normally Open/Normally Closed) and hysteresis can be configured. See Section 3.6.2.
15–16	Not connected

Figure 23 Electrical Terminal Block XZR400A3

2.10 Gas Connection

To ensure that the sample gas is properly conditioned a sampling system might be required.

Contact Michell Instruments if you wish to order a suitable sampling system.

Sample gas connections are made via the gas input and gas output ports located on the back panel (XZR400A1), bottom panel (XZR400A2) or side panel (XZR400A3) of the analyzer.

Both the input and output gas connections are Swagelok tube: 1/8" for XZR400A1 and 6 mm for all other models

NOTE: To facilitate ease of connection to the port, at least 75 mm (3") of the tubing coming out of the gas inlet port must be straight.

NOTE: Maximum sample pressure is 2 barg (29 psig).

NOTE: Sample is vented to atmosphere. Depending on the location of the analyzer it may require a vent line to a safe location that is freely ventilated.

3 OPERATION

It is recommended that the user becomes familiar with Section 2 of this manual in which all the equipment controls, indicators, the elements of the display and the overall menu structure are described.

Prior to operation, the analyzer must have been connected to the correct electrical power supply and the relevant analog and alarm outputs connected to external systems as described in Section 2.

On delivery, the instrument will have been set-up with a standard set of default parameters defining the operation of the analyzer. These parameters can be changed as required by means of the **Main Menu**.

3.1 General Operational Information

The input gas must be at a pressure of less than 2 barg (29 psig). The outlet of the system must be at atmospheric pressure.

NOTE: If the outlet is at higher pressure than atmospheric an optional process pressure correction is necessary. Please consult Michell Instruments in this case.

The instrument is designed to operate with a gas flow of 2 l/h \pm 1 l/h.

NOTE: For best results ensure that the sampling system is as close as possible to the XZR400 Series Analyzer.

For all applications the sample gas is taken into the instrument via the gas inlet port located on the bottom panel of the analyzer, from where it passes into an oven chamber. The gas flow rate is then measured on the outlet side of the sample chamber, prior to being exhausted from the instrument via the gas outlet port.

The flow, necessary for the sample gas circulation, is generated by the sensor oven which utilizes the heat convection principle. The hot sample gas from the sensor oven is pushed by the hot oven gases, which are still in the oven. On the way out of the oven the sample gas cools, passing through the gas outlet port, and is carried away by the main gas flow.

The XZR400 Series Analyzers are suitable for the measurement of oxygen in a wide variety of clean and dry gases. It will not contaminate high purity gases and is safe for use in critical semiconductor and fibre optic manufacturing applications.

It is possible to continuously visualize the oxygen concentration in the range between 0.01 ppm and 25% oxygen. If required, the analyzer can display the MSRS voltage, the oven temperature and the temperature of the cold junction in the thermocouple.

3.1.1 Signal Processing Path

The values of oxygen concentration and flow passing through the sensor are displayed continuously.

On specific screen pages the following control parameters are displayed:

- Oven temperature
- Ambient temperature (corresponding to the thermocouple junction temperature)
- O₂ concentration
- MSRS sensor voltage
- Barometric pressure (standard) or process pressure (optional)
- Flow passing through the sensor

Analog Outputs:

The analog output can be configured to represent the measured oxygen parameters and is provided as a 2-wire signal. It can be set-up as a current loop signal 4...20 mA. The configuration of the output can be set via the **Main Menu**.

The analog output is proportional to user-defined scale. The connection is inside the enclosure, behind the removable panel on the front of the unit. An optional second 4...20 mA output is available.

3.1.2 Alarm Outputs

Standard Alarms:

- general fault alarm
- 2 concentration alarms with user-configurable high/low thresholds and hysteresis

Two alarm relays are provided. They are connected to the instrument via the terminal block inside the XZR400A2 Analyzer.

Under the **Main Menu**, the two concentration alarms can be set-up to operate when a pre-set parameter threshold level is exceeded (refer to Section 3.6.2). The direction of the activation, as well as the hysteresis can be configured.

The fault alarm is a non-configurable alarm which continuously monitors the status of the analyzer. During normal operating conditions the alarm is off. The alarm will be triggered and both relay contacts will open if:

- the oven temperature is low
- the thermocouple breaks
- a fault with the memory occurs

Optional Alarm:

- an optional flow alarm is available

3.2 Powering-up the System

Carefully check the electrical connection before applying the power.

Wall Mount Version	Switch the external disconnecting device supplying power to the analyzer. This device does not have a built-in on/off switch.
Portable and Rack Versions	Switch the built-in on/off switch to the ON position

Power-up the system. Observe all normal safety precautions during the powering-up procedure.

Never allow sample gas to enter the analyzer when it is switched off.



In the case of power breakdown for more than 1 hour it is necessary to purge the analyzer with Nitrogen or instrument air < -40 °C (-40 °F) dew point.

This will prevent any condensation due to the oven being off.

Maintain the flow rate at 2 l/h ±1 l/h.

3.3 Warm-Up Period

Upon power up, the screen appears as shown below. The analyzer performs a series of internal checks for about 5 seconds.

NOTE: Touch the French or English area to display the menu in the required language.

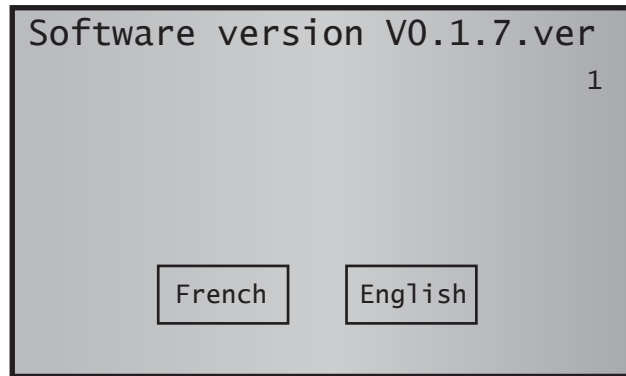

Figure 24 *Start-up Screen*

Wait about 15 minutes until the oven temperature reaches 634 °C, indicated by the oven temperature line.

The low temperature alarm is displayed digitally throughout the rise in oven temperature; the general alarm contact is activated.

NOTE: A flow greater than 3.5 l/h prevents the correct rise in oven temperature.

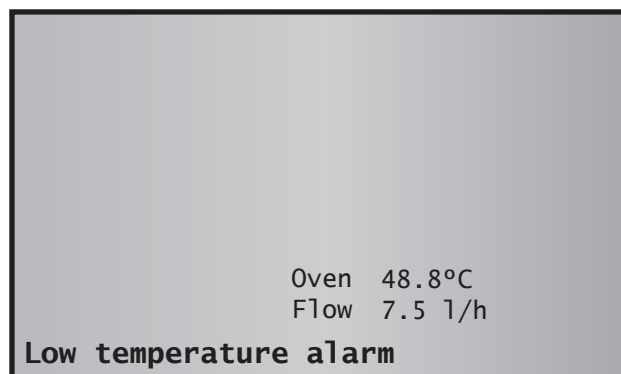

Figure 25 *Oven Temperature Screen*

If required, adjust the gas sample flow by operating the bypass valve (B) and then the end flow valve (A) to obtain a 2 ± 1 l/h flow rate (C).

NOTE: For optional measurement do not fully close the bypass valve.

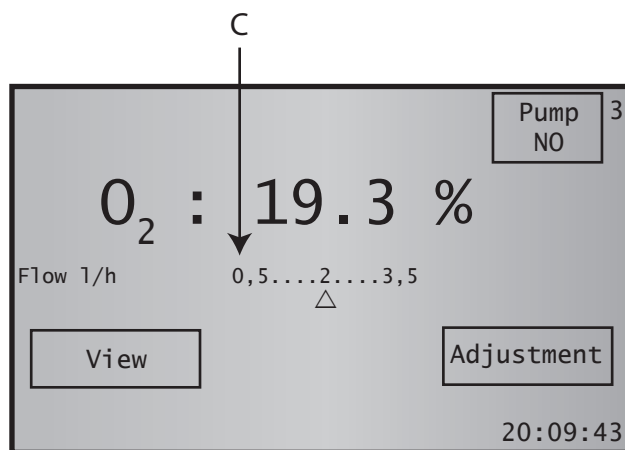

Figure 26 Sample Flow Adjustment

3.4 Main Screen

Once the temperature has been reached, the screen displays:

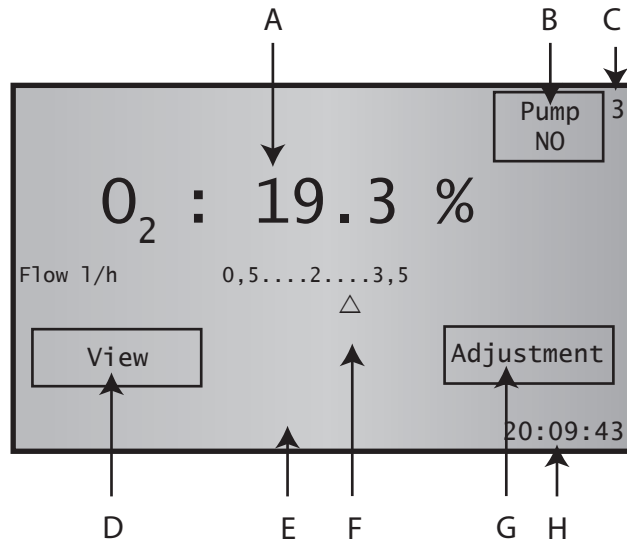

Figure 27 Main Screen

A	Measured oxygen concentration between 0.01 ppm and 25%. The maximum measurement precision can only be obtained following an adjustment performed after a minimum of 3 hours of operation. However, upon receipt of the analyzer, this adjustment will have been performed in the factory as shown in the manufacturing check and adjustment sheet.
B	Pump ON/OFF button available on the A1 model. The PUMP signal flashes when the pump is operating
C	Screen number
D	Touch-sensitive View area
E	Message display area
F	Sample gas flow between 0.5 and 3.5 l/h, shown by the cursor position
G	Touch sensitive Adjustment area Used to adjust the MSRS cell after changing the cell or the oven
H	Current time

3.5 Control Parameters Display

On the Measurement Display Screen (3) touch the **VIEW** area

The Control Parameters Screen (3.1) will appear.

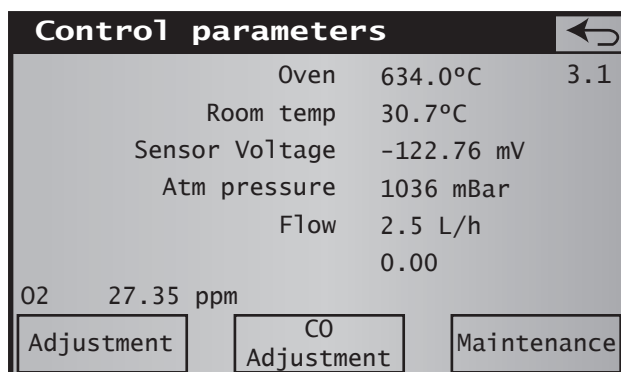



Figure 28 Control Parameters Screen

This displays the following information about the analyzer.

Oven	Current oven temperature. This must be 634 °C. Temperatures 30 °C below or 50 °C above trigger the fault alarm.
Room Temperature	Measurement from thermistor on PCB.
Sensor Voltage	Measurement in mV of the voltage supplied by the measuring cell, which must be between -300 and +250 mV. A value outside these limits triggers a fault alarm.
Atm pressure	The pressure at the analyzer outlet must be near atmospheric pressure (between 800 and 1750 mbar). A value above 1200 mbar and under 800 mbar generates an oxygen measurement error. NOTE: If the pressure is greater than 1750 mbar, the atmospheric pressure sensor can be damaged irreversibly.
Flow	The sample's flow in l/hour must be 2 ±1 l/h. A flow value below 0.5 or greater than 3.5 l/h generates a general fault alarm displaying a Flow fault.
O2	Measured oxygen percentage
	Return to Main Screen 3. The display returns to the Main Screen automatically if the touch screen is not used for 2 minutes.
Adjust	Displays the adjustment screen to calibrate the analyzer.
Maintenance	Displays the analyzer's parameter setting screen (access code, outputs, alarm limits, time-stamp, RS485, flow corrections).

3.5.1 Configuration

To reach the Main Menu Screen enter the access code as follows.

- Touch the **VIEW** area of Screen 3. The Control Parameters Screen is displayed.
- Touch the **Maintenance** area.

NOTE: To leave this screen touch Cancel area.

- Touch the box labelled 0 ____
- Enter the access code on the keyboard. The default access code is 0.
- To correct an entry error press **←**
- Touch the OK area.

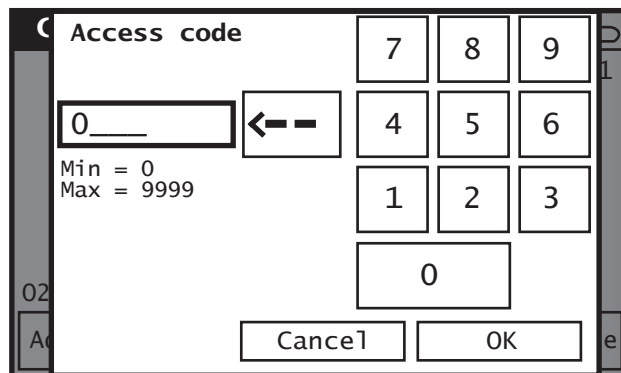

Figure 29 Main Menu Access Screen

If the access code is incorrect the screen goes back to Screen 3.1.

If the access code is correct the Main Menu Screen is displayed (5).

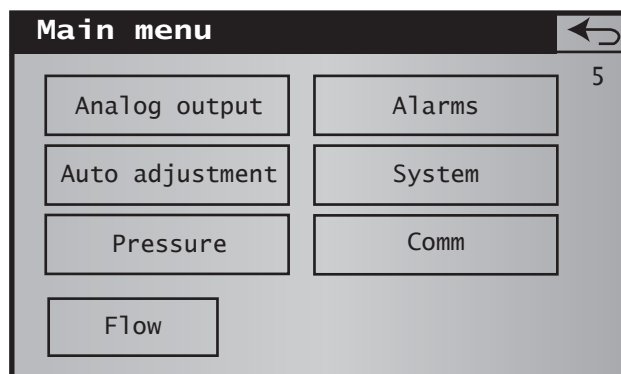

Figure 30 Main Menu Screen

3.5.2 Changing the Access Code

The default access code is 0000. To change this code proceed as follows:

NOTE: To leave a screen, touch .

- Touch the VIEW area of Screen 3. The Control Parameters Screen is displayed.

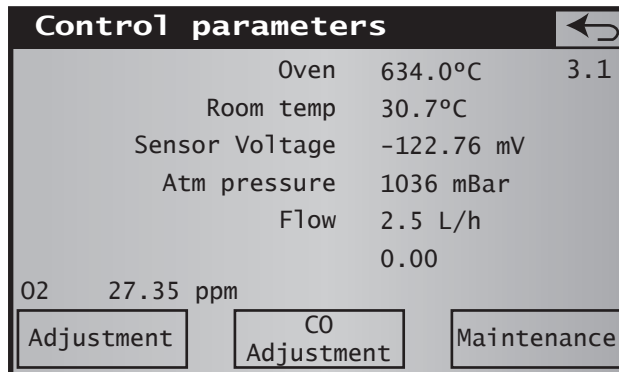

- Touch the Maintenance area.

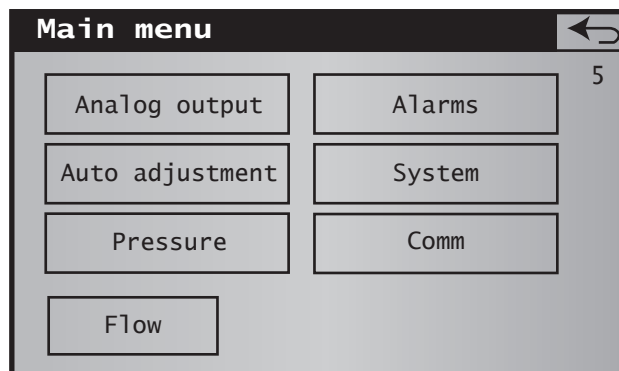

- Touch the System area.

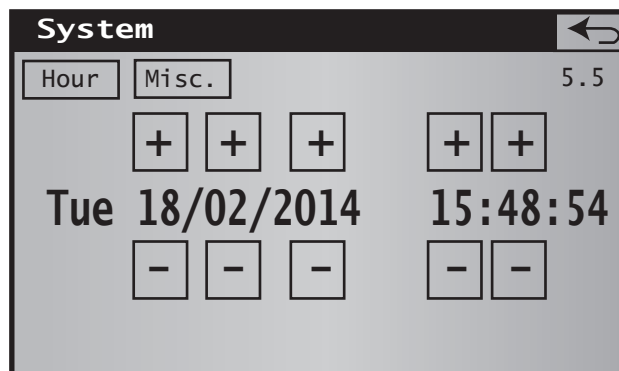

- Touch the Misc tab

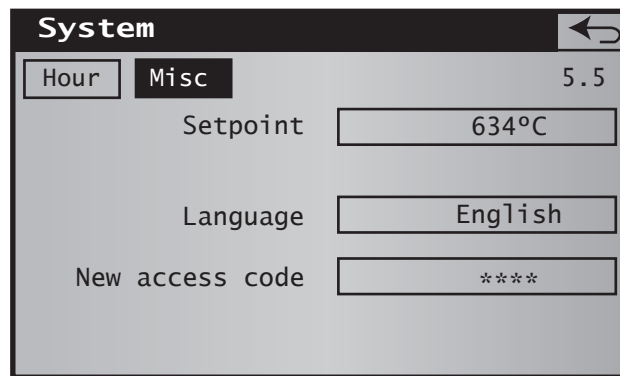

- Touch the **New Access code** area

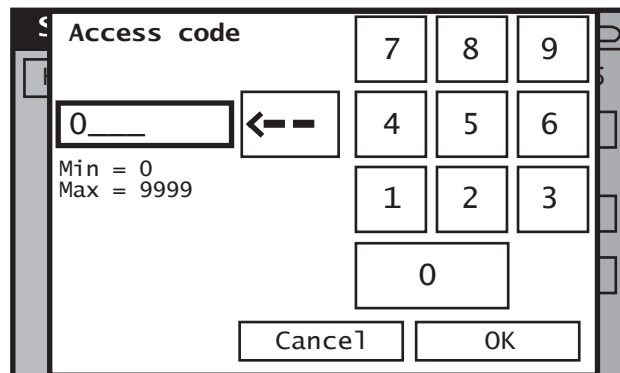

- Enter the new access code
- To correct an entry error, press the  area
- Press the **OK** area

3.6 The Main (Expert) Menu

This menu accesses all of the configuration functions of the analyzer. Press the corresponding area to display the required screen.

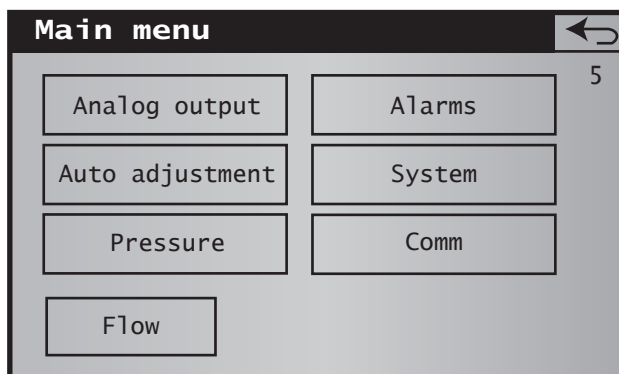

Figure 31 Main Menu Screen

Area	Function	Section
Analog output	Configures the 4...20 mA analog output 1	3.6.1
Alarms	Disables the 3 alarms (during adjustment and/or during normal operation) and sets the threshold and the function mode for alarm 1 and 2	3.6.2
Auto adjustment	Configures the automatic cyclical adjustment (adjust) of the analyzer Optional	6.1
System	Configures the analyzer timestamp function, oven temperature, menu display language, Expert access code and RS output configuration (Modbus address with RS485 or frame period with RS232).	3.6.3
Pressure	Configures the process pressure correction Optional for all models	6.2
←	Returns to the Measurement Display Screen (3)	
COM 232	Sets the frequency of the frame transmission Optional Cannot coexist with the RS485	6.3.1
COM 485	Sets the Modbus address of the analyzer and displays the message frames received by the analyzer via the RS485 interface Cannot coexist with the RS232	6.3.2
Flow	Configures the gas sample flow correction based on its density	3.6.4

3.6.1 Analog 1

The Analog Output 1 screen (5.1) sets the parameters for the 0/4...20 mA output.

- Touch the area to select it and change it.
- Enter the new numeric value on the virtual keypad.
- Click OK to confirm or Cancel to discard the changes.

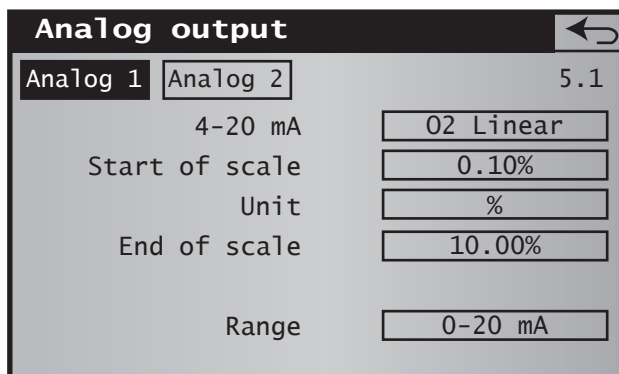

Figure 32 Analog Output Screen

Area	Function
4...20 mA	<p>Configuration of the 0/4...20 mA analog output No 1.</p> <p>LIN: the output voltage must be linearly proportional to the oxygen measurement value.</p> <p>LOG: the output voltage must be a logarithmic function with respect to the oxygen measurement value. Use this option when the signal span is greater than 3 decimal counts.</p> <p>A current of 3.80 mA (4...20 mA output configured) or 21 mA is automatically generated when there is a general fault if:</p> <ul style="list-style-type: none"> • oven temperature is lower than 30 °C or higher than 50 °C from the setpoint • thermocouple rupture • flow less than 0.5 and greater than 3.5 l/h • internal wiring fault
Start of scale	Configuring the concentration for the low scale and the measurement unit. Select a value and a unit corresponding to the concentration to be measured.
Unit	Configuration of the unit in which the value is expressed (% or ppm).
End of scale	<p>Configuring the high scale concentration and the measurement unit. Select a value and a unit corresponding to the concentration to be measured.</p> <p>NOTE: The difference between the low scale and high scale value is limited to three decimal places to ensure correct resolution. This limitation only applies to a linear output type.</p>
Range	Configuration of the analog output (0...20 or 4...20 mA).
←	Returns to the Main Menu screen.

Analog 2

The information is similar to that of the Analog 1 menu and can be reached by touching the Analog 2 area. When this option is not available, the display shows **Option not available**.

3.6.2 Alarms

The Main Tab

The Alarms Screen sets the general behaviour for alarms 1 and 2.

- Touch the area to select it and change it.
- Click **OK** to confirm or **Cancel** to discard the changes.

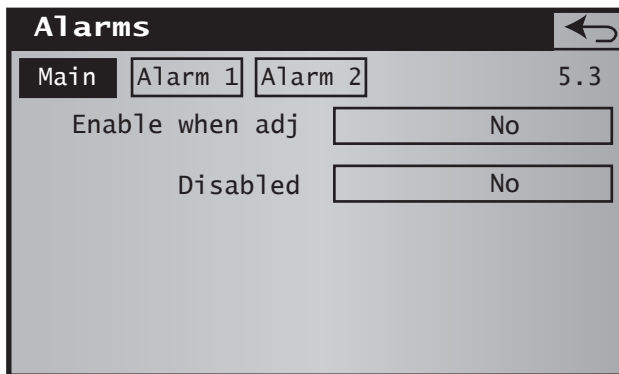

Figure 33 Alarm Screen (Main)

Area	Function
Enable when adj	<p>Sets the behaviour for alarms 1 and 2 exclusively during auto adjust operations or manual.</p> <ul style="list-style-type: none"> • No: exceeding the alarm threshold will not trigger the relay for alarms 1 and 2 during adjustment operations, or when alarm set off is configured by the user. • Yes: exceeding the alarm threshold will trigger the relay for alarms 1 and 2 during adjustment operations, or when alarm set off is configured by the user.
Disabled	<p>Sets the current behaviour for alarms 1 and 2 and that of the General fault exclusively in normal mode of operation (excluding adjustment).</p> <ul style="list-style-type: none"> • No: the alarms are operational; the corresponding alarm will be activated when an alarm is triggered and/or a fault occurs. This is the standard choice for the analyzer in normal operation. • Yes: no alarms will be activated regardless of the alarm and/or fault present. Use this option during the commissioning of the analyzer, especially before the wiring the alarms. The blinking Alarms Disabled message will be displayed on the Measurement Display Screen (3). <p>NOTE: Operating with alarms disabled must only be done temporarily, particularly during adjustments.</p>
Alarm 1 tab	Touch the area to display the alarm 1 threshold change screen.
Alarm 2 tab	Touch the area to display the alarm 2 threshold change screen.
←	Returns to the Main Menu Screen.

The Alarms Tabs

This screen is used to set the alarm function mode (high, low), the threshold and hysteresis for the selected alarm 1 or 2.

It is used mainly to enable or disable the alarms during the adjustment phases and during normal analyzer operation.

- Touch the area to select it and change it.
- Enter any new numeric value on the virtual keypad.
- Click **OK** to confirm or **Cancel** to discard the changes.

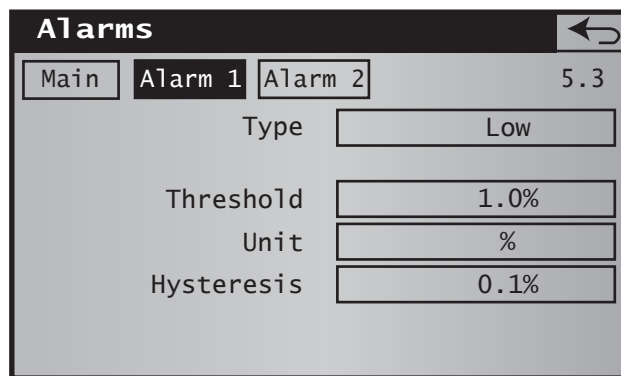

Figure 34 Alarm Screen (Alarm 1)

Area	Function
Type	<p>Sets the behaviour for alarm (1 or 2 according to the highlighted tab).</p> <ul style="list-style-type: none"> • Low: the alarm will be activated when the measurement value is equal or below the threshold set for the Alarm threshold line. The alarm must be disabled when the measurement value is above the threshold set for the Alarm threshold line. • High: the alarm will be activated when the measurement value is equal to or above the threshold set for the Alarm threshold line. The alarm must be disabled when the measurement value is below the threshold set for the Alarm threshold line.
Threshold	<p>Configures the alarm threshold value. Select the value and unit in relation to the future measurement.</p>
Hysteresis	<p>Sets the alarm 'delay' value to return to alarm-off condition. The greater this value is, the more the return to alarm-off condition value must be delayed. For example, with a hysteresis of 3ppm over a 15ppm alarm value, the alarm is triggered at 15ppm, but returns to the alarm-off position at a 12ppm value (15ppm...3ppm).</p>
←	<p>Returns to the Main Menu Screen.</p>

3.6.3 System

This screen is used to update the analyzer's real-time time stamp clock, to set the oven's temperature or the interval between two RS232 messages, as well as the factory reset.

- Touch the area to select it and change it.
- Enter the new numeric value on the virtual keypad.
- Click **OK** to confirm or **Cancel** to discard the changes.

3.6.3.1 Hour Tab

The Hour tab concerns the system timestamp.

- Touch the + and – area to set the current time and date.

NOTE: Seconds will be resettled.

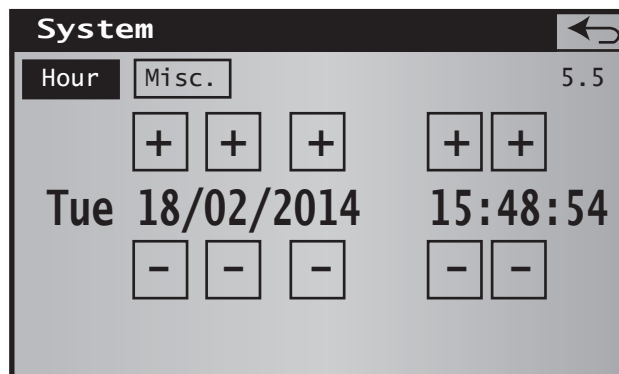

3.6.3.2 Misc Tab

The Misc tab of the System screen concerns the oven temperature setpoint, the menu display language and the access code modification.

- Touch the + and – area to set

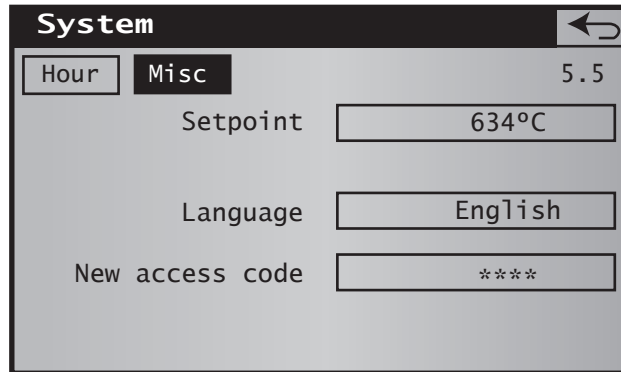

Area	Function
Setpoint	Enter the oven temperature value that the analyzer will use to operate. The default value is 634 °C. An unsuitable temperature setting reduces the performance of the analyzer and can damage the MSRS oxygen measuring cell.
Language	Touch the Language area. In the opened window, change the displayed language. The new language will be applied at the next start. NOTE: the language selection is proposed if this choice was not selected at the analyzer start.
New access code	Modifies the expert level code. By default, the expert code is 0. Warning: If the access code is forgotten the equipment will need to be returned to the factory for Expert level code reset.
Factory settings	The analyzer parameter values defaults are set at the factory, namely <ul style="list-style-type: none"> • Oven temperature: 634 °C • Alarm No. 1 High mode, threshold: 3 ppm • Alarm No. 2 High mode, threshold: 3.5 ppm • Low scale and high scale, 4...20 mA output No. 1: 0.1 and 10 ppm • Low scale and high scale, 4...20 mA output No. 2: 0.1 and 1000 ppm

3.6.4 Flow

This screen is used to define a flow correction factor depending on the density of the gas being analyzed. Use this function to optimize the flow measurement depending on the type of gas used.

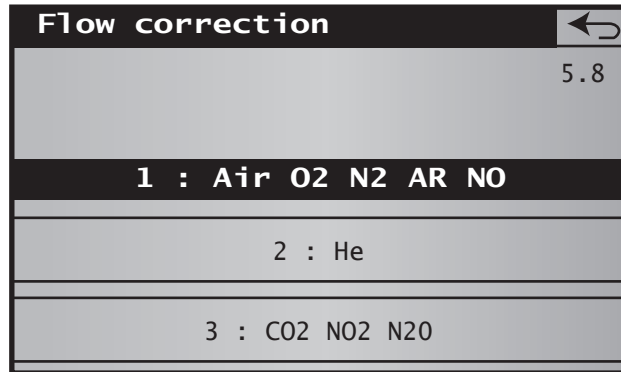

Figure 35 Flow Correction Screen

Area	Function
Flow correction	Selects the adjustment factor number (1, 2 or 3) depending on the gas analyzed. For this choice, take the main gas into account.
←	Returns to the Main Menu Screen.

4 CALIBRATION

The optimal measurement accuracy is reached when calibrating the analyzer after a minimum of three hours of operation.

Calibration is done on a single point ideally with an oxygen concentration of between 8% and 10% O₂. The gas concentration adjustment can be between 1 ppm and 25% oxygen.



Avoid calibration gas concentrations between 1,000 ppm (0.1%) and 5,000 ppm (0.5%) as this is too close to the internal reference.

It is possible to verify the linearity of the sensor with a second gas, rated at a different O₂ value. A single cylinder with O₂ at a known concentration is required for calibration. A second cylinder with a different concentration can be used to verify calibration (Control Gas).

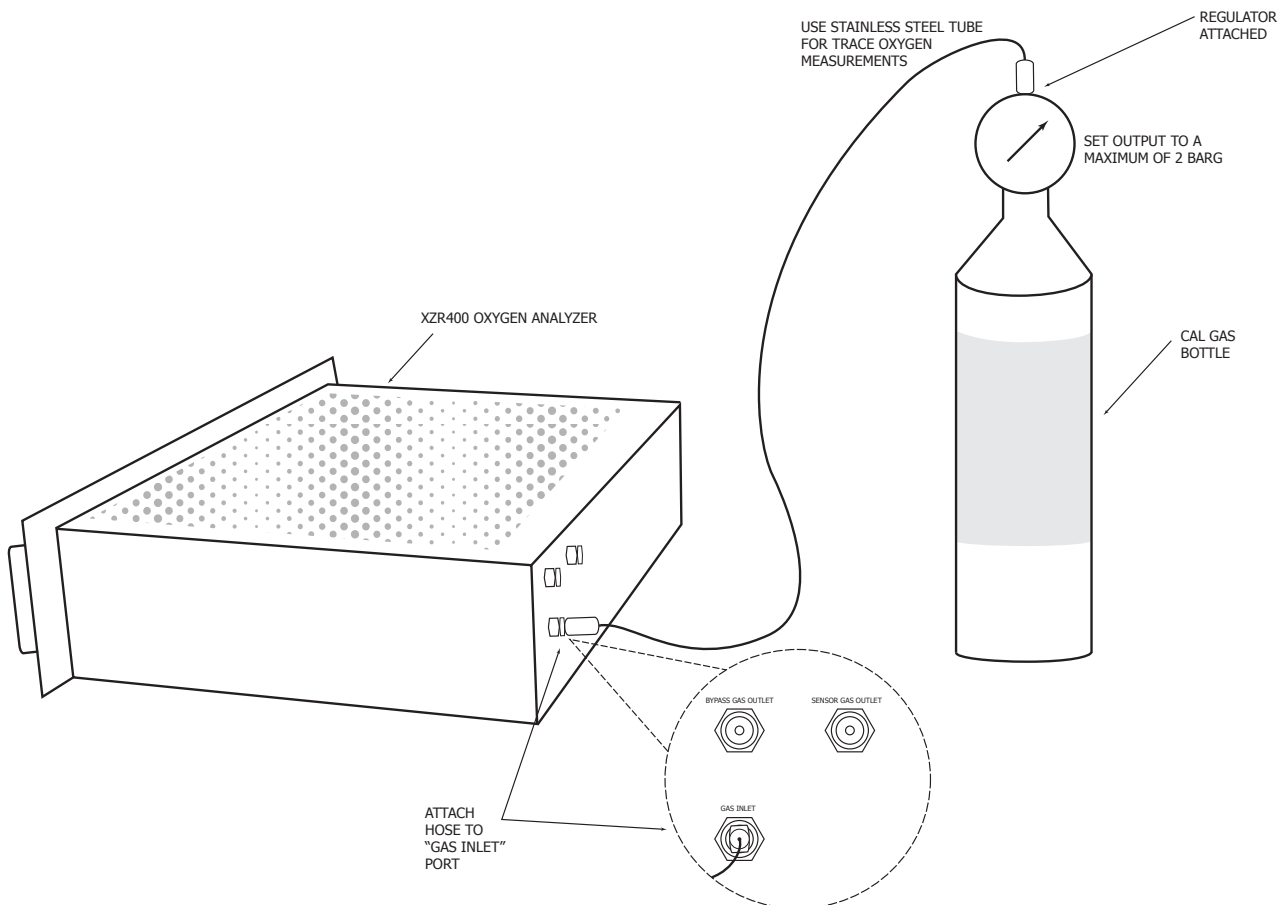

Figure 36 Calibration Procedure with XZR400A1

4.1 Definitions

- **Adjustment gas:** an adjustment gas used in order for the analyzer to correct a possible difference between the measured value and the actual O₂ content in the gas. The value which is written on the cylinder (or on the relevant analysis certificate) must be entered in the field **adjustment gas** section. The content can be in either % or ppm.
- **Control gas:** a gas with a different O₂ content than the adjustment gas. It helps in verifying the linearity of the sensor post calibration. The O₂ content can be either in % or ppm. This control is not compulsory.
- **Process gas:** the gas to be measured.
- **Calibration duration:** the period during which the adjustment gas eliminates the process gas out of the internal sample path. The quality of calibration will far be greater if the process gas is fully cleared away. A longer period is necessary when the adjustment gas value is low and/or when the difference between the process gas and the adjustment gas is large. Calibration with % level oxygen gas requires approximately 5 minutes. Calibration with ppm level oxygen gas may require 30 minutes.
- **Purging time:** the period during which the process gas eliminates the adjustment gas (or verification gas) out of the internal sample path.



If a low O₂ content (< 1000ppm) adjustment gas is used, a purge time is necessary to allow the stabilization of the measurement before starting the calibration sequence. This is even more important if the process gas is going to be at a very different concentration from that of the adjustment gas.

NOTE: The following sections describe the standard (manual) adjustment of the analyzer. Auto adjustment is available as an option and is described in Section 6.

4.1.1 Manual Adjustment

NOTE: Prior to commencement of the adjustment/calibration the alarms can be disabled from screen page 5.3.

From the Main Screen press **Adjustment** to get to screen page 3.2.

Pressing the  key from any of the Adjustment Screens will return to the previous screen.

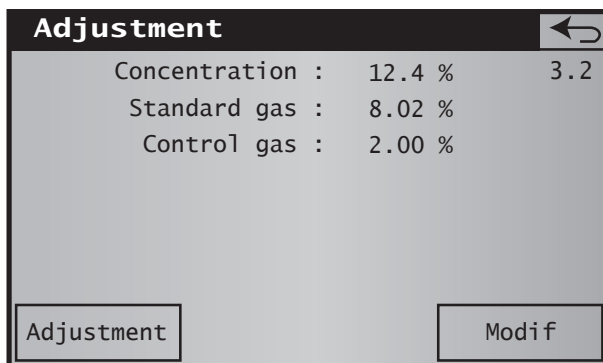

Figure 37 Screen Page 3.2

Ensure that the values on the Screen 3.2 are correct with respect to the calibration gas cylinder or certificate. If they are correct press the **Adjustment** button, this will take you to Screen 3.2.2.

If the values do not match press the **Modify** key, this will take you to Screen 3.2.1.

'MODIF' . Incorrect Values

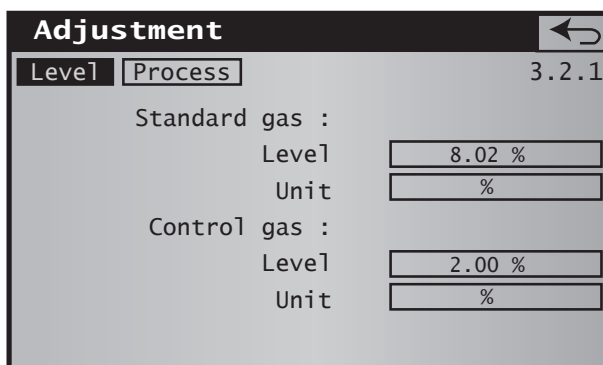

Figure 38 Screen Page 3.2.1

To change any of the values, press the relevant value key and use the numeric keypad to modify the value.

To change the gas unit (% to ppm or ppm to %), press the unit key.

Press the **Process** tab to check the Adjustment, Control and Purge times and correct and modify if necessary.

The length of time for each process should be long enough to ensure that the calibration gas sample is stable during Adjustment and Control and that the calibration gas is completely purged to a level close to normal operation (below any alarm threshold) before switching back to measuring the process.

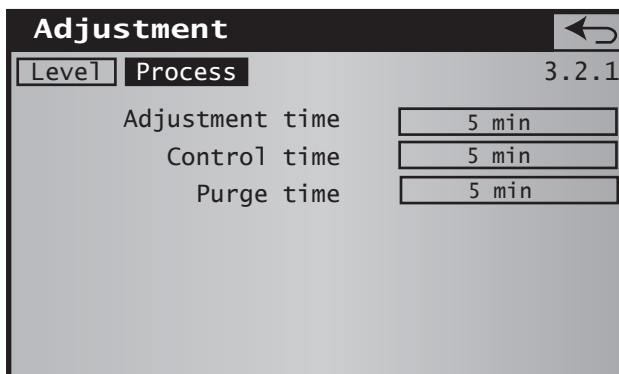

Press the  key to return to Screen 3.2 and press the **Adjust** key to start the calibration procedure (Screen 3.2.2).

ADJUST . Correct Values

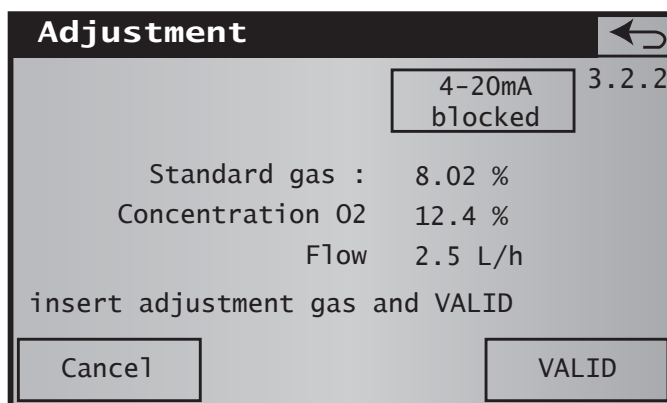

Figure 39 Screen Page 3.2.2

Press the 4...20 mA key to select whether the output is frozen (blocked) or will follow the gas concentration (active).

Open the gas cylinder to give a flow rate of 2 l/h ±1 l/h.

Wait for approximately 5 minutes for the concentration O₂ value to be close to the standard gas value and then press the **VALID** key. This will bring up Screen 3.2.3.



An incorrect gas flow (0.5 < flow < 3.5 l/h) will prevent the calibration sequence from starting.

An incorrect gas flow DURING the calibration will cancel the sequence and screen page 3 will appear showing the message: Impossible to calibrate: flow fault.

Screen page 3.2.3 shows the O₂ concentration in the adjustment gas and the time left before the purge sequence.

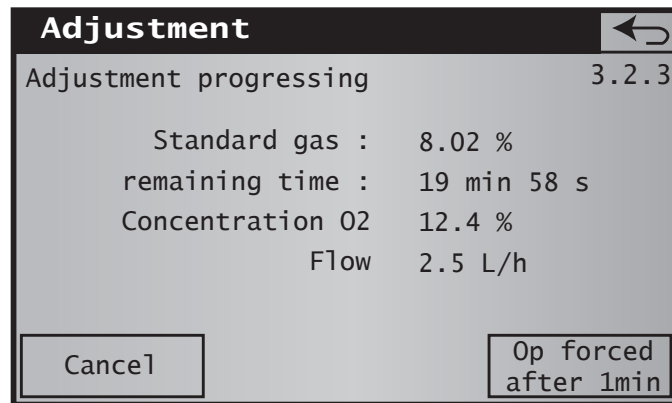

Figure 40 *Screen Page 3.2.3*

During the calibration sequence it is possible to:

- Force calibration after 1 minute if the reading is stable. Press the **Op forced after 1min** key and screen page 3.2.4 will show (after 1 minute).
- Cancel calibration at any time. Press the **Cancel** key and go to screen page 3.2.8.

Cancel Calibration

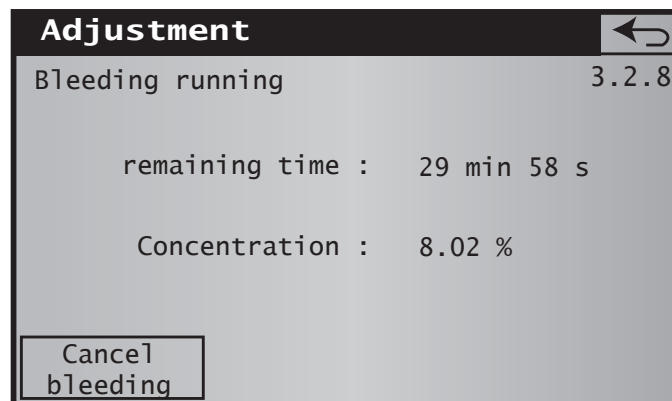

Figure 41 *Screen Page 3.2.8*

Pressing the **Cancel bleeding** key will return to the Main Screen.

4.1.2 Control Gas

While the control gas passes through the analyzer after a calibration sequence, the MSRS sensor status is diagnosed to assess the working order of the analyzer.

The system compares the theoretical and measured concentration of the control gas.

To begin this diagnosis complete a calibration sequence (see Section 4.1.1). When the calibration is over, screen page 3.2.4 will appear.

Alternatively if the reading was stable and the calibration was forced from screen page 3.2.3 by pressing the **VALID** key, then screen page 3.2.4 will appear.

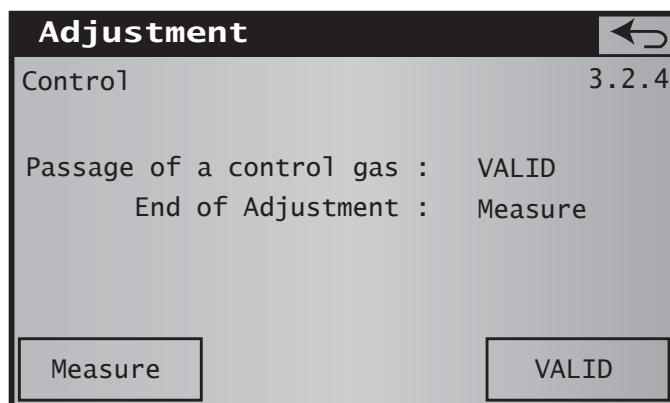

Figure 42 Screen Page 3.2.4

Pressing the **Measure** key will show screen page 3.2.7. To return to the measurement, close the adjustment gas cylinder. Pressing the **VALID** key will take you to screen page 3.2.8. A purge ends the calibration sequence.

Pressing the **VALID** key will start the Control gas process. The following screen page 3.2.5 will appear:

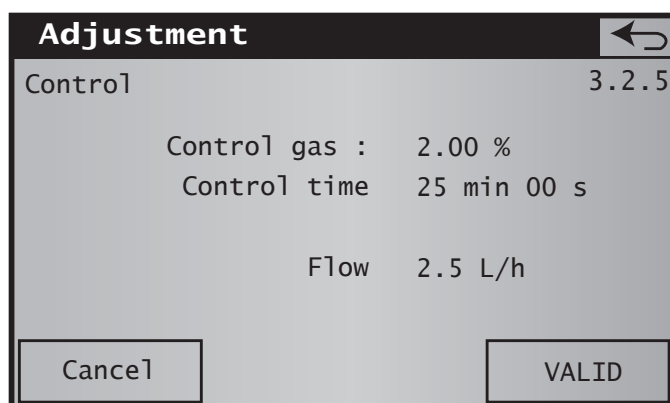

Figure 43 Screen Page 3.2.5

Pressing the **Cancel** key will take you to 3.2.8.

Press the **VALID** key **after** opening the control gas cylinder to give a flow rate of 2 l/h \pm 1 l/h and waiting until the control gas has cleared the process gas away from the internal sample path. Screen page 3.2.6 will appear:

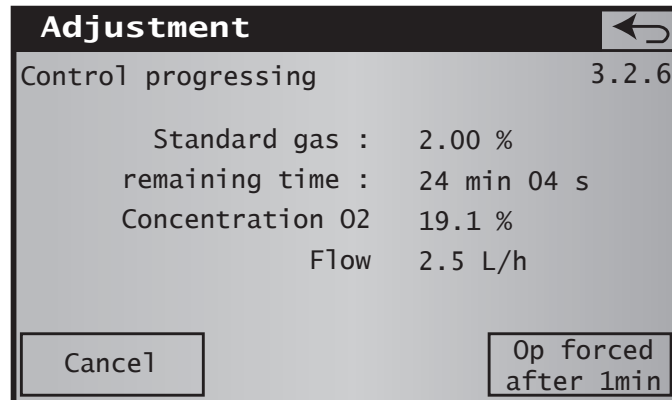

Figure 44 Screen Page 3.2.6

From this screen it is possible to:

- Force calibration after 1 minute if the reading is stable. Press the **Op forced after 1min** key and screen page 3.2.7 will show (after 1 minute).
- Cancel calibration at any time. Press the **Cancel** key and go to screen page 3.2.8.

At the end of the verification period, the diagnosis will appear on screen page 3.2.7:

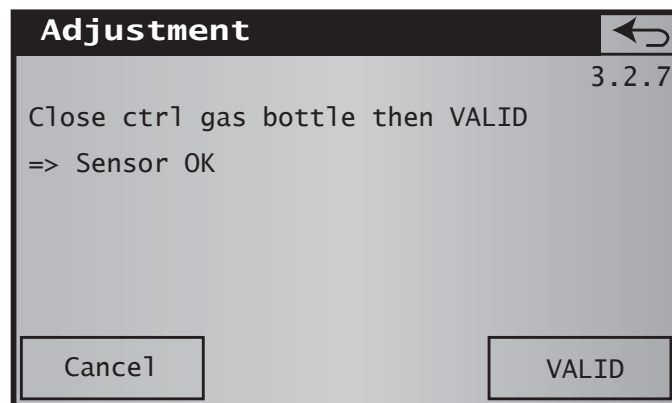

Figure 45 Screen Page 3.2.7

Three outcomes are possible and will be displayed as a message on the third row of the screen:

- The analyzer is operative.
- The analyzer's performance is not optimal. The MSRS sensor should be replaced at some time in the near future.
- The analyzer's performance is poor. Change the MSRS sensor immediately.

Pressing the **Cancel** key will return to the Main Screen.

Closing the control gas cylinder and pressing the **VALID** key will take you to screen page 3.2.8.

Managing The Alarms During The Calibration Sequence

The alarms can be active or inactive during the calibration sequence.

When **NO** is on in the **Active during ADJ** section on screen page 5.3 the alarm contacts are not active during the calibration sequence.

When **YES** is on in the **Active during ADJ** section on screen page 5.3 the alarm contacts will be activated during the calibration sequence and will respond according to the configuration set by the user.

De-Activation of Alarms





The alarms may be de-activated during installation and set-up. If the alarms are de-activated and the system detects a fault and/or an alarm threshold is passed, the alarm relays are not activated. In this case a message describing the fault will appear at the bottom of the default screen page 3.









When **NO** is on in the **Inhibit Alarms** section the alarms are operative.





When **YES** is on in the **Inhibit Alarms** section the alarms are de-activated.





5 MAINTENANCE

5.1 Troubleshooting Guide / Failure Analysis

Observation	Cause	Corrective Action
Mains power plugged in and switched on but no display present	Fuse blown	<ul style="list-style-type: none"> ● Replace mains fuse: ● Fuse Box: T2A/250 V ● Mains socket: T6.3A/250
	Analyzer not powered  	<p>BEWARE OF ELECTRIC SHOCK / BURN HAZARD</p> <ul style="list-style-type: none"> ● Remove the analyzer cover ● Measure the main inlet voltage ● If the measured voltage is 100...240 V AC ($\pm 10\%$) verify the mains power to the analyzer
	Display disconnected  	<p>BEWARE OF ELECTRIC SHOCK / BURN HAZARD</p> <ul style="list-style-type: none"> ● Remove the analyzer cover ● Ensure the plugs of the 20-way ribbon cable are connected to both the display PCB and the mother board and that the wiring is intact ● Ensure the plugs of the 2-way cable are connected to both the display PCB and the mother board and that the wiring is intact ● Ensure the plugs of the 4-way cable are connected to both the display PCB and the mother board and that the wiring is intact
	Faulty analyzer	Return the analyzer to Michell Instruments for further investigation

Observation	Cause	Corrective Action
Display indicates Low Temp	Analyzer initializing	Wait for up to 20 minutes to allow the analyzer's oven to stabilize at the correct temperature
	Power supply under-voltage  	BEWARE OF ELECTRIC SHOCK / BURN HAZARD <ul style="list-style-type: none"> Remove the analyzer cover Measure the main inlet voltage If the measured voltage is 100...240 V AC (±10%) verify the mains power to the analyzer
	Faulty heater element  	BEWARE OF ELECTRIC SHOCK / BURN HAZARD <ul style="list-style-type: none"> Remove the analyzer cover Measure the resistance of the heater across J11 pins 10...11 If $8\Omega < \text{measured value} < 11\Omega$ replace the oven
	15 V supply faulty  	BEWARE OF ELECTRIC SHOCK / BURN HAZARD <ul style="list-style-type: none"> Remove the analyzer cover Measure voltage across J11 pin 11 to J12 pin 10 If $13\text{ V} < \text{measured value} < 15\text{ V}$ return the analyzer to Michell Instruments for further investigation
	Thermocouple short circuit  	BEWARE OF ELECTRIC SHOCK / BURN HAZARD <ul style="list-style-type: none"> Remove the analyzer cover Replace the MSRS Sensor Assembly Recalibrate instrument
	Gas flow exceeds limit	Reduce the gas sample flow to 2 l/hr ±1 l/hr
	Faulty analyzer	Return the analyzer to Michell Instruments for further investigation

Observation	Cause	Corrective Action
Display Indicates T/C Fault	Open circuit thermocouple 	BEWARE OF ELECTRIC SHOCK / BURN HAZARD <ul style="list-style-type: none"> Remove the analyzer cover Check for faulty wiring of sensor – repair as necessary Replace the MSRS / thermocouple sensor assembly Recalibrate instrument
	Broken thermocouple 	BEWARE OF ELECTRIC SHOCK / BURN HAZARD <ul style="list-style-type: none"> Remove the analyzer cover Replace the MSRS / thermocouple sensor assembly Recalibrate instrument
	Faulty analyzer	Return the analyzer to Michell Instruments for further investigation
Display Indicates Low Flow	Gas flow too low 	BEWARE OF ELECTRIC SHOCK / BURN HAZARD <ul style="list-style-type: none"> Remove the analyzer cover Measure voltage across J11 pin 11 to J12 pin 10 If 13 V < measured value < 15 V return the analyzer to Michell Instruments for further investigation
	Leak in gas sample path 	BEWARE OF ELECTRIC SHOCK / BURN HAZARD <ul style="list-style-type: none"> Remove the analyzer cover Ensure all gas fittings are tight If the problem persists return the analyzer to Michell Instruments for further investigation
	Faulty electronic flow meter	Return the analyzer to Michell Instruments for further investigation
	Faulty analyzer	Return the analyzer to Michell Instruments for further investigation
Display Indicates High Flow	Gas flow too high	<ul style="list-style-type: none"> Open the flow adjustment valve Close the bypass valve Adjust both valves to achieve a gas sample flow to 2 l/hr ± 1 l/hr
	Faulty electronic flow meter	Return the analyzer to Michell Instruments for sensor replacement
	Faulty analyzer	Return the analyzer to Michell Instruments for further investigation

Observation	Cause	Corrective Action
Display indicates Sensor Fault	Faulty wiring to sensor 	BEWARE OF ELECTRIC SHOCK / BURN HAZARD <ul style="list-style-type: none"> Remove the analyzer cover Check wiring from MSRS sensor assembly to J12 pin 1...3 Replace the MSRS / thermocouple sensor assembly
	Faulty sensor 	BEWARE OF ELECTRIC SHOCK / BURN HAZARD <ul style="list-style-type: none"> Remove the analyzer cover Replace the MSRS / thermocouple sensor assembly
	Faulty analyzer	Return the analyzer to Michell Instruments for further investigation
Display indicates Pressure Fault	Internal pressure sensor fault	Return the analyzer to Michell Instruments for further investigation
	No signal from external pressure sensor 	BEWARE OF ELECTRIC SHOCK / BURN HAZARD <ul style="list-style-type: none"> Remove the analyzer cover Check wiring to ensure 4...20 mA input signal is present J12 pin 9...10 Replace external sensor if problem persists
	No power to external pressure sensor	Check the power supply to external sensor
	Faulty analyzer	Return the analyzer to Michell Instruments for further investigation
Calibration gas measurement fault	Gas measures out of specification	Calibrate analyzer
	Calibration gas empty	Check calibration gas cylinder – replace if empty
	Faulty analyzer	Return the analyzer to Michell Instruments for further investigation
After calibration and during calibration gas verification O ₂ outside tolerance	Unstable measurement	Wait for measurement to stabilize
	Sensor gas path leak 	BEWARE OF ELECTRIC SHOCK / BURN HAZARD <ul style="list-style-type: none"> Remove the analyzer cover Ensure all gas fittings are tight If the problem persists return the analyzer to Michell Instruments for further investigation
	Faulty MSRS Sensor 	BEWARE OF ELECTRIC SHOCK / BURN HAZARD <ul style="list-style-type: none"> Remove the analyzer cover Replace the MSRS / thermocouple sensor assembly
	Faulty analyzer	Return the analyzer to Michell Instruments for further investigation

6 AVAILABLE OPTIONS

6.1 Auto Adjustment

6.1.1 Purpose

This function is used for the analyzer's auto adjust at a set time and at regular intervals set in hours or days. Solenoid valves connected to the D-Sub DA15 on the XZR400A2, and 8 pin connector on the XZR400A1 control any adjustment gas and control gas inputs. Additional contacts are used to launch the sequence.

6.1.2 Hardware configuration

Figure 49 specifies the commands to be performed for the analyzer's auto adjustment.

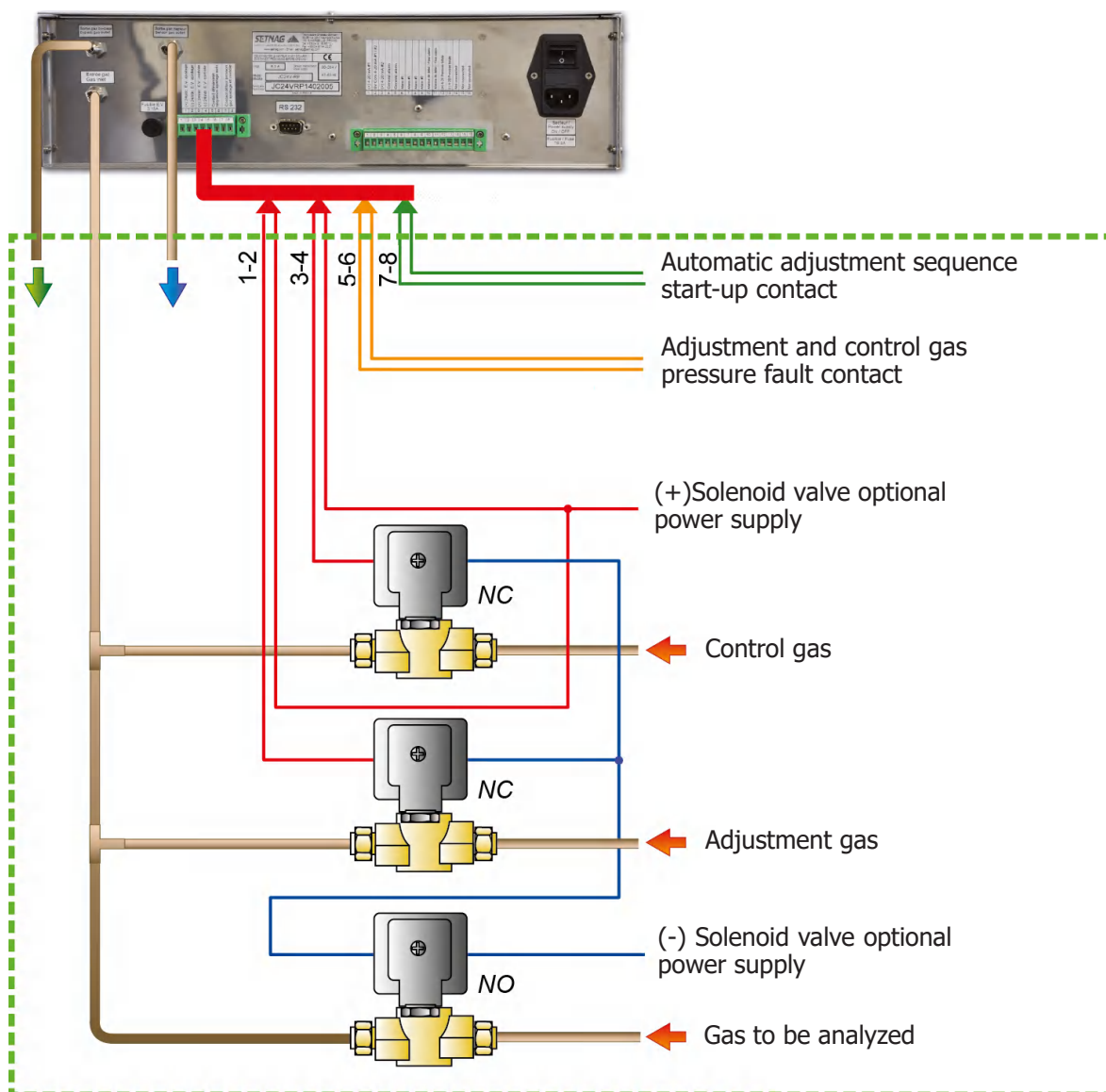

Supplied by customer

(*)NC: normally closed. NO: normally open.

Figure 46 Example of the required environment for the analyzer's auto adjustment

6.1.3 Parameter setting for auto adjust

The Auto Adjust Screen sets the array of parameters used for the analyzer's auto adjust.

- Touch the area to select it and change it.
- Enter the new numeric value on the virtual keypad.
- Click **OK** to confirm or **Cancel** to discard the changes.

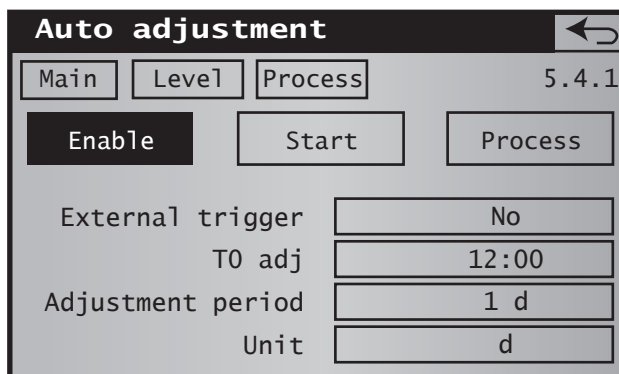
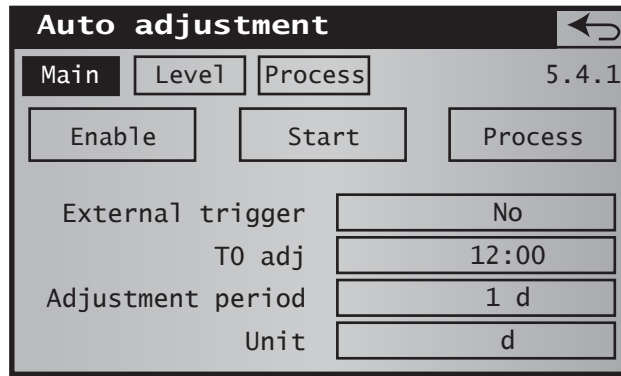

Figure 47 Auto Adjustment Screen

The three tabs, Main, Level and Process are described next.

6.1.4 Main Tab



Area	Function
Enable/Disable	Enables/disables the launch of the automatic adjustment.
Start	<p>Management of the start of the auto-adjust procedure.</p> <ul style="list-style-type: none"> Start: the auto adjust sequence is launched immediately, regardless of the other settings. T0 start: the auto-adjust sequence is launched at the time specified by the area T0 Adjust. <p>The interval is set by Adjustment period (see below).</p>
External trigger	<p>Management of an external launch control button (push-button or dry contact from an external PLC) controlling the launch of the auto adjust sequence (as opposed to the automatic launch of the Inter Start and Inter Adjust commands).</p> <ul style="list-style-type: none"> No: pressing the external button connected to terminals 5...6 of the D-Sub DA15 connector or the 8 pluggable pin connector will not allow the launch of the auto adjust sequence. Yes: pressing the external button connected to terminals 5...6 of the D-Sub DA15 connector or the 8 pluggable pin connector will allow the launch of the auto adjust sequence.
T0 adj	Sets the start time of the next auto-adjust.
Adjustment period	Adjustment interval Sets the time interval in hours or days between two auto-adjust sequences. See below.
Unit	d (day) or hr (hour) Defines the time unit of the Adjustment interval.

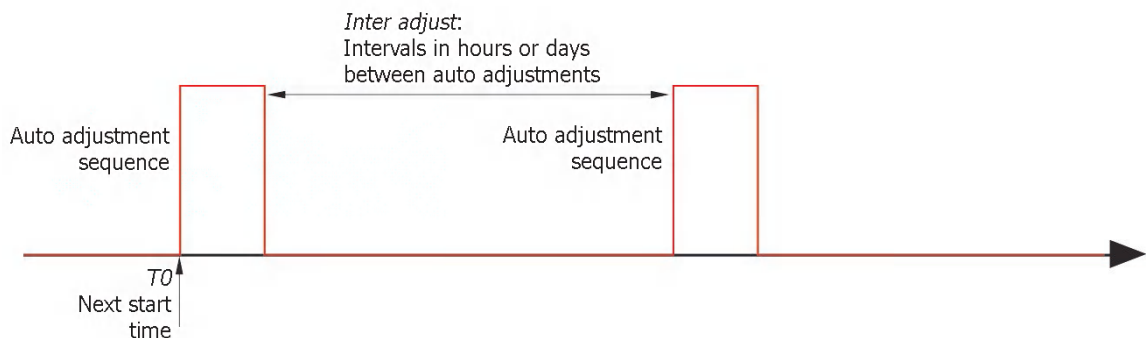

6.1.5 Level Tab

The Level tab of the Auto adjust screen defines the unit and the value of adjustment and control gases.

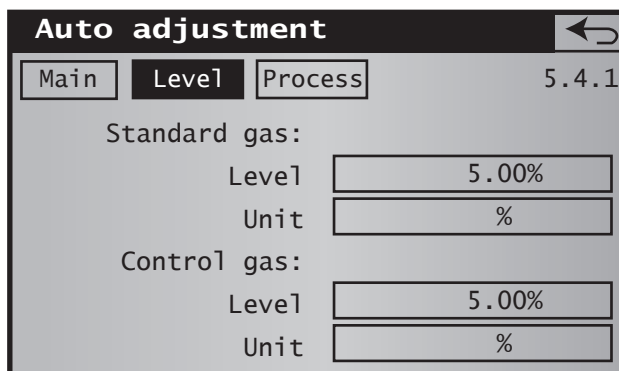

Area	Function
Standard gas	
Level	Defines the value of adjustment gas
Unit	Defines the unit of adjustment gas
Control gas	
Level	Defines the value of control gas
Unit	Defines the unit of control gas

6.1.6 Process Tab

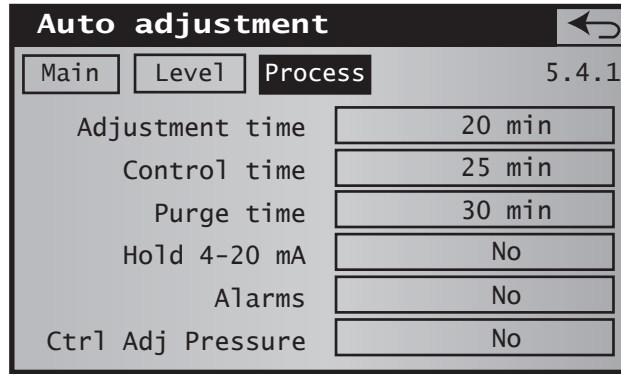

Area	Function
Adjustment time	Duration in minutes of the adjustment sequence.
Control time	Duration in minutes of the control sequence.
Purge time	Duration in minutes of purging.
Hold 4...20 mA	<p>Concerns the 4...20 mA analyzer outputs</p> <ul style="list-style-type: none"> No: 4...20 mA outputs will display the oxygen concentration during the adjusting sequence start until the purge end. Yes: 4...20 mA outputs are locked to the value measured before the adjustment sequence start until the end purge.
Alarms	<p>Concerns the analyzer general fault alarm as well as Alarms 1 and 2</p> <ul style="list-style-type: none"> No: alarms will remain operational during the adjust sequence start until the end of the purge. Yes: alarms will be disabled.
Ctrl Adj Pressure	<p>Gas adjustment and control gas bottle pressure checking</p> <ul style="list-style-type: none"> No: any pressure control on bottles of gas adjustment or gas control will be carried out. In case of fault in at least one of these bottles, the conformity of the adjustment or control cannot be guaranteed. Yes: the adjustment sequence or control will stop if any pressure fault is detected. The No adjusting message or Control not possible will be displayed. The previous adjustment will be retained.
	Returns to the Main Menu Screen.

6.1.7 Automatic Adjustment Usage

Launch	Action
Manual	If external trigger has been selected, touch the dedicated push-button (or launch via the contact controlled by the external PLC) to launch the auto adjust sequence immediately.
Immediately via the screen	Regardless of the configuration for alternative launch modes, touch the immediate start area to launch the auto adjust sequence immediately.
For defined date and interval	If adjustment period (time interval between adjustments) and T0 adj (start time for the next auto adjust) have been defined, the auto adjust sequence is launched automatically at the scheduled time (T0 adj) and resumes cyclically after the adjustment period. Example: interval adjustment 2h and T0 14h. If the operator pushes the Start area T0 at 17:00, self adjustment will be disabled until the next day to 14:00. It will then be started at 16:00, 18:00 and 20:00. To stop the automatic sequence, touch the Enable area.

6.2 Total Pressure Correction

This optional screen is used to adjust the low scale and the high scale of the external pressure sensor, which is connected to D-Sub DA15 for all versions, except for the XZR400A1 model, where the connection is carried out on the 8 pins connector. This sensor compensates the total pressure in the MSRS cell.

When the gas pressure at the analyzer output is greater than the atmospheric pressure sensor's upper limit (1,200 mbar), the total pressure adjustment is needed to guarantee optimum operation of the analyzer.

The input signal from the external pressure sensor is a 4...20 mA analog signal representing the output pressure of the analyzer. The signal enters the analyzer at terminals 11 and 12 of the D-Sub DA15 connector for all versions, except for the XZR400A1 model, where the connection is carried out on pins 12 and 13 of the screw terminal.

Defective wiring/electrical supply of the total pressure sensor, or no connection of the total pressure sensor's 4...20 mA signal to the analyzer, generates a general fault alarm and the display of a pressure fault message. This is not run if the sensor outputs a 0-5 V signal type.

In case of a pressure fault, the O₂ concentration will be displayed taking in account an atmospheric pressure of 1000mbar. If the pressure of the measured gas is not within a 1000mbar ±20mbar bracket, the O₂ concentration on the display will be off the relative 2% tolerance.

Pressure Correction Screen

- Touch the area to select it and change it.
- Enter any new numeric value on the virtual keypad.
- Click **OK** to confirm or **Cancel** to discard the changes.

6.2.1 Process Pressure Correction Input Connections

The 4...20 mA pressure transmitter signals should be connected to the DB15 socket on the rear panel of the analyzer.

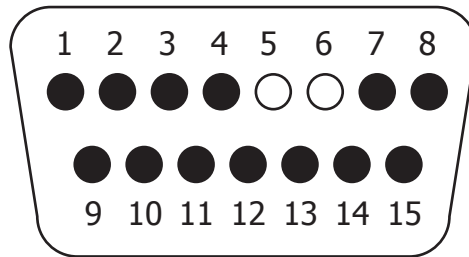

Contact No	Function
5	(+) 4...20 mA / analog input of process pressure
6	(+) 4...20 mA / analog input of process pressure

6.3 Digital Communications

6.3.1 RS232

Please refer to Appendix C, RS232 Serial Output, for information on the RS232 communications protocol.

Area	Function
Frame period	Sets the delay, in seconds, between two RS232 signal emissions, from 0 (no emission) to 999 seconds (one emission every about 16 minutes).
←	Returns to the Main Menu Screen.

6.3.2 RS485

Only available for analyzers equipped with this output.

Comm Screen

The COM RS485 screen sets the RS485 output parameters.

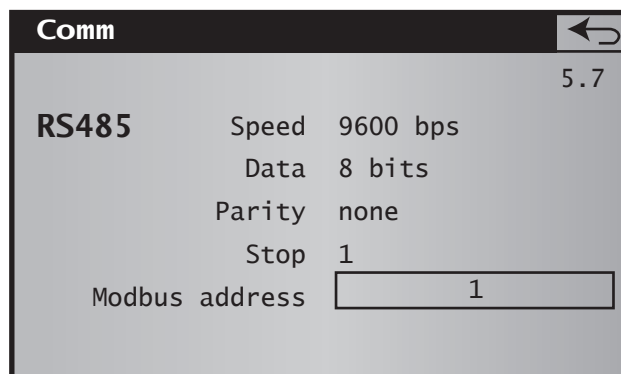

Figure 49 Comm Screen

Area	Function
RS485	Indications of the RS485 interface connection parameters that cannot be modified. <ul style="list-style-type: none"> • Speed: 9600 bauds • Number of bits • Parity: None • Stop: 1
Modbus address	The analyzer's Modbus slave address. Enter a value between 1 and 255, including terminals.

See Appendix B for the register maps.

6.4 XZR400A2 external pump options

The external pump can be supplied loose as per option (XZR400A2-J2) or fitted on a panel (XZR400A2-J3) as shown below.

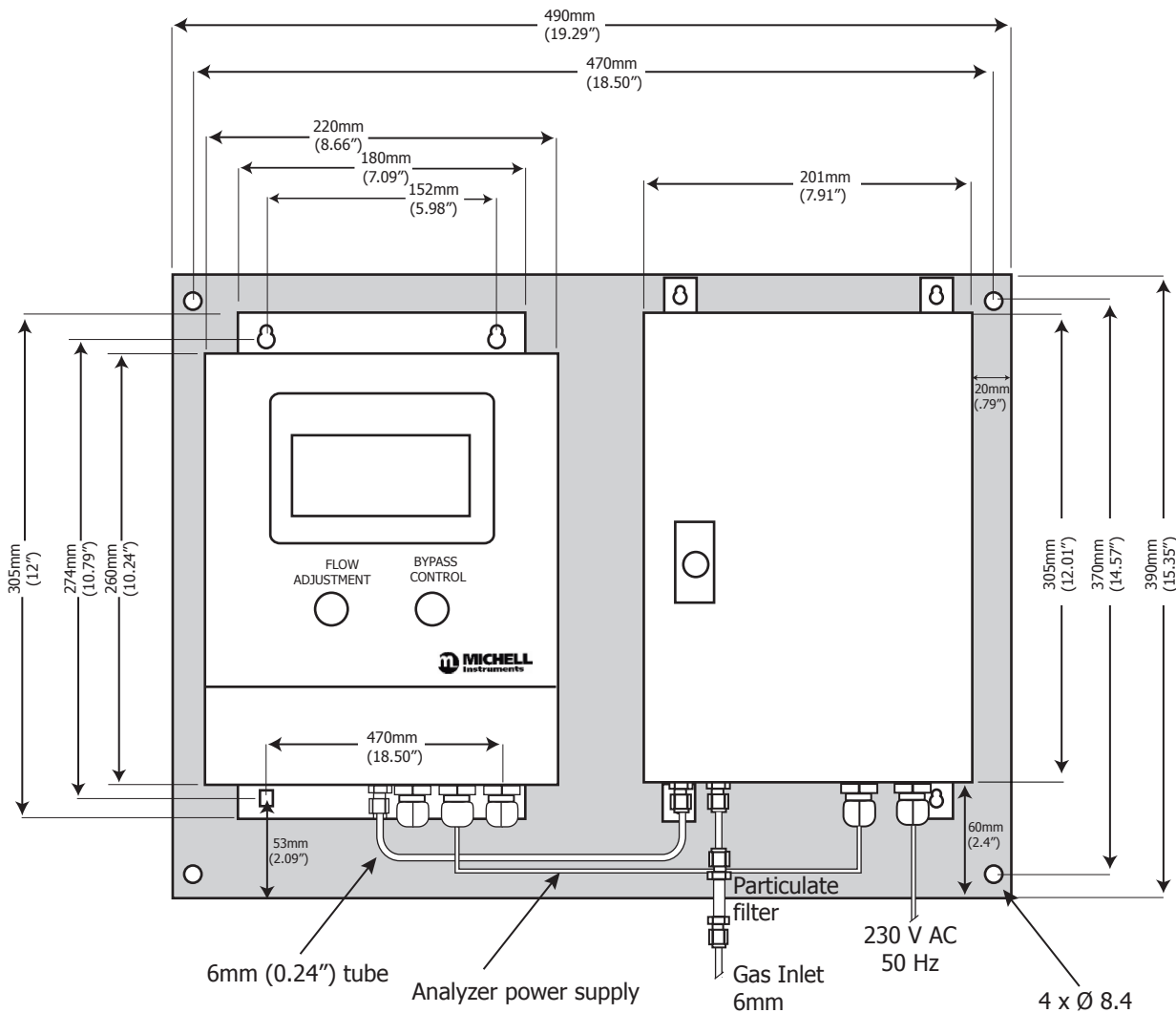

Figure 50 Dimensions for XZR400A2 – J3 Option

6.5 Extended Operating Range (0...100%)

This option should be requested at the time of order.

The default range is 0...25%.



WARNING: If an extended range is purchased ensure that the analyzer has been cleaned for oxygen service before use.

6.6 Flow Fault Contact

In normal conditions, the flow is between 0.5 l/h and 3.5 l/h, the contact is closed and potential free.

The relay switching capability is 150 W max (up to 5 A at 250 V AC or 5 A at 30 V DC).

6.6.1 Flow Fault Output Connections

Access to the flow fault contact is via the DB15 socket on the rear panel of the analyzer.

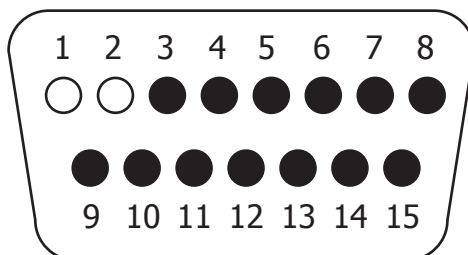

Contact No	Function
1	Flow fault contact
2	Flow fault contact

6.7 Commutable Scale (Auto-Ranging)

This option allows following the O₂ concentration:

- Between 0 and 10 ppm on the first 4...20 mA output
- Between 0 and 100ppm, 0 and 1000ppm, 10 and 10000ppm, or 0.01 and 25% on the second 4...20 mA output

The alarm contacts 1 and 2 indicate the beginning and the end of the scale used on the second 4...20 mA output.

Settings are indicated below:

4...20 mA output	Low Scale	Up Scale	Alarm 1 Contact Position	Alarm 2 Contact Position
No 1	0	10ppm		
No 2	0	100ppm	Open	Open
	0	1000ppm	Closed	Open
	10ppm	10000ppm	Open	Closed
	0.01%	25%	Closed	Closed

6.8 Optional Moisture Sensor

The XZR400 rack mount can be supplied with an Easidew moisture sensor fitted in the bypass leg to measure the moisture (dew point) of the sample. The sensor is capable of measuring dew point from -100 to +20 °C (-148 to +68 °F) dew point. If supplied with a moisture sensor, dew point will be displayed underneath the oxygen concentration as shown below.

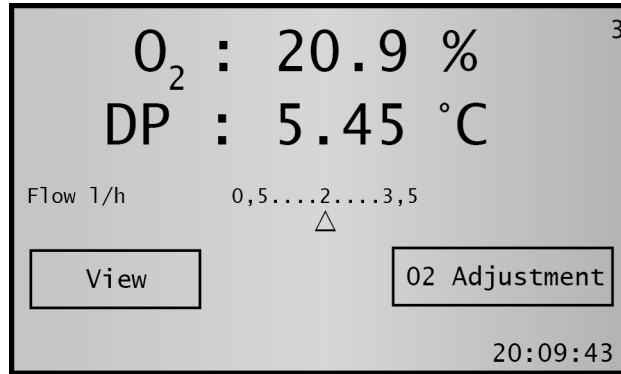

Figure 51 Main Page

In the control parameters page, the dew point is displayed to the right of the O₂ concentration as shown in Figure 56.

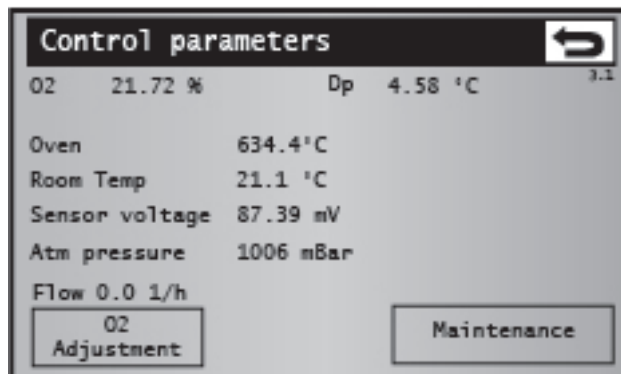

Figure 52 Control Parameters Page

In the main menu page, press the button labelled 'DP Sensor' to access the 4...20mA configuration.

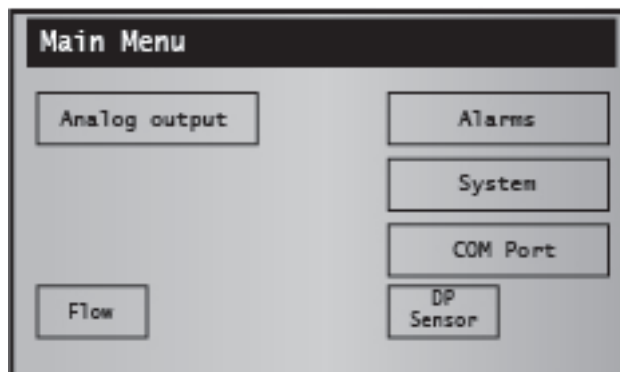

Figure 53 Main Menu

Even though the dew-point sensor located inside the analyzer, it is considered an external device by the firmware. In the DP Sensor page, you can configure the input range from the dew-point sensor by pressing the Start and/or End of scale buttons and adjusting in the normal way. Only adjust these settings if you have already altered the range of the Easidew transmitter.

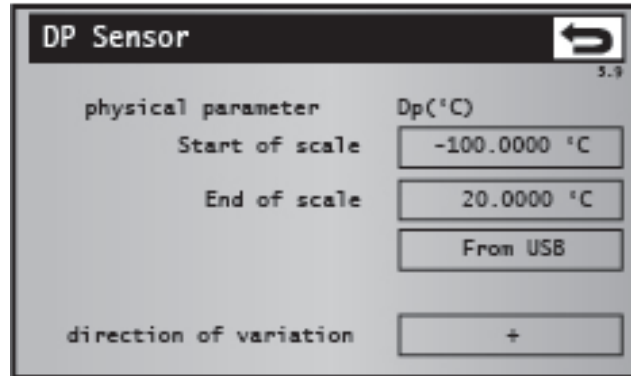

Figure 54 *DP Sensor Page*

NOTE: The analyzer will require a total flow of 60...300 NI/hour (1...5 NI/min) to ensure optimum response from the Easidew sensor.

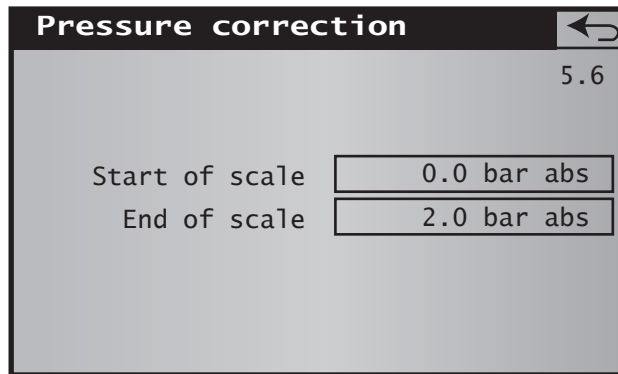

Figure 48 Pressure Correction Screen

Area	Function
Start of scale	Touch the area to enter the low scale pressure value of the external sensor.
End of scale	Touch the area to enter the high scale pressure value of the external sensor.
←	Returns to the Main Menu Screen.

Appendix A

Technical Specifications

Appendix A Technical Specifications

Sensor Type	
Measurement Principle	Zirconium Oxide Sensor with Metallic Sealed Reference and S Type thermocoupe
Performance	
Gas	Clean, dry, oil free with particles less than 3 µm
Measurement Range	0.01 ppm up to 25% O ₂ Extended ranges available up to 0...100% O ₂
Lowest detectable limit (LDL)	0.1ppm(v) O ₂
Accuracy (Intrinsic Error)	Less than 2% of reading
Response Time	< 5 seconds (with 60 l/hour through bypass)
Repeatability	±0.5% of reading
Stability	1% per month
Linearity	Better than ±1%
Drift	<1% of reading per week
Sample Flow Rate	1...3 NI/h to sensor and up to 300 NI/hour through bypass with built-in fast loop
Maximum Sample Pressure	2 barg (29 psig)
Maximum Sample Temperature	100 °C (212 °F)
Atmospheric Pressure Compensation	Built-in as standard
Optional sensor	
Moisture sensor	Easidew sensor can be fitted as an option in the rack mount model only. Please see separate datasheet for full specifications.
Measurement range	-100...+20 °C (-148...+68 °F)
Sample Flow rate	60...300 NI/hour
Outputs	
Analog Output	0, 1 or 2 off 0/4...20 mA Linear with Galvanic Isolation output
Digital Communications Output	Modbus RTU over RS485 protocol (Standard on XZR400A1) RS232 output (optional)
Output Load	Over 1,000 Ω
Self-Diagnostics	Via HMI
Output Ranges	0.0 ppm...1ppm up to 0...25% O ₂ Extended ranges available up to 0...100% O ₂
Alarms	2 threshold alarms, freely configurable 1 general fault alarm including flow alarm 1 flow alarm (optional)
Display Resolution	0.01 ppm between 0.01 ppm and 10 ppm 0.1 ppm between 10 ppm and 10,000 ppm 0.01% between 1 and 10% 0.1% between 10 and 100%
Power Supply	100...240 V AC ±10%; 50...60 Hz ±5%
Power Consumption	50 VA

Operating Conditions				
Ambient Temperature Range	0...55 °C (32...131 °F)			
Sensor Temperature	Optimized at 634 °C			
Operating Humidity	5...90% rh without condensation			
Mechanical Specification				
Model	Dimensions	Weight	Gas Connectors	Ingress Protection
Rack mount	19", 3U, 482.5 x 133 x 371.5 mm (19 x 5.24 x 14.63")	10 kg (22.05 lb)	1/8"	IP20
Wall mount	200 x 220 x 290 mm (7.87 x 8.66 x 11.42")	5 kg (11 lb)	6 mm	IP40
Bench mount	290 x 260 x 236 mm (11.42 x 10.24 x 9.29")	5.2 kg (11.46 lb)	6 mm	IP20
Sample Gas Connections	All gas connections are Swagelok (MALE) Fittings (316 SS)			

Appendix B

Modbus (RTU) over RS485

Appendix B Modbus (RTU) over RS485

B.1 Port Configuration

- Speed: 9600 bauds
- No parity
- 8 bits
- 1 stop
- No handshaking

B.2 Hardware Configuration

16-way terminal block connections

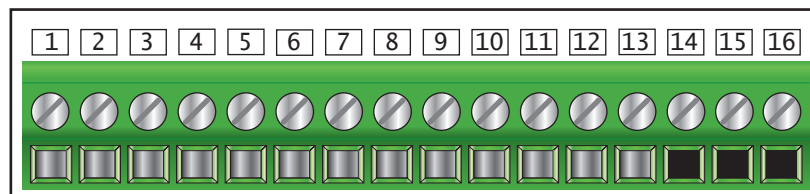

- pin 14 RS485 B – Data (-)
- pin 15 RS485 A – Data (+)
- pin 16 RS485 0 V

B.3 Exception handling

Error No.	Exception
1	Unrecognized function
2	Modbus address error (non-allowed zone)
3	Register quantity error or invalid data

B.4 Composition of the STATUS word

Composition of the STATUS word at address \$118.

N° bit	Signification
0	1= Adjustment refusal
1	0=GB, 1=FR
2	1=DE
4	1=active alarms during manual adjustment
5	1= 4...20mA locking during manual adjustment
6	1=active alarms during auto adjust
7	1= 4...20mA locking during auto adjust
8	1=auto adjust option enabled
9	External pressure control
10	External adjustment command authorized by TOR contact
12	Pump status
16	1= second 4...20mA output option present
17	1= Auto adjust option present
20	1= external total pressure measurement option
21	1= Flow alarm option present
22	1= pump present
23	0= RS232 option not present
24	1= RS485 option present
25	1= reverse blow function present
26	1= atmospheric pressure sensor present

B.5 Modbus Register Map

Action	@Modbus (hex, dec)	Function Modbus	Access	Size (bits)	Type	Function, action
Visu						
O ₂ Measurement	\$100, 256	3.4	R	32	Real 32-bit	Analyser oxygen measurement in ppm
Oven Temperature	\$104, 260	3.4	R	32	Real 32-bit	Oven temperature
Ambient Temperature	\$108, 264	3.4	R	32	Real 32-bit	Ambient temperature
MSRS Sensor Voltage	\$10C, 268	3.4	R	32	Real 32-bit	Voltage read at the MSRS terminals
Atmospheric Pressure	\$110, 272	3.4	R	32	Real 32-bit	Sensor measurement reading of atmospheric pressure
Flow	\$114, 276	3.4	R	32	Real 32-bit	Flow measurement reading
ADJUSTMENT						
Adjustment Gas	\$120, 288	3.4	R	32	Real 32-bit	Adjustment gas value in ppm
Control Gas	\$124, 292	3.4	R	32	Real 32-bit	Control gas value in ppm
Adjustment Gas Duration	\$128, 296	3.4	R	16	Unsigned	Adjustment gas conduction in minutes
Control Gas Duration	\$12A, 298	3.4	R	16	Unsigned	Control gas conduction in minutes
Purge Duration	\$12C, 300	3.4	R	16	Unsigned	Purge duration in minutes
System						
Temperature set point Oven	\$160, 352	3.4	R	32	Real 32-bit	Oven temperature setpoint value in °C
ANALOG OUTPUT 1						
Lin or Log type	\$150, 336	[1]	R	[1]	Bit	Type of Analog output No. 1 (0= Lin, 1=Log)
Low scale	\$130, 304	3.4	R	32	Real 32-bit	Low scale for output 1, in ppm
High scale	\$134, 308	3.4	R	32	Real 32-bit	High scale for output 1, in ppm
ANALOG OUTPUT 2						
Lin or Log type	\$151, 337	[1]	R	[1]	Bit	Type of Analog output No. 2 (0= Lin, 1=Log)
Low scale	\$138, 312	3.4	R	32	Real 32-bit	Low scale for output 2, in ppm
High scale	\$13C, 315	3.4	R	32	Real 32-bit	High scale for output 2, in ppm
ALARM OUTPUT 1						
Alarm mode	\$152, 338	[1]	R	[1]	Bit	Alarm #1 mode (0=low, 1=high)
Threshold	\$140, 320	3.4	R	32	Real 32-bit	Alarm #1 threshold, in ppm
ALARM OUTPUT 2						
Alarm mode	\$153, 339	[1]	R	[1]	Bit	Alarm #2 mode (0=low, 1=high)
Threshold	\$144, 324	3.4	R	32	Real 32-bit	Alarm #2 threshold, in ppm
Miscellaneous						
Status	\$118, 280	3.4	R	32	Unsigned	Device status word reading
Software version	\$11C, 284	3.4	R	16	Unsigned	Programme software version number (eg: 301 for v3.01)
Modbus slave address				8	Unsigned	Modbus slave address from 1...255

Appendix C

RS232 Serial Output

Appendix C RS232 Serial Output

C.1 Port Configuration

- Speed: 9600 bauds
- No parity
- 8 bits
- 1 stop
- No handshaking

C.2 Hardware Configuration

The wiring cable should be equipped with 1 DB9 female plug and bare wire connectors and connected as follows:

DB9	16 way terminal block
pin 2	pin 15 Tx
pin 3	pin 14 Rx
pin 5	pin 16 Ground
strap 7...8 (on same connector)	

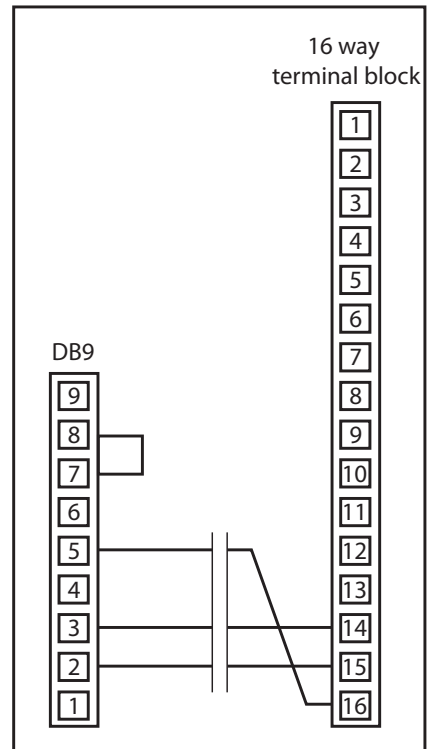

C.3 RS232 Command List

Mnemonic	ASCII Value	
_OXY↵	O ₂ concentration	XX.XX or X.XXE±XX
_TEM↵	Oven temperature	XXX.XX
_UMV↵	MSRS voltage	XXX.XX
_AMB↵	Ambient temperature	XX.XX
_ALR↵	K1, K2, K3 Relay status K1 +K2 +K3 = from 0 to 7 (1) (2) (4)	X
_CAL↵	Sets self calibration after 10 minutes bleed	RECEIPT PURGE?
_FIN↵	Sets a 5 minute bleed in case of failure in calibration	RECEIPT DEFAULT
_ACQ↵	Acknowledges the alarms	RECEIPT
_ETA↵	Display of calibration gas value	XX.XX
E_ETA_X.XX↵	Set of calibration gas value	X.XX
_STP↵	Display of oven temperature set point	XXX.XX
E_STP_XXX.XX↵	Set of oven temperature	XXX.XX
_AL1↵	Display of first alarm level	XXX.XX
E_AL1↵	Set of first alarm level	XX.XX
_AL2↵	Display of second alarm level	XXX.XX
E_AL2↵	Set of second alarm level	XX.XX
_NET↵	Starts self cleaning	RECEIPT
_YYY↵	Unknown entry	ERROR
_TCA↵	Measured oven temperature + coef. due to adjustment	XX.XX
_BRK↵	Allows for: Ending the bleed during calibration Ending self cleaning and start cooling down	XX.XX
_PAB↵	Value of atmospheric pressure	XXXX.XX

_ indication corresponds to the space bar
↵ indication corresponds to the return key

Table 2 RS232 Commands

C.4 RS232 Periodic Output

The XZR400 will periodically emit a message containing the following information; each data type is separated by a semicolon. The period can be set via the RS232 menu on the HMI.

- Date (DD/MM/YYYY)
- Time (hr:min:sec)
- Sensor voltage (mV)
- Oxygen concentration (ppm)
- Ambient temperature (°C)
- Oven temperature (°C)
- Atmospheric or process pressure (mBar)
- Gas sample flow (L/h)
- Easidew / SF Dew-Point Transmitter Reading (if fitted) (°C)
- Fault

Appendix D

Quality, Recycling & Warranty Information

Appendix D Quality, Recycling & Warranty Information

Michell Instruments is dedicated to complying to all relevant legislation and directives. Full information can be found on our website at:

www.michell.com/compliance

This page contains information on the following directives:

- Anti-Facilitation of Tax Evasion Policy
- ATEX Directive
- Calibration Facilities
- Conflict Minerals
- FCC Statement
- Manufacturing Quality
- Modern Slavery Statement
- Pressure Equipment Directive
- REACH
- RoHS3
- WEEE2
- Recycling Policy
- Warranty and Returns

Appendix E

Analyzer Return Document & Decontamination Declaration

Appendix E Analyzer Return Document & Decontamination Declaration

Decontamination Certificate

IMPORTANT NOTE: Please complete this form prior to this instrument, or any components, leaving your site and being returned to us, or, where applicable, prior to any work being carried out by a Michell engineer at your site.

Instrument			Serial Number	
Warranty Repair?	YES	NO	Original PO #	
Company Name			Contact Name	
Address				
Telephone #			E-mail address	
Reason for Return /Description of Fault:				
Has this equipment been exposed (internally or externally) to any of the following? Please circle (YES/NO) as applicable and provide details below				
Biohazards			YES	NO
Biological agents			YES	NO
Hazardous chemicals			YES	NO
Radioactive substances			YES	NO
Other hazards			YES	NO
Please provide details of any hazardous materials used with this equipment as indicated above (use continuation sheet if necessary)				
Your method of cleaning/decontamination				
Has the equipment been cleaned and decontaminated?			YES	NOT NECESSARY
Michell Instruments will not accept instruments that have been exposed to toxins, radio-activity or bio-hazardous materials. For most applications involving solvents, acidic, basic, flammable or toxic gases a simple purge with dry gas (dew point <-30°C) over 24 hours should be sufficient to decontaminate the unit prior to return. Work will not be carried out on any unit that does not have a completed decontamination declaration.				
Decontamination Declaration				
I declare that the information above is true and complete to the best of my knowledge, and it is safe for Michell personnel to service or repair the returned instrument.				
Name (Print)			Position	
Signature			Date	



F0121, Issue 2, December 2011

NOTES

www.ProcessSensing.com



<http://www.michell.com>