

For the electronic measurement of current: DC, AC, pulsed..., with galvanic separation between the primary and the secondary circuit.

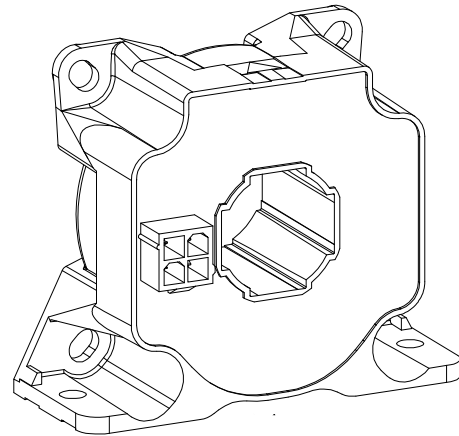

## Features

- Bipolar and insulated current measurement up to 500 A
- Current output
- Closed loop (compensated) current transducer
- Panel mounting.

## Special feature

- Connection to secondary circuit on MOLEX Mini-Fit Jr 5566 connector (gold plated).

## Advantages

- High accuracy
- Very low offset drift over temperature.

## Applications

- Windmill inverters
- Test and measurement
- Substations
- AC variable speed and servo motor drives
- Statics converters for DC motors drives
- Battery supplied applications
- Uninterruptible Power Supplies (UPS)
- Switched Mode Power Supplies (SMPS)
- Power supplies for welding applications.

## Standards

- EN 50178: 1997
- IEC 61010-1: 2010
- UL 508: 2010.

## Application Domain

- Industrial.

**Absolute maximum ratings**

Parameter	Symbol	Unit	Value
Maximum supply voltage (working) (-40 ... 85 °C)	$\pm U_C$	V	$\pm 21$
Primary conductor temperature	$T_B$	°C	100
Maximum steady state primary current (-40 ... 85 °C)	$I_{PN}$	A	300

Stresses above these ratings may cause permanent damage.  
Exposure to absolute maximum ratings for extended periods may degrade reliability.

**UL 508: Ratings and assumptions of certification**

File # E189713 Volume: 2 Section: 9

**Standards**

- USR indicates investigation to the Standard for Industrial Control Equipment UL 508.
- CNR indicates investigation to the Canadian standard for Industrial Control Equipment CSA C22.2 No. 14-13

**Conditions of acceptability**

When installed in the end-use equipment, with primary feedthrough potential involved of 600 V AC/DC, consideration shall be given to the following:

- 1 - *These products must be mounted in a suitable end-use enclosure.*
- 2 - *The secondary pin terminals have not been evaluated for field wiring.*
- 3 - *Low voltage control circuit shall be supplied by an isolating source (such as transformer, optical isolator, limiting impedance or electro-mechanical relay).*
- 4 - *Based on the temperature test performed on all Series, the primary bar or conductor shall not exceed 100 °C in the end use application.*

**Marking**

Only those products bearing the UL or UR Mark should be considered to be Listed or Recognized and covered under UL's Follow-Up Service. Always look for the Mark on the product.

**Insulation coordination**

Parameter	Symbol	Unit	Value	Comment
Rms voltage for AC insulation test, 50 Hz, 1 min	$U_d$	kV	3.8	
Impulse withstand voltage 1.2/50 $\mu$ s	$\hat{U}_w$	kV	10	
Insulation resistance	$R_{IS}$	M $\Omega$	1000	measured at 3.8 kV AC
Comparative tracking index	$CTI$		600	
Application example			300 V CAT III, PD2	Reinforced insulation, non uniform field according to EN 50178, IEC 61010
Application example			1000 V CAT III, PD2	Basic insulation, non uniform field according to EN 50178, IEC 61010
Case material	-	-	V0 according to UL 94	
Clearance and creepage	See dimensions drawing on page 7			

**Environmental and mechanical characteristics**

Parameter	Symbol	Unit	Min	Typ	Max	Comment
Ambient operating temperature	$T_A$	$^{\circ}$ C	-40		85	
Ambient storage temperature	$T_s$	$^{\circ}$ C	-50		90	
Mass	$m$	g		107		

## Electrical data

At  $T_A = 25\text{ °C}$ ,  $\pm U_C = \pm 15\text{ V}$ ,  $R_M = 1\ \Omega$ , unless otherwise noted.

Lines with a \* in the conditions column apply over the  $-40 \dots 85\text{ °C}$  ambient temperature range.

Parameter	Symbol	Unit	Min	Typ	Max	Conditions
Primary nominal rms current	$I_{PN}$	A			300	*
Primary current, measuring range	$I_{PM}$	A	-500		500	*
Measuring resistance	$R_M$	$\Omega$	0			* Max value of $R_M$ is given in figure 1
Secondary nominal rms current	$I_{SN}$	A	-0.15		0.15	*
Resistance of secondary winding	$R_S$	$\Omega$			22.5	$R_S(T_A) = R_S \times (1 + 0.004 \times (T_A + \Delta\text{temp} - 25))$ Estimated temperature increase @ $I_{PN}$ is $\Delta\text{temp} = 15\text{ °C}$
Secondary current	$I_S$	A	-0.25		0.25	*
Number of secondary turns	$N_S$			2000		
Theoretical sensitivity	$G_{th}$	mA/A		0.5		
Supply voltage	$\pm U_C$	V	$\pm 11.4$		$\pm 21$	*
Current consumption	$I_C$	mA		$33 + I_S$ $35 + I_S$ $38 + I_S$		$\pm U_C = \pm 12\text{ V}$ $\pm U_C = \pm 15\text{ V}$ $\pm U_C = \pm 20\text{ V}$
Offset current, referred to primary	$I_O$	A	-0.2		0.2	
Temperature variation of $I_O$ , referred to primary	$I_{OT}$	A	-0.2		0.2	*
Magnetic offset current, referred to primary	$I_{OM}$	A		$\pm 0.2$		After $3 \times I_{PN}$
Sensitivity error	$\epsilon_G$	%	-0.1		0.1	*
Linearity error	$\epsilon_L$	% of $I_{PN}$	-0.05		0.05	*
Overall accuracy at $I_{PN}$	$X_G$	% of $I_{PN}$	-0.2 -0.2		0.2 0.2	* 25 ... 85 °C -40 ... 85 °C
Output rms noise current referred to primary	$I_{no}$	mA		35		1 Hz to 100 kHz (see figure 4)
Reaction time @ 10 % of $I_{PN}$	$t_{ra}$	$\mu\text{s}$		0.5		0 to 300 A, 100 A/ $\mu\text{s}$ $R_M = 10\ \Omega$
Step response time to 90 % of $I_{PN}$	$t_r$	$\mu\text{s}$		0.5		0 to 300 A, 100 A/ $\mu\text{s}$ $R_M = 10\ \Omega$ (see figure 2)
Frequency bandwidth	$BW$	kHz		100		$R_M = 50\ \Omega$ ; -3 dB

## Definition of typical, minimum and maximum values

Minimum and maximum values for specified limiting and safety conditions have to be understood as such as well as values shown in "typical" graphs.

On the other hand, measured values are part of a statistical distribution that can be specified by an interval with upper and lower limits and a probability for measured values to lie within this interval.

Unless otherwise stated (e.g. "100 % tested"), the LEM definition for such intervals designated with "min" and "max" is that the probability for values of samples to lie in this interval is 99.73 %.

For a normal (Gaussian) distribution, this corresponds to an interval between -3 sigma and +3 sigma. If "typical" values are not obviously mean or average values, those values are defined to delimit intervals with a probability of 68.27 %, corresponding to an interval between -sigma and +sigma for a normal distribution.

Typical, minimum and maximum values are determined during the initial characterization of the product.

Typical performance characteristics

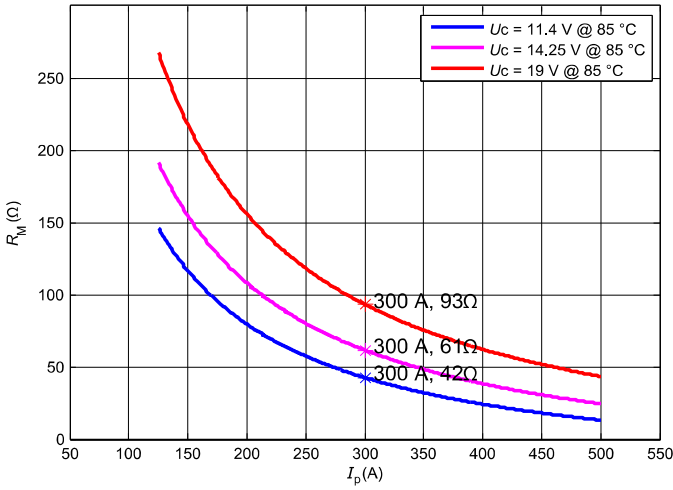

Figure 1: Maximum measuring resistance

$$R_{M \max} = N_s \times \frac{U_{C \min} - 0.3 \text{ V}}{I_p} - R_{S \max} - 2.4 \Omega$$

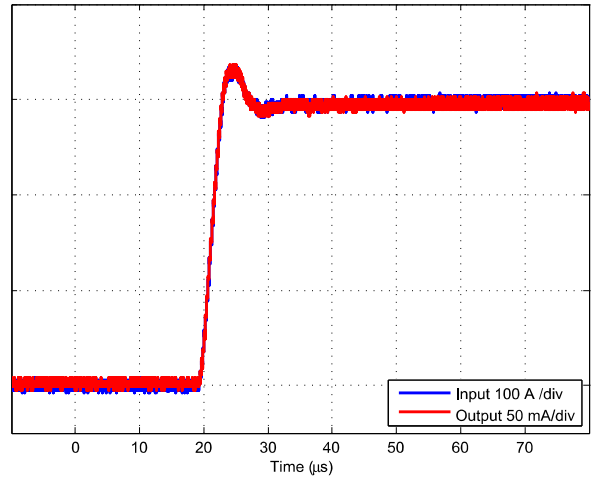

Figure 2: Typical step response (0 to 300 A, 100 A/μs  $R_M = 10 \Omega$ )

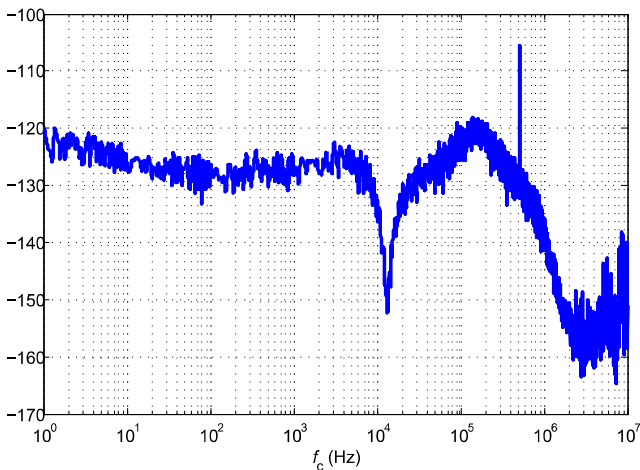

Figure 3: Typical noise voltage density  $e_{no}$  with  $R_M = 10 \Omega$

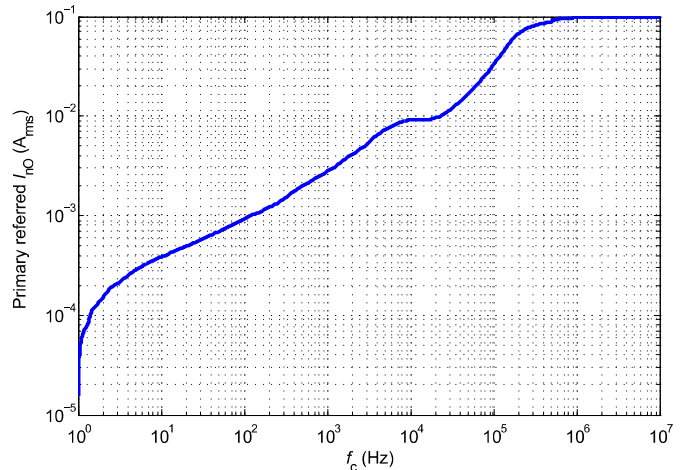

Figure 4: Typical total output current noise with (primary referred, rms) with  $R_M = 10 \Omega$

To calculate the noise in a frequency band  $f_1$  to  $f_2$ , the formula is:

$$I_{no}(f_1 \dots f_2) = \sqrt{I_{no}(f_2)^2 - I_{no}(f_1)^2}$$

with  $I_{no}(f)$  read from figure 4 (typical, rms value).

Example:

What is the noise from  $10^3$  to  $10^6$  Hz?

Figure 4 gives  $I_{no}(10^3 \text{ Hz}) = 3.19 \text{ mA}$  and  $I_{no}(10^6 \text{ Hz}) = 84.4 \text{ mA}$ .

The output current noise (rms) is therefore:

$$\sqrt{(84.4 \times 10^{-3})^2 - (3.19 \times 10^{-3})^2} = 84.34 \text{ mA referred to primary}$$

### Typical performance characteristics

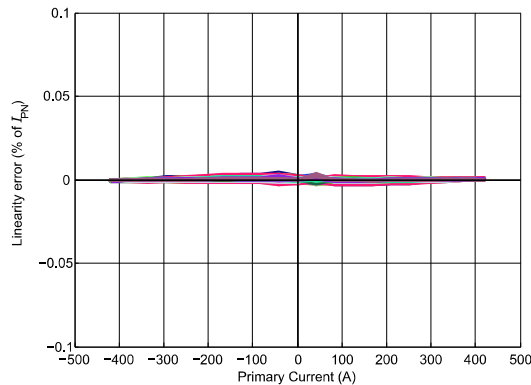

Figure 5: Linearity

### Performance parameters definition

#### Sensitivity and linearity

To measure sensitivity and linearity, the primary current (DC) is cycled from 0 to  $I_{PM}$ , then to  $-I_{PM}$  and back to 0 (equally spaced  $I_{PM}/10$  steps).

The sensitivity  $G$  is defined as the slope of the linear regression line for a cycle between  $\pm I_{PM}$ .

The linearity error  $\epsilon_L$  is the maximum positive or negative difference between the measured points and the linear regression line, expressed in % of the maximum measured value.

#### Magnetic offset

The magnetic offset  $I_{OM}$  is the change of offset after a given current has been applied to the input. It is included in the linearity error as long as the transducer remains in its measuring range.

#### Electrical offset

The electrical offset current  $I_{OE}$  is the residual output current when the input current is zero.

#### Overall accuracy

The overall accuracy  $X_G$  is the error at  $\pm I_{PN}$ , relative to the rated value  $I_{PN}$ . It includes all errors mentioned above.

#### Response and reaction times

The response time  $t_r$  and the reaction time  $t_{ra}$  are shown in the next figure.

Both slightly depend on the primary current  $di/dt$ . They are measured at nominal current.

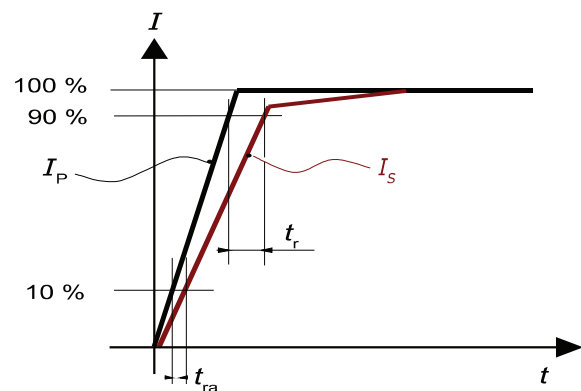
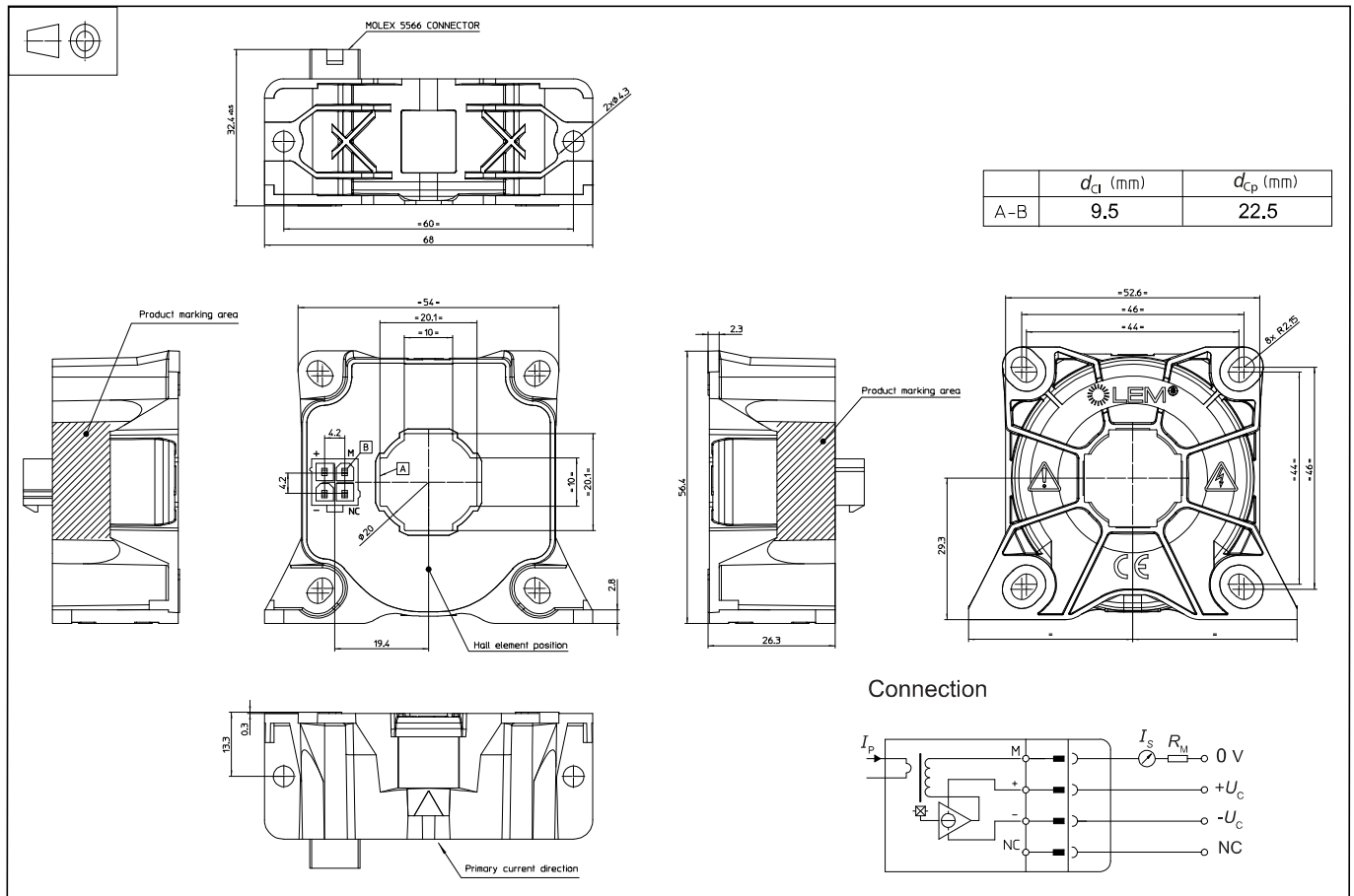

Figure 6: Response time  $t_r$  and reaction time  $t_{ra}$

**Dimensions (in mm)**

**Mechanical characteristics**

- General tolerance  $\pm 0.3$  mm
- Transducer fastening  
Vertical position  
2 holes  $\varnothing 4.3$  mm  
2 M4 steel screws  
Recommended fastening torque 2.1 N·m ( $\pm 10$  %)
- Transducer fastening  
Horizontal position  
4 holes  $\varnothing 4.3$  mm  
4 M4 steel screws  
Recommended fastening torque 2.1 N·m ( $\pm 10$  %)
- Connection of secondary  
MOLEX Mini-Fit Jr 5566
- Primary through hole  $\varnothing 20$  mm

**Remarks**

- $I_S$  is positive when  $I_P$  flows in the direction of arrow.
- The secondary cables also have to be routed together all the way.
- Installation of the transducer is to be done without primary current or secondary voltage present.
- Maximum temperature of primary conductor: see page 2.
- Installation of the transducer must be done unless otherwise specified on the datasheet, according to LEM Transducer Generic Mounting Rules. Please refer to LEM document N°ANE120504 available on our Web site: [Products/Product Documentation](#).

**Safety**

This transducer must be used in limited-energy secondary circuits according to IEC 61010-1.



This transducer must be used in electric/electronic equipment with respect to applicable standards and safety requirements in accordance with the manufacturer's operating instructions.



Caution, risk of electrical shock

When operating the transducer, certain parts of the module can carry hazardous voltage (eg. primary connection, power supply).

Ignoring this warning can lead to injury and/or cause serious damage.

This transducer is a build-in device, whose conducting parts must be inaccessible after installation.

A protective housing or additional shield could be used.

Main supply must be able to be disconnected.