



THERMAL CONDUCTIVITY  
AND THERMAL DIFFUSIVITY

**New Castle, DE USA**

**Lindon, UT USA**

**Hüllhorst, Germany**

Shanghai, China

Beijing, China

Tokyo, Japan

Seoul, South Korea

Taipei, Taiwan

Bangalore, India

Sydney, Australia

Guangzhou, China

Eschborn, Germany

Wetzlar, Germany

Brussels, Belgium

Ettten-Leur, Netherlands

Paris, France

Elstree, United Kingdom

Barcelona, Spain

Milano, Italy

Warsaw, Poland

Prague, Czech Republic

Sollentuna, Sweden

Copenhagen, Denmark

Chicago, IL USA

São Paulo, Brazil

Mexico City, Mexico

Montreal, Canada





## thermal conductivity and thermal diffusivity

Thermal conductivity, thermal diffusivity and specific heat capacity define a material's ability to store and transfer heat. Thorough understanding of these properties is critical for any process or material which experiences a large or fast temperature gradient, or for which the tolerance for temperature change is exacting. Accurate values of these properties are essential for modeling and managing heat, whether the component of interest is called on to insulate, conduct, or simply withstand temperature changes. Information about these properties is routinely used in heat transfer models of all complexities. Heat transfer property measurements also reflect important information about material composition, purity and structure, as well as secondary performance characteristics such as tolerance to thermal shock.

TA Instruments provides a full range of instruments for the precise and accurate measurement of heat transfer properties of a wide range of material types and temperatures. The Discovery Thermal Conductivity Heat Flow Meters provide direct measurement of thermal conductivity of low to medium conductivity materials according to ASTM E1530. The Discovery Flash Diffusivity instruments measure thermal diffusivity and specific heat capacity according to the Light or Laser Flash Method, which is ideal for moderate to high conductivity materials over the widest range of temperatures. Unique source and detector technology makes the Discovery Flash Diffusivity the most accurate platform for measurements by the Flash Method.

# thermal diffusivity

## BY THE FLASH METHOD

Thermal diffusivity is the thermophysical property that defines the speed of heat propagation by conduction during changes of temperature. The higher the thermal diffusivity, the faster the heat propagation. The thermal diffusivity is related to the thermal conductivity, specific heat capacity and density.

The most effective method used for measuring thermal diffusivity is the flash method. This transient technique features short measurement times, is completely non-destructive, and provides values with excellent accuracy and reproducibility. The flash method involves uniform irradiation of a small, disc-shaped specimen over its front face with a very short pulse of energy.

The time-temperature history of the rear face of the sample is recorded through high-speed data acquisition from an optical sensor with very fast thermal response. Based on this time-dependent thermogram of the rear face, the sample's thermal diffusivity is determined from the thickness ( $L$ ) of the sample and the time the thermogram takes to reach half of the maximal temperature increase ( $t_{1/2}$ ).

Thermal Conductivity

$$\text{Thermal Diffusivity } \alpha = \frac{\lambda}{\rho C_p}$$

Density      Specific Heat Capacity

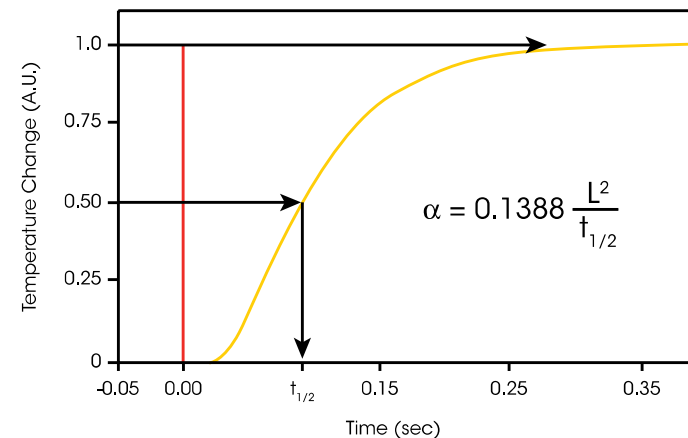
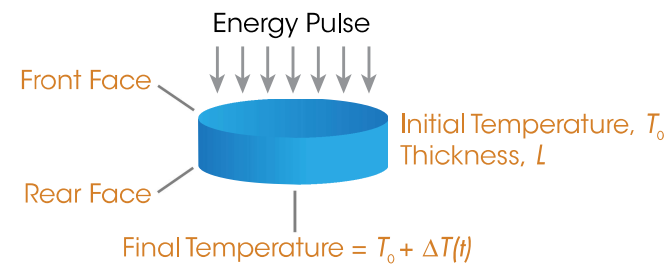

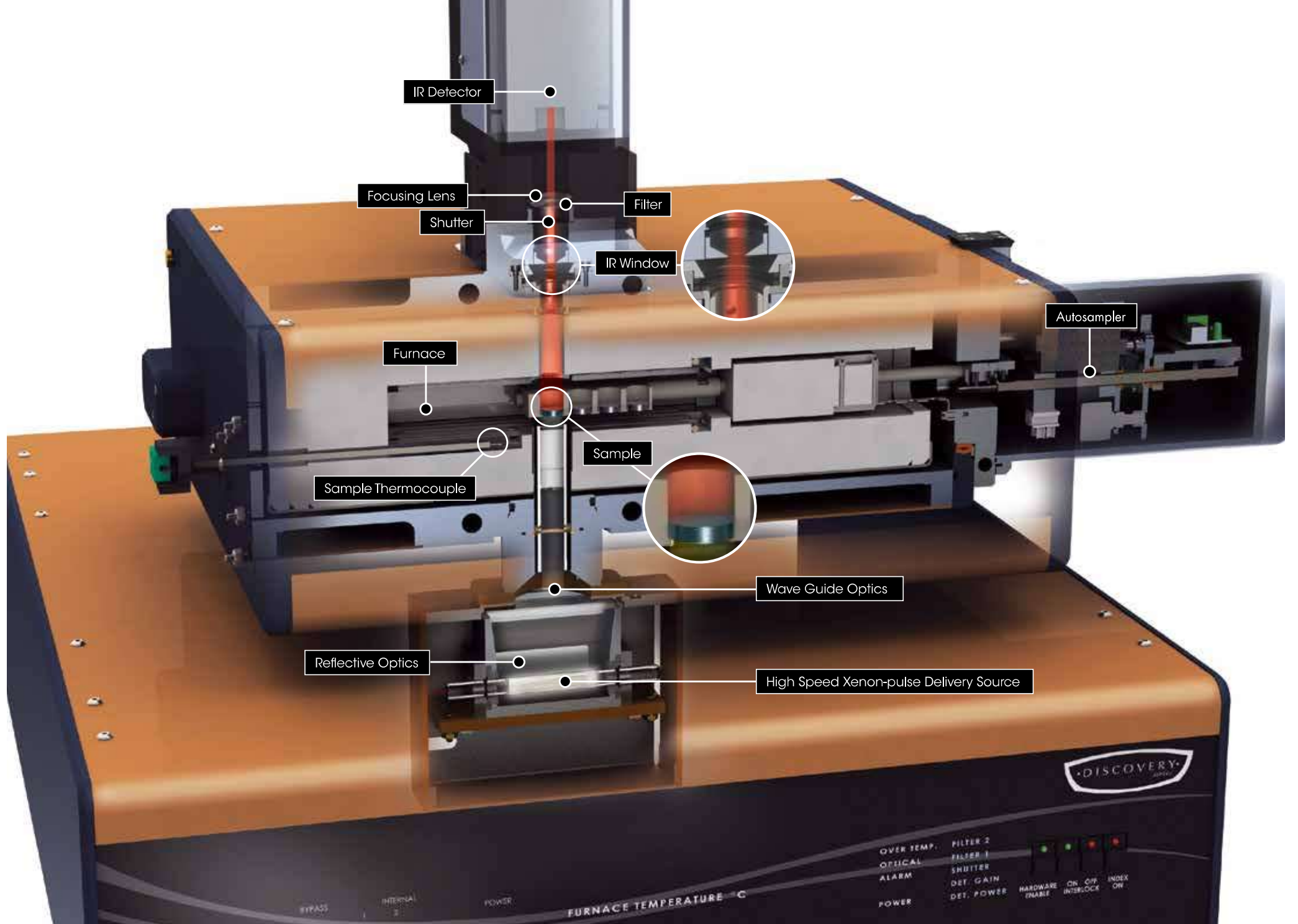

# discovery laser flash

DLF-1200

The Discovery Laser Flash system is the benchmark for high-performance laser flash analysis over a wide range of test temperatures. The flash source module consists of a custom Class 1 Nd:Glass Laser pulse source which provides a collimated, monochromatic energy pulse with a 300  $\mu$ s to 400  $\mu$ s pulse width. The DLF-1200 is ideal for labs that need to measure thermal conductivity, thermal diffusivity or heat capacity of specimens at temperatures up to 1200 °C, or that require the monochromatic pulse inherent with a laser source in a compact benchtop footprint.

Transient sample temperature measurements are made by a liquid nitrogen-cooled IR detector. This system provides high precision, quick response, non-contact measurement of the sample surface temperature through the laser pulse.

The DLF-1200 employs a resistance-heated furnace for accurate, stable temperature control. The system provides ambient to 1200 °C operation in air, inert gas or vacuum to  $10^{-3}$  torr. Simple to operate and safe to use, these systems are suitable for research and development programs, as well as quality control. They are easy to maintain and very economical to operate.



## DLF-1200

Radiation Source	Nd: Glass Laser
Pulse Width	300 $\mu$ s to 400 $\mu$ s
Pulse Energy (variable)	Up to 25 J
Thermal Diffusivity Range	0.01 to 1000 mm <sup>2</sup> /s
Thermal Conductivity Range	0.10 to 2000 W/(m·K)
<b>Repeatability</b>	
Thermal Diffusivity	$\pm$ 2%
Heat Capacity	$\pm$ 3.5%
Thermal Conductivity	$\pm$ 4%
<b>Accuracy</b>	
Thermal Diffusivity	$\pm$ 2.3%
Heat Capacity	$\pm$ 4%
Thermal Conductivity	$\pm$ 5%
<b>Sample Environment</b>	
Temperature Range	RT to 1200 °C
Atmosphere	Air, inert, vacuum (10 <sup>-3</sup> torr)
Maximum Samples	4
Sample Dimension	12.7/25.4 mm (d) up to 6 mm (t)

Repeatability and accuracy values reflect the results of systematic testing on standard reference materials.

# discovery xenon flash

DXF

The Discovery Xenon Flash (DXF) platform employs a High Speed Xenon-pulse Delivery source (HSXD) which has considerably lower cost and less maintenance than a laser and generates equivalent results. A reflective optics system harnesses the power of a Xenon flash tube and delivers it to the specimen. These proprietary optics feature an anamorphic multi-faceted light pipe that produces a flash of uniform intensity across the sample and efficiently collects the Xenon lamp radiation for the maximum possible intensity.

The DXF produces a pulse width that is shorter (400  $\mu$ s to 600  $\mu$ s) than many commercial laser-based systems, while uniformly concentrating sufficient power from the flash source directly on the entire face of the specimen. Due to this optimized optical arrangement and the broad light spectrum, specimens as large as 25 mm in diameter can be illuminated with sufficient energy to make a high-accuracy measurement. The use of large samples diminishes errors associated with inhomogeneity and permits representative measurements of poorly dispersed composites.

The DXF is available in any of three configurations, all of which feature the HSXD source and provide different test temperature ranges. The DXF platform is suitable for research and development programs as well as production control.



## DXF-200

The DXF-200 is a sub-ambient test system. Using an efficient liquid nitrogen cooling mechanism, the system provides accurate and stable temperature control from -150 °C to 200 °C in air or inert gas. Traditional IR detectors exhibit poor sensitivity at low temperatures. To overcome this limitation, the DXF-200 employs a solid-state detector that enables high-sensitivity measurements under cryogenic conditions.

## DXF-500

The DXF-500 employs nichrome heaters and an aluminum air-cooled shell for ambient to 500 °C operation in air or inert gas purge and is vacuum-tight to  $10^{-2}$  torr. Transient sample temperature measurements are made by a liquid nitrogen-cooled IR detector. This system provides high precision, quick response, non-contact measurement of the sample surface temperature through the pulse.

## DXF-900

The EM-900 employs a resistance-heated furnace, providing ambient to 900 °C operation in air, inert gas or vacuum to  $10^{-3}$  torr. Transient sample temperature measurements are made by a liquid nitrogen-cooled IR detector. This system provides high precision, quick response, non-contact measurement of the sample surface temperature through the pulse.



	<b>DXF-200</b>	<b>DXF-500</b>	<b>DXF-900</b>
Radiation Source	High Speed Xenon-pulse Delivery Source	High Speed Xenon-pulse Delivery Source	High Speed Xenon-pulse Delivery Source
Pulse Width	400 $\mu$ s to 600 $\mu$ s	400 $\mu$ s to 600 $\mu$ s	400 $\mu$ s to 600 $\mu$ s
Pulse Energy (variable)	Up to 15 J	Up to 15 J	Up to 15 J
Thermal Diffusivity Range	0.01 to 1000 mm <sup>2</sup> /s	0.01 to 1000 mm <sup>2</sup> /s	0.01 to 1000 mm <sup>2</sup> /s
Thermal Conductivity Range	0.10 to 2000 W/(m·K)	0.10 to 2000 W/(m·K)	0.10 to 2000 W/(m·K)
<b>Repeatability</b>			
Thermal Diffusivity	±2%	±2%	±2%
Heat Capacity	±3.5%	±3.5%	±3.5%
Thermal Conductivity	±4%	±4%	±4%
<b>Accuracy</b>			
Thermal Diffusivity	±2.3%	±2.3%	±2.3%
Heat Capacity	±4%	±4%	±4%
Thermal Conductivity	±5%	±5%	±5%
<b>Sample Environment</b>			
Temperature Range	-150°C to 200 °C	RT to 500 °C	RT to 900 °C
Atmosphere	Air, inert	Air, inert, vacuum (10 <sup>-2</sup> torr)	Air, inert, vacuum (10 <sup>-3</sup> torr)
Maximum Samples	2	4	4
Sample Dimension	12.7/25.4 mm (d) up to 6 mm (t)	12.7/25.4 mm (d) up to 6 mm (t)	12.7/25.4 mm (d) up to 6 mm (t)

Repeatability and accuracy values reflect the results of systematic testing on standard reference materials.

### Precision Detector Optics

The Discovery Flash instruments feature advanced detector optics that provide uniform, accurate measurement of the sample thermogram. With an IR detection area that covers more than 90% of the sample surface, representative data is collected that is not subject to sample inhomogeneity. The detector optics are designed to measure this large sample area exclusively. Isolation guards prevent contributions from extraneous radiation including edge effects such as flash-through that can arise from imperfect sample preparation.

IR intensity is tuned to the optimal detector range through the use of neutral density IR filters. Unlike systems that rely on multiple apertures or iris designs to attenuate intensity, the neutral density filter provides uniform moderation of intensity and is free from geometry factors and spectral band distortion. These carefully designed detector optics lead to unparalleled accuracy across the full range of thermal diffusivity.

### Sensor Technology

Discovery Flash instruments utilize high sensitivity, quick response sensors for the most accurate measurement of transient temperature changes. As an integral component of the environmental module, the detector is factory-aligned to the sample and does not require user exchange or alignment. The detector type is selected specifically for the operating temperature range of the Environmental Module. For moderate to high temperature measurements, an indium antimonide (InSb) IR detector is employed. The IR detector is cooled with liquid nitrogen to ensure the most stable output and maximum repeatability.

At lower temperatures, a proprietary solid-state PIN detector provides optimal sensitivity and response time compared to an IR detector. The amplitude of the directly measured signal (resulting from a flash pulse at  $-150^{\circ}\text{C}$ ) is approximately five times greater for the solid-state PIN detector than for a traditional IR detector signal at  $25^{\circ}\text{C}$ . This eliminates the need for the artificial signal amplification required for IR detectors operating at or below room temperature. The advantage of this improved thermogram resolution is a greater signal-to-noise ratio, increased accuracy of specific heat capacity and thermal conductivity measurements, and a reliable data set for effortless post-test analysis. The EM-200 employs this solid-state PIN detector, providing unprecedented accuracy and the ability to measure at lower temperatures than any IR detector-based system.

### Unparalleled Accuracy

All Discovery Flash source modules employ full-time pulse mapping and recording capability. This allows for precise pulse-shape and pulse-width correction calculations and the most accurate determination of the  $t_p$ .

The Discovery Flash data analysis software also employs the latest methods for heat loss corrections. The Clark and Taylor method is utilized as the most accurate general purpose procedure for accurately determining thermal diffusivity based on the finite pulse width, radiation heat losses, and non-isothermal local sample conditions. Additionally, more than 20 different analysis models and correction programs are incorporated into the software, providing the highest accuracy for all material types.

Available Models include:

- Clark and Taylor
- Cowan
- Degiovanni
- Koski
- Least Squares
- Logarithmic
- Moment
- Heckman
- Parker

## Simple Sample Containment

All Discovery Flash systems utilize an elegant sample containment system that makes sample preparation and loading fast and easy while providing optimal flash data. Sample holders of defined dimensions support the specimen around its perimeter. The system does not require any pressure or clamping, making it very well-suited for delicate specimens. Lava (alumina silicate) and Mullite are preferred for their ability to block off-sample flash energy. Alumina sample holders are also available.

## Standard and Universal

The flash method is widely accepted and is documented in ASTM E1461, ASTM E2585, ASTM C714, DIN EN821, DIN 30905, ISO 22007-4:2008, and ISO 18755:2005. All TA Instruments Discovery Flash instruments conform to these standards and can be relied on to produce accurate, repeatable results that can be easily compared between laboratories.

### Standard Available Sizes

Square (L)	Round (D)
8 mm	8 mm
10 mm	10 mm
12.7 mm	12.7 mm
	25.4 mm
Thickness: up to 6 mm	

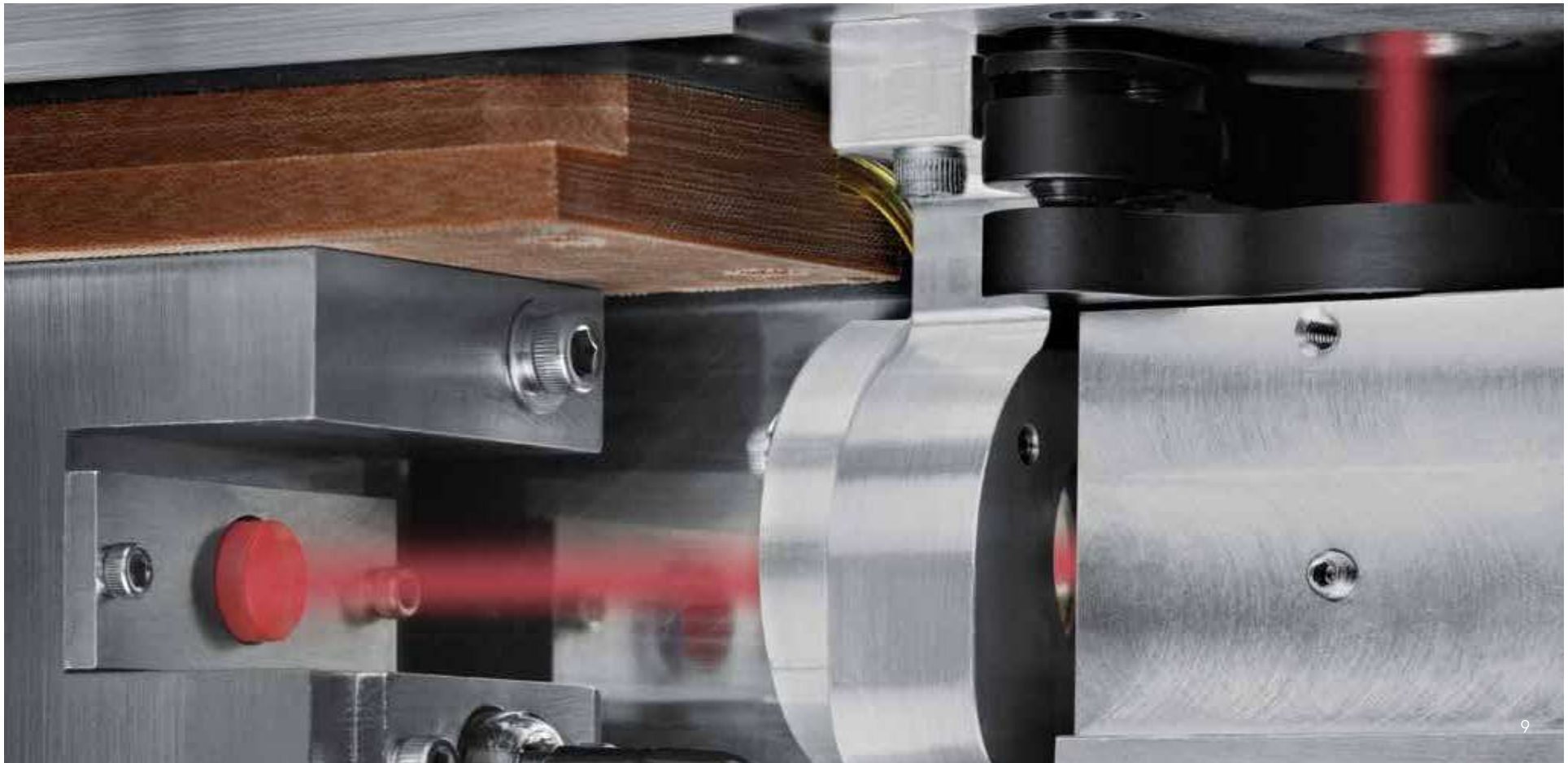

# automation

## PRODUCTIVITY AND ACCURACY

All Discovery Flash Diffusivity instruments include automated sampling systems. These systems allow for the measurement of two or four samples in a single experiment. While the length of an individual flash diffusivity measurement is very short, the total experiment time can be considerable when allowances are made for establishing a vacuum and inert purge, and stabilization of high operating temperatures.

In addition to time savings associated with sample throughput, automated sampling systems provide valuable improvements in measurement accuracy. Specific heat capacity measurements rely on the comparison of identical flash experiments performed on a sample and a reference material. This comparison of sequential experiments is most reliable if it can be made under the same conditions, without allowing the time for cooling, evacuation, and reheating that are required in single sample instruments. With the Discovery Flash Diffusivity instruments, the sample and reference can be measured sequentially, under identical circumstances, and in a short amount of time. This high accuracy measurement of heat capacity is essential for the subsequent calculation of thermal conductivity.

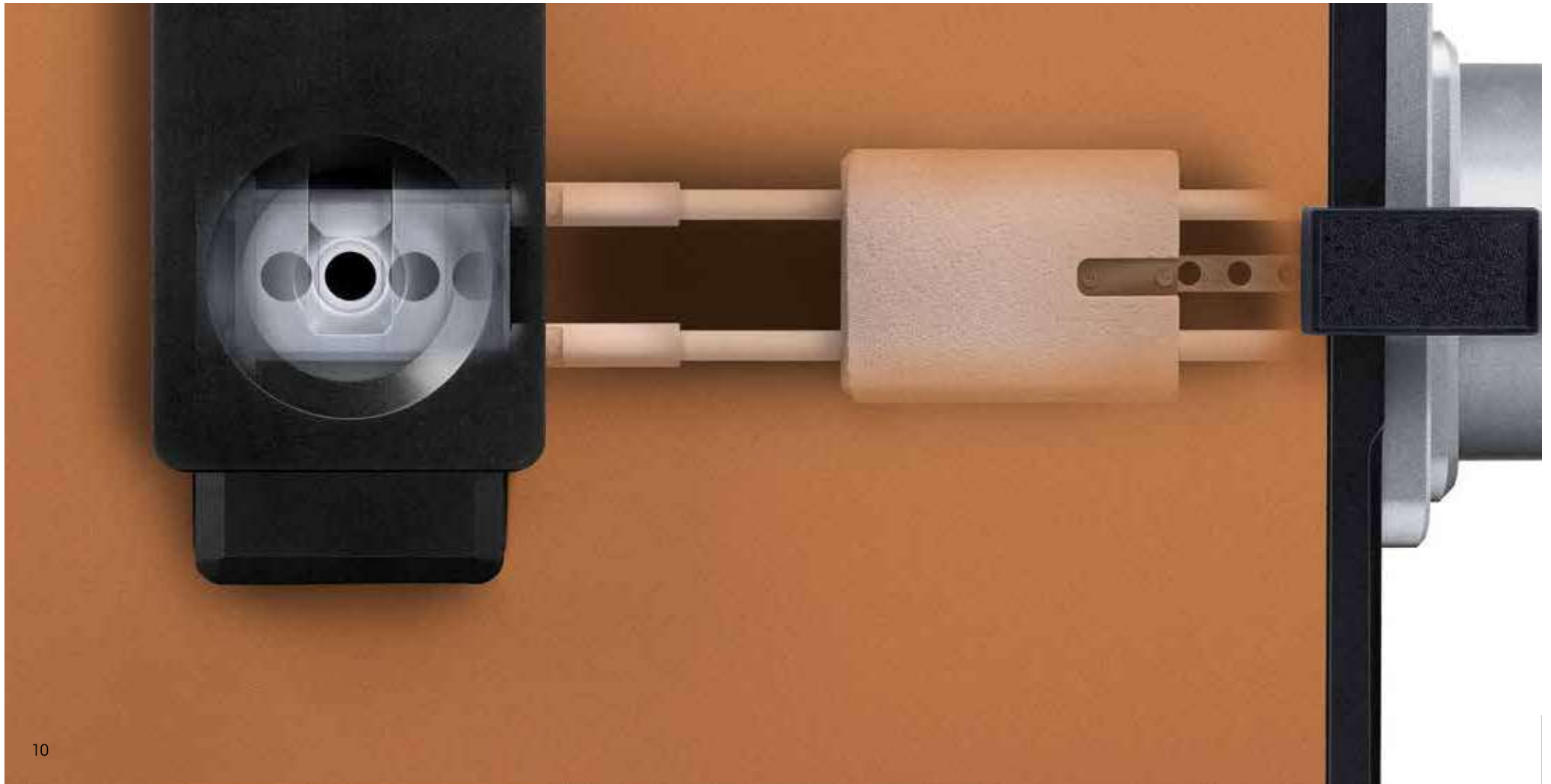

Heat transfer by conduction is governed by Fourier's Law, which defines the thermal conductivity,  $\lambda$ :

$$\lambda = \frac{Q/A}{\Delta T/L}$$

The heat flow,  $Q$ , through a cross-sectional area,  $A$ , arises from a temperature drop,  $\Delta T$ , over a length,  $L$ . The steady-state measurement of thermal conductivity relies on accurate measurement of the heat flow and temperature gradient.

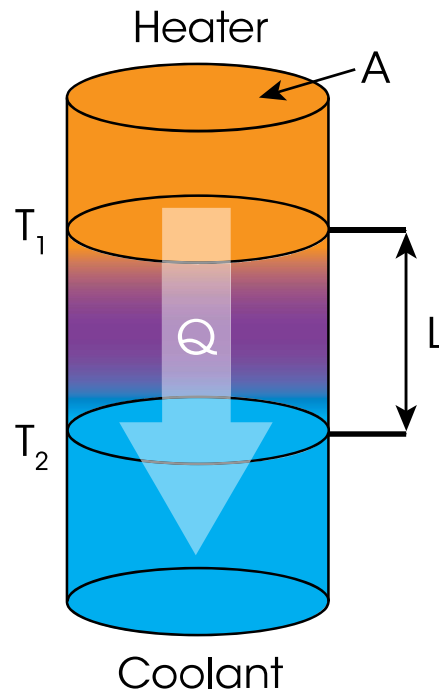

The TA Instruments DTC-25 and DTC-300 Thermal Conductivity Meters measure thermal conductivity according to the ASTM E1530 guarded heat flow meter method. In this technique, a sample of the material to be tested is held under a compressive load between two surfaces, each controlled at a different temperature. The lower surface is part of a calibrated heat flux transducer. As heat is transferred from the upper surface through the sample to the lower surface, an axial temperature gradient is established in the stack. By measuring the temperature difference across the sample along with the output from the heat flux transducer, thermal conductivity of the sample can be determined when the thickness is known.

The DTC-25 operates at room temperature, so lateral heat losses are negligible. The DTC-300 operates at higher temperatures where lateral heat losses to the environment would introduce measurement error. This error is eliminated through use of a guard furnace, which is set to the sample temperature; this minimizes lateral heat losses and ensures the highest measurement accuracy.

Positive thermal contact is required and is ensured by applying a reproducible, pneumatic load to the test stack. For rough samples, thermal interface pastes may also be used. When working with materials that tend to creep under load, stops may be used to define the gap at a specified value. The DTC-25 and DTC-300 are commonly employed for measurements of solids such as neat and filled polymers. Measurement systems are also available for use with pastes and liquids, making the Discovery Thermal Conductivity instrument an extremely versatile system.

### Test Section Schematic

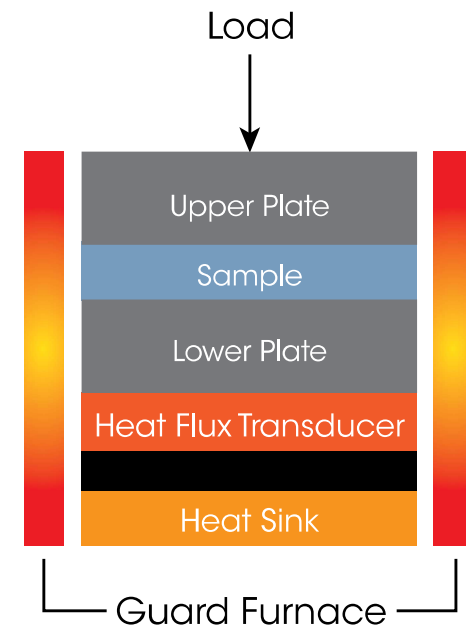

# DTC-25

## THERMAL CONDUCTIVITY METER

### DTC-25

The DTC-25 Thermal Conductivity Meter is a single temperature test instrument used for quick determination of thermal conductivity of solid materials using the guarded heat flow method. Because of its simple operation, small sample size, and short cycle time, the DTC-25 is ideally suited for quality control and screening of materials. Metals, ceramics, polymers, composites, glass and rubber can all be tested accurately. Thin samples like paper products and plastic films can also be tested.

The DTC-25 is completely self-contained and requires no additional instrumentation for the measurement. The instrument is factory-calibrated using specimens of known thermal resistance spanning the range of the instrument. Calibration reference sets are also available. An optional chiller providing coolant at a fixed temperature is recommended for optimal performance. The DTC-25 is a simple, fast and accurate laboratory instrument.



Method	Guarded Heat Flow Meter
Standard Test Method	ASTM E1530
Sample Compatibility	solids, pastes, liquids, thin films
Sample Size	
Thickness	Maximum 32 mm depending on thermal resistance. Thin films down to 0.1 mm, with optional software
Diameter	50 mm
Temperature Range	Near ambient
Thermal Conductivity Range	0.1 to 20 W/m.K
Thermal Resistance Range	0.0004 to 0.012 m <sup>2</sup> K/W
Accuracy	±3%
Reproducibility	±2%

Method	Guarded Heat Flow Meter
Standard Test Method	ASTM E1530
Sample Compatibility	solids, pastes, liquids, thin films
Sample Size	
Thickness	25 mm maximum Thin films down to 0.1 mm with optional software
Diameter	50 mm diameter
Temperature Range	-20 °C to 300 °C
Thermal Conductivity Range	0.1 to 40 W/m.K
Thermal Resistance Range	[1] 0.0005 – 0.010 m <sup>2</sup> K/W [2] 0.002 – 0.020 m <sup>2</sup> K/W [3] 0.01 – 0.05 m <sup>2</sup> K/W
Accuracy	±3%
Reproducibility	±1-2%

## DTC-300

The DTC-300 is a guarded heat flow meter used to measure thermal conductivity of a variety of materials, including polymers, ceramics, composites, glasses, rubbers, some metals, and other materials of low to medium thermal conductivity. Only a relatively small test sample is required. Non-solids, such as pastes or liquids, can be tested using special containers. Thin films can also be tested accurately using a multi-layer technique. The tests are performed in accordance with the ASTM E1530 standard.

A water-cooled heat sink allows operation with a lowest sample temperature of about 50°C. To fully utilize the range of the instrument, an optional refrigerated circulator can be used to provide a heat sink temperature to -40°C. The instrument is provided with one of three operating range modules. Each module covers a different thermal resistance region. The various modules are easily interchangeable.



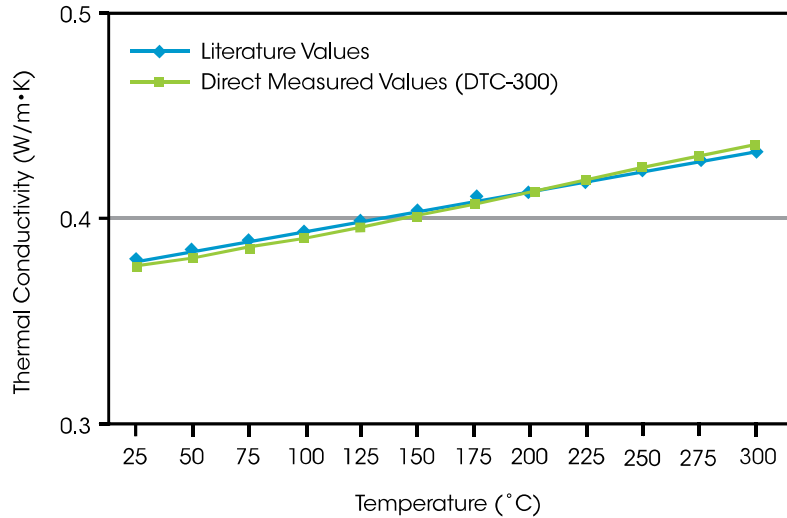

## Vespel® Thermal Conductivity

The data contained in the figure and table demonstrate the impressive accuracy and precision of the DTC-300 Thermal Conductivity Meter on the standard material, Vespel. As shown in the table, the measured error is less than 1% across the entire temperature range from ambient to 300°C.

Temperature (°C)	Thermal Conductivity (W/m·K)		
	Direct Measurement	Literature Values	Error (%)
25	0.377	0.379	0.53
50	0.381	0.384	0.78
75	0.386	0.389	0.77
100	0.391	0.394	0.76
125	0.396	0.399	0.75
150	0.402	0.404	0.50
175	0.407	0.409	0.49
200	0.413	0.414	0.24
225	0.419	0.419	0.00
250	0.425	0.424	0.24
275	0.430	0.429	0.23
300	0.436	0.434	0.46



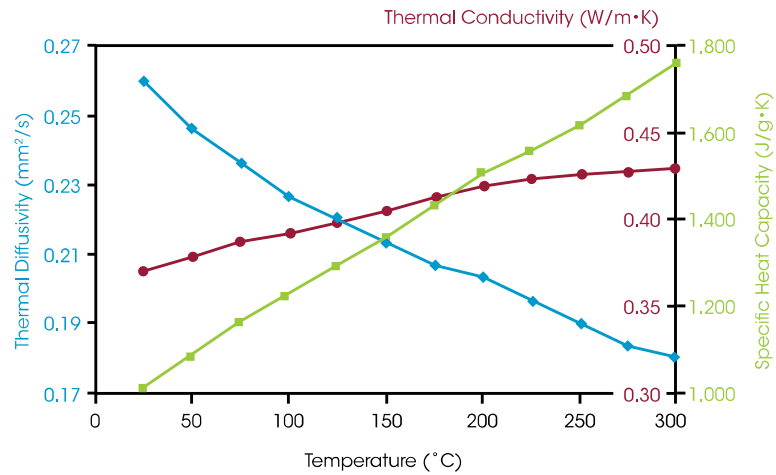

## VespeL Thermal Diffusivity

VespeL is a polyimide which is one of the commonly used thermal conductivity reference materials, due to its consistent thermophysical properties. There is, however, very little data available describing its thermal diffusivity and specific heat capacity.

This figure presents data for thermal diffusivity and specific heat capacity obtained using the flash method, with the latter also determined using a differential scanning calorimeter. From these data (and the equation found on Page 2), thermal conductivity can be determined. The calculated thermal conductivity is in good agreement with the values directly measured from the Guarded Heat Flow technique (shown on the previous page).

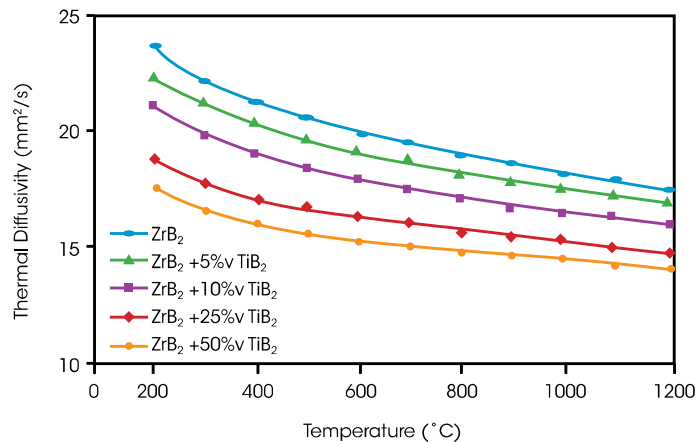

## Ultra-High-Temperature Ceramics

Zirconium diboride ( $ZrB_2$ ) and titanium diboride ( $TiB_2$ ), are classified as ultra-high-temperature ceramics due to their melting points in excess of  $3000^\circ C$ .  $ZrB_2$  is also remarkable for its high strength and hardness, good chemical stability and high thermal and electrical conductivities, making  $ZrB_2$  an attractive option for hypersonic flight and atmospheric re-entry vehicle applications. New high-maneuverability control surfaces experience temperatures in excess of  $2000^\circ C$  due to frictional heating on sharp leading and trailing edges. Knowledge of the thermal transport properties at temperature is critical to managing this heat. As seen in the figure, increasing the solid solution content of  $TiB_2$  in  $ZrB_2$  decreases thermal diffusivity over the entire use temperature range, which is readily elucidated by the DLF-1200.

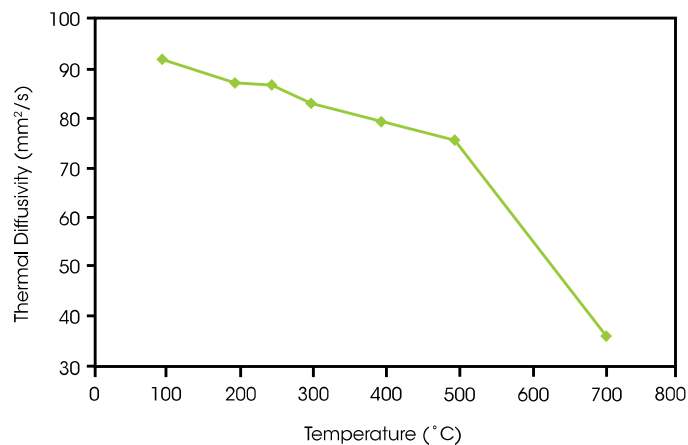

## Aluminum Through the Melt

A sample's thermophysical properties can change dramatically as it undergoes a phase transition such as melting. As such, it is critical for instruments to accommodate a sample during these important processes. The data in this figure show the measured thermal diffusivity of an aluminum standard as it is heated through its melting point ( $660^\circ C$ ). Note the precipitous drop in thermal diffusivity as the sample transitions from solid to liquid.

## Tungsten Alloys

Tungsten alloys are valued for their high hardness, which makes them ideal for use in cutting or abrasion tools or rocket nozzles, applications which also require efficient heat transfer.

The data in these figures are the result of a study on various tungsten alloys, in comparison to a sample of pure tungsten. Specific heat capacity literature values for pure tungsten were used to derive reference data for testing and analysis. Thermal diffusivity and specific heat capacity data were measured on the alloy pieces using a DLF-1200 system.

The data demonstrate the variance in thermophysical properties which can arise as a function of subtle changes in composition. Using the values for pure tungsten as a reference, two of the alloys show very little change in specific heat capacity or thermal conductivity. However, Tungsten Alloy 3 is observed to have a significant deviation in specific heat capacity. This is also found in the calculated thermal conductivity, where the alloy shows a difference in both absolute value as well as temperature dependence.

## Thermographite

Thermographite is a common reference material for thermal diffusivity by the flash method, as it is stable over a wide temperature range, and its thermophysical properties have been well-documented. The data in the figure show the measured thermal diffusivity of thermographite over the temperature range from ambient to 1200°C. At these elevated temperatures, measurement under an inert atmosphere (after evacuation) is critical to accurate thermal diffusivity results. The DLF-1200 system provides both the temperature range and environmental control required for these challenging conditions.

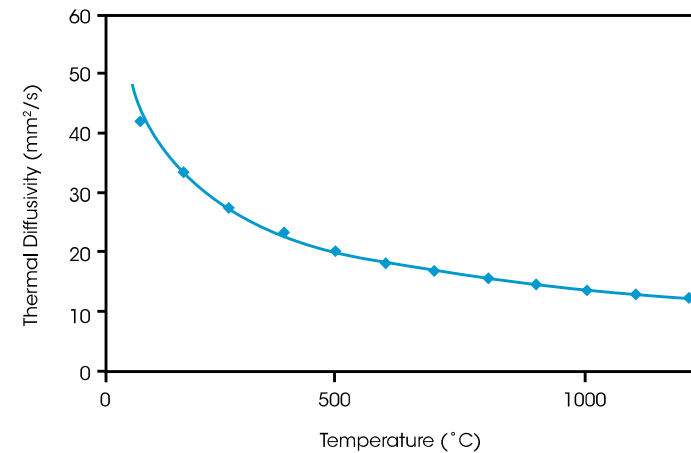
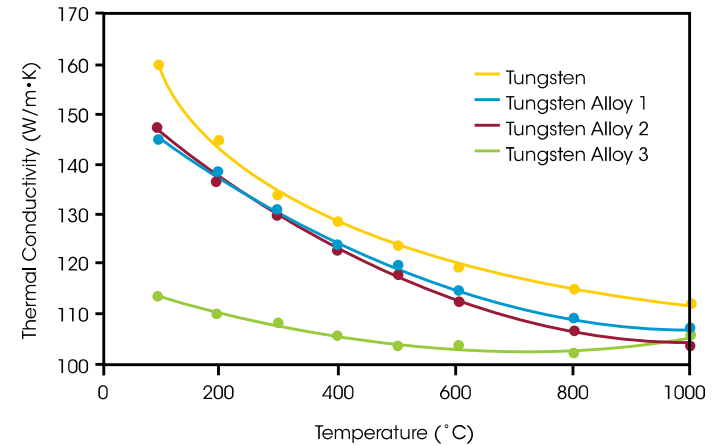
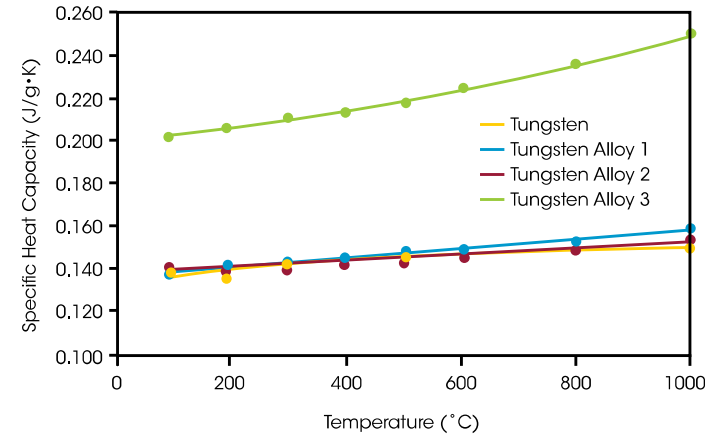

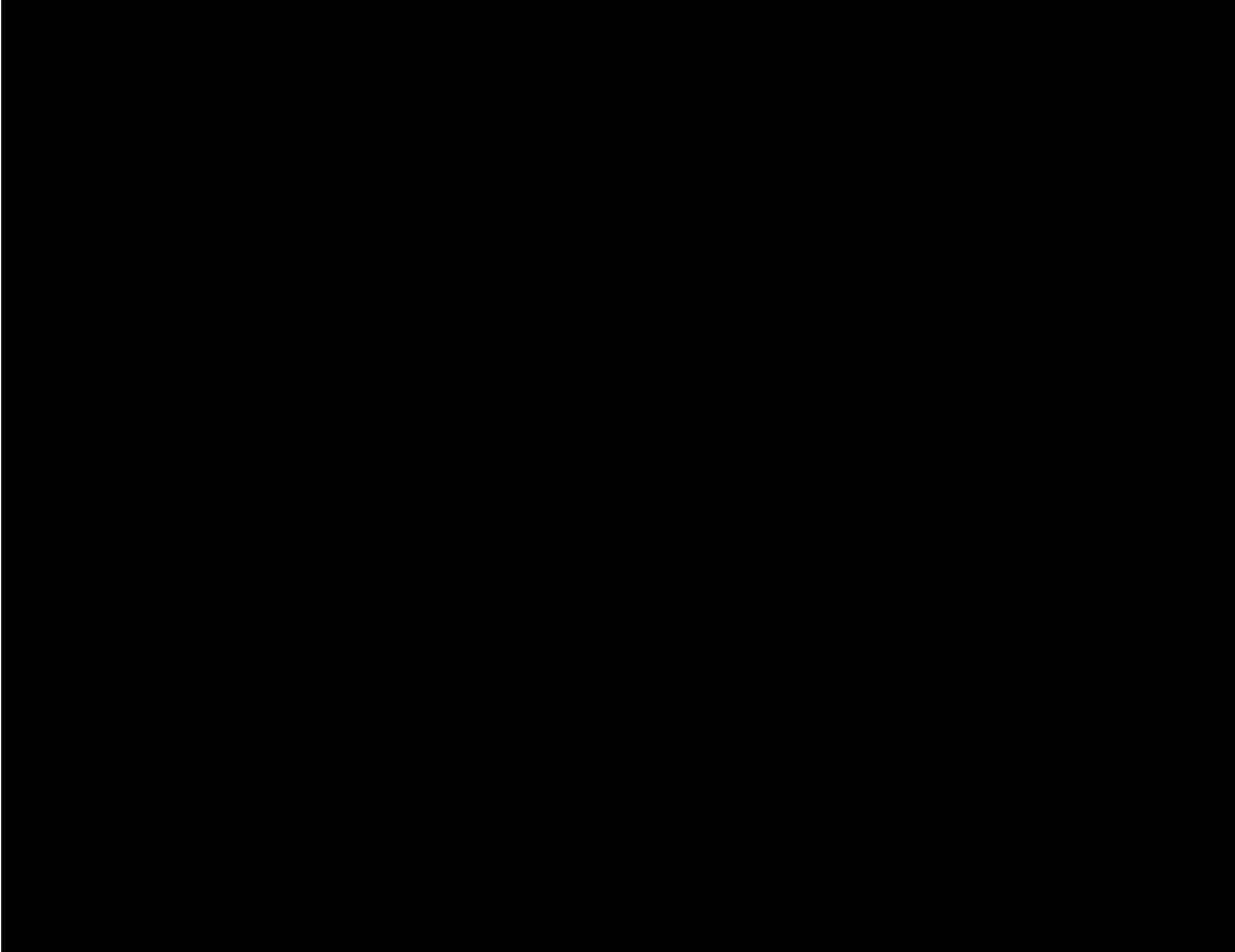



[tainstruments.com](http://tainstruments.com)