

797PCP Series Progressive Cavity Pump

Operating Manual



Electronic pdf files of Nordson EFD manuals are also available at www.nordsonefd.com



You have selected a reliable, high-quality dispensing system from Nordson EFD, the world leader in fluid dispensing. The 797PCP Series progressive cavity pump is designed specifically for industrial dispensing and will provide you with years of trouble-free, productive service.

This manual will help you maximize the usefulness of your 797PCP.

Please spend a few minutes to become familiar with the controls and features. Follow our recommended testing procedures. Review the helpful information we have included, which is based on more than 50 years of industrial dispensing experience.

Most questions you will have are answered in this manual. However, if you need assistance, please do not hesitate to contact EFD or your authorized EFD distributor. Detailed contact information is provided on the last page of this document.

The Nordson EFD Pledge

Thank You!

You have just purchased the world's finest precision dispensing equipment.

I want you to know that all of us at Nordson EFD value your business and will do everything in our power to make you a satisfied customer.

If at any time you are not fully satisfied with our equipment or the support provided by your Nordson EFD Product Application Specialist, please contact me personally at 800.556.3484 (US), 401.431.7000 (outside US), or Ferran.Ayala@nordsonefd.com.

I guarantee that we will resolve any problems to your satisfaction.

Thanks again for choosing Nordson EFD.

Ferran

Ferran Ayala, Vice President

Contents

| | |
|--|----|
| Contents | 3 |
| Introduction | 4 |
| Configuration Options..... | 4 |
| How the Pump Operates | 5 |
| How to Control the Pump..... | 5 |
| Specifications..... | 6 |
| Operating Features..... | 7 |
| Installation | 8 |
| Unpack the System Components..... | 8 |
| Assemble the Pump..... | 9 |
| Mount the Pump | 10 |
| Connect the Fluid Supply | 11 |
| Bleed the Pump | 12 |
| Purge Through the Outlet Adapter (No Tip)..... | 13 |
| Install the Tip | 14 |
| Purge Through the Tip..... | 15 |
| Complete the Installation..... | 16 |
| Example System Layout: 7197PCP-DIN Controller and 797PCP | 17 |
| Example System Layout: ValveMate 7197PCP Controller and 797PCP | 18 |
| Service..... | 19 |
| Pump Disassembly | 19 |
| Pump Assembly..... | 22 |
| Pump Storage | 24 |
| Part Numbers | 25 |
| 797PCPs..... | 25 |
| Pump Motor Cable | 25 |
| Accessories | 26 |
| Mounting Bracket | 26 |
| Fluid Supply..... | 26 |
| Fluid Inlet Fittings..... | 27 |
| Replacement Parts..... | 28 |
| Troubleshooting | 29 |

Introduction

This manual provides specifications, installation, service, part numbers, and troubleshooting information for 797PCP Series progressive cavity pumps. The 797PCP dispenses an exact, repeatable volume of fluid as small as 0.01 mL per revolution for applications that require extremely consistent dispensing control.



Features of the 797PCP:

- Viscosity-independent
- Low pulsing and shearing operation
- High dispensing accuracy
- High repeatability
- Suck-back operation to prevent drooling
- Conditionally appropriate for highly abrasive fluids*

Typical applications include:

- Coating of printed circuit boards
- Bead dispensing
- Underfilling
- Glue dispensing
- Filling compound dispensing
- Under certain conditions, highly viscous abrasive and corrosive fluid dispensing*

NOTE: Due to the risk of contamination, sealants such as hemp or putty are not recommended.

*If you will be dispensing highly abrasive or corrosive fluids, refer to “797PCP Selection for Highly Abrasive / Filled Materials” on page 25 for correct pump selection. While 797PCPs are capable of dispensing these fluids, there is a risk of equipment damage if the dispensing process is not properly set up and managed.

Configuration Options

| Pump Size | Material |
|-------------|---|
| 0.01 mL/rev | Anodized aluminum |
| 0.05 mL/rev | Anodized aluminum |
| 0.15 mL/rev | Anodized aluminum |
| | 303 stainless steel (SS) for medical device dispensing applications |
| 0.30 mL/rev | Anodized aluminum |



797PCP pump in anodized aluminum (available in all sizes and used for all illustrations in this manual)



SS 797PCP pump in 303 stainless steel (0.15 mL/rev only)

How the Pump Operates

The core components of the 797PCP are the metal rotor and rubber stator, which form a perfectly sealed metering chamber. As the chamber rotates, fluid moves from one sealed cavity to the next, allowing for continuous volumetric dispensing independent of fluid viscosity or changes in viscosity over time. Output is controlled by a 24 VDC motor, allowing the pump to dispense very precise amounts of fluid.

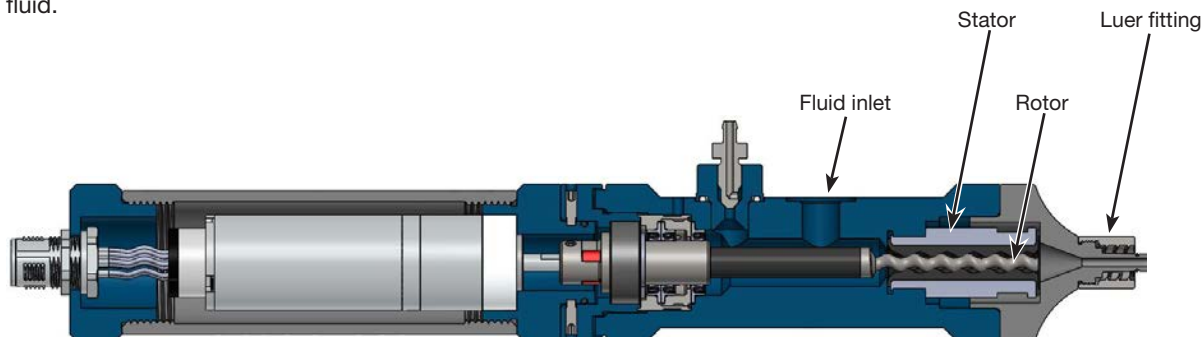

How to Control the Pump

For best results, use Nordson EFD 797PCPs with fully integrated 7197PCP controllers, which provide multiple programming modes — Line, Volume, Weight, or Timed — to meet the unique needs of your application. Advanced features, such as the ability to change the rotor speed when dispensing a line around corners, deliver a high level of process control.



ValveMate™ 7197PCP Controller provides desktop control of the pumps

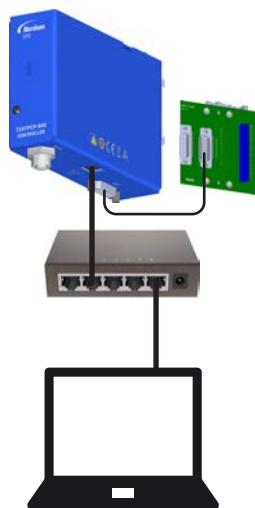

7197PCP-DIN Controller allows Internet-based control of the pumps

Specifications

NOTE: Specifications and technical details are subject to change without prior notification.

| Item | Specification |
|---|--|
| Size | 797PCP-0.01 / 0.05 mL/rev: 261.4L x 36.0DIA mm (10.29L x 1.42DIA") 797PCP-0.15 / 0.30 mL/rev: 297.9L x 36.0DIA mm (11.73L x 1.42DIA") SS-797PCP-0.15 mL/rev: 298.8L x 36.0DIA mm (11.76L x 1.42DIA") |
| Weight | 797PCP-0.01 / 0.05: 550.0 g (1.2 lb) 797PCP-0.15 / 0.30: 620.0 g (1.4 lb) SS-797PCP-0.15: 1.25 kg (2.75 lb) |
| Rotor speed | 10–150 RPM (depending on maximum motor speed) |
| Motor | 24 VDC incremental encoder, planetary gears |
| Starting torque | 797PCP-0.01 mL/rev: 0.22 N•m (1.95 in.-lb) 797PCP-0.05 mL/rev: 0.24 N•m (2.12 in.-lb) 797PCP-0.15 / 0.30 mL/rev: 0.73 N•m (6.46 in.-lb) |
| Maximum motor speed (based on fluid viscosity)* | 1–800 mPa s: Up to 100% of maximum motor speed 800–10,000 mPa s: 90% of maximum motor speed 10,000–25,000 mPa s: 70% of maximum motor speed 25,000–50,000 mPa s: 50% of maximum motor speed 50,000–150,000 mPa s: 25% of maximum motor speed |
| Flow rate | 797PCP-0.01: 0.13–1.95 mL/min 797PCP-0.05: 0.59–8.85 mL/min 797PCP-0.15: 1.63–24.50 mL/min 797PCP-0.30: 0.30–45.0 mL/min |
| Minimum dispensing volume | 797PCP-0.01: 0.002 mL 797PCP-0.05: 0.008 mL 797PCP-0.15: 0.01 mL 797PCP-0.30: 0.034 mL |
| Dispensing volume per revolution | 797PCP-0.01: 0.009 mL 797PCP-0.05: 0.047 mL 797PCP-0.15: 0.139 mL 797PCP-0.30: 0.304 mL |
| Repeatability | ±1% |
| Maximum fluid inlet pressure | 0–6 bar (0–87 psi) |
| Maximum generated fluid outlet pressure | 16–20 bar (232–290 psi) |
| Fluid inlet | 1/8 NPT |
| Fluid outlet | Luer fitting |
| Mounting | M4 |

*Maximum motor speed values are based on fluids without fillers. The pump is self-priming when certain conditions are met. However, higher viscosity fluids must first be introduced into the pump (pre-pressure). Do not exceed the pre-pressure values stated in the Technical Data Sheet for the fluid. These values can change depending on speed and viscosity. The values provided are guidelines only; maximum speed depends on the application and the environmental conditions. The maximum permitted speed is crucial for the service life or wear of the pump. The inlet pressure must be selected within the stated limits so that continuous filling of the pump is guaranteed.

Continued on next page

Specifications (continued)

| Item | Specification |
|--------------------------|---|
| Fluid chamber | Standard: Anodized aluminum Stainless-steel: 303 stainless steel |
| Rotor | 316Ti stainless steel |
| Stator | FFKM (perfluoroelastomer) |
| Drive shaft | 303 stainless steel |
| Bleed valve | 303 stainless steel, anodized aluminum |
| Operating temperature** | 10–40° C (50–104° F) |
| Fluid temperature | 10–40° C (50–104° F) |
| Storage conditions | 10–40° C (50–104° F), dry and dust-free; pumps must be stored unassembled |
| Enclosure rating (motor) | IP51 |
| Approvals | CE, UKCA, WEEE |

All stainless steel parts are passivated.

**Because the viscosity of fluid can change when the temperature changes, the minimum and maximum operating temperature depends on the composition of the O-rings / seals.

WEEE Directive



This equipment is regulated by the European Union under WEEE Directive (2012/19/EU). Refer to www.nordsonefd.com/WEEE for information about how to properly dispose of this equipment.

Operating Features

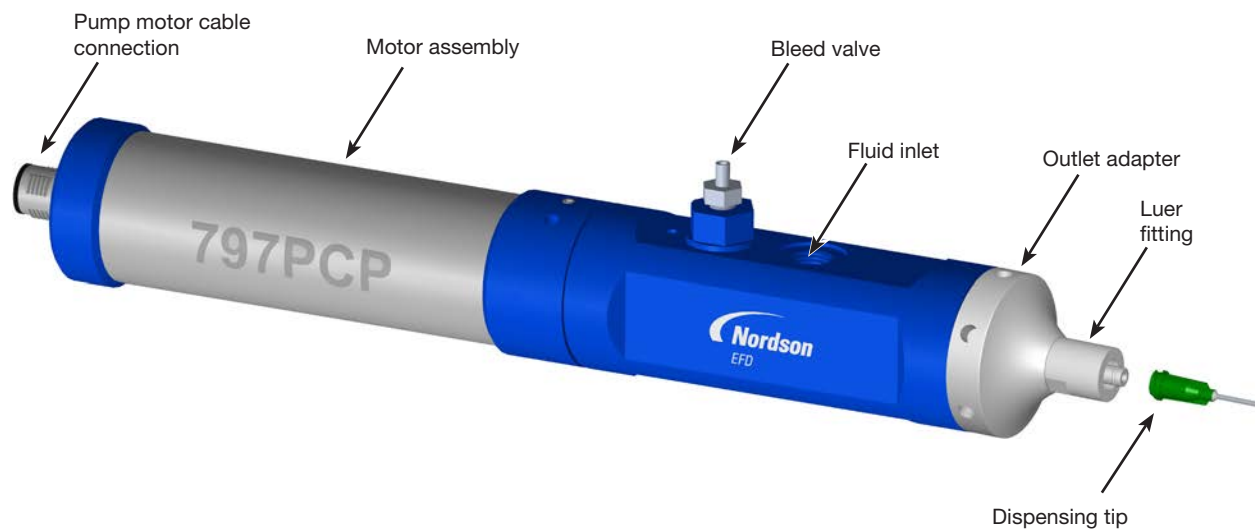

Installation

Prior to installing the pump, read the associated reservoir and pump controller operating manuals to become familiar with the operation of all components of the dispensing system.

Unpack the System Components



- 1 797PCP
- 2 Stator
- 3 Coupling anti-rotation pin

Ordered separately (not shown)

Pump motor cable



Dispensing tip

Installation (continued)

Assemble the Pump

To prevent damage, the stator is shipped separately. Follow this procedure to install the stator.

You will need the following items:

- Spanner wrench 
- Coupling anti-rotation pin (shipped with the pump) 
- 14 mm low-profile open-end wrench (for stator installation or removal)
- Process fluid (or compatible cleaning fluid)

CAUTION

Risk of equipment damage. Do not dry-assemble the rotor and stator. Excessive friction of dry components can damage the pump.

CAUTION

Do not use water with a 797PCP. Doing so can damage the lubricated shaft and bearings.

1. Use a spanner wrench to remove the outlet adapter. 

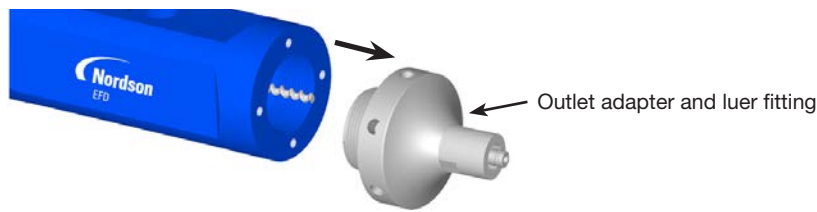

2. Wet the rotor and stator with the process fluid (or any appropriate lubricant that is compatible with the process fluid).

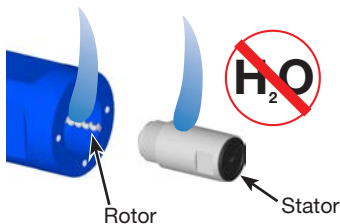

3. Insert the coupling anti-rotation pin into the housing to secure the coupling. If needed, carefully turn the stator / rotor assembly until you feel the pin drop in between the tabs of the gear ring.

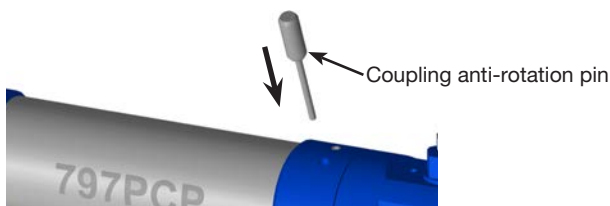

Installation (continued)

- Use a 14 mm low profile wrench to carefully screw the stator clockwise first onto the rotor, and then into the threads inside the pump housing.



- Thread the outlet adapter onto the pump body and hand tighten. Use the spanner wrench for final tightening.
NOTE: Do not install the dispensing tip at this time.

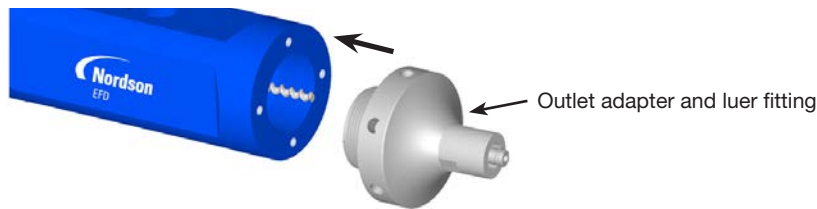

- Continue to “Mount the Pump” below.

Mount the Pump

You will need the following items:

- M3 hex wrench 
- Pump mounting bracket (refer to “Accessories” on page 26)

Determine the pump orientation and rotation that will be suitable for your application and then mount the pump on the production line. The 797PCP can be mounted in any orientation (vertical, diagonal, horizontal, etc.).

NOTES:

- Additional bleed valve ports are available. As needed, move the bleed valve to the port that best accommodates pump mounting and fluid inlet fitting installation. Use a port plug and O-ring to plug unused ports.
- If the pump is being incorporated into an automated dispensing system, ensure that the pump is mounted securely on the Z axis such that it cannot loosen during dispensing. The mounting method should also allow accurate adjustment of the distance between the dispensing tip and the workpiece using a device such as a laser or touch-type height sensor.

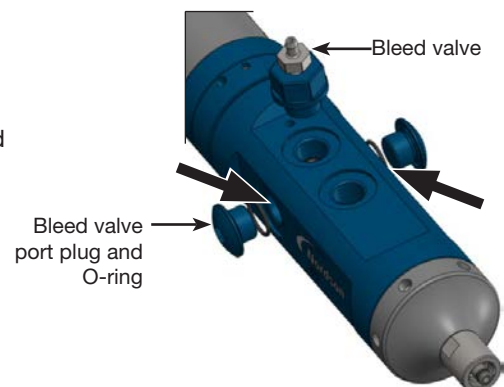
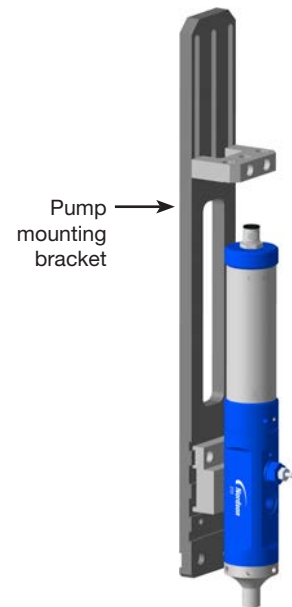

Location of optional bleed valve ports

Installation (continued)

Connect the Fluid Supply

You will need the following items:

- 8 mm low-profile open-end wrench (for the bleed valve hex nut)
- Fluid supply components and fluid inlet fitting (refer to “Accessories” on page 26)
- Process fluid (or compatible cleaning fluid)

CAUTION

Risk of equipment damage. Do not over-tighten fittings. Doing so can damage the anodized aluminum pump housing.

CAUTION

Do not use water with a 797PCP. Doing so can damage the lubricated shaft and bearings.

1. Connect the process fluid supply to the fluid inlet. **Do not pressurize the fluid supply at this time.**

NOTES:

- Nordson EFD recommends using a compatible cleaning fluid for initial startup.
 - Several fluid fitting options are available. Refer to “Accessories” on page 26.
2. Install any system components other than the 797PCP that will comprise the complete dispensing system, including the pump controller. Refer to the following system setup examples:
 - “Example System Layout: 7197PCP-DIN Controller and 797PCP” on page 17
 - “Example System Layout: ValveMate 7197PCP Controller and 797PCP” on page 18

NOTE: For example, if you are using a fluid reservoir, position and install all the fluid reservoir components. For all ancillary components, such as the pump controller, refer to the quick start guide and / or operating manual provided with those components for installation and setup instructions.

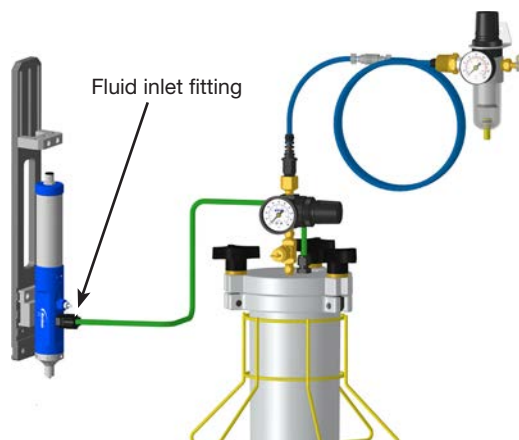

CAUTION

Risk of equipment damage. Bleed the 797PCP and then purge with the dispensing material before placing it into operation. Failure to bleed and purge before initial startup will damage the pump.

3. Continue to “Bleed the Pump” on page 12.

Installation (continued)

Bleed the Pump

⚠ WARNING

Risk of personal injury. Ensure that the fluid supply pressure is set very low. Higher pressures can cause low viscosity fluids to spray from the pump.

1. Set the fluid pressure to approx 0.3 bar (5 psi), depending on the viscosity of the fluid.
2. Place a towel or container under the pump bleed valve and then use an 8 mm low-profile open-end wrench to turn the bleed valve hex screw counterclockwise (about 1/2 turn or less).
3. Allow material to seep from the bleed valve until it is free of trapped air (no air bubbles).
4. Close the bleed valve.

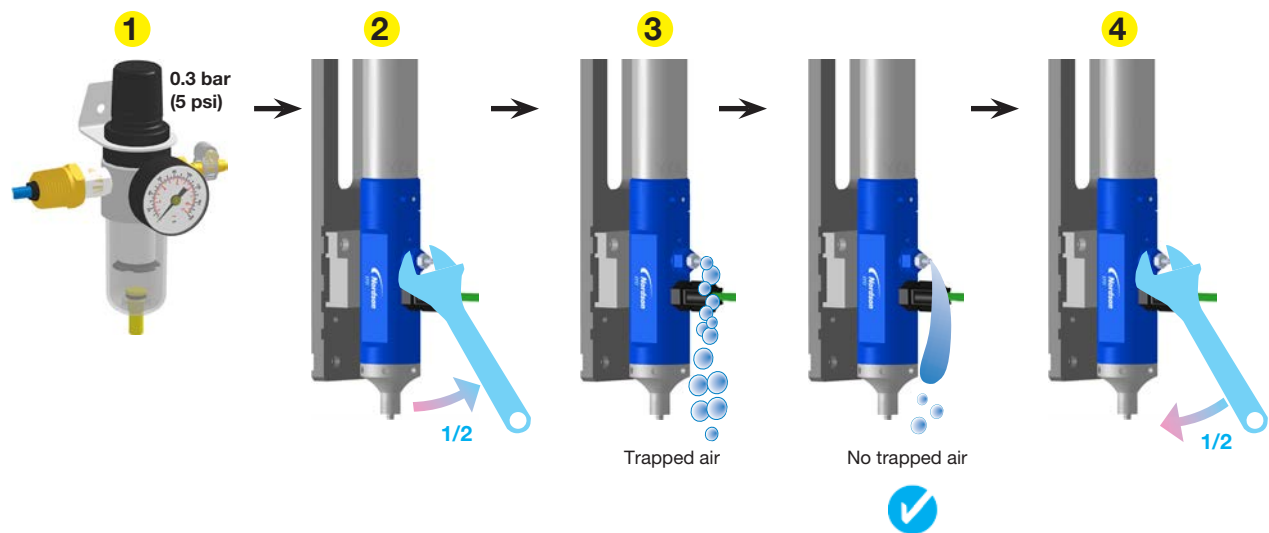

Installation (continued)

Purge Through the Outlet Adapter (No Tip)

Before purging the pump through the tip, first purge the pump without the tip installed.

CAUTION

Risk of equipment damage. **Do not operate a 797PCP without fluid.** Excessive friction of dry components can damage the pump.

- Ensure that:
 - The bleed valve is closed (turned fully clockwise).
 - The fluid supply pressure is set to 0.3 bar (5 psi).
 - The dispensing tip is not installed.
- Place a paper towel or container under the 797PCP outlet adapter to catch fluid.
- Refer to the table below to purge the pump through the outlet adapter based on the type of controller in your system:

NOTE: For programming instructions specific to your controller, refer to the controller manual.

| Your Controller | Purge Procedure |
|---|---|
|  7197PCP-DIN | <ol style="list-style-type: none"> Trigger the purge initiate circuit. NOTE: The default purge RPM is 10. To change the RPM, refer to the procedure for adjusting the purge RPM in the controller manual. Allow fluid to flow from the outlet adapter until it is completely free of trapped air. Stop the purge by removing the purge initiate signal. Continue to “Install the Tip” on page 14. |

Purging a pump through the outlet adapter



Installation (continued)

Purge Through the Outlet Adapter (No Tip) (continued)

| Your Controller | Purge Procedure |
|--|---|
|  <p>ValveMate 7197PCP</p> | <p>a. Go to PROGRAMS > LINE.</p> <p>NOTE: The Line program will be used to purge the pump.</p> <p>b. Select the ENABLE LINE PROGRAM radio button.</p> <p>c. Enter the following settings:</p> <ul style="list-style-type: none"> • RPM = 10 • Reverse % = 1 • Correction Factor = 1 • Analog Off <p>NOTE: The default purge RPM is 10. To change the RPM, refer to the procedure for adjusting the purge RPM in the controller manual.</p> <p>d. Select SUBMIT.</p> <p>e. Press the foot pedal.</p> <p>f. Allow fluid to flow from the outlet adapter until it is completely free of trapped air.</p> <p>g. Release the foot pedal.</p> <p>h. Continue to “Install the Tip” below.</p> |



Install the Tip

1. Install the dispensing tip and ensure that it is filled with fluid.

NOTES:

- For some applications, you can pre-fill the tip by installing it on a filled syringe barrel, then transferring it to the pump; alternatively, you can run the pump until the tip fills with fluid.
- For thick, higher viscosity fluids, Nordson EFD recommends SmoothFlow™ tapered tips.

2. Continue to “Purge Through the Tip” on page 15.

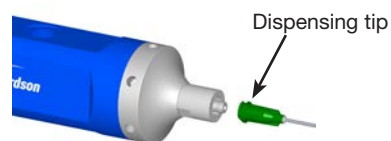

Installation (continued)

Purge Through the Tip

797PCPs should be purged as follows:

- After installation and before initial startup (first use)
- As needed with a cleaning material (depending on the process fluid)
- Before daily routine operation (depending on the process fluid)

Purging eliminates trapped air and ensures that the pumps are completely filled with fluid before dispensing.

CAUTION

Risk of equipment damage. **Do not operate 797PCPs without fluid.** Excessive friction of dry components can damage the pumps.

1. Ensure that:
 - The bleed valve is closed (turned fully clockwise).
 - The fluid supply pressure is set to 0.3 bar (5 psi).
2. Place a paper towel or container under the tip.

CAUTION

Ensure that all trapped air is purged. Trapped air inside a pump can negatively affect the quality of the deposit.

3. Purge a pump based on the type of controller in your system:

| Your Controller | Purge Procedure |
|--|---|
|  <p>7197PCP-DIN</p> | <ol style="list-style-type: none"> Trigger the purge initiate circuit. <p>NOTE: The default purge RPM is 10. To change the RPM, refer to the procedure for adjusting the purge RPM in the controller manual.</p> Allow fluid to flow from the tip until it is completely free of trapped air. Stop the purge by removing the purge initiate signal. Continue to “Complete the Installation” on page 16. |

Purging a pump through the tip

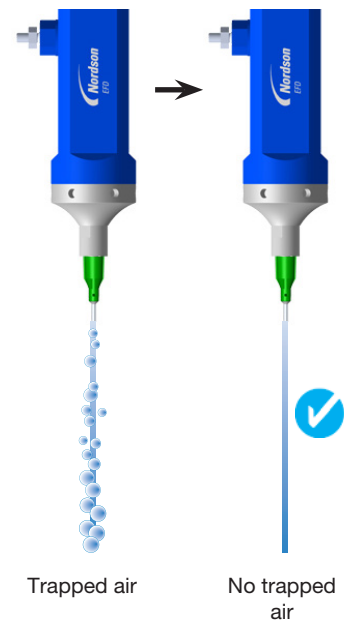

Trapped air

No trapped air

Installation (continued)

Purge Through the Tip (continued)

| Your Controller | Purge Procedure |
|--|--|
|  ValveMate 7197PCP | <ol style="list-style-type: none"> Go to PROGRAMS > LINE. NOTE: The Line program will be used to purge the pump. Select the ENABLE LINE PROGRAM radio button. Enter the following settings: <ul style="list-style-type: none"> RPM = 10 Reverse % = 1 Correction Factor = 1 Analog Off NOTE: The default purge RPM is 10. To change the RPM, refer to the procedure for adjusting the purge RPM in the controller manual. Select SUBMIT. Press the foot pedal. Allow fluid to flow from the tip until it is completely free of trapped air. Release the foot pedal. Continue to “Complete the Installation” below. |

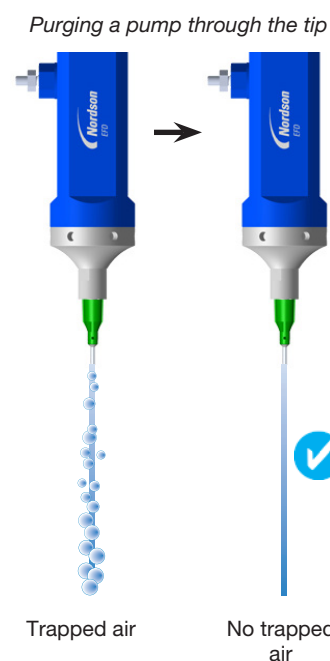

Complete the Installation

- If applicable, change the fluid supply to the desired material.
- Set the fluid pressure to the required application setting.

Refer to the controller manual for system setup and testing and for operating instructions.

Installation (continued)

Example System Layout: 7197PCP-DIN Controller and 797PCP

For controller setup and system startup and testing, refer to the controller operating manual.

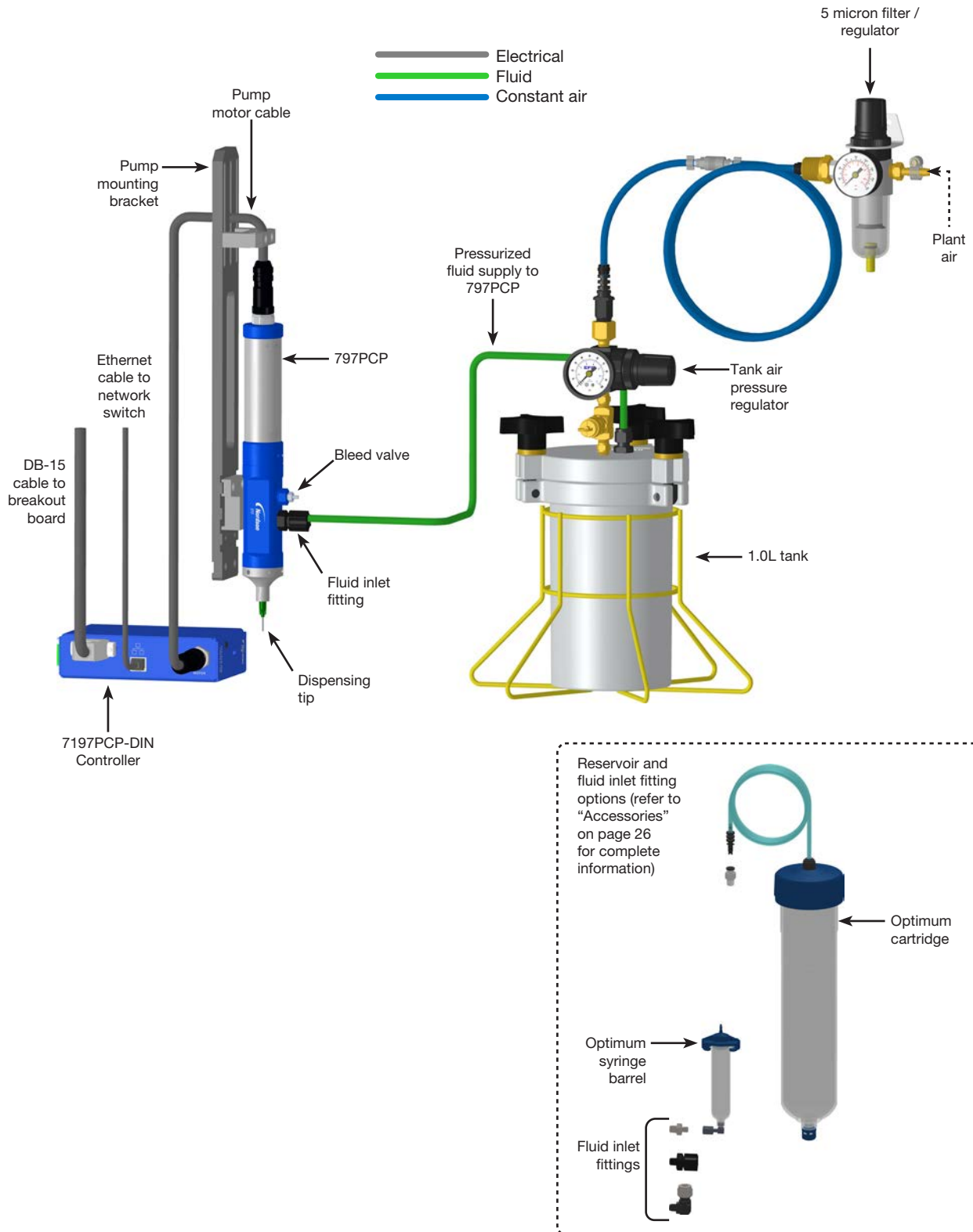

Installation (continued)

Example System Layout: ValveMate 7197PCP Controller and 797PCP

For controller setup and system startup and testing, refer to the controller operating manual.

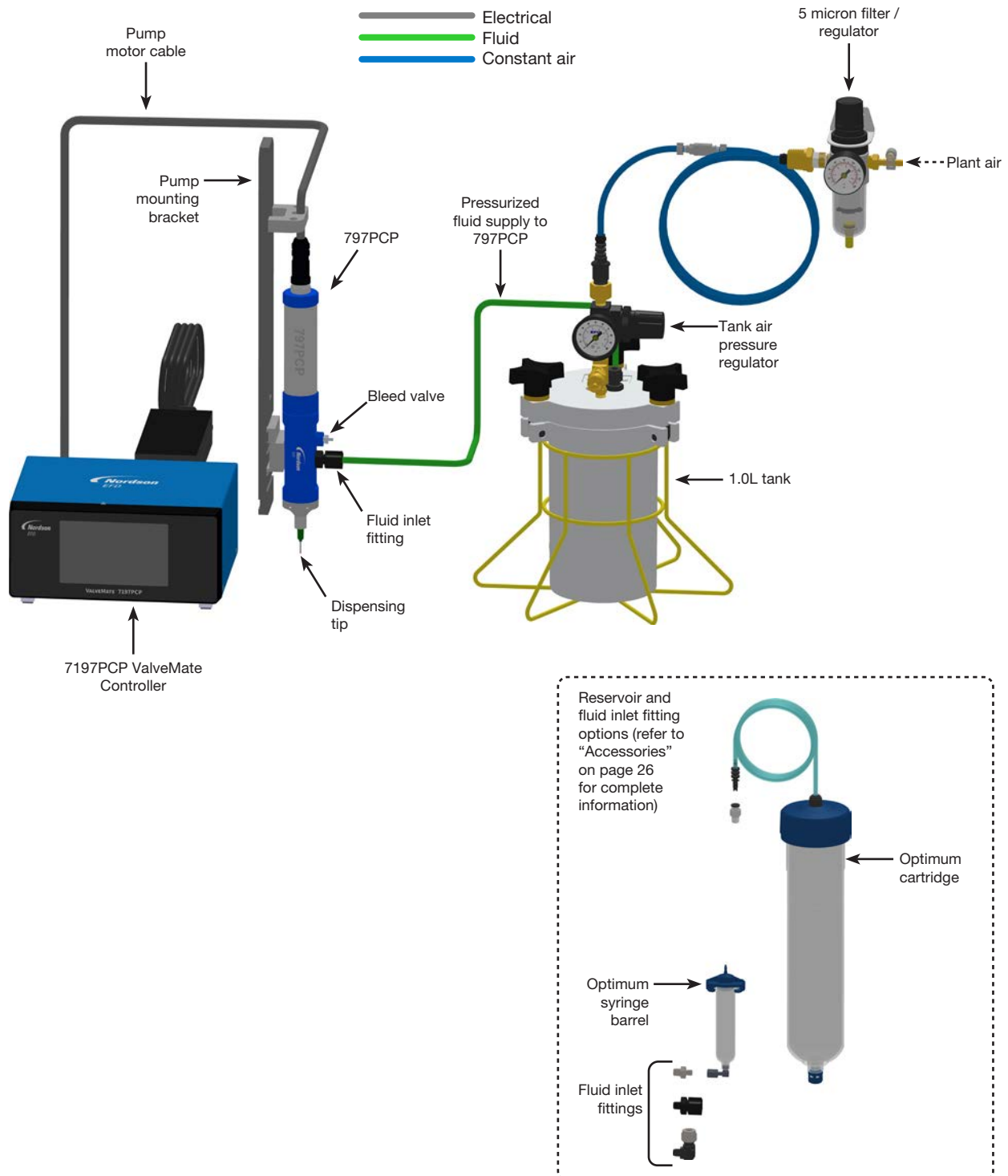

Service



797PCPs are largely maintenance-free. However, some operating conditions may subject the gaskets, bearings, stator, and rotor to wear, requiring them to be replaced at regular intervals. Regularly review your performance data to determine appropriate service intervals. Any time the pump is serviced, also perform the following actions:

- Check all fastening screws and connections to ensure they are securely tightened; re-tighten as needed.
- Check the coupling (elastomer) for wear.
- Check the leak resistance of the pump, especially the shaft seals.

Pump Disassembly

NOTE: During disassembly, observe the position of the pump components in relation to each other. Nordson EFD recommends marking the position of the components and numbering them consecutively.

Required Tools

- 11 mm low-profile open-end wrench (for luer fitting removal or installation)
- Spanner wrench 
- Coupling anti-rotation pin (shipped with the pump) 
- 14 mm low-profile open-end wrench (for stator removal or installation)
- M3 hex wrench 

Preparation for Service

1. Shut off the air supply to the system.
2. Stop the fluid supply to the pump and disconnect fluid supply tubing.
3. Disconnect the pump motor cable from the controller.
4. Remove the pump from the pump bracket.
5. Remove the dispensing tip.

Remove the Luer Fitting and Outlet Adapter

1. Use an 11 mm low-profile open-end wrench to remove the luer fitting.
2. Use a spanner wrench to remove the outlet adapter. 

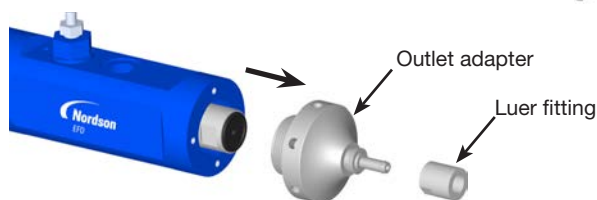

Pump Disassembly (continued)

Remove the Stator

1. Insert the coupling anti-rotation pin into the housing to secure the coupling. If needed, carefully turn the stator / robot assembly until you feel the pin drop in between the tabs of the gear ring.

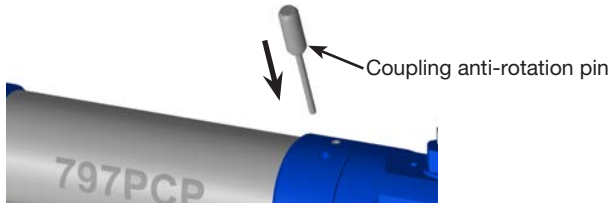

2. After the coupling is secured, use a 14 mm low-profile open-end wrench to carefully turn the stator counterclockwise to remove it.



3. If the pump will be returned to normal operation directly after service, continue to "Remove the Fluid Body" on page 21 to complete the pump disassembly.

If the pump will be stored, then disassembly is complete. Refer to "Pump Storage" on page 24 for details.

Pump Disassembly (continued)

Remove the Fluid Body

1. Use an M3 hex wrench to loosen the dog head set screws located in the mounting flange, then remove motor assembly.



2. Unscrew and remove the mounting flange.

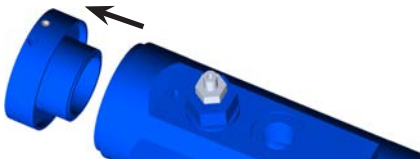

3. Remove the seal bearing and rotor assemblies.

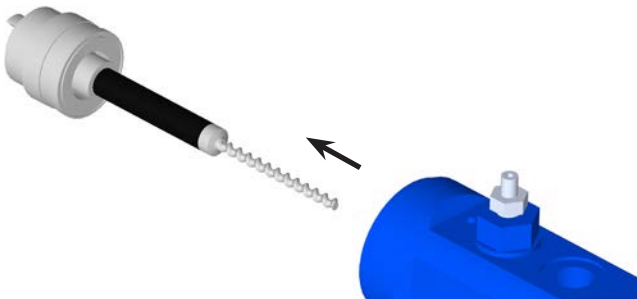

4. Carefully isolate the seal bearing assembly from the rotor.
5. Disassemble the seal bearing assembly and inspect the components. Obtain replacements for any damaged components.

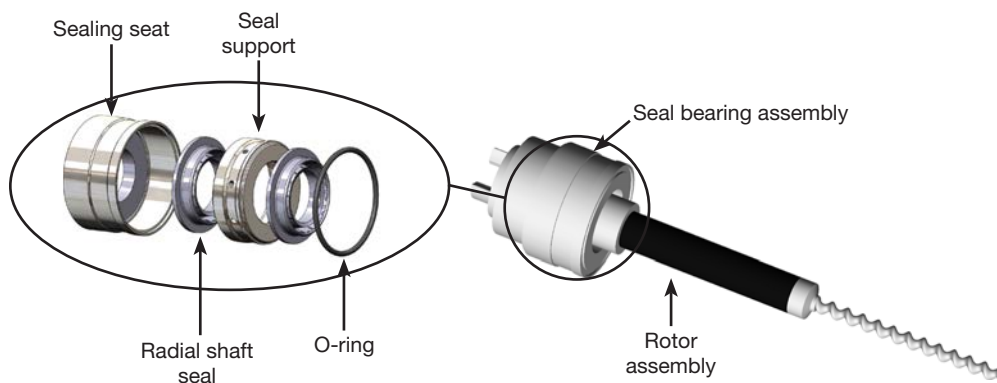

Pump Assembly

During assembly:

- Inspect O-rings and seals for damage and replace with new ones as needed.
- Always replace PTFE gaskets.
- Completely remove any sealant residue.

Reassemble the Fluid Body

1. Assemble the seal bearing assembly and install it on the rotor assembly.

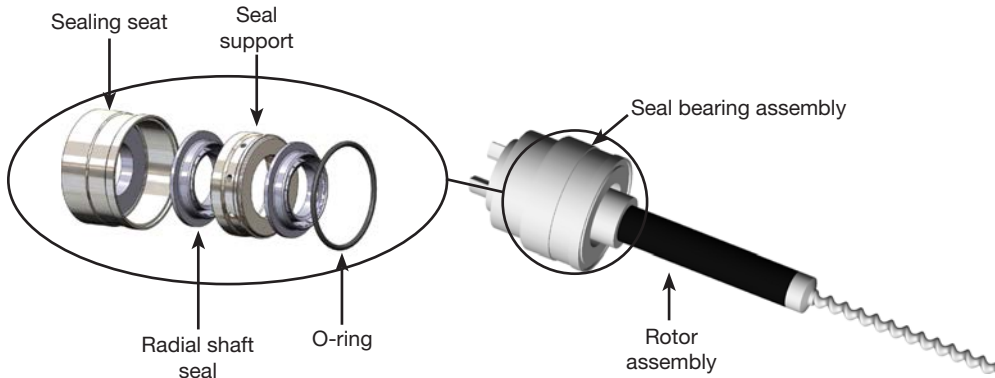

2. Insert the seal bearing and rotor assemblies in the pump housing.

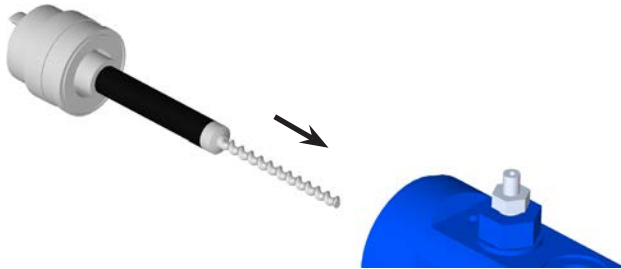

3. Reinstall the mounting flange.

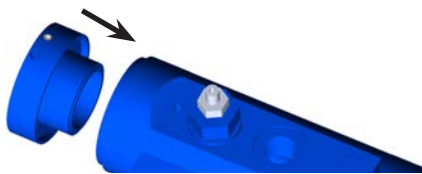

4. Use an M3 hex wrench to install the motor assembly using the two dog head set screws removed previously.

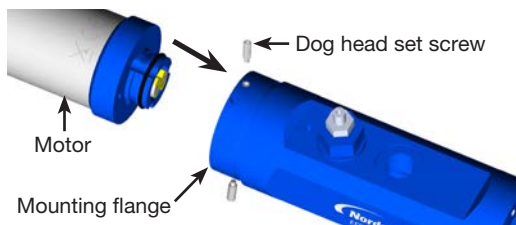

Pump Assembly (continued)

Install the Stator

1. Insert the coupling anti-rotation pin into the housing to secure the coupling. If needed, carefully turn the stator / robot assembly until you feel the pin drop in between the tabs of the gear ring.

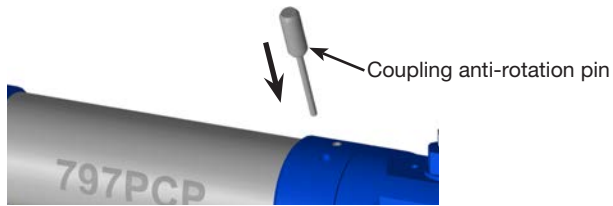

2. Carefully screw the stator clockwise first onto the rotor, and then into the threads inside the pump housing, until it is fully tightened in the fluid body housing. Avoid over-torquing.



3. Thread the outlet adapter onto the pump body and use the spanner wrench to tighten.
4. Use an 11 mm low-profile open-end wrench to reinstall the luer fitting.

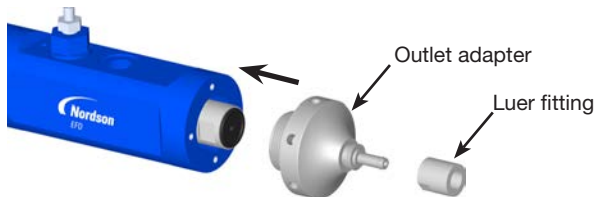

5. Install the dispensing tip.

Pump assembly is now complete. Reinstall the pump on the production line and restore the system to normal operation.

Pump Storage

For long periods of downtime or for storage, remove the stator from the rotor to prevent rotor deformation. Refer to the following procedures to remove the stator:

- “Remove the Luer Fitting and Outlet Adapter” on page 19
- “Remove the Stator” on page 20

To restore the pump to normal operation, refer to “Assemble the Pump” on page 9.

Ensure that the following conditions are met for pump storage:

- The stator is removed from the rotor.
- The maximum ambient storage temperature is 25° C (77° F); the relative humidity maximum is 80%.
- Pump and motor assemblies are stored in enclosed rooms.
- Pumps are protected against sunlight and UV light.
- No aggressive or corrosive materials or agents are stored nearby.

Part Numbers

The 797PCP and pump motor cable are ordered separately.

797PCPs

All 797PCPs include the coupling anti-rotation tool.



| Part # | Description | Material |
|---------|---|-------------------|
| 7364197 | 797PCP-0.01 pump, 0.01 mL per revolution, 0.13–1.95 mL per minute flow rate | Anodized aluminum |
| 7364198 | 797PCP-0.05 pump, 0.05 mL per revolution, 0.59–8.85 mL per minute flow rate | Anodized aluminum |
| 7364199 | 797PCP-0.15 pump, 0.15 mL per revolution, 1.63–24.50 mL per minute flow rate | Anodized aluminum |
| 7366147 | SS-797PCP-0.15 pump, 0.15 mL per revolution, 1.63–24.50 mL per minute flow rate | Stainless steel |
| 7366004 | 797PCP-0.30 pump, 0.30 mL per revolution, 0.30–45.0 mL per minute flow rate | Anodized aluminum |

797PCP Selection for Highly Abrasive / Filled Materials

Although 797PCPs can be used to dispense particle-filled materials, doing so will cause premature wear to the rotor and stator, requiring rotor / stator replacement. When using a 797PCP to dispense particle-filled materials, first consult with your Nordson EFD representative. Proper pump selection will be based on the percentage of particles in the fluid, the type and size of the particles, and the shape (sharp, soft and round, or hard and abrasive).

CAUTION

Risk of equipment damage. The dispensing of highly abrasive / filled materials or pastes causes premature rotor / stator damage.

Pump Motor Cable

| Item | Part # | Description |
|---|---------|---------------------------------|
|  | 7364280 | Pump motor cable, 5 m (16.4 ft) |

Accessories

Mounting Bracket

| Item | Part # | Description |
|---|---------|---|
|  | 7364423 | 797PCP mounting bracket for PROPlus / PRO Series, E / EV Series, and GV Series robots |

Fluid Supply

Many fluid supply options are available. Contact your Nordson EFD application specialist for assistance. For a complete list of Optimum™ components, see www.nordsonefd.com/Optimum.

Accessories (continued)

Fluid Inlet Fittings

| Item | Part # | Description | Material | Color |
|---|---------|--|-----------------|---------|
|  | 7364741 | Fitting: 1/8 NPT x M8 reducer NOTE: Use with syringe barrel adapter P/ Ns 7825120 and 7825121. | Stainless steel | Silver |
|  | 7825120 | Steel luer lock adapter for syringe barrels NOTE: Use with fitting P/N 7364741. | Stainless steel | Silver |
|  | 7825121 | Plastic luer lock adapter for syringe barrels NOTE: Use with fitting P/N 7364741. | Plastic (PEEK) | Natural |
|  | 7014732 | Fitting: 1/8 NPT x 3/8 compression elbow, stainless steel | Stainless steel | Silver |
|  | 7021532 | Fitting: 1/8 NPT x 1/4 compression | Polypropylene | Black |
|  | 7007038 | Fitting: 1/8 NPT x 3/8 compression | Polypropylene | Black |
|  | 7021499 | Fitting: 1/8 NPT x 1/4 compression elbow | Polypropylene | Black |
|  | 7020903 | Fitting: Barrel to 1/8 NPT elbow | Polypropylene | Black |
|  | 7021464 | Elbow fitting: 1/8 NPT x 1/8 barb | Polypropylene | Clear |
|  | 7020898 | Fitting: 1/8 NPT x 3/8 compression elbow | Nylon | Black |

Replacement Parts

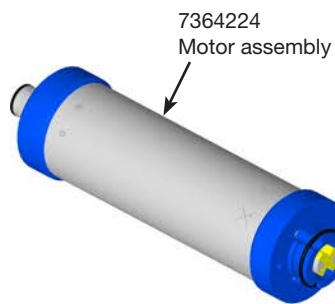

- 7364215 Stator / rotor, FFKM, 0.01 mL/rev
- 7364217 Stator / rotor, FFKM, 0.05 mL/rev
- 7364219 Stator / rotor, FFKM, 0.15 mL/rev
- 7366006 Stator / rotor, FFKM, 0.30 mL/rev
- 7364216 Stator, FFKM, 0.01 mL/rev
- 7364218 Stator, FFKM, 0.05 mL/rev
- 7364220 Stator, FFKM, 0.15 mL/rev
- 7366030 Stator, FFKM, 0.30 mL/rev

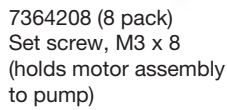

Dispensing tip
(refer to the
Nordson EFD
product catalog)

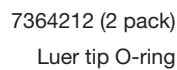

Troubleshooting

| Problem | Possible Cause | Corrective Action |
|---------------------------------------|---|---|
| No fluid flow | Dispense tip clogged | Replace the dispense tip. |
| | Loose or disconnected pump motor cable | Check the motor cable connection. Tighten if needed. |
| | Fluid supply low or empty | <div style="background-color: #e1f5fe; padding: 5px; text-align: center;">  CAUTION </div> Risk of equipment damage. Do not operate the 797PCP without fluid. Excessive friction of dry components can damage the pump. Check the fluid supply. |
| | Fluid pressure too low | Increase the fluid pressure. |
| Inconsistent deposit size | Fluid dried or cured | Replace the fluid supply with fresh fluid. |
| | Fluid pressure fluctuating | Ensure that the fluid pressure remains constant. |
| | Dispense time too short | Increase the dispense time. Refer to the controller manual for information on controlling the pump. |
| | Trapped air in the dispensing tip or fluid supply | Purge the system. Refer to “Purge Through the Tip” on page 15. |
| Skipped deposits | Intermittent pump motor signal | Check the pump motor cable and motor assembly; tighten connections or replace components as needed. |
| | Trapped air in the dispensing tip or fluid supply | Purge the system. Refer to “Purge Through the Tip” on page 15. |
| Fluid drools after pump is turned off | Trapped air in the dispensing tip or fluid supply | Purge the system. Refer to “Purge Through the Tip” on page 15. |
| | Suck-back setting too low | Adjust the suck-back setting (Reverse %). Refer to the controller manual. |