

You have selected a reliable, high-quality dispensing system from Nordson EFD, the world leader in fluid dispensing. The ValveMate™ 7197PCP controller is designed specifically for industrial dispensing and will provide you with years of trouble-free, productive service.

This manual will help you maximize the usefulness of your ValveMate 7197PCP controller.

Please spend a few minutes to become familiar with the controls and features. Follow our recommended testing procedures. Review the helpful information we have included, which is based on more than 50 years of industrial dispensing experience.

Most questions you will have are answered in this manual. However, if you need assistance, please do not hesitate to contact EFD or your authorized EFD distributor. Detailed contact information is provided on the last page of this document.

The Nordson EFD Pledge

Thank You!

You have just purchased the world's finest precision dispensing equipment.

I want you to know that all of us at Nordson EFD value your business and will do everything in our power to make you a satisfied customer.

If at any time you are not fully satisfied with our equipment or the support provided by your Nordson EFD Product Application Specialist, please contact me personally at 800.556.3484 (US), 401.431.7000 (outside US), or Ferran.Ayala@nordsonefd.com.

I guarantee that we will resolve any problems to your satisfaction.

Thanks again for choosing Nordson EFD.

The image shows a handwritten signature in black ink that reads "Ferran".

Ferran Ayala, Vice President

Contents

| | |
|---|----|
| Contents | 3 |
| Introduction | 5 |
| Nordson EFD Product Safety Statement | 6 |
| Halogenated Hydrocarbon Solvent Hazards | 7 |
| High Pressure Fluids | 7 |
| Qualified Personnel | 7 |
| Intended Use | 8 |
| Regulations and Approvals | 8 |
| Personal Safety | 8 |
| Fire Safety | 9 |
| Preventive Maintenance | 9 |
| Important Disposable Component Safety Information | 10 |
| Action in the Event of a Malfunction | 10 |
| Disposal | 10 |
| Specifications | 11 |
| Operating Features | 12 |
| Installation | 13 |
| Unpack the System Components | 13 |
| Install the 797PCP | 14 |
| Install the Ancillary System Components | 14 |
| Connect the ESTOP Jumper | 14 |
| Connect the Foot Pedal | 14 |
| Connect Power | 15 |
| Connect the Pump Motor Cable | 15 |
| Connect a Purge Initiate Signal (Optional) | 16 |
| Make the Ethernet Connection (Optional) | 16 |
| Purge the Pump | 17 |
| Installation Example | 18 |
| ValveMate 7197PCP Controller and 797PCP in a One-Component System | 18 |
| Programming | 19 |
| Navigation | 19 |
| Entering Values on the Touchscreen | 20 |
| Variable Table | 20 |
| Status Indications | 21 |
| Flowchart of Controller Screens (ValveMate 7197PCP) | 22 |
| Flowchart of Controller Screens (7197PCP Web Application) | 23 |
| Adjusting the Purge Speed Setting | 24 |
| Creating Programs | 25 |
| Line Programs | 27 |
| Volume Programs | 28 |
| Weight Programs | 29 |
| Teach Programs | 30 |
| Timed Programs | 31 |
| Saving a Program to the Program Library (Save Screen) | 32 |
| Opening a Saved Program (Load Screen) | 33 |
| Locking or Unlocking the System (Touchscreen Only) | 34 |
| Resetting the Password | 36 |
| Setting the Language | 37 |
| Viewing the System Information | 38 |
| Defining the Controller Network Settings | 39 |

Continued on next page

Contents (continued)

| | |
|--|----|
| Operation..... | 40 |
| Routine Startup..... | 40 |
| Errors and Emergency Stops (ESTOP)..... | 40 |
| Disabling a Pump..... | 41 |
| Longterm Shutdown..... | 42 |
| Firmware Update..... | 42 |
| Part Numbers..... | 43 |
| ValveMate 7197PCP Controller..... | 43 |
| 797PCPs and Pump Motor Cable..... | 43 |
| Accessories..... | 43 |
| Replacement Parts..... | 43 |
| Troubleshooting..... | 44 |
| Viewing the Log..... | 44 |
| Event Log Feedback Troubleshooting..... | 44 |
| General Troubleshooting..... | 45 |
| Technical Data..... | 46 |
| I/O Port Pin Assignments and Wiring Diagrams..... | 46 |
| Sourcing Wiring Diagram for Connecting the Cycle Initiate (Ex_Trig)..... | 47 |
| Sinking Wiring Diagram for Connecting the Cycle Initiate (Ex_Trig)..... | 47 |
| Wiring Diagram for Connecting the Emergency Stop (ESTOP) Circuit..... | 47 |
| Wiring Diagrams for Connecting the PURGE Initiate Circuit..... | 48 |
| Maximum Motor Speed Based on Viscosity..... | 49 |
| Motor Port Pin Assignments..... | 50 |
| Appendix A, Changing the IP Address of a Computer..... | 51 |
| Appendix B, Example Volume Program..... | 53 |

Introduction

This manual provides installation, setup, programming, and service information for the ValveMate 7197PCP controller. The ValveMate 7197PCP controller provides precise dispensing control for Nordson EFD 797PCP Series progressive cavity pumps. Refer to the applicable 797PCP operating manual for detailed information on the pump.

The ValveMate 7197PCP controller features an easy-to-use touchscreen interface for quick setup and operation of 797PCPs in a one-component application. Dispense programs are created based on the way you want to control material output, including the following:

- By dispense time, in milliseconds
- By material volume, in milliliters
- By material weight, in grams

The controller also includes a Teach feature, which allows you to “teach” the controller the desired dispense time and volume settings.

As with all EFD products, the ValveMate 7197PCP controller has been produced to exacting specifications and thoroughly tested prior to shipment.

To obtain maximum performance from this equipment, read this manual carefully.



Nordson EFD Product Safety Statement

WARNING

The safety message that follows has a WARNING level hazard.
Failure to comply could result in death or serious injury.



ELECTRIC SHOCK

Risk of electric shock. Disconnect power before removing covers and / or disconnect, lock out, and tag switches before servicing electrical equipment. If you receive even a slight electrical shock, shut down all equipment immediately. Do not restart the equipment until the problem has been identified and corrected.

CAUTION

The safety messages that follow have a CAUTION level hazard.
Failure to comply may result in minor or moderate injury.



READ MANUAL

Read manual for proper use of this equipment. Follow all safety instructions. Task- and equipment-specific warnings, cautions, and instructions are included in equipment documentation where appropriate. Make sure these instructions and all other equipment documents are accessible to persons operating or servicing equipment.



MAXIMUM AIR PRESSURE

Unless otherwise noted in the product manual, the maximum air input pressure is 7.0 bar (100 psi). Excessive air input pressure may damage the equipment. Air input pressure is intended to be applied through an external air pressure regulator rated for 0 to 7.0 bar (0 to 100 psi).



RELEASE PRESSURE

Release hydraulic and pneumatic pressure before opening, adjusting, or servicing pressurized systems or components.



BURNS

Hot surfaces! Avoid contact with the hot metal surfaces of heated components. If contact can not be avoided, wear heat-protective gloves and clothing when working around heated equipment. Failure to avoid contact with hot metal surfaces can result in personal injury.

Nordson EFD Product Safety Statement (continued)

Halogenated Hydrocarbon Solvent Hazards

Do not use halogenated hydrocarbon solvents in a pressurized system that contains aluminum components. Under pressure, these solvents can react with aluminum and explode, causing injury, death, or property damage. Halogenated hydrocarbon solvents contain one or more of the following elements.

| Element | Symbol | Prefix |
|----------|--------|-----------|
| Fluorine | F | “Fluoro-” |
| Chlorine | Cl | “Chloro-” |
| Bromine | Br | “Bromo-” |
| Iodine | I | “Iodo-” |

Check the Safety Data Sheet (SDS) or contact your material supplier for more information. If you must use halogenated hydrocarbon solvents, contact your EFD representative for compatible EFD components.

High Pressure Fluids

High pressure fluids, unless they are safely contained, are extremely hazardous. Always release fluid pressure before adjusting or servicing high pressure equipment. A jet of high pressure fluid can cut like a knife and cause serious bodily injury, amputation, or death. Fluids penetrating the skin can also cause toxic poisoning.

WARNING

Any injury caused by high pressure liquid can be serious. If you are injured or even suspect an injury:

- Go to an emergency room immediately.
- Tell the doctor that you suspect an injection injury.
- Show the doctor the following note.
- Tell the doctor what kind of material you were dispensing.

Medical Alert – Airless Spray Wounds: Note to Physician

Injection in the skin is a serious traumatic injury. It is important to treat the injury surgically as soon as possible. Do not delay treatment to research toxicity. Toxicity is a concern with some exotic coatings injected directly into the bloodstream.

Qualified Personnel

Equipment owners are responsible for making sure that EFD equipment is installed, operated, and serviced by qualified personnel. Qualified personnel are those employees or contractors who are trained to safely perform their assigned tasks. They are familiar with all relevant safety rules and regulations and are physically capable of performing their assigned tasks.

Nordson EFD Product Safety Statement (continued)

Intended Use

Use of EFD equipment in ways other than those described in the documentation supplied with the equipment may result in injury to persons or damage to property. Some examples of unintended use of equipment include:

- Using incompatible materials.
- Making unauthorized modifications.
- Removing or bypassing safety guards or interlocks.
- Using incompatible or damaged parts.
- Using unapproved auxiliary equipment.
- Operating equipment in excess of maximum ratings.
- Operating equipment in an explosive atmosphere.

Regulations and Approvals

Make sure all equipment is rated and approved for the environment in which it is used. Any approvals obtained for Nordson EFD equipment will be voided if instructions for installation, operation, and service are not followed. If the equipment is used in a manner not specified by Nordson EFD, the protection provided by the equipment may be impaired.

Personal Safety

To prevent injury, follow these instructions:

- Do not operate or service equipment unless you are qualified.
- Do not operate equipment unless safety guards, doors, and covers are intact and automatic interlocks are operating properly. Do not bypass or disarm any safety devices.
- Keep clear of moving equipment. Before adjusting or servicing moving equipment, shut off the power supply and wait until the equipment comes to a complete stop. Lock out power and secure the equipment to prevent unexpected movement.
- Make sure spray areas and other work areas are adequately ventilated.
- When using a syringe barrel, always keep the dispensing end of the tip pointing towards the work and away from the body or face. Store syringe barrels with the tip pointing down when they are not in use.
- Obtain and read the Safety Data Sheet (SDS) for all materials used. Follow the manufacturer's instructions for safe handling and use of materials and use recommended personal protection devices.
- Be aware of less-obvious dangers in the workplace that often cannot be completely eliminated, such as hot surfaces, sharp edges, energized electrical circuits, and moving parts that cannot be enclosed or otherwise guarded for practical reasons.
- Know where emergency stop buttons, shutoff valves, and fire extinguishers are located.
- Wear hearing protection to protect against hearing loss that can be caused by exposure to vacuum exhaust port noise over long periods of time.

Nordson EFD Product Safety Statement (continued)

Fire Safety

To prevent a fire or explosion, follow these instructions:

- Shut down all equipment immediately if you notice static sparking or arcing. Do not restart the equipment until the cause has been identified and corrected.
- Do not smoke, weld, grind, or use open flames where flammable materials are being used or stored.
- Do not heat materials to temperatures above those recommended by the manufacturer. Make sure heat monitoring and limiting devices are working properly.
- Provide adequate ventilation to prevent dangerous concentrations of volatile particles or vapors. Refer to local codes or the SDS for guidance.
- Do not disconnect live electrical circuits when working with flammable materials. Shut off power at a disconnect switch first to prevent sparking.
- Know where emergency stop buttons, shutoff valves, and fire extinguishers are located.

Preventive Maintenance

As part of maintaining continuous trouble-free use of this product, Nordson EFD recommends the following simple preventive maintenance checks:

- Periodically inspect tube-to-fitting connections for proper fit. Secure as necessary.
- Check tubing for cracks and contamination. Replace tubing as necessary.
- Check all wiring connections for looseness. Tighten as necessary.
- Clean: If a front panel requires cleaning, use a clean, soft, damp rag with a mild detergent cleaner. DO NOT USE strong solvents (MEK, acetone, THF, etc.) as they will damage the front panel material.
- Maintain: Use only a clean, dry air supply to the unit. The equipment does not require any other regular maintenance.
- Test: Verify the operation of features and the performance of equipment using the appropriate sections of this manual. Return faulty or defective units to Nordson EFD for replacement.
- Use only replacement parts that are designed for use with the original equipment. Contact your Nordson EFD representative for information and advice.

Nordson EFD Product Safety Statement (continued)

Important Disposable Component Safety Information

All Nordson EFD disposable components, including syringe barrels, cartridges, pistons, tip caps, end caps, and dispense tips, are precision engineered for one-time use. Attempting to clean and re-use components will compromise dispensing accuracy and may increase the risk of personal injury.

Always wear appropriate protective equipment and clothing suitable for your dispensing application and adhere to the following guidelines:

- Do not heat syringe barrels or cartridges to a temperature greater than 38° C (100° F).
- Dispose of components according to local regulations after one-time use.
- Do not clean components with strong solvents (MEK, acetone, THF, etc.).
- Clean cartridge retainer systems and barrel loaders with mild detergents only.
- To prevent fluid waste, use Nordson EFD SmoothFlow™ pistons.

Action in the Event of a Malfunction

If a system or any equipment in a system malfunctions, shut off the system immediately and perform the following steps:

1. Disconnect and lock out system electrical power. If using hydraulic and pneumatic shutoff valves, close and relieve pressure.
2. For Nordson EFD air-powered dispensers, remove the syringe barrel from the adapter assembly. For Nordson EFD electro-mechanical dispensers, slowly unscrew the barrel retainer and remove the barrel from the actuator.
3. Identify the reason for the malfunction and correct it before restarting the system.

Disposal

Dispose of equipment and materials used in operation and servicing according to local codes.

Specifications

NOTE: Specifications and technical details are subject to change without prior notification.

| Item | Specification |
|------------------------------|---|
| Cabinet size | 21.2W x 10.8H x 17.3D cm (8.33W x 4.27H x 6.82D") |
| Weight | 1.8 kg (4.0 lb) |
| Rotor speed | 10–150 RPM |
| Time range | 0.001–600,000 ms (1 s to 10 min) |
| Electrical power input | 24 VDC ($\pm 2\%$), 3.75 Amp maximum |
| Feedback circuits | Electronic switch, 24 VDC, 100 mA maximum |
| Cycle initiate | Foot pedal |
| Ambient operating conditions | Temperature: 5–45° C (41–113° F) Humidity: 85% RH at 30° C, 40% at 45° C non-condensing Height above sea level: 2,000 meters max (6,562 feet) |
| Product classification | Installation Category II Pollution Degree 2 |
| Approvals | CE, UKCA, TÜV, RoHS, China RoHS, WEEE |

RoHS标准相关声明 (China RoHS Hazardous Material Declaration)

| 产品名称 Part Name | 有害物质及元素 Toxic or Hazardous Substances and Elements | | | | | |
|---|---|----------------------|----------------------|--|--|--|
| | 铅 Lead (Pb) | 汞 Mercury (Hg) | 镉 Cadmium (Cd) | 六价铬 Hexavalent Chromium (Cr6) | 多溴联苯 Polybrominated Biphenyls (PBB) | 多溴联苯醚 Polybrominated Diphenyl Ethers (PBDE) |
| 外部接口 External Electrical Connectors | X | 0 | 0 | 0 | 0 | 0 |
| <p>0: 表示该产品所含有的危险成分或有害物质含量依照EIP-A, EIP-B, EIP-C 的标准低于SJ/T11363-2006 限定要求。Indicates that this toxic or hazardous substance contained in all the homogeneous materials for this part, according to EIP-A, EIP-B, EIP-C is below the limit requirement in SJ/T11363-2006.</p> <p>X: 表示该产品所含有的危险成分或有害物质含量依照EIP-A, EIP-B, EIP-C 的标准高于SJ/T11363-2006 限定要求。Indicates that this toxic or hazardous substance contained in all the homogeneous materials for this part, according to EIP-A, EIP-B, EIP-C is above the limit requirement in SJ/T11363-2006.</p> | | | | | | |

WEEE Directive



This equipment is regulated by the European Union under WEEE Directive (2012/19/EU). Refer to www.nordsonefd.com/WEEE for information about how to properly dispose of this equipment.

Operating Features

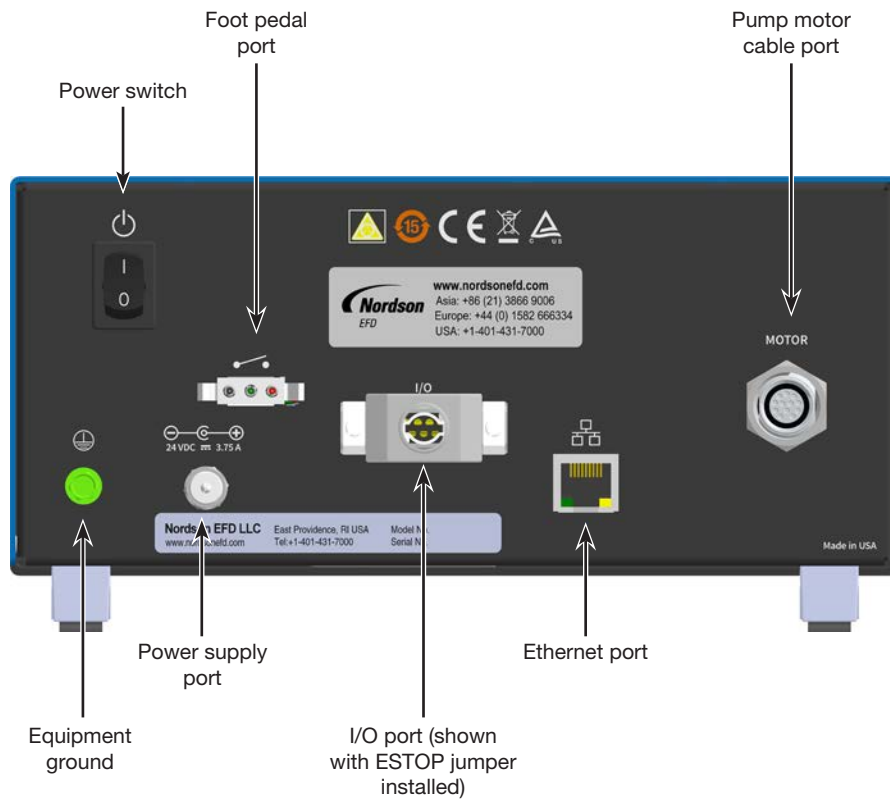
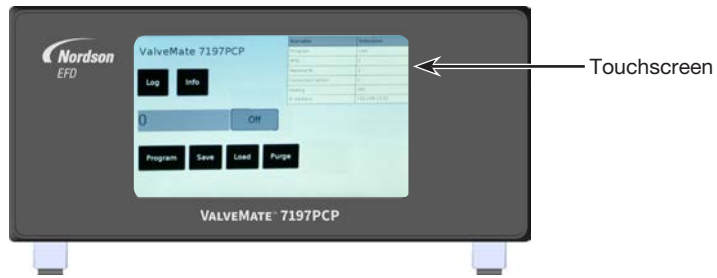

Installation

Use this section in tandem with the quick start guide and any other system component operating manuals to install all components of the system.

Unpack the System Components

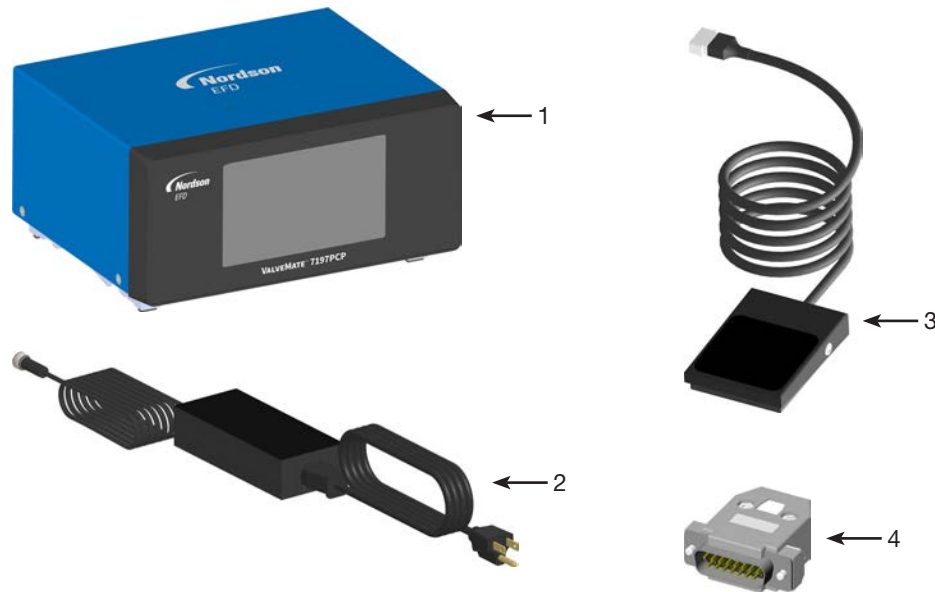

- 1 ValveMate 7197PCP controller
- 2 Power cord and power supply, 24V, 90 W (ordered separately)
- 3 Foot pedal (P/N 7014865)
- 4 ESTOP jumper, DB-15

(Not shown)

797PCP (ordered separately)

797PCP pump motor cable (ordered separately)

Quick start guide

Installation (continued)

Install the 797PCP

For pump installation instructions, refer to the applicable 797PCP manual.

Install the Ancillary System Components

NOTE: Refer to “Installation Example” on page 18 for system layout images of typical installations.

Install any system components (other than the controller and pumps) that will comprise the complete dispensing system. For example, if you are using a fluid reservoir, position and install all the fluid reservoir components. For all ancillary components, refer to the quick start guide and / or operating manual provided with those components for installation and setup instructions.

Connect the ESTOP Jumper

Connect the supplied ESTOP jumper to the I/O port on the back on the controller.

This jumper creates an ESTOP circuit. The pump will dispense only if the ESTOP pins (Estop_H and Estop_L) are connected. Refer to “I/O Port Pin Assignments and Wiring Diagrams” on page 46 for wiring details.

Connect the Foot Pedal

Connect the foot pedal to the foot pedal port on the back of the controller.

NOTE: An alternative to the foot pedal is a 24 VDC dispense cycle initiate signal connected to the I/O port. To use this option, you will need to remove the ESTOP jumper and then make the correct connections to the I/O port. Nordson EFD recommends using a breakout board and cable to connect wiring to the I/O port. Refer to “I/O Port Pin Assignments and Wiring Diagrams” on page 46 for wiring details. Contact your Nordson EFD representative for assistance in obtaining a breakout board and cable.



Installation (continued)

Connect Power

NOTES:

- Use only the power cord purchased with the unit.
 - Ensure that the power source is located near the equipment and is easily accessible.
 - Use only on a circuit with a fuse or circuit breaker that is 20 A or less.
1. Connect the power cord to the back of each controller and to your local power source.
 2. Connect a 16 AWG (1.3 mm) wire to the chassis grounding screw on the rear of the chassis using a toothed grounding lug. The wire must have green insulation with a yellow stripe or must be noninsulated (bare).
 3. Attach the opposite end of the wire to a permanent earth ground using toothed washers or a toothed lug.

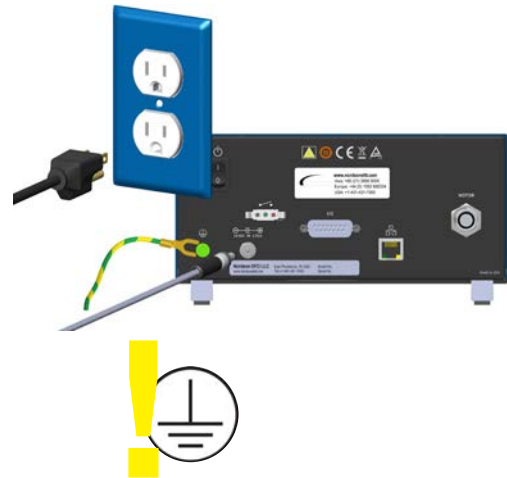

Connect the Pump Motor Cable

For each 797PCP, connect the pump motor cable to the MOTOR port on its controller.

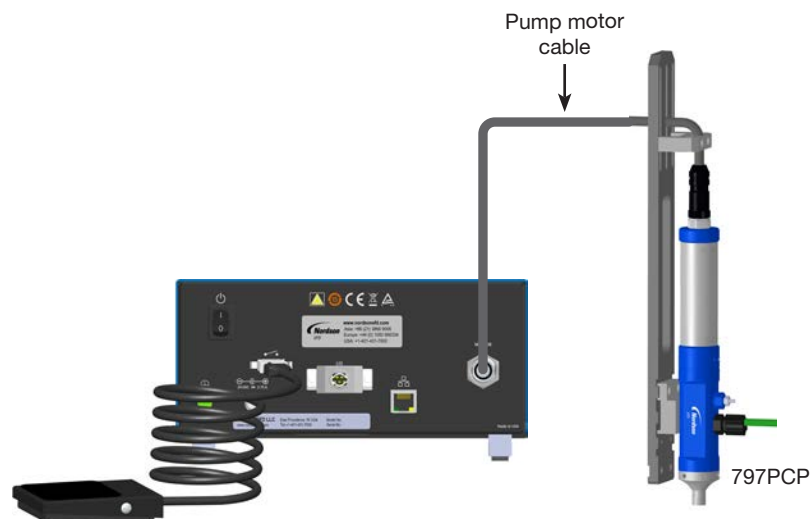

Installation (continued)

Connect a Purge Initiate Signal (Optional)

If you want to connect an external purge initiate, you will need to remove the ESTOP jumper and then make the appropriate connections to the I/O port. Nordson EFD recommends using a breakout board and DB-15 cable to make these connections.

- Contact your Nordson EFD representative for assistance in obtaining a breakout board and cable.
- Refer to “I/O Port Pin Assignments and Wiring Diagrams” on page 46 for wiring details.

Make the Ethernet Connection (Optional)

An Ethernet cable can be connected to the ValveMate 7197PCP controller to support factory integration and firmware updates. Make the Ethernet connection as applicable for your system.

NOTE: A ValveMate 7197PCP controller’s preprogrammed IP address is 192.168.10.51. If there are multiple ValveMate 7197PCP controllers on the same network, they each need a unique IP address:

- To change the IP address of a ValveMate 7197PCP controller, refer to “Defining the Controller Network Settings” on page 39.
- To change the IP address of a computer, refer to “Appendix A, Changing the IP Address of a Computer” on page 51.

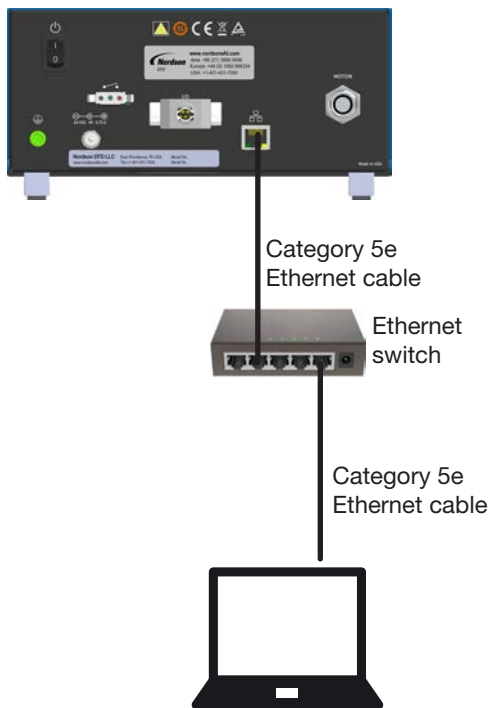

Making the Ethernet connection between the ValveMate 7197PCP and a computer

Installation (continued)

Purge the Pump

Before creating any programs or placing the system into operation for the first time, purge each pump without a tip installed and then with a tip installed.

CAUTION

Risk of equipment damage. **Do not operate a 797PCP without material.** Excessive friction of dry components can damage the pump.

1. (Touchscreen interface only) On the Main screen, select PROGRAM.
2. Select LINE.
3. Select the ENABLE LINE PROGRAM radio button.

NOTES:

- The Line program will be used to purge the pump.
 - The default purge speed is 10 RPM. To change the purge speed, refer to “Adjusting the Purge Speed Setting” on page 24.
4. **Refer to the pump purging procedures in the installation section of the pump manual to purge each 797PCP in the system. Return here to continue.**

The system is now ready for routine operation. Continue to “Programming” on page 19 to create dispense programs for pump operation.

ValveMate 7197PCP Touchscreen

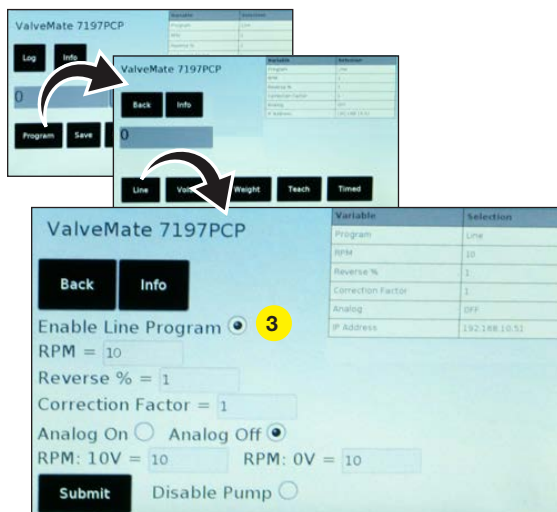

Line screen, touchscreen interface

7197PCP Web



Line screen, web interface

Installation Example

ValveMate 7197PCP Controller and 797PCP in a One-Component System

For pump installation instructions, refer to the 797PCP operating manual.

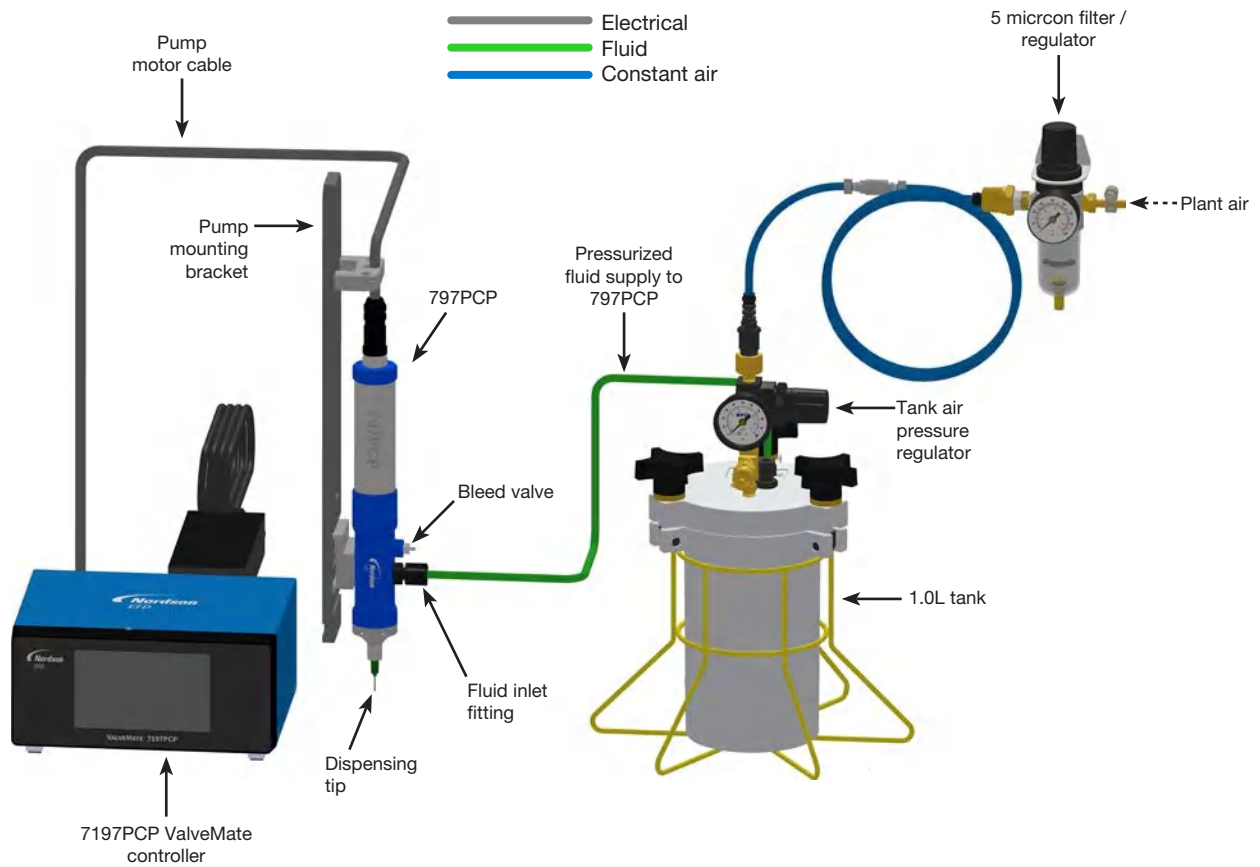

Programming

The ValveMate 7197PCP controller is operated via a touchscreen interface.

NOTE: Making an Ethernet connection allows you to also control the system via a web interface. Refer to “Make the Ethernet Connection (Optional)” on page 16 for details. This section applies to the ValveMate 7197PCP touchscreen interface. The 7197PCP web interface functions in the same manner except for the following: (1) The Program screen is eliminated.

Navigation

From the Main screen, you can access all other screens:

- On the touchscreen interface, all buttons except the program type buttons are present on the main screen. To access the program type buttons, select Program.
- On the web interface, all buttons are present on the Main screen.

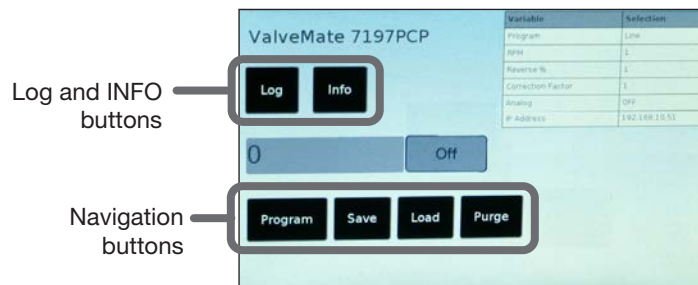

Main screen, touchscreen interface



Main screen, web interface

| Button | Description | Relevant Section in this Manual |
|--------------------------------------|---|--|
| Refresh (web only) | Returns the web interface to the Main screen | n/a |
| Log | Opens the Log screen | “Viewing the Log” on page 44 |
| INFO | Opens a screen that provides information about the currently selected screen | n/a |
| Program (touchscreen interface only) | Opens the Program screen, where you can select the type of program to create: Line, Volume, Weight, Teach, or Timed | “Creating Programs” on page 25 |
| Save | Opens the Save screen | “Saving a Program to the Program Library (Save Screen)” on page 32 |
| Load | Opens the Load screen | “Opening a Saved Program (Load Screen)” on page 33 |
| Purge | Displays the Purge screen to allow adjustment of the purge speed | “Adjusting the Purge Speed Setting” on page 24 |

Programming (continued)

Entering Values on the Touchscreen

When you select a numeric value to edit, a numeric keypad opens:

- Use the keypad to enter the desired value.
- To clear all entered numbers, select CLEAR.
- To delete only the last number entered, select DEL.
- To save the entered value, select DONE.



Variable Table

The variable table at the top right of the screen changes based on the open program. For the Line, Volume, Weight, Teach, and Timed program screens, the variable table shows the currently entered value of the variables. For example, when you select the Line Program screen, the table changes to show the current values of the Line Program settings.

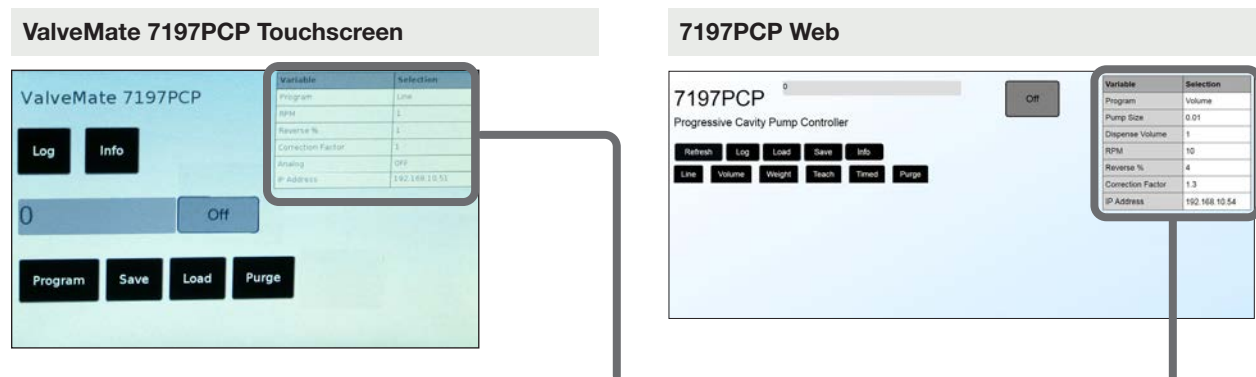

Variable table: The content of this table changes based on the selected program / variables.

Programming (continued)

Status Indications

On the touchscreen interface, the status indications shown below are present on the Main screen.

On the web interface, these status indication are present on the Line, Volume, Weight, Teach, Timed, and Purge screens.

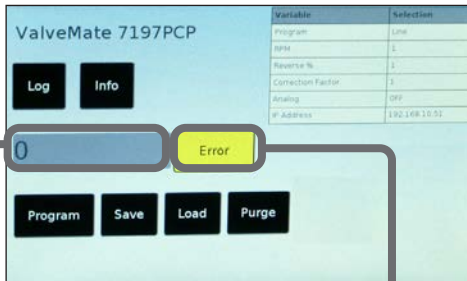

| Operating Mode | Indicator Description |
|------------------------|--|
| Volume program running | Shows what percentage of the dispense cycle remains |
| Weight program running | |
| Timed program running | |
| Teach program OFF | |
| Teach program ON | Shows how long the dispense cycle has been triggered |
| Line program running | Shows the speed in RPM |

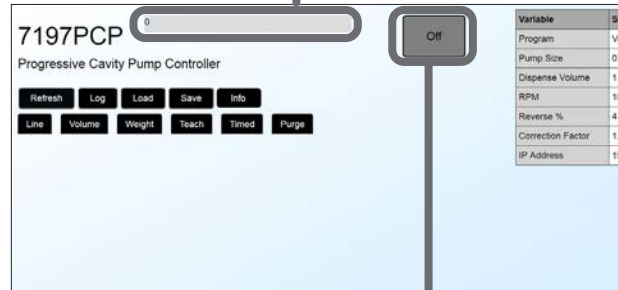

Main screen, touchscreen interface

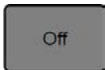

Main screen, web interface

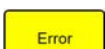
| Status | Color | Description |
|---------|---|---|
| Off |  Dark gray | The pump is not running. |
| Running |  Green | The system is running normally. |
| ESTOP |  Red | An emergency stop has occurred. |
| Error |  Yellow | An error has occurred. Refer to "Troubleshooting" on page 44. |

Programming (continued)

Flowchart of Controller Screens (ValveMate 7197PCP)

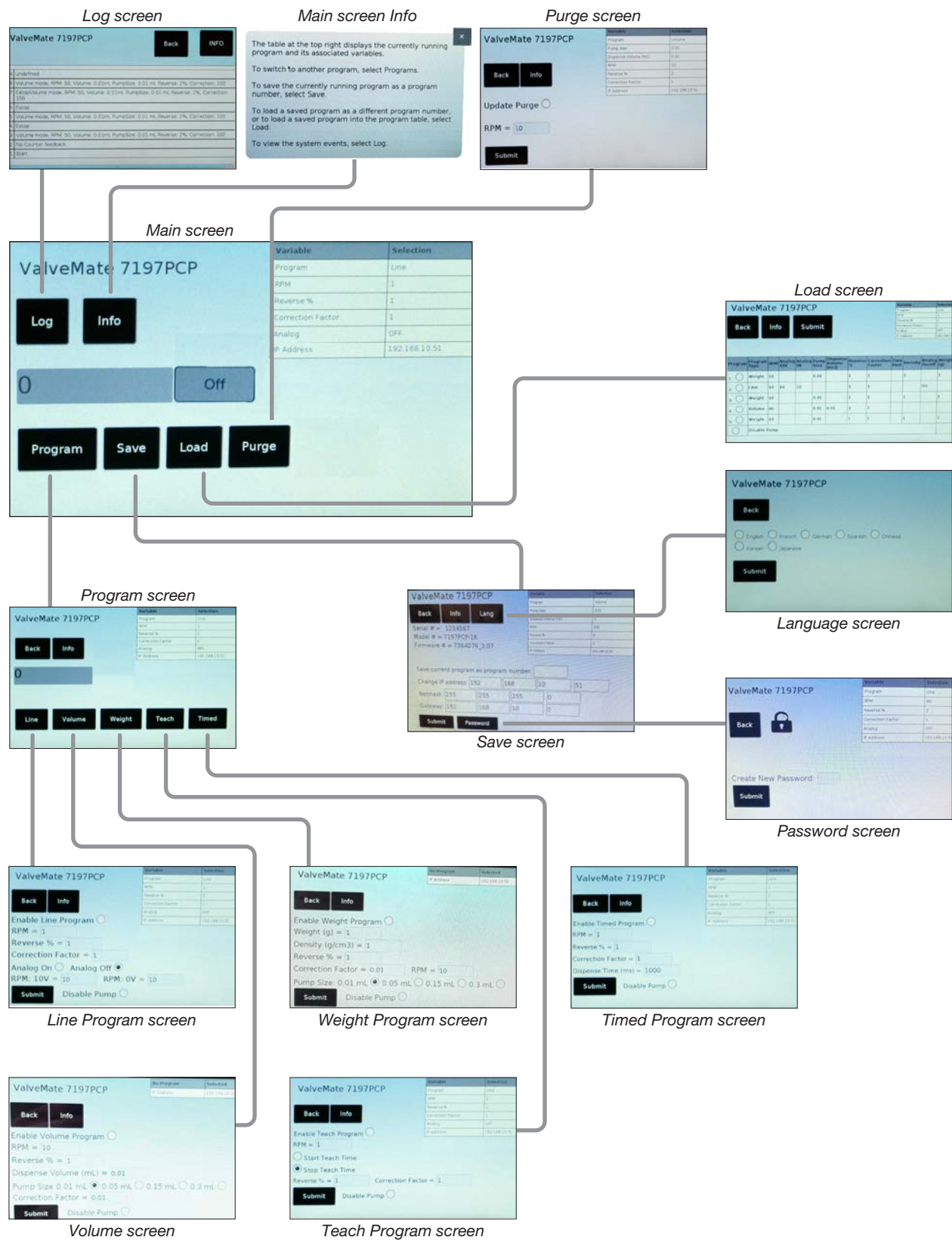

Programming (continued)

Flowchart of Controller Screens (7197PCP Web Application)

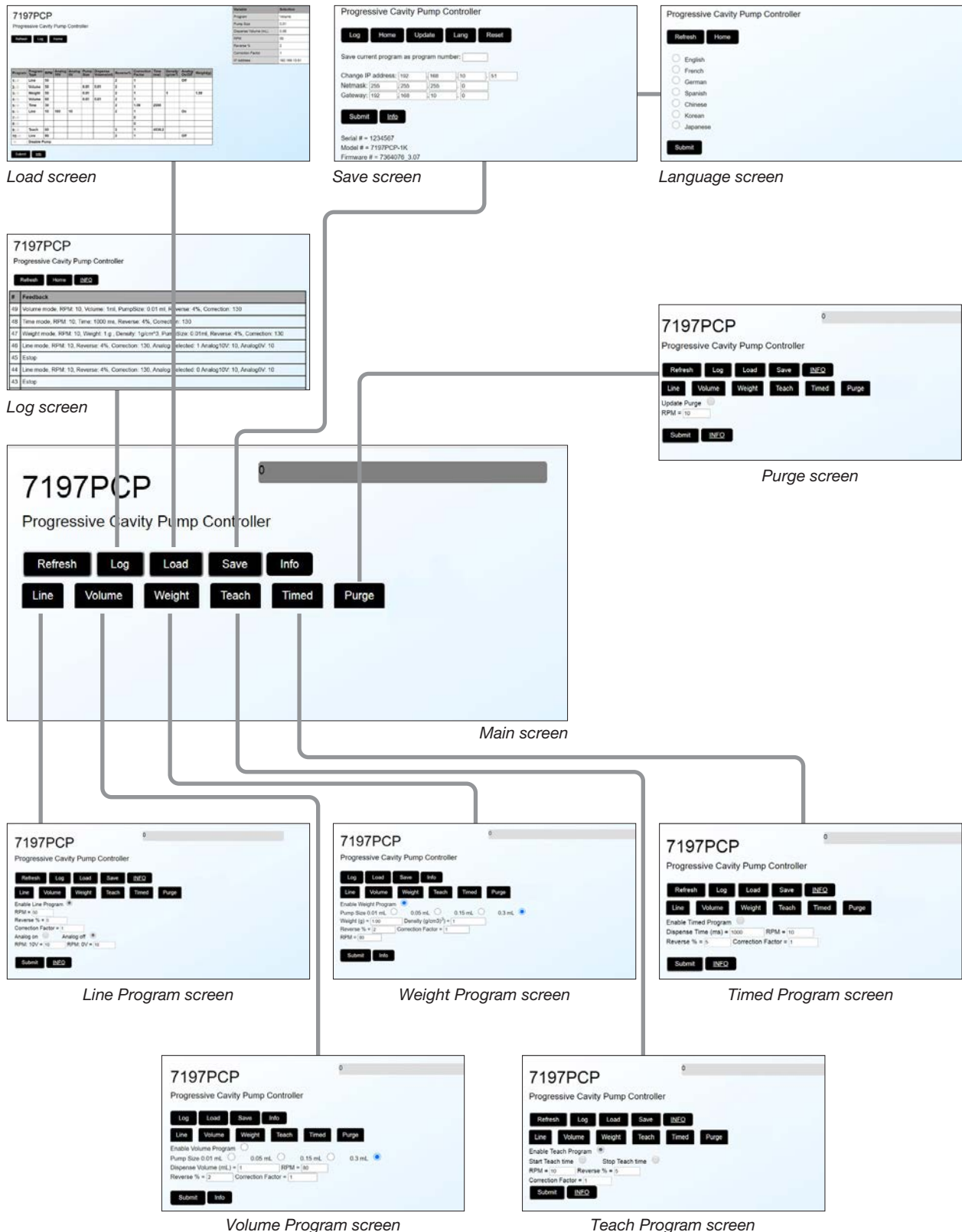

Programming (continued)

Adjusting the Purge Speed Setting

Before placing the system into operation, or anytime that purging is required, refer to the pump manual for the purging procedure. Use this procedure only to change the purge RPM, ensuring that the maximum allowable motor speed is not exceeded. Refer to “Maximum Motor Speed Based on Viscosity” on page 49.

1. On the Main screen, select PURGE.
2. Select the UPDATE PURGE radio button.
3. Enter the desired RPM setting, ensuring that the maximum allowable motor speed is not exceeded. Refer to “Maximum Motor Speed Based on Viscosity” on page 49.

NOTE: Values must be within the specified range limits, or they will not save.

4. Select SUBMIT. The Purge RPM speed updates, and the saved purge RPM is displayed in the Variable table next to RPM.

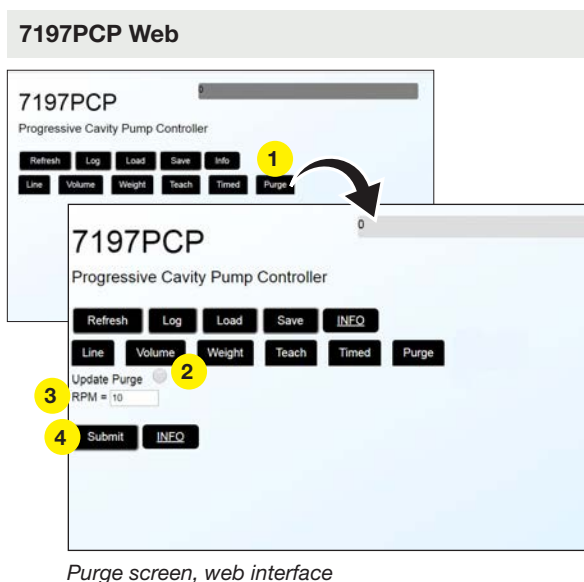
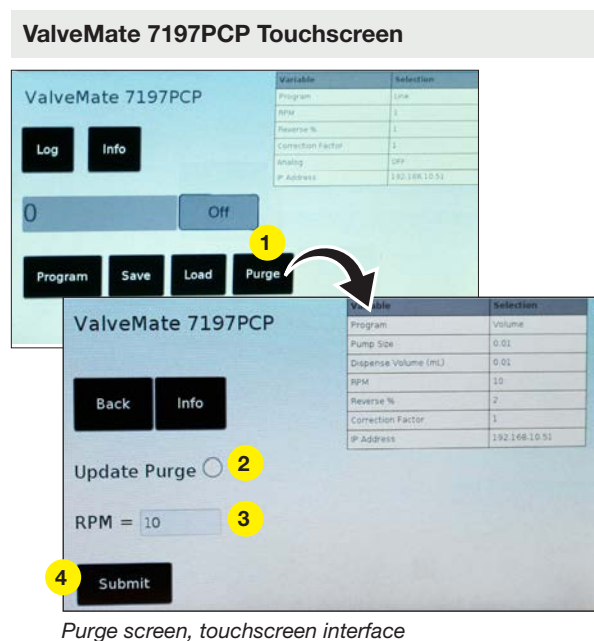

| Variable | Range | Description |
|----------|--------------|---|
| RPM | 10–150 (RPM) | Sets the purge motor speed in RPM; for guidance on setting the RPM, refer to “Maximum Motor Speed Based on Viscosity” on page 49. |
| INFO | n/a | Select to view information about the current screen, including the range limits for settings. |

Programming (continued)

Creating Programs

The controller allows you to create five types of program: Line, Volume, Weight, Teach, and Timed. A general programming procedure is provided on the next page. Specific programming procedures, including detailed information on all settings, are provided in the sections shown under “Detailed Information.”

| Program Type | Description | Typical Application | Detailed Information |
|--------------|---|---------------------------------------|--|
| Line | Use a Line program to dispense material continuously, for as long as the dispense cycle is activated. | Continuous lines, all viscosities | Refer to “Line Programs” on page 27. |
| Volume | Use a Volume program to dispense a specified amount of material in milliliters. | Filling a known volume | Refer to “Volume Programs” on page 28. |
| Weight | Use a Weight program to dispense a specified amount of material in grams. | Dispensing based on weight | Refer to “Weight Programs” on page 29. |
| Teach | Use Teach program to “Teach” the system the desired dispense time and volume. | Filling an unknown volume | Refer to “Teach Programs” on page 30. |
| Timed | Use a Timed program to dispense for a specified amount of time, in milliseconds per cycle. | Dispensing for a known period of time | Refer to “Timed Programs” on page 31. |

ValveMate 7197PCP Touchscreen

On the touchscreen interface, all program type buttons are on the Program screen

7197PCP Web

On the web interface, all program type buttons are on the Home screen

Variable table: The content of this table changes based on the selected program / variables.

Programming (continued)

Creating Programs (continued)

Follow this general procedure to enter settings for a program. A task-specific procedure is also provided for each program type later in this section.

1. (Touchscreen interface only) On the Main screen, select PROGRAM.
2. Select any program type button to display the variables for that selection.
3. To view information about the currently displayed screen, select INFO.
4. To enable a program, select the ENABLE [program type] PROGRAM radio button.
NOTE: If you don't enable the program, the system will not save any entered settings.
5. Make the desired radio button selections and / or enter settings inside the value fields. Refer to the applicable sections of this manual as noted in the table above for detailed information about each program type, including setting ranges.
6. When all variables are at the desired setting, select SUBMIT. The system saves the settings.
7. Select BACK (touchscreen) or REFRESH (web) to return to the Main screen.
8. To save the values you entered as a program in the Program Library, refer to "Saving a Program to the Program Library (Save Screen)" on page 32.

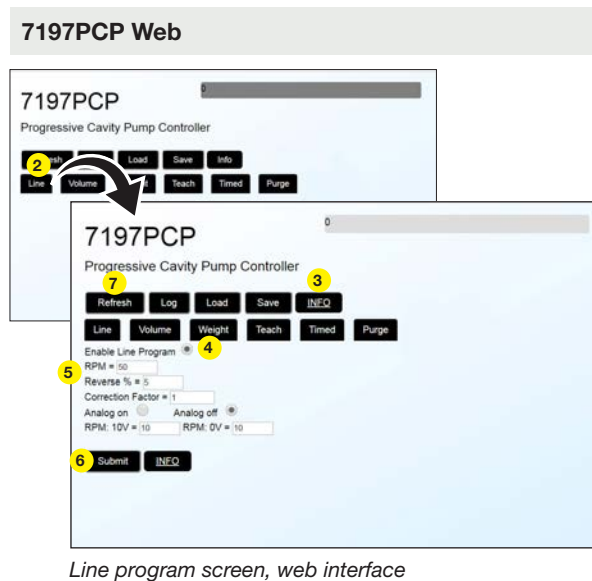
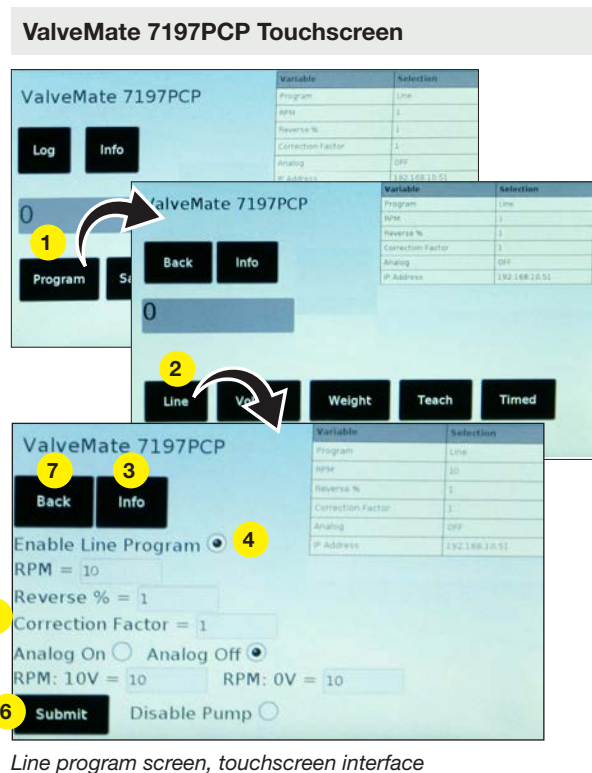

Example of general programming steps (Line program screen shown)

Programming (continued)

Line Programs

Use a Line program to dispense a continuous line of material. When a Line program is run, the pump dispenses for as long as the dispense cycle is initiated. You can enable Analog On to fine-tune the motor speed while running a Line program.

1. Navigate to the Line program screen.
2. Select the ENABLE LINE PROGRAM radio button.
NOTE: If you don't enable the program, the system will not save any entered settings.
3. Enter the desired settings, referring to the table below for detailed information on each variable.
4. Select SUBMIT to save the settings. The variable table shows the saved settings.
5. To save the values you entered as a program in the Program Library, refer to "Saving a Program to the Program Library (Save Screen)" on page 32.

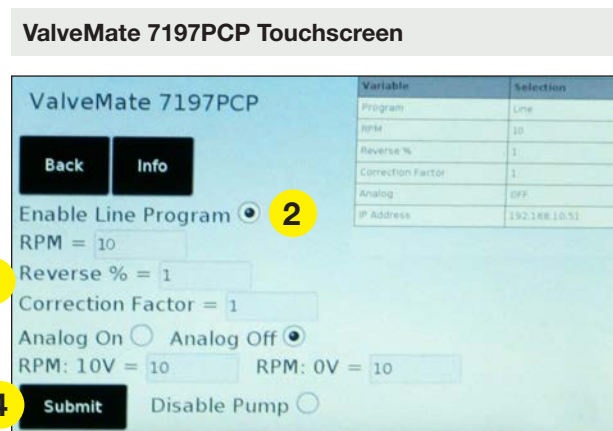

Line program screen, touchscreen interface

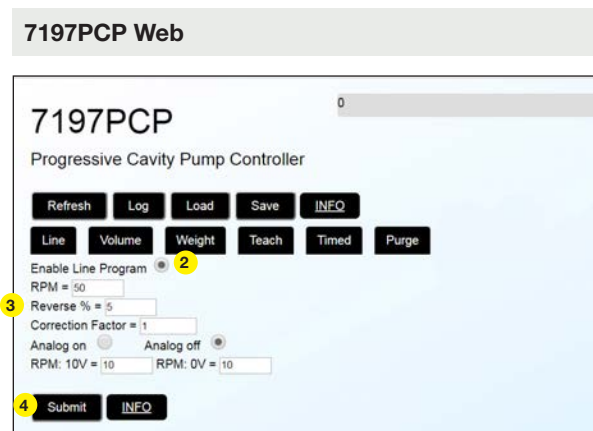

Line program screen, web interface

| Variable | Range | Description |
|---|---|--|
| INFO | n/a | Select to view information about the current screen, including the range limits for settings. |
| RPM | 10–150 (RPM) | Sets the motor speed in RPM; for guidance on setting the RPM, refer to "Maximum Motor Speed Based on Viscosity" on page 49. |
| Reverse % | 0–200 (%) (adjustable in increments of 1%) | Based on the percentage of rotation, sets the suck-back to reverse the motor at the end of a dispense cycle to prevent drooling. |
| Correction Factor | 0.12.00 (adjustable in increments of 0.01) | Because rotors and stators may not be perfectly matched, the Correction Factor linearly scales the output to ensure that the expected amount is deposited every time. |
| Analog On / Analog Off | n/a | Select Analog On to use the "RPM: 10V" and "RPM: 0V" fields to change the motor speed on-the-fly. When Analog Off is selected, the "RPM: 10V" and "RPM: 0V" fields are disabled. |
| Analog RPM: 10V | 10–150 | Scales the output RPM linearly from 0–10V based on the input analog voltage (pins 12 and 13 of the I/O port; refer to "I/O Port Pin Assignments and Wiring Diagrams" on page 46 as needed) |
| Analog RPM: 0V | 10–150 | |
| Disable Pump (touchscreen interface only) | Enabled or disabled | If selected, disables Pump 1 or Pump 2. |

Programming (continued)

Volume Programs

Use a Volume program to dispense primarily based on volume. When a Volume program is used, the pump dispenses until the specified amount (in milliliters) has been deposited.

NOTE: For an example of how to create a Volume program, including how to use Correction Factor and Reverse %, refer to “Appendix B, Example Volume Program” on page 53.

1. Navigate to the Volume program screen.
2. Select the ENABLE VOLUME PROGRAM radio button.
NOTE: If you don't enable the program, the system will not save any entered settings.
3. Enter the desired settings, referring to the table below for detailed information on each variable.
4. Select SUBMIT to save the settings. The variable table shows the saved settings.
5. To save the values you entered as a program in the Program Library, refer to “Saving a Program to the Program Library (Save Screen)” on page 32.

ValveMate 7197PCP Touchscreen

ValveMate 7197PCP

No Program Selected
IP Address 192.168.10.51

Back Info

Enable Volume Program 2

RPM = 10

Reverse % = 1

Dispense Volume (mL) = 0.01

Pump Size 0.01 mL 0.05 mL 0.15 mL 0.3 mL

Correction Factor = 0.01

Submit Disable Pump

Volume program screen, touchscreen interface

7197PCP Web

7197PCP

Progressive Cavity Pump Controller

Log Load Save Info

Line Volume Weight Teach Timed Purge

Enable Volume Program 2

Pump Size 0.01 mL 0.05 mL 0.15 mL 0.3 mL

Dispense Volume (mL) = 1 3

RPM = 80

Reverse % = 2 Correction Factor = 1

Submit Info 4

Volume program screen, web interface

| Variable | Range | Description |
|---|--|---|
| INFO | n/a | Select to view information about the current screen, including the range limits for settings. |
| RPM | 10–150 (RPM) | Sets the motor speed in RPM; for guidance on setting the RPM, refer to “Maximum Motor Speed Based on Viscosity” on page 49. |
| Reverse % | 0–200 (%) (adjustable in increments of 1%) | Based on the percentage of rotation, sets the suck-back to reverse the motor at the end of a dispense cycle to prevent drooling. |
| Dispense Volume (mL) | 0.001–15000.00 (mL) (adjustable in increments of 0.001) | Sets the amount of material (in mL) that will be dispensed for each cycle of the pump. |
| Pump Size | 0.01 mL, 0.05 mL, 0.15 mL, or 0.30 mL | Select the size of the pump for which you are creating the program. |
| Correction Factor | 0.1–2.00 (adjustable in increments of 0.01) | Because rotors and stators may not be perfectly matched, the Correction Factor linearly scales the output to ensure that the expected amount is deposited every time. |
| Disable Pump (touchscreen interface only) | Enabled or disabled | If selected, disables Pump 1 or Pump 2. |

Programming (continued)

Weight Programs

Use a Weight program to dispense primarily based on weight. When a Weight program is used, the pump dispenses until the specified material weight (in grams) has been deposited.

1. Navigate to the Weight program screen.
2. Select the ENABLE WEIGHT PROGRAM radio button.
NOTE: If you don't enable the program, the system will not save any entered settings.
3. Enter the desired settings, referring to the table below for detailed information on each variable.
4. Select SUBMIT to save the settings. The variable table shows the saved settings.
5. To save the values you entered as a program in the Program Library, refer to "Saving a Program to the Program Library (Save Screen)" on page 32.

ValveMate 7197PCP Touchscreen

ValveMate 7197PCP

No Program Selected
IP Address 192.168.10.51

Back Info

Enable Weight Program 2

Weight (g) = 1

Density (g/cm³) = 1

Reverse % = 1 3

Correction Factor = 0.01 RPM = 10

Pump Size: 0.01 mL 0.05 mL 0.15 mL 0.3 mL

4 Submit Disable Pump

Weight program screen, touchscreen interface

7197PCP Web

7197PCP

Progressive Cavity Pump Controller

Log Load Save Info

Line Volume Weight Teach Timed Purge

Enable Weight Program 2

Pump Size 0.01 mL 0.05 mL 0.15 mL 0.3 mL

3 Weight (g) = 1.00 Density (g/cm³) = 1

Reverse % = 2 Correction Factor = 1

RPM = 80

4 Submit Info

Weight program screen, web interface

| Variable | Range | Description |
|---|---|---|
| INFO | n/a | Select to view information about the current screen, including the range limits for settings. |
| Weight | 0–600 (g) (adjustable in increments of 0.001 g) | Sets the amount of material (in g) that will be dispensed for each cycle of the pump. |
| Density | 0–11000 (g/cm ³) (adjustable in increments of 0.01 g/cm ³) | Sets the density of the material (in g/cm ³) to be dispensed. |
| Reverse % | 0–200 (%) (adjustable in increments of 1%) | Based on the percentage of rotation, sets the suck-back to reverse the motor at the end of a dispense cycle to prevent drooling. |
| Correction Factor | 0.1–2.00 (adjustable in increments of 0.01) | Because rotors and stators may not be perfectly matched, the Correction Factor linearly scales the output to ensure that the expected amount is deposited every time. |
| RPM | 10–150 (RPM) | Sets the motor speed in RPM; for guidance on setting the RPM, refer to "Maximum Motor Speed Based on Viscosity" on page 49. |
| Pump Size | 0.01 mL, 0.05 mL, 0.15 mL, or 0.30 mL | Select the size of the pump for which you are creating the program. |
| Disable Pump (touchscreen interface only) | Enabled or disabled | If selected, disables Pump 1 or Pump 2. |

Programming (continued)

Teach Programs

The Teach program allows you to “Teach” the system how long to run at the specified speed. When a Teach program is selected and the dispense cycle is activated, the pump dispenses for the amount of time determined by the Teach program.

1. Navigate to the Teach program screen.
2. Select the ENABLE TEACH PROGRAM radio button.
NOTE: If you don't enable the program, the system will not save any entered settings.
3. Enter the desired settings, referring to the table below for detailed information on each variable.
NOTE: Values must be within the specified range limits, or they will not save.
4. Select the START TEACH TIME radio button, then select SUBMIT.
5. Press the foot pedal to start the dispense cycle.
NOTE: As long as the dispense cycle is activated, the controller tracks the dispense time. If the dispense cycle is stopped and restarted, the controller erases the previous time and starts tracking again.
6. When the desired amount of material has been dispensed, release the foot pedal and select the STOP TEACH TIME radio button.
7. Select SUBMIT.
The system saves the setting, and the new Teach Time (ms) is displayed in the Variable table.
8. To save the values you entered as a program in the Program Library, refer to “Saving a Program to the Program Library (Save Screen)” on page 32.

ValveMate 7197PCP Touchscreen

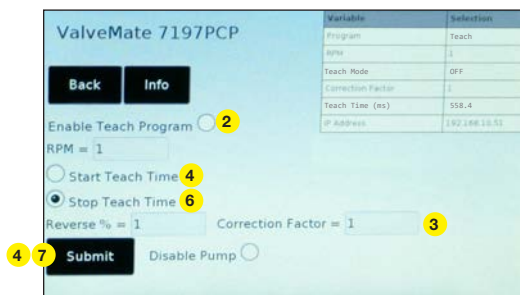

Teach program screen, touchscreen interface

7197PCP Web

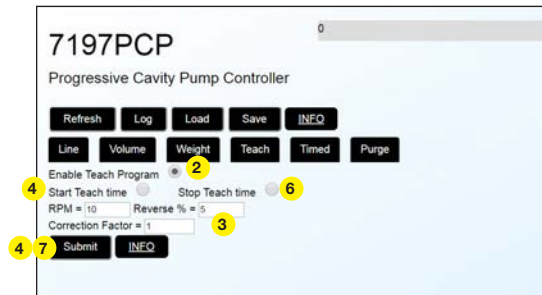

Teach program screen, web interface

| Variable | Range | Description |
|--|--|---|
| INFO | n/a | Select to view information about the current screen, including the range limits for settings. |
| RPM | 10–150 (RPM) | Sets the motor speed in RPM; for guidance on setting the RPM, refer to “Maximum Motor Speed Based on Viscosity” on page 49. |
| Reverse % | 0–200 (%) (adjustable in increments of 1%) | Based on the percentage of rotation, sets the suck-back to reverse the motor at the end of a dispense cycle to prevent drooling. |
| Correction Factor | 0.1–2.00 (adjustable in increments of 0.01) | Because rotors and stators may not be perfectly matched, the Correction Factor linearly scales the output to ensure that the expected amount is deposited every time. |
| Disable Pump (touchscreen interface only) | Enabled or disabled | If selected, disables Pump 1 or Pump 2. |

Programming (continued)

Timed Programs

Use a Timed program to dispense primarily based on time. When a Timed program is run, the pump dispenses for the specified time (in milliseconds) for each dispense cycle.

1. Navigate to the Timed program screen.
2. Select the ENABLE TIMED PROGRAM radio button.
NOTE: If you don't enable the program, the system will not save any entered settings.
3. Enter the desired settings, referring to the table below for detailed information on each variable.
4. Select SUBMIT to save the settings. The variable table shows the saved settings.
5. To save the values you entered as a program in the Program Library, refer to "Saving a Program to the Program Library (Save Screen)" on page 32.

ValveMate 7197PCP Touchscreen

| Variable | Selection |
|-------------------|---------------|
| Program | Line |
| RPM | 1 |
| Reverse % | 1 |
| Correction Factor | 1 |
| Analog | OFF |
| IP Address | 192.168.10.51 |

Enable Timed Program 2

RPM = 1

Reverse % = 1 3

Correction Factor = 1

Dispense Time (ms) = 1000

Submit 4 Disable Pump

Timed program screen, touchscreen interface

7197PCP Web

7197PCP

Progressive Cavity Pump Controller

Refresh Log Load Save INFO

Line Volume Weight Teach Timed Purge

Enable Timed Program 2

Dispense Time (ms) = 1000 RPM = 10

Reverse % = 5 3 Correction Factor = 1

Submit 4 INFO

Timed program screen, web interface

| Variable | Range | Description |
|---|--|---|
| INFO | n/a | Select to view information about the current screen, including the range limits for settings. |
| RPM | 10–150 (RPM) | Sets the motor speed in RPM; for guidance on setting the RPM, refer to "Maximum Motor Speed Based on Viscosity" on page 49. |
| Reverse % | 0–200 (%) (adjustable in increments of 1%) | Based on the percentage of rotation, sets the suck-back to reverse the motor at the end of a dispense cycle to prevent drooling. |
| Correction Factor | 0.1–2.00 (adjustable in increments of 0.01) | Because rotors and stators may not be perfectly matched, the Correction Factor linearly scales the output to ensure that the expected amount is deposited every time. |
| Dispense Time (ms) | 0.001–600,000 (ms) (adjustable in increments of 0.001 ms) | Sets the amount of time (in ms) to open the pump for each dispense cycle. NOTE: In other words, the Dispense Time is adjustable between 1 ms (0.001 s) and 10 minutes (600,000 ms). |
| Disable Pump (touchscreen interface only) | Enabled or disabled | If selected, disables Pump 1 or Pump 2. |

Programming (continued)

Saving a Program to the Program Library (Save Screen)

Follow this procedure to save a program to the Program Library.

1. Ensure that the program you want to save is displayed, and that the variable settings are correct.
2. On the Main screen, select SAVE. The Save screen opens.
3. Enter a program number next to “Save current program as program number.”
Up to 10 programs can be saved. The program shown in the variable table is saved to the selected program number.
4. Select SUBMIT. The system saves the program in the Program Library.
5. Select BACK (touchscreen) or HOME (web) to return to the Main screen.

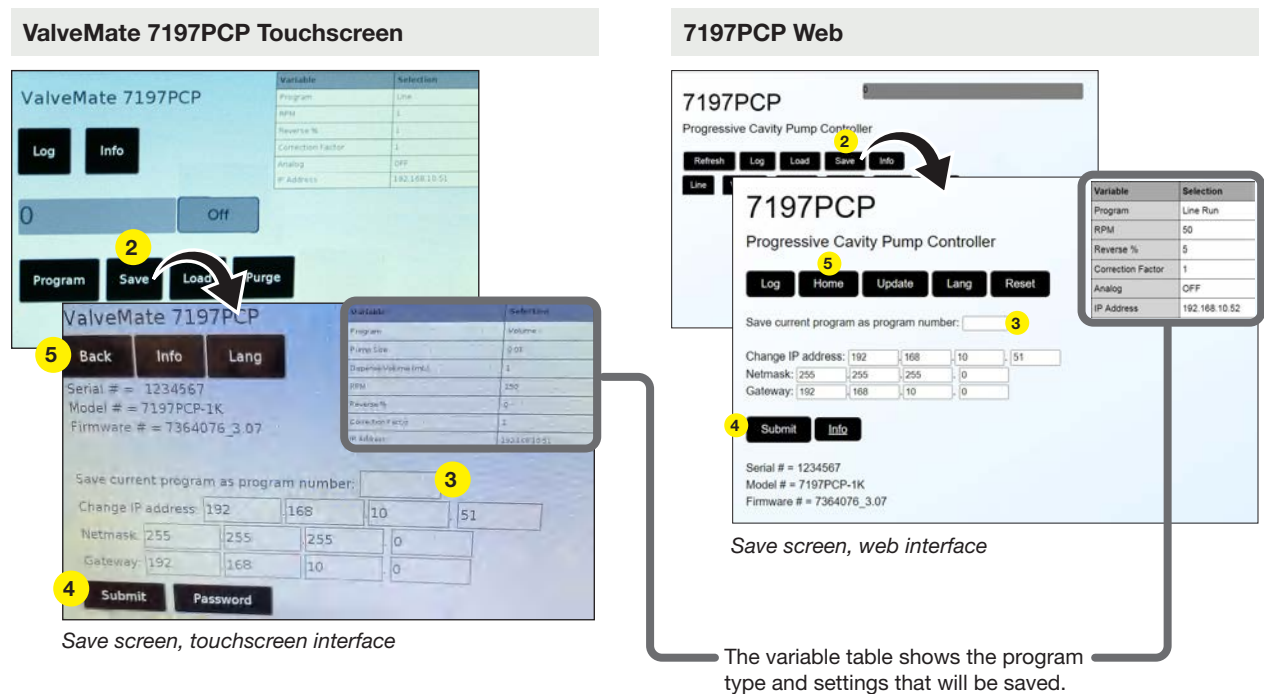

| Field | Description |
|---|--|
| Save current program as program number: | Used to save a program to the Program Library. |
| Change IP address, Netmask, and Gateway | Used to change the network settings of the controller. Refer to “Defining the Controller Network Settings” on page 39. |

Programming (continued)

Opening a Saved Program (Load Screen)

If you have saved a program to the Program Library, follow this procedure to load the program at any time.

NOTE: This screen also includes a radio button to disable the pump. Refer to “Disabling a Pump” on page 41 for details.

1. On the Main screen, select LOAD. The Load screen opens.
2. Select the radio button of the program number you want to load.
3. Select SUBMIT. The selected program loads into the variable table.
4. Select BACK (touchscreen) or HOME (web) to return to the Main screen.

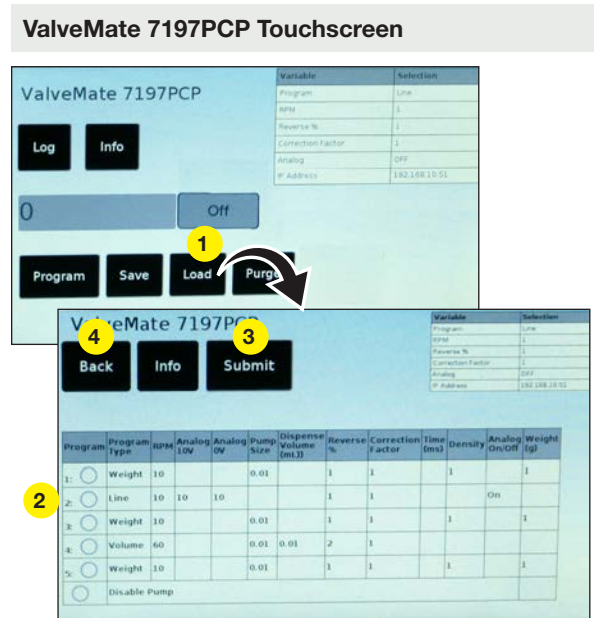

Load screen, touchscreen interface

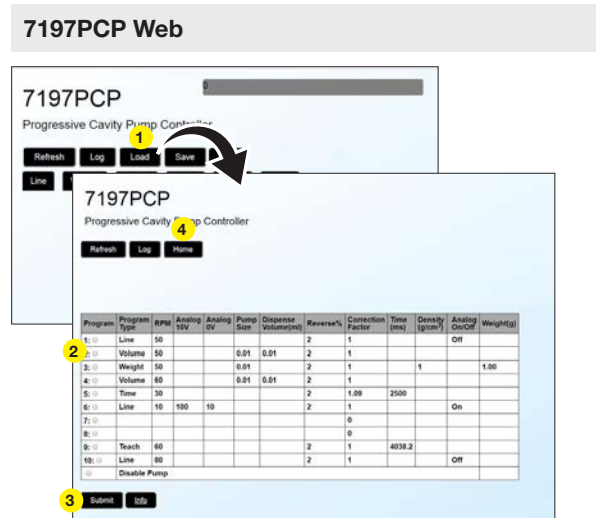

Load screen, web interface

Programming (continued)

Locking or Unlocking the System (Touchscreen Only)

Follow these procedures to use the lock / unlock function for a desktop controller. When the lock / unlock function is enabled, an unlock button appears on the Main screen. When the system is locked, the unlock button changes to a locked icon.

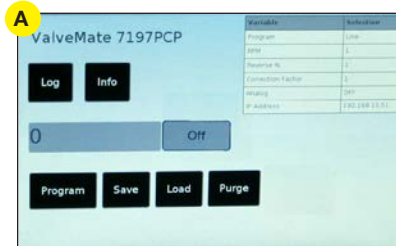

Main screen when the lock / unlock function is disabled (no lock / unlock icon)

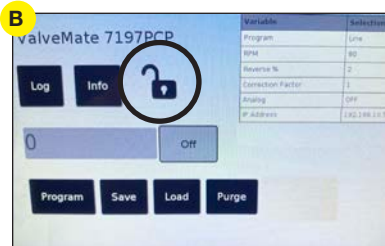

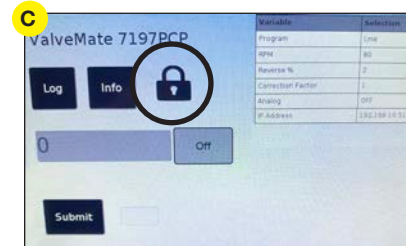

Main screen when the lock / unlock function is enabled, but the system is not locked



Main screen when the lock / unlock function is enabled and the system is locked; a password is required

Enabling the Lock / Unlock Function

1. On the Main screen, select SAVE. The Save screen opens.
2. Select PASSWORD. The Password screen opens.
3. Select the UNLOCK button  to enable lock / unlock function. When the lock / unlock function is enabled:
 - A lock button  appears on the Password screen.
 - The system password is automatically set as “0.” To change the password, refer to “Changing the Lock Function Password”.
 - A locked icon  appears on the Main screen.

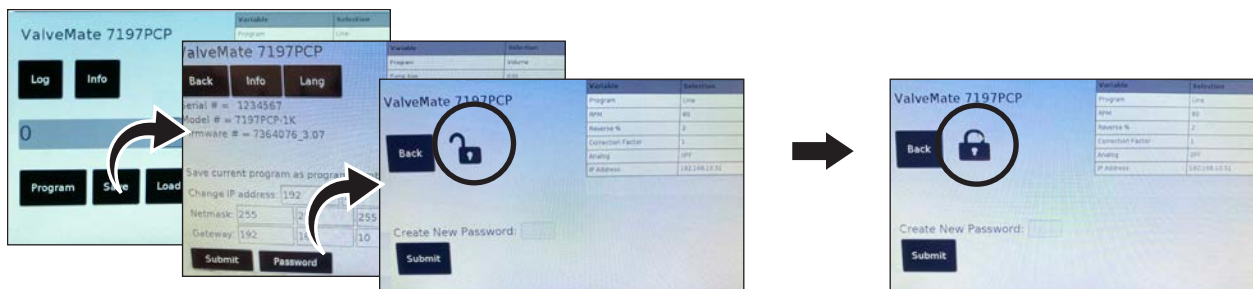

Password screen, lock / unlock function disabled

Password screen, lock / unlock function enabled

Changing the Lock Function Password

1. Open the Password screen (from the Main screen, select SAVE > PASSWORD).
2. Select the LOCK button .
3. Enter a numeric password (1 to 4 digits).

NOTE: If you do not enter a password, the system automatically enters “0” as the password.
4. Select SUBMIT.
5. Select BACK two times to return to the Main screen.

Programming (continued)

Locking or Unlocking the System (Touchscreen Only) (continued)

Unlocking and Relocking a Locked System

1. To unlock the system, enter the password in the field next to the Submit button, then select SUBMIT.

The locked icon changes to an unlock button.

NOTE: If you forget the password, you can use the web interface to reset the password to 0. Refer to “Resetting the Password” on page 36.



Main screen when the lock / unlock function is enabled and the system is locked; a password is required

2. To relock the system, select the UNLOCK button.

NOTE: The system stays unlocked until you select the unlock button.

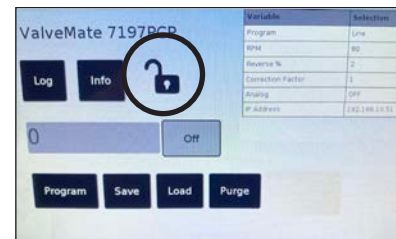

Main screen when the lock / unlock function is enabled, but the system is not locked

Disabling the Lock / Unlock Function

1. If the Main screen is locked, enter the password and select SUBMIT.
2. On the Main screen, select SAVE. The Save screen opens.
3. Select PASSWORD. The Password screen opens.
4. Select the LOCK button  to disable the Lock / Unlock function.

When the Lock / Unlock function is disabled, an unlock button  appears on the Password screen and the locked icon / unlock button is removed from the Main screen.

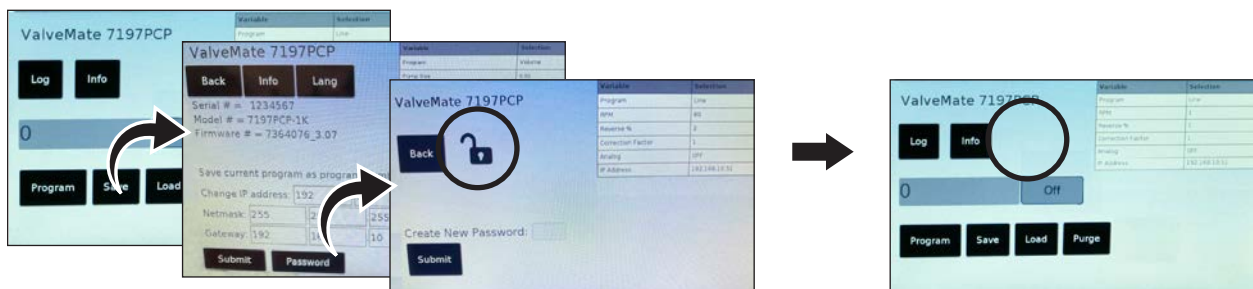

Password screen, lock / unlock function disabled

Main screen when the lock / unlock function is disabled (no locked icon or unlock button)

Programming (continued)

Resetting the Password

If you forget the lock / unlock password for the touchscreen lockout, follow this procedure to use the web interface to reset the password to 0.

1. On the Main screen, select SAVE. The Save screen opens.
2. Select RESET.
3. Select HOME to return to the Main screen.

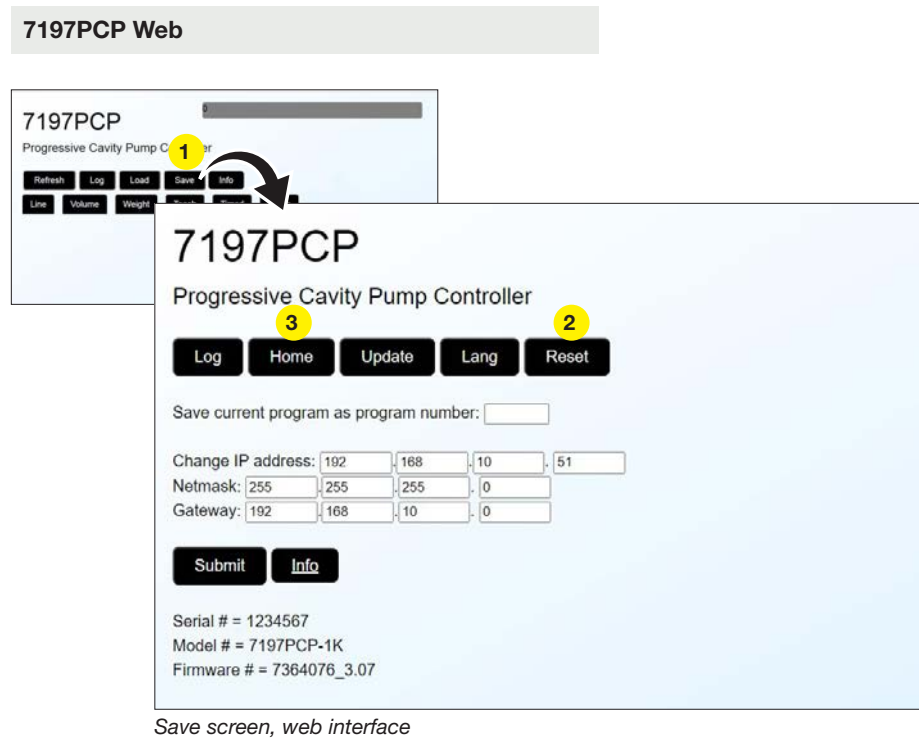

Programming (continued)

Setting the Language

Follow this procedure to select the desired language.

1. On the Main screen, select SAVE. The Save screen opens.
2. Select LANG.
3. Select the radio button for the desired language.
4. Select SUBMIT.
5. Select BACK (touchscreen) or HOME (web) to return to the Main screen.

ValveMate 7197PCP Touchscreen

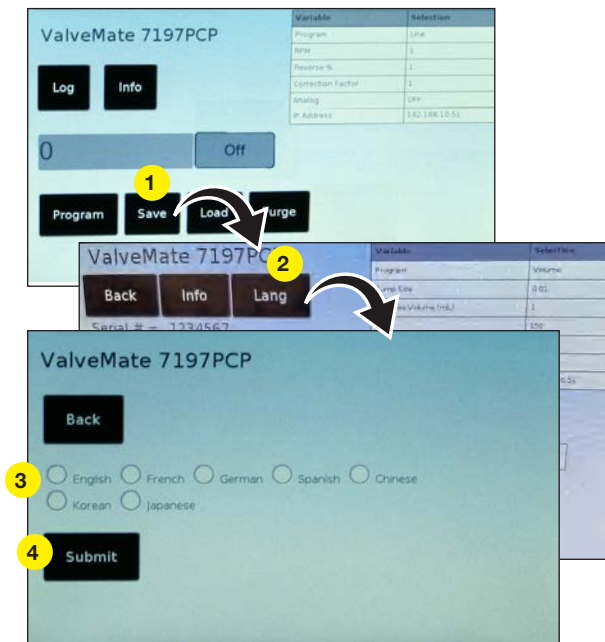

Language screen, touchscreen interface

7197PCP Web

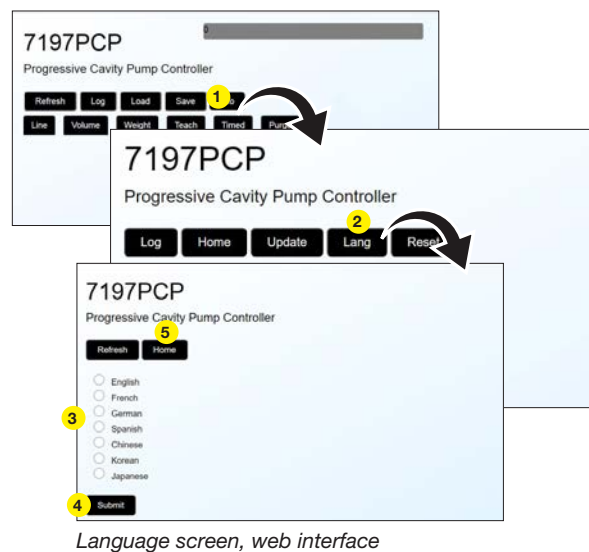

Language screen, web interface

Programming (continued)

Viewing the System Information

Follow this procedure to view the following information about the controller:

- Serial number
- Model number
- Firmware version

NOTE: To update the controller firmware, refer to “Firmware Update” on page 42.

1. On the Main screen, select SAVE. The Save screen opens.
The system information is displayed on the Save screen.
2. Select BACK (touchscreen) or HOME (web) to return to the Main screen.

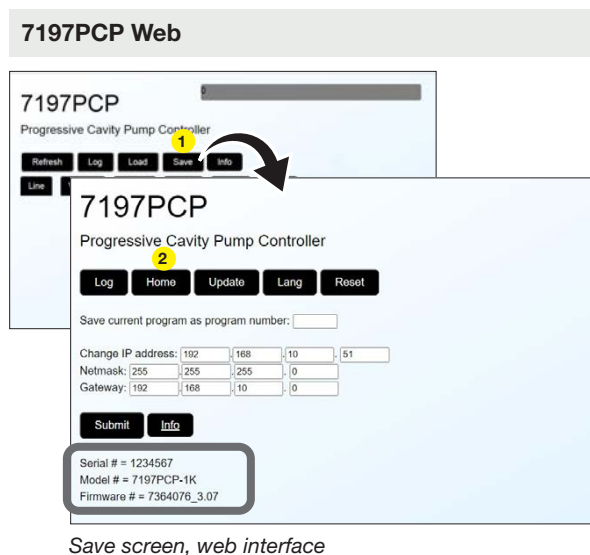
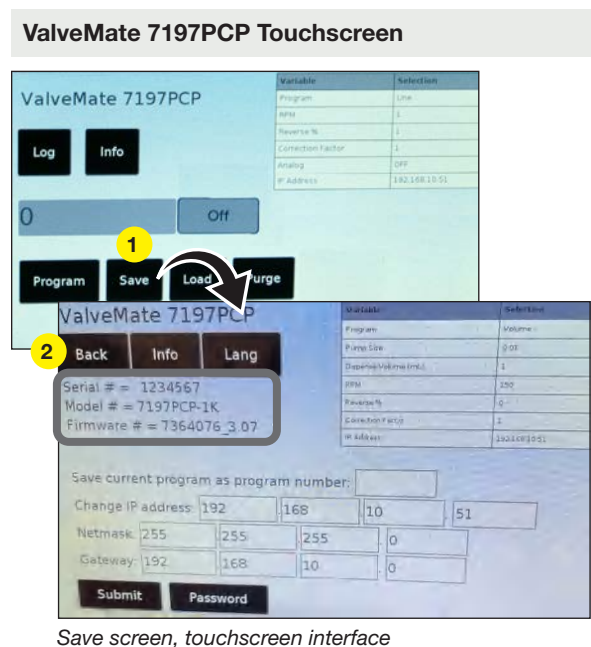

Programming (continued)

Defining the Controller Network Settings

Use the Save screen to define the IP address, netmask, and gateway settings for your system.

NOTES:

- A ValveMate 7197PCP controller must have a unique IP address. If a controller is connected to a network that includes another device with the same IP address, follow this procedure to change the IP address of a controller.
- Each computer in a 7197PCP system must also have a unique IP address. Refer to “Appendix A, Changing the IP Address of a Computer” on page 51 to change the IP address of a computer.

1. On the Main screen, select SAVE. The Save screen opens.
2. Enter the desired network settings.
3. Select SUBMIT.
4. Cycle the controller power to make the changes live.

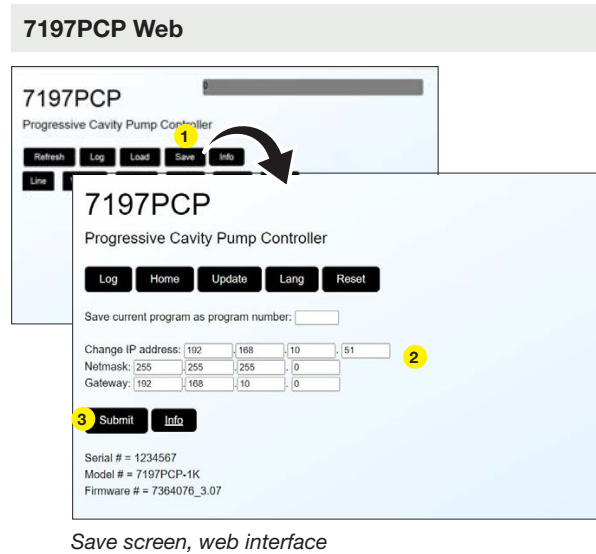
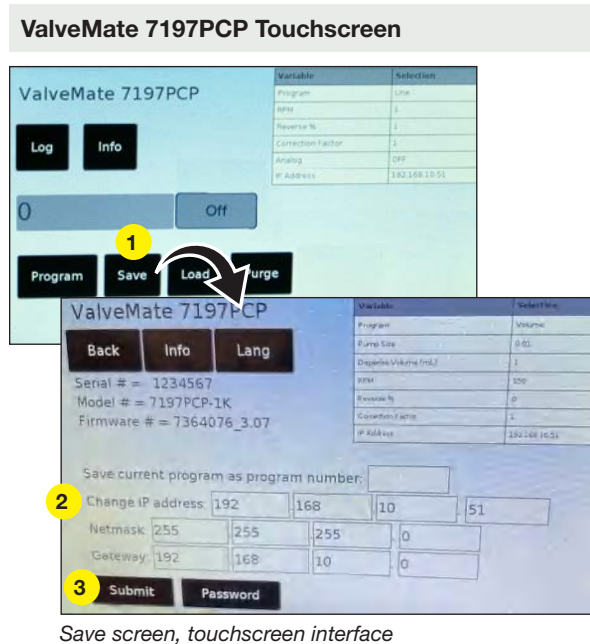

| Field | Description |
|---|--|
| Save current program as program number: | Used to save a program to the Program Library. |
| Change IP address: 192.168.10. | Used to change the IP address of the controller. |
| Netmask | Used to set the netmask address for the system |
| Gateway | Used to set the gateway address for the system |

Operation

After the dispensing system is fully installed and the desired dispensing programs are created, the system is ready for routine operation. Follow these recommended procedures for daily / routine startup and shutdown to obtain the best performance from your system.

Routine Startup

1. Switch on the power for all ValveMate 7197PCP controllers in the system.

CAUTION

Risk of equipment damage. **Do not operate a 797PCP without material.** Excessive friction of dry components can damage the pump.

2. Create or load the program to run. To load a saved program, refer to “Opening a Saved Program (Load Screen)” on page 33.
3. Start your process.

When the system is operating normally, the status indication on the Main screen indicates “Running.”

NOTE: Refer to “Status Indications” on page 21 for an explanation of all status indications provided on the Main screen.

Power switch



Errors and Emergency Stops (ESTOP)

If the status indication on the Main screen shows an error or emergency stop condition, check the Log screen and correct the problem that caused the error or stop. Refer to “Viewing the Log” on page 44 and to “Troubleshooting” on page 44.

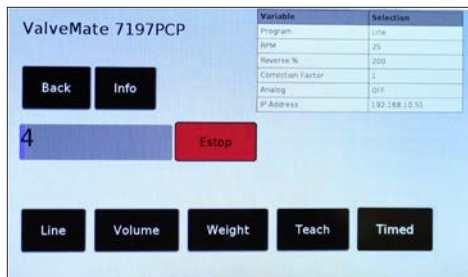

Main screen after an emergency stop

Operation (continued)

Disabling a Pump

Follow these procedures to disable a pump, whether for service or to test the output of a pump.

To Disable a Pump Using the Load Screen

1. On the Main screen, select LOAD. The Load screen opens.
2. Select the DISABLE PUMP radio button. The pump connected to the controller is now disabled.
To re-enable the pump, select a program to run by creating one on the Main screen or by selecting a program from the Load screen.

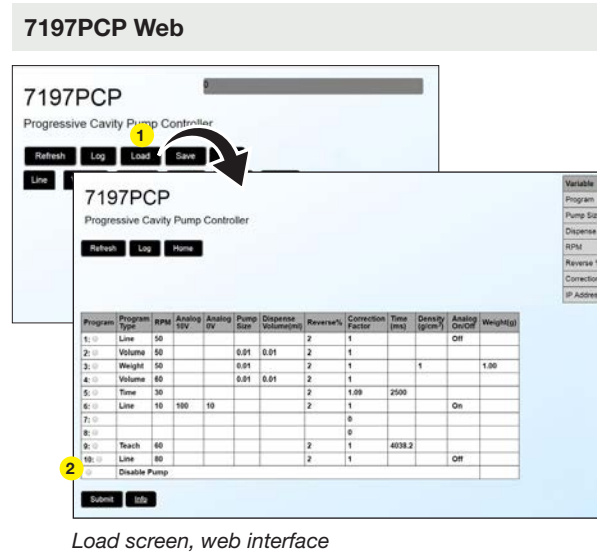
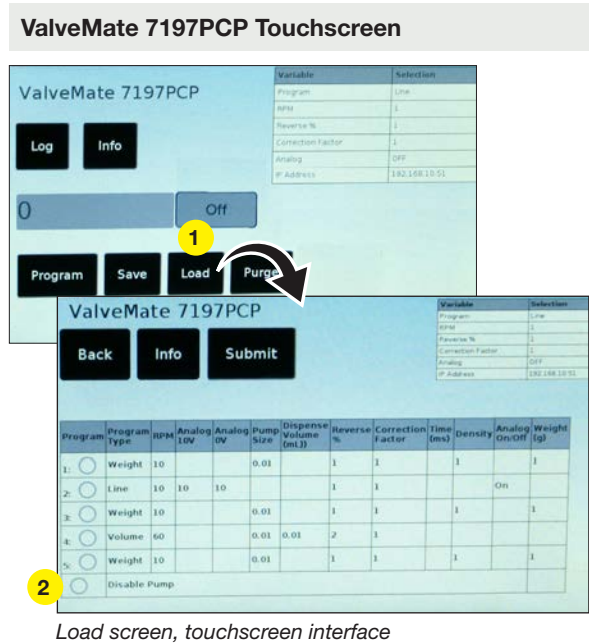

To Disable a Pump on a Program Screen (Touchscreen Only)

1. On the Line, Volume, Weight, Teach, or Time screen, select the ENABLE [xxxxxx] PROGRAM radio button.
NOTE: If you don't enable the program, Disable Pump will not work.
2. Select the DISABLE PUMP radio button, then select SUBMIT.
The pump connected to the controller is now disabled. To re-enable the pump, deselect the DISABLE PUMP radio button, select the ENABLE [xxxxxx] PROGRAM radio button, then select SUBMIT.
NOTE: If you select the BACK button, the pump will be re-enabled.

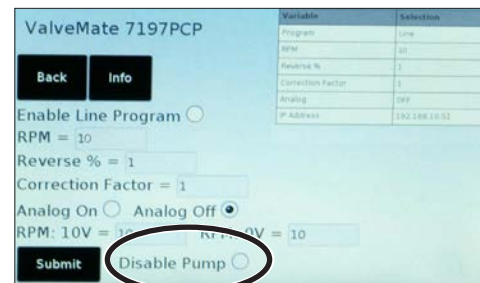

Location of the Disable Pump radio button on a program screen (touchscreen interface only)

Operation (continued)

Longterm Shutdown

For long periods of downtime or for storage, refer to the applicable pump manual to remove the pump stator(s). Removing the stator prevents rotor deformation.

Firmware Update

Follow this procedure to update the firmware.

1. Create an Ethernet connection between the ValveMate 7197PCP controller and a computer.
2. Go to www.nordsonefd.com/VM7197PCP to download the latest firmware and the firmware update instructions.
3. Open a web browser (Chrome or Firefox are preferred) and go to the following URL:
<http://192.168.10.51:8088/lface.php>.
4. Refer to the firmware update instructions to complete the update.

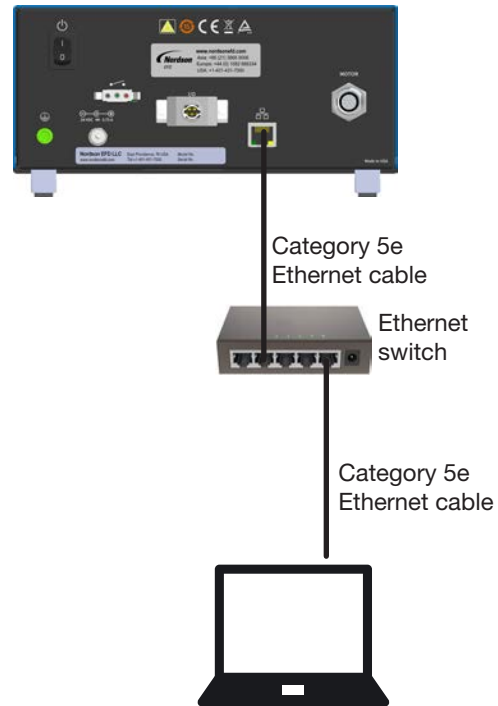

Making the Ethernet connection between the ValveMate 7197PCP and a computer

Part Numbers

ValveMate 7197PCP Controller



| Part # | Description | Compatible Pump |
|----------------------|--|-----------------|
| 7364076 | ValveMate 7197PCP controller (includes foot pedal, and ESTOP jumper) | 797PCP |
| 7014871 | Kit, power cord*, American plug | n/a |
| 7014872 | Kit, power cord*, European plug | n/a |
| *Ordered separately. | | |

797PCPs and Pump Motor Cable

797PCPs and the pump motor cable are ordered separately. Refer to the 797PCP manual for part numbers.

Accessories



| Part # | Description |
|---------|--|
| 7364775 | Breakout board and DB-15 cable (for Internet connectivity) |

Replacement Parts



| Part # | Description |
|---------|-------------|
| 7014865 | Foot pedal |

Troubleshooting

Use the troubleshooting table in this section, along with the system error log, to troubleshoot the dispensing system. Contact your Nordson EFD representative for assistance as needed.

Viewing the Log

The log is a list of notable system events. Events are listed in ascending order, starting with the most recent event. The system stores up to 50 events before it starts to overwrite the oldest ones.

NOTE: Log entries are in English only.

- On the Main screen, select LOG. The Log screen opens.
The event number is shown in the left column. The event is described in the right column.
- Select BACK (touchscreen) or HOME (web) to return to the Main screen.

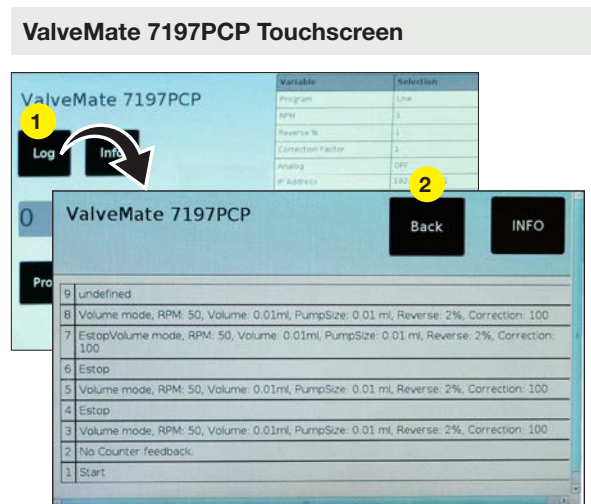

Log screen, touchscreen interface

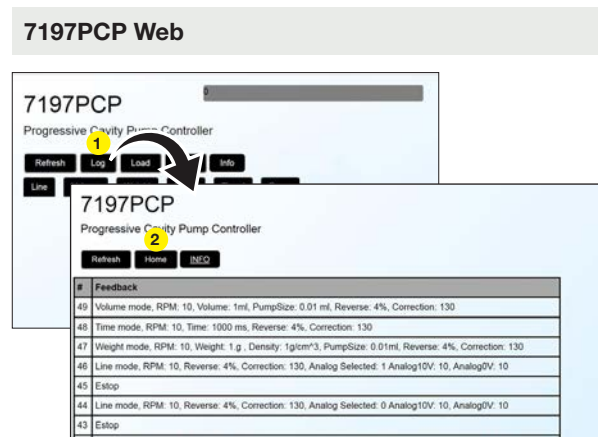

Log screen, web interface

Event Log Feedback Troubleshooting

| Feedback | Possible Cause | Corrective Action |
|---------------------|---|--|
| No motor feedback | Pump motor cable not connected, loose, or damaged | Disconnect and lock out power to the controller Ensure that the pump motor cable is properly connected. Replace the cable if it is damaged. |
| No counter feedback | Faulty printed circuit board | Cycle the controller power. If the problem persists, contact your Nordson EFD representative for assistance. |
| | Encoder feedback error | |

General Troubleshooting

| Problem | Possible Cause | Corrective Action |
|-----------------------------|---|---|
| Controller not powering on | Power supply not connected | Ensure that the power cord is properly connected. |
| Pump not dispensing | Foot pedal not connected or loose | Ensure that the foot pedal is properly connected. |
| | Pump motor cable not connected, loose, or damaged | Disconnect and lock out power to the controller Ensure that the pump motor cable is properly connected. Replace the cable if it is damaged. |
| | ESTOP signal not connected | Ensure that the ESTOP jumper is properly installed in the I/O port on the back of the controller. The pump will dispense only if pins 1 and 2 (Estop_H and Estop_L) and connected. |
| Entered value will not save | Value not within range limits | The values entered for program variables must be within the specified range limits. Refer to the information table for each program type for range limits. |
| | Program not enabled | Ensure that the program is enabled by selected the enable / disable radio button; program variables can be changed only after a program is enabled. |

Technical Data

I/O Port Pin Assignments and Wiring Diagrams

If desired, you can use a breakout board and DB-15 cable to make connections to the I/O port on the back of the controller. Contact your Nordson EFD representative for assistance.

- All outputs are rated at 70 mA.
- Inputs / outputs can be wired as either sinking or sourcing.
- Inputs / outputs can use either the courtesy 24 VDC power source at pin 15 or an external 24 VDC source.
- All inputs can be wired as shown in this section. Outputs are configured only for 24 VDC sourcing, but the source can be either pin 15 or an external source. To use the courtesy 24 VDC power source for the output signals, connect to pins 14 and 15. To use an external power source, connect to pin 14.

I/O Port Pin Assignments

NOTE: Do not connect the system ground (pin 9) and the analog ground (pin 13) together.

| I/O Pin | Direction | Assignment |
|---------|-----------|---------------------|
| 1 | Source | Estop_H |
| 2 | Input | Estop_L |
| 3 | Input | NC (not connected) |
| 4 | Input | NC (not connected) |
| 5 | Input | Ex_Trig (+) |
| 6 | Input | Ex_Trig (-) |
| 7 | Output | Error (output) |
| 8 | Output | Running (out) |
| 9 | n/a | GND |
| 10 | Input | Purge (+) |
| 11 | Input | Purge (-) |
| 12 | Input | Analog in (0–10V) |
| 13 | n/a | Analog GND |
| 14 | Input | External 24V input |
| 15 | Output | 24 VDC (100 mA) out |

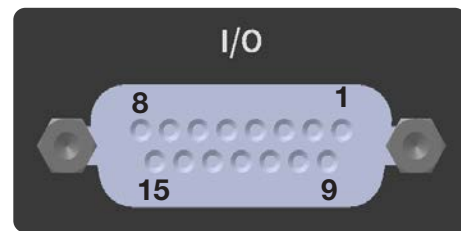

Technical Data (continued)

I/O Port Pin Assignments and Wiring Diagrams (continued)

NOTE: The breakout board shown in these diagrams is an optional component available to facilitate wiring connections to the I/O port. A DB-15 cable is also required. Both components are available in a kit (P/N 7364775).

Sourcing Wiring Diagram for Connecting the Cycle Initiate (Ex_Trig)

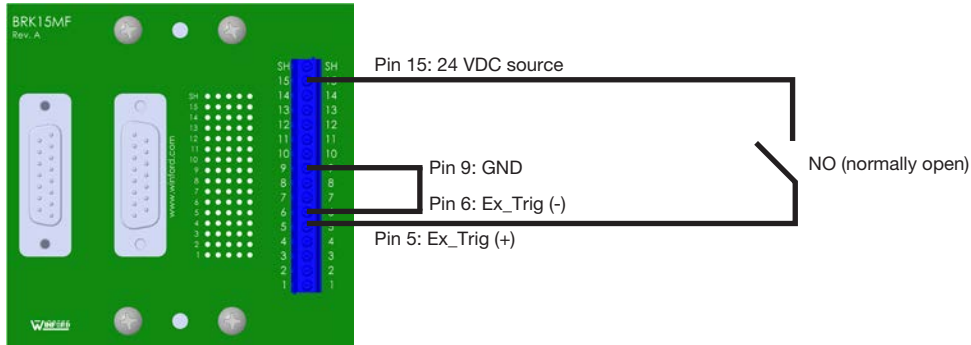

Sinking Wiring Diagram for Connecting the Cycle Initiate (Ex_Trig)

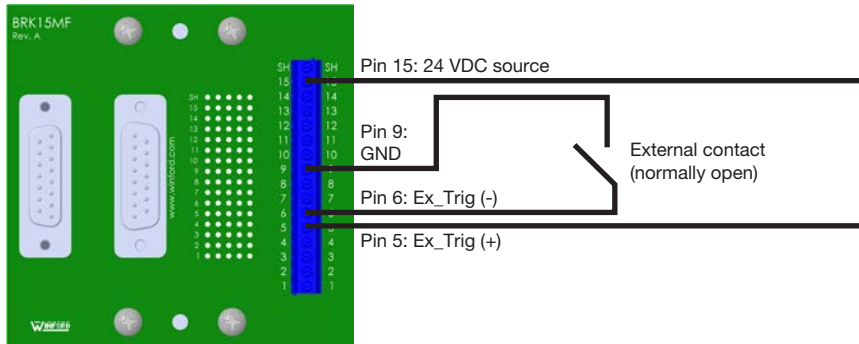

Wiring Diagram for Connecting the Emergency Stop (ESTOP) Circuit

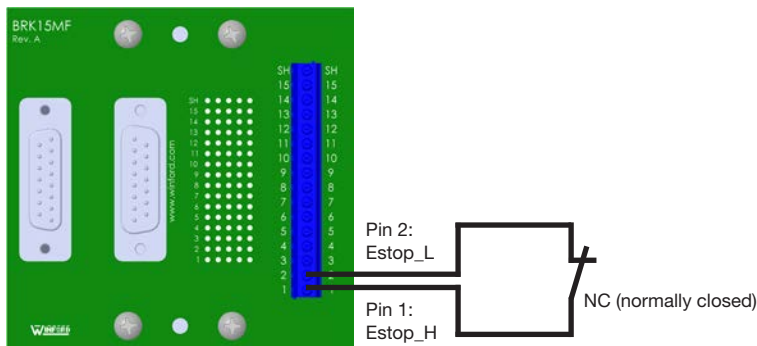

Technical Data (continued)

NOTE: The breakout board shown in these diagrams is an optional component available to facilitate wiring connections to the I/O port. A DB-15 cable is also required. Both components are available in a kit (P/N 7364775).

Wiring Diagrams for Connecting the PURGE Initiate Circuit

Sourcing

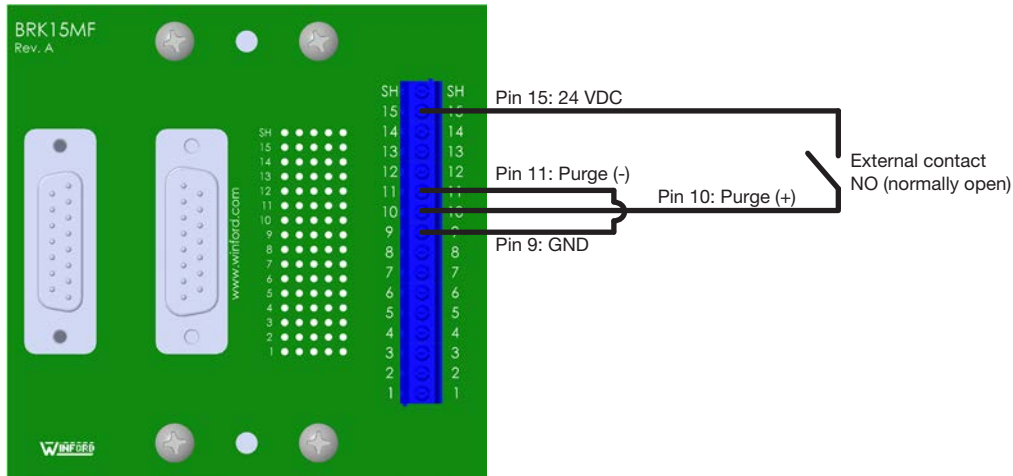

Sinking

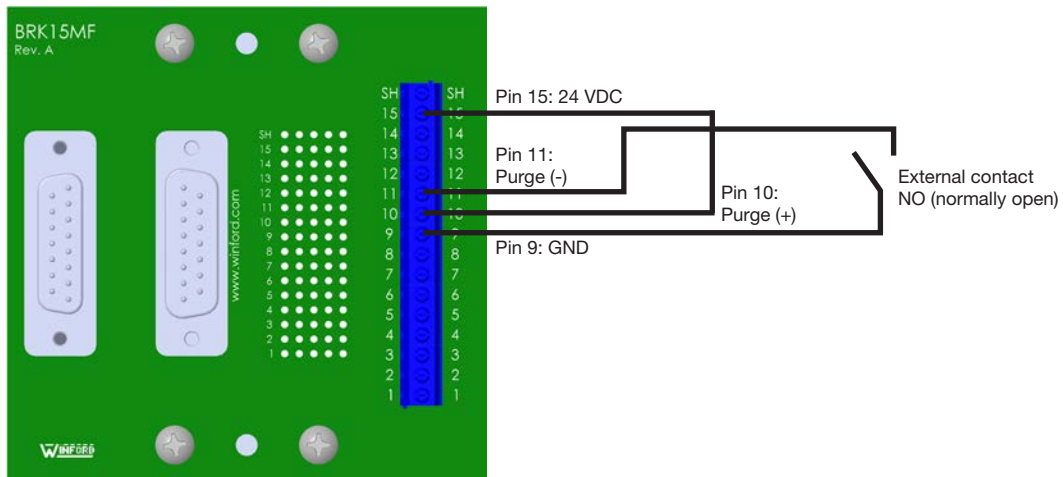

Technical Data (continued)

Maximum Motor Speed Based on Viscosity

Based on the viscosity of the dispensing material, ensure that the motor speed does not exceed the maximum RPM shown in the table and graph below.

Example: If the dispensing material has a viscosity of 8,000 mPa s, the RPM setting should be no higher than 135 RPM (90% of the allowable maximum setting of 150 RPM).

| Viscosity | Percentage of Maximum RPM |
|----------------------|---------------------------|
| 1–800 mPa s | 100% |
| 800–10,000 mPa s | 90% |
| 10,000–25,000 mPa s | 70% |
| 25,000–50,000 mPa s | 50% |
| 50,000–150,000 mPa s | 25% |

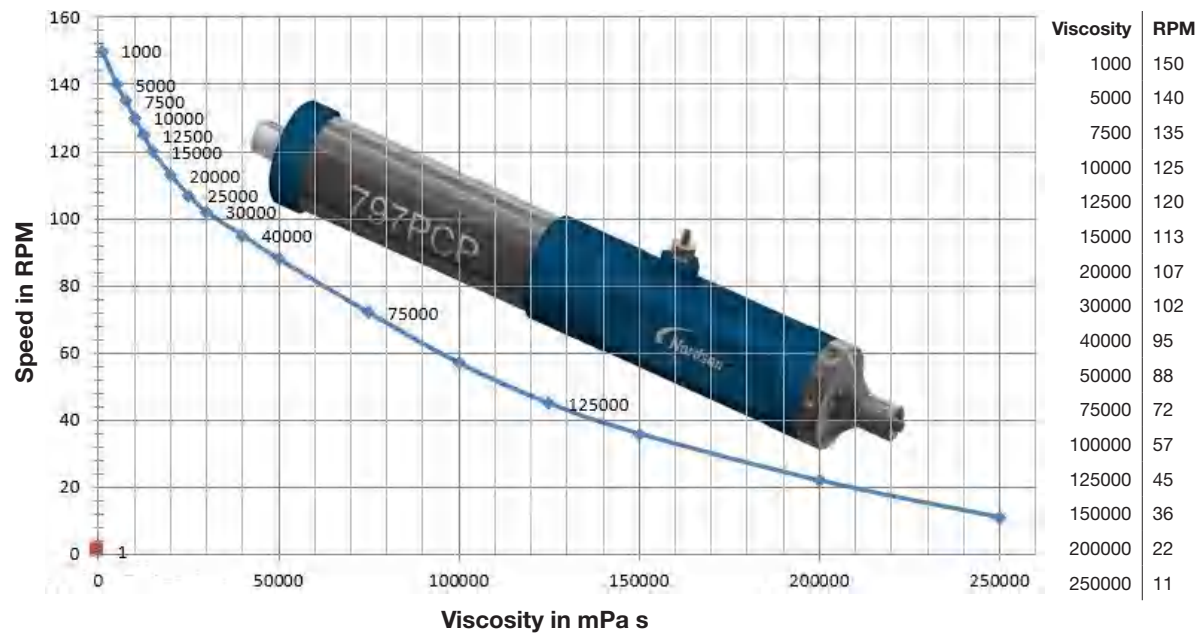

Technical Data (continued)

Motor Port Pin Assignments

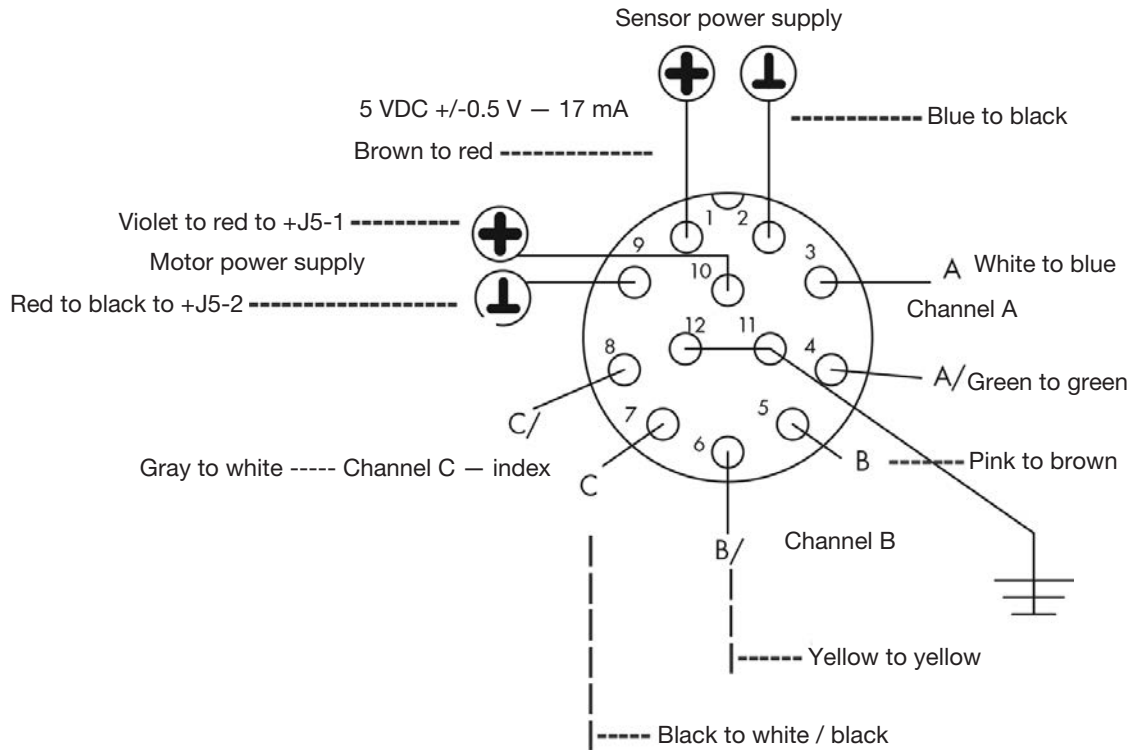

Appendix A, Changing the IP Address of a Computer

Each computer in a 797PCP system must have a unique IP address. Follow this procedure to change the IP address of a computer.

NOTE: To change the IP address of the ValveMate 7197PCP controller, refer to “Defining the Controller Network Settings” on page 39.

1. On your computer, navigate to the “Network and Sharing Center.”
2. Click “Change Adapter Settings.”

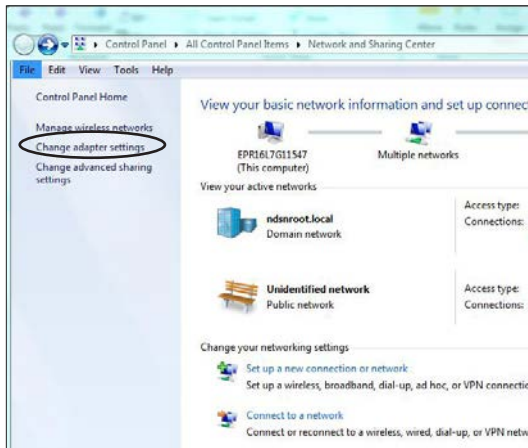

Windows® 7

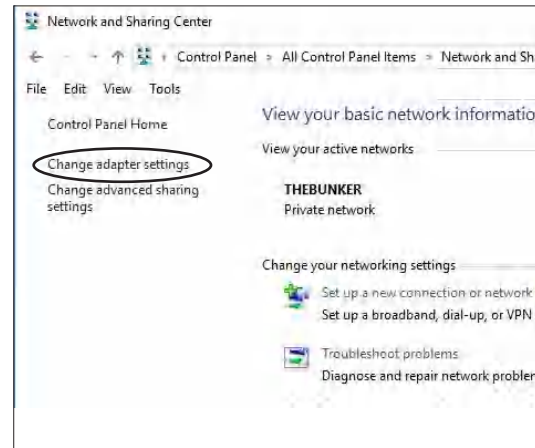

Windows 10

3. Select “Local Area Connection” (Windows 7) or “Ethernet” (Windows 10).

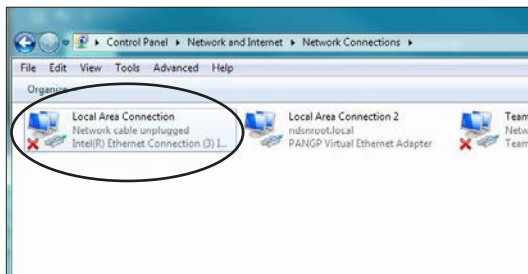

Windows 7

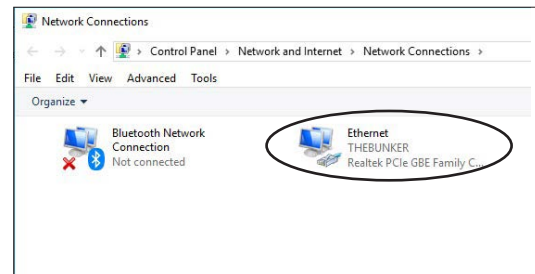

Windows 10

4. Double-click (Windows 7) or right-click (Windows 10) to select “Properties.”

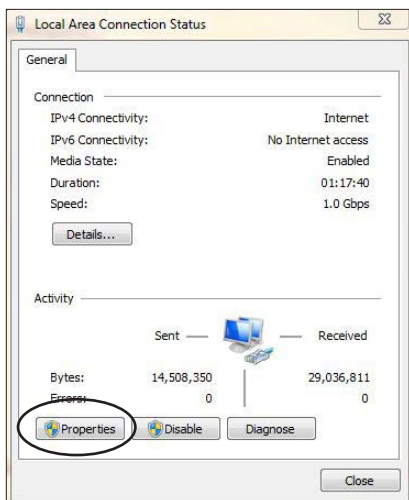

Windows 7

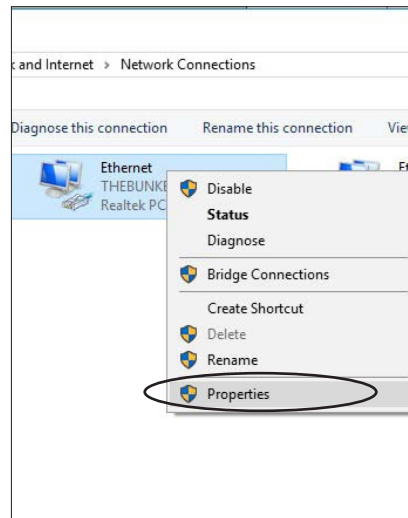

Windows 10

Appendix A, Changing the IP Address of a Computer (continued)

5. Double-click “Internet Protocol Version 4 (TCP/IPv4).”

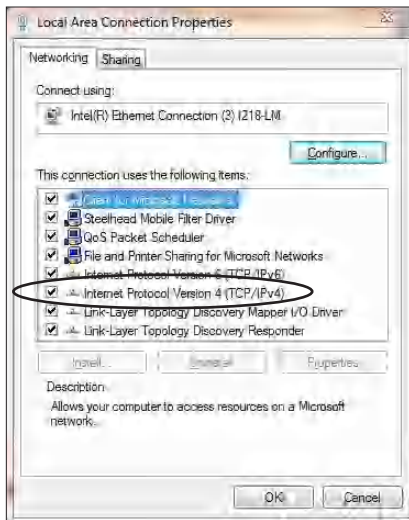

Windows 7

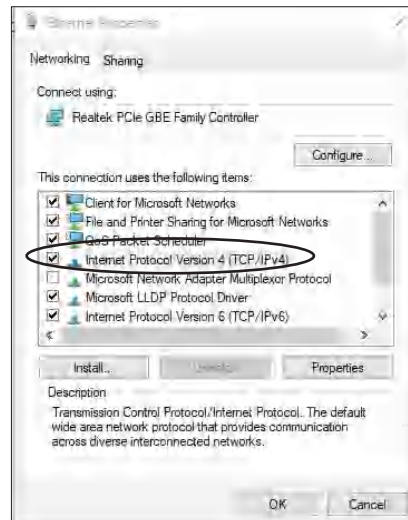

Windows 10

6. Click “Use the following IP address” and then enter the desired IP address.

NOTE: In this example, the entered IP address is 192.168.10.55. Because the IP address of the controller is 192.168.10.51, no IP conflicts can occur because the IP addresses are different. If you want to set up multiple controllers on one network, each controller and computer must have a unique IP address. The digit range for each field is 1–255.

7. Click OK > OK to save the new IP address.

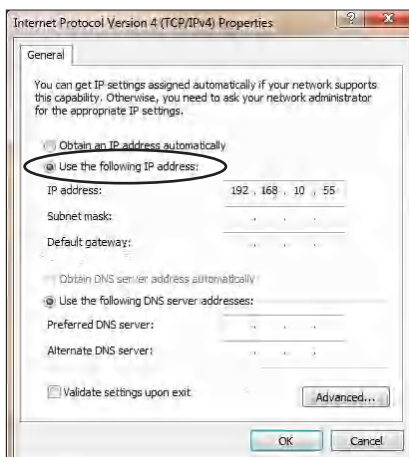

Windows 7

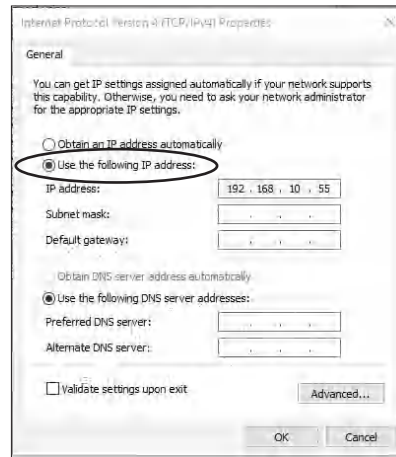

Windows 10

Appendix B, Example Volume Program

This appendix provides an example setup of a Volume program, including how to determine the amount of fluid dispensed and then how to use the Correction Factor and Reverse % variables to fine-tune the deposit size.

Determine the Maximum Motor Speed

To achieve the most repeatable deposit amount for an unknown fluid density, first consult the table below to determine the maximum operating RPM is based on the fluid viscosity:

NOTE: Refer to “Maximum Motor Speed Based on Viscosity” on page 49 for a graph.

| Viscosity | Percentage of Maximum RPM |
|----------------------|---------------------------|
| 1–800 mPa s | 100% |
| 800–10,000 mPa s | 90% |
| 10,000–25,000 mPa s | 70% |
| 25,000–50,000 mPa s | 50% |
| 50,000–150,000 mPa s | 25% |

The maximum allowable RPM setting is 150 RPM.

Based on a viscosity of 9,000 mPa s, the maximum motor speed should be $0.9 * 150 = 135$ RPM.

Ensure the System is Free of Trapped Air

Trapped air in the system can cause drooling of the fluid. Follow these steps to remove trapped air.

1. If a tip is installed, remove the tip.
2. Ensure that pressurized fluid is flowing into the fluid cavity of the pump.
3. Open the bleed valve hex screw and keep it open until fluid exists the bleed valve.
4. Install the tip and then turn the pump upside down.
5. Do one of the following:
 - Select the Line program and set the RPM to 50
 - Open the Purge screen and set the RPM to 50.
6. Run the pump until a steady stream of bubble-free fluid is exiting the tip.

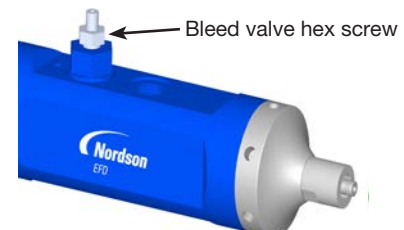

Appendix B, Example Volume Program (continued)

Determine the Deposit Weight After One Rotation

For an unknown density, follow these steps to determine the weight of the pump output after one (1) rotation. For example, if using a 0.01 mL/rev rotor / stator, one revolution of the motor should dispense approximately 0.01 mL of fluid.

1. Open the Volume screen and enter the following variables:

- Dispense Volume (mL) = 0.01
- RPM = 50
- Reverse % = 0
- Correction Factor = 1

NOTE: Volume and Weight programs are the most accurate and repeatable programs for this determination because they actively use the encoder to judge how many rotations the motor has made.

| Variable | Selection |
|----------------------|---------------|
| Program | Volume |
| Pump Size | 0.01 |
| Dispense Volume (mL) | 0.01 |
| RPM | 50 |
| Reverse % | 0 |
| Correction Factor | 1 |
| IP Address | 192.168.10.51 |

Volume Program screen

2. Make five (5) deposits and then determine the average amount of fluid dispensed for those five deposits. This provides the average amount of fluid dispensed in **mg/rev**.
3. Using this one-revolution average, calculate the closest revolutions to the amount you want to dispense. For example, if the average amount of fluid dispensed was 25 mg/rev, but you want to dispense 48 mg/rev, then the closest number of full revolutions required would be 2.
4. In the Volume program, change the Dispense Volume to 0.02 (because this represents 0.02 mL of fluid and should be the closest to the 48 mg/rev of dispense weight needed).

Appendix B, Example Volume Program (continued)

Use Correction Factor and Reverse % to Fine Tune the Deposit Size

1. Make five more deposits using the new setting, then again determine the average amount of fluid dispensed. If, at these settings, the average dispensed is 51 mg/rev (as compared to the desired 48 mg/rev), you can use the Correction Factor to reduce the target weight to 48 mg/rev.

2. To determine the Correction Factor, use the following equation:

$$\text{Correction Factor} = \frac{\text{Target weight}}{\text{Measured weight}}$$

So, for this example the resulting Correction Factor is: $\text{Correction Factor} = \frac{48 \text{ mg}}{51 \text{ mg}} = 0.94$

3. Enter the new 0.94 Correction Factor in the Volume program.
4. Make a few more deposits. If needed, increase Reverse % to eliminate drooling.

NOTE: Contact your Nordson EFD representative for assistance as needed to determine the best values for your application.

NORDSON EFD ONE YEAR LIMITED WARRANTY

This Nordson EFD product is warranted for one year from the date of purchase to be free from defects in material and workmanship (but not against damage caused by misuse, abrasion, corrosion, negligence, accident, faulty installation, or by dispensing material incompatible with equipment) when the equipment is installed and operated in accordance with factory recommendations and instructions.

Nordson EFD will repair or replace free of charge any defective part upon authorized return of the part prepaid to our factory during the warranty period. The only exceptions are those parts which normally wear and must be replaced routinely, such as, but not limited to, valve diaphragms, seals, valve heads, needles, and nozzles.

In no event shall any liability or obligation of Nordson EFD arising from this warranty exceed the purchase price of the equipment.

Before operation, the user shall determine the suitability of this product for its intended use, and the user assumes all risk and liability whatsoever in connection therewith. Nordson EFD makes no warranty of merchantability or fitness for a particular purpose. In no event shall Nordson EFD be liable for incidental or consequential damages.

This warranty is valid only when oil-free, clean, dry, filtered air is used, where applicable.



For Nordson EFD sales and service in over 40 countries, contact Nordson EFD or go to www.nordsonefd.com.

Global

800-556-3484; +1-401-431-7000
info@nordsonefd.com

Europe

+44 (0) 1582 666334
uk@nordsonefd.com

Asia

China: +86 (21) 3866 9006; china@nordsonefd.com
India: +91 80 4021 3600; india@nordsonefd.com
Japan: +81 03 5762 2760; japan@nordsonefd.com
Korea: +82-31-736-8321; korea@nordsonefd.com
SEAsia: +65 6796 9522; sin-mal@nordsonefd.com

Windows is a registered trademark of Microsoft Corporation.
The Wave Design is a trademark of Nordson Corporation.
©2023 Nordson Corporation 7364288 v101323