

754V-SS Dispense Valve

Installation Guide

Introduction

The 754V-SS dispense valve is designed to conform to biopharmaceutical regulations for sterile fluid applications. The 754V-SS wetted components are constructed of 316L stainless steel and PTFE with a smooth aseptic fluid path.

The 754V-SS valve is simple to use and will operate many millions of cycles without maintenance. The valve incorporates a compact, precise, adjustable diaphragm for dispensing low to medium viscosity fluids.

Each valve is shipped with a dispensing tip adapter, fluid inlet fitting and 5-foot actuating air hose installed.

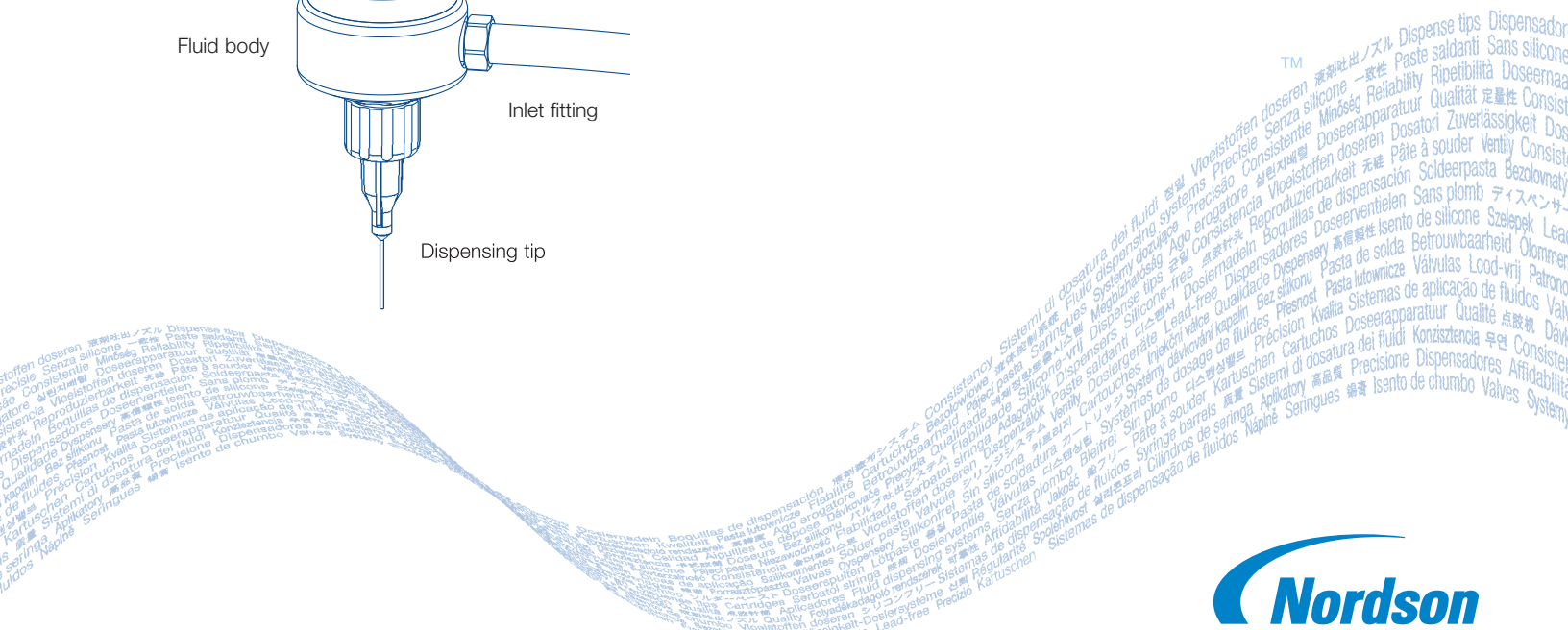
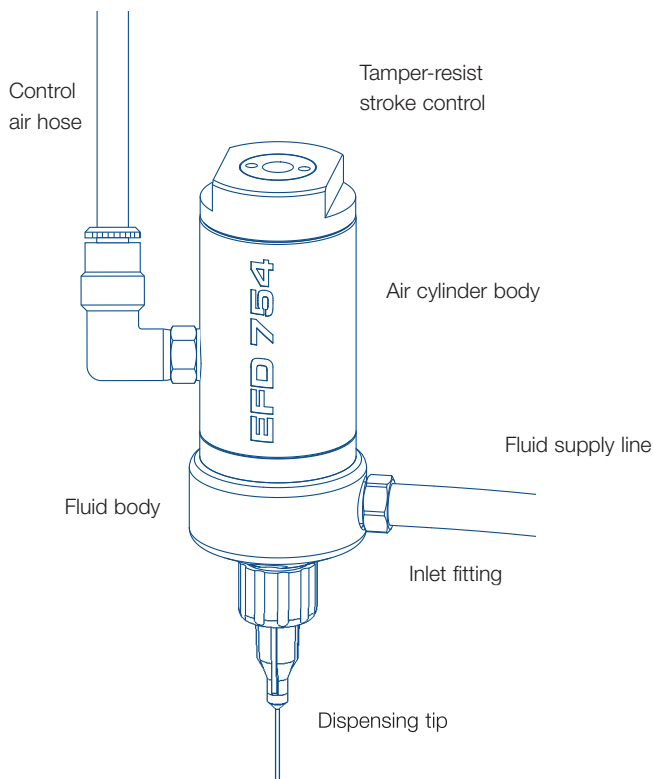
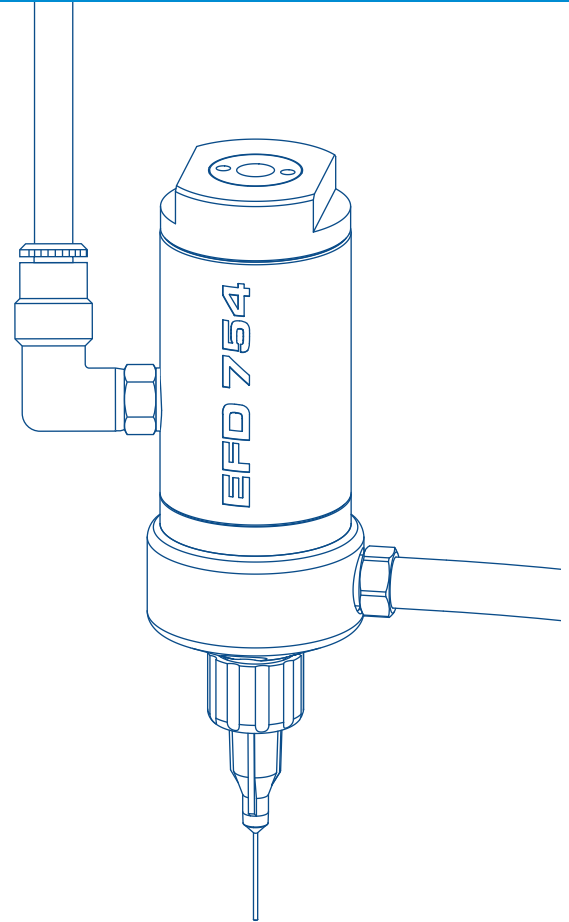

Installation

Prior to installing this valve, please read the associated reservoir and valve controller operating instructions to become familiar with the operation of all components of the dispensing system.

1. Connect fluid supply line to valve.
2. Connect the fluid supply line to reservoir.
3. Connect valve control air hose to ValveMate™ 8000 (solenoid pack) used to control valve open time.
4. Choose a dispensing tip—small tips (20 gauge) for low-viscosity fluids and larger (14 gauge) for higher viscosities.
5. Fill reservoir by pouring fluid directly into tank liner or manufacturer's bottle placed inside reservoir. Secure cover prior to setting pressure.
6. Set reservoir pressure to low for thin fluids and higher for thick fluids.
7. Set the diaphragm stroke starting with no more than 1/2 turn open.*
8. Place a cup under the dispensing tip and actuate the valve until fluid lines, valve and dispensing tip are free of air.
9. Set desired flow rate by adjusting fluid reservoir pressure, diaphragm stroke or changing dispensing tip.

* Do not over-tighten the stroke adjustment knob or open it more than two full turns. If open more than two turns, pressurized liquid could force open the diaphragm seal, resulting in continuous liquid flow.

Important Note: Set desired deposit size by adjusting valve open time. Refer to valve controller operating manual.

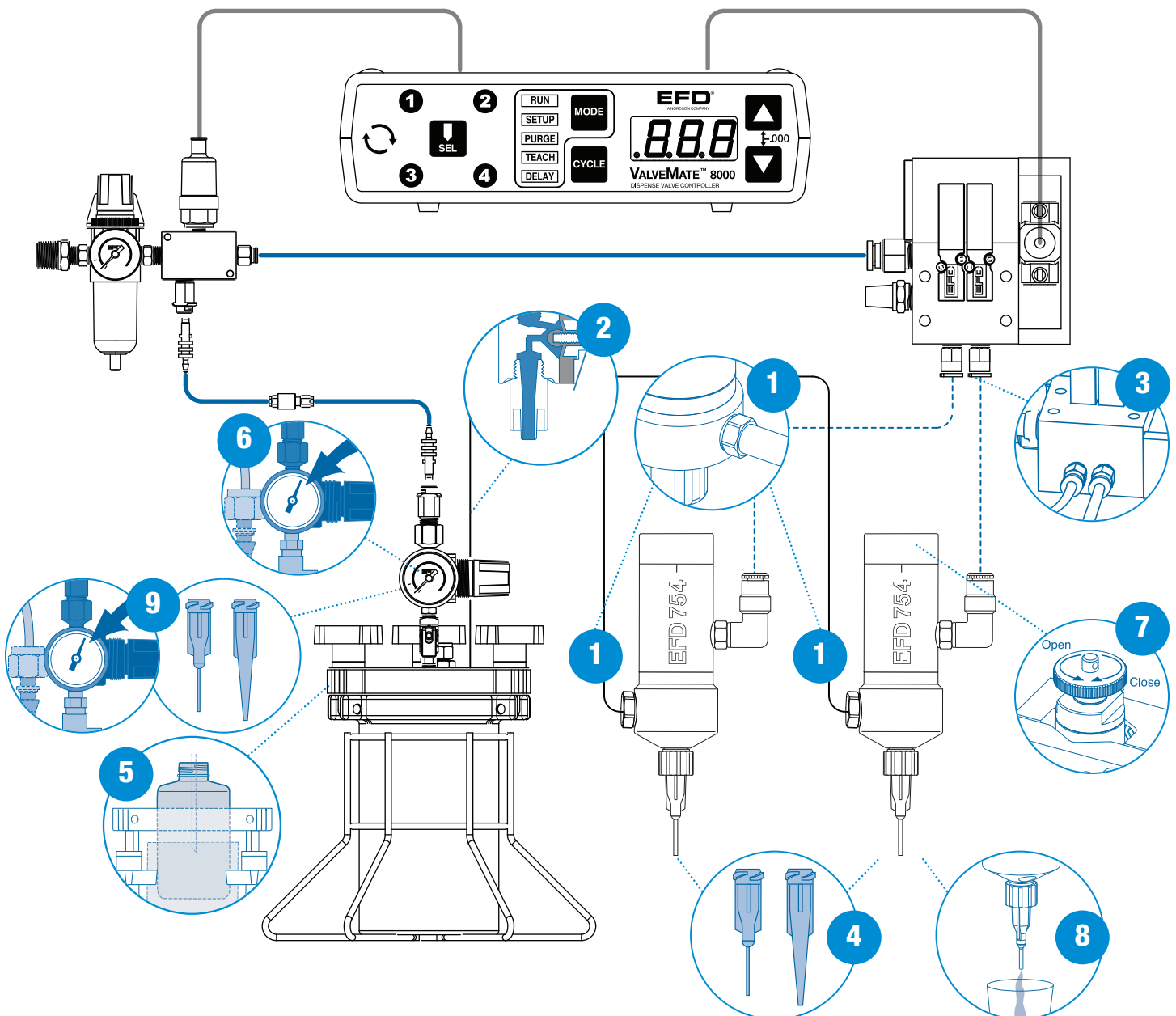

How the Valve Operates

Input air pressure at 70 psi (4.8 bar) forces the internal piston to move.

The piston rod pulls open the diaphragm seal, permitting fluid flow. When the input air pressure is relieved, the spring retracts the piston and the diaphragm closes.

The amount of fluid dispensed will depend on the time the valve is open, the viscosity of the fluid, the air pressure in the fluid reservoir, the dispensing tip size and the diaphragm stroke.

Flow rate is a function of reservoir pressure, tip size and fluid viscosity.

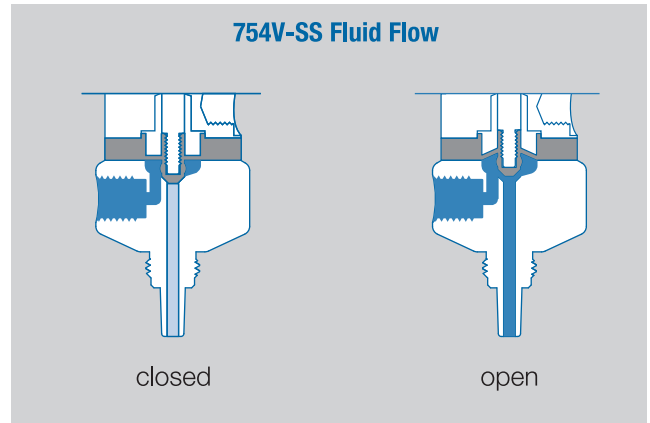

The primary control of deposit size is the valve open time.

ValveMate Concept

The ValveMate 8000 provides easy adjustment of valve output for maximum end-user convenience and efficiency. Valve open time is the primary control of deposit. The 8000 puts push-button adjustment of valve open time where it needs to be—at the valve.

The ValveMate 8000 features micro-processor circuitry for extremely precise control of deposit size. Feed lines can be purged, initial deposit sizes set, and adjustments made quickly and easily at the dispensing station, without stopping the production line.

Note: The EFD TT 325 and 525 XYZ automated dispensing systems have integrated ValveMate controllers for operating all EFD dispense valves.

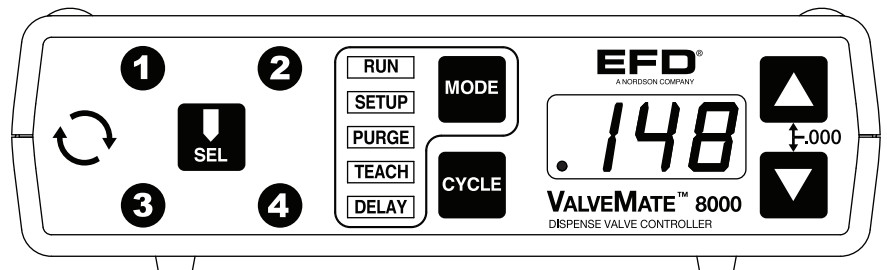

Important Note: Order your 1, 2, 3 or 4 solenoid manifold block assembly separately. Consult EFD for recommendations.

www.nordsonefd.com technical@nordsonefd.com USA 800-556-3484 Europe +44 (0) 1582 666334 Asia +86 (21) 3866 9006

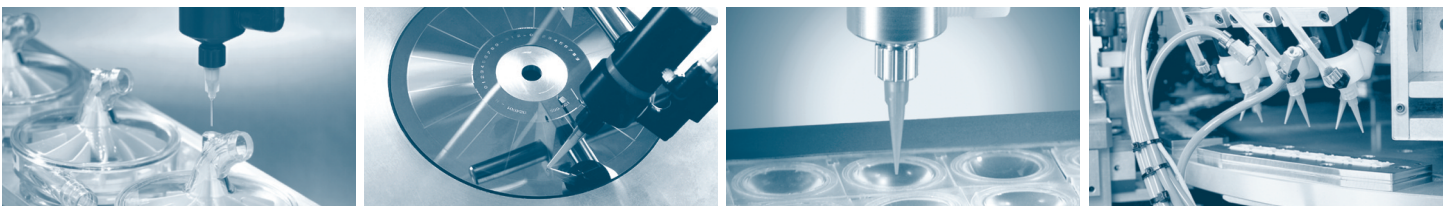

Specifications

Air pressure required: 70 to 90 psi (4.8 to 6.2 bar)

Maximum fluid pressure: 70 psi (4.8 bar)

Maximum fluid operating temperature: 43°C (110°F)

Maximum temperature - Autoclaving: 260°C (500°F)

The valve PTFE diaphragm should not stay in autoclave process longer than 15 minutes to prevent diaphragm warping.

Size: 77.5 mm length x 26.9 mm diameter (3.05" x 1.06")

Weight: 193.3 grams (6.82 oz.)

Air cylinder body: Type 316L stainless steel

Fluid body: Type 316L stainless steel

Diaphragm: PTFE

Free flow orifice: 2.03 mm diameter (.08")

Fluid inlet thread: 5/16-24 UNF

For Nordson EFD LLC sales and service in over 30 countries, contact Nordson EFD or go to www.nordsonefd.com

East Providence, RI USA
USA & Canada: 800-556-3484;
+1.401.431.7000
info@nordsonefd.com

Dunstable, Bedfordshire, UK
0800 585733; +44 (0) 1582 666334
Ireland 00800 8272 9444
europaenordsonefd.com

Nordson India Private Limited
+91 80 4021 3600
Mobile: +91 98450 48481
india@nordsonefd.com

China: +86 (21) 3866 9006
china@nordsonefd.com

Singapore: +65 6796 9522
sin-mal@nordsonefd.com

The Wave Design is a trademark of Nordson Corporation.
©2013 Nordson Corporation 7026836-EN v050613

For consistent dispense valve operation and easy adjustment of valve output, EFD recommends using the ValveMate 8000 controller on all automatic, semi-automatic and benchtop applications.

EFD dispensing robots incorporate dispensing control into the main system.

Contact the EFD Dispense Valve Systems Group for details.

