

R&S® EDS300

DME/PULSE Analyzer

User Manual



5202882502
Version 02



This manual applies to the following R&S®EDS300 models with software version 4.20 and later:

- R&S®EDS300 (5202.7006.02)

(For exceptions see the data sheet.)

In addition to the base unit, the following options are described:

- R&S®EDS-B1 Additional RX Unit (5202.7170.02)
- R&S®EDS-B2 Low-Power Interrogator (5202.8160.02)
- R&S®EDS-B4 High-Power Interrogator (5202.8177.02)
- R&S®EDS-B5 High-Power Amplifier (5202.7193.02)
- R&S®EDS-K1 TACAN Analysis (5202.8102.02)
- R&S®EDS-K2 Pulse Shape Analysis (5202.8119.02)
- R&S®EDS-K3 GPS Synchronization (5202.8125.02)
- R&S®EDS-K5 Multi-DME Mode (5202.8131.02)

© 2023 Rohde & Schwarz GmbH & Co. KG
Muehldorfstr. 15, 81671 Muenchen, Germany
Phone: +49 89 41 29 - 0
Email: info@rohde-schwarz.com
Internet: www.rohde-schwarz.com

Subject to change – data without tolerance limits is not binding.

R&S® is a registered trademark of Rohde & Schwarz GmbH & Co. KG.

All other trademarks are the properties of their respective owners.

5202.8825.02 | Version 02 | R&S®EDS300

Throughout this manual, products from Rohde & Schwarz are indicated without the ® symbol , e.g. R&S®EDS300 is indicated as R&S EDS300. R&S®EDS-Bxy/-Kxy is indicated as R&S EDS-Bxy/-Kxy.

Contents

1	Safety and regulatory information.....	7
1.1	Safety instructions.....	7
1.2	Labels on the product.....	9
1.3	Warning messages in the documentation.....	10
1.4	Korea certification class A.....	10
2	Documentation overview.....	11
3	Welcome to the R&S EDS300.....	12
4	Getting started.....	13
4.1	Preparing for use.....	13
4.2	Instrument tour.....	20
4.3	Operating basics.....	29
5	Measurement basics.....	35
5.1	Evaluating DME signals.....	35
5.2	Reply efficiency.....	36
5.3	RF attenuator.....	36
6	Measurements and results.....	38
6.1	DME and TACAN measurement mode.....	38
6.2	Multi-DME measurements.....	47
6.3	Graphical pulse analysis.....	48
7	Configuring and performing measurements.....	56
7.1	Configuring signal input and output.....	56
7.2	Configuring DME measurements.....	65
7.3	Performing pulse analysis.....	70
8	Data management.....	79
8.1	Storing and recalling measurement settings (preset).....	79
8.2	Logging measurement data.....	81
8.3	Creating and storing screenshots.....	82
8.4	Obtaining information on open-source resources.....	84
9	General instrument setup.....	85

9.1	General settings.....	85
9.2	Setting up a network (LAN) connection.....	86
9.3	Obtaining system information.....	90
9.4	Updating the software.....	95
9.5	Activating additional options.....	96
9.6	Configuring the display and audio output.....	97
10	How to perform measurements and analyze pulses with the R&S EDS300.....	101
10.1	How to configure signal input and output.....	101
10.2	How to perform a distance measurement.....	102
10.3	How to analyze interrogator pulses.....	103
10.4	How to set up the R&S EDS300 interrogator.....	103
10.5	How to analyze pulses graphically.....	104
10.6	How to set up the R&S EDS300 for TACAN measurements.....	105
10.7	How to save and load measurement settings.....	106
11	Remote commands for DME/Pulse analysis.....	109
11.1	Configuring remote operation.....	110
11.2	Obtaining instrument information.....	112
11.3	General instrument setup.....	116
11.4	Configuring signal input and output.....	118
11.5	Configuring measurements.....	123
11.6	Retrieving results.....	149
12	Troubleshooting.....	162
12.1	Contacting customer support.....	162
13	Maintenance, storage, transport and disposal.....	163
13.1	Cleaning.....	163
13.2	Calibration.....	163
13.3	Handling batteries.....	163
13.4	Storage.....	164
13.5	Transporting.....	164
13.6	Disposal.....	164
	Annex.....	166

A	References.....	166
B	DME channel frequency list.....	167
C	Format description of DME measurement data.....	183
	List of commands.....	189
	Index.....	193

1 Safety and regulatory information

The product documentation helps you use the product safely and efficiently. Follow the instructions provided here and in the following chapters.

Intended use

The R&S EDS300 is an analyzer designed for installing, testing and servicing pulsed terrestrial navigation systems like DME and TACAN ground equipment. Use the product only for its designated purpose. Observe the operating conditions and performance limits stated in the data sheet.

Target audience

This document is aimed at installers, technicians and operators of the R&S EDS300. It assumes the readers are familiar with basic handling of electrical equipment and have knowledge of avionic navigation systems.

Where do I find safety information?

Safety information is part of the product documentation. It warns you of potential dangers and gives instructions on how to prevent personal injury or damage caused by dangerous situations. Safety information is provided as follows:

- In [Chapter 1.1, "Safety instructions"](#), on page 7. The same information is provided in many languages as printed "Safety Instructions". The printed "Safety Instructions" are delivered with the product.
- Throughout the documentation, safety instructions are provided when you need to take care during setup or operation.

1.1 Safety instructions

Products from the Rohde & Schwarz group of companies are manufactured according to the highest technical standards. To use the products safely, follow the instructions provided here and in the product documentation. Keep the product documentation nearby and offer it to other users.

Use the product only for its intended use and within its performance limits. Intended use and limits are described in the product documentation such as the data sheet, manuals and the printed "Safety Instructions". If you are unsure about the appropriate use, contact Rohde & Schwarz customer service.

Using the product requires specialists or specially trained personnel. These users also need sound knowledge of at least one of the languages in which the user interfaces and the product documentation are available.

Reconfigure or adjust the product only as described in the product documentation or the data sheet. Any other modifications can affect safety and are not permitted.

Never open the casing of the product. Only service personnel authorized by Rohde & Schwarz are allowed to repair the product. If any part of the product is dam-

aged or broken, stop using the product. Contact Rohde & Schwarz customer service at <https://www.rohde-schwarz.com/support>.

Operating the product

The product is intended for mobile use. The maximum weight of the product is provided in the data sheet. If the product casing is not waterproof, use an adequate weather protection to carry the product outdoors with you.

When using the product in a vehicle or aircraft, make sure that the product is properly secured. If stacking is possible, secure the whole stack of products so that they cannot fall over and cause injury.

Observe the ambient conditions such as altitude, operating temperature and climatic loads; see the data sheet.

Due to their exposed location, mobile communications systems are at risk of damage from lightning. This also poses a risk to persons nearby. Vehicles carrying mobile communications systems require an electrically conductive body, a grounded antenna and also equipotential bonding that includes the cables routed into the vehicle.

Connecting to power

The product runs on DC voltage. For the specifications of the supply voltage for the product, refer to the data sheet. Under normal conditions, contact with DC voltage in this range poses a low risk of electric shock.

Take the following measures for your safety:

- If you connect the product to an external power supply, use one recommended in the product documentation.
- Before switching on the product, ensure that the voltage and frequency indicated on the product match the available power source.
- Only use intact cables and route them carefully so that they cannot be damaged. Also ensure that nobody can trip over loose cables.

Handling batteries safely

The product contains exchangeable or built-in lithium polymer or lithium ion cells or batteries. The use of the word battery in the following always means all types. Only the battery contents are potentially hazardous. As long as a battery is undamaged and the seals remain intact, there is no danger.

Impact, shock or heat can cause damage such as dents, punctures and other deformations. A damaged battery poses a risk of personal injury. Handle a damaged or leaking battery with extreme care. Immediately ventilate the area since the battery releases harmful gases. If you come into contact with the battery fluid, immediately remove all contaminated clothing. Irritation can occur if the battery fluid comes in contact with your skin or eyes. Immediately and thoroughly rinse your skin or eyes with water and seek medical aid.

For safe handling, follow these rules:

- Do not short-circuit the battery.
- Do not mechanically damage the battery. Do not open or disassemble the battery.

- Do not expose the battery to high temperatures such as open flames, hot surfaces and sunlight.
- Only use the battery with the designated Rohde & Schwarz product.
- Only use the appropriate Rohde & Schwarz charger to charge the batteries. If the batteries are improperly charged, there is a risk of explosion. For charging and discharging temperature ranges, see the product documentation.
- Replace exchangeable batteries only with the same battery type.
- Store the battery in the product or use the product packaging.
- Dispose of exchangeable batteries separately from normal household waste as specified by the local waste disposal agency.

If you disregard these rules, you risk serious personal injury or even death due to explosion, fire or hazardous chemical substances. The product documentation provides further details.



If exchangeable batteries or products with built-in batteries are defective, contact the Rohde & Schwarz customer service. Rohde & Schwarz classifies the severity of the defect. When returning batteries or Rohde & Schwarz products containing batteries, use a carrier qualified to transport dangerous goods and notify the carrier of this classification. Follow the carrier's transport stipulations in line with IATA-DGR, IMDG-Code, ADR or RID.

Using headphones

Take the following measures to prevent hearing damage. Before using headphones, check the volume and reduce it if necessary. If you monitor varying signal levels, take off the headphones and wait until the signal has settled. Then adjust the volume.

Meaning of safety labels

Safety labels on the product warn against potential hazards.



	<p>Potential hazard Read the product documentation to avoid personal injury or product damage.</p>
	<p>DC - direct current Connect to a DC power supply of the specified voltage range.</p>

1.2 Labels on the product

Labels on the casing inform about:

- Personal safety, see ["Meaning of safety labels"](#) on page 9
- Product and environment safety, see [Table 1-1](#)
- Identification of the product, see [Chapter 4.2.3, "Device ID"](#), on page 28:

Table 1-1: Labels regarding product and environment safety

	<p>Labeling in line with EN 50419 for disposal of electrical and electronic equipment after the product has come to the end of its service life.</p> <p>For more information, see "Disposing electrical and electronic equipment" on page 164.</p>
	<p>Labeling in line with directive 2006/66/EC for disposal of batteries after they have come to the end of their service life.</p> <p>For more information, see "Disposing batteries" on page 165.</p>

1.3 Warning messages in the documentation

A warning message points out a risk or danger that you need to be aware of. The signal word indicates the severity of the safety hazard and how likely it will occur if you do not follow the safety precautions.

NOTICE

Potential risks of damage. Could result in damage to the supported product or to other property.

1.4 Korea certification class A



이 기기는 업무용(A급) 전자파 적합기기로서 판매자 또는 사용자는 이 점을 주의하시기 바라며, 가정외의 지역에서 사용하는 것을 목적으로 합니다.

2 Documentation overview

This section provides an overview of the R&S EDS300 user documentation. Unless specified otherwise, you find the documents at:

www.rohde-schwarz.com/manual/EDS300

Further documents are available at:

www.rohde-schwarz.com/product/EDS300.

Getting Started manual

Introduces the R&S EDS300 and describes how to set up and start working with the product. Includes basic operations, typical measurement examples, and general information, e.g. safety instructions, etc.

A printed version is delivered with the instrument.

User manual

The user manual contains the description of all instrument modes and functions. It also provides an introduction to remote control, a complete description of the remote control commands with programming examples, and information on maintenance, instrument interfaces and error messages. Includes the contents of the getting started manual.

The user manual is also available for download or for immediate display on the Internet.

Data sheet and brochures

The data sheet contains the technical specifications of the R&S EDS300. It also lists the firmware applications and their order numbers, and optional accessories.

The brochure provides an overview of the instrument and deals with the specific characteristics.

Release notes and open source acknowledgment (OSA)

The release notes list new features, improvements and known issues of the current firmware version, and describe the firmware installation.

The software makes use of several valuable open source software packages. An open source acknowledgment document provides verbatim license texts of the used open source software.

Application notes, application cards, white papers, etc.

These documents deal with special applications or background information on particular topics.

See www.rohde-schwarz.com/apnotes.

3 Welcome to the R&S EDS300

The R&S EDS300 is an analyzer designed for installing, testing and servicing pulsed terrestrial navigation systems like DME and TACAN ground equipment. Its wide dynamic range and compact design make the R&S EDS300 ideal especially for wired and field measurements on DME and TACAN ground stations.

The R&S EDS300 provides high-precision stimulus and analysis functions for DME / TACAN signals in the frequency range from 960 MHz to 1215 MHz. It performs TX/RX measurements required for DME and TACAN ground stations in line with the relevant civil and military standards accurately and efficiently.

The R&S EDS300 can precisely determine characteristic parameters such as peak power, main delay, reply efficiency, and can decode the identifier of the ground station to be tested. The instrument also measures the parameters of TACAN stations (R&S EDS-K1 option) and performs in-depth pulse analysis (R&S EDS-K2 option).

The modular design of the R&S EDS300 provides a high degree of flexibility to adapt it to the task at hand. An interrogator (R&S EDS-B2 option) with adjustable output power (-80 dBm to +30 dBm peak power) is available for RX measurements. An internal battery and a test antenna (R&S EDST-Z1 option) deliver maximum flexibility when carrying out field measurements. Measured data can be exported to a control system via remote control (LAN), or stored on a USB flash drive.

4 Getting started

- [Preparing for use](#).....13
- [Instrument tour](#).....20
- [Operating basics](#).....29

4.1 Preparing for use

Here, you can find basic information about setting up the product for the first time.

4.1.1 Lifting and carrying

The carrying handle on the side of the instrument is designed to lift or carry the instrument. Do not apply excessive external force to the handle. The maximum weight of the product is provided in the data sheet.

4.1.2 Unpacking and checking

1. Unpack the product carefully.
2. Retain the original packing material. Use it when transporting or shipping the product later.
3. Using the delivery notes, check the equipment for completeness.
4. Check the equipment for damage.

If the delivery is incomplete or equipment is damaged, contact Rohde & Schwarz.

4.1.3 Choosing the operating site

Specific operating conditions ensure proper operation and avoid damage to the product and connected devices. For information on environmental conditions such as ambient temperature and humidity, see the data sheet.

If you operate the product with an external power supply, you can use it indoors only in pollution degree 2 environments where nonconductive contamination can occur.

See also "[Operating the product](#)" on page 8.

Operating altitude

The maximum operating altitude is provided in the data sheet. It differs in battery operation and operation with an external power supply.

Electromagnetic compatibility classes

The electromagnetic compatibility (EMC) class indicates where you can operate the product. The EMC class of the product is given in the data sheet.

- Class B equipment is suitable for use in:
 - Residential environments
 - Environments that are directly connected to a low-voltage supply network that supplies residential buildings
- Class A equipment is intended for use in industrial environments. It can cause radio disturbances in residential environments due to possible conducted and radiated disturbances. It is therefore not suitable for class B environments. If class A equipment causes radio disturbances, take appropriate measures to eliminate them.

4.1.4 Setting up the product indoors

The R&S EDS300 can be operated in various places without detrimental effects on its features. Even the movement caused by transportation or mobile use does not impair its functioning.

See also:

- ["Intended use"](#) on page 7

4.1.4.1 Placing the product on a bench top

If you want to set up the R&S EDS300 on a benchtop or prepare the R&S EDS300 for mobile use, proceed as follows.

To place the product on a bench top

1. Place the product on a stable, flat and level surface. Ensure that the surface can support the weight of the product. For information on the weight, see the data sheet.
2. Always fold the feet completely in or out. With folded-out feet, do not place anything on top or underneath the product.
3. **CAUTION!** A stack of products can fall over and cause injury. Never stack more than three products on top of each other. Instead, mount them in a rack.

Stack as follows:

- If the products have foldable feet, fold them in completely.
- It is best if all products have the same dimensions (width and length). If the products have different dimensions, stack according to size and place the smallest product on top.

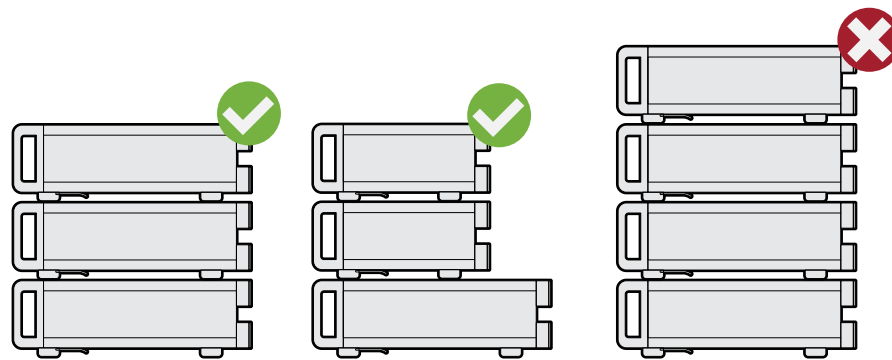

Left = Stacked correctly, same dimensions
 Middle = Stacked correctly, different dimensions
 Right = Stacked incorrectly, too many products

4. **NOTICE!** Overheating can damage the product.

Prevent overheating as follows:

- Keep a minimum distance of 10 cm between the fan openings of the product and any object in the vicinity.
- Do not place the product next to heat-generating equipment such as radiators or other products.

4.1.4.2 Mounting the R&S EDS300 in a rack

If you use the product in a vehicle or in aircraft, install it in a rack provided for this purpose. Secure the product safely so that it cannot fall out and hurt passengers when the vehicle or aircraft is moving.

To prepare the rack

1. Observe the requirements and instructions in "[Operating the product](#)" on page 8.
2. **NOTICE!** Insufficient airflow can cause overheating and damage the product. Design and implement an efficient ventilation concept for the rack.

To mount the R&S EDS300 in a rack

1. Use an adapter kit to prepare the R&S EDS300 for rack mounting.
 - a) Order the rack adapter kit designed for the R&S EDS300. For the order number, see the data sheet.
 - b) Mount the adapter kit. Follow the assembly instructions provided with the adapter kit.
2. Lift the R&S EDS300 to shelf height.
3. Grab the handle and push the R&S EDS300 onto the shelf until the rack brackets fit closely to the rack.
4. Tighten all screws in the rack brackets with a tightening torque of 1.2 Nm to secure the R&S EDS300 in the rack.

To unmount the R&S EDS300 from a rack

1. Loosen the screws at the rack brackets.
2. Remove the R&S EDS300 from the rack.
3. If placing the R&S EDS300 on a bench top again, unmount the adapter kit from the R&S EDS300. Follow the instructions provided with the adapter kit.

4.1.5 Preparing for outdoor usage

If you want to perform a walk test, the R&S EDS300 requires weather protection because the product casing is not waterproof. Only use the internal battery as a power supply for outdoor operation.

See also "[Operating the product](#)" on page 8.

4.1.6 Considerations for test setup**Cable selection and electromagnetic interference (EMI)**

Electromagnetic interference (EMI) can affect the measurement results.

To suppress electromagnetic radiation during operation:

- Use high-quality shielded cables, for example, double-shielded RF and LAN cables.
- Always terminate open cable ends.
- Ensure that connected external devices comply with EMC regulations.

Signal input and output levels

Information on signal levels is provided in the data sheet. Keep the signal levels within the specified ranges to avoid damage to the product and connected devices.

4.1.7 Connecting to power

To ensure high mobility and flexibility while using the R&S EDS300, it is equipped with an internal battery and a DC power supply connector on the rear panel of the instrument.

DC power can be supplied by one of the following sources:

- The installed battery (R&S EDS-B3)
- The provided DC power supply unit connected to a 230 V AC power supply (for indoor use only)
- External DC power sources with a voltage of 24 VDC±5%, protected by a 5 A fuse (Requires R&S EDS-B3)

Do not connect the instrument to available DC networks.

For safety information, see ["Connecting to power"](#) on page 8.

To connect the provided DC power supply

1. Plug the AC power cable of the provided DC power supply unit into a two-pin power outlet with ground contact.

The green operating LED on the power supply unit lights up.

2. Connect the DC power supply unit to the "POWER supply" connector on the back of the R&S EDS300 (see [Chapter 4.2.2, "Rear panel view"](#), on page 25).

The yellow "Standby" LED on the R&S EDS300 lights up.

To connect an optional external DC power supply

1. If necessary, connect a 12-Volt to 24-Volt DC/DC converter to the DC power supply. The supported DC range is provided in the data sheet.
2. Connect the DC power supply unit (or the DC/DC converter) to the "POWER supply" connector on the back of the R&S EDS300 (see [Chapter 4.2.2, "Rear panel view"](#), on page 25).

The yellow "Standby" LED on the R&S EDS300 lights up.

4.1.8 Connecting external devices

Various interfaces for external devices are provided.

- [Connecting an antenna](#)..... 17
- [Connecting a suppressor line](#)..... 18
- [Connecting a GPS receiver](#)..... 18
- [Connecting an external monitor](#)..... 18

4.1.8.1 Connecting an antenna

The standard R&S EDS300 base unit provides two receiving antenna connections ("RF1 IN/OUT", "RF2 IN", see [Chapter 4.2.1, "Front panel view"](#), on page 20).

If the interrogator option R&S EDS-B2 is installed on the R&S EDS300, the instrument can also provide HF output to a transmitter antenna via the "RF1 IN/OUT" connector (see also ["Antenna connections RF1 IN/OUT and RF2 IN"](#) on page 22).

To connect a receiver antenna

- ▶ Connect the receiver antenna to the "RF1 IN/OUT" or the "RF2 IN" interface on the front panel of the R&S EDS300.
The "RF2 IN" connector provides a higher sensitivity.
For details, see [Table 5-1](#).

To connect a transmit antenna

1. Connect the transmit antenna to the "RF1 IN/OUT" on the front panel of the R&S EDS300.
2. If necessary, insert an attenuation element between the laboratory equipment and the R&S EDS300 to prevent destruction of laboratory equipment in laboratory operation.

The R&S EDS300 transmitter antenna provides a maximum output of 500 W (57 dBm).

4.1.8.2 Connecting a suppressor line

Using a bi-directional suppressor line, the instruments in an aircraft send signals to each other. While a signal is being sent on the suppressor line, no other instrument can send a signal at the same time. Any receivers are switched off temporarily to avoid overloading.

- ▶ Connect the suppressor line to the "SUPPRESS IN / OUT" interface on the rear panel of the R&S EDS300 (see [Chapter 4.2.2.2, "SUPPRESS IN / OUT connector"](#), on page 26).

4.1.8.3 Connecting a GPS receiver

You can connect a GPS receiver to the RS232 interface on the rear panel of the R&S EDS300 (see also [Chapter 4.2.2.9, "RS232 GPS interface"](#), on page 28).

GPS support requires option R&S EDS-K3.

If available, the NMEA protocol data provided by the GPS receiver is displayed and stored with the recorded data.

4.1.8.4 Connecting an external monitor

You can connect an external monitor (or projector) to the "DVI" connector on the instrument's rear panel (see also [Chapter 4.2.2.8, "DVI"](#), on page 28). The screen resolution is always 640x480 pixels.

4.1.9 Activating the TACAN option

The TACAN (Tactical Air Navigation) option R&S EDS-K1 is implemented as a USB stick. The TACAN stick is linked to the R&S EDS300 unambiguously via the instrument's MAC address. The R&S EDS300 can evaluate TACAN signals only if the TACAN stick with the TACAN software is inserted in one of the USB ports.



The TACAN stick must be inserted *before* the R&S EDS300 is switched on. Do not remove the stick before switching off the R&S EDS300, or else the application is closed.



When the R&S EDS300 firmware is started, the TACAN functionality is copied from the stick to the RAM. After the R&S EDS300 is shut down, no TACAN functionality remains in the instrument.

The TACAN stick cannot be used to store data; however, a second USB stick can be connected simultaneously for data logging.

4.1.10 Switching on or off

The power state is indicated by two LEDs over the "Power" key.

Table 4-1: Overview of power states

Status	Left LED	Right LED	Position of power switch
Off	Off	Off	[0]
Ready	 green		[1]
Standby		 orange	[1]

To switch on the product

The product is off but connected to power.

The right power LED is yellow. See [Table 4-1](#).

- ▶ Press the [Power] key.

The left power LED lights up green. The product boots.

After the instrument has fully booted, the most recently used measurement mode is automatically started.



Using the installed battery

If the R&S EDS300 is powered using the internal battery and the batteries become empty, the instrument switches itself off. You cannot switch it back on until the DC power supply is connected.

See [Chapter 4.1.7, "Connecting to power"](#), on page 16.

To shut down the product

The product is in the ready state.

- ▶ Press the [Power] key.

The operating system shuts down. The LED changes to orange.

To disconnect from power

The product is in the standby state.

The right power LED is yellow. See [Table 4-1](#).

- ▶ **NOTICE!** Risk of data loss. If you disconnect the product from power when it is in the ready state, you can lose settings and data. Shut it down first.

Disconnect the product from the power source.

4.2 Instrument tour

4.2.1 Front panel view

This chapter describes the front panel of the R&S EDS300, including all function keys and connectors.

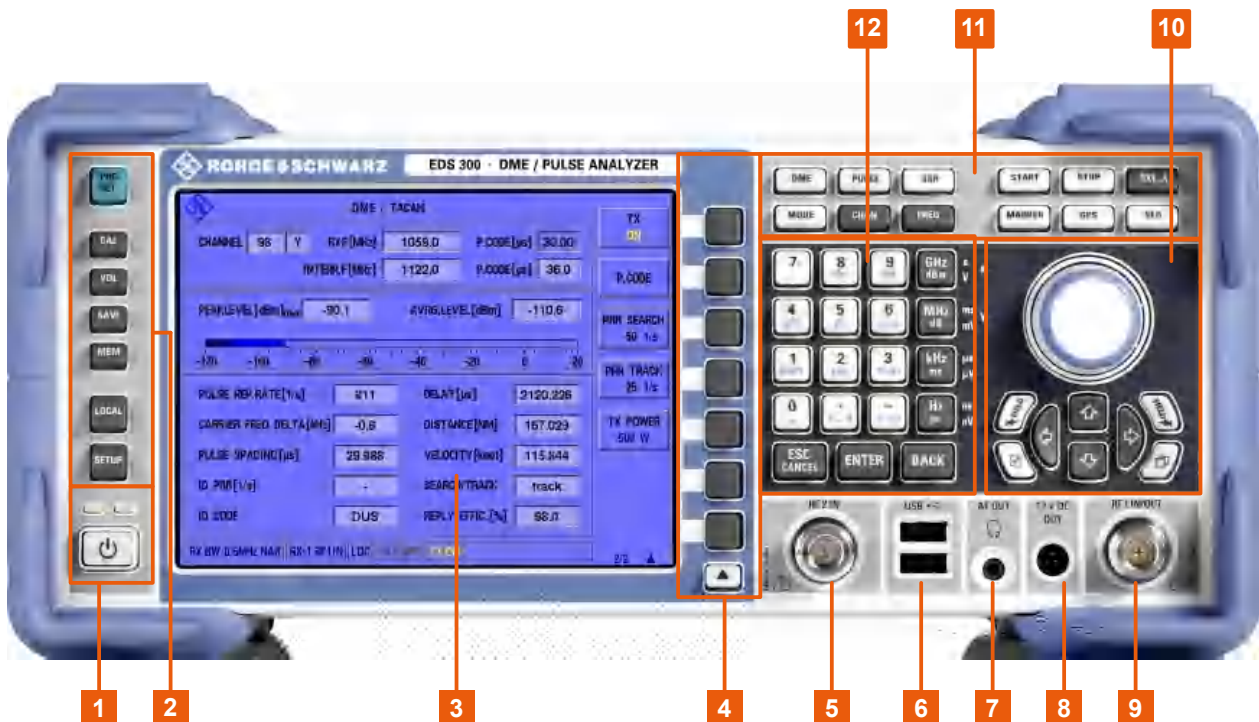

Figure 4-1: Front panel view of the R&S EDS300

- 1 = Power key (ON / OFF switch) with status LEDs
- 2 = System keys
- 3 = TFT Colour Display
- 4 = Softkeys
- 5 = RF 2 IN connector
- 6 = USB interface
- 7 = Headphone output AF OUT
- 8 = Voltage supply for external consumers: 12 VDC OUT

- 9 = [RF 1 IN/OUT connector](#)
- 10 = [Navigation controls and general functions](#)
- 11 = [Measurement keys](#)
- 12 = [Keypad](#)

4.2.1.1 Power key

The [Power] key is located on the lower left corner of the front panel. It starts up and shuts down the instrument.

See also ["Connecting to power"](#) on page 8 and [Chapter 4.1.10, "Switching on or off"](#), on page 19.

The status LEDs indicate the status of operation, see [Table 4-1](#).

4.2.1.2 System keys

System keys set the instrument to a predefined state, change basic settings, and provide print and display functions.

A detailed description of the corresponding functions is provided in [Chapter 9, "General instrument setup"](#), on page 85.

Table 4-2: SYSTEM keys

SYSTEM key	Assigned functions
[PRESET]	Resets the instrument to the default state.
[CAL]	Starts a calibration on the R&S EDS300
[VOL]	Volume control for audio output
[SAVE]	for future use
[MEM]	
[LOCAL]	Switches between remote and local operation of the R&S EDS300
[SETUP]	Provides basic instrument configuration functions, e.g.: <ul style="list-style-type: none"> • Reference frequency (external/internal), noise source • Date, time, display configuration • LAN interface • Self-alignment • Software update and enabling of options • Information about instrument configuration incl. software version and system error messages • Service support functions (self test etc.)

4.2.1.3 Softkeys

Softkeys are variable, software-defined keys. The functions depend on the measurement mode and current display.



The arrow toggles between different sets of functions in the same menu, if more menu items are available than softkeys.

4.2.1.4 Front panel interfaces

Various interfaces are provided on the front panel of the R&S EDS300.

- [Antenna connections RF1 IN/OUT and RF2 IN](#)..... 22
- [USB interface](#)..... 22
- [Headphone output AF OUT](#)..... 23
- [Voltage supply for external consumers: 12 VDC OUT](#)..... 23

Antenna connections RF1 IN/OUT and RF2 IN

The standard R&S EDS300 base unit provides two receiving antenna connections ("RF1 IN/OUT", "RF2 IN").

See also [Chapter 4.1.6, "Considerations for test setup"](#), on page 16 and [Chapter 4.1.8.1, "Connecting an antenna"](#), on page 17.

Table 4-3: Specification of RF input for the receiver units

Input level:	Max. +13 dBm (depending on attenuation mode)
Frequency range:	960 MHz ... 1215 MHz
VSWR:	<1.5
Connector:	N-socket, 50Ω

RF output with interrogator options

If the R&S EDS300 is equipped with the interrogator option R&S EDS-B2, the "RF1 IN/OUT" connector can provide HF output to a transmitter antenna. The antenna has an equivalent frequency range and (peak) power range (1 W).

Table 4-4: Specification of low-power interrogator, option R&S EDS-B2

Output power:	max. 1 W (+30 dBm) ±1.5 dB
Frequency range:	960 MHz ... 1215 MHz
Channel offset:	1 MHz
Distance range:	5.4 NM (approx. 10 km)
Resolution:	0.1 m
Deviation:	≤5 m
Connector:	N-socket, 50 Ω

USB interface

The front panel provides two female USB connectors (USB-A) to connect devices like a memory stick to store and reload instrument settings and measurement data. Only USB sticks using the FAT / FAT32 file system are supported.

The connectors are standard USB 2.0 ports with a maximum transmission rate of approximately 30 Mbit/s.

The rear panel provides further USB connectors (standard 3.0), see [Chapter 4.2.2.5, "USB"](#), on page 27.

Headphone output AF OUT

Audio output is available by connecting a headphone to the 3.5 mm jack plug "AF OUT".

Note the safety information provided in "Using headphones" on page 9.

For details, see [Chapter 9.6, "Configuring the display and audio output"](#), on page 97.

Voltage supply for external consumers: 12 VDC OUT

The R&S EDS300 provides a power supply for connected external devices at the 3-pole circular "12 VDC OUT" connector. The output for external consumers such as an active receiving antenna is supplied permanently with 12 VDC / 300 mA.

4.2.1.5 Navigation controls and general functions

The navigation controls include a rotary knob and navigation keys. They allow you to navigate within the display or within dialog boxes.

Rotary knob

The rotary knob has several functions:

- Increases (clockwise direction) or decreases (counter-clockwise direction) numeric values with a defined increment in editing mode.
- Scrolls within lists, tables or tree views.
- Acts like the [ENTER] key, when it is pressed.
- Shifts the selection bar within focused areas (e.g. lists), if the edit mode is activated.
- Moves the scroll bar vertically, if the scroll bar is focused and the edit mode is activated.



Turning or pressing the rotary knob is equivalent to pressing the [Up] and [Down] keys or the [ENTER] key in the keypad.

Up/ Down Keys

The up and down arrow keys do the following:



- In a numeric edit dialog box, increase or decrease the instrument parameter.
- In a list, table, window or dialog box, scroll vertically.

Left/ Right Keys

The left and right arrow keys do the following:

- In an alphanumeric edit dialog box, move the cursor forward and back.
- In a list, table, window or dialog box, scroll horizontally.

General function keys

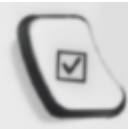
Key	Function
	Creates a screenshot of the current display
  	For future use

4.2.1.6 Measurement keys

Measurement keys provide access to the most common measurement settings and functions.

A detailed description of the corresponding functions is provided in [Chapter 7, "Configuring and performing measurements"](#), on page 56.

Table 4-5: Measurement keys

Measurement key	Assigned functions
DME	Selects DME/TACAN measurement mode
PULSE	Selects Pulse view mode
SSR	For future use
MODE	For future use
CHAN	Selects DME/TACAN channel number for measurements
FREQ	Toggles between RX and TX settings; Sets the center frequency and the start and stop frequencies for the RX and TX frequency range under consideration.
START STOP	Starts and stops streaming or storing measurement data.
RX1..4	Selects the receiver antenna input for measurement
MARKER	Sets and positions a measurement marker in "Pulse" view
GPS	Selects GPS mode Requires R&S EDS-K3
SEQ	Selects Multi-DME mode Requires R&S EDS-K5

4.2.1.7 Keypad

The keys in the data entry keypad are used to enter alphanumeric data and units.

Data entry keys are only enabled while the cursor is placed on a data input field in a dialog. Their function depends on the data type of the input field.

Keys	Description
0...9/abc	Enters the corresponding numbers (in numeric input fields) or characters (character input fields).
.	Inserts a decimal point (numeric input fields) or dot (character input fields) at the cursor position. Multiple decimal points are not allowed.
-	Changes the sign of a numeric parameter. For alphanumeric parameters, inserts a hyphen at the cursor position.
+/-	Changes the sign of a numeric parameter. For alphanumeric parameters, inserts a hyphen at the cursor position.
Unit keys	Adds the selected unit to the entered numeric value and completes the entry.
_	Adds a blank in a character input field.
*... #	Enters special characters. Toggles through the available characters if the key is pressed several times in a row.
A ↔ a	Toggles between uppercase and lowercase characters.
[BACK]	Deletes the last character before the cursor position or the selected character sequence.
[ENTER]	<ul style="list-style-type: none"> Concludes the entry of dimensionless entries. For other entries, this key can be used instead of the default unit key. The new value is accepted. Confirms ("OK") and closes open input windows. In a dialog box, selects the default or focused button. In a dialog box, activates the edit mode for the focused area, if available. In a dialog box, activates or deactivates the selected option of the focused area. Calls the next menu level. Pressing the rotary knob has the same effect.
[ESC/ESC / Cancel]	<ul style="list-style-type: none"> Closes the open window without accepting new entries; the old value or parameter is retained. Closes all kinds of dialog boxes. In dialog boxes that contain a "Cancel" button that it activates that button.

4.2.2 Rear panel view

This figure shows the rear panel view of the R&S EDS300. The individual elements are described in more detail in the subsequent sections.

The meanings of the labels on the product are described in [Chapter 1.2, "Labels on the product"](#), on page 9.



Figure 4-2: Rear panel view of the R&S EDS300

- 1 = DC power supply connection
- 2 = Chapter 4.2.2.2, "SUPPRESS IN / OUT connector", on page 26
- 3 = ANALOG IN connector
- 5 = ANALOG OUT connector
- 7 = TRIGGER OUT connector
- 8 = TRIGGER IN connector
- 9 = USB
- 10 = REF 10 MHz IN/OUT
- 11 = LAN interface
- 12 = DVI
- 13 = RS232 GPS interface
- 14 = Speaker for audio output

4.2.2.1 DC power supply connection

To ensure high mobility and flexibility while using the R&S EDS300, it is equipped with a DC power supply connector on the rear panel of the instrument.

For safety information, refer to ["Connecting to power"](#) on page 8.

For details, refer to [Chapter 4.1.7, "Connecting to power"](#), on page 16.

4.2.2.2 SUPPRESS IN / OUT connector

The R&S EDS300 allows for a suppressor line signal to be input or output via the BNC "SUPPRESS IN / OUT" connector (see [Chapter 4.1.8.2, "Connecting a suppressor line"](#), on page 18).

The (digital) voltage levels for the input can range from 8 V to 30 V (when active).

The (digital) voltage levels for the output depend on the power supply of the R&S EDS300. The power supply ranges from 20 V to 28 V.

With an internal battery, the output power supply range is 24 V \pm 5 %.

The output voltage is the supplied voltage minus approx. 1 V.

In both cases, the impedance is 30 k Ω .

4.2.2.3 ANALOG IN / ANALOG OUT connectors

The R&S EDS300 can provide various analog signals as output at the "ANALOG OUT" BNC connector. The signal is output with a peak power level of 4 V and an impedance of 50 Ω .

Configure which signal to output in the general instrument settings.

(See [Chapter 7.1.2, "Configuring signal output"](#), on page 58).

The R&S EDS300 can also analyze analog baseband signals from another device via the "ANALOG IN" BNC connector. Input the signal with a peak power level of 1 V and an impedance of 50 Ω .

4.2.2.4 TRIGGER INPUT / OUTPUT

Use the female BNC "TRIGGER INPUT" connector to input an external trigger. An external trigger, for example from the DME transmission system, can control the measurement on the R&S EDS300. The (digital) voltage levels can range from 3.3 V to 33 V. The input impedance is 100 k Ω .

Use the female BNC "TRIGGER OUTPUT" connector to provide a trigger signal from the R&S EDS300 to another connected device, such as the DME transmission system. The trigger can be a pulse, ARB, or MRB signal, for example. The (digital) output signal is TTL compatible (0 V / 5 V). The output impedance is 50 Ω .

Control the trigger signal in the measurement settings.

(See ["Trigger Out Mode"](#) on page 59, ["Trigger Source"](#) on page 76).

4.2.2.5 USB

The rear panel provides additional female USB (USB-A) connectors to connect a memory device or power sensor.

The connectors are standard USB 3.0 ports with a maximum transmission rate of 40 Mbit/s.

For further USB connectors, see also ["USB interface"](#) on page 22.

4.2.2.6 REF 10 MHz IN/OUT

The "REF 10 MHz IN/OUT" connector can provide an external reference signal to the R&S EDS300, or from the R&S EDS300 to a connected device. In either case, the ref-

reference signal is at 10 MHz, with a power level of $1 V_{\text{eff}}$. The connector is a 50Ω BNC socket.

Configure whether the connector is used for input or output in the general instrument settings.

(See [Chapter 7.1.3, "Configuring the reference frequency"](#), on page 60).

4.2.2.7 LAN interface

Use the "LAN" interface to connect the R&S EDS300 to a local network for remote control, printouts or data transfer. The data can be transferred with a rate of up to 1 Gbit per second. Configure the IP address and subnet mask in the general instrument settings.

(See [Chapter 9.2, "Setting up a network \(LAN\) connection"](#), on page 86).

4.2.2.8 DVI

You can connect an external (TFT) monitor or other display device to the R&S EDS300's DVI (Digital visual interface) to provide an enlarged display. The interface consists of a DVI-D socket (24+1).

For details, see [Chapter 4.1.8.4, "Connecting an external monitor"](#), on page 18.

4.2.2.9 RS232 GPS interface

2-port RS232, 9-pin D-Sub connector for a GPS receiver providing NMEA protocol data. The NMEA protocol data is displayed and stored with the recorded data.

GPS support requires option R&S EDS-K3.

4.2.3 Device ID

The unique device identifier is provided as a barcode sticker on the rear panel of the R&S EDS300.

It consists of the device order number and a serial number.





The serial number is used to define the **default instrument name**, which is:

<Type><variant>-<serial_number>

For example, EDS300-123456.

The instrument name is required to establish a connection to the instrument in a LAN.

4.3 Operating basics

This chapter provides an overview on how to work with the R&S EDS300. It describes what kind of information is displayed on the screen and how to operate the R&S EDS300 via the front panel keys and other interaction methods.

4.3.1 Understanding the display information

The following figure shows a typical screen display on the R&S EDS300. All different screen elements are labeled. They are explained in more detail in the following sections.

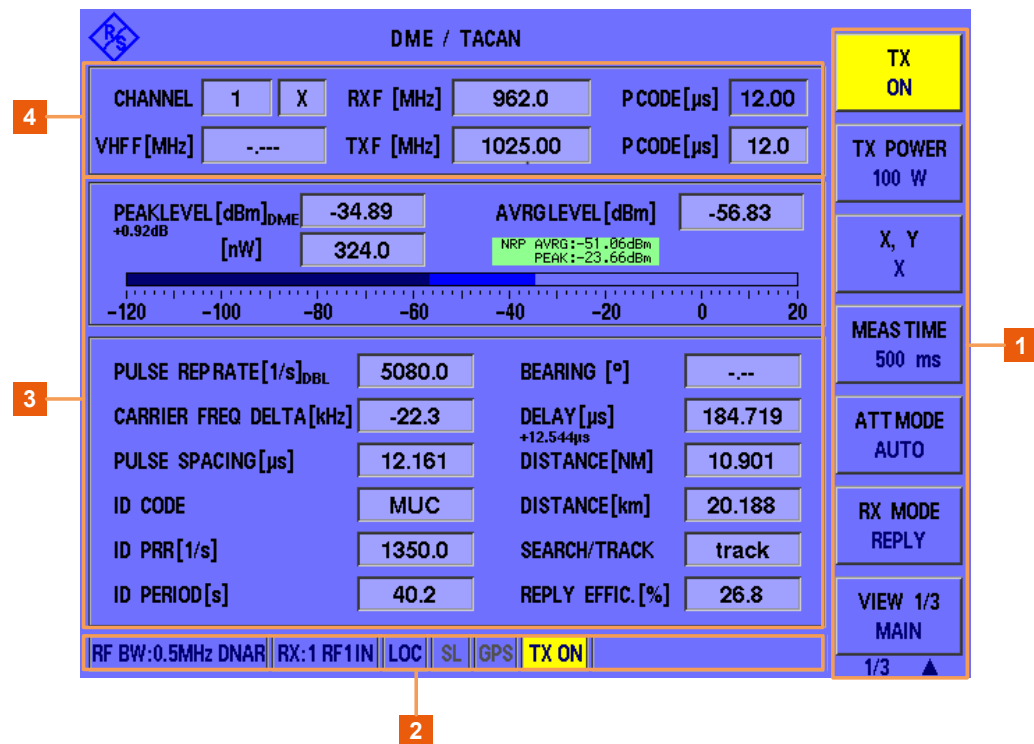

Figure 4-3: Typical R&S EDS300 screen display (using DME mode as an example)

- 1 = Softkeys to edit settings and activate functions
- 2 = Status bar
- 3 = Measurement result area
- 4 = Measurement settings area

Softkeys

Softkeys are virtual function keys whose actual function is defined by the software, depending on the currently selected measurement mode or key, or both.



Sometimes, more functions are available than softkeys can be displayed at the same time. In this case, a second or third menu of functions is available, indicated by "1/2" and "2/2" (or "1/3", "2/3", "3/3", respectively) beneath the softkeys in the display. To switch between the menus of softkey functions, press the "More softkeys" key beneath the softkeys on the front panel of the R&S EDS300.

Measurement settings and results area

During a measurement, the available settings are displayed at the top of the screen; the measurement results at the bottom. If a general instrument setting or data management function is selected, the settings and information are displayed in the main part of the screen.

Which settings and results are displayed depends on the current measurement or instrument function.

See the following chapters for details:

- [Chapter 7, "Configuring and performing measurements"](#), on page 56
- [Chapter 9, "General instrument setup"](#), on page 85
- [Chapter 8, "Data management"](#), on page 79

Status bar

The status bar at the bottom of the screen contains information on the operating status of the instrument and connected devices.

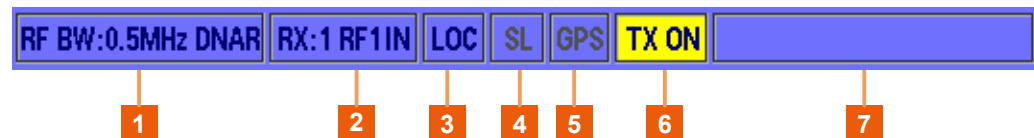

Figure 4-4: R&S EDS300 status bar

Table 4-6: Information in the R&S EDS300 status bar

	Section	Function	Example
1	Input settings	Input settings, e.g. the used RF and demodulation bandwidth (narrow, wide).	RF BW:0.5MHz DNAR
2	RX connectors	Connector used for each receive channel (RX1 / RX2 (optional))	RX:1 RF1 IN (The RF input for receive channel "RX1" is provided by the [RF1 IN] connector)

	Section	Function	Example
3	Operating mode	Local or remote operation of the instrument LOC : local operation (directly on the instrument) REM : remote operation by external PC (can be stopped using [LOCAL] key on front panel) RLC : (REMOTELock) local operation is locked by remote control	LOC
4	Suppress line status	Indicates incoming suppressor line signal (see Chapter 4.2.2.2, "SUPPRESS IN / OUT connector" , on page 26)	"SL"
5	GPS status	GPS connection available or not (see Chapter 4.2.2.9, "RS232 GPS interface" , on page 28)	"GPS"
6	TX status	Indicates use of "RF1 IN/OUT" connector for transmission (see "Antenna connections RF1 IN/OUT and RF2 IN" on page 22)	TX ON
7	Operating status	Messages on the type of power supply (battery/mains) currently in use, as well as the data logging status of the instrument, if applicable (see Error and status messages).	USB LOGGING ON

4.3.2 Accessing the functionality

All functions available on the R&S EDS300 can be accessed using the keys on the front panel of the instrument. Some keys provide a softkey menu on the display with further functions and settings.

To change a setting or activate a function

1. Select a key on the front panel of the instrument to activate a function directly, or to display a softkey menu.



Select the softkey for the setting or function as required.

If necessary, select the "More softkeys" key to switch to the second softkey menu.

The function is activated, or a new window is displayed to view or change specific settings.

3. To set the focus on a specific setting in the displayed window, scroll through the individual settings by turning the rotary knob or pressing the Up and Down arrow keys on the front panel (see [Chapter 4.2.1.5, "Navigation controls and general functions"](#), on page 23).
4. To edit the currently selected setting, press the rotary knob or the [ENTER] key on the front panel.
5. Scroll through the available setting values by turning the rotary knob or pressing the Up and Down arrow keys on the front panel, or enter a numeric or alphanumeric value as described in [Chapter 4.3.3, "Entering data"](#), on page 32.

6. Confirm the new setting by pressing the rotary knob or the [ENTER] key on the front panel.

4.3.3 Entering data

Data can be entered in input fields using elements provided by the front panel, e.g. the keypad, rotary knob, or navigation keys.

The rotary knob has the same effect as the [ENTER] key when it is pressed.



Red input fields - invalid input



If you enter invalid data in an input field, the value is displayed in red and cannot be stored.

4.3.3.1 Entering numeric parameters

If a field requires numeric input, the keypad provides only numbers.

1. Enter the parameter value using the keypad, or change the currently used parameter value by turning the rotary knob or pressing the Up or Down arrow keys.
2. After entering the numeric value via keypad, press the corresponding unit key. The unit is added to the entry.
3. If the parameter does not require a unit, confirm the entered value by pressing the [ENTER] key or any of the unit keys.

4.3.3.2 Entering alphanumeric parameters

If a field requires alphanumeric input, you can use the keypad on the front panel of the R&S EDS300. Every alphanumeric key represents several characters and one number. The decimal point key (.) represents special characters, and the sign key (-) toggles between capital and small letters. For the assignment, refer to [Table 4-7](#).

Entering numbers and (special) characters via the keypad

1. Press the key once to enter the first possible value.
2. All characters available via this key are displayed.
3. To choose another value provided by this key, press the key again, until your desired value is displayed.
4. With every key stroke, the next possible value of this key is displayed. If all possible values have been displayed, the series starts with the first value again. For information on the series refer to [Table 4-7](#).

5. To change from capital to small letters and vice versa, press the sign key (-).
6. When you have chosen the desired value, wait for 2 seconds (to use the same key again), or start the next entry by pressing another key.

Entering a blank

- ▶ Press the "0" key and wait 2 seconds.

Correcting an entry

1. Using the arrow keys (see [Chapter 4.2.1.5, "Navigation controls and general functions"](#), on page 23), move the cursor to the right of the entry you want to delete.
2. Press the [BACK] key.
The entry to the left of the cursor is deleted.
3. Enter your correction.

Completing the entry

- ▶ Press the [ENTER] key or the rotary knob.
For numeric values, the default unit is appended to the numeric input.
To enter a value using a different unit, select the corresponding

Aborting the entry

- ▶ Press the [ESC] key.
The previous entry is restored.

Table 4-7: Keys for alphanumeric parameters

Key name (upper inscription)	Series of (special) characters and number provided
7	7 μΩ°€¥ \$ ¢
8	A B C 8 Ä/ÆÅÇ
9	D E F 9 É
4	G H I 4
5	J K L 5
6	M N O 6 Ñ Ö
1	P Q R S 1
2	T U V 2 Ü
3	W X Y Z 3
0	<blank> 0 – @ + / \ < > = % &

Key name (upper inscription)	Series of (special) characters and number provided
.	. * : _ ; " ' ? () #
–	<toggles between capital and small letters>

4.3.4 Error and status messages

If errors or irregularities are detected, a keyword or error message is displayed at the top of the window. If an error occurs that affects the measurement, [UNCAL] is displayed in red letters at the top of the screen. In this case, check the error log for missed errors. The [UNCAL] display is only removed when the R&S EDS300 is switched off.



All error and status messages displayed on the R&S EDS300 are also stored to an error log on the instrument for later inspection.

(See [Chapter 9.3.1, "Error log"](#), on page 90).

The status bar contains status messages for the used power supply or data operations.

Table 4-8: Status messages

Message	Description
Battery	The internal battery pack is currently supplying power to the R&S EDS300.
Mains	The AC power adapter is currently supplying power to the R&S EDS300.
Mount USB-Stick	No USB storage device has been connected to the R&S EDS300 yet, for example for data logging.
Can't mount USB-Stick	The USB storage device connected to the R&S EDS300 could not be read correctly.
Mount USB-Stick: OK	The USB storage device connected to the R&S EDS300 is ready to store data.
USB LOGGING ON	Data logging to a USB storage device is active. (See Chapter 8, "Data management" , on page 79)
LOGGING STOPPED	Data logging to a USB storage device was stopped. (See Chapter 8, "Data management" , on page 79)

5 Measurement basics

Some background knowledge on basic terms and principles used in DME/Pulse measurements is provided here for a better understanding of the required configuration settings.

- [Evaluating DME signals](#)..... 35
- [Reply efficiency](#)..... 36
- [RF attenuator](#)..... 36

5.1 Evaluating DME signals

DME ground stations constantly send out squitter pulses or replies to other aircraft DME interrogations. Therefore, the interrogator needs to recognize which answers belong to their own requests. This task is usually solved in 3 possible modes (stages):

Search mode: In this mode, the interrogator sends request pulses on a specific channel to a ground station and searches the corresponding reply pulses in the output pulses of the ground station.

Initially, there is no information about the possible distance of the ground station. After sending out an interrogation, all reply pulses for a specified duration (5 ms) are collected. For a certain number of interrogations, the pulses can be expected to accumulate around one delay value, because one sender's reply pulses all have the same delay. Other pulses are spread randomly. If the accumulation is clear enough, the R&S EDS300 changes to "track" mode.

In this mode, the pulse repetition rate can be up to 150 pp/s (pulse pairs per second). However, after 30 seconds the pulse repetition rate in the search mode must be reduced to 30 pp/s.

Track mode: The delay and relative speed of the reply pulse is known. So for every outgoing pulse the R&S EDS300 can calculate a prediction where the next reply pulse is expected. If a reply pulse matches the prediction, a new distance value for the ground station is generated. The *reply efficiency* describes the percentage of valid replies (see [Chapter 5.2, "Reply efficiency"](#), on page 36). As long as the reply efficiency is above a specified threshold (e.g. 50 %), the R&S EDS300 remains in "track" mode.

Memory mode: The number of valid replies is too low to obtain reliable distance information, e.g. due to difficult receiving situations or during ID transmission. The R&S EDS300 still sends out pulses and calculates a prediction from the last valid replies. If the reply efficiency rises above the specified threshold, the R&S EDS300 immediately returns to the "track" mode. But after a specified time (by default: 10 s) the track is considered to be lost and the R&S EDS300 returns to the "search" mode to start over.

The **reply efficiency** is the criterion to switch between search/track/memory mode. It is calculated with all interrogations during a specific time (for example the last 2 s). If this

value is decreased, the R&S EDS300 moves to the "track" mode more quickly, but also returns to the "memory" mode more quickly.

5.2 Reply efficiency

The reply efficiency of a DME system is the ratio of the number of received reply pulses to the number of transmitted interrogation pulses. A reply efficiency of 100 % is very rarely achieved. There are several reasons why no reply pulse is sent on an interrogation pulse request:

- Interrogation pulse occurs during the dead time of the receiver.
- Interrogation pulse occurs in the key down time of an ID sequence (or during an MRB/ARB sequence of a TACAN ground station).
- Level of the interrogation pulse is below the receiver sensitivity of the ground station.

The reply efficiency drops dramatically when the maximum distance to the ground station is reached.

You must define a minimum reply efficiency that must be exceeded before the interrogator switches to track or search mode (see [Chapter 5.1, "Evaluating DME signals"](#), on page 35). Lower values are useful in difficult receiving conditions, for instance when the signals are weak. However, if the value is too low, random pulses that are mistaken for a reply can mislead the interrogator into thinking it is on a good track. Thus, you must determine the appropriate setting for the current transmission situation.

5.3 RF attenuator

Access: [DME] / [Pulse] > "Att.Mode Auto"

The attenuation mode determines the sensitivity of the receiver board. Depending on the level of the incoming signal, the attenuator must avoid overload due to high-level signals, while avoiding signal distortion for weak signals. The attenuation mode changes the sensitivity of the receiver board by selecting a different signal path for each mode.

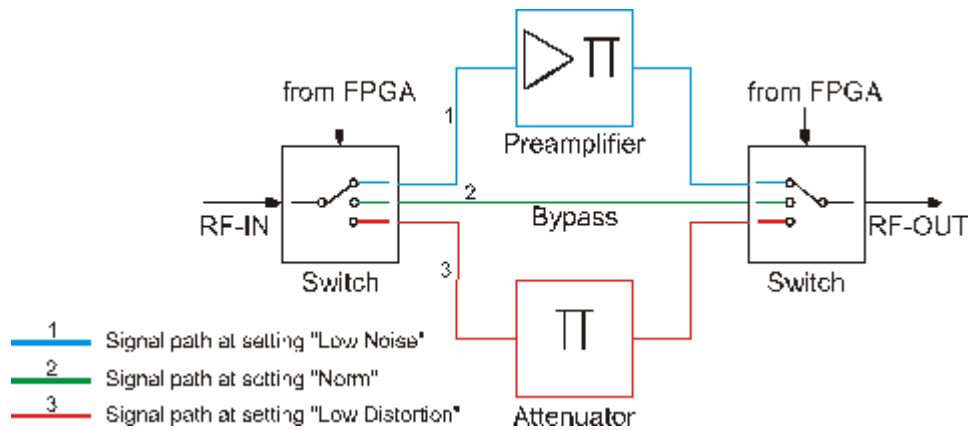

Figure 5-1: Signal paths for different attenuation modes

Select the attenuator mode such that the input level always remains within the specified range. For details, see ["Antenna connections RF1 IN/OUT and RF2 IN"](#) on page 22.

Table 5-1: Measurement ranges for different attenuation modes

Attenuation mode	Average input level	Peak input level
Low Noise	-110 dBm to -10 dBm	-100 dBm to -10 dBm
Norm	-100 dBm to +5 dBm	-90 dBm to +5 dBm
Low Distortion	-85 dBm to +13 dBm	-75 dBm to +13 dBm
Auto	-110 dBm to +13 dBm	-100 dBm to +13 dBm

6 Measurements and results

The R&S EDS300 provides different measurement modes depending on the task at hand and the required results.

- **DME/TACAN measurement mode:** determines numeric signal parameters for a specific DME/TACAN interrogator or transponder channel. The measurement results can be logged and output simultaneously to the measurement. TACAN measurements require the TACAN option (R&S EDS-K1).
- **Pulse analysis mode:** measures the power levels at a specific interrogator or transponder channel frequency to detect pulses and displays them in a power vs. time diagram. Additional signal parameters are not determined. Data logging is not available. Pulse analysis requires the Pulse Shape Analysis option (R&S EDS-K2).

Remote command:

<RX>:MEASMODE? on page 123

- [DME and TACAN measurement mode](#)..... 38
- [Multi-DME measurements](#).....47
- [Graphical pulse analysis](#)..... 48

6.1 DME and TACAN measurement mode

Access: [DME]

If the appropriate hardware option (Low-Power Interrogator, R&S EDS300-B2) is installed, the R&S EDS300 can act as a DME interrogator. It sends out pulses to the ground station which returns the signals to the R&S EDS300 at a different frequency with a delay (see [Chapter 5.1, "Evaluating DME signals"](#), on page 35).

The Low-Power Interrogator provides a pulse output power of 1 W for the local area (testing DME / TACAN ground stations, range 5.4 NM).

Basic measurement process

Initially, there is no information about the possible distance of the ground station. Thus, the R&S EDS300 interrogator starts in search mode. It sends request pulses on a specific channel to a ground station. Then it searches the corresponding reply pulses in the output pulses of the ground station.

Once a certain number of reply pulses accumulate around one delay value, the R&S EDS300 changes to track mode and reduces the reply pulse rate. While in the track mode, the R&S EDS300 displays the slant range to the ground station (indicated in nautical miles and meters). If the R&S EDS300 loses the synchronization, it moves to the memory mode and attempts to restore the synchronization based on the defined request rate. If synchronization is successful, the R&S EDS300 returns to the track mode. Otherwise it returns to the search mode, increasing the number of request pulses to restore the synchronization.

Receiver modes

The R&S EDS300 can measure either the pulses sent by the interrogator to the ground station, or the reply pulses sent from the ground station to the interrogator. You specify which signals you want to measure and analyze in the measurement settings.

Remote command:

<RX>:MEASMODE_DME on page 123

- [Displayed measurement settings](#).....39
- [DME measurement results](#).....40
- [TACAN measurement results](#).....43

6.1.1 Displayed measurement settings

For all DME/Pulse measurements, the following common settings are displayed (for details see [Chapter 7.2, "Configuring DME measurements"](#), on page 65):

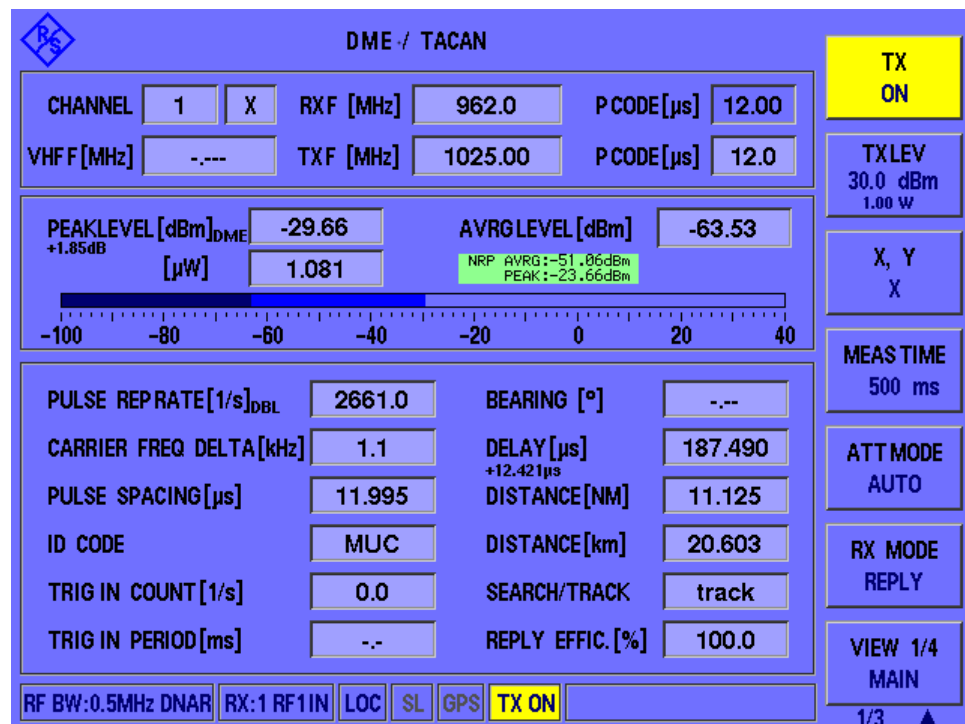

Table 6-1: Distance measurement settings

Display	Description
CHANNEL	DME/TACAN channel according to the ICAO frequency list
RX F [MHz]	Receiver frequency for the reply pulses of the ground station
P.CODE [μs]	Reply pulse code (distance of the double pulses), according to the ICAO frequency list
VHFF	Corresponding VHF frequency for the selected DME channel, for reference only

Display	Description
TX.F [MHz]	Transmit frequency for the interrogator pulse transmitted to the ground station by the R&S EDS300
P.CODE [μs]	Interrogator pulse code (distance of the double pulses), according to the ICAO frequency list.

6.1.2 DME measurement results

Access: [DME]

Distance measurements are performed in a specific mode on the R&S EDS300, the "DME" mode.

The following results are displayed for a distance measurement.



Graphical results are described in [Chapter 7.3, "Performing pulse analysis"](#), on page 70.

Background information on distance measurement equipment (DME) is provided in [Chapter 5.1, "Evaluating DME signals"](#), on page 35.

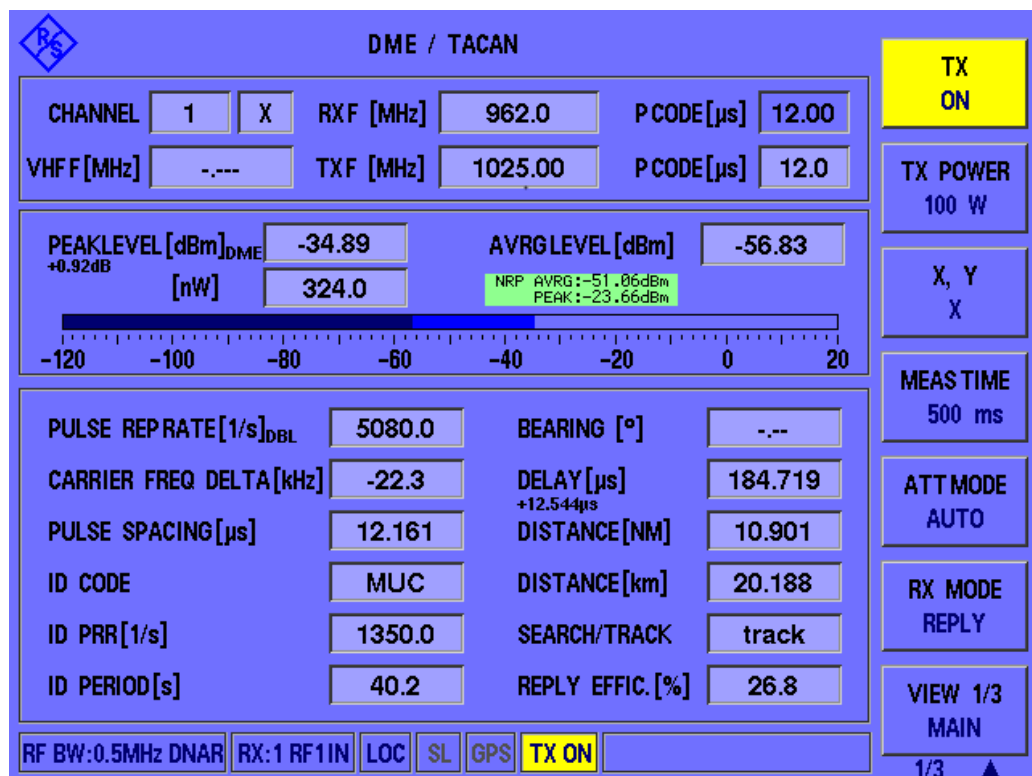



For reference measurements requiring very high accuracy, you can connect a power sensor from the R&S NRP family to the R&S EDS300 USB port. Results delivered by the power sensor are displayed on the R&S EDS300 without further configuration. See "NRP AVRГ/NRP PEAK" on page 41.

PEAKLEVEL [dBm]/[W].....	41
AVRG.LEVEL [dBm].....	41
NRP AVRГ/NRP PEAK.....	41
Bargraph.....	41
PULSE REPETITION RATE [1/s].....	42
CARRIER FREQ DELTA [kHz].....	42
PULSE SPACING [μs].....	42
ID-CODE.....	42
ID PRR [1/s].....	42
ID Period [s].....	42
BEARING [°].....	42
DELAY [μs].....	43
DISTANCE [km].....	43
DISTANCE [NM].....	43
SEARCH/TRACK.....	43
REPLY EFFIC. [%].....	43

PEAKLEVEL [dBm]/[W]

Measured peak level of the received signal

Note: A small "DME" indicates that the level refers to valid DME pulses (only double pulses with the correct pulse spacing). The signal can also contain components with higher levels which are not DME (like jammers).

If no "DME" is displayed, the maximum level in the signal is provided.

If external attenuation is applied (see "External Attenuation" on page 58), the attenuation considered for the peak level is indicated.

Remote command:

`<RX>:DME:PEAKLEVEL?` on page 155

AVRG.LEVEL [dBm]

Average measured level of the received signal

Remote command:

`<RX>:DME:AVRGLEVEL?` on page 154

NRP AVRГ/NRP PEAK

Average and peak measured level of an optional power sensor input connected to the R&S EDS300.

Remote command:

`GETNRPPOW` on page 157

Bargraph

Graphical display of the measured received signal level.

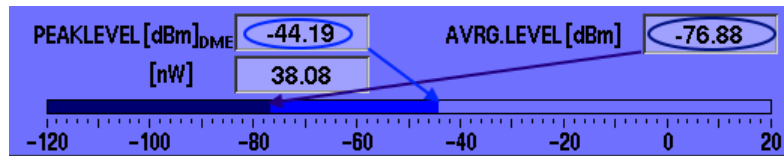

The dark blue bar indicates the average level; the light blue bar indicates the peak level.

PULSE REPETITION RATE [1/s]

Measured pulse repetition rate of the DME signal, i.e. number of interrogator/reply pulses (pairs) per second; only updated once per second

"DBL" indicates that double bursts are counted, "SGL" indicates that single pulses are counted (see [Count Pulses](#)).

Remote command:

`<RX>:DME:PULSE_REPT_RATE?` on page 155

CARRIER FREQ DELTA [kHz]

Measured frequency deviation relative to the defined channel frequency

Remote command:

`<RX>:DME:CARRIER_F_DELTA?` on page 154

PULSE SPACING [μs]

Measured pulse spacing between the pulses of a pulse pair

Remote command:

`<RX>:DME:PULSE_SPACING?` on page 155

ID-CODE

Decoded Morse-ID with three or four letters. Since the ID is usually only transmitted every 40 seconds, the ID remains on screen for 60 seconds.

Remote command:

`<RX>:DME:ID_CODE?` on page 154

ID PRR [1/s]

Pulse repetition rate during ID transmissions. When an ID is detected, this field blinks yellow and indicates the measured frequency.

Remote command:

`<RX>:DME:ID_PRR?` on page 154

ID Period [s]

Time between two measured ID sequences

BEARING [°]

TACAN signals only (requires option R&S EDS300-K1):

Direction of the ground station in relation to the R&S EDS300.

Remote command:

`<RX>:TACAN:BEARING?` on page 157

DELAY [μs]

Reply delay time, that is: the delay time between the interrogator and reply pulse, including the ground station delay (50 μs for X channels / 56 μs for Y channels).

If a delay offset is configured, it is also considered in the displayed delay value and for all other parameters based on the delay (see [<RX>:DST:DELAY_OFFSET](#) on page 131).

Requires R&S EDS-B2.

Remote command:

[<RX>:DST:DELAY?](#) on page 156

DISTANCE [km]

Measured distance in kilometers, calculated from the [DELAY \[μs\]](#)

Requires R&S EDS-B2.

Remote command:

[<RX>:DST:DST?](#) on page 156

DISTANCE [NM]

Measured distance in nautical miles, calculated from the [DELAY \[μs\]](#)

Requires R&S EDS-B2.

Remote command:

[<RX>:DST:DST?](#) on page 156

SEARCH/TRACK

Current mode of the interrogator (see [Chapter 5.1, "Evaluating DME signals"](#), on page 35)

"Search₃₀" indicates that the search mode has lasted longer than 30 seconds and thus the PPR has been reduced to 30 pulses per second.

Remote command:

[<RX>:DST:SOT?](#) on page 154

REPLY EFFIC. [%]

Reply efficiency, ratio of the valid reply pulses relative to the transmitted interrogator pulses in percent

Remote command:

[<RX>:DST:REPEFF?](#) on page 153

6.1.3 TACAN measurement results

Access: [DME] > "View" (> "TACAN1")

The DME part of the measurement is identical to [Chapter 5.1, "Evaluating DME signals"](#), on page 35. However, additional parameters are displayed, including:

- The bearing
- The modulation depth of the AF signals
- The frequency of the AF signals

- The phase shift between the two AF tones
- The absolute phase of the 15 Hz signal to the main reference burst (MRB)
- The absolute phase of the 135 Hz signal to the auxiliary reference burst (ARB)

The R&S EDS300 can evaluate TACAN signals only if the TACAN stick with the TACAN software is inserted in one of the USB ports (see [Chapter 4.1.9, "Activating the TACAN option"](#), on page 18).

If the TACAN stick is inserted, the DME view automatically includes the TACAN-specific results and functions. **In addition to the DME results described in [Chapter 6.1.2, "DME measurement results"](#), on page 40**, the following additional results are provided for TACAN signals.



The extended DME/TACAN view consists of several individual pages. To scroll through the results, select the "View" softkey in the DME menu until the required page is displayed.

The main view is identical to the DME view described in [Chapter 6.1.2, "DME measurement results"](#), on page 40.

The displayed measurement *settings* are described in [Chapter 6.1.1, "Displayed measurement settings"](#), on page 39.

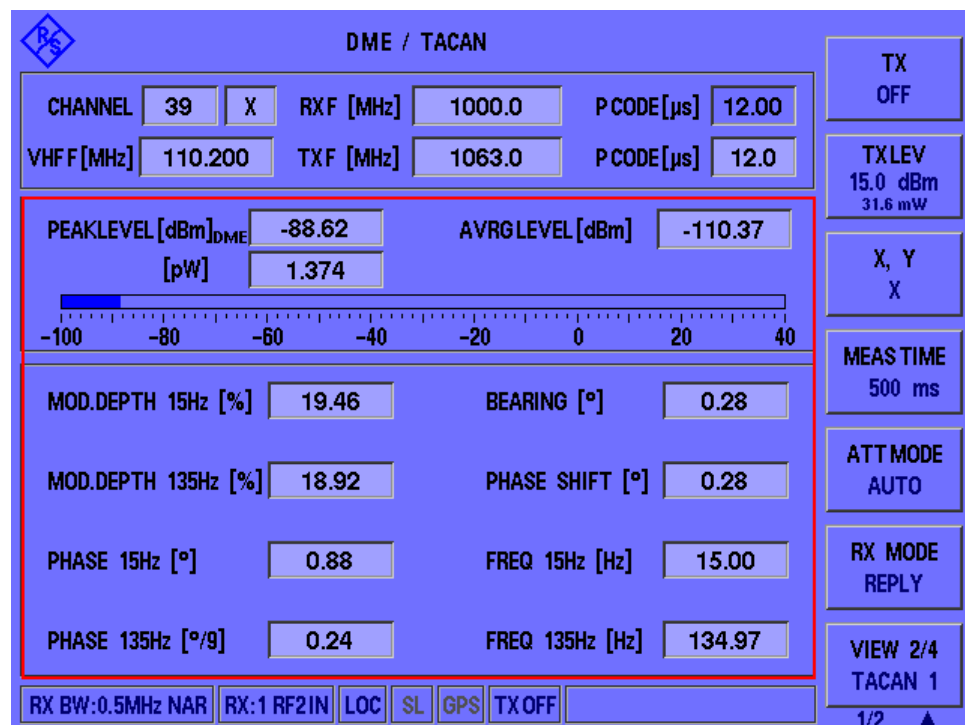

Figure 6-1: TACAN measurement results (page 1)

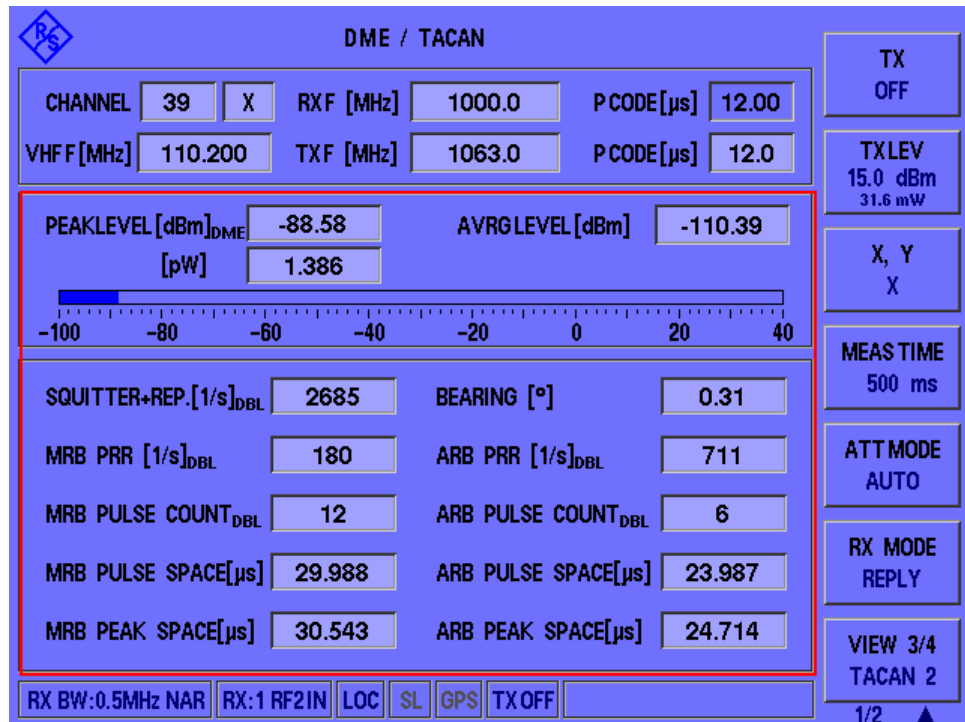

Figure 6-2: TACAN measurement results (page 2)

MOD.DEPTH 15Hz [%].....	45
MOD.DEPTH 135Hz [%].....	45
BEARING [°].....	46
PHASE SHIFT [°].....	46
FREQ 15Hz [Hz].....	46
FREQ 135Hz [Hz].....	46
PHASE 15Hz [°].....	46
PHASE 135Hz [°/9].....	46
Squitter+Rep [1/s].....	46
MRB PRR [1/s].....	46
MRB PULSE COUNT.....	47
MRB PULSE SPACE [µs].....	47
MRB PEAK SPACE [µs].....	47
ARB PRR [1/s].....	47
ARB PULSE COUNT.....	47
ARB PULSE SPACE [µs].....	47
ARB PEAK SPACE [µs].....	47

MOD.DEPTH 15Hz [%]

Measured modulation depth of the 15 Hz signal

Remote command:

<RX>:TACAN:MOD_DEPTH_15HZ? on page 158

MOD.DEPTH 135Hz [%]

Measured modulation depth of the 135 Hz signal

Remote command:

`<RX>:TACAN:MOD_DEPTH_135HZ?` on page 158

BEARING [°]

Direction of the ground station in relation to the R&S EDS300.

Remote command:

`<RX>:TACAN:BEARING?` on page 157

PHASE SHIFT [°]

Measured phase shift between the 15 Hz and 135 Hz components

Remote command:

`<RX>:TACAN:PHASE_SHIFT?` on page 159

FREQ 15Hz [Hz]

Measured frequency of nominal 15 Hz components

Remote command:

`<RX>:TACAN:FREQ_15HZ?` on page 157

FREQ 135Hz [Hz]

Measured frequency of nominal 135 Hz components

Remote command:

`<RX>:TACAN:FREQ_135HZ?` on page 157

PHASE 15Hz [°]

Measured phase of the 15 Hz components compared to the MRB; this value is updated 15 times per second.

Remote command:

`<RX>:TACAN:PHASE_15HZ?` on page 158

PHASE 135Hz [°/9]

Measured phase (0° to 40°) of the 135 Hz components compared to the ARB; this value is updated 120 times per second.

Remote command:

`<RX>:TACAN:PHASE_135HZ?` on page 158

Squitter+Rep [1/s]

Number of measured pulses, including the replies from the ground station to the interrogator's pulses

"DBL" indicates that double bursts are counted, "SGL" indicates that single pulses are counted (see [Count Pulses](#)).

MRB PRR [1/s]

Measured pulse repetition rate of the MRB (Main Reference Burst)

"DBL" indicates that double bursts are counted (X channels), "SGL" indicates that single pulses are counted (Y channels).

MRB PULSE COUNT

Number of pulses measured in one MRB.

"DBL" indicates that double bursts are counted (X channels), "SGL" indicates that single pulses are counted (Y channels).

MRB PULSE SPACE [μs]

Measured pulse spacing between two pulses of the MRB

MRB PEAK SPACE [μs]

Maximum measured pulse spacing between two pulses of the MRB

ARB PRR [1/s]

Measured pulse repetition rate of the ARB (Auxiliary Reference Burst)

"DBL" indicates that double bursts are counted (X channels), "SGL" indicates that single pulses are counted (Y channels).

ARB PULSE COUNT

Number of pulses measured in one ARB

"DBL" indicates that double bursts are counted (X channels), "SGL" indicates that single pulses are counted (Y channels).

ARB PULSE SPACE [μs]

Measured pulse spacing between two pulses of the ARB

ARB PEAK SPACE [μs]

Maximum measured pulse spacing between two pulses of the ARB.

6.2 Multi-DME measurements

Access: [SEQ]

Multi-DME measurements are a special method of performing distance measurements for 10 ground stations at the same time.



The optional R&S EDS300-K5 (Multi-DME) software is only usable in connection with the R&S EDS300-B2 or R&S EDS300-B4 (low- or high-power interrogator) hardware options and a second RX module option R&S EDS300-B1.

10 different DME channels can be received and analyzed at the same time in a time-multiplex process. To this end, all defined channels are started in sequence in a fixed time grid of 5 ms. The "Signal In" settings apply without restriction also for the multi-DME mode. For multi-DME, both RX modules are switched on the same RF input, which is selected in the setup for TX Board 1. If the interrogator is active, a query pulse is sent at an interval (slot) of every 5 ms. Thus, the pulse repeat rate (PRR) is permanently 20/s for every defined channel, regardless of whether the distance measurement is currently in the search, track or memory mode.

The following settings and results are displayed for a Multi-DME measurement.

Display	Description Remote command
SLOT	Slots 1 ... 10 The slot selected for entry is indicated by a green frame.
CHAN	Display and setting of the channel Set the receiving frequency via the channel setting according to the ICAO frequency list. Select the channel number extension directly.
Level [dBm]	Measured level of the received signal in dBm If the reception level is too high (overload), it is displayed in red and cannot be used.
PS [μ s]	Display of the measured pulse spacing between the pulses of a pulse pair (pulse spacing)
Freq [kHz]	Display of the measured deviation relative to the set channel frequency (carrier frequency delta)
ID-CODE	The decoded code of the identifier The background is highlighted in yellow during the transmission of the ID code; if the identifier is decoded, it is displayed for at least 60 seconds.
Dist [NM]	Display of the measured distance in nautical miles The delay time (main delay) of the ground station (50 μ s for X channels / 56 μ s for Y channels) is considered when converting the time to slant range. Values are only displayed if the interrogator function is activated in the corresponding slot.
Search/Track	Display of the current distance measurement mode The measurement always starts in search mode. After synchronizing to a DME station, the measurement switches to track mode. If synchronization fails, the measurement switches to memory mode after the time set in "SETUP" > "DME INTERROG" > "MEMORY TIME". Then it attempts to restore the synchronization. If resynchronization is not successful, the measurement switches to search mode, otherwise back to track mode. Values are only displayed if the interrogator function is enabled in the corresponding slot.
Reply Eff. [%]	Display of the reply efficiency Rating of the valid reply pulses relative to the transmitted request pulses in percent



If the same channel is set for two or more slots, you can only activate the interrogator in one of these slots. Otherwise, the query rate exceeds 20/s for this channel.

A pulse is sent only if "TX ON" is enabled, and during search or track mode. Using the high-power interrogator, the pulse output power is always 500 W. Using the low-power interrogator, the pulse output power is specified in the distance measurement mode.

Interrog. enabled

Activates the interrogator function for the selected slot.

6.3 Graphical pulse analysis

Access: [PULSE]

R&S EDS300 pulse analysis is used to test the RF output signal of DME / TACAN ground stations and interrogators and analyze pulse characteristics graphically. In "Pulse" mode, the power levels at a specific interrogator or transponder channel frequency are measured. If user-defined criteria are fulfilled, a pulse is detected and displayed in a power vs time diagram, similarly to an oscilloscope. Additionally, characteristic pulse parameters are determined using markers in the diagram.

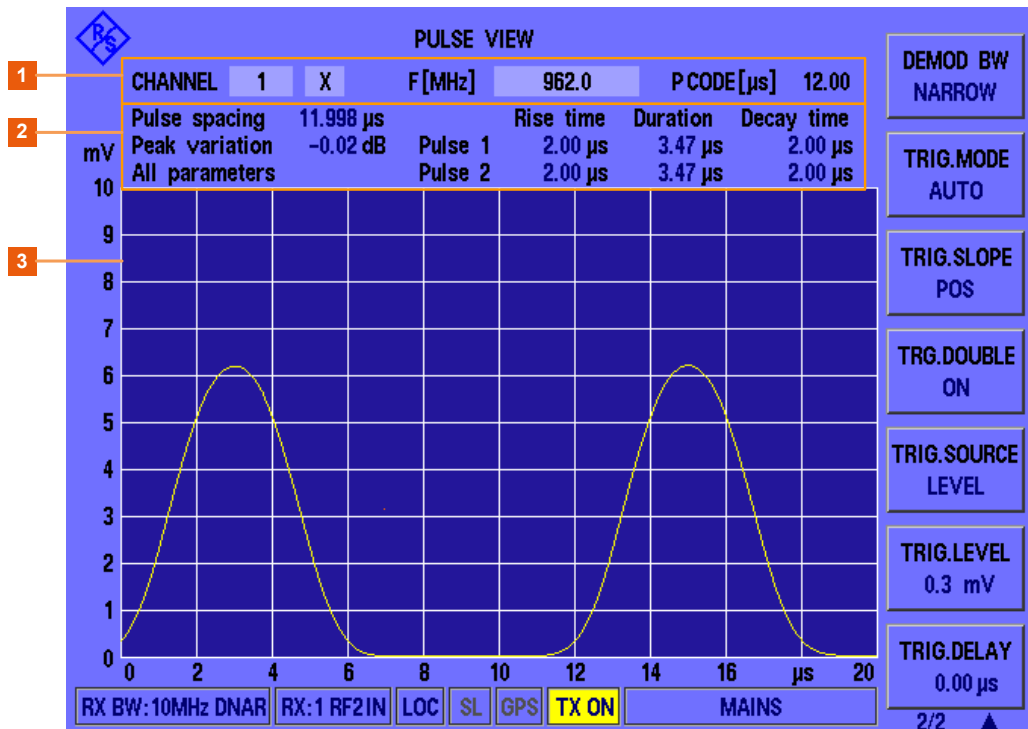

Figure 6-3: Default Pulse analysis view (All parameters)

- 1 = Selected receiver channel and frequency for measurement
- 2 = Marker and analysis results
- 3 = Power vs time diagram for measured channel



You can change the channel and frequency to be measured directly in the Pulse view, see ["Changing the receiver \(RX\) channel number"](#) on page 66 and ["Changing the receiver \(RX\) frequency"](#) on page 67.

The pulse code according to the ICAO frequency list is indicated for reference (see also [Chapter B, "DME channel frequency list"](#), on page 167).



Pulse mode is meant for graphical analysis; data streaming and data logging is not available. However, you can query the pulse trace data remotely. For numeric results, perform a DME/TACAN measurement (see [Chapter 6.1, "DME and TACAN measurement mode"](#), on page 38).

Analysis mode

By default, all main pulse characteristics are determined automatically ("All parameters"). The analysis mode determines which pulse parameters are indicated in the

"Pulse" view. Which analysis function is currently selected is displayed in the results area and on the "Analysis" softkey.

Markers

To determine the individual pulse parameters, the markers must be set to different points in the pulse traces. Thus, displaying the markers in the diagram is not useful for full analysis. In this case, only the parameter results are displayed in the "Pulse" view (see [Figure 6-3](#)).

For individual parameter analysis, the markers are displayed graphically in the diagram. The position and values of the markers are indicated numerically in the pulse results area.

Remote command:

"Pulse" view: `<RX>:MEASMODE_PULSE` on page 124

Results:

Trace data: `<RX>:PULSEVIEW:DATASET?` on page 160

Pulse parameters: `<RX>:PULSEVIEW:ANALYSIS?` on page 161

Analysis mode

Determines which pulse parameters are indicated in the "Pulse" view. Which analysis function is currently selected is displayed in the results area and on the "Analysis" softkey.

If the analysis is not successful, the mode in the results area is faded gray.

Pulse rise time

Pulse rise time for each pulse in μs , calculated as the difference between two markers (M2-M1). Marker 1 is set at 10 % of the rising pulse slope, marker 2 is set at 90 % of the rising pulse slope.

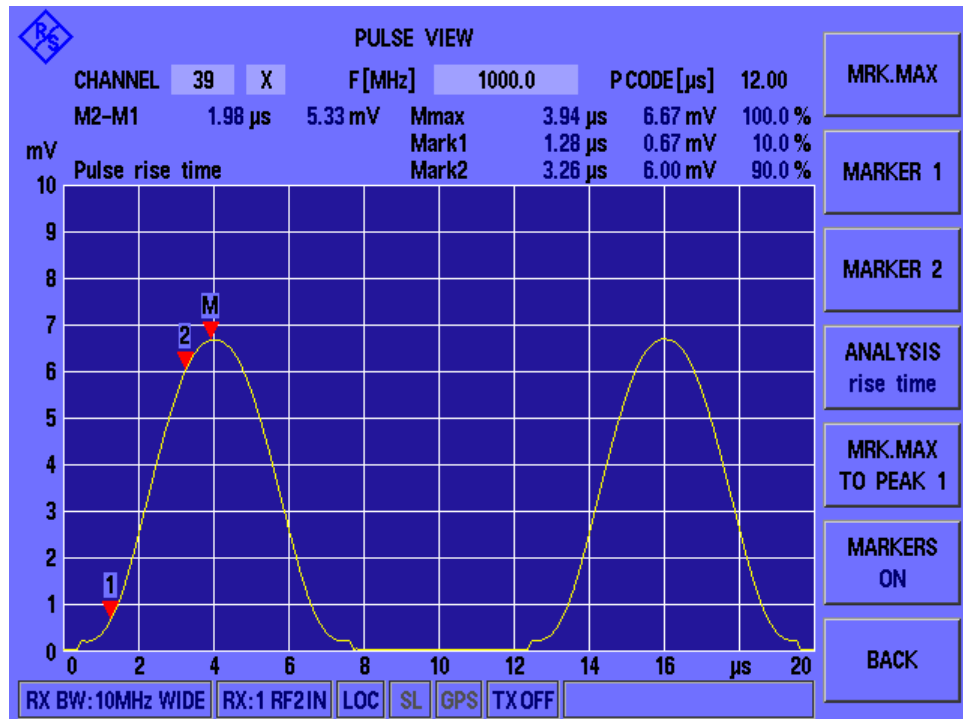

Figure 6-4: Pulse rise time results in Pulse view

Remote command:

`<RX>: PULSEVIEW: ANALYSIS? on page 161`

Pulse duration

Pulse duration for each pulse in μs, calculated as the difference between two markers (M2-M1). Marker 1 is set at 50 % of the rising pulse slope, marker 2 is set at 50 % of the falling pulse slope.

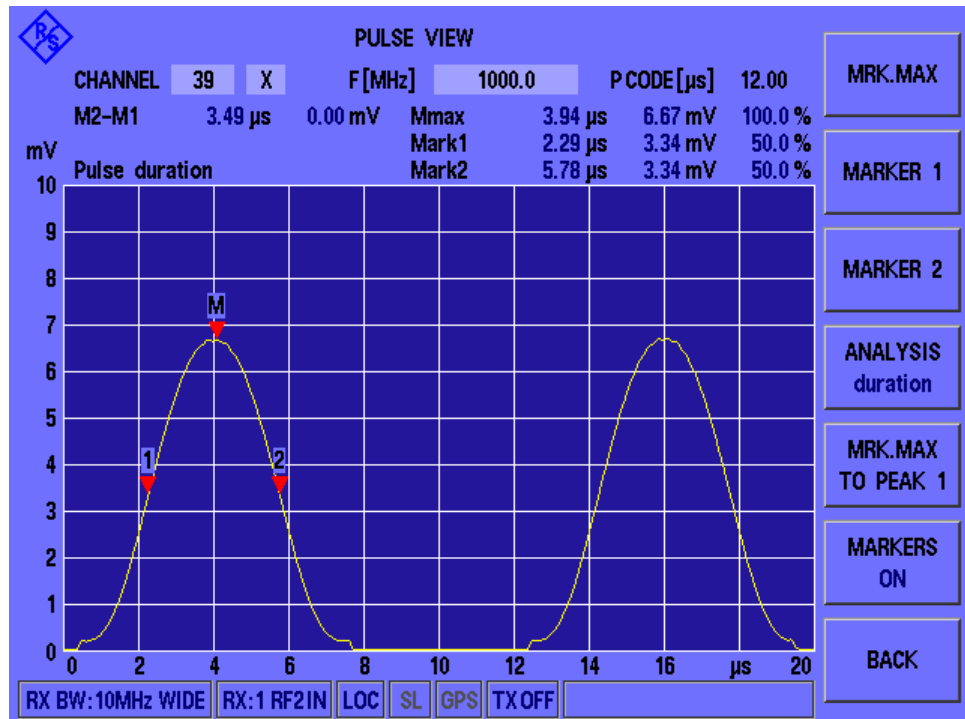

Figure 6-5: Pulse duration results in Pulse view

Remote command:

`<RX>: PULSEVIEW: ANALYSIS? on page 161`

Pulse decay time

Pulse decay time for each pulse in μs, calculated as the difference between two markers (M2-M1). Marker 1 is set at 90 % of the falling pulse slope, marker 2 is set at 10 % of the rising pulse slope.

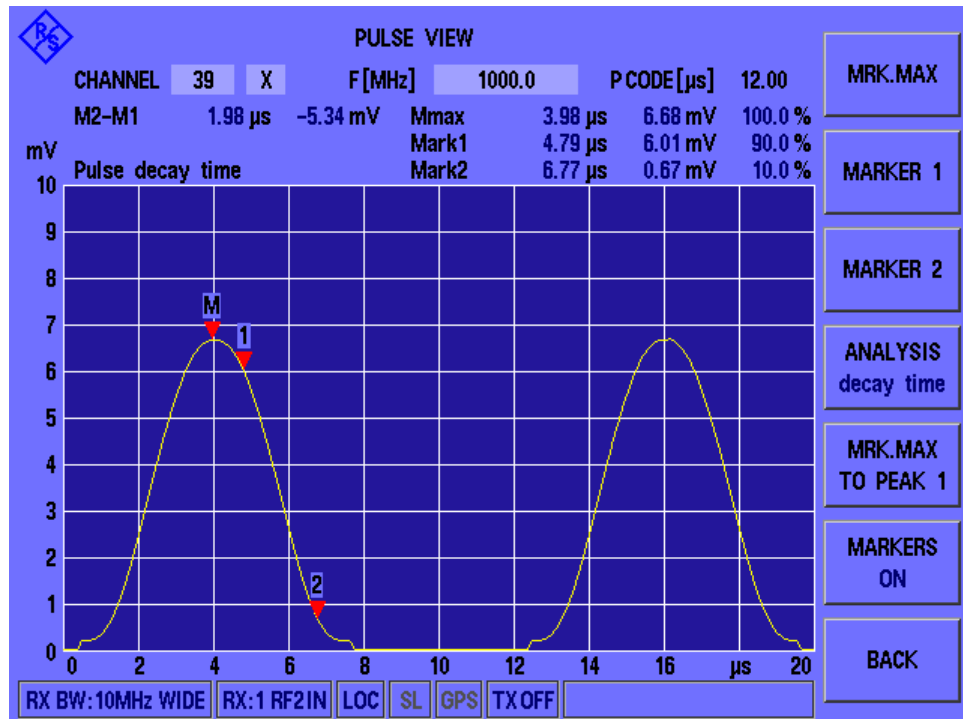

Figure 6-6: Pulse decay time results in Pulse view

Remote command:

<RX>: PULSEVIEW: ANALYSIS? on page 161

Pulse spacing

Pulse spacing between the pulses of a pulse pair in μs, calculated as the difference between two markers (M2-M1). Marker 1 is set at 50 % of the rising slope of the first pulse, marker 2 is set at 50 % of the rising slope of the second pulse.

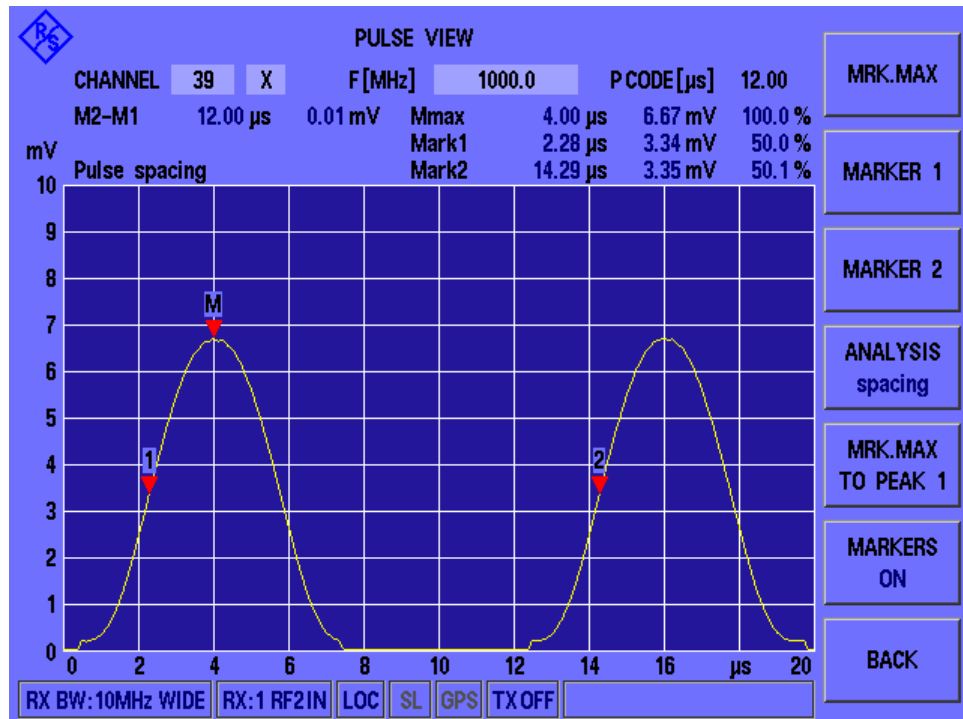

Figure 6-7: Pulse spacing results in Pulse view

Remote command:

`<RX>:PULSEVIEW:ANALYSIS?` on page 161

Peak variation

Variation in pulse peak power values between two pulses, in dB.

Remote command:

`<RX>:PULSEVIEW:ANALYSIS?` on page 161

Mark1

Measured power level in pulse 1, the time it was measured and percentage of total measured power.

Remote command:

`<RX>:PULSEVIEW:ANALYSIS?` on page 161

Mark2

Measured power level in pulse 2, the time it was measured and percentage of total measured power.

Remote command:

`<RX>:PULSEVIEW:ANALYSIS?` on page 161

Mmax

Maximum measured power level in the selected pulse (see "Pulse selection for peak marker (Mrk. Max to Peak 1/2)" on page 78), the time it was measured and percentage of total measured power at time of maximum.

Mrk. max to peak 1

The difference between two markers (M2-M1). Marker 1 is set to the peak power level of the first pulse, marker 2 is set to the peak power level of the second pulse.

Remote command:

[<RX>:PULSEVIEW:ANALYSIS?](#) on page 161

M2-M1

Difference between the time and power values for marker 2 and marker 1.

7 Configuring and performing measurements

- [Configuring signal input and output](#).....56
- [Configuring DME measurements](#).....65
- [Performing pulse analysis](#).....70

7.1 Configuring signal input and output

Access: [SETUP]

The R&S EDS300 can analyze signals received by its RF IN interface, but also provide output to the same interface. Furthermore, a reference signal can be provided as input to the R&S EDS300 to improve accuracy of the measurements. All settings concerning signal input and output are described here.



Signal input and output settings are maintained even when you switch measurement modes.



For reference measurements requiring very high accuracy, you can connect a power sensor from the R&S NRP family to the R&S EDS300 USB port. Results delivered by the power sensor are displayed on the R&S EDS300 without further configuration. See also [Chapter 6.1.2, "DME measurement results"](#), on page 40.

- [Configuring the input signal for analysis](#)..... 56
- [Configuring signal output](#)..... 58
- [Configuring the reference frequency](#).....60
- [Configuring DME interrogator signals](#)..... 61
- [Receiving GPS signals](#).....64

7.1.1 Configuring the input signal for analysis

Access: [SETUP] > "Signal In"

The signal to be analyzed by the R&S EDS300 can be obtained from different input connectors.

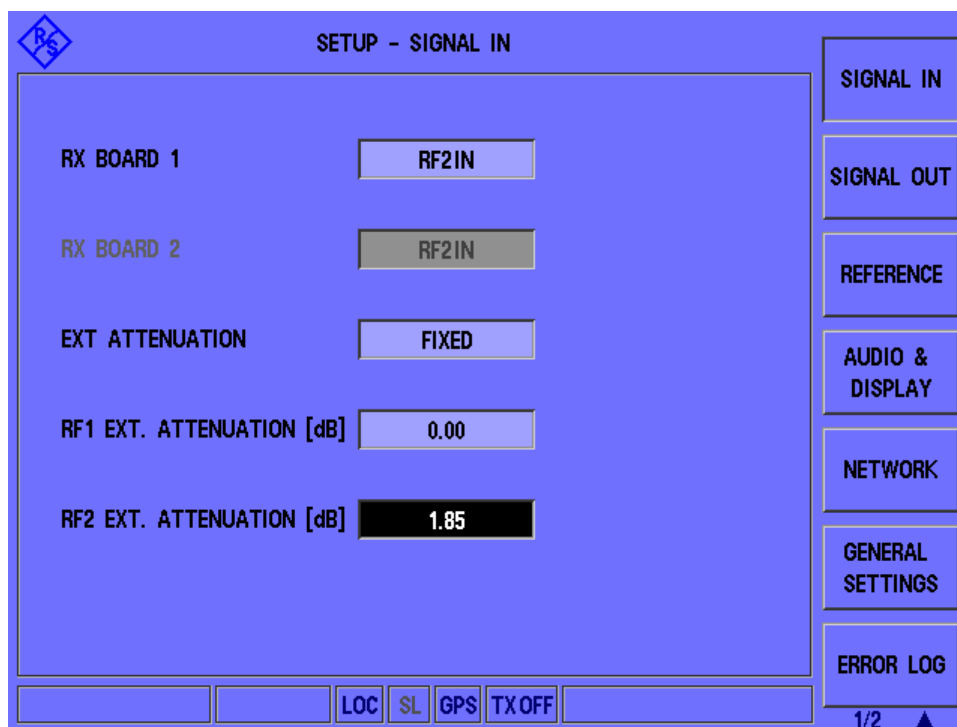

Input for RX Board 1..... 57
 Input from (optional) RX Board 2..... 57
 External Attenuation..... 58
 Fixed External Attenuation for RF Input 1/2..... 58

Input for RX Board 1

Defines the input signal for the first receiver board, that is, which connector the input signal is taken from.

- "RF 1 IN" RF input from the "RF 1 IN/OUT" connector on the front panel of the R&S EDS300
- "RF 2 IN" RF input from the "RF 2 IN" connector on the front panel of the R&S EDS300

Remote command:

<RX>: [SETUP: INPUT](#) on page 120

[SETRX](#) on page 129

Input from (optional) RX Board 2

Defines the input signal for the optional second receiver board. The same signals are available as for the first receiver board ([Input for RX Board 1](#)).

Only available if a second receiver board is installed on the instrument (requires R&S EDS300-B1).

Note: In Multi-DME mode, the same input signal is used for both receiver boards; thus, only the "RX Board 1" setting is available.

Remote command:

[SETRX](#) on page 129

External Attenuation

If enabled, external attenuation is considered when measuring the RF input. The attenuation value is indicated as an offset to the peak level in the measurement results (see "PEAKLEVEL [dBm]/[W]" on page 41).

- "None" No external attenuation is considered.
- "Fixed" A fixed attenuation is considered for the measured RF input (see "Fixed External Attenuation for RF Input 1/2" on page 58). You can define a different attenuation level for each RF input connector.

Remote command:

SETUP:EXT_ATTENUATION_TYPE on page 120

Fixed External Attenuation for RF Input 1/2

Defines the fixed power level by which the signal at the RF input 1 or 2 is attenuated during the measurement (for External Attenuation = "Fixed").

Remote command:

SETUP:RF1_EXTATTENUATION on page 120

SETUP:RF2_EXTATTENUATION on page 120

7.1.2 Configuring signal output

Access: [SETUP] > "Signal Out"

Different signals can be provided at one of the R&S EDS300's output connectors.

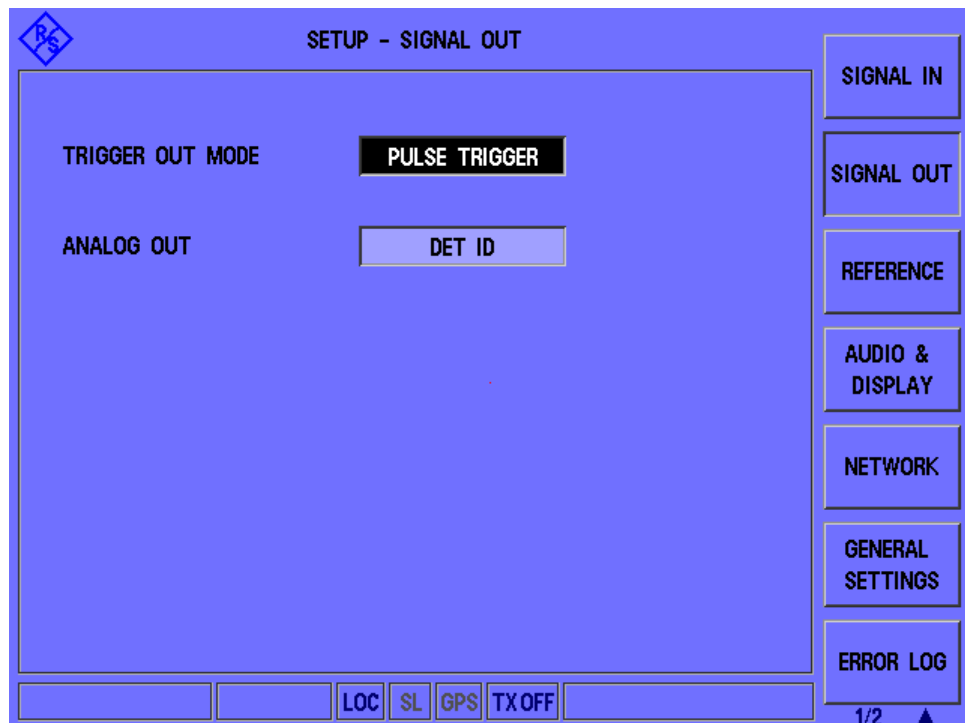

Trigger Out Mode..... 59

Analog Out..... 59

Trigger Out Mode

Defines the type of trigger signal to be provided at the [TRIGGER OUTPUT] connector on the rear panel of the R&S EDS300.

"PULSE_TRIGGER"

For each measured DME pulse, a square pulse with the same pulse width is output synchronously.

"PULSE DECODED"

For each measured DME pulse *pair* with the correct pulse code (=pulse spacing), a square pulse with a 1 μ s pulse width is output.

"INTERROG TRIGGER"

For each transmitted interrogator pulse pair, a square pulse with a 1 μ s pulse width is output.

"ID_CODE"

A high signal is output during the ID transmission.

"MRB_TRGGER"

For each decoded MRB (main reference burst), a square pulse with a 1 μ s pulse width is output.
Only available for TACAN analysis

"ARB_TRIGGER"

For each decoded ARB (auxiliary reference burst), a square pulse with a 1 μ s pulse width is output.
Only available for TACAN analysis (requires option R&S EDS300-K1).

"MDME SLOT" Each time the channel is switched, a square pulse with a 1 μ s pulse width is output.
Only available for Multi-DME analysis

Remote command:

[SETUP:TRIGGER_OUT_MODE](#) on page 122

Analog Out

Defines the type of analog signal to be provided at the [ANALOG OUTPUT] connector on the rear panel of the R&S EDS300.

"RX_DEMOD" The demodulated baseband signal is output.

"DET ENVELOPE"

The peak detector envelope of the pulse signal is output.

"DET 15HZ" The 15 Hz component in the peak detector envelope of the pulse signal is output.
Only available for TACAN analysis

"DET 135HZ" The 135 Hz component in the peak detector envelope of the pulse signal is output.
Only available for TACAN analysis

"DET ID" The audio signal (detector envelope) of the ID is output (at 1350 Hz, audible Morse code).

Remote command:

[SETUP:ANALOG_OUT_MODE](#) on page 119

7.1.3 Configuring the reference frequency

Access: [SETUP] > "Reference"

The R&S EDS300 can use the internal reference source or an external reference source as the frequency standard for all internal oscillators. A 10 MHz crystal oscillator is used as the internal reference source. If the external reference is used, all internal oscillators of the R&S EDS300 are synchronized to the external reference frequency. A reference frequency can also be provided by the R&S EDS300 to other devices that are connected to this instrument to synchronize multiple devices in a measurement setup.

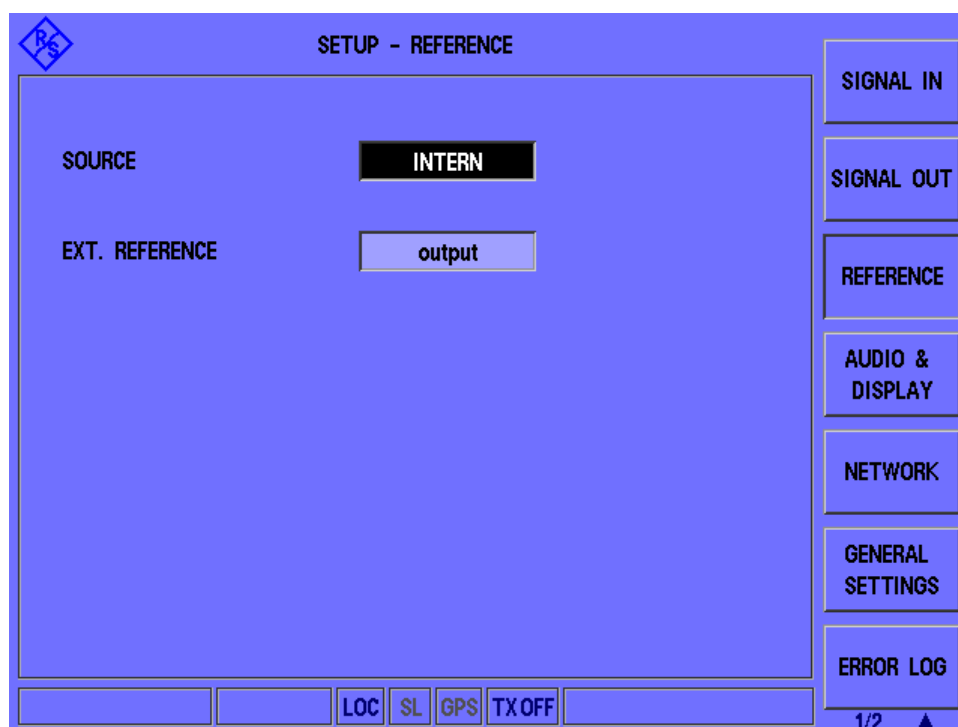

Source.....	60
Ext. Reference.....	61

Source

Defines whether the [REF 10 MHz IN/OUT] connector on the rear panel of the R&S EDS300 is used to receive a reference frequency from an external device, or to provide the internal reference frequency of the R&S EDS300 as output to a connected device.

- "Intern" The internal reference frequency of the R&S EDS300 is provided as output to a device at the [REF 10 MHz IN/OUT] connector.
- "Extern" The R&S EDS300 uses the external reference frequency provided by another device at the [REF 10 MHz IN/OUT] connector.
The [Ext. Reference](#) field shows the availability of a reference signal at the connector.

Remote command:

[SETUP:REFERENCE:SOURCE](#) on page 121

Ext. Reference

Indicates the usage and state of a reference frequency at the [REF 10 MHz IN/OUT] connector.

- "Present" A 10 MHz reference signal is provided by an external device at the [REF 10 MHz IN/OUT] connector of the R&S EDS300.
- "Not present" No reference signal is available at the [REF 10 MHz IN/OUT] connector of the R&S EDS300. The internal 10 MHz reference signal is used for measurement with the R&S EDS300.
- "Output" The internal 10 MHz reference signal of the R&S EDS300 is provided as output to a device at the [REF 10 MHz IN/OUT] connector (Source = "Intern").

Remote command:

SETUP:REFERENCE:EXTREFERENCE? on page 121

7.1.4 Configuring DME interrogator signals

Access: [SETUP] > "DME Interrog"

The R&S EDS300 can act as a DME interrogator, sending out pulses to the ground station which returns the signals to the R&S EDS300 at a different frequency with a delay (see Chapter 5.1, "Evaluating DME signals", on page 35).

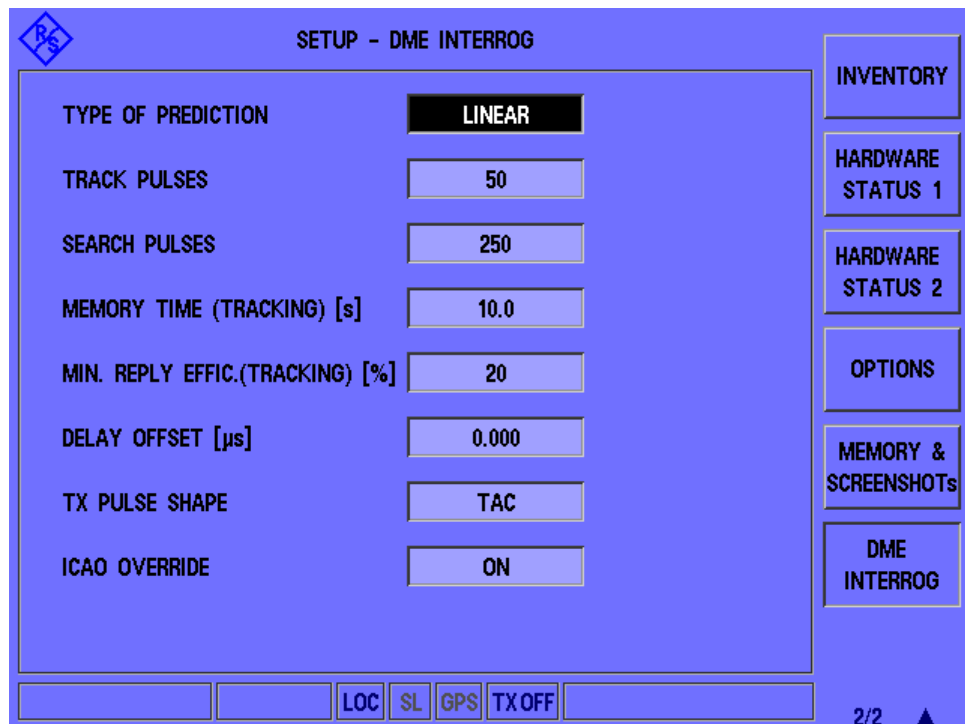

Type of Prediction..... 62

Track Pulses.....62

Search Pulses..... 62

Memory Time (Tracking)..... 62

Min. Reply Effic. (Tracking).....	62
Delay Offset.....	63
TX Pulse Shape.....	63
ICAO Override.....	63

Type of Prediction

Defines the type of algorithm used to calculate the expected reply pulse.

During the search on a DME ground station, the time of arrival for the reply pulse is calculated from the relative speed between the DME ground station and the interrogator.

"Linear"	The time delay for the subsequent pulse is derived linearly from the previously measured delay.
"Static"	The relative speed is assumed to be zero; the time delay for the subsequent pulse is thus calculated from the mean value of previous time delays. This setting is meant for fixed monitoring stations.

Remote command:

`<RX>:DST:PRED_TYPE` on page 132

Track Pulses

Number of pulses during track mode for which the reply efficiency is calculated.

The larger the value, the more stable and accurate the results, but the slower the interrogator.

Remote command:

`<RX>:DST:TPULSES` on page 134

Search Pulses

Number of pulses during search mode for which the reply efficiency is calculated.

The larger the value, the more stable and accurate the results, but the slower the interrogator.

Remote command:

`<RX>:DST:SPULSES` on page 133

Memory Time (Tracking)

Defines the maximum time that the interrogator remains in memory mode. After this time, the next search mode is triggered. Define a period that is at least long enough to finalize ID transmission.

Valid values are between 0.1 seconds and 50 seconds.

Remote command:

`<RX>:DST:MEM_TIME` on page 131

Min. Reply Effic. (Tracking)

Minimum reply efficiency (in percent) after which the interrogator switches between tracking, memory and search modes (see [Chapter 5.1, "Evaluating DME signals"](#), on page 35).

Smaller values are better for difficult receiving conditions.

Valid values are between 20 % and 99 %.

Remote command:

[<RX>:DST:MIN_REPLY_EFF](#) on page 132

Delay Offset

Defines an offset to the delay between the transmission of the request pulse and the reply pulse.

This setting is useful to compensate for delay times caused by cable lengths, for example.

Valid values are between -100 μ s and +100 μ s.

Remote command:

[<RX>:DST:DELAY_OFFSET](#) on page 131

TX Pulse Shape

Defines the shape of the transmitted (TX) interrogator pulse, if enabled.

"DME" Gauss pulse with a rise and fall time of 2.5 μ s

"TAC" Asymmetric Gauss pulse with a rise time of 2.0 μ s and a fall time of 2.7 μ s
Only available for TACAN measurements, requires option R&S EDS300-K1.

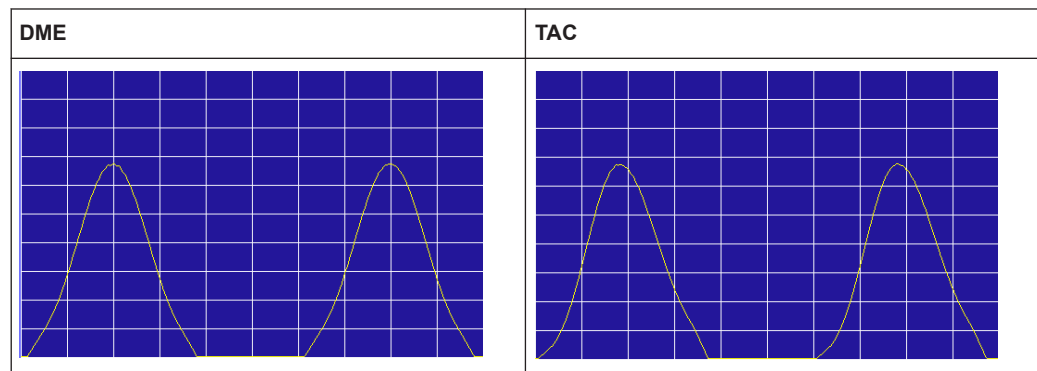

Remote command:

[<RX>:DST:PULSE_SHAPE](#) on page 133

ICAO Override

Ignores the ICAO specifications regarding the maximum pulse repetition rate.

If the ICAO override is enabled, pulse rates of up to 6000 pulses per second are available. The TX frequency range is extended to 962 MHz to 1213 MHz.

If this function is disabled, a maximum of 150 pulses per second are allowed for the first 30 seconds, then only 30 pulses per second are allowed. This restriction is required by the ICAO.

Remote command:

[SETEXPERT](#) on page 135

7.1.5 Receiving GPS signals

Access: [GPS]

A GPS input signal allows the R&S EDS300 to synchronize its time and positioning information with an accurate reference. Therefore, the R&S EDS300 provides an RS232 interface on its rear panel (see also [Chapter 4.2.2.9, "RS232 GPS interface"](#), on page 28).

In addition, the GPS option (R&S EDS300-K3) must be installed to evaluate and display the received GPS information.

The baud rate (or *signalling rate*) of the GPS signal is configurable. All GPS information and settings are available in the "GPS" window.

Figure 7-1: GPS view with GPS data

The following GPS data for the current position of the R&S EDS300 is displayed in the "GPS" window:

Table 7-1: GPS data in the GPS window

Label	Description	Unit
Latitude	Latitude	[°] Degree
Longitude	Longitude	[°] Degree
Altitude	Altitude	m
Speed	Speed (knots)	knots/h
Date	Date	dd.mm.yyyy

Label	Description	Unit
Speed	Speed (km/h)	km/h
Time	Time	hh.mm.ss
Protocol	GPS protocol, e.g. NMEA (National Marine Electronics Association)	
Status	GPS status and number of satellites detected	
GPRMC	The GPRMC (Global Positioning Recommended Minimum Specific = minimum information) dataset received by the R&S EDS300 is displayed as an ASCII character set with 4800 Bd.	
GPGGA	GPGGA (Global Positioning System Fix Dat) dataset containing the most important information of the GPS position and accuracy. Displayed as an ASCII character set with 4800 Bd.	
From COM	Data as received by the serial interface ([RS232])	

Baud Rate

Indicates and defines the currently used baud rate (or *signalling rate*) for the GPS signal. Values from 4800 Bd to 115200 Bd are available.

Remote command:

[SETGPSBAUD](#) on page 118

Sync

Time synchronization on incoming messages or PPS pulses makes the measurement more precise. Select the method of synchronization.

"NMEA" Time synchronization on incoming messages

"PPS" Time synchronization on PPS pulses

Remote command:

[SETGPSSYNC](#) on page 119

7.2 Configuring DME measurements

Access: [DME]

DME measurements for DME and (optionally) TACAN signals are configured in the "DME/TACAN" view.

See also [Chapter 7.1.4, "Configuring DME interrogator signals"](#), on page 61.

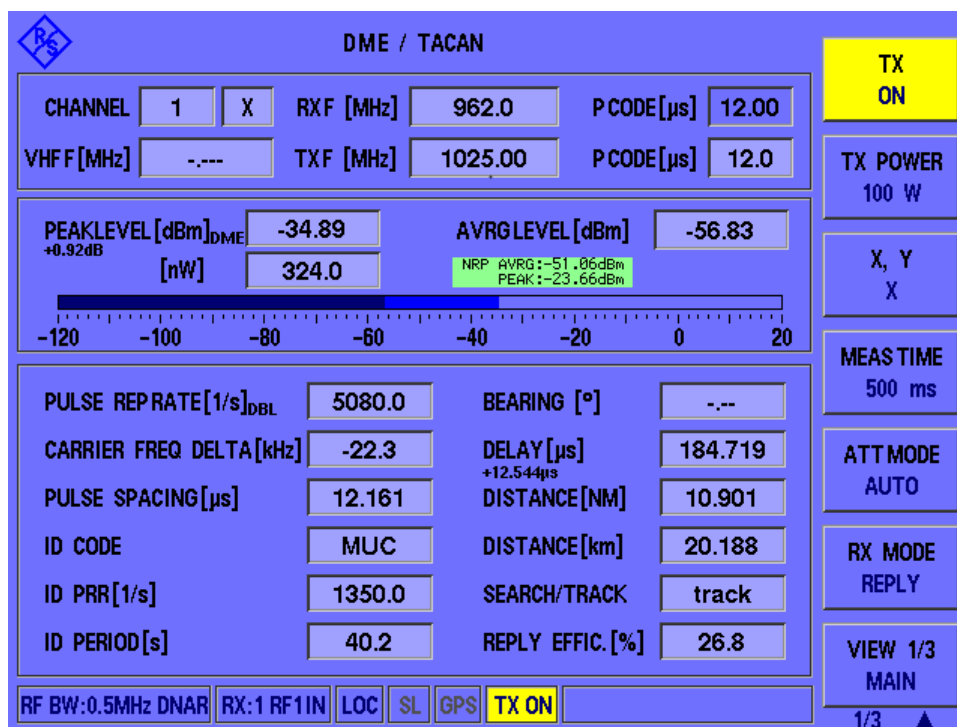

Changing the receiver (RX) channel number.....66
 Channel selection X, Y.....67
 Changing the receiver (RX) frequency.....67
 RX Pulse Code (P.Code).....67
 VHF Frequency (VHFF).....67
 Interrogator Transmission (TX) frequency.....68
 TX Pulse Code (P.Code).....68
 Transmitter (TX) State.....68
 Measurement Time.....68
 Att.Mode.....68
 Receiver (RX) Mode.....69
 View.....69
 Interrogator Transmission (TX) Pulse Width.....69
 PRR for Search Mode.....70
 PRR for Track Mode.....70
 RF bandwidth (RF BW).....70
 Demodulation bandwidth Demod BW.....70

Changing the receiver (RX) channel number

Access: [CHAN]

A DME channel is uniquely identified by its channel number (+extension) or its receive frequency. Thus, if you set the receiver (RX) channel to a different (valid) value and apply the change, the associated parameters are automatically adapted according to the ICAO frequency list. The associated parameters are the channel frequency, transmit (TX) frequency, and pulse spacing.

To change the extension, use the [Channel selection X, Y](#) function.

The valid channel number range for DME channels is from 1 to 126 (see [Chapter B, "DME channel frequency list"](#), on page 167).

Remote command:

`<RX>:DME:RFCH` on page 127

`<RX>:DME:RFCH_PS?` on page 155

Channel selection X, Y

Access: [CHAN]

Switches between the channel codes X and Y according to the ICAO frequency list. The currently selected channel is indicated at the bottom of the softkey.

Changing the receiver (RX) frequency

Access: [FREQ]

A DME channel is uniquely identified by its channel number (+extension) or its receive frequency. Thus, if you set the receiver (RX) frequency to a different (valid) value and apply the change, the associated parameters are adapted according to the ICAO frequency list automatically. The associated parameters are the channel number (+extension), transmit (TX) frequency, and pulse spacing.

For combined VORTAC ground stations, the channel is not only uniquely defined by the channel number or the RX frequency, but also by the corresponding VHF frequency. If you enter a valid VHF frequency in the "RX freq" field, the R&S EDS300 recognizes it. The entered frequency is then displayed as the "[VHF Frequency \(VHFF\)](#)" on page 67, and the "RX freq" is set to the corresponding RX frequency. This function is only available with the TACAN option (R&S EDS300-K1).

The valid frequency range for DME channels is from 960 MHz to 1215 MHz (see [Chapter B, "DME channel frequency list"](#), on page 167).

If the frequency is inside the valid range, but not assigned to a channel according to the ICAO frequency list, and it is not a VHF frequency, the associated parameters are indicated in yellow.

Remote command:

`<RX>:DME:FREQ` on page 125

RX Pulse Code (P.Code)

Indicates the reply pulse code (spacing) for the selected DME channel in μ s.

Remote command:

`<RX>:DME:RFCH_PS?` on page 155

VHF Frequency (VHFF)

For combined VORTAC ground stations, the channel is not only uniquely defined by the channel number or the RX frequency, but also by the corresponding VHF frequency. If the [RX freq](#) has a corresponding VHF frequency, it is displayed in this field.

Since this field is read-only, you cannot enter a VHF frequency directly. However, if you enter a valid VHF frequency in the [RX freq](#) field, the R&S EDS300 recognizes it. The entered frequency is then displayed as the "VHFF", and the [RX freq](#) is set to the corresponding RX frequency.

This function is only available with the TACAN option (R&S EDS300-K1).

Interrogator Transmission (TX) frequency

The frequency at which the interrogator pulses are transmitted, if enabled (see ["Transmitter \(TX\) State"](#) on page 68).

The valid frequency range for interrogator channels is from 1025 MHz to 1150 MHz (see [Chapter B, "DME channel frequency list"](#), on page 167).

If [ICAO Override](#) is enabled, the TX frequency range is extended to 962 MHz to 1213 MHz.

If a frequency outside the valid range is entered, the value is indicated in red and cannot be stored.

Remote command:

[<RX>:DME:TXFREQ](#) on page 129

TX Pulse Code (P.Code)

Defines the interrogator pulse code (spacing) in μ s.

The valid value range is from 11 μ s to 42 μ s.

If you enter a value that does not comply with the ICAO channel definition (see [Chapter B, "DME channel frequency list"](#), on page 167), the input field is highlighted yellow.

Remote command:

[<RX>:DME:RFCH_PS?](#) on page 155

For double pulses:

[<RX>:DST:TX_PCODE](#) on page 130

Transmitter (TX) State

Activates and deactivates the interrogator. If activated, the R&S EDS300 transmits interrogator pulses to the ground station in the specified pulse repetition rate (see [PRR for Search Mode/ PRR for Track Mode](#)). An active transmitter is indicated by a yellow "TX ON" message in the status bar of the R&S EDS300 screen.

NOTICE! Risk of damage to the instrument or injury due to false transmission settings. Only change transmission settings while the transmitter is deactivated. Falsely entered settings can lead to unexpected output levels that can cause damage or injury.

Remote command:

[<RX>:DST:TXON](#) on page 134

Measurement Time

Defines the time span in which the results are averaged. Each measurement is performed 130 times per second. Thus, each measurement requires approximately 7.4 ms. For the minimum measurement time of 7 ms, only one measurement is performed, and no averaging takes place.

Values between 7 ms and 10 seconds are available, in 10 ms steps.

Remote command:

[<RX>:DME:MEASTIME](#) on page 126

Att.Mode

The attenuation mode defines the sensitivity of the receiver board by selecting a different signal path for each mode (see [Figure 5-1](#)).

The following attenuation modes are provided (for DME measurements only):

"Low Noise"	Provides a high sensitivity; Suitable when scanning the area for distant signals
"Normal"	Provides a normal sensitivity;
"Low Distortion"	Provides a low sensitivity Suitable when analyzing a nearby signal, to avoid overload due to high-level signals.
"Auto"	The signal attenuation is selected automatically according to the signal strength in each slot. This mode works best with clean signals. In difficult receiving conditions, the "Low Noise", "Normal" or "Low Distortion" modes can be more stable. When monitoring signals with mostly constant signal levels, it is also recommended that you use the "Low Noise", "Normal" or "Low Distortion" mode. If the R&S EDS300 has to adapt the attenuation frequently, indicated by a frequent clicking noise from the attenuator, minor shifts in the trace can occur.

Remote command:

`<RX>:DME:ATTMODE` on page 125

Receiver (RX) Mode

Defines the signal to be received and analyzed by the R&S EDS300, depending on the measurement task.

The currently selected mode is indicated on the softkey.

"Reply"	(Default) The signal transmitted by the DME ground station is measured.
"Interrogator"	The signal transmitted by the interrogator is measured. In this case, the RX frequency is set to the transmit frequency (see Table 6-1).

Remote command:

`<RX>:DME:RXMODE` on page 128

View

Switches between the different measurement results as described in [Chapter 6, "Measurements and results"](#), on page 38.

Remote command:

`<RX>:DME:SET_VIEW` on page 159

Interrogator Transmission (TX) Pulse Width

Defines the width of the pulses the R&S EDS300 interrogator transmits to the ground station.

Values between 0.8 μ s and 4.5 μ s are allowed.

Remote command:

`<RX>:DST:TXPULSE_WIDTH` on page 130

PRR for Search Mode

Defines the pulse repetition rate (PRR) for the interrogator's search mode.

The valid value range is from 5 to 6000 pulses per second. (If [ICAO Override](#) is disabled, a maximum of 150 pulses per second are possible; see [Chapter 7.1.4, "Configuring DME interrogator signals"](#), on page 61.)

Note that according to the DME specification, after 30 seconds the pulse repetition rate in the search mode must be reduced to 30 pulse pairs per second. In this case, "Search₃₀" is displayed in the "Search/Track" field.

Remote command:

`<RX>:DST:PRR` on page 133

PRR for Track Mode

Defines the pulse repetition rate (PRR) for the interrogator's track mode.

The valid value range is from 5 to 6000 pulses per second. (If [ICAO Override](#) is disabled, a maximum of 150 pulses per second are possible; see [Chapter 7.1.4, "Configuring DME interrogator signals"](#), on page 61.)

Remote command:

`<RX>:DST:PRR` on page 133

RF bandwidth (RF BW)

Defines the RF bandwidth for DME measurements.

"0.5 MHz" 500 kHz bandwidth

"10 MHz" 10 MHz bandwidth

Remote command:

`<RX>:DME:RF_BW` on page 128

Demodulation bandwidth Demod BW

Defines the bandwidth of the digital filter used for DME measurement.

"Narrow" Narrow filter for narrow pulses. Adjacent pulses or signal effects outside the pulse are not measured. Wider pulses can be distorted or cut off. Measurement time increases.

"Wide" Wide filter for wider pulses; entire pulse is measured without distortions. Adjacent pulses or signal effects outside the pulse are possibly included.

Remote command:

`<RX>:DME:DEMOD_BW` on page 126

7.3 Performing pulse analysis

R&S EDS300 pulse analysis is used to test the RF output signal of DME / TACAN ground stations and interrogators and analyze pulse characteristics graphically. In Pulse mode, the power levels at a specific interrogator or transponder channel frequency are measured. If user-defined criteria are fulfilled, a pulse is detected and dis-

played in a power vs time diagram, similarly to an oscilloscope. Additionally, characteristic pulse parameters are determined using markers in the diagram.

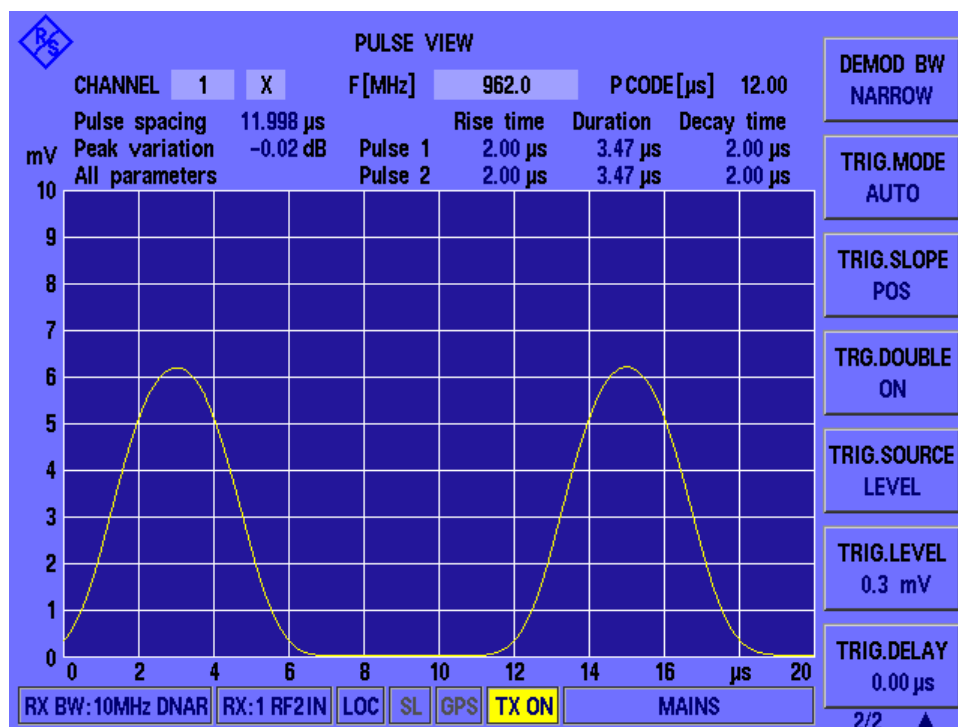

You can change the channel and frequency to be measured directly in the Pulse view, see ["Changing the receiver \(RX\) channel number"](#) on page 66 and ["Changing the receiver \(RX\) frequency"](#) on page 67.

The pulse code according to the ICAO frequency list is indicated for reference (see also [Chapter B, "DME channel frequency list"](#), on page 167).

- [Configuring the power vs. time diagram](#).....71
- [Configuring the pulse detection](#).....73
- [Using markers in pulse analysis](#).....77

7.3.1 Configuring the power vs. time diagram

Access: [Pulse]

The scaling and value range of the x-axis and y-axis in the power vs time diagram are configurable.

X-axis Scaling (Time/Div)	72
Y-axis Unit	72
Y-axis Scaling (<Unit>/Div)	72
Y-axis Range (Max. Lev)	72
Att.Mode	73
Trace Mode	73
Average Count (AVRG)	73

X-axis Scaling (Time/Div)

Time per division; defines the scaling of the x-axis, which consists of 10 divisions.

The valid value range is from 0.5 μ s to 50 μ s.

Note that the hardware supports a minimum of 2 μ s/div. Lower values do not reduce the time between two captured points, but represent a zoomed display.

Remote command:

`<RX>:PULSEVIEW:TIMEDIV` on page 138

Y-axis Unit

Unit for the power values; the following units are available:

- V (linear scaling)
- W (square scaling)
- dBm (logarithmic scaling)

Remote command:

`<RX>:PULSEVIEW:UNIT` on page 142

Y-axis Scaling (<Unit>/Div)

Power range per division; defines the scaling of the y-axis, which consists of 10 divisions.

Fixed values are available, depending on the specified **Y-axis Unit**.

Remote command:

`<RX>:PULSEVIEW:YSCALE_DB_DIV` on page 142

`<RX>:PULSEVIEW:YSCALE_MW_DIV` on page 143

`<RX>:PULSEVIEW:YSCALE_NW_DIV` on page 144

`<RX>:PULSEVIEW:YSCALE_PW_DIV` on page 144

`<RX>:PULSEVIEW:YSCALE_UW_DIV` on page 145

`<RX>:PULSEVIEW:YSCALE_V_DIV` on page 145

`<RX>:PULSEVIEW:YSCALE_MV_DIV` on page 143

`<RX>:PULSEVIEW:YSCALE_UV_DIV` on page 144

Y-axis Range (Max. Lev)

The maximum power level on the y-axis;

The valid value range depends on the specified **Y-axis Unit**:

- V: 10 μ V to 10 V
- W: 1 pW to 200 mW
- dBm: -70 dBm to 30 dBm

Remote command:

`<RX>:PULSEVIEW:YSCALE_MAXLEV_DBM` on page 146

`<RX>:PULSEVIEW:YSCALE_MAXLEV_MW` on page 146

`<RX>:PULSEVIEW:YSCALE_MAXLEV_UW` on page 146

`<RX>:PULSEVIEW:YSCALE_MAXLEV_NW` on page 147

`<RX>:PULSEVIEW:YSCALE_MAXLEV_PW` on page 147

`<RX>:PULSEVIEW:YSCALE_MAXLEV_V` on page 147

`<RX>:PULSEVIEW:YSCALE_MAXLEV_MV` on page 148

`<RX>:PULSEVIEW:YSCALE_MAXLEV_UV` on page 148

Att.Mode

The attenuation mode defines the sensitivity of the receiver board by selecting a different signal path for each mode (see [Figure 5-1](#)).

The following attenuation modes are provided (for Pulse view measurements only):

"Low Noise"	Provides a high sensitivity Suitable when scanning the area for distant signals
"Normal"	Provides a normal sensitivity
"Low Distortion"	Provides a low sensitivity Suitable when analyzing a nearby signal, to avoid overload due to high-level signals
"Auto"	The signal attenuation is set automatically <i>according to the power range</i> defined by " Y-axis Range (Max. Lev) " on page 72.

Remote command:

[<RX>: DME : ATTMODE](#) on page 125

Trace Mode

Defines the update mode for subsequent pulses (or pulse pairs)

"CLR/WR"	Clear/write (default): the pulse (pair) is overwritten by each new pulse (pair).
"AVRG"	The average is formed over several measurements. How many measurements are averaged is defined by the Average Count (AVRG) setting. As soon as the required number of pulses have been acquired, the display is updated after each sweep, averaging the specified number of previous pulses.
"Maxhold"	The maximum value is determined over all previously measured pulses (pairs) and displayed. The R&S EDS300 saves each trace point in the trace memory only if the new value is greater than the previous one.

Remote command:

[<RX>: PULSEVIEW: TRACE](#) on page 138

Average Count (AVRG)

Number of pulses used as a basis for averaged results ("Average" [trace mode](#)).

The valid value range is from 1 to 100.

Remote command:

[<RX>: PULSEVIEW: AVRG](#) on page 137

7.3.2 Configuring the pulse detection



Access: [Pulse] > "More softkeys"

Which pulses are detected and displayed in the power vs time diagram is configurable.

Changing the receiver (RX) channel number.....	74
Channel selection X, Y.....	74
Changing the receiver (RX) frequency.....	74
Demodulation bandwidth (Demod BW).....	75
Trigger Mode.....	75
Trigger Slope.....	75
Trigger Double.....	76
Trigger Source.....	76
Trigger Level.....	76
Trigger Delay.....	76

Changing the receiver (RX) channel number

Access: [CHAN]

A DME channel is uniquely identified by its channel number (+extension) or its receive frequency. Thus, if you set the receiver (RX) channel to a different (valid) value and apply the change, the associated parameters are automatically adapted according to the ICAO frequency list. The associated parameters are the channel frequency, transmit (TX) frequency, and pulse spacing.

To change the extension, use the [Channel selection X, Y](#) function.

The valid channel number range for DME channels is from 1 to 126 (see [Chapter B, "DME channel frequency list"](#), on page 167).

Remote command:

`<RX>:DME:RFCH` on page 127

`<RX>:DME:RFCH_PS?` on page 155

Channel selection X, Y

Access: [CHAN]

Switches between the channel codes X and Y according to the ICAO frequency list. The currently selected channel is indicated at the bottom of the softkey.

Changing the receiver (RX) frequency

Access: [FREQ]

A DME channel is uniquely identified by its channel number (+extension) or its receive frequency. Thus, if you set the receiver (RX) frequency to a different (valid) value and apply the change, the associated parameters are adapted according to the ICAO frequency list automatically. The associated parameters are the channel number (+extension), transmit (TX) frequency, and pulse spacing.

For combined VORTAC ground stations, the channel is not only uniquely defined by the channel number or the RX frequency, but also by the corresponding VHF frequency. If you enter a valid VHF frequency in the "RX freq" field, the R&S EDS300 recognizes it. The entered frequency is then displayed as the ["VHF Frequency \(VHFF\)"](#) on page 67, and the "RX freq" is set to the corresponding RX frequency. This function is only available with the TACAN option (R&S EDS300-K1).

The valid frequency range for DME channels is from 960 MHz to 1215 MHz (see [Chapter B, "DME channel frequency list"](#), on page 167).

If the frequency is inside the valid range, but not assigned to a channel according to the ICAO frequency list, and it is not a VHF frequency, the associated parameters are indicated in yellow.

Remote command:

`<RX>:DME:FREQ` on page 125

Demodulation bandwidth (Demod BW)

Defines the bandwidth of the digital filter used during pulse measurement.

The RF bandwidth remains fixed at 10 MHz and cannot be changed.

"Narrow"	Narrow filter (0.5 MHz). Suppresses adjacent channels, distorts the pulse shape for wider pulses.
"Wide"	Wide filter (10 MHz). For wider pulses. The entire pulse is measured without distortions. Adjacent pulses or signal effects outside the pulse can be included.

Remote command:

`<RX>:PULSEVIEW:BW` on page 137

Trigger Mode

Sets the trigger mode which determines the behavior of the instrument if no trigger occurs.

"Auto"	The instrument triggers automatically after a time interval if the trigger conditions are not fulfilled. If a real trigger occurs, a new measurement is started immediately. This mode helps you see the waveform even before the trigger conditions are set correctly. The waveform on the screen is not synchronized, and successive waveforms are not triggered at the same point of the waveform. The time interval depends on the time base settings.
"Normal"	The instrument acquires a waveform only if a trigger occurs, that is, if all trigger conditions are fulfilled. If no trigger occurs, no waveform is acquired and the last acquired waveform is displayed. If no waveform was captured before, none is displayed. When no trigger has been found for longer than one second, a message box appears that shows the time elapsed since the last trigger.
"Single shot"	The instrument performs a single sweep when you select the [ENTER] key and the trigger conditions are fulfilled. Each new sweep must be started manually.

Remote command:

`<RX>:PULSEVIEW:TRIGMODE` on page 140

Trigger Slope

Defines whether triggering occurs when the signal rises to the trigger level (positive slope) or falls down to it (negative slope).

Remote command:

`<RX>:PULSEVIEW:TRIGSLOPE` on page 141

Trigger Double

If enabled, triggering only occurs when a double pulse, that is: a pulse pair is detected. Single pulses do not trigger evaluation.

If disabled, each individual pulse that fulfills the trigger conditions is displayed and evaluated.

Remote command:

`<RX>:PULSEVIEW:TRIGDOUBLE` on page 139

Trigger Source

Defines the signal which triggers the measurement.

"Level"	The measured input signal
"External"	An external trigger signal provided by a device connected to the [trigger in] connector on the rear panel of the R&S EDS300; The defined trigger level is irrelevant.
"Interrog"	The pulses sent by the R&S EDS300 interrogator
"DME Pulse"	A detected DME double pulse
"TAC_MRB"	The TACAN main reference burst (if available)
"TAC_ARB"	The TACAN auxiliary reference burst (if available)

Remote command:

`<RX>:PULSEVIEW:TRIGSOURCE` on page 141

Trigger Level

Defines the trigger level that the specified [trigger source](#) must reach to trigger a measurement.

The valid value range depends on the selected [Y-axis Unit](#) and [maximum level](#) for the power axis:

- V: 0 μ V to 2 V
- W: 0 mW to 80 mW
- dBm: -121 dBm to 19 dBm

Remote command:

`<RX>:PULSEVIEW:TRIGLEVRF_MV` on page 140

Trigger Delay

Defines the time distance from the trigger point to the zero point of the diagram. If the trigger delay is 0, the trigger point matches the zero point. Positive values move the trigger to the right of the zero point. Negative values allow for measurement values to be displayed that occur shortly *before* the actual trigger event.

During the trigger delay, no further trigger events are detected.

The valid delay times depend on the "[X-axis Scaling \(Time/Div\)](#)" on page 72 setting. A delay outside the displayed time range is not possible. The maximum delay times are from -20 μ s to 320 μ s.

Remote command:

`<RX>:PULSEVIEW:TRIGDELAY` on page 139

7.3.3 Using markers in pulse analysis

Access: [Marker]

In the graphical pulse analysis display, up to three markers can be enabled to indicate special points of interest in the diagram. The R&S EDS300 can then use these specific marker values to analyze characteristic pulse parameters.

As described in [Chapter 6.3, "Graphical pulse analysis"](#), on page 48, the markers are placed at specific positions in the measured signal automatically to analyze the selected parameters. However, you can also place the markers at any other measured value in the signal manually. The positions and values of all three markers, as well as the difference between the markers 1 and 2 are displayed in the results area of the Pulse view.

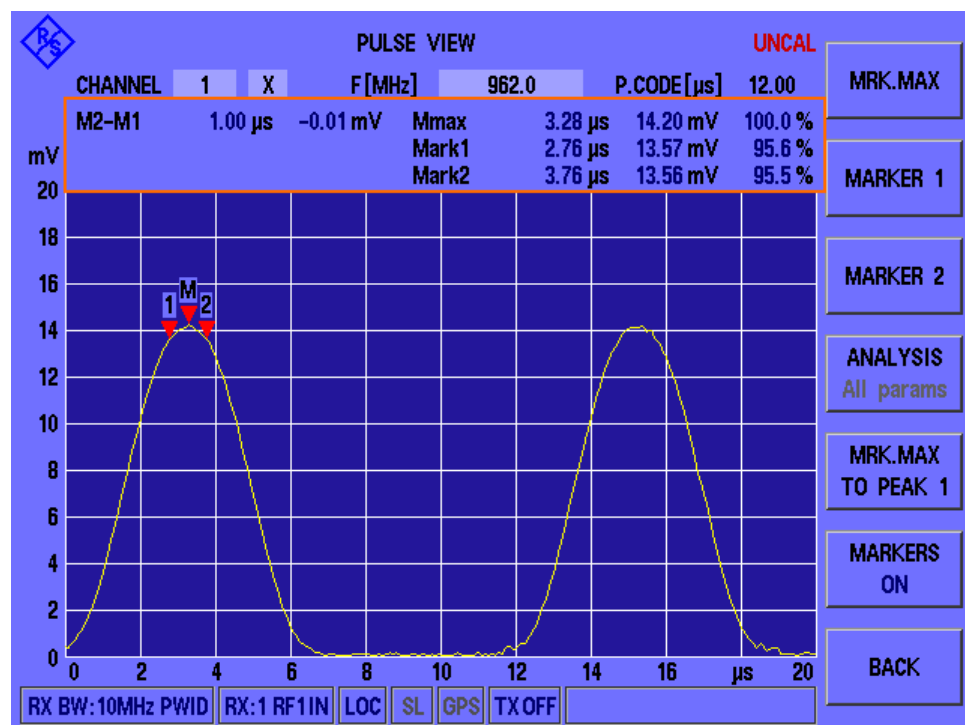

As soon as you select an analysis function, the manual marker positions are lost.

You cannot place the markers exactly at the defined positions required to determine the pulse parameters, if no sample was measured at that position. For automatic analysis, the required values are interpolated, if necessary.

Peak marker (Mrk. Max).....	78
Marker 1.....	78
Marker 2.....	78
Analysis functions.....	78
Pulse selection for peak marker (Mrk. Max to Peak 1/2).....	78
Markers On / Off.....	78
Back.....	78

Peak marker (Mrk. Max)

Allows you to place the peak marker to any position in the measured signal manually. Enter the time which defines the x-axis value of the marker, or move the marker using the rotary knob. The measured power value at the marker position is displayed in the result area ("Mmax") and defined as 100 %. The peak marker value is used as a reference for the delta markers 1 and 2.

Marker 1

Allows you to place marker 1 to any position in the measured signal manually. Enter the time which defines the x-axis value of the marker, or move the marker using the rotary knob. The measured power value at that time and the percentage of the [Peak marker \(Mrk. Max\)](#) power is displayed in the result area ("Mark1"). The difference between marker 2 and marker 1 is updated to the new result ("M2-M1").

Marker 2

Allows you to place marker 2 to any position in the measured signal manually. Enter the time which defines the x-axis value of the marker, or move the marker using the rotary knob. The measured power value at that time and the percentage of the [Peak marker \(Mrk. Max\)](#) power is displayed in the result area ("Mark2"). The difference between marker 2 and marker 1 is updated to the new result ("M2-M1").

Analysis functions

Selects the analysis function to be performed on the measured data. The currently selected function is indicated on the softkey. If manual positioning was active last, the previously selected function is indicated, but shaded gray.

If you select a function and confirm it, the markers are repositioned as required and manual positioning is lost.

"All parameters"	All parameters, see Figure 6-3 .
"Pulse rise time"	See "Pulse rise time" on page 50
"Pulse duration"	See "Pulse duration" on page 51
"Pulse decay time"	See "Pulse decay time" on page 52
"Pulse spacing"	See "Pulse spacing" on page 53

Pulse selection for peak marker (Mrk. Max to Peak 1/2)

Selects the pulse for which the peak marker ("Mmax") is set to the maximum.

Markers On / Off

Enables or disables the display of the markers in the Pulse view.

Note: Even when markers are not displayed (Off), the selected analysis functions are performed.

Back

Returns to the "Pulse" menu previously displayed.

8 Data management

The R&S EDS300 allows you to store and load measurement settings, and export measurement data for analysis later. Finally, you can store the measurement results displayed on the screen.

- [Storing and recalling measurement settings \(preset\)](#).....79
- [Logging measurement data](#)..... 81
- [Creating and storing screenshots](#)..... 82
- [Obtaining information on open-source resources](#)..... 84

8.1 Storing and recalling measurement settings (preset)

Possibly you would like to restore or repeat a measurement you performed under specific conditions on the R&S EDS300. Or you would like to troubleshoot a measurement and require a defined instrument state to detect the precise cause of the error. In these cases, you can store and recall instrument and measurement settings. Up to 20 different settings, referred to as *User Presets* can be stored and recalled on the instrument.

Settings stored in a User Preset

In each User Preset, the following current settings are stored:

- All measurement settings (see [Chapter 7, "Configuring and performing measurements"](#), on page 56)
- All general instrument settings except for the IP address and host name (see [Chapter 9, "General instrument setup"](#), on page 85)

The list of User Presets and the corresponding functions are available in the [Preset] softkey menu.

- [Storage and recall functions](#).....79

8.1.1 Storage and recall functions

Access: [Preset]

For each stored User Preset, the specified file name and the storage date are indicated in the "Preset" window. Empty User Presets are indicated by a simple "UserPreset" with no date.

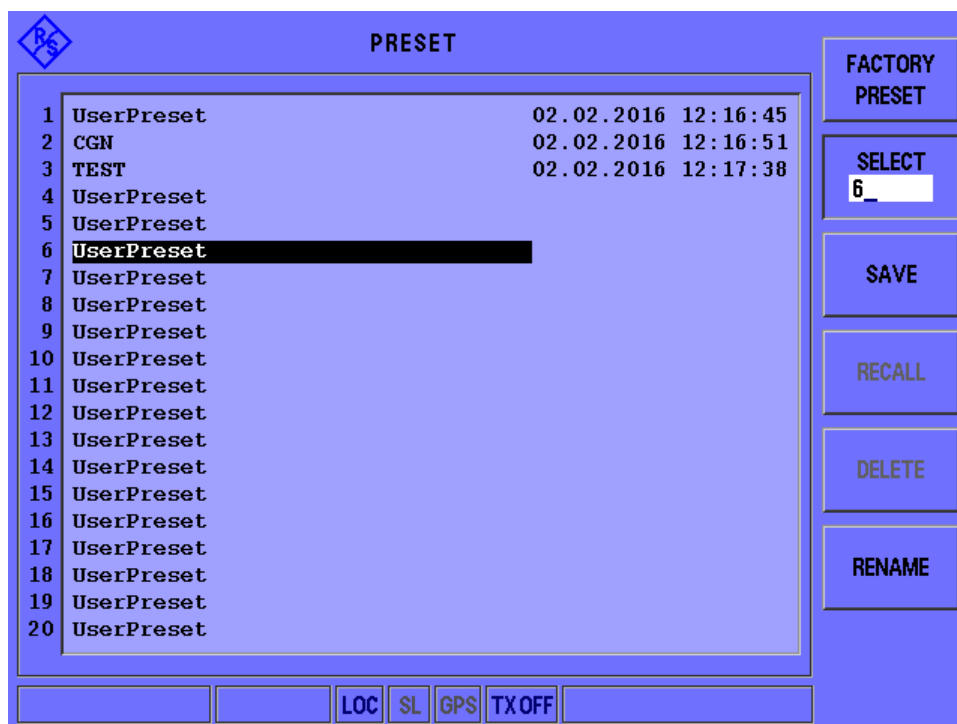

Factory Preset.....80
 Select<x>.....80
 Save.....80
 Recall.....81
 Delete.....81
 Rename.....81

Factory Preset

When delivered, the R&S EDS300 has a default configuration. You can restore this defined initial state at any time as a known starting point for measurements. Presetting is often recommendable as a first step in troubleshooting when unusual measurement results arise.

Note: The instrument's IP address and host name are not reset.

Remote command:

[FACTORY_PRESET](#) on page 116

Select<x>

The number of the currently selected User Preset is indicated on the softkey. By default, the User Preset number 1 is selected. To select a different User Preset for a subsequent function, select the "Select<x>" softkey and enter the number of the User Preset.

Save

Stores the current measurement settings in the selected User Preset under the specified name, together with the current date and time.

If the selected User Preset already contained settings before, they are overwritten.

Recall

Overwrites the current measurement settings by the settings stored in the selected User Preset.

Delete

Deletes the settings and the name assigned to the selected User Preset.

Rename

Renames the selected User Preset.

8.2 Logging measurement data

During a measurement with the R&S EDS300, the input signal is captured and various results are calculated and displayed on the screen (see [Chapter 6, "Measurements and results"](#), on page 38). These results can also be stored to a connected USB memory device, simultaneously to the running measurement. In this case, data is stored continuously for all measurements that are performed after logging is started and until it is stopped. The data for each logging session is stored to a file in the main directory of the USB storage device. The file name includes the date and time, using the following syntax:

```
edslog_<dd.mm.yyyy><hh.mm.ss>.txt
```

The data is stored in FAT32 format, in files with a maximum size of 2 GB each.

The stored data corresponds to the results of the remote commands (see [Chapter C, "Format description of DME measurement data"](#), on page 183).



The optional TACAN stick cannot be used to store data; however, a second USB stick can be connected simultaneously for data logging.

[START]

If a USB storage device is connected to the R&S EDS300, a data file is created on the USB device. All measurement results from the running measurement are stored in the file. The message `USB LOGGING ON` is displayed in the status bar.

If no USB device is detected, or the device cannot be read correctly, `Can't mount USB-Stick` is displayed.

Remote command:

`<RX>:STREAM` on page 153

Log interval:

`SETUSBLOGTIME` on page 151

Log file creation:

`SETUSBLOGMODE` on page 151

[STOP]

Data logging is stopped, the file is closed, and the message `LOGGING STOPPED` is displayed in the status bar. The USB device can be removed from the R&S EDS300.

Remote command:

<RX>:STOPSTREAM on page 152

8.3 Creating and storing screenshots

Access: [Setup] > "More Softkeys" > "Memory & Screenshots"

You can create a screenshot of the current display on the R&S EDS300 at any time during operation. Screenshots are useful to document measurement results, for example.

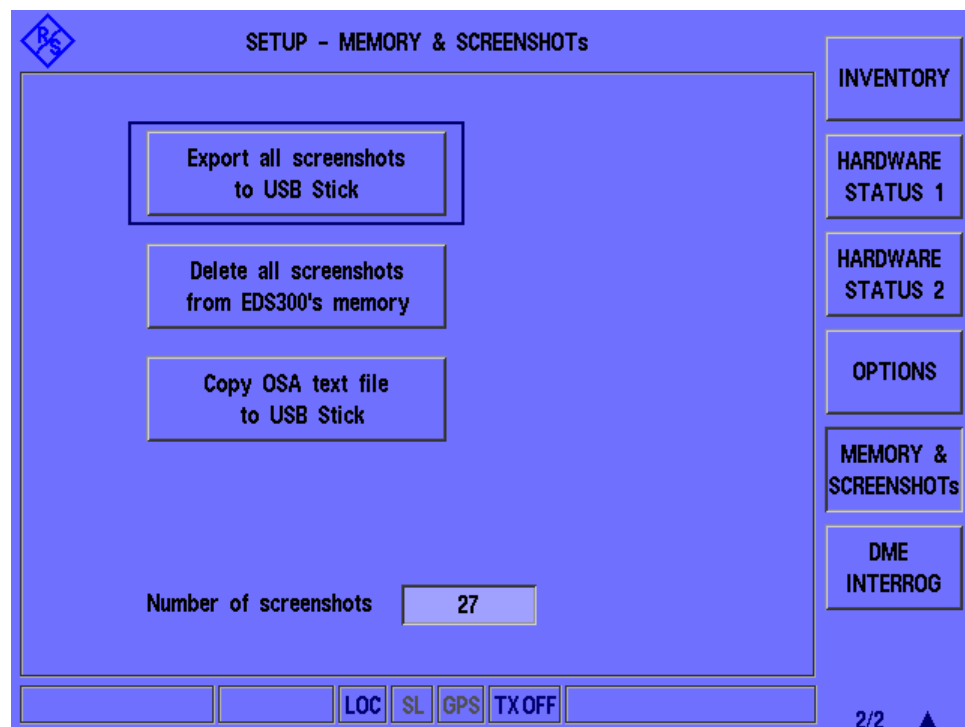

Creating a screenshot.....	82
L Color vs. black and white screenshot.....	83
Exporting screenshots to a USB device.....	83
Deleting all screenshots stored on the R&S EDS300.....	84
Number of Screenshots.....	84



Creating a screenshot

When you select the [screenshot] key, the display is stored as a graphic file on the instrument (until it is explicitly deleted) and can be copied to a USB memory device later (see [Exporting screenshots to a USB device](#)). Internally, the screenshot files are named "Screenshot_", followed by a consecutive number.

If a USB device is connected to the R&S EDS300 when the screenshot is created, the screenshot is stored there directly as a .PNG file. A dialog box with the default file name is displayed. To change the name of the file on the USB device, click in the name field and overwrite the default name. Note, however, that the file is also stored internally, and the file name remains unchanged. Thus, if you export all screenshots to a USB device later, the same screenshot is stored with the internal name again.

The [Number of Screenshots](#) indicated in the "Setup - Memory & Screenshots" window is increased after each new screenshot.

Remote command:

KEY 'DIRECTORY'

Color vs. black and white screenshot ← Creating a screenshot

If you store the screenshot to a connected USB device immediately, you can define whether a color or black and white screenshot is stored.

When you create a screenshot, a dialog box with the default file name and the output color is displayed.

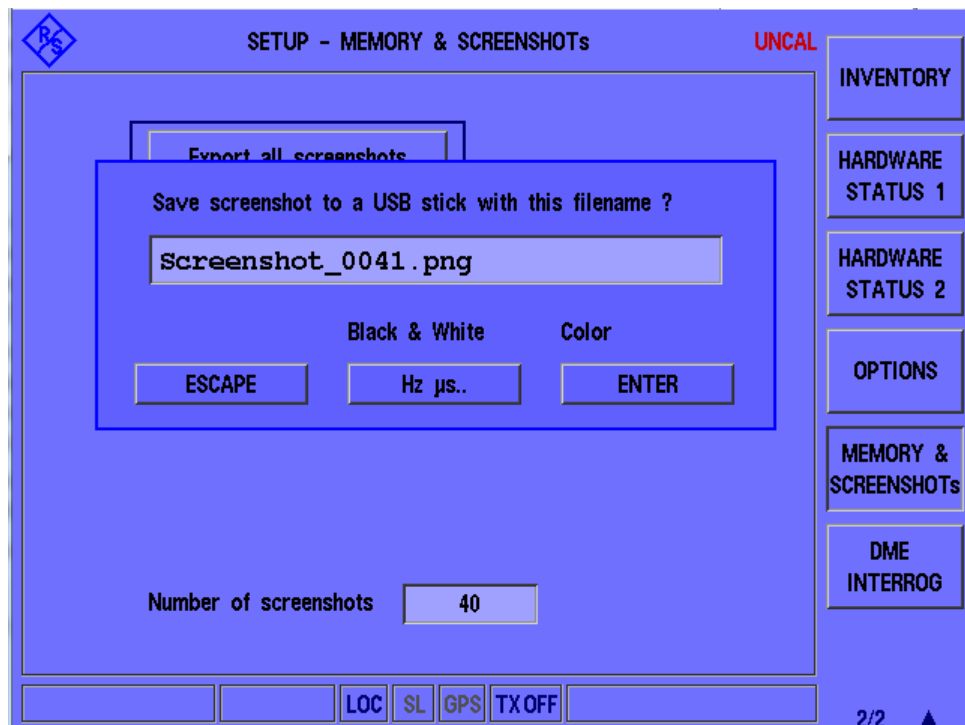

- For black & white output: Press the [HZ]/μs key.
- For color output: Press the [ENTER] key.

Exporting screenshots to a USB device

All screenshots on the R&S EDS300 are stored as .PNG files in the main directory of the connected USB device.

Note: If a USB device is connected to the R&S EDS300 while the screenshot is taken, the screenshot is immediately stored to the USB device as a .PNG file. However, it remains in the internal storage and is included in the export until it is deleted.

If you changed the name of a screenshot when it was stored to a USB device directly, and export all screenshots to a USB device later, the same screenshot is stored with the internal name again.

Deleting all screenshots stored on the R&S EDS300

All screenshots stored on the R&S EDS300 are deleted irrevocably.

Once the screenshots have been stored to an external memory device, you can delete them from the instrument. Otherwise, you copy them again each time you create new screenshots and want to store them to a USB device.

Number of Screenshots

Indicates the number of screenshots currently stored on the instrument.

8.4 Obtaining information on open-source resources

The software makes use of several valuable open source software packages. An open-source acknowledgment document provides verbatim license texts of the used open source software. You can copy the document to a USB stick for further inspection.

Access: [Setup] > "More Softkeys" > "Memory & Screenshots" > "Copy OSA text file to USB stick"

9 General instrument setup

Access: [SETUP]

Some basic instrument settings can be configured independently of the selected measurement mode. Usually, you configure most of these settings initially when you set up the instrument according to your personal preferences or requirements. Later you only adapt individual settings to special circumstances when necessary. Some special functions are provided for service and basic system configuration.

Additional settings in the [SETUP] softkey menu are described in these chapters:

- [Chapter 8, "Data management"](#), on page 79
- [Chapter 7, "Configuring and performing measurements"](#), on page 56
- [General settings](#).....85
- [Setting up a network \(LAN\) connection](#).....86
- [Obtaining system information](#).....90
- [Updating the software](#).....95
- [Activating additional options](#).....96
- [Configuring the display and audio output](#).....97

9.1 General settings

Access: [SETUP] > "General Settings"

The screenshot displays the 'SETUP - GENERAL SETTINGS' interface. The main area contains three settings:

- DATE [dd.mm.yyyy]: 02.02.2016
- TIME [hh:mm:ss]: 12:18:26
- COUNT PULSES: Double

On the right side, there is a vertical menu with the following options:

- SIGNAL IN
- SIGNAL OUT
- REFERENCE
- AUDIO & DISPLAY
- NETWORK
- GENERAL SETTINGS (highlighted)
- ERROR LOG

At the bottom, the status bar shows: LOC SL GPS TX OFF 1/2 ▲

Date.....	86
Time.....	86
Count Pulses.....	86

Date

Sets the date of the internal clock in the format `dd.mm.yyyy`.

Time

Sets the time of the internal clock in the format `hh:mm:ss`.

Count Pulses

Determines whether the R&S EDS300 counts single or double pulses (pulse pairs) in the measured signal.

"Double" Only double pulses are counted, that is: two identical pulses sent with the required pulse spacing.

"Single" Each detected pulse is counted individually.

Remote command:

[SETUP:COUNT_PULSES](#) on page 117

9.2 Setting up a network (LAN) connection

The R&S EDS300 is equipped with a network interface and can be connected to an Ethernet LAN (local area network). The interface can be used, for example:

- To transfer data between a controlling device and the test device, e.g. to run a remote control program.
See [Chapter 11, "Remote commands for DME/Pulse analysis"](#), on page 109
- To establish a VNC connection to the R&S EDS300 and control it manually, but from a remote PC.

Permanent vs dynamic IP addresses

Depending on the network capacities, the TCP/IP address information for the instrument can be obtained in different ways.

- If the network supports dynamic TCP/IP configuration using the Dynamic Host Configuration Protocol (DHCP), all address information can be assigned automatically.
- If the network does not support DHCP, or if the instrument is set to use alternate TCP/IP configuration, the addresses must be set manually.

By default, the instrument is configured to use dynamic TCP/IP configuration and obtain all address information automatically. Thus, it is safe to establish a physical connection to the LAN without any previous instrument configuration.

NOTICE**Risk of network errors**

Connection errors can affect the entire network. If your network does not support DHCP, or if you choose to disable dynamic TCP/IP configuration, you must assign valid address information *before* connecting the instrument to the LAN.

Contact your network administrator to obtain a valid IP address and subnet mask for the R&S EDS300 and the IP address for the local default gateway.

If the instrument is configured to use dynamic TCP/IP configuration, but no DHCP server is available, the boot process on the R&S EDS300 takes longer.

IP address vs host name

In a LAN that uses a DNS (Domain Name System) server, each PC or instrument in the LAN can be accessed via an unambiguous host name instead of the IP address. The DNS server translates the host name to the IP address. Using host names is especially useful when a DHCP server is used, as a new IP address can be assigned each time the instrument is restarted.

Each instrument is delivered with an assigned host name (`eds300`), but you can change this name.

- [Network settings](#).....87
- [How to configure the network \(LAN\) connection](#).....89
- [How to set up a remote connection](#).....89

9.2.1 Network settings

Access: [Setup] > "Network"

To operate the R&S EDS300 in a network, the following settings must be configured.

SETUP - NETWORK

TCP/IP DHCP: **ON** ADDR: 172.17.102.7
MASK: 255.255.255.0

TCP/IP ADDRESS: 172.17.40.139

TCP/IP NETMASK: 255.255.255.0

TCP/IP GATEWAY: 192.168.1.1

HOSTNAME: edst2

SIGNAL IN
SIGNAL OUT
REFERENCE
AUDIO & DISPLAY
NETWORK
GENERAL SETTINGS
ERROR LOG

LOC SL GPS TX OFF

1/2 ▲

TCP/IP DHCP	88
TCP/IP Address	88
TCP/IP Netmask	88
TCP/IP Gateway	89
Hostname	89

TCP/IP DHCP

If the network supports dynamic TCP/IP configuration using the Dynamic Host Configuration Protocol (DHCP), all address information can be assigned automatically. In this case, the TCP/IP parameters are not editable. The currently assigned [TCP/IP Address](#) and [TCP/IP Netmask](#) are indicated next to the "TCP/IP DHCP" setting.

If the network does not support DHCP, the addresses must be set manually.

By default, the instrument is configured to use dynamic TCP/IP configuration and obtain all address information automatically. Thus, it is safe to establish a physical connection to the LAN without any previous instrument configuration.

TCP/IP Address

Unique address of the instrument in the network. The currently assigned IP address and submask are indicated next to the setting.

The IP address consists of four number blocks separated by dots. Each block contains values between 0 and 255.

See also "[IP address vs host name](#)" on page 87.

TCP/IP Netmask

The subnet mask consists of four number blocks separated by dots. Each block contains values between 0 and 255.

TCP/IP Gateway

The gateway consists of four number blocks separated by dots. Each block contains values between 0 and 255.

Hostname

Unique instrument name in the network, as an alternative to the unique IP address. Each instrument is delivered with an assigned host name (`eds300`), but this name can be changed.

See also "[IP address vs host name](#)" on page 87.

9.2.2 How to configure the network (LAN) connection

To use the R&S EDS300 in a network, connect the instrument to the network by its LAN connector (see [Chapter 4.2.2.7, "LAN interface"](#), on page 28). Then configure the instrument-specific network connection settings.

1. Press the [SETUP] key.
2. Select the "Network" softkey.
3. If necessary, disable the use of the Dynamic Host Configuration Protocol (DHCP) by toggling the "TCP/IP DHCP" setting.
Contact your network administrator to obtain a valid IP address and subnet mask for the R&S EDS300 and the IP address for the local default gateway.
4. Enter the "TCP/IP Address", for example `192.0.2.0`.
5. Enter the subnet mask ("TCP/IP Netmask"), for example `255.255.255.0`.
6. Enter the "TCP/IP Gateway", for example `192.0.1.1`.
7. Change the "Hostname" of the R&S EDS300.

9.2.3 How to set up a remote connection

To establish a connection to the R&S EDS300 from a control PC for remote operation, you require a computer networking service such as the free tools *netcat* or *PuTTY*.

Using such a network client, send the following command to the R&S EDS300, for example:

```
netcat <EDST300 IP_address> 8009
```

Once the connection has been established, you can send any of the commands described in [Remote commands for DME/Pulse analysis](#) to control the R&S EDS300.



Only one remote connection at a time is possible; a second connection request overrides and terminates the first.

9.3 Obtaining system information

Information on the current system configuration and system messages are available on the R&S EDS300. This information is particularly useful if errors occur or you require help with the instrument from Rohde & Schwarz.

- [Error log](#)..... 90
- [Installed hardware and software](#)..... 91
- [Installed options](#)..... 92
- [Hardware status overview](#).....92

9.3.1 Error log

Access: [Setup] > "Error Log"

The last 100 instrument status messages or errors displayed in the status bar during operation of the R&S EDS300 are also stored in an error log file on the instrument (see also [Chapter 4.3.4, "Error and status messages"](#), on page 34). Thus, if problems occur, you can check the error log for irregular behavior or failures.

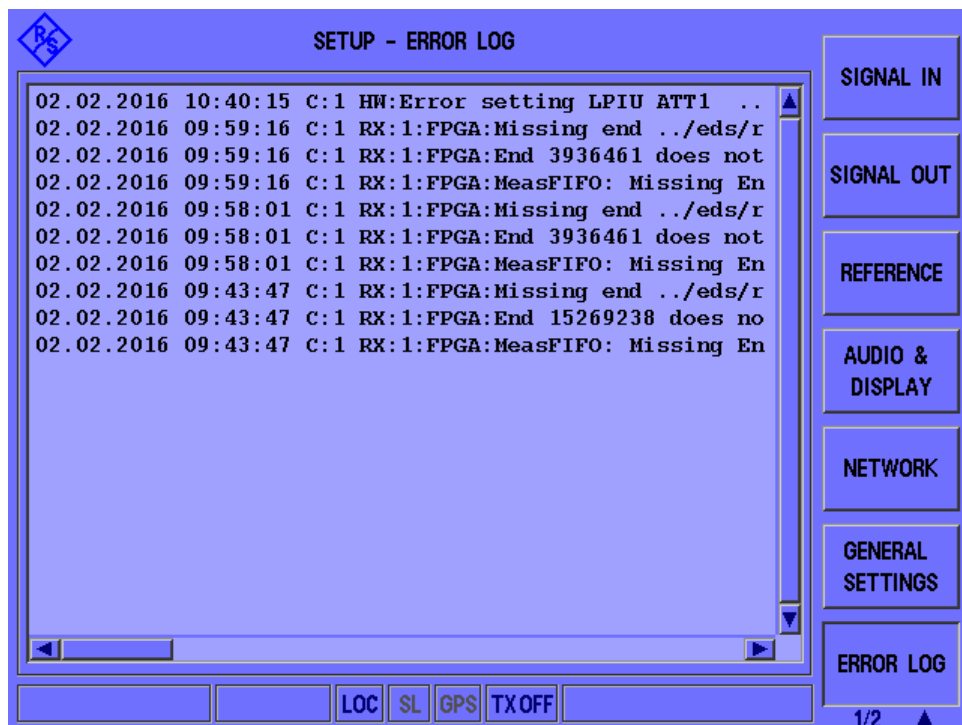

To clear the error log

You can clear the error log, but beware that all entries are deleted irrevocably.

- ▶ While the error log is displayed, press the [ESC] key.

9.3.2 Installed hardware and software



Access: [Setup] > "More Softkeys" > "Inventory"

The hardware and software inventory list provides information on the hardware version of the instrument (integrated modules, options etc.) and on the currently installed software versions. Additionally installed software options are provided in the "Options" list.

For each piece of hardware, the identification number, serial number and revision are provided in the inventory list. For each software item, the installed version number is provided.

SETUP - INVENTORY			
HARDWARE	IDENT NR.	SERIAL NR.	REV.
K-MAT	5202.7006K02	101319	01.00
EDS300	5202.7006.02	101319	03.00
MAIN BOARD	5202.7035.03	100942	07.03
DISTRIBUTION BOARD	5202.7058.02	101343	05.00
RX1 BOARD	5202.7012.02	100876	05.01
RX2 BOARD	5202.7012.02	100877	05.01
HPIU BOARD	5202.8402.00	101059	2.10
LPIU BOARD	5202.8602.02	100755	03.00
POWER SUPPLY BOARD	5202.7070.02	101470	02.01
SOFTWARE			
RELEASE	VERSION NR.		
MAIN EDS	04.20 BETA8		
MAIN FPGA	01.65t TACAN (TacDec1.68)		
MAIN CPLD	03.28-0		
RX FPGA	01.01		
LPIU FPGA	05.08-1		
LINUX OS	03.00-5		
	3.14.57-rt58edst1 SP1		
For software update from USB stick press key <ENTER>			

Figure 9-1: Example of an inventory list for an R&S EDS300



If you detect that the latest software version is not yet installed, simply insert a USB storage device with the latest version in the R&S EDS300 and press the [ENTER] key. If a software installation file is found on the USB device, a software update is automatically started (after confirmation). See [Chapter 9.4, "Updating the software"](#), on page 95 for details.

Remote commands:

[GETHWINVENTORY](#) on page 113

[VER?](#) on page 115

[LPIU_FPGA_VER?](#) on page 114

[MAIN_BOARD_CPLD_VER?](#) on page 115

[MAIN_BOARD_FPGA_VER?](#) on page 115

[RX_BOARD_FPGA_VER?](#) on page 115

9.3.3 Installed options



Access: [Setup] > "More Softkeys" > "Options"

For each possible option, the instrument indicates whether it is "available" or "not available".

Option	Status
EDS-K1 TACAN	available
EDS-K2 PULSE VIEW	available
EDS-K3 GPS	available
EDS-K5 MULTI DME	available
Z10 PRESENT	not available

MAC: 00:e0:33:0d:bc:cb

KEY: valid

Vertical Menu: INVENTORY, HARDWARE STATUS 1, HARDWARE STATUS 2, OPTIONS, MEMORY & SCREENSHOTS, DME INTERROG

Bottom Buttons: LOC, SL, GPS, TX OFF, 2/2 ▲

To install further options, see [Chapter 9.5, "Activating additional options"](#), on page 96.

Remote commands:

[GETOPTIONS](#) on page 114

9.3.4 Hardware status overview



Access: [Setup] > "More Softkeys" > "Hardware Status 1"

The hardware status overview provides information on the current operating status of the individual hardware components in the R&S EDS300, such as test voltages and temperatures.

Test voltages

The test voltages are measured continuously, internally, and checked against defined limit values. If one of the test voltages exceeds the tolerance for more than 10 s, the following measures are taken by the R&S EDS300:

- An error message is created in the error log (see [Chapter 9.3.1, "Error log"](#), on page 90).
- The measured test voltage is indicated in red (see [Table 9-1](#)).
- "UNCAL" is displayed in the measurement window to indicate that the measured values can be invalid.
- The "Overall Status" in the hardware status overview is indicated as "NOK" (not OK).

As soon as the test voltage returns to the allowed range, the "Overall Status" returns to "OK". The "UNCAL" display, however, remains until the R&S EDS300 is switched off.

Test voltages are color-coded:

Table 9-1: Test voltage color-coding

Color	Meaning
black	ok
red	error, the "UNCAL" message is displayed at the top of the window
blue	irrelevant for R&S EDS300 operating status

Hardware Status Display

The first overview ("Hardware Status 1") provides information on the mainboard, the power supply and the antenna distributing unit (DU board).

The "Overall Status" indicates whether the instrument as a whole is operating correctly - at a glance.

SETUP - HARDWARE STATUS 1						
Nr.	MAIN BOARD		DU BOARD		POWER SUPPLY	
1	+5V1_KEYB	5.0	LNA2_IMON	3.2	+12V0_B	11.9
2	+3V3_CPLD	3.3	LNA1_IMON	0.0	+12V0_A	11.9
3	+12V_SW	12.2	-12V	-11.6	+3V1	3.2
4	+5V2_MAIN	5.2	+2V5_VREF	2.5	+3V9	3.9
5	+3V3_VCC	3.2	+5V_ADC	5.0	+1V6	1.6
6	+2V5_AUX	2.6	+5V_SW	5.0	+5V6_A	5.5
7	AGND	0.0	LNA1_OVLD_BITE	0.0	+5V6_B	5.5
8	+1V0_VCCINT	1.0	LNA2_OVLD_BITE	0.0	-5V5	-5.5
9	AGND	0.5	-10V	-10.8		
10	AGND	3.0	+4	3.8		
11	+1V2_AVTTX	1.2	-100V	-104		
12	+1V2_AVTRX	1.2	+10V	9.9		
13	+1V2_AVCCPLL	1.2	+3V3	3.3		
14	+1V0_AVCC	1.0	4V8_LNA_2	4.8		
15	+3V3_REF_OSC	3.3	4V8_LNA_1	4.8		
16	-5V2_MAIN	-5.1	+3V3_SW	3.3		
	Temp[°C]	31.8	Temp[°C]	35.8	Temp[°C]	36.2

OVERALL STATUS: OK

LOC SL GPS TXOFF

2/2 ▲

Figure 9-2: Hardware status for the mainboard, the power supply and the antenna distributing unit (DU board) - page 1

The second overview ("Hardware Status 2") provides information on the integrated receiver modules.

SETUP - HARDWARE STATUS 2				
Nr.	RX-BOARDS	RX1	LPIU	
1	+5V_ADC	5.0	+12V0	0.0
2	+3V3_VCC_FPGA	3.4	+5V6	5.6
3	9V_LO2_AMP	8.9	3V3_DUC_AVDD	3.4
4	5V_IF2_AMP	5.0	+32V_UD	11.6
5	IF_DETECT_1	0.0	+3V9	3.9
6	IF_DETECT_2	0.3	+1V8_DUC_AVDD	1.9
7	+3V3_RFSW_ADC	3.3	HPIU_+5V_SENSE	0.8
8	+5V_PLL1	4.9	HPIU_+3V3_SENSE	0.0
9	+5V_IF1_AMP	4.9	HPIU_+50V_SENSE	0.8
10	+5V_LNA	4.9	LO1_LEV	3.0
11	+5V_PLL2	5.0	IF800M_AMP2_SENSE	3.3
12	+3V3_PLL2	3.3	AMP_DRV1_SENSE	4.8
13	+3V3_IFSW	3.3	AMP_DRV2_SENSE	0.0
14	+3V3_PLL1	3.3	IF800M_AMP1_SENSE	3.2
15	+3V3_ADC	3.4	LO2_LEV	1.9
16	-5V_ADC	-5.0	AMP_DRV3_SENSE	0.0
	Temp[°C]	62.8	---	Temp[°C] LPIU 48.8/---

OVERALL STATUS: OK

LOC SL GPS TX OFF

2/2 ▲

Figure 9-3: Hardware status for the integrated receiver modules (page 2)

Remote command:

[GETHWSTATUS](#) on page 114

[GETUNCAL](#) on page 114

[TEMP?](#) on page 115

9.4 Updating the software



Access: [Setup] > "More Softkeys" > "Inventory"

Software updates and the Release Notes describing the improvements and modifications for the R&S EDS300 are provided on the Internet at:

<http://www.rohde-schwarz.com/firmware/eds300>

To update the software version

1. Store the software version to a USB storage device.
2. On the R&S EDS300, press the [SETUP] key.

3.



Press the "More softkeys" key.

4. Press the "Inventory" softkey.
5. Insert the USB storage device with the software in one of the USB connectors on the R&S EDS300.

The R&S EDS300 automatically searches the USB device for new software. The update file has the extension `.eds` and must be located in the main directory of the USB device. The search can take a few seconds.

6. When the software has been found, press the [ENTER] key to confirm the message to install the software.

The software installation is started.

Note: Never remove the USB device or switch off the instrument during a software update. Otherwise, an undefined software state can be the result.

If the USB device is removed during update, an error message is displayed ("Cannot unpack update"). Press the [ESC] key to acknowledge and close the message. The update is interrupted, and the instrument can be operated again.

7. When the installation is complete, a message is displayed prompting you to restart the instrument. Press [Enter] to confirm and close the message.
8. Remove the USB device from the instrument.
9. Press the [Power ON/OFF] key twice to restart the instrument and activate the new software.

9.5 Activating additional options



Access: [Setup] > "More Softkeys" > "Options"

For all purchased R&S EDS300 options, a license key is provided by Rohde & Schwarz. To activate the options on the instrument, enter the number of the license key in the software.

To activate the license key

1. Press the [Setup] key.



Press the "More softkeys" key.

3. Press the "Options" softkey to display an overview of all available R&S EDS300 options.
4. Press the [Enter] button to open an input edit field for "Key".
5. Enter the license key number as provided by Rohde & Schwarz.

(Note: the license key consists of 18 numbers, separated by commas)

- Press [Enter] to confirm the entry.

If the key is valid, the purchased options are enabled and identified as "available" in the overview.

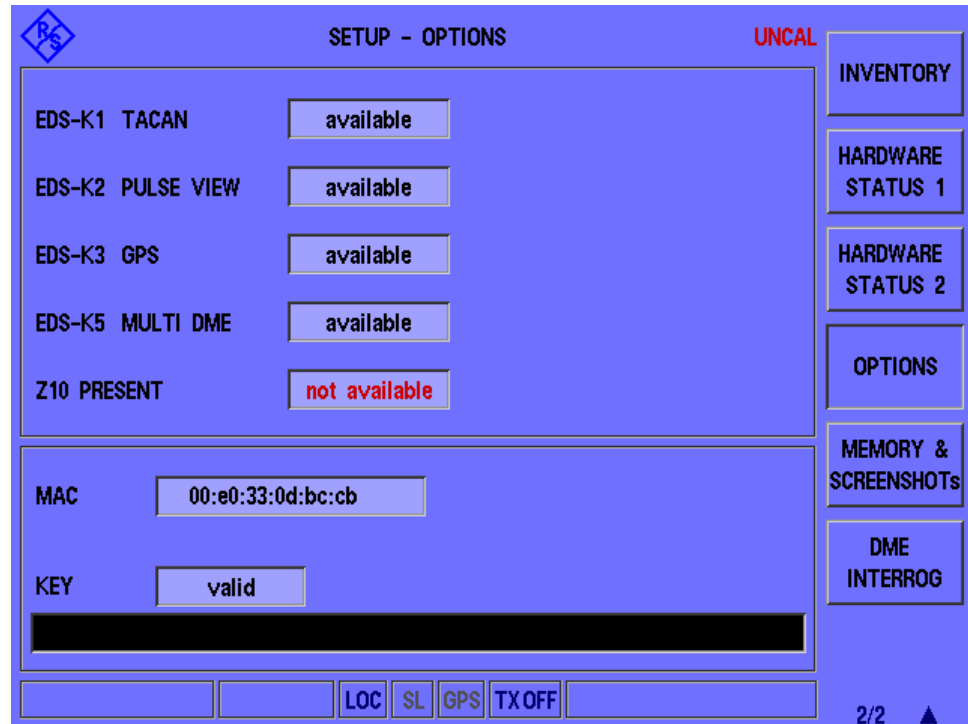

Figure 9-4: Available R&S EDS300 options

If the key is not valid, the entered number is displayed in red.

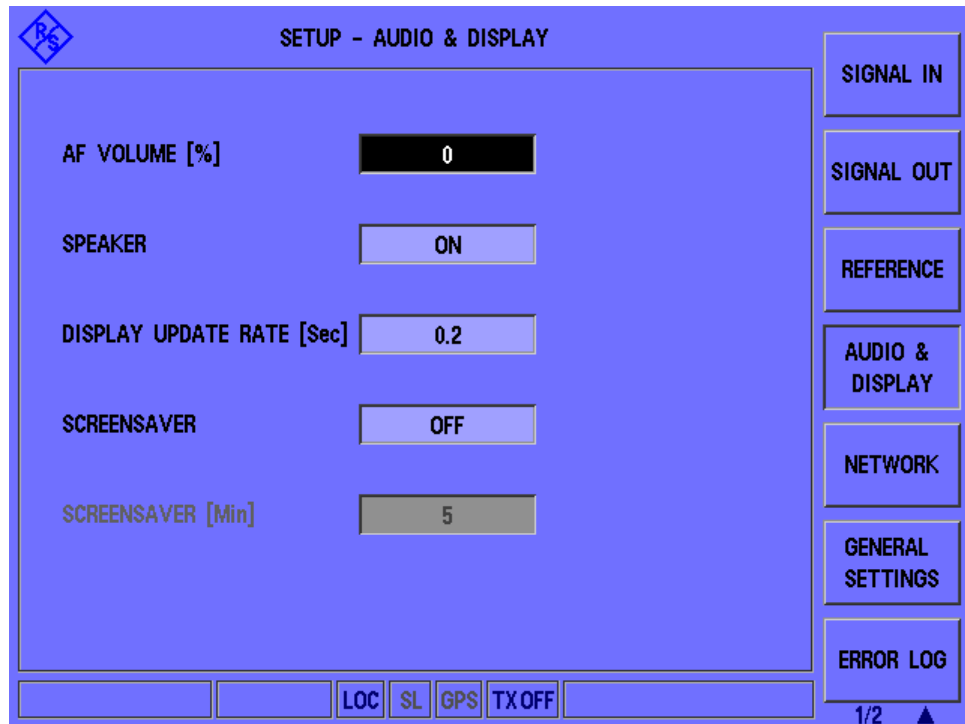

Figure 9-5: Invalid option key

Correct the number and try again.

9.6 Configuring the display and audio output

Some general settings are available for the display and audio output in the "Audio & Display" window, which is available from the [Setup] softkey menu.



- [Audio and display settings](#)..... 98
- [How to configure audio output](#)..... 99

9.6.1 Audio and display settings

AF Volume	98
Speaker	98
Display Update Rate	98
Screensaver	99
[VOL]	99

AF Volume

Defines the volume of the AF output at the loudspeaker or headphones connector as a percentage (0 % to 100 %).

Remote command:

[SETUP:AF_VOLUME](#) on page 116

Speaker

Enables or disables AF output at the loudspeaker on the rear panel of the R&S EDS300.

Remote command:

[SETUP:ANALOG_OUT_MODE](#) on page 119

Display Update Rate

Defines the rate at which the display is updated to show new measurement results. Define a value between 0.1 seconds and 2 seconds.

A short update span allows you to trace rapid value changes, while a longer span improves the measurement performance.

Note, however, that if you reduce the update rate below the defined measurement time (see "[Measurement Time](#)" on page 68), performance is not increased further. In this case, the same values are displayed for several updates until a new value is measured.

Remote command:

[SETUP:DISPLAY_UPDATE_MS](#) on page 117

Screensaver

Activates or deactivates a **screensaver** for the display. Specify a duration between 1 minute and 60 minutes after which the screen saver is activated.

If no interaction is performed on the R&S EDS300 for the specified duration, the background light of the display is temporarily switched off to protect the screen and save battery power. A running measurement and data logging continues as usual.

To switch the light back on, press any key or turn the rotary knob on the R&S EDS300.

Note: Do **not** press the [Power On/Off] switch. Turning off the instrument results in a data loss if a measurement was running.

[VOL]

The [VOL] key on the front panel of the R&S EDS300 changes the volume setting for the AF output quickly during regular operation. When you press the key, the volume setting is temporarily displayed as a bar graph in the status bar of the display. Turn the rotary knob to change the volume and confirm the setting by pressing the [ENTER] key or the rotary knob. As soon as the setting has been confirmed, the original status bar display is restored.

Remote command:

[SETUP:AF_VOLUME](#) on page 116

9.6.2 How to configure audio output

To configure audio output

1. Press the [SETUP] key.
2. Press the "Audio & Display" softkey.
3. To enable or disable AF output at the loudspeaker, toggle the "Speaker" setting. To change the volume of the AF output at the loudspeaker or headphones, select the "AF Volume" field and do one of the following:
 - Turn the rotary knob.
 - Press the Up arrow or Down arrow keys.
 - Enter a percentage value between 0 and 100.
4. Press [Enter] to confirm the entry.

**VOL key**

To change the volume setting for the loudspeaker quickly during regular operation of the R&S EDS300, press the [VOL] key on the front panel. The volume setting is temporarily displayed as a bar graph in the status bar of the display. Turn the rotary knob to change the volume and confirm the setting by pressing the [ENTER] key or the rotary knob. When the setting has been confirmed, the original status bar display is restored.

10 How to perform measurements and analyze pulses with the R&S EDS300

The following step-by-step instructions demonstrate how to perform the most important tasks on the R&S EDS300, in particular configuring and performing DME/TACAN measurements and analyzing pulses.

- [How to configure signal input and output](#)..... 101
- [How to perform a distance measurement](#)..... 102
- [How to analyze interrogator pulses](#)..... 103
- [How to set up the R&S EDS300 interrogator](#)..... 103
- [How to analyze pulses graphically](#)..... 104
- [How to set up the R&S EDS300 for TACAN measurements](#)..... 105
- [How to save and load measurement settings](#)..... 106

10.1 How to configure signal input and output

The R&S EDS300 can analyze signals received by its "RF IN" interface. It can also provide output to other interfaces.

To configure the input signal for analysis

1. Press the [SETUP] key.
2. Select the "Signal In" softkey.
3. Select the input signal for the first receiver board ("RX Board 1"), that is, which connector provides the input signal.
 - a) Select "RF 1 IN" or "RF 2 IN".
 - b) Confirm the setting by pressing the [ENTER] key or the rotary knob.
 - c) Make sure that the signal provider is connected to the corresponding connector on the front panel of the R&S EDS300.
4. Optionally, if a second receiver board is installed on the instrument (requires R&S EDS-B1), select the input signal for "RX Board 2". The same signals are available as for the first receiver board.

Note: In Multi-DME mode, the same input signal is used for both receiver boards; thus, only the "RX Board 1" setting is available.

To receive GPS data

Prerequisite:

Option R&S EDS-K3 is installed.

The GPS receiver is connected to the RS232 interface on the rear panel of the R&S EDS300.

1. Press the [GPS] key.

2. Select the "Baudrate" softkey.
3. Define the signalling rate for the GPS signal.
4. Confirm the setting by pressing the [ENTER] key or the rotary knob.
5. Optionally, switch time synchronization to NMEA messages or PPS pulses:
 - a) Select the "SYNC" softkey to toggle between the available settings.
 - b) Confirm the setting by pressing the [ENTER] key or the rotary knob.

To configure the use of an external reference frequency on the R&S EDS300

1. Connect a device that provides the external reference frequency to the [REF 10 MHz IN/OUT] connector on the rear panel of the R&S EDS300.
2. Press the [SETUP] key.
3. Select the "Reference" softkey.
4. Select the reference "Source: Extern".
If an external reference source is found, "Ext.Reference: Present" is indicated.
5. Confirm the setting by pressing the [ENTER] key or the rotary knob.
The R&S EDS300 uses the external frequency from the connected device as a reference.

To provide the internal reference frequency on the R&S EDS300 as output

1. Press the [SETUP] key.
2. Select the "Reference" softkey.
3. Select the reference "Source: Intern".
"Ext.Reference: Output" is indicated.
4. Confirm the setting by pressing the [ENTER] key or the rotary knob.
5. Connect a device to the [REF 10 MHz IN/OUT] connector on the rear panel of the R&S EDS300.
The R&S EDS300 provides its internal 10 MHz reference signal as output at the [REF 10 MHz IN/OUT] connector.

10.2 How to perform a distance measurement

The following step-by-step instructions demonstrate how to perform a basic distance measurement with the R&S EDS300.

1. Select [DME] to display the "DME/TACAN" view.
2. Select the channel to measure (see [Chapter B, "DME channel frequency list"](#), on page 167) by doing one of the following:

- Select [CHAN] and enter the channel number.
 - Select [FREQ] and enter the channel frequency.
3. Select "Meas Time" and define how long to acquire data for a single evaluation during averaging.

10.3 How to analyze interrogator pulses

The following step-by-step instructions demonstrate how to perform basic pulse analysis on interrogator pulses with the R&S EDS300.

1. Select [DME] to display the "DME/TACAN" view.
2. Select the channel to measure (see [Chapter B, "DME channel frequency list"](#), on page 167) by doing one of the following:
 - Select [CHAN] and enter the channel number.
 - Select [FREQ] and enter the channel frequency.

3. Select the "RX Mode": "Interrog."

The receive frequency ("RX.F") is set to the defined transmission frequency ("TX.F").

4. If the results are not reasonable or the measurement is unstable, adapt the interrogator settings as described in [Chapter 10.4, "How to set up the R&S EDS300 interrogator"](#), on page 103.

10.4 How to set up the R&S EDS300 interrogator

The following step-by-step instructions demonstrate how to set up the R&S EDS300 to send interrogator pulses and evaluate them.

1. Select [Setup].
2. Select "More softkeys", then "DME Interrog."
3. Define the number of pulses to calculate the reply efficiency time for.
The larger the value, the more stable and accurate the results, but the weaker the performance of the interrogator.
4. Define the minimum reply efficiency (in percent) after which the interrogator switches between tracking, memory and search modes.
The smaller the value, the quicker the interrogator reaches the track mode, but also the quicker it returns to the memory mode.
The larger the value, the more stable and accurate the results, but the weaker the performance of the interrogator.

5. If necessary, define an offset to the delay between the transmission of the request pulse and the reply pulse to compensate for delay times caused by cable lengths, for example.
6. Select the unit for the distance results.
7. Select [DME] to start the distance measurement.
8. Select "TX" (ON) to activate transmission of the interrogator signals.
The transmission frequency ("TX.F") is set to the defined receiver frequency ("RX.F") + 63 MHz. The transmission pulse code is set to the same as the receiver pulse code ("P.Code")
9. If necessary, select "PRR Search" or "PRR Track" (in the second softkey menu) to change the pulse repetition rate for the interrogator's search or track modes.
10. If necessary, select "TX P. Width" or "TX Level" (in the second softkey menu) to change the interrogator pulse width or the pulse power level, respectively.

The R&S EDS300 now acts and behaves like the on-board interrogator of a normal plane, sending interrogator pulses at the defined pulse rate.

Now you can perform a distance measurement as described in [Chapter 10.2, "How to perform a distance measurement"](#), on page 102 to analyze the interrogator pulses or the reply pulses from the ground station.

10.5 How to analyze pulses graphically

The following step-by-step instructions demonstrate how to analyze pulses, for example from a DME or TACAN signal, or sent by the interrogator, using the graphical display of the R&S EDS300.

1. Select [Pulse].
2. Select [CHAN] and select the channel to measure (see [Chapter B, "DME channel frequency list"](#), on page 167).
3. Select [FREQ] and select the frequency to measure (see [Chapter B, "DME channel frequency list"](#), on page 167).
The measured signal power is displayed over time. The pulse parameters for the measured signal are automatically calculated and displayed.
4. Select "Time/Div" and define the time range to be displayed in each division (1/10 of the width) of the x-axis.
5. Select "Unit" to change the unit of the power axis.
6. Select "mV/Div" and define the power range to be displayed in each division (1/10 of the height) of the y-axis.
7. Select "Max.Lev" and define the maximum power level for the y-axis.

8. To analyze the pulse characteristics over an average of several measured pulses, select "TRACE": "AVRG" and define the number of pulses to average ("AVRG").
9. To analyze wide pulses, select "Bandwidth": "Wide", otherwise they can be cut off or distorted.
To analyze narrow pulses, select "Bandwidth": "Narrow", otherwise adjacent pulses or signal effects outside the pulse can be included.
10. To trigger measurements only if specific conditions are fulfilled, select the "TRIG.MODE": "Normal" and define the trigger source and, if necessary, the level.
To analyze interrogator signals, select the trigger source "Interrog". In this case, a measurement is triggered each time the R&S EDS300 interrogator transmits a pulse. Thus, you can analyze the interrogator and reply pulses in the same diagram.
11. To trigger only on valid pulse pairs (double pulses), select "TRG. Double": "ON".
12. To analyze the signal immediately before the trigger event, define a negative trigger delay.
13. To determine the power level at a specific time in the measurement, set a marker in the diagram.

To set a marker in the diagram

1. Select [MARKER].
2. Select "Marker 1".
3. Define the time for which you want to determine the measured power level.
The power level for the marker is displayed above the diagram ("Mark1").

10.6 How to set up the R&S EDS300 for TACAN measurements

The following step-by-step instructions demonstrate how to set up the R&S EDS300 to measure and analyze pulses from TACAN signals.

1. Switch off the R&S EDS300.
2. Connect the USB stick that contains the TACAN option to one of the USB ports of the R&S EDS300.
3. Switch on the R&S EDS300.
After booting, the DME / TACAN mode is active.

4. Continue as described in [Chapter 10.2, "How to perform a distance measurement"](#), on page 102.

In addition to the DME pulse results, the bearing of the plane is displayed, and details on the MRB and ARB signal components. Furthermore, the ground station's ID pulses can be analyzed in detail.

Select "View" to scroll through the available results.

10.7 How to save and load measurement settings

Instrument settings can be saved to a file and loaded again later, so that you can repeat the measurement with the same settings. Default factory settings can also be restored to the instrument at any time.

To restore factory default settings

1. Press the [Preset] key on the front panel of the R&S EDS300.
2. Select the "Factory Preset" softkey.
3. Confirm the message.

All instrument and measurement settings - except for the IP address and host name - are replaced by the default factory settings.

To store the current measurement settings

1. Press the [Preset] key on the front panel of the R&S EDS300.
2. Select the "Select" softkey.
The number of the currently selected User Preset is indicated on the softkey. By default, the User Preset number 1 is selected.
3. If necessary, select a different User Preset using the Up and Down arrow keys or the rotary knob.
4. Press [Enter] to confirm the entry.
The selected User Preset number is indicated on the "Select" softkey.
5. Select the "Save" softkey.
The file name currently used by the User Preset is displayed.
6. If necessary, change the file name to store the selected User Preset.
7. Press [Enter] to confirm the entry.
8. Press [Enter] to confirm the security message.

The current measurement settings are stored, together with the current date and time.

To recall stored measurement settings

1. Press the [Preset] key on the front panel of the R&S EDS300.
2. Select the "Select" softkey.
The number of the currently selected User Preset is indicated on the softkey. By default, the User Preset number 1 is selected.
3. If necessary, select a different User Preset using the Up and Down arrow keys or the rotary knob.
4. Press [Enter] to confirm the entry.
The selected User Preset number is indicated on the "Select" softkey.
5. Select the "Recall" softkey.
6. Press [Enter] to confirm the security message.
The current measurement settings are overwritten by the settings stored in the selected User Preset.

To rename stored measurement settings files

When measurement settings are stored to the selected User Preset, you can define a name to distinguish the individual User Presets. The name assigned to a User Preset can be changed anytime.

1. Press the [Preset] key on the front panel of the R&S EDS300.
2. Select the "Select" softkey.
The number of the currently selected User Preset is indicated on the softkey. By default, the User Preset number 1 is selected.
3. If necessary, select a different User Preset using the Up and Down arrow keys or the rotary knob.
4. Press [Enter] to confirm the entry.
The selected User Preset number is indicated on the "Select" softkey.
5. Select the "Rename" softkey.
6. Change the name of the selected User Preset.
7. Press [Enter] to confirm the entry.
The User Preset is indicated by its new name in the "Preset" window.

To delete stored measurement settings

When a User Preset is stored, a file is created or an existing file with the same file name is overwritten. The file name assigned to a User Preset can be changed anytime.

1. Press the [Preset] key on the front panel of the R&S EDS300.
2. Select the "Select" softkey.

The number of the currently selected User Preset is indicated on the softkey. By default, the User Preset number 1 is selected.

3. If necessary, select a different User Preset using the Up and Down arrow keys or the rotary knob.

4. Press [Enter] to confirm the entry.

The selected User Preset number is indicated on the "Select" softkey.

5. Select the "Delete" softkey.

6. Press [Enter] to confirm the message.

The settings and the name assigned to the selected User Preset are deleted.

11 Remote commands for DME/Pulse analysis

The following commands are required to perform DME/ pulse analysis with the R&S EDS300 in a remote environment. It is assumed that the R&S EDS300 has already been set up for remote operation in a network as described in [Chapter 9.2](#), "Setting up a network (LAN) connection", on page 86.



Conventions used in remote command descriptions

Note the following conventions used in the remote command descriptions:

- **Command and parameter syntax**
All commands and parameters described here are case-**insensitive**.
- **Command usage**
If not specified otherwise, commands can be used both for setting and for querying parameters.
If a command can be used for setting or querying only, or if it initiates an event, the usage is stated explicitly.
- **Parameter usage**
If not specified otherwise, a parameter can be used to set a value and it is the result of a query.
Parameters required only for setting are indicated as **Setting parameters**.
Parameters required only to refine a query are indicated as **Query parameters**.
Parameters that are only returned as the result of a query are indicated as **Return values**.
- **<RX> prefix**
If an optional second receiver board is available, the <RX> prefix defines which receiver board the command is addressed to (RX1, RX2).
If no prefix is provided, the currently active receiver board is addressed (see [SETRX](#) on page 129 and [RX?](#) on page 128).
- **Default value (*RST)**
The *RST value indicates the default value used in the factory preset state.
- **Default unit**
The unit used for numeric values if no other unit is provided with the parameter.
- **Manual operation**
If the result of a remote command can also be achieved in manual operation, a link to the description is inserted.

The following tasks are described here:

- [Configuring remote operation](#)..... 110
- [Obtaining instrument information](#)..... 112
- [General instrument setup](#)..... 116
- [Configuring signal input and output](#)..... 118
- [Configuring measurements](#)..... 123
- [Retrieving results](#)..... 149

11.1 Configuring remote operation

The R&S EDS300 can be operated in the following modes:

- **Local** mode: manual operation using the graphical user interface directly at the instrument is available; remote commands can also be executed
- **Remote** mode: remote operation by sending commands from a remote control PC only; manual operation directly at the instrument is not possible, except for the [LOCAL] key to switch back to manual operation
- **Exclusive remote** mode: remote operation by sending commands from a remote control PC only; gui on the instrument is locked, including the [LOCAL] key; return to manual operation only via remote command

HELP?.....	110
KEY.....	111
LOCAL.....	111
REMOTELOCK?.....	112
REMOTELOCK.....	112

HELP? <Command>

Returns information on the selected command.

Query parameters:

<Command> <Command_Name> | ALL

<Command_Name>

Returns information on the specified command, for example concerning parameters or return values.

A list of commands is provided at the end of the document.

ALL

Returns information on all available remote commands.

Return values:

<Information> string

Example:

HELP REMOTELOCK

Queries information on the REMOTELOCK command.

Usage:

Query only

KEY <KeyCode>

Sends the specified key code as a remote command. Note that this command only works in local mode. If necessary, use the [LOCAL](#) key first to switch to local mode.

Parameters:

<KeyCode> PRESET | CAL | VOL | SAVE | MEM | LOCAL | SETUP | SK1 | SK2 | SK3 | SK4 | SK5 | SK6 | SK7 | MORE | DME | PULSE | SSR | MODE | CHAN | FREQ | 0 | 1 | 2 | 3 | 4 | 5 | 6 | 7 | 8 | 9 | POINT | MINUS | GHZ | MHZ | KHZ | HZ | ESCANCEL | ENTER | BACK | START | STOP | MARKER | GPS | RX1_4 | SEQ | WHLEFT | WHRIGHT | WHPUSH | LEFT | RIGHT | UP | DOWN | FIELDL | FIELDR | MARK | DIRECTORY

For a description of the keys see also [Chapter 4.2.1, "Front panel view"](#), on page 20. Only the keys that are not self-explanatory are described here.

MARK

(Checkmark) Restart FPGA

DIRECTORY

Create screenshot.

WHLEFT

Turn rotary knob left.

WHRIGHT

Turn rotary knob right.

WHPUSH

Press rotary knob.

SAVE | MEM | SSR | GPS | RX1_4 | SEQ | FIELDL | FIELDR

Currently no function assigned

Return values:

<SettingResult>

READY

Command was successfully sent.

ERROR

An error occurred; command was not successful.

Example:

```
LOCAL
KEY 'DIRECTORY'
```

Usage:

Setting only

Manual operation: See ["Creating a screenshot"](#) on page 82

LOCAL

Switches back to local operation of the R&S EDS300. The graphical user interface of the R&S EDS300 becomes available again.

Return values:

<SettingResult>

READY

Setting was successfully applied.

ERROR

An error occurred; setting was not successful.

Usage: Setting only

REMOTELOCK?

REMOTELOCK <State>

Queries or defines the state of the remote lock.

Parameters:

<State> ON | OFF

ON

Remote lock is set; no local operation by keyboard is possible. The "LOCAL" button on the R&S EDS300 has no effect. To enable local operation again, release the remote lock (using `REMOTELOCK OFF`).

OFF

Releases the remote lock; local operation is enabled again.

*RST: OFF

Return values:

<SettingResult>

READY

Setting was successfully applied.

ERROR

An error occurred; setting was not successful.

11.2 Obtaining instrument information

*IDN?	112
CLEARERRORLOG	113
GETERRORLOG	113
GETHWINVENTORY	113
GETHWSTATUS	114
GETOPTIONS	114
GETUNCAL	114
LINUX_VER?	114
LPIU_FPGA_VER?	114
MAIN_BOARD_CPLD_VER?	115
MAIN_BOARD_FPGA_VER?	115
RX_BOARD_FPGA_VER?	115
TEMP?	115
VER?	115

***IDN?**

Returns the instrument identification

Return values:

<ID> Rohde&Schwarz,<device type>,<serial number>,<firmware version> [TACAN]

Note: TACAN is displayed only if the TACAN option R&S EDS300-K1 is available on the instrument.

Example:

*IDN?

Example:

Rohde&Schwarz, EDST300, 1234546/02.00, 01.55t
TACAN

Usage:

Query only

CLEARERRORLOG

This command clears the error log.

Return values:

<State>

READY.

The command was executed successfully.

GETERRORLOG

This command retrieves error log entries.

Return values:

<Error-Log>

GETHWINVENTORY

Queries the hardware modules installed in the R&S EDS300.

Return values:

<HWModules>

string

Example:

```
GETHWINVENTORY
//Result:
//EDS300K:5202.7006K02,999999,01.00
//EDST300:5202.7006.02,101325,02.00
//MAINBOARD:5202.7035.02,999999,06.00
//EDS_DU:5202.7058.02,101343,05.00
//RX_BOARD:5202.7012.02,100874,05.03
//...
//LOW_POWER_INTERROGATOR_UNIT:
5202.8602.02,100786,03.00
//POWERSUPPLY:5202.7070.02,101470,02.01
//...
//READY.
```

GETHWSTATUS

Queries the status of the hardware modules inside the R&S EDS300.

Return values:

<HWStatus> OK | NOK

NOK

An error has occurred for at least one hardware element.

Example:

```
GETHWSTATUS
//Result:
//OK
```

GETOPTIONS

Queries the options installed on the R&S EDS300.

Return values:

<Options> string

Example:

```
GETOPTIONS
//Result:
//EDS-K1 TACAN; EDS-K2 PULSEVIEW; EDS-Z10 CAL;
```

GETUNCAL

Queries the UNCAL status of the R&S EDS300.

Return values:

<CalState> CAL | UNCAL

CAL

Status of R&S EDS300 operation ok

UNCAL

Serious errors have occurred during operation.

Example:

```
GETUNCAL
//Result:
//CAL
```

LINUX_VER?

Queries the Linux operating system version of the R&S EDS300.

Return values:

<Version> string

Usage:

Query only

LPIU_FPGA_VER?

Queries the LPIU board FPGA-Software version

Return values:

<Version> string

Usage: Query only

MAIN_BOARD_CPLD_VER?

Queries the main board CPLD-Software version

Return values:

<Version> string

Usage: Query only

MAIN_BOARD_FPGA_VER?

Queries the main board FPGA-Software version

Return values:

<Version> string

Usage: Query only

RX_BOARD_FPGA_VER?

Queries the FPGA software version of the RX board

Return values:

<Version> string

Usage: Query only

TEMP?

Queries the temperature of all internal built-in temperature sensors

Return values:

<Temp>

Usage: Query only

VER?

Queries the currently installed software version

Return values:

<Version> string

Usage: Query only

11.3 General instrument setup

*RST.....	116
FACTORY_PRESET.....	116
SETUP:AF_VOLUME?.....	116
SETUP:AF_VOLUME.....	116
SETUP:COUNT_PULSES?.....	117
SETUP:COUNT_PULSES.....	117
SETUP:DISPLAY_UPDATE_MS?.....	117
SETUP:DISPLAY_UPDATE_MS.....	117
SETUP:MORSEMOST.....	117
SETUP:SPEAKER?.....	117
SETUP:SPEAKER.....	117

*RST

FACTORY_PRESET

Executes the factory preset

Return values:

<SettingResult>

READY

Setting was successfully applied.

ERROR

An error occurred; setting was not successful.

Usage:

Setting only

Manual operation: See "[Factory Preset](#)" on page 80

SETUP:AF_VOLUME?

SETUP:AF_VOLUME

Queries or defines the audio volume

Parameters:

SetAudio <volume in percent>

Return values:

<SettingResult>

READY

Setting was successfully applied.

ERROR

An error occurred; setting was not successful.

Manual operation: See "[AF Volume](#)" on page 98

See "[\[VOL\]](#)" on page 99

SETUP:COUNT_PULSES?**SETUP:COUNT_PULSES** <PulseType>

Determines whether the R&S EDS300 counts single or double pulses (pulse pairs) in the measured signal.

Parameters:

<PulseType>

DOUBLE

Only double pulses are counted, that is: two identical pulses sent with the required pulse spacing.

SINGLE

Each detected pulse is counted individually.

Manual operation: See "[Count Pulses](#)" on page 86

SETUP:DISPLAY_UPDATE_MS?**SETUP:DISPLAY_UPDATE_MS**

Queries or defines the display update rate, that is: the rate at which the display is updated to show new measurement results.

Parameters:

SetDisplInt

<time>

Range: 0.1 ms to 2.0 ms

Default unit: ms

Return values:

<SettingResult>

READY

Setting was successfully applied.

ERROR

An error occurred; setting was not successful.

Manual operation: See "[Display Update Rate](#)" on page 98

SETUP:MORSEMOST <Threshold>

Defines the threshold for the morse code power. If the power level sinks below this value, the morse decoder returns the most probable code.

Parameters:

<Threshold>

numeric value

Range: -140 to +20

*RST: -70

Default unit: dBm

SETUP:SPEAKER?**SETUP:SPEAKER**

Queries or defines the speaker mode

Parameters:

SwitchSpek ON | OFF

Return values:

<SettingResult>

READY

Setting was successfully applied.

ERROR

An error occurred; setting was not successful.

11.4 Configuring signal input and output

GPSBAUDRATE?	118
GPSBAUDRATE	118
SETGPSBAUD	118
GETGPSSYNC	119
SETGPSSYNC	119
SETUP:ANALOG_OUT_MODE?	119
SETUP:ANALOG_OUT_MODE	119
SETUP:EXT_ATTENUATION_TYPE?	120
SETUP:EXT_ATTENUATION_TYPE	120
SETUP:RF1_EXTATTENUATION?	120
SETUP:RF1_EXTATTENUATION	120
SETUP:RF2_EXTATTENUATION?	120
SETUP:RF2_EXTATTENUATION	120
<RX>:SETUP:INPUT?	120
<RX>:SETUP:INPUT	120
SETUP:REFERENCE:EXTREFERENCE?	121
SETUP:REFERENCE:SOURCE?	121
SETUP:REFERENCE:SOURCE	121
SETUP:TRIGGER_OUT_MODE?	122
SETUP:TRIGGER_OUT_MODE	122

GPSBAUDRATE?**GPSBAUDRATE** <BaudRate>**SETGPSBAUD** <BaudRate>

Defines and queries the currently used baud rate (or *signalling rate*) for the GPS signal.

Parameters:

<BaudRate> 4800 | 9600 | 19200 | 38400 | 57600 | 115200

Default unit: Bd

Manual operation: See "[Baud Rate](#)" on page 65

GETGPSSYNC**SETGPSSYNC** <SyncMethod>

Defines or queries the method of time synchronization.

Parameters:

<SyncMethod>

MESSAGE

Time synchronization on incoming messages

PPS

Time synchronization on PPS pulses

Manual operation: See "[Sync](#)" on page 65**SETUP:ANALOG_OUT_MODE?****SETUP:ANALOG_OUT_MODE** <Output>

Queries or defines the type of analog signal to be provided at the [ANALOG OUTPUT] connector on the rear panel of the R&S EDS300.

Parameters:

<Output>

RX_DEMOD

The demodulated baseband signal is output.

DET ENVELOPE

The peak detector envelope of the pulse signal is output.

DET_ID

The audio signal (detector envelope) of the ID is output (at 1350 Hz, audible Morse code).

DET_15HZ

The 15 Hz component in the peak detector envelope of the pulse signal is output.

Only available for TACAN analysis

DET_135HZ

The 135 Hz component in the peak detector envelope of the pulse signal is output.

Only available for TACAN analysis

Return values:

<SettingResult>

READY

Setting was successfully applied.

ERROR

An error occurred; setting was not successful.

Manual operation: See "[Analog Out](#)" on page 59See "[Speaker](#)" on page 98

SETUP:EXT_ATTENUATION_TYPE?**SETUP:EXT_ATTENUATION_TYPE** <Type>

Activates or deactivates external attenuation.

Parameters:

<Type>

NONE

No external attenuation is applied.

FIXED

A fixed attenuation is applied to the RF input from the receiver board (see [SETUP:RF2_EXTATTENUATION](#) on page 120). You can define a different attenuation level for each RF input connector.

Manual operation: See "[External Attenuation](#)" on page 58**SETUP:RF1_EXTATTENUATION?****SETUP:RF1_EXTATTENUATION** <Attenuation>**SETUP:RF2_EXTATTENUATION?****SETUP:RF2_EXTATTENUATION** <Attenuation>

Defines the fixed power level by which the signal at the RF input 1 or 2 is attenuated during the measurement (for [SETUP:EXT_ATTENUATION_TYPE](#) Fixed).

Parameters:

<Attenuation>

numeric value in dB

Range: -10 to +99

Manual operation: See "[Fixed External Attenuation for RF Input 1/2](#)" on page 58**<RX>:SETUP:INPUT?****<RX>:SETUP:INPUT** <InputSource>

Queries or defines the input source of the specified RX board

Parameters:

<InputSource>

INPUT_RF1

RF input from the "RF 1 IN" connector on the front panel of the R&S EDS300

INPUT_RF2

RF input from the "RF 2 IN" connector on the front panel of the R&S EDS300

INPUT_BBAND

Analog input from the [ANALOG IN] connector on the rear panel of the R&S EDS300

*RST: INPUT_RF1

Return values:

<SettingResult>

READY

Setting was successfully applied.

ERROR

An error occurred; setting was not successful.

Usage: Setting only

Manual operation: See "Input for RX Board 1" on page 57

SETUP:REFERENCE:EXTREFERENCE?

Queries the usage and state of a reference frequency at the [REF 10 MHz IN/OUT] connector of the R&S EDS300.

Return values:

<State>

Present

A 10 MHz reference signal is provided by an external device at the [REF 10 MHz IN/OUT] connector of the R&S EDS300.

Not present

No reference signal is available at the [REF 10 MHz IN/OUT] connector of the R&S EDS300. The internal 10 MHz reference signal is used for measurement with the R&S EDS300.

Output

The internal 10 MHz reference signal of the R&S EDS300 is provided as output to a device at the [REF 10 MHz IN/OUT] connector (for `SETUP:REFERENCE:SOURCE INTERN`).

*RST: Output

Usage: Query only

Manual operation: See "Ext. Reference" on page 61

SETUP:REFERENCE:SOURCE?

SETUP:REFERENCE:SOURCE <RefSource>

Queries or defines whether the [REF 10 MHz IN/OUT] connector on the rear panel of the R&S EDS300 is used for input or output.

Parameters:

<RefSource>

Intern

The internal reference frequency of the R&S EDS300 is provided as output to a device at the [REF 10 MHz IN/OUT] connector.

Extern

The R&S EDS300 uses the external reference frequency provided by another device at the [REF 10 MHz IN/OUT] connector.

Tip: The `SETUP:REFERENCE:EXTREFERENCE?` command queries the availability of a reference signal at the connector.

Return values:

<SettingResult>

READY

Setting was successfully applied.

ERROR

An error occurred; setting was not successful.

Manual operation: See "[Source](#)" on page 60

SETUP:TRIGGER_OUT_MODE?

SETUP:TRIGGER_OUT_MODE <OutputTrig>

Queries or defines the type of trigger signal to be provided at the [TRIGGER OUTPUT] connector on the rear panel of the R&S EDS300.

Parameters:

<OutputTrig>

PULSE_TRIGGER

For each measured DME pulse, a square pulse with the same pulse width is output synchronously.

PULSE_DECODED

For each measured DME pulse *pair* with the correct pulse code (=pulse spacing), a square pulse with a 1 µs pulse width is output.

INTERROG_TRIGGER

For each transmitted interrogator pulse pair, a square pulse with a 1 µs pulse width is output.

ID_CODE

A high signal is output during the ID transmission.

MRB_TRGGER

For each decoded MRB (main reference burst), a square pulse with a 1 µs pulse width is output.

Only available for TACAN analysis

ARB_TRIGGER

For each decoded ARB (auxiliary reference burst), a square pulse with a 1 µs pulse width is output.

Only available for TACAN analysis

MDME_SLOT

Each time the channel is switched, a square pulse with a 1 µs pulse width is output.

Only available for Multi-DME analysis

*RST: PULSE_TRIGGER

Return values:

<SettingResult>

READY

Setting was successfully applied.

ERROR

An error occurred; setting was not successful.

Manual operation: See "[Trigger Out Mode](#)" on page 59

11.5 Configuring measurements

- [Configuring the measurement mode](#)..... 123
- [DME measurements](#)..... 124
- [DME interrogator](#)..... 131
- [Pulse analysis](#)..... 136
- [Multi-DME measurements](#)..... 148

11.5.1 Configuring the measurement mode

<RX>:MEASMODE?	123
<RX>:MEASMODE_DME	123
<RX>:MEASMODE_MDME	123
<RX>:MEASMODE_PULSE	124

<RX>:MEASMODE?

Queries the current measuring mode

Return values:

<Mode>	MODE_DMETAC DME/TACAN measurement mode, see Chapter 6.1, "DME and TACAN measurement mode" , on page 38
	MODE_PULSE Pulse analysis mode, see Chapter 6.3, "Graphical pulse analysis" , on page 48

Usage: Query only

<RX>:MEASMODE_DME

Switches to the DME measurement mode (standard distance measurement, see [Chapter 6.1, "DME and TACAN measurement mode"](#), on page 38). Numeric signal parameters for a specific interrogator or transponder channel are determined. Simultaneous data logging of the measurement results is available.

Return values:

<SettingResult>	READY Setting was successfully applied.
	ERROR An error occurred; setting was not successful.

Usage: Setting only

<RX>:MEASMODE_MDME

Switches on the MDME measurement mode. Uses both RX boards. Requires MDME option.

For details see [Chapter 6.2, "Multi-DME measurements"](#), on page 47.

Return values:

<SettingResult> **READY**
Setting was successfully applied.

ERROR
An error occurred; setting was not successful.

Usage: Setting only

<RX>:MEASMODE_PULSE

Switches to pulse analysis mode (see [Chapter 6.3, "Graphical pulse analysis"](#), on page 48). Provides power levels at a specific interrogator or transponder channel frequency in a power vs. time diagram. Additional signal parameters are not determined; data logging is not available.

Return values:

<SettingResult> **READY**
Setting was successfully applied.

ERROR
An error occurred; setting was not successful.

Usage: Setting only

11.5.2 DME measurements

<RX>:DME:ATTMODE?	125
<RX>:DME:ATTMODE	125
<RX>:DME:FREQ?	125
<RX>:DME:FREQ	125
<RX>:DME:MEASTIME?	126
<RX>:DME:MEASTIME	126
<RX>:DME:DEMOD_BW?	126
<RX>:DME:DEMOD_BW	126
<RX>:DME:RFCH?	127
<RX>:DME:RFCH	127
<RX>:DME:RF_BW?	128
<RX>:DME:RF_BW	128
<RX>:DME:RXMODE?	128
<RX>:DME:RXMODE	128
RX?	128
SETRX	129
<RX>:DME:TRIG_IN_COUNT?	129
<RX>:DME:TRIG_IN_PERIOD?	129
<RX>:DME:TXFREQ?	129
<RX>:DME:TXFREQ	129
<RX>:DST:TX_PCODE	130
<RX>:DST:TXPULSE_WIDTH?	130
<RX>:DST:TXPULSE_WIDTH	130

<RX>:DME:ATTMODE?

<RX>:DME:ATTMODE <Mode>

This command defines the attenuation mode. The query returns the mode that was actually used for the current measurement.

The attenuation mode defines the sensitivity of the receiver board by selecting a different signal path for each mode (see [Figure 5-1](#)).

The following attenuation modes are provided (for DME and Pulse view measurements only):

Parameters:

<Mode>

LOW_NOISE

Provides a high sensitivity;

NORM

Provides a normal sensitivity;

LOW_DIST

Provides a low sensitivity

AUTO

The signal attenuation is selected automatically according to the signal strength in each slot (for DME measurements) or the user-defined power range (Pulse analysis).

*RST: AUTO

Return values:

<SettingResult>

READY

Setting was successfully applied.

ERROR

An error occurred; setting was not successful.

Example:

RX1:DME:ATTMODE LOW_DIST

Manual operation:

See "[Att.Mode](#)" on page 68

See "[Att.Mode](#)" on page 73

<RX>:DME:FREQ?

<RX>:DME:FREQ <RXFreq>

Queries or defines the receiver (RX) frequency of the DME channel to be measured.

A DME channel is uniquely identified by its channel number (+extension) and its receive frequency. Thus, if the receiver (RX) frequency is set to a different value, the channel number is automatically adapted according to the ICAO frequency list (see [Chapter B, "DME channel frequency list"](#), on page 167).

Parameters:

<RXFreq> numeric value
 Range: 960 MHz to 1215 MHz
 *RST: 962.0 MHz
 Default unit: MHz

Return values:

<SettingResult> **READY**
 Setting was successfully applied.
ERROR
 An error occurred; setting was not successful.

Manual operation: See "[Changing the receiver \(RX\) frequency](#)" on page 67

<RX>:DME:MEASTIME?

<RX>:DME:MEASTIME <Duration>

Queries or defines the time span in which the results are averaged. Each measurement is performed 130 times per second. For the minimum measurement time of 7 ms, only one measurement is performed, and no averaging takes place.

Parameters:

<Duration> numeric value
 Range: 7 ms to 10000 ms
 *RST: 500 ms
 Default unit: ms

Return values:

<SettingResult> **READY**
 Setting was successfully applied.
ERROR
 An error occurred; setting was not successful.

Manual operation: See "[Measurement Time](#)" on page 68

<RX>:DME:DEMOD_BW?

<RX>:DME:DEMOD_BW <Bandwidth>

Queries or defines the bandwidth of the digital filter used for DME measurement.

Parameters:

<Bandwidth> **NAR**
 Narrow filter for narrow pulses. Adjacent pulses or signal effects outside the pulse are not measured. Wider pulses can be distorted or cut off. Measurement time increases.

WIDE

Wide filter for wider pulses; entire pulse is measured without distortions. Adjacent pulses or signal effects outside the pulse are possibly included.

Return values:
<SettingResult>

READY

Setting was successfully applied.

ERROR

An error occurred; setting was not successful.

Manual operation: See "[Demodulation bandwidth Demod BW](#)" on page 70

<RX>:DME:RFCH?

<RX>:DME:RFCH <ChanNo>,<ChanExt>

Queries or defines the receiver (RX) channel for pulse detection. When defining the channel, the extension can also be provided.

A DME channel is uniquely identified by its channel number (+extension) and its receive frequency. Thus, if the receiver (RX) channel is set to a different number, the frequency is automatically adapted according to the ICAO frequency list (see [Chapter B](#), "[DME channel frequency list](#)", on page 167).

Parameters:

<ChanNo> integer
 Channel number
 Range: 1 to 126

Setting parameters:

<ChanExt> X | Y
 Channel extension

Return values:

<SettingResult>

READY

Setting was successfully applied.

ERROR

An error occurred; setting was not successful.

Example:

```
DME:RFCH 2,Y
DME:RFCH?
Result:
002
```

Manual operation: See "[Changing the receiver \(RX\) channel number](#)" on page 66

<RX>:DME:RF_BW?

<RX>:DME:RF_BW <Bandwidth>

Queries or defines the RF bandwidth of the receiver (IF2 bandwidth) for DME measurements. The demodulation bandwidth is not affected.

Parameters:

<Bandwidth>

500K
500 kHz bandwidth

10M
10 MHz bandwidth

Return values:

<SettingResult>

READY
Setting was successfully applied.

ERROR
An error occurred; setting was not successful.

Manual operation: See "[RF bandwidth \(RF BW\)](#)" on page 70

<RX>:DME:RXMODE?

<RX>:DME:RXMODE <SignalType>

Queries or defines the signal to be received and analyzed by the R&S EDS300, depending on the measurement task.

Parameters:

<SignalType>

REPLY
The signal transmitted by the DME ground station is measured.

INTERROG
A signal on the interrogator frequency is measured. In this case, the [RX frequency](#) is set to the transmit frequency (see [Table 6-1](#)).

*RST: REPLY

Return values:

<SettingResult>

READY
Setting was successfully applied.

ERROR
An error occurred; setting was not successful.

Manual operation: See "[Receiver \(RX\) Mode](#)" on page 69

RX?

Queries the active receiver board number (only useful if optional second receiver board is installed).

Tip: to change the active receiver board use [SETRX](#).

Return values:

<Board> RX:1 | RX:2

Usage: Query only

SETRX <BoardNo>

Activates a receiver board for measurement (useful only if optional second receiver board is installed). Only one board at a time can be active.

Parameters:

<BoardNo> 1 | 2

Return values:

<SettingResult> **READY**
Setting was successfully applied.
ERROR
An error occurred; setting was not successful.

Usage: Setting only

Manual operation: See "Input for RX Board 1" on page 57
See "Input from (optional) RX Board 2" on page 57

<RX>:DME:TRIG_IN_COUNT? <TrigCount>

Number of measured trigger events on external trigger input. Only single pulses are counted.

Parameters:

<TrigCount> numeric value
Number of pulses per capture time (1/s)
If no trigger is counted: 0

Usage: Query only

<RX>:DME:TRIG_IN_PERIOD? <Interval>

Interval in which trigger events are detected in external trigger input.

Parameters:

<Interval> numeric value
Interval in ms
If no trigger events are detected: inf

Usage: Query only

<RX>:DME:TXFREQ?

<RX>:DME:TXFREQ <TXFreq>

Queries or defines the interrogator frequency (see [Table 6-1](#)).

Parameters:

<TXFreq> numeric value
 Range: 960 MHz to 1215 MHz
 *RST: 1025 MHz
 Default unit: MHz

Return values:

<SettingResult> **READY**
 Setting was successfully applied.
ERROR
 An error occurred; setting was not successful.

Manual operation: See "[Interrogator Transmission \(TX\) frequency](#)" on page 68

<RX>:DST:TX_PCODE <InterrogPCode>

Defines the time between the 2 pulses of a DME double pulse code.

Parameters:

<InterrogPCode> numeric value
 Pulse code (spacing) of the interrogator pulses
 Range: 11 to 42
 Default unit: μ s

Usage: Setting only

Manual operation: See "[TX Pulse Code \(P.Code\)](#)" on page 68

<RX>:DST:TXPULSE_WIDTH?

<RX>:DST:TXPULSE_WIDTH <PWidth>

Defines or queries the width of the pulses the R&S EDS300 interrogator transmits to the ground station.

Parameters:

<PWidth> numeric value
 Width in μ s
 Range: 0.8 to 4.5

Return values:

<State> **READY.**
 The command was executed successfully.

Example:

```
DST:TXPULSE_WIDTH?
//Result: 3.5
DST:TXPULSE_WIDTH 4.2
//Result: READY.
DST:TXPULSE_WIDTH?
//Result: 4.2
```

Manual operation: See "[Interrogator Transmission \(TX\) Pulse Width](#)" on page 69

11.5.3 DME interrogator

<RX>:DST:DELAY_OFFSET?	131
<RX>:DST:DELAY_OFFSET	131
<RX>:DST:MEM_TIME?	131
<RX>:DST:MEM_TIME	131
<RX>:DST:MIN_REPLY_EFF?	132
<RX>:DST:MIN_REPLY_EFF	132
<RX>:DST:PRED_TYPE	132
<RX>:DST:PRR?	133
<RX>:DST:PRR	133
<RX>:DST:PULSE_SHAPE	133
<RX>:DST:SPULSES?	133
<RX>:DST:SPULSES	133
<RX>:DST:TPULSES?	134
<RX>:DST:TPULSES	134
<RX>:DST:TXON?	134
<RX>:DST:TXON	134
<RX>:DST:TXPOWER	135
SET_ICAO_OVR	135
SETEXPERT	135

<RX>:DST:DELAY_OFFSET?

<RX>:DST:DELAY_OFFSET <Offset>

Defines an offset to the delay between the transmission of the request pulse and the reply pulse.

This setting is useful to compensate for delay times caused by cable lengths, for example.

Parameters:

<Offset> numeric value
 Offset in μ s
 Range: -100 to +100

Return values:

<State> **READY.**
 The command was executed successfully.

Manual operation: See "[Delay Offset](#)" on page 63

<RX>:DST:MEM_TIME?

<RX>:DST:MEM_TIME <TrackTime>

Defines or queries the maximum time that the interrogator remains in memory mode. After this time, the next search mode is triggered. Define a period that is at least long enough to finalize ID transmission.

Parameters:

<TrackTime> numeric value
 Period in s
 Range: 0.1 to 50

Return values:

<State> **READY.**
 The command was executed successfully.

Manual operation: See "[Memory Time \(Tracking\)](#)" on page 62

<RX>:DST:MIN_REPLY_EFF?

<RX>:DST:MIN_REPLY_EFF <Value>

Defines or queries the minimum reply efficiency after which the interrogator switches between tracking, memory and search modes (see [Chapter 5.1, "Evaluating DME signals"](#), on page 35).

Smaller values are better for difficult receiving conditions.

Parameters:

<Value> numeric value
 Reply efficiency in percent
 Range: 20 to 99

Return values:

<State> **READY.**
 The command was executed successfully.

Manual operation: See "[Min. Reply Effic. \(Tracking\)](#)" on page 62

<RX>:DST:PRED_TYPE <Algorithm>

Defines the type of algorithm used to calculate the expected reply pulse.

During the search on a DME ground station, the time of arrival for the reply pulse is calculated from the relative speed between the DME ground station and the interrogator.

Parameters:

<Algorithm> **LINEAR**
 The time delay for the subsequent pulse is derived linearly from the previously measured delay.

STATIC
 The relative speed is assumed to be zero; the time delay for the subsequent pulse is thus calculated from the mean value of previous time delays. This setting is meant for fixed monitoring stations.

Manual operation: See "[Type of Prediction](#)" on page 62

<RX>:DST:PRR?**<RX>:DST:PRR** <SearchPRR>, <TrackPRR>

Defines or queries the pulse repetition rate (PRR) for the interrogator's search and track modes.

Note that if [SETEXPERT](#) on page 135 is disabled, a maximum of 150 pulses per second are possible for both parameters; see [Chapter 7.1.4, "Configuring DME interrogator signals"](#), on page 61.)

Parameters:

<SearchPRR>	integer
	Range: 5 to 6000
<TrackPRR>	integer
	Range: 5 to 6000

Return values:

<SettingResult>	READY Setting was successfully applied.
	ERROR An error occurred; setting was not successful.

Example: DST:PRR 100,10**Usage:** Setting only**Manual operation:** See ["PRR for Search Mode"](#) on page 70
See ["PRR for Track Mode"](#) on page 70

<RX>:DST:PULSE_SHAPE <Shape>

Defines the shape of the transmitted (TX) interrogator pulse, if enabled.

Parameters:

<Shape>	DME Gauss pulse with a rise and fall time of 2.5 μ s
	TAC Asymmetric Gauss pulse with a rise time of 2.0 μ s and a fall time of 2.7 μ s Only available for TACAN measurements, requires option R&S EDS300-K1.

Manual operation: See ["TX Pulse Shape"](#) on page 63

<RX>:DST:SPULSES?**<RX>:DST:SPULSES** <NoPulses>

Defines or queries the number of pulses for which the reply efficiency is calculated during search mode.

The larger the value, the more stable and accurate the results, but the weaker the performance of the interrogator.

Parameters:

<NoPulses> integer
 Range: 50 to 1000
 *RST: 250

Return values:

<SettingResult> **READY**
 Setting was successfully applied.
ERROR
 An error occurred; setting was not successful.

Manual operation: See "[Search Pulses](#)" on page 62

<RX>:DST:TPULSES?

<RX>:DST:TPULSES <NoPulses>

Defines or queries the number of pulses for which the reply efficiency is calculated during track mode.

The larger the value, the more stable and accurate the results, but the weaker the performance of the interrogator.

Parameters:

<NoPulses> integer
 Range: 25 to 100
 *RST: 50

Return values:

<SettingResult> **READY**
 Setting was successfully applied.
ERROR
 An error occurred; setting was not successful.

Manual operation: See "[Track Pulses](#)" on page 62

<RX>:DST:TXON?

<RX>:DST:TXON <State>

Queries or defines the state of the interrogator. If activated, the R&S EDS300 transmits interrogator pulses to the ground station with the specified pulse repetition rate (see [PRR for Search Mode/ PRR for Track Mode](#)).

Parameters:

<State> ON | OFF
ON
OFF
 *RST: OFF

Return values:

<SettingResult> **READY**
 Setting was successfully applied.

ERROR

An error occurred; setting was not successful.

Manual operation: See "[Transmitter \(TX\) State](#)" on page 68

<RX>:DST:TXPOWER <Power>

Defines the level at which the R&S EDS300 high-power interrogator transmits pulses to the ground station.

For low-power units, the power is fixed at 20 W (43 dBm).

Parameters:

<Power> 100W | 250W | 500W
Power in W

Return values:

<SettingResult> **READY**
Setting was successfully applied.

ERROR

An error occurred; setting was not successful.

SET_ICAO_OVR <State>**SETEXPERT <State>**

Enables or disables expert features which override the maximum pulse rates defined by the ICAO.

Setting parameters:

<State> ON | OFF
ON
Pulse rates of up to 6000 pulses per second are available
OFF
A maximum of 150 pulses per second are allowed for the first 30 seconds, then only 30 pulses per second are allowed.
*RST: OFF

Return values:

<SettingResult> **READY**
Setting was successfully applied.
ERROR
An error occurred; setting was not successful.

Usage: Setting only

Manual operation: See "[ICAO Override](#)" on page 63

11.5.4 Pulse analysis



The following commands are only available in Pulse mode, see <RX>:

[MEASMODE_PULSE](#) on page 124.

<RX>:PULSEVIEW:AVRG?	137
<RX>:PULSEVIEW:AVRG	137
<RX>:PULSEVIEW:BW?	137
<RX>:PULSEVIEW:BW	137
<RX>:PULSEVIEW:TIMEDIV?	138
<RX>:PULSEVIEW:TIMEDIV	138
<RX>:PULSEVIEW:TRACE?	138
<RX>:PULSEVIEW:TRACE	138
<RX>:PULSEVIEW:TRIGDELAY?	139
<RX>:PULSEVIEW:TRIGDELAY	139
<RX>:PULSEVIEW:TRIGDOUBLE?	139
<RX>:PULSEVIEW:TRIGDOUBLE	139
<RX>:PULSEVIEW:TRIGLEVRF_MV?	140
<RX>:PULSEVIEW:TRIGLEVRF_MV	140
<RX>:PULSEVIEW:TRIGMODE?	140
<RX>:PULSEVIEW:TRIGMODE	140
<RX>:PULSEVIEW:TRIGSLOPE?	141
<RX>:PULSEVIEW:TRIGSLOPE	141
<RX>:PULSEVIEW:TRIGSOURCE?	141
<RX>:PULSEVIEW:TRIGSOURCE	141
<RX>:PULSEVIEW:UNIT?	142
<RX>:PULSEVIEW:UNIT	142
<RX>:PULSEVIEW:YSCALE_DB_DIV?	142
<RX>:PULSEVIEW:YSCALE_DB_DIV	142
<RX>:PULSEVIEW:YSCALE_MV_DIV?	143
<RX>:PULSEVIEW:YSCALE_MV_DIV	143
<RX>:PULSEVIEW:YSCALE_MW_DIV?	143
<RX>:PULSEVIEW:YSCALE_MW_DIV	143
<RX>:PULSEVIEW:YSCALE_NW_DIV?	144
<RX>:PULSEVIEW:YSCALE_NW_DIV	144
<RX>:PULSEVIEW:YSCALE_PW_DIV?	144
<RX>:PULSEVIEW:YSCALE_PW_DIV	144
<RX>:PULSEVIEW:YSCALE_UV_DIV?	144
<RX>:PULSEVIEW:YSCALE_UV_DIV	144
<RX>:PULSEVIEW:YSCALE_UW_DIV?	145
<RX>:PULSEVIEW:YSCALE_UW_DIV	145
<RX>:PULSEVIEW:YSCALE_V_DIV?	145
<RX>:PULSEVIEW:YSCALE_V_DIV	145
<RX>:PULSEVIEW:YSCALE_MAXLEV_DBM?	146
<RX>:PULSEVIEW:YSCALE_MAXLEV_DBM	146
<RX>:PULSEVIEW:YSCALE_MAXLEV_MW?	146
<RX>:PULSEVIEW:YSCALE_MAXLEV_MW	146
<RX>:PULSEVIEW:YSCALE_MAXLEV_UW?	146

<RX>:PULSEVIEW:YSCALE_MAXLEV_UW.....	146
<RX>:PULSEVIEW:YSCALE_MAXLEV_NW?.....	147
<RX>:PULSEVIEW:YSCALE_MAXLEV_NW.....	147
<RX>:PULSEVIEW:YSCALE_MAXLEV_PW?.....	147
<RX>:PULSEVIEW:YSCALE_MAXLEV_PW.....	147
<RX>:PULSEVIEW:YSCALE_MAXLEV_V?.....	147
<RX>:PULSEVIEW:YSCALE_MAXLEV_V.....	147
<RX>:PULSEVIEW:YSCALE_MAXLEV_MV?.....	148
<RX>:PULSEVIEW:YSCALE_MAXLEV_MV.....	148
<RX>:PULSEVIEW:YSCALE_MAXLEV_UV?.....	148
<RX>:PULSEVIEW:YSCALE_MAXLEV_UV.....	148

<RX>:PULSEVIEW:AVRG?**<RX>:PULSEVIEW:AVRG** <NoPulses>

Queries or defines the number of pulses used as a basis for averaged results (see [<RX>:PULSEVIEW:TRACE](#) on page 138).

Parameters:

<NoPulses> integer
 Range: 1 to 100

Return values:

<SettingResult> **READY**
 Setting was successfully applied.

ERROR
 An error occurred; setting was not successful.

Example: PULSEVIEW:AVRG 10

Manual operation: See "[Average Count \(AVRG\)](#)" on page 73

<RX>:PULSEVIEW:BW?**<RX>:PULSEVIEW:BW** <Bandwidth>

Queries or defines the bandwidth of the digital filter used during pulse measurement.

Parameters:

<Bandwidth> **NAR**
 Narrow filter (0.5 MHz)
 Suppresses adjacent channels, distorts the pulse shape for wider pulses.

WIDE
 Wide filter (10 MHz)
 For wider pulses. Entire pulse is measured without distortions.
 Adjacent pulses or signal effects outside the pulse possibly included.

Return values:

<SettingResult> **READY**
 Setting was successfully applied.

ERROR

An error occurred; setting was not successful.

Manual operation: See "[Demodulation bandwidth \(Demod BW\)](#)" on page 75

<RX>:PULSEVIEW:TIMEDIV?

<RX>:PULSEVIEW:TIMEDIV <Time>

Queries or defines the time per division, that is: the scaling of the x-axis, which consists of 10 divisions

Parameters:

<Time> 0.5 | 1 | 2 | 5 | 10 | 20 | 50

Default unit: μ s

Return values:

<SettingResult>

READY

Setting was successfully applied.

ERROR

An error occurred; setting was not successful.

Manual operation: See "[X-axis Scaling \(Time/Div\)](#)" on page 72

<RX>:PULSEVIEW:TRACE?

<RX>:PULSEVIEW:TRACE <Mode>

Queries or defines the trace mode, that is: the update mode for subsequent pulses (or pulse pairs)

Parameters:

<Mode> CLRWR | AVRG | MAXHOLD

CLRWR

Clear/write: the pulse (pair) is overwritten by each new pulse (pair).

AVRG

The average is formed over several measurements. How many measurements are averaged is defined by the **<RX>:PULSEVIEW:AVRG** command.

As soon as the required number of pulses have been acquired, the display is updated after each sweep, averaging the specified number of previous pulses.

As soon as the required number of pulses have been acquired, the display is updated after each sweep, averaging the specified number of previous pulses.

MAXHOLD

The maximum value is determined over all previously measured pulses (pairs) and displayed. The R&S EDS300 saves each trace point in the trace memory only if the new value is greater than the previous one.

*RST: CLRWR

Return values:

<SettingResult>

READY

Setting was successfully applied.

ERROR

An error occurred; setting was not successful.

Manual operation: See ["Trace Mode"](#) on page 73

<RX>:PULSEVIEW:TRIGDELAY?**<RX>:PULSEVIEW:TRIGDELAY <Time>**

Queries or defines the trigger delay.

The valid delay times depend on the x-axis scaling (see [<RX>:PULSEVIEW:TIMEDIV?](#) on page 138). A delay outside the displayed time range is not possible.

Parameters:

<Time> time
 Range: -20 us (for 0.5 us per div) to 320 us (for 50 us per div)
 Default unit: μ s

Return values:

<SettingResult>

READY

Setting was successfully applied.

ERROR

An error occurred; setting was not successful.

Manual operation: See ["Trigger Delay"](#) on page 76

<RX>:PULSEVIEW:TRIGDOUBLE?**<RX>:PULSEVIEW:TRIGDOUBLE <State>**

Queries or defines the behavior of the R&S EDS300 after a single trigger.

Parameters:

<State> ON | OFF
ON
 Triggering only occurs when a double pulse, that is: a pulse pair is detected. Single pulses are not displayed or evaluated.
OFF
 Each individual pulse that fulfills the trigger conditions is displayed and evaluated.
 *RST: OFF

Return values:

<SettingResult>

READY

Setting was successfully applied.

ERROR

An error occurred; setting was not successful.

Manual operation: See ["Trigger Double"](#) on page 76

<RX>:PULSEVIEW:TRIGLEVRF_MV?**<RX>:PULSEVIEW:TRIGLEVRF_MV <Level>**

Queries or defines the RF trigger level. The valid value range depends on the selected y-axis unit for the power axis (see **<RX>:PULSEVIEW:UNIT** on page 142).

- V: 0 μ V to 2 V
- W: 0 mW to 80 mW
- dBm: -121 dBm to 19 dBm

Parameters:**<Level>** numeric value**Return values:****<SettingResult>****READY**

Setting was successfully applied.

ERROR

An error occurred; setting was not successful.

Example:

```
PULSEVIEW:UNIT V
PULSEVIEW:TRIGLEVRF_MV 1V
```

Manual operation: See "[Trigger Level](#)" on page 76**<RX>:PULSEVIEW:TRIGMODE?****<RX>:PULSEVIEW:TRIGMODE <Mode>**

Queries or defines the trigger mode which determines the behavior of the instrument if no trigger occurs.

Parameters:**<Mode>** NORMAL | SINGLE | AUTO**AUTO**

The instrument triggers automatically after a time interval if the trigger conditions are not fulfilled. If a real trigger occurs, a new measurement is started immediately. This mode helps you see the waveform even before the trigger conditions are set correctly. The waveform on the screen is not synchronized, and successive waveforms are not triggered at the same point of the waveform. The time interval depends on the time base settings.

NORMAL

The instrument acquires a waveform only if a trigger occurs, that is, if all trigger conditions are fulfilled. If no trigger occurs, no waveform is acquired and the last acquired waveform is displayed. If no waveform was captured before, none is displayed. When no trigger has been found for longer than one second, a message box appears that shows the time elapsed since the last trigger.

SINGLE

The instrument performs a single sweep when you select the [ENTER] key and the trigger conditions are fulfilled. Each new sweep must be started manually.

Return values:
<SettingResult>

READY

Setting was successfully applied.

ERROR

An error occurred; setting was not successful.

Manual operation: See "[Trigger Mode](#)" on page 75

<RX>:PULSEVIEW:TRIGSLOPE?

<RX>:PULSEVIEW:TRIGSLOPE <Slope>

Queries or defines the trigger slope.

Parameters:

<Slope>

POS

Triggering occurs when the signal rises to the trigger level (positive slope).

NEG

Triggering occurs when the signal falls down to the trigger level (negative slope).

Return values:

<SettingResult>

READY

Setting was successfully applied.

ERROR

An error occurred; setting was not successful.

Manual operation: See "[Trigger Slope](#)" on page 75

<RX>:PULSEVIEW:TRIGSOURCE?

<RX>:PULSEVIEW:TRIGSOURCE <Source>

Queries or defines the trigger source.

Parameters:

<Source>

LEVEL

The measured input signal

EXTERN

An external trigger signal provided by a device connected to the [trigger in] connector on the rear panel of the R&S EDS300

INTERROG

The pulses sent by the R&S EDS300 interrogator

TAC_MRB

The TACAN main reference burst (if available)

TAC_ARB

The TACAN auxiliary reference burst (if available)

DME_PULSE

A detected DME double pulse

Return values:

<SettingResult>

READY

Setting was successfully applied.

ERROR

An error occurred; setting was not successful.

Manual operation: See "[Trigger Source](#)" on page 76**<RX>:PULSEVIEW:UNIT?****<RX>:PULSEVIEW:UNIT <Unit>**

Queries or defines the unit for power values in the Pulse view.

Parameters:

<Unit> DBM | MW | UW | NW | PW | V | MV | UV

DBM

dBm

MW

mW

UW

μW

NW

nW

PW

pW

V

Volt

MV

mV

UV

μV

Return values:

<SettingResult>

READY

Setting was successfully applied.

ERROR

An error occurred; setting was not successful.

Manual operation: See "[Y-axis Unit](#)" on page 72**<RX>:PULSEVIEW:YSCALE_DB_DIV?****<RX>:PULSEVIEW:YSCALE_DB_DIV <Scaling>**

Power range in dB per division; defines the scaling of the y-axis, which consists of 10 divisions.

Parameters:

<Scaling> 1 | 2 | 3 | 5 | 10

Return values:

<SettingResult>

READY

Setting was successfully applied.

ERROR

An error occurred; setting was not successful.

Manual operation: See "[Y-axis Scaling \(<Unit>/Div\)](#)" on page 72

<RX>:PULSEVIEW:YSCALE_MV_DIV?

<RX>:PULSEVIEW:YSCALE_MV_DIV <Scaling>

Power range per division; defines the scaling of the y-axis, which consists of 10 divisions.

Parameters:

<Scaling> 0.1 | 0.2 | 0.3 | 0.5 | 1 | 2 | 3 | 5 | 10 | 20 | 30 | 50 | 100

Default unit: mV

Return values:

<SettingResult>

READY

Setting was successfully applied.

ERROR

An error occurred; setting was not successful.

Example:

```
PULSEVIEW:UNIT MV
//Result: READY.
PULSEVIEW:YSCALE_MV_DIV 2
//Result: READY.
PULSEVIEW:YSCALE_MAXLEV_MV 20
//Result: READY.
```

Manual operation: See "[Y-axis Scaling \(<Unit>/Div\)](#)" on page 72

<RX>:PULSEVIEW:YSCALE_MW_DIV?

<RX>:PULSEVIEW:YSCALE_MW_DIV <Scaling>

Power range per division; defines the scaling of the y-axis, which consists of 10 divisions.

Parameters:

<Scaling> 0.1 | 0.2 | 0.3 | 0.5 | 1 | 2 | 3 | 5 | 10 | 20

Default unit: mW

Return values:

<SettingResult>

READY

Setting was successfully applied.

ERROR

An error occurred; setting was not successful.

Example:

```
PULSEVIEW:UNIT MW
//Result: READY.
PULSEVIEW:YSCALE_MW_DIV 0:5
//Result: READY.
PULSEVIEW:YSCALE_MAXLEV_MW 5
//Result: READY.
```

Manual operation: See "[Y-axis Scaling \(<Unit>/Div\)](#)" on page 72

<RX>:PULSEVIEW:YSCALE_NW_DIV?
<RX>:PULSEVIEW:YSCALE_NW_DIV <Scaling>

Power range per division; defines the scaling of the y-axis, which consists of 10 divisions.

Parameters:

<Scaling> 0.1 | 0.2 | 0.3 | 0.5 | 1 | 2 | 3 | 5 | 10 | 20 | 30 | 50 | 100
 Default unit: nW

Return values:

<SettingResult> **READY**
 Setting was successfully applied.
ERROR
 An error occurred; setting was not successful.

Manual operation: See "[Y-axis Scaling \(<Unit>/Div\)](#)" on page 72

<RX>:PULSEVIEW:YSCALE_PW_DIV?
<RX>:PULSEVIEW:YSCALE_PW_DIV <Scaling>

Power range per division; defines the scaling of the y-axis, which consists of 10 divisions.

Parameters:

<Scaling> 0.1 | 0.2 | 0.3 | 0.5 | 1 | 2 | 3 | 5 | 10 | 20 | 30 | 50 | 100
 Default unit: pW

Return values:

<SettingResult> **READY**
 Setting was successfully applied.
ERROR
 An error occurred; setting was not successful.

Manual operation: See "[Y-axis Scaling \(<Unit>/Div\)](#)" on page 72

<RX>:PULSEVIEW:YSCALE_UV_DIV?
<RX>:PULSEVIEW:YSCALE_UV_DIV <Scaling>

Power range per division; defines the scaling of the y-axis, which consists of 10 divisions.

Parameters:

<Scaling> 1 | 2 | 3 | 5 | 10 | 20 | 30 | 50 | 100
 Default unit: μV

Return values:

<SettingResult> **READY**
 Setting was successfully applied.
ERROR
 An error occurred; setting was not successful.

Manual operation: See "[Y-axis Scaling \(<Unit>/Div\)](#)" on page 72

<RX>:PULSEVIEW:YSCALE_UW_DIV?

<RX>:PULSEVIEW:YSCALE_UW_DIV <Scaling>

Power range per division; defines the scaling of the y-axis, which consists of 10 divisions.

Parameters:

<Scaling> 0.1 | 0.2 | 0.3 | 0.5 | 1 | 2 | 3 | 5 | 10 | 20 | 30 | 50 | 100
 Default unit: μW

Return values:

<SettingResult> **READY**
 Setting was successfully applied.
ERROR
 An error occurred; setting was not successful.

Manual operation: See "[Y-axis Scaling \(<Unit>/Div\)](#)" on page 72

<RX>:PULSEVIEW:YSCALE_V_DIV?

<RX>:PULSEVIEW:YSCALE_V_DIV <Scaling>

Power range per division; defines the scaling of the y-axis, which consists of 10 divisions.

Parameters:

<Scaling> 0.1 | 0.2 | 0.3 | 0.5 | 1
 Default unit: V

Return values:

<SettingResult> **READY**
 Setting was successfully applied.
ERROR
 An error occurred; setting was not successful.

Manual operation: See "[Y-axis Scaling \(<Unit>/Div\)](#)" on page 72

<RX>:PULSEVIEW:YSCALE_MAXLEV_DBM?

<RX>:PULSEVIEW:YSCALE_MAXLEV_DBM <Scaling>

The maximum power level on the y-axis.

Parameters:

<Range> Range: -70 to +30
 Default unit: dBm

Return values:

<SettingResult> **READY**
 Setting was successfully applied.

ERROR
 An error occurred; setting was not successful.

Manual operation: See "[Y-axis Range \(Max. Lev\)](#)" on page 72

<RX>:PULSEVIEW:YSCALE_MAXLEV_MW?

<RX>:PULSEVIEW:YSCALE_MAXLEV_MW <Scaling>

The maximum power level on the y-axis.

Parameters:

<Range> Range: 1.0 to 200
 Default unit: mW

Return values:

<SettingResult> **READY**
 Setting was successfully applied.

ERROR
 An error occurred; setting was not successful.

Manual operation: See "[Y-axis Range \(Max. Lev\)](#)" on page 72

<RX>:PULSEVIEW:YSCALE_MAXLEV_UW?

<RX>:PULSEVIEW:YSCALE_MAXLEV_UW <Scaling>

The maximum power level on the y-axis.

Parameters:

<Range> Range: 1.0 to 1000
 Default unit: μ W

Return values:

<SettingResult> **READY**
 Setting was successfully applied.

ERROR
 An error occurred; setting was not successful.

Manual operation: See "[Y-axis Range \(Max. Lev\)](#)" on page 72

<RX>:PULSEVIEW:YSCALE_MAXLEV_NW?

<RX>:PULSEVIEW:YSCALE_MAXLEV_NW <Range>

The maximum power level on the y-axis.

Parameters:

<Range> Range: 1.0 to 1000
 Default unit: nW

Return values:

<SettingResult> **READY**
 Setting was successfully applied.

ERROR
 An error occurred; setting was not successful.

Manual operation: See "[Y-axis Range \(Max. Lev\)](#)" on page 72

<RX>:PULSEVIEW:YSCALE_MAXLEV_PW?

<RX>:PULSEVIEW:YSCALE_MAXLEV_PW <Range>

The maximum power level on the y-axis.

Parameters:

<Range> Range: 1.0 to 1000
 Default unit: pW

Return values:

<SettingResult> **READY**
 Setting was successfully applied.

ERROR
 An error occurred; setting was not successful.

Manual operation: See "[Y-axis Range \(Max. Lev\)](#)" on page 72

<RX>:PULSEVIEW:YSCALE_MAXLEV_V?

<RX>:PULSEVIEW:YSCALE_MAXLEV_V <Scaling>

The maximum power level on the y-axis.

Parameters:

<Range> Range: 1.0 to 10.0
 Default unit: V

Return values:

<SettingResult> **READY**
 Setting was successfully applied.

ERROR
 An error occurred; setting was not successful.

Manual operation: See "[Y-axis Range \(Max. Lev\)](#)" on page 72

<RX>:PULSEVIEW:YSCALE_MAXLEV_MV?

<RX>:PULSEVIEW:YSCALE_MAXLEV_MV <Scaling>

The maximum power level on the y-axis.

Parameters:

<Range> Range: 1.0 to 1000
 Default unit: mV

Return values:

<SettingResult> **READY**
 Setting was successfully applied.

ERROR
 An error occurred; setting was not successful.

Manual operation: See "Y-axis Range (Max. Lev)" on page 72

<RX>:PULSEVIEW:YSCALE_MAXLEV_UV?

<RX>:PULSEVIEW:YSCALE_MAXLEV_UV <Scaling>

The maximum power level on the y-axis.

Parameters:

<Range> Range: 10 to 1000
 Default unit: μV

Return values:

<SettingResult> **READY**
 Setting was successfully applied.

ERROR
 An error occurred; setting was not successful.

Manual operation: See "Y-axis Range (Max. Lev)" on page 72

11.5.5 Multi-DME measurements

Useful commands for retrieving results described elsewhere:

- [<RX>:MDME:STREAMCFG](#) on page 150
- [<RX>:MDMEDATA?](#) on page 150

Remote commands exclusive to Multi-DME measurements

<RX>:MDME:ATTMODE	148
<RX>:MDME:AVRG	149
<RX>:MDME:CH	149

<RX>:MDME:ATTMODE

Set the MDME attenuation mode

Parameters:
MultiDMEMode LOW_NOISE | NORM | LOW_DIST | AUTO

Return values:
<SettingResult> **READY**
Setting was successfully applied.
ERROR
An error occurred; setting was not successful.

Usage: Setting only

<RX>:MDME:AVRG

Activation / deactivation of the average function.

Parameters:
ActDeactAverage ON | OFF

Return values:
<SettingResult> **READY**
Setting was successfully applied.
ERROR
An error occurred; setting was not successful.

Usage: Setting only

<RX>:MDME:CH

Configure one Multi-DME Slot.

Parameters:
ConfigMultiSlot Slot 1..10 Channel Nr X/Y TX enable ONOFF

Return values:
<SettingResult> **READY**
Setting was successfully applied.
ERROR
An error occurred; setting was not successful.

Usage: Setting only

11.6 Retrieving results

- [Streaming measurement results](#)..... 150
- [DME measurements](#)..... 153
- [TACAN measurements](#)..... 157
- [Pulse analysis results](#).....160

11.6.1 Streaming measurement results

These results can also be stored to a connected USB memory device, simultaneously to the running measurement. In this case, data is stored continuously for all measurements that are performed after logging is started and until it is stopped. For details see [Chapter 8.2, "Logging measurement data"](#), on page 81.

<RX>:MDMEDATA?	150
<RX>:MDME:STREAMCFG	150
<RX>:MEASDATA?	150
<RX>:MEASDEF?	151
SETUSBLOGTIME	151
SETUSBLOGMODE	151
SETSTREAMTRG	152
<RX>:STOPSTREAM	152
<RX>:STREAM	153

<RX>:MDMEDATA?

Queries a single dataset of one slot in MDME mode.

Parameters:

DatasetSlot Dataset definition Slot 1 ... 10

Return values:

Result string

Usage: Query only

<RX>:MDME:STREAMCFG

Select MDME Slots for streaming; Only selected slots are streamed out

Parameters:

MultiDMESlots Slots 1..10, separated by ; (default:1;2;3;4;5;6; 7;8;9;10)

Return values:

<SettingResult> **READY**
Setting was successfully applied.

ERROR

An error occurred; setting was not successful.

Usage: Setting only

<RX>:MEASDATA? <ListType>

This command returns the contents of one line in the logged data as a comma-separated list.

For details on the returned values, see the [Chapter C, "Format description of DME measurement data"](#), on page 183.

Setting parameters:

<ListType> FULL | FULL2 | FULL3 | SHORT | DST | TAC3 | TAC2 | TAC
 For a description of the list types, see [Table C-1](#).
 *RST: FULL3

Usage: Query only

<RX>:MEASDEF? <ListType>

This command returns the description of the contents of one line in the streamed data. The result can be used as a header row for a result table, for example.

For details on the returned values, see the [Chapter C, "Format description of DME measurement data"](#), on page 183.

Setting parameters:

<ListType> FULL | FULL2 | FULL3 | SHORT | DST | TAC3 | TAC2 | TAC
 For a description of the list types, see [Table C-1](#).
 *RST: FULL3

Return values:

Result <{string}>

Example: MEASDEF? FULL3
 Returns the header row for a complete table of streamed data.

Usage: Query only

SETUSBLOGTIME <Interval>

Set the minimum time interval between 2 measurements logged on USB.

Parameters:

<Interval> numeric value
 Interval in ms
 Range: 0 to 3600000

Example: Set the log interval to once per second.
 SETUSBLOGTIME 1000
 //Result: READY.

Manual operation: See "[START]" on page 81

SETUSBLOGMODE <Mode>

Defines how often a new log file is created.

Parameters:

<Mode> **SINGLE**
 All log data is saved in a single file.
HOURLY
 A new file is created every hour.

DAY

A new file is created every day.

Manual operation: See "[START]" on page 81

SETSTREAMTRG <TriggerType>

Determines when a line of the data stream is triggered.

Only for single DME.

Parameters:

<TriggerType> MEAS | PULSE | BOTH

MEAS

Data stream is initiated by a measurement.

The data is output in equidistant time intervals, depending on the measurement time (see also [Chapter 8.2, "Logging measurement data"](#), on page 81).

PULSE

Data stream is initiated by an outgoing interrogator pulse (status flag P, see [Chapter C, "Format description of DME measurement data"](#), on page 183). The data is output in intervals equivalent to the TX pulse rate.

BOTH

Both a measurement and an interrogator pulse initiate a data stream. The data is not necessarily output in regular intervals, depending on when pulses occur in relation to the measurement time.

*RST: BOTH

Return values:

<SettingResult>

READY

Setting was successfully applied.

ERROR

An error occurred; setting was not successful.

Usage:

Setting only

<RX>:STOPSTREAM

This command stops the data stream.

Return values:

<EventResult>

READY

Command was executed successfully.

ERROR

An error occurred; command was not successful.

Usage:

Event

Manual operation: See "[STOP]" on page 81

<RX>:STREAM <ListType>

This command enables the R&S EDS300 to start sending a data stream to the remote control device as soon as the trigger event occurs (see [SETSTREAMTRG](#) on page 152). The data stream contains the results of the specified channel and time slots. The data stream continues until the [<RX>:STOPSTREAM](#) command is executed.

Which parameters are contained in which list type is indicated in detail in [Chapter C, "Format description of DME measurement data"](#), on page 183.

Setting parameters:

<ListType> FULL | FULL2 | FULL3 | SHORT | DST | TAC3 | TAC2 | TAC
 For a description of the list type, see [Table C-1](#).
 *RST: FULL3

Usage: Event

Manual operation: See "[\[START\]](#)" on page 81

11.6.2 DME measurements

Useful commands for retrieving results described elsewhere:

- [Chapter 11.5.3, "DME interrogator"](#), on page 131

Remote commands exclusive to retrieving results:

<RX>:DST:REPEFF?	153
<RX>:DST:SOT?	154
<RX>:DME:AVRGLEVEL?	154
<RX>:DME:CARRIER_F_DELTA?	154
<RX>:DME:ID_CODE?	154
<RX>:DME:ID_PRR?	154
<RX>:DME:ID_SEQLEN?	155
<RX>:DME:PEAKLEVEL?	155
<RX>:DME:PULSE_REPT_RATE?	155
<RX>:DME:PULSE_SPACING?	155
<RX>:DME:RFCH_PS?	155
<RX>:DST:DELAY?	156
<RX>:DST:DST?	156
GETNRPPOW	157

<RX>:DST:REPEFF?

Queries the current reply efficiency in %.

Return values:

<Result> numeric value
 Default unit: %

Usage: Query only

Manual operation: See "[REPLY EFFIC. \[%\]](#)" on page 43

<RX>:DST:SOT?

Queries the search or track status. For details see [Chapter 5.1, "Evaluating DME signals"](#), on page 35.

Return values:

Result SEARCH | TRACK | MEMORY | INACTIVE

Usage: Query only

Manual operation: See "[SEARCH/TRACK](#)" on page 43

<RX>:DME:AVRGLEVEL?

Returns the average measured level of the received signal

Return values:

<Result> Default unit: dBm

Usage: Query only

Manual operation: See "[AVRG.LEVEL \[dBm\]](#)" on page 41

<RX>:DME:CARRIER_F_DELTA?

Returns the measured carrier frequency deviation relative to the defined channel frequency

Return values:

<Result> Default unit: kHz

Usage: Query only

Manual operation: See "[CARRIER_FREQ_DELTA \[kHz\]](#)" on page 42

<RX>:DME:ID_CODE?

Returns the Morse-decoded ID.

Return values:

<Result>

Usage: Query only

Manual operation: See "[ID-CODE](#)" on page 42

<RX>:DME:ID_PRR?

Returns the pulse repetition rate during ID transmissions

Return values:

<Result> Default unit: 1/s

Usage: Query only

Manual operation: See "[ID_PRR \[1/s\]](#)" on page 42

<RX>:DME:ID_SEQLEN?

Returns the length of an individual ID sequence.

Return values:

<Result> Length in ms

Usage: Query only

<RX>:DME:PEAKLEVEL?

Returns the peak measured level of the received signal

Return values:

<Result> Default unit: dBm

Usage: Query only

Manual operation: See "[PEAKLEVEL \[dBm\]/\[W\]](#)" on page 41

<RX>:DME:PULSE_REPT_RATE?

Returns the measured pulse repetition rate of the DME signal, i.e. number of interrogator/reply pulse (pairs) per second

Return values:

<Result> Default unit: 1/s

Usage: Query only

Manual operation: See "[PULSE REPETITION RATE \[1/s\]](#)" on page 42

<RX>:DME:PULSE_SPACING?

Returns the measured pulse spacing in us (corresponds to the pulse code as specified in the [Chapter B, "DME channel frequency list"](#), on page 167).

Return values:

<PCode> integer
Range: 11 to 42
Default unit: μ s

Usage: Query only

Manual operation: See "[PULSE SPACING \[\$\mu\$ s\]](#)" on page 42

<RX>:DME:RFCH_PS?

Returns the RF channel and the pulse spacing used for the DME measurement (according to the ICAO frequency list, see [Chapter B, "DME channel frequency list"](#), on page 167).

Return values:

<ChannelNo>	integer using 3 digits Channel number Range: 000 to 126
<ChannelExt>	X Y Channel extension
<ReplyPulseCode>	integer Pulse code (spacing) of the reply pulses Range: 11 to 42 Default unit: μs
<InterrogPCode>	Pulse code (spacing) of the interrogator pulses Range: 11 to 42 Default unit: μs

Example:

001Y-30-36
DME channel 1Y with reply pulse code 30 and interrogator pulse code 36

Usage: Query only

Manual operation: See "[Changing the receiver \(RX\) channel number](#)" on page 66
See "[RX Pulse Code \(P.Code\)](#)" on page 67
See "[TX Pulse Code \(P.Code\)](#)" on page 68

<RX>:DST:DELAY?

Queries the measured reply pulse delay, that is: the delay time between the interrogator and reply pulse, including the ground station delay (50 μs for X channels / 56 μs for Y channels)

Return values:

<Result> numeric value
Default unit: μs

Usage: Query only

Manual operation: See "[DELAY \[\$\mu\text{s}\$ \]](#)" on page 43

<RX>:DST:DST?

Queries the measured distance of the interrogator (aircraft) from the ground station.

Return values:

<Result> numeric value
Default unit: m

Usage: Query only

Manual operation: See "[DISTANCE \[km\]](#)" on page 43
See "[DISTANCE \[NM\]](#)" on page 43

GETNRPPOW

Returns the average and peak power levels from a connected power sensor.

Return values:

<AvgPower>	Average power Default unit: dBm
<PeakPower>	Peak power Default unit: dBm

Manual operation: See "[NRP AVR/NRP PEAK](#)" on page 41

11.6.3 TACAN measurements

<RX>:TACAN:BEARING?	157
<RX>:TACAN:FREQ_135HZ?	157
<RX>:TACAN:FREQ_15HZ?	157
<RX>:TACAN:MOD_DEPTH_135HZ?	158
<RX>:TACAN:MOD_DEPTH_15HZ?	158
<RX>:TACAN:PHASE_135HZ?	158
<RX>:TACAN:PHASE_15HZ?	158
<RX>:TACAN:PHASE_SHIFT?	159
<RX>:TACAN:SET_DMESCREEN_PAGE	159
<RX>:DME:SET_VIEW	159

<RX>:TACAN:BEARING?

Direction of the ground station in relation to the R&S EDS300.

Return values:

<Result>	Default unit: degrees
----------	-----------------------

Usage: Query only

Manual operation: See "[BEARING \[°\]](#)" on page 42
See "[BEARING \[°\]](#)" on page 46

<RX>:TACAN:FREQ_135HZ?

Returns the measured frequency of the nominal 135 Hz components

Return values:

<Result>	Default unit: Hz
----------	------------------

Usage: Query only

Manual operation: See "[FREQ 135Hz \[Hz\]](#)" on page 46

<RX>:TACAN:FREQ_15HZ?

Returns the measured frequency of the nominal 15 Hz components

Return values:

<Result> Default unit: Hz

Usage: Query only

Manual operation: See "[FREQ 15Hz \[Hz\]](#)" on page 46

<RX>:TACAN:MOD_DEPTH_135HZ?

Returns the measured modulation depth of the 135 Hz signal

Return values:

<Result> Default unit: percent

Usage: Query only

Manual operation: See "[MOD.DEPTH 135Hz \[%\]](#)" on page 45

<RX>:TACAN:MOD_DEPTH_15HZ?

Returns the measured modulation depth of the 15 Hz signal

Return values:

<Result> Default unit: percent

Usage: Query only

Manual operation: See "[MOD.DEPTH 15Hz \[%\]](#)" on page 45

<RX>:TACAN:PHASE_135HZ?

Returns the measured phase of the 135 Hz components compared to the ARB, divided by 9.

Return values:

<Result> Range: 0 to 40 (360/9)
Default unit: degrees

Usage: Query only

Manual operation: See "[PHASE 135Hz \[°/9\]](#)" on page 46

<RX>:TACAN:PHASE_15HZ?

Returns the measured phase of the 15 Hz components compared to the MRB

Return values:

<Result> Default unit: degrees

Usage: Query only

Manual operation: See "[PHASE 15Hz \[°\]](#)" on page 46

<RX>:TACAN:PHASE_SHIFT?

Returns the measured phase shift between the 15 Hz and 135 Hz components

Return values:

<Result> Range: 0 to 40
 Default unit: degrees

Usage: Query only

Manual operation: See "[PHASE SHIFT \[°\]](#)" on page 46

<RX>:TACAN:SET_DMESCREEN_PAGE <Page>

Switches the displayed window between the TACAN and DME measurement results.

This command is only available for TACAN measurements.

Note that this command is maintained for compatibility reasons only. Use **<RX>:DME:SET_VIEW** for new remote control programs.

Parameters:

<Page> **DMESCREENPAGE_DME**
 DME measurement results
DMESCREENPAGE_TAC1
 TACAN measurement results (page 1)
 (TACAN only, requires option R&S EDS300-K1)
DMESCREENPAGE_TAC2
 TACAN measurement results (page 2)
DMESCREENPAGE_MAINT
 ID Analysis results
 (TACAN only, requires option R&S EDS300-K1)

Return values:

<SettingResult> **READY**
 Setting was successfully applied.
ERROR
 An error occurred; setting was not successful.

Usage: Setting only

<RX>:DME:SET_VIEW <View>

Switches the displayed window between the different TACAN measurement results as described in [Chapter 6, "Measurements and results"](#), on page 38.

This command is only available for TACAN measurements.

Parameters:

<View> **DME**
 DME measurement results

TAC1

TACAN measurement results (page 1)
(TACAN only, requires option R&S EDS300-K1)

TAC2

TACAN measurement results (page 2)

ID

ID Analysis results
(TACAN only, requires option R&S EDS300-K1)

Return values:

<SettingResult>

READY

Setting was successfully applied.

ERROR

An error occurred; setting was not successful.

Usage:

Setting only

Manual operation: See "View" on page 69

11.6.4 Pulse analysis results

Pulse mode is meant for graphical analysis; data streaming and data logging is not available. However, the measured power values can be queried remotely.

<RX>:PULSEVIEW:DATASET?.....	160
<RX>:PULSEVIEW:ANALYSIS?.....	161

<RX>:PULSEVIEW:DATASET?

Returns the measured power values from the power vs time diagram ("Pulse" view).

Return values:

<Result>

comma-separated list of numeric values

The number of values depends on the x-axis scaling (see <RX>:PULSEVIEW:TIMEDIV on page 138) of the diagram:

For scaling between 2 μ s/div and the maximum of 50 μ s/div, all 2000 internally captured measurement points are returned.

For a scaling of 1 μ s/div, only the first 1000 internally captured measurement points are returned.

For a scaling of 0.5 μ s/div, only the first 500 internally captured measurement points are returned.

The unit of the power levels is always dBm, regardless of the <RX>:PULSEVIEW:UNIT setting.

<State>

READY.

The command was executed successfully.

Example: PULSEVIEW:TIMEDIV 2
 Scaling: 2 us/div -> 2000 values
 PULSEVIEW:DATASET?
Result:
 -54.328,-54.328,-54.328,-54.835,-55.010,
 -55.559,-56.349,-56.773,-56.993,-57.933,
 -58.444,-58.987,-59.566,-60.187,-61.579,
 -61.966,-61.966,-62.370,-63.239,-63.709,
 -63.709,-64.205,-64.732,-64.732,-64.205,
 ...READY.

Usage: Query only

<RX>:PULSEVIEW:ANALYSIS?

Returns the analyzed pulse parameter values from the power vs time diagram ("Pulse" view). The values for all parameters are returned as a comma-separated list. For details on the parameters, see [Chapter 6.3, "Graphical pulse analysis"](#), on page 48.

Return values:

<State> **READY.**
 The command was executed successfully.

Example: PULSEVIEW:ANALYSIS?
 Analysis_OK: true,
 Pulse1_Risetime_us: 2.000,
 Pulse1_Widthtime_us: 3.464,
 Pulse1_Decaytime_us: 1.987,
 Pulse2_Risetime_us: 1.995,
 Pulse2_Widthtime_us: 3.466,
 Pulse2_Decaytime_us: 1.999,
 Pulse_Spacingtime_us: 11.998,
 Peak_Variation_dB: -0.023,
 Peak_1_dBm: -31.164,
 Peak_2_dBm: -31.140,
 READY.

Usage: Query only

Manual operation: See ["Pulse rise time"](#) on page 50
 See ["Pulse duration"](#) on page 51
 See ["Pulse decay time"](#) on page 52
 See ["Pulse spacing"](#) on page 53
 See ["Peak variation"](#) on page 54
 See ["Mark1"](#) on page 54
 See ["Mark2"](#) on page 54
 See ["Mrk. max to peak 1"](#) on page 55

12 Troubleshooting

Blown fuse

If the product does not start, a blown fuse in the power supply can be the cause. Contact the Rohde & Schwarz customer service to confirm the fault symptoms. If the power supply has a blown fuse, you must return the product to the Rohde & Schwarz customer service to have the power supply replaced. Follow the instructions from the Rohde & Schwarz customer service.

If you need to transport or ship the product, see [Chapter 13.5, "Transporting"](#), on page 164.

12.1 Contacting customer support

Technical support – where and when you need it

For quick, expert help with any Rohde & Schwarz product, contact our customer support center. A team of highly qualified engineers provides support and works with you to find a solution to your query on any aspect of the operation, programming or applications of Rohde & Schwarz products.

Contact information

Contact our customer support center at www.rohde-schwarz.com/support, or follow this QR code:



Figure 12-1: QR code to the Rohde & Schwarz support page

13 Maintenance, storage, transport and disposal

The product does not require regular maintenance. It only requires occasional cleaning. It is however advisable to check the nominal data from time to time.

- [Cleaning](#)..... 163
- [Calibration](#)..... 163
- [Handling batteries](#)..... 163
- [Storage](#)..... 164
- [Transporting](#)..... 164
- [Disposal](#)..... 164

13.1 Cleaning

Use a dry, lint-free cloth to clean the product. When cleaning, keep in mind that the casing is not waterproof. Do not use liquid cleaning agents.

Cleaning agents, solvents (thinners, acetone), acids and bases can damage the front panel labeling, plastic parts and display.

13.2 Calibration

Access: [CAL]

It is recommended that the R&S EDS300 be calibrated once a year by a certified Rohde & Schwarz service technician.

13.3 Handling batteries

Safe handling of batteries is described in "[Handling batteries safely](#)" on page 8. Maintenance information is provided here.

Keep the batteries clean and dry. If the terminals become soiled, clean them with a dry, clean cloth.

Replacing batteries

The instrument is powered by a firmly installed battery. It can only be replaced by Rohde & Schwarz service personnel.

The R&S EDS300 contains an internal clock. A lithium battery supplies this clock with the necessary voltage when the instrument is switched off. If the lithium battery is empty (life-span is approximately 5 years), the time and date is lost. To exchange the

lithium battery, the instrument has to be opened. Only technical personnel authorized by Rohde & Schwarz are allowed to open the instrument.

In both cases, contact Rohde & Schwarz customer service. See [Chapter 12.1, "Contacting customer support"](#), on page 162.

13.4 Storage

Protect the product against dust. Ensure that the environmental conditions, e.g. temperature range and climatic load, meet the values specified in the data sheet.

13.5 Transporting

Packing

Use the original packaging material. It consists of antistatic wrap for electrostatic protection and packing material designed for the product.

If you do not have the original packaging, use similar materials that provide the same level of protection. You can also contact your local Rohde & Schwarz service center for advice.

Securing

When moving the product in a vehicle or using transporting equipment, make sure that the product is properly secured. Only use items intended for securing objects.

Transport altitude

The maximum transport altitude is provided in the data sheet. It differs in battery operation and operation with an external power supply.

13.6 Disposal

Rohde & Schwarz is committed to making careful, ecologically sound use of natural resources and minimizing the environmental footprint of our products. Help us by disposing of waste in a way that causes minimum environmental impact.

Disposing electrical and electronic equipment

A product that is labeled as follows cannot be disposed of in normal household waste after it has come to the end of its service life. Even disposal via the municipal collection points for waste electrical and electronic equipment is not permitted.



Figure 13-1: Labeling in line with EU directive WEEE

Rohde & Schwarz has developed a disposal concept for the eco-friendly disposal or recycling of waste material. As a manufacturer, Rohde & Schwarz completely fulfills its obligation to take back and dispose of electrical and electronic waste. Contact your local service representative to dispose of the product.

Disposing batteries

A product that contains a battery cannot be disposed of in the normal household waste after it has come to the end of its service life. It is labeled as follows:



Figure 13-2: Disposal information in line with EU battery directive

Dispose of batteries as specified by the local waste disposal agency. Alternatively, you can contact the Rohde & Schwarz local service representative.

For information on returning batteries to Rohde & Schwarz subsidiaries, see "[Handling batteries safely](#)" on page 8.

Annex

A References

[1] Convention on International Civil Aviation

Convention on International Civil Aviation, Volume 1 (Radio Navigation Aids), Sixth Edition of Volume 1 – July 2006; International Civil Aviation Organization Annex 10, Volume I Radio Navigation Aids, ICAO

Application Notes:

- Rohde & Schwarz Application Note: [1EF91: Testing of DME/TACAN Ground Stations](#)

B DME channel frequency list

The following table indicates the frequencies and pulse codes for the interrogator (DME on-board transmitter) and reply (DME ground station) signals for specific DME channels as defined by the International Civil Aviation Organization (ICAO, see [\[1\]](#)).



A DME channel is uniquely identified by its channel number (+extension) and its receive frequency.

DME channel number	Interrogation				Reply	
	Frequency [MHz]	DME/N [μ s]	Initial approach (IA) [μ s]	Final approach (FA) [μ s]	Frequency [MHz]	Pulse codes [μ s]
1X	1025	12	-	-	962	12
1Y	1025	36	-	-	1088	30
2X	1026	12	-	-	963	12
2Y	1026	36	-	-	1089	30
3X	1027	12	-	-	964	12
3Y	1027	36	-	-	1090	30
4X	1028	12	-	-	965	12
4Y	1028	36	-	-	1091	30
5X	1029	12	-	-	966	12
5Y	1029	36	-	-	1092	30
6X	1030	12	-	-	967	12
6Y	1030	36	-	-	1093	30
7X	1031	12	-	-	968	12
7Y	1031	36	-	-	1094	30
8X	1032	12	-	-	969	12
8Y	1032	36	-	-	1095	30

DME channel number	Interrogation				Reply	
	Frequency [MHz]	DME/N [μs]	Initial approach (IA) [μs]	Final approach (FA) [μs]	Frequency [MHz]	Pulse codes [μs]
9X	1033	12	-	-	970	12
9Y	1033	36	-	-	1096	30
10X	1034	12	-	-	971	12
10Y	1034	36	-	-	1097	30
11X	1035	12	-	-	972	12
11Y	1035	36	-	-	1098	30
12X	1036	12	-	-	973	12
12Y	1036	36	-	-	1099	30
13X	1037	12	-	-	974	12
13Y	1037	36	-	-	1100	30
14X	1038	12	-	-	975	12
14Y	1038	36	-	-	1101	30
15X	1039	12	-	-	976	12
15Y	1039	36	-	-	1102	30
16X	1040	12	-	-	977	12
16Y	1040	36	-	-	1103	30
17X	1041	12	-	-	978	12
17Y	1041	36	36	42	1104	30
17Z	1041	-	21	27	1104	15
18X	1042	12	12	18	979	12
18W	1042	-	24	30	979	24
18Y	1042	36	36	42	1105	30

DME channel number	Interrogation				Reply	
	Frequency [MHz]	DME/N [μs]	Initial approach (IA) [μs]	Final approach (FA) [μs]	Frequency [MHz]	Pulse codes [μs]
18Z	1042	-	21	27	1105	15
19X	1043	12	-	-	980	12
19Y	1043	36	36	42	1106	30
19Z	1043	-	21	27	1106	15
20X	1044	12	12	18	981	12
20W	1044	-	24	30	981	24
20Y	1044	36	36	42	1107	30
20Z	1044	-	21	27	1107	15
21X	1045	12	-	-	982	12
21Y	1045	36	36	42	1108	30
21Z	1045	-	21	27	1108	15
22X	1046	12	12	18	983	12
22W	1046	-	24	30	983	24
22Y	1046	36	36	42	1109	30
22Z	1046	-	21	27	1109	15
23X	1047	12	-	-	984	12
23Y	1047	36	36	42	1110	30
23Z	1047	-	21	27	1110	15
24X	1048	12	12	18	985	12
24W	1048	-	24	30	985	24
24Y	1048	36	36	42	1111	30
24Z	1048	-	21	27	1111	15
25X	1049	12	-	-	986	12
25Y	1049	36	36	42	1112	30
25Z	1049	-	21	27	1112	15

DME channel number	Interrogation				Reply	
	Frequency [MHz]	DME/N [μ s]	Initial approach (IA) [μ s]	Final approach (FA) [μ s]	Frequency [MHz]	Pulse codes [μ s]
26X	1050	12	12	18	987	12
26W	1050	-	24	30	987	24
26Y	1050	36	36	42	1113	30
26Z	1050	-	21	27	1113	15
27X	1051	12	-	-	988	12
27Y	1051	36	36	42	1114	30
27Z	1051	-	21	27	1114	15
28X	1052	12	12	18	989	12
28W	1052	-	24	30	989	24
28Y	1052	36	36	42	1115	30
28Z	1052	-	21	27	1115	15
29X	1053	12	-	-	990	12
29Y	1053	36	36	42	1116	30
29Z	1053	-	21	27	1116	15
30X	1054	12	12	18	991	12
30W	1054	-	24	30	991	24
30Y	1054	36	36	42	1117	30
30Z	1054	-	21	27	1117	15
31X	1055	12	-	-	992	12
31Y	1055	36	36	42	1118	30
31Z	1055	-	21	27	1118	15
32X	1056	12	12	18	993	12
32W	1056	-	24	30	993	24
32Y	1056	36	36	42	1119	30

DME channel number	Interrogation				Reply	
	Frequency [MHz]	DME/N [μ s]	Initial approach (IA) [μ s]	Final approach (FA) [μ s]	Frequency [MHz]	Pulse codes [μ s]
32Z	1056	-	21	27	1119	15
33X	1057	12	-	-	994	12
33Y	1057	36	36	42	1120	30
33Z	1057	-	21	27	1120	15
34X	1058	12	12	18	995	12
34W	1058	-	24	30	995	24
34Y	1058	36	36	42	1121	30
34Z	1058	-	21	27	1121	15
35X	1059	12	-	-	996	12
35Y	1059	36	36	42	1122	30
35Z	1059	-	21	27	1122	15
36X	1060	12	12	18	997	12
36W	1060	-	24	30	997	24
36Y	1060	36	36	42	1123	30
36Z	1060	-	21	27	1123	15
37X	1061	12	-	-	998	12
37Y	1061	36	36	42	1124	30
37Z	1061	-	21	27	1124	15
38X	1062	12	12	18	999	12
38W	1062	-	24	30	999	24
38Y	1062	36	36	42	1125	30
38Z	1062	-	21	27	1125	15
39X	1063	12	-	-	1000	12
39Y	1063	36	36	42	1126	30

DME channel number	Interrogation				Reply	
	Frequency [MHz]	DME/N [μs]	Initial approach (IA) [μs]	Final approach (FA) [μs]	Frequency [MHz]	Pulse codes [μs]
39Z	1063	-	21	27	1126	15
40X	1064	12	12	18	1001	12
40W	1064	-	24	30	1001	24
40Y	1064	36	36	42	1127	30
40Z	1064	-	21	27	1127	15
41X	1065	12	-	-	1002	12
41Y	1065	36	36	42	1128	30
41Z	1065	-	21	27	1128	15
42X	1065	12	12	18	1003	12
42W	1066	-	24	30	1003	24
42Y	1066	36	36	42	1129	30
42Y	1066	-	21	27	1129	15
43X	1067	12	-	-	1004	12
43Y	1067	36	36	42	1130	30
43Z	1067	-	21	27	1130	15
44X	1068	12	12	18	1005	12
44W	1068	-	24	30	1005	24
44Y	1068	36	36	42	1131	30
44Z	1068	-	21	27	1131	15
45X	1069	12	-	-	1006	12
45Y	1069	36	36	42	1132	30
45Z	1069	-	21	27	1132	15
46X	1070	12	12	18	1007	12
46W	1070	-	24	30	1007	24
46Y	1070	36	36	42	1133	30

DME channel number	Interrogation				Reply	
	Frequency [MHz]	DME/N [μ s]	Initial approach (IA) [μ s]	Final approach (FA) [μ s]	Frequency [MHz]	Pulse codes [μ s]
46Z	1070	-	21	27	1133	15
47X	1071	12	-	-	1008	12
47Y	1071	36	36	42	1134	30
47Z	1071	-	21	27	1134	15
48X	1072	12	12	18	1009	12
48W	1072	-	24	30	1009	24
48Y	1072	36	36	42	1135	30
48Z	1072	-	21	27	1135	15
49X	1073	12	-	-	1010	12
49Y	1073	36	36	42	1136	30
49Z	1073	-	21	27	1136	15
50X	1074	12	12	18	1011	12
50W	1074	-	24	30	1011	24
50Y	1074	36	36	42	1137	30
50Z	1074	-	21	27	1137	15
51X	1075	12	-	-	1012	12
51Y	1075	36	36	42	1138	30
51Z	1075	-	21	27	1138	15
52X	1076	12	12	18	1013	12
52W	1076	-	24	30	1013	24
52Y	1076	36	36	42	1139	30
52Z	1076	-	21	27	1139	15
53X	1077	12	-	-	1014	12
53Y	1077	36	36	42	1140	30

DME channel number	Interrogation				Reply	
	Frequency [MHz]	DME/N [μs]	Initial approach (IA) [μs]	Final approach (FA) [μs]	Frequency [MHz]	Pulse codes [μs]
53Z	1077	-	21	27	1140	15
54X	1078	12	12	18	1015	12
54W	1078	-	24	30	1015	24
54Y	1078	36	36	42	1141	30
54Z	1078	-	21	27	1141	15
55X	1079	12	-	-	1016	12
55Y	1079	36	36	42	1142	30
55Z	1079	-	21	27	1142	15
56X	1080	12	12	18	1017	12
56W	1080	-	24	30	1017	24
56Y	1080	36	36	42	1143	30
56Z	1080	-	21	27	1143	15
57X	1081	12	-	-	1018	12
57Y	1081	36	-	-	1144	30
58X	1082	12	-	-	1019	12
58Y	1082	36	-	-	1145	30
59X	1083	12	-	-	1020	12
59Y	1083	36	-	-	1146	30
60X	1084	12	-	-	1021	12
60Y	1084	36	-	-	1147	30
61X	1085	12	-	-	1022	12
61Y	1085	36	-	-	1148	30

DME channel number	Interrogation				Reply	
	Frequency [MHz]	DME/N [μ s]	Initial approach (IA) [μ s]	Final approach (FA) [μ s]	Frequency [MHz]	Pulse codes [μ s]
62X	1086	12	-	-	1023	12
62Y	1086	36	-	-	1149	30
63X	1087	12	-	-	1024	12
63Y	1087	36	-	-	1150	30
64X	1088	12	-	-	1151	12
64Y	1088	36	-	-	1025	30
65X	1089	12	-	-	1152	12
65Y	1089	36	-	-	1026	30
66X	1090	12	-	-	1153	12
66Y	1090	36	-	-	1027	30
67X	1091	12	-	-	1154	12
67Y	1091	36	-	-	1028	30
68X	1092	12	-	-	1155	12
68Y	1092	36	-	-	1029	30
69X	1093	12	-	-	1156	12
69Y	1093	36	-	-	1030	30
70X	1094	12	-	-	1157	12
70Y	1094	36	-	-	1031	30
71X	1095	12	-	-	1158	12
71Y	1095	36	-	-	1032	30
72X	1096	12	-	-	1159	12

DME channel number	Interrogation				Reply	
	Frequency [MHz]	DME/N [μ s]	Initial approach (IA) [μ s]	Final approach (FA) [μ s]	Frequency [MHz]	Pulse codes [μ s]
72Y	1096	36	-	-	1033	30
73X	1097	12	-	-	1160	12
73Y	1097	36	-	-	1034	30
74X	1098	12	-	-	1161	12
74Y	1098	36	-	-	1035	30
75X	1099	12	-	-	1162	12
75Y	1099	36	-	-	1036	30
76X	1100	12	-	-	1163	12
76Y	1100	36	-	-	1037	30
77X	1101	12	-	-	1164	12
77Y	1101	36	-	-	1038	30
78X	1102	12	-	-	1165	12
78Y	1102	36	-	-	1039	30
79X	1103	12	-	-	1166	12
79Y	1103	36	-	-	1040	30
80X	1104	12	-	-	1167	12
80Y	1104	36	36	42	1041	30
80Z	1104	-	21	27	1041	15
81X	1105	12	-	-	1168	12
81Y	1105	36	36	42	1042	30
81Z	1105	-	21	27	1042	15
82X	1106	12	-	-	1169	12

DME channel number	Interrogation				Reply	
	Frequency [MHz]	DME/N [μs]	Initial approach (IA) [μs]	Final approach (FA) [μs]	Frequency [MHz]	Pulse codes [μs]
82Y	1106	36	36	42	1043	30
82Z	1106	-	21	27	1043	15
83X	1107	12	-	-	1170	12
83Y	1107	36	36	42	1044	30
83Z	1107	-	21	27	1044	15
84X	1108	12	-	-	1171	12
84Y	1108	36	36	42	1045	30
84Z	1108	-	21	27	1045	15
85X	1109	12	-	-	1172	12
85Y	1109	36	36	42	1046	30
85Z	1109		21	27	1046	15
86X	1110	12	-	-	1173	12
86Y	1110	36	36	42	1047	30
86Z	1110	-	21	27	1047	15
87X	1111	12	-	-	1174	12
87Y	1111	36	36	42	1048	30
87Z	1111	-	21	27	1048	15
88X	1112	12	-	-	1175	12
88Y	1112	36	36	42	1049	30
88Z	1112	-	21	27	1049	15
89X	1113	12	-	-	1176	12
89Y	1113	36	36	42	1050	30
89Z	1113	-	21	27	1050	15

DME channel number	Interrogation				Reply	
	Frequency [MHz]	DME/N [μ s]	Initial approach (IA) [μ s]	Final approach (FA) [μ s]	Frequency [MHz]	Pulse codes [μ s]
90X	1114	12	-	-	1177	12
90Y	1114	36	36	42	1051	30
90Z	1114	-	21	27	1051	15
91X	1115	12	-	-	1178	12
91Y	1115	36	36	42	1052	30
91Z	1115	-	21	27	1052	15
92X	1116	12	-	-	1179	12
92Y	1116	36	36	42	1053	30
92Z	1116	-	21	27	1053	15
93X	1117	12	-	-	1180	12
93Y	1117	36	36	42	1054	30
93Z	1117	-	21	27	1054	15
94X	1118	12	-	-	1181	12
94Y	1118	36	36	42	1055	30
94Z	1118	-	21	27	1055	15
95X	1119	12	-	-	1182	12
95Y	1119	36	36	42	1056	30
95Z	1119	-	21	27	1056	15
96X	1120	12	-	-	1183	12
96Y	1120	36	36	42	1057	30
96Z	1120	-	21	27	1057	15
97X	1121	12	-	-	1184	12
97Y	1121	36	36	42	1058	30
97Z	1121	-	21	27	1058	15

DME channel number	Interrogation				Reply	
	Frequency [MHz]	DME/N [μs]	Initial approach (IA) [μs]	Final approach (FA) [μs]	Frequency [MHz]	Pulse codes [μs]
98X	1122	12	-	-	1185	12
98Y	1122	36	36	42	1059	30
98Z	1122	-	21	27	1059	15
99X	1123	12	-	-	1186	12
99Y	1123	36	36	42	1060	30
99Z	1123	-	21	27	1060	15
100X	1124	12	-	-	1187	12
100Y	1124	36	36	42	1061	30
100Z	1124	-	21	27	1061	15
101X	1125	12	-	-	1188	12
101Y	1125	36	36	42	1062	30
101Z	1125	-	21	27	1062	15
102X	1126	12	-	-	1189	12
102Y	1126	36	36	42	1063	30
102Z	1126	-	21	27	1063	15
103X	1127	12	-	-	1190	12
103Y	1127	36	36	42	1064	30
103Z	1127	-	21	27	1064	15
104X	1128	12	-	-	1191	12
104Y	1128	36	36	42	1065	30
104Z	1128	-	21	27	1065	15
105X	1129	12	-	-	1192	12
105Y	1129	36	36	42	1066	30

DME channel number	Interrogation				Reply	
	Frequency [MHz]	DME/N [μ s]	Initial approach (IA) [μ s]	Final approach (FA) [μ s]	Frequency [MHz]	Pulse codes [μ s]
105Z	1129	-	21	27	1066	15
106X	1130	12	-	-	1193	12
106Y	1130	36	36	42	1067	30
106Z	1130	-	21	27	1067	15
107X	1131	12	-	-	1194	12
107Y	1131	36	36	42	1068	30
107Z	1131	-	21	27	1068	15
108X	1132	12	-	-	1195	12
108Y	1132	36	36	42	1069	30
108Z	1132	-	21	27	1069	15
109X	1133	12	-	-	1196	12
109Y	1133	36	36	42	1070	30
109Z	1133	-	21	27	1070	15
110X	1134	12	-	-	1197	12
110Y	1134	36	36	42	1071	30
110Z	1134	-	21	27	1071	15
111X	1135	12	-	-	1198	12
111Y	1135	36	36	42	1072	30
111Z	1135	-	21	27	1072	15
112X	1136	12	-	-	1199	12
112Y	1136	36	36	42	1073	30
112Z	1136	-	21	27	1073	15
113X	1137	12	-	-	1200	12

DME channel number	Interrogation				Reply	
	Frequency [MHz]	DME/N [μ s]	Initial approach (IA) [μ s]	Final approach (FA) [μ s]	Frequency [MHz]	Pulse codes [μ s]
113Y	1137	36	36	42	1074	30
113Z	1137	-	21	27	1074	15
114X	1138	12	-	-	1201	12
114Y	1138	36	36	42	1075	30
114Z	1138	-	21	27	1075	15
115X	1139	12	-	-	1202	12
115Y	1139	36	36	42	1076	30
115Z	1139	-	21	27	1076	15
116X	1140	12	-	-	1203	12
116Y	1140	36	36	42	1077	30
116Z	1140	-	21	27	1077	15
117X	1141	12	-	-	1204	12
117Y	1141	36	36	42	1078	30
117Z	1141	-	21	27	1078	15
118X	1142	12	-	-	1205	12
118Y	1142	36	36	42	1079	30
118Z	1142	-	21	27	1079	15
119X	1143	12	-	-	1206	12
119Y	1143	36	36	42	1080	30
119Z	1143	-	21	27	1080	15
120X	1144	12	-	-	1207	12
120Y	1144	36	-	-	1081	30
121X	1145	12	-	-	1208	12

DME channel number	Interrogation				Reply	
	Frequency [MHz]	DME/N [μ s]	Initial approach (IA) [μ s]	Final approach (FA) [μ s]	Frequency [MHz]	Pulse codes [μ s]
121Y	1145	36	-	-	1082	30
122X	1146	12	-	-	1209	12
122Y	1146	36	-	-	1083	30
123X	1147	12	-	-	1210	12
123Y	1147	36	-	-	1084	30
124X	1148	12	-	-	1211	12
124Y	1148	36	-	-	1085	30
125X	1149	12	-	-	1212	12
125Y	1149	36	-	-	1086	30
126X	1150	12	-	-	1213	12
126Y	1150	36	-	-	1087	30

C Format description of DME measurement data

Which set of parameters are logged is user-definable and can be defined individually for each measurement by selecting the list type. When a list is stored to a file, a header line is automatically included that describes the provided parameters.

The format of the data for each measurement with the same list type is identical, regardless whether a parameter contains data or not (if a parameter value is not available, `nan` is inserted). This allows you to create a table from the exported comma-separated list.

The amount of data in the list depends on the [Measurement Time](#). One row of data is stored for each [Measurement Time](#) interval, which means the number of rows is:

$$\text{total measurement duration} / \text{meastime}$$

with a maximum of 135 rows per second

Example:

For a [Measurement Time](#) of 1 s, one row is measured per second of the entire measurement.

For the minimum [Measurement Time](#) of 7 ms, 135 rows are measured per second of the entire measurement.

Table C-1: Parameter set depending on the selected list type

List type	Description
FULL3	Complete list of data with all available parameters Used for manual operation; default for remote command;
FULL2	Subset of FULL3, compatible to the FULL2 list type in previous R&S EDS300 DME/Pulse Analyzers; maintained for compatibility reasons only and not described in detail
FULL	Subset of FULL3, compatible to the FULL list type in previous R&S EDS300 DME/Pulse Analyzers; maintained for compatibility reasons only and not described in detail:
SHORT	Selection of only the most important parameters
DST	DME distance measurement parameters
TAC3	Selection of most important general parameters and specific TACAN parameters
TAC2	Subset of TAC3, compatible to the TAC2 list type in previous R&S EDS300 DME/Pulse Analyzers; maintained for compatibility reasons only and not described in detail:
TAC	Subset of TAC3, compatible to the TAC list type in previous R&S EDS300 DME/Pulse Analyzers; maintained for compatibility reasons only and not described in detail:

The following overview describes all available parameters and which list type they are included in.



If a parameter value is not available, nan is inserted.

Table C-2: Logged parameters and their assignment to list types

Parameter	Value range	Description	S H O R T	T A C A N	F U L L	D S T
Ctr		Stream Counter. Counts the outgoing stream messages, starting with the STREAM command	X	X	X	X
RX		RX-Board 1 or 2	X	X	X	-
MDME		MDME Slot In Multi-DME configuration each station is assigned to a slot that contains the channel.	X	X	X	X
Flags		This field is always 10 characters long and indicates status bits: T: external triggered (future use) O: Overload condition I: Invalid (future use) U: Uncal condition present P: This indicates that the dataset is initiated by an interrogator pulse; in this case the dataset time belongs to the time of the outgoing pulse. G: Synchronized with GPS Dataset time is generated from the PC clock D: DME detector active S: PPS Sync OK X: Outgoing pulse TX This reply is not only initiated by an interrogator pulse, the pulse was really transmitted. Might be absent if the TX was suppressed by the suppressor line, or in MDME if the slot is not on TX L: Suppressor line activity Indicates that there was an event on the suppressor line R: Indicates that DME pulses were received in the 4ms response window of this pulse. Only present on P-Messages	X	X	X	X
Date		Date of the dataset Example: "19.04.2012"	-	-	X	X
Time		Time of the dataset with ms precision Example: "13:17:42.115"	X	X	X	X
dTime[ms]		Time in ms since the DME mode of the EDS was started; this is supposed to be easier to evaluate than << the "Time" value above.	X	X	X	-
*) only available with TACAN measurement option						

Parameter	Value range	Description	S H O R T	T A C A N	F U L L	D S T
Freq[MHz]		The RX frequency setting	X	X	X	X
MeasTime[ms]		Measurement time setting	-	-	X	-
AttMode	"LOW_NOISE", "NORM", "LOW_DIST"	Attenuator at time of measurement In Attmode "AUTO" this value shows the real hardware setting.	-	-	X	-
IF2Gain	GAIN0,GAIN15 or GAIN30	Internal hardware setting.	-	-	X	-
PeakLevel[dBm]		Peaklevel	X	X	X	X
AvrgLevel[dBm]		Average Level	-	-	X	-
PulseRepRate[1/s]		Pulse Repetition rate. This value is updated only 1 / s, so it usually appears the same value is subsequent datasets	X	X	X	-
DeltaFreq[kHz]		Frequency deviation from the channel frequency	-	-	X	X
PulseSpacing[us]		Measured Pulse Spacing in μ s	X	X	X	X
ID_ON	1 or 0	Indicates that an ID transmission is currently active.	-	-	X	X
ID_PRR[1/s]		Pulse repetition rate of ID code. Only measured during ID transmission,	-	-	X	-
ID_CODE		Decoded ID code (3 or 4 characters) Once the code is decoded it remains visible for at least 60 s	-	-	X	X
ID_PERIOD[s]		Time between the start of 2 ID transmissions	-	-	X	-
* Mod15[%]		TACAN Modulation depth of 15Hz component	-	X	X	-
* Mod135[%]		TACAN Modulation depth of 135Hz component	-	X	X	-
* Freq15[Hz]		Frequency of 15Hz component	-	X	X	-
* Freq135[Hz]		Frequency of 135Hz component	-	X	X	-
* Phase15[°]		Phase of 15Hz component	-	X	X	-
* Phase135[°]		Phase of 135Hz component	-	X	X	-
* Bearing[°]	Deg 0 .. 360°	TACAN Bearing in	-	X	X	-
* Phaseshift[°]	0°..40°	Phase shift between 15Hz and 135Hz	-	X	X	-
*MRB PRR[1/s]		Number of MRB pulses per second; for X channels, number of pulse pairs	-	X	X	-
*ARB PRR[1/s]		Number of ARB pulses per second; for X channels, number of pulse pairs	-	X	X	-
*) only available with TACAN measurement option						

Parameter	Value range	Description	S H O R T	T A C A N	F U L L	D S T
*MRB PULSE COUNT		Number of pulse (pairs) per MRB group	-	X	X	-
*ARB PULSE COUNT		Number of pulse (pairs) per ARB group	-	X	X	-
*MRB Spacing[μs]		Pulse spacing of MRB pulses	-	X	X	-
*ARB Spacing[μs]		Pulse spacing of ARB pulses	-	X	X	-
*MRB Peak Space[μs]		Maximum pulse spacing of MRB pulses	-	X	X	-
*ARB Peak Space[μs]		Maximum pulse spacing of ARB pulses	-	X	X	-
Counter [1/s]		Counter for detected IDs	-	-	X	-
dot len[ms]		Length of time a dot is transmitted in the used Morse code	-	-	X	-
dash len[ms]		Length of time a dash is transmitted in the used Morse code	-	-	X	-
gap[ms]		Length of time that passes between a transmitted dot and a dash in the used Morse code	-	-	X	-
letter gap[ms]		Length of time that passes between two transmitted letters in the used Morse code	-	-	X	-
EQ pulse [μs]		Equalizer pulse time - Delay time of equalizer pulses from the ID pulses during ID transmission	-	X	X	-
Delay[μs]		Delay of reply pulse, including base station delay Example: "69.982"	-	-	X	-
Dist[m]		Resulting distance in m Example: "2994.4"	X	-	X	X
RepEff[%]		Reply efficiency in percent	X	-	X	X
DME Speed[m/s]		Speed calculated from the preceding pulses; only available with linear prediction, in static prediction the speed is always 0	-	-	X	X
SoT	Possible values are "search", "track" or "memory"	Search or Track	X	-	X	X
DstPred[μs]		In Track or Memory the prediction is calculated to identify the reply to the outgoing pulse	-	-	X	X
PredWind.[μs]		Size of the prediction window	-	-	X	X
RX Pulses		Number of RX pulses detected in analyzed window	-	-	X	X
*) only available with TACAN measurement option						

Parameter	Value range	Description	S H O R T	T A C A N	F U L L	D S T
Lat.		GPS Latitude All GPS data refer to the time of the dataset	X	X	X	X
Long.		GPS longitude	X	X	X	X
Alt.[m]		GPS altitude	-	-	X	X
Speed[km/h]		GPS speed	-	-	X	X
Sats.		Number of GPS satellites	-	-	X	X
GPS fix	"NO GPS" "INVALID" "GPS" "DGPS" (also used for EGNOS) "GPS Prec." "RTK fix" "RTK float" "estimated" "manual" "simulated"	GPS Status	X	X	X	X
*) only available with TACAN measurement option						

Example:

The following extract of a sample file shows the data results for a TAC3 list.

```

Ctr,RX,MDME,Flags,Date,Time,dTime[ms],Freq[MHz],MeasTime[ms],AttMode,IF2Gain,
PeakLevel[dBm],AvrgLevel[dBm],PulseRepRate[1/s],DeltaFreq[kHz],PulseSpacing[μs],ID_ON,
ID_PRR[1/s],ID_CODE,ID_PERIOD,Mod15[%],Mod135[%],Freq15[Hz],Freq135[Hz],Phase15[°],
Phase135[°/9],Bearing[°],Phaseshift[°],MRB_PRR[1/s],ARB_PRR[1/s],MRB_COUNT,ARB_COUNT,
MRB Spacing[μs],ARB Spacing[μs],MRB Peak Space[μs],ARB Peak Space[μs],Counter [1/s],
dot len[ms],dash len[ms],gap[ms],letter gap[ms],EQ pulse [μs],Delay[μs],Dist[km],
RepEff[%],DME Speed[m/s],SoT,DstPred[μs],PredWind.[μs],RX Pulses,Lat.,Long.,Alt.[m],
Speed[km/h],Sats.,GPS fix,01.62u TACAN (TacDecl.68)
0,1,0,      D      ,26.05.2016,17:02:23.569,1028063,1040.0,7,LOW_NOISE,GAIN24,-93.137,
-112.482,2443.00,-4.776,30.525,0,-nan,TST,-nan,18.11,21.43,15.00,134.99,288.12,16.91,
257.11,31.09,194,1393,13,13,29.929,15.150,30.314,16.200,0.0,125.2,374.4,123.9,374.0,
-nan,-nan,-nan,-nan,-nan,inactive,-nan,-nan,-nan,00° 00.00000000' N,00° 00.00000000' E,
0.00,0.00,0,NO GPS,
0,1,0,      D      ,26.05.2016,17:02:23.576,1028071,1040.0,7,LOW_NOISE,GAIN24,-92.791,
-112.397,2443.00,-6.806,30.143,0,-nan,TST,-nan,17.40,21.38,15.00,135.25,288.12,16.85,
257.11,31.09,194,1393,13,12,29.929,15.100,30.314,16.200,0.0,125.2,374.4,123.9,374.0,
-nan,-nan,-nan,-nan,-nan,inactive,-nan,-nan,-nan,00° 00.00000000' N,00° 00.00000000' E,
0.00,0.00,0,NO GPS,
0,1,0,      D      ,26.05.2016,17:02:23.583,1028078,1040.0,7,LOW_NOISE,GAIN24,-92.432,
-112.306,2443.00,-8.698,30.171,0,-nan,TST,-nan,16.69,21.25,15.00,134.76,288.12,16.93,
257.11,31.09,194,1393,13,13,29.929,15.089,30.314,16.200,0.0,125.2,374.4,123.9,374.0,
-nan,-nan,-nan,-nan,-nan,inactive,-nan,-nan,-nan,00° 00.00000000' N,00° 00.00000000' E,
0.00,0.00,0,NO GPS,
...

```

List of commands

*IDN?	112
*RST	116
<RX>:DME:ATTMODE	125
<RX>:DME:ATTMODE?	125
<RX>:DME:AVRGLEVEL?	154
<RX>:DME:CARRIER_F_DELTA?	154
<RX>:DME:DEMOD_BW	126
<RX>:DME:DEMOD_BW?	126
<RX>:DME:FREQ	125
<RX>:DME:FREQ?	125
<RX>:DME:ID_CODE?	154
<RX>:DME:ID_PRR?	154
<RX>:DME:ID_SEQLEN?	155
<RX>:DME:MEASTIME	126
<RX>:DME:MEASTIME?	126
<RX>:DME:PEAKLEVEL?	155
<RX>:DME:PULSE_REPT_RATE?	155
<RX>:DME:PULSE_SPACING?	155
<RX>:DME:RF_BW	128
<RX>:DME:RF_BW?	128
<RX>:DME:RFCH	127
<RX>:DME:RFCH_PS?	155
<RX>:DME:RFCH?	127
<RX>:DME:RXMODE	128
<RX>:DME:RXMODE?	128
<RX>:DME:SET_VIEW	159
<RX>:DME:TRIG_IN_COUNT?	129
<RX>:DME:TRIG_IN_PERIOD?	129
<RX>:DME:TXFREQ	129
<RX>:DME:TXFREQ?	129
<RX>:DST:DELAY_OFFSET	131
<RX>:DST:DELAY_OFFSET?	131
<RX>:DST:DELAY?	156
<RX>:DST:DST?	156
<RX>:DST:MEM_TIME	131
<RX>:DST:MEM_TIME?	131
<RX>:DST:MIN_REPLY_EFF	132
<RX>:DST:MIN_REPLY_EFF?	132
<RX>:DST:PRED_TYPE	132
<RX>:DST:PRR	133
<RX>:DST:PRR?	133
<RX>:DST:PULSE_SHAPE	133
<RX>:DST:REPEFF?	153
<RX>:DST:SOT?	154
<RX>:DST:SPULSES	133
<RX>:DST:SPULSES?	133
<RX>:DST:TPULSES	134

<RX>:DST:TPULSES?	134
<RX>:DST:TX_PCODE	130
<RX>:DST:TXON	134
<RX>:DST:TXON?	134
<RX>:DST:TXPOWER	135
<RX>:DST:TXPULSE_WIDTH	130
<RX>:DST:TXPULSE_WIDTH?	130
<RX>:MDME:ATTMODE	148
<RX>:MDME:AVRG	149
<RX>:MDME:CH	149
<RX>:MDME:STREAMCFG	150
<RX>:MDMEDATA?	150
<RX>:MEASDATA?	150
<RX>:MEASDEF?	151
<RX>:MEASMODE_DME	123
<RX>:MEASMODE_MDME	123
<RX>:MEASMODE_PULSE	124
<RX>:MEASMODE?	123
<RX>:PULSEVIEW:ANALYSIS?	161
<RX>:PULSEVIEW:AVRG	137
<RX>:PULSEVIEW:AVRG?	137
<RX>:PULSEVIEW:BW	137
<RX>:PULSEVIEW:BW?	137
<RX>:PULSEVIEW:DATASET?	160
<RX>:PULSEVIEW:TIMEDIV	138
<RX>:PULSEVIEW:TIMEDIV?	138
<RX>:PULSEVIEW:TRACE	138
<RX>:PULSEVIEW:TRACE?	138
<RX>:PULSEVIEW:TRIGDELAY	139
<RX>:PULSEVIEW:TRIGDELAY?	139
<RX>:PULSEVIEW:TRIGDOUBLE	139
<RX>:PULSEVIEW:TRIGDOUBLE?	139
<RX>:PULSEVIEW:TRIGLEVRF_MV	140
<RX>:PULSEVIEW:TRIGLEVRF_MV?	140
<RX>:PULSEVIEW:TRIGMODE	140
<RX>:PULSEVIEW:TRIGMODE?	140
<RX>:PULSEVIEW:TRIGSLOPE	141
<RX>:PULSEVIEW:TRIGSLOPE?	141
<RX>:PULSEVIEW:TRIGSOURCE	141
<RX>:PULSEVIEW:TRIGSOURCE?	141
<RX>:PULSEVIEW:UNIT	142
<RX>:PULSEVIEW:UNIT?	142
<RX>:PULSEVIEW:YSCALE_DB_DIV	142
<RX>:PULSEVIEW:YSCALE_DB_DIV?	142
<RX>:PULSEVIEW:YSCALE_MAXLEV_DBM	146
<RX>:PULSEVIEW:YSCALE_MAXLEV_DBM?	146
<RX>:PULSEVIEW:YSCALE_MAXLEV_MV	148
<RX>:PULSEVIEW:YSCALE_MAXLEV_MV?	148
<RX>:PULSEVIEW:YSCALE_MAXLEV_MW	146
<RX>:PULSEVIEW:YSCALE_MAXLEV_MW?	146

<RX>:PULSEVIEW:YSCALE_MAXLEV_NW.....	147
<RX>:PULSEVIEW:YSCALE_MAXLEV_NW?.....	147
<RX>:PULSEVIEW:YSCALE_MAXLEV_PW.....	147
<RX>:PULSEVIEW:YSCALE_MAXLEV_PW?.....	147
<RX>:PULSEVIEW:YSCALE_MAXLEV_UV.....	148
<RX>:PULSEVIEW:YSCALE_MAXLEV_UV?.....	148
<RX>:PULSEVIEW:YSCALE_MAXLEV_UW.....	146
<RX>:PULSEVIEW:YSCALE_MAXLEV_UW?.....	146
<RX>:PULSEVIEW:YSCALE_MAXLEV_V.....	147
<RX>:PULSEVIEW:YSCALE_MAXLEV_V?.....	147
<RX>:PULSEVIEW:YSCALE_MV_DIV.....	143
<RX>:PULSEVIEW:YSCALE_MV_DIV?.....	143
<RX>:PULSEVIEW:YSCALE_MW_DIV.....	143
<RX>:PULSEVIEW:YSCALE_MW_DIV?.....	143
<RX>:PULSEVIEW:YSCALE_NW_DIV.....	144
<RX>:PULSEVIEW:YSCALE_NW_DIV?.....	144
<RX>:PULSEVIEW:YSCALE_PW_DIV.....	144
<RX>:PULSEVIEW:YSCALE_PW_DIV?.....	144
<RX>:PULSEVIEW:YSCALE_UV_DIV.....	144
<RX>:PULSEVIEW:YSCALE_UV_DIV?.....	144
<RX>:PULSEVIEW:YSCALE_UW_DIV.....	145
<RX>:PULSEVIEW:YSCALE_UW_DIV?.....	145
<RX>:PULSEVIEW:YSCALE_V_DIV.....	145
<RX>:PULSEVIEW:YSCALE_V_DIV?.....	145
<RX>:SETUP:INPUT.....	120
<RX>:SETUP:INPUT?.....	120
<RX>:STOPSTREAM.....	152
<RX>:STREAM.....	153
<RX>:TACAN:BEARING?.....	157
<RX>:TACAN:FREQ_15HZ?.....	157
<RX>:TACAN:FREQ_135HZ?.....	157
<RX>:TACAN:MOD_DEPTH_15HZ?.....	158
<RX>:TACAN:MOD_DEPTH_135HZ?.....	158
<RX>:TACAN:PHASE_15HZ?.....	158
<RX>:TACAN:PHASE_135HZ?.....	158
<RX>:TACAN:PHASE_SHIFT?.....	159
<RX>:TACAN:SET_DMESCREEN_PAGE.....	159
CLEARERRORLOG.....	113
FACTORY_PRESET.....	116
GETERRORLOG.....	113
GETGPSSYNC.....	119
GETHWINVENTORY.....	113
GETHWSTATUS.....	114
GETNRPPOW.....	157
GETOPTIONS.....	114
GETUNCAL.....	114
GPSBAUDRATE.....	118
GPSBAUDRATE?.....	118
HELP?.....	110
KEY.....	111

LINUX_VER?.....	114
LOCAL.....	111
LPIU_FPGA_VER?.....	114
MAIN_BOARD_CPLD_VER?.....	115
MAIN_BOARD_FPGA_VER?.....	115
REMOTELOCK.....	112
REMOTELOCK?.....	112
RX_BOARD_FPGA_VER?.....	115
RX?.....	128
SET_ICAO_OVR.....	135
SETEXPERT.....	135
SETGPSBAUD.....	118
SETGPSSYNC.....	119
SETRX.....	129
SETSTREAMTRG.....	152
SETUP:AF_VOLUME.....	116
SETUP:AF_VOLUME?.....	116
SETUP:ANALOG_OUT_MODE.....	119
SETUP:ANALOG_OUT_MODE?.....	119
SETUP:COUNT_PULSES.....	117
SETUP:COUNT_PULSES?.....	117
SETUP:DISPLAY_UPDATE_MS.....	117
SETUP:DISPLAY_UPDATE_MS?.....	117
SETUP:EXT_ATTENUATION_TYPE.....	120
SETUP:EXT_ATTENUATION_TYPE?.....	120
SETUP:MORSEMOST.....	117
SETUP:REFERENCE:EXTREFERENCE?.....	121
SETUP:REFERENCE:SOURCE.....	121
SETUP:REFERENCE:SOURCE?.....	121
SETUP:RF1_EXTATTENUATION.....	120
SETUP:RF1_EXTATTENUATION?.....	120
SETUP:RF2_EXTATTENUATION.....	120
SETUP:RF2_EXTATTENUATION?.....	120
SETUP:SPEAKER.....	117
SETUP:SPEAKER?.....	117
SETUP:TRIGGER_OUT_MODE.....	122
SETUP:TRIGGER_OUT_MODE?.....	122
SETUSBLOGMODE.....	151
SETUSBLOGTIME.....	151
TEMP?.....	115
VER?.....	115

Index

A

Alphanumeric parameters	32
ANALOG IN	
Connector	27
ANALOG OUT	
Connector	27
Application cards	11
Application notes	11
Arrow keys	23
Attenuation	
Basics	36

B

Brochures	11
-----------------	----

C

Casing	
Labels	9
Connector	
ANALOG IN	27
ANALOG OUT	27
DC power supply	26
Display Port	28
DVI	28
LAN	28
REF INPUT	27
TRIGGER INPUT / OUTPUT	27
USB	27
Cursor keys	23
Customer support	162

D

Data Logger	
Format description	183
Data sheet	11
Date	
Setting	85
Default	
Restoring settings	80
DHCP server	
LAN configuration	87
Display	
Information	29
Display Port	
Connector	28
DNS server	
LAN configuration	87
DVI	
Connector	28

E

Entering data	32
Error log	
Displaying	90
External monitor	
Connectors	28

F

Factory defaults	80
Restoring	106

G

GBAS	
Data format	183

H

Hardware	
Installed	91
Status	92
Host name	
Changing	87

I

Initial configuration	80
Inventory list	
Displaying	91

K

Key	
Power	21
Keypad	24, 32
Key layout	33
Keys	
PRESET	80

L

Labels on casing	9
LAN	
Configuration	86
Connector	28
Loudspeaker	
Activating/Deactivating	97
Volume	97
Low distortion	
Attenuation mode	37
Low noise	
Attenuation mode	37

M

Measurement keys	
Details - see User Manual	24
Overview	24

N

Navigation keys	23
Numeric parameters	32

O

On-screen keyboard	32
Options	
GBAS (K9)	12
Installed	92
SCAT-I (K10)	12

P

Parameters	
Entering	32
Power	
Key	21
Power supply	
Connector	26
Preset	
Key	80
Presettings	79

R

REF INPUT	
Connector	27
Release notes	11
Restoring	
Factory defaults	106
RF input attenuation	
Basics	36

S

Safety instructions	7
Warning messages	10
SCAT-I	
Data format	183
Screen saver	
Activating/Deactivating	97
Settings	
Factory defaults	80
Software	
Installed	91
Storing	
Measurement settings	79
SYSTEM	
Keys	21

T

Time	
Setting	85
TRIGGER INPUT / OUTPUT	
Connectors	27

U

Units	
Input	24
USB	
Connector	27
User Presets	79

V

VHF frequency	67
---------------------	----

W

Warning messages	10
White papers	11