

R&S®FSVR

Realtime Spectrum Analyzer

User Manual

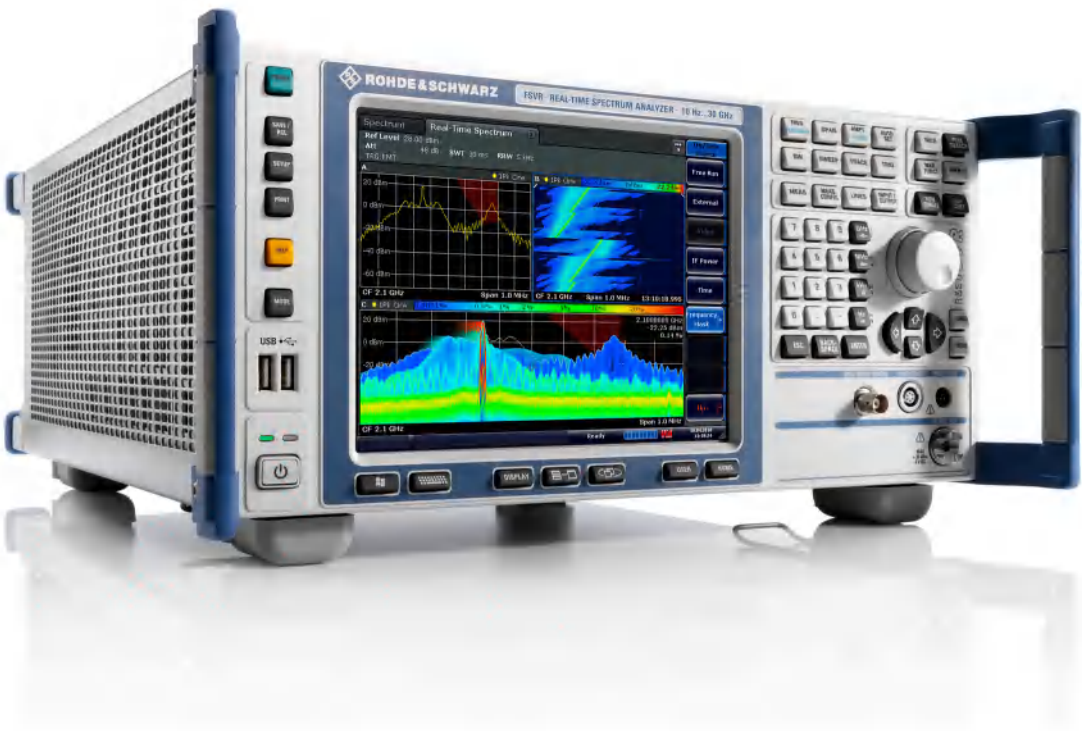

1311.0687.32 – 06

This manual covers the following products:

- R&S FSVR7 (1311.0006K07)
- R&S FSVR13 (1311.0006K13)
- R&S FSVR30 (1311.0006K30)
- R&S FSVR40 (1311.0006K40)
- R&S FSV-B17 (1310.9568.02)
- R&S FSV-B21 (1310.9597.02)
- R&S FSV-K7S (1310.8126.02)
- R&S FSV-K9 (1310.8203.02)

The contents of this manual correspond to firmware version 2.23 or higher.

The software contained in this product makes use of several valuable open source software packages. For information, see the "Open Source Acknowledgement" on the user documentation CD-ROM (included in delivery).

Rohde & Schwarz would like to thank the open source community for their valuable contribution to embedded computing.

© 2015 Rohde & Schwarz GmbH & Co. KG

Mühlhofstr. 15, 81671 München, Germany

Phone: +49 89 41 29 - 0

Fax: +49 89 41 29 12 164

Email: info@rohde-schwarz.com

Internet: www.rohde-schwarz.com

Subject to change – Data without tolerance limits is not binding.

R&S® is a registered trademark of Rohde & Schwarz GmbH & Co. KG.

Trade names are trademarks of the owners.

The following abbreviations are used throughout this manual: R&S®FSVR is abbreviated as R&S FSVR.

Basic Safety Instructions

Always read through and comply with the following safety instructions!

All plants and locations of the Rohde & Schwarz group of companies make every effort to keep the safety standards of our products up to date and to offer our customers the highest possible degree of safety. Our products and the auxiliary equipment they require are designed, built and tested in accordance with the safety standards that apply in each case. Compliance with these standards is continuously monitored by our quality assurance system. The product described here has been designed, built and tested in accordance with the EC Certificate of Conformity and has left the manufacturer's plant in a condition fully complying with safety standards. To maintain this condition and to ensure safe operation, you must observe all instructions and warnings provided in this manual. If you have any questions regarding these safety instructions, the Rohde & Schwarz group of companies will be happy to answer them.

Furthermore, it is your responsibility to use the product in an appropriate manner. This product is designed for use solely in industrial and laboratory environments or, if expressly permitted, also in the field and must not be used in any way that may cause personal injury or property damage. You are responsible if the product is used for any purpose other than its designated purpose or in disregard of the manufacturer's instructions. The manufacturer shall assume no responsibility for such use of the product.

The product is used for its designated purpose if it is used in accordance with its product documentation and within its performance limits (see data sheet, documentation, the following safety instructions). Using the product requires technical skills and, in some cases, a basic knowledge of English. It is therefore essential that only skilled and specialized staff or thoroughly trained personnel with the required skills be allowed to use the product. If personal safety gear is required for using Rohde & Schwarz products, this will be indicated at the appropriate place in the product documentation. Keep the basic safety instructions and the product documentation in a safe place and pass them on to the subsequent users.

Observing the safety instructions will help prevent personal injury or damage of any kind caused by dangerous situations. Therefore, carefully read through and adhere to the following safety instructions before and when using the product. It is also absolutely essential to observe the additional safety instructions on personal safety, for example, that appear in relevant parts of the product documentation. In these safety instructions, the word "product" refers to all merchandise sold and distributed by the Rohde & Schwarz group of companies, including instruments, systems and all accessories. For product-specific information, see the data sheet and the product documentation.

Safety labels on products

The following safety labels are used on products to warn against risks and dangers.

Symbol	Meaning	Symbol	Meaning
	Notice, general danger location Observe product documentation		ON/OFF Power
	Caution when handling heavy equipment		Standby indication
	Danger of electric shock		Direct current (DC)

Basic Safety Instructions

Symbol	Meaning	Symbol	Meaning
	Caution ! Hot surface		Alternating current (AC)
	Protective conductor terminal To identify any terminal which is intended for connection to an external conductor for protection against electric shock in case of a fault, or the terminal of a protective earth		Direct/alternating current (DC/AC)
	Earth (Ground)		Class II Equipment to identify equipment meeting the safety requirements specified for Class II equipment (device protected by double or reinforced insulation)
	Frame or chassis Ground terminal		EU labeling for batteries and accumulators For additional information, see section "Waste disposal/Environmental protection", item 1.
	Be careful when handling electrostatic sensitive devices		EU labeling for separate collection of electrical and electronic devices For additional information, see section "Waste disposal/Environmental protection", item 2.
	Warning! Laser radiation For additional information, see section "Operation", item 7.		

Signal words and their meaning

The following signal words are used in the product documentation in order to warn the reader about risks and dangers.



Indicates a hazardous situation which, if not avoided, will result in death or serious injury.



Indicates a hazardous situation which, if not avoided, could result in death or serious injury.



Indicates a hazardous situation which, if not avoided, could result in minor or moderate injury.



Indicates information considered important, but not hazard-related, e.g. messages relating to property damage.
In the product documentation, the word ATTENTION is used synonymously.

These signal words are in accordance with the standard definition for civil applications in the European Economic Area. Definitions that deviate from the standard definition may also exist in other economic areas or military applications. It is therefore essential to make sure that the signal words described here are always used only in connection with the related product documentation and the related product. The use of signal words in connection with unrelated products or documentation can result in misinterpretation and in personal injury or material damage.

Basic Safety Instructions

Operating states and operating positions

The product may be operated only under the operating conditions and in the positions specified by the manufacturer, without the product's ventilation being obstructed. If the manufacturer's specifications are not observed, this can result in electric shock, fire and/or serious personal injury or death. Applicable local or national safety regulations and rules for the prevention of accidents must be observed in all work performed.

1. Unless otherwise specified, the following requirements apply to Rohde & Schwarz products: predefined operating position is always with the housing floor facing down, IP protection 2X, use only indoors, max. operating altitude 2000 m above sea level, max. transport altitude 4500 m above sea level. A tolerance of $\pm 10\%$ shall apply to the nominal voltage and $\pm 5\%$ to the nominal frequency, overvoltage category 2, pollution degree 2.
2. Do not place the product on surfaces, vehicles, cabinets or tables that for reasons of weight or stability are unsuitable for this purpose. Always follow the manufacturer's installation instructions when installing the product and fastening it to objects or structures (e.g. walls and shelves). An installation that is not carried out as described in the product documentation could result in personal injury or even death.
3. Do not place the product on heat-generating devices such as radiators or fan heaters. The ambient temperature must not exceed the maximum temperature specified in the product documentation or in the data sheet. Product overheating can cause electric shock, fire and/or serious personal injury or even death.

Electrical safety

If the information on electrical safety is not observed either at all or to the extent necessary, electric shock, fire and/or serious personal injury or death may occur.

1. Prior to switching on the product, always ensure that the nominal voltage setting on the product matches the nominal voltage of the mains-supply network. If a different voltage is to be set, the power fuse of the product may have to be changed accordingly.
2. In the case of products of safety class I with movable power cord and connector, operation is permitted only on sockets with a protective conductor contact and protective conductor.
3. Intentionally breaking the protective conductor either in the feed line or in the product itself is not permitted. Doing so can result in the danger of an electric shock from the product. If extension cords or connector strips are implemented, they must be checked on a regular basis to ensure that they are safe to use.
4. If there is no power switch for disconnecting the product from the mains, or if the power switch is not suitable for this purpose, use the plug of the connecting cable to disconnect the product from the mains. In such cases, always ensure that the power plug is easily reachable and accessible at all times. For example, if the power plug is the disconnecting device, the length of the connecting cable must not exceed 3 m. Functional or electronic switches are not suitable for providing disconnection from the AC supply network. If products without power switches are integrated into racks or systems, the disconnecting device must be provided at the system level.
5. Never use the product if the power cable is damaged. Check the power cables on a regular basis to ensure that they are in proper operating condition. By taking appropriate safety measures and carefully laying the power cable, ensure that the cable cannot be damaged and that no one can be hurt by, for example, tripping over the cable or suffering an electric shock.

Basic Safety Instructions

6. The product may be operated only from TN/TT supply networks fuse-protected with max. 16 A (higher fuse only after consulting with the Rohde & Schwarz group of companies).
7. Do not insert the plug into sockets that are dusty or dirty. Insert the plug firmly and all the way into the socket provided for this purpose. Otherwise, sparks that result in fire and/or injuries may occur.
8. Do not overload any sockets, extension cords or connector strips; doing so can cause fire or electric shocks.
9. For measurements in circuits with voltages $V_{rms} > 30$ V, suitable measures (e.g. appropriate measuring equipment, fuse protection, current limiting, electrical separation, insulation) should be taken to avoid any hazards.
10. Ensure that the connections with information technology equipment, e.g. PCs or other industrial computers, comply with the IEC 60950-1 / EN 60950-1 or IEC 61010-1 / EN 61010-1 standards that apply in each case.
11. Unless expressly permitted, never remove the cover or any part of the housing while the product is in operation. Doing so will expose circuits and components and can lead to injuries, fire or damage to the product.
12. If a product is to be permanently installed, the connection between the protective conductor terminal on site and the product's protective conductor must be made first before any other connection is made. The product may be installed and connected only by a licensed electrician.
13. For permanently installed equipment without built-in fuses, circuit breakers or similar protective devices, the supply circuit must be fuse-protected in such a way that anyone who has access to the product, as well as the product itself, is adequately protected from injury or damage.
14. Use suitable overvoltage protection to ensure that no overvoltage (such as that caused by a bolt of lightning) can reach the product. Otherwise, the person operating the product will be exposed to the danger of an electric shock.
15. Any object that is not designed to be placed in the openings of the housing must not be used for this purpose. Doing so can cause short circuits inside the product and/or electric shocks, fire or injuries.
16. Unless specified otherwise, products are not liquid-proof (see also section "Operating states and operating positions", item 1). Therefore, the equipment must be protected against penetration by liquids. If the necessary precautions are not taken, the user may suffer electric shock or the product itself may be damaged, which can also lead to personal injury.
17. Never use the product under conditions in which condensation has formed or can form in or on the product, e.g. if the product has been moved from a cold to a warm environment. Penetration by water increases the risk of electric shock.
18. Prior to cleaning the product, disconnect it completely from the power supply (e.g. AC supply network or battery). Use a soft, non-linting cloth to clean the product. Never use chemical cleaning agents such as alcohol, acetone or diluents for cellulose lacquers.

Operation

1. Operating the products requires special training and intense concentration. Make sure that persons who use the products are physically, mentally and emotionally fit enough to do so; otherwise, injuries or material damage may occur. It is the responsibility of the employer/operator to select suitable personnel for operating the products.

Basic Safety Instructions

2. Before you move or transport the product, read and observe the section titled "Transport".
3. As with all industrially manufactured goods, the use of substances that induce an allergic reaction (allergens) such as nickel cannot be generally excluded. If you develop an allergic reaction (such as a skin rash, frequent sneezing, red eyes or respiratory difficulties) when using a Rohde & Schwarz product, consult a physician immediately to determine the cause and to prevent health problems or stress.
4. Before you start processing the product mechanically and/or thermally, or before you take it apart, be sure to read and pay special attention to the section titled "Waste disposal/Environmental protection", item 1.
5. Depending on the function, certain products such as RF radio equipment can produce an elevated level of electromagnetic radiation. Considering that unborn babies require increased protection, pregnant women must be protected by appropriate measures. Persons with pacemakers may also be exposed to risks from electromagnetic radiation. The employer/operator must evaluate workplaces where there is a special risk of exposure to radiation and, if necessary, take measures to avert the potential danger.
6. Should a fire occur, the product may release hazardous substances (gases, fluids, etc.) that can cause health problems. Therefore, suitable measures must be taken, e.g. protective masks and protective clothing must be worn.
7. Laser products are given warning labels that are standardized according to their laser class. Lasers can cause biological harm due to the properties of their radiation and due to their extremely concentrated electromagnetic power. If a laser product (e.g. a CD/DVD drive) is integrated into a Rohde & Schwarz product, absolutely no other settings or functions may be used as described in the product documentation. The objective is to prevent personal injury (e.g. due to laser beams).
8. EMC classes (in line with EN 55011/CISPR 11, and analogously with EN 55022/CISPR 22, EN 55032/CISPR 32)
 - Class A equipment:
Equipment suitable for use in all environments except residential environments and environments that are directly connected to a low-voltage supply network that supplies residential buildings
Note: Class A equipment is intended for use in an industrial environment. This equipment may cause radio disturbances in residential environments, due to possible conducted as well as radiated disturbances. In this case, the operator may be required to take appropriate measures to eliminate these disturbances.
 - Class B equipment:
Equipment suitable for use in residential environments and environments that are directly connected to a low-voltage supply network that supplies residential buildings

Repair and service

1. The product may be opened only by authorized, specially trained personnel. Before any work is performed on the product or before the product is opened, it must be disconnected from the AC supply network. Otherwise, personnel will be exposed to the risk of an electric shock.

Basic Safety Instructions

- Adjustments, replacement of parts, maintenance and repair may be performed only by electrical experts authorized by Rohde & Schwarz. Only original parts may be used for replacing parts relevant to safety (e.g. power switches, power transformers, fuses). A safety test must always be performed after parts relevant to safety have been replaced (visual inspection, protective conductor test, insulation resistance measurement, leakage current measurement, functional test). This helps ensure the continued safety of the product.

Batteries and rechargeable batteries/cells

If the information regarding batteries and rechargeable batteries/cells is not observed either at all or to the extent necessary, product users may be exposed to the risk of explosions, fire and/or serious personal injury, and, in some cases, death. Batteries and rechargeable batteries with alkaline electrolytes (e.g. lithium cells) must be handled in accordance with the EN 62133 standard.

- Cells must not be taken apart or crushed.
- Cells or batteries must not be exposed to heat or fire. Storage in direct sunlight must be avoided. Keep cells and batteries clean and dry. Clean soiled connectors using a dry, clean cloth.
- Cells or batteries must not be short-circuited. Cells or batteries must not be stored in a box or in a drawer where they can short-circuit each other, or where they can be short-circuited by other conductive materials. Cells and batteries must not be removed from their original packaging until they are ready to be used.
- Cells and batteries must not be exposed to any mechanical shocks that are stronger than permitted.
- If a cell develops a leak, the fluid must not be allowed to come into contact with the skin or eyes. If contact occurs, wash the affected area with plenty of water and seek medical aid.
- Improperly replacing or charging cells or batteries that contain alkaline electrolytes (e.g. lithium cells) can cause explosions. Replace cells or batteries only with the matching Rohde & Schwarz type (see parts list) in order to ensure the safety of the product.
- Cells and batteries must be recycled and kept separate from residual waste. Rechargeable batteries and normal batteries that contain lead, mercury or cadmium are hazardous waste. Observe the national regulations regarding waste disposal and recycling.

Transport

- The product may be very heavy. Therefore, the product must be handled with care. In some cases, the user may require a suitable means of lifting or moving the product (e.g. with a lift-truck) to avoid back or other physical injuries.
- Handles on the products are designed exclusively to enable personnel to transport the product. It is therefore not permissible to use handles to fasten the product to or on transport equipment such as cranes, fork lifts, wagons, etc. The user is responsible for securely fastening the products to or on the means of transport or lifting. Observe the safety regulations of the manufacturer of the means of transport or lifting. Noncompliance can result in personal injury or material damage.
- If you use the product in a vehicle, it is the sole responsibility of the driver to drive the vehicle safely and properly. The manufacturer assumes no responsibility for accidents or collisions. Never use the product in a moving vehicle if doing so could distract the driver of the vehicle. Adequately secure the product in the vehicle to prevent injuries or other damage in the event of an accident.

Instrucciones de seguridad elementales

Waste disposal/Environmental protection

1. Specially marked equipment has a battery or accumulator that must not be disposed of with unsorted municipal waste, but must be collected separately. It may only be disposed of at a suitable collection point or via a Rohde & Schwarz customer service center.
2. Waste electrical and electronic equipment must not be disposed of with unsorted municipal waste, but must be collected separately.
Rohde & Schwarz GmbH & Co. KG has developed a disposal concept and takes full responsibility for take-back obligations and disposal obligations for manufacturers within the EU. Contact your Rohde & Schwarz customer service center for environmentally responsible disposal of the product.
3. If products or their components are mechanically and/or thermally processed in a manner that goes beyond their intended use, hazardous substances (heavy-metal dust such as lead, beryllium, nickel) may be released. For this reason, the product may only be disassembled by specially trained personnel. Improper disassembly may be hazardous to your health. National waste disposal regulations must be observed.
4. If handling the product releases hazardous substances or fuels that must be disposed of in a special way, e.g. coolants or engine oils that must be replenished regularly, the safety instructions of the manufacturer of the hazardous substances or fuels and the applicable regional waste disposal regulations must be observed. Also observe the relevant safety instructions in the product documentation. The improper disposal of hazardous substances or fuels can cause health problems and lead to environmental damage.

For additional information about environmental protection, visit the Rohde & Schwarz website.

Instrucciones de seguridad elementales

¡Es imprescindible leer y cumplir las siguientes instrucciones e informaciones de seguridad!

El principio del grupo de empresas Rohde & Schwarz consiste en tener nuestros productos siempre al día con los estándares de seguridad y de ofrecer a nuestros clientes el máximo grado de seguridad. Nuestros productos y todos los equipos adicionales son siempre fabricados y examinados según las normas de seguridad vigentes. Nuestro sistema de garantía de calidad controla constantemente que sean cumplidas estas normas. El presente producto ha sido fabricado y examinado según el certificado de conformidad de la UE y ha salido de nuestra planta en estado impecable según los estándares técnicos de seguridad. Para poder preservar este estado y garantizar un funcionamiento libre de peligros, el usuario deberá atenerse a todas las indicaciones, informaciones de seguridad y notas de alerta. El grupo de empresas Rohde & Schwarz está siempre a su disposición en caso de que tengan preguntas referentes a estas informaciones de seguridad.

Además queda en la responsabilidad del usuario utilizar el producto en la forma debida. Este producto está destinado exclusivamente al uso en la industria y el laboratorio o, si ha sido expresamente autorizado, para aplicaciones de campo y de ninguna manera deberá ser utilizado de modo que alguna persona/cosa pueda sufrir daño. El uso del producto fuera de sus fines definidos o sin tener en cuenta las instrucciones del fabricante queda en la responsabilidad del usuario. El fabricante no se hace en ninguna forma responsable de consecuencias a causa del mal uso del producto.

Instrucciones de seguridad elementales

Se parte del uso correcto del producto para los fines definidos si el producto es utilizado conforme a las indicaciones de la correspondiente documentación del producto y dentro del margen de rendimiento definido (ver hoja de datos, documentación, informaciones de seguridad que siguen). El uso del producto hace necesarios conocimientos técnicos y ciertos conocimientos del idioma inglés. Por eso se debe tener en cuenta que el producto solo pueda ser operado por personal especializado o personas instruidas en profundidad con las capacidades correspondientes. Si fuera necesaria indumentaria de seguridad para el uso de productos de Rohde & Schwarz, encontraría la información debida en la documentación del producto en el capítulo correspondiente. Guarde bien las informaciones de seguridad elementales, así como la documentación del producto, y entréguelas a usuarios posteriores.

Tener en cuenta las informaciones de seguridad sirve para evitar en lo posible lesiones o daños por peligros de toda clase. Por eso es imprescindible leer detalladamente y comprender por completo las siguientes informaciones de seguridad antes de usar el producto, y respetarlas durante el uso del producto. Deberán tenerse en cuenta todas las demás informaciones de seguridad, como p. ej. las referentes a la protección de personas, que encontrarán en el capítulo correspondiente de la documentación del producto y que también son de obligado cumplimiento. En las presentes informaciones de seguridad se recogen todos los objetos que distribuye el grupo de empresas Rohde & Schwarz bajo la denominación de "producto", entre ellos también aparatos, instalaciones así como toda clase de accesorios. Los datos específicos del producto figuran en la hoja de datos y en la documentación del producto.

Señalización de seguridad de los productos

Las siguientes señales de seguridad se utilizan en los productos para advertir sobre riesgos y peligros.

Símbolo	Significado	Símbolo	Significado
	Aviso: punto de peligro general Observar la documentación del producto		Tensión de alimentación de PUESTA EN MARCHA / PARADA
	Atención en el manejo de dispositivos de peso elevado		Indicación de estado de espera (standby)
	Peligro de choque eléctrico		Corriente continua (DC)
	Advertencia: superficie caliente		Corriente alterna (AC)
	Conexión a conductor de protección		Corriente continua / Corriente alterna (DC/AC)
	Conexión a tierra		El aparato está protegido en su totalidad por un aislamiento doble (reforzado)
	Conexión a masa		Distintivo de la UE para baterías y acumuladores Más información en la sección "Eliminación/protección del medio ambiente", punto 1.

Instrucciones de seguridad elementales

Símbolo	Significado	Símbolo	Significado
	Aviso: Cuidado en el manejo de dispositivos sensibles a la electrostática (ESD)		Distintivo de la UE para la eliminación por separado de dispositivos eléctricos y electrónicos Más información en la sección "Eliminación/protección del medio ambiente", punto 2.
	Advertencia: rayo láser Más información en la sección "Funcionamiento", punto 7.		

Palabras de señal y su significado

En la documentación del producto se utilizan las siguientes palabras de señal con el fin de advertir contra riesgos y peligros.



Indica una situación de peligro que, si no se evita, causa lesiones graves o incluso la muerte.



Indica una situación de peligro que, si no se evita, puede causar lesiones graves o incluso la muerte.



Indica una situación de peligro que, si no se evita, puede causar lesiones leves o moderadas.



Indica información que se considera importante, pero no en relación con situaciones de peligro; p. ej., avisos sobre posibles daños materiales.

En la documentación del producto se emplea de forma sinónima el término CUIDADO.

Las palabras de señal corresponden a la definición habitual para aplicaciones civiles en el área económica europea. Pueden existir definiciones diferentes a esta definición en otras áreas económicas o en aplicaciones militares. Por eso se deberá tener en cuenta que las palabras de señal aquí descritas sean utilizadas siempre solamente en combinación con la correspondiente documentación del producto y solamente en combinación con el producto correspondiente. La utilización de las palabras de señal en combinación con productos o documentaciones que no les correspondan puede llevar a interpretaciones equivocadas y tener por consecuencia daños en personas u objetos.

Estados operativos y posiciones de funcionamiento

El producto solamente debe ser utilizado según lo indicado por el fabricante respecto a los estados operativos y posiciones de funcionamiento sin que se obstruya la ventilación. Si no se siguen las indicaciones del fabricante, pueden producirse choques eléctricos, incendios y/o lesiones graves con posible consecuencia de muerte. En todos los trabajos deberán ser tenidas en cuenta las normas nacionales y locales de seguridad del trabajo y de prevención de accidentes.

Instrucciones de seguridad elementales

1. Si no se convino de otra manera, es para los productos Rohde & Schwarz válido lo que sigue: como posición de funcionamiento se define por principio la posición con el suelo de la caja para abajo, modo de protección IP 2X, uso solamente en estancias interiores, utilización hasta 2000 m sobre el nivel del mar, transporte hasta 4500 m sobre el nivel del mar. Se aplicará una tolerancia de $\pm 10\%$ sobre el voltaje nominal y de $\pm 5\%$ sobre la frecuencia nominal. Categoría de sobrecarga eléctrica 2, índice de suciedad 2.
2. No sitúe el producto encima de superficies, vehículos, estantes o mesas, que por sus características de peso o de estabilidad no sean aptos para él. Siga siempre las instrucciones de instalación del fabricante cuando instale y asegure el producto en objetos o estructuras (p. ej. paredes y estantes). Si se realiza la instalación de modo distinto al indicado en la documentación del producto, se pueden causar lesiones o, en determinadas circunstancias, incluso la muerte.
3. No ponga el producto sobre aparatos que generen calor (p. ej. radiadores o calefactores). La temperatura ambiente no debe superar la temperatura máxima especificada en la documentación del producto o en la hoja de datos. En caso de sobrecalentamiento del producto, pueden producirse choques eléctricos, incendios y/o lesiones graves con posible consecuencia de muerte.

Seguridad eléctrica

Si no se siguen (o se siguen de modo insuficiente) las indicaciones del fabricante en cuanto a seguridad eléctrica, pueden producirse choques eléctricos, incendios y/o lesiones graves con posible consecuencia de muerte.

1. Antes de la puesta en marcha del producto se deberá comprobar siempre que la tensión preseleccionada en el producto coincida con la de la red de alimentación eléctrica. Si es necesario modificar el ajuste de tensión, también se deberán cambiar en caso dado los fusibles correspondientes del producto.
2. Los productos de la clase de protección I con alimentación móvil y enchufe individual solamente podrán enchufarse a tomas de corriente con contacto de seguridad y con conductor de protección conectado.
3. Queda prohibida la interrupción intencionada del conductor de protección, tanto en la toma de corriente como en el mismo producto. La interrupción puede tener como consecuencia el riesgo de que el producto sea fuente de choques eléctricos. Si se utilizan cables alargadores o regletas de enchufe, deberá garantizarse la realización de un examen regular de los mismos en cuanto a su estado técnico de seguridad.
4. Si el producto no está equipado con un interruptor para desconectarlo de la red, o bien si el interruptor existente no resulta apropiado para la desconexión de la red, el enchufe del cable de conexión se deberá considerar como un dispositivo de desconexión. El dispositivo de desconexión se debe poder alcanzar fácilmente y debe estar siempre bien accesible. Si, p. ej., el enchufe de conexión a la red es el dispositivo de desconexión, la longitud del cable de conexión no debe superar 3 m). Los interruptores selectores o electrónicos no son aptos para el corte de la red eléctrica. Si se integran productos sin interruptor en bastidores o instalaciones, se deberá colocar el interruptor en el nivel de la instalación.
5. No utilice nunca el producto si está dañado el cable de conexión a red. Compruebe regularmente el correcto estado de los cables de conexión a red. Asegúrese, mediante las medidas de protección y de instalación adecuadas, de que el cable de conexión a red no pueda ser dañado o de que nadie pueda ser dañado por él, p. ej. al tropezar o por un choque eléctrico.

Instrucciones de seguridad elementales

6. Solamente está permitido el funcionamiento en redes de alimentación TN/TT aseguradas con fusibles de 16 A como máximo (utilización de fusibles de mayor amperaje solo previa consulta con el grupo de empresas Rohde & Schwarz).
7. Nunca conecte el enchufe en tomas de corriente sucias o llenas de polvo. Introduzca el enchufe por completo y fuertemente en la toma de corriente. La no observación de estas medidas puede provocar chispas, fuego y/o lesiones.
8. No sobrecargue las tomas de corriente, los cables alargadores o las regletas de enchufe ya que esto podría causar fuego o choques eléctricos.
9. En las mediciones en circuitos de corriente con una tensión $U_{\text{eff}} > 30 \text{ V}$ se deberán tomar las medidas apropiadas para impedir cualquier peligro (p. ej. medios de medición adecuados, seguros, limitación de tensión, corte protector, aislamiento etc.).
10. Para la conexión con dispositivos informáticos como un PC o un ordenador industrial, debe comprobarse que éstos cumplan los estándares IEC60950-1/EN60950-1 o IEC61010-1/EN 61010-1 válidos en cada caso.
11. A menos que esté permitido expresamente, no retire nunca la tapa ni componentes de la carcasa mientras el producto esté en servicio. Esto pone a descubierto los cables y componentes eléctricos y puede causar lesiones, fuego o daños en el producto.
12. Si un producto se instala en un lugar fijo, se deberá primero conectar el conductor de protección fijo con el conductor de protección del producto antes de hacer cualquier otra conexión. La instalación y la conexión deberán ser efectuadas por un electricista especializado.
13. En el caso de dispositivos fijos que no estén provistos de fusibles, interruptor automático ni otros mecanismos de seguridad similares, el circuito de alimentación debe estar protegido de modo que todas las personas que puedan acceder al producto, así como el producto mismo, estén a salvo de posibles daños.
14. Todo producto debe estar protegido contra sobretensión (debida p. ej. a una caída del rayo) mediante los correspondientes sistemas de protección. Si no, el personal que lo utilice quedará expuesto al peligro de choque eléctrico.
15. No debe introducirse en los orificios de la caja del aparato ningún objeto que no esté destinado a ello. Esto puede producir cortocircuitos en el producto y/o puede causar choques eléctricos, fuego o lesiones.
16. Salvo indicación contraria, los productos no están impermeabilizados (ver también el capítulo "Estados operativos y posiciones de funcionamiento", punto 1). Por eso es necesario tomar las medidas necesarias para evitar la entrada de líquidos. En caso contrario, existe peligro de choque eléctrico para el usuario o de daños en el producto, que también pueden redundar en peligro para las personas.
17. No utilice el producto en condiciones en las que pueda producirse o ya se hayan producido condensaciones sobre el producto o en el interior de éste, como p. ej. al desplazarlo de un lugar frío a otro caliente. La entrada de agua aumenta el riesgo de choque eléctrico.
18. Antes de la limpieza, desconecte por completo el producto de la alimentación de tensión (p. ej. red de alimentación o batería). Realice la limpieza de los aparatos con un paño suave, que no se deshilache. No utilice bajo ningún concepto productos de limpieza químicos como alcohol, acetona o diluyentes para lacas nitrocelulósicas.

Instrucciones de seguridad elementales

Funcionamiento

1. El uso del producto requiere instrucciones especiales y una alta concentración durante el manejo. Debe asegurarse que las personas que manejen el producto estén a la altura de los requerimientos necesarios en cuanto a aptitudes físicas, psíquicas y emocionales, ya que de otra manera no se pueden excluir lesiones o daños de objetos. El empresario u operador es responsable de seleccionar el personal usuario apto para el manejo del producto.
2. Antes de desplazar o transportar el producto, lea y tenga en cuenta el capítulo "Transporte".
3. Como con todo producto de fabricación industrial no puede quedar excluida en general la posibilidad de que se produzcan alergias provocadas por algunos materiales empleados —los llamados alérgenos (p. ej. el níquel)—. Si durante el manejo de productos Rohde & Schwarz se producen reacciones alérgicas, como p. ej. irritaciones cutáneas, estornudos continuos, enrojecimiento de la conjuntiva o dificultades respiratorias, debe avisarse inmediatamente a un médico para investigar las causas y evitar cualquier molestia o daño a la salud.
4. Antes de la manipulación mecánica y/o térmica o el desmontaje del producto, debe tenerse en cuenta imprescindiblemente el capítulo "Eliminación/protección del medio ambiente", punto 1.
5. Ciertos productos, como p. ej. las instalaciones de radiocomunicación RF, pueden a causa de su función natural, emitir una radiación electromagnética aumentada. Deben tomarse todas las medidas necesarias para la protección de las mujeres embarazadas. También las personas con marcapasos pueden correr peligro a causa de la radiación electromagnética. El empresario/operador tiene la obligación de evaluar y señalar las áreas de trabajo en las que exista un riesgo elevado de exposición a radiaciones.
6. Tenga en cuenta que en caso de incendio pueden desprenderse del producto sustancias tóxicas (gases, líquidos etc.) que pueden generar daños a la salud. Por eso, en caso de incendio deben usarse medidas adecuadas, como p. ej. máscaras antigás e indumentaria de protección.
7. Los productos con láser están provistos de indicaciones de advertencia normalizadas en función de la clase de láser del que se trate. Los rayos láser pueden provocar daños de tipo biológico a causa de las propiedades de su radiación y debido a su concentración extrema de potencia electromagnética. En caso de que un producto Rohde & Schwarz contenga un producto láser (p. ej. un lector de CD/DVD), no debe usarse ninguna otra configuración o función aparte de las descritas en la documentación del producto, a fin de evitar lesiones (p. ej. debidas a irradiación láser).
8. Clases de compatibilidad electromagnética (conforme a EN 55011 / CISPR 11; y en analogía con EN 55022 / CISPR 22, EN 55032 / CISPR 32)
 - Aparato de clase A:
Aparato adecuado para su uso en todos los entornos excepto en los residenciales y en aquellos conectados directamente a una red de distribución de baja tensión que suministra corriente a edificios residenciales.
Nota: Los aparatos de clase A están destinados al uso en entornos industriales. Estos aparatos pueden causar perturbaciones radioeléctricas en entornos residenciales debido a posibles perturbaciones guiadas o radiadas. En este caso, se le podrá solicitar al operador que tome las medidas adecuadas para eliminar estas perturbaciones.
 - Aparato de clase B:
Aparato adecuado para su uso en entornos residenciales, así como en aquellos conectados directamente a una red de distribución de baja tensión que suministra corriente a edificios residenciales.

Instrucciones de seguridad elementales

Reparación y mantenimiento

1. El producto solamente debe ser abierto por personal especializado con autorización para ello. Antes de manipular el producto o abrirlo, es obligatorio desconectarlo de la tensión de alimentación, para evitar toda posibilidad de choque eléctrico.
2. El ajuste, el cambio de partes, el mantenimiento y la reparación deberán ser efectuadas solamente por electricistas autorizados por Rohde & Schwarz. Si se reponen partes con importancia para los aspectos de seguridad (p. ej. el enchufe, los transformadores o los fusibles), solamente podrán ser sustituidos por partes originales. Después de cada cambio de partes relevantes para la seguridad deberá realizarse un control de seguridad (control a primera vista, control del conductor de protección, medición de resistencia de aislamiento, medición de la corriente de fuga, control de funcionamiento). Con esto queda garantizada la seguridad del producto.

Baterías y acumuladores o celdas

Si no se siguen (o se siguen de modo insuficiente) las indicaciones en cuanto a las baterías y acumuladores o celdas, pueden producirse explosiones, incendios y/o lesiones graves con posible consecuencia de muerte. El manejo de baterías y acumuladores con electrolitos alcalinos (p. ej. celdas de litio) debe seguir el estándar EN 62133.

1. No deben desmontarse, abrirse ni triturarse las celdas.
2. Las celdas o baterías no deben someterse a calor ni fuego. Debe evitarse el almacenamiento a la luz directa del sol. Las celdas y baterías deben mantenerse limpias y secas. Limpiar las conexiones sucias con un paño seco y limpio.
3. Las celdas o baterías no deben cortocircuitarse. Es peligroso almacenar las celdas o baterías en estuches o cajones en cuyo interior puedan cortocircuitarse por contacto recíproco o por contacto con otros materiales conductores. No deben extraerse las celdas o baterías de sus embalajes originales hasta el momento en que vayan a utilizarse.
4. Las celdas o baterías no deben someterse a impactos mecánicos fuertes indebidos.
5. En caso de falta de estanqueidad de una celda, el líquido vertido no debe entrar en contacto con la piel ni los ojos. Si se produce contacto, lavar con agua abundante la zona afectada y avisar a un médico.
6. En caso de cambio o recarga inadecuados, las celdas o baterías que contienen electrolitos alcalinos (p. ej. las celdas de litio) pueden explotar. Para garantizar la seguridad del producto, las celdas o baterías solo deben ser sustituidas por el tipo Rohde & Schwarz correspondiente (ver lista de recambios).
7. Las baterías y celdas deben reciclarse y no deben tirarse a la basura doméstica. Las baterías o acumuladores que contienen plomo, mercurio o cadmio deben tratarse como residuos especiales. Respete en esta relación las normas nacionales de eliminación y reciclaje.

Transporte

1. El producto puede tener un peso elevado. Por eso es necesario desplazarlo o transportarlo con precaución y, si es necesario, usando un sistema de elevación adecuado (p. ej. una carretilla elevadora), a fin de evitar lesiones en la espalda u otros daños personales.

Instrucciones de seguridad elementales

2. Las asas instaladas en los productos sirven solamente de ayuda para el transporte del producto por personas. Por eso no está permitido utilizar las asas para la sujeción en o sobre medios de transporte como p. ej. grúas, carretillas elevadoras de horquilla, carros etc. Es responsabilidad suya fijar los productos de manera segura a los medios de transporte o elevación. Para evitar daños personales o daños en el producto, siga las instrucciones de seguridad del fabricante del medio de transporte o elevación utilizado.
3. Si se utiliza el producto dentro de un vehículo, recae de manera exclusiva en el conductor la responsabilidad de conducir el vehículo de manera segura y adecuada. El fabricante no asumirá ninguna responsabilidad por accidentes o colisiones. No utilice nunca el producto dentro de un vehículo en movimiento si esto pudiera distraer al conductor. Asegure el producto dentro del vehículo debidamente para evitar, en caso de un accidente, lesiones u otra clase de daños.

Eliminación/protección del medio ambiente

1. Los dispositivos marcados contienen una batería o un acumulador que no se debe desechar con los residuos domésticos sin clasificar, sino que debe ser recogido por separado. La eliminación se debe efectuar exclusivamente a través de un punto de recogida apropiado o del servicio de atención al cliente de Rohde & Schwarz.
2. Los dispositivos eléctricos usados no se deben desechar con los residuos domésticos sin clasificar, sino que deben ser recogidos por separado.
Rohde & Schwarz GmbH & Co.KG ha elaborado un concepto de eliminación de residuos y asume plenamente los deberes de recogida y eliminación para los fabricantes dentro de la UE. Para desechar el producto de manera respetuosa con el medio ambiente, dirijase a su servicio de atención al cliente de Rohde & Schwarz.
3. Si se trabaja de manera mecánica y/o térmica cualquier producto o componente más allá del funcionamiento previsto, pueden liberarse sustancias peligrosas (polvos con contenido de metales pesados como p. ej. plomo, berilio o níquel). Por eso el producto solo debe ser desmontado por personal especializado con formación adecuada. Un desmontaje inadecuado puede ocasionar daños para la salud. Se deben tener en cuenta las directivas nacionales referentes a la eliminación de residuos.
4. En caso de que durante el trato del producto se formen sustancias peligrosas o combustibles que deban tratarse como residuos especiales (p. ej. refrigerantes o aceites de motor con intervalos de cambio definidos), deben tenerse en cuenta las indicaciones de seguridad del fabricante de dichas sustancias y las normas regionales de eliminación de residuos. Tenga en cuenta también en caso necesario las indicaciones de seguridad especiales contenidas en la documentación del producto. La eliminación incorrecta de sustancias peligrosas o combustibles puede causar daños a la salud o daños al medio ambiente.

Se puede encontrar más información sobre la protección del medio ambiente en la página web de Rohde & Schwarz.

Quality management and environmental management

Certified Quality System
ISO 9001

Certified Environmental System
ISO 14001

Sehr geehrter Kunde,

Sie haben sich für den Kauf eines Rohde&Schwarz Produktes entschieden. Sie erhalten damit ein nach modernsten Fertigungsmethoden hergestelltes Produkt. Es wurde nach den Regeln unserer Qualitäts- und Umweltmanagementsysteme entwickelt, gefertigt und geprüft. Rohde&Schwarz ist unter anderem nach den Managementsystemen ISO9001 und ISO 14001 zertifiziert.

Der Umwelt verpflichtet

- Energie-effiziente, RoHS-konforme Produkte
- Kontinuierliche Weiterentwicklung nachhaltiger Umweltkonzepte
- ISO 14001-zertifiziertes Umweltmanagementsystem

Dear customer,

You have decided to buy a Rohde&Schwarz product. This product has been manufactured using the most advanced methods. It was developed, manufactured and tested in compliance with our quality management and environmental management systems. Rohde&Schwarz has been certified, for example, according to the ISO9001 and ISO 14001 management systems.

Environmental commitment

- Energy-efficient products
- Continuous improvement in environmental sustainability
- ISO 14001-certified environmental management system

Cher client,

Vous avez choisi d'acheter un produit Rohde&Schwarz. Vous disposez donc d'un produit fabriqué d'après les méthodes les plus avancées. Le développement, la fabrication et les tests de ce produit ont été effectués selon nos systèmes de management de qualité et de management environnemental. La société Rohde&Schwarz a été homologuée, entre autres, conformément aux systèmes de management ISO 9001 et ISO 14001.

Engagement écologique

- Produits à efficience énergétique
- Amélioration continue de la durabilité environnementale
- Système de management environnemental certifié selon ISO 14001



Customer Support

Technical support – where and when you need it

For quick, expert help with any Rohde & Schwarz equipment, contact one of our Customer Support Centers. A team of highly qualified engineers provides telephone support and will work with you to find a solution to your query on any aspect of the operation, programming or applications of Rohde & Schwarz equipment.

Up-to-date information and upgrades

To keep your instrument up-to-date and to be informed about new application notes related to your instrument, please send an e-mail to the Customer Support Center stating your instrument and your wish. We will take care that you will get the right information.

Europe, Africa, Middle East

Phone +49 89 4129 12345
customersupport@rohde-schwarz.com

North America

Phone 1-888-TEST-RSA (1-888-837-8772)
customer.support@rsa.rohde-schwarz.com

Latin America

Phone +1-410-910-7988
customersupport.la@rohde-schwarz.com

Asia/Pacific

Phone +65 65 13 04 88
customersupport.asia@rohde-schwarz.com

China

Phone +86-800-810-8228 /
+86-400-650-5896
customersupport.china@rohde-schwarz.com



Contents

1	Preface	5
1.1	Documentation Overview.....	5
1.2	Conventions Used in the Documentation.....	7
1.3	How to Use the Help System.....	8
2	Selecting the Measurement Mode	10
2.1	Measurement Mode Menus – HOME Key.....	10
2.2	Measurement Modes of the R&S FSVR.....	10
3	Using the Realtime Analyzer	15
3.1	Data Acquisition and Processing in a Realtime Analyzer.....	16
3.2	Selecting the Result Display.....	18
3.3	The Realtime Spectrum Result Display.....	19
3.4	The Spectrogram Result Display.....	21
3.5	The Persistence Spectrum Result Display.....	33
3.6	The Power vs Time Result Display.....	41
3.7	The Power vs Time Waterfall Result Display.....	43
3.8	Configuring Realtime Measurements.....	43
3.9	Using Markers.....	47
3.10	Triggering Measurements.....	49
4	Using the Spectrum Analyzer	56
4.1	Measurement Parameters.....	56
4.2	Measurement Functions.....	119
4.3	Using the Spectrogram in Spectrum Mode.....	276
4.4	Instrument Functions - I/Q Analyzer.....	277
4.5	Instrument Functions - Power Sensor (R&S FSV-K9).....	304
5	Using the Analog Demodulator	318
5.1	About the Analog Demodulator.....	318
5.2	Functions of the Analog Demodulator.....	334
5.3	Functions of the Stereo FM Demodulator.....	388
5.4	Information on Remote Control Commands.....	423
6	General Setup of the R&S FSVR	426

6.1	Instrument Setup and Interface Configuration – SETUP Key.....	426
6.2	Saving and Recalling Settings Files – SAVE/RCL Key.....	449
6.3	Manual Operation – Local Menu.....	464
6.4	Measurement Documentation – PRINT Key.....	464
6.5	User-Defined Menu – USER key.....	467
7	R&S FSVR Options.....	469
7.1	Instrument Functions - R&S Digital I/Q Interface (Option R&S FSV-B17).....	469
7.2	Instrument Functions – External Mixer (Option R&S FSV-B21).....	487
8	Remote Operation of the R&S FSVR.....	508
8.1	Remote Control - Basics.....	508
8.2	Remote Control – Commands.....	547
8.3	Remote Control – Programming Examples.....	1015
9	Maintenance.....	1058
9.1	Storing and Packing.....	1058
9.2	List of Available Power Cables.....	1058
10	Error Messages.....	1060
	List of Commands.....	1062
	Index.....	1081

1 Preface

1.1 Documentation Overview

The user documentation for the R&S FSVR is divided as follows:

- Quick Start Guide
- Operating Manuals for base unit and options
- Service Manual
- Online Help
- Release Notes

Quick Start Guide

This manual is delivered with the instrument in printed form and in PDF format on the CD. It provides the information needed to set up and start working with the instrument. Basic operations and basic measurements are described. Also a brief introduction to remote control is given. The manual includes general information (e.g. Safety Instructions) and the following chapters:

Chapter 1	Introduction, General information
Chapter 2	Front and Rear Panel
Chapter 3	Preparing for Use
Chapter 4	Firmware Update and Installation of Firmware Options
Chapter 5	Basic Operations
Chapter 6	Basic Measurement Examples
Chapter 7	Brief Introduction to Remote Control
Appendix	Printer Interface
Appendix	LAN Interface

Operating Manuals

The Operating Manuals are a supplement to the Quick Start Guide. Operating Manuals are provided for the base unit and each additional (software) option.

The Operating Manual for the base unit provides basic information on operating the R&S FSVR in general, and the "Spectrum" mode in particular. Furthermore, the software options that enhance the basic functionality for various measurement modes are described here. The set of measurement examples in the Quick Start Guide is expanded by more advanced measurement examples. In addition to the brief introduction to remote control in the Quick Start Guide, a description of the basic analyzer commands and programming examples is given. Information on maintenance, instrument interfaces and error messages is also provided.

In the individual option manuals, the specific instrument functions of the option are described in detail. For additional information on default settings and parameters, refer to the data sheets. Basic information on operating the R&S FSVR is not included in the option manuals.

The following Operating Manuals are available for the R&S FSVR:

- R&S FSVR base unit; in addition:
 - R&S FSV-K7S Stereo FM Measurements
 - R&S FSV-K9 Power Sensor Support
 - R&S FSV-K14 Spectrogram Measurement
- R&S FSV-K10 GSM/EDGE Measurement
- R&S FSV-K30 Noise Figure Measurement
- R&S FSV-K40 Phase Noise Measurement
- R&S FSV-K70 Vector Signal Analysis Operating Manual
R&S FSV-K70 Vector Signal Analysis Getting Started (First measurements)
- R&S FSV-K72 3GPP FDD BTS Analysis
- R&S FSV-K73 3GPP FDD UE Analysis
- R&S FSV-K76/77 3GPP TD-SCDMA BTS/UE Measurement
- R&S FSV-K82/83 CDMA2000 BTS/MS Analysis
- R&S FSV-K84/85 1xEV-DO BTS/MS Analysis
- R&S FSV-K91 WLAN IEEE 802.11
- R&S FSV-K93 WiMAX IEEE 802.16 OFDM/OFDMA Analysis
- R&S FSV-K100/K104 EUTRA / LTE Downlink Measurement Application
- R&S FSV-K101/K105 EUTRA / LTE Uplink Measurement Application

These manuals are available in PDF format on the CD delivered with the instrument.

Service Manual

This manual is available in PDF format on the CD delivered with the instrument. It describes how to check compliance with rated specifications, instrument function, repair, troubleshooting and fault elimination. It contains all information required for repairing the R&S FSVR by replacing modules. The manual includes the following chapters:

Chapter 1	Performance Test
Chapter 2	Adjustment
Chapter 3	Repair
Chapter 4	Software Update / Installing Options
Chapter 5	Documents

Online Help

The online help contains context-specific help on operating the R&S FSVR and all available options. It describes both manual and remote operation. The online help is

installed on the R&S FSVR by default, and is also available as an executable .chm file on the CD delivered with the instrument.

Release Notes

The release notes describe the installation of the firmware, new and modified functions, eliminated problems, and last minute changes to the documentation. The corresponding firmware version is indicated on the title page of the release notes. The current release notes are provided in the Internet.

1.2 Conventions Used in the Documentation

1.2.1 Typographical Conventions

The following text markers are used throughout this documentation:

Convention	Description
"Graphical user interface elements"	All names of graphical user interface elements on the screen, such as dialog boxes, menus, options, buttons, and softkeys are enclosed by quotation marks.
KEYS	Key names are written in capital letters.
File names, commands, program code	File names, commands, coding samples and screen output are distinguished by their font.
<i>Input</i>	Input to be entered by the user is displayed in italics.
Links	Links that you can click are displayed in blue font.
"References"	References to other parts of the documentation are enclosed by quotation marks.

1.2.2 Conventions for Procedure Descriptions

When describing how to operate the instrument, several alternative methods may be available to perform the same task. In this case, the procedure using the touchscreen is described. Any elements that can be activated by touching can also be clicked using an additionally connected mouse. The alternative procedure using the keys on the instrument or the on-screen keyboard is only described if it deviates from the standard operating procedures.

The term "select" may refer to any of the described methods, i.e. using a finger on the touchscreen, a mouse pointer in the display, or a key on the instrument or on a keyboard.

1.2.3 Notes on Screenshots

When describing the functions of the product, we use sample screenshots. These screenshots are meant to illustrate as much as possible of the provided functions and possible interdependencies between parameters.

The screenshots usually show a fully equipped product, that is: with all options installed. Thus, some functions shown in the screenshots may not be available in your particular product configuration.

1.3 How to Use the Help System

Calling context-sensitive and general help

- ▶ To display the general help dialog box, press the HELP key on the front panel. The help dialog box "View" tab is displayed. A topic containing information about the current menu or the currently opened dialog box and its function is displayed.



For standard Windows dialog boxes (e.g. File Properties, Print dialog etc.), no context-sensitive help is available.

-
- ▶ If the help is already displayed, press the softkey for which you want to display help. A topic containing information about the softkey and its function is displayed.



If a softkey opens a submenu and you press the softkey a second time, the submenu of the softkey is displayed.

Contents of the help dialog box

The help dialog box contains four tabs:

- "Contents" - contains a table of help contents
- "View" - contains a specific help topic
- "Index" - contains index entries to search for help topics
- "Zoom" - contains zoom functions for the help display

To change between these tabs, press the tab on the touchscreen.

Navigating in the table of contents

- To move through the displayed contents entries, use the UP ARROW and DOWN ARROW keys. Entries that contain further entries are marked with a plus sign.
- To display a help topic, press the ENTER key. The "View" tab with the corresponding help topic is displayed.

- To change to the next tab, press the tab on the touchscreen.

Navigating in the help topics

- To scroll through a page, use the rotary knob or the UP ARROW and DOWN ARROW keys.
- To jump to the linked topic, press the link text on the touchscreen.

Searching for a topic

1. Change to the "Index" tab.
2. Enter the first characters of the topic you are interested in. The entries starting with these characters are displayed.
3. Change the focus by pressing the ENTER key.
4. Select the suitable keyword by using the UP ARROW or DOWN ARROW keys or the rotary knob.
5. Press the ENTER key to display the help topic.
The "View" tab with the corresponding help topic is displayed.

Changing the zoom

1. Change to the "Zoom" tab.
2. Set the zoom using the rotary knob. Four settings are available: 1-4. The smallest size is selected by number 1, the largest size is selected by number 4.

Closing the help window

- ▶ Press the ESC key or a function key on the front panel.

2 Selecting the Measurement Mode

The R&S FSVR realtime spectrum analyzer comes with a variety of measurement modes. Some are already available with the basic configuration of the R&S FSVR, while others are available as options and firmware applications.

You can select the measurement mode you want to work with via the MODE key. The R&S FSVR then shows a list of measurement modes that are available on your R&S FSVR.

2.1 Measurement Mode Menus – HOME Key

The HOME key provides a quick access to the root menu of the current measurement mode.

2.2 Measurement Modes of the R&S FSVR

This chapter provides an overview of the measurement modes that are available for the R&S FSVR.

2.2.1 Realtime Analyzer

The realtime analyzer performs measurements in the frequency spectrum of a test signal without losing any signal data. You can evaluate the measurement results in several result displays that are designed for the realtime analysis and complement one another.

For details on the functionality of the realtime analyzer refer to [chapter 3, "Using the Realtime Analyzer"](#), on page 15

SCPI:

`INSTRument[:SElect]` on page 739

2.2.2 Spectrum Analyzer

In the "Spectrum" mode the provided functions correspond to those of a conventional spectrum analyzer. The analyzer measures the frequency spectrum of the test signal over the selected frequency range with the selected resolution and sweep time, or, for a fixed frequency, displays the waveform of the video signal. This mode is set in the initial configuration.

You can use up to four spectrum displays simultaneously. The additional spectrum displays are independent of each other. You can set up each display as you like without

affecting measurement configurations in another one. Each additional spectrum display opens in an extra tab labelled "Spectrum 1" to "Spectrum 4".

- ▶ To add a new spectrum display, press the "New Spectrum" softkey. The R&S FSVR opens an additional "Spectrum" tab each time you press the softkey up to a maximum of four.

SCPI Command:

[INSTRument\[:SElect\]](#) on page 739

[INSTRument:NSElect](#) on page 741

[INSTRument:CREate\[:NEW\]](#) on page 740

2.2.3 I/Q Analyzer Mode

The "I/Q Analyzer" mode provides measurement and display functions for digital I/Q signals. For details refer to [chapter 4.4, "Instrument Functions - I/Q Analyzer"](#), on page 277.

2.2.4 Analog Demodulation Mode

The "Analog Demodulation" mode is part of the R&S FSVR firmware. It provides measurement functions for demodulating AM, FM, or PM signals.

For more information see [chapter 5, "Using the Analog Demodulator"](#), on page 318.

2.2.5 FM Stereo Mode (Option R&S FSV-K7S)

The "FM Stereo" mode provides measurement functions for demodulating FM Stereo signals. The R&S FSV-K7S is an add-on to the analog demodulation mode that the R&S FSVR provides.

For more information on the functionality of the FM Stereo application see [chapter 5, "Using the Analog Demodulator"](#), on page 318.

2.2.6 Bluetooth Mode (Option R&S FSV-K8)

The "Bluetooth" mode requires an instrument equipped with the corresponding optional software. This mode provides measurement functions for performing Bluetooth measurements.

For details see the R&S FSV-K8 document.

2.2.7 GSM/EDGE Analyzer Mode (GSM/EDGE Option, R&S FSV-K10)

The "GSM/EDGE Analyzer" mode requires an instrument equipped with the corresponding optional software. This mode provides measurement functions for downlink or uplink signals according to the Third Generation Partnership Project (3GPP) standards for GSM/EDGE in different domains (Time, Frequency, I/Q).

For details see the R&S FSV-K10 document.

2.2.8 Noise Figure Mode (Noise Figure Measurements Option, R&S FSV-K30)

The "Noise Figure" mode requires an instrument equipped with the corresponding optional software. This mode provides noise figure measurements.

For details see the R&S FSV-K30 document.

2.2.9 Phase Noise Mode (Phase Noise Measurements Option, R&S FSV-K40)

The "Phase Noise" mode requires an instrument equipped with the corresponding optional software. This mode provides measurements for phase noise tests.

For details see the R&S FSV-K40 document.

2.2.10 Vector Signal Analysis mode (VSA Option, R&S FSV-K70)

The "Vector Signal Analysis" (VSA) mode requires an instrument equipped with the corresponding optional software. This mode provides measurement functions for vector signal analysis.

For details refer to the R&S FSV-K70 document.

2.2.11 3G FDD BTS Mode (3GPP Base Station Measurements Option, R&S FSV-K72)

The "3G FDD BTS" mode requires an instrument equipped with the corresponding optional software. This mode provides test measurements for WCDMA downlink signals (base station signals) according to the test specification.

For details see the R&S FSV-K72 document.

2.2.12 3G FDD UE Mode (3GPP User Equipment Measurements Option, R&S FSV-K73)

The "3G FDD UE" mode requires an instrument equipped with the corresponding optional software. This mode provides test measurements for WCDMA uplink signals (mobile signals) according to the test specification.

For details see the R&S FSV-K73 document.

2.2.13 TDS BTS and TDS UE Mode (Option R&S FSV-K76/-K77)

Equipped with the firmware application R&S FSV-K76, the R&S FSVR performs code domain measurements on forward link signals according to the 3GPP standard (Third Generation Partnership Project). TD-SCDMA BTS Analysis is performed in "TDS BTS" mode.

Equipped with the firmware application R&S FSV-K77, the R&S FSV performs code domain measurements on downlink signals according to the 3GPP standard. TD-SCDMA ue Analysis is performed in "TDS ue" mode.

For details see the R&S FSV-K76/-K77 document.

2.2.14 CDMA2000 BTS and MS Mode (Options R&S FSV-K82/-K83)

The "CDMA2000 BTS" mode requires an instrument equipped with the optional software R&S FSV-K82. This mode provides test measurements for basic CDMA2000 base station tests.

The "CDMA2000 MS" mode requires an instrument equipped with the optional software R&S FSV-K83. This mode provides test measurements for basic CDMA2000 mobile station tests.

FSVNeu_k82_k83, 2, en_US For details see the R&S FSV-K82/-K83 document.

2.2.15 1xEV-DO BTS and MS Mode (Options R&S FSV-K84/-K85)

The "1xEV-DO BTS" mode requires an instrument equipped with the optional software R&S FSV-K84. This mode provides Code Domain measurements on forward link signals according to the 3GPP2 Standard (Third Generation Partnership Project 2) High Rate Packet Data, generally referred to as "1xEV-DO".

The "1xEV-DO MS" mode requires an instrument equipped with the optional software R&S FSV-K85. This mode provides Code Domain measurements on reverse link signals according to the 3GPP2 Standard (Third Generation Partnership Project 2) High Rate Packet Data, generally referred to as "1xEV-DO".

For details see the R&S FSV-K84/-K85 document.

2.2.16 WLAN Mode (WLAN TX Measurements Option, R&S FSV-K91)

The "WLAN" mode requires an instrument equipped with the corresponding optional software. This mode provides Wireless LAN TX measurement functions according to IEEE 802.11 a, b, g and j standards.

For details see the R&S FSV-K91 document.

2.2.17 WiMAX Mode (WiMAX IEEE 802.16 OFDM, OFDMA Measurements Option, R&S FSV-K93)

The "WiMAX" mode requires an instrument equipped with the WiMAX IEEE 802.16 OFDM, OFDMA Measurements option (R&S FSV-K93). This mode provides WiMAX and WiBro measurement functions according to IEEE standards 802.16-2004 OFDM and 802.16e-2005 OFDMA/WiBro. It includes the WiMAX 802.16 OFDM Measurements option.

For details see the R&S FSV-K93 document.

2.2.18 LTE Mode

The LTE mode requires an instrument equipped with one of the EUTRA/LTE DL measurement applications that are available for the R&S FSVR.

- R&S FSV-K100 LTE FDD DL
- R&S FSV-K101 LTE FDD UL
- R&S FSV-K104 LTE TDD DL
- R&S FSV-K105 LTE TDD UL

The application provides EUTRA/LTE measurement functions according to the 3GPP standard.

For details see the corresponding manuals.

3 Using the Realtime Analyzer

The R&S FSVR combines a realtime spectrum analyzer with a conventional spectrum analyzer. It also provides an analog demodulator in its basic configuration. For special tasks, you can also fit the R&S FSVR with various firmware applications.

Usually, the functionality of a conventional spectrum analyzer is sufficient to perform a lot of the measurement tasks. The R&S FSVR has all the functionality of a spectrum analyzer if you use it in spectrum mode.

However, there might be some tasks that require signal analysis without gaps or information loss. You may also need different ways to look at a signal than those provided by a conventional spectrum or signal analyzer. For these you can use the realtime mode of the R&S FSVR.

When you start the R&S FSVR for the first time or after a preset, it starts in spectrum mode. To enter the realtime mode, press the MODE key and select the "Realtime Spectrum" softkey in the corresponding menu. The R&S FSVR then opens a new tab that runs the realtime analyzer.

3.1	Data Acquisition and Processing in a Realtime Analyzer	16
3.2	Selecting the Result Display	18
3.3	The Realtime Spectrum Result Display	19
3.3.1	Screen Layout of the Realtime Spectrum Result Display.....	20
3.3.2	Applications of the Realtime Spectrum.....	20
3.4	The Spectrogram Result Display	21
3.4.1	Screen Layout.....	23
3.4.2	Applications of the Spectrogram Result Display.....	23
3.4.3	Configuring the Spectrogram.....	24
3.5	The Persistence Spectrum Result Display	33
3.5.1	Screen Layout of the Persistence Spectrum.....	38
3.5.2	Applications of the Persistence Spectrum.....	38
3.5.3	Configuring the Persistence Spectrum.....	39
3.6	The Power vs Time Result Display	41
3.6.1	Screen Layout of the Power vs Time Result Display.....	42
3.6.2	Applications of the Power vs Time Result Display.....	42
3.7	The Power vs Time Waterfall Result Display	43
3.7.1	Screen Layout of the PvT Waterfall Result Display.....	43
3.7.2	Applications of the PvT Waterfall Result Display.....	43
3.8	Configuring Realtime Measurements	43
3.8.1	Configuring the Sweep.....	44

3.8.2	Setting the Sweep Time.....	44
3.8.3	Working with FFT Windows.....	45
3.8.4	Setting the Span.....	45
3.8.5	Setting the Resolution Bandwidth.....	46
3.9	Using Markers.....	47
3.9.1	Markers in a Spectrogram.....	47
3.9.2	Markers in the Persistence Spectrum.....	49
3.10	Triggering Measurements.....	49
3.10.1	Working with the Frequency Mask Trigger.....	49
3.10.2	Using the Time Domain Trigger.....	53
3.10.3	Using Other Triggers.....	54
3.10.4	Using Pre- and Posttrigger.....	54
3.10.5	Rearming the Trigger and Stopping on Trigger.....	54

3.1 Data Acquisition and Processing in a Realtime Analyzer

This chapter shows the way the R&S FSVR acquires and processes the data compared to a conventional spectrum analyzer.

A conventional spectrum analyzer typically loses information after it has captured the signal ('blind time'). This is because the LO has to return to the start frequency after a sweep of the selected frequency range (LO flyback). Blind time therefore occurs after the data capture and signal processing and before the next data capture can begin.

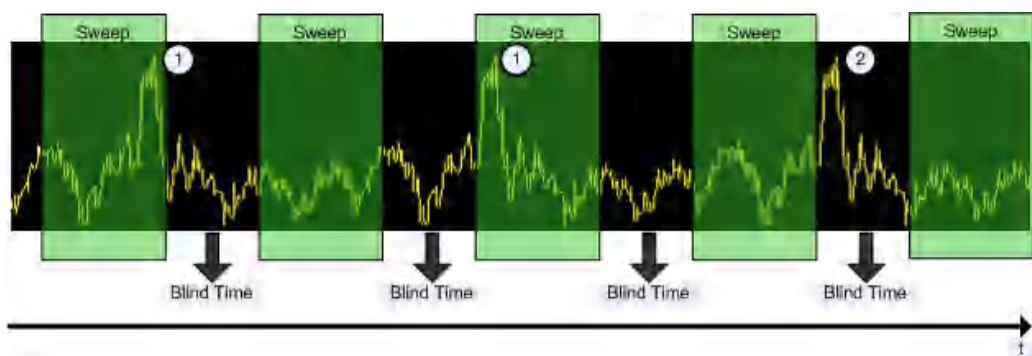

Fig. 3-1: Conventional spectrum analyzer measurement principle

= Note that the time axis is not true to scale. Blind time is a lot shorter in reality.

1 = Signals are captured by the sweep.

2 = Signal is missed by the sweep because of LO flyback (blind time).

Because of a number of reasons, a realtime analyzer does not lose any information.

First, there is no LO flyback because the LO of the realtime analyzer is set to a fixed frequency. Second, it performs overlapping Fast Fourier Transformations (FFT) instead of sweeping the spectrum or performing one FFT after another. The overlap of FFTs also ensures that the R&S FSVR can process pulses with a length of at least one FFT with correct levels. Third, the R&S FSVR captures data and performs FFTs at the same time instead of sequentially capturing data and performing FFT.

To get the results, the R&S FSVR simultaneously performs several processing stages:

- Acquiring the data
- Processing the data
- Displaying the data

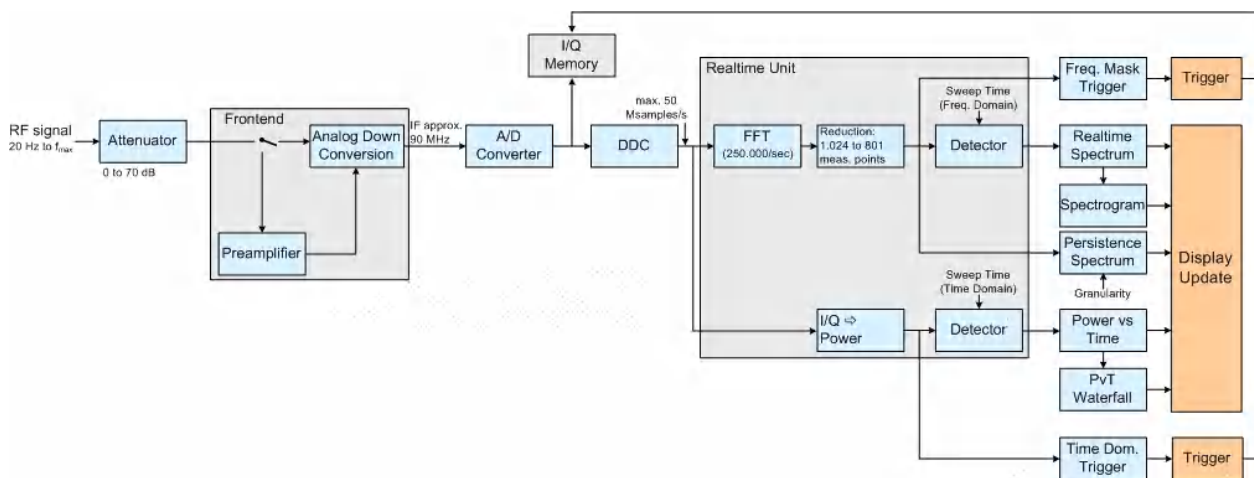

Fig. 3-2: Block diagram of the R&S FSVR

Acquiring the data

The data acquisition process is the same as in a conventional spectrum analyzer. First, the R&S FSVR either attenuates the signal that you have applied to the RF input to get a signal level that the R&S FSVR can handle or, if you have a weak signal, preamplifies the signal and then down-converts the RF signal to an intermediary frequency (IF), usually in several stages.

After the down-conversion, the R&S FSVR samples the signal into a digital data stream that is the basis for the Fast Fourier Transformation (FFT). The sampling rate the R&S FSVR uses for sampling is variable, but depends on the span you have set. The maximum span is 40 MHz.



Fig. 3-3: Continuous data stream

At the same time, the A/D data is captured in the I/Q memory.

Processing the data

The R&S FSVR then splits the data stream stored in the I/Q memory into data blocks whose length is 1024 samples each to prepare it for the FFT.

Then the R&S FSVR performs the FFT on all data blocks it has acquired. The FFT processing rate of the R&S FSVR is 250.000 FFTs per second.

The distinctive feature of a realtime analyzer is that it uses a particular amount of data more than once to get the measurement results. It takes the first data block of 1024 samples and performs the FFT on it. The second and all subsequent data blocks, however, do not start at the next sample (in the case of the second block, the 1025th), but at an earlier one. In fact, all data, except the first few samples, is processed more than once and overlapped to get the results.

At full span (40 MHz) this overlap of the FFTs is 80%. That means the second data block the R&S FSVR performs the FFT on covers the last 80% of the data of the first FFT with only 20% new data. The third data block still covers 60% of the first data block and 80% of the second data block and so on.

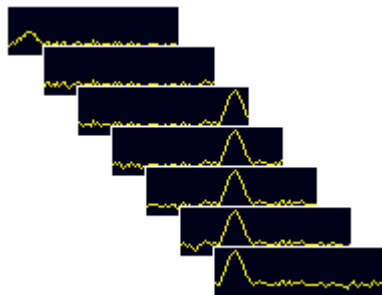

Fig. 3-4: Overlapping FFTs

The percentage of the overlap depends on the sampling rate and therefore on the span that you have set. With a span of 40 MHz, the overlap is 80%. If you reduce the span, the FFT machine tries to keep the FFT processing rate and increases the overlap accordingly. In that way, the overlap can increase up to a value of 1023 overlapping samples out of 1024 samples.

After the FFT is done and the spectrums have been calculated, the result is a stream of spectrums without information loss. For every spectrum, the R&S FSVR gets 1024 measurement points. However, because of data reduction and the filter slope of the DDC, it only uses 801 points to get the displayed results.

Displaying the data

From here on, the data processing depends on the result display that you have selected. The details for every available result displays are discussed below.

3.2 Selecting the Result Display

The R&S FSVR, when operated in realtime mode has several result displays. You can select a result display with one of the softkeys in the "Home" menu that you can

access via the  key. An alternative way to configure the display is the "Display Configuration" dialog box that you can open with the "Display Config" softkey.

The dialog box has four tabs (Screen A through D) to configure up to four result displays. In the default state, Screen A and Screen B are active and show the realtime spectrum and the spectrogram respectively. You can, however, customize the display of the R&S FSVR as you like.

You can add or remove a result display by checking or unchecking the "Screen Active" item and define the corresponding result display with the radio button below.

The "Predefined" tab contains customized screen layouts. Some of those are already provided with the firmware. You can also add your own screen layouts to the list in order to avoid configuring the screen every time you start the R&S FSVR.

The "Add" button adds a new screen layout to the list. Pressing the "Apply" button applies the screen layout you have selected and the "Remove" button removes the selected layout from the list. If you want to restore the default configurations, press the "Restore" button.

[CALCulate<n>:FEED](#) on page 705

3.3 The Realtime Spectrum Result Display

In principle, the realtime spectrum result display looks just like the result display of a conventional spectrum analyzer. It is a two-dimensional diagram that contains a line trace that shows the power levels for each frequency for a particular bandwidth or span with the horizontal and vertical axis representing frequency and amplitude. The big difference to a conventional spectrum analyzer is the way the realtime spectrum analyzer gets its data.

[CALCulate<n>:FEED](#) on page 705

Displaying the data

The evaluation of the final displayed results again is standard spectrum analyzer functionality. The R&S FSVR combines a spectrum consisting of 801 measurement points and adjusts them to the number of pixels that the display has. The way it evaluates the final results that you see on the display, depends on the type of detector that you have set.

For more information refer to [chapter 4.1.8.6, "Detector Overview"](#), on page 106.

As the number of FFTs is considerably higher than the sweep time, the R&S FSVR combines several FFTs in one trace. The number of FFTs combined in a trace at a bandwidth of 40 MHz depends on the sweep time and is according to the following formula.

$$N = \text{SweepTime}[\text{sec}] \cdot 250.000 \left[\frac{\text{FFT}}{\text{sec}} \right]$$

3.3.1 Screen Layout of the Realtime Spectrum Result Display

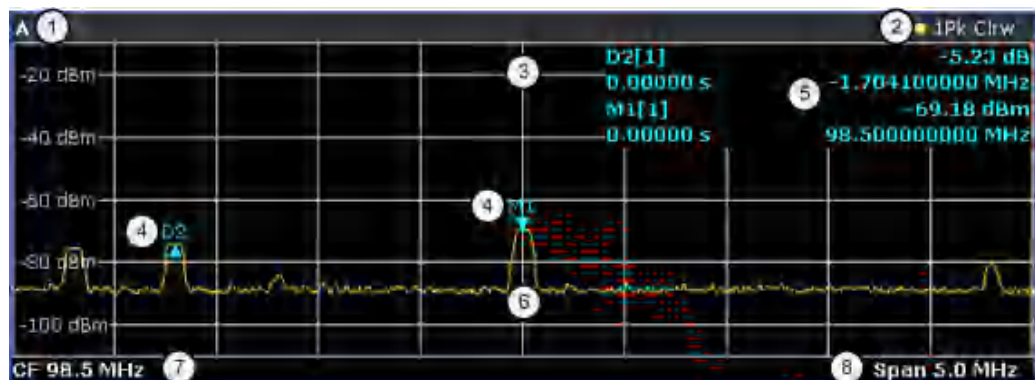

- 1 = Window number: shows the window of the result display (A through D)
- 2 = Trace information: includes trace mode and detector
- 3 = Trace diagram
- 4 = Markers: Mx for normal markers and Dx for deltamarkers
- 5 = Marker information: trace number, marker frequency and corresponding amplitude
- 6 = Realtime trace (yellow line)
- 7 = Center frequency
- 8 = Span

3.3.2 Applications of the Realtime Spectrum

Just like the spectrum results of a conventional analyzer, you can find many applications for the realtime spectrum result display.

If you use it as a standalone result display, the advantage of the realtime spectrum result display is the ability to monitor the spectrum without losing information.

The best way to use this feature, however, is to combine the realtime spectrum result display with the spectrogram result display in split screen mode. The spectrogram shows the results with a large history depth, but is not suited for detailed analysis of the data. You can, however, select a particular frame in the spectrogram's history with the marker and recall the spectrum of that frame for further and more detailed and full analysis of the measured signal.

The picture below shows that application. The realtime spectrum is not the currently measured spectrum, but the one that was measured at the time of marker 1. The realtime spectrum corresponds to the spectrogram frame of the marker position.

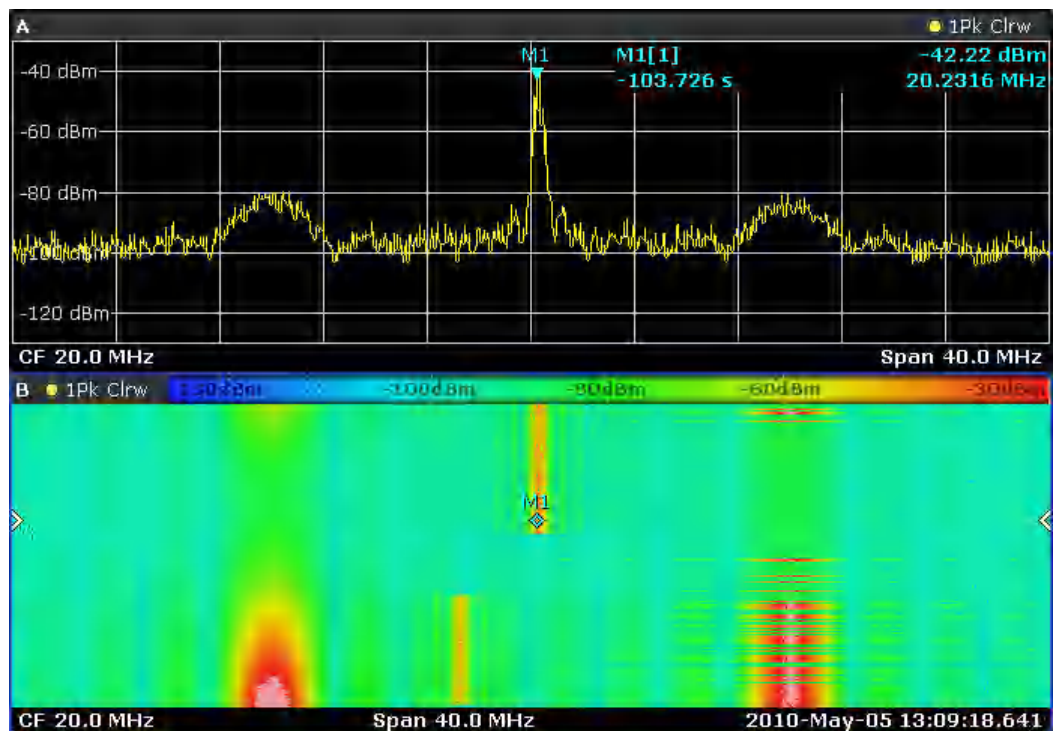

Fig. 3-5: Simultaneous display of realtime spectrum and spectrogram showing a past spectrum

3.4 The Spectrogram Result Display

The spectrogram result display shows the spectral density of a signal in the frequency domain and over time simultaneously. It provides an overview of the spectrum over time and so allows for an easy detection of anomalies and interfering signals.

Like the realtime spectrum, the horizontal axis represents the frequency span. The vertical axis represents time. Time in the spectrogram runs chronologically from top to bottom. Therefore, the top of the diagram is the most recently recorded data. The spectrogram also shows the power levels for every realtime spectrum trace. To display the level information, the R&S FSVR maps different colors to each power level that has been measured. The result is therefore still a two dimensional diagram.

[CALCulate<n>:FEED](#) on page 705

The process to get the spectrogram result display is as follows:

- capturing the data from the realtime trace
- coloring the results.
- processing the data

The stages occur at the same time.

Capturing the data

The spectrogram uses the realtime spectrum traces as its data basis. The data capture process is therefore the same as that of the realtime spectrum result display.

For more information, see [chapter 3.1, "Data Acquisition and Processing in a Realtime Analyzer"](#), on page 16

After the data has been captured, the R&S FSVR transforms the data of the realtime spectrum into the spectrogram result display.

Coloring the results

To get the final looks of the spectrogram, the R&S FSVR applies colors to visualize the power levels in a two dimensional diagram.

Each color in the spectrogram corresponds to a particular power level that is shown in the color map in the title bar of the result display. The color the R&S FSVR assigns to each power level depends on:

- the color scheme you have selected
- the (customized) color mapping settings

In the default configuration, the R&S FSVR displays low power levels in 'cold' colors (blue, green etc.) and higher power levels in 'warm' colors (red, yellow etc.).

For more information, see [chapter 3.4.3.3, "Customizing the Color Mapping"](#), on page 29

Displaying the results

Now that the data is available, the R&S FSVR processes the data to display it in the spectrogram result display.

To understand the structure and contents of the spectrogram, it is best to activate the realtime spectrum result display in combination with the spectrogram, as the data that is shown in the spectrogram is always based on the data of the trace in the realtime spectrum result display.

The spectrogram is made up out of a number of horizontal lines, each one pixel high, that are called (time) frames. Like the trace of the realtime spectrum, a spectrogram frame contains several FFTs. The exact number of FFTs contained in a frame depends on the sweep time. As the sweep time also sets the length of a realtime spectrum trace, by default a frame in the spectrogram always corresponds to exactly one trace in single sweep mode in the realtime spectrum result display. You can change this ratio by changing the sweep count.

In the default state, a frame is added to the spectrogram after each sweep. As the spectrogram in the R&S FSVR runs from top to bottom, the outdated frame(s) move down one position, so that the most recently recorded frame is always on top of the diagram.

The number of frames the R&S FSVR can display simultaneously is only limited by the vertical screen size. The number of frames the R&S FSVR stores in its history memory is bigger. It depends on the history depth you have set, with the maximum being 100.000. You can then navigate to any of the frames stored in the history buffer.



Note that the R&S FSVR stores just the trace information in its memory, not the I/Q data itself.

For more information, see [chapter 3.4.3.1, "Working with the Spectrogram History"](#), on page 24.

By default, the currently shown realtime spectrum trace corresponds to the spectrogram frame that has been recorded last. In single sweep mode, you can, however, recall the spectrums up to a maximum of 100.000 frames and evaluate them at a later time. The number of spectrums available depends on the history depth.

3.4.1 Screen Layout

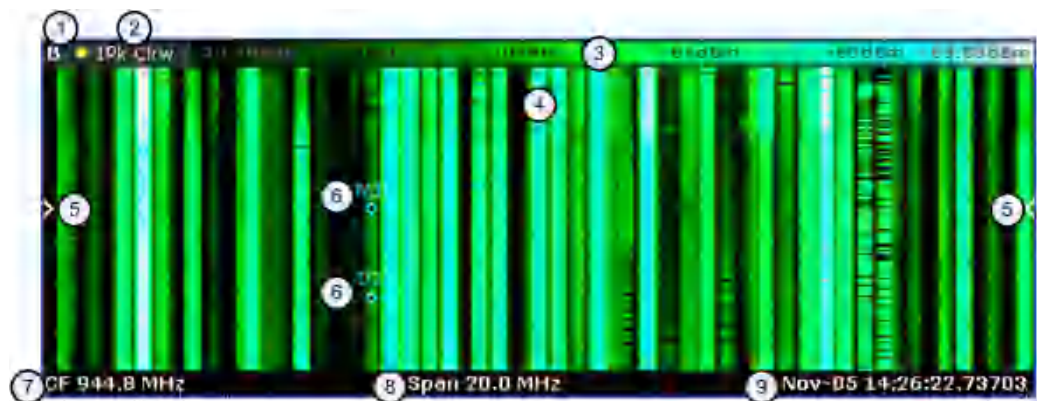

- 1 = Window number: shows the window of the result display (A through D)
- 2 = Trace information: includes trace mode and detector
- 3 = Color Map
- 4 = Spectrogram
- 5 = Marker indicator: shows the vertical position of the active marker
- 6 = Markers and deltamarkers
- 7 = Center frequency
- 8 = Span
- 9 = Time stamp information; if time stamp is inactive this shows the currently active frame instead

3.4.2 Applications of the Spectrogram Result Display

The spectrogram provides an easy way to monitor the changes of a signal's frequency and amplitude over time. Typically, it is used for measurements in which time is a factor. However, there are a lot of applications you could think of.

A typical applications of a spectrogram is the monitoring of telecommunications systems that are based on frequency hopping techniques, e.g. GSM. Using the spectrogram, you can see at a glance whether slots are allocated correctly or not. In addition, the result display also provides information on the time a particular channel is in use.

Again in telecommunications systems that use frequency hopping techniques, you can use the spectrogram to monitor the settling time to a new frequency after the channel switching.

The spectrogram is also suited for more general measurement tasks like measuring the settling time of a DUT or the detection of the time and statistical frequency of interfering signals.

3.4.3 Configuring the Spectrogram

The spectrogram has two distinctive features: information over a period of time and the colors. That means that it is important that you can customize various things concerning these two features.

[TRACe<n>\[:DATA\]? on page 889](#)

[MMEMory:STORe:SGRam on page 743](#)

3.4.3.1 Working with the Spectrogram History

In realtime mode, the spectrogram provides a record of the spectrum without gaps. Because the R&S FSVR stores the history of the spectrum in its memory, you can analyze the data in detail at a later time by recalling one of the spectrums in the spectrogram history.

Defining the History Depth

The "History Depth" softkey defines the number of frames that the R&S FSVR stores in its memory. The maximum history depth is 100.000 frames.

It is possible to recall the realtime traces to any of the frames that the R&S FSVR has in its memory.

For more information, see

- [chapter 3.3.2, "Applications of the Realtime Spectrum"](#), on page 20
- [chapter 3.4.2, "Applications of the Spectrogram Result Display"](#), on page 23
- [CALCulate<n>:SGRam:HDEPth on page 695](#)

Defining a Frame Count

The frame count defines the number of traces the R&S FSVR plots in the spectrogram result display in a single sweep. The maximum number of possible frames depends on the history depth.

The sweep count, on the other hand, determines how many sweeps are combined in one frame in the spectrogram, i.e. how many sweeps the R&S FSVR performs to plot one trace in the Spectrogram result display.

You can set the frame count with the "Frame Count" softkey which is available in single sweep mode.

[CALCulate<n>:SGRam:FRAMe:COUNT on page 694](#)

Selecting a Frame

To get more information, you can select any frame that is stored in the memory of the R&S FSVR with the "Select Frame" softkey. Depending on whether you have activated a time stamp or not, you select the frame either by time in seconds from the most recent recorded frame (time stamp On) or by directly entering the frame number you'd like to see (time stamp Off).

To select a specific frame, the R&S FSVR has to be in single sweep mode.

[CALCulate<n>:SGRam:FRAMe:SElect](#) on page 695

Using the Time Stamp

The time stamp shows the time information of the selected frame. The length of one frame corresponds to the sweep time.

If the time stamp is active, the time stamp shows the time and date the selected frame was recorded. To select a specific frame, you have to enter the time in seconds, relative to the frame that was recorded last. An active time stamp is the default configuration.

If you deactivate the time stamp with the "Time Stamp (On Off)" softkey, the time information is an index. The index is also relative to the frame that was recorded last, which has the index number 0. The index ends with a negative number that corresponds to the history depth. To select a specific frame, you have to enter the index number of the frame you want to analyze.

[CALCulate<n>:SGRam:TSTamp\[:STATe\]](#) on page 696

[CALCulate<n>:SGRam:TSTamp:DATA?](#) on page 696

Exporting the Spectrogram Data

The R&S FSVR allows you to export the spectrogram data to an ASCII file.

When you export the spectrogram to an ASCII file, the R&S FSVR writes the complete contents in its memory to an ASCII file. The amount of data depends on the [history depth](#).

To export the spectrogram, the spectrogram window has to be in focus (blue frame). To perform the export itself, use the "ASCII Trace Export" softkey in the "Trace" menu.



File size

Depending on the contents of the capture buffer, the export may take some time and the size of the ASCII file may be very large.

Clearing the Spectrogram

If you need to restart the spectrogram, you can clear the memory of the R&S FSVR with the "Clear Spectrogram" softkey at any time.

It is also possible to clear the spectrogram after each sweep automatically if you are in single sweep mode. You can do so with the "Continue Frame (On Off)" softkey. If it is

active, the spectrogram keeps filling up with data after a single sweep. If inactive, however, the R&S FSVR clears the spectrogram after every single sweep.

`CALCulate<n>:SGRam:CLEar[:IMMediate]` on page 693

`CALCulate<n>:SGRam:CONT` on page 694

3.4.3.2 Zooming into the Spectrogram

For further and more detailed analysis of the data you have captured, the R&S FSVR provides a zoom.

The zoom is available for the spectrogram result display, but has effects on other result displays. The spectrogram has to be active and selected (blue border) for the zoom to work.

You can activate the zoom with the  icon and define the zoom area by drawing a rectangle on the touchscreen. When you draw the zoom area, its boundaries are shown as a dashed line. The R&S FSVR stops the live measurement and enlargens the area you have defined. The definition of the color map remains the same.

Inside the zoom area, you can use the spectrogram functionality as usual (like frame selection or scrolling through the spectrogram).

For quick comparisons of the zoomed spectrogram and the unzoomed one, you can use the "Replay Zoom (On Off)" softkey in the "Meas" menu.

Zooming into the spectrogram causes the R&S FSVR to reprocess and reevaluate the data that has been measured previously and stored in the R&S FSVR memory. The zoom also reduces the sweep time and/or resolution bandwidth and span. This in turn improves the resolution of the data (while a graphical zoom merely interpolates the data and thus reduces the resolution).

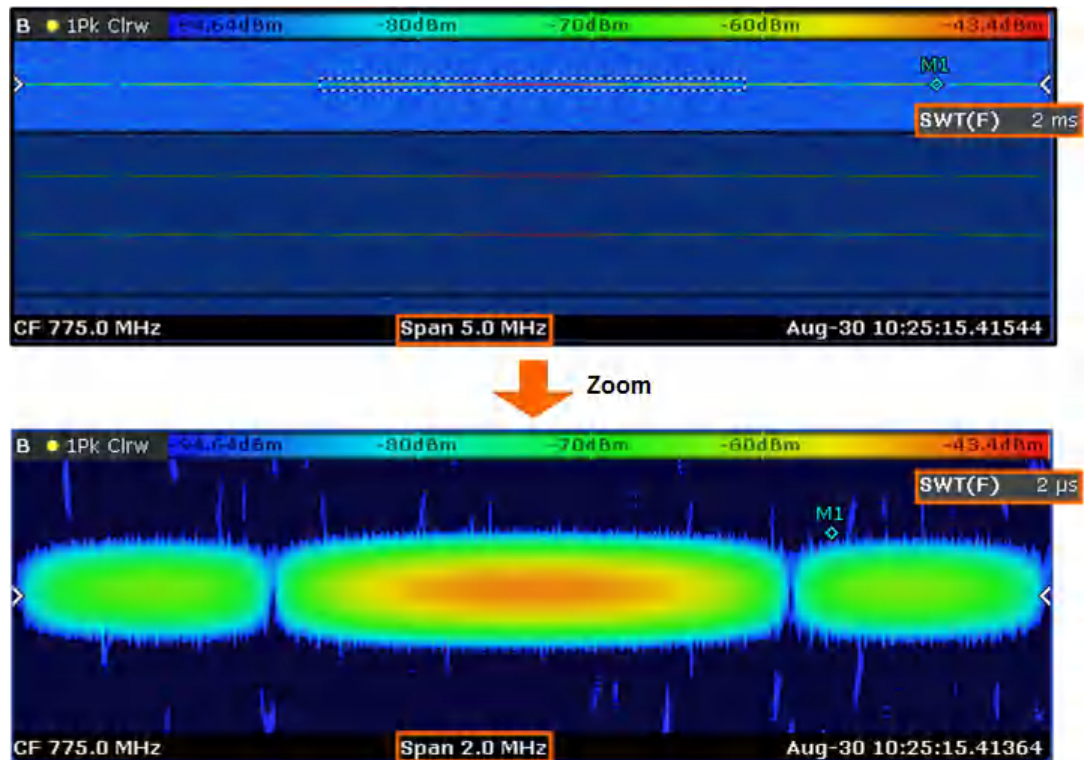

Because the zoom is based on data that has already been captured, the zoom also allows for faster sweep times (and thus spans) than those possible during live measurements (which are limited to 100 μ s).

As mentioned above, selecting an area in the spectrogram to zoom into changes the sweep time and span (and thus the start and stop frequencies of the diagrams). It may also change the center frequency. The magnitude of the change depends on the size of the zoom area. If the zoom is already active, this mechanism also works the other way round. You can change the zoom factor by changing the sweep time or the span.

Zoom restrictions

Principally, the zoom is available for all measurement situations, whether you measure continuously, in single sweep mode or use a trigger. However, possible zoom areas are restricted by the size of the memory (4 seconds). If it is not possible to zoom into a spectrogram area, the R&S FSVR colors that area in a darker color when you touch it.

The zoom factor is restricted to 10% of the original span of the frequency axis.

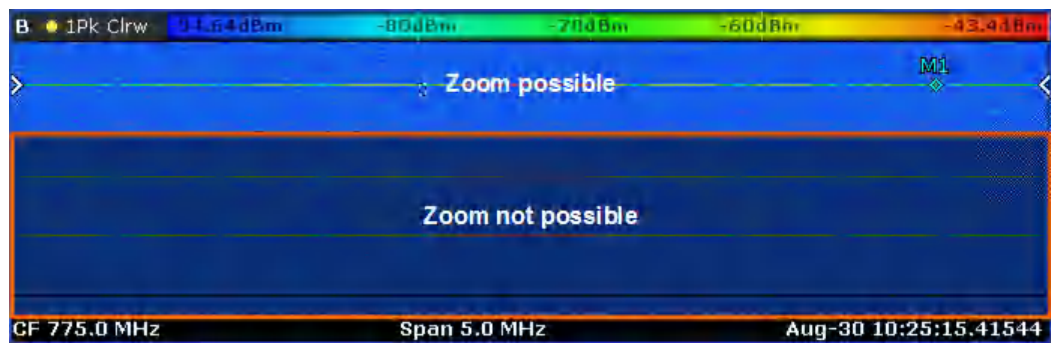

In addition, the zoom is also restricted by the original bandwidth or span you have set. Zooming into areas that are outside this bandwidth is not possible.

Note also that zoom availability depends on the trigger mode. Zooming while the measurement is running is possible only in Free Run mode. For all other trigger modes, you have to wait until the measurement is paused.

Effects on other result displays

Zooming has an effect on the realtime spectrum and the power vs time result displays. All other result displays are unaffected.

- The R&S FSVR updates the range of horizontal axis of the realtime spectrum according to the zoomed (new) spectrogram span. The range has an effect on the start, stop and center frequency as well as the span. The realtime spectrum still shows the spectrum of the currently selected spectrogram frame.
- The R&S FSVR updates the time period shown on the horizontal axis of the power vs time result display according to the new height (sweep time) of the spectrogram. The new time period is the result of the height of the new spectrogram and the number of spectrums inside a spectrogram frame. Note that it is not possible to change the sweep time or the trigger offset for the power vs time while the zoom is active.

Updates in the result displays only take effect if they have been active while the spectrogram data has been reevaluated.

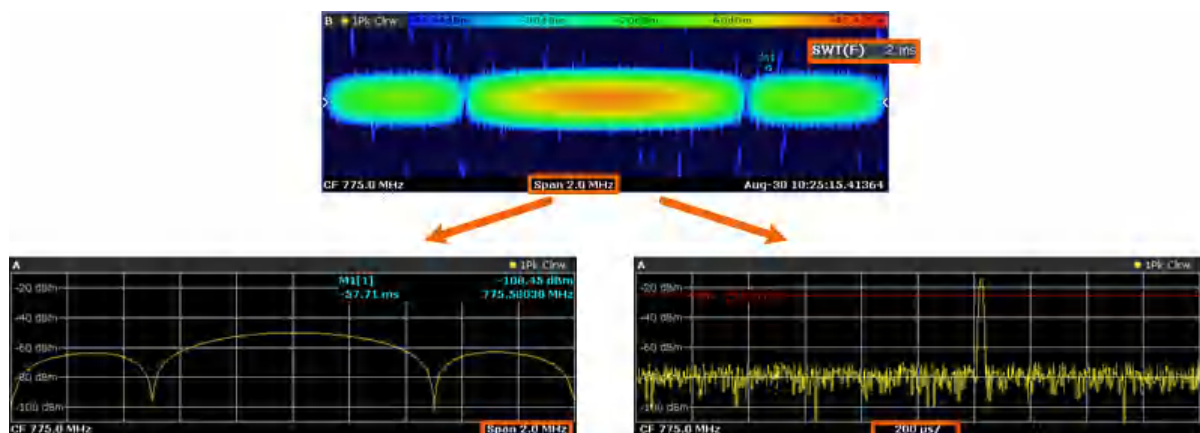

DISPlay:WINDow[:SUBWindow]:ZOOM:AREA on page 714

DISPlay:WINDow[:SUBWindow]:ZOOM:STATE on page 715

3.4.3.3 Customizing the Color Mapping

Colors are an important part of the both the persistence spectrum and the spectrogram. Therefore, the R&S FSVR provides various ways to customize the display for best viewing results.

You can access the Color Mapping dialog via the "Color Mapping" softkey or by tapping on the color map. The dialog looks and works similar for the histogram and the spectrogram, only the the scaling or unit of the color map is different. For the persistence spectrum the R&S FSVR maps the colors to percentages, for the spectrogram it maps power levels (dBm). In addition, the dialog box of the persistence spectrum offers a truncate function.

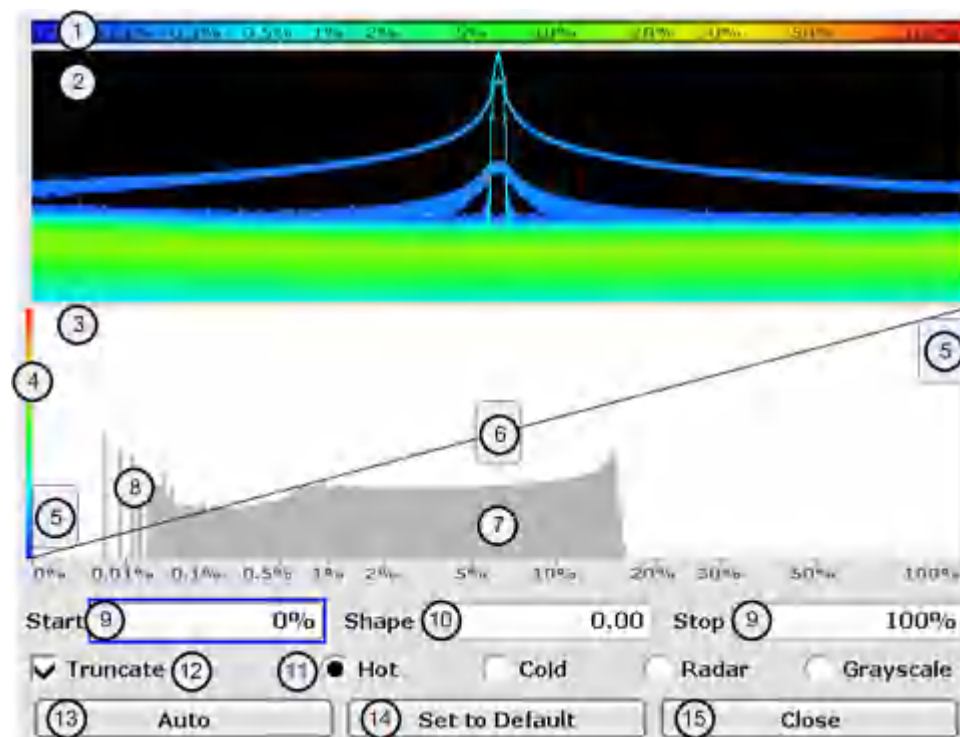

- 1 = Color map: shows the current color distribution
- 2 = Preview pane: shows a preview of the histogram / spectrogram with any changes that you make to the color scheme
- 3 = Color curve pane: graphic representation of all settings available to customize the color scheme
- 4 = Color curve in its linear form
- 5 = Color range start and stop sliders: define the range of the color map; percentages for the histogram or amplitudes for the spectrogram
- 6 = Color curve slider: adjusts the focus of the color curve
- 7 = Histogram: shows the distribution of measured values
- 8 = Scale of the horizontal axis (value range): in the spectrogram this is linear, in the histogram it is the function of the density
- 9 = Color range start and stop: numerical input to define the range of the color map
- 10 = Color curve: numerical input to define the shape of the color curve
- 11 = Color scheme selection
- 12 = Truncate: if active, only shows the results inside the value range; only available for the persistence spectrum

- 13 = Auto button: automatically sets the value range of the color map
- 14 = Default button: resets the color settings
- 15 = Close button: closes the dialog box

Setting the Color Scheme

Before adjusting the details of the color map, you should select the color scheme you are most comfortable with. You can select from four different color schemes:

- 

The "Hot" color scheme shows the results in colors ranging from blue to red. Blue colors indicate low probabilities or levels respectively. Red colors indicate high ones.

- 

The "Cold" color scheme shows the results in colors ranging from red to blue. Red colors indicate low probabilities or levels respectively. Blue colors indicate high ones.

The "Cold" color scheme is the inverse "Hot" color scheme.

- 

The "Radar" color scheme shows the colors ranging from black over green to light turquoise with shades of green in between. Dark colors indicate low probabilities or levels respectively. Light colors indicate high ones.

- 

The "Grayscale" color scheme shows the results in shades of gray. Dark grays indicate low probabilities or levels respectively. Light grays indicate high ones.

If a result lies outside the defined range of the color map, it is colored in black at the lower end of the color range. On the upper end of the color range it is always the lightest color possible, regardless of differences in amplitude (e.g. black and blue in case of the "Cold" scheme).

[DISPlay:WINDow:SGRam:COLor\[:STYLE\]](#) on page 726

[DISPlay:WINDow:SGRam:COLor:DEFault](#) on page 726

Defining the Range of the Color Map

The current configuration could be a color map that you can optimize for better visualization of the measured signal, e.g. if the results cover only a small part of the color map. In the resulting trace, it would be hard to distinguish between values that are close together.

There are several ways to optimize the distribution of the colors over the results and then get the best viewing results.

Note that the following examples are based on the "Hot" color scheme and the spectrogram. Color settings in the histogram are the same with the exception of the unit of the color map that is % in the histogram. If something applies to the spectrogram only, you'll find a note at that place.

The easiest way to adjust the colors is to use the color range sliders in the "Color Mapping" dialog.

In the histogram that is in the background of the color curve pane (grey bars), you can observe the distribution of measurement results. If no significant shifts in result distribution occur after evaluating this for a time, you can adjust the color map to the overall shape of the measurement results. To do so and still cover the whole signal, move the sliders in a way that the first and last bar of the histogram are still inside the range. You can optimize the display further, if you suppress the noise by excluding the lower 10 to 20 dB of the distribution. Note that the color map has to cover at least 10% of the range of the horizontal axis.

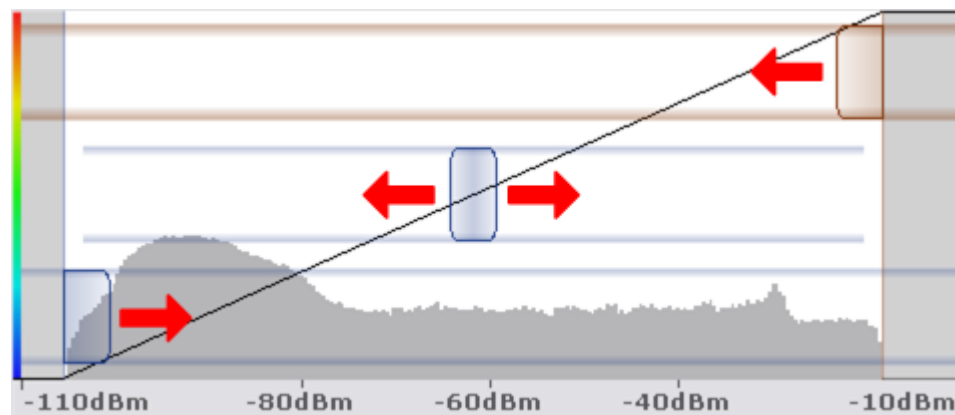

Alternatively, you can set the range in the numeric input field. For the spectral histogram, you enter the percentages as they are plotted on the horizontal axis and displayed in the spectral histogram itself. For the spectrogram however, you have to enter the distance from the right and left border as a percentage.

Example:

The color map starts at -100 dBm and ends at 0 dBm (i.e. a range of 100 dB). You, however, want the color map to start at -90 dBm. To do so, you have to enter 10% in the Start field. The FSVR shifts the start point 10% to the right, to -90 dBm.

In the spectrogram, cutting the range as far as possible is also a good way if you want to observe and put the focus on signals with a certain amplitude only. Then, only those signal amplitudes that you really want see are displayed. The rest of the display remains dark (or light, depending on the color scheme). It is also a good way to eliminate noise from the display. In the spectrogram you can do this easily by excluding the corresponding power levels at the low end of the power level distribution.

In the histogram, cutting down the color range is also a good way to eliminate unwanted signal parts. Very frequent level and frequency combinations are most likely noise, so cutting them away means that the color resolution for all other combinations is enhanced and makes it more easy to detect, for example, weak and rare signals.

The persistence spectrum provides an additional truncate function. If active, all values that are outside the color range are no longer displayed in the histogram.

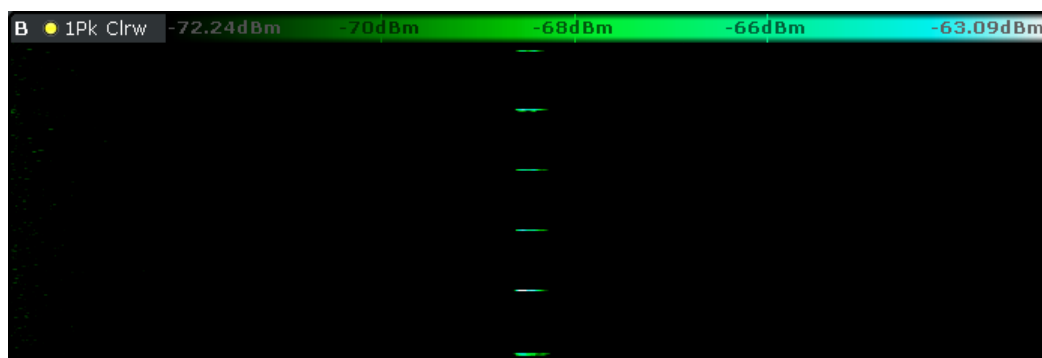

Fig. 3-6: Spectrogram that shows the peaks of a pulsed signal only



Adjusting the reference level and level range

Changing the reference level and level range also affects the color scheme in the spectrogram.

Make sure, however, that you never adjust in a way that could overload the R&S FSVR.

For more information, see [AMPT menu](#)

[DISPlay:WINDow:SGRam:COLor:LOWer](#) on page 726

[DISPlay:WINDow:SGRam:COLor:UPPer](#) on page 727

Defining the Shape of the Color Curve

Now that the color scheme and range of the color map suit your needs, you can improve the color map even more by changing the shape of the color curve.

The color curve is a tool to shift the focus of the color distribution on the color map. By default, the color curve is linear. The color curve is linear, i.e. the colors on the color map are distributed evenly. If you shift the curve to the left or right, the distribution becomes non-linear. The slope of the color curve increases or decreases. One end of the color palette then covers a large amount results while the the other end distributes a lot of colors on relatively small result range.

You can use this feature to put the focus on a particular region in the diagram and to be able to detect small variations of the signal.

Example:

Fig. 3-7: Linear color curve shape = 0

The color map above is based on a linear color curve. Colors are distributed evenly over the complete result range.



Fig. 3-8: Non-linear color curve shape = -0.5

After shifting the color curve to the left (negative value), more colors cover the range from -105.5 dBm to -60 dBm (blue, green and yellow). In the color map based on the linear color curve, the same range is covered by blue and a few shades of green only. The range from -60 dBm to -20 dBm on the other hand is dominated by various shades of red, but no other colors. In the linear color map, the same range is covered by red, yellow and a few shades of green.

The result of shifting the color curve is that results in a particular result range (power levels in case of the spectrogram and densities in the case of the spectral histogram) become more differentiated.

You can adjust the color curve by moving the middle slider in the color curve pane to a place you want it to be. Moving the slider to the left shifts the focus in the direction of low values. Most of the colors in the color map are then concentrated on the low power levels (spectrogram) or densities (histogram), while only a few colors cover the upper end of the color map or high power levels or densities. Moving the slider to the right shifts the focus to the higher amplitudes or densities.

Alternatively, you can enter the shape of the color curve in the corresponding input field below the color curve pane. A value of 0 corresponds to a linear shape, negative values up to -1 shift the curve to the left, positive values up to 1 shift the curve to the right.

[DISPlay:WINDow:SGRam:COLor:SHAPE](#) on page 726

3.5 The Persistence Spectrum Result Display

The persistence spectrum is a two dimensional histogram that shows the statistical frequency of any frequency and level combinations for every pixel on the display ('hits' per pixel). As the number of FFTs used to create the histogram is very large, you can also look at it as a probability distribution.

Note that the word 'density' in this context means how frequent a certain level and frequency combination has occurred during the measurement.

In principle, the result display looks just like that of a conventional spectrum analyzer with the horizontal and vertical axis representing the frequency and level respectively.

Unlike the trace in a conventional spectrum analyzer, the persistence spectrum includes a third type of information (a virtual z-axis). This virtual axis represents the number of hits that occurred during a particular period of time. This would result in a three dimensional diagram with the height of each bar on the z-axis representing the number of hits per pixel. This makes the result display a (spectral) histogram.

However, in the final display of the results the R&S FSVR still shows the trace in two dimensions with the number of hits represented by different shades of color. The result is a trace that covers an area instead of a line trace as you know it from the realtime spectrum result display, for example.

[CALCulate<n>:FEED](#) on page 705

For better orientation, the R&S FSVR also always shows the realtime spectrum line trace in the histogram as a white line superimposed over the histogram.



You can turn off the realtime trace by setting the trace mode for that one to "Blank".

To get the final result display for a single frame, the R&S FSVR sequentially runs through a number of processing steps:

- collecting the data
- evaluating the data
- calculating relative values of the data
- coloring the results.

The stages occur at the same time.

Collecting the data

The persistence spectrum that the R&S FSVR displays at any time always represents the data it has collected in exactly one frame. That means that in single sweep mode, it shows the data of one frame after it has finished the sweep. The number of FFTs in one frame is variable and depends on the sweep time that you have set. You can calculate the number of FFTs in each frame for a 40 MHz bandwidth with the following formula:

$$N = \text{Granularity}[\text{sec}] \cdot 250.000 \left[\frac{\text{FFT}}{\text{sec}} \right]$$

Example:

If you have set a granularity of 0.5 seconds, the number of FFTs that a frame (and the trace) contains is 125.000.

Note that this number refers to the instantaneous histogram. If you work with an active persistence, you can also see the shadows of past histograms on the display. The persistence functionality displays all spectrums that were captured within the persistence time.

For more information on persistence, refer to

- [chapter 3.5.3.1, "Using Persistence"](#), on page 39

Evaluating the data

After it has collected the data of one frame, the R&S FSVR copies all the spectrums included in that frame into the display. If all spectrums were identical, the resulting persistence spectrum would look like a line trace, but in color. However, in reality none of the spectrums looks alike, therefore the fact that many spectrums are on top of each other leads to a diagram that covers a two dimensional area on the screen instead of just a line.

There will be pixels that the spectrum runs through more often than others, whose spectral density is higher than elsewhere. To represent this fact, the R&S FSVR copies all spectrums into a virtual table whose dimensions correspond to the resolution of the display with each cell representing one pixel. The horizontal represents the frequency, the vertical axis the amplitude. In the case of the R&S FSVR with a resolution of 600x801 pixels, this means that the table would have 480.600 cells. With a full span of 40 MHz and the default display range of 100 dB, one cell would cover about 50 kHz and 0.16 dB.

After the R&S FSVR has performed the first FFT and has transferred the corresponding spectrum, the table would, for example, look like this:

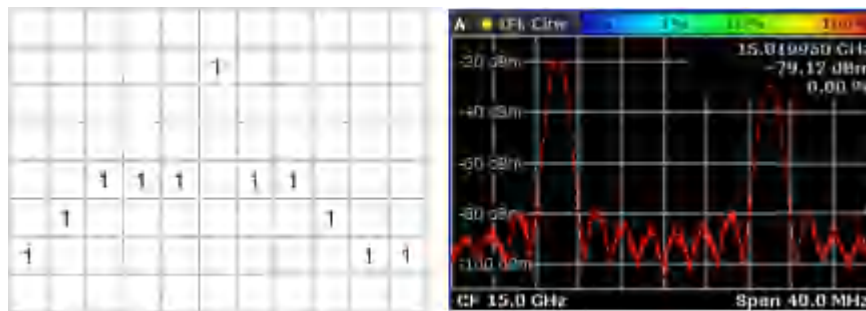

Fig. 3-9: Virtual table and diagram containing the results after one FFT

Since there is only one spectrum and every number in the table represents the number of hits in that cell, each column, at this point, has to contain exactly one value. The sum of each column may not exceed the value '1', as, currently, there is only one spectrum. Additionally, every column must include a number (one for each frequency/ level combination). The display of the trace after this step would look like a line trace.

But as the frame consists of more than one spectrum, the R&S FSVR accumulates all spectrums it has captured. Let's assume a frame consists of 10 spectrums. After a single sweep, the table would, for example, look like this:



Fig. 3-10: Virtual table and diagram containing the results after one frame (n FFTs)

As you can see many cells contain a value greater than '1'. A number greater than one expresses an overlap of several spectrums on this pixel. As the assumed frame consists of 10 spectrums, the sum of values in each column must equal '10'.

Calculating percentages

Now that all values have been transferred into the table, the R&S FSVR converts the absolute numbers into relative values or percentages. The percentages are the basis of the final histogram that the R&S FSVR shows on the display.

The percentage of one cell is simply the ratio of the number of hits in that cell over the number of accumulated spectrums.

Example:

The percentage of, e.g., the value in the highlighted cells would be 0.2 or 20% (2 hits and a total number of 10 spectrums, $n=(2/10)*100\%$). After the R&S FSVR has calculated all percentages, the table would look like this:

					80					
				30	10	20				
			20	50	60	10				
	10	70	60	10		10	70	10		
	80	20	10				10	80	90	
100	10	10	10	10	10	10	10	10	10	100

Fig. 3-11: Virtual table containing the percentages of the results after one frame

The values in the table are the percentages, so that the sum of each column is always 100%.

With a long observation time, the percentage becomes a statistical value that shows the probability of the occurrence of a particular frequency/ level combination.

Coloring

To visualize the percentages in the persistence spectrum, the R&S FSVR uses different colors for different values. That means the final step of creating the persistence

spectrum is the mapping of colors to every pixel with each color representing a particular percentage or probability that is shown in the color map in the title bar of the result display.

The color the R&S FSVR assigns to the percentage depends on:

- the color scheme you have selected
- the color mapping settings you have set

In the default configuration (color scheme "Hot"), the R&S FSVR shows low percentages with 'cold' colors (blue, green etc.) and high percentages in 'warm' colors (red, yellow etc.).

Applying colors to 3-11 would result in a picture like this:

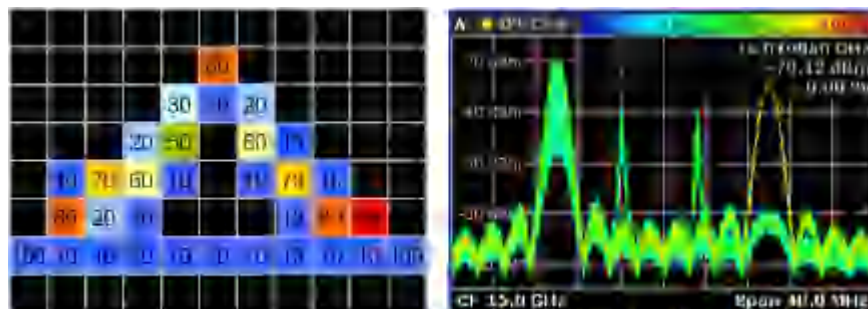

Fig. 3-12: Virtual table and result display containing the colored results

As you can see in 3-12, the most frequent spectral parts appear in red, while all others appear in colder colors.

Up until now, the process was for one frame only and no active persistence and no maxhold function. If you activate those, the process of drawing the persistence spectrum gets more complex.

For more information, see

- [chapter 3.5.3.1, "Using Persistence"](#), on page 39
- [chapter 3.5.3.2, "Activating Maxhold"](#), on page 40

3.5.1 Screen Layout of the Persistence Spectrum

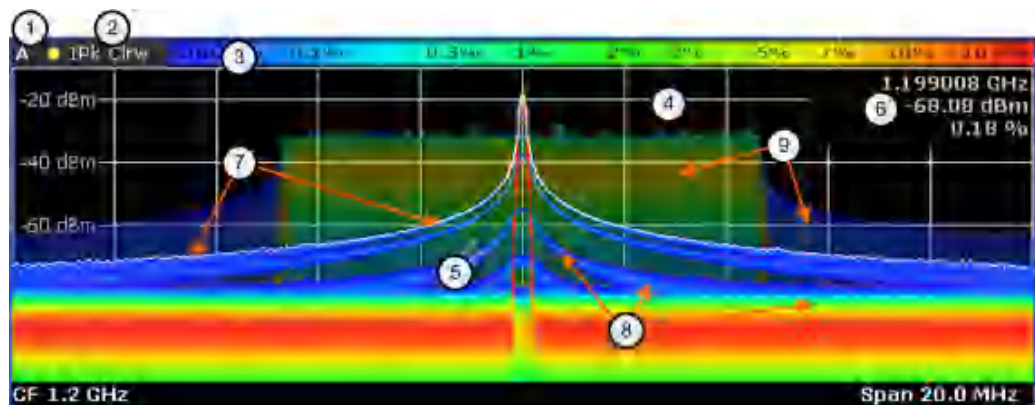

- 1 = Screen number
- 2 = Trace information for the realtime spectrum trace (trace mode and detector)
- 3 = Color map
- 4 = Trace window (or diagram area)
- 5 = Marker
- 6 = Marker information
- 7 = Realtime spectrum trace (white line)
- 8 = Persistence spectrum (colored trace)
- 9 = maxhold trace (weak color intensity)

The persistence spectrum has three 'layers':

- the realtime spectrum trace. This trace is always white so that you can recognize it inside the histogram. It is updated continuously.
- the histogram. The histogram is the main feature of the result display. The colors the histogram show the number of hits of level/frequency combinations. The number of FFTs each pixel in the measurement diagram contains depends on the granularity. The histogram is multicolored.
- the maxhold trace. The maxhold trace is a transparent trace in the background of the histogram that shows the maximum percentages that have been measured up to the present. The maxhold trace is in the 'background' of the result display with a lower intensity than the histogram. By default, the maxhold trace is inactive, i.e. it has an intensity of 0. You can, however, adjust the color intensity to the point where the maxhold trace has the same intensity as the regular histogram. The maxhold trace is also multicolored.

3.5.2 Applications of the Persistence Spectrum

The persistence spectrum is useful for any measurement task that requires information about the statistical frequency of a spectral event. When you know the relative frequency of an event, you can also deduce the probability with which that event will occur.

A typical application for the persistence spectrum is the detection of weak or hidden signals that occur infrequent. Weak signals may be hidden in the noise or occur in between strong pulses and therefore cannot be detected with standard result displays. The persistence spectrum on the other hand shows those signals because they have a

different probability than other signals. With a different probability, the color mapping also is different and it is easy for you to identify those signals.

You can also identify spurs more easily with the persistence spectrum because their probability differs. With an active persistence, you can also see them or their shadows for a longer time on the result display which makes it easier not to miss them.

This fact also makes it easier to monitor the spectrum and, e.g. observe interfering signals in a frequency band reserved for a particular application. When monitoring the spectrum with the persistence spectrum, you can not only see interfering signals but also observe the frequency with which they occur and therefore derive from the density if it was a one time occurrence only or if the interfering signal is transmitted regularly.

There are however limits to the information the persistence spectrum is capable to provide. If you need to know, for example, how long a particular frequency/level combination is present, you have to use another result display, because the persistence spectrum doesn't tell whether there is a single very long pulse (e.g. one 5 ms pulse) or several short ones (e.g. ten 50 μ s pulses).

3.5.3 Configuring the Persistence Spectrum

You can customize the persistence spectrum in several ways. You can change the colors with which the densities are visualized, you can change the persistence of the data and change the style of the displayed results.

[TRACe<n> \[: DATA \] ?](#) on page 889

3.5.3.1 Using Persistence

Persistence is a term to describe the time period shadows of past histogram traces remain visible in the display before fading away.

The term persistence has its origins in cathode ray tube devices (CRTs). It describes the time period one point on the display stays illuminated after it has been lit by the cathode ray. The higher the persistence, the longer you could observe the illuminated point on the display.

In the persistence spectrum, the persistence results from the moving 'density' (like a moving average) over a certain number of traces. The number of traces that are considered for calculating the density depend on the persistence length that you can define with the "Persistence" softkey. The longer the persistence, the more traces are part of the calculation and the deeper the history of displayed information gets. A spectral event that has occurred a single time is visible for up to 8 seconds. That means that colors will change as densities get smaller at coordinates with signal parts that are not constantly there, but still have the same intensity as the original signal. The rate of the color change is high with a low persistence and small with a high persistence.

Note that a signal with constant frequency and level characteristics does not show the effects of persistence on the trace. As soon as the power or frequency of a signal change slightly, however, the effect of persistence gets visible through color changes or changes in the shape of the trace.

You can turn off persistence if you set it to 0 seconds.

`DISPlay:WINDow<n>[:SUBWindow<m>]:TRACe<t>:PERSistence:DURation`
on page 713

Defining the granularity

The amount of data that the R&S FSVR uses to draw a single frame in the persistence spectrum is variable. By default it uses the data that was captured in a 100 ms in the moving 'density'. With the "Persistence Granularity" softkey, you can set the amount of data that the R&S FSVR uses to build the persistence spectrum by increasing or decreasing the persistence granularity.

`DISPlay:WINDow[:SUBWindow]:TRACe:PERSistence:GRANularity`
on page 714

3.5.3.2 Activating Maxhold

The maxhold function remembers and shows the maximum densities that have been measured at each point in the diagram. The maxhold trace is visible as soon as you increase the color intensity and will remain visible until you reset the maxhold, turn it off or preset the R&S FSVR.

Changing the color intensity

In its default state, the R&S FSVR does not display the maxhold trace. You can turn it on by increasing the color intensity. With the "Maxhold Intensity" softkey, you can regulate the brightness of the trace up to the point where it is as intense as the current trace.

Note that the color intensity of the maxhold trace is lower than that of the trace itself. The color distribution, however, is the same for both traces.

`DISPlay:WINDow<n>[:SUBWindow<m>]:TRACe<t>:MAXHold[:INTensity]`
on page 713

Resetting the maxhold trace

You can reset the maxhold trace with the "Maxhold Reset" softkey. The R&S FSVR then starts to build the maxhold trace again.

`DISPlay:WINDow[:SUBWindow]:TRACe:MAXHold:RESet` on page 712

Turning off the maxhold trace

To turn off the maxhold trace, set the maxhold intensity to zero.

`DISPlay:WINDow<n>[:SUBWindow<m>]:TRACe<t>:MAXHold[:INTensity]`
on page 713

3.5.3.3 Selecting the Style of the Trace

The R&S FSVR offers two styles that you can apply to the persistence spectrum, vectorial or dotted display. Select the style of the trace with the "Style (Vec Dots)" softkey.

The vectorial display of the measurement results is an interpolation of all the individual points and therefore an interpolation of densities. The result is a persistence spectrum that contains no gaps between coordinates. Each point of the histogram is connected to the neighboring ones.

The dotted display on the other hand plots and colors only those coordinates where data has been actually measured. The result is a histogram made up out of literally thousands of individual points.

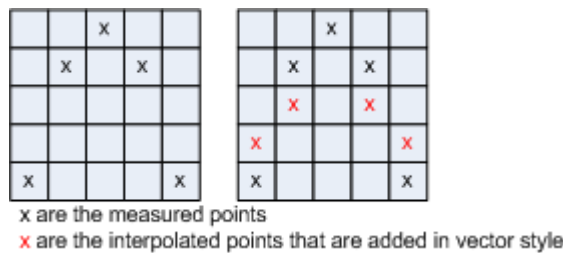

Fig. 3-13: Dotted trace style vs Vector trace style

`DISPlay:WINDow<n>[:SUBWindow<m>]:TRACe<t>:SYMBOL` on page 714

3.5.3.4 Customizing the Color Mapping

For more information, see [chapter 3.4.3.3, "Customizing the Color Mapping"](#), on page 29

3.6 The Power vs Time Result Display

For measurements in the time domain the R&S FSVR features the power vs time (PvT) result display.

The PvT result display is a two-dimensional result display that shows the power levels of a signal over a particular time period as a line trace. The horizontal axis represents the (current sweep) time. The vertical axis shows the power levels.

`CALCulate<n>:FEED` on page 705

Displaying the data

Up to the point the data enters the realtime unit, the data capture and processing is the same as in the frequency domain. For more information see [chapter 3.1, "Data Acquisition and Processing in a Realtime Analyzer"](#), on page 16.

After the data has been digitally down-converted and has entered the realtime unit, the R&S FSVR turns the I/Q data into absolute power levels ($|I+jQ|^2$). The amount of data that a single sweep is made up out of depends on the sweep time you have set. The

R&S FSVR then combines the data in a way that it can display it on the available pixels of the screen.

The way the R&S FSVR evaluates the final results that you see on the display depends on the detector type that you have selected.

For more information see [chapter 4.1.8.6, "Detector Overview"](#), on page 106

3.6.1 Screen Layout of the Power vs Time Result Display

The PvT result display features the same elements as the realtime spectrum result display except that the horizontal axis represents time.

For more information see [chapter 3.3.1, "Screen Layout of the Realtime Spectrum Result Display"](#), on page 20.

3.6.2 Applications of the Power vs Time Result Display

A typical application for time domain measurements is to measure pulses. If you use the PvT to that end, you can see any necessary information about pulses that you need to know like pulse repetition rate, pulse length and the power of the pulse.

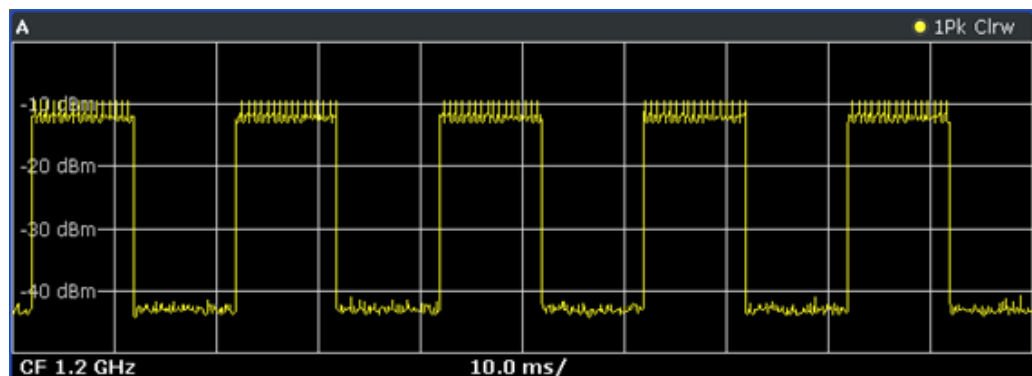

The best way to use the PvT result display is in combination with the power vs time waterfall result display in split screen mode. In that case, you can select a particular frame of the waterfall diagram history with the marker and recall the trace of that frame for further and more detailed analysis of the signal.

The PvT result display is also a good addition to measurements with the persistence spectrum as the persistence spectrum does not provide information about the time period a signal is present. If you, e.g., do measurements on pulses you will not get information about the pulse length and repetition rate from the persistence spectrum. To get that information you can either use the spectrogram or the PvT result display as you can get that information at a glance from that result display.

3.7 The Power vs Time Waterfall Result Display

The PvT waterfall result display shows the characteristics of a signal in the time domain and its history at the same time. It is an addition to the PvT result display that allows you to observe the time domain characteristics of a signal over a period of time. This way of analyzing a signal makes it an easy way to detect anomalies.

The horizontal and vertical axes both represent time. The horizontal axis represents the time covered by a single sweep (corresponding to the current sweep time) while the vertical axis shows the information contained in the traces of the PvT result display in a chronological order. The information runs from top to bottom, with the top of the diagram containing the data that was recorded last. To display the level information, the R&S FSVR maps different colors to each power level that has been measured. The result is therefore still a two dimensional diagram.

The data processing is similar to that of the spectrogram. The difference is that the PvT waterfall result display uses the PvT traces as its data basis.

For more information on the data processing see [chapter 3.6, "The Power vs Time Result Display"](#), on page 41.

For more information on the coloring process and filling process of the diagram see [chapter 3.4, "The Spectrogram Result Display"](#), on page 21.

3.7.1 Screen Layout of the PvT Waterfall Result Display

The PvT waterfall result display features the same elements as the spectrogram result display except that the horizontal axis represents time.

For more information see [chapter 3.4.1, "Screen Layout"](#), on page 23.

3.7.2 Applications of the PvT Waterfall Result Display

Typical applications are similar to those of the PvT result display. For more information see [chapter 3.6.2, "Applications of the Power vs Time Result Display"](#), on page 42.

3.8 Configuring Realtime Measurements

Three distinctive parameters for realtime analysis are the span, the sweep time and the resolution bandwidth.

The span and resolution bandwidth are directly coupled to each other.

The settings are also defined by the FFT window that you are using.

3.8.1 Configuring the Sweep

The R&S FSVR provides various functions to configure the way it performs measurements.

In its default state, the R&S FSVR continuously measures the signal that you have applied in the way described in [chapter 3.1, "Data Acquisition and Processing in a Realtime Analyzer"](#), on page 16 and according to the trigger settings.

You can interrupt the continuous measurement with the "Continuous Sweep Stop" softkey if you want to examine a signal further. To resume the continuous measurement, use the "Continuous Sweep Start" softkey.

In single sweep mode, on the other hand, the R&S FSVR performs a finite number of sweeps. The number of sweeps that the R&S FSVR performs depends on the sweep count, defined with the "Sweep Count" softkey in the sweep menu. If you set the sweep count to 0 or 1, the R&S FSVR performs one sweep. One sweep corresponds to the sweep time. You can activate the single sweep mode with the "Single Sweep" softkey.

After the single sweep has ended, you can repeat the single sweep measurement with either the "Single Sweep" softkey or the "Continue Single Sweep" softkey. The difference is that when continuing the single sweep, the R&S FSVR does not delete the trace data of the last measurement for averaging purposes. When you instead repeat the single sweep with the "Single Sweep" softkey, the R&S FSVR completely rebuilds the trace from new data.

[INITiate<n>:CONTInuous](#) on page 730

[INITiate<n>:CONMeas](#) on page 729

[\[SENSe:\]SWEep:COUNT](#) on page 866

[CALCulate<n>:SGRam:FRAMe:COUNT](#) on page 694

3.8.2 Setting the Sweep Time

In the frequency domain of the realtime analyzer, the sweep time defines the number of FFTs that the R&S FSVR combines in one frame or single sweep.

In realtime mode, the R&S FSVR has a sweep time range from 52 μ s to 1 s, with 1 s processing 250.000 FFTs. The step size of the sweep time is 4 μ s.

The advantage of a small sweep time therefore is a very detailed evaluation and display of the signal that you are measuring. On the other hand, a high sweep time displays more time in a single frame. That means that you can observe a longer time span in the spectrogram the higher the sweep time is.

In the time domain of the realtime analyzer, the sweep time corresponds to the width of the horizontal axis. It therefore defines the time that the R&S FSVR displays in a single sweep. The range depends on the bandwidth that you have currently set.

Manual setting of the sweep time

You can set the sweep time as you need with the "Sweep Manual". This softkey is available in the span, bandwidth and sweep menus.

[SENSe:] SWEEp:TIME on page 872

Automatic setting of the sweep time

If you activate the automatic sweep time with the "Sweep Auto" softkey, the R&S FSVR sets the sweep time to 30 ms. The "Sweep Auto" softkey is available in the bandwidth and sweep menus.

[SENSe:] SWEEp:TIME:AUTO on page 873

3.8.3 Working with FFT Windows

In the realtime mode you can select one of several FFT window types. The window type is coupled to the resolution bandwidth.

The following window types are available:

- Blackman-Harris
- Flattop
- Gaussian
- Rectangle
- Hanning
- Kaiser

3.8.4 Setting the Span

The span (or realtime bandwidth) defines the frequency range that the R&S FSVR shows in result displays with a horizontal axis showing the frequency.

The span you should use depends on the signal that you are measuring. It should, however, be about twice as large as the bandwidth of the signal.

In realtime mode, the R&S FSVR has a minimum span of 100 Hz and a maximum span of 40 MHz.

You can set the span in several ways.

Setting the span

You can set the directly with the "Span Manual" softkey or the SPAN key.

If you change the span in this way, the center frequency always corresponds to the center of the span and remains the same, no matter how you change the span.

[SENSe:] FREQuency:SPAN on page 811

Defining a start and stop frequency

Another way to set the span is to define a start and stop frequency with the "Start" and "Stop" softkeys in the frequency menu.

Changing the start and stop frequencies invalidates the center frequency and span settings that you have previously made.

Note that if you enter a start and stop frequency that would result in a span larger than 40 MHz, the R&S FSVR always narrows the span down to 40 MHz.

Example:

If you first enter a start frequency of 100 MHz and then a stop frequency of 150 MHz, the R&S FSVR adjusts the start frequency to 110 MHz.

If you first enter a stop frequency of 150 MHz and then a start frequency of 100 MHz, the R&S FSVR adjusts the stop frequency to 140 MHz.

[SENSe:] FREQuency: START on page 811

[SENSe:] FREQuency: STOP on page 811

Restoring the full span

You can always restore the full span (40 MHz) with the "Full Span" softkey.

[SENSe:] FREQuency: SPAN: FULL on page 811

3.8.5 Setting the Resolution Bandwidth

The aspect of the signal as appears on the display of the R&S FSVR depends on the resolution filter bandwidth that you have set. The resolution bandwidth determines the frequency resolution of a measurements.

The resolution bandwidth is directly coupled to the span of the R&S FSVR. If you increase or decrease the span, the resolution bandwidth also goes up or down.

A small resolution bandwidth has several advantages. The smaller the resolution bandwidth, the better you can observe signals whose frequencies are close together and the less noise is displayed. However, a small resolution bandwidth also leads to a slower measurement as it takes the filter more time to settle. That means that if you increase or decrease the resolution bandwidth, the R&S FSVR adjusts the sweep time accordingly.

The R&S FSVR has resolution bandwidths from 500 mHz to 200 kHz in 1-2-5 steps (1 Hz - 2 Hz - 5 Hz - 10 Hz etc.).

You can set the resolution bandwidth with the "Manual Res BW" softkey.

With option R&S FSV-K54, you can select several 6 dB resolution bandwidths. You can turn the functionality on with the "Res BW 6 dB (On Off)" softkey and then select the available bandwidths with the "Res BW Manual" softkey.

[SENSe:] BANDwidth|BWIDth[:RESolution] on page 782

[SENSe:]BANDwidth|BWIDth[:RESolution]:AUTO on page 782

3.9 Using Markers

All of the result displays available in realtime spectrum mode support marker functionality.

Markers are a means to mark points of interest in the diagram, to read out measurement results or to quickly get hold of measurement results that are currently not visible. In most result displays, you can either use markers or deltamarkers with deltamarkers always having a relative position to a normal marker.

The marker that you can control is the active marker.

The R&S FSVR displays all necessary information about the active marker inside the diagram area in the marker information field. The information that is displayed depends on the result display.

This chapter describes distinctive features of the marker functionality for the result displays in realtime spectrum mode.

For general information about markers and the contents of the marker, marker to and marker function softkey menus, see

- [chapter 4.2.1, "Using Markers and Delta Markers – MKR Key"](#), on page 119
- [chapter 4.2.4, "Changing Settings via Markers – MKR-> Key"](#), on page 141

3.9.1 Markers in a Spectrogram

Upon pressing the MKR key, the R&S FSVR opens an input field to define the position of the first marker.

A screenshot of a marker input field. It consists of two adjacent input boxes. The first box contains the text "25.0 kHz" and is highlighted with a blue dashed border. The second box contains the text "-1.998 s".

Fig. 3-14: Marker input field

Every marker in the spectrogram has two coordinates. If the realtime spectrum is active at the same time the spectrogram is active, the realtime spectrum markers also have two coordinates.

The first coordinate defines the frequency of the marker.

The second coordinate defines the position of the marker in time. The unit depends on whether the time stamp is active or not. If it is inactive, you have to define a particular frame number relative to the current frame. If not, you have to set the distance to the current frame in seconds. The R&S FSVR then evaluates the corresponding frame number automatically. The time value for normal markers is always negative, because the temporal marker position is always relative to the current frame. Deltamarkers can also have positive values, if you set them on a frame recorded after the frame the marker is on.

The recording date and time of the frame (displayed in the spectrogram footer) is adjusted accordingly.

The available history depth defines the maximum time range.

As soon as the first marker is active, the R&S FSVR also shows the marker information in the diagram area

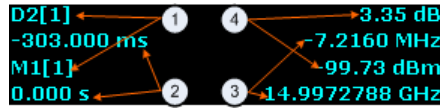

Fig. 3-15: Marker information

- 1 = Marker (Mx) and deltamarker (Dx) information including the trace number [x] the marker is on
- 2 = Position of the marker in time (relative to the marker in case of the deltamarker)
- 3 = Frequency position of the marker (relative to the marker in case of the deltamarker)
- 4 = Level of the marker position (relative to the marker in case of the deltamarker)

If necessary (for example to get a better view of the diagram contents), you can turn the marker information on or off with the "Marker info (On Off)" softkey.

All results concerning normal markers are absolute values (frequency, level and time information) while results of the deltamarker are relative to the normal marker.

Markers and deltamarkers in the realtime spectrum result display are always coupled to the spectrogram and vice versa, no matter if you are viewing both at the same time or not.

In the realtime spectrum, markers have the form of a triangle (▼). As long as the spectrogram is running, markers are not available in the realtime spectrum. If you stop the spectrogram by switching to single sweep mode or by interrupting the continuous sweep mode, markers become available for the realtime spectrum. You can then select a particular frame in the spectrogram to recall the corresponding realtime spectrum, and place the markers there. The markers of spectrogram and realtime spectrum are always synchronized in time.

Markers in the spectrogram look like diamonds (◆). You can set them on any frame stored in the spectrogram history and on any frequency you want. No matter the sweep mode, they will be visible and stay where you have put them. If you place them too far in the past or too far from each other vertically or horizontally, however, it may be that one or more markers are no longer visible in the result display. To see the marker in that case, you have to select it first.

For more information, see

- [chapter 3.4.3.1, "Working with the Spectrogram History"](#), on page 24

Setting a marker on a trigger event

In the spectrogram, you can set the marker directly on the most recent trigger event with the "Marker to Trigger" softkey available in the marker to menu. The functionality is available only if there was a trigger event already.

For a list of remote commands to control markers and deltamarkers see

- ["CALCulate:DELTAmarker:SGRam subsystem"](#) on page 571

- ["CALCulate:MARKer:SGRam subsystem"](#) on page 656

3.9.2 Markers in the Persistence Spectrum

If you press the MKR key in the persistence spectrum, the R&S FSVR activates a marker and opens a dialog box to define the position of the marker. In the persistence spectrum the marker looks like cross hairs with the center focusing on the pixel that you want to analyze.

A Marker in the persistence spectrum has two coordinates. The first coordinate defines the frequency position of the marker. The second coordinate defines the position on the amplitude axis.

In addition to those two values, the marker provides the number of times the pixel it is on has been hit by the signal. The result is the statistical frequency in %.

As soon as the first marker is active, the R&S FSVR also shows the marker information in the diagram area.

All results concerning normal markers are absolute values (frequency and level) while results of the frequency and amplitude information of a deltamarker are relative to the normal marker. The statistical frequency distribution that the marker also shows is always absolute.

Defining the trace to put the marker on

In the persistence spectrum result display, you can place each marker either on the persistence trace or the maxhold trace, if it is active. The R&S FSVR then returns the data of the marker position for the corresponding trace. You can select the trace with the "(Current Maxhold)" softkey.

[CALCulate<n>:MARKer<m>:TRACe](#) on page 617

3.10 Triggering Measurements

To respond to certain events and trigger a measurement when that event happens, the R&S FSVR offers several trigger functions. You can access these via the TRIG key and the corresponding softkey menu.

This chapter describes trigger functions available for the measurements in realtime spectrum analyzer mode.

3.10.1 Working with the Frequency Mask Trigger

The Frequency Mask Trigger (FMT) is a trigger designed to trigger measurements if the signal violates certain conditions with respect to a frequency mask that you can define prior to the measurement.

To create and edit a frequency mask, you can access the corresponding dialog box via the "Frequency Mask" softkey in the trigger menu.

Opening the dialog box also opens a softkey submenu that contains various functionality to work with frequency masks.

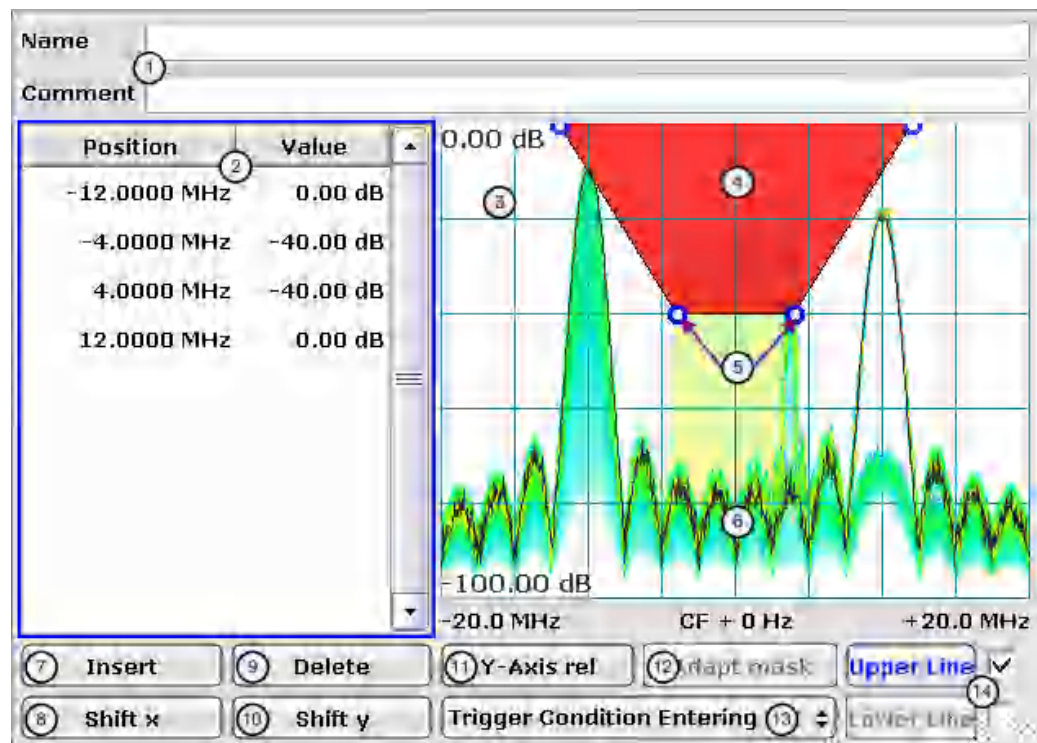

- 1 = Name and description of the frequency mask
- 2 = Mask point table: table containing all mask points
- 3 = Preview pane
- 4 = Frequency mask preview: the area the frequency mask currently covers is red
- 5 = Frequency mask data points: define the shape of the frequency mask
- 6 = Preview of the current measurement trace; type and shape depend on currently selected measurement
- 7 = Insert button: insert a new data points
- 8 = Shift X button: shifts the complete frequency mask horizontally
- 9 = Delete button: deletes an existing data points
- 10 = Shift Y button: shifts the complete frequency mask vertically
- 11 = Y-Axis Rel/Abs button: switches between relative (dB) and absolute (dBm) amplitude values
- 12 = Adapt Mask button: creates a frequency mask automatically
- 13 = Trigger Condition menu: sets the trigger condition
- 14 = Activate Line buttons: select the upper and lower frequency mask; check marks next to the buttons activate and deactivate a line

3.10.1.1 Creating a Frequency Mask

Upon opening the "Edit Frequency Mask" dialog box, the R&S FSVR already provides a basic structure of an upper frequency mask in the live preview window.

It is also possible to create a new mask by pressing the "New Mask" softkey. The "New Mask" softkey resets the current shape of the mask to its default state.

Labelling a frequency mask

Assign a name to the frequency mask in the "Name" field. Activate the input in the "Name" field either by touching it or via the "Edit Name" softkey. This is also the save name of the frequency mask.

In addition to naming the mask, you can also comment on the frequency mask you are working on in the "Comment" field. Again, activate the input either by touching it or with the "Edit Comment" softkey.

Remote command:

[CALCulate<n>:MASK:COMMeNt](#) on page 684

[CALCulate<n>:MASK:NAME](#) on page 686

Defining the frequency mask span

Define the span of the frequency mask.

The span defines the range that the frequency mask covers on the frequency axis.

Remote command:

[CALCulate<n>:MASK:SPAN](#) on page 687

Working with upper and lower lines

A frequency mask may have an upper and a lower threshold, with the signal in between. The checkboxes next to the "Upper Line" and "Lower Line" buttons activate or deactivate the corresponding line. Note that it is not possible to deactivate both lines.

You can select the line you want to edit with the "Upper Line" / "Lower Line" buttons or by touching the corresponding area in the preview to apply any changes. The buttons turn blue if a line is selected and the R&S FSVR shows the data points in the area covered by the mask in the preview pane.

Remote command:

[CALCulate<n>:MASK:LOWer\[:STATe\]](#) on page 685

[CALCulate<n>:MASK:UPPer\[:STATe\]](#) on page 688

Setting the trigger condition

To make the trigger work, you need to set a trigger condition with the "Trigger Condition" button. The R&S FSVR supports four conditions.

"Entering"	Activates the trigger as soon as the signal enters the frequency mask. To arm the trigger, the signal initially has to be outside the frequency mask.
"Leaving"	Activates the trigger as soon as the signal leaves the frequency mask. To arm the trigger, the signal initially has to be inside the frequency mask.

Remote command:

[TRIGger<n>\[:SEQuence\]:MASK:CONDition](#) on page 913

3.10.1.2 Editing Mask Points

You can adjust the frequency mask any way you want by adding, removing and repositioning frequency mask data points.

Data points define the shape of the frequency mask. In the preview pane, the R&S FSVR visualizes data points as blue circles. In addition, all data point positions are listed in the data point table. The number of data points is limited to 801.

Data points are defined by two values. The first value defines the position of the data point on the horizontal (frequency) axis. Frequency information is relative to the center frequency.

Note that in realtime mode, the span depends on the realtime bandwidth. That also means that the distance of a data point to the center frequency can never exceed 20 MHz as the maximum realtime bandwidth is 40 MHz.

The second value defines the position of the data point on the vertical (level) axis. By default, level information is relative to the reference level. You can, however, turn the level axis to absolute scaling with the "Y-Axis Abs/Rel" button. This also changes the unit of the vertical axis (dB for relative data points, dBm for absolute data points).

Adding data points

To add a new data point, press the "Insert" button or the "Insert Value Above" softkey. The R&S FSVR always adds the data point to the left (or in case of the table, above) of the currently selected data point. The currently selected data point is highlighted gray in the table. If no data point was selected previously, the buttons add a new point next to the very first one.

Deleting data points

The "Delete" button or the "Delete Value" softkey remove a data point from the mask. The R&S FSVR deletes the currently selected data point. If no data point is selected, it deletes the first one. The "Delete" button is inactive in that case.

Positioning data points

There are two ways to move a single data point.

In the preview pane, you can drag around the data points on the touchscreen or with a mouse and position it roughly in the place you want it to be. A more exact method is to edit the data point table itself and enter the frequencies and levels as you need.

Remote command:

`CALCulate<n>:MASK:LOWer[:DATA]` on page 686

`CALCulate<n>:MASK:UPPer[:DATA]` on page 688

Shifting mask points as a whole

With the "Shift X" and "Shift Y" buttons you are able to move all mask points of a frequency mask as one. The "Shift X" button moves the mask point set horizontally, while the "Shift Y" button moves them vertically. This is an easy method to move mask points if the relative position of mask points to each other is alright already without adjusting each one by itself.

Remote command:

`CALCulate<n>:MASK:LOWer:SHIFt:X` on page 685

`CALCulate<n>:MASK:LOWer:SHIFt:Y` on page 685

`CALCulate<n>:MASK:UPPer:SHIFt:X` on page 687

`CALCulate<n>:MASK:UPPer:SHIFt:Y` on page 687

Automatic alignment of the frequency mask

Instead of defining the position of every data point by hand, the R&S FSVR is able to shape the frequency mask according to the shape of the current signal. On pressing the "Auto Set Mask" button, the R&S FSVR forms the frequency mask around the current spectrum.

Note the the automatic alignment of the frequency mask works only for the upper frequency mask.

Remote command:

`CALCulate<n>:MASK:UPPer[:DATA]` on page 688

3.10.1.3 Managing Frequency Masks

To be able to reuse or edit a frequency mask that you have defined later, you can save and restore particular frequency mask configurations.

The R&S FSVR stores files that contain such configurations on its internal hard disk.

Save Mask

The "Save" softkey opens a dialog box to save the current frequency mask configuration in a file.

If you do not name the file in the dialog box, the R&S FSVR names the file like the name of the frequency mask itself.

Load Mask

The "Load" softkey opens a dialog box to restore a frequency mask.

The dialog box contains all frequency masks already on the hard disk of the R&S FSVR. Select the mask you need and confirm the selection with the "Load" button.

Remote command:

Path selection:

`CALCulate<n>:MASK:CDIRectory` on page 684

Load mask:

`CALCulate<n>:MASK:NAME` on page 686

Delete Mask

The Delete softkey opens a dialog box to delete a previously saved frequency mask.

The "Delete" button deletes the file. Note that you have to confirm the deletion process.

Remote command:

`CALCulate<n>:MASK:DElete` on page 685

3.10.2 Using the Time Domain Trigger

The time domain trigger is a trigger designed to trigger measurements if the signal exceeds a particular power level. Activate and define a power level for the time domain trigger by pressing the "Time Domain Trigger" softkey in the trigger menu.

The time domain trigger is available for measurements in the time domain. You can turn it off by selecting the free run mode.

[TRIGger<n>\[:SEquence\]:TDTRigger:LEVel](#) on page 915

3.10.3 Using Other Triggers

Besides the frequency mask trigger and the time domain trigger, the R&S FSVR features various other trigger modes.

Available trigger sources

- External
Activate and define a power level for the external trigger by pressing the "Time Domain Trigger" softkey in the trigger menu.
- Free Run
Turns off all trigger sources.

For more information see

- ["Free Run"](#) on page 110
- ["External"](#) on page 110

3.10.4 Using Pre- and Posttrigger

When using a trigger, you can set a "Pretrigger" and a "Posttrigger" period with the corresponding softkeys. Each can last up to three seconds. Both combined, however cannot be longer than four seconds.

Example:

If the pretrigger has a length of 3 seconds, the posttrigger can last a maximum of 1 second.

3.10.5 Rearming the Trigger and Stopping on Trigger

Auto Rearm

By default, a trigger event causes the R&S FSVR to start a measurement and to immediately rearm the trigger. In that case, measurements are continuously triggered and measurement results may become obsolete in a very short time. The pre- and posttrigger periods are completely displayed.

Stop on Trigger

However, you may be interested in the results after the first trigger event only. To do so, you can activate the "Stop on Trigger" feature. If active, this feature does not rearm the trigger after the first trigger event has occurred and stop the measurement after one sweep. The measurement results will remain on the display. If a posttrigger is active,

the R&S FSVR includes this period in the result display. The pretrigger period may not be displayed.

You can return to the default state (continuous triggering) with the "Auto Rearm" soft-key.

[TRIGger:MODE](#) on page 908

4 Using the Spectrum Analyzer

You can also perform conventional spectrum analysis with the R&S FSVR.

When you start the R&S FSVR for the first time or after a preset, it starts in normal spectrum analyzer mode. If it is inactive, press the MODE key and select the "Realtime Spectrum" softkey in the corresponding menu to enter the spectrum mode.

This chapter of the manual describes all functionality that is available in spectrum mode.

- [chapter 4.1, "Measurement Parameters"](#), on page 56
This section describes how to reset the instrument, to set up specific measurements and to set the measurement parameters. Examples of basic operations are provided in the Quick Start Guide, chapter 5 "Basic Measurement Examples". Advanced examples are described in the Operating Manual on CD-ROM, chapter "Advanced Measurement Examples".
- [chapter 4.2, "Measurement Functions"](#), on page 119
This section informs about how to select and configure the measurement functions. Examples of basic operations are provided in the Quick Start Guide, chapter 5 "Basic Measurement Examples". Advanced examples are described in the Operating Manual on CD-ROM, chapter "Advanced Measurement Examples".
- [chapter 7.1, "Instrument Functions - R&S Digital I/Q Interface \(Option R&S FSV-B17\)"](#), on page 469
This section provides information on how to configure and use the optional Digital Baseband Interface for digital input and output (B17).
- [chapter 4.4, "Instrument Functions - I/Q Analyzer"](#), on page 277
This section provides information on using the IQ Analyzer.
- [chapter 4.3, "Using the Spectrogram in Spectrum Mode"](#), on page 276
This section describes how to perform Spectrogram measurements in spectrum mode.
- [chapter 4.5, "Instrument Functions - Power Sensor \(R&S FSV-K9\)"](#), on page 304
This section describes how to configure and use an optional Power Sensor with an R&S FSVR(option R&S FSVR-K9).

4.1 Measurement Parameters

In this section all menus necessary for setting measurement parameters are described. For details on changing the mode refer to [chapter 2, "Selecting the Measurement Mode"](#), on page 10.



Editing measurement parameters in the information bar

The currently defined main measurement parameters are displayed in the information bar of the display. They can easily be edited by touching the setting in the display (with a finger or mouse pointer). The corresponding (edit) dialog box is displayed where you can edit the setting.

If you touch the setting in the display longer than 1 second or right-click it, a context-sensitive menu is displayed. The entries correspond to the functions available in the softkey menu for that setting.

Table 4-1: Sweep ranges

Abbreviation	Definition	R&S FSVR7	R&S FSVR13	R&S FSVR30	R&S FSVR40
f_{\min}	min. frequency	0 Hz	0 Hz	0 Hz	0 Hz
f_{\max}	max. frequency	7 GHz	13.6 GHz	30 GHz	40 GHz
span_{\min}	smallest possible span > 0 Hz	10 Hz	10 Hz	10 Hz	10 Hz

- [Initializing the Configuration – PRESET Key](#)..... 57
- [Selecting the Frequency and Span – FREQ Key](#).....59
- [Setting the Frequency Span – SPAN Key](#).....65
- [Setting the Level Display and Configuring the RF Input – AMPT Key](#)..... 66
- [Defining Automatic Settings – AUTO SET Key](#).....75
- [Setting the Bandwidths and Sweep Time – BW Key](#)..... 79
- [Configuring the Sweep Mode – SWEEP Key](#).....88
- [Setting Traces – TRACE Key](#).....92
- [Triggering the Sweep – TRIG Key](#)..... 108

4.1.1 Initializing the Configuration – PRESET Key

The PRESET key resets the instrument to the default setting and therefore provides a defined initial state as a known starting point for measurements.



If the "local lockout" function is active in the remote control mode, the PRESET key is disabled.

Further information

- [chapter 4.1.1.2, "Initial Configuration"](#), on page 58

Task

- [chapter 4.1.1.1, "Presetting the Instrument"](#), on page 58

4.1.1.1 Presetting the Instrument

1. Define the data set for the presetting:
 - a) To retrieve the originally provided settings file (see [chapter 4.1.1.2, "Initial Configuration"](#), on page 58), deactivate the "Startup Recall" softkey in the "SAVE/RCL" menu.
 - b) To retrieve a customized settings file, in the "File" menu, activate the "Startup Recall" softkey, press the "Startup Recall Setup" softkey, and select the corresponding file.
For details refer to [chapter 6.2, "Saving and Recalling Settings Files – SAVE/RCL Key"](#), on page 449.
2. Press the PRESET key to perform a preset.

Remote: *RST or SYSTem:PRESet



After you use the PRESET function, the history of previous actions is deleted, i.e. any actions performed previously cannot be undone or redone using the UNDO/REDO keys.

4.1.1.2 Initial Configuration

The initial configuration is selected such that the RF input is always protected against overload, provided that the applied signal levels are in the allowed range for the instrument.

The parameter set of the initial configuration can be customized using the "Startup Recall" softkey in the "Save/Rcl" menu. For further information refer to [chapter 6.2, "Saving and Recalling Settings Files – SAVE/RCL Key"](#), on page 449.

Table 4-2: Initial configuration

Parameter	Setting
mode	Spectrum
sweep mode	auto
center frequency	$f_{\max}/2$
center frequency step size	0.1 * span
span	maximum possible (depends on instrument model)
RF attenuation	0 dB
reference level	-10 dBm
level range	100 dB log
level unit	dBm
sweep time	auto

Parameter	Setting
resolution bandwidth	auto (3 MHz)
video bandwidth	auto (3 MHz)
FFT filters	off
span/RBW	100
RBW/VBW	1
sweep	cont
trigger	free run
trace 1	clr write
trace 2/3/4/5/6	blank
detector	auto peak
frequency offset	0 Hz
reference level offset	0 dB
reference level position	100 %
grid	abs
cal correction	on
noise source	off
input	RF

4.1.2 Selecting the Frequency and Span – FREQ Key

The FREQ key is used to configure the frequency axis, to set the frequency offset and the signal track function. You can configure the frequency axis either by the start and stop frequency or the center frequency and the span.

To open the Frequency menu

- Press the FREQ key.
The "Frequency" menu is displayed. The "Frequency Center" edit dialog box is displayed.

Menu and softkey description

- [chapter 4.1.2.1, "Softkeys of the Frequency Menu"](#), on page 60

Tasks

- [chapter 4.1.2.2, "Specifying the Frequency Axis by the Start and Stop Frequency"](#), on page 64
- [chapter 4.1.2.3, "Specifying the Frequency Axis by the Center Frequency and the Span"](#), on page 64

- chapter 4.1.2.4, "Specifying the Step Size for the Arrow Keys and the Rotary Knob", on page 64
- chapter 4.1.2.5, "Modifying the Frequency Axis by an Offset", on page 65
- chapter 4.1.2.6, "Tracking Signals (Span > 0)", on page 65

4.1.2.1 Softkeys of the Frequency Menu

The following chapter describes all softkeys available in the "Frequency" menu. It is possible that your instrument configuration does not provide all softkeys. If a softkey is only available with a special option, model or (measurement) mode, this information is provided in the corresponding softkey description.

Center.....	60
CF Stepsize.....	60
L 0.1*Span (span > 0).....	61
L 0.1*RBW (span > 0).....	61
L 0.5*Span (span > 0).....	61
L 0.5*RBW (span > 0).....	61
L x*Span (span > 0).....	61
L x*RBW (span > 0).....	62
L =Center.....	62
L =Marker.....	62
L Manual.....	62
Start.....	62
Stop.....	62
Frequency Offset.....	62
Signal Track (span > 0).....	63
L Track On/Off (span > 0).....	63
L Track BW (span > 0).....	63
L Track Threshold (span > 0).....	63
L Select Trace (span > 0).....	63
External Mixer.....	63

Center

Opens an edit dialog box to enter the center frequency. The allowed range of values for the center frequency depends on the frequency span.

$$\text{span} > 0: \text{span}_{\min}/2 \leq f_{\text{center}} \leq f_{\max} - \text{span}_{\min}/2$$

$$\text{span} = 0: 0 \text{ Hz} \leq f_{\text{center}} \leq f_{\max}$$

f_{\max} and span_{\min} are specified in the data sheet.

Remote command:

[SENSe:] FREQuency:CENTer on page 808

CF Stepsize

Opens a submenu to set the step size of the center frequency.

The step size defines the value by which the center frequency is increased or decreased when the arrow keys are pressed. When you use the rotary knob the center frequency changes in steps of 10% of the "Center Frequency Stepsize".

The step size can be set to a fraction of the span ($\text{span} > 0$) or a fraction of the resolution bandwidth ($\text{span} = 0$) or it can be set to a fixed value manually.

Apart from the **=Center**, **=Marker** and **Manual** softkeys, the other softkeys are displayed depending on the selected frequency span.

0.1*Span (span > 0) ← CF Stepsize

Sets the step size for the center frequency to 10 % of the span.

Remote command:

FREQ:CENT:STEP:LINK SPAN, see [SENSe:]FREQuency:CENTer:STEP:LINK on page 809

FREQ:CENT:STEP:LINK:FACT 10PCT, see [SENSe:]FREQuency:CENTer:STEP:LINK:FACTor on page 809

0.1*RBW (span > 0) ← CF Stepsize

Sets the step size for the center frequency to 10 % of the resolution bandwidth.

This is the default setting.

Remote command:

FREQ:CENT:STEP:LINK RBW, see [SENSe:]FREQuency:CENTer:STEP:LINK on page 809

FREQ:CENT:STEP:LINK:FACT 10PCT, see [SENSe:]FREQuency:CENTer:STEP:LINK:FACTor on page 809

0.5*Span (span > 0) ← CF Stepsize

Sets the step size for the center frequency to 50 % of the span.

Remote command:

FREQ:CENT:STEP:LINK SPAN, see [SENSe:]FREQuency:CENTer:STEP:LINK on page 809

FREQ:CENT:STEP:LINK:FACT 50PCT, see [SENSe:]FREQuency:CENTer:STEP:LINK:FACTor on page 809

0.5*RBW (span > 0) ← CF Stepsize

Sets the step size for the center frequency to 50 % of the resolution bandwidth.

Remote command:

FREQ:CENT:STEP:LINK RBW, see [SENSe:]FREQuency:CENTer:STEP:LINK on page 809

FREQ:CENT:STEP:LINK:FACT 50PCT, see [SENSe:]FREQuency:CENTer:STEP:LINK:FACTor on page 809

x*Span (span > 0) ← CF Stepsize

Opens an edit dialog box to set the step size for the center frequency as a percentage (%) of the span.

Remote command:

FREQ:CENT:STEP:LINK SPAN, see [SENSe:]FREQuency:CENTer:STEP:LINK on page 809

FREQ:CENT:STEP:LINK:FACT 20PCT, see [SENSe:]FREQuency:CENTer:STEP:LINK on page 809

x*RBW (span > 0) ← CF Stepsize

Opens an edit dialog box to set the step size for the center frequency as a percentage (%) of the resolution bandwidth. Values between 1 % and 100 % in steps of 1 % are allowed. The default setting is 10 %.

Remote command:

FREQ:CENT:STEP:LINK RBW, see [\[SENSe:\]FREQuency:CENTer:STEP:LINK](#) on page 809

FREQ:CENT:STEP:LINK:FACT 20PCT, see [\[SENSe:\]FREQuency:CENTer:STEP:LINK](#) on page 809

=Center ← CF Stepsize

Sets the step size to the value of the center frequency and removes the coupling of the step size to span or resolution bandwidth.

This function is especially useful for measurements of the signal harmonics. In this case, each stroke of the arrow key selects the center frequency of another harmonic.

=Marker ← CF Stepsize

Sets the step size to the value of the current marker and removes the coupling of the step size to span or resolution bandwidth.

This function is especially useful for measurements of the signal harmonics. In this case, each stroke of the arrow key selects the center frequency of another harmonic.

Manual ← CF Stepsize

Opens an edit dialog box to enter a fixed step size for the center frequency.

Remote command:

[\[SENSe:\]FREQuency:CENTer:STEP](#) on page 808

Start

Opens an edit dialog box to define the start frequency. The following range of values is allowed:

$$f_{\min} \leq f_{\text{start}} \leq f_{\max} - \text{span}_{\min}$$

f_{\min} , f_{\max} and span_{\min} are specified in the data sheet.

Remote command:

[\[SENSe:\]FREQuency:START](#) on page 811

Stop

Opens an edit dialog box to define the stop frequency. The following range of values for the stop frequency is allowed:

$$f_{\min} + \text{span}_{\min} \leq f_{\text{stop}} \leq f_{\max}$$

f_{\min} , f_{\max} and span_{\min} are specified in the data sheet.

Remote command:

[\[SENSe:\]FREQuency:STOP](#) on page 811

Frequency Offset

Opens an edit dialog box to enter a frequency offset that shifts the displayed frequency range by the specified offset.

The softkey indicates the current frequency offset. The allowed values range from -100 GHz to 100 GHz. The default setting is 0 Hz.

Remote command:

[SENSe:] FREQuency: OFFSet on page 811

Signal Track (span > 0)

Opens a submenu to define the signal tracking characteristics:

- search bandwidth
- threshold value
- trace

The search bandwidth and the threshold value are shown in the diagram by two vertical lines and one horizontal line, which are labeled as "TRK". After each sweep the center frequency is set to the maximum signal found within the searched bandwidth. If no maximum signal above the set threshold value is found in the searched bandwidth, the track mechanism stops.

The submenu contains the following softkeys:

- "Track On/Off (span > 0)" on page 63
- "Track BW (span > 0)" on page 63
- "Track Threshold (span > 0)" on page 63
- "Select Trace (span > 0)" on page 63

Track On/Off (span > 0) ← Signal Track (span > 0)

Switches the signal tracking on and off.

Remote command:

CALCulate<n>:MARKer<m>:FUNCTION:STRack[:STATE] on page 665

Track BW (span > 0) ← Signal Track (span > 0)

Opens an edit dialog box to set the search bandwidth for signal tracking. The frequency range is calculated as a function of the center frequency.

Remote command:

CALCulate<n>:MARKer<m>:FUNCTION:STRack:BANDwidth|BWIDth on page 664

Track Threshold (span > 0) ← Signal Track (span > 0)

Opens an edit dialog box to set the threshold value for signal tracking.

Remote command:

CALCulate<n>:MARKer<m>:FUNCTION:STRack:THReshold on page 664

Select Trace (span > 0) ← Signal Track (span > 0)

Opens an edit dialog box to select the trace on which the signal is tracked.

Remote command:

CALCulate<n>:MARKer<m>:FUNCTION:STRack:TRACe on page 664

External Mixer

Opens the "Ext. Mixer" submenu to activate and configure an optional external mixer. This function is only available for R&S FSVR30 and 40 instruments with the B21 option installed.

For details on the external mixer functionality, see [chapter 7.2, "Instrument Functions – External Mixer \(Option R&S FSV-B21\)"](#), on page 487.

4.1.2.2 Specifying the Frequency Axis by the Start and Stop Frequency

1. Press the **Start** softkey and enter a start frequency.
2. Press the **Stop** softkey and enter a stop frequency.

4.1.2.3 Specifying the Frequency Axis by the Center Frequency and the Span

1. Press the **FREQ** key and enter a center frequency in the "Frequency Center" edit dialog box.
2. Press the **SPAN** key and enter the bandwidth you want to analyze.



Entering a value of 0 Hz causes a change to the zero span analysis mode.

4.1.2.4 Specifying the Step Size for the Arrow Keys and the Rotary Knob

1. Press the **CF Stepsize** softkey.
The available softkeys depend on the selected frequency span (zero span or span > 0).
2. To define the step size of the center frequency:
 - a) If span > 0:
Press "0.1*Span", "0.5*Span" or "x*Span" to define the step size for the center frequency as percentage of the span (see [CF Stepsize](#)).
 - b) If span = 0:
Press "0.1*RBW", "0.5*RBW", or "x*RBW" to define the step size for the center frequency as percentage of the resolution bandwidth (see [CF Stepsize](#)).
 - c) Press the **=Center** softkey to set the step size to the value of the center frequency and remove the dependency of the step size to span or resolution bandwidth.
 - d) Press the **=Marker** softkey to set the step size to the value of the marker and remove the dependency of the step size to span or resolution bandwidth.
 - e) Press the **Manual** softkey and enter a fixed step size for the center frequency.



The step size assigned to arrow keys corresponds to the selected value.
The step size of the rotary knob is always 10 % of it.

4.1.2.5 Modifying the Frequency Axis by an Offset

- Press the [Frequency Offset](#) softkey and enter the offset to shift the displayed frequency span.

4.1.2.6 Tracking Signals (Span > 0)

Note that signal tracking is available for frequency spans > 0.

- Press the [Signal Track \(span > 0\)](#) softkey to open the submenu and start and stop signal tracking with specified parameters.
- Press the [Track On/Off \(span > 0\)](#) softkey to switch signal tracking on or off.
- Press the [Track BW \(span > 0\)](#) softkey and enter a bandwidth for signal tracking.
- Press the [Track Threshold \(span > 0\)](#) softkey and enter the threshold for signal tracking.
- Press the [Select Trace \(span > 0\)](#) softkey and select the trace for signal tracking.

4.1.3 Setting the Frequency Span – SPAN Key

The SPAN key is used to set the frequency span to be analyzed.

To open the Span menu

- Press the SPAN key.
The "Span" menu is displayed. For span > 0 an edit dialog box to enter the frequency is displayed. For zero span, an edit dialog box to enter the sweep time is displayed.

Menu and softkey description

- [chapter 4.1.3.1, "Softkeys of the Span Menu"](#), on page 65

Task

- [chapter 4.1.3.2, "Specifying the Span \(Alternatives\)"](#), on page 66

4.1.3.1 Softkeys of the Span Menu

The following chapter describes all softkeys available in the "Span" menu. It is possible that your instrument configuration does not provide all softkeys. If a softkey is only available with a special option, model or (measurement) mode, this information is provided in the corresponding softkey description.

Span Manual	66
Full Span	66
Zero Span	66
Last Span	66

Span Manual

Opens an edit dialog box to enter the frequency span. The center frequency remains the same when you change the span.

The following range is allowed:

span = 0: 0 Hz

span >0: $\text{span}_{\min} \leq f_{\text{span}} \leq f_{\max}$

f_{\max} and span_{\min} are specified in the data sheet.

Remote command:

[\[SENSe:\] FREQuency: SPAN](#) on page 811

Full Span

Sets the span to the full frequency range of the R&S FSVR specified in the data sheet. This setting is useful for overview measurements.

Remote command:

[\[SENSe:\] FREQuency: SPAN: FULL](#) on page 811

Zero Span

Sets the span to 0 Hz (zero span). The x-axis becomes the time axis with the grid lines corresponding to 1/10 of the current sweep time ("SWT").

Remote command:

FREQ: SPAN 0Hz, see [\[SENSe:\] FREQuency: SPAN](#) on page 811

Last Span

Sets the span to the previous value. With this function e.g. a fast change between overview measurement and detailed measurement is possible.

Remote command:

-

4.1.3.2 Specifying the Span (Alternatives)

1. To set the span, use the [Span Manual](#), [Full Span](#), [Zero Span](#) and [Last Span](#) softkeys.
2. To define a frequency range, use the [Start](#) and [Stop](#) softkeys of the "Frequency" menu.
3. In zero span, the span corresponds to the sweep time. In that case, press the [Sweptime Manual](#) softkey and enter a sweep time.

4.1.4 Setting the Level Display and Configuring the RF Input – AMPT Key

The AMPT key is used to set the reference level, the level range and unit, the scaling and the RF attenuation.

To open the amplitude menu

- Press the AMPT key.
The "Amplitude" menu is displayed. The "Reference Level" dialog box is displayed.

Menu and softkey description

- [chapter 4.1.4.1, "Softkeys of the Amplitude Menu"](#), on page 67

Tasks

- [chapter 4.1.4.2, "Specifying the Amplitude"](#), on page 74
- [chapter 4.1.4.3, "Using Electronic Attenuation \(Option Electronic Attenuator, R&S FSV-B25\)"](#), on page 74

4.1.4.1 Softkeys of the Amplitude Menu

The following table shows all softkeys available in the "Amplitude" menu. It is possible that your instrument configuration does not provide all softkeys. If a softkey is only available with a special option, model or (measurement) mode, this information is provided in the corresponding softkey description.

Ref Level.....	67
Range.....	68
L Range Log 100 dB.....	68
L Range Log 50 dB.....	68
L Range Log 10 dB.....	68
L Range Log 5 dB.....	68
L Range Log 1 dB.....	69
L Range Log Manual.....	69
L Range Linear %.....	69
L Range Lin. Unit.....	69
Unit.....	69
Preamp On/Off.....	70
RF Atten Manual/Mech Att Manual.....	70
RF Atten Auto/Mech Att Auto.....	71
EI Atten On/Off.....	71
EI Atten Mode (Auto/Man).....	71
Ref Level Offset.....	72
Ref Level Position.....	72
Grid Abs/Rel.....	72
Noise Correction.....	72
Input (AC/DC).....	73
Input 50 Ω /75 Ω	73
YIG Filter (On Off).....	73

Ref Level

Opens an edit dialog box to enter the reference level in the current unit (dBm, dB μ V, etc).

The reference level is the maximum value the AD converter can handle without distortion of the measured value. Signal levels above this value will not be measured correctly, which is indicated by the "IFOVL" status display.

Remote command:

`DISPlay[:WINDow<n>]:TRACe<t>:Y[:SCALe]:RLEVEL` on page 720

Range

Opens a submenu to define the display range of the level axis.

Range Log 100 dB ← Range

Sets the level display range to 100 dB.

Remote command:

Logarithmic scaling:

`DISP:WIND:TRAC:Y:SPAC LOG`, see `DISPlay[:WINDow<n>]:TRACe<t>:Y:SPACing` on page 717

Display range:

`DISP:WIND:TRAC:Y 100DB`, see `DISPlay[:WINDow<n>]:TRACe<t>:Y[:SCALe]` on page 718

Range Log 50 dB ← Range

Sets the level display range to 50 dB.

Remote command:

Logarithmic scaling:

`DISP:WIND:TRAC:Y:SPAC LOG`, see `DISPlay[:WINDow<n>]:TRACe<t>:Y:SPACing` on page 717

Display range:

`DISP:WIND:TRAC:Y 50DB`, see `DISPlay[:WINDow<n>]:TRACe<t>:Y[:SCALe]` on page 718

Range Log 10 dB ← Range

Sets the level display range to 10 dB.

Remote command:

Logarithmic scaling:

`DISP:WIND:TRAC:Y:SPAC LOG`, see `DISPlay[:WINDow<n>]:TRACe<t>:Y:SPACing` on page 717

Display range:

`DISP:WIND:TRAC:Y 10DB`, see `DISPlay[:WINDow<n>]:TRACe<t>:Y[:SCALe]` on page 718

Range Log 5 dB ← Range

Sets the level display range to 5 dB.

Remote command:

Logarithmic scaling:

`DISP:WIND:TRAC:Y:SPAC LOG`, see `DISPlay[:WINDow<n>]:TRACe<t>:Y:SPACing` on page 717

Display range:

`DISP:WIND:TRAC:Y 5DB`, see `DISPlay[:WINDow<n>]:TRACe<t>:Y[:SCALe]` on page 718

Range Log 1 dB ← Range

Sets the level display range to 1 dB.

Remote command:

Logarithmic scaling:

DISP:WIND:TRAC:Y:SPAC LOG, see [DISPlay\[:WINDow<n>\]:TRACe<t>:Y:SPACing](#) on page 717

Display range:

DISP:WIND:TRAC:Y 1DB, see [DISPlay\[:WINDow<n>\]:TRACe<t>:Y\[:SCALe\]](#) on page 718

Range Log Manual ← Range

Opens an edit dialog box to define the display range of a logarithmic level axis manually.

Remote command:

Logarithmic scaling:

DISP:WIND:TRAC:Y:SPAC LOG, see [DISPlay\[:WINDow<n>\]:TRACe<t>:Y:SPACing](#) on page 717

Display range:

[DISPlay\[:WINDow<n>\]:TRACe<t>:Y\[:SCALe\]](#) on page 718

Range Linear % ← Range

Selects linear scaling for the level axis in %.

The grid is divided into decadal sections.

Markers are displayed in the selected unit ("Unit" softkey). Delta markers are displayed in % referenced to the voltage value at the position of marker 1. This is the default setting for linear scaling.

Remote command:

DISP:TRAC:Y:SPAC LIN, see [DISPlay\[:WINDow<n>\]:TRACe<t>:Y:SPACing](#) on page 717

Range Lin. Unit ← Range

Selects linear scaling in dB for the level display range, i.e. the horizontal lines are labeled in dB.

Markers are displayed in the selected unit ("Unit" softkey). Delta markers are displayed in dB referenced to the power value at the position of marker 1.

Remote command:

DISP:TRAC:Y:SPAC LDB, see [DISPlay\[:WINDow<n>\]:TRACe<t>:Y:SPACing](#) on page 717

Unit

Opens the "Unit" submenu to select the unit for the level axis.

The default setting is dBm.

If a transducer is switched on, the softkey is not available.

In general, the signal analyzer measures the signal voltage at the RF input. The level display is calibrated in RMS values of an unmodulated sine wave signal. In the default state, the level is displayed at a power of 1 mW (= dBm). Via the known input impedance (50 Ω or 75 Ω), conversion to other units is possible. The following units are available and directly convertible:

- dBm
- dBmV
- dBμV
- dBμA
- dBpW
- Volt
- Ampere
- Watt

Remote command:

`CALCulate<n>:UNIT:POWer` on page 704

Preamp On/Off

Switches the preamplifier on and off.

If option R&S FSV-B22 is installed, the preamplifier is only active below 7 GHz.

If option R&S FSV-B24 is installed, the preamplifier is active for all frequencies.

When measuring Spurious Emissions, using this softkey automatically opens the "Sweep List" dialog, see "[Sweep List dialog box](#)" on page 219.

This function is not available for input from the R&S Digital I/Q Interface (option R&S FSV-B17).

Remote command:

`INPut:GAIN:STATe` on page 737

RF Atten Manual/Mech Att Manual

Opens an edit dialog box to enter the attenuation, irrespective of the reference level. If electronic attenuation is activated (option R&S FSV-B25 only; "EI Atten Mode Auto" softkey), this setting defines the mechanical attenuation.

The mechanical attenuation can be set in 10 dB steps.

The RF attenuation can be set in 5 dB steps (with option R&S FSV-B25: 1 dB steps).

The range is specified in the data sheet. If the current reference level cannot be set for the set RF attenuation, the reference level is adjusted accordingly.

This function is not available for input from the R&S Digital I/Q Interface (option R&S FSV-B17).

The RF attenuation defines the level at the input mixer according to the formula:

$$\text{level}_{\text{mixer}} = \text{level}_{\text{input}} - \text{RF attenuation}$$

Note: As of firmware version 1.63, the maximum mixer level allowed is **0 dBm**. Mixer levels above this value may lead to incorrect measurement results, which are indicated by the "OVL" status display. The increased mixer level allows for an improved signal, but also increases the risk of overloading the instrument!

When measuring spurious emissions, using this softkey automatically opens the "Sweep List" dialog box, see ["Sweep List dialog box"](#) on page 219.

Remote command:

[INPut:ATTenuation](#) on page 732

RF Atten Auto/Mech Att Auto

Sets the RF attenuation automatically as a function of the selected reference level. This ensures that the optimum RF attenuation is always used. It is the default setting.

When measuring spurious emissions, using this softkey automatically opens the "Sweep List" dialog, see ["Sweep List dialog box"](#) on page 219.

This function is not available for input from the R&S Digital I/Q Interface (option R&S FSV-B17).

Remote command:

[INPut:ATTenuation:AUTO](#) on page 732

EI Atten On/Off

This softkey switches the electronic attenuator on or off. This softkey is only available with option R&S FSV-B25.

When the electronic attenuator is activated, the mechanical and electronic attenuation can be defined separately. Note however, that both parts must be defined in the same mode, i.e. either both manually, or both automatically.

This function is not available for input from the R&S Digital I/Q Interface (option R&S FSV-B17).

- To define the mechanical attenuation, use the [RF Atten Manual/Mech Att Manual](#) or [RF Atten Auto/Mech Att Auto](#) softkeys.
- To define the electronic attenuation, use the [EI Atten Mode \(Auto/Man\)](#) softkey.

Note: This function is not available for stop frequencies (or center frequencies in zero span) >7 GHz. In this case, the electronic and mechanical attenuation are summarized and the electronic attenuation can no longer be defined individually. As soon as the stop or center frequency is reduced below 7 GHz, this function is available again. When the electronic attenuator is switched off, the corresponding RF attenuation mode (auto/manual) is automatically activated.

Remote command:

[INPut:EATT:AUTO](#) on page 736

EI Atten Mode (Auto/Man)

This softkey defines whether the electronic attenuator value is to be set automatically or manually. If manual mode is selected, an edit dialog box is opened to enter the value. This softkey is only available with option R&S FSV-B25, and only if the electronic attenuator has been activated via the [EI Atten On/Off](#) softkey.

Note: This function is not available for stop frequencies (or center frequencies in zero span) >7 GHz. In this case, the electronic and mechanical attenuation are summarized and the electronic attenuation can no longer be defined individually. As soon as the stop or center frequency is reduced below 7 GHz, electronic attenuation is available again. If the electronic attenuation was defined manually, it must be re-defined.

The attenuation can be varied in 1 dB steps from 0 to 30 dB. Other entries are rounded to the next lower integer value.

To re-open the edit dialog box for manual value definition, select the "Man" mode again.

If the defined reference level cannot be set for the given RF attenuation, the reference level is adjusted accordingly and the warning "Limit reached" is output.

Remote command:

`INPut:EATT:AUTO` on page 736

`INPut:EATT` on page 736

Ref Level Offset

Opens an edit dialog box to enter the arithmetic level offset. This offset is added to the measured level irrespective of the selected unit. The scaling of the y-axis is changed accordingly. The setting range is ± 200 dB in 0.1 dB steps.

Remote command:

`DISPlay[:WINDow<n>]:TRACe<t>:Y[:SCALe]:RLEVEL:OFFSet` on page 720

Ref Level Position

Opens an edit dialog box to enter the reference level position, i.e. the position of the maximum AD converter value on the level axis. The setting range is from -200 to +200 %, 0 % corresponding to the lower and 100 % to the upper limit of the diagram.

Only available for RF measurements.

Remote command:

`DISPlay[:WINDow<n>]:TRACe<t>:Y[:SCALe]:RPOSITION` on page 720

Grid Abs/Rel

Switches between absolute and relative scaling of the level axis (not available with "Linear" range).

Only available for RF measurements.

"Abs" Absolute scaling: The labeling of the level lines refers to the absolute value of the reference level. Absolute scaling is the default setting.

"Rel" Relative scaling: The upper line of the grid is always at 0 dB. The scaling is in dB whereas the reference level is always in the set unit (for details on unit settings see the "Unit" softkey).

Remote command:

`DISPlay[:WINDow<n>]:TRACe<t>:Y[:SCALe]:MODE` on page 719

Noise Correction

If activated, the results are corrected by the instrument's inherent noise, which increases the dynamic range.

"ON"	<p>A reference measurement of the instrument's inherent noise is carried out. The noise power measured is then subtracted from the power in the channel that is being examined.</p> <p>The inherent noise of the instrument depends on the selected center frequency, resolution bandwidth and level setting. Therefore, the correction function is disabled whenever one of these parameters is changed. A disable message is displayed on the screen. Noise correction must be switched on again manually after the change.</p>
"OFF"	No noise correction is performed.
"AUTO"	Noise correction is performed. After a parameter change, noise correction is restarted automatically and a new correction measurement is performed.

Remote command:

`[SENSe:]POWer:NCORrection` on page 854

Input (AC/DC)

Toggles the RF input of the R&S FSVR between AC and DC coupling.

This function is not available for input from the R&S Digital I/Q Interface (option R&S FSV-B17).

Remote command:

`INPut:COUPling` on page 732

Input 50 Ω/75 Ω

Uses 50 Ω or 75 Ω as reference impedance for the measured levels. Default setting is 50 Ω.

The setting 75 Ω should be selected if the 50 Ω input impedance is transformed to a higher impedance using a 75 Ω adapter of the RAZ type (= 25 Ω in series to the input impedance of the instrument). The correction value in this case is 1.76 dB = 10 log (75 Ω/50 Ω).

All levels specified in this Operating Manual refer to the default setting of the instrument (50 Ω).

This function is not available for input from the R&S Digital I/Q Interface (option R&S FSV-B17).

Remote command:

`INPut:IMPedance` on page 737

YIG Filter (On Off)

Activates or deactivates the YIG filter by means of relays or by bypassing the filter.

If the YIG filter at the input of the R&S FSVR is removed from the signal path, you can use the maximum bandwidth for signal analysis. However, image-frequency rejection is no longer ensured.

Note that the YIG filter is active only on frequencies greater than 7 GHz. Therefore, switching the YIG filter on and off has no effect if the frequency is below that value.

`INPut:FILTer:YIG[:STATe]` on page 737

4.1.4.2 Specifying the Amplitude

1. Set the reference level, offset and position using the "Ref Level", "Ref Level Offset" and "Ref Level Position" softkeys (see "Ref Level" on page 67, "Ref Level Offset" on page 72 and "Ref Level Position" on page 72).
2. Select the level range and the unit for the level axis using the "Range" and "Unit" softkeys (see "Range" on page 68 and "Unit" on page 69).
3. Set the scaling using the "Ref Level Position" and/or "Grid Abs/Rel" softkeys (see "Ref Level Position" on page 72 and "Grid Abs/Rel" on page 72).
4. Set the attenuation using the "RF Atten Manual/Mech Atten Manual" or "RF Atten Auto/Mech Att Auto", or (for option B25 only) "EI Atten Mode" softkeys (see "RF Atten Manual/Mech Att Manual" on page 70, "RF Atten Auto/Mech Att Auto" on page 71, "EI Atten Mode (Auto/Man)" on page 71).
5. Define the RF input coupling using the "Input (AC/DC)" softkey, or a reference impedance using the "Input (50Ω/75Ω)" softkey (see "Input (AC/DC)" on page 73, "Input 50 Ω/75 Ω" on page 73).
6. If available, activate or deactivate the RF Preamplifier (option R&S FSV-B22/B24) using the "Preamp" softkey (see "Preamp On/Off" on page 70).

4.1.4.3 Using Electronic Attenuation (Option Electronic Attenuator, R&S FSV-B25)

Besides the mechanical attenuator at the RF input, the R&S FSVR also offers an electronic attenuation setting (option Electronic Attenuator B25). The electronic attenuator can be set manually or automatically. The default attenuation is preset by the mechanical attenuator. The attenuation can be varied in 1 dB steps from 0 to 30 dB. Other entries are rounded to the next lower integer value.

In automatic mode, the electronic attenuator is set to 0 dB. If a reference level outside the allowed 30 dB range is set, the mechanical attenuator performs the setting. From this new reference level to over 30dB, the electronic attenuator performs the setting again.



For stop frequencies (or center frequencies in zero span) >7 GHz, electronic attenuation cannot be defined individually. In this case, the electronic and mechanical attenuation are summarized and the electronic attenuation can no longer be defined manually. As soon as the stop or center frequency is reduced below 7 GHz, electronic attenuation is available again. If the electronic attenuation was defined manually, it must be re-defined.

Setting electronic attenuation

1. Activate the electronic attenuation by pressing the **EI Atten On/Off** softkey.

2. Select the required attenuator mode by pressing the [EI Atten Mode \(Auto/Man\)](#) softkey until the required mode is highlighted.
Two new softkeys are displayed to set the mechanical attenuation. The same mode is activated for mechanical attenuation as was selected for electronic attenuation.
3. To define the attenuation manually:
 - a) Press the [EI Atten Mode \(Auto/Man\)](#) softkey again, if necessary, to display the edit dialog box.
 - b) Enter the value for the electronic attenuator in the edit dialog box.
 - c) If necessary, press the [RF Atten Manual/Mech Att Manual](#) softkey to open the edit dialog box for mechanical attenuation and enter the required value.

4.1.5 Defining Automatic Settings – AUTO SET Key

The "Auto Set" menu allows you define automatic settings for measurements quickly.

To open the Auto Set menu

- Press the AUTO SET key.
The "Auto Set" menu is displayed.

Menu and softkey description

- [chapter 4.1.5.1, "Softkeys of the Auto Set Menu"](#), on page 75

4.1.5.1 Softkeys of the Auto Set Menu

The following table shows all softkeys available in the "Auto Set" menu. It is possible that your instrument configuration does not provide all softkeys. If a softkey is only available with a special option, model or (measurement) mode, this information is provided in the corresponding softkey description.



Adjusting settings automatically during triggered measurements

When you select an auto adjust function a measurement is performed to determine the optimal settings. If you select an auto adjust function for a triggered measurement, you can select how the R&S FSVR should behave:

- (default:) The measurement for adjustment waits for the next trigger
- The measurement for adjustment is performed without waiting for a trigger. The trigger source is temporarily set to "Free Run". After the measurement is completed, the original trigger source is restored. The trigger level is adjusted as follows:
 - For IF Power and RF Power triggers:
Trigger Level = Reference Level - 15 dB
 - For Video trigger:
Trigger Level = 85 %

SCPI command:

[SENSe:]ADJust:CONFigure:TRIG on page 778

Auto All.....	76
Auto Freq.....	76
Auto Level.....	77
Settings.....	77
L Meas Time Manual.....	77
L Meas Time Auto.....	77
L Upper Level Hysteresis.....	77
L Lower Level Hysteresis.....	77
Sweep Type.....	78
L Sweep.....	78
L FFT.....	78
L Auto.....	78
L FFT Filter Mode.....	78
L Auto.....	78
L Narrow.....	79

Auto All

Performs all automatic settings.

- "Auto Freq" on page 76
- "Auto Level" on page 77

Remote command:

[SENSe:]ADJust:ALL on page 776

Auto Freq

Defines the center frequency and the reference level automatically by determining the highest frequency level in the frequency span. This function uses the signal counter; thus it is intended for use with sinusoidal signals.

This function is not available for input from the R&S Digital I/Q Interface (option R&S FSV-B17).

Remote command:

`[SENSe:]ADJust:FREQuency` on page 776

Auto Level

Defines the optimal reference level for the current measurement automatically.

The measurement time for automatic leveling can be defined using the [Settings](#) softkey.

You can define a threshold that the signal must exceed before the reference level is adjusted, see "[Upper Level Hysteresis](#)" on page 77 and "[Lower Level Hysteresis](#)" on page 77.

Remote command:

`[SENSe:]ADJust:LEVel` on page 777

Settings

Opens a submenu to define settings for automatic leveling.

Possible settings are:

- "[Meas Time Manual](#)" on page 77
- "[Meas Time Auto](#)" on page 77

Meas Time Manual ← Settings

Opens an edit dialog box to enter the duration of the level measurement in seconds. The level measurement is used to determine the optimal reference level automatically (see the "Auto Level" softkey, "[Auto Level](#)" on page 77). The default value is 1 ms.

Remote command:

`[SENSe:]ADJust:CONFIgure:LEVel:DURation` on page 777

Meas Time Auto ← Settings

The level measurement is used to determine the optimal reference level automatically (see the [Auto Level](#) softkey).

This softkey resets the level measurement duration for automatic leveling to the default value of 100 ms.

Upper Level Hysteresis ← Settings

Defines an upper threshold the signal must exceed before the reference level is automatically adjusted when the "Auto Level" function is performed.

Remote command:

`[SENSe:]ADJust:CONFIguration:HYSTeresis:UPPer` on page 778

Lower Level Hysteresis ← Settings

Defines a lower threshold the signal must exceed before the reference level is automatically adjusted when the "Auto Level" function is performed.

Remote command:

`[SENSe:]ADJust:CONFIguration:HYSTeresis:LOWer` on page 777

Sweep Type

Opens a submenu to define the sweep type.

This function is not available in IQ Analyzer mode or for input from the R&S Digital I/Q Interface (option R&S FSV-B17).

In frequency sweep mode, the analyzer provides several possible methods of sweeping:

- "Sweep" on page 78
- "FFT" on page 78 (not available with 5-Pole filters, channel filters or RRC filters, see [chapter 4.1.6.3, "Selecting the Appropriate Filter Type"](#), on page 85)
- "Auto" on page 78

Sweep ← Sweep Type

Sets the [Sweep Type](#) to standard analog frequency sweep.

In the standard sweep mode, the local oscillator is set to provide the spectrum quasi analog from the start to the stop frequency.

Remote command:

`SWE:TYPE SWE`, see [\[SENSe:\]SWEep:TYPE](#) on page 873

FFT ← Sweep Type

Sets the [Sweep Type](#) to FFT mode.

The FFT sweep mode samples on a defined frequency value and transforms it to the spectrum by fast Fourier transformation (FFT).

FFT is not available when using 5-Pole filters, Channel filters or RRC filters. In this case, sweep mode is used.

Remote command:

`SWE:TYPE FFT`, see [\[SENSe:\]SWEep:TYPE](#) on page 873

Auto ← Sweep Type

Automatically sets the fastest available [Sweep Type](#) for the current measurement. Auto mode is set by default.

Remote command:

`SWE:TYPE AUTO`, see [\[SENSe:\]SWEep:TYPE](#) on page 873

FFT Filter Mode ← Sweep Type

Defines the filter mode to be used for FFT filters by defining the partial span size. The partial span is the span which is covered by one FFT analysis.

Auto ← FFT Filter Mode ← Sweep Type

The firmware determines whether to use wide or narrow filters to obtain the best measurement results.

Remote command:

[\[SENSe:\]BANDwidth|BWIDth\[:RESolution\]:FFT](#) on page 782

Narrow ← FFT Filter Mode ← Sweep Type

For an RBW \leq 10kHz, the FFT filters with the smaller partial span are used. This allows you to perform measurements near a carrier with a reduced reference level due to a narrower analog prefilter.

Remote command:

`[SENSE:]BANDwidth|BWIDth[:RESolution]:FFT` on page 782

4.1.6 Setting the Bandwidths and Sweep Time – BW Key

The BW key is used to set the resolution bandwidth, video bandwidth (VBW) and sweep time (SWT). The values available for resolution bandwidth and video bandwidth depend on the selected filter type. For details on channel filters see also [chapter 4.1.6.4, "List of Available RRC and Channel Filters"](#), on page 86 .

To open the bandwidth menu

- Press the BW key.
The "Bandwidth" menu is displayed.

Menu and softkey description

- [chapter 4.1.6.1, "Softkeys of the Bandwidth Menu"](#), on page 79

Further information

- [chapter 4.1.6.4, "List of Available RRC and Channel Filters"](#), on page 86
- [table 4-3](#)

Tasks

- [chapter 4.1.6.2, "Specifying the Bandwidth"](#), on page 85
- [chapter 4.1.6.3, "Selecting the Appropriate Filter Type"](#), on page 85

4.1.6.1 Softkeys of the Bandwidth Menu

The following table shows all softkeys available in the "Bandwidth" menu. It is possible that your instrument configuration does not provide all softkeys. If a softkey is only available with a special option, model or (measurement) mode, this information is provided in the corresponding softkey description.



For Spurious Emission Measurements, the settings are defined in the "Sweep List" dialog, see ["Sweep List dialog box"](#) on page 219.

Bandwidth settings are only available for RF measurements.

Res BW Manual	80
Res BW Auto	80
Video BW Manual	80
Video BW Auto	81

Sweeptime Manual.....	81
Sweeptime Auto.....	82
Sweep Type.....	82
L Sweep.....	82
L FFT.....	82
L Auto.....	83
L FFT Filter Mode.....	83
L Auto.....	83
L Narrow.....	83
Coupling Ratio.....	83
L RBW/VBW Sine [1/1].....	83
L RBW/VBW Pulse [.1].....	83
L RBW/VBW Noise [10].....	84
L RBW/VBW Manual.....	84
L Span/RBW Auto [100].....	84
L Span/RBW Manual.....	84
L Default Coupling.....	85
Filter Type.....	85

Res BW Manual

Opens an edit dialog box to enter a value for the resolution bandwidth. The available resolution bandwidths are specified in the data sheet.

For details on the correlation between resolution bandwidth and filter type refer to [chapter 4.1.6.3, "Selecting the Appropriate Filter Type"](#), on page 85.

Numeric input is always rounded to the nearest possible bandwidth. For rotary knob or UP/DNARROW key inputs, the bandwidth is adjusted in steps either upwards or downwards.

The manual input mode of the resolution bandwidth is indicated by a green bullet next to the "RBW" display in the channel bar.

When measuring Spurious Emissions, using this softkey automatically opens the "Sweep List" dialog (see ["Sweep List dialog box"](#) on page 219).

Remote command:

`[SENSE:]BANDwidth|BWIDth[:RESolution]:AUTO` on page 782

`[SENSE:]BANDwidth|BWIDth[:RESolution]` on page 782

Res BW Auto

Couples the resolution bandwidth to the selected span (for span > 0). If you change the span, the resolution bandwidth is automatically adjusted.

This setting is recommended if you need the ideal resolution bandwidth in relation to a particular span.

Remote command:

`[SENSE:]BANDwidth|BWIDth[:RESolution]:AUTO` on page 782

Video BW Manual

Opens an edit dialog box to enter the video bandwidth. The available video bandwidths are specified in the data sheet.

Numeric input is always rounded to the nearest possible bandwidth. For rotary knob or UP/DOWN key inputs, the bandwidth is adjusted in steps either upwards or downwards.

The manual input mode of the video bandwidth is indicated by a green bullet next to the "VBW" display in the channel bar.

Note: RMS detector and VBW.

If an RMS detector is used, the video bandwidth in the hardware is bypassed. Thus, duplicate trace averaging with small VBWs and RMS detector no longer occurs. However, the VBW is still considered when calculating the sweep time. This leads to a longer sweep time for small VBW values. Thus, you can reduce the VBW value to achieve more stable trace curves even when using an RMS detector. Normally, if the RMS detector is used the sweep time should be increased to get more stable trace curves. For details on detectors see [chapter 4.1.8.6, "Detector Overview"](#), on page 106.

When measuring Spurious Emissions, using this softkey automatically opens the "Sweep List" dialog (see ["Sweep List dialog box"](#) on page 219).

Remote command:

[SENSe:]BANDwidth|BWIDth:VIDeo:AUTO on page 784

[SENSe:]BANDwidth|BWIDth:VIDeo on page 784

Video BW Auto

Couples the video bandwidth to the resolution bandwidth. If you change the resolution bandwidth, the video bandwidth is automatically adjusted.

This setting is recommended if a minimum sweep time is required for a selected resolution bandwidth. Narrow video bandwidths result in longer sweep times due to the longer settling time. Wide bandwidths reduce the signal/noise ratio.

Remote command:

[SENSe:]BANDwidth|BWIDth:VIDeo:AUTO on page 784

Sweeptime Manual

Opens an edit dialog box to enter the sweep time.

Sweep time	
absolute max. sweep time value:	16000 s
absolute min. sweep time value:	zero span: 1 μ s
	span > 0: depends on device model (refer to data sheet)

Allowed values depend on the ratio of span to RBW and RBW to VBW. For details refer to the data sheet.

Numeric input is always rounded to the nearest possible sweep time. For rotary knob or UPARROW/DNARROW key inputs, the sweep time is adjusted in steps either downwards or upwards.

The manual input mode of the sweep time is indicated by a green bullet next to the "SWT" display in the channel bar. If the selected sweep time is too short for the selected bandwidth and span, level measurement errors will occur due to a too short settling time for the resolution or video filters. In this case, the R&S FSVR displays the error message "UNCAL" and marks the indicated sweep time with a red bullet.

When measuring Spurious Emissions, using this softkey automatically opens the "Sweep List" dialog, see ["Sweep List dialog box"](#) on page 219.

Remote command:

SWE:TIME:AUTO OFF, see [\[SENSe:\]SWEep:TIME:AUTO](#) on page 873

[\[SENSe:\]SWEep:TIME](#) on page 872

Sweeptime Auto

Couples the sweep time to the span, video bandwidth (VBW) and resolution bandwidth (RBW) (not available for zero span). If you change the span, resolution bandwidth or video bandwidth, the sweep time is automatically adjusted.

The R&S FSVR always selects the shortest sweep time that is possible without falsifying the signal. The maximum level error is < 0.1 dB, compared to using a longer sweep time.

When measuring Spurious Emissions, using this softkey automatically opens the "Sweep List" dialog, see ["Sweep List dialog box"](#) on page 219.

Remote command:

[\[SENSe:\]SWEep:TIME:AUTO](#) on page 873

Sweep Type

Opens a submenu to define the sweep type.

This function is not available in IQ Analyzer mode or for input from the R&S Digital I/Q Interface (option R&S FSV-B17).

In frequency sweep mode, the analyzer provides several possible methods of sweeping:

- ["Sweep"](#) on page 78
- ["FFT"](#) on page 78 (not available with 5-Pole filters, channel filters or RRC filters, see [chapter 4.1.6.3, "Selecting the Appropriate Filter Type"](#), on page 85)
- ["Auto"](#) on page 78

Sweep ← Sweep Type

Sets the [Sweep Type](#) to standard analog frequency sweep.

In the standard sweep mode, the local oscillator is set to provide the spectrum quasi analog from the start to the stop frequency.

Remote command:

SWE:TYPE SWE, see [\[SENSe:\]SWEep:TYPE](#) on page 873

FFT ← Sweep Type

Sets the [Sweep Type](#) to FFT mode.

The FFT sweep mode samples on a defined frequency value and transforms it to the spectrum by fast Fourier transformation (FFT).

FFT is not available when using 5-Pole filters, Channel filters or RRC filters. In this case, sweep mode is used.

Remote command:

SWE:TYPE FFT, see [\[SENSe:\]SWEep:TYPE](#) on page 873

Auto ← Sweep Type

Automatically sets the fastest available [Sweep Type](#) for the current measurement. Auto mode is set by default.

Remote command:

SWE:TYPE AUTO, see [\[SENSe:\]SWEep:TYPE](#) on page 873

FFT Filter Mode ← Sweep Type

Defines the filter mode to be used for FFT filters by defining the partial span size. The partial span is the span which is covered by one FFT analysis.

Auto ← FFT Filter Mode ← Sweep Type

The firmware determines whether to use wide or narrow filters to obtain the best measurement results.

Remote command:

[\[SENSe:\]BANDwidth|BWIDth\[:RESolution\]:FFT](#) on page 782

Narrow ← FFT Filter Mode ← Sweep Type

For an RBW \leq 10kHz, the FFT filters with the smaller partial span are used. This allows you to perform measurements near a carrier with a reduced reference level due to a narrower analog prefilter.

Remote command:

[\[SENSe:\]BANDwidth|BWIDth\[:RESolution\]:FFT](#) on page 782

Coupling Ratio

Opens a submenu to select the coupling ratios for functions coupled to the bandwidth.

RBW/VBW Sine [1/1] ← Coupling Ratio

Sets the following coupling ratio:

"video bandwidth = resolution bandwidth"

This is the default setting for the coupling ratio resolution bandwidth/video bandwidth.

This is the coupling ratio recommended if sinusoidal signals are to be measured.

This setting takes effect if you define the video bandwidth automatically ([Video BW Auto](#)).

Remote command:

BAND:VID:RAT 1, see [\[SENSe:\]BANDwidth|BWIDth:VIDeo:RATio](#) on page 784

RBW/VBW Pulse [.1] ← Coupling Ratio

Sets the following coupling ratio:

"video bandwidth = 10 × resolution bandwidth or"

"video bandwidth = 10 MHz (= max. VBW)."

This coupling ratio is recommended whenever the amplitudes of pulsed signals are to be measured correctly. The IF filter is exclusively responsible for pulse shaping. No additional evaluation is performed by the video filter.

This setting takes effect if you define the video bandwidth automatically ([Video BW Auto](#)).

Remote command:

BAND:VID:RAT 10, see [\[SENSe:\]BANDwidth|BWIDth:VIDeo:RATio](#) on page 784

RBW/VBW Noise [10] ← Coupling Ratio

Sets the following coupling ratio:

"video bandwidth = resolution bandwidth/10"

At this coupling ratio, noise and pulsed signals are suppressed in the video domain. For noise signals, the average value is displayed.

This setting takes effect if you define the video bandwidth automatically ([Video BW Auto](#)).

Remote command:

BAND:VID:RAT 0.1, see [\[SENSe:\]BANDwidth|BWIDth:VIDeo:RATio](#) on page 784

RBW/VBW Manual ← Coupling Ratio

Activates the manual input of the coupling ratio.

The resolution bandwidth/video bandwidth ratio can be set in the range 0.001 to 1000.

This setting takes effect if you define the video bandwidth automatically ([Video BW Auto](#)).

Remote command:

BAND:VID:RAT 10, see [\[SENSe:\]BANDwidth|BWIDth:VIDeo:RATio](#) on page 784

Span/RBW Auto [100] ← Coupling Ratio

Sets the following coupling ratio:

"resolution bandwidth = span/100"

This coupling ratio is the default setting of the R&S FSVR.

This setting takes effect if you define the resolution bandwidth automatically ([Res BW Auto](#)).

Remote command:

BAND:VID:RAT 0.001, see [\[SENSe:\]BANDwidth|BWIDth:VIDeo:RATio](#) on page 784

Span/RBW Manual ← Coupling Ratio

Activates the manual input of the coupling ratio.

This setting takes effect if you define the resolution bandwidth automatically ([Res BW Auto](#)).

The span/resolution bandwidth ratio can be set in the range 1 to 10000.

Remote command:

BAND:RAT 0.1, see [\[SENSe:\]BANDwidth|BWIDth\[:RESolution\]:RATio](#) on page 783

Default Coupling ← Coupling Ratio

Sets all coupled functions to the default state ("AUTO").

In addition, the ratio "RBW/VBW" is set to "SINE [1/1]" and the ratio "SPAN/RBW" to 100.

Remote command:

[SENSe:]BANDwidth|BWIDth[:RESolution]:AUTO on page 782

[SENSe:]BANDwidth|BWIDth:VIDeo:AUTO on page 784

[SENSe:]SWEep:TIME:AUTO on page 873

Filter Type

Opens a submenu to select the filter type.

When measuring Spurious Emissions, using this softkey automatically opens the "Sweep List" dialog (see "[Sweep List dialog box](#)" on page 219).

The submenu contains the following softkeys:

- Normal (3 dB)
- CISPR (6 dB)
- MIL Std (6 dB)
Note that the 6 dB bandwidths are available only with option R&S FSV-K54.
- Channel
- RRC
- 5-Pole (not available for sweep type "FFT")

For detailed information on filters see [chapter 4.1.6.3, "Selecting the Appropriate Filter Type"](#), on page 85 and [chapter 4.1.6.4, "List of Available RRC and Channel Filters"](#), on page 86.

Remote command:

[SENSe:]BANDwidth|BWIDth[:RESolution]:TYPE on page 783

4.1.6.2 Specifying the Bandwidth

1. Set the resolution bandwidth using the [Res BW Manual](#) or [Res BW Auto](#) softkey.
2. Set the video bandwidth using the [Video BW Manual](#) or [Video BW Auto](#) softkey.
3. Set the sweep time using the [Sweeptime Manual](#) or [Sweeptime Auto](#) softkey.
4. Press the [Filter Type](#) softkey and select the appropriate filters.

4.1.6.3 Selecting the Appropriate Filter Type

All resolution bandwidths are realized with digital filters.

The video filters are responsible for smoothing the displayed trace. Using video bandwidths that are small compared to the resolution bandwidth, only the signal average is displayed and noise peaks and pulsed signals are repressed. If pulsed signals are to be measured, it is advisable to use a video bandwidth that is large compared to the resolution bandwidth ($VBW * 10 \times RBW$) for the amplitudes of pulses to be measured correctly.

The following filter types are available:

- Normal (3dB) (Gaussian) filters
The Gaussian filters are set by default. The available bandwidths are specified in the data sheet.
- CISPR (6 dB) filters
- MIL Std (6 dB) filters
Note that the 6 dB bandwidths are available only with option R&S FSV-K54.
- Channel filters
For details see [chapter 4.1.6.4, "List of Available RRC and Channel Filters"](#), on page 86 .
Channel filters do not support FFT mode.
- RRC filters
For details see [chapter 4.1.6.4, "List of Available RRC and Channel Filters"](#), on page 86 .
RRC filters do not support FFT mode.
- 5-Pole filters
The available bandwidths are specified in the data sheet.
5-Pole filters do not support FFT mode.

4.1.6.4 List of Available RRC and Channel Filters

For power measurement a number of especially steep-edged channel filters are available (see the following table). The indicated filter bandwidth is the 3 dB bandwidth. For RRC filters, the fixed roll-off factor (α) is also indicated.

Table 4-3: Filter types

Filter Bandwidth	Filter Type	Application
100 Hz	CFILter	
200 Hz	CFILter	A0
300 Hz	CFILter	
500 Hz	CFILter	
1 kHz	CFILter	
1.5 kHz	CFILter	
2 kHz	CFILter	
2.4 kHz	CFILter	SSB
2.7 kHz	CFILter	
3 kHz	CFILter	
3.4 kHz	CFILter	
4 kHz	CFILter	DAB, Satellite
4.5 kHz	CFILter	

Filter Bandwidth	Filter Type	Application
5 kHz	CFILter	
6 kHz	CFILter	
6 kHz, a=0.2	RRC	APCO
8.5 kHz	CFILter	ETS300 113 (12.5 kHz channels)
9 kHz	CFILter	AM Radio
10 kHz	CFILter	
12.5 kHz	CFILter	CDMAone
14 kHz	CFILter	ETS300 113 (20 kHz channels)
15 kHz	CFILter	
16 kHz	CFILter	ETS300 113 (25 kHz channels)
18 kHz, a=0.35	RRC	TETRA
20 kHz	CFILter	
21 kHz	CFILter	PDC
24.3 kHz, a=0.35	RRC	IS 136
25 kHz	CFILter	
30 kHz	CFILter	CDPD, CDMAone
50 kHz	CFILter	
100 kHz	CFILter	
150 kHz	CFILter	FM Radio
192 kHz	CFILter	PHS
200 kHz	CFILter	
300 kHz	CFILter	
500 kHz	CFILter	J.83 (8-VSB DVB, USA)
1 MHz	CFILter	CDMAone
1.228 MHz	CFILter	CDMAone
1.28 MHz, a=0.22	RRC	
1.5 MHz	CFILter	DAB
2 MHz	CFILter	
3 MHz	CFILter	
3.75 MHz	CFILter	

Filter Bandwidth	Filter Type	Application
3.84 MHz, a=0.22	RRC	W-CDMA 3GPP
4.096 MHz, a=0.22	RRC	W-CDMA NTT DOCoMo
5 MHz	CFILter	
20 MHz	CFILter	
28 MHz	CFILter	
40 MHz	CFILter	

4.1.7 Configuring the Sweep Mode – SWEEP Key

The SWEEP key is used to configure the sweep mode. Continuous sweep or single sweep is possible. The sweep time and the number of measured values are set.

To open the Sweep menu

- Press the SWEEP key.
The "Sweep" menu is displayed.

Menu and softkey description

- [chapter 4.1.7.1, "Softkeys of the Sweep Menu"](#), on page 88

Task

- [chapter 4.1.7.2, "Specifying the Sweep Settings"](#), on page 92

4.1.7.1 Softkeys of the Sweep Menu

The following table shows all softkeys available in the "Sweep" menu. It is possible that your instrument configuration does not provide all softkeys. If a softkey is only available with a special option, model or (measurement) mode, this information is provided in the corresponding softkey description.

Continuous Sweep.....	89
Single Sweep.....	89
Continue Single Sweep.....	89
Sweeptime Manual.....	89
Sweeptime Auto.....	90
Sweep Type.....	90
L Sweep.....	90
L FFT.....	90
L Auto.....	91
L FFT Filter Mode.....	91
L Auto.....	91
L Narrow.....	91
Sweep Count.....	91
Sweep Points.....	91

Continuous Sweep

Sets the continuous sweep mode: the sweep takes place continuously according to the trigger settings. This is the default setting.

The trace averaging is determined by the sweep count value (see the "Sweep Count" softkey, "[Sweep Count](#)" on page 91).

Remote command:

INIT:CONT ON, see [INITiate<n>:CONTinuous](#) on page 730

Single Sweep

Sets the single sweep mode: after triggering, starts the number of sweeps that are defined by using the [Sweep Count](#) softkey. The measurement stops after the defined number of sweeps has been performed.

Remote command:

INIT:CONT OFF, see [INITiate<n>:CONTinuous](#) on page 730

Continue Single Sweep

Repeats the number of sweeps set by using the [Sweep Count](#) softkey, without deleting the trace of the last measurement.

This is particularly of interest when using the trace configurations "Average" or "Max Hold" to take previously recorded measurements into account for averaging/maximum search.

For details on trace configuration refer to [chapter 4.1.8, "Setting Traces – TRACE Key"](#), on page 92.

Remote command:

[INITiate<n>:CONMeas](#) on page 729

Sweeptime Manual

Opens an edit dialog box to enter the sweep time.

Sweep time	
absolute max. sweep time value:	16000 s
absolute min. sweep time value:	zero span: 1 μ s
	span > 0: depends on device model (refer to data sheet)

Allowed values depend on the ratio of span to RBW and RBW to VBW. For details refer to the data sheet.

Numeric input is always rounded to the nearest possible sweep time. For rotary knob or UPARROW/DNARROW key inputs, the sweep time is adjusted in steps either downwards or upwards.

The manual input mode of the sweep time is indicated by a green bullet next to the "SWT" display in the channel bar. If the selected sweep time is too short for the selected bandwidth and span, level measurement errors will occur due to a too short settling time for the resolution or video filters. In this case, the R&S FSVR displays the error message "UNCAL" and marks the indicated sweep time with a red bullet.

When measuring Spurious Emissions, using this softkey automatically opens the "Sweep List" dialog, see ["Sweep List dialog box"](#) on page 219.

Remote command:

SWE:TIME:AUTO OFF, see [\[SENSe:\]SWEep:TIME:AUTO](#) on page 873

[\[SENSe:\]SWEep:TIME](#) on page 872

Sweeptime Auto

Couples the sweep time to the span, video bandwidth (VBW) and resolution bandwidth (RBW) (not available for zero span). If you change the span, resolution bandwidth or video bandwidth, the sweep time is automatically adjusted.

The R&S FSVR always selects the shortest sweep time that is possible without falsifying the signal. The maximum level error is < 0.1 dB, compared to using a longer sweep time.

When measuring Spurious Emissions, using this softkey automatically opens the "Sweep List" dialog, see ["Sweep List dialog box"](#) on page 219.

Remote command:

[\[SENSe:\]SWEep:TIME:AUTO](#) on page 873

Sweep Type

Opens a submenu to define the sweep type.

This function is not available in IQ Analyzer mode or for input from the R&S Digital I/Q Interface (option R&S FSV-B17).

In frequency sweep mode, the analyzer provides several possible methods of sweeping:

- ["Sweep"](#) on page 78
- ["FFT"](#) on page 78 (not available with 5-Pole filters, channel filters or RRC filters, see [chapter 4.1.6.3, "Selecting the Appropriate Filter Type"](#), on page 85)
- ["Auto"](#) on page 78

Sweep ← Sweep Type

Sets the [Sweep Type](#) to standard analog frequency sweep.

In the standard sweep mode, the local oscillator is set to provide the spectrum quasi analog from the start to the stop frequency.

Remote command:

SWE:TYPE SWE, see [\[SENSe:\]SWEep:TYPE](#) on page 873

FFT ← Sweep Type

Sets the [Sweep Type](#) to FFT mode.

The FFT sweep mode samples on a defined frequency value and transforms it to the spectrum by fast Fourier transformation (FFT).

FFT is not available when using 5-Pole filters, Channel filters or RRC filters. In this case, sweep mode is used.

Remote command:

SWE:TYPE FFT, see [\[SENSe:\]SWEep:TYPE](#) on page 873

Auto ← Sweep Type

Automatically sets the fastest available [Sweep Type](#) for the current measurement. Auto mode is set by default.

Remote command:

`SWE:TYPE AUTO`, see [\[SENSe:\]SWEep:TYPE](#) on page 873

FFT Filter Mode ← Sweep Type

Defines the filter mode to be used for FFT filters by defining the partial span size. The partial span is the span which is covered by one FFT analysis.

Auto ← FFT Filter Mode ← Sweep Type

The firmware determines whether to use wide or narrow filters to obtain the best measurement results.

Remote command:

[\[SENSe:\]BANDwidth|BWIDth\[:RESolution\]:FFT](#) on page 782

Narrow ← FFT Filter Mode ← Sweep Type

For an RBW \leq 10kHz, the FFT filters with the smaller partial span are used. This allows you to perform measurements near a carrier with a reduced reference level due to a narrower analog prefilter.

Remote command:

[\[SENSe:\]BANDwidth|BWIDth\[:RESolution\]:FFT](#) on page 782

Sweep Count

Opens an edit dialog box to enter the number of sweeps to be performed in the single sweep mode. Values from 0 to 32767 are allowed. If the values 0 or 1 are set, one sweep is performed. The sweep count is applied to all the traces in a diagram.

If the trace configurations "Average", "Max Hold" or "Min Hold" are set, the sweep count value also determines the number of averaging or maximum search procedures.

In continuous sweep mode, if sweep count = 0 (default), averaging is performed over 10 sweeps. For sweep count = 1, no averaging, maxhold or minhold operations are performed.

For details on trace configuration see [chapter 4.1.8, "Setting Traces – TRACE Key"](#), on page 92.

Example:

- Press the TRACE key > [Trace 1/Trace 2/Trace 3/Trace 4/Trace 5/Trace 6](#) softkey > "Max Hold" on page 94 softkey.
- Press the SWEEP key > "Sweep Count" softkey.
- In the "Average Sweep Count" dialog box, enter 10.
- Press the ["Single Sweep"](#) on page 89 softkey:
R&S FSVR performs the "Max Hold" function over 10 sweeps.

Remote command:

[\[SENSe:\]SWEep:COUNT](#) on page 866

Sweep Points

Opens an edit dialog box to enter the number of measured values to be collected during one sweep.

- Entry via rotary knob:
 - In the range from 101 to 1001, the sweep points are increased or decreased in steps of 100 points.
 - In the range from 1001 to 32001, the sweep points are increased or decreased in steps of 1000 points.
- Entry via keypad:
All values in the defined range can be set.

The default value is 691 sweep points.

When measuring spurious emissions, using this softkey automatically opens the "Sweep List" dialog, see "[Sweep List dialog box](#)" on page 219.

Remote command:

[SENSe:] SWEEp: POINTs on page 872

4.1.7.2 Specifying the Sweep Settings

1. Press the [Sweep Count](#) softkey and enter the sweep count.
2. Press the [Sweeptime Manual](#) or [Sweeptime Auto](#) softkey to set the sweep time.
3. Press the [Sweep Type](#) softkey to select the sweep type.
4. Press the [Sweep Points](#) softkey and enter the number of sweep points.
5. Press the [Continuous Sweep](#) or [Single Sweep](#) softkey to select the sweep mode.
6. Press the [Continue Single Sweep](#) softkey to repeat the single sweep.

4.1.8 Setting Traces – TRACE Key

The TRACE key is used to configure the data acquisition for measurement and the analysis of the measurement data.

The R&S FSVR is capable of displaying up to six different traces at a time in a diagram. A trace consists of a maximum of 691 displayed measurement points on the horizontal axis (frequency or time). If more measured values than measurement points are available, several measured values are combined in one displayed measurement point.

The trace functions include the following:

- Display mode of the trace
For details on trace modes see [chapter 4.1.8.4, "Trace Mode Overview"](#), on page 104.
- Evaluation of the trace as a whole
For details on averaging see [chapter 4.1.8.5, "Description of the Averaging Method"](#), on page 105.
- Evaluation of individual measurement points of a trace. For details on detectors see [chapter 4.1.8.6, "Detector Overview"](#), on page 106.

To open the Trace menu

- Press the TRACE key.
The "Trace" menu is displayed. The "Trace Configuration" dialog box is displayed.

Menu and softkey description

- [chapter 4.1.8.1, "Softkeys of the Trace Menu"](#), on page 93

Further information

- [chapter 4.1.8.4, "Trace Mode Overview"](#), on page 104
- [chapter 4.1.8.6, "Detector Overview"](#), on page 106
- [chapter 4.1.8.7, "ASCII File Export Format"](#), on page 107

Tasks

- [chapter 4.1.8.2, "Configuring Traces"](#), on page 101
- [chapter 4.1.8.3, "Specifying the Trace Settings"](#), on page 103

4.1.8.1 Softkeys of the Trace Menu

The following table shows all softkeys available in the "Trace" menu. It is possible that your instrument configuration does not provide all softkeys. If a softkey is only available with a special option, model or (measurement) mode, this information is provided in the corresponding softkey description.

Trace 1/Trace 2/Trace 3/Trace 4/Trace 5/Trace 6.....	94
L Clear Write.....	94
L Max Hold.....	94
L Min Hold.....	95
L Average.....	95
L View.....	95
L Blank.....	95
L Hold/Cont.....	95
L Detector.....	96
L Auto Select.....	96
L Auto Peak.....	97
L Positive Peak.....	97
L Negative Peak.....	97
L Sample.....	97
L RMS.....	97
L Average.....	97
L Quasipeak.....	97
L CISPR Average.....	97
L RMS Average.....	98
More Traces.....	98
Copy Trace.....	98
Trace Wizard.....	98
Spectrogram.....	98
Average Mode.....	98

L Lin.....	99
L Log.....	99
L Power.....	99
ASCII Trace Export.....	99
Decim Sep.....	100
Trace Math.....	100
Trace Math Mode.....	100
L Lin.....	100
L Log.....	101
L Power.....	101
Trace Math Position.....	101
Trace Math Off.....	101

Trace 1/Trace 2/Trace 3/Trace 4/Trace 5/Trace 6

Selects the active trace (1, 2, 3, 4, 5, 6) and opens the "Trace Mode" submenu for the selected trace.

The default setting is trace 1 in the overwrite mode (see "Clear Write" on page 94), the other traces are switched off (see "Blank" on page 95). For details see [chapter 4.1.8.4, "Trace Mode Overview"](#), on page 104.

Tip: To configure several traces in one step, press the [Trace Wizard](#) softkey to open a trace configuration dialog. See also [chapter 4.1.8.2, "Configuring Traces"](#), on page 101.

Remote command:

Selected via numeric suffix of:TRACe<1 . . . 6> commands

Clear Write ← Trace 1/Trace 2/Trace 3/Trace 4/Trace 5/Trace 6

Overwrite mode: the trace is overwritten by each sweep. This is the default setting.

All available detectors can be selected.

Remote command:

DISP:TRAC:MODE WRIT, see [DISPlay\[:WINDow<n>\]:TRACe<t>:MODE](#) on page 716

Max Hold ← Trace 1/Trace 2/Trace 3/Trace 4/Trace 5/Trace 6

The maximum value is determined over several sweeps and displayed. The R&S FSVR saves the sweep result in the trace memory only if the new value is greater than the previous one.

The detector is automatically set to "Positive Peak".

This mode is especially useful with modulated or pulsed signals. The signal spectrum is filled up upon each sweep until all signal components are detected in a kind of envelope.

This mode is not available for statistics measurements.

Remote command:

DISP:TRAC:MODE MAXH, see [DISPlay\[:WINDow<n>\]:TRACe<t>:MODE](#) on page 716

Min Hold ← Trace 1/Trace 2/Trace 3/Trace 4/Trace 5/Trace 6

The minimum value is determined from several measurements and displayed. The R&S FSVR saves the smallest of the previously stored/currently measured values in the trace memory.

The detector is automatically set to "Negative Peak".

This mode is useful e.g. for making an unmodulated carrier in a composite signal visible. Noise, interference signals or modulated signals are suppressed whereas a CW signal is recognized by its constant level.

This mode is not available for statistics measurements.

Remote command:

DISP:TRAC:MODE MINH, see [DISPlay\[:WINDow<n>\]:TRACe<t>:MODE](#)
on page 716

Average ← Trace 1/Trace 2/Trace 3/Trace 4/Trace 5/Trace 6

The average is formed over several sweeps. The [Sweep Count](#) determines the number of averaging procedures.

All available detectors can be selected. If the detector is automatically selected, the sample detector is used (see [chapter 4.1.8.6, "Detector Overview"](#), on page 106).

This mode is not available for statistics measurements.

Remote command:

DISP:TRAC:MODE AVER, see [DISPlay\[:WINDow<n>\]:TRACe<t>:MODE](#)
on page 716

View ← Trace 1/Trace 2/Trace 3/Trace 4/Trace 5/Trace 6

The current contents of the trace memory are frozen and displayed.

Note: If a trace is frozen, the instrument settings, apart from level range and reference level (see below), can be changed without impact on the displayed trace. The fact that the displayed trace no longer matches the current instrument setting is indicated by the  icon on the tab label.

If the level range or reference level is changed, the R&S FSVR automatically adapts the measured data to the changed display range. This allows an amplitude zoom to be made after the measurement in order to show details of the trace.

Remote command:

DISP:TRAC:MODE VIEW, see [DISPlay\[:WINDow<n>\]:TRACe<t>:MODE](#)
on page 716

Blank ← Trace 1/Trace 2/Trace 3/Trace 4/Trace 5/Trace 6

Hides the selected trace.

Remote command:

DISP:TRAC OFF, see [DISPlay\[:WINDow<n>\]:TRACe<t>\[:STATE\]](#) on page 715

Hold/Cont ← Trace 1/Trace 2/Trace 3/Trace 4/Trace 5/Trace 6

Switches the reset of the traces in Min Hold, Max Hold and Average mode after some specific parameter changes have been made on and off. The default setting is off.

Normally, the measurement is started anew after parameter changes, before the measurement results are evaluated (e.g. using a marker). In all cases that require a new measurement after parameter changes, the trace is reset automatically to avoid false results (e.g. with span changes). For applications that require no reset after parameter changes, the automatic reset can be switched off.

Remote command:

`DISPlay[:WINDow<n>]:TRACe<t>:MODE:HCONtinuous` on page 716

Detector ← Trace 1/Trace 2/Trace 3/Trace 4/Trace 5/Trace 6

Opens a submenu to select the detector manually, or activate automatic selection.

Note: When measuring spurious emissions, using this softkey automatically opens the Sweep List dialog, see "[Sweep List dialog box](#)" on page 219.

If a detector was selected manually, the "MAN" indicator is highlighted.

If "AUTO" is selected, the detector is defined automatically, depending on the selected trace mode:

Trace mode	Detector
Clear Write	Auto Peak
Max Hold	Positive Peak
Min Hold	Negative Peak
Average	Sample Peak
View	–
Blank	–

Note: In Analog Demod mode, if AUTO is selected, the Auto Peak detector is used regardless of the trace mode. However, if Noise or Phase Noise measurements are performed in Analog Demod mode, the Sample Detector is used.

Auto Select ← Detector ← Trace 1/Trace 2/Trace 3/Trace 4/Trace 5/Trace 6

Selects the best detector for the selected trace and filter mode. This is the default setting.

Trace mode	Detector
Clear/Write	Auto Peak
Average	Sample
Max Hold	Max Peak
Min Hold	Min Peak

Remote command:

`[SENSe:] [WINDow:] DETECTOR<trace>[:FUNCTION]:AUTO` on page 875

Auto Peak ← Detector ← Trace 1/Trace 2/Trace 3/Trace 4/Trace 5/Trace 6

Selects the "Auto Peak" detector.

Remote command:

DET APE, see [SENSe:] [WINDow:] DETector<trace>[:FUNCTION]

on page 874

Positive Peak ← Detector ← Trace 1/Trace 2/Trace 3/Trace 4/Trace 5/Trace 6

Selects the "Positive Peak" detector.

Remote command:

DET POS, see [SENSe:] [WINDow:] DETector<trace>[:FUNCTION]

on page 874

Negative Peak ← Detector ← Trace 1/Trace 2/Trace 3/Trace 4/Trace 5/Trace 6

Selects the "Negative Peak" detector.

Remote command:

DET NEG, see [SENSe:] [WINDow:] DETector<trace>[:FUNCTION]

on page 874

Sample ← Detector ← Trace 1/Trace 2/Trace 3/Trace 4/Trace 5/Trace 6

Selects the "Sample" detector.

Remote command:

DET SAMP, see [SENSe:] [WINDow:] DETector<trace>[:FUNCTION]

on page 874

RMS ← Detector ← Trace 1/Trace 2/Trace 3/Trace 4/Trace 5/Trace 6

Selects the "RMS" detector.

Remote command:

DET RMS, see [SENSe:] [WINDow:] DETector<trace>[:FUNCTION]

on page 874

Average ← Detector ← Trace 1/Trace 2/Trace 3/Trace 4/Trace 5/Trace 6

Selects the "Average" detector.

Remote command:

DET AVER, see [SENSe:] [WINDow:] DETector<trace>[:FUNCTION]

on page 874

Quasipeak ← Detector ← Trace 1/Trace 2/Trace 3/Trace 4/Trace 5/Trace 6

Selects the "Quasipeak" detector.

The quasipeak detector is available with option R&S FSV-K54.

Remote command:

DET QPE, see [SENSe:] [WINDow:] DETector<trace>[:FUNCTION]

on page 874

CISPR Average ← Detector ← Trace 1/Trace 2/Trace 3/Trace 4/Trace 5/Trace 6

Selects the "CISPR Average" detector.

The CISPR Average detector is available with option R&S FSV-K54.

Remote command:

DET CAV, see [SENSe:] [WINDow:] DETector<trace>[:FUNCTION]
on page 874

RMS Average ← Detector ← Trace 1/Trace 2/Trace 3/Trace 4/Trace 5/Trace 6

Selects the "RMS Average" detector.

The quasipeak detector is available with option R&S FSV-K54.

Remote command:

DET CRMS, see [SENSe:] [WINDow:] DETector<trace>[:FUNCTION]
on page 874

More Traces

Opens a submenu to select one of the traces not currently displayed in the main menu.

Copy Trace

Opens an edit dialog box to enter the number of the trace memory in which the currently selected trace will be copied.

Remote command:

TRACe<n>:COPY on page 889

Trace Wizard

Opens the "Trace Wizard" dialog. See [chapter 4.1.8.2, "Configuring Traces"](#), on page 101.

Spectrogram

Opens the submenu for the spectrogram view (firmware option R&S FSVR-K14).

For details on this application refer to [chapter 4.3, "Using the Spectrogram in Spectrum Mode"](#), on page 276.

Average Mode

Opens a submenu to select the averaging method for the average trace mode. The following methods are available:

- [Lin](#)
- [Log](#)
- [Power](#)

Logarithmic averaging is recommended to display signals with a low signal to noise ratio. While positive peak values are decreased in logarithmic averaging due to the characteristics involved, it is also true that negative peaks are increased relative to the average value. If the distorted amplitude distribution is averaged, a value is obtained that is smaller than the actual average value. The difference is -2.5 dB.

This low average value is usually corrected in noise power measurements by a 2.5 dB factor. Therefore the R&S FSVR offers the selection of linear averaging. The trace data is converted to linear values prior to averaging, then averaged and reconverted to logarithmic values. After these conversions the data is displayed on the screen. The average value is always correctly displayed irrespective of the signal characteristic.

In case of stationary sinusoidal signals both logarithmic and linear averaging has the same results.

Lin ← Average Mode

Activates linear averaging. Linear averaging means that the power level values are converted into linear units prior to averaging. After the averaging, the data is converted back into its original unit.

This softkey takes effect if the grid is set to a linear scale (see "Range Linear" softkey, "Range Linear %" on page 69). In this case, the averaging is done in two ways (depending on the set unit – see "Unit" softkey):

- The unit is set to either W or dBm: the data is converted into W prior to averaging, i.e. averaging is done in W.
- The unit is set to either V, A, dBmV, dBμV, dBμA or dBpW: the data is converted into V prior to averaging, i.e. averaging is done in V.

Remote command:

SENS: AVER1: TYPE LIN, see [SENSe:] AVERage<n>: TYPE on page 780

Log ← Average Mode

Activates logarithmic averaging.

This averaging method only takes effect if the grid is set to a logarithmic scale ("Range" softkey), i.e. the unit of the data is dBm. In this case the values are averaged in dBm. Otherwise (i.e. with linear scaling), the behavior is the same as with linear averaging (see Lin softkey). For further information on logarithmic scaling refer to the "Average Mode" softkey.

Remote command:

SENS: AVER1: TYPE VID, see [SENSe:] AVERage<n>: TYPE on page 780

Power ← Average Mode

Activates linear power averaging.

The power level values are converted into unit Watt prior to averaging. After the averaging, the data is converted back into its original unit.

Unlike the linear mode, the averaging is always done in W.

Remote command:

SENS: AVER1: TYPE POW, see [SENSe:] AVERage<n>: TYPE on page 780

ASCII Trace Export

Opens the "ASCII Trace Export Name" dialog box and saves the active trace in ASCII format to the specified file and directory.

The file consists of the header containing important scaling parameters and a data section containing the trace data. For details on an ASCII file see [chapter 4.1.8.7, "ASCII File Export Format"](#), on page 107.

This format can be processed by spreadsheet calculation programs, e.g. MS-Excel. It is necessary to define ';' as a separator for the data import. Different language versions of evaluation programs may require a different handling of the decimal point. It is therefore possible to select between separators '.' (decimal point) and ',' (comma) using the "Decim Sep" softkey (see "Decim Sep" on page 100).

Remote command:

`FORMat:DEXPort:DSEParator` on page 728

`MMEMory:STORe<n>:TRACe` on page 744

`MMEMory:STORe:SGRam` on page 743

Decim Sep

Selects the decimal separator with floating-point numerals for the ASCII Trace export to support evaluation programs (e.g. MS-Excel) in different languages. The values '.' (decimal point) and ',' (comma) can be set.

Remote command:

`FORMat:DEXPort:DSEParator` on page 728

Trace Math

Opens the "Trace Mathematics" dialog box to define which trace is subtracted from trace 1. The result is displayed in trace 1 and refers to the zero point defined with the [Trace Math Position](#) softkey. The following subtractions can be performed:

"T1"->"T1"-T2"	Subtracts trace 2 from trace 1.
"T1"->"T1"-T3"	Subtracts trace 3 from trace 1
"T1"->"T1"-T4"	Subtracts trace 4 from trace 1
"T1"->"T1"-T5"	Subtracts trace 5 from trace 1
"T1"->"T1"-T6"	Subtracts trace 6 from trace 1

To switch off the trace math, use the [Trace Math Off](#) softkey.

Remote command:

`CALCulate<n>:MATH[:EXPrESSION][:DEFine]` on page 688

`CALCulate<n>:MATH:STATe` on page 689

Trace Math Mode

Opens a submenu to select the mode for the trace math calculations.

Lin ← Trace Math Mode

Activates linear subtraction, which means that the power level values are converted into linear units prior to subtraction. After the subtraction, the data is converted back into its original unit.

This softkey takes effect if the grid is set to a linear scale (see [Range](#) softkey). In this case, subtraction is done in two ways (depending on the set unit – see [Unit](#) softkey):

- The unit is set to either W or dBm: the data is converted into W prior to subtraction, i.e. averaging is done in W.

- The unit is set to either V, A, dBmV, dBμV, dBμA or dBpW: the data is converted into V prior to subtraction, i.e. subtraction is done in V.

Remote command:

CALC:MATH:MODE LIN, see [CALCulate<n>:MATH:MODE](#) on page 690

Log ← Trace Math Mode

Activates logarithmic subtraction.

This subtraction method only takes effect if the grid is set to a logarithmic scale (see [Range](#) softkey), i.e. the unit of the data is dBm. In this case the values are subtracted in dBm. Otherwise (i.e. with linear scaling) the behavior is the same as with linear subtraction (see [Lin](#) softkey). For further information on logarithmic scaling refer to the [Average Mode](#) softkey.

Remote command:

CALC:MATH:MODE LOG, see [CALCulate<n>:MATH:MODE](#) on page 690

Power ← Trace Math Mode

Activates linear power subtraction.

The power level values are converted into unit Watt prior to subtraction. After the subtraction, the data is converted back into its original unit.

Unlike the linear mode, the subtraction is always done in W.

Remote command:

CALC:MATH:MODE POW, see [CALCulate<n>:MATH:MODE](#) on page 690

Trace Math Position

Opens an edit dialog box to define the zero point in % of the diagram height. The range of values extends from -100 % to +200 %.

Remote command:

[CALCulate<n>:MATH:POSition](#) on page 689

Trace Math Off

Deactivates any previously selected trace math functions.

Remote command:

CALC:MATH:STAT OFF, see [CALCulate<n>:MATH:STATe](#) on page 689

4.1.8.2 Configuring Traces

1. To open the trace wizard, press the TRACE key and then the "Trace Wizard" softkey (see ["Trace Wizard"](#) on page 98).

Tip: Context-sensitive menus for traces. Traces have context-sensitive menus. If you right-click on a trace in the display or a trace setting in the information channel bar (or touch it for about 1 second), a menu is displayed which corresponds to the softkey functions available for traces. This is useful, for example, when the softkey display is hidden.

If a menu entry contains an arrow to the right of it, a submenu is available for that entry.

To close the menu, press the ESC key or click in the display outside of the menu.

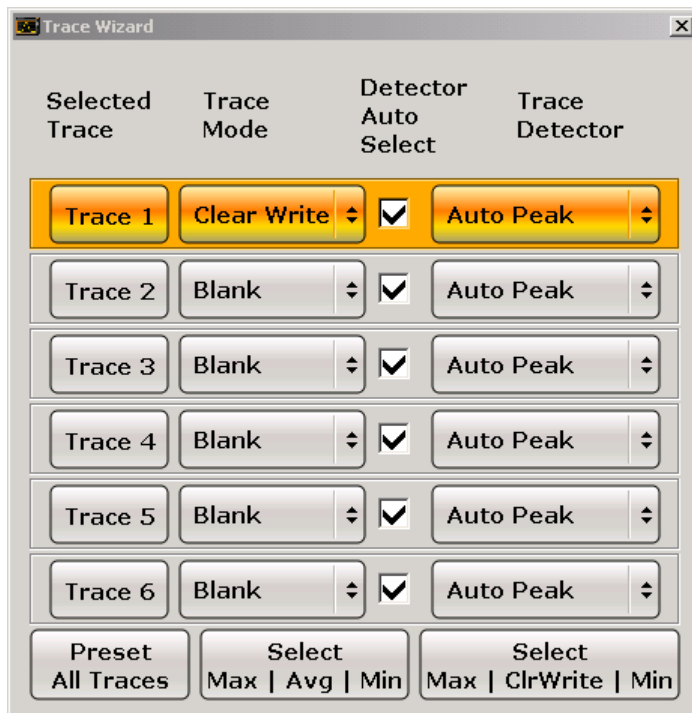

2. For each trace you can define the following settings:

Display Mode	<ul style="list-style-type: none"> • Clear Write • Max Hold • Min Hold • Average • View • Blank <p>For details see chapter 4.1.8.4, "Trace Mode Overview", on page 104.</p>
Detector Auto Select	Activates automatic detector selection (see Auto Select softkey). If activated, the "Trace Detector" setting is ignored.
Trace Detector	<p>Defines a specific trace detector. If one of the following settings is defined, the "Detector Auto Select" option is deactivated.</p> <ul style="list-style-type: none"> • "Auto Select" on page 96 • "Auto Peak" on page 97 • "Positive Peak" on page 97 • "Negative Peak" on page 97 • "Sample" on page 97 • "RMS" on page 97 • "Average" on page 97

3. To configure several traces to predefined display modes in one step, press the button for the required function:

Preset All Traces	Trace 1: Clear Write Trace 2-6: Blank
Select Max Avg Min	Trace 1: Max Hold Trace 2: Average Trace 3: Min Hold Trace 4-6: Blank
Select Max ClrWrite Min	Trace 1: Max Hold Trace 2: Clear Write Trace 3: Min Hold Trace 4-6: Blank

For details see [chapter 4.1.8.4, "Trace Mode Overview"](#), on page 104.

4.1.8.3 Specifying the Trace Settings

1. To configure one or more traces, see [chapter 4.1.8.2, "Configuring Traces"](#), on page 101.
2. To select the trace mode for the selected trace, press the softkey for the corresponding trace (for details see [chapter 4.1.8.4, "Trace Mode Overview"](#), on page 104).
3. To select a detector, press the [Auto Select](#) softkey for automatic detector selection, or press the [Detector](#) softkey (for details see [chapter 4.1.8.6, "Detector Overview"](#), on page 106).
4. To change the sweep count setting, which also determines trace averaging, press the [Sweep Count](#) softkey.
5. To deactivate the reset of the traces in "Min Hold" and "Max Hold" mode after some specific parameter changes, press the [Trace Math](#) softkey.
6. To copy a trace into another trace memory, press the [Copy Trace](#) softkey. Upon copying, the contents of the selected memory are overwritten and the new contents are displayed in the View mode.
7. To export the active trace in ASCII format:
 - a) Press the "More" softkey.
 - b) If necessary, press the [Decim Sep](#) softkey to change the decimal separator with floating-point numerals.
 - c) Press the [ASCII File Export](#) softkey to enter the ASCII file export name. The active trace is saved in ASCII format on the harddisk on or an external storage device.

4.1.8.4 Trace Mode Overview

The traces can be activated individually for a measurement or frozen after completion of a measurement. Traces that are not activate are hidden. Each time the trace mode is changed, the selected trace memory is cleared.

The R&S FSVR offers 6 different trace modes:

Clear Write

Overwrite mode: the trace is overwritten by each sweep. This is the default setting.

All available detectors can be selected.

Remote command:

`DISP:TRAC:MODE WRIT`, see `DISPlay[:WINDow<n>]:TRACe<t>:MODE`
on page 716

Max Hold

The maximum value is determined over several sweeps and displayed. The R&S FSVR saves the sweep result in the trace memory only if the new value is greater than the previous one.

The detector is automatically set to "Positive Peak".

This mode is especially useful with modulated or pulsed signals. The signal spectrum is filled up upon each sweep until all signal components are detected in a kind of envelope.

This mode is not available for statistics measurements.

Remote command:

`DISP:TRAC:MODE MAXH`, see `DISPlay[:WINDow<n>]:TRACe<t>:MODE`
on page 716

Min Hold

The minimum value is determined from several measurements and displayed. The R&S FSVR saves the smallest of the previously stored/currently measured values in the trace memory.

The detector is automatically set to "Negative Peak".

This mode is useful e.g. for making an unmodulated carrier in a composite signal visible. Noise, interference signals or modulated signals are suppressed whereas a CW signal is recognized by its constant level.

This mode is not available for statistics measurements.

Remote command:

`DISP:TRAC:MODE MINH`, see `DISPlay[:WINDow<n>]:TRACe<t>:MODE`
on page 716

Average

The average is formed over several sweeps. The [Sweep Count](#) determines the number of averaging procedures.

All available detectors can be selected. If the detector is automatically selected, the sample detector is used (see [chapter 4.1.8.6, "Detector Overview"](#), on page 106).

This mode is not available for statistics measurements.

Remote command:

DISP:TRAC:MODE AVER, see [DISPlay\[:WINDow<n>\]:TRACe<t>:MODE](#) on page 716

View

The current contents of the trace memory are frozen and displayed.

Note: If a trace is frozen, the instrument settings, apart from level range and reference level (see below), can be changed without impact on the displayed trace. The fact that the displayed trace no longer matches the current instrument setting is indicated by the  icon on the tab label.

If the level range or reference level is changed, the R&S FSVR automatically adapts the measured data to the changed display range. This allows an amplitude zoom to be made after the measurement in order to show details of the trace.

Remote command:

DISP:TRAC:MODE VIEW, see [DISPlay\[:WINDow<n>\]:TRACe<t>:MODE](#) on page 716

Blank

Hides the selected trace.

Remote command:

DISP:TRAC OFF, see [DISPlay\[:WINDow<n>\]:TRACe<t>\[:STATe\]](#) on page 715

4.1.8.5 Description of the Averaging Method

Averaging is carried out over the measurement points derived from the measurement samples. Several measured values may be combined in a measurement point. This means that with linear level display the average is formed over linear amplitude values. The sweep mode (continuous or single sweep, for details see [chapter 4.1.7, "Configuring the Sweep Mode – SWEEP Key"](#), on page 88) and running averaging apply to the average display analogously. In principle, two methods for calculating the average are used: continuous averaging and averaging over the selected number of sweeps.

- sweep count > 1
Depending on the relation of the following two parameters, two different situations exist:
n = number of sweeps performed since measurement start
c = sweep count (number of sweeps forming one statistics cycle)
 - n ≤ c
In single sweep or continuous sweep mode during the first statistics cycle, averaging over the selected number of sweeps is performed. The average trace "n" is calculated at each measurement point according to:

$$Avg(n) = \frac{n-1}{n} Avg(n-1) + \frac{1}{n} Curr(n)$$

Fig. 4-1: Equation 1

with Avg = average trace; Curr = current trace

Until the first statistics cycle is completed ($n < c$), a preliminary average is displayed which represents the arithmetic mean value over all measured sweeps. With n increasing, the displayed trace is increasingly smoothed since there are more single sweeps for averaging.

When the first statistics cycle is completed ($n = c$), the average trace is saved in the trace memory.

- $n > c$

In continuous sweep mode after the first statistics cycle, continuous averaging is performed. The average trace "n" is calculated at each measurement point according to:

$$Avg(n) = \frac{c-1}{c} Avg(n-1) + \frac{1}{c} Curr(n)$$

Fig. 4-2: Equation 2

with Avg = average trace; Curr = current trace

In single sweep mode, the same formula is valid if the [Continue Single Sweep](#) softkey is pressed.

- sweep count = 0
In continuous sweep mode, a continuous average is calculated according to [figure 4-2](#) with $c = 10$:

$$Avg(n) = \frac{9}{10} Avg(n-1) + \frac{1}{10} Curr(n)$$

Fig. 4-3: Equation 3

with Avg = average trace; Curr = current trace

Due to the weighting between the current trace and the average trace, past values have practically no influence on the displayed trace after about ten sweeps. With this setting, signal noise is effectively reduced without need for restarting the averaging process after a change of the signal.

- sweep count = 1
The current trace is displayed. No averaging is performed. This is a special case of [figure 4-1](#) with $n = 0$.

4.1.8.6 Detector Overview

The measurement detector for the individual display modes can be selected directly by the user or set automatically by the R&S FSVR. The detector activated for the specific trace is indicated in the corresponding trace display field by an abbreviation.

The detectors of the R&S FSVR are implemented as pure digital devices. They collect signal power data within each measured point during a sweep. The default number of sweep points is 691. The following detectors are available:

Table 4-4: Detector types

Detector	Indicator	Function
Auto Peak	Ap	Determines the maximum and the minimum value within a measurement point (not available for SEM)
Positive Peak	Pk	Determines the maximum value within a measurement point
Negative Peak (min peak)	Mi	Determines the minimum value within a measurement point
RMS	Rm	Determines the root mean square power within a measurement point
Average	Av	Determines the linear average power within a measurement point
Sample	Sa	Selects the last value within a measurement point

The result obtained from the selected detector within a measurement point is displayed as the power value at this measurement point.

All detectors work in parallel in the background, which means that the measurement speed is independent of the detector combination used for different traces.

Number of measured values

During a frequency sweep, the R&S FSVR increments the first local oscillator in steps that are smaller than approximately 1/10 of the bandwidth. This ensures that the oscillator step speed is conform to the hardware settling times and does not affect the precision of the measured power.

The number of measured values taken during a sweep is independent of the number of oscillator steps. It is always selected as a multiple or a fraction of 691 (= default number of trace points displayed on the screen). Choosing less than 691 measured values (e.g. 125 or 251) will lead to an interpolated measurement curve, choosing more than 691 points (e.g. 1001, 2001 ...) will result in several measured values being overlaid at the same frequency position.

RMS detector and VBW

If the RMS detector is selected, the video bandwidth in the hardware is bypassed. Thus, duplicate trace averaging with small VBWs and RMS detector no longer occurs. However, the VBW is still considered when calculating the sweep time. This leads to a longer sweep time for small VBW values. Thus, you can reduce the VBW value to achieve more stable trace curves even when using an RMS detector. Normally, if the RMS detector is used the sweep time should be increased to get more stable trace curves.

4.1.8.7 ASCII File Export Format

The data of the file header consist of three columns, each separated by a semicolon: parameter name; numeric value; basic unit. The data section starts with the keyword "Trace <n>" (<n> = number of stored trace), followed by the measured data in one or

several columns (depending on measurement) which are also separated by a semicolon.

File contents: header and data section	Description
Type;FSVR;	
Version;1.45;	
Date;01.Apr 2010;	Date of data set storage
Screen;A;	Instrument mode
Points per Symbol;4;	Points per symbol
x Axis Start;-13;sym;	Start value of the x axis
x Axis Stop;135;sym;	Stop value of the x axis
Ref value y axis;-10.00;dBm;	Y axis reference value
Ref value position;100;%;	Y axis reference position
Trace;1;	Trace number
Meas;Result;	Result type
Meas Signal;Magnitude;	Result display
Demodulator;Offset QPSK;	Demodulation type
ResultMode;Trace;	Result mode
x unit;sym;	Unit of the x axis
y unit;dBm;	Unit of the y axis
Trace Mode;Clear Write;	Trace mode
Values;592;	Number of results
<values>	List of results

4.1.9 Triggering the Sweep – TRIG Key

The TRIG key is used to select trigger mode, trigger threshold, trigger delay, trigger polarity and for gated sweep the gate configuration.

To open the Trigger menu

- Press the TRIG key.
The "Trigger" menu is displayed.

Menu and softkey description

- [chapter 4.1.9.1, "Softkeys of the Trigger Menu"](#), on page 109

Tasks

- [chapter 4.1.9.2, "Specifying the Trigger Settings"](#), on page 116

- [chapter 4.1.9.3, "Using Gated Sweep Operation"](#), on page 116

4.1.9.1 Softkeys of the Trigger Menu

The following table shows all softkeys available in the "Trigger" menu. It is possible that your instrument configuration does not provide all softkeys. If a softkey is only available with a special option, model or (measurement) mode, this information is provided in the corresponding softkey description.

Trg/Gate Source.....	109
L Free Run.....	110
L External.....	110
L Video.....	110
L RF Power.....	110
L IF Power/BB Power.....	111
L Power Sensor.....	111
L Time.....	112
Trg/Gate Level.....	112
Trg/Gate Polarity.....	112
Trigger Offset.....	113
Repetition Interval.....	113
Trigger Hysteresis.....	113
Trigger Holdoff.....	113
Gated Trigger.....	114
Gate Settings.....	114
L Gate Mode (Lvl/Edge).....	114
L Gate Delay.....	115
L Gate Length (Gate Mode Edge).....	115
L Trg/Gate Source.....	115
L Trg/Gate Level.....	115
L Trg/Gate Polarity.....	115
L Sweep Time.....	115
L Res BW Manual.....	115

Trg/Gate Source

Opens the "Trigger/Gate Source" dialog box to select the trigger/gate mode.

As gate modes, all modes except "Power Sensor" are available. For details see also [chapter 4.1.9.3, "Using Gated Sweep Operation"](#), on page 116.

The default setting is "Free Run". If a trigger mode other than "Free Run" has been set, the enhancement label "TRG" is displayed and the trigger source is indicated.

Note: When triggering or gating is activated, the squelch function is automatically disabled (see ["Squelch"](#) on page 132).

Remote command:

TRIGger<n> [: SEquence] : SOURce on page 913

[SENSE :] SWEep : EGATE : SOURce on page 868

Free Run ← Trg/Gate Source

The start of a sweep is not triggered. Once a measurement is completed, another is started immediately.

Remote command:

TRIG:SOUR IMM, see TRIGger<n>[:SEQuence]:SOURce on page 913

External ← Trg/Gate Source

Defines triggering via a TTL signal at the "EXT TRIG/GATE IN" input connector on the rear panel.

Remote command:

TRIG:SOUR EXT, see TRIGger<n>[:SEQuence]:SOURce on page 913

SWE:EGAT:SOUR EXT for gated triggering, see [SENSe:]SWEep:EGATe:SOURce on page 868

Video ← Trg/Gate Source

Defines triggering by the displayed voltage.

A horizontal trigger line is shown in the diagram. It is used to set the trigger threshold from 0 % to 100 % of the diagram height.

Video mode is only available in the time domain.

Remote command:

TRIG:SOUR VID, see TRIGger<n>[:SEQuence]:SOURce on page 913

SWE:EGAT:SOUR VID for gated triggering, see [SENSe:]SWEep:EGATe:SOURce on page 868

RF Power ← Trg/Gate Source

Defines triggering of the measurement via signals which are outside the measurement channel.

This trigger mode is available with detector board 1307.9554.02 Rev 05.00 or higher. It is not available for input from the R&S Digital I/Q Interface (option R&S FSVR-B17). If RF Power trigger mode is selected and digital baseband input is activated, the trigger mode is automatically switched to "Free Run".

In RF Power trigger mode the instrument uses a level detector at the first intermediate frequency. The detector threshold can be selected in a range between - 50 dBm and -10 dBm at the input mixer. The resulting trigger level at the RF input lies within the following range:

$$(-24\text{dBm} + \text{RF Att}) \leq \text{Triggerlevel} \leq (+5\text{dBm} + \text{RF Att}), \text{ max. } 30 \text{ dBm, for Preamp} = \text{OFF}$$

$$(-40\text{dBm} + \text{RF Att}) \leq \text{Triggerlevel} \leq (-11\text{dBm} + \text{RF Att}), \text{ max. } 30 \text{ dBm, for Preamp} = \text{ON}$$

with

$$500 \text{ MHz} \leq \text{InputSignal} \leq 7 \text{ GHz}$$

Note: If input values outside of this range occur (e.g. for fullspan measurements), the sweep may be aborted and a message indicating the allowed input values is displayed in the status bar.

A [Trigger Offset](#), [Trg/Gate Polarity](#) and [Trigger Holdoff](#) can be defined for the RF trigger to improve the trigger stability, but no hysteresis.

Remote command:

TRIG:SOUR RFP, see [TRIGger<n>\[:SEQuence\]:SOURce](#) on page 913

SWE:EGAT:SOUR RFP for gated triggering, see [\[SENSe:\]SWEep:EGATe:SOURce](#) on page 868

IF Power/BB Power ← Trg/Gate Source

For this purpose, the R&S FSVR uses a level detector at the second intermediate frequency.

The available trigger levels depend on the RF attenuation and preamplification. A reference level offset, if defined, is also considered.

For details on available trigger levels and trigger bandwidths see the data sheet.

The bandwidth at the intermediate frequency depends on the RBW and sweep type:

Sweep mode:

- RBW > 500 kHz: 40 MHz, nominal
- RBW ≤ 500 kHz: 6 MHz, nominal

FFT mode:

- RBW > 20 kHz: 40 MHz, nominal
- RBW ≤ 20 kHz: 6 MHz, nominal

Note: Be aware that in auto sweep type mode, due to a possible change in sweep types, the bandwidth may vary considerably for the same RBW setting.

The R&S FSVR is triggered as soon as the trigger level is exceeded around the selected frequency (= start frequency in the frequency sweep).

Thus, the measurement of spurious emissions, e.g. for pulsed carriers, is possible even if the carrier lies outside the selected frequency span.

For digital input via the R&S Digital I/Q Interface (R&S FSV-B17), the baseband power ("BB Power") is used as the trigger source.

Remote command:

TRIG:SOUR IFP, see [TRIGger<n>\[:SEQuence\]:SOURce](#) on page 913

TRIG:SOUR BBP for digital input

SWE:EGAT:SOUR IFP for gated triggering, see [\[SENSe:\]SWEep:EGATe:SOURce](#) on page 868

Power Sensor ← Trg/Gate Source

Uses an external power sensor as a trigger function. This option is only available if the R&S FSV-K9 Power Sensor option is installed and a power sensor is connected and configured.

(See [chapter 4.5, "Instrument Functions - Power Sensor \(R&S FSV-K9\)"](#), on page 304.)

Power sensors are configured in the "Input/Output" menu, see [chapter 4.5.3, "Configuring an External Power Trigger"](#), on page 309.

If a power sensor is selected as the trigger mode, the following softkeys are not available; these settings are configured in the "Power Sensor Configuration" dialog box (see [chapter 4.5.5, "Power Sensor Configuration Dialog"](#), on page 313).

- [Trg/Gate Level](#)
- [Trg/Gate Polarity](#)
- [Trigger Hysteresis](#)
- [Trigger Holdoff](#)

Note: For R&S power sensors, the "Gate Mode" *Lvl* is not supported. The signal sent by these sensors merely reflects the instant the level is first exceeded, rather than a time period. However, only time periods can be used for gating in level mode. Thus, the trigger impulse from the sensors is not long enough for a fully gated measurement; the measurement cannot be completed.

Remote command:

TRIG:SOUR PSE, see [TRIGger<n>\[:SEQuence\]:SOURce](#) on page 913

SWE:EGAT:SOUR PSE for gated triggering, see [\[SENSe:\]SWEep:EGATe:SOURce](#) on page 868

[TRACe<n>:IQ:SET](#) on page 904

Time ← Trg/Gate Source

Opens an edit dialog box to define a repetition interval in which the measurement is triggered. The shortest interval is 2 ms.

Remote command:

TRIG:SOUR TIMETRIGger<n>[:SEQuence]:SOURce on page 913

Trg/Gate Level

Opens an edit dialog box to enter the trigger/gate level.

For details see also [chapter 4.1.9.3, "Using Gated Sweep Operation"](#), on page 116.

In the trigger modes "Time" and "Power Sensor", this softkey is not available.

Remote command:

[TRIGger<n>\[:SEQuence\]:LEVel:IFPower](#) on page 911

[TRIGger<n>\[:SEQuence\]:LEVel:VIDeo](#) on page 912

Trg/Gate Polarity

Sets the polarity of the trigger/gate source.

The sweep starts after a positive or negative edge of the trigger signal. The default setting is "Pos". The setting applies to all trigger modes with the exception of the "Free Run", "Power Sensor" and "Time" mode.

For details also see [chapter 4.1.9.3, "Using Gated Sweep Operation"](#), on page 116.

- | | |
|-------|---|
| "Pos" | Level triggering: the sweep is stopped by the logic "0" signal and restarted by the logical "1" signal after the gate delay time has elapsed. |
| "Neg" | Edge triggering: the sweep is continued on a "0" to "1" transition for the gate length duration after the gate delay time has elapsed. |

Remote command:

[TRIGger<n>\[:SEQuence\]:SLOPe](#) on page 913

[\[SENSe:\]SWEep:EGATe:POLarity](#) on page 868

Trigger Offset

Opens an edit dialog box to enter the time offset between the trigger signal and the start of the sweep.

offset > 0:	Start of the sweep is delayed
offset < 0:	<p>Sweep starts earlier (pre-trigger)</p> <p>Only possible for span = 0 (e.g. I/Q Analyzer mode) and gated trigger switched off</p> <p>Maximum allowed range limited by the sweep time: $\text{pretrigger}_{\text{max}} = \text{sweep time}$</p> <p>When using the R&S Digital I/Q Interface (R&S FSV-B17) with I/Q Analyzer mode, the maximum range is limited by the number of pretrigger samples.</p> <p>See table 7-2.</p> <p>See the R&S Digital I/Q Interface(R&S FSV-B17) description in the base unit.</p>

In the "External" or "IF Power" trigger mode, a common input signal is used for both trigger and gate. Therefore, changes to the gate delay will affect the trigger delay (trigger offset) as well.

Tip: To determine the trigger point in the sample (for "External" or "IF Power" trigger mode), use the `TRACe<n>:IQ:TPISample?` command.

In the "Time" trigger mode, this softkey is not available.

Remote command:

`TRIGger<n>[:SEquence]:HOLDoff[:TIME]` on page 908

Repetition Interval

Opens an edit dialog box to define a repetition interval in which the measurement is triggered. The shortest interval is 2 ms. This softkey is only available if the trigger source "Time" is selected (see "Time" on page 112).

Remote command:

`TRIGger<n>[:SEquence]:TIME:RINterval` on page 915

Trigger Hysteresis

Defines the value for the trigger hysteresis for "IF power" or "RF Power" trigger sources. The hysteresis in dB is the value the input signal must stay below the power trigger level in order to allow a trigger to start the measurement. The range of the value is between 3 dB and 50 dB with a step width of 1 dB.

Remote command:

`TRIGger<n>[:SEquence]:IFPower:HYSTeresis` on page 909

Trigger Holdoff

Defines the value for the trigger holdoff. The holdoff value in s is the time which must pass before triggering, in case another trigger event happens.

This softkey is only available if "IFPower", "RF Power" or "BBPower" is the selected trigger source.

Remote command:

[TRIGger<n>\[:SEquence\]:IFPower:HOLDoff](#) on page 909

For digital input via the R&S Digital I/Q Interface, R&S FSV-B17:

[TRIGger<n>\[:SEquence\]:BBPower:HOLDoff](#) on page 909

Gated Trigger

Switches the sweep mode with gate on or off.

This softkey requires the following "Trigger Mode" (see ["Trg/Gate Source"](#) on page 109):

This softkey requires the following "Trigger Mode" (see ["Trigger Source"](#) on page 372):

span > 0	External or IF Power/BB PowerIF Power
span = 0	External or IF Power/BB PowerIF Power or Video

If a different mode is active, the [IF Power/BB Power](#) trigger mode is automatically selected.

Note: When triggering or gating is activated, the squelch function is automatically disabled (see ["Squelch"](#) on page 132).

If the gate is switched on, a gate signal applied to the rear panel connector "EXT TRIGGER/GATE" or the internal IF power detector controls the sweep of the analyzer.

In the trigger mode [Time](#), this softkey is not available.

For details also see [chapter 4.1.9.3, "Using Gated Sweep Operation"](#), on page 116.

Remote command:

[\[SENSe:\]SWEep:EGATe](#) on page 867

[\[SENSe:\]SWEep:EGATe:SOURce](#) on page 868

Gate Settings

Opens a submenu to make all the settings required for gated sweep operation.

In the "Time" trigger mode, this softkey is not available.

For details also see [chapter 4.1.9.3, "Using Gated Sweep Operation"](#), on page 116.

Gate Mode (Lvl/Edge) ← Gate Settings

Sets the gate mode. As settings level-triggered or edge-triggered gate mode can be selected.

For details also see [chapter 4.1.9.3, "Using Gated Sweep Operation"](#), on page 116.

"Edge" Edge-triggered gate mode

"Lvl" Level-triggered gate mode

This mode is not supported when using R&S Power Sensors as power triggers ("Trg/Gate Source" = *Power Sensor* or *External*).

Remote command:

[\[SENSe:\]SWEep:EGATe:TYPE](#) on page 871

Gate Delay ← Gate Settings

Opens an edit dialog box to enter the gate delay time between the gate signal and the continuation of the sweep. The delay position on the time axis in relation to the sweep is indicated by a line labeled "GD".

This is useful for e.g. taking into account a delay between the gate signal and the stabilization of an RF carrier.

As a common input signal is used for both trigger and gate when selecting the "External" or "IF Power" trigger mode, changes to the gate delay will affect the trigger delay (trigger offset) as well.

For details also see [chapter 4.1.9.3, "Using Gated Sweep Operation"](#), on page 116.

Remote command:

`[SENSe:] SWEep:EGATe:HOLDoff` on page 867

Gate Length (Gate Mode Edge) ← Gate Settings

Opens an edit dialog box to enter the gate length. The gate length in relation to the sweep is indicated by a line labeled "GL".

The length of the gate signal defines if the sweep is to be interrupted. Only in the edge-triggered mode the gate length can be set, while in the level-triggered the gate length depends on the length of the gate signal.

For details also see [chapter 4.1.9.3, "Using Gated Sweep Operation"](#), on page 116.

Remote command:

`[SENSe:] SWEep:EGATe:LENGth` on page 868

Trg/Gate Source ← Gate Settings

See ["Trg/Gate Source"](#) on page 109.

Trg/Gate Level ← Gate Settings

See ["Trg/Gate Level"](#) on page 112.

Trg/Gate Polarity ← Gate Settings

See ["Trg/Gate Polarity"](#) on page 112.

Sweep Time ← Gate Settings

Opens an edit dialog box to change the sweep time in order to obtain a higher resolution for positioning gate delay and gate length. When leaving the "Gate Settings" sub-menu, the original sweep time is retrieved.

For details also see [chapter 4.1.9.3, "Using Gated Sweep Operation"](#), on page 116.

Res BW Manual ← Gate Settings

Opens an edit dialog box to enter a value for the resolution bandwidth. The available resolution bandwidths are specified in the data sheet.

For details on the correlation between resolution bandwidth and filter type refer to [chapter 4.1.6.3, "Selecting the Appropriate Filter Type"](#), on page 85.

Numeric input is always rounded to the nearest possible bandwidth. For rotary knob or UP/DNARROW key inputs, the bandwidth is adjusted in steps either upwards or downwards.

The manual input mode of the resolution bandwidth is indicated by a green bullet next to the "RBW" display in the channel bar.

When measuring Spurious Emissions, using this softkey automatically opens the "Sweep List" dialog (see ["Sweep List dialog box"](#) on page 219).

Remote command:

[SENSe:]BANDwidth|BWIDth[:RESolution]:AUTO on page 782

[SENSe:]BANDwidth|BWIDth[:RESolution] on page 782

4.1.9.2 Specifying the Trigger Settings

1. Press the "Trg/Gate Source" softkey to select the trigger mode (for details see ["Trg/Gate Source"](#) on page 109).
2. Press the [Trg/Gate Level](#) softkey to set the trigger level.
3. Press the [Trigger Offset](#) softkey to set the trigger offset. In addition, a [Trigger Hysteresis](#) and [Trigger Holdoff](#) can be defined via the corresponding softkeys.

For details on gated sweep operation, see [chapter 4.1.9.3, "Using Gated Sweep Operation"](#), on page 116.

4.1.9.3 Using Gated Sweep Operation

By using a gate in sweep mode and stopping the measurement while the gate signal is inactive, the spectrum for pulsed RF carriers can be displayed without the superposition of frequency components generated during switching. Similarly, the spectrum can also be examined for an inactive carrier. The sweep can be controlled by an external gate or by the internal power trigger.

Gated sweep operation is also possible for span = 0. This enables – e.g. in burst signals – level variations of individual slots to be displayed versus time.

1. Press the [Gate Settings](#) softkey to define the settings of the gate mode.
At the center frequency a transition to zero span is made and the time parameters gate delay and gate length are displayed as vertical lines to adjust them easily.
When quitting the [Gate Settings](#) submenu, the original span is retrieved so the desired measurement can be performed with the accurately set gate.
2. Setting the parameters gate delay and gate length highly accurate, press the [Sweep Time](#) softkey to alter the x-axis in a way that the signal range concerned (e.g. one full burst) is displayed.
3. Press the [Gate Delay](#) softkey to set the sampling time in a way that the desired portion of the signal is shown.
4. Press the [Gate Mode \(Lvl/Edge\)](#) softkey to set the gate mode.

5. If the "Edge" gate mode has been selected, press the **Gate Length (Gate Mode Edge)** softkey to set the sampling duration in a way that the desired portion of the signal is shown.
6. Press the **Trg/Gate Polarity** softkey to set the polarity of the trigger source.
7. Press the **Gated Trigger** softkey to activate the gated sweep mode.

To indicate that a gate is used for the sweep, the enhancement label "GAT" is displayed on the screen. This label appears to the right of the window for which the gate is configured.

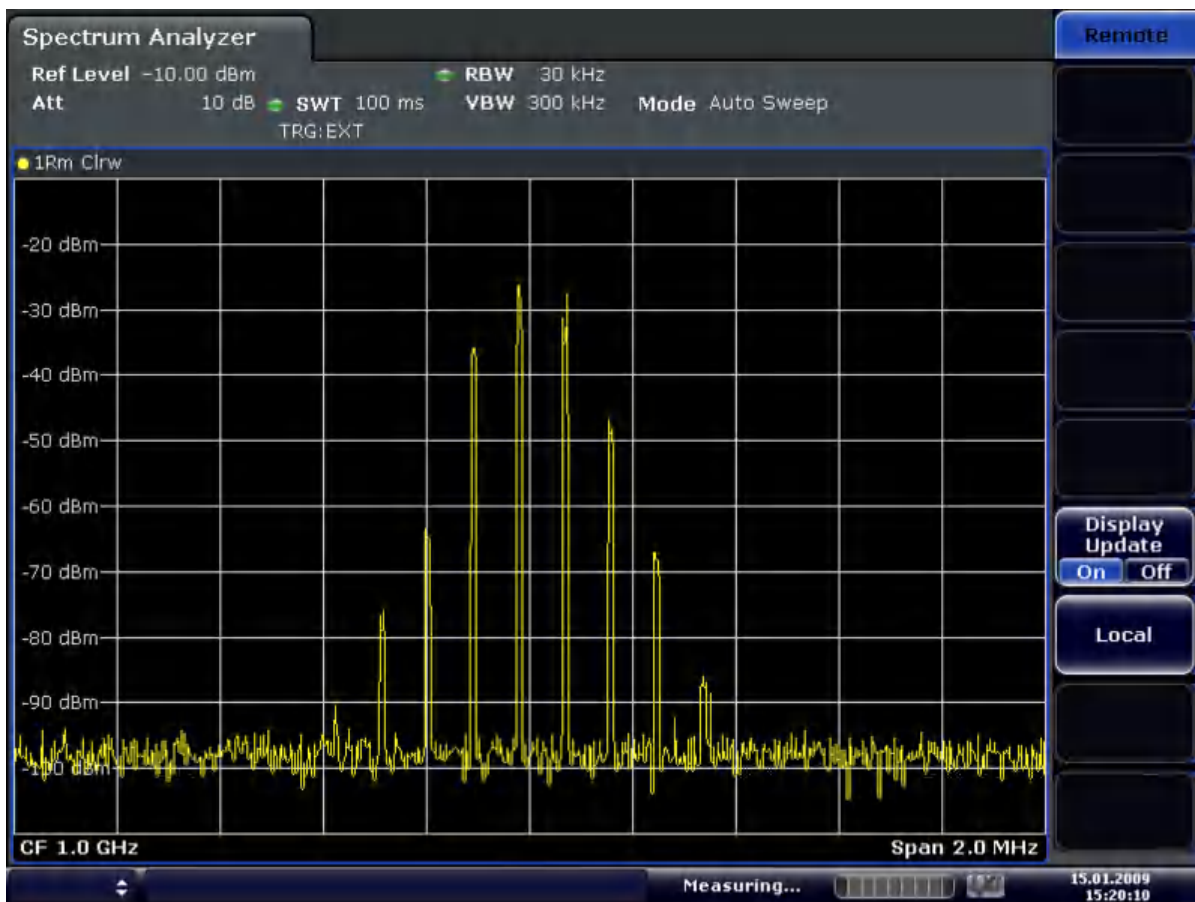

Fig. 4-4: TDMA signal with GATE OFF

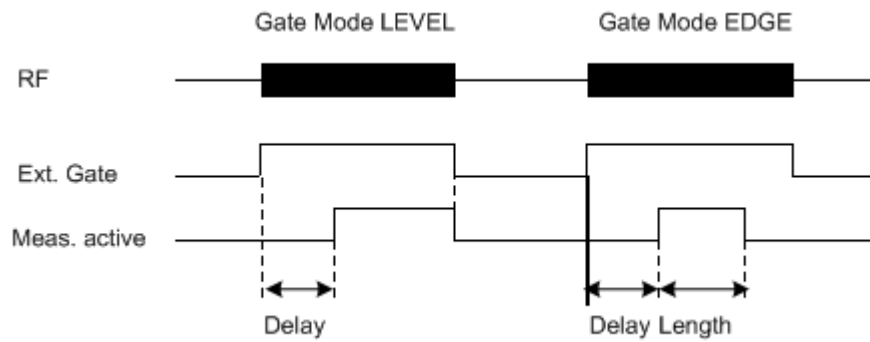

Fig. 4-5: Timing diagram for GATE, GATE DELAY and GATE LENGTH

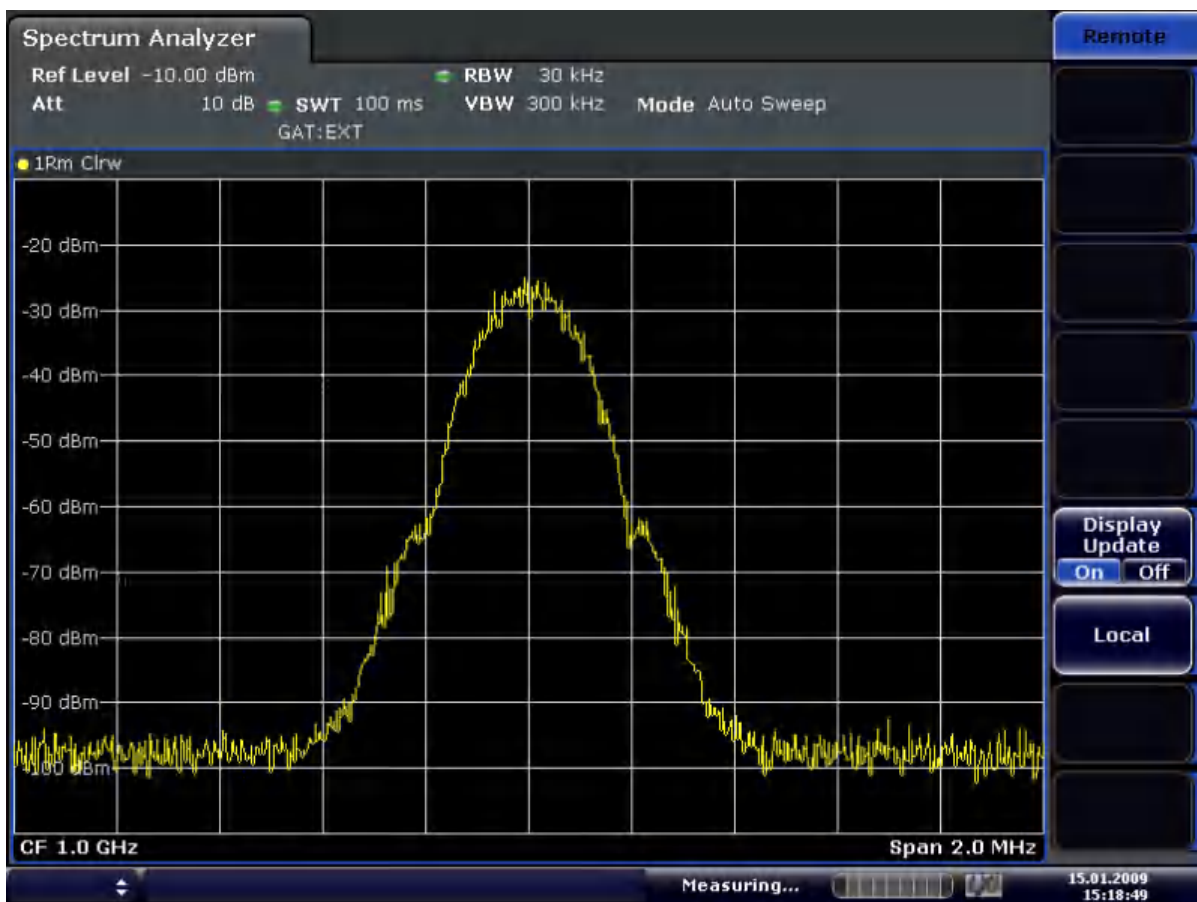

Fig. 4-6: TDMA signal with GATE ON

4.2 Measurement Functions

In this section all menus necessary for setting measurement functions are described. This includes the following topics and keys:

- Using Markers and Delta Markers – MKR Key..... 119
- Performing Peak Searches with Markers – PEAK SEARCH Key..... 127
- Performing Marker Functions – MKR FUNC Key..... 127
- Changing Settings via Markers – MKR-> Key..... 141
- Power Measurements – MEAS Key..... 151
- Measurement Configuration – MEAS CONFIG Key..... 256
- Using Limit Lines and Display Lines – LINES Key..... 256
- Input/Output Configuration – INPUT/OUTPUT Key..... 268
- Performing Measurements – RUN SINGLE/RUN CONT Keys..... 276

4.2.1 Using Markers and Delta Markers – MKR Key

The markers are used for marking points on traces, reading out measurement results and for selecting a display section quickly. The R&S FSVR provides 16 markers per trace.

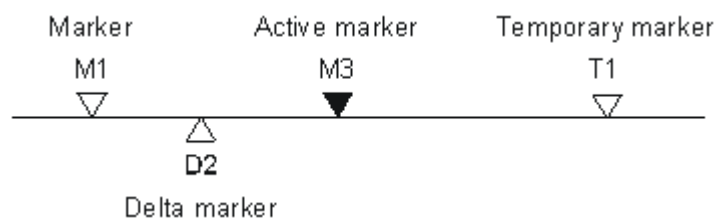

Fig. 4-7: Marker types

All markers can be used either as markers or delta markers. The marker that can be moved by the user is defined in the following as the active marker. Temporary markers are used in addition to the markers and delta markers to evaluate the measurement results. They disappear when the associated function is deactivated.

The measurement results of the active marker (also called marker values) are displayed in the marker field, which is located at the upper right corner of the diagram, or in a separate table beneath the diagram. The marker information includes the following:

- marker type (M1 in the example)
- trace in square brackets ([1] in the example)
- level (-33.09 dBm in the example)
- marker location (3 GHz in the example)

```

M1[1]                      -33.09 dBm
                                    3.000000000 GHz
  
```

Fig. 4-8: Marker values

The MKR key is used to select and position the absolute and relative measurement markers (markers and delta markers). In addition, the functions for the frequency counter, a fixed reference point for relative measurement markers, and for enlargement of the measurement area are assigned to this key.

To open the Marker menu

- Press the MKR key.
The "Marker" menu is displayed. If no marker is active, marker 1 is activated and a peak search on the trace is carried out. Otherwise, the edit dialog box for the last activated marker is opened and the current frequency/time value is displayed.

Further information

- [chapter 4.2.1.3, "Displayed Marker Information"](#), on page 126
- [chapter 4.2.4, "Changing Settings via Markers – MKR-> Key"](#), on page 141.

Menu and softkey description

- [chapter 4.2.1.1, "Softkeys of the Marker Menu"](#), on page 120

Tasks

- [chapter 4.2.1.2, "Basic Marker Functions"](#), on page 124

4.2.1.1 Softkeys of the Marker Menu

The following table shows all softkeys available in the "Marker" menu. It is possible that your instrument configuration does not provide all softkeys. If a softkey is only available with a special option, model or (measurement) mode, this information is provided in the corresponding softkey description.

Marker 1 / Marker 2 / Marker 3 / ... Marker 16,/ Marker Norm/Delta	120
More Markers	121
Marker to Trace	121
Marker Wizard	121
L All Marker Off	122
All Marker Off	123
Marker Table	123
Marker Stepsize	123
L Stepsize Standard	123
L Stepsize Sweep Points	123
Marker Zoom (span > 0)	124
Link Mkr1 and Delta1	124
Marker Info (On Off)	124

Marker 1 / Marker 2 / Marker 3 / ... Marker 16,/ Marker Norm/Delta

The "Marker X" softkey activates the corresponding marker and opens an edit dialog box to enter a value for the marker to be set to. Pressing the softkey again deactivates the selected marker.

If a marker value is changed using the rotary knob, the step size is defined via the [Stepsize Standard](#) or [Stepsize Sweep Points](#) softkeys.

Marker 1 is always the reference marker for relative measurements. If activated, markers 2 to 16 are delta markers that refer to marker 1. These markers can be converted into markers with absolute value display using the "Marker Norm/Delta" softkey. If marker 1 is the active marker, pressing the "Marker Norm/Delta" softkey switches on an additional delta marker.

Remote command:

[CALCulate<n>:MARKer<m>\[:STATe\]](#) on page 608

[CALCulate<n>:MARKer<m>:X](#) on page 618

[CALCulate<n>:MARKer<m>:Y](#) on page 620

[CALCulate<n>:DELTamarker<m>\[:STATe\]](#) on page 557

[CALCulate<n>:DELTamarker<m>:X](#) on page 568

[CALCulate<n>:DELTamarker<m>:X:RELative?](#) on page 569

[CALCulate<n>:DELTamarker<m>:Y](#) on page 569

More Markers

Opens a sub-menu to select one of up to 16 available markers. See "[Marker 1 / Marker 2 / Marker 3 / ... Marker 16, / Marker Norm/Delta](#)" on page 120.

Marker to Trace

Opens an edit dialog box to enter the number of the trace on which the marker is to be placed.

Remote command:

[CALCulate<n>:MARKer<m>:TRACe](#) on page 617

[CALCulate<n>:DELTamarker<m>:TRACe](#) on page 567

Marker Wizard

Opens a configuration dialog for markers. The marker wizard allows you to configure and activate up to 16 different markers in one dialog. The first 8 markers are displayed on one tab, the last 8 markers on a second tab. For each marker, the following settings are available:



"Selected/ State" When you press the "Selected" or "State" field the corresponding marker is activated and the marker row is highlighted.

"Normal/Delta" Defines whether it is a normal marker or delta marker. For delta markers you can define a reference marker.

"Ref. Marker" Reference marker for delta markers. The marker values for the delta marker are indicated relative to the specified reference marker. The reference marker can either be another active marker, or a fixed reference marker ("FXD", see "Ref Fixed" on page 131).

"Trace" Trace for which the marker is to be set.

Remote command:

[CALCulate<n>:MARKer<m>\[:STATe\]](#) on page 608

[CALCulate<n>:DELTAmarker<m>\[:STATe\]](#) on page 557

[CALCulate<n>:MARKer<m>:TRACe](#) on page 617

[CALCulate<n>:DELTAmarker<m>:TRACe](#) on page 567

[CALCulate<n>:DELTAmarker<m>:MREF](#) on page 567

All Marker Off ← Marker Wizard

Switches all markers off. It also switches off all functions and displays that are associated with the markers/delta markers.

Remote command:

[CALCulate<n>:MARKer<m>:AOFF](#) on page 608

All Marker Off

Switches all markers off. It also switches off all functions and displays that are associated with the markers/delta markers.

Remote command:

[CALCulate<n>:MARKer<m>:AOFF](#) on page 608

Marker Table

Defines how the marker information is displayed.

For more information, see "Displayed Marker Information" in the description of the base unit.

For more information, see [Displayed Marker Information](#).

"On"	Displays the marker information in a table in a separate area beneath the diagram.
"Off"	Displays the marker information within the diagram area.
"Aut"	(Default) The marker table is displayed automatically if more than 2 markers are active, and removed if only 1 or 2 markers are active. This helps keep the information in the display clear.

Remote command:

[DISPlay:MTABLE](#) on page 710

Marker Stepsize

Opens a submenu to set the step size of all markers and delta markers.

Default value for the marker step size is [Stepsize Sweep Points](#).

Stepsize Standard ← Marker Stepsize

Moves the marker or delta marker from one measurement point to the next, if the marker or delta marker value is changed via the rotary knob ("Marker 1 / Marker 2 / Marker 3 / ... Marker 16,/ Marker Norm/Delta" softkeys, see "[Marker 1 / Marker 2 / Marker 3 / ... Marker 16,/ Marker Norm/Delta](#)" on page 120). If more measured values than measurement points exist, it is not possible to read out all measured values. In this case, use the [Stepsize Sweep Points](#) softkey.

Remote command:

CALC:MARK:X:SSIZ STAN (see [CALCulate<n>:MARKer<m>:X:SSIZE](#) on page 620)

Stepsize Sweep Points ← Marker Stepsize

Moves the marker or delta marker from one measured value to the next, if the marker or delta marker value is changed via the rotary knob ("Marker 1 / Marker 2 / Marker 3 / ... Marker 16,/ Marker Norm/Delta" softkeys, see "[Marker 1 / Marker 2 / Marker 3 / ... Marker 16,/ Marker Norm/Delta](#)" on page 120). If more measured values than measurement points exist, every single measured value is accessible and its value is displayed in the marker field.

The number of measured values is defined in the ""Sweep"" menu via the [Sweep Points](#) softkey.

This functionality is available for all base unit measurements with the exception of statistics ("APD" and "CCDF" softkeys in the "Measurement" menu).

Remote command:

`CALC:MARK:X:SSIZ POIN` (see `CALCulate<n>:MARKer<m>:X:SSIZe` on page 620)

Marker Zoom (span > 0)

Opens an edit dialog box to enter a display range for the zoom. The area around marker 1 is expanded accordingly and more details of the result can be seen. If no marker is activated, marker 1 is switched on and set on the largest signal.

The following sweep is stopped at the position of the reference marker. The frequency of the signal is counted and the measured frequency becomes the new center frequency. The zoomed display range is then configured and the new settings are used by the R&S FSVR for further measurements.

If the display has not yet been switched to the new frequency display range and you press the softkey, the procedure is aborted. If an instrument setting is changed during this operation, the procedure is also aborted.

This function is not available in I/Q Analyzer mode.

Remote command:

`CALCulate<n>:MARKer<m>:FUNction:ZOOM` on page 640

Link Mkr1 and Delta1

The delta marker 1 is linked to marker 1, so if the x-axis value of the marker 1 is changed, the delta marker 1 will follow on the same x-position. The link is off by default.

You can set the two markers on different traces to measure the difference (e.g. between a max hold trace and a min hold trace or between a measurement and a reference trace).

Remote command:

`CALCulate<n>:DELTAmarker<m>:LINK` on page 563

Marker Info (On Off)

Turns the numerical marker information in the diagram area on and off.

Remote command:

`DISPlay[:WINDow<n>]:MINFo:STATe` on page 711

4.2.1.2 Basic Marker Functions

- To open the "Marker" menu, press the MKR key.
Marker 1 is activated and positioned on the maximum value of the trace as a normal marker. If several traces are displayed, the marker is set to the maximum value (peak) of the trace which has the lowest number (1 to 3) and is not frozen (View mode). In case a marker is already located there, the new marker is set to the frequency of the next lowest level (next peak).

- To change marker settings quickly, right-click on the marker in the display (or touch it for about 1 second). A context-sensitive menu is displayed which corresponds to the softkey functions available for markers.
- To configure and activate several markers at once, select the "Marker Wizard" to open a configuration dialog for all markers.
- To change to another trace, press the "Marker to Trace" softkey ("**Marker to Trace**" on page 121) and enter the number of the trace on which the marker is to be placed.
The marker changes to the selected trace, but remains on the previous frequency or time. If a trace is turned off, the corresponding markers and marker functions are also deactivated.
- To switch to another marker, click on the marker label in the diagram. Alternatively, select the corresponding softkey. If necessary, select the **More Markers** softkey first to open a submenu that contains all marker numbers.
- To move the marker to a different position, click the marker label in the diagram and then drag it to the new position. When a marker label is selected, a vertical line is displayed which indicates the marker's current x-value.

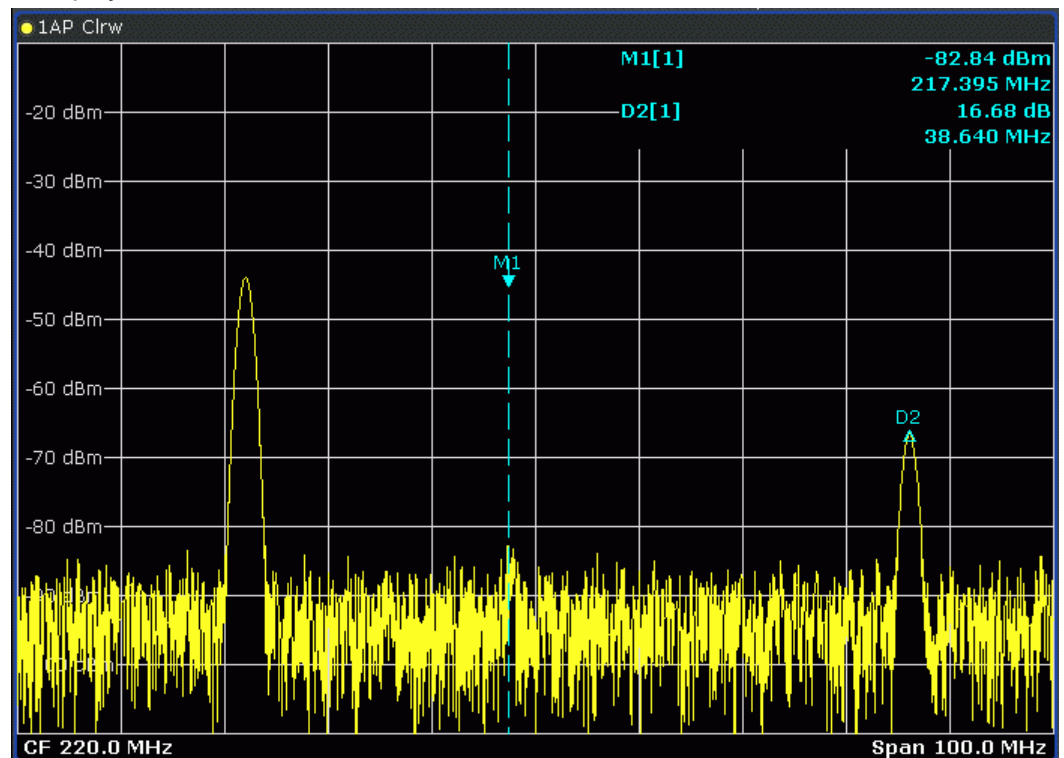

- To switch on a delta marker, select the softkey for the corresponding marker, then press the "Marker 1 / Marker 2 / Marker 3 / ... Marker 16, / Marker Norm/Delta" ("**Marker 1 / Marker 2 / Marker 3 / ... Marker 16, / Marker Norm/Delta**" on page 120) until "Delta" is highlighted.
The selected marker is switched on as a delta marker. The frequency and level of the marker are displayed in relation to marker 1 in the marker field.
- To change the marker type of a marker, select the softkey for the corresponding marker, then press the "Marker 1 / Marker 2 / Marker 3 / ... Marker 16, / Marker

Norm/Delta" softkey ("[Marker 1 / Marker 2 / Marker 3 / ... Marker 16, / Marker Norm/Delta](#)" on page 120).

For a normal marker, the frequency and level are displayed as absolute values in the marker field. For a delta marker, the frequency and level of the marker are displayed in relation to marker 1 in the marker field.

- To switch off a marker, press the corresponding softkey again. The marker is deactivated. Marker 1 becomes the active marker for entry. The frequency and level of marker 1 are displayed in the marker field.
- To switch off all markers, press the [All Marker Off](#) softkey.
- To change the stepsize between one measured value and the next when the marker or delta marker value is changed via the rotary knob, press either the [Stepsize Standard](#) softkey or the [Stepsize Sweep Points](#) softkey.
- To zoom into the display around a marker, press the "[Marker Zoom \(span > 0\)](#)" on page 124 softkey and enter a span.
- To link the delta marker1 to marker1, so if the x-axis value of the marker 1 is changed, the delta marker 1 follows on the same x-position, press the [Link Mkr1 and Delta1](#) softkey.

4.2.1.3 Displayed Marker Information

The following additional information is displayed within the diagram grid or in a marker table beneath the diagram. The marker table is displayed automatically if more than 2 markers are active. You can hide or show the table using the [Marker Table](#) softkey.

Marker information in Diagram Grid

The x and y axis positions of the last 2 markers or delta markers that were set, as well as their index, are displayed within the diagram grid, if available. The value in the square brackets after the index indicates the trace to which the marker is assigned. (Example: M1[1] defines marker 1 on trace 1.) For more than 2 markers, a separate marker table is displayed beneath the diagram.

If applicable, the active measurement function for the marker and its main results are indicated, as well. The functions are indicated with the following abbreviations:

FXD	Reference fixed marker active
PHNoise	Phase noise measurement active
CNT	Frequency counter active
TRK	Signal track active
NOIse	Noise measurement active
MDepth	Measurement of the AM modulation depth active
TOI	TOI measurement active
Occ BW	Occupied bandwidth

Marker Information in Marker Table

In addition to the marker information displayed within the diagram grid, a separate marker table may be displayed beneath the diagram. This table provides the following information for all active markers:



As of firmware version 1.50, the marker table also provides information from connected power sensors (requires option R&S FSV-K9).

See also [chapter 4.5, "Instrument Functions - Power Sensor \(R&S FSV-K9\)"](#), on page 304.

No.	Serial number
Type	Marker type: N (normal), D (delta), T (temporary, internal)
Dgr	Diagram number
Trc	Trace to which the marker is assigned
Stimulus	x-value of the marker
Response	y-value of the marker
Func	Activated marker or measurement function
Func.Result	Result of the active marker or measurement function

4.2.2 Performing Peak Searches with Markers – PEAK SEARCH Key

The PEAK SEARCH key is used to perform a peak search with the currently active marker. If no marker is active, marker 1 is activated in normal mode and set as the peak.

If the selected diagram does not support markers, this key is ignored.

4.2.3 Performing Marker Functions – MKR FUNC Key

The MKR FUNC key provides various functions for markers, e.g.

- Phase Noise measurements
- Setting reference points
- Marker demodulation
- Defining Marker peak lists
- Signal counts
- Measuring the power for a band around the marker

To open the marker function menu

- Press the MKR FUNC key.
The "Mkr Func" (marker function) menu is displayed.

Menu and softkey description

- [chapter 4.2.3.1, "Softkeys of the Marker Function Menu"](#), on page 128

Further information

- [chapter 4.2.3.4, "AF Demodulation"](#), on page 137
- [chapter 4.2.3.5, "Frequency Measurement with the Frequency Counter"](#), on page 138
- [chapter 4.2.3.6, "Measurement of Noise Density"](#), on page 138
- [chapter 4.2.3.7, "Measurement example for Phase Noise Auto Peak Search"](#), on page 139

Tasks

- [chapter 4.2.3.2, "Setting a Fixed Reference Point \(Phase Noise Measurement\)"](#), on page 137
- [chapter 4.2.3.3, "Setting the Demodulation Mode and Duration"](#), on page 137
- [chapter 4.2.3.8, "Performing Band Power Measurements"](#), on page 140

4.2.3.1 Softkeys of the Marker Function Menu

The following table shows all softkeys available in the marker function menu. It is possible that your instrument configuration does not provide all softkeys. If a softkey is only available with a special option, model or (measurement) mode, this information is provided in the corresponding softkey description.

Select Marker (No).....	129
Signal Count.....	129
Noise Meas On/Off.....	129
Phase Noise.....	130
L Phase Noise On/Off.....	130
L Ref Point Level.....	130
L Ref Point Frequency (span > 0)/Ref Point Time (zero span).....	130
L Peak Search.....	130
L Ph. Noise Auto Peak Search.....	130
L Select Marker (No).....	131
Ref Fixed.....	131
L Ref. Fixed On/Off.....	131
L Ref Point Level.....	131
L Ref Point Frequency (span > 0)/Ref Point Time (zero span).....	131
L Peak Search.....	131
Marker Demod.....	131
L Mkr Demod On/Off.....	132
L AM.....	132
L FM.....	132
L Mkr Stop Time.....	132
L Continuous Demod (span > 0).....	132
L Squelch.....	132
L Squelch Level.....	133

n dB down.....	133
Marker Peak List.....	134
L Peak List On/Off.....	134
L Sort Mode Freq/Lvl.....	134
L Max Peak Count.....	134
L Peak Excursion.....	134
L Left Limit.....	134
L Right Limit.....	135
L Threshold.....	135
L ASCII File Export.....	135
L Decim Sep.....	135
L Marker Number.....	135
Band Power.....	136
L Select Marker (No).....	136
L Band Power On/Off.....	136
L Span.....	136
L Power.....	136
L Density.....	136

Select Marker (No)

Opens a submenu to select one of 16 markers and define whether the marker is a normal or a delta marker (see "[Marker 1 / Marker 2 / Marker 3 / ... Marker 16, / Marker Norm/Delta](#)" on page 120). "(No)" indicates the number of the currently active marker.

See "[Marker 1 / Marker 2 / Marker 3 / ... Marker 16, / Marker Norm/Delta](#)" on page 120.

Signal Count

Switches the frequency counter on or off, and opens an edit dialog box to define the resolution of the frequency counter, if enabled. The frequency is counted at the position of the reference marker (marker 1). If no marker is activate, marker 1 is switched on and positioned on the largest signal.

The sweep stops at the reference marker until the frequency counter has delivered a result. The result is displayed in the marker field (see [figure 4-8](#)), labeled with [Tx CNT].

For more information see [chapter 4.2.3.5, "Frequency Measurement with the Frequency Counter"](#), on page 138.

Remote command:

`CALCulate<n>:MARKer<m>:COUNT` on page 608

`CALCulate<n>:MARKer<m>:COUNT:FREQuency?` on page 609

Noise Meas On/Off

Switches the noise measurement for the active marker on or off. The corresponding marker becomes the normal marker.

For more information on noise measurement see [chapter 4.2.3.6, "Measurement of Noise Density"](#), on page 138.

Remote command:

`CALCulate<n>:MARKer<m>:FUNction:NOISe[:STATe]` on page 636

`CALCulate<n>:MARKer<m>:FUNction:NOISe:RESult` on page 637

Phase Noise

This softkey opens a submenu that contains functionality to configure and perform phase noise measurements.

Phase Noise On/Off ← Phase Noise

Switches the phase noise measurement with all active delta markers on and off. The correction values for the bandwidth and the log amplifier are taken into account in the measurement.

Marker 1 is activated, if necessary, and a peak search is performed. If marker 1 is activated, its position becomes the reference point for the measurement.

Delta marker 2 is activated and can be used to read out the phase noise value at a given frequency offset.

Remote command:

`CALCulate<n>:DELTAmarker<m>:FUNCTION:PNOise[:STATe]` on page 561

`CALCulate<n>:DELTAmarker<m>:FUNCTION:PNOise:RESult?` on page 562

Ref Point Level ← Phase Noise

Opens an edit dialog box to enter a reference level value. All relative level values of the delta markers refer to this reference level.

Remote command:

`CALCulate<n>:DELTAmarker<m>:FUNCTION:FIXed:RPoint:Y` on page 561

Ref Point Frequency (span > 0)/Ref Point Time (zero span) ← Phase Noise

Opens an edit dialog box to enter a frequency reference or time value. All relative frequency or time values of the delta markers refer to this frequency reference. For phase noise measurement, input of reference time is not possible.

Remote command:

`CALCulate<n>:DELTAmarker<m>:FUNCTION:FIXed:RPoint:X` on page 560

Peak Search ← Phase Noise

Sets the maximum value of the selected trace as the reference point.

Remote command:

`CALCulate<n>:DELTAmarker<m>:FUNCTION:FIXed:RPoint:MAXimum[:PEAK]`
on page 560

Ph. Noise Auto Peak Search ← Phase Noise

Activates an automatic peak search for the reference fixed marker 1 at the end of each particular sweep.

This function can be used to track a drifting source during a phase noise measurement. The delta marker 2, which shows the phase noise measurement result, keeps the delta frequency value. Therefore the phase noise measurement leads to reliable results in a certain offset although the source is drifting. Only if the marker 2 reaches the border of the span, the delta marker value is adjusted to be within the span. In these cases, select a larger span.

Remote command:

`CALCulate<n>:DELTAmarker<m>:FUNCTION:PNOise:AUTO` on page 562

Select Marker (No) ← Phase Noise

Opens a submenu to select one of 16 markers and define whether the marker is a normal or a delta marker (see "[Marker 1 / Marker 2 / Marker 3 / ... Marker 16, / Marker Norm/Delta](#)" on page 120). "(No)" indicates the number of the currently active marker.

See "[Marker 1 / Marker 2 / Marker 3 / ... Marker 16, / Marker Norm/Delta](#)" on page 120.

Ref Fixed

Opens a submenu to set all values of a reference point. Instead of using the current values of the reference marker (marker 1) as reference point for the delta markers, level and frequency or time are set to fixed values and used as reference point.

Ref. Fixed On/Off ← Ref Fixed

Switches the relative measurement to a fixed reference value on or off. The level and frequency or time values of marker 1 immediately become the reference point, but can be altered using the corresponding softkeys ("[Ref Point Level](#)" on page 130, "[Ref Point Frequency \(span > 0\)/Ref Point Time \(zero span\)](#)" on page 130 and "[Peak Search](#)" on page 130).

When set to ON, all delta markers which previously referenced marker 1 are automatically set to reference the fixed marker.

The reference marker assignment can be changed using the "Marker Wizard" (see "[Marker Wizard](#)" on page 121).

Remote command:

`CALCulate<n>:DELTAmarker<m>:FUNCTION:FIXed[:STATe]` on page 559

Ref Point Level ← Ref Fixed

Opens an edit dialog box to enter a reference level value. All relative level values of the delta markers refer to this reference level.

Remote command:

`CALCulate<n>:DELTAmarker<m>:FUNCTION:FIXed:RPOINT:Y` on page 561

Ref Point Frequency (span > 0)/Ref Point Time (zero span) ← Ref Fixed

Opens an edit dialog box to enter a frequency reference or time value. All relative frequency or time values of the delta markers refer to this frequency reference. For phase noise measurement, input of reference time is not possible.

Remote command:

`CALCulate<n>:DELTAmarker<m>:FUNCTION:FIXed:RPOINT:X` on page 560

Peak Search ← Ref Fixed

Sets the maximum value of the selected trace as the reference point.

Remote command:

`CALCulate<n>:DELTAmarker<m>:FUNCTION:FIXed:RPOINT:MAXimum[:PEAK]` on page 560

Marker Demod

The marker demodulation function sends the AM data at the current marker frequency (in a bandwidth corresponding to the RBW) to the audio output. The "Marker Demod" softkey opens a submenu to set the demodulation output settings.

For more information see [chapter 4.2.3.4, "AF Demodulation"](#), on page 137.

Marker demodulation is only available with option R&S FSVR-B3 and is not available for Spectrum Emission Mask measurements.

Mkr Demod On/Off ← Marker Demod

Switches the demodulation output on or off.

For more information see [chapter 4.2.3.4, "AF Demodulation"](#), on page 137.

Remote command:

`CALCulate<n>:MARKer<m>:FUNCTION:DEModulation[:STATe]` on page 627

AM ← Marker Demod

Sets AM as the output demodulation mode. This is the default setting.

For more information see [chapter 4.2.3.4, "AF Demodulation"](#), on page 137.

Remote command:

`CALC:MARK1:FUNC:DEM:SEL AM`, see `CALCulate<n>:MARKer<m>:FUNCTION:DEModulation:SElect` on page 626

FM ← Marker Demod

Sets FM as the output demodulation mode. Default setting is AM.

For more information see [chapter 4.2.3.4, "AF Demodulation"](#), on page 137.

Remote command:

`CALC:MARK1:FUNC:DEM:SEL FM`, see `CALCulate<n>:MARKer<m>:FUNCTION:DEModulation:SElect` on page 626

Mkr Stop Time ← Marker Demod

Opens an edit dialog box to define how long demodulation should be output for span > 0.

For more information see [chapter 4.2.3.4, "AF Demodulation"](#), on page 137.

Remote command:

`CALCulate<n>:MARKer<m>:FUNCTION:DEModulation:HOLDoff` on page 626

Continuous Demod (span > 0) ← Marker Demod

Switches the continuous demodulation on or off. If the sweep time is long enough, the set frequency range can be monitored acoustically.

For more information see [chapter 4.2.3.4, "AF Demodulation"](#), on page 137.

Remote command:

`CALCulate<n>:MARKer<m>:FUNCTION:DEModulation:CONTinuous` on page 625

Squelch ← Marker Demod

Activates the squelch function, i.e. the audible AF is cut off below a defined threshold level. Thus, you avoid hearing noise at the audio output when no signal is available.

The squelch function activates the video trigger function (see ["Video"](#) on page 110) and deactivates any other trigger or gating settings. The squelch level and trigger level are set to the same value.

The trigger source in the channel information bar is indicated as "SQL" for squelch. The squelch level is indicated by a red line in the diagram.

Remote command:

[\[SENSe:\]DEMod:SQUelch\[:STATe\]](#) on page 790

Squelch Level ← Marker Demod

Defines the level threshold below which the audible AF is cut off if squelching is enabled. The video trigger level is set to the same value.

The squelch level is indicated by a red line in the diagram.

Remote command:

[\[SENSe:\]DEMod:SQUelch:LEVel](#) on page 790

n dB down

Opens an edit dialog box to enter a value to define the level spacing of the two temporary markers to the right and left of marker 1 (default setting: 3 dB). Activates the temporary markers T1 and T2. The values of the temporary markers (T1, T2) and the entered value (ndB) are displayed in the marker field.

If a positive value is entered, the markers T1 and T2 are placed below the active reference marker. If a negative value (e.g. for notch filter measurements) is entered, the markers T1 and T2 are placed above the active reference marker. Marker T1 is placed to the left and marker T2 to the right of the reference marker.

In the marker table, the following results are displayed:

Span setting	Parameter name	Description
span > 0	Bw	frequency spacing of the two temporary markers
	Q factor	quality of the displayed bandwidth value (Bw)
span = 0	PWid	pulse width between the two temporary markers

If it is not possible to form the frequency spacing for the n dB value (e.g. because of noise display), dashes instead of a measured value are displayed.

Remote command:

[CALC:MARK1:FUNC:NDBD:STAT ON](#), see [CALCulate<n>:MARKer<m>:FUNCTION:NDBDown:STATe](#) on page 635

[CALC:MARK1:FUNC:NDBD 3dB](#), see [CALCulate<n>:MARKer<m>:FUNCTION:NDBDown](#) on page 633

[CALC:MARK1:FUNC:NDBD:RES?](#), see [CALCulate<n>:MARKer<m>:FUNCTION:NDBDown:RESult?](#) on page 635

[CALC:MARK:FUNC:NDBD:QFAC?](#), see [CALCulate<n>:MARKer<m>:FUNCTION:NDBDown:QFACTOR](#) on page 634

[CALC:MARK1:FUNC:NDBD:FREQ?](#) (span > 0), see [CALCulate<n>:MARKer<m>:FUNCTION:NDBDown:FREQuency?](#) on page 634

[CALC:MARK1:FUNC:NDBD:TIME?](#) (span = 0), see [CALCulate<n>:MARKer<m>:FUNCTION:NDBDown:TIME?](#) on page 636

Marker Peak List

Opens the "Peak List" submenu to define criteria for the sort order and the contents of the peak list. For each listed peak the frequency ("Stimulus") and level ("Response") values are given. In addition, the peaks are indicated in the trace display. A maximum of 50 entries are listed.

Remote command:

[CALCulate<n>:MARKer<m>:FUNction:FPEaks:COUNT?](#) on page 629

[CALCulate<n>:MARKer<m>:FUNction:FPEaks:X](#) on page 630

[CALCulate<n>:MARKer<m>:FUNction:FPEaks:Y?](#) on page 631

Peak List On/Off ← Marker Peak List

Activates/deactivates the marker peak list. If activated, the peak list is displayed and the peaks are indicated in the trace display.

Remote command:

[CALCulate<n>:MARKer<m>:FUNction:FPEaks:STAT](#) on page 630

Sort Mode Freq/Lvl ← Marker Peak List

Defines the criteria for sorting:

"Freq" sorting in ascending order of frequency values (span > 0) or time values (span = 0)

"Lvl" sorting in ascending order of the level

Remote command:

[CALCulate<n>:MARKer<m>:FUNction:FPEaks:SORT](#) on page 630

Max Peak Count ← Marker Peak List

Defines the maximum number of peaks to be determined and displayed.

Remote command:

[CALCulate<n>:MARKer<m>:FUNction:FPEaks:LIST:SIZE](#) on page 629

Peak Excursion ← Marker Peak List

Opens an edit dialog box for level measurements to enter the minimum level value by which a signal must rise or fall so that it will be identified as a maximum or a minimum by the search functions. Entries from 0 dB to 80 dB are allowed; the resolution is 0.1 dB. The default setting for the peak excursion is 6 dB.

For more information see "Specifying the suitable peak excursion" and "Effect of different peak excursion settings".

Remote command:

[CALCulate<n>:MARKer<m>:PEXCursion](#) on page 616

Left Limit ← Marker Peak List

Opens an edit dialog box to enter a value for the lower limit (left vertical line: S1 for span > 0; T1 for zero span). The search is performed between the lines of the left and right limit (see also [Right Limit](#) softkey).

Remote command:

[CALCulate<n>:MARKer<m>:X:SLIMits:LEFT](#) on page 618

Right Limit ← Marker Peak List

Opens an edit dialog box to enter a value for the upper limit (left vertical line: S2 for span > 0; T2 for zero span). The search is performed between the lines of the left and right limit (see also [Left Limit](#) softkey). If no value is set, the upper limit corresponds to the stop frequency.

Remote command:

[CALCulate<n>:MARKer<m>:X:SLIMits:RIGHT](#) on page 619

Threshold ← Marker Peak List

Opens an edit dialog box to define the threshold line. The threshold line represents the lower level limit for a "Peak" search and the upper level limit for a "Min" search.

Remote command:

[CALCulate<n>:THReshold:STATe](#) on page 703

[CALCulate<n>:THReshold](#) on page 702

ASCII File Export ← Marker Peak List

Opens the "ASCII File Export Name" dialog box and saves the active peak list in ASCII format to the specified file and directory.

The file consists of the header containing important scaling parameters and a data section containing the marker data. For details on an ASCII file see [chapter 4.1.8.7, "ASCII File Export Format"](#), on page 107.

This format can be processed by spreadsheet calculation programs, e.g. MS-Excel. It is necessary to define ';' as a separator for the data import. Different language versions of evaluation programs may require a different handling of the decimal point. It is therefore possible to select between separators '.' (decimal point) and ',' (comma) using the "Decim Sep" softkey (see ["Decim Sep"](#) on page 100).

An example of an output file for Spectrum Emission Mask measurements is given in ["ASCII File Export Format \(Spectrum Emission Mask\)"](#) on page 210.

Remote command:

[FORMat:DEXPort:DSEParator](#) on page 728

[MMEMory:STORe<n>:LIST](#) on page 742

Decim Sep ← Marker Peak List

Selects the decimal separator with floating-point numerals for the ASCII Trace export to support evaluation programs (e.g. MS-Excel) in different languages. The values '.' (decimal point) and ',' (comma) can be set.

Remote command:

[FORMat:DEXPort:DSEParator](#) on page 728

Marker Number ← Marker Peak List

If enabled, the determined peaks are indicated by their corresponding marker number in the trace display.

Remote command:

[CALCulate<n>:MARKer<m>:FUNCTion:FPEaks:ANN:LAB:STAT](#) on page 628

Band Power

Opens a submenu to activate and configure a band power marker. Band power markers allow you to measure the integrated power for a defined span (band) around a marker. The result can be displayed either as a power (dBm) or density (dBm/Hz). The span is indicated by lines in the diagram.

Band power markers are only available for standard frequency measurements in Spectrum mode.

Note: Band Power markers are also available in the I/Q Analyzer, but only for **Spectrum** displays (see "Display Config" on page 284).

For more information see [chapter 4.2.3.8, "Performing Band Power Measurements"](#), on page 140.

Select Marker (No) ← Band Power

Opens a submenu to select one of 16 markers and define whether the marker is a normal or a delta marker (see "[Marker 1 / Marker 2 / Marker 3 / ... Marker 16, / Marker Norm/Delta](#)" on page 120). "(No)" indicates the number of the currently active marker.

See "[Marker 1 / Marker 2 / Marker 3 / ... Marker 16, / Marker Norm/Delta](#)" on page 120.

Band Power On/Off ← Band Power

Activates or deactivates the band power marker. When switched to on, if no marker is active yet, marker 1 is activated. Otherwise, the currently active marker is used as a band power marker (all other marker functions for this marker are deactivated). All markers can be defined as band power markers, each with a different span.

Remote command:

`CALCulate<n>:MARKer<m>:FUNCTION:BPOWER[:STATe]` on page 624

Span ← Band Power

Defines the span (band) around the marker for which the power is measured. The span is indicated by lines in the diagram.

Remote command:

`CALCulate<n>:MARKer<m>:FUNCTION:BPOWER:SPAN` on page 624

Power ← Band Power

Selects the power mode for the band power marker, i.e. the result is displayed in dBm.

Remote command:

`CALCulate<n>:MARKer<m>:FUNCTION:BPOWER:MODE` on page 623

`CALCulate<n>:MARKer<m>:FUNCTION:BPOWER:RESult?` on page 624

Density ← Band Power

Selects the density mode for the band power marker, i.e. the result is displayed in dBm/Hz.

Remote command:

`CALCulate<n>:MARKer<m>:FUNCTION:BPOWER:MODE` on page 623

`CALCulate<n>:MARKer<m>:FUNCTION:BPOWER:RESult?` on page 624

4.2.3.2 Setting a Fixed Reference Point (Phase Noise Measurement)

1. Press the **Phase Noise** softkey.
The submenu with the **Phase Noise On/Off** softkey switched on is displayed. The level and frequency or time values of marker 1 immediately become the reference point.
2. Setting the maximum of the selected trace as reference point, press the **Peak Search** softkey.
3. To define the values for the reference point, proceed as follows:
 - a) Press the **Ref Fixed** softkey.
 - b) Press the **Ref Point Level** softkey and enter a reference level value.
 - c) If span > 0, press the **Ref Point Frequency (span > 0)/Ref Point Time (zero span)** softkey and enter a frequency reference value.
 - d) If span = 0, press the "Ref Point Time" softkey and enter a reference time value (see "**Ref Point Frequency (span > 0)/Ref Point Time (zero span)**" on page 130).

4.2.3.3 Setting the Demodulation Mode and Duration

1. Press the **Marker Demod** softkey.
The submenu with the **Mkr Demod On/Off** softkey switched on is displayed.
2. To change the demodulation mode, press the **AM** or **FM** softkey.
3. For details see [chapter 4.2.3.4, "AF Demodulation"](#), on page 137.
4. To modify the demodulation time for span > 0, press the **Mkr Stop Time** softkey.
5. To change to continuous demodulation for span > 0, press the **Continuous Demod (span > 0)** softkey.

4.2.3.4 AF Demodulation

The R&S FSVR provides demodulators for AM and FM signals. With these demodulators, a displayed signal can be identified acoustically by using headphones.

CAUTION**Risk of hearing damage**

To protect your hearing, make sure that the volume setting is not too high before putting on the headphones.

The volume for the headphones is controlled using the rotary knob next to the "AF Output" interface on the front panel of the instrument.

For span > 0, the demodulation is not continuous. The frequency at which the demodulation takes place is determined by the active marker. The demodulation bandwidth corresponds to the RBW. If the level of the selected frequency is above the threshold line, the sweep stops for the selected time (stop time) and the RF signal is demodulated. For span = 0, the demodulation is continuously active irrespective of the stop time set.

4.2.3.5 Frequency Measurement with the Frequency Counter

In order to accurately determine the frequency of a signal, the R&S FSVR is equipped with a frequency counter which measures the frequency of the RF signal at the intermediate frequency. Using the measured IF, the R&S FSVR calculates the frequency of the RF input signal by applying the known frequency conversion factors.

The frequency measurement uncertainty depends only upon the accuracy of the frequency reference used (external or internal reference). Although the R&S FSVR always operates synchronously irrespective of the set span, the frequency counter delivers a more exact result than a measurement performed with a marker. This is due to the following:

- The marker measures only the position of the point on the trace and infers from this value the signal frequency. The trace, however, contains only a limited number of points. Depending upon the selected span, each point may contain many measurement values, which therefore limits the frequency resolution.
- The resolution with which the frequency can be measured with a marker is dependent on the selected resolution bandwidth, which in return affects the necessary measurement time. For this reason, the bandwidth is normally defined as wide as possible and the sweep time as short as possible. This results in a loss of frequency resolution. For the measurement with the frequency counter, the sweep is stopped at the reference marker, the frequency is counted with the desired resolution and then the sweep is allowed to continue.

In IQ Analyzer mode (see [chapter 4.4, "Instrument Functions - I/Q Analyzer"](#), on page 277), the resolution with which the frequency can be measured with a marker is always the filter bandwidth, which is derived from the defined sample rate.

4.2.3.6 Measurement of Noise Density

During noise measurement, the noise power density is measured at the position of the marker. For span = 0, all points of the trace are used to determine the noise power density. For span > 0, two points to the right and left of the marker are used for the measurement to obtain a stable result.

The noise power density is indicated in the marker field. With logarithmic amplitude units (dBm, dBmV, dBm μ V, dB μ A), the noise power density is output in dBm/Hz, i.e. as level in 1 Hz bandwidth with reference to 1 mW. With linear amplitude units (V, A, W), the noise voltage density is evaluated in μ V/Hz, the noise current density in μ A/Hz or the noise power density in μ W/Hz.

In the default setting, the R&S FSVR uses the sample detector for the noise function.

With the sample detector, the trace can additionally be set to AVERAGE to stabilize the measured values. With RMS detector used, trace averaging must not be used since in this case it produces too low noise levels which cannot be corrected. Instead, the sweep time can be increased to obtain stable measurement results.

Prerequisite settings

The following settings have to be made to ensure that the power density measurement yields correct values:

- Detector: Sample or RMS
- Video bandwidth:
 - ≤ 0.1 resolution bandwidth with sample detector
 - ≥ 3 x resolution bandwidth with RMS detector
- Trace averaging:

With the sample detector, the trace can additionally be set to average to stabilize the measured values. With RMS detector used, trace averaging must not be used since in this case it produces too low noise levels which cannot be corrected. Instead, the sweep time can be increased to obtain stable measurement results.

Correction factors

The R&S FSVR uses the following correction factors to evaluate the noise density from the marker level:

- Since the noise power is indicated with reference to 1 Hz bandwidth, the bandwidth correction value is deducted from the marker level. It is $10 \times \lg(1 \text{ Hz}/\text{BW}_{\text{Noise}})$, where BW_{Noise} is the noise or power bandwidth of the set resolution filter (RBW).
- RMS detector: With the exception of bandwidth correction, no further corrections are required since this detector already indicates the power with every point of the trace.
- Sample detector: As a result of video filter averaging and trace averaging, 1.05 dB is added to the marker level. This is the difference between the average value and the RMS value of white noise. With a logarithmic level axis, 1.45 dB is added additionally. Logarithmic averaging is thus fully taken into account which yields a value that is 1.45 dB lower than that of linear averaging.
- To allow a more stable noise display the adjacent (symmetric to the measurement frequency) points of the trace are averaged.
- For span > 0, the measured values are averaged versus time (after a sweep).



The R&S FSVR noise figure can be calculated from the measured power density level. It is calculated by deducting the set RF attenuation (RF Att) from the displayed noise level and adding 174 to the result.

4.2.3.7 Measurement example for Phase Noise Auto Peak Search

The phase noise of a CW signal at 100 MHz with 0 dBm level is to be measured at 800 kHz from the carrier.

1. PRESET
The R&S FSP is set to the default setting.
2. *FREQ > "CENTER": 100 MHz*
The center frequency is set to 100 MHz.
3. *SPAN: 2 MHz*
The span is set to 2 MHz.
4. *AMPT: 0 dBm*
The reference level is set to 0 dBm.
5. *MKR FCTN > "MARKER 1"*
Marker 1 is switched on and positioned at the maximum of the displayed trace.
6. *"PHASE NOISE": 800 kHz*
The phase noise measurement is switched on. The delta marker is positioned on the main marker and the measured phase noise value is displayed in the marker info field. The sample detector is used and the video bandwidth is set to $3 \times \text{RBW}$. When the phase noise measurement function is enabled, the entry of the delta marker frequency is activated. It can be entered directly.

4.2.3.8 Performing Band Power Measurements

Band power markers allow you to measure the integrated power (similar to ACP measurements) for a defined span (band) around a marker. By default, 5 % of the current span is used. The span is indicated by colored lines in the diagram. The result can be displayed either as a power (dBm) or density (dBm/Hz).



Band power markers are only available for standard frequency measurements in Spectrum mode (not zero span, I/Q Analyzer etc.).

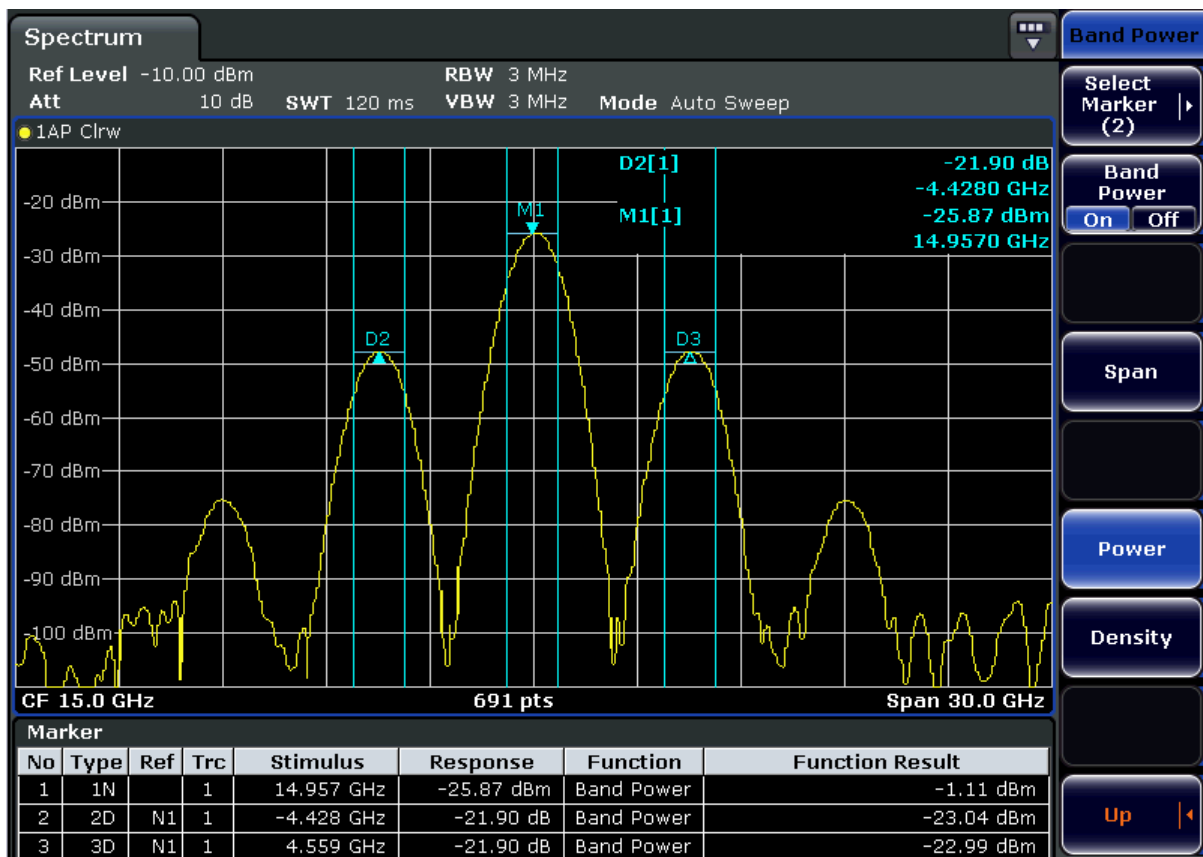

All markers can be defined as band power markers, each with a different span. When a band power marker is activated, if no marker is active yet, marker 1 is activated. Otherwise, the currently active marker is used as a band power marker (all other marker functions for this marker are deactivated).

If the detector mode for the marker trace is set to "AutoSelect", the RMS detector is used.

1. In the MKR FUNC menu, press "Band Power".
2. In the "Band Power" menu, press "Span" and enter the width of the band around the marker for which the power is to be measured.
3. To display the measurement result in dBm/Hz, press "Density". By default, the result is displayed as a power in dBm.
4. Press "Band Power On" to activate the band power marker.

The measurement results are displayed as usual in the marker table or in the diagram.

4.2.4 Changing Settings via Markers – MKR-> Key

The MKR -> key is used for search functions of measurement markers, assignment of the marker frequency as center frequency, restriction of the search area and character-

ization of maxima and minima. For details on markers in general, see [chapter 4.2.1, "Using Markers and Delta Markers – MKR Key"](#), on page 119.

To open the Marker To menu

- Press the MKR -> key.
The "Marker To" menu is displayed. If no marker is active, marker 1 will be activated and a peak search on the trace carried out. Otherwise, the edit dialog box for the last activated marker is opened and the current frequency/time value is displayed.

Menu and softkey description

- [chapter 4.2.4.1, "Softkeys of the Marker To Menu"](#), on page 142 Menu"

Further information

- [chapter 4.2.4.8, "Effect of Different Peak Excursion Settings \(Example\)"](#), on page 150

Tasks

- [chapter 4.2.4.2, "Searching for a Maximum"](#), on page 148
- [chapter 4.2.4.3, "Searching for a Minimum"](#), on page 148
- [chapter 4.2.4.4, "Specifying the Search Limits"](#), on page 149
- [chapter 4.2.4.5, "Specifying the Search Range"](#), on page 149
- [chapter 4.2.4.6, "Examining a Signal at the Center in Detail"](#), on page 149
- [chapter 4.2.4.7, "Specifying the Suitable Peak Excursion"](#), on page 149

4.2.4.1 Softkeys of the Marker To Menu

The following table shows all softkeys available in the "Marker To" menu. It is possible that your instrument configuration does not provide all softkeys. If a softkey is only available with a special option, model or (measurement) mode, this information is provided in the corresponding softkey description.

Select Marker (No).....	143
Peak.....	143
Next Peak.....	143
Center =Mkr Freq (span > 0).....	143
Ref Lvl =Mkr Lvl.....	143
Marker to Trace.....	143
Min.....	144
Next Min.....	144
Auto Max Peak/Auto Min Peak.....	144
Search Limits.....	144
L Left Limit.....	144
L Right Limit.....	144
L Threshold.....	145
L Use Zoom Limits.....	145

L Search Lim Off.....	145
Next Mode.....	145
Exclude LO.....	146
Search Mode (Spectrograms).....	146
L Search Mode for Next Peak in X Direction.....	146
L Search Mode for Next Peak in Y Direction.....	147
L Marker Search Type.....	147
L Marker Search Area.....	148
Peak Excursion.....	148

Select Marker (No)

Opens a submenu to select one of 16 markers and define whether the marker is a normal or a delta marker (see "[Marker 1 / Marker 2 / Marker 3 / ... Marker 16 / Marker Norm/Delta](#)" on page 120). "(No)" indicates the number of the currently active marker.

Peak

Sets the active marker/delta marker to the highest maximum of the trace.

Remote command:

[CALCulate<n>:MARKer<m>:MAXimum\[:PEAK\]](#) on page 611

[CALCulate<n>:DELTAmarker<m>:MAXimum\[:PEAK\]](#) on page 564

Next Peak

Sets the active marker/delta marker to the next maximum of the selected trace.

Remote command:

[CALCulate<n>:MARKer<m>:MAXimum:NEXT](#) on page 612

[CALCulate<n>:DELTAmarker<m>:MAXimum:NEXT](#) on page 564

Center =Mkr Freq (span > 0)

Sets the center frequency to the current marker or delta marker frequency. A signal can thus be set to as center frequency, for example to examine it in detail with a smaller span.

Remote command:

[CALCulate<n>:MARKer<m>:FUNCTION:CENTer](#) on page 625

Ref Lvl =Mkr Lvl

Sets the reference level to the current marker level.

Remote command:

[CALCulate<n>:MARKer<m>:FUNCTION:REFerence](#) on page 638

Marker to Trace

Opens an edit dialog box to enter the number of the trace on which the marker is to be placed.

Remote command:

[CALCulate<n>:MARKer<m>:TRACe](#) on page 617

[CALCulate<n>:DELTAmarker<m>:TRACe](#) on page 567

Min

Sets the active marker/delta marker to the minimum of the selected trace.

Remote command:

`CALCulate<n>:MARKer<m>:MINimum[:PEAK]` on page 613

`CALCulate<n>:DELTAmarker<m>:MINimum[:PEAK]` on page 565

Next Min

Sets the active marker/delta marker to the next minimum of the selected trace.

Remote command:

`CALCulate<n>:MARKer<m>:MINimum:NEXT` on page 615

`CALCulate<n>:DELTAmarker<m>:MINimum:NEXT` on page 567

Auto Max Peak/Auto Min Peak

Adds an automatic peak search action for marker 1 at the end of each particular sweep. This function may be used during adjustments of a device under test to keep track of the current peak marker position and level.

The current marker search limit settings ([Left Limit](#), [Right Limit](#), [Threshold](#) softkeys) are taken into account.

Remote command:

`CALCulate<n>:MARKer<m>:MAXimum:AUTO` on page 611

`CALCulate<n>:MARKer<m>:MINimum:AUTO` on page 614

Search Limits

Opens a submenu to set the limits for maximum or minimum search in the x and y direction.

Remote command:

`CALCulate<n>:MARKer<m>:X:SLIMits[:STATE]` on page 618

Left Limit ← Search Limits

Opens an edit dialog box to enter a value for the lower limit (left vertical line: S1 for span > 0; T1 for zero span). The search is performed between the lines of the left and right limit (see also [Right Limit](#) softkey).

Remote command:

`CALCulate<n>:MARKer<m>:X:SLIMits:LEFT` on page 618

Right Limit ← Search Limits

Opens an edit dialog box to enter a value for the upper limit (left vertical line: S2 for span > 0; T2 for zero span). The search is performed between the lines of the left and right limit (see also [Left Limit](#) softkey). If no value is set, the upper limit corresponds to the stop frequency.

Remote command:

`CALCulate<n>:MARKer<m>:X:SLIMits:RIGHT` on page 619

Threshold ← Search Limits

Opens an edit dialog box to define the threshold line. The threshold line represents the lower level limit for a "Peak" search and the upper level limit for a "Min" search.

Remote command:

`CALCulate<n>:THReshold:STATe` on page 703

`CALCulate<n>:THReshold` on page 702

Use Zoom Limits ← Search Limits

Restricts the marker search to the zoomed area.

Remote command:

`CALCulate<n>:MARKer<m>:X:SLIMits:ZOOM` on page 620

Search Lim Off ← Search Limits

Deactivates all limits of the search range.

Remote command:

`CALCulate<n>:MARKer<m>:X:SLIMits[:STATe]` on page 618

`CALCulate<n>:THReshold:STATe` on page 703

Next Mode

Selects the mode of the [Next Peak](#) or [Next Min](#) softkey.

Three settings are available:

- | | |
|-------|---|
| "<" | Sets the active marker/delta marker to the next maximum/minimum left to the marker of the selected trace. |
| "abs" | Sets the active marker/delta marker to the next lower maximum/higher minimum of the selected trace. |

">" Sets the active marker/delta marker to the next maximum/minimum right to the marker of the selected trace.

Remote command:

Next Peak:

CALC:MARK:MAX:LEFT (<): [CALCulate<n>:MARKer<m>:MAXimum:LEFT](#)
on page 612

[CALCulate<n>:DELTamarker<m>:MAXimum:LEFT](#) on page 564

CALC:MARK:MAX:RIGH (>): [CALCulate<n>:MARKer<m>:MAXimum:RIGHT](#)
on page 613

[CALCulate<n>:DELTamarker<m>:MAXimum:RIGHT](#) on page 565

CALC:DELT:MAX:NEXT (abs): [CALCulate<n>:MARKer<m>:MAXimum:NEXT](#)
on page 612

[CALCulate<n>:DELTamarker<m>:MAXimum:NEXT](#) on page 564

Next Min:

CALC:MARK:MIN:LEFT (>): [CALCulate<n>:MARKer<m>:MINimum:LEFT](#)
on page 614

[CALCulate<n>:DELTamarker<m>:MINimum:LEFT](#) on page 566

CALC:MARK:MIN:RIGH (>): [CALCulate<n>:MARKer<m>:MINimum:RIGHT](#)
on page 615

[CALCulate<n>:DELTamarker<m>:MINimum:RIGHT](#) on page 566

CALC:MARK:MIN:NEXT (abs): [CALCulate<n>:MARKer<m>:MINimum:NEXT](#)
on page 615

[CALCulate<n>:DELTamarker<m>:MINimum:NEXT](#) on page 567

Exclude LO

Switches the frequency range limit for the marker search functions on or off.

"ON" The minimum frequency included in the peak search range is $\geq 5 \times$ resolution bandwidth (RBW).
Due to the interference by the first local oscillator to the first intermediate frequency at the input mixer, the LO is represented as a signal at 0 Hz. To avoid the peak marker jumping to the LO signal at 0 Hz, this frequency is excluded from the peak search.

"OFF" No restriction to the search range. The frequency 0 Hz is included in the marker search functions.

Remote command:

[CALCulate<n>:MARKer<m>:LOEXclude](#) on page 610

Search Mode (Spectrograms)

Spectrograms show not only the current sweep results, but also the sweep history. Thus, when searching for peaks, you must define the search settings within a single time frame (x-direction) and within several time frames (y-direction).

This setting is only available for spectrogram displays.

Search Mode for Next Peak in X Direction ← Search Mode (Spectrograms)

Selects the search mode for the next peak search within the currently selected frame.

"Left" Determines the next maximum/minimum to the left of the current peak.

- "Absolute" Determines the next maximum/minimum to either side of the current peak.
- "Right" Determines the next maximum/minimum to the right of the current peak.

Remote command:

[CALCulate<n>:MARKer<m>:MAXimum:LEFT](#) on page 612

[CALCulate<n>:MARKer<m>:MAXimum:NEXT](#) on page 612

[CALCulate<n>:MARKer<m>:MAXimum:RIGHT](#) on page 613

[CALCulate<n>:MARKer<m>:MINimum:LEFT](#) on page 614

[CALCulate<n>:MARKer<m>:MINimum:NEXT](#) on page 615

[CALCulate<n>:MARKer<m>:MINimum:RIGHT](#) on page 615

Search Mode for Next Peak in Y Direction ← Search Mode (Spectrograms)

Selects the search mode for the next peak search within all frames at the current marker position.

- "Up" Determines the next maximum/minimum above the current peak (in more recent frames).
- "Absolute" Determines the next maximum/minimum above or below the current peak (in all frames).
- "Down" Determines the next maximum/minimum below the current peak (in older frames).

Remote command:

[CALCulate<n>:MARKer<m>:SGRam:Y:MAXimum:ABOVE](#) on page 659

[CALCulate<n>:DELTAmarker<m>:SGRam:Y:MAXimum:ABOVE](#) on page 573

[CALCulate<n>:MARKer<m>:SGRam:Y:MAXimum:BELOW](#) on page 659

[CALCulate<n>:DELTAmarker<m>:SGRam:Y:MAXimum:BELOW](#) on page 574

[CALCulate<n>:MARKer<m>:SGRam:Y:MAXimum:NEXT](#) on page 660

[CALCulate<n>:DELTAmarker<m>:SGRam:Y:MAXimum:NEXT](#) on page 574

[CALCulate<n>:MARKer<m>:SGRam:Y:MINimum:ABOVE](#) on page 660

[CALCulate<n>:DELTAmarker<m>:SGRam:Y:MINimum:ABOVE](#) on page 575

[CALCulate<n>:MARKer<m>:SGRam:Y:MINimum:BELOW](#) on page 661

[CALCulate<n>:DELTAmarker<m>:SGRam:Y:MINimum:BELOW](#) on page 576

[CALCulate<n>:MARKer<m>:SGRam:Y:MINimum:NEXT](#) on page 661

[CALCulate<n>:DELTAmarker<m>:SGRam:Y:MINimum:NEXT](#) on page 576

Marker Search Type ← Search Mode (Spectrograms)

Defines the type of search to be performed in the spectrogram.

- "X-Search" Searches only within the currently selected frame.
- "Y-Search" Searches within all frames but only at the current marker position.

"XY-Search" Searches in all frames at all positions.

Remote command:

[CALCulate<n>:MARKer<m>:SGRam:XY:MAXimum\[:PEAK\]](#) on page 658

[CALCulate<n>:DELTamarker<m>:SGRam:XY:MAXimum\[:PEAK\]](#) on page 572

[CALCulate<n>:MARKer<m>:SGRam:XY:MINimum\[:PEAK\]](#) on page 658

[CALCulate<n>:DELTamarker<m>:SGRam:XY:MINimum\[:PEAK\]](#) on page 573

[CALCulate<n>:MARKer<m>:SGRam:Y:MAXimum\[:PEAK\]](#) on page 660

[CALCulate<n>:DELTamarker<m>:SGRam:Y:MAXimum\[:PEAK\]](#) on page 575

[CALCulate<n>:MARKer<m>:SGRam:Y:MINimum\[:PEAK\]](#) on page 662

[CALCulate<n>:DELTamarker<m>:SGRam:Y:MINimum\[:PEAK\]](#) on page 577

[CALCulate<n>:MARKer<m>:MAXimum\[:PEAK\]](#) on page 611

[CALCulate<n>:DELTamarker<m>:MAXimum\[:PEAK\]](#) on page 564

[CALCulate<n>:MARKer<m>:MINimum\[:PEAK\]](#) on page 613

[CALCulate<n>:DELTamarker<m>:MINimum\[:PEAK\]](#) on page 565

Marker Search Area ← Search Mode (Spectrograms)

Defines which frames the search is performed in.

"Visible" Only the visible frames are searched.

"Memory" All frames stored in the memory are searched.

Remote command:

[CALCulate<n>:MARKer<m>:SGRam:SARea](#) on page 657

[CALCulate<n>:DELTamarker<m>:SGRam:SARea](#) on page 572

Peak Excursion

Opens an edit dialog box for level measurements to enter the minimum level value by which a signal must rise or fall so that it will be identified as a maximum or a minimum by the search functions. Entries from 0 dB to 80 dB are allowed; the resolution is 0.1 dB. The default setting for the peak excursion is 6 dB.

For more information see "Specifying the suitable peak excursion" and "Effect of different peak excursion settings".

Remote command:

[CALCulate<n>:MARKer<m>:PEXCursion](#) on page 616

4.2.4.2 Searching for a Maximum

- To search for the highest maximum, press the **Peak** softkey.
- To define the search mode for the next maximum, use the **Next Mode** softkey.
- To start the search, press the **Next Peak** softkey.



You can define an automatic peak search action for marker 1 at the end of each particular sweep using the **Auto Max Peak/Auto Min Peak** softkey.

4.2.4.3 Searching for a Minimum

- To search for the minimum, press the **Min** softkey.

- To define the search mode for the next minimum, use the **Next Mode** softkey.
- To start the search, press the **Next Min** softkey.



You can define an automatic peak search action for marker 1 at the end of each particular sweep using the **Auto Max Peak/Auto Min Peak** softkey.

4.2.4.4 Specifying the Search Limits

- To define the lower limit, press the **Left Limit** softkey.
- To define the upper limit, press the **Right Limit** softkey.
- To define the threshold, press the **Threshold** softkey.
- To switch the search limits off, press the **Search Lim Off** softkey.

4.2.4.5 Specifying the Search Range

- Press the **Exclude LO** softkey to deactivate the "Exclude LO" mode in order to include the frequency down to 0 Hz in the marker search functions.

4.2.4.6 Examining a Signal at the Center in Detail

1. Press the PRESET key to set the R&S FSVR to the default setting.
2. Press the MKR -> key to open the "Marker To" menu.
3. Marker 1 is activated and set to the largest signal of the trace.
4. Press the **Center =Mkr Freq (span > 0)** softkey to set to the marker frequency.
5. The span is adapted in such a way that the minimum frequency (= 0 Hz) or the maximum frequency is not exceeded.
6. Press the **Ref Lvl =Mkr Lvl** softkey to set the reference level to the measured marker level.
7. Press the SPAN key.
8. The edit dialog box to enter a frequency span is displayed.
9. Reduce the span, e.g. using the rotary knob.

4.2.4.7 Specifying the Suitable Peak Excursion

1. If the **Peak Excursion** softkey is used, the default value is sufficient, since, in this mode, the next lower maximum or next higher minimum will always be detected.
2. If the < or > of the softkey **Next Mode** is used, the 6 dB level change set as a default value may already be attained by the inherent noise of the instrument. To

avoid identifying noise peaks as maxima or minima, enter a peak excursion value that is higher than the difference between the highest and the lowest value measured for the displayed inherent noise.

4.2.4.8 Effect of Different Peak Excursion Settings (Example)

The following figure shows a trace to be examined.

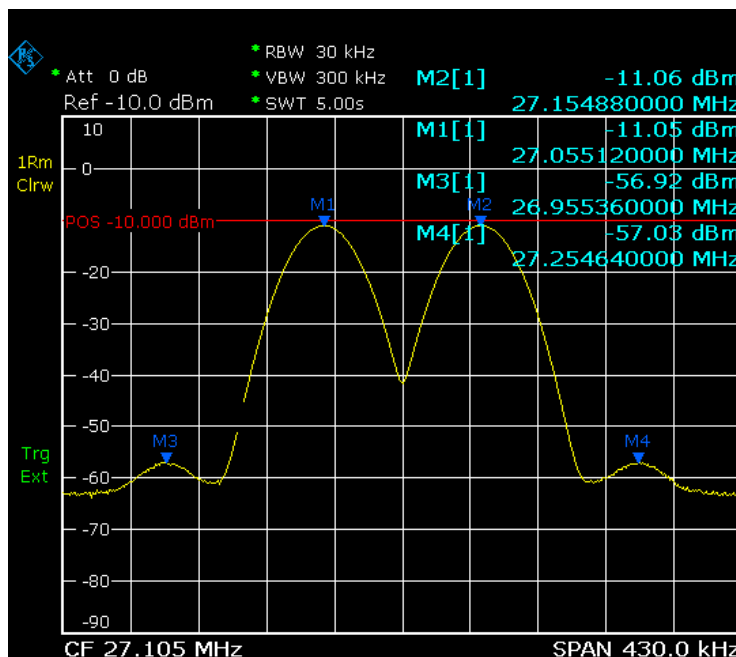

Fig. 4-9: Trace example

The following table lists the signals as indicated by the marker numbers in the diagram above, as well as the minimum of the amplitude decrease to both sides of the signal:

Signal #	Min. amplitude decrease to both sides of the signal
1	30 dB
2	29.85 dB
3	7 dB
4	7 dB

The detected signals and their order are different depending on the peak excursion setting and the peak search method (whether the next lower maximum or the next relative maximum is searched). The following results are obtained. All tests start with the marker set to signal 1 by pressing the **Peak** softkey.

- 40 dB peak excursion
Result: With both methods apart from signal 1 no signal is detected, as the signal level does not decrease by more than 30 dB to either side of any signal.

Next lower maximum	Next relative maximum
Next Mode abs: signal 1 (no further signal detected)	Next Mode <: signal 1 (no further signal detected)
	Next Mode >: signal 1 (no further signal detected)

- 20 dB peak excursion
Result: With both methods apart from signal 1 signal 2 is detected, as the signal level decreases at least by 29.85 dB to either side of this signal, which is now greater than the peak excursion.

Next lower maximum	Next relative maximum
Next Mode abs: signal 2	Next Mode <: signal 1 (no further signal detected)
Next Mode abs: signal 2 (no further signal detected)	Next Mode >: signal 2
	Next Mode >: signal 2 (no further signal detected)

- 6 dB peak excursion
Result: With both methods all signals are detected.

Next lower maximum	Next relative maximum
Next Mode abs: signal 2	Next Mode <: signal 3
Next Mode abs: signal 3	Next Mode >: signal 1
Next Mode abs: signal 4	Next Mode >: signal 2
	Next Mode >: signal 4

4.2.5 Power Measurements – MEAS Key

With its power measurement functions, the R&S FSVR is able to measure all the necessary parameters with high accuracy in a wide dynamic range.

A modulated carrier is almost always used (except e.g. SSB-AM) for high-frequency transmission of information. Due to the information modulated upon the carrier, the latter covers a spectrum which is defined by the modulation, the transmission data rate and the signal filtering. Within a transmission band each carrier is assigned a channel taking into account these parameters. In order to ensure error-free transmission, each transmitter must be conforming to the specified parameters. These include among others:

- the output power
- the occupied bandwidth, i.e. the bandwidth which must contain a defined percentage of the power

- the power dissipation allowed in the adjacent channels

The MEAS key is used for complex measurement functions as power measurements, occupied bandwidth, signal statistic, carrier to noise spacing, AM modulation depth, third-order intercept point, harmonics and spurious emissions. For measurement examples refer to the Quick Start Guide, "Basic Measurement Examples".

The following measurements can be performed:

- Channel power and adjacent-channel power with span > 0 and with a single or several carriers ("CH Power ACLR" softkey, for details see [chapter 4.2.5.2, "Measuring Channel Power and Adjacent-Channel Power"](#), on page 155)
- Carrier-to-noise ratio ("C/N C/NO" softkey, for details see [chapter 4.2.5.3, "Measuring the Carrier-to-Noise Ratio"](#), on page 179)
- Occupied bandwidth ("OBW" softkey, for details see [chapter 4.2.5.4, "Measuring the Occupied Bandwidth"](#), on page 182)
- Spectrum Emission Mask measurements ("Spectrum Emission Mask" softkey, for details see [chapter 4.2.5.5, "Measuring with Spectrum Emission Masks"](#), on page 186)
- Spurious Emissions measurements ("Spurious Emissions" softkey, for details see [chapter 4.2.5.6, "Measuring Spurious Emissions"](#), on page 213)
- Power in zero span ("Time Domain Power" softkey, for details see [chapter 4.2.5.7, "Measuring the Power in Zero Span"](#), on page 224).
- Amplitude probability distribution ("APD" and "CCDF" softkeys, for details see [chapter 4.2.5.8, "Calculating Signal Amplitude Statistics"](#), on page 227)
- 3rd order intercept ("TOI" softkey, for details see [chapter 4.2.5.9, "Measuring the Third Order Intercept Point \(TOI\)"](#), on page 245)
- Modulation depth ("AM Mod Depth" softkey, for details see [chapter 4.2.5.10, "Measuring the AM Modulation Depth"](#), on page 251)
- Harmonic Distortion measurements ("Harmonic Distortion" softkey, for details see [chapter 4.2.5.11, "Measuring Harmonic Distortion"](#), on page 252)

To open the power measurement menu

- Press the MEAS key.
The measurement menu for spectrum analysis is displayed (see [chapter 4.2.5.1, "Softkeys of the Power Measurement Menu"](#), on page 152).

4.2.5.1 Softkeys of the Power Measurement Menu

The following table shows all softkeys available in the power measurement menu. It is possible that your instrument configuration does not provide all softkeys. If a softkey is only available with a special option, model or (measurement) mode, this information is provided in the corresponding softkey description.

Ch Power ACLR.....	153
C/N, C/No (span > 0).....	153
OBW (span > 0).....	153
Spectrum Emission Mask.....	153

Spurious Emissions.....	153
Time Domain Power (zero span).....	154
All Functions Off.....	154
APD.....	154
CCDF.....	154
TOI.....	154
AM Mod Depth.....	154
Harmonic Distortion.....	155
All Functions Off.....	155

Ch Power ACLR

Activates the active channel or adjacent-channel power measurement either for a single carrier signal or for several carrier signals, depending on the current measurement configuration, and opens a submenu to configure the channel power measurement.

For details see [chapter 4.2.5.2, "Measuring Channel Power and Adjacent-Channel Power"](#), on page 155.

Remote command:

`CALCulate<n>:MARKer<m>:FUNCTION:POWER:SElect` on page 654

`CALCulate<n>:MARKer<m>:FUNCTION:POWER:RESult?` on page 651

`CALCulate<n>:MARKer<m>:FUNCTION:POWER[:STATe]` on page 655

C/N, C/No (span > 0)

Opens a submenu to configure the carrier/noise ratio measurement. Measurements without (C/N) and measurements with reference to the bandwidth (C/No) are possible.

For details see [chapter 4.2.5.3, "Measuring the Carrier-to-Noise Ratio"](#), on page 179.

OBW (span > 0)

Activates measurement of the occupied bandwidth according to the current configuration and opens a submenu to configure the measurement. For details see [chapter 4.2.5.4, "Measuring the Occupied Bandwidth"](#), on page 182.

Remote command:

`CALCulate<n>:MARKer<m>:FUNCTION:POWER:SElect` on page 654

`CALCulate<n>:MARKer<m>:FUNCTION:POWER:RESult?` on page 651

`CALCulate<n>:MARKer<m>:FUNCTION:POWER[:STATe]` on page 655

Spectrum Emission Mask

Opens a submenu to configure the Spectrum Emission Mask measurement.

The Spectrum Emission Mask (SEM) measurement defines a measurement that monitors compliance with a spectral mask.

For details see [chapter 4.2.5.5, "Measuring with Spectrum Emission Masks"](#), on page 186.

Remote command:

`SENS:SWE:MODE ESP`, see `[SENSe:]SWEep:MODE` on page 872

Spurious Emissions

Opens a submenu to configure the Spurious Emissions measurement.

The Spurious Emissions measurement defines a measurement that monitors unwanted RF products outside the assigned frequency band generated by an amplifier.

For details see [chapter 4.2.5.6, "Measuring Spurious Emissions"](#), on page 213.

Remote command:

`SENS:SWE:MODE LIST`, see `[SENSe:]SWEep:MODE` on page 872

Time Domain Power (zero span)

Activates the power measurement in zero span and opens a submenu to configure the power measurement. For details see [chapter 4.2.5.7, "Measuring the Power in Zero Span"](#), on page 224.

Remote command:

`CALCulate<n>:MARKer<m>:FUNCTION:SUMMary[:STATe]` on page 678

All Functions Off

Switches off all power measurement functions.

APD

Activates the function to measure the amplitude probability density (APD) and opens a submenu.

For details see [chapter 4.2.5.8, "Calculating Signal Amplitude Statistics"](#), on page 227.

Remote command:

`CALCulate<n>:STATistics:APD[:STATe]` on page 698

CCDF

Activates the function to measure the complementary cumulative distribution function (CCDF) and opens a submenu.

For details see [chapter 4.2.5.8, "Calculating Signal Amplitude Statistics"](#), on page 227.

Remote command:

`CALCulate<n>:STATistics:CCDF[:STATe]` on page 698

TOI

Opens a submenu and activates the measurement of the 3rd order intercept point.

For details see [chapter 4.2.5.9, "Measuring the Third Order Intercept Point \(TOI\)"](#), on page 245.

Remote command:

`CALCulate<n>:MARKer<m>:FUNCTION:TOI[:STATe]` on page 640

`CALCulate<n>:MARKer<m>:FUNCTION:TOI:RESult?` on page 639

AM Mod Depth

Opens a submenu and activates the measurement of the AM modulation depth. An AM-modulated carrier is required on the screen to ensure correct operation.

For details see [chapter 4.2.5.10, "Measuring the AM Modulation Depth"](#), on page 251.

Remote command:

`CALCulate<n>:MARKer<m>:FUNCTION:MDEPth[:STATe]` on page 632

`CALCulate<n>:MARKer<m>:FUNCTION:MDEPth:RESult?` on page 632

Harmonic Distortion

Opens a submenu to determine the settings for harmonics measurement and activates the harmonic distortion measurement.

For details see [chapter 4.2.5.11, "Measuring Harmonic Distortion"](#), on page 252.

Remote command:

`CALCulate<n>:MARKer<m>:FUNction:HARMonics[:STATe]` on page 649

`CALCulate<n>:MARKer<m>:FUNction:HARMonics:DISToRtion?` on page 647

`CALCulate<n>:MARKer<m>:FUNction:HARMonics:LIST?` on page 647

All Functions Off

Switches off all power measurement functions.

4.2.5.2 Measuring Channel Power and Adjacent-Channel Power

Measuring the power in channels adjacent to the carrier or transmission channel is useful to detect interference. The results are displayed as a bar chart for the individual channels.

- [About Channel Power Measurements](#)..... 155
- [Channel Power Measurement Results](#)..... 159
- [Configuring and Performing Channel Power Measurements](#)..... 161
- [Softkeys for Channel and Adjacent-Channel Power Measurements](#)..... 165
- [Predefined CP/ACLR Standards](#)..... 176
- [Optimized Settings for CP/ACLR Test Parameters](#)..... 177

About Channel Power Measurements

Measuring channel power and adjacent channel power is one of the most important tasks in the field of digital transmission for a signal analyzer with the necessary test routines. While, theoretically, channel power could be measured at highest accuracy with a power meter, its low selectivity means that it is not suitable for measuring adjacent channel power as an absolute value or relative to the transmit channel power. The power in the adjacent channels can only be measured with a selective power meter.

A signal analyzer cannot be classified as a true power meter, because it displays the IF envelope voltage. However, it is calibrated such as to correctly display the power of a pure sine wave signal irrespective of the selected detector. This calibration cannot be applied for non-sinusoidal signals. Assuming that the digitally modulated signal has a Gaussian amplitude distribution, the signal power within the selected resolution bandwidth can be obtained using correction factors. These correction factors are normally used by the signal analyzer's internal power measurement routines in order to determine the signal power from IF envelope measurements. These factors apply if and only if the assumption of a Gaussian amplitude distribution is correct.

Apart from this common method, the R&S FSVR also has a true power detector, i.e. an RMS detector. It correctly displays the power of the test signal within the selected resolution bandwidth irrespective of the amplitude distribution, without additional correction factors being required. The absolute measurement uncertainty of the R&S FSVR is < 1.5 dB and a relative measurement uncertainty of < 0.5 dB (each with a confidence level of 95 %).

Measurement Methods

The channel power is defined as the integration of the power across the channel bandwidth.

The **Adjacent Channel Power Ratio (ACPR)**, also known as the **Adjacent Channel Leakage Power Ratio (ACLR)**, is defined as the ratio between the total power of the adjacent channel to the carrier channel's power. An ACLR measurement with several carrier (transmission) channels (TX channels) is also possible and is referred to as a "multi-carrier ACLR measurement".

There are two possible methods for measuring channel and adjacent channel power with a signal analyzer:

- IBW method (Integration **B**andwidth **M**ethod)
- Zero-span method (Fast ACLR), i.e. using a channel filter
- [IBW method](#)..... 156
- [Fast ACLR](#)..... 157

IBW method

When measuring the channel power, the R&S FSVR integrates the linear power which corresponds to the levels of the pixels within the selected channel. The signal analyzer uses a resolution bandwidth which is far smaller than the channel bandwidth. When sweeping over the channel, the channel filter is formed by the passband characteristics of the resolution bandwidth (see [figure 4-10](#)).

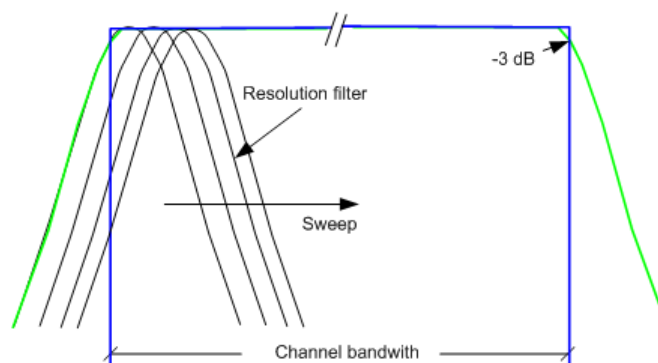

Fig. 4-10: Approximating the channel filter by sweeping with a small resolution bandwidth

The following steps are performed:

1. The linear power of all the trace pixels within the channel is calculated.

$$P_i = 10^{(L_i/10)}$$
 where P_i = power of the trace pixel i
 L_i = displayed level of trace point i
2. The powers of all trace pixels within the channel are summed up and the sum is divided by the number of trace pixels in the channel.
3. The result is multiplied by the quotient of the selected channel bandwidth and the noise bandwidth of the resolution filter (RBW).

Since the power calculation is performed by integrating the trace within the channel bandwidth, this method is called the IBW method (Integration **B**andwidth method).

Fast ACLR

Using Fast ACLR, the R&S FSVR sets the center frequency to the different channel center frequencies consecutively and measures the power with the selected measurement time (= sweep time/number of channels).

The RBW filters suitable for the selected standard and frequency offset are automatically used (e.g. root raised cos with IS 136).

The RMS detector is used for obtaining correct power measurement results. Therefore no software correction factors are required.

Measurement Repeatability

The repeatability of the results, especially in the narrow adjacent channels, strongly depends on the measurement time for a given resolution bandwidth. A longer sweep time may increase the probability that the measured value converges to the true value of the adjacent channel power, but obviously increases measurement time.

The integrated bandwidth method (IBW) calculates channel power and ACLR from the trace data obtained during a continuous sweep over the selected span. Most parts of this sweep are neither part of the channel itself nor the defined adjacent channels. Therefore, most of the samples taken during the sweeptime cannot be used for channel power or ACLR calculation.

To obtain a high repeatability with short measurement times, the R&S FSVR offers a "Fast ACLR" mode. In the Fast ACLR mode, the R&S FSVR measures the power of each channel at the defined channel bandwidth, while being tuned to the center frequency of the channel in question. The digital implementation of the resolution bandwidths makes it possible to select filter characteristics that are precisely tailored to the signal. In case of CDMA2000, the power in the useful channel is measured with a bandwidth of 1.23 MHz and that of the adjacent channels with a bandwidth of 30 kHz. Therefore the R&S FSVR changes from one channel to the other and measures the power at a bandwidth of 1.23 MHz or 30 kHz using the RMS detector. The power of the frequency range between the channels of interest is not measured in Fast ACLR mode, because it is not required for channel power or ACLR calculation. The measurement time per channel is set with the sweep time. It is equal to the selected measurement time divided by the selected number of channels.

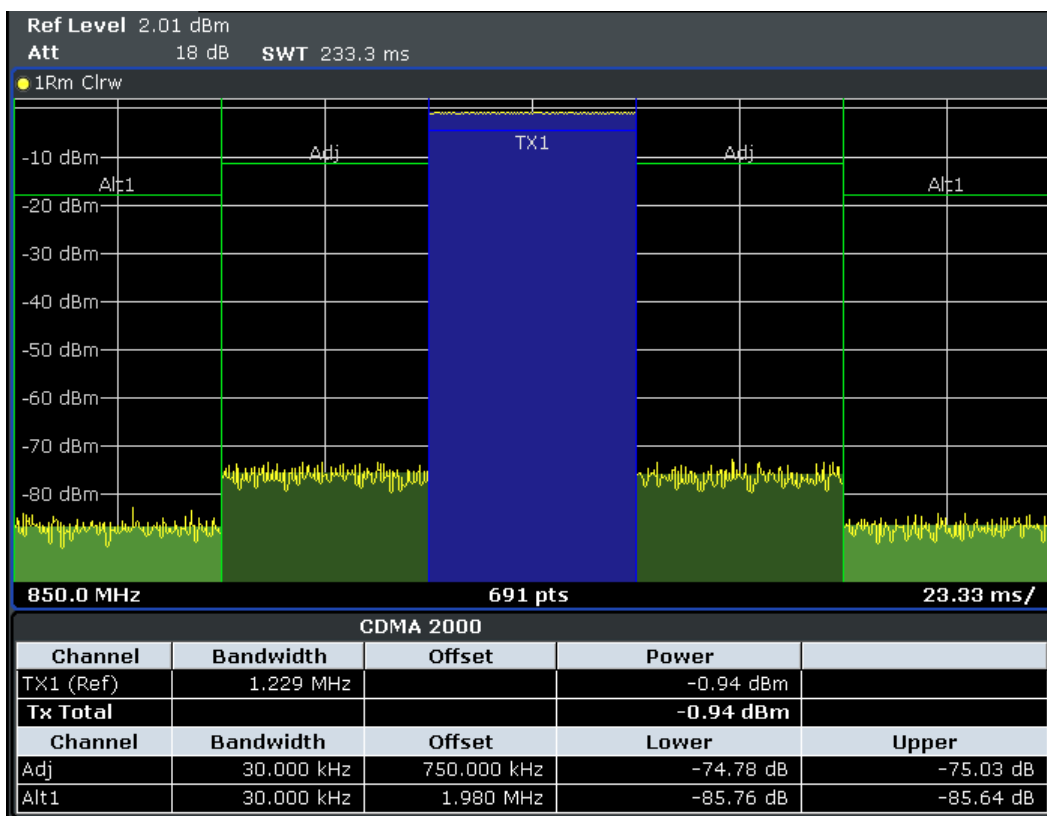

Fig. 4-11: Measuring the channel power and adjacent channel power ratio for CDMA2000 1X signals with zero span (Fast ACP)

Assuming a measurement with five channels (1 channel plus 2 lower and 2 upper adjacent channels) and a sweep time of 100 ms, a measurement time per channel of 20 ms is required. The number of effective samples taken into account for power calculation in one channel is the product of sweeptime in channel times the selected resolution bandwidth.

Assuming a sweeptime of 100 ms, there are $(30 \text{ kHz} / 4.19 \text{ MHz}) * 100 \text{ ms} * 10 \text{ kHz} \approx 7$ samples. Whereas in Fast ACLR mode, there are $(100 \text{ ms} / 5) * 30 \text{ kHz} \approx 600$ samples. Comparing these numbers explains the increase of repeatability with a 95% confidence level (2σ) from $\pm 2.8 \text{ dB}$ to $\pm 0.34 \text{ dB}$ for a sweeptime of 100 ms (as shown in figure 4-12 and).

For the same repeatability, the sweep time would have to be set to 8.5 s with the integration method. The figure 4-13 shows the standard deviation of the results as a function of the sweep time.

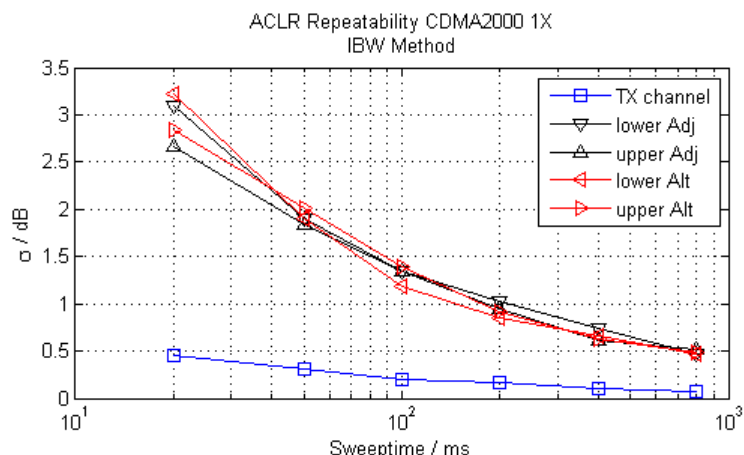

Fig. 4-12: Repeatability of adjacent channel power measurement on CDMA2000 standard signals if the integration bandwidth method is used

The figure 4-13 shows the repeatability of power measurements in the transmit channel and of relative power measurements in the adjacent channels as a function of sweep time. The standard deviation of measurement results is calculated from 100 consecutive measurements. Take scaling into account if comparing power values.

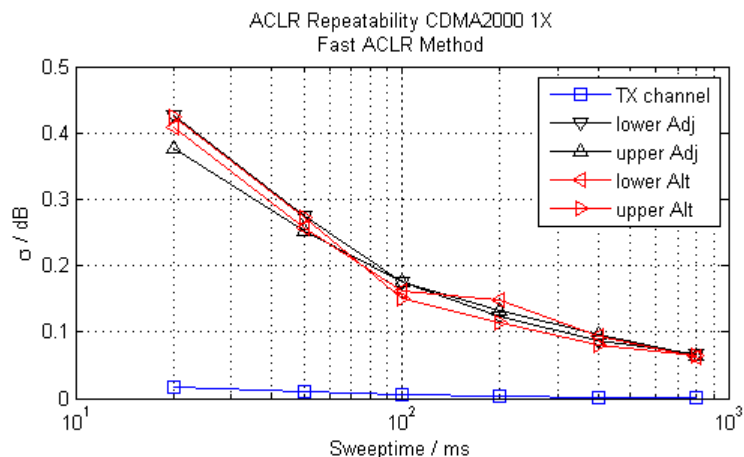
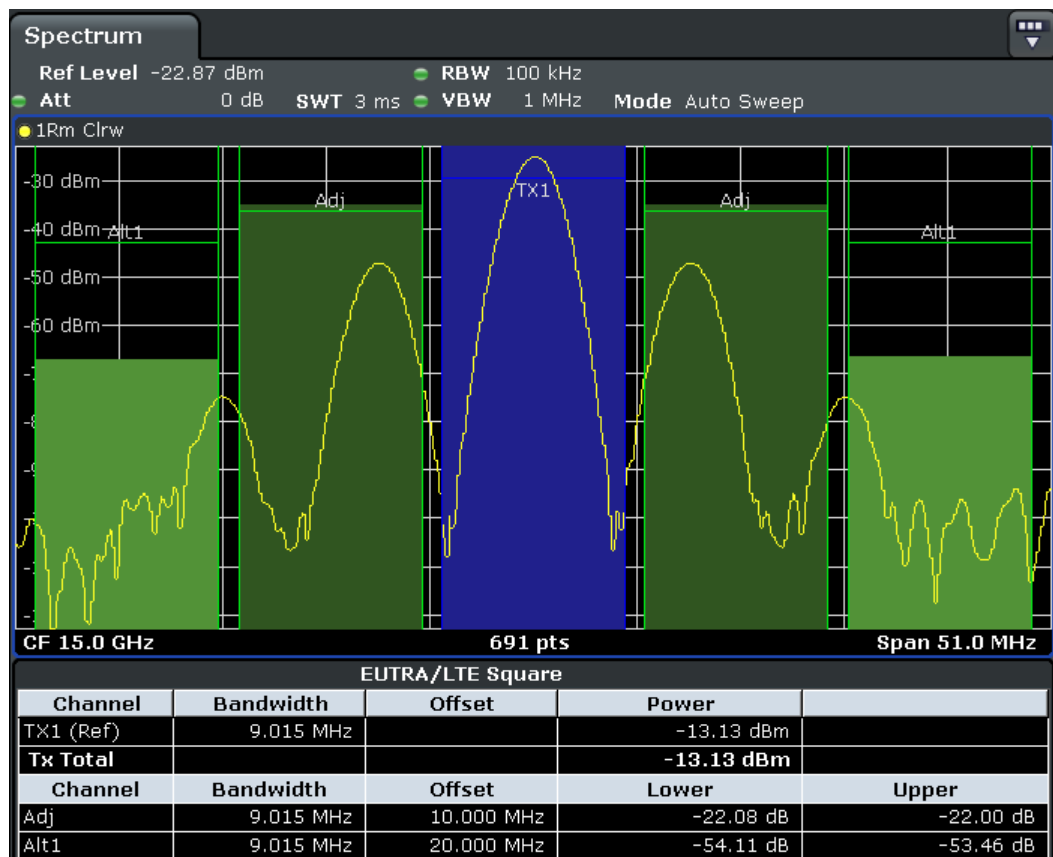

Fig. 4-13: Repeatability of adjacent channel power measurements on CDMA2000 signals in the fast ACP mode

Channel Power Measurement Results

For channel or adjacent-channel power measurements, the individual channels are indicated by different colored bars in the diagram. The height of each bar corresponds to the measured power of that channel. In addition, the name of the channel ("Adj", "Alt1", "TX1", etc. or a user-defined name) is indicated above the bar (separated by a line which has no further meaning).



Results are provided for the TX channel and the number of defined adjacent channels *above and below* the TX channel. If more than one TX channel is defined, the carrier channel to which the relative adjacent-channel power values should be referenced must be defined.

The measured power values for the TX and adjacent channels are also output as a table in the second screen. Which powers are measured depends on the number of configured channels, see "# of Adj Chan" on page 167.

For each channel, the following values are displayed:

Label	Description
Channel	Channel name as specified in the "Channel Settings" (see "Names" on page 170).
Bandwidth	Configured channel bandwidth (see "Bandwidth" on page 168)
Offset	Offset of the channel to the TX channel (Configured channel spacing, see "Spacing" on page 169)
Power (Lower/Upper)	The measured power values for the TX and lower and upper adjacent channels. The powers of the transmission channels are output in dBm or dBm/Hz, or in dBc, relative to the specified reference TX channel.

Retrieving Results via Remote Control

All or specific channel power measurement results can be retrieved using the `CALCulate<n>:MARKer<m>:FUNCTION:POWER:RESult?` command from a remote computer.

Alternatively, the results can be output as channel power density, i.e. in reference to the measurement bandwidth (see `CALCulate<n>:MARKer<m>:FUNCTION:POWER:RESult:PHZ` on page 654).

Furthermore, the measured power values of the displayed trace can be retrieved as usual using the `TRAC:DATA?` commands (see `TRACe<n>[:DATA]?` on page 889). In this case, the measured power value for each sweep point (max. 691) is returned.

Configuring and Performing Channel Power Measurements

Predefined standards contain the main measurement settings for standard measurements. When such a standard is loaded, the required channel settings are automatically set on the R&S FSVR. However, the settings can be changed, and measurements with user-defined configurations are also possible.

Once the channels have been set up, other instrument settings such as the used filter bandwidths, frequency span and detector and trace settings can be optimized automatically (see "Adjust Settings" on page 173).

For an overview of the softkeys and menus see "Softkeys for Channel and Adjacent-Channel Power Measurements" on page 165.

Selecting a Predefined Standard

Predefined standards contain the main measurement settings for standard measurements. When such a standard is loaded, the required channel settings are automatically set on the R&S FSVR.

The selected standard defines the following settings:

- "Bandwidth" on page 168
- "Spacing" on page 169
- Detector, see "Optimized Settings for CP/ACLR Test Parameters" on page 177
- Trace averaging, see "Average Mode" on page 98
- RBW, see "Optimized Settings for CP/ACLR Test Parameters" on page 177
- "Weighting Filter" on page 170

► Select a predefined standard via the `CP/ACLR Standard` softkey.

Setting up the Channels

Channel definition is the basis for measuring power levels in certain frequency ranges. Usually, the power levels in one or more carrier (TX) channels and possibly the adjacent channels are of interest. Up to 18 carrier channels and up to 12 adjacent channels can be defined.



In the R&S FSVR's display, only the first neighboring channel of the carrier (TX) channel is labelled "Adj" (adjacent) channel; all others are labelled "Alt" (alternate) channels. In this manual, "adjacent" refers to both adjacent and alternate channels.

When an ACLR measurement is started by pressing the "Ch Power ACLR" softkey, all settings including the channel bandwidths and channel spacings are set according to the selected standard and can be adjusted afterwards.

Channel setup consists of the following settings:

- The number of transmission (TX) and adjacent channels
- The bandwidth of each channel
- For multi-carrier ACLR measurements: which TX channel is used as a reference ("ACLR Reference")
- The spacing between the individual channels
- Optionally: the names of the channels displayed in the diagram and result table
- Optionally: the influence of individual channels on the total measurement result ("Weighting Filter")
- Optionally: limits for a limit check on the measured power levels



Changes to an existing standard can be stored as a user-defined standard, see "[User-Defined Configurations](#)" on page 164.

- ▶ In the "Ch Power" menu, press [Channel Setup](#), then press the [Channel Setup](#) softkey to configure the channels in the "Channel Setup" dialog box.



In the "Channel Setup" dialog box you define the channel settings for all channels, independent of the defined number of *used* TX or adjacent channels.

- [Defining Channel Bandwidths](#)..... 162
- [Defining Channel Spacings](#)..... 163
- [Configuring a Limit Check](#)..... 164

Defining Channel Bandwidths

The transmission-channel bandwidth is normally defined by the transmission standard. The correct bandwidth is set automatically for the selected standard (see "[Optimized Settings for CP/ACLR Test Parameters](#)" on page 177).

For measurements that require channel bandwidths which deviate from those defined in the selected standard, use the IBW method (see [Fast ACLR \(On/Off\)](#) softkey). With the IBW method, the channel bandwidth borders are right and left of the channel center frequency. Thus, you can visually check whether the entire power of the signal under test is within the selected channel bandwidth.

- ▶ In the "Channel Setup" dialog box, select the "Bandwidth" tab to define the channel bandwidths.

The value entered for any TX channel is automatically also defined for all subsequent TX channels. Thus, only one value needs to be entered if all TX channels have the same bandwidth.

The value entered for any ADJ or ALT channel is automatically also defined for all alternate (ALT) channels. Thus, only one value needs to be entered if all adjacent channels have the same bandwidth.

Defining Channel Spacings

Channel spacings are normally defined by the selected standard but can be changed.

If the spacings are not equal, the channel distribution according to the center frequency is as follows:

Odd number of TX channels	The middle TX channel is centered to center frequency.
Even number of TX channels	The two TX channels in the middle are used to calculate the frequency between those two channels. This frequency is aligned to the center frequency.

- ▶ In the "Channel Setup" dialog box, select the "Spacing" tab to define the channel spacings.
The value entered for any TX channel is automatically also defined for all subsequent TX channels. Thus, only one value needs to be entered if all TX channels have the same spacing.
If the channel spacing for the adjacent or an alternate channel is changed, all higher alternate channel spacings are multiplied by the same factor (new spacing value/old spacing value). The lower adjacent-channel spacings remain unchanged.
Only one value needs to be entered for equal channel spacing.

Example: Defining channel spacing

In the default setting, the adjacent channels have the following spacing: 20 kHz ("ADJ"), 40 kHz ("ALT1"), 60 kHz ("ALT2"), 80 kHz ("ALT3"), 100 kHz ("ALT4"), ...

If the spacing of the first adjacent channel ("ADJ") is set to 40 kHz, the spacing of all other adjacent channels is multiplied by factor 2 to result in 80 kHz ("ALT1"), 120 kHz ("ALT2"), 160 kHz ("ALT3"), ...

If, starting from the default setting, the spacing of the 5th adjacent channel ("ALT4") is set to 150 kHz, the spacing of all higher adjacent channels is multiplied by factor 1.5 to result in 180 kHz ("ALT5"), 210 kHz ("ALT6"), 240 kHz ("ALT7"), ...



For the R&S FSVR, the channel spacing is defined as the distance between the center frequency of the adjacent channel and the center frequency of the transmission channel. The definition of the adjacent-channel spacing in standards IS95C and CDMA 2000 is different. These standards define the adjacent-channel spacing from the center of the transmission channel to the closest border of the adjacent channel. This definition is also used for the R&S FSVR if the standards marked with an asterisk *) are selected.

Configuring a Limit Check

During an ACLR measurement, the power values can be checked whether they exceed user-defined limits. A relative or absolute limit can be defined, or both. Both limit types are considered, regardless whether the measured levels are absolute or relative values. The check of both limit values can be activated independently. If any active limit value is exceeded, the measured value is displayed in red and marked by a preceding asterisk in the result table.

W-CDMA 3GPP FWD				
Channel	Bandwidth	Offset	Power	
TX1 (Ref)	3.840 MHz		-124.39 dBm	
Tx Total			-124.39 dBm	
Channel	Bandwidth	Offset	Lower	Upper
Adj*	3.840 MHz	5.000 MHz	81.17 dB*	81.17 dB*
Alt1*	3.840 MHz	10.000 MHz	0.00 dB*	0.00 dB*

To configure a limit check

1. In the "Channel Setup" dialog box, select the "Limits" tab to define a limit check.
2. For each channel, define a relative or absolute value that should not be exceeded.
3. Select the channels to be included in the limit check by activating the "Check" option.
4. Activate limit checking for the selected channels by setting "Limit Checking" to *On*.

Performing a Channel Power Measurement

A channel power measurement is started automatically according to the currently selected standard when you press the "Ch Power ACLR" softkey in the MEAS menu.

- ▶ To start a new measurement after changing the settings, press the RUN SINGLE or RUN CONT hardkeys.
Alternatively, you can save your settings as a user standard (see "[User-Defined Configurations](#)" on page 164), then select that standard and start the measurement as usual by pressing the "Ch Power ACLR" softkey.

The configured measurement is performed (depending on the number of defined channels, see "[# of Adj Chan](#)" on page 167) and the results are displayed in the graphic and the result table.

User-Defined Configurations

You can define measurement configurations independently of a predefined standard and save the current ACLR configuration as a "user standard" in an xml file. You can then load the file and thus the settings again at a later time.

User-defined standards are not supported for "Fast ACLR" and Multi-Carrier ACLR measurements.



Compatibility to R&S FSP

User standards created on an analyzer of the R&S FSP family are compatible to the R&S FSVR. User standards created on an R&S FSVR, however, are not necessarily compatible to the analyzers of the R&S FSP family and may not work there.

To store a user-defined configuration

1. Select the "User Standard" softkey in the "Ch Power" menu.
2. Press "Save".
3. Define a file name for the user standard and select its storage location.
By default, the xml file is stored in C:\R_S\Instr\acp_std\. However, you can define any other storage location.
4. Press "Save".

The following parameter definitions are saved:

- "# of Adj Chan" on page 167
- Channel spacing and adjacent-channel spacing, see "Spacing" on page 169
- Channel bandwidth of transmission (Tx), adjacent (Adj) and alternate (Alt) channels, see "Bandwidth" on page 168
- Resolution bandwidth, see "Res BW Auto" on page 80
- Video bandwidth, see "Video BW Auto" on page 81
- Detector, see "Detector" on page 96
- ACLR limits and their state, see "Limits" on page 171
- Sweep time and sweep time coupling, see "Sweep Time" on page 173
- Trace and power mode, see "Select Trace" on page 173 and "Power Mode" on page 172

To load a user-defined configuration

- ▶ Press "User Standard > Load" and select the user standard file.

Softkeys for Channel and Adjacent-Channel Power Measurements

Ch Power ACLR.....	166
L CP/ACLR Standard.....	166
L CP/ACLR Settings.....	167
L # of TX Chan.....	167
L # of Adj Chan.....	167
L Channel Setup.....	167
L Bandwidth.....	168
L ACLR Reference.....	169
L Spacing.....	169
L Names.....	170
L Weighting Filter.....	170
L Limits.....	171
L Limit Checking.....	171
L Relative Limit.....	172
L Absolute Limit.....	172

L Check.....	172
L Chan Pwr/Hz.....	172
L Power Mode.....	172
L Clear/Write.....	173
L Max Hold.....	173
L Select Trace.....	173
L ACLR (Abs/Rel).....	173
L Adjust Settings.....	173
L Sweep Time.....	173
L Fast ACLR (On/Off).....	174
L Set CP Reference.....	174
L User Standard.....	174
L Load.....	175
L Save.....	175
L Delete.....	175
L Noise Correction.....	175
L Adjust Ref Lvl.....	176

Ch Power ACLR

Activates the active channel or adjacent-channel power measurement either for a single carrier signal or for several carrier signals, depending on the current measurement configuration, and opens a submenu to configure the channel power measurement. With default settings the measurement is performed by integrating the powers at the display points within the specified channels (IBW method).

If several TX channels (carriers) are activated, the number of measured values is increased to ensure that adjacent-channel powers are measured with adequate accuracy.

For general information on performing channel or adjacent-channel power measurements, see [chapter 4.2.5.2, "Measuring Channel Power and Adjacent-Channel Power"](#), on page 155.

Remote command:

`CALCulate<n>:MARKer<m>:FUNCTION:POWER:SElect` on page 654

`CALCulate<n>:MARKer<m>:FUNCTION:POWER:RESult?` on page 651

`CALCulate<n>:MARKer<m>:FUNCTION:POWER[:STATe]` on page 655

CP/ACLR Standard ← Ch Power ACLR

Opens an edit dialog box to select the settings according to predefined standards. For details on the available standards see ["Predefined CP/ACLR Standards"](#) on page 176. By default no standard is set.

The selection of the standard influences the following parameters (see ["Optimized Settings for CP/ACLR Test Parameters"](#) on page 177):

- channel spacing and adjacent-channel spacing
- channel bandwidth, adjacent-channel bandwidth, and type of filtering
- resolution bandwidth
- video bandwidth
- detector
- # of adjacent channels

- trace averaging (switched off)

Remote command:

`CALCulate<n>:MARKer<m>:FUNCTION:POWER:PRESet` on page 650

CP/ACLR Settings ← Ch Power ACLR

Opens a submenu to configure the channel power and adjacent channel power measurement independently of the predefined standards (for details see also "[Predefined CP/ACLR Standards](#)" on page 176 and "[Optimized Settings for CP/ACLR Test Parameters](#)" on page 177).

of TX Chan ← CP/ACLR Settings ← Ch Power ACLR

Opens an edit dialog box to enter the number of carrier signals to be taken into account in channel and adjacent-channel power measurements. Values from 1 to 18 are allowed.

Remote command:

`[SENSe:]POWER:ACHannel:TXChannel:COUNT` on page 853

of Adj Chan ← CP/ACLR Settings ← Ch Power ACLR

Opens an edit dialog box to enter the number of adjacent channels to be considered in the adjacent-channel power measurement. Values from 0 to 12 are allowed.

The following measurements are performed depending on the number of the channels:

0	Only the channel powers are measured.
1	The channel powers and the power of the upper and lower adjacent channel are measured.
2	The channel powers, the power of the upper and lower adjacent channel, and of the next higher and lower channel (alternate channel 1) are measured.
3	The channel power, the power of the upper and lower adjacent channel, the power of the next higher and lower channel (alternate channel 1), and of the next but one higher and lower adjacent channel (alternate channel 2) are measured.
...	...
12	The channel power, the power of the upper and lower adjacent channel, and the power of the all higher and lower channels (alternate channel 1 to 11) are measured.

Remote command:

`[SENSe:]POWER:ACHannel:ACPairs` on page 845

Channel Setup ← CP/ACLR Settings ← Ch Power ACLR

Opens a dialog to define the channel settings for all channels, independent of the defined number of *used* TX or adjacent channels.

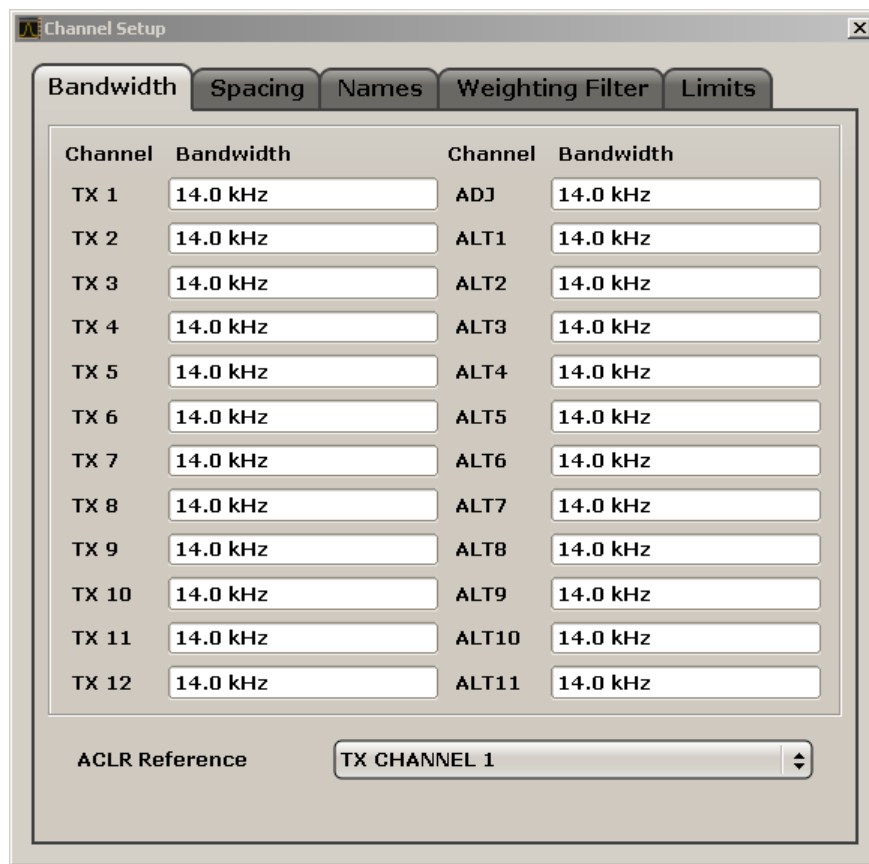

The dialog contains the following tabs:

- ["Bandwidth"](#) on page 168
- ["Spacing"](#) on page 169
- ["Names"](#) on page 170
- ["Weighting Filter"](#) on page 170
- ["Limits"](#) on page 171

Bandwidth ← Channel Setup ← CP/ACLR Settings ← Ch Power ACLR

Define the channel bandwidths for the transmission channels and the adjacent channels. "TX" is only available for the multi-carrier ACLR measurement. When you change the bandwidth for one channel, the value is automatically also defined for all subsequent channels of the same type.

The transmission-channel bandwidth is normally defined by the transmission standard. The correct bandwidth is set automatically for the selected standard (see ["Optimized Settings for CP/ACLR Test Parameters"](#) on page 177).

- Measurements in zero span (see [Fast ACLR \(On/Off\)](#) softkey) are performed in the zero span mode. The channel limits are indicated by vertical lines. For measurements requiring channel bandwidths deviating from those defined in the selected standard the IBW method is to be used.
- With the IBW method (see [Fast ACLR \(On/Off\)](#) softkey), the channel bandwidth limits are marked by two vertical lines right and left of the channel center frequency. Thus you can visually check whether the entire power of the signal under test is within the selected channel bandwidth.

If measuring according to the IBW method ("Fast ACLR Off"), the bandwidths of the different adjacent channels are to be entered numerically. Since all adjacent channels often have the same bandwidth, the other alternate channels are set to the bandwidth of the adjacent channel when it is changed. Thus, only one value needs to be entered in case of equal adjacent channel bandwidths.

For details on available channel filters see [chapter 4.1.6.3, "Selecting the Appropriate Filter Type"](#), on page 85.

Remote command:

`[SENSe:]POWer:ACHannel:BANDwidth|BWIDth[:CHANnel<channel>]`

on page 845

`[SENSe:]POWer:ACHannel:BANDwidth|BWIDth:ACHannel` on page 846

`[SENSe:]POWer:ACHannel:BANDwidth|BWIDth:ALternate<channel>`

on page 846

ACLR Reference ← Bandwidth ← Channel Setup ← CP/ACLR Settings ← Ch Power ACLR

Select the transmission channel to which the relative adjacent-channel power values should be referenced.

TX Channel 1	Transmission channel 1 is used.
Min Power TX Channel	The transmission channel with the lowest power is used as a reference channel.
Max Power TX Channel	The transmission channel with the highest power is used as a reference channel.
Lowest & Highest Channel	The outer left-hand transmission channel is the reference channel for the lower adjacent channels, the outer right-hand transmission channel that for the upper adjacent channels.

Remote command:

`[SENSe:]POWer:ACHannel:REference:TXCHannel:MANual` on page 852

`[SENSe:]POWer:ACHannel:REference:TXCHannel:AUTO` on page 851

Spacing ← Channel Setup ← CP/ACLR Settings ← Ch Power ACLR

Define the channel spacings for the TX channels and for the adjacent channels.

- TX channels (left column)

TX1-2	spacing between the first and the second carrier
TX2-3	spacing between the second and the third carrier
...	...

The spacings between all adjacent TX channels can be defined separately. When you change the spacing for one channel, the value is automatically also defined for all subsequent TX channels in order to set up a system with equal TX channel spacing quickly. For different spacings, a setup from top to bottom is necessary.

If the spacings are not equal, the channel distribution according to the center frequency is as follows:

Odd number of TX channels	The middle TX channel is centered to center frequency.
Even number of TX channels	The two TX channels in the middle are used to calculate the frequency between those two channels. This frequency is aligned to the center frequency.

- **Adjacent channels (right column)**
 Since all the adjacent channels often have the same distance to each other, the modification of the adjacent-channel spacing (ADJ) causes a change in all higher adjacent-channel spacings (ALT1, ALT2, ...): they are all multiplied by the same factor (new spacing value/old spacing value). Thus only one value needs to be entered in case of equal channel spacing. A modification of a higher adjacent-channel spacing (ALT1, ALT2, ...) causes a change by the same factor in all higher adjacent-channel spacings, while the lower adjacent-channel spacings remain unchanged.

Example:

In the default setting, the adjacent channels have the following spacing: 20 kHz ("ADJ"), 40 kHz ("ALT1"), 60 kHz ("ALT2"), 80 kHz ("ALT3"), 100 kHz ("ALT4"), ...
 If the spacing of the first adjacent channel ("ADJ") is set to 40 kHz, the spacing of all other adjacent channels is multiplied by factor 2 to result in 80 kHz ("ALT1"), 120 kHz ("ALT2"), 160 kHz ("ALT3"), ...

If, starting from the default setting, the spacing of the 5th adjacent channel ("ALT4") is set to 150 kHz, the spacing of all higher adjacent channels is multiplied by factor 1.5 to result in 180 kHz ("ALT5"), 210 kHz ("ALT6"), 240 kHz ("ALT7"), ...

If a ACLR or MC-ACLR measurement is started, all settings according to the standard including the channel bandwidths and channel spacings are set and can be adjusted afterwards.

Remote command:

[SENSe:] POWer:ACHannel:SPACing:CHANnel<channel> on page 853

[SENSe:] POWer:ACHannel:SPACing[:ACHannel] on page 852

[SENSe:] POWer:ACHannel:SPACing:ALternate<channel> on page 853

Names ← Channel Setup ← CP/ACLR Settings ← Ch Power ACLR

Define user-specific channel names for each channel. The names defined here are displayed in the result diagram and result table.

Remote command:

[SENSe:] POWer:ACHannel:NAME:ACHannel on page 849

[SENSe:] POWer:ACHannel:NAME:ALternate<channel> on page 850

[SENSe:] POWer:ACHannel:NAME:CHANnel<channel> on page 850

Weighting Filter ← Channel Setup ← CP/ACLR Settings ← Ch Power ACLR

Define weighting filters for all channels. Weighting filters are not available for all supported standards and cannot always be defined manually where they are available.

The dialog contains the following fields:

Field	Description
Channel	<ul style="list-style-type: none"> • TX 1-18: TX channels • ADJ: Adjacent channel • ALT1-11: Alternate channels
Active	Activates/Deactivates the weighting filter for the selected and any subsequent channels of the same type
Alpha	Defines the alpha value for the weighting filter for the selected and any subsequent channels of the same type

Remote command:

POW:ACH:FILT:CHAN1 ON, see [SENSe:]POW:ACHannel:FILTer[:STATe]:CHANnel<channel> on page 848

Activates the weighting filter for TX channel 1.

POW:ACH:FILT:ALPH:CHAN1 0,35 see [SENSe:]POW:ACHannel:FILTer:ALPHa:CHANnel<channel> on page 847

Sets the alpha value for the weighting filter for TX channel 1 to 0,35.

POW:ACH:FILT:ACH ON see [SENSe:]POW:ACHannel:FILTer[:STATe]:ACHannel on page 848

Activates the weighting filter for the adjacent channel.

POW:ACH:FILT:ALPH:ACH 0,35 see [SENSe:]POW:ACHannel:FILTer:ALPHa:ACHannel on page 847

Sets the alpha value for the weighting filter for the adjacent channel to 0,35.

POW:ACH:FILT:ALT1 ON see [SENSe:]POW:ACHannel:FILTer[:STATe]:ALTErnate<channel> on page 848

Activates the alpha value for the weighting filter for the alternate channel 1.

POW:ACH:FILT:ALPH:ALT1 0,35 see [SENSe:]POW:ACHannel:FILTer:ALPHa:ALTErnate<channel> on page 847

Sets the alpha value for the weighting filter for the alternate channel 1 to 0,35.

Limits ← Channel Setup ← CP/ACLR Settings ← Ch Power ACLR

Activate and define the limits for the ACLR measurement.

Limit Checking ← Limits ← Channel Setup ← CP/ACLR Settings ← Ch Power ACLR

Activate or deactivate limit checking for the ACLR measurement.

The following rules apply for the limits:

- A separate limit can be defined for each adjacent channel. The limit applies to both the upper and the lower adjacent channel.
- A relative and/or absolute limit can be defined. The check of both limit values can be activated independently.
- The R&S FSVR checks adherence to the limits irrespective of whether the limits are absolute or relative or whether the measurement is carried out with absolute or

relative levels. If both limits are active and if the higher of both limit values is exceeded, the measured value is marked by a preceding asterisk.

Remote command:

[CALCulate<n>:LIMit<k>:ACPoweR\[:STATe\]](#) on page 585

[CALCulate<n>:LIMit<k>:ACPoweR:ACHannel:RESult](#) on page 588

[CALCulate<n>:LIMit<k>:ACPoweR:ALternate<channel>\[:RELative\]](#)
on page 589

Relative Limit ← Limits ← Channel Setup ← CP/ACLR Settings ← Ch Power ACLR

Defines a limit relative to the carrier signal.

Remote command:

[CALC:LIM:ACP ON](#), see [CALCulate<n>:LIMit<k>:ACPoweR\[:STATe\]](#)
on page 585

[CALC:LIM:ACP:<adjacent-channel> 0dBc,0dBc](#)

[CALC:LIM:ACP:<adjacent-channel>:STAT ON](#)

Absolute Limit ← Limits ← Channel Setup ← CP/ACLR Settings ← Ch Power ACLR

Defines an absolute limit.

Remote command:

[CALC:LIM:ACP ON](#), see [CALCulate<n>:LIMit<k>:ACPoweR\[:STATe\]](#)
on page 585

[CALC:LIM:ACP:<adjacent-channel>:ABS -10dBm,-10dBm](#)

[CALC:LIM:ACP:<adjacent-channel>:ABS:STAT ON](#), see [CALCulate<n>:LIMit<k>:ACPoweR:ACHannel:ABSolute:STATe](#) on page 587

Check ← Limits ← Channel Setup ← CP/ACLR Settings ← Ch Power ACLR

Activate or deactivate the limit to be considered during a limit check. The check of both limit values can be activated independently.

Chan Pwr/Hz ← CP/ACLR Settings ← Ch Power ACLR

If deactivated, the channel power is displayed in dBm. If activated, the channel power density is displayed instead. Thus, the absolute unit of the channel power is switched from dBm to dBm/Hz. The channel power density in dBm/Hz corresponds to the power inside a bandwidth of 1 Hz and is calculated as follows:

"channel power density = channel power – log₁₀(channel bandwidth)"

By means of this function it is possible e.g. to measure the signal/noise power density or use the additional functions "[ACLR \(Abs/Rel\)](#)" on page 173 and "[ACLR Reference](#)" on page 169 to obtain the signal to noise ratio.

Remote command:

[CALCulate<n>:MARKer<m>:FUNCTION:POWer:RESult:PHZ](#) on page 654

Power Mode ← CP/ACLR Settings ← Ch Power ACLR

Opens a submenu to select the power mode.

Clear/Write ← Power Mode ← CP/ACLR Settings ← Ch Power ACLR

If this mode is activated, the channel power and the adjacent channel powers are calculated directly from the current trace (default mode).

Remote command:

CALC:MARK:FUNC:POW:MODE WRIT, see [CALCulate<n>:MARKer<m>:FUNCTion:POWer:MODE](#) on page 650

Max Hold ← Power Mode ← CP/ACLR Settings ← Ch Power ACLR

If this mode is activated, the power values are calculated from the current trace and compared with the previous power value using a maximum algorithm. The higher value is retained. If activated, the enhancement label "Pwr Max" is displayed.

Remote command:

CALC:MARK:FUNC:POW:MODE MAXH, see [CALCulate<n>:MARKer<m>:FUNCTion:POWer:MODE](#) on page 650

Select Trace ← CP/ACLR Settings ← Ch Power ACLR

Opens an edit dialog box to enter the trace number on which the CP/ACLR measurement is to be performed. Only activated traces can be selected.

For details on trace modes see [chapter 4.1.8.4, "Trace Mode Overview"](#), on page 104.

Remote command:

[SENSe:]POWer:TRACe on page 855

ACLR (Abs/Rel) ← CP/ACLR Settings ← Ch Power ACLR

Switches between absolute and relative power measurement in the adjacent channels.

Abs	The absolute power in the adjacent channels is displayed in the unit of the y-axis, e.g. in dBm, dBμV.
Rel	The level of the adjacent channels is displayed relative to the level of the transmission channel in dBc.

Remote command:

[SENSe:]POWer:ACHannel:MODE on page 849

Adjust Settings ← CP/ACLR Settings ← Ch Power ACLR

Automatically optimizes all instrument settings for the selected channel configuration (channel bandwidth, channel spacing) within a specific frequency range (channel bandwidth). The adjustment is carried out only once. If necessary, the instrument settings can be changed later.

For details on the settings of span, resolution bandwidth, video bandwidth, detector and trace averaging see ["Optimized Settings for CP/ACLR Test Parameters"](#) on page 177.

Remote command:

[SENSe:]POWer:ACHannel:PRESet on page 850

Sweep Time ← Ch Power ACLR

Opens an edit dialog box to enter the sweep time. With the RMS detector, a longer sweep time increases the stability of the measurement results.

The function of this softkey is identical to the [Sweeptime Manual](#) softkey in the "Bandwidth" menu.

Remote command:

[\[SENSe:\] SWEep: TIME](#) on page 872

Fast ACLR (On/Off) ← Ch Power ACLR

Switches between the IBW method ("Fast ACLR Off") and the zero span method ("Fast ACLR On").

When switched on, the R&S FSVR sets the center frequency consecutively to the different channel center frequencies and measures the power with the selected measurement time (= sweep time/number of channels). The RBW filters suitable for the selected standard and frequency offset are automatically used (e.g. root raised cos with IS 136). For details on available channel filters see [chapter 4.1.6.3, "Selecting the Appropriate Filter Type"](#), on page 85.

The RMS detector is used for obtaining correct power measurement results. Therefore this requires no software correction factors.

Measured values are output as a list. The powers of the transmission channels are output in dBm, the powers of the adjacent channels in dBm.

The sweep time is selected depending on the desired reproducibility of results. Reproducibility increases with sweep time since power measurement is then performed over a longer time period. As a general approach, it can be assumed that approx. 500 non-correlated measured values are required for a reproducibility of 0.5 dB (99 % of the measurements are within 0.5 dB of the true measured value). This holds true for white noise. The measured values are considered as non-correlated if their time interval corresponds to the reciprocal of the measured bandwidth.

With IS 136 the measurement bandwidth is approx. 25 kHz, i.e. measured values at an interval of 40 µs are considered as non-correlated. A measurement time of 40 ms is thus required per channel for 1000 measured values. This is the default sweep time which the R&S FSVR sets in coupled mode. Approx. 5000 measured values are required for a reproducibility of 0.1 dB (99 %), i.e. the measurement time is to be increased to 200 ms.

Remote command:

[\[SENSe:\] PWeR: HSPeed](#) on page 854

Set CP Reference ← Ch Power ACLR

Defines the currently measured channel power as the reference value if channel power measurement is activated. The reference value is displayed in the "Tx1 (Ref) Power" field; the default value is 0 dBm.

The softkey is available only for multi carrier ACLR measurements.

In adjacent-channel power measurement with one or several carrier signals, the power is always referenced to a transmission channel, i.e. no value is displayed for "Tx1 (Ref) Power".

Remote command:

[\[SENSe:\] PWeR: ACHannel: REference: AUTO ONCE](#) on page 851

User Standard ← Ch Power ACLR

Opens a submenu to configure customized standards.

Load ← User Standard ← Ch Power ACLR

Opens a dialog to select and load a user defined ACLR standard.

Remote command:

Querying available standards:

`CALCulate<n>:MARKer<m>:FUNCTION:POWER:STANdard:CATalog?`

on page 656

Loading a standard:

`CALCulate<n>:MARKer<m>:FUNCTION:POWER:PRESet` on page 650

Save ← User Standard ← Ch Power ACLR

Saves the current ACLR configuration in an xml file in order for you to use it again at a later time. You can define the drive, path and file name in the corresponding dialog.

The default location is `C:\R_S\Instr\acp_std\`.

Note that the ACLR user standard is not supported by Fast ACLR and Multi Carrier ACLR measurements.

If you create your own standard, you can customize the following parameters:

- number of adjacent channels
- channel bandwidth of transmission (Tx), adjacent (Adj) and alternate (Alt) channels
- channel spacings
- resolution and video bandwidth
- ACLR limits and their state
- sweep time and sweep time coupling
- detector
- trace mode

Remote command:

Configuring channels:

see "[SENSe:POWER Subsystem](#)" on page 844

Saving custom channel configurations:

`CALCulate<n>:MARKer<m>:FUNCTION:POWER:STANdard:SAVE` on page 656

Delete ← User Standard ← Ch Power ACLR

Deletes the user standard that you select in the corresponding dialog box. Note that the R&S FSVR deletes the file without further notice.

Remote command:

`CALCulate<n>:MARKer<m>:FUNCTION:POWER:STANdard:DELeTe` on page 656

Noise Correction ← Ch Power ACLR

If activated, the results are corrected by the instrument's inherent noise, which increases the dynamic range.

"ON"

A reference measurement of the instrument's inherent noise is carried out. The noise power measured is then subtracted from the power in the channel that is being examined.

The inherent noise of the instrument depends on the selected center frequency, resolution bandwidth and level setting. Therefore, the correction function is disabled whenever one of these parameters is changed. A disable message is displayed on the screen. Noise correction must be switched on again manually after the change.

"OFF"	No noise correction is performed.
"AUTO"	Noise correction is performed. After a parameter change, noise correction is restarted automatically and a new correction measurement is performed.

Remote command:

[SENSe:]POWER:NCORrection on page 854

Adjust Ref Lvl ← Ch Power ACLR

Adjusts the reference level to the measured channel power. This ensures that the settings of the RF attenuation and the reference level are optimally adjusted to the signal level without overloading the R&S FSVR or limiting the dynamic range by a too small S/N ratio.

For details on manual settings see "[Optimized Settings for CP/ACLR Test Parameters](#)" on page 177.

The reference level is not influenced by the selection of a standard. To achieve an optimum dynamic range, the reference level has to be set in a way that places the signal maximum close to the reference level without forcing an overload message. Since the measurement bandwidth for channel power measurements is significantly lower than the signal bandwidth, the signal path may be overloaded although the trace is still significantly below the reference level.

Remote command:

[SENSe:]POWER:ACHannel:PRESet:RLEVEL on page 851

Predefined CP/ACLR Standards

When using predefined standards for ACLR measurement, the test parameters for the channel and adjacent-channel measurements are configured automatically. The available standards are listed below.



Predefined standards are selected using the "CP/ACLR Standard" softkey or the CALC:MARK:FUNC:POW:PRES command.

Standard	GUI-Parameter	SCPI-Parameter
EUTRA/LTE Square	EUTRA/LTE Square	EUTRa
EUTRA/LTE Square/RRC	EUTRA/LTE Square/RRC	REUTRa
W-CDMA 3.84 MHz forward	W-CDMA 3GPP FWD	FW3G
W-CDMA 3.84 MHz reverse	W-CDMA 3GPP REV	RW3G
CDMA IS95A forward	CDMA IS95A FWD	F8CD FIS95a
CDMA IS95A reverse	CDMA IS95A REV	R8CD RIS95a
CDMA IS95C Class 0 forward*)	CDMA IS95C Class 0 FWD	FIS95c0
CDMA IS95C Class 0 reverse*)	CDMA IS95C Class 0 REV	RIS95c0
CDMA J-STD008 forward	CDMA J-STD008 FWD	F19C FJ008

Standard	GUI-Parameter	SCPI-Parameter
CDMA J-STD008 reverse	CDMA J-STD008 REV	R19C RJ008
CDMA IS95C Class 1 forward*)	CDMA IS95C Class 1 FWD	FIS95c1
CDMA IS95C Class 1 reverse*)	CDMA IS95C Class 1 REV	RIS95c1
CDMA 2000	CDMA 2000	S2CD
TD-SCDMA forward	TD SCDMA FWD	FTCD TCDMa
TD-SCDMA reverse	TD SCDMA REV	RTCD
WLAN 802.11A	WLAN 802.11A	AWLan
WLAN 802.11B	WLAN 802.11B	BWLan
WiMAX	WiMAX	WiMAX
WiBRO	WiBRO	WiBRO
GSM	GSM	GSM
RFID 14443	RFID 14443	RFID14443
TETRA	TETRA	TETRA
PDC	PDC	PDC
PHS	PHS	PHS
CDPD	CDPD	CDPD
APCO-25 Phase 2	APCO-25 P2	PAPCo25



For the R&S FSVR, the channel spacing is defined as the distance between the center frequency of the adjacent channel and the center frequency of the transmission channel. The definition of the adjacent-channel spacing in standards IS95C and CDMA 2000 is different. These standards define the adjacent-channel spacing from the center of the transmission channel to the closest border of the adjacent channel. This definition is also used for the R&S FSVR if the standards marked with an asterisk *) are selected.

Optimized Settings for CP/ACLR Test Parameters

The "Adjust Settings" softkey (see ["Adjust Settings"](#) on page 173) automatically optimizes all instrument settings for the selected channel configuration, as described in the following:

- **Frequency span**

The frequency span must at least cover the channels to be measured plus a measurement margin of approx. 10 %.

If the frequency span is large in comparison to the channel bandwidth (or the adjacent-channel bandwidths) being examined, only a few points on the trace are available per channel. This reduces the accuracy of the waveform calculation for the channel filter used, which has a negative effect on the measurement accuracy. It is therefore strongly recommended that the formulas mentioned be taken into consideration when selecting the frequency span.

For channel power measurements the [Adjust Settings](#) softkey sets the frequency span as follows:

"(No. of transmission channels – 1) x transmission channel spacing + 2 x transmission channel bandwidth + measurement margin"

For adjacent-channel power measurements, the [Adjust Settings](#) softkey sets the frequency span as a function of the number of transmission channels, the transmission channel spacing, the adjacent-channel spacing, and the bandwidth of one of adjacent-channels ADJ, ALT1 or ALT2, whichever is furthest away from the transmission channels:

"(No. of transmission channels – 1) x transmission channel spacing + 2 x (adjacent-channel spacing + adjacent-channel bandwidth) + measurement margin"

The measurement margin is approx. 10 % of the value obtained by adding the channel spacing and the channel bandwidth.

- **Resolution bandwidth (RBW)**

To ensure both, acceptable measurement speed and required selection (to suppress spectral components outside the channel to be measured, especially of the adjacent channels), the resolution bandwidth must not be selected too small or too large. As a general approach, the resolution bandwidth is to be set to values between 1% and 4% of the channel bandwidth.

A larger resolution bandwidth can be selected if the spectrum within the channel to be measured and around it has a flat characteristic. In the standard setting, e.g. for standard IS95A REV at an adjacent channel bandwidth of 30 kHz, a resolution bandwidth of 30 kHz is used. This yields correct results since the spectrum in the neighborhood of the adjacent channels normally has a constant level.

With the exception of the IS95 CDMA standards, the [Adjust Settings](#) softkey sets the resolution bandwidth (RBW) as a function of the channel bandwidth:

" $RBW \leq 1/40$ of channel bandwidth"

The maximum possible resolution bandwidth (with respect to the requirement $RBW \leq 1/40$) resulting from the available RBW steps (1, 3) is selected.

- **Video bandwidth (VBW)**

For a correct power measurement, the video signal must not be limited in bandwidth. A restricted bandwidth of the logarithmic video signal would cause signal averaging and thus result in a too low indication of the power (-2.51 dB at very low video bandwidths). The video bandwidth should therefore be selected at least three times the resolution bandwidth:

" $VBW \geq 3 \times RBW$ "

The [Adjust Settings](#) softkey sets the video bandwidth (VBW) as a function of the channel bandwidth (see formula above) and the smallest possible VBW with regard to the available step size will be selected.

- **Detector**

The [Adjust Settings](#) softkey selects the RMS detector. This detector is selected since it correctly indicates the power irrespective of the characteristics of the signal to be measured. The whole IF envelope is used to calculate the power for each measurement point. The IF envelope is digitized using a sampling frequency which is at least five times the resolution bandwidth which has been selected. Based on the sample values, the power is calculated for each measurement point using the following formula:

$$P_{\text{RMS}} = \sqrt{\frac{1}{N} \cdot \sum_{i=1}^N s_i^2}$$

where:

" s_i = linear digitized video voltage at the output of the A/D converter"

"N = number of A/D converter values per measurement point"

" P_{RMS} = power represented by a measurement point"

When the power has been calculated, the power units are converted into decibels and the value is displayed as a measurement point.

In principle, the sample detector would be possible as well. Due to the limited number of measurement points used to calculate the power in the channel, the sample detector would yield less stable results.

- **Trace averaging**

The [Adjust Settings](#) softkey switches off this function. Averaging, which is often performed to stabilize the measurement results, leads to a too low level indication and should therefore be avoided. The reduction in the displayed power depends on the number of averages and the signal characteristics in the channel to be measured.

- **Reference level**

The [Adjust Settings](#) softkey does not influence the reference level. It can be adjusted separately using the "Adjust Ref Lvl" softkey (see ["Adjust Ref Lvl"](#) on page 176).

4.2.5.3 Measuring the Carrier-to-Noise Ratio

The R&S FSVR can easily determine the carrier-to-noise ratio, also normalized to a 1 Hz bandwidth.

The largest signal in the frequency span is the carrier. It is searched when the C/N or C/NO function is activated (see ["C/N, C/No"](#) on page 181) and is marked using a fixed reference marker ("FXD").

To determine the noise power, a channel at the defined center frequency is examined. The bandwidth of the channel is defined by the "Channel Bandwidth" setting. The power within this channel is integrated to obtain the noise power level. (If the carrier is within this channel, an extra step is required to determine the correct noise power level, see below.)

The noise power of the channel is subtracted from the maximum carrier signal level, and in the case of a C/NO measurement, it is referred to a 1 Hz bandwidth.



For this measurement, the RMS detector is activated.

The carrier-to-noise measurements are only available in the frequency domain (span >0).

There are two methods to measure the carrier-to-noise ratio:

- The carrier is outside the examined channel: In this case, it is sufficient to switch on the desired measurement function and to set the channel bandwidth. The carrier/noise ratio is displayed on the screen.
- The carrier is inside the examined channel: In this case, the measurement must be performed in two steps:
 - First, perform the reference measurement by switching on either the C/N or the C/NO measurement and waiting for the end of the next measurement run. The fixed reference marker is set to the maximum of the measured carrier signal.
 - Then, switch off the carrier so that only the noise of the test setup is active in the channel. The carrier-to-noise ratio is displayed after the subsequent measurement has been completed.



The frequency span should be set to approximately 4 times the channel bandwidth in order to measure the carrier-to-noise ratio correctly. This setting is defined automatically by the "Adjust Settings" function.

To determine the carrier-to-noise ratio

1. Press the "C/N, C/NO" softkey to configure the carrier-to-noise ratio measurement.
2. To change the channel bandwidth to be examined, press the "Channel Bandwidth" softkey.
3. To optimize the settings for the selected channel configuration, press the "Adjust Settings" softkey.
4. To activate the measurements without reference to the bandwidth, press the "C/N" softkey.
To activate the measurements with reference to the bandwidth, press the "C/NO" softkey .
5. If the carrier signal is located within the examined channel bandwidth, switch off the carrier signal so that only the noise is displayed in the channel and perform a second measurement.

The carrier-to-noise ratio is displayed after the measurement has been completed.

Measurement results

As a result of the carrier-to-noise measurement the evaluated bandwidth and the calculated C/N ratio are indicated beneath the diagram.

You can also query the determined carrier-to-noise ratio via the remote command `CALC:MARK:FUNC:POW:RES? CN` or `CALC:MARK:FUNC:POW:RES? CNO`, see [CALCulate<n>:MARKer<m>:FUNCTION:POWer:RESult?](#) on page 651.

Softkeys for Carrier-to-Noise Ratio Measurements

C/N, C/No..... 181

L C/N.....	181
L C/No.....	181
L Channel Bandwidth	181
L Adjust Settings	182

C/N, C/No

Opens a submenu to configure the carrier/noise ratio measurement. Measurements without (C/N) and measurements with reference to the bandwidth (C/No) are possible.

Carrier-to-noise measurements are not available in zero span mode.

Note: Carrier-to-noise measurements are also available in the I/Q Analyzer, but only for **Spectrum** displays (see "Display Config" on page 284).

For general information on performing carrier-to-noise ratio measurements see [chapter 4.2.5.3, "Measuring the Carrier-to-Noise Ratio"](#), on page 179.

C/N ← C/N, C/No

Switches the measurement of the carrier/noise ratio on or off. If no marker is active, marker 1 is activated.

The measurement is performed on the trace that marker 1 is assigned to. To shift marker 1 and measure another trace, use the [Marker to Trace](#) softkey in the "Marker To" menu.

Remote command:

[CALCulate<n>:MARKer<m>:FUNCTION:POWER:SElect](#) on page 654

[CALCulate<n>:MARKer<m>:FUNCTION:POWER:RESult?](#) on page 651

[CALCulate<n>:MARKer<m>:FUNCTION:POWER\[:STATe\]](#) on page 655

C/No ← C/N, C/No

Switches the measurement of the carrier/noise ratio with reference to a 1 Hz bandwidth on or off. If no marker is active, marker 1 is activated.

The measurement is performed on the trace that marker 1 is assigned to. To shift marker 1 and measure another trace, use the [Marker to Trace](#) softkey in the "Marker To" menu.

Remote command:

[CALCulate<n>:MARKer<m>:FUNCTION:POWER:SElect](#) on page 654

[CALCulate<n>:MARKer<m>:FUNCTION:POWER:RESult?](#) on page 651

[CALCulate<n>:MARKer<m>:FUNCTION:POWER\[:STATe\]](#) on page 655

Channel Bandwidth ← C/N, C/No

Opens an edit dialog box to enter the measurement channel bandwidth for each channel.

The default setting is 14 kHz.

Note that in the I/Q Analyzer the channel bandwidth does not change the measurement span or sampling rate; it merely defines the range for the carrier-to-noise analysis.

Remote command:

[\[SENSe:\]POWER:ACHannel:ACPairs](#) on page 845

Adjust Settings ← C/N, C/No

Enables the RMS detector (see also [chapter 4.1.8.6, "Detector Overview"](#), on page 106) and adjusts the span to the selected channel bandwidth according to:

"4 x channel bandwidth + measurement margin"

The adjustment is performed once; if necessary, the setting can be changed later on.

Note: in the I/Q Analyzer, this function is not available. The channel bandwidth defines the range for the carrier-to-noise analysis.

Remote command:

[SENSe:]POWER:ACHannel:PRESet on page 850

4.2.5.4 Measuring the Occupied Bandwidth

An important characteristic of a modulated signal is its occupied bandwidth. In a radio communications system for instance the occupied bandwidth must be limited to enable distortion-free transmission in adjacent channels. The occupied bandwidth is defined as the bandwidth containing a defined percentage of the total transmitted power. A percentage between 10 % and 99.9 % can be set.

The measurement principle is the following: The bandwidth containing 99% of the signal power is to be determined, for example. The routine first calculates the total power of all displayed points of the trace. In the next step, the points from the right edge of the trace are summed up until 0.5 % of the total power is reached. Auxiliary marker 1 is positioned at the corresponding frequency. Then the points from the left edge of the trace are summed up until 0.5 % of the power is reached. Auxiliary marker 2 is positioned at this point. 99 % of the power is now between the two markers. The distance between the two frequency markers is the occupied bandwidth which is displayed in the marker field.



New: OBW now also possible within defined search limits - multi-carrier OBW measurement in one sweep

The occupied bandwidth of the signal can be determined within defined search limits instead of for the entire signal. Thus, only a single sweep is required to determine the OBW for a multi-carrier signal. To do so, search limits are defined for an individual carrier and the OBW measurement is restricted to the frequency range contained within those limits. Then the search limits are adapted for the next carrier and the OBW is automatically re-calculated for the new range.

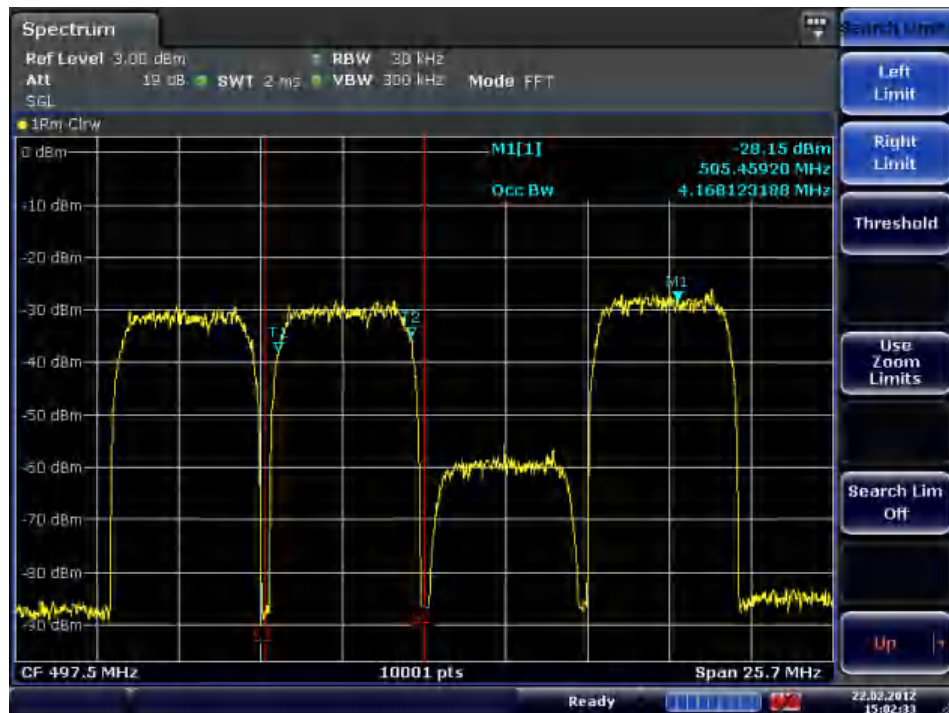

The OBW measurement uses the same search limits as defined for marker search (see "[Search Limits](#)" on page 144). However, only the left and right limits are considered.

To ensure correct power measurement, especially for noise signals, and to obtain the correct occupied bandwidth, the following prerequisites and settings are necessary:

- Only the signal to be measured is displayed on the screen. An additional signal would falsify the measurement.
- $RBW \ll$ occupied bandwidth
(approx. 1/20 of occupied bandwidth, for voice communication type 300 Hz or 1 kHz)
- $VBW \geq 3 \times RBW$
- RMS detector
- $Span \geq 2$ to $3 \times$ occupied bandwidth

Some of the measurement specifications (e.g. PDC, RCR STD-27B) require measurement of the occupied bandwidth using a peak detector. The detector setting of the R&S FSVR has to be changed accordingly then.



A remote control programming example is described in [chapter 8.3.5, "Occupied Bandwidth Measurement"](#), on page 1031.

To determine the occupied bandwidth

1. Press the **OBW** softkey to activate the measurement of the occupied bandwidth. The corresponding submenu is displayed.
2. Press the "% Power Bandwidth" softkey to enter the percentage of power (see "[% Power Bandwidth \(span > 0\)](#)" on page 185).
3. To change the channel bandwidth for the transmission channel, press the "Channel Bandwidth" softkey (see "[Channel Bandwidth \(span > 0\)](#)" on page 185).
4. To optimize the settings for the selected channel configuration, press the **Adjust Settings** softkey. For details see also "[Optimized Settings for CP/ACLR Test Parameters](#)" on page 177.
5. To adjust the reference level to the measured total power after the first sweep, press the **Adjust Ref Lvl** softkey.

Measurement results

As a result of the OBW measurement the occupied bandwidth ("Occ BW") is indicated in the marker results. Furthermore, the marker at the center frequency and the temporary markers are indicated.



The OBW calculation is repeated if the [Search Limits](#) are changed, without performing a new sweep. Thus, the OBW for a multi-carrier signal can be determined using only one sweep.

The determined occupied bandwidth can also be queried using the remote command `CALC:MARK:FUNC:POW:RES? OBW` or `CALC:MARK:FUNC:POW:RES? AOBW`. While the `OBW` parameter returns only the occupied bandwidth, the `AOBW` parameter also returns the position and level of the temporary markers T1 and T2 used to calculate the occupied bandwidth.

Softkeys for Occupied Bandwidth (OBW) Measurements

OBW	184
L % Power Bandwidth (span > 0).....	185
L Channel Bandwidth (span > 0).....	185
L Adjust Ref Lvl (span > 0).....	185
L Adjust Settings.....	185

OBW

Activates measurement of the occupied bandwidth according to the current configuration and opens a submenu to configure the measurement. The occupied bandwidth is displayed in the marker display field and marked on the trace by temporary markers. For details see [chapter 4.2.5.4, "Measuring the Occupied Bandwidth"](#), on page 182.

This measurement is not available in zero span.

The measurement is performed on the trace with marker 1. In order to evaluate another trace, marker 1 must be placed on another trace (see the [Marker to Trace](#) softkey in the "Marker" menu).

Remote command:

`CALCulate<n>:MARKer<m>:FUNCTION:POWER:SElect` on page 654

`CALCulate<n>:MARKer<m>:FUNCTION:POWER:RESult?` on page 651

`CALCulate<n>:MARKer<m>:FUNCTION:POWER[:STATe]` on page 655

% Power Bandwidth (span > 0) ← OBW

Opens an edit dialog box to enter the percentage of total power in the displayed frequency range which defines the occupied bandwidth. Values from 10% to 99.9% are allowed.

Remote command:

`[SENSe:] POWER: BANDwidth| BWIDth` on page 854

Channel Bandwidth (span > 0) ← OBW

Opens an edit dialog box to enter the channel bandwidth for the transmission channel. The specified channel bandwidth is used for optimization of the test parameters (for details see "[Optimized Settings for CP/ACLR Test Parameters](#)" on page 177). The default setting is 14 kHz.

For measurements in line with a specific transmission standard, the bandwidth specified by the standard for the transmission channel must be entered.

Remote command:

`[SENSe:] POWER: ACHannel: BANDwidth| BWIDth[:CHANnel<channel>]`
on page 845

Adjust Ref Lvl (span > 0) ← OBW

Adjusts the reference level to the measured total power of the signal. the softkey is activated after the first sweep with active measurement of the occupied bandwidth has been completed and the total power of the signal is thus known.

Adjusting the reference level ensures that the signal path will not be overloaded and the dynamic range not limited by too low a reference level. Since the measurement bandwidth for channel power measurements is significantly lower than the signal bandwidth, the signal path may be overloaded although the trace is distinctly below the reference level. If the measured channel power is equal to the reference level, the signal path cannot be overloaded.

Remote command:

`[SENSe:] POWER: ACHannel: PRESet: RLEVEL` on page 851

Adjust Settings ← OBW

Automatically optimizes all instrument settings for the selected channel configuration (channel bandwidth, channel spacing) within a specific frequency range (channel bandwidth). The adjustment is carried out only once. If necessary, the instrument settings can be changed later.

For details on the settings of span, resolution bandwidth, video bandwidth, detector and trace averaging see ["Optimized Settings for CP/ACLR Test Parameters"](#) on page 177.

Remote command:

`[SENSe:]POWER:ACHannel:PRESet` on page 850

4.2.5.5 Measuring with Spectrum Emission Masks

The Spectrum Emission Mask (SEM) measurement defines a measurement that monitors compliance with a spectral mask. The SEM measurement is used to measure the excess emissions of a TX channel that would interfere to other channels or to other systems.

The SEM measurement of the base unit allows a flexible definition of all parameters in the SEM measurement. It is performed using the [Spectrum Emission Mask](#) softkey in the "Measurement" menu. Most parameters are defined in the "Sweep List" dialog box (see ["Sweep List dialog box"](#) on page 188). After a preset, the sweep list contains a set of default ranges and parameters. For each range, you can change the parameters. For information on other SEM settings, see the description of the corresponding softkeys (["Spectrum Emission Mask"](#) on page 188).

If you want a parameter set to be available permanently, you can create an XML file for this configuration and, if necessary, export this file to another application (for details refer to ["Format Description of Spectrum Emission Mask XML Files"](#) on page 205 and ["ASCII File Export Format \(Spectrum Emission Mask\)"](#) on page 210).

Some predefined XML files are provided that contain ranges and parameters according to the selected standard (see ["Provided XML Files for the Spectrum Emission Mask Measurement"](#) on page 202).

In order to improve the performance of the R&S FSVR for spectrum emission mask measurements, a "Fast SEM" mode is available. For details see ["Fast Spectrum Emission Mask Measurements"](#) on page 211.

Monitoring compliance of the spectrum is supported by a special limit check for SEM measurements, see ["Working with Limit Lines in SEM Measurements"](#) on page 201.



A remote control programming example is described in [chapter 8.3.12, "Spectrum Emission Mask Measurement"](#), on page 1042.

Softkeys for Spectrum Emission Mask (SEM) Measurements.....	187
Result Evaluation.....	198
Ranges and Range Settings.....	199
Working with Limit Lines in SEM Measurements.....	201
Provided XML Files for the Spectrum Emission Mask Measurement.....	202

Format Description of Spectrum Emission Mask XML Files.....	205
ASCII File Export Format (Spectrum Emission Mask).....	210
Fast Spectrum Emission Mask Measurements.....	211

Softkeys for Spectrum Emission Mask (SEM) Measurements

Spectrum Emission Mask.....	188
L Sweep List.....	188
L Sweep List dialog box.....	188
L Range Start / Range Stop.....	189
L Fast SEM.....	189
L Filter Type.....	189
L RBW.....	189
L VBW.....	190
L Sweep Time Mode.....	190
L Sweep Time.....	190
L Ref. Level.....	190
L RF Att. Mode.....	190
L RF Attenuator.....	190
L Preamp.....	190
L Transd. Factor.....	190
L Limit Check 1-4.....	191
L Abs Limit Start.....	191
L Abs Limit Stop.....	191
L Rel Limit Start.....	191
L Rel Limit Stop.....	191
L Close Sweep List.....	192
L Insert before Range.....	192
L Insert after Range.....	192
L Delete Range.....	192
L Symmetric Setup.....	192
L Edit Reference Range.....	193
L List Evaluation.....	193
L List Evaluation (On/Off).....	194
L Margin.....	194
L Show Peaks.....	194
L Save Evaluation List.....	194
L ASCII File Export.....	194
L Decim Sep.....	195
L Edit Reference Range.....	195
L Edit Power Classes.....	196
L Used Power Classes.....	196
L PMin/PMax.....	196
L Sweep List.....	197
L Add/Remove.....	197
L Load Standard.....	197
L Save As Standard.....	197
L Meas Start/Stop.....	197
L Restore Standard Files.....	197

Spectrum Emission Mask

Opens a submenu to configure the Spectrum Emission Mask measurement.

The Spectrum Emission Mask (SEM) measurement defines a measurement that monitors compliance with a spectral mask. The SEM measurement of the base unit allows a flexible definition of all parameters in the SEM measurement.

For general information on performing SEM measurements, see [chapter 4.2.5.5, "Measuring with Spectrum Emission Masks"](#), on page 186.

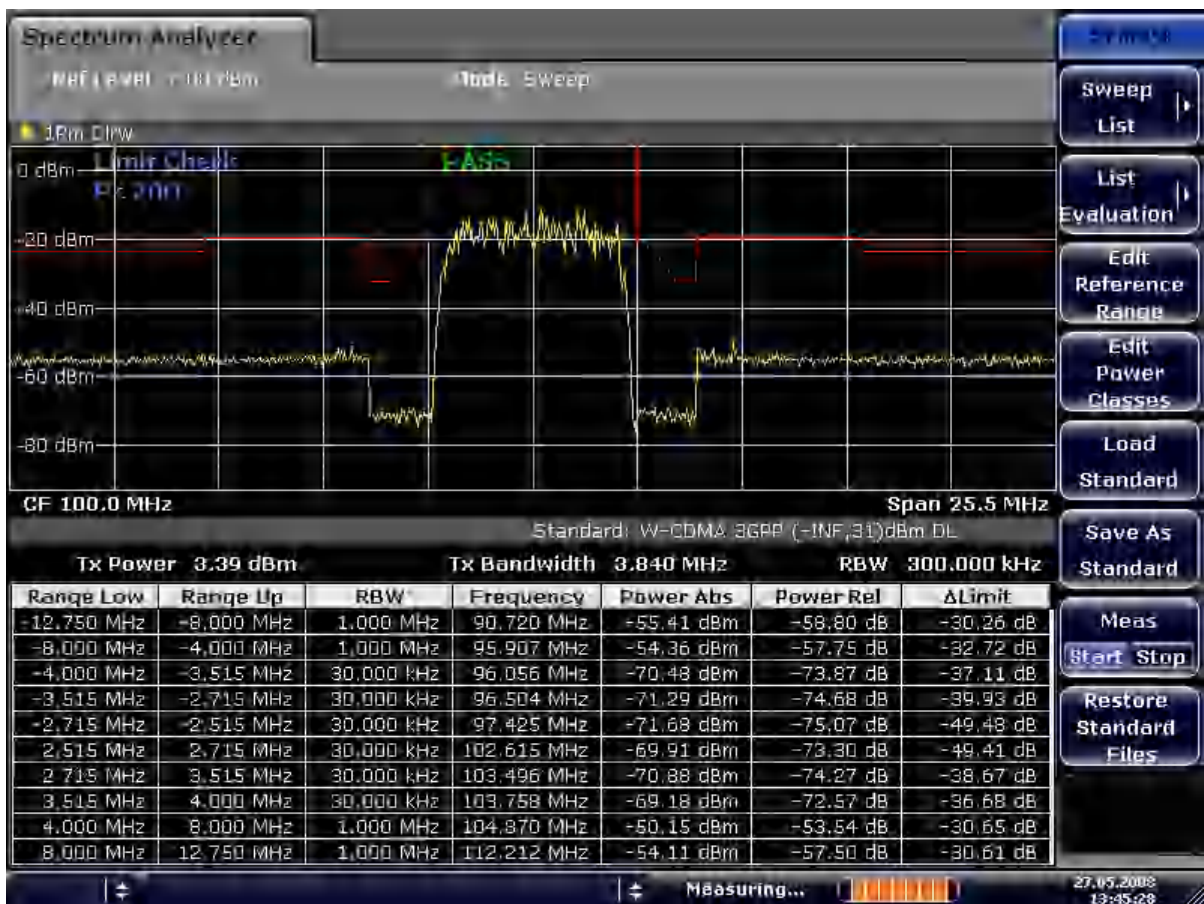

Remote command:

SENS:SWE:MODE ESP, see [\[SENSe:\]SWEep:MODE](#) on page 872

Sweep List ← Spectrum Emission Mask

Opens a submenu to edit the sweep list and displays the "Sweep List" dialog box.

Sweep List dialog box ← Sweep List ← Spectrum Emission Mask

After a preset, the sweep list contains a set of default ranges and parameters. For each range, you can change the parameters listed below. To insert or delete ranges, use the "Insert Before Range", "Insert After Range", "Delete Range" softkeys. The measurement results are not updated during editing but on closing the dialog box ("Edit Sweep List/ Close Sweep List" softkey, see ["Close Sweep List"](#) on page 192).

The changes of the sweep list are only kept until you load another parameter set (by pressing PRESET or by loading an XML file). If you want a parameter set to be available permanently, create an XML file for this configuration (for details refer to "[Format Description of Spectrum Emission Mask XML Files](#)" on page 205).

If you load one of the provided XML files ("Load Standard" softkey, see "[Load Standard](#)" on page 197), the sweep list contains ranges and parameters according to the selected standard. For further details refer also to "[Provided XML Files for the Spectrum Emission Mask Measurement](#)" on page 202.

Note: If you edit the sweep list, always follow the rules and consider the limitations described in "[Ranges and Range Settings](#)" on page 199.

Range Start / Range Stop ← Sweep List dialog box ← Sweep List ← Spectrum Emission Mask

Sets the start frequency/stop frequency of the selected range. Follow the rules described in "[Ranges and Range Settings](#)" on page 199.

In order to change the start/stop frequency of the first/last range, select the appropriate span with the SPAN key. If you set a span that is smaller than the overall span of the ranges, the measurement includes only the ranges that lie within the defined span and have a minimum span of 20 Hz. The first and last ranges are adapted to the given span as long as the minimum span of 20 Hz is not violated.

Frequency values for each range have to be defined relative to the center frequency. The reference range has to be centered on the center frequency. The minimum span of the reference range is given by the current TX Bandwidth.

Remote command:

`[SENSe:]ESpectrum:RANGe<range>[:FREQuency]:START` on page 796

`[SENSe:]ESpectrum:RANGe<range>[:FREQuency]:STOP` on page 796

Fast SEM ← Sweep List dialog box ← Sweep List ← Spectrum Emission Mask

Activates "Fast SEM" mode for all ranges in the sweep list. For details see "[Fast Spectrum Emission Mask Measurements](#)" on page 211.

Note: If "Fast SEM" mode is deactivated while [Symmetric Setup](#) mode is on, "Symmetrical Setup" mode is automatically also deactivated.

If "Fast SEM" mode is activated while "Symmetrical Setup" mode is on, not all range settings can be set automatically.

Remote command:

`[SENSe:]ESpectrum:HighSPeed` on page 792

Filter Type ← Sweep List dialog box ← Sweep List ← Spectrum Emission Mask

Sets the filter type for this range. For details on filters see also [chapter 4.1.6.3, "Selecting the Appropriate Filter Type"](#), on page 85.

Remote command:

`[SENSe:]ESpectrum:RANGe<range>:FILTer:TYPE` on page 795

RBW ← Sweep List dialog box ← Sweep List ← Spectrum Emission Mask

Sets the RBW value for this range.

Remote command:

`[SENSe:]ESpectrum:RANGe<range>:BANDwidth[:RESolution]` on page 794

VBW ← Sweep List dialog box ← Sweep List ← Spectrum Emission Mask

Sets the VBW value for this range.

Remote command:

[\[SENSe:\]ESpectrum:RANGe<range>:BANDwidth:VIDeo](#) on page 794

Sweep Time Mode ← Sweep List dialog box ← Sweep List ← Spectrum Emission Mask

Activates or deactivates the auto mode for the sweep time.

Remote command:

[\[SENSe:\]ESpectrum:RANGe<range>:SWEep:TIME:AUTO](#) on page 801

Sweep Time ← Sweep List dialog box ← Sweep List ← Spectrum Emission Mask

Sets the sweep time value for the range.

Remote command:

[\[SENSe:\]ESpectrum:RANGe<range>:SWEep:TIME](#) on page 800

Ref. Level ← Sweep List dialog box ← Sweep List ← Spectrum Emission Mask

Sets the reference level for the range.

Remote command:

[\[SENSe:\]ESpectrum:RANGe<range>:RLEVel](#) on page 800

RF Att. Mode ← Sweep List dialog box ← Sweep List ← Spectrum Emission Mask

Activates or deactivates the auto mode for RF attenuation.

Remote command:

[\[SENSe:\]ESpectrum:RANGe<range>:INPut:ATTenuation:AUTO](#) on page 797

RF Attenuator ← Sweep List dialog box ← Sweep List ← Spectrum Emission Mask

Sets the attenuation value for that range.

Remote command:

[\[SENSe:\]ESpectrum:RANGe<range>:INPut:ATTenuation](#) on page 797

Preamp ← Sweep List dialog box ← Sweep List ← Spectrum Emission Mask

Switches the preamplifier on or off.

Remote command:

[\[SENSe:\]ESpectrum:RANGe<range>:INPut:GAIN:STATe](#) on page 797

Transd. Factor ← Sweep List dialog box ← Sweep List ← Spectrum Emission Mask

Sets a transducer for the specified range. You can only choose a transducer that fulfills the following conditions:

- The transducer overlaps or equals the span of the range.
- The x-axis is linear.
- The unit is dB.

Remote command:

[\[SENSe:\]ESpectrum:RANGe<range>:TRANsducer](#) on page 801

Limit Check 1-4 ← Sweep List dialog box ← Sweep List ← Spectrum Emission Mask

Sets the type of limit check for all ranges.

For details on limit checks see ["Working with Limit Lines in SEM Measurements"](#) on page 201.

For details on limit checks see the base unit description ["Working with Lines in SEM"](#).

The limit state affects the availability of all limit settings (["Abs Limit Start"](#) on page 191, ["Abs Limit Stop"](#) on page 191, ["Rel Limit Start"](#) on page 191, ["Rel Limit Stop"](#) on page 191).

Depending on the number of active power classes (see ["Power Class"](#) dialog box), the number of limits that can be set varies. Up to four limits are possible. The sweep list is extended accordingly.

Remote command:

[\[SENSe:\]ESpectrum:RANGe<range>:LIMit<source>:STATe](#) on page 800
[CALCulate<n>:LIMit<k>:FAIL?](#) on page 582

Abs Limit Start ← Sweep List dialog box ← Sweep List ← Spectrum Emission Mask

Sets an absolute limit value at the start frequency of the range [dBm].

This parameter is only available if the limit check is set accordingly (see ["Limit Check 1-4"](#) on page 191).

Remote command:

[\[SENSe:\]ESpectrum:RANGe<range>:LIMit<source>:ABSolute:START](#)
on page 798

Abs Limit Stop ← Sweep List dialog box ← Sweep List ← Spectrum Emission Mask

Sets an absolute limit value at the stop frequency of the range [dBm].

This parameter is only available if the limit check is set accordingly (see ["Limit Check 1-4"](#) on page 191).

Remote command:

[\[SENSe:\]ESpectrum:RANGe<range>:LIMit<source>:ABSolute:STOP](#)
on page 798

Rel Limit Start ← Sweep List dialog box ← Sweep List ← Spectrum Emission Mask

Sets a relative limit value at the start frequency of the range [dBc].

This parameter is only available if the limit check is set accordingly (see ["Limit Check 1-4"](#) on page 191).

Remote command:

[\[SENSe:\]ESpectrum:RANGe<range>:LIMit<source>:RELative:START](#)
on page 799

Rel Limit Stop ← Sweep List dialog box ← Sweep List ← Spectrum Emission Mask

Sets a relative limit value at the stop frequency of the range [dBc].

This parameter is only available if the limit check is set accordingly (see "[Sweep List dialog box](#)" on page 188).

Remote command:

`[SENSe:]ESpectrum:RANGe<range>:LIMit<source>:RELative:STOP`
on page 799

Close Sweep List ← Sweep List ← Spectrum Emission Mask

Closes the "Sweep List" dialog box and updates the measurement results.

Insert before Range ← Sweep List ← Spectrum Emission Mask

Inserts a new range to the left of the currently focused range. The range numbers of the currently focused range and all higher ranges are increased accordingly. The maximum number of ranges is 20.

For further details refer to "[Ranges and Range Settings](#)" on page 199.

Remote command:

`ESP:RANG3:INS BEF`, see `[SENSe:]ESpectrum:RANGe<range>:INSert`
on page 798

Insert after Range ← Sweep List ← Spectrum Emission Mask

Inserts a new range to the right of the currently focused range. The range numbers of all higher ranges are increased accordingly. The maximum number of ranges is 20.

For further details refer to "[Ranges and Range Settings](#)" on page 199.

Remote command:

`ESP:RANG1:INS AFT`, see `[SENSe:]ESpectrum:RANGe<range>:INSert`
on page 798

Delete Range ← Sweep List ← Spectrum Emission Mask

Deletes the currently focused range, if possible. The range numbers are updated accordingly. For further details refer to "[Ranges and Range Settings](#)" on page 199.

Remote command:

`[SENSe:]ESpectrum:RANGe<range>:DELete` on page 795

Symmetric Setup ← Sweep List ← Spectrum Emission Mask

If activated, the current sweep list configuration is changed to define a symmetrical setup regarding the reference range. The number of ranges to the left of the reference range is reflected to the right, i.e. any missing ranges on the right are inserted, while superfluous ranges are removed. The values in the ranges to the right of the reference range are adapted symmetrically to those in the left ranges.

Any changes to the range settings in active "Symmetric Setup" mode lead to symmetrical changes in the other ranges (where possible). In particular, this means:

- Inserting ranges: a symmetrical range is inserted on the other side of the reference range
- Deleting ranges: the symmetrical range on the other side of the reference range is also deleted
- Editing range settings: the settings in the symmetrical range are adapted accordingly

Note: If "Fast SEM" mode is deactivated while "Symmetric Setup" mode is on, "Sym Setup" mode is automatically also deactivated.
If "Fast SEM" mode is activated while "Symmetric Setup" mode is on, not all range settings can be set automatically.

Edit Reference Range ← Sweep List ← Spectrum Emission Mask

Opens the "Reference Range" dialog box to edit the additional settings used for SEM measurements.

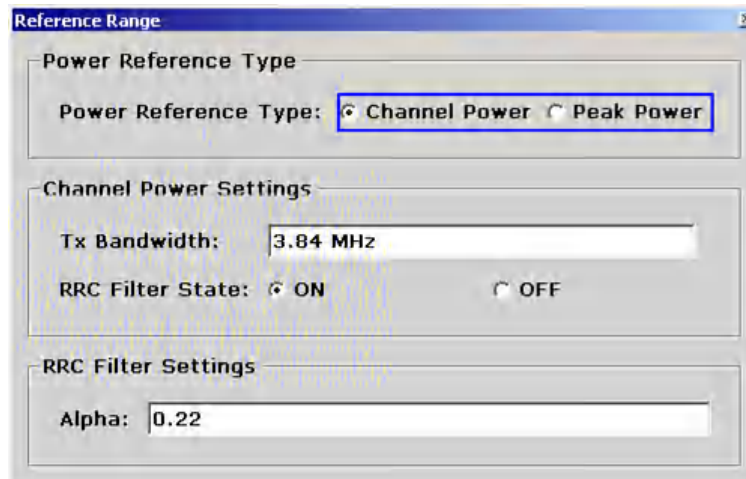

Two different power reference types are supported:

- "Peak Power"
Measures the highest peak within the reference range.
- "Channel Power"
Measures the channel power within the reference range (integral bandwidth method).
If the "Channel Power" reference power type is activated, the dialog box is extended to define additional settings:
- "Tx Bandwidth"
Defines the bandwidth used for measuring the channel power:
minimum span ≤ value ≤ span of reference range
- "RRC Filter State"
Activates or deactivates the use of an RRC filter.
- "RRC Filter Settings"
Sets the alpha value of the RRC filter. This window is only available if the RRC filter is activated.

For further details refer to ["Ranges and Range Settings"](#) on page 199.

Remote command:

[SENSe:]ESpectrum:RTYPE on page 802

[SENSe:]ESpectrum:BWID on page 791

[SENSe:]ESpectrum:FILTer[:RRC][:STATe] on page 792

[SENSe:]ESpectrum:FILTer[:RRC]:ALPHa on page 792

List Evaluation ← Spectrum Emission Mask

Opens a submenu to edit the list evaluation settings.

List Evaluation (On/Off) ← List Evaluation ← Spectrum Emission Mask

Activates or deactivates the list evaluation.

Remote command:

Turning list evaluation on and off:

[CALCulate<n>:PEAKsearch|PSEarch:AUTO](#) on page 692

Querying list evaluation results:

[TRACe<n>\[:DATA\]?](#) on page 889

Margin ← List Evaluation ← Spectrum Emission Mask

Opens an edit dialog box to enter the margin used for the limit check/peak search.

Remote command:

[CALCulate<n>:PEAKsearch|PSEarch:MARGin](#) on page 692

Show Peaks ← List Evaluation ← Spectrum Emission Mask

In the diagram, marks all peaks with blue squares that have been listed during an active list evaluation.

Remote command:

[CALCulate<n>:ESpectrum:PSEarch|:PEAKsearch:PSHow](#) on page 579

Save Evaluation List ← List Evaluation ← Spectrum Emission Mask

Opens the "ASCII File Export Name" dialog box to save the result in ASCII format to a specified file and directory. For further details refer also to the "ASCII File Export" softkey ("[ASCII File Export](#)" on page 135).

Remote command:

[MMEMy:STORe<n>:LIST](#) on page 742

ASCII File Export ← Save Evaluation List ← List Evaluation ← Spectrum Emission Mask

Opens the "ASCII File Export Name" dialog box and saves the active peak list in ASCII format to the specified file and directory.

The file consists of the header containing important scaling parameters and a data section containing the marker data. For details on an ASCII file see [chapter 4.1.8.7, "ASCII File Export Format"](#), on page 107.

This format can be processed by spreadsheet calculation programs, e.g. MS-Excel. It is necessary to define ';' as a separator for the data import. Different language versions of evaluation programs may require a different handling of the decimal point. It is therefore possible to select between separators '.' (decimal point) and ',' (comma) using the "Decim Sep" softkey (see "[Decim Sep](#)" on page 100).

An example of an output file for Spectrum Emission Mask measurements is given in "[ASCII File Export Format \(Spectrum Emission Mask\)](#)" on page 210.

Remote command:

[FORMat:DEXPort:DSEParator](#) on page 728

[MMEMy:STORe<n>:LIST](#) on page 742

Decim Sep ← Save Evaluation List ← List Evaluation ← Spectrum Emission Mask

Selects the decimal separator with floating-point numerals for the ASCII Trace export to support evaluation programs (e.g. MS-Excel) in different languages. The values '.' (decimal point) and ',' (comma) can be set.

Remote command:

[FORMat:DEXPort:DSEParator](#) on page 728

Edit Reference Range ← Spectrum Emission Mask

Opens the "Reference Range" dialog box to edit the additional settings used for SEM measurements.

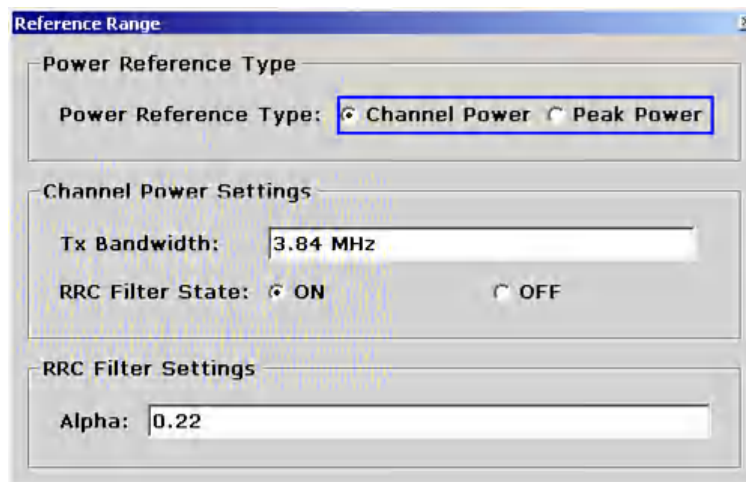

Two different power reference types are supported:

- "Peak Power"
Measures the highest peak within the reference range.
- "Channel Power"
Measures the channel power within the reference range (integral bandwidth method).
If the "Channel Power" reference power type is activated, the dialog box is extended to define additional settings:
- "Tx Bandwidth"
Defines the bandwidth used for measuring the channel power:
minimum span ≤ value ≤ span of reference range
- "RRC Filter State"
Activates or deactivates the use of an RRC filter.
- "RRC Filter Settings"
Sets the alpha value of the RRC filter. This window is only available if the RRC filter is activated.

For further details refer to "[Ranges and Range Settings](#)" on page 199.

Remote command:

[\[SENSe:\]ESpectrum:RTYPE](#) on page 802

[\[SENSe:\]ESpectrum:BWID](#) on page 791

[\[SENSe:\]ESpectrum:FILTer\[:RRC\]\[:STATE\]](#) on page 792

[\[SENSe:\]ESpectrum:FILTer\[:RRC\]:ALPHA](#) on page 792

Edit Power Classes ← Spectrum Emission Mask

Opens a dialog box to modify the power class settings.

Power Class	PMin	<=P<	PMax
Power Class 1	-INF		-63.5 dBm
Power Class 2	-63.5 dBm		-40.0 dBm
Power Class 3	-40.0 dBm		+INF

Used Power Classes ← Edit Power Classes ← Spectrum Emission Mask

Choose the power classes to be used from this dropdown menu. It is only possible to select either one of the defined power classes or all of the defined power classes together.

Only power classes for which limits are defined are available for selection.

If "All" is selected, the power class that corresponds to the currently measured power in the reference range is used. The limits assigned to that power class are applied (see "PMin/PMax" on page 196).

Remote command:

```
CALCulate<n>:LIMit<k>:ESpectrum:PClass<Class>[:EXCLUSIVE]
```

on page 597

To define all limits in one step:

```
CALCulate<n>:LIMit<k>:ESpectrum:PClass<Class>:LIMit[:STATE]
```

on page 598

PMin/PMax ← Edit Power Classes ← Spectrum Emission Mask

Defines the level limits for each power class. The range always starts at -200 dBm (-INF) and always stops at 200 dBm (+INF). These fields cannot be modified. If more than one Power Class is defined, the value of "PMin" must be equal to the value of "PMax" of the last Power Class and vice versa.

Note that the power level may be equal to the lower limit, but must be lower than the upper limit:

$$P_{\min} \leq P < P_{\max}$$

Remote command:

[CALCulate<n>:LIMIT<k>:ESpectrum:PClass<Class>:MINimum](#) on page 599

[CALCulate<n>:LIMIT<k>:ESpectrum:PClass<Class>:MAXimum](#) on page 598

Sweep List ← Edit Power Classes ← Spectrum Emission Mask

See "[Sweep List](#)" on page 188

Add/Remove ← Edit Power Classes ← Spectrum Emission Mask

Activates or deactivates power classes to be defined. Up to four power classes can be defined. The number of active power classes affects the availability of the items of the Used Power Classes dropdown menu.

Remote command:

[CALCulate<n>:LIMIT<k>:ESpectrum:PClass<Class>\[:EXCLUSIVE\]](#)

on page 597

Load Standard ← Spectrum Emission Mask

Opens a dialog box to select an XML file which includes the desired standard specification. For details on the provided XML files refer to "[Provided XML Files for the Spectrum Emission Mask Measurement](#)" on page 202.

Remote command:

[\[SENSe:\]ESpectrum:PRESet\[:STANDARD\]](#) on page 793

Save As Standard ← Spectrum Emission Mask

Opens the "Save As Standard" dialog box, in which the currently used SEM settings and parameters can be saved and exported into an *.xml file. Enter the name of the file in the "File name" field. For details on the structure and contents of the XML file refer to "[Format Description of Spectrum Emission Mask XML Files](#)" on page 205.

Remote command:

[\[SENSe:\]ESpectrum:PRESet:STORe](#) on page 794

Meas Start/Stop ← Spectrum Emission Mask

Aborts/restarts the current measurement and displays the status:

"Start" The measurement is currently running.

"Stop" The measurement has been stopped, or, in single sweep mode, the end of the sweep has been reached.

Remote command:

[ABORt](#) on page 555

[INITiate<n>:ESpectrum](#) on page 731

Restore Standard Files ← Spectrum Emission Mask

Copies the XML files from the C:\R_S\instr\sem_backup folder to the C:\R_S\instr\sem_std folder. Files of the same name are overwritten.

Remote command:

[\[SENSe:\]ESpectrum:PRESet:RESTore](#) on page 793

Result Evaluation

As a result of the Spectrum Emission Mask measurement, the measured signal levels, the result of the limit check (mask monitoring) and the defined limit line are displayed in a diagram (see also ["Working with Limit Lines in SEM Measurements"](#) on page 201). Furthermore, the TX channel power "P" is indicated in relation to the defined power class ranges.

Example:

For example, "P<31" is indicated if the lowest power class is defined from infinity to 31 and the power is currently 17 dBm.

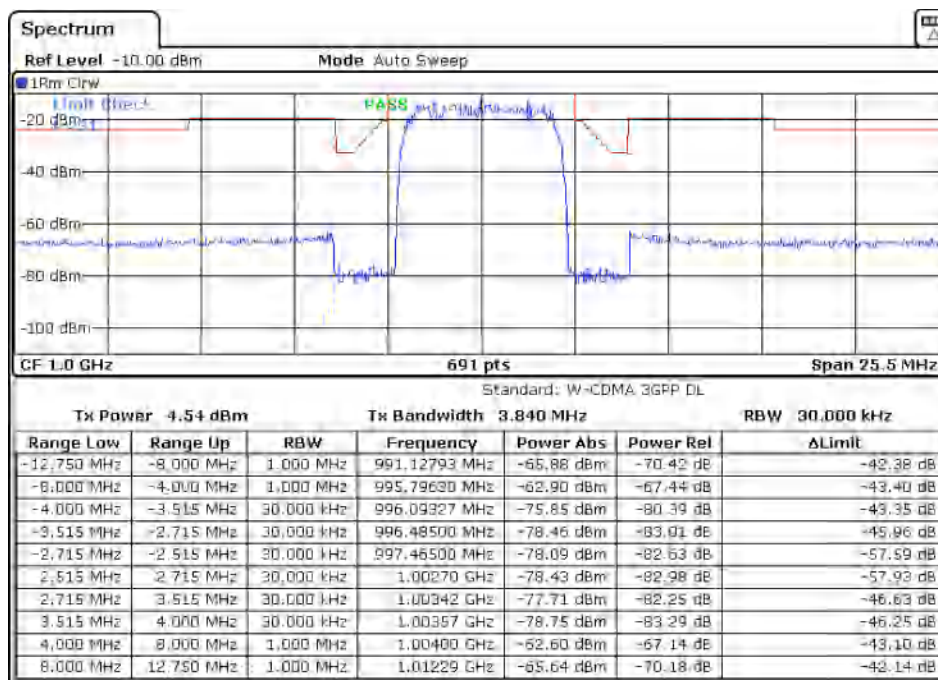

In addition to the graphical results of the SEM measurement displayed in the diagram, a result table is displayed to evaluate the limit check results (see also ["Working with Limit Lines in SEM Measurements"](#) on page 201).

The following information is provided in the result table:

Label	Description
General Information	
Standard	Loaded standard settings
Tx Power	Tx channel power
Tx Bandwidth	Tx channel bandwidth
RBW	RBW for the Tx channel
Range results	
Range Low	Frequency range start for range the peak value belongs to

Label	Description
Range Up	Frequency range stop for range the peak value belongs to
RBW	RBW of the range
Frequency	Frequency
Power Abs	Absolute power level
Power Rel	Power level relative to the TX channel power
ΔLimit	Deviation of the power level from the defined limit

In which detail the data is displayed in the result table can be defined in the [List Evaluation](#) menu. By default, one peak per range is displayed. However, you can change the settings to display only peaks that exceed a threshold ("Margin").

In addition to listing the peaks in the list evaluation, detected peaks can be indicated by blue squares in the diagram ("Show Peaks").

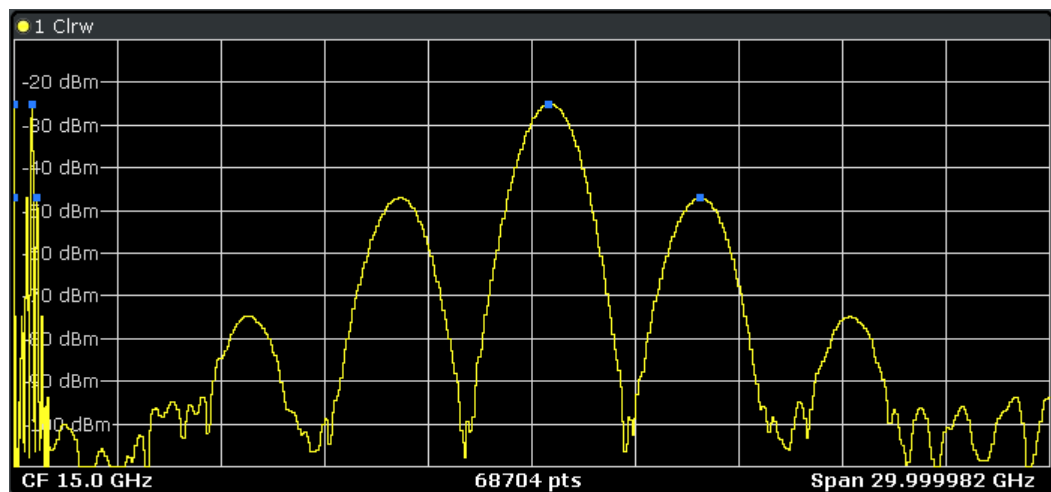

Furthermore, you can save the evaluation list to a file ("Save Evaluation List").

Retrieving Results via Remote Control

The measurement results of the spectrum emission mask test can be retrieved using the `CALCulate<n>:LIMit<k>:FAIL?` command from a remote computer.

The power result for the reference range can be queried using `CALC:MARK:FUNC:POW:RES? CPOW`, the peak power for the reference range using `CALC:MARK:FUNC:POW:RES? PPOW`.

For details see `CALCulate<n>:MARKer<m>:FUNction:POWer:RESult?` on page 651.

Ranges and Range Settings

In the Spectrum Emission Mask measurements, a range defines a segment for which you can define the following parameters separately:

- Start and stop frequency

- RBW
- VBW
- Sweep time
- Sweep points
- Reference level
- Attenuator settings
- Limit values

Via the sweep list, you define the ranges and their settings. For details on settings refer to "[Sweep List dialog box](#)" on page 188.

For details on defining the limits (masks) see "[Working with Limit Lines in SEM Measurements](#)" on page 201.

For details on defining the limits (masks) see the base unit description "[Working with Lines in SEM](#)".

The following rules apply to ranges:

- The minimum span of a range is 20 Hz.
- The individual ranges must not overlap (but need not directly follow one another).
- The maximum number of ranges is 20.
- A minimum of three ranges is mandatory.
- The reference range cannot be deleted (it is marked in blue color).
- The reference range has to be centered on the center frequency.
- The minimum span of the reference range is given by the current TX Bandwidth.
- Frequency values for each range have to be defined relative to the center frequency.

In order to change the start frequency of the first range or the stop frequency of the last range, select the appropriate span with the SPAN key. If you set a span that is smaller than the overall span of the ranges, the measurement includes only the ranges that lie within the defined span and have a minimum span of 20 Hz. The first and last ranges are adapted to the given span as long as the minimum span of 20 Hz is not violated.



Symmetrical ranges

You can easily define a sweep list with symmetrical range settings, i.e. the ranges to the left and right of the center range are defined symmetrically. In the "Sweep List" menu, select the "Symmetrical Setup" softkey to activate symmetrical setup mode. The current sweep list configuration is changed to define a symmetrical setup regarding the reference range. The number of ranges to the left of the reference range is reflected to the right, i.e. any missing ranges on the right are inserted, while superfluous ranges are removed. The values in the ranges to the right of the reference range are adapted symmetrically to those in the left ranges.

For details see "[Symmetric Setup](#)" on page 192.

Symmetrical ranges fulfill the conditions required for "Fast SEM" mode (see "[Fast Spectrum Emission Mask Measurements](#)" on page 211).

Working with Limit Lines in SEM Measurements

Using the R&S FSVR, the spectrum emission mask is defined using limit lines. Limit lines allow you to check the measured data against specified limit values. Generally, it is possible to define limit lines for any measurement in Spectrum mode using the LINES key. For SEM measurements, however, special limit lines are available via the "Sweep List", and it is strongly recommended that you use only these limit line definitions.

In the "Sweep List" you can define a limit line for each power class that varies its level according to the specified frequency ranges. Distinguished limit lines ("_SEM_LINE_ABS<0...3>"/ "_SEM_LINE_REL<0...3>") are automatically defined for each power class according to the current "Sweep List" settings every time the settings change.

The limit line defined for the current power class is indicated by a red line in the display, and the result of the limit check is indicated at the top of the diagram. Note that only "Pass" or "Fail" is indicated; a "margin" function as for general limit lines is not available.

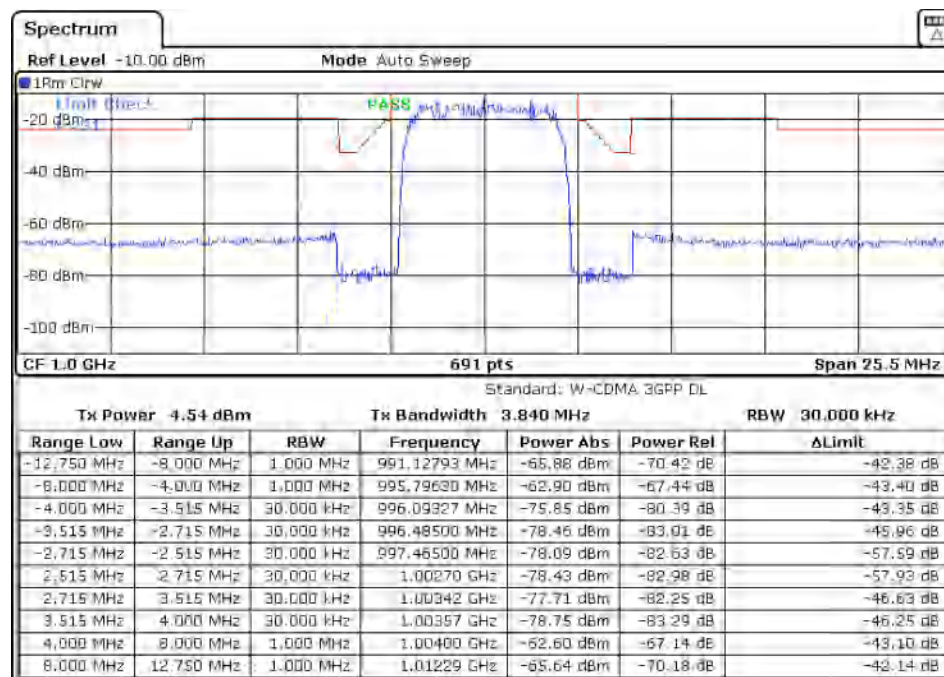

The indicated limit line depends on the settings in the "Sweep List". Several types of limit checks are possible:

Limit check type	Pass/fail criteria	Indicated limit line
Absolute	Absolute power levels may not exceed limit line	Defined by the "Abs Limit Start"/ "Abs Limit Stop" values for each range
Relative	Power deviations relative to the TX channel power may not exceed limit line	Defined by the "Rel Limit Start"/ "Rel Limit Stop" values (relative to the center frequency) for each range

Limit check type	Pass/fail criteria	Indicated limit line
Abs and Rel	Only if the power exceeds both the absolute and the relative limits, the check fails.	The less strict (higher) limit line is displayed for each range.
Abs or Rel	If the power exceeds either the absolute or the relative limits, the check fails.	The stricter (lower) limit line is displayed for each range.

The largest deviations of the power from the limit line for each range are displayed in the evaluation list. Furthermore, the absolute powers for those values, as well as the relative deviation from the TX channel power are displayed. Values that exceed the limit are indicated in red and by an asterisk (*).

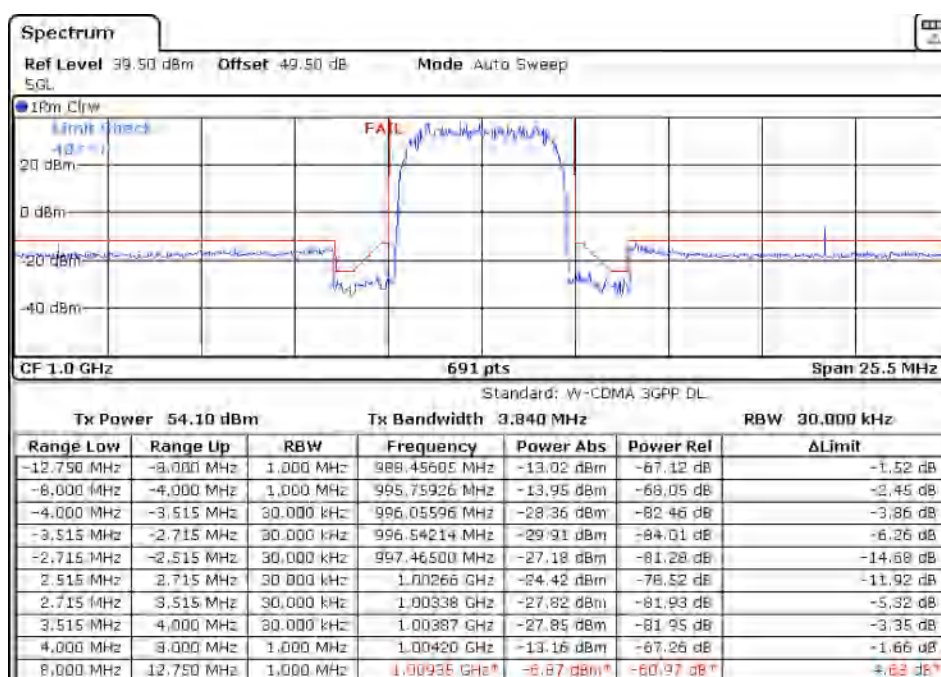

Although a margin functionality is not available for the limit check, a margin (threshold) for the peak values to be displayed in the evaluation list can be defined in the list evaluation settings. For details see ["Result Evaluation"](#) on page 198.

Provided XML Files for the Spectrum Emission Mask Measurement

You can change the settings manually or via XML files. The XML files offer a quick way to change the configuration. A set of ready-made XML files for different standards is already provided. For details see [table 4-5](#). You can also create and use your own XML files (for details see ["Format Description of Spectrum Emission Mask XML Files"](#) on page 205). All XML files are stored under "C:\r_s\instr\sem_std". Use the "Load Standard" softkey for quick access to the available XML files (see ["Load Standard"](#) on page 197).

Table 4-5: Provided XML files

Path	XML file name	Displayed standard characteristics*
cdma2000\DL	default0.xml	CDMA2000 BC0 DL
	default1.xml	CDMA2000 BC1 DL
cdma2000\UL	default0.xml	CDMA2000 BC0 UL
	default1.xml	CDMA2000 BC1 UL
WCDMA\3GPP\DL	PowerClass_31_39.xml	W-CDMA 3GPP (31,39)dBm DL
	PowerClass_39_43.xml	W-CDMA 3GPP (39,43)dBm DL
	PowerClass_43_INF.xml	W-CDMA 3GPP (43,INF)dBm DL
	PowerClass_negINF_31.xml	W-CDMA 3GPP (-INF,31)dBm DL
WIBRO\DL	PowerClass_29_40.xml	WiBro TTA (29,40)dBm DL
	PowerClass_40_INF.xml	WiBro TTA (40,INF)dBm DL
	PowerClass_negINF_29.xml	WiBro TTA (-INF,29)dBm DL
WIBRO\UL	PowerClass_23_INF.xml	WiBro TTA (23,INF)dBm UL
	PowerClass_negINF_23.xml	WiBro TTA (23,INF)dBm UL
WIMAX\DL\ETSI...MHz (1.75 MHz, 2.00 MHz, 3.5 MHz, 7.00 MHz, 14.00 MHz, 28 MHz)	System_Type_E.xml	WIMAX System Type E DL
	System_Type_F.xml	WIMAX System Type F DL
	System_Type_G.xml	WIMAX System Type G DL
WIMAX\DL\IEEE	10MHz.xml	WIMAX 10MHz DL
	20MHz.xml	WIMAX 20MHz DL
WIMAX\UL\ETSI...MHz (1.75 MHz, 2.00 MHz, 3.5 MHz, 7.00 MHz, 14.00 MHz, 28 MHz)	System_Type_E.xml	WIMAX System Type E UL
	System_Type_F.xml	WIMAX System Type F UL
	System_Type_G.xml	WIMAX System Type G UL
WIMAX\UL\IEEE	10MHz.xml	WIMAX 10MHz UL
	20MHz.xml	WIMAX 20MHz UL
WLAN\802_11_TURBO	ETSI.xml	IEEE 802.11
	IEEE.xml	IEEE 802.11
WLAN\802_11a	ETSI.xml	IEEE 802.11a
	IEEE.xml	IEEE 802.11a
WLAN\802_11b	IEEE.xml	IEEE 802.11b
WLAN\802_11j_10MHz	ETSI.xml	IEEE.802.11j

Path	XML file name	Displayed standard characteristics*
	IEEE.xml	IEEE.802.11j
WLAN\802_11j_20MHz	ETSI.xml	IEEE 802.11j
	IEEE.xml	IEEE 802.11j
EUTRA-LTE\DL\CategoryA\	BW_01_4_MHz__CFhigher1GHz.xml	LTE Cat. A >1GHz DL
EUTRA-LTE\DL\CategoryA\	BW_01_4_MHz__CFlower1GHz.xml	LTE Cat. A <1GHz DL
EUTRA-LTE\DL\CategoryA\	BW_03_0_MHz__CFhigher1GHz.xml	LTE Cat. A >1GHz DL
EUTRA-LTE\DL\CategoryA\	BW_03_0_MHz__CFlower1GHz.xml	LTE Cat. A <1GHz DL
EUTRA-LTE\DL\CategoryA\	BW_05_0_MHz__CFhigher1GHz.xml	LTE Cat. A >1GHz DL
EUTRA-LTE\DL\CategoryA\	BW_05_0_MHz__CFlower1GHz.xml	LTE Cat. A <1GHz DL
EUTRA-LTE\DL\CategoryA\	BW_10_0_MHz__CFhigher1GHz.xml	LTE Cat. A >1GHz DL
EUTRA-LTE\DL\CategoryA\	BW_10_0_MHz__CFlower1GHz.xml	LTE Cat. A >1GHz DL
EUTRA-LTE\DL\CategoryA\	BW_15_0_MHz__CFhigher1GHz.xml	LTE Cat. A >1GHz DL
EUTRA-LTE\DL\CategoryA\	BW_15_0_MHz__CFlower1GHz.xml	LTE Cat. A <1GHz DL
EUTRA-LTE\DL\CategoryA\	BW_20_0_MHz__CFhigher1GHz.xml	LTE Cat. A >1GHz DL
EUTRA-LTE\DL\CategoryA\	BW_20_0_MHz__CFlower1GHz.xml	LTE Cat. A <1GHz DL
EUTRA-LTE\DL\CategoryB\	BW_01_4_MHz__CFhigher1GHz.xml	LTE Cat. B >1GHz DL
EUTRA-LTE\DL\CategoryB\	BW_01_4_MHz__CFlower1GHz.xml	LTE Cat. B <1GHz DL
EUTRA-LTE\DL\CategoryB\	BW_03_0_MHz__CFhigher1GHz.xml	LTE Cat. B >1GHz DL
EUTRA-LTE\DL\CategoryB\	BW_03_0_MHz__CFlower1GHz.xml	LTE Cat. B <1GHz DL
EUTRA-LTE\DL\CategoryB\	BW_05_0_MHz__CFhigher1GHz.xml	LTE Cat. B >1GHz DL
EUTRA-LTE\DL\CategoryB\	BW_05_0_MHz__CFlower1GHz.xml	LTE Cat. B <1GHz DL
EUTRA-LTE\DL\CategoryB\	BW_10_0_MHz__CFhigher1GHz.xml	LTE Cat. B >1GHz DL
EUTRA-LTE\DL\CategoryB\	BW_10_0_MHz__CFlower1GHz.xml	LTE Cat. B >1GHz DL
EUTRA-LTE\DL\CategoryB\	BW_15_0_MHz__CFhigher1GHz.xml	LTE Cat. B >1GHz DL
EUTRA-LTE\DL\CategoryB\	BW_15_0_MHz__CFlower1GHz.xml	LTE Cat. B <1GHz DL
EUTRA-LTE\DL\CategoryB\	BW_20_0_MHz__CFhigher1GHz.xml	LTE Cat. B >1GHz DL
EUTRA-LTE\DL\CategoryB\	BW_20_0_MHz__CFlower1GHz.xml	LTE Cat. B <1GHz DL

Path	XML file name	Displayed standard characteristics*
EUTRA-LTEUL\Standard\	BW_05_0_MHz.xml	LTE UL
EUTRA-LTEUL\Standard\	BW_10_0_MHz.xml	LTE UL
EUTRA-LTEUL\Standard\	BW_15_0_MHz.xml	LTE UL
EUTRA-LTEUL\Standard\	BW_20_0_MHz.xml	LTE UL

*Used abbreviations:

BC: band class

UL: uplink

DL: downlink

TTA: Telecommunications Technology Association

Format Description of Spectrum Emission Mask XML Files

The files for importing range settings are in XML format and therefore obey the rules of the XML standard. Below, the child nodes, attributes, and structure defined for the data import is described. Build your own XML files according to these conventions because the R&S FSVR can only interpret XML files of a known structure. For example files look in the C:\r_s\instr\sem_std directory.

Spectrum Emission Mask							Standard: W-CDMA 3GPP (39,43)dBm DL	
Tx Power		Tx Bandwidth		RBW				
-47.93 dBm		3.840 MHz		30.000 kHz				
Range Low	Range Up	RBW	Frequency	Power Abs	Power Rel	ΔLimit		
-12.750 MHz	-8.000 MHz	1.000 MHz	14.99094 GHz*	-74.76 dBm*	-26.83 dB*	27.67 dB*		
-8.000 MHz	-4.000 MHz	1.000 MHz	14.99598 GHz	-36.79 dBm	11.14 dB	-25.29 dB		
-4.000 MHz	-3.515 MHz	30.000 kHz	14.99628 GHz	-100.18 dBm	-52.25 dB	-75.68 dB		
-3.515 MHz	-2.715 MHz	30.000 kHz	14.99648 GHz	-103.55 dBm	-55.63 dB	-79.05 dB		
-2.715 MHz	-2.515 MHz	30.000 kHz	14.99747 GHz	-108.91 dBm	-60.98 dB	-96.41 dB		
2.515 MHz	2.715 MHz	30.000 kHz	15.00251 GHz	-48.25 dBm	-0.32 dB	-35.75 dB		
2.715 MHz	3.515 MHz	30.000 kHz	15.00272 GHz	-52.48 dBm	-4.56 dB	-39.98 dB		
3.515 MHz	4.000 MHz	30.000 kHz	15.00398 GHz	-74.53 dBm	-26.60 dB	-50.03 dB		
4.000 MHz	8.000 MHz	1.000 MHz	15.00769 GHz	-74.76 dBm	-26.83 dB	-63.26 dB		
8.000 MHz	12.750 MHz	1.000 MHz	15.01273 GHz*	-36.79 dBm*	11.14 dB*	65.64 dB*		

Fig. 4-14: Example Spectrum emission mask standard file (PowerClass_39_43.xml)



Be sure to follow the structure exactly as shown below or else the R&S FSVR is not able to interpret the XML file and error messages are shown on the screen. Therefore, we recommend you make a copy of an existing file (see [Save As Standard](#) softkey) and edit the copy of the file.

Alternatively, edit the settings using the "Spectrum Emission Mask" softkey and the [Sweep List dialog box](#) and save the XML file with the [Save As Standard](#) softkey afterwards. This way, no modifications have to be done in the XML file itself.

Basically, the file consists of three elements that can be defined:

- The "BaseFormat" element
- The "PowerClass" element

- The "Range" element

The "BaseFormat" element

It carries information about basic settings. In this element only the "ReferencePower" child node has any effects on the measurement itself. The other attributes and child nodes are used to display information about the Spectrum Emission Mask Standard on the measurement screen. The child nodes and attributes of this element are shown in [table 4-6](#).

In the example above (`PowerClass_39_43.xml` under `C:\r_s\instr\sem_std\WCDMA\3GPP`, see [figure 4-14](#)), these attributes are defined as follows:

- `Standard="W-CDMA 3GPP"`
- `LinkDirection="DL"`
- `PowerClass="(39,43)dBm"`

The "PowerClass" element

It is embedded in the "BaseFormat" element and contains settings information about the power classes. Up to four different power classes can be defined. For details refer to the "Sweep List" softkey ("[Sweep List](#)" on page 188) and the corresponding parameter description. The child nodes and attributes of this element are shown in [table 4-7](#).

The "Range" element

This element is embedded in the "PowerClass" element. It contains the settings information of the range. There have to be at least three defined ranges: one reference range and at least one range to either side of the reference range. The maximum number of ranges is 20. Note that the R&S FSVR uses the same ranges in each power class. Therefore, the contents of the ranges of each defined power class have to be identical to the first power class. An exception are the Start and Stop values of the two Limit nodes that are used to determine the power class. Note also, that there are two Limit nodes to be defined: one that gives the limit in absolute values and one in relative values. Make sure units for the Start and Stop nodes are identical for each Limit node.

For details refer to the "Sweep List" softkey ("[Sweep List](#)" on page 188) and the corresponding parameter description. The child nodes and attributes of this element are shown in [table 4-8](#).

The following tables show the child nodes and attributes of each element and show if a child node or attribute is mandatory for the R&S FSVR to interpret the file or not. Since the hierarchy of the XML can not be seen in the tables, either view one of the default files already stored on the R&S FSVR in the "C:\r_s\instr\sem_std" directory or check the structure as shown below.

Below, a basic example of the structure of the file is shown, containing all mandatory attributes and child nodes. Note that the "PowerClass" element and the range element are themselves elements of the "BaseFormat" element and are to be inserted where noted. The separation is done here simply for reasons of a better overview. Also, no example values are given here to allow a quick reference to the tables above. *Italic font* shows the placeholders for the values.

- The "BaseFormat" element is structured as follows:
 - `<RS_SEM_ACP_FileFormat Version=""1.0.0.0"">`
`<Name>"Standard"</Name>`
`<Instrument>`
`<Type>"Instrument Type"</Type>`
`<Application>"Application"</Application>`
`</Instrument>`
`<LinkDirection Name=""Name"">`
`<ReferencePower>`
`<Method>"Method"</Method>`
`</ReferencePower>`
`<PowerClass Index=""n"">`
`<!-- For contents of the PowerClass node see`
`table 4-7 -->`
`<!-- Define up to four PowerClass nodes -->`
`</PowerClass>`
`</LinkDirection>`
`</RS_SEM_ACP_File>`
- The "PowerClass" element is structured as follows:
 - `<PowerClass Index=""n"">`
`<StartPower Unit=""dBm"" InclusiveFlag=""true"" Value=""StartPowerValue""/>`
`<StopPower Unit=""dBm"" InclusiveFlag=""false"" Value=""StopPowerValue""/>`
`<DefaultLimitFailMode>"Limit Fail Mode"</DefaultLimitFailMode>`
`<Range Index=""n"">`
`<!-- For contents of the Range node see table 4-8 -->`
`<!-- Define up to twenty Range nodes -->`
`</Range>`
`...`
`</PowerClass>`
- The "Range" element is structured as follows:
 - `<Range Index=""n"">`
`<Name=""Name"">`
`<ChannelType>"Channel Type"</Channel Type>`
`<WeightingFilter>`
`<Type>"FilterType"</Type>`
`<RollOffFactor>"Factor"</RollOffFactor>`
`<Bandwidth>"Bandwidth"</Bandwidth>`
`</WeightingFilter>`
`<FrequencyRange>`
`<Start>"RangeStart"</Start>`
`<Stop>"RangeStop"</Stop>`
`</FrequencyRange>`
`<Limit>`
`<Start Unit=""Unit"" Value=""Value""/>`
`<Stop Unit=""Unit"" Value=""Value""/>`
`</Limit>`
`<Limit>`
`<Start Unit=""Unit"" Value=""Value""/>`
`<Stop Unit=""Unit"" Value=""Value""/>`

```

</Limit>
<RBW Bandwidth=""Bandwidth"" Type=""FilterType""/>
<VBW Bandwidth=""Bandwidth""/>
<Detector>"Detector"</Detector>
<Sweep Mode=""SweepMode"" Time=""SweepTime""/>
<Amplitude>
<ReferenceLevel Unit=""dBm"" Value=""Value""/>
<RFAttenuation Mode=""Auto"" Unit=""dB"" Value=""Value""/>
<Preamplifier State=""State""/>
</Amplitude>
</Range>

```

Table 4-6: Attributes and child nodes of the BaseFormat element

Child Node	Attribute	Value	Parameter Description	Mand.
	FileFormatVersion	1.0.0.0		Yes
	Date	YYYY-MM-DD HH:MM:SS	Date in ISO 8601 format	No
Name		<string>	Name of the standard	Yes
Instrument	Type	FSL	Name of the instrument	No
	Application	SA K72 K82	Name of the application	No
LinkDirection	Name	Downlink Uplink None		Yes
	ShortName	DL UL		No
Reference- Power				Yes
Method	TX Channel Power TX Channel Peak Power			Yes
Reference- Channel	<string>			No

Table 4-7: Attributes and child nodes of the PowerClass element

Child Node	Attribute	Value	Parameter Description	Mand.
StartPower	Value	<power in dBm>	The start power must be equal to the stop power of the previous power class. The StartPower value of the first range is -200	Yes
	Unit	dBm		Yes
	InclusiveFlag	true		Yes
StopPower	Value	<power in dBm>	The stop power must be equal to the start power of the next power class. The StopPower value of the last range is 200	Yes
	Unit	dBm		

Child Node	Attribute	Value	Parameter Description	Mand.
	InclusiveFlag	false		Yes
DefaultLimitFailMode		Absolute Relative Absolute and Relative Absolute or Relative		Yes

Table 4-8: Attributes and child nodes of the Range element (normal ranges)

Child Node	Attribute	Value	Parameter Description	Mand.
	Index	0...19	Indices are continuous and have to start with 0	Yes
	Name	<string>	Name of the range	Only if ReferenceChannel contains a name and the range is the reference range
	Short-Name	<string>	Short name of the range	No
ChannelType		TX Adjacent		Yes
WeightingFilter				Only if ReferencePower method is TX Channel Power and the range is the reference range
Type		RRC CFilter	Type of the weighting filter	Yes
Roll Off Factor		0...1	Excess bandwidth of the filter	Only if the filter type is RRC
Bandwidth		<bandwidth in Hz>	Filter bandwidth	Only if the filter type is RRC
FrequencyRange				Yes
Start		<frequency in Hz>	Start value of the range	Yes
Stop		<frequency in Hz>	Stop value of the range	Yes
Limit		dBm/Hz dBm dBc dBr dB	A Range must contain exactly two limit nodes; one of the limit nodes has to have a relative unit (e.g. dBc), the other one must have an absolute unit (e.g. dBm)	Yes
Start	Value	<numeric_value>	Power limit at start frequency	Yes
	Unit	dBm/Hz dBm dBc dBr dB	Sets the unit of the start value	
Stop	Value	<numeric_value>	Power limit at stop frequency	

Child Node	Attribute	Value	Parameter Description	Mand.
	Unit	dBm/Hz dBm dBc dBr dB	Sets the unit of the stop value	
LimitFailMode		Absolute Relative Absolute and Relative Absolute or Relative	If used, it has to be identical to DefaultLimitFailMode	No
RBW	Bandwidth	<bandwidth in Hz>	"RBW" on page 189	Yes
	Type	NORM PULS CFIL RRC		No
VBW	Bandwidth	<bandwidth in Hz>	"VBW" on page 190	Yes
Detector		NEG POS SAMP RMS AVER QUAS	If used, it has to be identical in all ranges.	No
Sweep	Mode	Manual Auto	"Sweep Time Mode" on page 190	Yes
	Time	<time in sec>	"Sweep Time" on page 190	No
Amplitude				No
ReferenceLevel	Value	<power in dBm>	"Ref. Level" on page 190	Yes, if the ReferenceLevel child node is used
	Unit	dBm	Defines dBm as unit	Yes, if the ReferenceLevel node is used
RFAttenuation	Mode	Manual Auto	"RF Att. Mode" on page 190	Yes, if the ReferenceLevel child node is used
Preamplifier		ON OFF	"Preamp" on page 190	Yes

ASCII File Export Format (Spectrum Emission Mask)

The first part of the file lists information about the signal analyzer and the general setup. For a detailed description refer to [chapter 4.1.8.7, "ASCII File Export Format"](#), on page 107.

File contents	Description
RefType; CPOWER; TxBandwidth;9540000;Hz Filter State; ON; Alpha;0.22;	reference range setup, for details see "Edit Reference Range" on page 193
PeaksPerRange;1; Values;4;	evaluation list information
0;-22500000;-9270000;1000000;2986455000;-74.762840270996094; -10.576210021972656;-45.762840270996094;PASS; 1;-9270000;-4770000;1000000;2991405000;-100.17695617675781; -35.990325927734375;-1.490325927734375;PASS 3;4770000;9270000;1000000;3005445000;-100.17695617675781; -35.990325927734375;-1.490325927734375;PASS; 4;9270000;22500000;1000000;3018225000;-74.762840270996094; -10.576210021972656;-45.762840270996094;PASS;	information about each peak: <range number>; <start frequency>; <stop frequency>; <resolution bandwidth of range>; <frequency of peak>; <absolute power in dBm of peak>; <relative power in dBc of peak (related to the channel power)>; <distance to the limit line in dB (positive value means above the limit)>; <limit fail (pass = 0, fail =1)>;

Fast Spectrum Emission Mask Measurements

In order to improve the performance of the R&S FSVR for spectrum emission mask measurements, a "Fast SEM" mode is available. If this mode is activated, several consecutive ranges with identical sweep settings are combined to one sweep internally, which makes the measurement considerably more efficient. The displayed results remain unchanged and still consist of several ranges. Thus, measurement settings that apply only to the results, such as limits or transducer factors, can nevertheless be defined individually for each range.

Prerequisites

"Fast SEM" mode is available if the following criteria apply:

- The frequency ranges are consecutive, without frequency gaps
- The following sweep settings are identical:
 - "Filter Type", see ["Filter Type"](#) on page 189
 - "RBW", see ["RBW"](#) on page 189
 - "VBW", see ["VBW"](#) on page 190
 - "Sweep Time Mode", see ["Sweep Time Mode"](#) on page 190
 - "Ref Level", see ["Ref. Level"](#) on page 190
 - "Rf Att. Mode", see ["RF Att. Mode"](#) on page 190
 - "RF Attenuator", see ["RF Att. Mode"](#) on page 190
 - "Preamp", see ["Preamp"](#) on page 190

Activating Fast SEM mode

"Fast SEM" mode is activated in the sweep list (see ["Fast SEM"](#) on page 189) or using a remote command. Activating the mode for one range automatically activates it for all ranges in the sweep list.

In the provided XML files for the Spectrum Emission Mask measurement, "Fast SEM" mode is activated by default.

SCPI command:

`[SENSe:]ESpectrum:HighSPeed` on page 792

Consequences

When the "Fast SEM" mode is activated, the ranges for which these criteria apply are displayed as one single range. The sweep time is defined as the sum of the individual sweep times, initially, but can be changed. When the "Fast SEM" mode is deactivated, the originally defined individual sweep times are reset.



If "Symmetrical Setup" mode is active when "Fast SEM" mode is activated, not all sweep list settings can be configured symmetrically automatically (see also ["Symmetric Setup"](#) on page 192).

Any other changes to the sweep settings of the combined range are applied to each included range and remain changed even after deactivating "Fast SEM" mode.

Example

	Range 1	Range 2	Range 3	Range 4	Range 5
Range Start	-12.75 MHz	-8 MHz	-4 MHz	-3.515 MHz	-2.715 MHz
Range Stop	-8 MHz	-4 MHz	-3.515 MHz	-2.715 MHz	-2.515 MHz
Fast SEM	On	On	On	On	On
Filter Type	Channel	---	Gaussian	---	---
RBW	1 MHz	---	30 kHz	---	---
VBW	10 MHz	---	10 MHz	---	---
Sweep Time Mode	---	---	---	---	---
Sweep Time	10 ms	---	30 ms	---	---
Ref. Level	-10 dBm	---	-10 dBm	---	---
RF Att. Mode	Auto	---	Auto	---	---
RF Attenuator	10 dB	---	10 dB	---	---
Preamp	Off	---	Off	---	---
Transd. Factor	None	None	None	None	None
Limit Check 1	Absolute	Absolute	Absolute	Absolute	Absolute
Abs Limit Start 1	-23.5 dBm	-19.5 dBm	-32.5 dBm	-32.5 dBm	-20.5 dBm
Abs Limit Stop 1	-23.5 dBm	-19.5 dBm	-32.5 dBm	-20.5 dBm	-20.5 dBm
Rel Limit Start 1	-50 dBc	-50 dBc	-50 dBc	-50 dBc	-50 dBc
Rel Limit Stop 1	-50 dBc	-50 dBc	-50 dBc	-50 dBc	-50 dBc
Limit Check 2	Relative	Relative	Relative	Relative	Relative

Fig. 4-15: Sweep list using Fast SEM mode

In [figure 4-15](#), a sweep list is shown for which Fast SEM is activated. The formerly 5 separately defined ranges are combined to 2 sweep ranges internally.

4.2.5.6 Measuring Spurious Emissions

The Spurious Emissions measurement defines a measurement that monitors unwanted RF products outside the assigned frequency band generated by an amplifier. The spurious emissions are usually measured across a wide frequency range. The Spurious Emissions measurement allows a flexible definition of all parameters. A result table indicates the largest deviations of the absolute power from the limit line for each range, and the results can be checked against defined limits automatically.

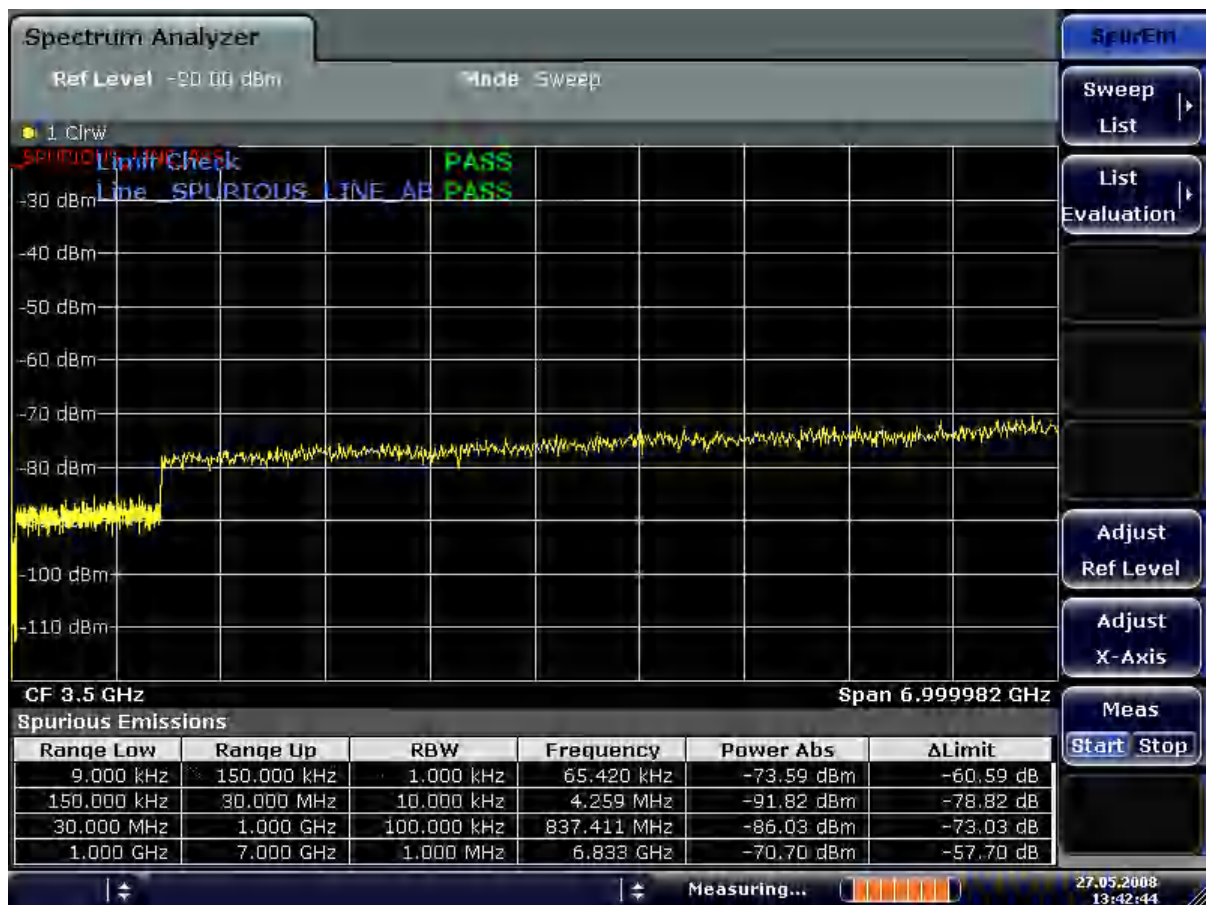

Spurious Emissions measurements are performed using the "Spurious Emissions" softkey in the "Measurement" menu (see ["Spurious Emissions"](#) on page 219).

Most parameters are defined in the "Sweep List" dialog box (see ["Sweep List dialog box"](#) on page 219). For information on other parameters, see the corresponding softkeys (["Spurious Emissions"](#) on page 219).

Conditions for ranges

The following rules apply to ranges:

- The minimum span of a range is 20 Hz.
- The individual ranges must not overlap (but need not directly follow one another).
- The maximum number of ranges is 20.
- The maximum number of sweep points in all ranges is limited to 100001.

In order to change the start/stop frequency of the first/last range, select the appropriate span with the SPAN key. If you set a span that is smaller than the overall span of the ranges, the measurement includes only the ranges that lie within the defined span and have a minimum span of 20 Hz. The first and last ranges are adapted to the given span as long as the minimum span of 20 Hz is not violated.



Defining ranges by remote control

In Spurious Emissions measurements, there are no remote commands to insert new ranges between existing ranges directly. However, you can delete or re-define the existing ranges to create the required order.

A remote command example for defining parameters and ranges in spurious emissions measurements can be found in chapter 7 "Remote Control – Programming Examples" of the Operating manual on the CD-ROM.

Result Evaluation

In addition to the graphical results of the spurious measurement displayed in the diagram, a result table can be displayed to evaluate the limit check results (see also "[Working with Limit Lines in Spurious Measurements](#)" on page 216). Which data is displayed in the evaluation list can be defined in the "List Evaluation" menu (see "[List Evaluation](#)" on page 222).

The following information is provided in the evaluation list:

Column	Description
Range Low	Frequency range start for range the peak value belongs to
Range Up	Frequency range stop for range the peak value belongs to
RBW	RBW of the range
Frequency	Frequency at the peak value
Power Abs	Absolute power level at the peak value
Δ Limit	Deviation of the absolute power level from the defined limit for the peak value

By default, one peak per range is displayed. However, you can change the settings to:

- Display all peaks ("Details ON")
- Display a certain number of peaks per range ("Details ON" + "Peaks per Range")
- Display only peaks that exceed a threshold ("Margin")

In addition to listing the peaks in the list evaluation, detected peaks can be indicated by blue squares in the diagram ("Show Peaks").

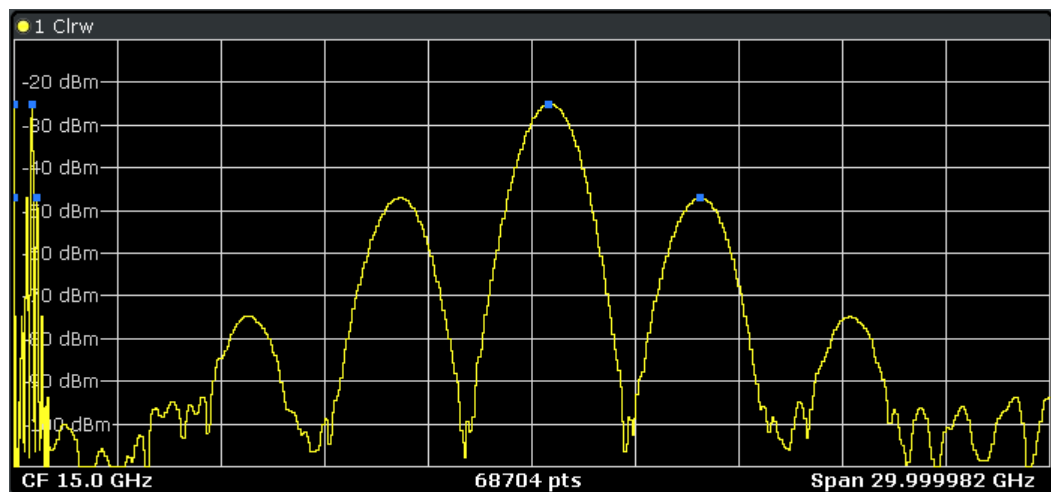

Furthermore, you can save the evaluation list to a file ("Save Evaluation List").

Retrieving Results via Remote Control

The spurious measurement results can be retrieved using the `CALC:PSE?` command from a remote computer (see `CALCulate<n>:PEAKsearch|PSEarch[:IMMEDIATE]` for a detailed description).

Alternatively, the measured spurious values of the displayed trace can be retrieved using the `TRAC:DATA? SPUR` command (see `TRACe<n>[:DATA]?` on page 889).

Working with Limit Lines in Spurious Measurements

Limit lines allow you to check the measured data against specified limit values. Generally, it is possible to define limit lines for any measurement in Spectrum mode using the `LINES` key. For Spurious measurements, however, a special limit line is available via the "Sweep List", and it is strongly recommended that you use only this limit line definition.

In the "Sweep List" you can define a limit line that varies its level according to the specified frequency ranges. A distinguished limit line ("`_SPURIOUS_LINE_ABS`") is automatically defined according to the current "Sweep List" settings every time the settings change.

If a limit check is activated in the "Sweep List", the "`_SPURIOUS_LINE_ABS`" limit line is indicated by a red line in the display, and the result of the limit check is indicated at the top of the diagram. Note that only "Pass" or "Fail" is indicated; a "margin" function as for general limit lines is not available. Also, only absolute limits can be checked, not relative ones.

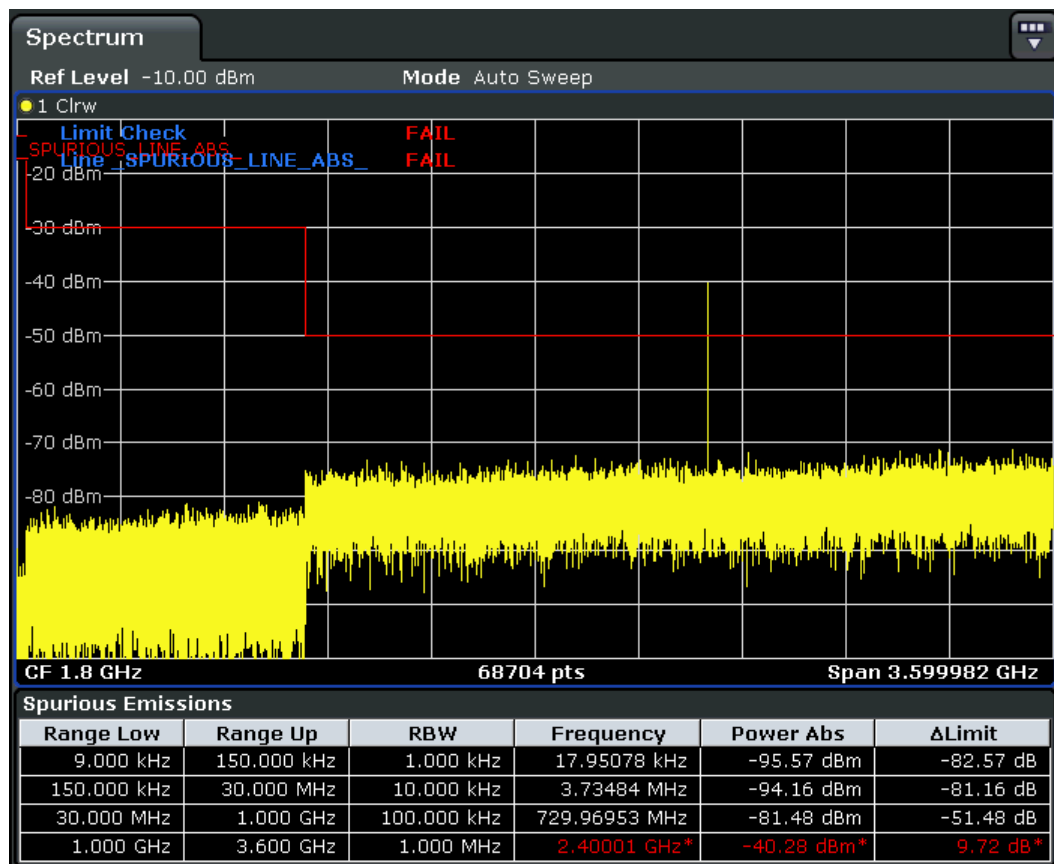

As for general limit lines, the results of each limit line check are displayed (here: "_SPURIOUS_LINE_ABS"), as well as the combined result for all defined limit lines ("Limit Check").

In addition to the limit line itself, the largest deviations of the absolute power from the limit line for each range are displayed in the evaluation list if the limit check is activated. Values that exceed the limit are indicated in red and by an asterisk (*).



Although a margin functionality is not available for the limit check, a margin (threshold) for the peak values to be displayed in the evaluation list can be defined in the list evaluation settings. Furthermore, you can define how many peaks per range are listed. For details see ["Result Evaluation"](#) on page 215.

To define a limit check for spurious measurements

The limit check is defined in the "Sweep List" dialog box, see ["Sweep List dialog box"](#) on page 219 for details.

1. Press the MEAS CONFIG key to open the main "Spurious" menu.
2. Press the "Sweep List" softkey to open the "Sweep List" dialog box.

3. In the "Sweep List" dialog box, define the limit line for each range using the "Abs Limit Start" and "Abs Limit Stop" settings.
The limit values are absolute values for the absolute power level.
4. Set the "Limit Check" setting to "Absolute" to activate the limit check.
5. Close the "Sweep List" dialog box.
The limit line and the result of the limit check are displayed in the diagram and the result table displays the largest deviations from the limit for each range.
6. To reduce the number of displayed delta values, change the margin (threshold) for peak detection in the list evaluation. By default, this value is very high (200 dB), so that initially all peaks are detected.
In the "Spurious" menu, press "List Evaluation > Margin" and enter a value in dB.
Only delta values that exceed this margin are displayed in the result table.

Softkeys for Spurious Emissions Measurement

Spurious Emissions.....	219
L Sweep List.....	219
L Sweep List dialog box.....	219
L Range Start / Range Stop.....	219
L Filter Type.....	220
L RBW.....	220
L VBW.....	220
L Sweep Time Mode.....	220
L Sweep Time.....	220
L Detector.....	220
L Ref. Level.....	220
L RF Att. Mode.....	220
L RF Attenuator.....	220
L Preamp.....	221
L Sweep Points.....	221
L Stop After Sweep.....	221
L Transd. Factor.....	221
L Limit Check 1-4.....	221
L Abs Limit Start.....	221
L Abs Limit Stop.....	222
L Close Sweep List.....	222
L Insert before Range.....	222
L Insert after Range.....	222
L Delete Range.....	222
L Adjust Ref Lvl (span > 0).....	222
L Adjust X-Axis.....	222
L List Evaluation.....	222
L List Evaluation (On/Off).....	223
L Details On/Off.....	223
L Margin.....	223
L Peaks per Range.....	223
L Show Peaks.....	223
L Save Evaluation List.....	223

L ASCII File Export.....	223
L Decim Sep.....	224
L Adjust Ref Lvl (span > 0).....	224
L Adjust X-Axis.....	224
L Meas Start/Stop.....	224

Spurious Emissions

Opens a submenu to configure the Spurious Emissions measurement and immediately starts a measurement.

For general information on performing Spurious Emissions measurements see [chapter 4.2.5.6, "Measuring Spurious Emissions"](#), on page 213.

Remote command:

`[SENSe:] SWEep:MODE` on page 872

Sweep List ← Spurious Emissions

Opens a submenu to edit the sweep list and displays the "Sweep List" dialog box.

Note: If you edit the sweep list, always follow the rules described in [chapter 4.2.5.6, "Measuring Spurious Emissions"](#), on page 213.

Sweep List dialog box ← Sweep List ← Spurious Emissions

After a preset, the sweep list contains a set of default ranges and parameters. For each range, you can change the parameters listed below. To insert or delete ranges, use the "Insert Before Range", "Insert After Range", "Delete Range" softkeys. The measurement results are not updated during editing but on closing the dialog box.

For details and limitations regarding spurious emissions configuration, see [chapter 4.2.5.6, "Measuring Spurious Emissions"](#), on page 213.

Range Start / Range Stop ← Sweep List dialog box ← Sweep List ← Spurious Emissions

Sets the start frequency/stop frequency of the selected range. Follow the rules described in [chapter 4.2.5.6, "Measuring Spurious Emissions"](#), on page 213.

In order to change the start/stop frequency of the first/last range, select the appropriate span with the SPAN key. If you set a span that is smaller than the overall span of the ranges, the measurement includes only the ranges that lie within the defined span and have a minimum span of 20 Hz. The first and last ranges are adapted to the given span as long as the minimum span of 20 Hz is not violated.

Frequency values for each range have to be defined relative to the center frequency. The reference range has to be centered on the center frequency. The minimum span of the reference range is given by the current TX Bandwidth.

Remote command:

`[SENSe:] LIST:RANGe<range> [:FREQuency] :START` on page 820

`[SENSe:] LIST:RANGe<range> [:FREQuency] :STOP` on page 821

Filter Type ← Sweep List dialog box ← Sweep List ← Spurious Emissions

Sets the filter type for this range. For details on filters see also [chapter 4.1.6.3, "Selecting the Appropriate Filter Type"](#), on page 85.

Remote command:

`[SENSe:]LIST:RANGe<range>:FILTer:TYPE` on page 821

RBW ← Sweep List dialog box ← Sweep List ← Spurious Emissions

Sets the RBW value for this range.

Remote command:

`[SENSe:]LIST:RANGe<range>:BANDwidth[:RESolution]` on page 818

VBW ← Sweep List dialog box ← Sweep List ← Spurious Emissions

Sets the VBW value for this range.

Remote command:

`[SENSe:]LIST:RANGe<range>:BANDwidth:VIDeo` on page 819

Sweep Time Mode ← Sweep List dialog box ← Sweep List ← Spurious Emissions

Activates or deactivates the auto mode for the sweep time.

Remote command:

`[SENSe:]LIST:RANGe<range>:SWEep:TIME:AUTO` on page 825

Sweep Time ← Sweep List dialog box ← Sweep List ← Spurious Emissions

Sets the sweep time value for the range.

Remote command:

`[SENSe:]LIST:RANGe<range>:SWEep:TIME` on page 825

Detector ← Sweep List dialog box ← Sweep List ← Spurious Emissions

Sets the detector for the range. For details refer to [chapter 4.1.8.6, "Detector Overview"](#), on page 106.

Remote command:

`[SENSe:]LIST:RANGe<range>:DETEctor` on page 820

Ref. Level ← Sweep List dialog box ← Sweep List ← Spurious Emissions

Sets the reference level for the range.

Remote command:

`[SENSe:]LIST:RANGe<range>:RLEVel` on page 824

RF Att. Mode ← Sweep List dialog box ← Sweep List ← Spurious Emissions

Activates or deactivates the auto mode for RF attenuation.

Remote command:

`[SENSe:]LIST:RANGe<range>:INPut:ATTenuation:AUTO` on page 822

RF Attenuator ← Sweep List dialog box ← Sweep List ← Spurious Emissions

Sets the attenuation value for that range.

Remote command:

`[SENSe:]LIST:RANGe<range>:INPut:ATTenuation` on page 822

Preamp ← Sweep List dialog box ← Sweep List ← Spurious Emissions

Switches the preamplifier on or off.

Remote command:

[\[SENSe:\]LIST:RANGe<range>:INPut:GAIN:STATe](#) on page 823

Sweep Points ← Sweep List dialog box ← Sweep List ← Spurious Emissions

Sets the number of sweep points for the specified range.

Remote command:

[\[SENSe:\]LIST:RANGe<range>:POINTs](#) on page 824

Stop After Sweep ← Sweep List dialog box ← Sweep List ← Spurious Emissions

This command configures the sweep behavior.

"ON" The R&S FSVR stops after one range is swept and continues only if you confirm (a message box is displayed).

"OFF" The R&S FSVR sweeps all ranges in one go.

Remote command:

[\[SENSe:\]LIST:RANGe<range>:BREak](#) on page 819

Transd. Factor ← Sweep List dialog box ← Sweep List ← Spurious Emissions

Sets a transducer for the specified range. You can only choose a transducer that fulfills the following conditions:

- The transducer overlaps or equals the span of the range.
- The x-axis is linear.
- The unit is dB.

Remote command:

[\[SENSe:\]LIST:RANGe<range>:TRANsducer](#) on page 825

Limit Check 1-4 ← Sweep List dialog box ← Sweep List ← Spurious Emissions

Sets the type of limit check for all ranges. Possible states are:

Absolute	Checks the absolute limits defined.
None	No limit check performed.

The limit settings are only available if limit check is activated ("Absolute"). If activated, the limit line and the results of the check are indicated in the diagram.

Remote command:

[\[SENSe:\]LIST:RANGe<range>:LIMit:STATe](#) on page 823

[CALCulate<n>:LIMit<k>:FAIL?](#) on page 582

Abs Limit Start ← Sweep List dialog box ← Sweep List ← Spurious Emissions

Sets an absolute limit value at the start frequency of the range [dBm].

This parameter is only available if the limit check is set to "Absolute" (see "[Limit Check 1-4](#)" on page 221).

Remote command:

[\[SENSe:\]LIST:RANGe<range>:LIMit:START](#) on page 823

Abs Limit Stop ← Sweep List dialog box ← Sweep List ← Spurious Emissions

Sets an absolute limit value at the stop frequency of the range [dBm].

This parameter is only available if the limit check is set to "Absolute" (see ["Limit Check 1-4"](#) on page 221).

Remote command:

`[SENSe:]LIST:RANGe<range>:LIMit:STOP` on page 824

Close Sweep List ← Sweep List ← Spurious Emissions

Closes the "Sweep List" dialog box and updates the measurement results.

Insert before Range ← Sweep List ← Spurious Emissions

Inserts a new range to the left of the currently focused range. The range numbers of the currently focused range and all higher ranges are increased accordingly. The maximum number of ranges is 20.

For further details refer to ["Ranges and Range Settings"](#) on page 199.

Insert after Range ← Sweep List ← Spurious Emissions

Inserts a new range to the right of the currently focused range. The range numbers of all higher ranges are increased accordingly. The maximum number of ranges is 20.

For further details refer to ["Ranges and Range Settings"](#) on page 199.

Delete Range ← Sweep List ← Spurious Emissions

Deletes the currently focused range, if possible. The range numbers are updated accordingly. For further details refer to ["Ranges and Range Settings"](#) on page 199.

Remote command:

`[SENSe:]LIST:RANGe<range>:DELete` on page 820

Adjust Ref Lvl (span > 0) ← Sweep List ← Spurious Emissions

Adjusts the reference level to the measured total power of the signal. The softkey is activated after the first sweep with active measurement of the occupied bandwidth has been completed and the total power of the signal is thus known.

Adjusting the reference level ensures that the signal path will not be overloaded and the dynamic range not limited by too low a reference level. Since the measurement bandwidth for channel power measurements is significantly lower than the signal bandwidth, the signal path may be overloaded although the trace is distinctly below the reference level. If the measured channel power is equal to the reference level, the signal path cannot be overloaded.

Remote command:

`[SENSe:]POWer:ACHannel:PRESet:RLEVel` on page 851

Adjust X-Axis ← Sweep List ← Spurious Emissions

Adjusts the frequency axis of measurement diagram automatically so that the start frequency matches the start frequency of the first sweep range, and the stop frequency of the last sweep range.

List Evaluation ← Spurious Emissions

Opens a submenu to edit the list evaluation settings.

For more information on list evaluation see ["Result Evaluation"](#) on page 215.

List Evaluation (On/Off) ← List Evaluation ← Spurious Emissions

Activates or deactivates the list evaluation.

Remote command:

[CALCulate<n>:PEAKsearch|PSEarch:AUTO](#) on page 692

[TRACe<n>\[:DATA\]?](#) on page 889

Details On/Off ← List Evaluation ← Spurious Emissions

Configures the list contents.

On	Displays the whole list contents.
Off	Displays only the highest peaks (one peak per range).

Margin ← List Evaluation ← Spurious Emissions

Opens an edit dialog box to enter the margin used for the limit check/peak search. Only peaks that exceed the limit and are larger than the specified margin are indicated in the evaluation list.

Remote command:

[CALCulate<n>:PEAKsearch|PSEarch:MARGin](#) on page 692

Peaks per Range ← List Evaluation ← Spurious Emissions

Opens an edit dialog box to enter the number of peaks per range that are stored in the list. Once the selected number of peaks has been reached, the peak search is stopped in the current range and continued in the next range. The maximum value is 50.

Remote command:

[CALCulate<n>:PEAKsearch|PSEarch:SUBRanges](#) on page 693

Show Peaks ← List Evaluation ← Spurious Emissions

In the diagram, marks all peaks with blue squares that have been listed during an active list evaluation.

Remote command:

[CALCulate<n>:PEAKsearch|PSEarch:PSHow](#) on page 692

Save Evaluation List ← List Evaluation ← Spurious Emissions

Opens the "ASCII File Export Name" dialog box and a submenu to save the result in ASCII format to a specified file and directory.

Remote command:

[MMEMory:STORe<n>:LIST](#) on page 742

ASCII File Export ← Save Evaluation List ← List Evaluation ← Spurious Emissions

Saves the evaluation list in ASCII format to a specified file and directory.

Remote command:

[MMEMory:STORe<n>:LIST](#) on page 742

Decim Sep ← Save Evaluation List ← List Evaluation ← Spurious Emissions

Selects the decimal separator with floating-point numerals for the ASCII Trace export to support evaluation programs (e.g. MS-Excel) in different languages. The values '.' (decimal point) and ',' (comma) can be set.

Remote command:

`FORMat:DEXPort:DSEParator` on page 728

Adjust Ref Lvl (span > 0) ← Spurious Emissions

Adjusts the reference level to the measured total power of the signal. The softkey is activated after the first sweep with active measurement of the occupied bandwidth has been completed and the total power of the signal is thus known.

Adjusting the reference level ensures that the signal path will not be overloaded and the dynamic range not limited by too low a reference level. Since the measurement bandwidth for channel power measurements is significantly lower than the signal bandwidth, the signal path may be overloaded although the trace is distinctly below the reference level. If the measured channel power is equal to the reference level, the signal path cannot be overloaded.

Remote command:

`[SENSe:]POWER:ACHannel:PRESet:RLEVEL` on page 851

Adjust X-Axis ← Spurious Emissions

Adjusts the frequency axis of measurement diagram automatically so that the start frequency matches the start frequency of the first sweep range, and the stop frequency of the last sweep range.

Meas Start/Stop ← Spurious Emissions

Aborts/restarts the current measurement and displays the status:

"Start"	The measurement is currently running.
"Stop"	The measurement has been stopped, or, in single sweep mode, the end of the sweep has been reached.

4.2.5.7 Measuring the Power in Zero Span

Using the power measurement function, the R&S FSVR determines the power of the signal in zero span by summing up the power at the individual measurement points and dividing the result by the number of measurement points. Thus it is possible to measure the power of TDMA signals during transmission, for example, or during the muting phase. Both the mean power and the RMS power can be measured.

For this measurement, the sample detector is activated.

Measurement results

Several different power results can be determined simultaneously:

Mode	Description
Peak	Peak value from the points of the displayed trace or a segment thereof.
RMS	RMS value from the points of the displayed trace or a segment thereof.
Mean	Mean value from the points of the displayed trace or a segment thereof. The linear mean value of the equivalent voltages is calculated. For example to measure the mean power during a GSM burst
Std Dev	The standard deviation of the measurement points from the mean value.

The result is displayed in the marker results, indicated by "Power" and the selected power mode, e.g. "RMS". The measured values are updated after each sweep or averaged over a user-defined number of sweeps (trace averaging).

The results can also be queried using the remote commands described in "[CALCulate:MARKer:FUNCTion:SUMMery Subsystem](#)" on page 665.

Restricting the measurement range using limit lines

The range of the measured signal to be evaluated for the power measurement can be restricted using limit lines. The left and right limit lines (S1, S2) define the evaluation range and are indicated by vertical red lines in the diagram. If activated, the power results are only calculated from the levels within the limit lines.

For example, if both the on and off phase of a burst signal are displayed, the measurement range can be limited to the transmission or to the muting phase. The ratio between signal and noise power of a TDMA signal for instance can be measured using a measurement as a reference value and then varying the measurement range.

To measure the power in the time domain

1. Press the "Time Domain Power" softkey to activate the power measurement.
2. Select the type of power measurement using the "Peak", "Mean", "RMS" or "Std Dev" softkeys.
3. To limit the power evaluation range, switch on the limits ("Limits (On/Off)" softkey) and enter the limits using the "Left Limit" and "Right Limit" softkeys.

Softkeys for Time Domain Power Measurements

Time Domain Power.....	226
L Peak.....	226
L RMS.....	226
L Mean.....	226
L Std Dev.....	226
L Limits (On/Off).....	226
L Left Limit.....	227
L Right Limit.....	227

Time Domain Power

Activates the power measurement in zero span and opens a submenu to configure the power measurement. For more details see also [chapter 4.2.5.7, "Measuring the Power in Zero Span"](#), on page 224.

Remote command:

`CALCulate<n>:MARKer<m>:FUNCTION:SUMMARY[:STATE]` on page 678

Peak ← Time Domain Power

Activates the calculation of the peak value from the points of the displayed trace or a segment thereof.

Remote command:

`CALCulate<n>:MARKer<m>:FUNCTION:SUMMARY:PPEak[:STATE]` on page 672

`CALCulate<n>:MARKer<m>:FUNCTION:SUMMARY:PPEak:RESULT?` on page 672

RMS ← Time Domain Power

Activates the calculation of the RMS value from the points of the displayed trace or a segment thereof.

Remote command:

`CALCulate<n>:MARKer<m>:FUNCTION:SUMMARY:RMS[:STATE]` on page 675

`CALCulate<n>:MARKer<m>:FUNCTION:SUMMARY:RMS:RESULT?` on page 674

Mean ← Time Domain Power

Activates the calculation of the mean value from the points of the displayed trace or a segment thereof. The linear mean value of the equivalent voltages is calculated.

This can be used for instance to measure the mean power during a GSM burst.

Remote command:

`CALCulate<n>:MARKer<m>:FUNCTION:SUMMARY:MEAN[:STATE]` on page 670

`CALCulate<n>:MARKer<m>:FUNCTION:SUMMARY:MEAN:RESULT?` on page 669

Std Dev ← Time Domain Power

Activates the calculation of the standard deviation of measurement points from the mean value and displays them as measured value. The measurement of the mean power is automatically switched on at the same time.

Remote command:

`CALCulate<n>:MARKer<m>:FUNCTION:SUMMARY:SDEVIation[:STATE]`

on page 677

`CALCulate<n>:MARKer<m>:FUNCTION:SUMMARY:SDEVIation:RESULT?`

on page 677

Limits (On/Off) ← Time Domain Power

Switches the limitation of the evaluation range on or off. Default setting is off.

If switched off, the evaluation range is not limited. If switched on, the evaluation range is defined by the left and right limit. If only one limit is set, it corresponds to the left limit and the right limit is defined by the stop frequency. If the second limit is also set, it defines the right limit.

Remote command:

`CALCulate<n>:MARKer<m>:X:SLIMits[:STATE]` on page 618

Left Limit ← Time Domain Power

Opens an edit dialog box to enter a value for line 1.

Remote command:

`CALCulate<n>:MARKer<m>:X:SLIMits:LEFT` on page 618

Right Limit ← Time Domain Power

Opens an edit dialog box to enter a value for line 2.

Remote command:

`CALCulate<n>:MARKer<m>:X:SLIMits:RIGHT` on page 619

4.2.5.8 Calculating Signal Amplitude Statistics

To measure the amplitude distribution, the R&S FSVR has simple measurement functions to determine both the APD = Amplitude Probability Distribution and CCDF = Complementary Cumulative Distribution Function.

To determine the amplitude distribution

- ▶ To activate and configure the measurement of the amplitude probability distribution (APD), press the "APD" softkey (see "APD" on page 154).
To activate and configure the measurement of the complementary cumulative distribution (CCDF), press the "CCDF" softkey (see "CCDF" on page 154).

Only one of the signal statistic functions can be switched on at a time. When a statistic function is switched on, the R&S FSVR is set into zero span mode automatically. The R&S FSVR measures the statistics of the signal applied to the RF input with the defined resolution bandwidth. To avoid affecting the peak amplitudes the video bandwidth is automatically set to 10 times the resolution bandwidth. The sample detector is used for detecting the video voltage.

About the Statistical Measurements.....	227
Result Evaluation.....	229
Softkeys for APD Measurements.....	231
Softkeys for CCDF Measurements.....	236
Defining Gated Triggering for APD and CCDF.....	242

About the Statistical Measurements

Digital modulated signals are similar to white noise within the transmit channel, but are different in their amplitude distribution. In order to transmit the modulated signal without distortion all amplitudes of the signal have to be transmitted linearly, e.g. from the output power amplifier. Most critical are the peak amplitude values. Degradation in transmit quality caused by a transmitter two port network is dependent on the amplitude of the peak values as well as on their probability.

If modulation types are used that do not have a constant zero span envelope, the transmitter has to handle peak amplitudes that are greater than the average power. This includes all modulation types that involve amplitude modulation, QPSK for exam-

ple. CDMA transmission modes in particular may have power peaks that are large compared to the average power.

For signals of this kind, the transmitter must provide large reserves for the peak power to prevent signal compression and thus an increase of the bit error rate at the receiver. The peak power or the crest factor of a signal is therefore an important transmitter design criterion. The crest factor is defined as the peak power/mean power ratio or, logarithmically, as the peak level minus the average level of the signal. To reduce power consumption and cut costs, transmitters are not designed for the largest power that could ever occur, but for a power that has a specified probability of being exceeded (e.g. 0.01 %).

The probability of amplitude values can be measured with the APD function (Amplitude Probability Distribution). During a selectable measurement time all occurring amplitude values are assigned to an amplitude range. The number of amplitude values in the specific ranges is counted and the result is displayed as a histogram.

Alternatively, the Complementary Cumulative Distribution Function (CCDF) can be displayed. It shows the probability that the mean signal power amplitude will be exceeded in percent.

Bandwidth selection

When the amplitude distribution is measured, the resolution bandwidth must be set so that the complete spectrum of the signal to be measured falls within the bandwidth. This is the only way of ensuring that all the amplitudes will pass through the IF filter without being distorted. If the selected resolution bandwidth is too small for a digitally modulated signal, the amplitude distribution at the output of the IF filter becomes a Gaussian distribution according to the central limit theorem and thus corresponds to a white noise signal. The true amplitude distribution of the signal therefore cannot be determined.

Selecting the number of samples

For statistics measurements with the R&S FSVR, the number of samples to be measured is defined instead of the sweep time. Since only statistically independent samples contribute to statistics, the acquisition or sweep time is calculated automatically and displayed in the channel bar (AQT). The samples are statistically independent if the time difference is at least 1/RBW. The acquisition time AQT is, therefore, expressed as follows:

$$AQT = N_{\text{Samples}} / RBW$$

Statistic measurements on pulsed signals

Statistic measurements on pulsed signals can be performed using a gated trigger. An external frame trigger is required as a time (frame) reference. For details see ["Defining Gated Triggering for APD and CCDF"](#) on page 242.

Result Evaluation

Amplitude Probability Distribution (APD)

As a result of the APD function (Amplitude Probability Distribution), the probability of measured amplitude values is displayed. During a selectable measurement time all occurring amplitude values are assigned to an amplitude range. The number of amplitude values in the specific ranges is counted and the result is displayed as a histogram. Each bar of the histogram represents the percentage of measured amplitudes within the specific amplitude range. The x-axis is scaled in absolute values in dBm.

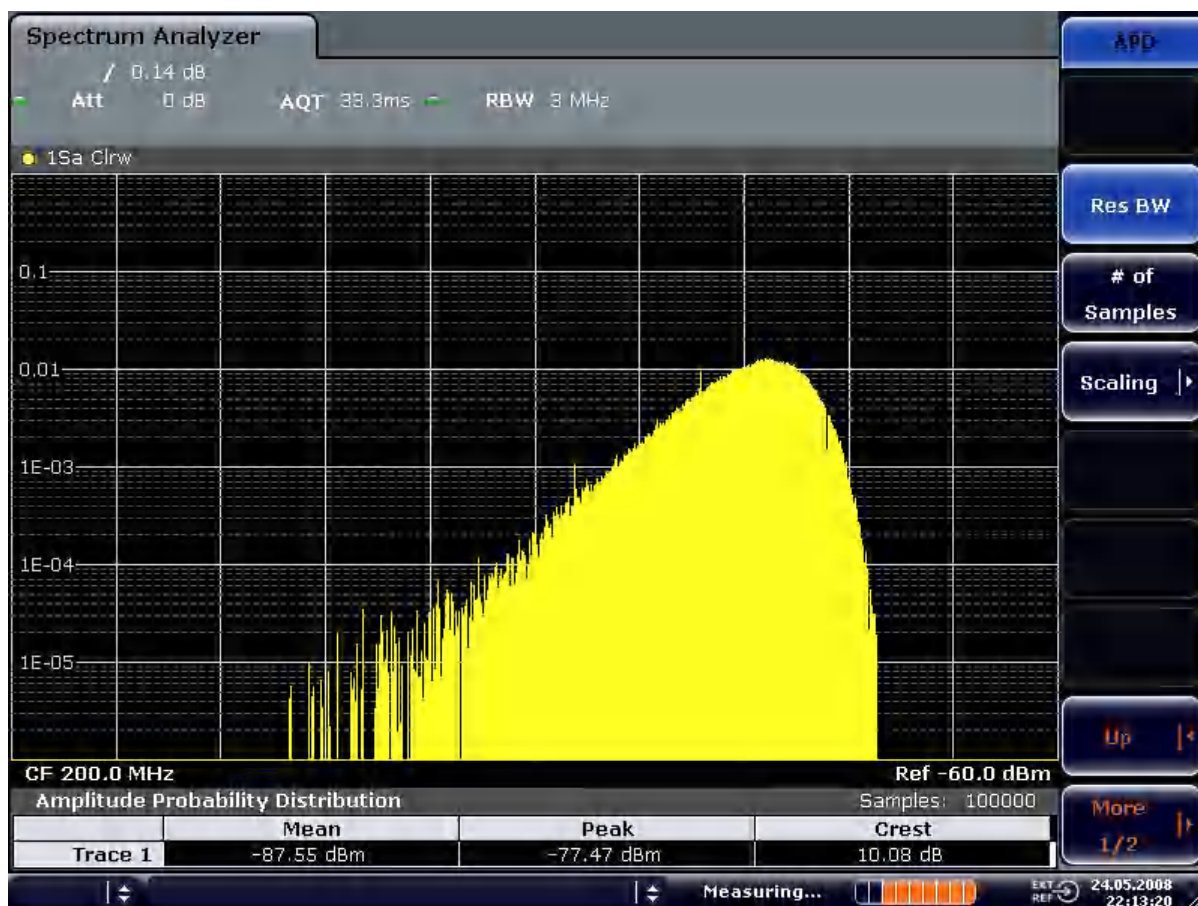

Fig. 4-16: Amplitude probability distribution of white noise

In addition to the histogram, a result table is displayed containing the following information:

- Number of samples used for calculation
- For each displayed trace:
 - Mean amplitude
 - Peak amplitude
 - Crest factor

Complementary Cumulative Distribution Function (CCDF)

The Complementary Cumulative Distribution Function (CCDF) shows the probability that the mean signal power amplitude will be exceeded in percent. The level above the mean power is plotted along the x-axis of the graph. The origin of the axis corresponds to the mean power level. The probability that a level will be exceeded is plotted along the y-axis.

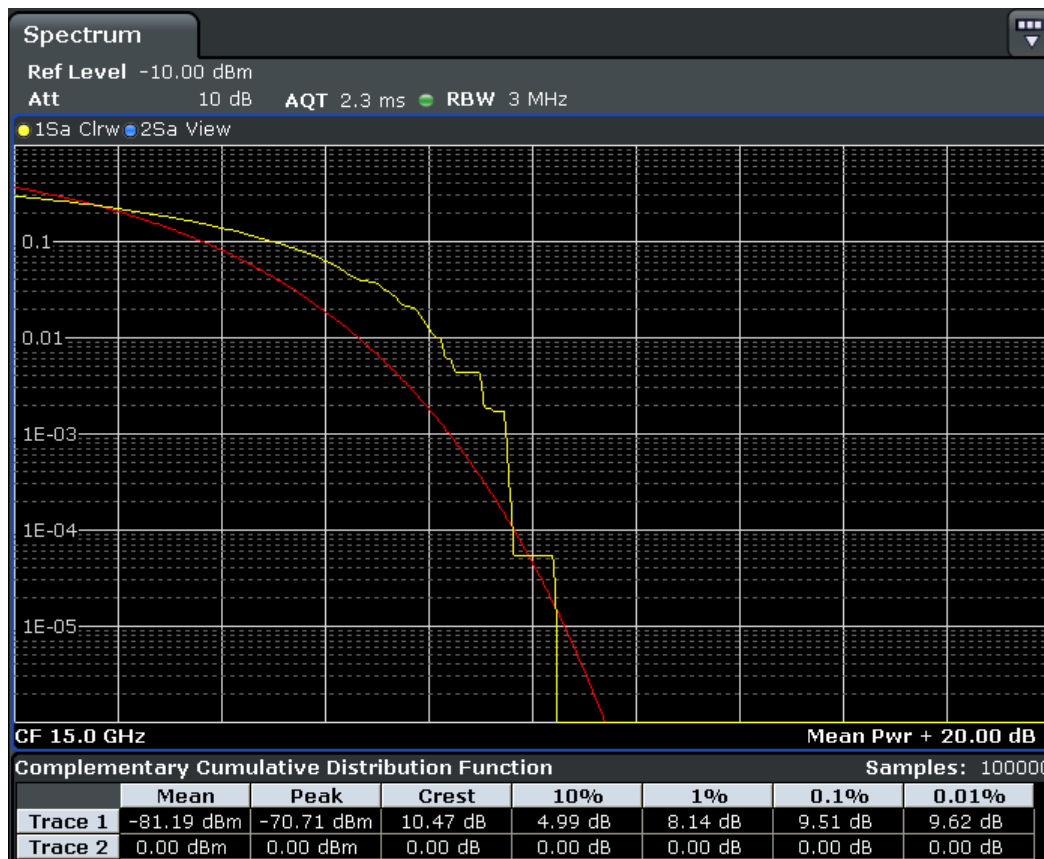

Fig. 4-17: CCDF of white noise



A red line indicates the ideal Gaussian distribution for the measured amplitude range (white noise).

The displayed amplitude range is indicated as "Mean Pwr + <x dB>"

In addition to the histogram, a result table is displayed containing the following information:

- Number of samples used for calculation
- For each displayed trace:

Mean	Mean power
Peak	Peak power

Crest	Crest factor (peak power – mean power)
0,01 %	Level values over 0,01 % above mean power
0,1 %	Level values over 0,1 % above mean power
1 %	Level values over 1 % above mean power
10 %	Level values over 10 % above mean power

Softkeys for APD Measurements

APD.....	231
L Res BW.....	231
L # of Samples.....	232
L Scaling.....	232
L x-Axis Ref Level.....	232
L x-Axis Range.....	232
L Range Log 100 dB.....	232
L Range Log 50 dB.....	233
L Range Log 10 dB.....	233
L Range Log 5 dB.....	233
L Range Log 1 dB.....	233
L Range Log Manual.....	234
L Range Linear %.....	234
L Range Lin. Unit.....	234
L y-Axis Max Value.....	234
L y-Axis Min Value.....	234
L y-Unit % / Abs.....	235
L Default Settings.....	235
L Adjust Settings.....	235
L Gated Trigger (On/Off).....	235
L Gate Ranges.....	235
L Adjust Settings.....	236

APD

Activates the function to measure the amplitude probability density (APD) and opens a submenu.

For general information on calculating signal statistics see [chapter 4.2.5.8, "Calculating Signal Amplitude Statistics"](#), on page 227.

Remote command:

`CALCulate<n>:STATistics:APD[:STATe]` on page 698

Res BW ← APD

Opens an edit dialog box to set the resolution bandwidth directly.

For correct measurement of the signal statistics the resolution bandwidth has to be wider than the signal bandwidth in order to measure the actual peaks of the signal amplitude correctly. In order not to influence the peak amplitudes the video bandwidth is automatically set to 10 MHz. The sample detector is used for detecting the video voltage.

Remote command:

`[SENSe:]BANDwidth|BWIDth[:RESolution]` on page 782

of Samples ← APD

Opens an edit dialog box to set the number of power measurements that are taken into account for the statistics.

Apart from the number of measurements the overall measurement time depends also on the set resolution bandwidth as the resolution bandwidth directly influences the sampling rate.

For details see "Selecting the number of samples" on page 228.

Remote command:

`CALCulate<n>:STATistics:NSAMples` on page 699

Scaling ← APD

Opens a submenu to change the scaling parameters of x- and y-axis.

x-Axis Ref Level ← Scaling ← APD

Opens an edit dialog box to enter the reference level in the currently active unit (dBm, dBμV, etc). The function of this softkey is identical to the "Ref Level" softkey in the "Amplitude" menu (see "Ref Level" on page 67).

For the APD function this value is mapped to the right diagram border. For the CCDF function there is no direct representation of this value on the diagram as the x-axis is scaled relatively to the measured mean power.

Remote command:

`CALCulate<n>:STATistics:SCALE:X:RLEVel` on page 701

x-Axis Range ← Scaling ← APD

Opens the "Range" submenu to select a value for the level range to be covered by the statistics measurement selected.

Remote command:

`CALCulate<n>:STATistics:SCALE:X:RANGE` on page 701

Range Log 100 dB ← x-Axis Range ← Scaling ← APD

Sets the level display range to 100 dB.

Remote command:

Logarithmic scaling:

`DISP:WIND:TRAC:Y:SPAC LOG`, see `DISP:WIND:TRAC:Y:SPAC` on page 717

Display range:

`DISP:WIND:TRAC:Y 100DB`, see `DISP:WIND:TRAC:Y[:SCALE]` on page 718

Range Log 50 dB ← x-Axis Range ← Scaling ← APD

Sets the level display range to 50 dB.

Remote command:

Logarithmic scaling:

DISP:WIND:TRAC:Y:SPAC LOG, see [DISPlay\[:WINDow<n>\]:TRACe<t>:Y:SPACing](#) on page 717

Display range:

DISP:WIND:TRAC:Y 50DB, see [DISPlay\[:WINDow<n>\]:TRACe<t>:Y\[:SCALe\]](#) on page 718

Range Log 10 dB ← x-Axis Range ← Scaling ← APD

Sets the level display range to 10 dB.

Remote command:

Logarithmic scaling:

DISP:WIND:TRAC:Y:SPAC LOG, see [DISPlay\[:WINDow<n>\]:TRACe<t>:Y:SPACing](#) on page 717

Display range:

DISP:WIND:TRAC:Y 10DB, see [DISPlay\[:WINDow<n>\]:TRACe<t>:Y\[:SCALe\]](#) on page 718

Range Log 5 dB ← x-Axis Range ← Scaling ← APD

Sets the level display range to 5 dB.

Remote command:

Logarithmic scaling:

DISP:WIND:TRAC:Y:SPAC LOG, see [DISPlay\[:WINDow<n>\]:TRACe<t>:Y:SPACing](#) on page 717

Display range:

DISP:WIND:TRAC:Y 5DB, see [DISPlay\[:WINDow<n>\]:TRACe<t>:Y\[:SCALe\]](#) on page 718

Range Log 1 dB ← x-Axis Range ← Scaling ← APD

Sets the level display range to 1 dB.

Remote command:

Logarithmic scaling:

DISP:WIND:TRAC:Y:SPAC LOG, see [DISPlay\[:WINDow<n>\]:TRACe<t>:Y:SPACing](#) on page 717

Display range:

DISP:WIND:TRAC:Y 1DB, see [DISPlay\[:WINDow<n>\]:TRACe<t>:Y\[:SCALe\]](#) on page 718

Range Log Manual ← x-Axis Range ← Scaling ← APD

Opens an edit dialog box to define the display range of a logarithmic level axis manually.

Remote command:

Logarithmic scaling:

DISP:WIND:TRAC:Y:SPAC LOG, see [DISPlay\[:WINDow<n>\]:TRACe<t>:Y:SPACing](#) on page 717

Display range:

[DISPlay\[:WINDow<n>\]:TRACe<t>:Y\[:SCALe\]](#) on page 718

Range Linear % ← x-Axis Range ← Scaling ← APD

Selects linear scaling for the level axis in %.

The grid is divided into decadal sections.

Markers are displayed in the selected unit ("Unit" softkey). Delta markers are displayed in % referenced to the voltage value at the position of marker 1. This is the default setting for linear scaling.

Remote command:

DISP:TRAC:Y:SPAC LIN, see [DISPlay\[:WINDow<n>\]:TRACe<t>:Y:SPACing](#) on page 717

Range Lin. Unit ← x-Axis Range ← Scaling ← APD

Selects linear scaling in dB for the level display range, i.e. the horizontal lines are labeled in dB.

Markers are displayed in the selected unit ("Unit" softkey). Delta markers are displayed in dB referenced to the power value at the position of marker 1.

Remote command:

DISP:TRAC:Y:SPAC LDB, see [DISPlay\[:WINDow<n>\]:TRACe<t>:Y:SPACing](#) on page 717

y-Axis Max Value ← Scaling ← APD

Opens an edit dialog box to define the upper limit of the displayed probability range.

Values on the y-axis are normalized which means that the maximum value is 1.0. The y-axis scaling is defined via the [y-Unit % / Abs](#) softkey. The distance between max and min value must be at least one decade.

Remote command:

[CALCulate<n>:STATistics:SCALE:Y:UPPer](#) on page 702

y-Axis Min Value ← Scaling ← APD

Opens an edit dialog box to define the lower limit of the displayed probability range.

Values in the range $1e^{-9} < value < 0.1$ are allowed. The y-axis scaling is defined via the [y-Unit % / Abs](#) softkey. The distance between max and min value must be at least one decade.

Remote command:

[CALCulate<n>:STATistics:SCALE:Y:LOWer](#) on page 701

y-Unit % / Abs ← Scaling ← APD

Defines the scaling type of the y-axis. The default value is absolute scaling.

Remote command:

[CALCulate<n>:STATistics:SCALE:Y:UNIT](#) on page 702

Default Settings ← Scaling ← APD

Resets the x- and y-axis scalings to their preset values.

x-axis ref level:	-10 dBm
x-axis range APD:	100 dB
x-axis range CCDF:	20 dB
y-axis upper limit:	1.0
y-axis lower limit:	1E-6

Remote command:

[CALCulate<n>:STATistics:PRESet](#) on page 699

Adjust Settings ← Scaling ← APD

Adjusts the level settings according to the measured difference between peak and minimum power for APD measurement or peak and mean power for CCDF measurement in order to obtain maximum power resolution. Adjusts the reference level to the current input signal. For details see also the [Adjust Ref Lvl](#) softkey.

Remote command:

[CALCulate<n>:STATistics:SCALE:AUTO ONCE](#) on page 700

Gated Trigger (On/Off) ← APD

Activates and deactivates the gating for statistics functions for the ACP and the CCDF channel. The trigger source is changed to "EXTERN" if this function is switched on. The gate ranges are defined using the ["Gate Ranges"](#) on page 235 softkey.

Remote command:

[\[SENSe:\]SWEep:EGATe](#) on page 867

[\[SENSe:\]SWEep:EGATe:SOURce](#) on page 868

Gate Ranges ← APD

Opens a dialog to configure up to 3 gate ranges for each trace.

For details on configuration, see ["Defining Gated Triggering for APD and CCDF"](#) on page 242.

Gate Ranges						
	Trace 1	Trace 2	Trace 3	Trace 4	Trace 5	Trace 6
Comment	SlotA					
Period	8 ms	8 ms	8 ms	8 ms	8 ms	8 ms
Range 1 Start	1 ms	1 μ s	1 μ s	1 μ s	1 μ s	1 μ s
Range 1 Stop	3 ms	1 μ s	1 μ s	1 μ s	1 μ s	1 μ s
Range 1 Use	On	Off	Off	Off	Off	Off
Range 2 Start	1 μ s	1 μ s	1 μ s	1 μ s	1 μ s	1 μ s
Range 2 Stop	1 μ s	1 μ s	1 μ s	1 μ s	1 μ s	1 μ s
Range 2 Use	Off	Off	Off	Off	Off	Off
Range 3 Start	1 μ s	1 μ s	1 μ s	1 μ s	1 μ s	1 μ s
Range 3 Stop	1 μ s	1 μ s	1 μ s	1 μ s	1 μ s	1 μ s
Range 3 Use	Off	Off	Off	Off	Off	Off

Remote command:

SWE:EGAT ON (see [SENSe:]SWEep:EGATe on page 867)

Switches on the external gate mode.

SWE:EGAT:TRAC1:COMM "SlotA" (see [SENSe:]SWEep:EGATe:TRACe<k>:COMMENT on page 869)

Adds a comment to trace 1.

SWE:EGAT:TRAC1:STAT1 ON (see [SENSe:]SWEep:EGATe:TRACe<k>[:STATe<range>] on page 869)

Activates tracing for range 1 of trace 1.

SWE:EGAT:TRAC1:STAR1 3ms (see [SENSe:]SWEep:EGATe:TRACe<k>:STARt<range> on page 869)

Sets the starting point for range 1 on trace 1 at 3 ms.

SWE:EGAT:TRAC1:STOp1 5ms (see [SENSe:]SWEep:EGATe:TRACe<k>:STOp<range> on page 870)

Sets the stopping point for range 1 on trace 1 at 5 ms.

SWE:EGAT:TRAC1:PER 5ms (see [SENSe:]SWEep:EGATe:TRACe<k>:PERIOD on page 870)

Defines the period for gated triggering to 5 ms.

Adjust Settings ← APD

Adjusts the level settings according to the measured difference between peak and minimum power for APD measurement or peak and mean power for CCDF measurement in order to obtain maximum power resolution. Adjusts the reference level to the current input signal. For details see also the [Adjust Ref Lvl](#) softkey.

Remote command:

CALCulate<n>:STATistics:SCALE:AUTO ONCE on page 700

Softkeys for CCDF Measurements

CCDF.....	237
L Percent Marker.....	237
L Res BW.....	238
L # of Samples.....	238
L Scaling.....	238
L x-Axis Ref Level.....	238

L x-Axis Range.....	238
L Range Log 100 dB.....	239
L Range Log 50 dB.....	239
L Range Log 10 dB.....	239
L Range Log 5 dB.....	239
L Range Log 1 dB.....	240
L Range Log Manual.....	240
L Range Linear %.....	240
L Range Lin. Unit.....	240
L y-Axis Max Value.....	240
L y-Axis Min Value.....	241
L y-Unit % / Abs.....	241
L Default Settings.....	241
L Adjust Settings.....	241
L Gated Trigger (On/Off).....	241
L Gate Ranges.....	241
L Adjust Settings.....	242

CCDF

Activates the function to measure the complementary cumulative distribution function (CCDF) and opens a submenu.

After a CCDF measurement, the results are displayed in a table beneath the diagram.

Mean	Mean power
Peak	Peak power
Crest	Crest factor (peak power – mean power)
0,01 %	Level values over 0,01 % above mean power
0,1 %	Level values over 0,1 % above mean power
1 %	Level values over 1 % above mean power
10 %	Level values over 10 % above mean power

In addition, a red reference line indicating the calculated Gauss distribution is displayed.

Remote command:

`CALCulate<n>:STATistics:CCDF[:STATe]` on page 698

Activates the CCDF measurement.

`CALCulate<n>:STATistics:CCDF:X<Trace>` on page 698

Reads out the level values for 1 % probability.

Percent Marker ← CCDF

Opens an edit dialog box to enter a probability value and to position marker 1. Thus, the power which is exceeded with a given probability can be determined very easily. If marker 1 is deactivated, it will be switched on automatically.

As all markers, the percent marker can be moved simply by touching it with a finger or mouse cursor and dragging it to the desired position.

Remote command:

`CALCulate<n>:MARKer<m>:Y:PERCent` on page 622

Res BW ← CCDF

Opens an edit dialog box to set the resolution bandwidth directly.

For correct measurement of the signal statistics the resolution bandwidth has to be wider than the signal bandwidth in order to measure the actual peaks of the signal amplitude correctly. In order not to influence the peak amplitudes the video bandwidth is automatically set to 10 MHz. The sample detector is used for detecting the video voltage.

Remote command:

`[SENSe:]BANDwidth|BWIDth[:RESolution]` on page 782

of Samples ← CCDF

Opens an edit dialog box to set the number of power measurements that are taken into account for the statistics.

Apart from the number of measurements the overall measurement time depends also on the set resolution bandwidth as the resolution bandwidth directly influences the sampling rate.

For details see "[Selecting the number of samples](#)" on page 228.

Remote command:

`CALCulate<n>:STATistics:NSAMples` on page 699

Scaling ← CCDF

Opens a submenu to change the scaling parameters of x- and y-axis.

x-Axis Ref Level ← Scaling ← CCDF

Opens an edit dialog box to enter the reference level in the currently active unit (dBm, dBμV, etc). The function of this softkey is identical to the "Ref Level" softkey in the "Amplitude" menu (see "[Ref Level](#)" on page 67).

For the APD function this value is mapped to the right diagram border. For the CCDF function there is no direct representation of this value on the diagram as the x-axis is scaled relatively to the measured mean power.

Remote command:

`CALCulate<n>:STATistics:SCALE:X:RLEVEL` on page 701

x-Axis Range ← Scaling ← CCDF

Opens the "Range" submenu to select a value for the level range to be covered by the statistics measurement selected.

Remote command:

`CALCulate<n>:STATistics:SCALE:X:RANGE` on page 701

Range Log 100 dB ← x-Axis Range ← Scaling ← CCDF

Sets the level display range to 100 dB.

Remote command:

Logarithmic scaling:

DISP:WIND:TRAC:Y:SPAC LOG, see [DISPlay\[:WINDow<n>\]:TRACe<t>:Y:SPACing](#) on page 717

Display range:

DISP:WIND:TRAC:Y 100DB, see [DISPlay\[:WINDow<n>\]:TRACe<t>:Y\[:SCALe\]](#) on page 718

Range Log 50 dB ← x-Axis Range ← Scaling ← CCDF

Sets the level display range to 50 dB.

Remote command:

Logarithmic scaling:

DISP:WIND:TRAC:Y:SPAC LOG, see [DISPlay\[:WINDow<n>\]:TRACe<t>:Y:SPACing](#) on page 717

Display range:

DISP:WIND:TRAC:Y 50DB, see [DISPlay\[:WINDow<n>\]:TRACe<t>:Y\[:SCALe\]](#) on page 718

Range Log 10 dB ← x-Axis Range ← Scaling ← CCDF

Sets the level display range to 10 dB.

Remote command:

Logarithmic scaling:

DISP:WIND:TRAC:Y:SPAC LOG, see [DISPlay\[:WINDow<n>\]:TRACe<t>:Y:SPACing](#) on page 717

Display range:

DISP:WIND:TRAC:Y 10DB, see [DISPlay\[:WINDow<n>\]:TRACe<t>:Y\[:SCALe\]](#) on page 718

Range Log 5 dB ← x-Axis Range ← Scaling ← CCDF

Sets the level display range to 5 dB.

Remote command:

Logarithmic scaling:

DISP:WIND:TRAC:Y:SPAC LOG, see [DISPlay\[:WINDow<n>\]:TRACe<t>:Y:SPACing](#) on page 717

Display range:

DISP:WIND:TRAC:Y 5DB, see [DISPlay\[:WINDow<n>\]:TRACe<t>:Y\[:SCALe\]](#) on page 718

Range Log 1 dB ← x-Axis Range ← Scaling ← CCDF

Sets the level display range to 1 dB.

Remote command:

Logarithmic scaling:

DISP:WIND:TRAC:Y:SPAC LOG, see [DISPlay\[:WINDow<n>\]:TRACe<t>:Y:SPACing](#) on page 717

Display range:

DISP:WIND:TRAC:Y 1DB, see [DISPlay\[:WINDow<n>\]:TRACe<t>:Y\[:SCALe\]](#) on page 718

Range Log Manual ← x-Axis Range ← Scaling ← CCDF

Opens an edit dialog box to define the display range of a logarithmic level axis manually.

Remote command:

Logarithmic scaling:

DISP:WIND:TRAC:Y:SPAC LOG, see [DISPlay\[:WINDow<n>\]:TRACe<t>:Y:SPACing](#) on page 717

Display range:

[DISPlay\[:WINDow<n>\]:TRACe<t>:Y\[:SCALe\]](#) on page 718

Range Linear % ← x-Axis Range ← Scaling ← CCDF

Selects linear scaling for the level axis in %.

The grid is divided into decadal sections.

Markers are displayed in the selected unit ("Unit" softkey). Delta markers are displayed in % referenced to the voltage value at the position of marker 1. This is the default setting for linear scaling.

Remote command:

DISP:TRAC:Y:SPAC LIN, see [DISPlay\[:WINDow<n>\]:TRACe<t>:Y:SPACing](#) on page 717

Range Lin. Unit ← x-Axis Range ← Scaling ← CCDF

Selects linear scaling in dB for the level display range, i.e. the horizontal lines are labeled in dB.

Markers are displayed in the selected unit ("Unit" softkey). Delta markers are displayed in dB referenced to the power value at the position of marker 1.

Remote command:

DISP:TRAC:Y:SPAC LDB, see [DISPlay\[:WINDow<n>\]:TRACe<t>:Y:SPACing](#) on page 717

y-Axis Max Value ← Scaling ← CCDF

Opens an edit dialog box to define the upper limit of the displayed probability range.

Values on the y-axis are normalized which means that the maximum value is 1.0. The y-axis scaling is defined via the [y-Unit % / Abs](#) softkey. The distance between max and min value must be at least one decade.

Remote command:

[CALCulate<n>:STATistics:SCALe:Y:UPPer](#) on page 702

y-Axis Min Value ← **Scaling** ← **CCDF**

Opens an edit dialog box to define the lower limit of the displayed probability range. Values in the range $1e^{-9} < value < 0.1$ are allowed. The y-axis scaling is defined via the **y-Unit % / Abs** softkey. The distance between max and min value must be at least one decade.

Remote command:

`CALCulate<n>:STATistics:SCALE:Y:LOWer` on page 701

y-Unit % / Abs ← **Scaling** ← **CCDF**

Defines the scaling type of the y-axis. The default value is absolute scaling.

Remote command:

`CALCulate<n>:STATistics:SCALE:Y:UNIT` on page 702

Default Settings ← **Scaling** ← **CCDF**

Resets the x- and y-axis scalings to their preset values.

x-axis ref level:	-10 dBm
x-axis range APD:	100 dB
x-axis range CCDF:	20 dB
y-axis upper limit:	1.0
y-axis lower limit:	1E-6

Remote command:

`CALCulate<n>:STATistics:PRESet` on page 699

Adjust Settings ← **Scaling** ← **CCDF**

Adjusts the level settings according to the measured difference between peak and minimum power for APD measurement or peak and mean power for CCDF measurement in order to obtain maximum power resolution. Adjusts the reference level to the current input signal. For details see also the **Adjust Ref Lvl** softkey.

Remote command:

`CALCulate<n>:STATistics:SCALE:AUTO ONCE` on page 700

Gated Trigger (On/Off) ← **CCDF**

Activates and deactivates the gating for statistics functions for the ACP and the CCDF channel. The trigger source is changed to "EXTERN" if this function is switched on. The gate ranges are defined using the **"Gate Ranges"** on page 235 softkey.

Remote command:

`[SENSe:]SWEep:EGATe` on page 867

`[SENSe:]SWEep:EGATe:SOURce` on page 868

Gate Ranges ← **CCDF**

Opens a dialog to configure up to 3 gate ranges for each trace.

For details on configuration, see **"Defining Gated Triggering for APD and CCDF"** on page 242.

Gate Ranges						
	Trace 1	Trace 2	Trace 3	Trace 4	Trace 5	Trace 6
Comment	SlotA					
Period	8 ms	8 ms	8 ms	8 ms	8 ms	8 ms
Range 1 Start	1 ms	1 μ s	1 μ s	1 μ s	1 μ s	1 μ s
Range 1 Stop	3 ms	1 μ s	1 μ s	1 μ s	1 μ s	1 μ s
Range 1 Use	On	Off	Off	Off	Off	Off
Range 2 Start	1 μ s	1 μ s	1 μ s	1 μ s	1 μ s	1 μ s
Range 2 Stop	1 μ s	1 μ s	1 μ s	1 μ s	1 μ s	1 μ s
Range 2 Use	Off	Off	Off	Off	Off	Off
Range 3 Start	1 μ s	1 μ s	1 μ s	1 μ s	1 μ s	1 μ s
Range 3 Stop	1 μ s	1 μ s	1 μ s	1 μ s	1 μ s	1 μ s
Range 3 Use	Off	Off	Off	Off	Off	Off

Remote command:

SWE:EGAT ON (see [\[SENSe:\]SWEep:EGATe](#) on page 867)

Switches on the external gate mode.

SWE:EGAT:TRAC1:COMM "SlotA" (see [\[SENSe:\]SWEep:EGATe:TRACe<k>:COMMENT](#) on page 869)

Adds a comment to trace 1.

SWE:EGAT:TRAC1:STAT1 ON (see [\[SENSe:\]SWEep:EGATe:TRACe<k>\[:STATe<range>\]](#) on page 869)

Activates tracing for range 1 of trace 1.

SWE:EGAT:TRAC1:STAR1 3ms (see [\[SENSe:\]SWEep:EGATe:TRACe<k>:STARt<range>](#) on page 869)

Sets the starting point for range 1 on trace 1 at 3 ms.

SWE:EGAT:TRAC1:STOp1 5ms (see [\[SENSe:\]SWEep:EGATe:TRACe<k>:STOp<range>](#) on page 870)

Sets the stopping point for range 1 on trace 1 at 5 ms.

SWE:EGAT:TRAC1:PER 5ms (see [\[SENSe:\]SWEep:EGATe:TRACe<k>:PERIOD](#) on page 870)

Defines the period for gated triggering to 5 ms.

Adjust Settings ← CCDF

Adjusts the level settings according to the measured difference between peak and minimum power for APD measurement or peak and mean power for CCDF measurement in order to obtain maximum power resolution. Adjusts the reference level to the current input signal. For details see also the [Adjust Ref Lvl](#) softkey.

Remote command:

[CALCulate<n>:STATistics:SCALE:AUTO ONCE](#) on page 700

Defining Gated Triggering for APD and CCDF

Statistic measurements on pulsed signals can be performed using GATED TRIGGER. An external frame trigger is required as a time (frame) reference.

The gate ranges define the part of the I/Q capture data taken into account for the statistics calculation. These ranges are defined relative to a reference point T=0. The gate interval is repeated for each period until the end of the I/Q capture buffer.

The reference point $T=0$ is defined by the external trigger event and the instrument's trigger offset.

For each trace you can define up to 3 separate ranges of a single period to be traced.

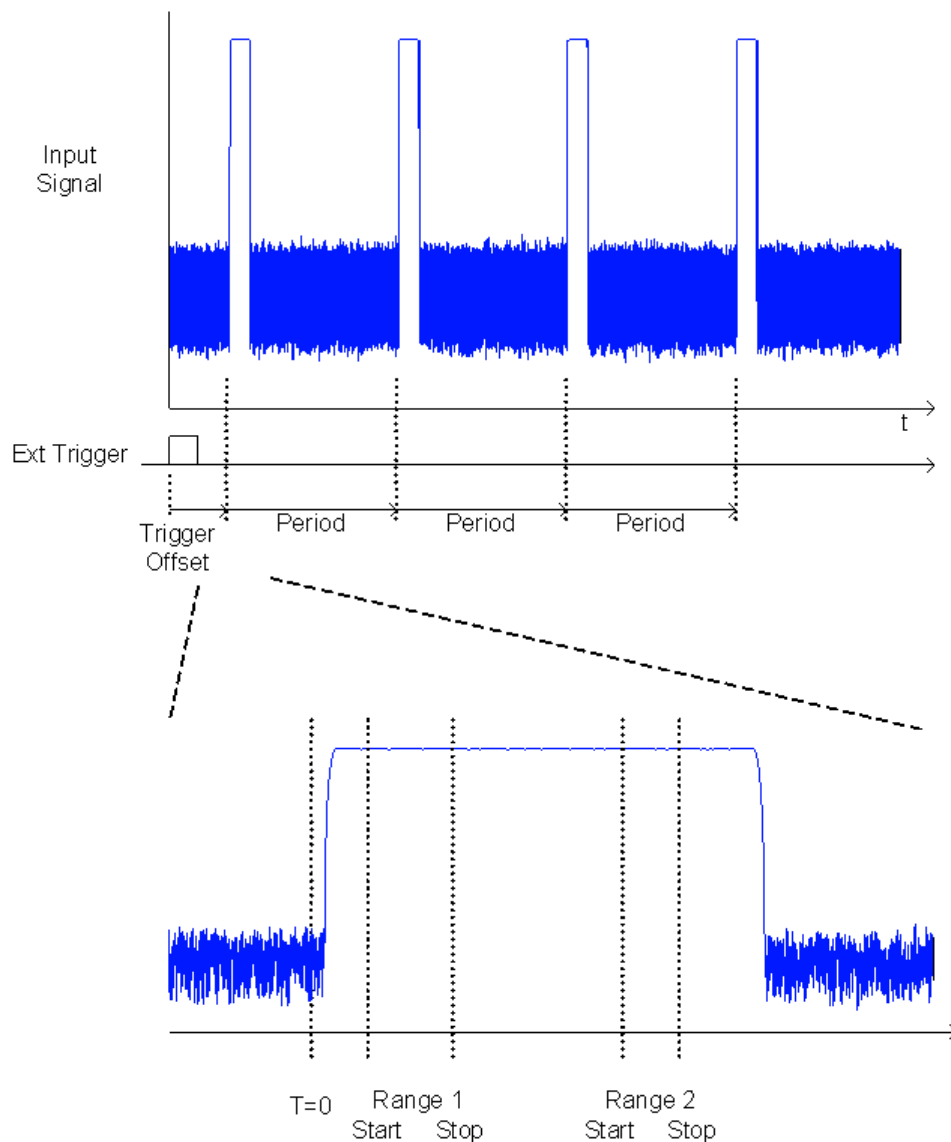

Defining gated triggering

1. Press the "Gated Trigger" softkey to activate gated triggering (see ["Gated Trigger \(On/Off\)"](#) on page 235).
2. Press the "Gate Ranges" softkey to open the "Gate Ranges" dialog (see ["Gate Ranges"](#) on page 235).
3. Define the length of the period to be analyzed in the "Period" field.

Note: The period is the same for all traces. If you change the period for one trace, it is automatically changed for all traces.

Make sure the defined period is not longer than the acquisition time of the current measurement. Keep in mind that the acquisition time depends on the bandwidth and the number of samples settings (see ["Selecting the number of samples"](#) on page 228). The current acquisition time is indicated as "AQT" in the channel bar.

4. Optionally, define a description of the trace in the "Comment" field.
5. Activate tracing for the range by selecting "On" in the "Range <number> Use" field for the corresponding range and trace.

The start and stop time edit fields are ready for input.

Note: The time values have full numerical resolution and are only rounded for display.

6. Define the starting point of the range within the period.
7. Define the stopping point for the range within the period. Make sure the value for the stopping time is smaller than the length of the period.
8. To define further ranges for the same period in the same trace, repeat steps 5- 7 for the same trace.

To define further ranges for the same period in a different trace, repeat steps 4- 7 for a different trace.

9. If necessary, activate the configured traces in the "Trace" menu.

Gated statistics configuration example

A statistics evaluation has to be done over the useful part of the signal between t_3 and t_4 . The period of the GSM signal is 4.61536 ms

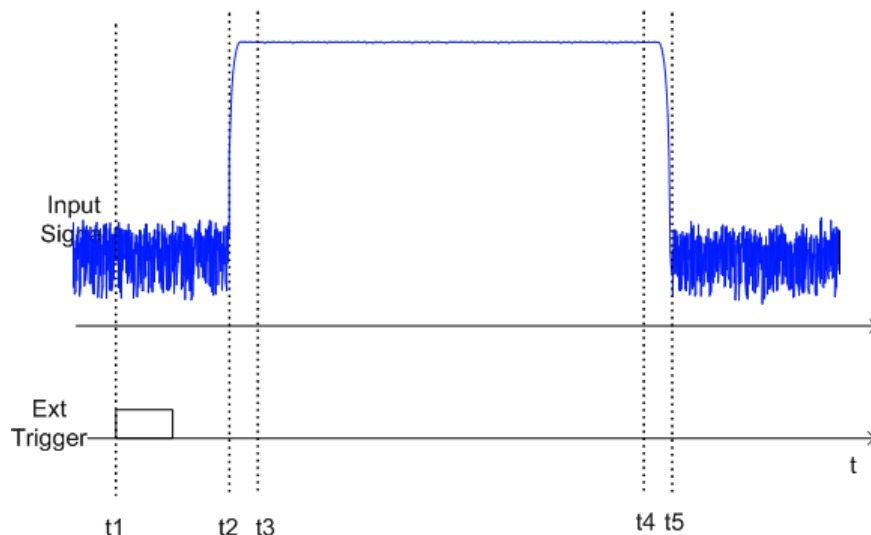

t_1 : External positive trigger slope

t_2 : Begin of burst (after 25 μ s)

t_3 : Begin of useful part, to be used for statistics (after 40 μ s)

t4: End of useful part, to be used for statistics (after 578 μ s)

t5: End of burst (after 602 μ s)

The instrument has to be configured as follows:

Trigger Offset	$t2 - t1 = 25 \mu\text{s}$	now the gate ranges are relative to t2
Range1 Start	$t3 - t2 = 15 \mu\text{s}$	start of range 1 relative to t2
Range1 End	$t4 - t2 = 553 \mu\text{s}$	end of range 1 relative to t2

4.2.5.9 Measuring the Third Order Intercept Point (TOI)

In order to measure the third order intercept point (TOI), a two-tone signal with equal carrier levels is expected at the R&S FSVR input. Marker 1 and marker 2 (both normal markers) are set to the maximum of the two signals. Marker 3 and marker 4 are placed on the intermodulation products.

The R&S FSVR calculates the third order intercept point from the level difference between the first 2 markers and the markers 3 and 4 and displays it in the marker field.

The third order intercept point is measured using the "TOI" softkey, see "TOI" on page 154.

About TOI Measurement

If several signals are applied to a transmission two-port device with nonlinear characteristic, intermodulation products appear at its output at the sums and differences of the signals. The nonlinear characteristic produces harmonics of the useful signals which intermodulate at the characteristic. The intermodulation products of lower order have a special effect since their level is largest and they are near the useful signals. The intermodulation product of third order causes the highest interference. It is the intermodulation product generated from one of the useful signals and the 2nd harmonic of the second useful signal in case of two-tone modulation.

The frequencies of the intermodulation products are above and below the useful signals. The [figure 4-18](#) shows intermodulation products P_{11} and P^{12} generated by the two useful signals P_{U1} and P_{U2} .

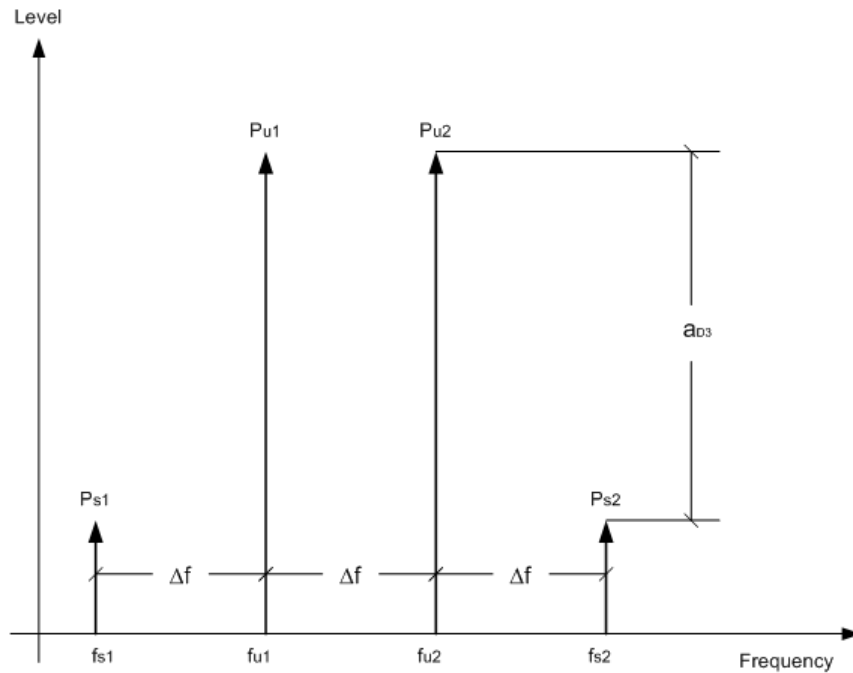

Fig. 4-18: Intermodulation products PU1 and PU2

The intermodulation product at f_{i2} is generated by mixing the 2nd harmonic of useful signal P_{U2} and signal P_{U1} , the intermodulation product at f_{i1} by mixing the 2nd harmonic of useful signal P_{U1} and signal P_{U2} .

$$f_{i1} = 2 \times f_{u1} - f_{u2} \quad (6)$$

$$f_{i2} = 2 \times f_{u2} - f_{u1} \quad (7)$$

Dependency on level of useful signals

The level of the intermodulation products depends on the level of the useful signals. If the two useful signals are increased by 1 dB, the level of the intermodulation products increases by 3 dB, which means that spacing a_{D3} between intermodulation signals and useful signals are reduced by 2 dB. This is illustrated in [figure 4-19](#).

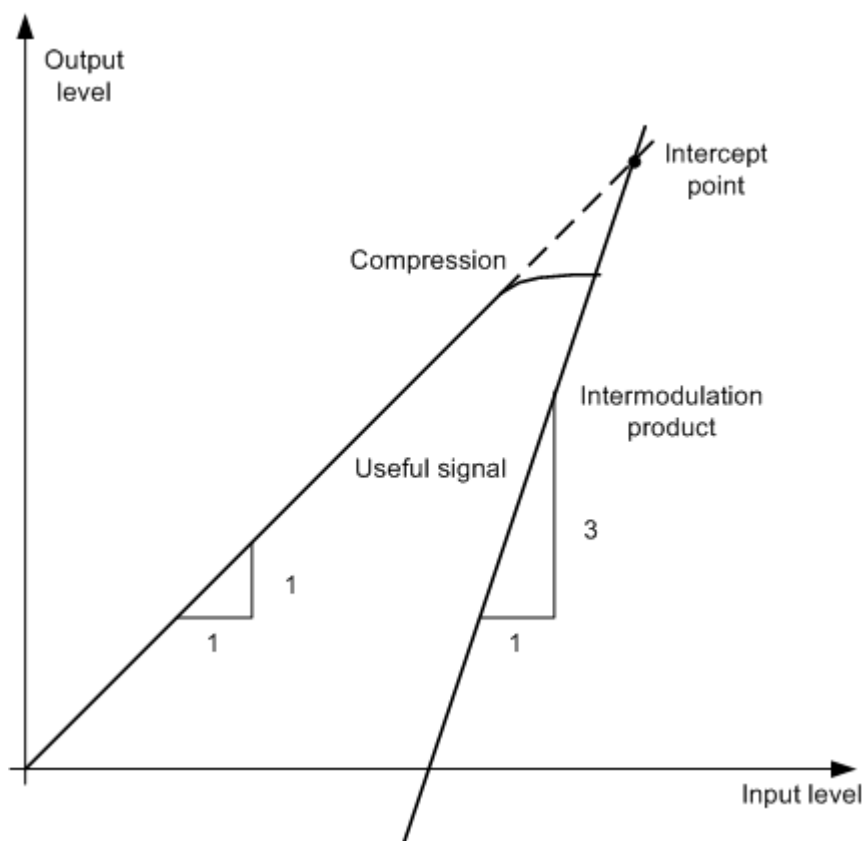

Fig. 4-19: Dependency of intermodulation level on useful signal level

The useful signals at the two-port output increase proportionally with the input level as long as the two-port is in the linear range. A level change of 1 dB at the input causes a level change of 1 dB at the output. Beyond a certain input level, the two-port goes into compression and the output level stops increasing. The intermodulation products of the third order increase three times as much as the useful signals. The intercept point is the fictitious level where the two lines intersect. It cannot be measured directly since the useful level is previously limited by the maximum two-port output power.

Calculation method

It can be calculated from the known line slopes and the measured spacing a_{D3} at a given level according to the following formula:

$$IP3 = \frac{a_{D3}}{2} + P_N$$

The 3rd order intercept point (TOI), for example, is calculated for an intermodulation of 60 dB and an input level P_U of -20 dBm according to the following formula:

$$IP3 = \frac{60}{2} + (-20dBm) = 10dBm$$

Intermodulation-free dynamic range

The "Intermodulation-free dynamic range", i.e. the level range in which no internal intermodulation products are generated if two-tone signals are measured, is determined by the 3rd order intercept point, the phase noise and the thermal noise of the signal analyzer. At high signal levels, the range is determined by intermodulation products. At low signal levels, intermodulation products disappear below the noise floor, i.e. the noise floor and the phase noise of the signal analyzer determine the range. The noise floor and the phase noise depend on the resolution bandwidth that has been selected. At the smallest resolution bandwidth, the noise floor and phase noise are at a minimum and so the maximum range is obtained. However, a large increase in sweep time is required for small resolution bandwidths. It is, therefore, best to select the largest resolution bandwidth possible to obtain the range that is required. Since phase noise decreases as the carrier-offset increases, its influence decreases with increasing frequency offset from the useful signals.

The following diagrams illustrate the intermodulation-free dynamic range as a function of the selected bandwidth and of the level at the input mixer (= signal level – set RF attenuation) at different useful signal offsets.

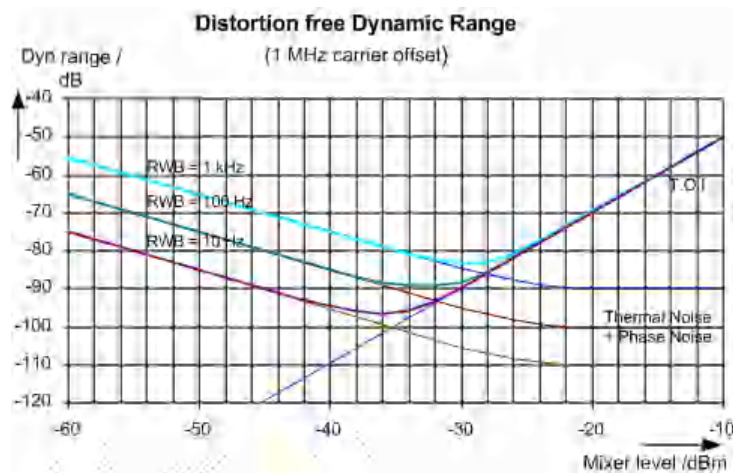

Fig. 4-20: Intermodulation-free range of the R&S FSVR as a function of level at the input mixer and the set resolution bandwidth

(Useful signal offset = 1 MHz, DANL = -145 dBm/Hz, TOI = 15 dBm; typical values at 2 GHz)

The optimum mixer level, i.e. the level at which the intermodulation distance is at its maximum, depends on the bandwidth. At a resolution bandwidth of 10 Hz, it is approx. -35 dBm and at 1 kHz increases to approx. -30 dBm.

Phase noise has a considerable influence on the intermodulation-free range at carrier offsets between 10 and 100 kHz (figure 4-20). At greater bandwidths, the influence of the phase noise is greater than it would be with small bandwidths. The optimum mixer level at the bandwidths under consideration becomes almost independent of bandwidth and is approx. -40 dBm.

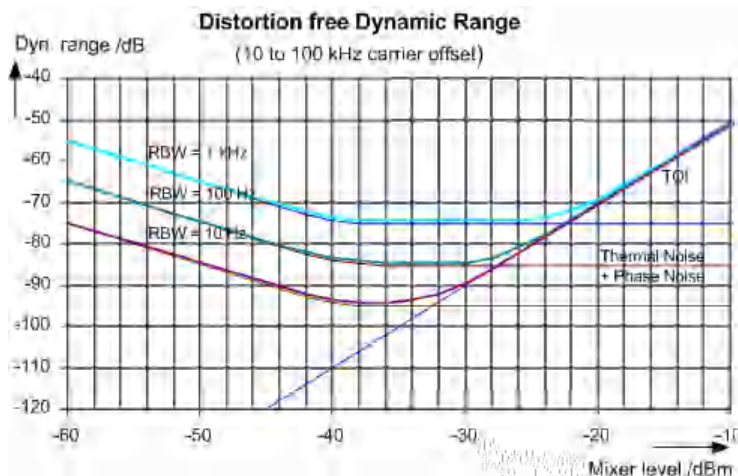

Fig. 4-21: Intermodulation-free dynamic range of the R&S FSVR as a function of level at the input mixer and of the selected resolution bandwidth

(Useful signal offset = 10 to 100 kHz, DANL = -145 dBm/Hz, TOI = 15 dBm; typical values at 2 GHz).



If the intermodulation products of a DUT with a very high dynamic range are to be measured and the resolution bandwidth to be used is therefore very small, it is best to measure the levels of the useful signals and those of the intermodulation products separately using a small span. The measurement time will be reduced- in particular if the offset of the useful signals is large. To find signals reliably when frequency span is small, it is best to synchronize the signal sources and the R&S FSVR.

Measurement Results

As a result of the TOI measurement, the following values are displayed in the marker area of the diagram:

Label	Description
TOI	Third-order intercept point
M1	Maximum of first useful signal
M2	Maximum of second useful signal
M3	First intermodulation product
M4	Second intermodulation product

Remote command

The TOI can also be queried using the remote command `CALCulate<n>:MARKer<m>:FUNCTION:TOI:RESULT?` on page 639.

Softkeys for TOI Measurements

TOI.....	250
L Marker 1 / Marker 2 / Marker 3 / ... Marker 16,/ Marker Norm/Delta.....	250
L Search Signals.....	250

TOI

Opens a submenu and activates the measurement of the 3rd order intercept point.

A two-tone signal with equal carrier levels is expected at the R&S FSVR input. Marker 1 and marker 2 (both normal markers) are set to the maximum of the two signals. Marker 3 and marker 4 are placed on the intermodulation products.

The R&S FSVR calculates the third order intercept point from the level difference between the first 2 markers and the markers 3 and 4 and displays it in the marker field.

For general information on measuring the TOI see [chapter 4.2.5.9, "Measuring the Third Order Intercept Point \(TOI\)"](#), on page 245.

Remote command:

`CALCulate<n>:MARKer<m>:FUNCTion:TOI[:STATe]` on page 640

`CALCulate<n>:MARKer<m>:FUNCTion:TOI:RESult?` on page 639

Marker 1 / Marker 2 / Marker 3 / ... Marker 16,/ Marker Norm/Delta ← TOI

The "Marker X" softkey activates the corresponding marker and opens an edit dialog box to enter a value for the marker to be set to. Pressing the softkey again deactivates the selected marker.

If a marker value is changed using the rotary knob, the step size is defined via the [Stepsize Standard](#) or [Stepsize Sweep Points](#) softkeys.

Marker 1 is always the reference marker for relative measurements. If activated, markers 2 to 16 are delta markers that refer to marker 1. These markers can be converted into markers with absolute value display using the "Marker Norm/Delta" softkey. If marker 1 is the active marker, pressing the "Marker Norm/Delta" softkey switches on an additional delta marker.

Remote command:

`CALCulate<n>:MARKer<m>[:STATe]` on page 608

`CALCulate<n>:MARKer<m>:X` on page 618

`CALCulate<n>:MARKer<m>:Y` on page 620

`CALCulate<n>:DELTamarker<m>[:STATe]` on page 557

`CALCulate<n>:DELTamarker<m>:X` on page 568

`CALCulate<n>:DELTamarker<m>:X:RELative?` on page 569

`CALCulate<n>:DELTamarker<m>:Y` on page 569

Search Signals ← TOI

Activates all markers.

Remote command:

`CALCulate<n>:MARKer<m>:FUNCTion:TOI:SEARChsignal ONCE` on page 639

4.2.5.10 Measuring the AM Modulation Depth

The AM modulation depth, also known as a modulation index, indicates by how much the modulated signal varies around the carrier amplitude. It is defined as:

$$MDepth = \text{peak signal amplitude} / \text{unmodulated carrier amplitude}$$

So for MDepth = 0.5, for example, the carrier amplitude varies by 50% above and below its unmodulated level, and for h = 1.0 it varies by 100%.

You can measure the modulation depth of a modulated signal using the [AM Mod Depth](#) function.

When this function is activated, marker 1 is set to the peak level, which is considered to be the carrier level. Deltamarkers 2 and 3 are automatically set symmetrically to the carrier on the adjacent peak values of the trace. The markers can be adjusted manually, if necessary.

The R&S FSVR calculates the power at the marker positions from the measured levels. The AM modulation depth is calculated as the ratio between the power values at the reference marker and at the delta markers. If the powers of the two AM side bands are unequal, the mean value of the two power values is used for AM modulation depth calculation.



A remote control programming example is described in [chapter 8.3.2.3, "Measuring the AM Modulation Depth"](#), on page 1026 and an example of how to perform the measurement manually in the R&S FSVR Quick Start Guide in chapter "Measurement Examples".

Measurement results

The AM modulation depth in percent is displayed as a result of the measurement, indicated in the marker results as "MDepth".

It can also be queried using the remote command `CALCulate<n>:MARKer<m>:FUNction:MDEPth:RESult?` on page 632.

Softkeys for AM Modulation Depth Measurements

AM Mod Depth.....	251
L Marker 1 / Marker 2 / Marker 3 / ... Marker 16, / Marker Norm/Delta.....	252
L Search Signals.....	252

AM Mod Depth

Activates the measurement of the AM modulation depth. An AM-modulated carrier is required on the screen to ensure correct operation.

When this function is activated, marker 1 is set to the peak level, which is considered to be the carrier level. Deltamarkers 2 and 3 are automatically set symmetrically to the carrier on the adjacent peak values of the trace. An edit dialog box is displayed for deltamarker 2 in order to adjust the position manually.

When the position of deltamarker 2 is changed, deltamarker 3 is moved symmetrically with respect to the reference marker 1.

Deltamarker 3, on the other hand, can be moved for fine adjustment irrespective of marker 2.

Marker 1 can also be moved manually for re-adjustment without affecting the position of the deltamarkers.

For general information on measuring the AM modulation depth see [chapter 4.2.5.10, "Measuring the AM Modulation Depth"](#), on page 251.

Remote command:

`CALCulate<n>:MARKer<m>:FUNction:MDEPth[:STATe]` on page 632

`CALCulate<n>:MARKer<m>:FUNction:MDEPth:RESult?` on page 632

Marker 1 / Marker 2 / Marker 3 / ... Marker 16,/ Marker Norm/Delta ← AM Mod Depth

The "Marker X" softkey activates the corresponding marker and opens an edit dialog box to enter a value for the marker to be set to. Pressing the softkey again deactivates the selected marker.

If a marker value is changed using the rotary knob, the step size is defined via the [Stepsize Standard](#) or [Stepsize Sweep Points](#) softkeys.

Marker 1 is always the reference marker for relative measurements. If activated, markers 2 to 16 are delta markers that refer to marker 1. These markers can be converted into markers with absolute value display using the "Marker Norm/Delta" softkey. If marker 1 is the active marker, pressing the "Marker Norm/Delta" softkey switches on an additional delta marker.

Remote command:

`CALCulate<n>:MARKer<m>[:STATe]` on page 608

`CALCulate<n>:MARKer<m>:X` on page 618

`CALCulate<n>:MARKer<m>:Y` on page 620

`CALCulate<n>:DELTamarker<m>[:STATe]` on page 557

`CALCulate<n>:DELTamarker<m>:X` on page 568

`CALCulate<n>:DELTamarker<m>:X:RELative?` on page 569

`CALCulate<n>:DELTamarker<m>:Y` on page 569

Search Signals ← AM Mod Depth

Activates all markers.

Remote command:

`CALCulate<n>:MARKer<m>:FUNction:MDEPth:SEARChsignal ONCE`

on page 632

4.2.5.11 Measuring Harmonic Distortion

The harmonics and their distortion can be measured using the ["Harmonic Distortion"](#) on page 155 function.

With this measurement it is possible to measure the harmonics e.g. from a VCO easily. In addition the THD (total harmonic distortion) is calculated in % and dB.

With span > 0 Hz, an automatic search for the first harmonic is carried out within the set frequency range. Also the level is adjusted. In zero span, the center frequency is unchanged.

As a result, the zero span sweeps on all harmonics are shown, as well as the RMS values and the THD (total harmonic distortion).

About Harmonics Distortion Measurement

Measuring the harmonics of a signal is a frequent problem which can be solved best using a signal analyzer. In general, every signal contains harmonics which are larger than others. Harmonics are particularly critical regarding high-power transmitters such as transceivers because large harmonics can interfere with other radio services.

Harmonics are generated by nonlinear characteristics. They can often be reduced by low pass filters. Since the signal analyzer has a nonlinear characteristic, e.g. in its first mixer, measures must be taken to ensure that harmonics produced in the signal analyzer do not cause spurious results. If necessary, the fundamental wave must be selectively attenuated with respect to the other harmonics with a high pass filter.

Obtainable dynamic range

When harmonics are being measured, the obtainable dynamic range depends on the second harmonic intercept of the signal analyzer. The second harmonic intercept is the virtual input level at the RF input mixer at which the level of the 2nd harmonic becomes equal to the level of the fundamental wave. In practice, however, applying a level of this magnitude would damage the mixer. Nevertheless, the available dynamic range for measuring the harmonic distance of a DUT can be calculated relatively easily using the second harmonic intercept.

As shown in [figure 4-22](#), the level of the 2nd harmonic drops by 20 dB if the level of the fundamental wave is reduced by 10 dB.

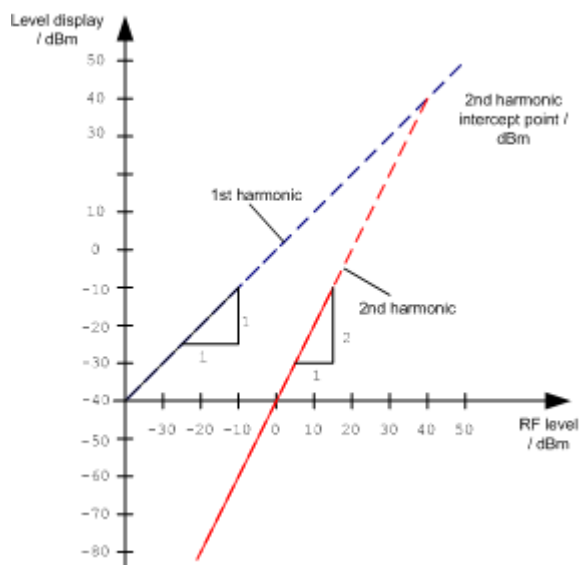

Fig. 4-22: Extrapolation of the 1st and 2nd harmonics to the 2nd harmonic intercept at 40 dBm

The following formula for the obtainable harmonic distortion d_2 in dB is derived from the straight-line equations and the given intercept point:

$$d_2 = \text{S.H.I} - P_1 (1)$$

where:

d2	=	harmonic distortion
P ₁	=	mixer level/dBm
S.H.I.	=	second harmonic intercept



The mixer level is the RF level applied to the RF input minus the set RF attenuation.

The formula for the internally generated level P₁ at the 2nd harmonic in dBm is:

$$P_1 = 2 * P_1 - \text{S.H.I.} \quad (2)$$

The lower measurement limit for the harmonic is the noise floor of the signal analyzer. The harmonic of the measured DUT should – if sufficiently averaged by means of a video filter – be at least 4 dB above the noise floor so that the measurement error due to the input noise is less than 1 dB.

The following rules for measuring high harmonic ratios can be derived:

- Select the smallest possible IF bandwidth for a minimal noise floor.
- Select an RF attenuation which is high enough to just measure the harmonic ratio.

The maximum harmonic distortion is obtained if the level of the harmonic equals the intrinsic noise level of the receiver. The level applied to the mixer, according to (2), is:

$$P_1 = \frac{P_{\text{noise}} / \text{dBm} + \text{IP2}}{2}$$

At a resolution bandwidth of 10 Hz (noise level -143 dBm, S.H.I. = 40 dBm), the optimum mixer level is – 51.5 dBm. According to (1) a maximum measurable harmonic distortion of 91.5 dB minus a minimum S/N ratio of 4 dB is obtained.



If the harmonic emerges from noise sufficiently (approx. >15 dB), it is easy to check (by changing the RF attenuation) whether the harmonics originate from the DUT or are generated internally by the signal analyzer. If a harmonic originates from the DUT, its level remains constant if the RF attenuation is increased by 10 dB. Only the displayed noise is increased by 10 dB due to the additional attenuation. If the harmonic is exclusively generated by the signal analyzer, the level of the harmonic is reduced by 20 dB or is lost in noise. If both – the DUT and the signal analyzer – contribute to the harmonic, the reduction in the harmonic level is correspondingly smaller.

High-Sensitivity Harmonics Measurements

If harmonics have very small levels, the resolution bandwidth required to measure them must be reduced considerably. The sweep time is, therefore, also increased considerably. In this case, the measurement of individual harmonics is carried out with the

R&S FSVR set to a small span. Only the frequency range around the harmonics will then be measured with a small resolution bandwidth.

Measurement Results

As a result of the harmonics distortion measurement, the zero span sweeps on all detected harmonics are shown in the diagram, separated by red display lines. This provides a very good overview of the measurement.

In addition, a result table is displayed providing the following information:

- 1st harmonic frequency
- THD (total harmonic distortion), relative and absolute values
- For each detected harmonic:
 - Frequency
 - RBW
 - Power

The results can also be queried using the remote commands:

THD: `CALCulate<n>:MARKer<m>:FUNction:HARMonics:DISToRTion?`
on page 647

List of harmonics: `CALCulate<n>:MARKer<m>:FUNction:HARMonics:LIST?`
on page 647

Softkeys for Harmonic Distortion Measurements

Harmonic Distortion.....	255
L No. of Harmonics.....	256
L Harmonic Sweep Time.....	256
L Harmonic RBW Auto.....	256
L Adjust Settings.....	256

Harmonic Distortion

Opens a submenu to determine the settings for harmonics measurement and activates the harmonic distortion measurement.

With this measurement you can measure the harmonics of a signal. In addition the THD (total harmonic distortion) is calculated in % and dB.

With span > 0 Hz, an automatic search for the first harmonic is carried out within the set frequency range. Also the level is adjusted. In zero span, the center frequency is unchanged.

In the upper window, the zero span sweeps on all harmonics are shown, separated by display lines. In the lower window, the mean RMS results are displayed in numerical values. The THD values are displayed in the marker field.

For details see [chapter 4.2.5.11, "Measuring Harmonic Distortion"](#), on page 252.

Remote command:

`CALCulate<n>:MARKer<m>:FUNction:HARMonics[:STATe]` on page 649

`CALCulate<n>:MARKer<m>:FUNction:HARMonics:DISToRTion?` on page 647

`CALCulate<n>:MARKer<m>:FUNction:HARMonics:LIST?` on page 647

No. of Harmonics ← Harmonic Distortion

Sets the number of harmonics that shall be measured. The range is from 1 to 26.

Remote command:

`CALCulate<n>:MARKer<m>:FUNction:HARMonics:NHARmonics` on page 648

Harmonic Sweep Time ← Harmonic Distortion

For details refer to the [Sweptime Manual](#) softkey in the "Bandwidth" menu.

Harmonic RBW Auto ← Harmonic Distortion

Enables/disables the automatic adjustment of the resolution bandwidth for filter types Normal (3dB) (Gaussian) and 5-Pole filters. The automatic adjustment is carried out according to:

$RBW_n = RBW_1 * n$

If RBW_n is not available, the next higher value is used.

Remote command:

`CALCulate<n>:MARKer<m>:FUNction:HARMonics:BANDwidth:AUTO`
on page 646

Adjust Settings ← Harmonic Distortion

Activates the frequency search in the frequency range that was set before starting the harmonic measurement (if harmonic measurement was with span > 0) and adjusts the level.

Remote command:

`CALCulate<n>:MARKer<m>:FUNction:HARMonics:PRESet` on page 648

4.2.6 Measurement Configuration – MEAS CONFIG Key

The MEAS CONFIG key displays the submenu of the currently activated and running measurement function, e.g. the submenu of "TOI" or "Harmonic Distortion" (see [chapter 4.2.5, "Power Measurements – MEAS Key"](#), on page 151, for quick access to the measurement configuration. If no measurement function is activated, this key has no effect.

4.2.7 Using Limit Lines and Display Lines – LINES Key

The LINES key is used to configure limit and display lines.

To open the Lines menu

- Press the LINES key.

The "Lines" menu and the "Select Limit Line" dialog box are displayed. For details on the "Select Limit Line" dialog box refer to [chapter 4.2.7.5, "Selecting a Limit Line"](#), on page 263.

Menu and softkey description

- [chapter 4.2.7.1, "Softkeys of the Lines Menu"](#), on page 257

Further information

- [chapter 4.2.7.2, "Display Lines"](#), on page 261
- [chapter 4.2.7.3, "Limit Lines \(Frequency/Time Lines\)"](#), on page 262

Tasks

- [chapter 4.2.7.4, "Working with Lines"](#), on page 262
- [chapter 4.2.7.5, "Selecting a Limit Line"](#), on page 263
- [chapter 4.2.7.6, "Creating a New Limit Line"](#), on page 264
- [chapter 4.2.7.7, "Editing an Existing Limit Line"](#), on page 267
- [chapter 4.2.7.8, "Creating a New Limit Line Based upon an Existing Limit Line"](#), on page 267
- [chapter 4.2.7.9, "Activating/Deactivating a Limit Line"](#), on page 268

4.2.7.1 Softkeys of the Lines Menu

The following table shows all softkeys available in the "Lines" menu.

(Lines are only available for RF measurements.)

Further information

- [chapter 4.2.7.2, "Display Lines"](#), on page 261
- [chapter 4.2.7.3, "Limit Lines \(Frequency/Time Lines\)"](#), on page 262

Tasks

- [chapter 4.2.7.4, "Working with Lines"](#), on page 262
- [chapter 4.2.7.5, "Selecting a Limit Line"](#), on page 263
- [chapter 4.2.7.6, "Creating a New Limit Line"](#), on page 264
- [chapter 4.2.7.7, "Editing an Existing Limit Line"](#), on page 267
- [chapter 4.2.7.8, "Creating a New Limit Line Based upon an Existing Limit Line"](#), on page 267
- [chapter 4.2.7.9, "Activating/Deactivating a Limit Line"](#), on page 268

Select Traces to check.....	258
Deselect All.....	258
New.....	258
L Edit Name.....	258
L Edit Comment.....	258
L Edit Margin.....	258
L Edit Value.....	259
L Insert Value.....	259
L Delete Value.....	259
L Save Limit Line.....	259

Edit.....	259
Copy to.....	259
Delete.....	260
X Offset.....	260
Y Offset.....	260
Display Lines.....	260
L Display Line 1 / Display Line 2.....	260
L Frequency Line 1 / Frequency Line 2	261
L Time Line 1 / Time Line 2.....	261

Select Traces to check

Opens a dialog box to activate the selected limit line for a trace. One limit line can be activated for several traces simultaneously. For details see also [chapter 4.2.7.9, "Activating/Deactivating a Limit Line"](#), on page 268.

Remote command:

`CALCulate<n>:LIMit<k>:TRACe` on page 584

`CALCulate<n>:LIMit<k>:STATe` on page 583

Deselect All

Deactivates the selected limit line for all assigned traces. For details see also [chapter 4.2.7.9, "Activating/Deactivating a Limit Line"](#), on page 268.

Remote command:

`CALCulate<n>:LIMit<k>:STATe` on page 583

New

Opens the "Edit Limit Line" dialog box and a submenu to define a new limit line. For details see also [chapter 4.2.7.3, "Limit Lines \(Frequency/Time Lines\)"](#), on page 262 and [chapter 4.2.7.5, "Selecting a Limit Line"](#), on page 263.

Edit Name ← New

Sets the focus on the "Name" field to enter or change the limit line name. All names must be compatible with the Windows conventions for file names. The limit line data are stored under this name. The instrument stores all limit lines with LIM as extension.

Remote command:

`CALCulate<n>:LIMit<k>:LOWer:MODE` on page 601

Edit Comment ← New

Sets the focus on the "Comment" field to enter or change a comment for the limit line. The text must not exceed 40 characters.

Remote command:

`CALCulate<n>:LIMit<k>:COMMent` on page 581

Edit Margin ← New

Sets the focus on the "Margin" field to enter or change a margin for the limit line. The default setting is 0 dB (i.e. no margin).

Edit Value ← New

Opens an edit dialog box to change an existing x or y value, depending on the selected column. The softkey is only available if an existing value is selected.

The desired data points are entered in ascending order (two repeated frequencies/time values are permitted).

Remote command:

`CALCulate<n>:LIMit<k>:CONTRol[:DATA]` on page 593

`CALCulate<n>:LIMit<k>:UPPer[:DATA]` on page 604

`CALCulate<n>:LIMit<k>:LOWer[:DATA]` on page 600

Insert Value ← New

Creates an empty line above the selected data point to enter a new data point.

It is also possible to add a data point at the end of the list, if the focus is set below the last entry line of the list.

The data points are entered in ascending order (two repeated frequencies/time values are permitted). If the entered values are not in accordance with the ascending order rule, an error message is displayed and the values are discarded.

Delete Value ← New

Deletes the selected data point (x and y value). All succeeding data points are shifted up accordingly. This softkey is only available if an existing value is selected.

Save Limit Line ← New

Saves the currently edited limit line under the name defined in the "Name" field.

Edit

Opens a submenu to edit limit lines. For details see also [chapter 4.2.7.3, "Limit Lines \(Frequency/Time Lines\)"](#), on page 262 and [chapter 4.2.7.7, "Editing an Existing Limit Line"](#), on page 267.

The submenu contains the same commands as the "New" menu, see ["New"](#) on page 258.

Remote command:

see [chapter 8.3.3, "Limit Lines and Limit Test"](#), on page 1026

Copy to

Copies the data of the selected limit line and displays it in the "Edit Limit Line" dialog box. If the limit line is edited and saved under a new name, a new limit line can be easily generated by parallel translation or editing of an existing limit line.

For details see also [chapter 4.2.7.3, "Limit Lines \(Frequency/Time Lines\)"](#), on page 262 and [chapter 4.2.7.8, "Creating a New Limit Line Based upon an Existing Limit Line"](#), on page 267.

The submenu contains the same commands as the "New" menu, see ["New"](#) on page 258.

Remote command:

`CALCulate<n>:LIMit<k>:COPY` on page 581

Delete

Deletes the selected limit line.

Remote command:

`CALCulate<n>:LIMit<k>:DELete` on page 582

X Offset

Horizontally shifts a limit line that has been specified for relative frequencies or times (x-axis). The softkey opens an edit dialog box in which the value for shifting can be entered numerically or via the rotary knob.

Note: This softkey does not have any effect on limit lines that represent absolute values for the x-axis.

Remote command:

`CALCulate<n>:LIMit<k>:CONTrol:OFFSet` on page 594

Y Offset

Vertically shifts a limit line that has relative values for the y-axis (levels or linear units such as volt). The softkey opens an edit dialog box in which the value for shifting can be entered numerically or via the rotary knob.

Note: This softkey does not have any effect on limit lines that represent absolute values for the y-axis.

Remote command:

`CALCulate<n>:LIMit<k>:LOWer:OFFSet` on page 601

`CALCulate<n>:LIMit<k>:UPPer:OFFSet` on page 605

Display Lines

Opens a submenu to enable, disable and set display lines. Which softkeys are available depends on the display mode (frequency or time range).

For details see also [chapter 4.2.7.2, "Display Lines"](#), on page 261 and [chapter 4.2.7.4, "Working with Lines"](#), on page 262.

The submenu contains the following functions:

- "Display Line 1 / Display Line 2" on page 260
- "Display Line 1 / Display Line 2" on page 260
- "Frequency Line 1 / Frequency Line 2 " on page 261
- "Frequency Line 1 / Frequency Line 2 " on page 261
- "Time Line 1 / Time Line 2" on page 261
- "Time Line 1 / Time Line 2" on page 261

Display Line 1 / Display Line 2 ← Display Lines

Enables or disables the level lines 1/2 and opens an edit dialog box to enter the position of the lines.

For details see also [chapter 4.2.7.2, "Display Lines"](#), on page 261 and [chapter 4.2.7.4, "Working with Lines"](#), on page 262.

Remote command:

`CALCulate<n>:DLINe<k>` on page 577

`CALCulate<n>:DLINe<k>:STATe` on page 578

Frequency Line 1 / Frequency Line 2 ← Display Lines

Enables or disables the frequency lines 1/2 (span > 0) and opens an edit dialog box to enter the position of the lines.

For details see also [chapter 4.2.7.2, "Display Lines"](#), on page 261 and [chapter 4.2.7.4, "Working with Lines"](#), on page 262.

Remote command:

`CALCulate<n>:FLINe<k>` on page 579

`CALCulate<n>:FLINe<k>:STATe` on page 580

Time Line 1 / Time Line 2 ← Display Lines

Enables or disables the time lines 1/2 (zero span) and opens an edit dialog box to enter the position of the lines.

For details see also [chapter 4.2.7.2, "Display Lines"](#), on page 261 and [chapter 4.2.7.4, "Working with Lines"](#), on page 262.

Remote command:

`CALCulate<n>:TLINe<Line>` on page 703

`CALCulate<n>:TLINe<Line>:STATe` on page 703

4.2.7.2 Display Lines

Display lines help to evaluate a trace – as do markers. The function of a display line is comparable to that of a ruler that can be shifted on the trace in order to mark absolute values. They are used exclusively to visually mark relevant frequencies or points in time (span = 0), as well as constant level values. It is not possible to check automatically whether the points are below or above the marked level values.

For details on setting and switching the display lines on/off see [chapter 4.2.7.4, "Working with Lines"](#), on page 262.

Two different types of display lines are provided:

- Two horizontal level lines for marking levels – Display Line 1 and 2
The level lines are continuous horizontal lines across the entire width of a diagram and can be shifted in y direction.
- Two vertical frequency or time lines for marking frequencies or points in time – Frequency/Time Line 1 and 2
The frequency or time lines are continuous vertical lines across the entire height of the diagram and can be shifted in x direction.

Lables

Each line is identified by one of the following abbreviations in the display:

- D1: Display Line 1
- D2: Display Line 2
- F1: Frequency Line 1
- F2: Frequency Line 2
- T1: Time Line 1

- T2: Time Line 2

4.2.7.3 Limit Lines (Frequency/Time Lines)

Limit lines are used to define amplitude curves or spectral distribution boundaries on the display screen which are not to be exceeded. They indicate, for example, the upper limits for interference radiation or spurious waves which are allowed from a device under test (DUT). For transmission of information in TDMA systems (e.g. GSM), the amplitude of the bursts in a timeslot must adhere to a curve that falls within a specified tolerance band. The lower and upper limits may each be specified by a limit line. Then, the amplitude curve can be controlled either visually or automatically for any violations of the upper or lower limits (GO/NOGO test).

The instrument supports limit lines with a maximum of 50 data points. 8 of the limit lines stored in the instrument can be activated simultaneously. The number of limit lines stored in the instrument is only limited by the capacity of the flash disk used. Which softkeys are available depends on the display mode (frequency or time range). For details see also [chapter 4.2.7.5, "Selecting a Limit Line"](#), on page 263.

Limit lines are compatible with the current measurement settings, if the following applies:

- The x unit of the limit line has to be identical to the current setting.
- The y unit of the limit line has to be identical to the current setting with the exception of dB based units; all dB based units are compatible with each other.

At the time of entry, the R&S FSVR immediately checks that all limit lines are in accordance with the following guidelines:

- The frequencies/times for each data point must be entered in ascending order, however, for any single frequency/time, two data points may be entered (vertical segment of a limit line).
- The data points are allocated in order of ascending frequency/time. Gaps are not allowed. If gaps are desired, two separate limit lines must be defined and then both enabled.
- The entered frequencies/times need not necessarily be selectable in R&S FSVR. A limit line may also exceed the specified frequency or time range. The minimum frequency for a data point is -200 GHz, the maximum frequency is 200 GHz. For the time range representation, negative times may also be entered. The allowed range is -1000 s to +1000 s.

4.2.7.4 Working with Lines

If a line is switched on, the softkey is highlighted.

Switching a line on or off

1. Press the [Display Lines](#) softkey.
2. Press the softkey for the required line, e.g. [Display Line 1 / Display Line 2](#).

An edit dialog box is opened to enter the position of the line. If the line was switched off, it is switched on. If it was switched on, it remains switched on.

3. If another softkey is pressed, the edit dialog box for the line is closed, but the line remains switched on (softkey with highlighted background).
4. When you press the **Display Line 1 / Display Line 2** softkey for the second time, the edit dialog box for the line is opened again.
5. When you press the **Display Line 1 / Display Line 2** softkey the third time, the line is switched off (softkey without highlighted background).

4.2.7.5 Selecting a Limit Line

- To display the "Select Limit Line" dialog box, press the LINES key.

All limit lines saved in the default directory and all subdirectories are displayed. For each limit line, the following information is given:

"Unit"	unit of the y-axis
"Traces"	selected traces to check
"Show"	limit line displayed in the measurement diagram or hidden
"Compatible"	compatibility of the limit line to the current measurement settings
"Offset"	user-definable X- and Y-offset for the limit line

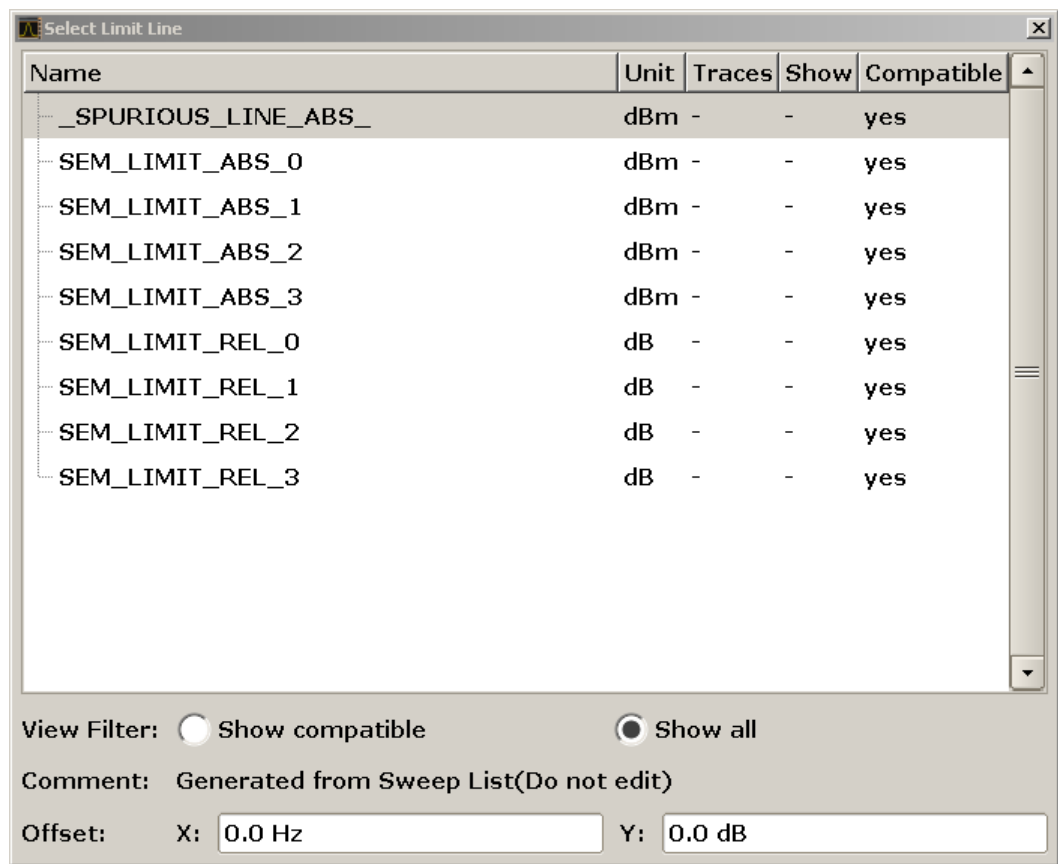

- To display only the limit lines that are compatible, activate the "Show compatible" option. For details on compatibility refer to [chapter 4.2.7.3, "Limit Lines \(Frequency/Time Lines\)"](#), on page 262.

4.2.7.6 Creating a New Limit Line

Press the **New** softkey to define a new limit line.

The "Edit Limit Line" dialog box is displayed. For more details on limit lines refer also to [chapter 4.2.7.3, "Limit Lines \(Frequency/Time Lines\)"](#), on page 262. The following settings can be defined:

Setting	Description
Name	The name under which the limit line is to be stored in the main directory. To save the limit line in an existing subdirectory, enter the relative path. A new subdirectory can only be created using the FILE key (for details refer to "Save File / Recall File" on page 451).
Comment	Optional description
Threshold	Absolute threshold value that works as a lower limit for the relative limit values (only for relative scaling of the y-axis).
Margin	A fixed distance to the limit line. Margins are not as strict as limits and belong to the valid value range, but violation is also indicated in the display.

Setting	Description
Position	Position of data point
Value	Value of data point
X-Axis:	
Span setting	<ul style="list-style-type: none"> • "Hz" for span > 0 Hz • "s" for zero span
Scale mode	<ul style="list-style-type: none"> • Absolute: The frequencies or times are interpreted as absolute physical units. • Relative: In the data point table, the frequencies are referred to the currently set center frequency. In the zero span mode, the left boundary of the diagram constitutes the reference. Relative scaling is always suitable if masks for bursts are to be defined in zero span or if masks for modulated signals are required for span > 0 Hz.
Scale	<ul style="list-style-type: none"> • Linear • Logarithmic
Y-Axis:	
Scale unit	Unit of the y-axis
Scale mode	<ul style="list-style-type: none"> • Absolute: The limit values refer to absolute levels or voltages. • Relative: The limit values refer to the reference level (Ref Level). Limit values with the unit dB are always relative values.
Limit type	<ul style="list-style-type: none"> • Upper limit • Lower limit

In addition, the following functions are available for the limit line:

Defining a threshold

If the scaling of the y-axis is relative, you can define an absolute threshold value that works as a lower limit for the relative limit values (see figure below).

- ▶ Enter a value in the "Threshold" field of the "Edit Limit Line" dialog box.

The function is especially useful for mobile radio applications provided the limit values are defined in relation to the carrier power as long as they are above an absolute limit value.

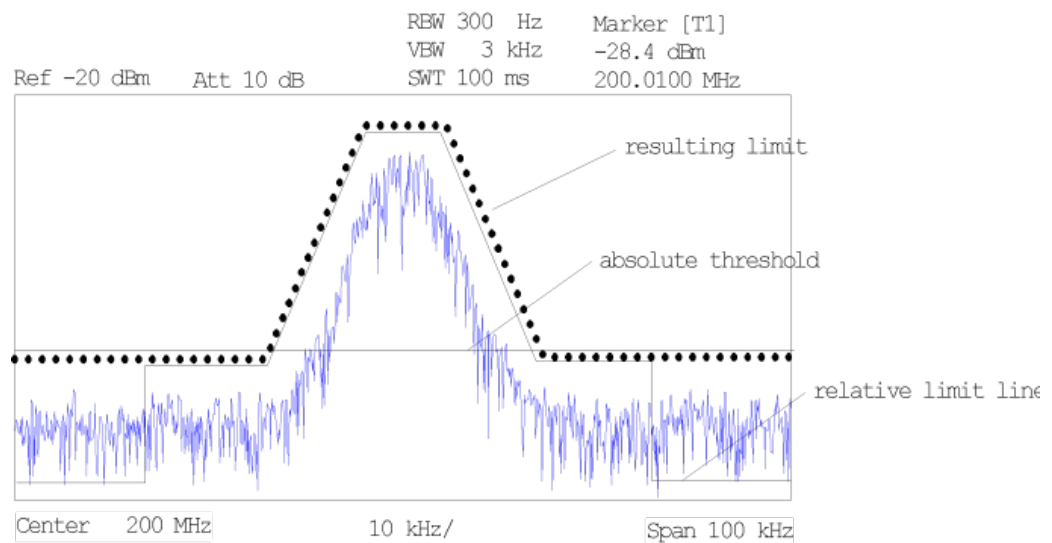

Defining a margin

A margin is similar to a limit, but less strict and it still belongs to the valid data range. It can be used as a warning that the limit is almost reached. The margin is not indicated by a separate line in the display.

- ▶ Enter a value in the "Margin" field of the "Edit limit Line" dialog box.
 If the limit line is defined as an upper limit, the margin is below the limit line. If the limit line is defined as a lower limit, the margin is above the limit line.

Entering a new data point

1. Press the "Insert value" button in the dialog, or select an existing data point in the table and press the [Insert Value](#) softkey.
2. Enter the new position (x) and value (y) in the edit dialog box.

Changing a data point

1. Press on the data point to be changed in the table.
2. Enter the new position (x) and value (y) in the edit dialog box.

Deleting a data point

1. Press on the data point to be deleted in the table.
2. Press the "Delete" button in the dialog.

Shifting a limit line horizontally

- ▶ Select the "Shift x" button and enter a shift width for the x value in the edit dialog box.

Shifting a limit line vertically

- ▶ Select the "Shift y" button and enter a shift width for the y value in the edit dialog box.

Saving the limit line settings

- ▶ Press the "Save" button in the dialog.
If an existing name is used, a message box is displayed. You have to confirm before the limit line is overwritten.

4.2.7.7 Editing an Existing Limit Line

In the "Select Limit Line" dialog box, select the limit line you want to change. For details see also [chapter 4.2.7.5, "Selecting a Limit Line"](#), on page 263.



Note that any changes to the special limit lines for spurious and SEM measurements are automatically overwritten when the sweep list settings are changed.

1. Press the "Edit" on page 259 softkey.
2. Edit the data as described in [chapter 4.2.7.6, "Creating a New Limit Line"](#), on page 264.
3. Save the limit line ("Save Limit Line" on page 259 softkey).

4.2.7.8 Creating a New Limit Line Based upon an Existing Limit Line

1. In the "Select Limit Line" dialog box, select the limit line you want to use as a basis for a new limit line. For details see also [chapter 4.2.7.5, "Selecting a Limit Line"](#), on page 263.
2. Press the **Copy to** softkey to transfer the data of the limit line into the "Edit Limit Line" dialog box.
3. Press the **Edit Name** softkey and enter a new name.
4. To shift the complete limit line parallel in the horizontal direction, select the "Shift x" button and enter an x shift value. In this manner, a new limit line can be easily generated based upon an existing limit line which has been shifted horizontally.
5. To shift the complete limit line parallel in the vertical direction, select the "Shift y" button and enter a y shift value. In this manner, a new limit line can be easily generated based upon an existing limit line which has been shifted vertically.
6. If required, edit the data as described in [chapter 4.2.7.5, "Selecting a Limit Line"](#), on page 263.
7. Save the limit line (**Save Limit Line** softkey).

4.2.7.9 Activating/Deactivating a Limit Line

Prerequisites:

The x- and y-units of limit line and current measurement setting have to be compatible. For details refer to [chapter 4.2.7.3, "Limit Lines \(Frequency/Time Lines\)"](#), on page 262.

The limit line has to consist of 2 or more data points.

1. In the "Select Limit Line" dialog box, select the limit line you want to activate/deactivate. For details see also [chapter 4.2.7.5, "Selecting a Limit Line"](#), on page 263.
2. To activate or deactivate a limit line for a trace, press the ["Select Traces to check"](#) on page 258 softkey and select or deselect the trace(s) to which this limit line applies.
3. To deactivate the limit line for all traces, press the ["Deselect All"](#) on page 258 softkey.

4.2.8 Input/Output Configuration – INPUT/OUTPUT Key

The INPUT/OUTPUT key is used to configure input and output sources for measurement functions.

4.2.8.1 Softkeys of the Input/Output Menu

The following table shows all softkeys available in the "Input/Output" menu. It is possible that your instrument configuration does not provide all softkeys. If a softkey is only available with a special option, model or (measurement) mode, this information is provided in the corresponding softkey description.

Input (AC/DC).....	269
Noise Source.....	269
Video Output.....	269
Power Sensor.....	269
Trigger Out.....	269
External Mixer.....	270
Probe Config.....	270
Signal Source.....	270
L Input Path.....	270
L Connected Device.....	270
L Input Sample Rate.....	270
L Full Scale Level.....	270
L Level Unit.....	271
L Adjust Reference Level to Full Scale Level.....	271
EXIQ.....	271
L TX Settings.....	271
L RX Settings.....	271
L Send To.....	271

L Firmware Update.....	271
L R&S Support.....	272
L DiglConf.....	272
Digital Output.....	272
Digital IQ Info.....	273

Input (AC/DC)

Toggles the RF input of the R&S FSVR between AC and DC coupling.

This function is not available for input from the R&S Digital I/Q Interface (option R&S FSV-B17).

Remote command:

[INPut:COUPling](#) on page 732

Noise Source

Switches the supply voltage for an external noise source on or off. For details on connectors refer to the R&S FSVR Quick Start Guide, "Front and Rear Panel" chapter.

Remote command:

[DIAGnostic<n>:SERVice:NSource](#) on page 928

Video Output

Turns output on the IF / Video output available with option R&S FSV-B5 on and off.

When you turn on the output, you can select to output either the intermediate frequency or the video signal.

Note: Video output does not return valid values in IQ or FFT mode.

Remote command:

[OUTPut:IF VID](#), see [OUTPut:IF\[:SOURce\]](#) on page 959

Power Sensor

For precise power measurement a power sensor can be connected to the instrument via the front panel (USB connector) or the rear panel (power sensor, option R&S FSV-B5). The Power Sensor Support firmware option (R&S FSV-K9) provides the power measurement functions for this test setup.

This softkey is only available if the R&S FSVR option Power Sensor (R&S FSV-K9) is installed.

For details see [chapter 4.5, "Instrument Functions - Power Sensor \(R&S FSV-K9\)"](#), on page 304.

For details see the chapter "Instrument Functions Power Sensor (K9)" in the base unit description.

This softkey is available for RF measurements.

Trigger Out

Sets the Trigger Out port in the Additional Interfaces (option R&S FSV-B5 only) to low or high. Thus, you can trigger an additional device via the external trigger port, for example.

Remote command:

[OUTPut:TRIGger](#) on page 959

External Mixer

Opens the submenu for the external mixer.

For details see the base unit description.

Probe Config

Opens an edit dialog box to activate and configure a connected probe which is to provide an input signal. It is only available if a probe is connected to the instrument's RF INPUT and USB connectors.

For details see [chapter 4.2.8.2, "Using Active Probes for Input"](#), on page 273.

For details see the base unit Operating Manual.

Remote command:

[PROBe \[:STATe \]](#) on page 748

[PROBe :SETup:MODE](#) on page 747

Signal Source

Opens a dialog box to select the signal source.

For "Digital Baseband (I/Q)", the source can also be configured here.

Input Path ← Signal Source

Defines whether the "RF Radio Frequency" or the "Digital IQ" input path is used for measurements. "Digital IQ" is only available if option R&S FSV-B17 (R&S Digital I/Q Interface) is installed.

Note: Note that the input path defines the characteristics of the signal, which differ significantly between the RF input and digital input.

Remote command:

[INPut:SElect](#) on page 738

Connected Device ← Signal Source

Displays the name of the device connected to the optional R&S Digital I/Q Interface (R&S FSV-B17) to provide Digital IQ input. The device name cannot be changed here.

The device name is unknown.

Remote command:

[INPut:DIQ:CDEvice](#) on page 733

Input Sample Rate ← Signal Source

Defines the sample rate of the digital I/Q signal source. This sample rate must correspond with the sample rate provided by the connected device, e.g. a generator.

Remote command:

[INPut:DIQ:SRATe](#) on page 735

Full Scale Level ← Signal Source

The "Full Scale Level" defines the level that should correspond to an I/Q sample with the magnitude "1".

The level can be defined either in dBm or Volt.

Remote command:

[INPut:DIQ:RANGe \[:UPPer \]](#) on page 734

Level Unit ← Signal Source

Defines the unit used for the full scale level.

Remote command:

`INPut:DIQ:RANGe[:UPPer]:UNIT` on page 735

Adjust Reference Level to Full Scale Level ← Signal Source

If enabled, the reference level is adjusted to the full scale level automatically if any change occurs.

(See the [Auto Level](#) softkey).

Remote command:

`INPut:DIQ:RANGe:COUPling` on page 734

EXIQ

Opens a configuration dialog box for an optionally connected R&S EX-IQ-BOX and a submenu to access the main settings quickly.

Note: The EX-IQ-Box functionality is not supported for R&S FSVR models 1321.3008Kxx.

If the optional R&S DigiConf software is installed, the submenu consists only of one key to access the software. **Note that R&S DigiConf requires a USB connection (not LAN!) from the R&S FSVR to the R&S EX-IQ-BOX in addition to the R&S Digital I/Q Interface connection. R&S DigiConf version 2.10 or higher is required.**

For typical applications of the R&S EX-IQ-BOX see also the description of the R&S Digital I/Q Interface (R&S FSV-B17) in the base unit manual.

For details on configuration see the "R&S®Ex I/Q Box - External Signal Interface Module Manual".

For details on installation and operation of the R&S DigiConf software, see the "R&S®EX-IQ-BOX Digital Interface Module R&S®DigiConf Software Operating Manual".

TX Settings ← EXIQ

Opens the "EX-IQ-BOX Settings" dialog box to configure the R&S FSVR for digital output to a connected device ("Transmitter" Type).

RX Settings ← EXIQ

Opens the "EX-IQ-BOX Settings" dialog box to configure the R&S FSVR for digital input from a connected device ("Receiver" Type).

Send To ← EXIQ

The configuration settings defined in the dialog box are transferred to the R&S EX-IQ-BOX.

Firmware Update ← EXIQ

If a firmware update for the R&S EX-IQ-BOX is delivered with the R&S FSVR firmware, this function is available. In this case, when you select the softkey, the firmware update is performed.

R&S Support ← EXIQ

Stores useful information for troubleshooting in case of errors.

This data is stored in the `C:\R_S\Instr\user\Support` directory on the instrument.

If you contact the Rohde&Schwarz support to get help for a certain problem, send these files to the support in order to identify and solve the problem faster.

DigIConf ← EXIQ

Starts the optional R&S DigIConf application. This softkey is only available if the optional software is installed.

To return to the R&S FSVR application, press any key on the front panel. The application is displayed with the "EXIQ" menu, regardless of which key was pressed.

For details on the R&S DigIConf application, see the "R&S®EX-IQ-BOX Digital Interface Module R&S®DigIConf Software Operating Manual".

Note: If you close the R&S DigIConf window using the "Close" icon, the window is minimized, not closed.

If you select the "File > Exit" menu item in the R&S DigIConf window, the application is closed. Note that in this case the settings are lost and the EX-IQ-BOX functionality is no longer available until you restart the application using the "DigIConf" softkey in the R&S FSVR once again.

Remote command:

Remote commands for the R&S DigIConf software always begin with `SOURce:EBOX`. Such commands are passed on from the R&S FSVR to the R&S DigIConf automatically which then configures the R&S EX-IQ-BOX via the USB connection.

All remote commands available for configuration via the R&S DigIConf software are described in the "R&S®EX-IQ-BOX Digital Interface Module R&S®DigIConf Software Operating Manual".

Example 1:

```
SOURce:EBOX:*RST
SOURce:EBOX:*IDN?
```

Result:

```
"Rohde&Schwarz,DigIConf,02.05.436 Build 47"
```

Example 2:

```
SOURce:EBOX:USER:CLOCK:REFERENCE:FREQUENCY 5MHZ
```

Defines the frequency value of the reference clock.

Digital Output

Opens a dialog box to enable a digital output stream to the optional R&S Digital I/Q Interface (R&S FSV-B17), if available.

The displayed sample rate is identical to the sample rate defined under [Data Acquisition](#) (I/Q Analyzer) and is not editable here.

For details see "Digital Output" in the description of the R&S Digital I/Q Interface for the base unit.

Remote command:

```
OUTPut:DIQ on page 744
```

Digital IQ Info

Displays a dialog box with information on the digital I/Q input and output connection via the optional R&S Digital I/Q Interface (R&S FSV-B17), if available. The information includes:

- Device identification
- Used port
- (Maximum) digital input/output sample rates and maximum digital input/output transfer rates
- Status of the connection protocol
- Status of the PRBS descewing test

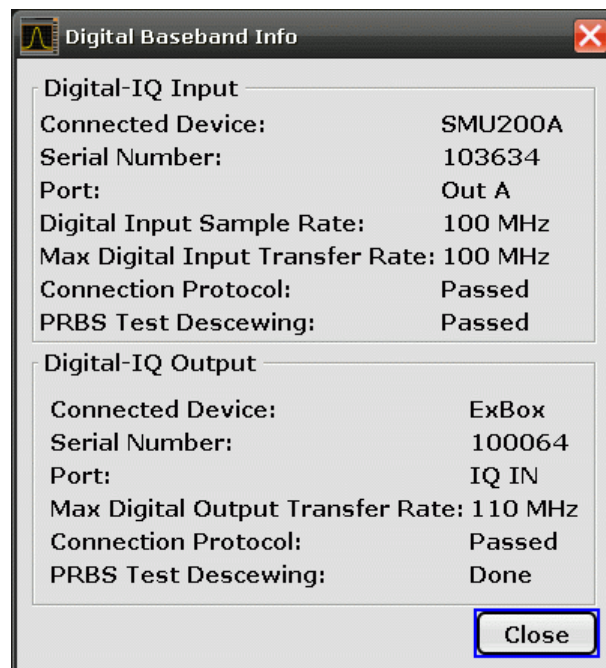

For details see "Interface Status Information" in "Instrument Functions - R&S Digital I/Q Interface (Option R&S FSV-B17)" in the description of the base unit.

Remote command:

[INPut:DIQ:CDEvice](#) on page 733

4.2.8.2 Using Active Probes for Input

When the input from the device under test requires high impedance, an active probe can be connected between the device and the R&S FSVR.

The R&S FSVR supports active probes from the R&S RT-ZS series when using the new probe adapter RT-ZA9.

When the probe has been connected to and recognized by the R&S FSVR, a pre-defined "Generic Probe" transducer factor with 20 dB is automatically activated and the unit of the spectrum analyzer is changed to dB μ V. (The same applies after presetting the instrument.) Then the system is ready to analyze circuit points that cannot be loaded with the 50 Ω of the analyzer input, but require a higher impedance.

Optionally, the probe can be deactivated while remaining connected to the R&S FSVR, for instance to analyze the digital input from the probe without considering the transducer factor.

All RT probes (except for ZS10E) have a micro button. The action for the micro button can be defined. Currently, either a single sweep or no action can be performed when the button is pressed. By default, when you press the probe's micro button, the R&S FSVR is set to single sweep mode and a single sweep is performed. This allows you to start a measurement whilst applying the probe to a certain pin on the board under test.

When using RT probes, consider the following:

- Active probes require operating power from the instrument and have a proprietary interface to the instrument.
- The probe is automatically recognized by the instrument, no adjustment is required.
- Connections should be as short as possible to keep the usable bandwidth high.
- Observe the operating voltage range.

For more information on RT probes, refer to the probe's documentation.

Connecting Active Probes

In order to use active probes with an R&S FSVR, an RT-ZA9 adapter is required. The RT-ZA9 provides an interface between the probe's BNC socket and the analyzer's N-socket and provides the necessary supply voltages for the probe via the USB connection. Using this adapter, the following probes are currently supported:

- R&S RT-ZS10
- RT-ZS10E
- RT-ZS20
- RT-ZS30

To connect an active probe, proceed as follows:

1. Connect the adapter to the RF Input connector on the R&S FSVR.
2. Connect the adapter's USB cable to a USB connector on the R&S FSVR.
3. Connect the probe to the adapter.

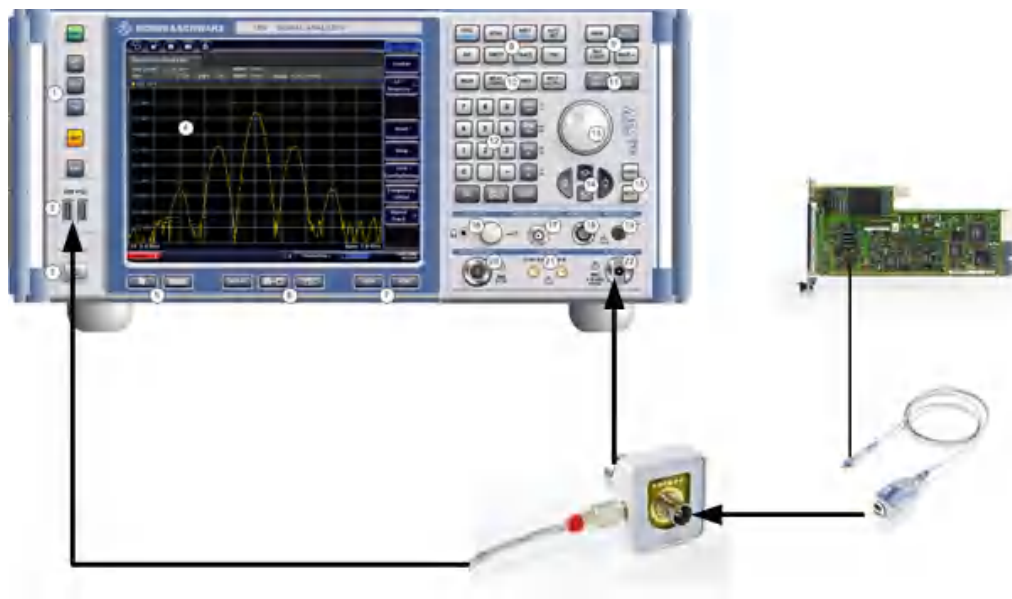

Once the probe and adapter have been connected to the R&S FSVR correctly and the analyzer has recognized the probe, the "Generic Probe" transducer is activated and you can start a measurement.



To determine whether the probe has been connected properly and recognized by the R&S FSVR, use the remote control command `PROB:SET:STAT?` (see [PROBe:SETup:STATe?](#) on page 747).

To perform a measurement with the probe

- ▶ Place the probe on the required position on the test equipment, then press the micro button on the probe to perform a single sweep measurement.

Probe Configuration

Principally, the probe is automatically recognized by the instrument and no further adjustment is required. However, you can switch off the probe while leaving it connected, and you can configure which action is to be performed when the probe's micro button is pressed.

To display the "Probe Configuration" dialog box, select the INPUT/OUTPUT key and then the "Probe Config" softkey.

The following settings are available:

State	276
Name	276
Serial Number	276
Part number	276
Micro Button Action	276

State

Activates a connected probe. Use this command to switch off the probe and measure the digital input without considering the transducer factor of the probe.

Remote command:

[PROBe\[:STATe\]](#) on page 748

Name

Indicates the name of the connected probe.

Remote command:

[PROBe:SETup:NAME?](#) on page 747

Serial Number

Indicates the serial number of the connected probe.

Remote command:

[PROBe:ID:SRNumber?](#) on page 747

Part number

Indicates the material part number of the connected probe.

Remote command:

[PROBe:ID:PARTnumber?](#) on page 747

Micro Button Action

Defines which action is taken when the probe's micro button is pressed.

"RunSingle" A single sweep is performed.

"No Action" No action is taken.

Remote command:

[PROBe:SETup:MODE](#) on page 747

4.2.9 Performing Measurements – RUN SINGLE/RUN CONT Keys

The RUN SINGLE and RUN CONT keys are used to start measurement tasks.

- RUN SINGLE switches to single sweep mode and performs a single sweep, just as the [Single Sweep](#) softkey in the "Sweep" menu does.
- RUN CONT switches to continuous sweep mode and starts sweeping, just as the [Continuous Sweep](#) softkey in the "Sweep" menu does.

4.3 Using the Spectrogram in Spectrum Mode

In addition to the spectrogram result display in realtime mode, the R&S FSVR also provides a spectrogram result display in spectrum mode.

You can access the spectrogram with the "Spectrogram" softkey located in the "Trace" menu.

The spectrogram starts running as soon as you activate it. You can stop and resume the spectrogram with the "Spectrogram (On Off)" softkey in the spectrogram menu.

Not all measurement types available in spectrum mode can be displayed in the "Spectrogram" result display. If the spectrogram is active and a measurement cannot be displayed in form of a spectrogram, the softkey of the corresponding measurement is disabled.

All settings of the spectrum mode are also valid for the spectrogram view and vice versa.

For more information on spectrogram functionality including remote control refer to [The Spectrogram Result Display](#) in realtime mode.

Some spectrogram functions in spectrum mode are not in the same place as in realtime mode. In spectrum mode, these functions are:

- The "Frame Count" softkey is in the "Sweep" menu.

4.4 Instrument Functions - I/Q Analyzer

The I/Q Analyzer provides functions to capture, visualize and evaluate I/Q data. These functions include:

- capturing data from the RF input or an R&S Digital I/Q Interface (with R&S FSV-B17 option)
- displaying I/Q data in various result types, e.g. separate Real/Imag diagrams or as an I/Q-vector
- providing I/Q data to a digital output for further processing in other devices (with R&S FSV-B17 option)

Menu and softkey description

The "I/Q Analyzer" menu is displayed when you select the "I/Q Analyzer" softkey in the MODE menu. The same menu is displayed when you press the MEAS or MEAS CONFIG keys in "I/Q Analyzer" mode. For details see [chapter 4.4.1, "Softkeys and Parameters of the I/Q Analyzer Menu"](#), on page 278.

The "Amplitude" menu, which is displayed when you select the AMPT key, is described in [chapter 4.4.2, "Softkeys of the Amplitude Menu in I/Q Analyzer Mode"](#), on page 288.

The "Input/Output" menu, which is displayed when you select the INPUT/OUTPUT key, as well as the "Save/Recall" menu (SAVE/RCL key) contain the same functions in I/Q Analyzer mode as in "Spectrum" mode (see [chapter 4.2.8.1, "Softkeys of the Input/Output Menu"](#), on page 268).

The "Marker" menu is identical to the one in Spectrum mode for display modes "Magnitude", "Real/Imag" and "Spectrum" (except for "Marker Zoom"), see ["Display Config"](#) on page 284. For the other display modes this menu is not available.

The "Marker To" menu is identical to the one in Spectrum mode. For the "Real / Imag (I/Q)" display mode, an additional function is available, see [chapter 4.4.4, "Softkeys of the Marker To Menu in I/Q Analyzer Mode"](#), on page 296.

The "Marker Function" menu, which is displayed when you select the MKR FUNC key, is described in [chapter 4.4.5, "Softkeys of the Marker Function Menu in I/Q Analyzer Mode"](#), on page 297.

The "Trace" menu is identical to the one in Spectrum mode, except in "I/Q Vector" display mode. In this case, only 1 trace is available and no detector can be selected (see [chapter 4.1.8.1, "Softkeys of the Trace Menu"](#), on page 93).

The "Trigger" menu, which is displayed when you select the TRIG key, is described in see [chapter 4.4.3, "Softkeys of the Trigger Menu in I/Q Analyzer Mode"](#), on page 291.

The "Span", "BW", and "Lines" menus are not available in this mode. For digital input, the "Frequency" menu is also not available. All other menus are identical to those described for "Spectrum" mode (see [chapter 4.1, "Measurement Parameters"](#), on page 56 and [chapter 4.2, "Measurement Functions"](#), on page 119).

Remote Control

Measurements with the I/Q Analyzer can also be performed via remote control.

The required commands are contained in the following subsystems:

- [chapter 8.2.3.9, "INPut Subsystem"](#), on page 731
- ["TRACe:IQ Subsystem"](#) on page 893
- [chapter 8.2.3.12, "OUTPut Subsystem"](#), on page 744

Further information

- Some general information on working with I/Q data can be found in [chapter 4.4.6, "Working with I/Q Data"](#), on page 301.
- When measuring I/Q data, you may make use of the optional R&S Digital I/Q Interface (R&S FSV-B17); for details see [chapter 7.1, "Instrument Functions - R&S Digital I/Q Interface \(Option R&S FSV-B17\)"](#), on page 469.

4.4.1 Softkeys and Parameters of the I/Q Analyzer Menu

This section describes the softkeys and parameters of the "I/Q Analyzer" submenu which is displayed when you select the "I/Q Analyzer" softkey in the MODE menu. The same menu is displayed when you press the MEAS or MEAS CONFIG keys in "I/Q Analyzer" mode.

I/Q Analyzer.....	279
L Signal Source.....	279
L Input Path.....	279
L Connected Device.....	280
L Input Sample Rate.....	280
L Full Scale Level.....	280
L Level Unit.....	280
L Adjust Reference Level to Full Scale Level.....	280

L EXIQ.....	280
L TX Settings.....	281
L RX Settings.....	281
L Send To.....	281
L Firmware Update.....	281
L R&S Support.....	281
L DigiConf.....	281
L Level.....	282
L Reference Level.....	282
L Auto Level.....	282
L Preamp On/Off.....	282
L Data Acquisition.....	282
L Sample Rate.....	283
L Filter BW.....	283
L No Filter.....	283
L Meas Time.....	283
L Record Length.....	283
L Display Config.....	284
L Digital Output.....	285
L Digital IQ Info.....	286
L C/N, C/No.....	286
L C/N.....	287
L C/No.....	287
L Channel Bandwidth.....	287
L Adjust Settings.....	287

I/Q Analyzer

Starts the I/Q Analyzer evaluation mode and opens the submenu for the I/Q analyzer, which allows you to configure and display measurements of I/Q data, e.g. digital base-band signals.

Remote command:

Starting I/Q Analyzer:

[TRACe<n>:IQ\[:STATe\]](#) on page 895

Selecting evaluation mode:

[TRACe<n>:IQ:EVAL](#) on page 902

Selecting the I/Q Analyzer display configuration

[CALCulate<n>:FORMat](#) on page 708

Signal Source ← I/Q Analyzer

Opens a dialog box to select the signal source.

For "Digital Baseband (I/Q)", the source can also be configured here.

Input Path ← Signal Source ← I/Q Analyzer

Defines whether the "RF Radio Frequency" or the "Digital IQ" input path is used for measurements. "Digital IQ" is only available if option R&S FSV-B17 (R&S Digital I/Q Interface) is installed.

Note: Note that the input path defines the characteristics of the signal, which differ significantly between the RF input and digital input.

Remote command:

`INPut:SELEct` on page 738

Connected Device ← Signal Source ← I/Q Analyzer

Displays the name of the device connected to the optional R&S Digital I/Q Interface (R&S FSV-B17) to provide Digital IQ input. The device name cannot be changed here.

The device name is unknown.

Remote command:

`INPut:DIQ:CDEvice` on page 733

Input Sample Rate ← Signal Source ← I/Q Analyzer

Defines the sample rate of the digital I/Q signal source. This sample rate must correspond with the sample rate provided by the connected device, e.g. a generator.

Remote command:

`INPut:DIQ:SRATe` on page 735

Full Scale Level ← Signal Source ← I/Q Analyzer

The "Full Scale Level" defines the level that should correspond to an I/Q sample with the magnitude "1".

The level can be defined either in dBm or Volt.

Remote command:

`INPut:DIQ:RANGe[:UPPer]` on page 734

Level Unit ← Signal Source ← I/Q Analyzer

Defines the unit used for the full scale level.

Remote command:

`INPut:DIQ:RANGe[:UPPer]:UNIT` on page 735

Adjust Reference Level to Full Scale Level ← Signal Source ← I/Q Analyzer

If enabled, the reference level is adjusted to the full scale level automatically if any change occurs.

(See the [Auto Level](#) softkey).

Remote command:

`INPut:DIQ:RANGe:COUPling` on page 734

EXIQ ← I/Q Analyzer

Opens a configuration dialog box for an optionally connected R&S EX-IQ-BOX and a submenu to access the main settings quickly.

Note: The EX-IQ-Box functionality is not supported for R&S FSVR models 1321.3008Kxx.

If the optional R&S DigIConf software is installed, the submenu consists only of one key to access the software. **Note that R&S DigIConf requires a USB connection (not LAN!) from the R&S FSVR to the R&S EX-IQ-BOX in addition to the R&S Digital I/Q Interface connection. R&S DigIConf version 2.10 or higher is required.**

For typical applications of the R&S EX-IQ-BOX see also the description of the R&S Digital I/Q Interface (R&S FSV-B17) in the base unit manual.

For details on configuration see the "R&S®Ex I/Q Box - External Signal Interface Module Manual".

For details on installation and operation of the R&S DigIConf software, see the "R&S®EX-IQ-BOX Digital Interface Module R&S®DigIConf Software Operating Manual".

TX Settings ← EXIQ ← I/Q Analyzer

Opens the "EX-IQ-BOX Settings" dialog box to configure the R&S FSVR for digital output to a connected device ("Transmitter" Type).

RX Settings ← EXIQ ← I/Q Analyzer

Opens the "EX-IQ-BOX Settings" dialog box to configure the R&S FSVR for digital input from a connected device ("Receiver" Type).

Send To ← EXIQ ← I/Q Analyzer

The configuration settings defined in the dialog box are transferred to the R&S EX-IQ-BOX.

Firmware Update ← EXIQ ← I/Q Analyzer

If a firmware update for the R&S EX-IQ-BOX is delivered with the R&S FSVR firmware, this function is available. In this case, when you select the softkey, the firmware update is performed.

R&S Support ← EXIQ ← I/Q Analyzer

Stores useful information for troubleshooting in case of errors.

This data is stored in the `C:\R_S\Instr\user\Support` directory on the instrument.

If you contact the Rohde&Schwarz support to get help for a certain problem, send these files to the support in order to identify and solve the problem faster.

DigIConf ← EXIQ ← I/Q Analyzer

Starts the optional R&S DigIConf application. This softkey is only available if the optional software is installed.

To return to the R&S FSVR application, press any key on the front panel. The application is displayed with the "EXIQ" menu, regardless of which key was pressed.

For details on the R&S DigIConf application, see the "R&S®EX-IQ-BOX Digital Interface Module R&S®DigIConf Software Operating Manual".

Note: If you close the R&S DigIConf window using the "Close" icon, the window is minimized, not closed.

If you select the "File > Exit" menu item in the R&S DigIConf window, the application is closed. Note that in this case the settings are lost and the EX-IQ-BOX functionality is no longer available until you restart the application using the "DigIConf" softkey in the R&S FSVR once again.

Remote command:

Remote commands for the R&S DigIConf software always begin with `SOURCE:EBOX`. Such commands are passed on from the R&S FSVR to the R&S DigIConf automatically which then configures the R&S EX-IQ-BOX via the USB connection.

All remote commands available for configuration via the R&S DigIConf software are described in the "R&S®EX-IQ-BOX Digital Interface Module R&S®DigIConf Software Operating Manual".

Example 1:

`SOURCE:EBOX:*RST`

`SOURCE:EBOX:*IDN?`

Result:

"Rohde&Schwarz,DigIConf,02.05.436 Build 47"

Example 2:

`SOURCE:EBOX:USER:CLOCK:REFERENCE:FREQUENCY 5MHZ`

Defines the frequency value of the reference clock.

Level ← I/Q Analyzer

Opens a dialog box to define the level settings.

Reference Level ← Level ← I/Q Analyzer

Specifies the reference level for the I/Q measurement.

Remote command:

`DISPLAY[:WINDOW<n>]:TRACE<t>:Y[:SCALE]:RVALUE` on page 721

Auto Level ← Level ← I/Q Analyzer

If enabled, the reference level is adjusted to the full scale level automatically if the full scale level changes.

Remote command:

`INPUT:DIQ:RANGE:COUPLING` on page 734

Preamp On/Off ← Level ← I/Q Analyzer

Switches the preamplifier on and off.

If option R&S FSV-B22 is installed, the preamplifier is only active below 7 GHz.

If option R&S FSV-B24 is installed, the preamplifier is active for all frequencies.

When measuring Spurious Emissions, using this softkey automatically opens the "Sweep List" dialog, see "[Sweep List dialog box](#)" on page 219.

This function is not available for input from the R&S Digital I/Q Interface (option R&S FSV-B17).

Remote command:

`INPUT:GAIN:STATE` on page 737

Data Acquisition ← I/Q Analyzer

Opens a dialog box to configure data acquisition in I/Q Analyzer mode.

Sample Rate ← Data Acquisition ← I/Q Analyzer

Defines the I/Q data sample rate of the R&S FSVR.

This rate may differ from the sample rate of the connected device (see ["Input Sample Rate"](#) on page 270).

If the R&S Digital I/Q Interface (R&S FSV-B17) is active, restrictions to the sample rate apply, see [table 7-1](#).

Remote command:

`TRACe<n>:IQ:SRATe` on page 906

Filter BW ← Data Acquisition ← I/Q Analyzer

Displays the flat, usable bandwidth of the final I/Q data.

This value is dependent on the defined [Data Acquisition](#) and the defined [Signal Source](#) and cannot be edited manually.

To avoid using a filter and use the [Input Sample Rate](#) instead, select the "No Filter" option.

Remote command:

`TRACe<n>:IQ:BWIDth` on page 896

No Filter ← Data Acquisition ← I/Q Analyzer

This setting is only available when using the Digital Baseband Interface (R&S FSVR-B17).

If enabled, no digital decimation filter is used during data acquisition. Thus, the [Sample Rate](#) is identical to the input sample rate configured for the Digital I/Q input source (see ["Input Sample Rate"](#) on page 270).

Note, however, that in this case noise, artifacts, and the second IF side band may not be suppressed in the captured I/Q data.

Remote command:

`TRACe<n>:IQ:DIQFilter` on page 900

Meas Time ← Data Acquisition ← I/Q Analyzer

Defines the I/Q acquisition time. By default, the measurement time is calculated as the number of I/Q samples ("Record Length") divided by the sample rate. If you change the measurement time, the [Record Length](#) is automatically changed, as well.

For details on the maximum number of samples see also [chapter 4.4.6, "Working with I/Q Data"](#), on page 301.

Remote command:

`[SENSe:]SWEep:TIME` on page 872

Record Length ← Data Acquisition ← I/Q Analyzer

Defines the number of I/Q samples to record. By default, the number of sweep points is used. The record length is calculated as the measurement time multiplied by the sample rate. If you change the record length, the [Meas Time](#) is automatically changed, as well.

Remote command:

`TRACe<n>:IQ:RLENgth` on page 903

`TRACe<n>:IQ:SET` on page 904

Display Config ← I/Q Analyzer

Opens a selection list to specify the result display configuration. The following displays are available:

"Magnitude" Shows the values in time domain

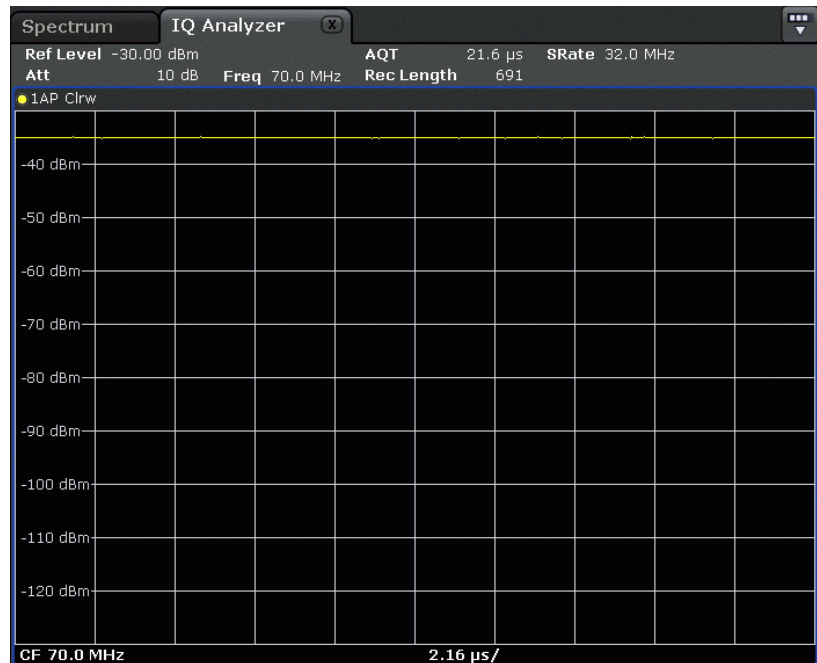

"Spectrum" Displays the frequency spectrum of the captured I/Q samples.

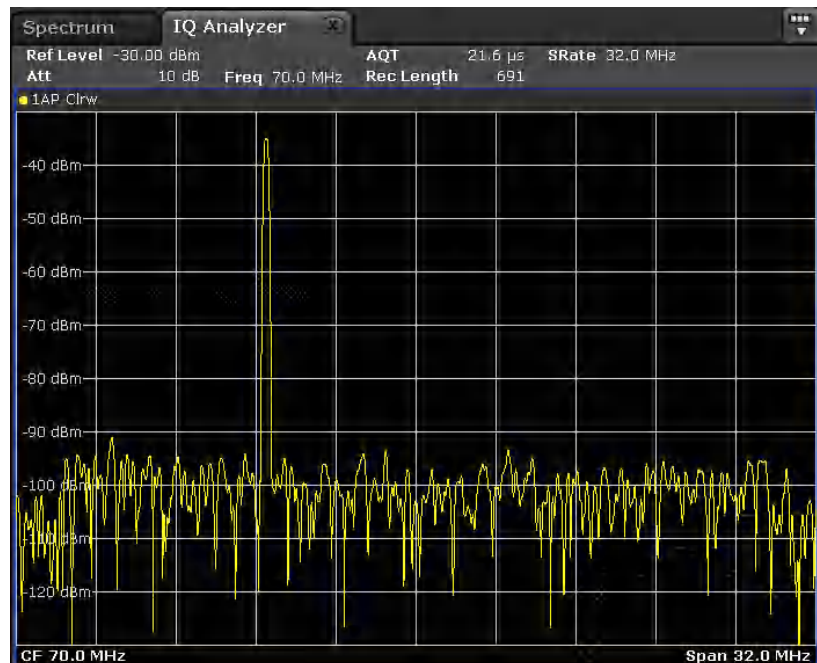

"I/Q-Vector" Displays the captured samples in an I/Q-plot. The samples are connected by a line.

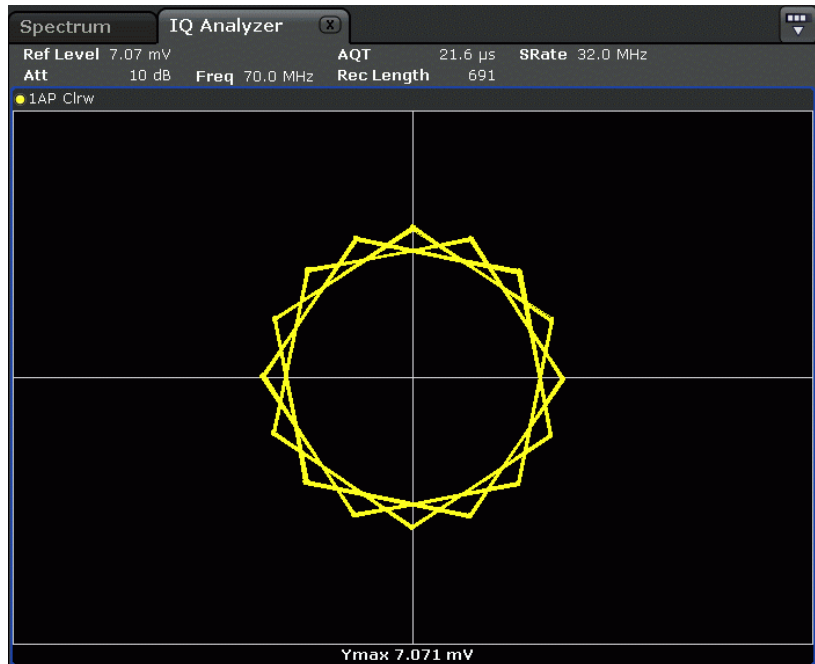

"Real/Imag (I/Q)" Displays the I and Q values in separate diagrams.

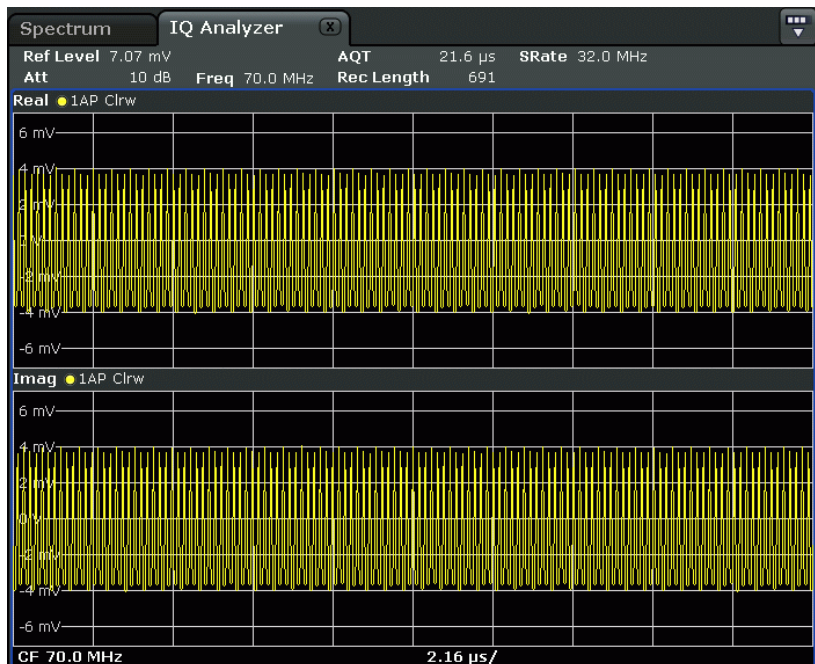

Remote command:

[CALCulate<n>:FORMat](#) on page 708

Digital Output ← I/Q Analyzer

Opens a dialog box to enable a digital output stream to the optional R&S Digital I/Q Interface (R&S FSV-B17), if available.

The displayed sample rate is identical to the sample rate defined under [Data Acquisition](#) (I/Q Analyzer) and is not editable here.

For details see "Digital Output" in the description of the R&S Digital I/Q Interface for the base unit.

Remote command:

[OUTPut:DIQ](#) on page 744

Digital IQ Info ← I/Q Analyzer

Displays a dialog box with information on the digital I/Q input and output connection via the optional R&S Digital I/Q Interface (R&S FSV-B17), if available. The information includes:

- Device identification
- Used port
- (Maximum) digital input/output sample rates and maximum digital input/output transfer rates
- Status of the connection protocol
- Status of the PRBS descewing test

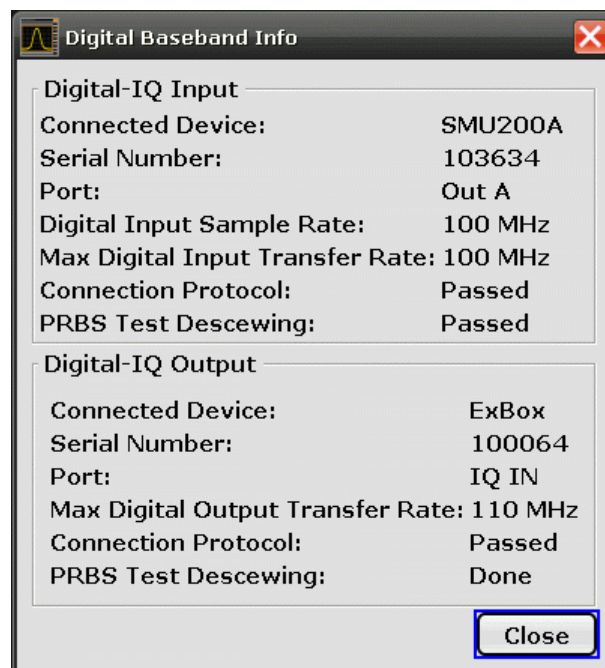

For details see "Interface Status Information" in "Instrument Functions - R&S Digital I/Q Interface (Option R&S FSV-B17)" in the description of the base unit.

Remote command:

[INPut:DIQ:CDEvice](#) on page 733

C/N, C/No ← I/Q Analyzer

Opens a submenu to configure the carrier/noise ratio measurement. Measurements without (C/N) and measurements with reference to the bandwidth (C/No) are possible.

Carrier-to-noise measurements are not available in zero span mode.

Note: Carrier-to-noise measurements are also available in the I/Q Analyzer, but only for **Spectrum** displays (see "Display Config" on page 284).

For general information on performing carrier-to-noise ratio measurements see [chapter 4.2.5.3, "Measuring the Carrier-to-Noise Ratio"](#), on page 179.

C/N ← C/N, C/No ← I/Q Analyzer

Switches the measurement of the carrier/noise ratio on or off. If no marker is active, marker 1 is activated.

The measurement is performed on the trace that marker 1 is assigned to. To shift marker 1 and measure another trace, use the [Marker to Trace](#) softkey in the "Marker To" menu.

Remote command:

[CALCulate<n>:MARKer<m>:FUNCTION:POWER:SElect](#) on page 654

[CALCulate<n>:MARKer<m>:FUNCTION:POWER:RESult?](#) on page 651

[CALCulate<n>:MARKer<m>:FUNCTION:POWER\[:STATe\]](#) on page 655

C/No ← C/N, C/No ← I/Q Analyzer

Switches the measurement of the carrier/noise ratio with reference to a 1 Hz bandwidth on or off. If no marker is active, marker 1 is activated.

The measurement is performed on the trace that marker 1 is assigned to. To shift marker 1 and measure another trace, use the [Marker to Trace](#) softkey in the "Marker To" menu.

Remote command:

[CALCulate<n>:MARKer<m>:FUNCTION:POWER:SElect](#) on page 654

[CALCulate<n>:MARKer<m>:FUNCTION:POWER:RESult?](#) on page 651

[CALCulate<n>:MARKer<m>:FUNCTION:POWER\[:STATe\]](#) on page 655

Channel Bandwidth ← C/N, C/No ← I/Q Analyzer

Opens an edit dialog box to enter the measurement channel bandwidth for each channel.

The default setting is 14 kHz.

Note that in the I/Q Analyzer the channel bandwidth does not change the measurement span or sampling rate; it merely defines the range for the carrier-to-noise analysis.

Remote command:

[\[SENSe:\]POWER:ACHannel:ACPairs](#) on page 845

Adjust Settings ← C/N, C/No ← I/Q Analyzer

Enables the RMS detector (see also [chapter 4.1.8.6, "Detector Overview"](#), on page 106) and adjusts the span to the selected channel bandwidth according to:

"4 x channel bandwidth + measurement margin"

The adjustment is performed once; if necessary, the setting can be changed later on.

Note: in the I/Q Analyzer, this function is not available. The channel bandwidth defines the range for the carrier-to-noise analysis.

Remote command:

[\[SENSe:\]POWER:ACHannel:PRESet](#) on page 850

4.4.2 Softkeys of the Amplitude Menu in I/Q Analyzer Mode

In I/Q Analyzer mode, the "Amplitude" menu, which is displayed when you select the AMPT key, contains the following functions.



If the display configuration for the I/Q Analyzer is set to "I/Q Vector" or "Real/Imag (I/Q)", the **Range** and **Unit** functions are not available.

Ref Level.....	288
Range.....	288
L Range Log 100 dB.....	288
L Range Log 50 dB.....	289
L Range Log 10 dB.....	289
L Range Log 5 dB.....	289
L Range Log 1 dB.....	289
L Range Log Manual.....	290
L Range Linear %.....	290
L Range Lin. Unit.....	290
Unit.....	290
Y-Axis Max.....	291
Ref Level Offset.....	291
Ref Level Position.....	291
Grid Abs/Rel	291

Ref Level

Opens an edit dialog box to enter the reference level in the current unit (dBm, dBμV, etc).

The reference level is the maximum value the AD converter can handle without distortion of the measured value. Signal levels above this value will not be measured correctly, which is indicated by the "IFOVL" status display.

Remote command:

`DISPlay[:WINDow<n>]:TRACe<t>:Y[:SCALE]:RLEVEL` on page 720

Range

Opens a submenu to define the display range of the level axis.

Range Log 100 dB ← Range

Sets the level display range to 100 dB.

Remote command:

Logarithmic scaling:

`DISP:WIND:TRAC:Y:SPAC LOG`, see `DISPlay[:WINDow<n>]:TRACe<t>:Y:SPACing` on page 717

Display range:

`DISP:WIND:TRAC:Y 100DB`, see `DISPlay[:WINDow<n>]:TRACe<t>:Y[:SCALE]` on page 718

Range Log 50 dB ← Range

Sets the level display range to 50 dB.

Remote command:

Logarithmic scaling:

DISP:WIND:TRAC:Y:SPAC LOG, see [DISPlay\[:WINDow<n>\]:TRACe<t>:Y:SPACing](#) on page 717

Display range:

DISP:WIND:TRAC:Y 50DB, see [DISPlay\[:WINDow<n>\]:TRACe<t>:Y\[:SCALe\]](#) on page 718

Range Log 10 dB ← Range

Sets the level display range to 10 dB.

Remote command:

Logarithmic scaling:

DISP:WIND:TRAC:Y:SPAC LOG, see [DISPlay\[:WINDow<n>\]:TRACe<t>:Y:SPACing](#) on page 717

Display range:

DISP:WIND:TRAC:Y 10DB, see [DISPlay\[:WINDow<n>\]:TRACe<t>:Y\[:SCALe\]](#) on page 718

Range Log 5 dB ← Range

Sets the level display range to 5 dB.

Remote command:

Logarithmic scaling:

DISP:WIND:TRAC:Y:SPAC LOG, see [DISPlay\[:WINDow<n>\]:TRACe<t>:Y:SPACing](#) on page 717

Display range:

DISP:WIND:TRAC:Y 5DB, see [DISPlay\[:WINDow<n>\]:TRACe<t>:Y\[:SCALe\]](#) on page 718

Range Log 1 dB ← Range

Sets the level display range to 1 dB.

Remote command:

Logarithmic scaling:

DISP:WIND:TRAC:Y:SPAC LOG, see [DISPlay\[:WINDow<n>\]:TRACe<t>:Y:SPACing](#) on page 717

Display range:

DISP:WIND:TRAC:Y 1DB, see [DISPlay\[:WINDow<n>\]:TRACe<t>:Y\[:SCALe\]](#) on page 718

Range Log Manual ← Range

Opens an edit dialog box to define the display range of a logarithmic level axis manually.

Remote command:

Logarithmic scaling:

DISP:WIND:TRAC:Y:SPAC LOG, see [DISPlay\[:WINDow<n>\]:TRACe<t>:Y:SPACing](#) on page 717

Display range:

[DISPlay\[:WINDow<n>\]:TRACe<t>:Y\[:SCALe\]](#) on page 718

Range Linear % ← Range

Selects linear scaling for the level axis in %.

The grid is divided into decadal sections.

Markers are displayed in the selected unit ("Unit" softkey). Delta markers are displayed in % referenced to the voltage value at the position of marker 1. This is the default setting for linear scaling.

Remote command:

DISP:TRAC:Y:SPAC LIN, see [DISPlay\[:WINDow<n>\]:TRACe<t>:Y:SPACing](#) on page 717

Range Lin. Unit ← Range

Selects linear scaling in dB for the level display range, i.e. the horizontal lines are labeled in dB.

Markers are displayed in the selected unit ("Unit" softkey). Delta markers are displayed in dB referenced to the power value at the position of marker 1.

Remote command:

DISP:TRAC:Y:SPAC LDB, see [DISPlay\[:WINDow<n>\]:TRACe<t>:Y:SPACing](#) on page 717

Unit

Opens the "Unit" submenu to select the unit for the level axis.

The default setting is dBm.

If a transducer is switched on, the softkey is not available.

In general, the signal analyzer measures the signal voltage at the RF input. The level display is calibrated in RMS values of an unmodulated sine wave signal. In the default state, the level is displayed at a power of 1 mW (= dBm). Via the known input impedance (50 Ω or 75 Ω), conversion to other units is possible. The following units are available and directly convertible:

- dBm
- dBmV
- dBμV
- dBμA
- dBpW
- Volt
- Ampere

- Watt

Remote command:

`CALCulate<n>:UNIT:POWer` on page 704

Y-Axis Max

Opens an edit dialog box to specify the maximum value of the y-axis in either direction (in Volts). Thus, the y-axis scale starts at $-<Y\text{-AxisMax}>$ and ends at $+<Y\text{-AxisMax}>$.

This command is only available if the display configuration for the I/Q Analyzer is set to "I/Q Vector" or "Real/Imag (I/Q)", see "Display Config" on page 284.

Ref Level Offset

Opens an edit dialog box to enter the arithmetic level offset. This offset is added to the measured level irrespective of the selected unit. The scaling of the y-axis is changed accordingly. The setting range is ± 200 dB in 0.1 dB steps.

Remote command:

`DISPlay[:WINDow<n>]:TRACe<t>:Y[:SCALe]:RLEVEL:OFFSet` on page 720

Ref Level Position

Opens an edit dialog box to enter the reference level position, i.e. the position of the maximum AD converter value on the level axis. The setting range is from -200 to +200 %, 0 % corresponding to the lower and 100 % to the upper limit of the diagram.

Only available for RF measurements.

Remote command:

`DISPlay[:WINDow<n>]:TRACe<t>:Y[:SCALe]:RPOSITION` on page 720

Grid Abs/Rel

Switches between absolute and relative scaling of the level axis (not available with "Linear" range).

Only available for RF measurements.

"Abs"	Absolute scaling: The labeling of the level lines refers to the absolute value of the reference level. Absolute scaling is the default setting.
"Rel"	Relative scaling: The upper line of the grid is always at 0 dB. The scaling is in dB whereas the reference level is always in the set unit (for details on unit settings see the "Unit" softkey).

Remote command:

`DISPlay[:WINDow<n>]:TRACe<t>:Y[:SCALe]:MODE` on page 719

4.4.3 Softkeys of the Trigger Menu in I/Q Analyzer Mode

In I/Q Analyzer mode, the "Trigger" menu, which is displayed when you select the TRIG key, contains the following functions:

Trg/Gate Source.....	292
L Free Run.....	292
L External.....	292
L Video.....	292

L RF Power.....	293
L IF Power/BB Power.....	293
L Power Sensor.....	294
L Time.....	294
Trigger Level.....	294
Trigger Polarity.....	295
Trigger Offset.....	295
Repetition Interval.....	296
Trigger Hysteresis.....	296
Trigger Holdoff.....	296

Trg/Gate Source

Opens the "Trigger/Gate Source" dialog box to select the trigger/gate mode.

As gate modes, all modes except "Power Sensor" are available. For details see also [chapter 4.1.9.3, "Using Gated Sweep Operation"](#), on page 116.

The default setting is "Free Run". If a trigger mode other than "Free Run" has been set, the enhancement label "TRG" is displayed and the trigger source is indicated.

Note: When triggering or gating is activated, the squelch function is automatically disabled (see ["Squelch"](#) on page 132).

Remote command:

TRIGger<n>[:SEQuence]:SOURce on page 913

[SENSe:]SWEep:EGATe:SOURce on page 868

Free Run ← Trg/Gate Source

The start of a sweep is not triggered. Once a measurement is completed, another is started immediately.

Remote command:

TRIG:SOUR IMM, see TRIGger<n>[:SEQuence]:SOURce on page 913

External ← Trg/Gate Source

Defines triggering via a TTL signal at the "EXT TRIG/GATE IN" input connector on the rear panel.

Remote command:

TRIG:SOUR EXT, see TRIGger<n>[:SEQuence]:SOURce on page 913

SWE:EGAT:SOUR EXT for gated triggering, see [SENSe:]SWEep:EGATe:SOURce on page 868

Video ← Trg/Gate Source

Defines triggering by the displayed voltage.

A horizontal trigger line is shown in the diagram. It is used to set the trigger threshold from 0 % to 100 % of the diagram height.

Video mode is only available in the time domain.

Remote command:

TRIG:SOUR VID, see TRIGger<n>[:SEQuence]:SOURce on page 913

SWE:EGAT:SOUR VID for gated triggering, see [SENSe:]SWEep:EGATe:SOURce on page 868

RF Power ← Trg/Gate Source

Defines triggering of the measurement via signals which are outside the measurement channel.

This trigger mode is available with detector board 1307.9554.02 Rev 05.00 or higher. It is not available for input from the R&S Digital I/Q Interface (option R&S FSVR-B17). If RF Power trigger mode is selected and digital baseband input is activated, the trigger mode is automatically switched to "Free Run".

In RF Power trigger mode the instrument uses a level detector at the first intermediate frequency. The detector threshold can be selected in a range between - 50 dBm and -10 dBm at the input mixer. The resulting trigger level at the RF input lies within the following range:

$(-24\text{dBm} + \text{RF Att}) \leq \text{Triggerlevel} \leq (+5\text{dBm} + \text{RF Att})$, max. 30 dBm, for Preamp = OFF

$(-40\text{dBm} + \text{RF Att}) \leq \text{Triggerlevel} \leq (-11\text{dBm} + \text{RF Att})$, max. 30 dBm, for Preamp = ON

with

$500 \text{ MHz} \leq \text{InputSignal} \leq 7 \text{ GHz}$

Note: If input values outside of this range occur (e.g. for fullspan measurements), the sweep may be aborted and a message indicating the allowed input values is displayed in the status bar.

A [Trigger Offset](#), [Trg/Gate Polarity](#) and [Trigger Holdoff](#) can be defined for the RF trigger to improve the trigger stability, but no hysteresis.

Remote command:

TRIG:SOUR RFP, see [TRIGger<n>\[:SEQuence\]:SOURce](#) on page 913

SWE:EGAT:SOUR RFP for gated triggering, see [\[SENSe:\]SWEep:EGATe:SOURce](#) on page 868

IF Power/BB Power ← Trg/Gate Source

For this purpose, the R&S FSVR uses a level detector at the second intermediate frequency.

The available trigger levels depend on the RF attenuation and preamplification. A reference level offset, if defined, is also considered.

For details on available trigger levels and trigger bandwidths see the data sheet.

The bandwidth at the intermediate frequency depends on the RBW and sweep type:

Sweep mode:

- RBW > 500 kHz: 40 MHz, nominal
- RBW ≤ 500 kHz: 6 MHz, nominal

FFT mode:

- RBW > 20 kHz: 40 MHz, nominal
- RBW ≤ 20 kHz: 6 MHz, nominal

Note: Be aware that in auto sweep type mode, due to a possible change in sweep types, the bandwidth may vary considerably for the same RBW setting.

The R&S FSVR is triggered as soon as the trigger level is exceeded around the selected frequency (= start frequency in the frequency sweep).

Thus, the measurement of spurious emissions, e.g. for pulsed carriers, is possible even if the carrier lies outside the selected frequency span.

For digital input via the R&S Digital I/Q Interface (R&S FSV-B17), the baseband power ("BB Power") is used as the trigger source.

Remote command:

TRIG:SOUR IFP, see [TRIGger<n>\[:SEQuence\]:SOURce](#) on page 913

TRIG:SOUR BBP for digital input

SWE:EGAT:SOUR IFP for gated triggering, see [\[SENSe:\]SWEep:EGATe:SOURce](#) on page 868

Power Sensor ← Trg/Gate Source

Uses an external power sensor as a trigger function. This option is only available if the R&S FSV-K9 Power Sensor option is installed and a power sensor is connected and configured.

(See [chapter 4.5, "Instrument Functions - Power Sensor \(R&S FSV-K9\)"](#), on page 304.)

Power sensors are configured in the "Input/Output" menu, see [chapter 4.5.3, "Configuring an External Power Trigger"](#), on page 309.

If a power sensor is selected as the trigger mode, the following softkeys are not available; these settings are configured in the "Power Sensor Configuration" dialog box (see [chapter 4.5.5, "Power Sensor Configuration Dialog"](#), on page 313).

- [Trg/Gate Level](#)
- [Trg/Gate Polarity](#)
- [Trigger Hysteresis](#)
- [Trigger Holdoff](#)

Note: For R&S power sensors, the "Gate Mode" *Lvl* is not supported. The signal sent by these sensors merely reflects the instant the level is first exceeded, rather than a time period. However, only time periods can be used for gating in level mode. Thus, the trigger impulse from the sensors is not long enough for a fully gated measurement; the measurement cannot be completed.

Remote command:

TRIG:SOUR PSE, see [TRIGger<n>\[:SEQuence\]:SOURce](#) on page 913

SWE:EGAT:SOUR PSE for gated triggering, see [\[SENSe:\]SWEep:EGATe:SOURce](#) on page 868

[TRACe<n>:IQ:SET](#) on page 904

Time ← Trg/Gate Source

Opens an edit dialog box to define a repetition interval in which the measurement is triggered. The shortest interval is 2 ms.

Remote command:

TRIG:SOUR TIMETRIGger<n>[:SEQuence]:SOURce on page 913

Trigger Level

Defines the trigger level as a numeric value.

In the trigger mode "Time", this softkey is not available.

Remote command:

[TRIGger<n>\[:SEquence\]:LEVel:IFPower](#) on page 911

[TRIGger<n>\[:SEquence\]:LEVel:VIDeo](#) on page 912

For digital input via the R&S Digital I/Q Interface, R&S FSV-B17:

[TRIGger<n>\[:SEquence\]:LEVel:BBPower](#) on page 910

Trigger Polarity

Sets the polarity of the trigger source.

The sweep starts after a positive or negative edge of the trigger signal. The default setting is "Pos". The setting applies to all modes with the exception of the "Free Run" and "Time" mode.

"Pos" Level triggering: the sweep is stopped by the logic "0" signal and restarted by the logical "1" signal after the gate delay time has elapsed.

"Neg" Edge triggering: the sweep is continued on a "0" to "1" transition for the gate length duration after the gate delay time has elapsed.

Remote command:

[TRIGger<n>\[:SEquence\]:SLOPe](#) on page 913

[\[SENSe:\]SWEep:EGATe:POLarity](#) on page 868

Trigger Offset

Opens an edit dialog box to enter the time offset between the trigger signal and the start of the sweep.

offset > 0:	Start of the sweep is delayed
offset < 0:	<p>Sweep starts earlier (pre-trigger)</p> <p>Only possible for span = 0 (e.g. I/Q Analyzer mode) and gated trigger switched off</p> <p>Maximum allowed range limited by the sweep time: $\text{pretrigger}_{\text{max}} = \text{sweep time}$</p> <p>When using the R&S Digital I/Q Interface (R&S FSV-B17) with I/Q Analyzer mode, the maximum range is limited by the number of pretrigger samples.</p> <p>See table 7-2.</p> <p>See the R&S Digital I/Q Interface(R&S FSV-B17) description in the base unit.</p>

In the "External" or "IF Power" trigger mode, a common input signal is used for both trigger and gate. Therefore, changes to the gate delay will affect the trigger delay (trigger offset) as well.

Tip: To determine the trigger point in the sample (for "External" or "IF Power" trigger mode), use the [TRACe<n>:IQ:TPISample?](#) command.

In the "Time" trigger mode, this softkey is not available.

Remote command:

[TRIGger<n>\[:SEquence\]:HOLDoff\[:TIME\]](#) on page 908

Repetition Interval

Opens an edit dialog box to define a repetition interval in which the measurement is triggered. The shortest interval is 2 ms. This softkey is only available if the trigger source "Time" is selected (see "Time" on page 112).

Remote command:

[TRIGger<n>\[:SEquence\]:TIME:RINTerval](#) on page 915

Trigger Hysteresis

Defines the value for the trigger hysteresis for "IF power" or "RF Power" trigger sources. The hysteresis in dB is the value the input signal must stay below the power trigger level in order to allow a trigger to start the measurement. The range of the value is between 3 dB and 50 dB with a step width of 1 dB.

Remote command:

[TRIGger<n>\[:SEquence\]:IFPower:HYSteresis](#) on page 909

Trigger Holdoff

Defines the value for the trigger holdoff. The holdoff value in s is the time which must pass before triggering, in case another trigger event happens.

This softkey is only available if "IFPower", "RF Power" or "BBPower" is the selected trigger source.

Remote command:

[TRIGger<n>\[:SEquence\]:IFPower:HOLDoff](#) on page 909

For digital input via the R&S Digital I/Q Interface, R&S FSV-B17:

[TRIGger<n>\[:SEquence\]:BBPower:HOLDoff](#) on page 909

4.4.4 Softkeys of the Marker To Menu in I/Q Analyzer Mode

In I/Q Analyzer mode, The "Marker To" menu is identical to the one in Spectrum mode (see [chapter 4.2.4.1, "Softkeys of the Marker To Menu"](#), on page 142). For the "Real/Imag (I/Q)" display mode, however, an additional function is available.

Search Settings

Opens a dialog box to define which data is used for marker search functions.

Note: The search settings apply to all markers, not only the currently selected one.

"Search Real"	Marker search functions are performed on the real trace of the I/Q measurement.
"Search Imag"	Marker search functions are performed on the imaginary trace of the I/Q measurement.
"Search Magnitude"	Marker search functions are performed on the magnitude of the I and Q data.

Remote command:

["CALCulate:MARKer:FUNCTION Subsystem"](#) on page 622

4.4.5 Softkeys of the Marker Function Menu in I/Q Analyzer Mode

In I/Q Analyzer mode, the "Marker Function" menu is similar to the one in Spectrum mode (see [chapter 4.2.3.1, "Softkeys of the Marker Function Menu"](#), on page 128). For the "I/Q Vector" display mode, however, this menu is not available.

Select Marker (No).....	297
Signal Count.....	297
n dB down.....	298
Marker Peak List.....	298
L Peak List On/Off.....	299
L Sort Mode Freq/Lvl.....	299
L Max Peak Count.....	299
L Peak Excursion.....	299
L Left Limit.....	299
L Right Limit.....	299
L Threshold.....	300
L ASCII File Export.....	300
L Decim Sep.....	300
L Marker Number.....	300
Band Power.....	300
L Select Marker (No).....	301
L Band Power On/Off.....	301
L Span.....	301
L Power.....	301
L Density.....	301

Select Marker (No)

Opens a submenu to select one of 16 markers and define whether the marker is a normal or a delta marker (see "[Marker 1 / Marker 2 / Marker 3 / ... Marker 16, / Marker Norm/Delta](#)" on page 120). "(No)" indicates the number of the currently active marker.

See "[Marker 1 / Marker 2 / Marker 3 / ... Marker 16, / Marker Norm/Delta](#)" on page 120.

Signal Count

Switches the frequency counter on or off, and opens an edit dialog box to define the resolution of the frequency counter, if enabled. The frequency is counted at the position of the reference marker (marker 1). If no marker is activate, marker 1 is switched on and positioned on the largest signal.

The sweep stops at the reference marker until the frequency counter has delivered a result. The result is displayed in the marker field (see [figure 4-8](#)), labeled with [Tx CNT].

For more information see [chapter 4.2.3.5, "Frequency Measurement with the Frequency Counter"](#), on page 138.

Remote command:

CALCulate<n>:MARKer<m>:COUNT on page 608

CALCulate<n>:MARKer<m>:COUNT:FREQuency? on page 609

n dB down

Opens an edit dialog box to enter a value to define the level spacing of the two temporary markers to the right and left of marker 1 (default setting: 3 dB). Activates the temporary markers T1 and T2. The values of the temporary markers (T1, T2) and the entered value (ndB) are displayed in the marker field.

If a positive value is entered, the markers T1 and T2 are placed below the active reference marker. If a negative value (e.g. for notch filter measurements) is entered, the markers T1 and T2 are placed above the active reference marker. Marker T1 is placed to the left and marker T2 to the right of the reference marker.

In the marker table, the following results are displayed:

Span setting	Parameter name	Description
span > 0	Bw	frequency spacing of the two temporary markers
	Q factor	quality of the displayed bandwidth value (Bw)
span = 0	PWid	pulse width between the two temporary markers

If it is not possible to form the frequency spacing for the n dB value (e.g. because of noise display), dashes instead of a measured value are displayed.

Remote command:

CALC:MARK1:FUNC:NDBD:STAT ON, see [CALCulate<n>:MARKer<m>:FUNCTION:NDBDown:STATe](#) on page 635

CALC:MARK1:FUNC:NDBD 3dB, see [CALCulate<n>:MARKer<m>:FUNCTION:NDBDown](#) on page 633

CALC:MARK1:FUNC:NDBD:RES? , see [CALCulate<n>:MARKer<m>:FUNCTION:NDBDown:RESult?](#) on page 635

CALC:MARK:FUNC:NDBD:QFAC?, see [CALCulate<n>:MARKer<m>:FUNCTION:NDBDown:QFACtor](#) on page 634

CALC:MARK1:FUNC:NDBD:FREQ? (span > 0), see [CALCulate<n>:MARKer<m>:FUNCTION:NDBDown:FREQuency?](#) on page 634

CALC:MARK1:FUNC:NDBD:TIME? (span = 0), see [CALCulate<n>:MARKer<m>:FUNCTION:NDBDown:TIME?](#) on page 636

Marker Peak List

Opens the "Peak List" submenu to define criteria for the sort order and the contents of the peak list. For each listed peak the frequency ("Stimulus") and level ("Response") values are given. In addition, the peaks are indicated in the trace display. A maximum of 50 entries are listed.

Remote command:

[CALCulate<n>:MARKer<m>:FUNCTION:FPEaks:COUNT?](#) on page 629

[CALCulate<n>:MARKer<m>:FUNCTION:FPEaks:X](#) on page 630

[CALCulate<n>:MARKer<m>:FUNCTION:FPEaks:Y?](#) on page 631

Peak List On/Off ← Marker Peak List

Activates/deactivates the marker peak list. If activated, the peak list is displayed and the peaks are indicated in the trace display.

Remote command:

[CALCulate<n>:MARKer<m>:FUNCTION:FPEaks:STAT](#) on page 630

Sort Mode Freq/Lvl ← Marker Peak List

Defines the criteria for sorting:

"Freq" sorting in ascending order of frequency values (span > 0) or time values (span = 0)

"Lvl" sorting in ascending order of the level

Remote command:

[CALCulate<n>:MARKer<m>:FUNCTION:FPEaks:SORT](#) on page 630

Max Peak Count ← Marker Peak List

Defines the maximum number of peaks to be determined and displayed.

Remote command:

[CALCulate<n>:MARKer<m>:FUNCTION:FPEaks:LIST:SIZE](#) on page 629

Peak Excursion ← Marker Peak List

Opens an edit dialog box for level measurements to enter the minimum level value by which a signal must rise or fall so that it will be identified as a maximum or a minimum by the search functions. Entries from 0 dB to 80 dB are allowed; the resolution is 0.1 dB. The default setting for the peak excursion is 6 dB.

For more information see "Specifying the suitable peak excursion" and "Effect of different peak excursion settings".

Remote command:

[CALCulate<n>:MARKer<m>:PEXCursion](#) on page 616

Left Limit ← Marker Peak List

Opens an edit dialog box to enter a value for the lower limit (left vertical line: S1 for span > 0; T1 for zero span). The search is performed between the lines of the left and right limit (see also [Right Limit](#) softkey).

Remote command:

[CALCulate<n>:MARKer<m>:X:SLIMits:LEFT](#) on page 618

Right Limit ← Marker Peak List

Opens an edit dialog box to enter a value for the upper limit (left vertical line: S2 for span > 0; T2 for zero span). The search is performed between the lines of the left and right limit (see also [Left Limit](#) softkey). If no value is set, the upper limit corresponds to the stop frequency.

Remote command:

[CALCulate<n>:MARKer<m>:X:SLIMits:RIGHT](#) on page 619

Threshold ← Marker Peak List

Opens an edit dialog box to define the threshold line. The threshold line represents the lower level limit for a "Peak" search and the upper level limit for a "Min" search.

Remote command:

`CALCulate<n>:THReshold:STATe` on page 703

`CALCulate<n>:THReshold` on page 702

ASCII File Export ← Marker Peak List

Opens the "ASCII File Export Name" dialog box and saves the active peak list in ASCII format to the specified file and directory.

The file consists of the header containing important scaling parameters and a data section containing the marker data. For details on an ASCII file see [chapter 4.1.8.7, "ASCII File Export Format"](#), on page 107.

This format can be processed by spreadsheet calculation programs, e.g. MS-Excel. It is necessary to define ';' as a separator for the data import. Different language versions of evaluation programs may require a different handling of the decimal point. It is therefore possible to select between separators '.' (decimal point) and ',' (comma) using the "Decim Sep" softkey (see ["Decim Sep"](#) on page 100).

An example of an output file for Spectrum Emission Mask measurements is given in ["ASCII File Export Format \(Spectrum Emission Mask\)"](#) on page 210.

Remote command:

`FORMat:DEXPort:DSEPARATOR` on page 728

`MMEMory:STORe<n>:LIST` on page 742

Decim Sep ← Marker Peak List

Selects the decimal separator with floating-point numerals for the ASCII Trace export to support evaluation programs (e.g. MS-Excel) in different languages. The values '.' (decimal point) and ',' (comma) can be set.

Remote command:

`FORMat:DEXPort:DSEPARATOR` on page 728

Marker Number ← Marker Peak List

If enabled, the determined peaks are indicated by their corresponding marker number in the trace display.

Remote command:

`CALCulate<n>:MARKer<m>:FUNCTION:FPEaks:ANN:LAB:STAT` on page 628

Band Power

Opens a submenu to activate and configure a band power marker. Band power markers allow you to measure the integrated power for a defined span (band) around a marker. The result can be displayed either as a power (dBm) or density (dBm/Hz). The span is indicated by lines in the diagram.

Band power markers are only available for standard frequency measurements in Spectrum mode.

Note: Band Power markers are also available in the I/Q Analyzer, but only for **Spectrum** displays (see ["Display Config"](#) on page 284).

For more information see [chapter 4.2.3.8, "Performing Band Power Measurements"](#), on page 140.

Select Marker (No) ← Band Power

Opens a submenu to select one of 16 markers and define whether the marker is a normal or a delta marker (see ["Marker 1 / Marker 2 / Marker 3 / ... Marker 16, / Marker Norm/Delta"](#) on page 120). "(No)" indicates the number of the currently active marker. See ["Marker 1 / Marker 2 / Marker 3 / ... Marker 16, / Marker Norm/Delta"](#) on page 120.

Band Power On/Off ← Band Power

Activates or deactivates the band power marker. When switched to on, if no marker is active yet, marker 1 is activated. Otherwise, the currently active marker is used as a band power marker (all other marker functions for this marker are deactivated). All markers can be defined as band power markers, each with a different span.

Remote command:

`CALCulate<n>:MARKer<m>:FUNCTION:BPOWer[:STATe]` on page 624

Span ← Band Power

Defines the span (band) around the marker for which the power is measured. The span is indicated by lines in the diagram.

Remote command:

`CALCulate<n>:MARKer<m>:FUNCTION:BPOWer:SPAN` on page 624

Power ← Band Power

Selects the power mode for the band power marker, i.e. the result is displayed in dBm.

Remote command:

`CALCulate<n>:MARKer<m>:FUNCTION:BPOWer:MODE` on page 623

`CALCulate<n>:MARKer<m>:FUNCTION:BPOWer:RESult?` on page 624

Density ← Band Power

Selects the density mode for the band power marker, i.e. the result is displayed in dBm/Hz.

Remote command:

`CALCulate<n>:MARKer<m>:FUNCTION:BPOWer:MODE` on page 623

`CALCulate<n>:MARKer<m>:FUNCTION:BPOWer:RESult?` on page 624

4.4.6 Working with I/Q Data

I/Q data can be captured either from RF input, or via the optional R&S Digital I/Q Interface (R&S FSV-B17), or it can be imported from a file (see [chapter 6.2.3, "Importing and Exporting I/Q Data"](#), on page 459). The captured I/Q data can then be processed further, e.g. using the I/Q Analyzer, or in the applications that support the R&S Digital I/Q Interface. Additionally, the captured I/Q data can be exported to a file in order to process it in another application, e.g. Vector Signal Analysis, if available.

Working with digital input is described in [chapter 7.1, "Instrument Functions - R&S Digital I/Q Interface \(Option R&S FSV-B17\)"](#), on page 469 and in the applications that support that interface.

Working with digital input is described in detail in the R&S Digital I/Q Interface description for the base unit.

This section describes I/Q data processing of RF input, e.g. in the I/Q Analyzer.

The block diagram in [figure 4-23](#) shows the analyzer hardware for active RF input from the IF section to the processor.

The A/D converter samples the IF signal at a rate of 128 MHz. The digital signal is down-converted to the complex baseband, lowpass-filtered, and the sample rate is reduced. The continuously adjustable sample rates are realized using an optimal decimation filter and subsequent resampling on the set sample rate.

The I/Q data is written to a single memory, the data acquisition is hardware-triggered.

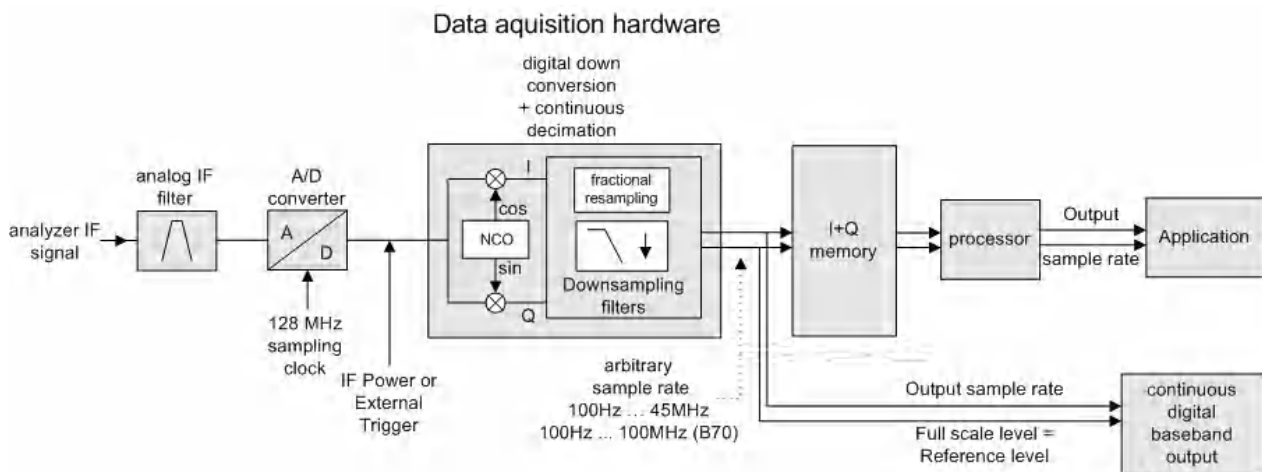

Fig. 4-23: Block diagram illustrating the R&S FSVR signal processing

Maximum number of samples

The maximum number of samples for RF input is 200 MS.

For digital input using the R&S Digital I/Q Interface (R&S FSV-B17), see [table 7-2](#).

For digital input using the R&S Digital I/Q Interface (B17), see "Sample rates, bandwidths and other limitations" in the base unit description.

4.4.6.1 Sample Rate and Maximum Usable Bandwidth (RF Input)



Information on sample rates and maximum usable bandwidths for Digital I/Q input is described in [table 7-1](#).

Information on sample rates and maximum usable bandwidths for Digital I/Q input is described in the base unit manual.

Definitions

- **Input sample rate (ISR):** the sample rate of the useful data provided by the connected instrument to the R&S FSVR input
- (User, Output) **Sample rate (SR):** the sample rate that is defined by the user (e.g. in the "Data Acquisition" dialog box in the "I/Q Analyzer" application) and which is used as the basis for analysis or output
- **Usable I/Q (Analysis) bandwidth:** the bandwidth range in which the signal remains undistorted in regard to amplitude characteristic and group delay; this range can be used for accurate analysis by the R&S FSVR

For the I/Q data acquisition, digital decimation filters are used internally. The passband of these digital filters determines the *maximum usable I/Q bandwidth*. In consequence, signals within the usable I/Q bandwidth (passband) remain unchanged, while signals outside the usable I/Q bandwidth (passband) are suppressed. Usually, the suppressed signals are noise, artifacts, and the second IF side band. If frequencies of interest to you are also suppressed, you should try to increase the output sample rate, since this increases the maximum usable I/Q bandwidth.

Relationship between sample rate and usable bandwidth

The diagram [figure 4-24](#) shows the maximum usable I/Q bandwidths depending on the user sample rates.

As a rule, the usable bandwidth is proportional to the output sample. Yet, when the I/Q bandwidth reaches the bandwidth of the analog IF filter (at very high sample rates), the curve breaks.

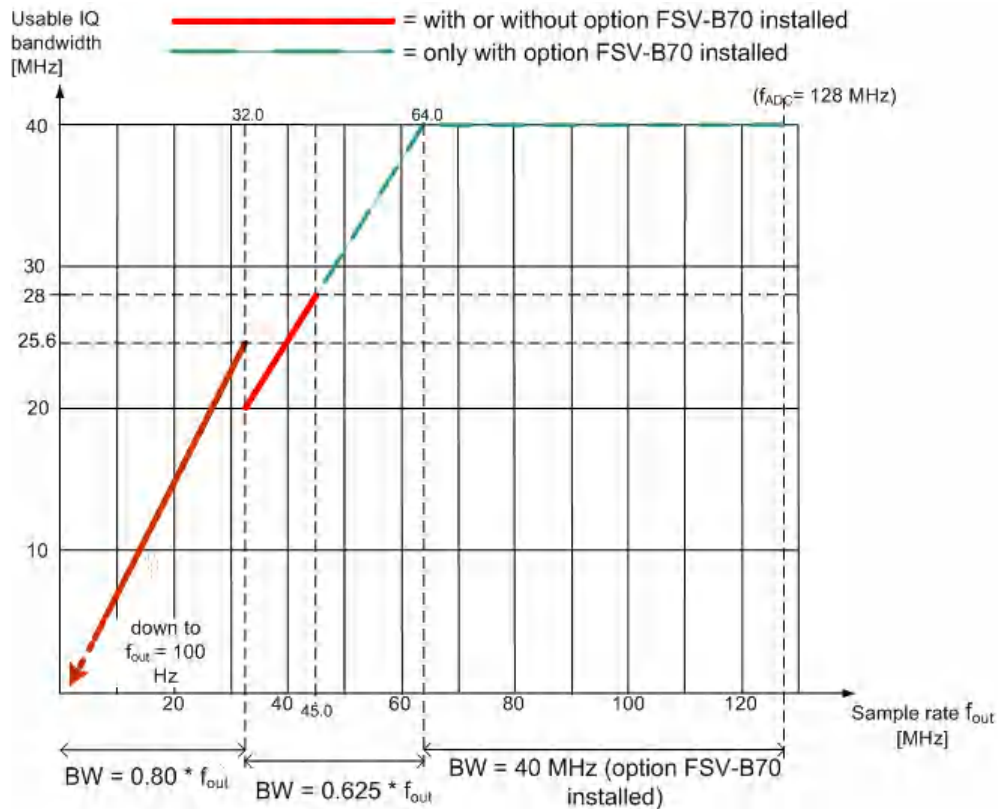
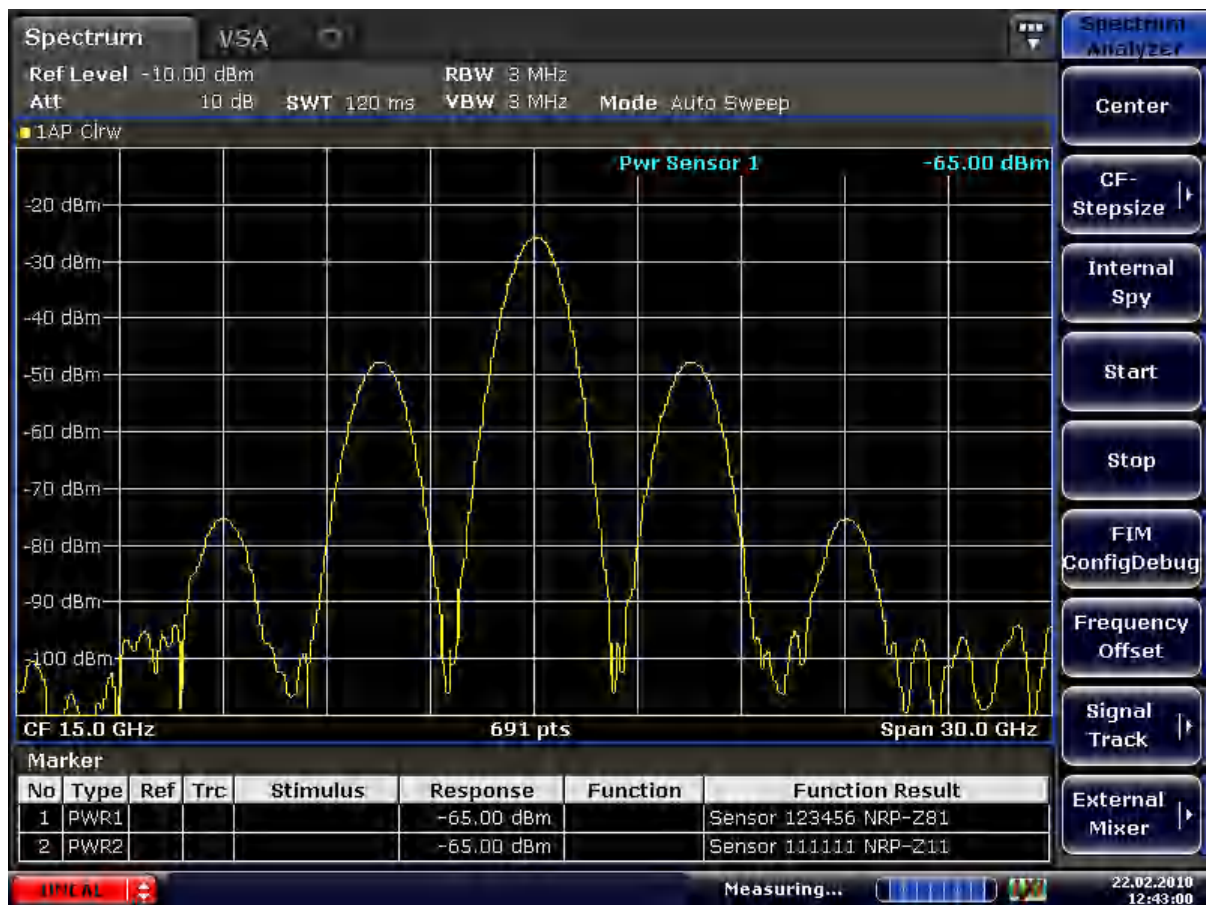

Fig. 4-24: Relation between maximum usable bandwidth and sample rate (RF input)

4.5 Instrument Functions - Power Sensor (R&S FSV-K9)

For precise power measurement up to 4 power sensors can be connected to the instrument via the power sensor interface (option R&S FSV-B5, front panel) or the USB connector (front or rear panel). The Power Sensor Support firmware option provides the power measurement functions for this test setup. Both manual operation and remote control are supported. The power sensor results are displayed in the marker table.



For details on the connectors and compatible power sensors refer to the Quick Start Guide, chapter 1, "Front and Rear Panel".

Power Sensors can also be used to trigger a measurement at a specified power level, e.g. from a signal generator.

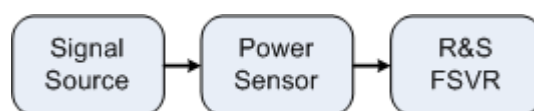

Fig. 4-25: Power sensor support – standard test setup



Using the power sensor with several applications

The power sensor cannot be used from the R&S FSVR firmware and the R&S Power Viewer (virtual power meter for displaying results of the R&S NRP power sensors) simultaneously. After using the Power Viewer, close the application, then unplug and replug the sensor. Afterwards the power sensor can be used by the R&S FSVR again.

To open the Power Sensor menu

The power sensor option R&S FSV-K9 is integrated within the "Input/Output" menu.

- Press the INPUT/OUTPUT key.

- Press the "Power Sensor" softkey. The "Power Sensor" menu is displayed.

Menu and softkey description

- [chapter 4.5.4, "Softkeys of the Power Sensor Menu \(R&S FSV-K9\)"](#), on page 311
- [chapter 4.5.5, "Power Sensor Configuration Dialog"](#), on page 313

Remote operation

Power sensors can be operated using the following remote command subsystems:

- ["CALCulate:PMETer Subsystem \(Power Sensor, R&S FSV-K9\)"](#) on page 690
- [chapter 8.2.3.3, "CALibration:PMETer Subsystem \(Power Sensor, R&S FSV-K9\)"](#), on page 709
- [chapter 8.2.3.6, "FETCh:PMETer Subsystem \(Power Sensor, R&S FSV-K9\)"](#), on page 727
- [chapter 8.2.3.14, "READ:PMETer Subsystem"](#), on page 748
- ["SENSe:PMETer<p> Subsystem \(Power Sensor, R&S FSV-K9\)"](#) on page 837
- [chapter 8.2.3.21, "UNIT Subsystem"](#), on page 920

Results display

The results of the power sensor measurements are displayed in the marker table. For each power sensor, a row is inserted. The sensor index is indicated in the "Function" column.

Marker						
No	Type	Trc	Stimulus	Response	Function	Function Result
1	PWR2			---	Sensor 2	Sensor ?
2	PWR3			---	Sensor 3	Sensor ?
3	PWR4			---	Sensor 4	Sensor ?

Alternatively, you can query the results using the remote command `FETCh<n>:PMETer<p>?` on page 728.

Tasks

The following tasks with Power Sensors are described in this chapter:

- [chapter 4.5.2, "Zeroing the Power Sensor"](#), on page 308
- [chapter 4.5.1, "Using Power Sensors"](#), on page 307
- [chapter 4.5.3, "Configuring an External Power Trigger"](#), on page 309

Further information

Information on possible error messages when using the Power Sensor is provided in [chapter 4.5.6, "Error Messages"](#), on page 317.

4.5.1	Using Power Sensors.....	307
4.5.2	Zeroing the Power Sensor.....	308
4.5.3	Configuring an External Power Trigger.....	309

4.5.4	Softkeys of the Power Sensor Menu (R&S FSV-K9).....	311
4.5.5	Power Sensor Configuration Dialog.....	313
4.5.6	Error Messages.....	317

4.5.1 Using Power Sensors

Up to 4 external power sensors can be configured separately and used for precise power measurement, as a trigger, or both. All power sensors can be activated and deactivated individually.

The following procedure describes in detail how to configure and activate power sensors.



For details on the settings in the "Power Sensor Configuration" dialog box, see [chapter 4.5.5, "Power Sensor Configuration Dialog"](#), on page 313.

1. Press INPUT/OUTPUT > "Power Sensor" to display the "Power Sensor" menu.
2. Press "Power Sensor Config" to display the configuration dialog box.
3. Select the tab for the power sensor index you want to configure, e.g. "Sensor 1".
Note: if automatic assignment is active (default) and a power sensor is already connected to the R&S FSVR, the serial number of the sensor is indicated in one of the tabs. In this case, you configure that particular sensor in the corresponding tab. If no serial number is indicated, you can set up a configuration and assign a sensor manually later.
4. Press "Select" to evaluate the power sensor when power measurement is activated.
5. Define the frequency of the signal whose power you want to measure.
 - a) To define the frequency manually, select "Frequency Manual" and enter a frequency.
 - b) To determine the frequency automatically, select "Frequency Coupling" and then either "Center", to use the center frequency, or "Marker", to use the frequency defined by marker 1.
6. Select the "Unit" for the power result display.
7. Select the measurement time for which the average is calculated. To define the number of readings to be taken into account manually, select "Manual" and enter the number in the "Number of Readings" field.
8. To activate the duty cycle correction, select "DutyCycle" and enter a percentage as the correction value.
9. If you selected "dB" or "%" as units (relative display), define a reference value:
 - a) To set the currently measured power as a reference value, press the "Meas -> Ref" button.

- b) Alternatively, enter a value manually in the "Reference Value" field.
 - c) Optionally, select the "Use Ref Level Offset" option to take the reference level offset set for the analyzer ([Ref Level Offset](#) softkey) into account for the measured power.
10. Optionally, define the usage of an external power trigger (see [chapter 4.5.3, "Configuring an External Power Trigger"](#), on page 309).
 11. If necessary, repeat steps 3-10 for another power sensor.
 12. By default, automatic assignment is active. If a power sensor is already connected to the R&S FSVR, it is automatically assigned to an index and the serial number of the sensor is indicated on the corresponding tab. In this case, you already configured the settings for the assigned power sensor.
Otherwise, assign the connected power sensors to the power sensor configurations manually:
 - a) Press the "Power Sensor Assignment" softkey in the "Power Sensor" menu to display the assignment dialog box.
 - b) For each configuration, define whether it is to be assigned automatically or manually by activating or deactivating the "Auto Assignment" option for the corresponding power sensor index.
 - c) For manual assignment, select the serial number of one of the connected power sensors from the list.
 13. Press the "Power Sensor On" softkey in the "Power Sensor" menu to activate power measurement for the selected power sensors.

The results of the power measurement are displayed in the marker table (Function: "Sensor<1...4>") and can be queried via the remote command `FETC:PMET<p>?` (see [FETCh<n>:PMETer<p>?](#) on page 728).

4.5.2 Zeroing the Power Sensor

You can reset each power sensor to zero. This can be done using the remote command `CALibration:PMETer<p>:ZERO:AUTO ONCE` on page 709 or manually, as described here.

1. In the "Power Sensor" menu (INPUT/OUTPUT > "Power Sensor"), press "Power Sensor Config" to display the configuration dialog box.
2. Select the tab that is assigned to the power sensor you want to zero.
3. Press the "Zeroing Power Sensor" button.
A dialog box is displayed that prompts you to disconnect all signals from the input of the power sensor.
4. Disconnect all signals from the input of the power sensor and press ENTER to continue.
5. Wait until zeroing is complete.

A corresponding message is displayed.

4.5.3 Configuring an External Power Trigger

Power Sensors can be used to trigger a measurement at a specified power level, e.g. from a signal generator.



Currently, only R&S NRP-Zxy power sensors are supported.

The power sensors can be connected to the "Power Sensor" interface directly, and no further cables are required. They can then be configured as an external trigger or a power sensor trigger. The measured power results are displayed as usual.



The previous connection and configuration of a power sensor as an external trigger is still supported. It is not necessary to change an existing trigger setup unless you want to evaluate the measured power results further.

Power Trigger Parameters

With the new implementation of the power sensor triggers some additional trigger parameters were introduced. The following figure illustrates the trigger parameters for an external power trigger.

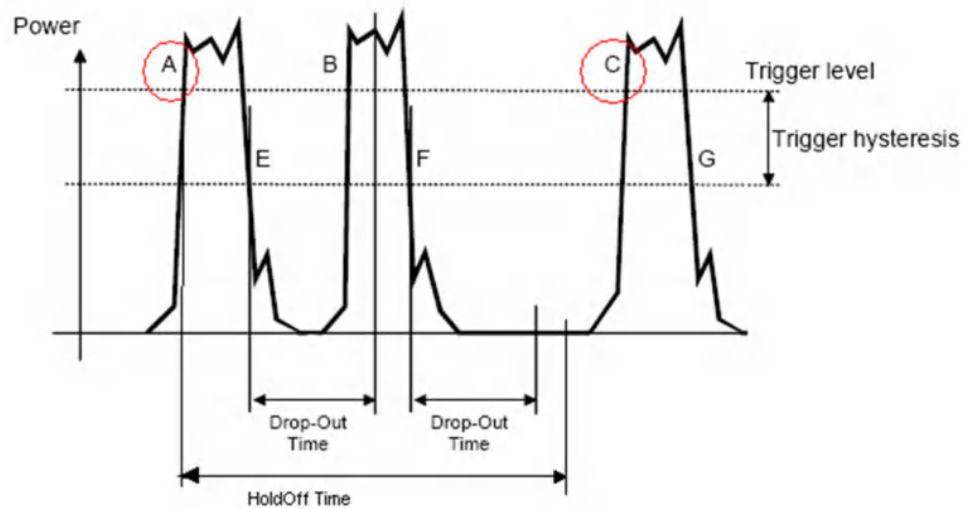

Fig. 4-26: Power Sensor Trigger Parameters

- **Level:** Power that triggers the measurement
- **Hysteresis:** Distance the input signal must stay below the trigger level before triggering again
- **Holdoff time:** Time which must pass before triggering again
- **Dropout time:** Time the input signal must stay below the trigger level before triggering again
- **Slope:** Direction of edge on which the trigger occurs (positive = rising, negative = falling)

Example:

In [Power Sensor Trigger Parameters](#), the events A and C are valid trigger events for triggering on a positive slope. The trigger level is exceeded and the dropout time and holdoff time have elapsed. For triggering on a negative slope, E and G are valid trigger events. B and F, however, are not valid trigger events: For B, the dropout time has not elapsed; for F, the holdoff time has not yet elapsed.

To configure a power sensor as an external power sensor (PSE) trigger

This is the way to configure a power sensor as an explicit power sensor trigger.

1. Connect the power sensor to the "Power Sensor" interface on the front panel of the R&S FSVR.
2. Configure the power sensor for use as described in [chapter 4.5.1, "Using Power Sensors"](#), on page 307.
3. Select the "External Power Trigger" option.
4. Enter the power level at which the measurement is to be triggered ("External Trigger Level").

5. Enter the minimum power difference that should occur between two trigger events ("Hysteresis").
6. Enter the minimum time that should pass between two trigger events ("Holdoff").
7. Enter the minimum time the signal should remain beneath the trigger level before the next trigger event occurs ("Dropout").
8. Select whether the measurement is triggered on a rising (positive) or falling (negative) edge ("Slope").
9. Press the TRIG key on the front panel of the instrument to display the "Trigger" menu.
10. Press the "Trg/Gate Source" softkey.
11. Select the "Power Sensor" softkey.
12. If necessary, configure the "Gate Settings" to define a gated sweep (see [chapter 4.1.9.3, "Using Gated Sweep Operation"](#), on page 116).



The "Gate Mode" *Lvl* is not supported for R&S power sensors. The trigger impulse sent by these sensors is not long enough to be used as a level for the gated sweep.

The R&S FSVR is configured to trigger when the defined conditions for the power sensor occur. Power measurement results are provided as usual.

4.5.4 Softkeys of the Power Sensor Menu (R&S FSV-K9)

The following table shows all softkeys available in the "Power Sensor" menu. It is possible that your instrument configuration does not provide all softkeys. If a softkey is only available with a special option, model or (measurement) mode, this information is delivered in the corresponding softkey description.

For details on how to configure and activate power sensors, see [chapter 4.5.1, "Using Power Sensors"](#), on page 307.

Power Sensor On/Off	311
Power Sensor Config	312
Power Sensor Assignment	312
Continuous Value Update	312

Power Sensor On/Off

Switches the power measurement for all power sensors on or off. Note that in addition to this general setting, each power sensor can be activated or deactivated individually in the "Power Sensor Configuration" dialog box (see ["Power Sensor Config"](#) on page 312). However, the general setting overrides the individual settings.

Remote command:

[SENSe:] PMETer<p> [: STATe] on page 838

Power Sensor Config

Opens the "Power Sensor Configuration" dialog box to configure up to 4 different power sensors. Each sensor configuration is displayed on a separate tab. The serial number of the power sensor connected to the instrument and currently assigned to the displayed configuration is indicated on the tab.

Power Sensor Assignment

Opens the "Power Sensor Assignment" dialog box to assign the connected power sensors to the configuration sets.

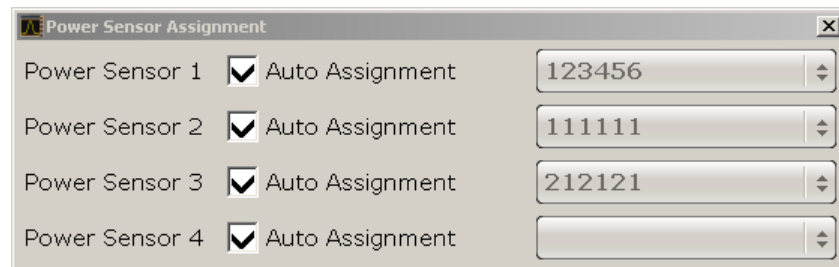

The detected serial numbers of the power sensors connected to the instrument are provided in a selection list. For each of the four available power sensor indexes ("Power Sensor 1"..."Power Sensor 4"), which correspond to the tabs in the configuration dialog, one of the detected serial numbers can be assigned. The physical sensor is thus assigned to the configuration setting for the selected power sensor index.

By default, serial numbers not yet assigned are automatically assigned to the next free power sensor index for which "Auto Assignment" is selected.

Alternatively, you can assign the sensors manually by deactivating the "Auto Assignment" option and selecting a serial number from the list.

Remote command:

[SYSTem:COMMunicate:RDEvice:PMETer<p>:DEFine](#) on page 887

[SYSTem:COMMunicate:RDEvice:PMETer<p>:CONFigure:AUTO\[:STATe\]](#)
on page 888

[SYSTem:COMMunicate:RDEvice:PMETer<p>:COUNT?](#) on page 888

Continuous Value Update

If activated, the power sensor data is updated continuously even after a single sweep has completed. For continuous sweeps this setting is irrelevant.

This function cannot be activated for individual sensors; if you change the setting for one sensor, it is automatically applied to all sensors.

If the power sensor is being used as a trigger (see ["Power Sensor"](#) on page 111), continuous update is not possible; this setting is ignored.

Remote command:

[\[SENSe:\] PMETer<p>:UPDate\[:STATe\]](#) on page 844

4.5.5 Power Sensor Configuration Dialog

Power sensors are configured in the "Power Sensor Configuration" dialog box, which is displayed when you select the "Power Sensor Config" softkey in the "Power Sensor" menu.

Up to 4 different power sensors can be configured. Each sensor configuration is displayed on a separate tab. The serial number of the power sensor connected to the instrument and currently assigned to the displayed configuration is indicated on the tab.



For details on how to configure and activate power sensors, see [chapter 4.5.1, "Using Power Sensors"](#), on page 307.

Select

If enabled, the power sensor is evaluated when power measurement is activated.

Remote command:

`[SENSe:] PMETer<p>[:STATe]` on page 838

Zeroing Power Sensor

Starts zeroing of the power sensor. For details on the zeroing process refer to [chapter 4.5.2, "Zeroing the Power Sensor"](#), on page 308 .

Remote command:

`CALibration:PMETer<p>:ZERO:AUTO ONCE` on page 709

Frequency Manual

The frequency of the signal to be measured. The power sensor has a memory with frequency-dependent correction factors. This allows extreme accuracy for signals of a known frequency.

Remote command:

[SENSe:] PMETer<p>:FREQuency on page 839

Frequency Coupling

If enabled, the frequency is coupled to the center frequency of the instrument or to the frequency of marker 1 automatically.

Remote command:

[SENSe:] PMETer<p>:FREQuency:LINK on page 839

Unit / Scale

Select the unit with which the measured power is to be displayed. Available units are dBm, dB, W and %.

If dB or % is selected, the display is relative to a reference value that is defined either by the measurement (**Meas -> Ref**) or the value in the **Reference Value** field.

Remote command:

UNIT<n>:PMETer<p>:POWer on page 920

UNIT<n>:PMETer<p>:POWer:RATIo on page 920

Meas Time / Average

Selects the measurement time or switches to manual averaging mode. In general, results are more precise with longer measurement times. The following settings are recommended for different signal types to obtain stable and precise results:

Short	Stationary signals with high power (> -40dBm), because they require only a short measurement time and short measurement time provides the highest repetition rates.
Normal	Signals with lower power or of modulated signals
Long	Signals at the lower end of the measurement range (<-50 dBm) or signals with lower power to minimize the influence of noise.
Manual	Switches to manual averaging mode. The average count is defined by the "Number of Readings" on page 315 value.

Remote command:

[SENSe:] PMETer<p>:MTIME on page 840

[SENSe:] PMETer<p>:MTIME:AVERage [:STATe] on page 840

Duty Cycle

Sets the duty cycle to a percentage for the correction of pulse-modulated signals and activates the duty cycle correction. If enabled, the sensor calculates the signal pulse power from this value and the mean power.

Remote command:

[SENSe:] PMETer<p>:DCYClE:STATe on page 838

[SENSe:] PMETer<p>:DCYClE:VALue on page 839

Meas -> Ref

Sets the currently measured power as a reference value for the relative display. The reference value can also be set manually via the [Reference Value](#) setting.

Remote command:

`CALCulate<n>:PMETer<p>:RELative[:MAGNitude]:AUTO ONCE` on page 691

Reference Value

Defines the reference value for relative measurements in the unit dBm.

Remote command:

`CALCulate<n>:PMETer<p>:RELative[:MAGNitude]` on page 690

Use Ref Level Offset

If activated, takes the reference level offset set for the analyzer ([Ref Level Offset](#) soft-key) into account for the measured power.

Remote command:

`[SENSe:] PMETer<p>:ROFFset[:STATe]` on page 841

Number of Readings

Defines the number of readings (averagings) to be performed after a single sweep has been started. This setting is only available if manual averaging is selected ([Meas Time / Average](#) setting).

The values for the average count range from 0 to 256 in binary steps (1, 2, 4, 8, ...).

For average count = 0 or 1, one reading is performed. The averaging and sweep count of the "Trace" menu are independent from this setting.

Results become more stable with extended averaging, particularly if signals with low power are measured. This setting can be used to minimize the influence of noise in the power sensor measurement.

Remote command:

`[SENSe:] PMETer<p>:MTIME:AVERage:COUNT` on page 841

External Power Trigger

Activates the creation of a trigger signal in the power sensor.

This option is only available in conjunction with a NRP-Z81, NRP-Z85 or NRP-Z86 power sensor.

For details see [figure 4-26](#).

When you select this option, the following settings in the configuration dialog become unavailable:

- Unit/Scale
- Reference Value
- Use Ref Lev Offset
- Number of Readings

The following trigger settings become available.

Remote command:

[\[SENSe:\] PMETer<p>:TRIGger\[:STATe\]](#) on page 842

Selecting this option causes the transmission of the following remote commands to the power sensor:

```
*RST
SENS: AVER: STAT OFF
TRIG: MAST: STAT ON
TRIG: SOUR INT
TRIG: SLOP POS
TRIG: DTIM 100e-6
INIT: CONT ON
```

External Trigger Level ← External Power Trigger

Defines the trigger level for the external power trigger.

Remote command:

[\[SENSe:\] PMETer<p>:TRIGger:LEVel](#) on page 843

Hysteresis ← External Power Trigger

Defines the value for the trigger hysteresis. The hysteresis in dB is the value the input signal must stay below the IF power trigger level in order to allow a trigger to start the measurement. The range of the value is between 3 dB and 50 dB with a step width of 1 dB.

Remote command:

[\[SENSe:\] PMETer<p>:TRIGger:HYSTeresis](#) on page 843

Holdoff ← External Power Trigger

Defines the holdoff value in s, which is the time which must pass before triggering, in case another trigger event happens.

Remote command:

[\[SENSe:\] PMETer<p>:TRIGger:HOLDoff](#) on page 842

Dropout ← External Power Trigger

Defines the time the input signal must stay below the IF power trigger level in order to allow a trigger to start the measurement. The range of the value is between 0 s and 1 s with a step width of 100 ns.

Remote command:

[\[SENSe:\] PMETer<p>:TRIGger:DTIME](#) on page 842

Slope ← External Power Trigger

Defines whether the sweep starts after a positive or negative edge of the trigger signal. The default setting is "Pos".

Remote command:

[\[SENSe:\] PMETer<p>:TRIGger:SLOPe](#) on page 844

4.5.6 Error Messages

Error messages are entered in the error/event queue of the status reporting system in the remote control mode and can be queried with the command `SYSTem:ERRor?`.

A short explanation of the device-specific error messages for R&S FSVR-K9 is given below.

Status bar message	Description
Zeroing could not be performed	Zeroing could not be performed because the RF power applied is too high.
Power sensor zero failed	

5 Using the Analog Demodulator

In addition to the realtime and spectrum modes, the R&S FSVR also provides a mode to perform analog demodulation measurements.

To start the analog demodulation measurement mode, press the MODE key and select the "Analog Demod" softkey in the corresponding menu. The R&S FSVR then opens a new tab that runs the realtime analyzer.

This chapter of the manual describes the functionality of the analog demodulation mode.

- [chapter 5.1, "About the Analog Demodulator"](#), on page 318 describes the overall instrument functions and provides further information
- [chapter 5.2, "Functions of the Analog Demodulator"](#), on page 334 shows all softkeys available when using the analog demodulator.
- All remote control commands available for the analog demodulator are part of [chapter 8.2, "Remote Control – Commands"](#), on page 547. They are labelled ADE-MOD.

5.1 About the Analog Demodulator

The digital signal processing in the R&S FSVR, used in the analyzer mode for digital IF filters, is also ideally suited for demodulating AM, FM, or PM signals. The firmware option analog demodulation provides the necessary measurement functions.

The R&S FSVR is equipped with a demodulator that is capable of performing AM, FM, and PM demodulation at a time. Additionally maximum, minimum and average or current values can be obtained parallel over a selected number of measurements.

By sampling (digitization) already at the IF and digital down-conversion to the base-band (I/Q), the demodulator achieves maximum accuracy and temperature stability. There is no evidence of typical errors of an analog down-conversion and demodulation like AM to FM conversion and vice versa, deviation error, frequency response or frequency drift at DC coupling.

5.1.1 Circuit Description – Block Diagrams

The software demodulator runs on the main processor of the analyzer. The demodulation process is shown in [figure 5-1](#) the figure below. All calculations are performed simultaneously with the same I/Q data set. Magnitude (= amplitude) and phase of the complex I/Q pairs are determined. The frequency result is obtained from the differential phase.

For details on the analyzer signal processing refer to the TRACe : IQ subsystem in the base unit.

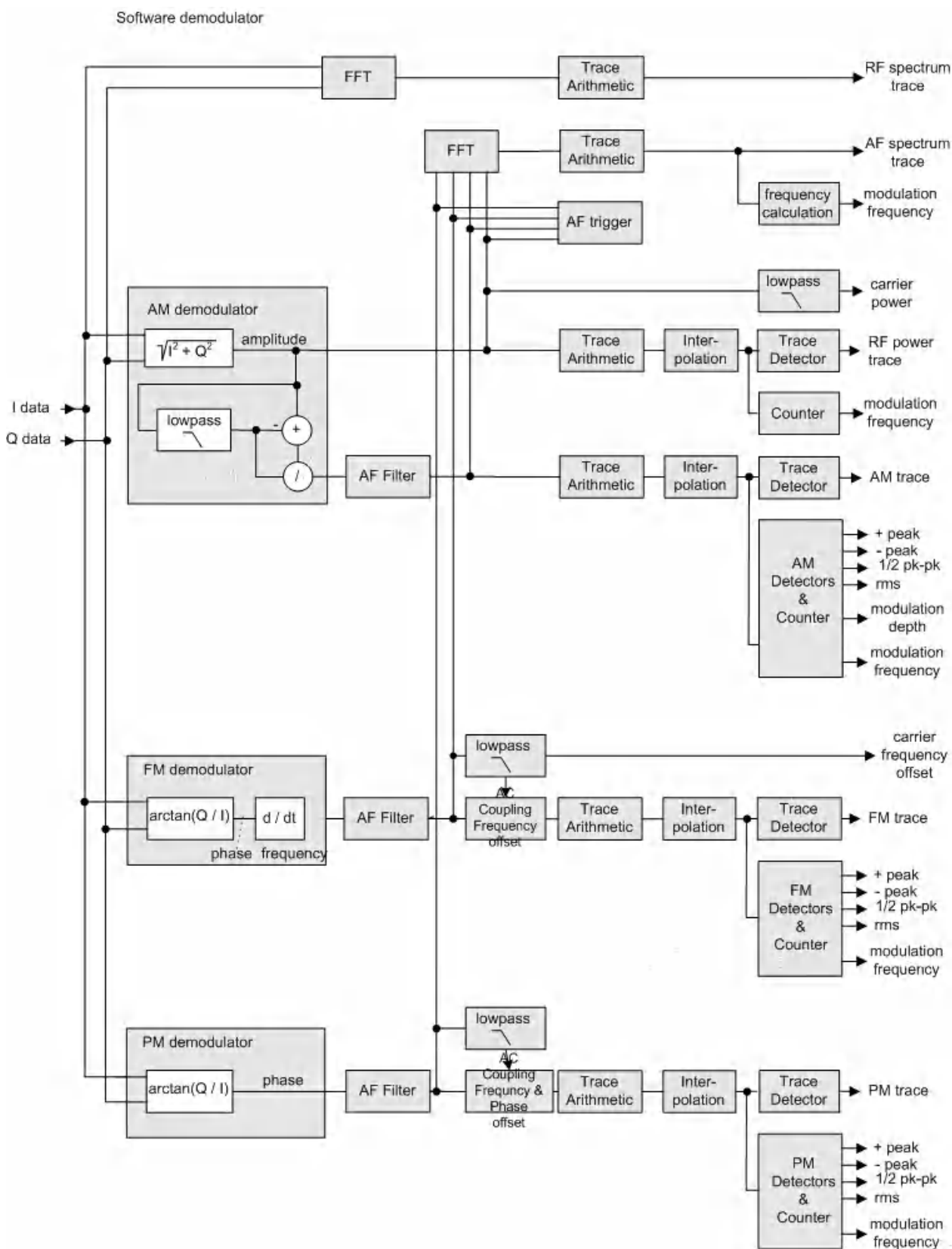

Fig. 5-1: Block diagram of software demodulator

The AM DC, FM DC and PM DC raw data of the demodulators is fed into the `Trace Arithmetic` block that combines consecutive data sets. Possible trace modes are: Clear Write, Max Hold, Min Hold and Average (for details refer to [chapter 4.1.8.4, "Trace Mode Overview"](#), on page 104. The output data of the `Trace Arithmetic` block can be read via remote control.

The collected measured values are evaluated by the selected detector (for details refer to [chapter 4.1.8.6, "Detector Overview"](#), on page 106. The result is displayed on the screen and can be read out via remote control.

In addition, important parameters are calculated:

- A counter determines the modulation frequency for AM, FM, and PM.
- average power = carrier power (RF power)
- average frequency = carrier frequency offset (FM)
- The modulation depth or the frequency or phase deviation is displayed.
- AC coupling is possible with FM and PM display. The deviations are determined from the trace data. +Peak, -Peak, ½ Peak-Peak and RMS are displayed.

5.1.2 Demodulation Bandwidth

The demodulation bandwidth is not the 3 dB bandwidth but the useful bandwidth which is distortion-free with regard to phase and amplitude.

Therefore the following formulas apply:

- AM: demodulation bandwidth $\geq 2 \times$ modulation frequency
- FM: demodulation bandwidth $\geq 2 \times$ (frequency deviation + modulation frequency)
- PM: demodulation bandwidth $\geq 2 \times$ modulation frequency $\times (1 + \text{phase deviation})$



If the center frequency of the analyzer is not set exactly to the signal frequency, the demodulation bandwidth must be selected larger by the carrier offset, in addition to the requirement described above. This also applies if FM or PM AC coupling has been selected.

In general, the demodulation bandwidth should be as narrow as possible to improve the S/N ratio. The residual FM caused by noise floor and phase noise increases dramatically with the bandwidth, especially with FM.

5.1.3 Configuring Traces

1. To open the trace wizard, press the TRACE key and then the "Trace Wizard" soft-key (see ["Trace Wizard"](#) on page 98).

Tip: Context-sensitive menus for traces. Traces have context-sensitive menus. If you right-click on a trace in the display or a trace setting in the information channel bar (or touch it for about 1 second), a menu is displayed which corresponds to the

softkey functions available for traces. This is useful, for example, when the softkey display is hidden.

If a menu entry contains an arrow to the right of it, a submenu is available for that entry.

To close the menu, press the ESC key or click in the display outside of the menu.

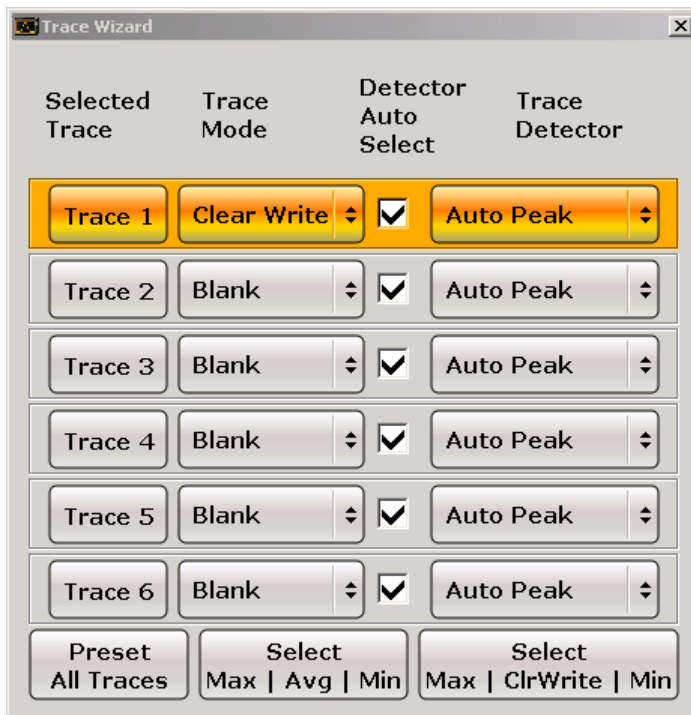

2. For each trace you can define the following settings:

Display Mode	<ul style="list-style-type: none"> • Clear Write • Max Hold • Min Hold • Average • View • Blank <p>For details see chapter 4.1.8.4, "Trace Mode Overview", on page 104.</p>
Detector Auto Select	Activates automatic detector selection (see Auto Select softkey). If activated, the "Trace Detector" setting is ignored.
Trace Detector	<p>Defines a specific trace detector. If one of the following settings is defined, the "Detector Auto Select" option is deactivated.</p> <ul style="list-style-type: none"> • "Auto Select" on page 96 • "Auto Peak" on page 97 • "Positive Peak" on page 97 • "Negative Peak" on page 97 • "Sample" on page 97 • "RMS" on page 97 • "Average" on page 97

3. To configure several traces to predefined display modes in one step, press the button for the required function:

Preset All Traces	Trace 1: Clear Write Trace 2-6: Blank
Select Max Avg Min	Trace 1: Max Hold Trace 2: Average Trace 3: Min Hold Trace 4-6: Blank
Select Max ClrWrite Min	Trace 1: Max Hold Trace 2: Clear Write Trace 3: Min Hold Trace 4-6: Blank

For details see [chapter 4.1.8.4, "Trace Mode Overview"](#), on page 104.

5.1.4 Trace Mode Overview

The traces can be activated individually for a measurement or frozen after completion of a measurement. Traces that are not activate are hidden. Each time the trace mode is changed, the selected trace memory is cleared.

The R&S FSVR offers 6 different trace modes:

Clear Write

Overwrite mode: the trace is overwritten by each sweep. This is the default setting.

All available detectors can be selected.

Remote command:

`DISP:TRAC:MODE WRIT`, see [DISPlay\[:WINDow<n>\]:TRACe<t>:MODE](#)
on page 716

Max Hold

The maximum value is determined over several sweeps and displayed. The R&S FSVR saves the sweep result in the trace memory only if the new value is greater than the previous one.

The detector is automatically set to "Positive Peak".

This mode is especially useful with modulated or pulsed signals. The signal spectrum is filled up upon each sweep until all signal components are detected in a kind of envelope.

This mode is not available for statistics measurements.

Remote command:

`DISP:TRAC:MODE MAXH`, see [DISPlay\[:WINDow<n>\]:TRACe<t>:MODE](#)
on page 716

Min Hold

The minimum value is determined from several measurements and displayed. The R&S FSVR saves the smallest of the previously stored/currently measured values in the trace memory.

The detector is automatically set to "Negative Peak".

This mode is useful e.g. for making an unmodulated carrier in a composite signal visible. Noise, interference signals or modulated signals are suppressed whereas a CW signal is recognized by its constant level.

This mode is not available for statistics measurements.

Remote command:

DISP:TRAC:MODE MINH, see [DISPlay\[:WINDow<n>\]:TRACe<t>:MODE](#) on page 716

Average

The average is formed over several sweeps. The [Sweep Count](#) determines the number of averaging procedures.

All available detectors can be selected. If the detector is automatically selected, the sample detector is used (see [chapter 4.1.8.6, "Detector Overview"](#), on page 106).

This mode is not available for statistics measurements.

Remote command:

DISP:TRAC:MODE AVER, see [DISPlay\[:WINDow<n>\]:TRACe<t>:MODE](#) on page 716

View

The current contents of the trace memory are frozen and displayed.

Note: If a trace is frozen, the instrument settings, apart from level range and reference level (see below), can be changed without impact on the displayed trace. The fact that the displayed trace no longer matches the current instrument setting is indicated by the  icon on the tab label.

If the level range or reference level is changed, the R&S FSVR automatically adapts the measured data to the changed display range. This allows an amplitude zoom to be made after the measurement in order to show details of the trace.

Remote command:

DISP:TRAC:MODE VIEW, see [DISPlay\[:WINDow<n>\]:TRACe<t>:MODE](#) on page 716

Blank

Hides the selected trace.

Remote command:

DISP:TRAC OFF, see [DISPlay\[:WINDow<n>\]:TRACe<t>\[:STATe\]](#) on page 715

5.1.5 AF Trigger

The analog demodulation option allows triggering to the demodulated signal. The display is stable if a minimum of five modulation periods are within the recording time.

Triggering is always DC-coupled. Therefore triggering is possible directly to the point where a specific carrier level, phase or frequency is exceeded or not attained.

5.1.6 Stability of Measurement Results

Despite amplitude and frequency modulation, the display of carrier power and carrier frequency offset is stable.

This is achieved by a digital filter which sufficiently suppresses the modulation, provided, however, that the measurement time is $\geq 3 \times 1 / \text{modulation frequency}$, i.e. that at least three periods of the AF signal are recorded.

The mean carrier power for calculating the AM is also calculated with a digital filter that returns stable results after a measurement time of $\geq 3 \times 1 / \text{modulation frequency}$, i.e. at least three cycles of the AF signal must be recorded before a stable AM can be shown.

5.1.7 Detector Overview

The measurement detector for the individual display modes can be selected directly by the user or set automatically by the R&S FSVR. The detector activated for the specific trace is indicated in the corresponding trace display field by an abbreviation.

The detectors of the R&S FSVR are implemented as pure digital devices. They collect signal power data within each measured point during a sweep. The default number of sweep points is 691. The following detectors are available:

Table 5-1: Detector types

Detector	Indicator	Function
Auto Peak	Ap	Determines the maximum and the minimum value within a measurement point (not available for SEM)
Positive Peak	Pk	Determines the maximum value within a measurement point
Negative Peak (min peak)	Mi	Determines the minimum value within a measurement point
RMS	Rm	Determines the root mean square power within a measurement point
Average	Av	Determines the linear average power within a measurement point
Sample	Sa	Selects the last value within a measurement point

The result obtained from the selected detector within a measurement point is displayed as the power value at this measurement point.

All detectors work in parallel in the background, which means that the measurement speed is independent of the detector combination used for different traces.



Number of measured values

During a frequency sweep, the R&S FSVR increments the first local oscillator in steps that are smaller than approximately 1/10 of the bandwidth. This ensures that the oscillator step speed is conform to the hardware settling times and does not affect the precision of the measured power.

The number of measured values taken during a sweep is independent of the number of oscillator steps. It is always selected as a multiple or a fraction of 691 (= default number of trace points displayed on the screen). Choosing less than 691 measured values (e.g. 125 or 251) will lead to an interpolated measurement curve, choosing more than 691 points (e.g. 1001, 2001 ...) will result in several measured values being overlaid at the same frequency position.



RMS detector and VBW

If the RMS detector is selected, the video bandwidth in the hardware is bypassed. Thus, duplicate trace averaging with small VBWs and RMS detector no longer occurs. However, the VBW is still considered when calculating the sweep time. This leads to a longer sweep time for small VBW values. Thus, you can reduce the VBW value to achieve more stable trace curves even when using an RMS detector. Normally, if the RMS detector is used the sweep time should be increased to get more stable trace curves.

5.1.8 Sample Rate, Measurement Time and Trigger Offset

Depending on the sample rate, the maximum demodulation bandwidths listed in the table can be obtained during the measurement. The permissible value range of the measurement time and trigger offset depends on the selected demodulation bandwidth and demodulation filter. If the AF filter or the AF trigger are not active, the measurement time increases by 20 %.



Option K7S

The K7S option always uses the demodulation bandwidth 400 kHz.

Table 5-2: Sample Rate, Measurement Time and Trigger Offset using a flat demodulation filter

Demod. band-width	Sample rate	Measurement time		Trigger offset	
		Min.	Max.	Min.	Max.
160 MHz ¹⁾	200 MHz	5 ns	8 ms	-8 ms	1.0486 s
80 MHz ²⁾	128 MHz	7.8125 ns	12.5 ms	-12.5 ms	1.6384 s
40 MHz ²⁾	64 MHz	15.625 ns	25 ms	-25 ms	3.2768 s
28 MHz	64 MHz	15.625 ns	25 ms	-25 ms	3.2768 s
18 MHz	32 MHz	31.25 ns	50 ms	-50 ms	6.5536 s
10 MHz	32 MHz	31.25 ns	50 ms	-50 ms	6.5536 s
8 MHz	16 MHz	62.5 ns	100 ms	-100 ms	13.1072 s

Demod. band-width	Sample rate	Measurement time		Trigger offset	
		Min.	Max.	Min.	Max.
5 MHz	8 MHz	125 ns	200 ms	-200 ms	26.2144 s
3 MHz	4 MHz	250 ns	400 ms	-400 ms	52.4288 s
1.6 MHz	2 MHz	500 ns	800 ms	-800 ms	104.8576 s
800 kHz	1 MHz	1 µs	1.6 s	-1.6 s	209.7152 s
400 kHz	500 kHz	2 µs	3.2 s	-3.2 s	419.4304 s
200 kHz	250 kHz	4 µs	6.4 s	-6.4 s	838.8608 s
100 kHz	125 kHz	8 µs	12.8 s	-12.8 s	1677.7216 s
50 kHz	62.5 kHz	16 µs	25.6 s	-25.6 s	3355.4432 s
25 kHz	31.25 kHz	32 µs	51.2 s	-51.2 s	6710.8864 s
12.5 kHz	15.625 kHz	64 µs	102.4 s	-102.4 s	13421.7728 s
6.4 kHz	7.8125 kHz	128 µs	204.8 s	-204.8 s	26843.5456 s
3.2 kHz	3.90625 kHz	256 µs	409.6 s	-409.6 s	53687.0912 s
1.6 kHz	1.953125 kHz	512 µs	819.2 s	-819.2 s	107374.1824 s
800 Hz	976.5625 Hz	1.024 ms	1638.4 s	-1638.4 s	214748.3648 s
400 Hz	488.28125 Hz	2.048 ms	3276.8 s	-3276.8 s	429496.7296 s
200 Hz	244.140625 Hz	4.096 ms	6553.6 s	-6553.6 s	858993.4592 s
100 Hz	122.0703125 Hz	8.192 ms	13107.2 s	-13107.2 s	1717986.918 s
¹⁾ only available with option B160 ²⁾ only available with option B70					

Table 5-3: Sample Rate, Measurement Time and Trigger Offset using a Gaussian demodulation filter

Demod. band-width	Sample rate	Measurement time		Trigger offset	
		Min.	Max.	Min.	Max.
28 MHz ¹⁾	112 MHz	8.929 ns	14.28 ms	-14.28	1.872457134 s
18 MHz ¹⁾	72 MHz	13.88 ns	22.22 ms	-22.22 ms	2.912711097 s
10 MHz	40 MHz	25 ns	40 ms	-40 ms	5,242879975 s
8 MHz	32 MHz	31.25 ns	50 ms	-50 ms	6.553599969 s
5 MHz	12 MHz	83.33 ns	133.3 ms	-80 ms	10,48575995 s
3 MHz	10.666 MHz	93.75 ns	150 ms	-133.3 ms	17,47626667 s
1.6 MHz	6.4 MHz	156.25 ns	250 ms	-250 ms	32.76799984 s
800 kHz	3.2 MHz	312.5 ns	5 ms	-5 ms	65.53599969 s
¹⁾ gaussian filter curve is limited by IQ bandwidth					

Demod. band-width	Sample rate	Measurement time		Trigger offset	
		Min.	Max.	Min.	Max.
400 kHz	1.6 MHz	625 ns	1 s	-1 s	131.0719994 s
200 kHz	800 kHz	1.25 us	2 s	-2 s	262.1439988 s
100 kHz	400 kHz	2.5 us	4 s	-4 s	524.2879975 s
50 kHz	200 kHz	5 us	8 s	-8 s	1048.575995 s
25 kHz	100 kHz	10 us	16 s	-16 s	2097.15199 s
12.5 kHz	50 kHz	20 us	32 s	-32 s	4194.30398 s
6.4 kHz	25.6 kHz	39.0625 us	62.5 s	-62.5 s	8191.999961 s
3.2 kHz	12.8 kHz	78.125 us	125 s	-125 s	16383.99992 s
1.6 kHz	6.4 kHz	156.25 us	250 s	-250 s	32767.99984 s
800 Hz	3.2 kHz	312.5 us	500 s	-500 s	65535.99969 s
400 Hz	1.6 kHz	625 us	1000 s	-1000 s	131071.9994 s
200 Hz	800 Hz	1.25 ms	2000 s	-2000 s	262143.9988 s
100 Hz	400 Hz	2.5 ms	4000 s	-4000 s	524287.9975 s

¹⁾ gaussian filter curve is limited by IQ bandwidth

Large numbers of samples

Principally, the R&S FSVR can handle up to 1.6 million samples. However, when 480 001 samples are exceeded, all traces that are not currently being displayed on a screen are deactivated to improve performance. The traces can only be activated again when the samples are reduced.

5.1.9 Measurement Result Display

In Analog Demodulation mode, the measurement results can be displayed in up to 4 different screens (windows), plus an additional marker table, if applicable. Each screen shows either the measurement results as a diagram or the results of evaluation functions in a table ("Result Summary").

All displays are determined by the I/Q data set recorded for the measurement.

You can define the display configuration for up to 4 different screens at once using the ["Display Config"](#) on page 336 softkey.

Screen configuration

For each screen you can define:

- **Off:** Whether it is displayed or not
- **Summary:** Whether a result summary for all screens is displayed instead of a diagram

- **AM/FM/PM/RF Diagrams:** Which type of diagram is displayed

Diagram types

The following diagram types can be selected for display.

- **AM/FM/PM Time Domain**
Selects the AF display in zero span, calculated from the AM, FM, or PM signal.

SCPI command:

```
CALC:FEED 'XTIM:FM' (see CALCulate<n>:FEED on page 705)
```

Displays the demodulated FM signal from trace 1 in screen A.

- **AM/FM/PM Spectrum**
Selects the display of the AF spectrum. The AF spectrum can be calculated from the AM, FM, or PM signal in zero span.

SCPI command:

```
DISP:WIND2:SEL
```

Sets the focus on screen B.

```
CALC2:FEED 'XTIME:FM:AFSPektrum2' (see CALCulate<n>:FEED on page 705)
```

Displays an AF spectrum diagram of the demodulated FM signal from trace 2 in screen B.

- **RF Time Domain**
Selects the display of the RF power in zero span. In contrast to normal analyzer operation, the level values are the magnitude of the I/Q data set.

SCPI command:

```
CALC:FEED 'XTIM:RFP' (see CALCulate<n>:FEED on page 705)
```

- **RF Spectrum**
Selects the display of the RF signal in span > 0. In contrast to normal spectrum analyzer operation, the measured values are determined using FFT from the recorded I/Q data set.

SCPI command:

```
CALC:FEED 'XTIM:SPECTRUM' (see CALCulate<n>:FEED on page 705)
```

Diagram header information

For each diagram, the header provides the following information:

```
A(FM) ● 1AP Clrw Ref:0.00 Hz DC
1 2 3 4 5 6 7 8
```

1. Screen A/B/C/D
2. Modulation type
3. Trace color

4. Trace number
5. Detector
6. Trace mode
7. Reference value
8. AF coupling (AC/DC), only in AF time domains, if applicable

Result Summary

The result summary displays the results of the evaluation functions for all channels in a table.

D Result Summary							
Carrier Power: -30.00 dBm				Carrier Offset: -1.08 Hz			
	+Peak	-Peak	±Peak/2	RMS	Mod Freq	SINAD	THD
FM	113.87 kHz	-114.06 kHz	113.96 kHz	71.052 kHz	99.999 kHz	54.479 dB	-61.820 dB
PM	1.0028 rad	-1.0024 rad	1.0026 rad	707.15 mrad	99.999 kHz	---	---



Summaries that take up the entire width of the screen are displayed as tables; if only half the screen width is available (2 windows next to each other), the summary is displayed as a list. Thus, the factory-set predefined screen configurations contain only 3 screens: 2 for diagrams and one full-width screen for the summary.

For each channel, the following information is provided:

Label	Description
+Peak	Positive peak (maximum)
-Peak	Negative peak (minimum)
+/-Peak/2	Average of positive and negative peaks
RMS	Root Mean Square value
Mod Freq	Modulation frequency

Label	Description
SINAD	<p>Signal-to-noise and distortion</p> <p>Measures the ratio of the total power to the power of noise and harmonic distortions. The noise and harmonic power is calculated inside the AF spectrum span. The DC offset is removed before the calculation.</p> $SINAD[dB] = 20 \cdot \log \left[\frac{\text{total power}}{\text{noise + distortion power}} \right]$
THD	<p>Total harmonic distortion</p> <p>The ratio of the harmonics to the fundamental and harmonics. All harmonics inside the AF spectrum span are considered up to the tenth harmonic.</p> $THD[dB] = 20 \cdot \log \left[\frac{\sqrt{\sum_{i=2}^{\infty} U_i^2}}{\sqrt{\sum_{i=1}^{\infty} U_i^2}} \right]$

In addition, the following general information for the input signal is provided:

- Carrier Power
- Carrier Offset
- Modulation Depth

5.1.10 Measurement Result Display (FM Stereo)

In FM Stereo mode, the measurement results can be displayed in up to 4 different screens (windows), plus an additional marker table, if applicable. Each screen shows either the measurement results as a diagram or the results of evaluation functions in a table ("Result Summary").

All displays are determined by the I/Q data set recorded for the measurement.

You can define the display configuration for up to 4 different screens at once using the "Display Config" on page 390 softkey.

Screen configuration

For each screen you can define:

- **Off:** Whether it is displayed or not
- **Summary:** Whether a result summary for all screens is displayed instead of a diagram
- **RF Diagrams:** Whether an RF diagram is displayed; these displays correspond to those for Analog Demodulation mode (R&S FSVR-K7, see [chapter 5.1.9, "Measurement Result Display"](#), on page 327)

- **FM Stereo Diagrams:** For which channel a time domain or spectrum diagram is displayed

Diagram types

The following diagram types can be selected for display.

- **RF Time Domain**
Selects the display of the RF power in zero span. In contrast to normal analyzer operation, the level values are the magnitude of the I/Q data set.

SCPI command:

`CALC:FEED 'XTIM:RFP'` (see `CALCulate<n>:FEED` on page 705)

- **RF Spectrum**
Selects the display of the RF signal in span > 0. In contrast to normal spectrum analyzer operation, the measured values are determined using FFT from the recorded I/Q data set.

SCPI command:

`CALC:FEED 'XTIM:SPECTRUM'` (see `CALCulate<n>:FEED` on page 705)

- **<FM Stereo Channel Type> Time Domain**
Selects the display of the channel power in zero span. In contrast to normal analyzer operation, the level values are the magnitude of the I/Q data set.

SCPI command:

`CALC:FEED 'XTIM:SFM:<ChannelType>'`, e.g. `CALC:FEED 'XTIM:SFM:LEFT'` (see `CALCulate<n>:FEED` on page 705)

- **<FM Stereo Channel Type> Spectrum**
Selects the display of the channel signal in span > 0. In contrast to normal spectrum analyzer operation, the measured values are determined using FFT from the recorded I/Q data set.

SCPI command:

`CALC:FEED 'XFR:SFM:<ChannelType>'`, e.g. `CALC:FEED 'XFR:SFM:LEFT'` (see `CALCulate<n>:FEED` on page 705)

Diagram header information

For each diagram, the header provides the following information:

A(Right) 1AP Clrw Ref:0.00 Hz

1 2 3 4 5 6 7

1. Screen A/B/C/D
2. Channel type
3. Trace color
4. Trace number

5. Detector
6. Trace mode
7. Reference value

Diagram footer information

In addition to the used frequency and span information, the diagram footer also indicates the used weighting filter, if any, in FM stereo mode.

Result Summary

The result summary displays the results of the evaluation functions for all channels in a table.

D Result Summary							
Carrier Power: -30.00 dBm		Carrier Freq: 15.0 GHz			Ref Deviation: 54.305 kHz		
Gross Talk: -2.87 dB							
	Detector	Result Mode	Dev.	Rel. to Ref.	Mod. Freq.	SINAD	THD
Left	±Peak/2	Clear Write	54.305 kHz	0.00 dB	1.0000 kHz	70.88 dB	-92.99 dB
Right	±Peak/2	Clear Write	39.010 kHz	-2.87 dB	3.0000 kHz	67.95 dB	-97.02 dB
MPX	±Peak/2	Clear Write	73.596 kHz	2.64 dB	3.0000 kHz	1.98 dB	-85.42 dB
Mono	±Peak/2	Clear Write	36.336 kHz	-3.49 dB	1.0000 kHz	4.68 dB	-4.68 dB
Stereo	±Peak/2	Clear Write	63.823 kHz	1.40 dB	3.0000 kHz		
RDS	±Peak/2	Clear Write	2.046 kHz	-28.48 dB			
Pilot	±Peak/2	Clear Write	7.508 kHz	-17.19 dB	19.000 kHz		



Summaries that take up the entire width of the screen are displayed as tables; if only half the screen width is available (2 windows next to each other), the summary is displayed as a list. Thus, the factory-set predefined screen configurations contain only 3 screens: 2 for diagrams and one full-width screen for the summary.

For each channel, the following information is provided:

Label	Description
Detector	Selected detector type
Result Mode	Selected result mode
Dev.	Deviation
Rel. to Ref.	Relative to reference
Mod. Freq.	Modulation frequency

Label	Description
SINAD	<p>Signal-to-noise and distortion</p> <p>Measures the ratio of the total power to the power of noise and harmonic distortions. The noise and harmonic power is calculated inside the AF spectrum span. The DC offset is removed before the calculation.</p> $SINAD[dB] = 20 \cdot \log \left[\frac{\text{total power}}{\text{noise + distortion power}} \right]$
THD	<p>Total harmonic distortion</p> <p>The ratio of the harmonics to the fundamental and harmonics. All harmonics inside the AF spectrum span are considered up to the tenth harmonic.</p> $THD[dB] = 20 \cdot \log \left[\frac{\sqrt{\sum_{i=2}^{\infty} U_i^2}}{\sqrt{\sum_{i=1}^{\infty} U_i^2}} \right]$

In addition, the following general information for the input signal is provided:

- Carrier Power
- Carrier Frequency
- Reference Deviation
- Cross Talk (difference between left and right signal in dB), see also [CALCulate<n>:MARKer:FUNCTION:SFM:<ChannelType>\[:RESult<m>\]?](#) on page 682)

5.1.11 ASCII File Export Format

The data of the file header consist of three columns, each separated by a semicolon: parameter name; numeric value; basic unit. The data section starts with the keyword "Trace <n>" (<n> = number of stored trace), followed by the measured data in one or several columns (depending on measurement) which are also separated by a semicolon.

File contents: header and data section	Description
Type;FSVR;	
Version;1.45;	
Date;01.Apr 2010;	Date of data set storage
Screen;A;	Instrument mode
Points per Symbol;4;	Points per symbol
x Axis Start;-13;sym;	Start value of the x axis
x Axis Stop;135;sym;	Stop value of the x axis

File contents: header and data section	Description
Ref value y axis;-10.00;dBm;	Y axis reference value
Ref value position;100;%;	Y axis reference position
Trace;1;	Trace number
Meas;Result;	Result type
Meas Signal;Magnitude;	Result display
Demodulator;Offset QPSK;	Demodulation type
ResultMode;Trace;	Result mode
x unit;sym;	Unit of the x axis
y unit;dBm;	Unit of the y axis
Trace Mode;Clear Write;	Trace mode
Values;592;	Number of results
<values>	List of results

5.2 Functions of the Analog Demodulator

This section provides information on the analog demodulation parameters and settings and its softkey menus. All menus not described here are provided as described for the base unit.

5.2.1 Softkeys of the Analog Demodulation Menu

The following table shows all softkeys available in the "Analog Demod" menu.

AM.....	336
L Display Config.....	336
L Screen A-D.....	336
L Predefined.....	337
L Add.....	337
L Apply.....	337
L Remove.....	337
L Restore.....	338
L Select Trace.....	338
L Demod BW.....	338
L Meas Time.....	338
L AF Filter.....	338
L High Pass.....	338
L Low Pass.....	339
L Weighting.....	339
L None.....	339
L CCITT.....	339
L CCIR Unweighted.....	340

L CCIR Weighted.....	340
L A Weighted.....	340
L Deemphasis.....	340
L All AF Filter Off.....	341
L AF Range.....	341
L Dev per Division.....	341
L Reference Position.....	341
L Reference Value.....	342
L AF Coupling AC/DC.....	342
L Deviation Lin/Log.....	343
L Unit.....	343
L Phase Unit (Rad/Deg).....	343
L THD Unit (% / DB).....	343
L Abs. Dev Unit (kHz/dBm).....	343
L Rel. Dev Unit (dB / %).....	343
L Time Domain Zoom.....	343
L State On / Off.....	343
L Start.....	344
L Length Manual.....	344
L Length Auto.....	344
L Squelch.....	344
L Squelch Level.....	344
FM.....	344
L Display Config.....	344
L Select Trace.....	344
L Demod BW.....	345
L Meas Time.....	345
L AF Filter.....	345
L AF Range.....	345
L Time Domain Zoom.....	345
L Squelch.....	345
L Squelch Level.....	345
PM.....	345
L Display Config.....	345
L Select Trace.....	345
L Demod BW.....	345
L Meas Time.....	345
L AF Filter.....	345
L AF Range.....	345
L Time Domain Zoom.....	346
L Squelch.....	346
L Squelch Level.....	346
L Zero Phase Reference Point.....	346
L Phase Wrap On/Off.....	346
RF Power.....	346
L Display Config.....	346
L Select Trace.....	346
L Demod BW.....	346
L Meas Time.....	347
L AF Filter.....	347

- L AF Range.....347
- L Time Domain Zoom..... 347
- L Squelch..... 347
- L Squelch Level..... 347
- Display Config..... 347

AM

Selects AM as the modulation type, changes the signal display, and opens a submenu to set the measurement configuration.

In single sweep mode, the data is determined from the current I/Q data set, i.e. a change to a different type does not trigger a new measurement.

This menu is also displayed when you press the MEAS CONFIG key after changing the modulation type.

Remote command:

CALC:FEED 'XTIM:AM' (see CALCulate<n>:FEED on page 705)

Display Config ← AM

You configure the display settings for the results in the "Display Configuration" dialog box. This dialog box contains the following tabs:

- "Screen A-D": a separate tab for each of the four available screens
- "Predefined": for predefined display configurations

Screen A-D ← Display Config ← AM

For each of the four available screens you can configure what is to be displayed. To define the result display configuration for a screen, select the corresponding tab. For each screen you can define:

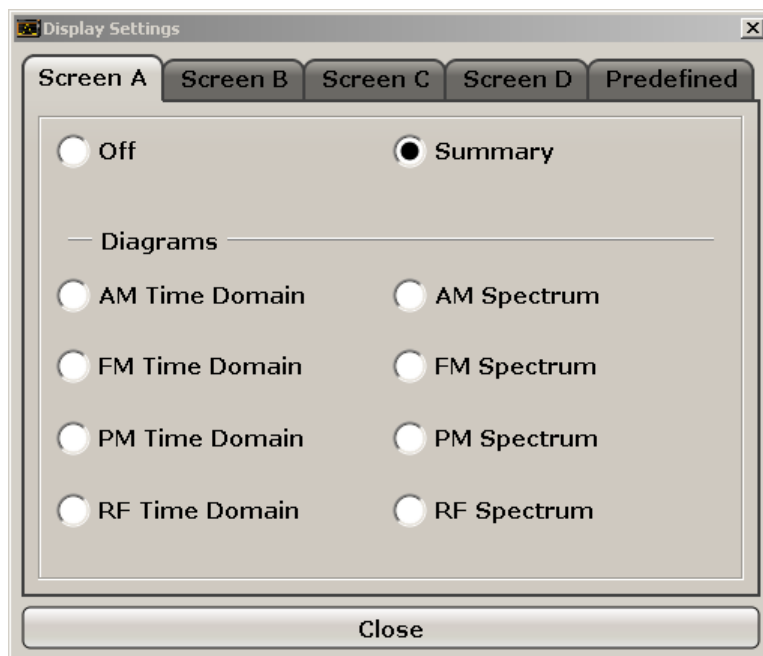

- **Off**: Whether it is displayed or not

- **Summary:** Whether a summary of the evaluation lists from all screens is displayed instead of a diagram
- **AM/FM/PM/RF Diagrams:** Which type of diagram is displayed
For details on the result diagram types, see [chapter 5.1.9, "Measurement Result Display"](#), on page 327.

Note: By default, the diagram or summary displays the data from trace 1. To change the trace, use the [Select Trace](#) softkey.

Remote command:

DISP:WIND2:STAT ON (see [DISPlay\[:WINDow<n>\]:STATe](#) on page 721)

Displays second window (Screen B).

CALC2:FEED 'XTIME:FM:AFSPektrum1' (see [CALCulate<n>:FEED](#) on page 705)

Displays an AF spectrum diagram of the demodulated FM signal from trace 1 in screen B.

Predefined ← Display Config ← AM

You can store and load predefined screen configurations. All available configurations are displayed in the "Predefined" tab. The current screen configuration is indicated under "Current" at the top of the list.

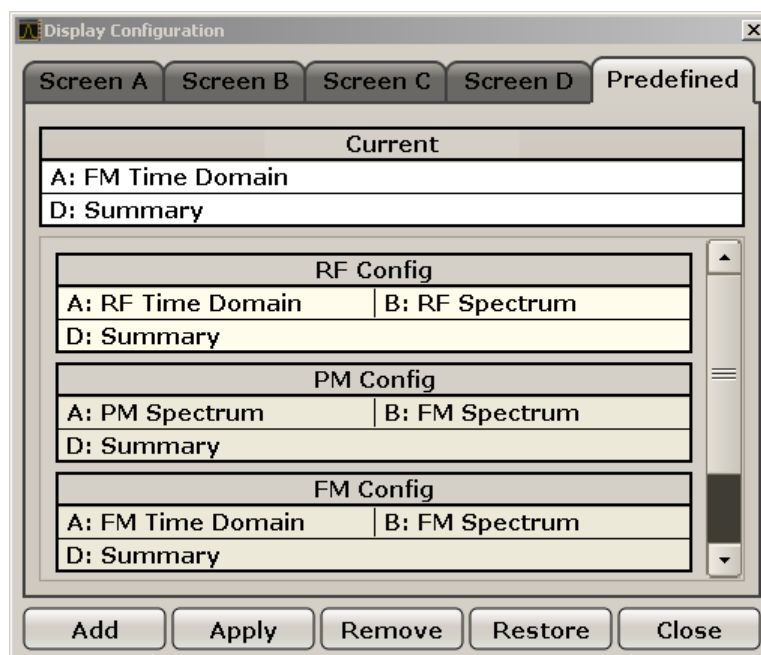

Add ← Predefined ← Display Config ← AM

Opens an edit dialog box to enter a name for the current screen configuration. The configuration is then stored and added to the list.

Apply ← Predefined ← Display Config ← AM

Applies the currently selected configuration from the list to the current display.

Remove ← Predefined ← Display Config ← AM

Removes the currently selected configuration from the list.

Restore ← Predefined ← Display Config ← AM

Restores the default display configurations. Existing configurations with the default names are replaced.

Select Trace ← AM

Opens an edit dialog box to enter the number of the trace for which the data is to be displayed in the currently selected screen. Only activated traces can be selected.

Demod BW ← AM

Opens an edit dialog box to enter the demodulation bandwidth of the analog demodulation. The demodulation bandwidth determines the sampling rate for recording the signal to be analyzed. For details on the relation between demodulation bandwidth and sampling rate refer to [chapter 5.1.8, "Sample Rate, Measurement Time and Trigger Offset"](#), on page 325.

Remote command:

[\[SENSe:\]BANDwidth|BWIDth:DEMod](#) on page 781

Meas Time ← AM

Opens an editor for entering the measurement time of the analog demodulation. For details on the measurement time values refer to [chapter 5.1.8, "Sample Rate, Measurement Time and Trigger Offset"](#), on page 325.

Note: For FM Stereo measurements (option K7S), the minimum measurement time is 2 ms.

Remote command:

[\[SENSe:\]ADEMod:MTIME](#) on page 764

AF Filter ← AM

The bandwidth of the demodulated signal can be reduced by high pass or low pass filters and also a de-emphasis can be switched on. The selected filters are used for AM, FM and PM demodulation in common. Individual settings are not possible.

High Pass ← AF Filter ← AM

Opens the "High Pass" selection list to switch on a high pass filter with the given limit to separate the DC component. The filters are indicated by the 3 dB cutoff frequency. The 50 Hz and 300 Hz filters are designed as 2nd-order Butterworth filter (12 dB/octave). The 20 Hz filter is designed as 3rd-order Butterworth filter (18 dB/octave).

"None" deactivates the AF high pass filter. Default is "None".

The high pass filters are active in the following demodulation bandwidth range:

20 Hz	100 Hz ≤ demodulation bandwidth ≤ 1.6 MHz
50 Hz:	200 Hz ≤ demodulation bandwidth ≤ 3 MHz
300 Hz:	800 Hz ≤ demodulation bandwidth ≤ 8 MHz
Note: for FM stereo (K7S), all filters are active at all times, as the demodulation range is always 400 kHz	

Remote command:

[\[SENSe:\]FILTer<n>:HPASs\[:STATe\]](#) on page 805

[\[SENSe:\]FILTer<n>:HPASs:FREQuency](#) on page 806

Low Pass ← AF Filter ← AM

Opens the "Low Pass" selection list to select the filter type. Relative and absolute low pass filter are available.

- Absolute low pass filters:
The 3 kHz, 15 kHz; 23 kHz and 150 kHz softkeys switch on a absolute low pass filter. The filters are indicated by the 3 dB cutoff frequency. The 3 kHz, 15 kHz and 23 kHz filters are designed as 5th-order Butterworth filters (30 dB/octave). The 150 kHz filter is designed as 8th-order Butterworth filter (48 dB/octave).
The absolute low pass filters are active in the following demodulation bandwidth range:

3 kHz:	$6.4 \text{ kHz} \leq \text{demodulation bandwidth} \leq 3 \text{ MHz}$
15 kHz:	$50 \text{ kHz} \leq \text{demodulation bandwidth} \leq 8 \text{ MHz}$
23 kHz	$50 \text{ kHz} \leq \text{demodulation bandwidth} \leq 18 \text{ MHz}$
150 kHz:	$400 \text{ kHz} \leq \text{demodulation bandwidth} \leq 8 \text{ MHz}$
Note: for FM stereo (K7S), all filters are active at all times, as the demodulation range is always 400 kHz	

- Relative low pass filters:
The filters (3 dB) can be selected in % of the demodulation bandwidth. The filters are designed as 5th-order Butterworth filter (30 dB/octave) and active for all demodulation bandwidths.
- "None" deactivates the AF low pass filter. Default is "None".

Remote command:

[\[SENSe:\] FILTer<n>:LPASs\[:STATe\]](#) on page 806

[\[SENSe:\] FILTer<n>:LPASs:FREQuency\[:ABSolute\]](#) on page 807

[\[SENSe:\] FILTer<n>:LPASs:FREQuency:RELative](#) on page 807

SFM:

[\[SENSe:\] SFM:<ChannelType>:FILTer:LPASs:STATe](#) on page 861

[\[SENSe:\] SFM:<ChannelType>:FILTer:LPASs:FREQuency](#) on page 861

Weighting ← AF Filter ← AM

Opens the "Weighting" selection list to select the weighting AF filter.

None ← Weighting ← AF Filter ← AM

Deactivates the weighting filter. This is the default setting.

Remote command:

[\[SENSe:\] FILTer<n>:HPASs\[:STATe\]](#) on page 805

CCITT ← Weighting ← AF Filter ← AM

Switches on a CCITT P.53 weighting filter. The weighting filter is active in the following demodulation bandwidth range:

$20 \text{ kHz} \leq \text{demodulation bandwidth} \leq 3 \text{ MHz}$

For FM stereo (K7S), the filter is active at all times, as the demodulation range is always 400 kHz.

Remote command:

[SENSe:] FILTer<n>:CCIT on page 803

SFM:

[SENSe:] SFM:<ChannelType>:FILTer:CCITt:STATe on page 858

CCIR Unweighted ← Weighting ← AF Filter ← AM

Switches on the CCIR unweighted filter, which is the combination of the 20 Hz high-pass and 23 kHz low pass filter. The weighting filter is active in the following demodulation bandwidth range:

50 kHz ≤ demodulation bandwidth ≤ 1.6 MHz

For FM stereo (K7S), the filter is active at all times, as the demodulation range is always 400 kHz.

Remote command:

[SENSe:] FILTer<n>:CCIR[:UNWeighted] [:STATe] on page 804

SFM:

[SENSe:] SFM:<ChannelType>:FILTer:CCIR[:UNWeighted] [:STATe] on page 858

CCIR Weighted ← Weighting ← AF Filter ← AM

Switches on the CCIR weighted filter. The weighting filter is active in the following demodulation bandwidth range:

100 kHz ≤ demodulation bandwidth ≤ 3.0 MHz

For FM stereo (K7S), the filter is active at all times, as the demodulation range is always 400 kHz.

Remote command:

[SENSe:] FILTer<n>:CCIR:WEIGhted[:STATe] on page 804

SFM:

[SENSe:] SFM:<ChannelType>:FILTer:CCIR:WEIGhted[:STATe] on page 859

A Weighted ← Weighting ← AF Filter ← AM

Switches on the A weighted filter. The weighting filter is active in the following demodulation bandwidth range:

100 kHz ≤ demodulation bandwidth ≤ 800 kHz

Remote command:

[SENSe:] FILTer<n>:AWEIGhted[:STATe] on page 803

SFM:

[SENSe:] SFM:<ChannelType>:FILTer:AWEIGhted[:STATe] on page 858

Deemphasis ← AF Filter ← AM

Opens the "Deemphasis" selection list to switch on a deemphasis with the given time constant.

The deemphasis is active in the following demodulation bandwidth range:

Note: For FM stereo measurements (K7S), the demodulation bandwidth is always 400 kHz, thus the deemphasis is always active.

25 μ s:	25 kHz \leq demodulation bandwidth \leq 40 MHz
50 μ s:	6.4 kHz \leq demodulation bandwidth \leq 18 MHz
75 μ s:	6.4 kHz \leq demodulation bandwidth \leq 18 MHz
750 μ s:	800 Hz \leq demodulation bandwidth \leq 3 MHz

The following table shows the required demodulation bandwidth for an error less than 0.5 dB up to a maximum AF frequency.

deemphasis	25 μ s	50 μ s	75 μ s	750 μ s
max. AF frequency	25 kHz	12 kHz	8 kHz	800 Hz
required demodulation bandwidth	\geq 200 kHz	\geq 100 kHz	\geq 50 kHz	\geq 6.4 kHz

For higher AF frequencies the demodulation bandwidth must be increased.

Remote command:

[\[SENSe:\]FILTer<n>:DEMPHasis\[:STATe\]](#) on page 805

[\[SENSe:\]FILTer<n>:DEMPHasis:TCONstant](#) on page 805

SFM:

[\[SENSe:\]SFM:<ChannelType>:FILTer:DEMPHasis:STATe](#) on page 859

[\[SENSe:\]SFM:<ChannelType>:FILTer:DEMPHasis:TCONstant](#) on page 860

All AF Filter Off ← AF Filter ← AM

Disables all specified AF Filters.

Remote command:

[\[SENSe:\]FILTer<n>:AOFF](#) on page 803

AF Range ← AM

Opens a submenu to define the diagram scaling for AF displays.

Dev per Division ← AF Range ← AM

Opens an edit dialog box to set the modulation depth or the phase deviation (analog demodulation only), or frequency deviation per division:

AM display:	0.0001 % to 1000 %
FM display:	1 Hz/div to 100 MHz/div
PM display:	0.0001 rad/div to 1000 rad/div

The softkey is not available if logarithmic display is set ("Deviation Lin/Log" softkey).

Remote command:

[DISPlay\[:WINDow<n>\]:TRACe<t>:MODE:HCONtinuous](#) on page 719

Reference Position ← AF Range ← AM

Determines the position of the reference line for the modulation depth or the phase deviation (analog demodulation only) or frequency deviation on the y-axis of the diagram. By default, this line is set to 0.

The position is entered as a percentage of the diagram height with 100 % corresponding to the upper diagram border. The default setting is 50 % (diagram center) for the display of the AM, FM, or PM signal, and 100 % (upper diagram border) for the AF spectrum display of the AM, FM, or PM signal.

Remote command:

`DISPlay[:WINDow<n>]:TRACe<t>:Y[:SCALe]:RPOSition` on page 720

Reference Value ← AF Range ← AM

Determines the modulation depth or the phase deviation (analog demodulation only) or the frequency deviation at the reference line of the y-axis. The reference value is set separately for each display of the AM, FM, and PM signal and the AF spectrum of the AM, FM, and PM signal.

- AM/FM/PM signal display
The trace display takes individual frequency/phase offsets into account (in contrast, the **AF Coupling AC/DC** softkey permits automatic correction by the average frequency/phase offset of the signal, and can therefore not be activated simultaneously).
Possible values: 0 and ± 10000 % (AM), 0 and ± 10 MHz (FM), 0 and ± 10000 rad (PM).
- AF spectrum display of the AM/FM/PM signal
In the default setting, the reference value defines the modulation depth or the FM/PM deviation at the upper diagram border.
Possible values: 0 and 10000 % (AM), 0 and 10 MHz (FM), 0 and 10000 rad (PM).

Remote command:

`DISPlay[:WINDow<n>]:TRACe<t>:Y[:SCALe]:RVALue` on page 721

AF Coupling AC/DC ← AF Range ← AM

Controls the automatic correction of the frequency offset and phase offset of the input signal:

(**Note:** This function is not available with the AF spectrum display of the FM or PM signal.)

- FM signal display
If DC is selected, the absolute frequency is displayed, i.e. an input signal with an offset relative to the center frequency is not displayed symmetrically with respect to the zero line.
If AC is selected, the frequency offset is automatically corrected, i.e. the trace is always symmetric with respect to the zero line.
- PM signal display
If DC is selected, the phase runs according to the existing frequency offset. In addition, the DC signal contains a phase offset of $\pm \pi$.
If AC is selected, the frequency offset and phase offset are automatically corrected, i.e. the trace is always symmetric with respect to the zero line.

Remote command:

`[SENSe:]ADEMod<n>:AF:COUPling` on page 752

Deviation Lin/Log ← AF Range ← AM

Switches between logarithmic and linear display of the modulation depth or the phase deviation (analog demodulation only) or the frequency deviation.

Remote command:

`DISPlay[:WINDow<n>]:TRACe<t>:Y:SPACing` on page 717

Unit ← AF Range ← AM

Opens a submenu to define the modulation unit.

Phase Unit (Rad/Deg) ← Unit ← AF Range ← AM

Sets the phase unit to rad or deg for displaying PM signals.

Remote command:

`UNIT:THD` on page 921

THD Unit (% / DB) ← Unit ← AF Range ← AM

Sets the unit to percent or DB for THD measurements.

Remote command:

`UNIT:THD` on page 921

Abs. Dev Unit (kHz/dBm) ← Unit ← AF Range ← AM

Sets the unit for absolute deviation to kHz or dBm. This softkey is only available with the FM Stereo option K7S.

Remote command:

`UNIT:ADEV` on page 921

Rel. Dev Unit (dB / %) ← Unit ← AF Range ← AM

Sets the unit for relative deviation to dB or percent. This softkey is only available with the FM Stereo option K7S.

Remote command:

`UNIT:RDEV` on page 922

Time Domain Zoom ← AM

Opens a submenu to activate and configure the zoom function.

State On / Off ← Time Domain Zoom ← AM

Activates or deactivates the time domain zoom according to the defined settings.

"ON" Activates the time domain zoom. The zoom area is defined using the "Start" ["Start"](#) on page 344 and "Length Manual" ["Length Manual"](#) on page 344 / "Length Auto" ["Length Auto"](#) on page 344 softkeys.

"OFF" If more measured values than measurement points are available, several measured values are combined in one measurement point according to the method of the selected trace detector. For details on detectors refer to [chapter 4.1.8.6, "Detector Overview"](#), on page 106.

Remote command:

`[SENSe:]ADEMod<n>:ZOOM[:STATe]` on page 774

Start ← Time Domain Zoom ← AM

Opens an edit dialog box to define the start time for the zoom area.

Remote command:

[SENSe:]ADEMod<n>:ZOOM:START on page 775

Length Manual ← Time Domain Zoom ← AM

Opens an edit dialog box to define the length of the zoom area (as a time value) manually.

Remote command:

[SENSe:]ADEMod<n>:ZOOM:LENGTH on page 775

Length Auto ← Time Domain Zoom ← AM

Automatically sets the length of the zoom area to the number of sweep points (see "Sweep Points" on page 91).

Remote command:

[SENSe:]ADEMod<n>:ZOOM:LENGTH:MODE on page 776

Squelch ← AM

Activates the squelch function, i.e. if the signal falls below a defined threshold, the demodulated data is automatically set to 0. This is useful, for example, to avoid demodulation noise during transmission breaks.

Remote command:

[SENSe:]ADEMod:SQUelch[:STATe] on page 773

Squelch Level ← AM

Defines the level threshold below which the demodulated data is set to 0 if squelching is enabled. The squelch level is an absolute value.

Remote command:

[SENSe:]ADEMod:SQUelch:LEVEl on page 773

FM

Selects FM as the modulation type, changes the signal display, and opens a submenu to set the measurement configuration. The average value of the demodulated signal is mapped depending on the "AF Coupling" softkey setting (see "AF Coupling AC/DC" on page 342).

In single sweep mode, the data is determined from the current I/Q data set, i.e. a change to a different type does not trigger a new measurement.

This menu is also displayed when you press the MEAS CONFIG key after changing the modulation type.

Remote command:

CALC:FEED 'XTIM:FM' (see CALCulate<n>:FEED on page 705)

Display Config ← FM

See "Display Config" on page 336.

Select Trace ← FM

See "Select Trace" on page 338.

Demod BW ← FM

See "[Demod BW](#)" on page 338.

Meas Time ← FM

See "[Meas Time](#)" on page 338.

AF Filter ← FM

See "[AF Filter](#)" on page 338.

AF Range ← FM

See "[AF Range](#)" on page 341.

Time Domain Zoom ← FM

See "[Time Domain Zoom](#)" on page 343.

Squelch ← FM

See "[Squelch](#)" on page 344.

Squelch Level ← FM

See "[Squelch Level](#)" on page 344.

PM

Selects PM as the modulation type, changes the signal display, and opens a submenu to set the measurement configuration.

In single sweep mode, the data is determined from the current I/Q data set, i.e. a change to a different type does not trigger a new measurement.

This menu is also displayed when you press the MEAS CONFIG key after changing the modulation type.

Remote command:

`CALC:FEED 'XTIM:PM'` (see [CALCulate<n>:FEED](#) on page 705)

Display Config ← PM

See "[Display Config](#)" on page 336.

Select Trace ← PM

See "[Select Trace](#)" on page 338.

Demod BW ← PM

See "[Demod BW](#)" on page 338.

Meas Time ← PM

See "[Meas Time](#)" on page 338.

AF Filter ← PM

See "[AF Filter](#)" on page 338.

AF Range ← PM

See "[AF Range](#)" on page 341.

Time Domain Zoom ← PM

See ["Time Domain Zoom"](#) on page 343.

Squelch ← PM

See ["Squelch"](#) on page 344.

Squelch Level ← PM

See ["Squelch Level"](#) on page 344.

Zero Phase Reference Point ← PM

Defines the position at which the phase of the PM-demodulated signal is set to 0 rad. The entry is made with respect to time. In the default setting, the first measured value is set to 0 rad.

This softkey is only available in the PM display with DC coupling.

Remote command:

[\[SENSe:\]ADEMod:PM:RPOint\[:X\]](#) on page 768

Phase Wrap On/Off ← PM

Activates/deactivates the phase wrap.

On	The phase will be displayed in the range $\pm 180^\circ$ ($\pm \Pi$). For example, if the phase exceeds $+180^\circ$, 360° is subtracted from the phase value, with the display thus showing $>-180^\circ$.
Off	The phase will not be wrapped.

This softkey is available in the PM signal displays.

Remote command:

[CALC:FORM PHAS](#) (see [CALCulate<n>:FORMat](#) on page 708)

RF Power

Selects RF power as the modulation type, changes the signal display, and opens a submenu to set the measurement configuration.

In single sweep mode, the data is determined from the current I/Q data set, i.e. a change to a different type does not trigger a new measurement.

This menu is also displayed when you press the MEAS CONFIG key after changing the modulation type.

Remote command:

[CALC:FEED 'XTIM:RFPower'](#) (see [CALCulate<n>:FEED](#) on page 705)

Display Config ← RF Power

See ["Display Config"](#) on page 336.

Select Trace ← RF Power

See ["Select Trace"](#) on page 338.

Demod BW ← RF Power

See ["Demod BW"](#) on page 338.

Meas Time ← RF Power

See "Meas Time" on page 338.

AF Filter ← RF Power

See "AF Filter" on page 338.

AF Range ← RF Power

See "AF Range" on page 341.

Time Domain Zoom ← RF Power

See "Time Domain Zoom" on page 343.

Squelch ← RF Power

See "Squelch" on page 344.

Squelch Level ← RF Power

See "Squelch Level" on page 344.

Display Config

See "Display Config" on page 336.

5.2.2 Softkeys of the Frequency Menu – FREQ Key (analog demodulation)

The following table shows all softkeys available in the "Frequency" menu in "Analog Demodulation" mode (FREQ key). It is possible that your instrument configuration does not provide all softkeys. If a softkey is only available with a special option, model or (measurement) mode, this information is delivered in the corresponding softkey description.

Center.....	347
CF Stepsize.....	348
L 0.1*Span (RF Spectrum).....	348
L 0.1*Demod BW (AF/RF Time Domain, AF Spectrum).....	348
L 0.5*Span (RF Spectrum).....	348
L 0.5*Demod BW (AF/RF Time Domain, AF Spectrum).....	348
L x*Span (RF Spectrum).....	348
L x*Demod BW (AF/RF Time Domain, AF Spectrum).....	349
L =Center.....	349
L Manual.....	349
AF Center (AF Spectrum).....	349
AF Start.....	349
AF Stop.....	349

Center

Opens an edit dialog box to enter the center frequency. The allowed range of values for the center frequency depends on the frequency span.

$$\text{span} > 0: \text{span}_{\min}/2 \leq f_{\text{center}} \leq f_{\max} - \text{span}_{\min}/2$$

$$\text{span} = 0: 0 \text{ Hz} \leq f_{\text{center}} \leq f_{\max}$$

f_{\max} and span_{\min} are specified in the data sheet.

Remote command:

[SENSe:] FREQuency:CENTer on page 808

CF Stepsize

Opens a submenu to set the step size of the center frequency. Apart from the =Center and Manual softkeys, the other softkeys are displayed depending on the selected frequency span.

The step size can be coupled to the span ($\text{span} > 0$) or the demodulation bandwidth ($\text{span} = 0$) or it can be manually set to a fixed value.

0.1*Span (RF Spectrum) ← CF Stepsize

Sets the step size for the center frequency to 10 % of the span.

Remote command:

[SENSe:] FREQuency:CENTer:STEP:LINK on page 809

[SENSe:] FREQuency:CENTer:STEP:LINK:FACTor on page 809

0.1*Demod BW (AF/RF Time Domain, AF Spectrum) ← CF Stepsize

Sets the step size for the center frequency to 10 % of the demodulation bandwidth. This is the default setting.

Remote command:

[SENSe:] FREQuency:CENTer:STEP:LINK on page 809

[SENSe:] FREQuency:CENTer:STEP:LINK:FACTor on page 809

0.5*Span (RF Spectrum) ← CF Stepsize

Sets the step size for the center frequency to 50 % of the span.

Remote command:

[SENSe:] FREQuency:CENTer:STEP:LINK on page 809

[SENSe:] FREQuency:CENTer:STEP:LINK:FACTor on page 809

0.5*Demod BW (AF/RF Time Domain, AF Spectrum) ← CF Stepsize

Sets the step size for the center frequency to 50 % of the demodulation bandwidth.

Remote command:

[SENSe:] FREQuency:CENTer:STEP:LINK on page 809

[SENSe:] FREQuency:CENTer:STEP:LINK:FACTor on page 809

x*Span (RF Spectrum) ← CF Stepsize

Opens an edit dialog box to set the step size for the center frequency as % of the span.

Remote command:

[SENSe:] FREQuency:CENTer:STEP:LINK on page 809

[SENSe:] FREQuency:CENTer:STEP:LINK:FACTor on page 809

x*Demod BW (AF/RF Time Domain, AF Spectrum) ← CF Stepsize

Opens an edit dialog box to set the step size for the center frequency as % of the demodulation bandwidth. Values between 1 and 100 % in steps of 1 % are allowed. The default setting is 10 %.

Remote command:

[SENSe:]FREQuency:CENTer:STEP:LINK on page 809

[SENSe:]FREQuency:CENTer:STEP:LINK:FACTor on page 809

=Center ← CF Stepsize

Sets the step size to the value of the center frequency and removes the coupling of the step size to span or resolution bandwidth.

This function is especially useful for measurements of the signal harmonics. In this case, each stroke of the arrow key selects the center frequency of another harmonic.

Manual ← CF Stepsize

Opens an edit dialog box to enter a fixed step size for the center frequency.

Remote command:

[SENSe:]FREQuency:CENTer:STEP on page 808

AF Center (AF Spectrum)

Opens an edit box to enter the center frequency within the AF spectrum.

Remote command:

[SENSe:]ADEMod<n>:AF:CENTer on page 752

AF Start

Opens an edit box to define the start frequency within the AF spectrum.

Remote command:

[SENSe:]ADEMod<n>:AF:START on page 754

AF Stop

Opens an edit box to define the stop frequency within the AF spectrum.

The maximum AF stop frequency corresponds to half the demodulation bandwidth.

Remote command:

[SENSe:]ADEMod<n>:AF:STOP on page 754

5.2.3 Softkeys of the Span Menu – SPAN Key (analog demodulation)

The following table shows all softkeys available in the "Span" menu in "Analog Demodulation" mode (SPAN key). It is possible that your instrument configuration does not provide all softkeys. If a softkey is only available with a special option, model or (measurement) mode, this information is delivered in the corresponding softkey description.

Span Manual (RF Spectrum).....	350
AF Span Manual (AF Spectrum).....	350
Demod BW.....	350
Full Span (RF Spectrum).....	350
AF Full Span (AF Spectrum).....	350

Span Manual (RF Spectrum)

Opens an edit dialog box to enter the frequency span. The center frequency is kept constant. If the RF spectrum display is active, values between the sampling rate/1000 and the demodulation bandwidth are allowed.

Remote command:

[SENSe:]ADEMod:SPECTrum:SPAN:ZOOM on page 773

AF Span Manual (AF Spectrum)

Opens an edit dialog box to enter the frequency range for the AF spectrum display. Values between the sampling rate/1000 and the demodulation bandwidth/2 are allowed.

Remote command:

[SENSe:]ADEMod<n>:AF:SPAN on page 753

Demod BW

Opens an edit dialog box to enter the demodulation bandwidth of the analog demodulation. The demodulation bandwidth determines the sampling rate for recording the signal to be analyzed. For details on the relation between demodulation bandwidth and sampling rate refer to [chapter 5.1.8, "Sample Rate, Measurement Time and Trigger Offset"](#), on page 325.

Remote command:

[SENSe:]BANDwidth|BWIDth:DEMod on page 781

Full Span (RF Spectrum)

Sets the span to the maximum frequency range of the R&S FSVR specified in the data sheet. This setting is useful for overview measurements.

If the RF spectrum display is active, the full frequency range corresponds to the demodulation bandwidth.

Remote command:

[SENSe:]ADEMod:SPECTrum:SPAN:ZOOM on page 773

AF Full Span (AF Spectrum)

Sets the span to the maximum frequency range for the AF spectrum display. The maximum frequency range corresponds to half the demodulation bandwidth.

Remote command:

[SENSe:]ADEMod<n>:AF:SPAN:FULL on page 753

5.2.4 Softkeys of the Amplitude Menu – AMPT Key (analog demodulation)

The following table shows all softkeys available in the "Amplitude" menu in "Analog Demodulation" mode (AMPT key). It is possible that your instrument configuration does not provide all softkeys. If a softkey is only available with a special option, model or (measurement) mode, this information is delivered in the corresponding softkey description.

Ref Level.....	351
AF Range.....	351
Range.....	352
L Range Log 100 dB.....	352
L Range Log 50 dB.....	352
L Range Log 10 dB.....	352
L Range Log 5 dB.....	352
L Range Log 1 dB.....	353
L Range Log Manual.....	353
L Range Linear %.....	353
L Range Lin. Unit.....	353
Unit.....	353
L Phase Unit (Rad/Deg).....	353
L THD Unit (% / DB).....	354
Preamp On/Off.....	354
RF Atten Manual/Mech Att Manual.....	354
RF Atten Auto/Mech Att Auto.....	354
EI Atten On/Off.....	355
EI Atten Mode (Auto/Man).....	355
Ref Level Offset.....	356
Ref Level Position.....	356
Grid Abs/Rel.....	356
Input (AC/DC).....	356
Input 50 Ω/75 Ω.....	356

Ref Level

Opens an edit dialog box to enter the reference level in the current unit (dBm, dBμV, etc).

The reference level is the maximum value the AD converter can handle without distortion of the measured value. Signal levels above this value will not be measured correctly, which is indicated by the "IFOVL" status display.

Remote command:

`DISPlay[:WINDow<n>]:TRACe<t>:Y[:SCALE]:RLEVEL` on page 720

AF Range

Only available for AM/FM/PM measurements (see [chapter 5.1.9, "Measurement Result Display"](#), on page 327).

For details refer to the "AF Range" softkey of the main menu (see ["AF Range"](#) on page 341).

Range

Only available for RF measurements (see [chapter 5.1.9, "Measurement Result Display"](#), on page 327).

Opens a submenu to define the level display range.

Range Log 100 dB ← Range

Sets the level display range to 100 dB.

Remote command:

Logarithmic scaling:

DISP:WIND:TRAC:Y:SPAC LOG, see [DISPlay\[:WINDow<n>\]:TRACe<t>:Y:SPACing](#) on page 717

Display range:

DISP:WIND:TRAC:Y 100DB, see [DISPlay\[:WINDow<n>\]:TRACe<t>:Y\[:SCALe\]](#) on page 718

Range Log 50 dB ← Range

Sets the level display range to 50 dB.

Remote command:

Logarithmic scaling:

DISP:WIND:TRAC:Y:SPAC LOG, see [DISPlay\[:WINDow<n>\]:TRACe<t>:Y:SPACing](#) on page 717

Display range:

DISP:WIND:TRAC:Y 50DB, see [DISPlay\[:WINDow<n>\]:TRACe<t>:Y\[:SCALe\]](#) on page 718

Range Log 10 dB ← Range

Sets the level display range to 10 dB.

Remote command:

Logarithmic scaling:

DISP:WIND:TRAC:Y:SPAC LOG, see [DISPlay\[:WINDow<n>\]:TRACe<t>:Y:SPACing](#) on page 717

Display range:

DISP:WIND:TRAC:Y 10DB, see [DISPlay\[:WINDow<n>\]:TRACe<t>:Y\[:SCALe\]](#) on page 718

Range Log 5 dB ← Range

Sets the level display range to 5 dB.

Remote command:

Logarithmic scaling:

DISP:WIND:TRAC:Y:SPAC LOG, see [DISPlay\[:WINDow<n>\]:TRACe<t>:Y:SPACing](#) on page 717

Display range:

DISP:WIND:TRAC:Y 5DB, see [DISPlay\[:WINDow<n>\]:TRACe<t>:Y\[:SCALe\]](#) on page 718

Range Log 1 dB ← Range

Sets the level display range to 1 dB.

Remote command:

Logarithmic scaling:

DISP:WIND:TRAC:Y:SPAC LOG, see [DISPlay\[:WINDow<n>\]:TRACe<t>:Y:SPACing](#) on page 717

Display range:

DISP:WIND:TRAC:Y 1DB, see [DISPlay\[:WINDow<n>\]:TRACe<t>:Y\[:SCALe\]](#) on page 718

Range Log Manual ← Range

Opens an edit dialog box to define the display range of a logarithmic level axis manually.

Remote command:

Logarithmic scaling:

DISP:WIND:TRAC:Y:SPAC LOG, see [DISPlay\[:WINDow<n>\]:TRACe<t>:Y:SPACing](#) on page 717

Display range:

[DISPlay\[:WINDow<n>\]:TRACe<t>:Y\[:SCALe\]](#) on page 718

Range Linear % ← Range

Selects linear scaling for the level axis in %.

The grid is divided into decadal sections.

Markers are displayed in the selected unit ("Unit" softkey). Delta markers are displayed in % referenced to the voltage value at the position of marker 1. This is the default setting for linear scaling.

Remote command:

DISP:TRAC:Y:SPAC LIN, see [DISPlay\[:WINDow<n>\]:TRACe<t>:Y:SPACing](#) on page 717

Range Lin. Unit ← Range

Selects linear scaling in dB for the level display range, i.e. the horizontal lines are labeled in dB.

Markers are displayed in the selected unit ("Unit" softkey). Delta markers are displayed in dB referenced to the power value at the position of marker 1.

Remote command:

DISP:TRAC:Y:SPAC LDB, see [DISPlay\[:WINDow<n>\]:TRACe<t>:Y:SPACing](#) on page 717

Unit

Opens a submenu to define the unit of the measurement results.

Phase Unit (Rad/Deg) ← Unit

Sets the phase unit to rad or deg for displaying PM signals.

Remote command:

[UNIT:THD](#) on page 921

THD Unit (% / DB) ← Unit

Sets the unit to percent or DB for THD measurements.

Remote command:

`UNIT:THD` on page 921

Preamp On/Off

Switches the preamplifier on and off.

If option R&S FSV-B22 is installed, the preamplifier is only active below 7 GHz.

If option R&S FSV-B24 is installed, the preamplifier is active for all frequencies.

When measuring Spurious Emissions, using this softkey automatically opens the "Sweep List" dialog, see "[Sweep List dialog box](#)" on page 219.

This function is not available for input from the R&S Digital I/Q Interface (option R&S FSV-B17).

Remote command:

`INPut:GAIN:STATe` on page 737

RF Atten Manual/Mech Att Manual

Opens an edit dialog box to enter the attenuation, irrespective of the reference level. If electronic attenuation is activated (option R&S FSV-B25 only; "EI Atten Mode Auto" softkey), this setting defines the mechanical attenuation.

The mechanical attenuation can be set in 10 dB steps.

The RF attenuation can be set in 5 dB steps (with option R&S FSV-B25: 1 dB steps).

The range is specified in the data sheet. If the current reference level cannot be set for the set RF attenuation, the reference level is adjusted accordingly.

This function is not available for input from the R&S Digital I/Q Interface (option R&S FSV-B17).

The RF attenuation defines the level at the input mixer according to the formula:

$$\text{level}_{\text{mixer}} = \text{level}_{\text{input}} - \text{RF attenuation}$$

Note: As of firmware version 1.63, the maximum mixer level allowed is **0 dBm**. Mixer levels above this value may lead to incorrect measurement results, which are indicated by the "OVLd" status display. The increased mixer level allows for an improved signal, but also increases the risk of overloading the instrument!

When measuring spurious emissions, using this softkey automatically opens the "Sweep List" dialog box, see "[Sweep List dialog box](#)" on page 219.

Remote command:

`INPut:ATTenuation` on page 732

RF Atten Auto/Mech Att Auto

Sets the RF attenuation automatically as a function of the selected reference level.

This ensures that the optimum RF attenuation is always used. It is the default setting.

When measuring spurious emissions, using this softkey automatically opens the "Sweep List" dialog, see "[Sweep List dialog box](#)" on page 219.

This function is not available for input from the R&S Digital I/Q Interface (option R&S FSV-B17).

Remote command:

[INPut:ATTenuation:AUTO](#) on page 732

El Atten On/Off

This softkey switches the electronic attenuator on or off. This softkey is only available with option R&S FSV-B25.

When the electronic attenuator is activated, the mechanical and electronic attenuation can be defined separately. Note however, that both parts must be defined in the same mode, i.e. either both manually, or both automatically.

This function is not available for input from the R&S Digital I/Q Interface (option R&S FSV-B17).

- To define the mechanical attenuation, use the [RF Atten Manual/Mech Att Manual](#) or [RF Atten Auto/Mech Att Auto](#) softkeys.
- To define the electronic attenuation, use the [El Atten Mode \(Auto/Man\)](#) softkey.

Note: This function is not available for stop frequencies (or center frequencies in zero span) >7 GHz. In this case, the electronic and mechanical attenuation are summarized and the electronic attenuation can no longer be defined individually. As soon as the stop or center frequency is reduced below 7 GHz, this function is available again. When the electronic attenuator is switched off, the corresponding RF attenuation mode (auto/manual) is automatically activated.

Remote command:

[INPut:EATT:AUTO](#) on page 736

El Atten Mode (Auto/Man)

This softkey defines whether the electronic attenuator value is to be set automatically or manually. If manual mode is selected, an edit dialog box is opened to enter the value. This softkey is only available with option R&S FSV-B25, and only if the electronic attenuator has been activated via the [El Atten On/Off](#) softkey.

Note: This function is not available for stop frequencies (or center frequencies in zero span) >7 GHz. In this case, the electronic and mechanical attenuation are summarized and the electronic attenuation can no longer be defined individually. As soon as the stop or center frequency is reduced below 7 GHz, electronic attenuation is available again. If the electronic attenuation was defined manually, it must be re-defined.

The attenuation can be varied in 1 dB steps from 0 to 30 dB. Other entries are rounded to the next lower integer value.

To re-open the edit dialog box for manual value definition, select the "Man" mode again.

If the defined reference level cannot be set for the given RF attenuation, the reference level is adjusted accordingly and the warning "Limit reached" is output.

Remote command:

[INPut:EATT:AUTO](#) on page 736

[INPut:EATT](#) on page 736

Ref Level Offset

Opens an edit dialog box to enter the arithmetic level offset. This offset is added to the measured level irrespective of the selected unit. The scaling of the y-axis is changed accordingly. The setting range is ± 200 dB in 0.1 dB steps.

Remote command:

`DISPlay[:WINDow<n>]:TRACe<t>:Y[:SCALe]:RLEVel:OFFSet` on page 720

Ref Level Position

Opens an edit dialog box to enter the reference level position, i.e. the position of the maximum AD converter value on the level axis. The setting range is from -200 to +200 %, 0 % corresponding to the lower and 100 % to the upper limit of the diagram.

Only available for RF measurements.

Remote command:

`DISPlay[:WINDow<n>]:TRACe<t>:Y[:SCALe]:RPOSition` on page 720

Grid Abs/Rel

Switches between absolute and relative scaling of the level axis (not available with "Linear" range).

Only available for RF measurements.

"Abs" Absolute scaling: The labeling of the level lines refers to the absolute value of the reference level. Absolute scaling is the default setting.

"Rel" Relative scaling: The upper line of the grid is always at 0 dB. The scaling is in dB whereas the reference level is always in the set unit (for details on unit settings see the "Unit" softkey).

Remote command:

`DISPlay[:WINDow<n>]:TRACe<t>:Y[:SCALe]:MODE` on page 719

Input (AC/DC)

Toggles the RF input of the R&S FSVR between AC and DC coupling.

This function is not available for input from the R&S Digital I/Q Interface (option R&S FSV-B17).

Remote command:

`INPut:COUPling` on page 732

Input 50 Ω /75 Ω

Uses 50 Ω or 75 Ω as reference impedance for the measured levels. Default setting is 50 Ω .

The setting 75 Ω should be selected if the 50 Ω input impedance is transformed to a higher impedance using a 75 Ω adapter of the RAZ type (= 25 Ω in series to the input impedance of the instrument). The correction value in this case is 1.76 dB = $10 \log(75 \Omega/50 \Omega)$.

All levels specified in this Operating Manual refer to the default setting of the instrument (50 Ω).

This function is not available for input from the R&S Digital I/Q Interface (option R&S FSV-B17).

Remote command:

[INPut : IMPedance](#) on page 737

5.2.5 Softkeys of the Auto Set menu - AUTO SET Key (analog demodulation)

The following table shows all softkeys available in the "Auto Set" menu. It is possible that your instrument configuration does not provide all softkeys. If a softkey is only available with a special option, model or (measurement) mode, this information is provided in the corresponding softkey description.



Adjusting settings automatically during triggered measurements

When you select an auto adjust function a measurement is performed to determine the optimal settings. If you select an auto adjust function for a triggered measurement, you can select how the R&S FSVR should behave:

- (default:) The measurement for adjustment waits for the next trigger
- The measurement for adjustment is performed without waiting for a trigger. The trigger source is temporarily set to "Free Run". After the measurement is completed, the original trigger source is restored. The trigger level for IF Power and RF Power triggers is adjusted as follows:
Trigger Level = Reference Level - 15 dB

Auto All	357
Auto Freq	357
Auto Level	358
Settings	358
L Meas Time Manual	358
L Meas Time Auto	358
L Upper Level Hysteresis	358
L Lower Level Hysteresis	358
AF Auto Scale	359

Auto All

Performs all automatic settings.

- ["Auto Freq"](#) on page 76
- ["Auto Level"](#) on page 77

Remote command:

[\[SENSe:\]ADJust:ALL](#) on page 776

Auto Freq

Defines the center frequency and the reference level automatically by determining the highest frequency level in the frequency span. This function uses the signal counter; thus it is intended for use with sinusoidal signals.

This function is not available for input from the R&S Digital I/Q Interface (option R&S FSV-B17).

Remote command:

[SENSe:]ADJust:FREQuency on page 776

Auto Level

Defines the optimal reference level for the current measurement automatically.

The measurement time for automatic leveling can be defined using the [Settings](#) softkey.

You can define a threshold that the signal must exceed before the reference level is adjusted, see "[Upper Level Hysteresis](#)" on page 77 and "[Lower Level Hysteresis](#)" on page 77.

Remote command:

[SENSe:]ADJust:LEVel on page 777

Settings

Opens a submenu to define settings for automatic leveling.

Possible settings are:

- "[Meas Time Manual](#)" on page 77
- "[Meas Time Auto](#)" on page 77

Meas Time Manual ← Settings

Opens an edit dialog box to enter the duration of the level measurement in seconds. The level measurement is used to determine the optimal reference level automatically (see the "Auto Level" softkey, "[Auto Level](#)" on page 77). The default value is 1 ms.

Remote command:

[SENSe:]ADJust:CONFIgure:LEVel:DURation on page 777

Meas Time Auto ← Settings

The level measurement is used to determine the optimal reference level automatically (see the [Auto Level](#) softkey).

This softkey resets the level measurement duration for automatic leveling to the default value of 100 ms.

Upper Level Hysteresis ← Settings

Defines an upper threshold the signal must exceed before the reference level is automatically adjusted when the "Auto Level" function is performed.

Remote command:

[SENSe:]ADJust:CONFIguration:HYSTeresis:UPPer on page 778

Lower Level Hysteresis ← Settings

Defines a lower threshold the signal must exceed before the reference level is automatically adjusted when the "Auto Level" function is performed.

Remote command:

[SENSe:]ADJust:CONFIguration:HYSTeresis:LOWer on page 777

AF Auto Scale

Activates automatic scaling of the y-axis for AF measurements. RF power and RF spectrum measurements are not affected by the auto-scaling.

Remote command:

[SENSe:]ADJust:SCALe:Y:AUTO[:CONTInuous] on page 778

5.2.6 Softkeys of the Bandwidth Menu – BW Key (analog demodulation)

The following table shows all softkeys available in the "Bandwidth" menu in "Analog Demodulation" mode (BW key). It is possible that your instrument configuration does not provide all softkeys. If a softkey is only available with a special option, model or (measurement) mode, this information is delivered in the corresponding softkey description.

Res BW (span > 0).....	359
Demod BW.....	359
Meas Time.....	360
AF Filter.....	360
L High Pass.....	360
L Low Pass.....	360
L Weighting.....	361
L None.....	361
L CCITT.....	361
L CCIR Unweighted.....	361
L CCIR Weighted.....	362
L A Weighted.....	362
L Deemphasis.....	362
L All AF Filter Off.....	363
Demod Filter.....	363

Res BW (span > 0)

Opens an edit dialog box to enter a value for the resolution bandwidth. The range is specified in the data sheet.

This softkey is only available for spectrum measurements (see [chapter 5.1.9, "Measurement Result Display"](#), on page 327).

Remote command:

[SENSe:]ADEMod:SPECTrum:BANDwidth|BWIDth[:RESolution] on page 771

Demod BW

Opens an edit dialog box to enter the demodulation bandwidth of the analog demodulation. The demodulation bandwidth determines the sampling rate for recording the signal to be analyzed. For details on the relation between demodulation bandwidth and sampling rate refer to [chapter 5.1.8, "Sample Rate, Measurement Time and Trigger Offset"](#), on page 325.

Remote command:

[SENSe:]BANDwidth|BWIDth:DEMod on page 781

Meas Time

Opens an editor for entering the measurement time of the analog demodulation. For details on the measurement time values refer to [chapter 5.1.8, "Sample Rate, Measurement Time and Trigger Offset"](#), on page 325.

Note: For FM Stereo measurements (option K7S), the minimum measurement time is 2 ms.

Remote command:

[SENSe:] ADEMod:MTIME on page 764

AF Filter

The bandwidth of the demodulated signal can be reduced by high pass or low pass filters and also a de-emphasis can be switched on. The selected filters are used for AM, FM and PM demodulation in common. Individual settings are not possible.

High Pass ← AF Filter

Opens the "High Pass" selection list to switch on a high pass filter with the given limit to separate the DC component. The filters are indicated by the 3 dB cutoff frequency. The 50 Hz and 300 Hz filters are designed as 2nd-order Butterworth filter (12 dB/octave). The 20 Hz filter is designed as 3rd-order Butterworth filter (18 dB/octave).

"None" deactivates the AF high pass filter. Default is "None".

The high pass filters are active in the following demodulation bandwidth range:

20 Hz	100 Hz ≤ demodulation bandwidth ≤ 1.6 MHz
50 Hz:	200 Hz ≤ demodulation bandwidth ≤ 3 MHz
300 Hz:	800 Hz ≤ demodulation bandwidth ≤ 8 MHz
Note: for FM stereo (K7S), all filters are active at all times, as the demodulation range is always 400 kHz	

Remote command:

[SENSe:] FILTER<n>:HPASs[:STATe] on page 805

[SENSe:] FILTER<n>:HPASs:FREQuency on page 806

Low Pass ← AF Filter

Opens the "Low Pass" selection list to select the filter type. Relative and absolute low pass filter are available.

- Absolute low pass filters:
The 3 kHz, 15 kHz; 23 kHz and 150 kHz softkeys switch on a absolute low pass filter. The filters are indicated by the 3 dB cutoff frequency. The 3 kHz, 15 kHz and 23 kHz filters are designed as 5th-order Butterworth filters (30 dB/octave). The 150 kHz filter is designed as 8th-order Butterworth filter (48 dB/octave).
The absolute low pass filters are active in the following demodulation bandwidth range:

3 kHz:	6.4 kHz ≤ demodulation bandwidth ≤ 3 MHz
15 kHz:	50 kHz ≤ demodulation bandwidth ≤ 8 MHz
Note: for FM stereo (K7S), all filters are active at all times, as the demodulation range is always 400 kHz	

23 kHz	$50 \text{ kHz} \leq \text{demodulation bandwidth} \leq 18 \text{ MHz}$
150 kHz:	$400 \text{ kHz} \leq \text{demodulation bandwidth} \leq 8 \text{ MHz}$
Note: for FM stereo (K7S), all filters are active at all times, as the demodulation range is always 400 kHz	

- Relative low pass filters:
The filters (3 dB) can be selected in % of the demodulation bandwidth. The filters are designed as 5th-order Butterworth filter (30 dB/octave) and active for all demodulation bandwidths.
- "None" deactivates the AF low pass filter. Default is "None".

Remote command:

[\[SENSe:\] FILTer<n>:LPASs\[:STATe\]](#) on page 806

[\[SENSe:\] FILTer<n>:LPASs:FREQuency\[:ABSolute\]](#) on page 807

[\[SENSe:\] FILTer<n>:LPASs:FREQuency:RELative](#) on page 807

SFM:

[\[SENSe:\] SFM:<ChannelType>:FILTer:LPASs:STATe](#) on page 861

[\[SENSe:\] SFM:<ChannelType>:FILTer:LPASs:FREQuency](#) on page 861

Weighting ← AF Filter

Opens the "Weighting" selection list to select the weighting AF filter.

None ← Weighting ← AF Filter

Deactivates the weighting filter. This is the default setting.

Remote command:

[\[SENSe:\] FILTer<n>:HPASs\[:STATe\]](#) on page 805

CCITT ← Weighting ← AF Filter

Switches on a CCITT P.53 weighting filter. The weighting filter is active in the following demodulation bandwidth range:

$20 \text{ kHz} \leq \text{demodulation bandwidth} \leq 3 \text{ MHz}$

For FM stereo (K7S), the filter is active at all times, as the demodulation range is always 400 kHz.

Remote command:

[\[SENSe:\] FILTer<n>:CCIT](#) on page 803

SFM:

[\[SENSe:\] SFM:<ChannelType>:FILTer:CCITt:STATe](#) on page 858

CCIR Unweighted ← Weighting ← AF Filter

Switches on the CCIR unweighted filter, which is the combination of the 20 Hz high-pass and 23 kHz low pass filter. The weighting filter is active in the following demodulation bandwidth range:

$50 \text{ kHz} \leq \text{demodulation bandwidth} \leq 1.6 \text{ MHz}$

For FM stereo (K7S), the filter is active at all times, as the demodulation range is always 400 kHz.

Remote command:

`[SENSe:]FILTer<n>:CCIR[:UNWeighted][:STATe]` on page 804

SFM:

`[SENSe:]SFM:<ChannelType>:FILTer:CCIR[:UNWeighted][:STATe]`
on page 858

CCIR Weighted ← Weighting ← AF Filter

Switches on the CCIR weighted filter. The weighting filter is active in the following demodulation bandwidth range:

$100 \text{ kHz} \leq \text{demodulation bandwidth} \leq 3.0 \text{ MHz}$

For FM stereo (K7S), the filter is active at all times, as the demodulation range is always 400 kHz.

Remote command:

`[SENSe:]FILTer<n>:CCIR:WEIGhted[:STATe]` on page 804

SFM:

`[SENSe:]SFM:<ChannelType>:FILTer:CCIR:WEIGhted[:STATe]` on page 859

A Weighted ← Weighting ← AF Filter

Switches on the A weighted filter. The weighting filter is active in the following demodulation bandwidth range:

$100 \text{ kHz} \leq \text{demodulation bandwidth} \leq 800 \text{ kHz}$

Remote command:

`[SENSe:]FILTer<n>:AWEIGhted[:STATe]` on page 803

SFM:

`[SENSe:]SFM:<ChannelType>:FILTer:AWEIGhted[:STATe]` on page 858

Deemphasis ← AF Filter

Opens the "Deemphasis" selection list to switch on a deemphasis with the given time constant.

The deemphasis is active in the following demodulation bandwidth range:

Note: For FM stereo measurements (K7S), the demodulation bandwidth is always 400 kHz, thus the deemphasis is always active.

25 μ s:	$25 \text{ kHz} \leq \text{demodulation bandwidth} \leq 40 \text{ MHz}$
50 μ s:	$6.4 \text{ kHz} \leq \text{demodulation bandwidth} \leq 18 \text{ MHz}$
75 μ s:	$6.4 \text{ kHz} \leq \text{demodulation bandwidth} \leq 18 \text{ MHz}$
750 μ s:	$800 \text{ Hz} \leq \text{demodulation bandwidth} \leq 3 \text{ MHz}$

The following table shows the required demodulation bandwidth for an error less than 0.5 dB up to a maximum AF frequency.

deemphasis	25 µs	50 µs	75 µs	750 µs
max. AF frequency	25 kHz	12 kHz	8 kHz	800 Hz
required demodulation bandwidth	≥ 200 kHz	≥ 100 kHz	≥ 50 kHz	≥ 6.4 kHz

For higher AF frequencies the demodulation bandwidth must be increased.

Remote command:

[\[SENSe:\] FILTER<n>:DEMPHasis\[:STATe\]](#) on page 805

[\[SENSe:\] FILTER<n>:DEMPHasis:TCONstant](#) on page 805

SFM:

[\[SENSe:\] SFM:<ChannelType>:FILTER:DEMPHasis:STATe](#) on page 859

[\[SENSe:\] SFM:<ChannelType>:FILTER:DEMPHasis:TCONstant](#) on page 860

All AF Filter Off ← AF Filter

Disables all specified AF Filters.

Remote command:

[\[SENSe:\] FILTER<n>:AOFF](#) on page 803

Demod Filter

By default, a flat demodulation filter is used in Analog Demodulation mode. However, in order to optimize the settling behaviour of the filter, a Gaussian filter can be used instead.

For details on sample rates, measurement times and trigger offsets for various demodulation bandwidths when using a Gaussian filter, see [chapter 5.1.8, "Sample Rate, Measurement Time and Trigger Offset"](#), on page 325.

Remote command:

[\[SENSe:\] BANDwidth:DEMod:TYPE](#) on page 781

5.2.7 Softkeys of the Sweep Menu – SWEEP Key (analog demodulation)

The following table shows all softkeys available in the "Sweep" menu in "Analog Demodulation" mode (SWEEP key). It is possible that your instrument configuration does not provide all softkeys. If a softkey is only available with a special option, model or (measurement) mode, this information is delivered in the corresponding softkey description.

Continuous Sweep	364
Single Sweep	364
Continue Single Sweep	364
Meas Time	364
Sweep Count	364
Sweep Points	365
Capture Mode	365
Capture Time	365
Demod Offset	366

Continuous Sweep

Sets the continuous sweep mode: the sweep takes place continuously according to the trigger settings. This is the default setting.

The trace averaging is determined by the sweep count value (see the "Sweep Count" softkey, "Sweep Count" on page 91).

Remote command:

INIT:CONT ON, see [INITiate<n>:CONTinuous](#) on page 730

Single Sweep

Sets the single sweep mode: after triggering, starts the number of sweeps that are defined by using the [Sweep Count](#) softkey. The measurement stops after the defined number of sweeps has been performed.

Remote command:

INIT:CONT OFF, see [INITiate<n>:CONTinuous](#) on page 730

Continue Single Sweep

Repeats the number of sweeps set by using the [Sweep Count](#) softkey, without deleting the trace of the last measurement.

This is particularly of interest when using the trace configurations "Average" or "Max Hold" to take previously recorded measurements into account for averaging/maximum search.

For details on trace configuration refer to [chapter 4.1.8, "Setting Traces – TRACE Key"](#), on page 92.

Remote command:

[INITiate<n>:CONMeas](#) on page 729

Meas Time

Opens an editor for entering the measurement time of the analog demodulation. For details on the measurement time values refer to [chapter 5.1.8, "Sample Rate, Measurement Time and Trigger Offset"](#), on page 325.

Note: For FM Stereo measurements (option K7S), the minimum measurement time is 2 ms.

Remote command:

[\[SENSe:\]ADEMod:MTIME](#) on page 764

Sweep Count

Opens an edit dialog box to enter the number of sweeps to be performed in the single sweep mode. Values from 0 to 32767 are allowed. If the values 0 or 1 are set, one sweep is performed. The sweep count is applied to all the traces in a diagram.

If the trace configurations "Average", "Max Hold" or "Min Hold" are set, the sweep count value also determines the number of averaging or maximum search procedures.

In continuous sweep mode, if sweep count = 0 (default), averaging is performed over 10 sweeps. For sweep count = 1, no averaging, maxhold or minhold operations are performed.

For details on trace configuration see [chapter 4.1.8, "Setting Traces – TRACE Key"](#), on page 92.

Example:

- Press the TRACE key > [Trace 1/Trace 2/Trace 3/Trace 4/Trace 5/Trace 6](#) softkey > "Max Hold" on page 94 softkey.
- Press the SWEEP key > "Sweep Count" softkey.
- In the "Average Sweep Count" dialog box, enter 10.
- Press the ["Single Sweep"](#) on page 89 softkey:
R&S FSVR performs the "Max Hold" function over 10 sweeps.

Remote command:

[\[SENSe:\] SWEEp:COUNT](#) on page 866

Sweep Points

Opens an edit dialog box to enter the number of measured values to be collected during one sweep.

- Entry via rotary knob:
 - In the range from 101 to 1001, the sweep points are increased or decreased in steps of 100 points.
 - In the range from 1001 to 32001, the sweep points are increased or decreased in steps of 1000 points.
- Entry via keypad:
All values in the defined range can be set.

The default value is 691 sweep points.

When measuring spurious emissions, using this softkey automatically opens the "Sweep List" dialog, see ["Sweep List dialog box"](#) on page 219.

Remote command:

[\[SENSe:\] SWEEp:POINTs](#) on page 872

Capture Mode

This command defines how the size of the capture buffer is defined for analog demodulation.

In Auto mode, the size of the capture buffer is identical to the defined [Meas Time](#).

In Manual mode, the size of the capture buffer can be defined manually ([Capture Time](#)).

Remote command:

[\[SENSe:\] ADEMod:CAPTure\[:MODE\]](#) on page 751

Capture Time

Defines the size of the capture buffer for analog demodulation if [Capture Mode](#) is set to "Manual".

The maximum capture buffer size is 7.5 MSamples; the capture time depends on the defined DBW. For a DBW of 25 kHz, for example, the maximum capture time is 240 s.

Remote command:

[\[SENSe:\] ADEMod:CAPTure:TIME](#) on page 751

Demod Offset

This command defines an offset of the defined measurement time from the beginning of the capture buffer for analog demodulation if **Capture Mode** is set to "Manual". All results are recalculated automatically based on the new data.

Remote command:

[SENSe:]ADEMod:CAPTure:DOFFset on page 750

5.2.8 Softkeys of the Trace Menu – TRACE key (analog demodulation)

The TRACE key is used to configure the data acquisition for measurement and the analysis of the measurement data.

Trace 1/Trace 2/Trace 3/Trace 4/Trace 5/Trace 6

Selects the active trace (1, 2, 3, 4, 5, 6) and opens the "Trace Mode" submenu for the selected trace.

The default setting is trace 1 in the overwrite mode (see "Clear Write" on page 94), the other traces are switched off (see "Blank" on page 95). For details see [chapter 4.1.8.4, "Trace Mode Overview"](#), on page 104.

Tip: To configure several traces in one step, press the **Trace Wizard** softkey to open a trace configuration dialog. See also [chapter 4.1.8.2, "Configuring Traces"](#), on page 101.

Remote command:

Selected via numeric suffix of:TRACe<1 . . . 6> commands

Clear Write ← Trace 1/Trace 2/Trace 3/Trace 4/Trace 5/Trace 6

Overwrite mode: the trace is overwritten by each sweep. This is the default setting.

All available detectors can be selected.

Remote command:

DISP:TRAC:MODE WRIT, see [DISPlay\[:WINDow<n>\]:TRACe<t>:MODE](#) on page 716

Max Hold ← Trace 1/Trace 2/Trace 3/Trace 4/Trace 5/Trace 6

The maximum value is determined over several sweeps and displayed. The R&S FSVR saves the sweep result in the trace memory only if the new value is greater than the previous one.

The detector is automatically set to "Positive Peak".

This mode is especially useful with modulated or pulsed signals. The signal spectrum is filled up upon each sweep until all signal components are detected in a kind of envelope.

This mode is not available for statistics measurements.

Remote command:

DISP:TRAC:MODE MAXH, see [DISPlay\[:WINDow<n>\]:TRACe<t>:MODE](#) on page 716

Min Hold ← Trace 1/Trace 2/Trace 3/Trace 4/Trace 5/Trace 6

The minimum value is determined from several measurements and displayed. The R&S FSVR saves the smallest of the previously stored/currently measured values in the trace memory.

The detector is automatically set to "Negative Peak".

This mode is useful e.g. for making an unmodulated carrier in a composite signal visible. Noise, interference signals or modulated signals are suppressed whereas a CW signal is recognized by its constant level.

This mode is not available for statistics measurements.

Remote command:

DISP:TRAC:MODE MINH, see [DISPlay\[:WINDow<n>\]:TRACe<t>:MODE](#)
on page 716

Average ← Trace 1/Trace 2/Trace 3/Trace 4/Trace 5/Trace 6

The average is formed over several sweeps. The [Sweep Count](#) determines the number of averaging procedures.

All available detectors can be selected. If the detector is automatically selected, the sample detector is used (see [chapter 4.1.8.6, "Detector Overview"](#), on page 106).

This mode is not available for statistics measurements.

Remote command:

DISP:TRAC:MODE AVER, see [DISPlay\[:WINDow<n>\]:TRACe<t>:MODE](#)
on page 716

View ← Trace 1/Trace 2/Trace 3/Trace 4/Trace 5/Trace 6

The current contents of the trace memory are frozen and displayed.

Note: If a trace is frozen, the instrument settings, apart from level range and reference level (see below), can be changed without impact on the displayed trace. The fact that the displayed trace no longer matches the current instrument setting is indicated by the  icon on the tab label.

If the level range or reference level is changed, the R&S FSVR automatically adapts the measured data to the changed display range. This allows an amplitude zoom to be made after the measurement in order to show details of the trace.

Remote command:

DISP:TRAC:MODE VIEW, see [DISPlay\[:WINDow<n>\]:TRACe<t>:MODE](#)
on page 716

Blank ← Trace 1/Trace 2/Trace 3/Trace 4/Trace 5/Trace 6

Hides the selected trace.

Remote command:

DISP:TRAC OFF, see [DISPlay\[:WINDow<n>\]:TRACe<t>\[:STATE\]](#) on page 715

Hold/Cont ← Trace 1/Trace 2/Trace 3/Trace 4/Trace 5/Trace 6

Switches the reset of the traces in Min Hold, Max Hold and Average mode after some specific parameter changes have been made on and off. The default setting is off.

Normally, the measurement is started anew after parameter changes, before the measurement results are evaluated (e.g. using a marker). In all cases that require a new measurement after parameter changes, the trace is reset automatically to avoid false results (e.g. with span changes). For applications that require no reset after parameter changes, the automatic reset can be switched off.

Remote command:

`DISPlay[:WINDow<n>]:TRACe<t>:MODE:HCONtinuous` on page 716

Detector ← Trace 1/Trace 2/Trace 3/Trace 4/Trace 5/Trace 6

Opens a submenu to select the detector manually, or activate automatic selection.

Note: When measuring spurious emissions, using this softkey automatically opens the Sweep List dialog, see "[Sweep List dialog box](#)" on page 219.

If a detector was selected manually, the "MAN" indicator is highlighted.

If "AUTO" is selected, the detector is defined automatically, depending on the selected trace mode:

Trace mode	Detector
Clear Write	Auto Peak
Max Hold	Positive Peak
Min Hold	Negative Peak
Average	Sample Peak
View	–
Blank	–

Note: In Analog Demod mode, if AUTO is selected, the Auto Peak detector is used regardless of the trace mode. However, if Noise or Phase Noise measurements are performed in Analog Demod mode, the Sample Detector is used.

Auto Select ← Detector ← Trace 1/Trace 2/Trace 3/Trace 4/Trace 5/Trace 6

Selects the best detector for the selected trace and filter mode. This is the default setting.

Trace mode	Detector
Clear/Write	Auto Peak
Average	Sample
Max Hold	Max Peak
Min Hold	Min Peak

Remote command:

`[SENSe:] [WINDow:] DETECTOR<trace>[:FUNCTION]:AUTO` on page 875

Auto Peak ← Detector ← Trace 1/Trace 2/Trace 3/Trace 4/Trace 5/Trace 6

Selects the "Auto Peak" detector.

Remote command:

DET APE, see [SENSe:] [WINDow:] DETector<trace>[:FUNCTION]

on page 874

Positive Peak ← Detector ← Trace 1/Trace 2/Trace 3/Trace 4/Trace 5/Trace 6

Selects the "Positive Peak" detector.

Remote command:

DET POS, see [SENSe:] [WINDow:] DETector<trace>[:FUNCTION]

on page 874

Negative Peak ← Detector ← Trace 1/Trace 2/Trace 3/Trace 4/Trace 5/Trace 6

Selects the "Negative Peak" detector.

Remote command:

DET NEG, see [SENSe:] [WINDow:] DETector<trace>[:FUNCTION]

on page 874

Sample ← Detector ← Trace 1/Trace 2/Trace 3/Trace 4/Trace 5/Trace 6

Selects the "Sample" detector.

Remote command:

DET SAMP, see [SENSe:] [WINDow:] DETector<trace>[:FUNCTION]

on page 874

RMS ← Detector ← Trace 1/Trace 2/Trace 3/Trace 4/Trace 5/Trace 6

Selects the "RMS" detector.

Remote command:

DET RMS, see [SENSe:] [WINDow:] DETector<trace>[:FUNCTION]

on page 874

Average ← Detector ← Trace 1/Trace 2/Trace 3/Trace 4/Trace 5/Trace 6

Selects the "Average" detector.

Remote command:

DET AVER, see [SENSe:] [WINDow:] DETector<trace>[:FUNCTION]

on page 874

Quasipeak ← Detector ← Trace 1/Trace 2/Trace 3/Trace 4/Trace 5/Trace 6

Selects the "Quasipeak" detector.

The quasipeak detector is available with option R&S FSV-K54.

Remote command:

DET QPE, see [SENSe:] [WINDow:] DETector<trace>[:FUNCTION]

on page 874

CISPR Average ← Detector ← Trace 1/Trace 2/Trace 3/Trace 4/Trace 5/Trace 6

Selects the "CISPR Average" detector.

The CISPR Average detector is available with option R&S FSV-K54.

Remote command:

DET CAV, see [SENSe:] [WINDow:] DETector<trace>[:FUNCTION]
on page 874

RMS Average ← Detector ← Trace 1/Trace 2/Trace 3/Trace 4/Trace 5/Trace 6

Selects the "RMS Average" detector.

The quasipeak detector is available with option R&S FSV-K54.

Remote command:

DET CRMS, see [SENSe:] [WINDow:] DETector<trace>[:FUNCTION]
on page 874

More Traces

Opens a submenu to select one of the traces not currently displayed in the main menu.

Trace Wizard

Opens the "Trace Wizard" dialog. See [chapter 4.1.8.2, "Configuring Traces"](#), on page 101.

Average Mode

Opens a submenu to select the averaging method for the average trace mode. The following methods are available:

- [Lin](#)
- [Log](#)
- [Power](#)

Logarithmic averaging is recommended to display signals with a low signal to noise ratio. While positive peak values are decreased in logarithmic averaging due to the characteristics involved, it is also true that negative peaks are increased relative to the average value. If the distorted amplitude distribution is averaged, a value is obtained that is smaller than the actual average value. The difference is -2.5 dB.

This low average value is usually corrected in noise power measurements by a 2.5 dB factor. Therefore the R&S FSVR offers the selection of linear averaging. The trace data is converted to linear values prior to averaging, then averaged and reconverted to logarithmic values. After these conversions the data is displayed on the screen. The average value is always correctly displayed irrespective of the signal characteristic.

In case of stationary sinusoidal signals both logarithmic and linear averaging has the same results.

Lin ← Average Mode

Activates linear averaging. Linear averaging means that the power level values are converted into linear units prior to averaging. After the averaging, the data is converted back into its original unit.

This softkey takes effect if the grid is set to a linear scale (see "Range Linear" softkey, ["Range Linear %"](#) on page 69). In this case, the averaging is done in two ways (depending on the set unit – see "Unit" softkey):

- The unit is set to either W or dBm: the data is converted into W prior to averaging, i.e. averaging is done in W.

- The unit is set to either V, A, dBmV, dBμV, dBμA or dBpW: the data is converted into V prior to averaging, i.e. averaging is done in V.

Remote command:

SENS:AVER1:TYPE LIN, see [SENSe:]AVERage<n>:TYPE on page 780

Log ← Average Mode

Activates logarithmic averaging.

This averaging method only takes effect if the grid is set to a logarithmic scale ("Range" softkey), i.e. the unit of the data is dBm. In this case the values are averaged in dBm. Otherwise (i.e. with linear scaling), the behavior is the same as with linear averaging (see [Lin](#) softkey). For further information on logarithmic scaling refer to the "Average Mode" softkey.

Remote command:

SENS:AVER1:TYPE VID, see [SENSe:]AVERage<n>:TYPE on page 780

Power ← Average Mode

Activates linear power averaging.

The power level values are converted into unit Watt prior to averaging. After the averaging, the data is converted back into its original unit.

Unlike the linear mode, the averaging is always done in W.

Remote command:

SENS:AVER1:TYPE POW, see [SENSe:]AVERage<n>:TYPE on page 780

ASCII Trace Export

Opens the "ASCII Trace Export Name" dialog box and saves the active trace in ASCII format to the specified file and directory.

The file consists of the header containing important scaling parameters and a data section containing the trace data. For details on an ASCII file see [chapter 4.1.8.7, "ASCII File Export Format"](#), on page 107.

This format can be processed by spreadsheet calculation programs, e.g. MS-Excel. It is necessary to define ';' as a separator for the data import. Different language versions of evaluation programs may require a different handling of the decimal point. It is therefore possible to select between separators '.' (decimal point) and ',' (comma) using the "Decim Sep" softkey (see ["Decim Sep"](#) on page 100).

Remote command:

FORMat:DEXPort:DSEPARATOR on page 728

MMEMory:STORe<n>:TRACe on page 744

MMEMory:STORe:SGRam on page 743

Decim Sep

Selects the decimal separator with floating-point numerals for the ASCII Trace export to support evaluation programs (e.g. MS-Excel) in different languages. The values '.' (decimal point) and ',' (comma) can be set.

Remote command:

FORMat:DEXPort:DSEPARATOR on page 728

5.2.9 Softkeys of the Trigger Menu – TRIG Key (analog demodulation)

The following table shows all softkeys available in the "Trigger" menu in "Analog Demodulation" mode (TRIG key). It is possible that your instrument configuration does not provide all softkeys. If a softkey is only available with a special option, model or (measurement) mode, this information is delivered in the corresponding softkey description.

Trigger Source.....	372
L FM.....	372
L AM.....	372
L PM.....	373
L RF.....	373
Trigger Level.....	373
Trigger Polarity.....	373
Trigger Offset.....	373
Repetition Interval.....	374
Trigger Hysteresis.....	374
Trigger Holdoff.....	374

Trigger Source

Opens the "Trg Source" submenu to select the trigger source.

In "Analog Demodulation" mode, the next measurement is triggered if the selected input signal exceeds the threshold specified using the "Trigger Level" softkey (see "Trigger Level" on page 294). A periodic signal modulated onto the carrier frequency can be displayed in this way. It is recommended that the measurement time covers at least five periods of the audio signal.

For triggering with AM, FM, PM or RF trigger sources to be successful, the measurement time must cover at least 5 periods of the audio signal.

For more information on trigger sources also available in the Spectrum application refer to the following topics:

- "Free Run" on page 110
- "External" on page 110
- "RF Power" on page 110
- "IF Power/BB Power" on page 111
- "Time" on page 112

Remote command:

TRIGger<n>[:SEquence]:SOURce on page 913

FM ← Trigger Source

Triggers on the specified frequency level of the FM signal.

Remote command:

TRIG:SEQ:SOUR FM, see TRIGger<n>[:SEquence]:SOURce on page 913

AM ← Trigger Source

Triggers on the specified modulation depth of the AM signal.

Remote command:

TRIG:SEQ:SOUR AMR, see TRIGger<n>[:SEquence]:SOURce on page 913

PM ← Trigger Source

Triggers on the specified phase of the PM signal.

Remote command:

TRIG:SEQ:SOUR PM, see [TRIGger<n>\[:SEQuence\]:SOURce](#) on page 913

RF ← Trigger Source

Triggers on the specified level of the RF signal.

Note: The RF **offline** trigger is based on the I/Q data of the demodulated signal, limited to the demodulation bandwidth. For a wider trigger bandwidth and triggering based on the currently measured RF input signal, use the more powerful [RF Power](#) trigger.

Remote command:

TRIG:SEQ:SOUR AM, see [TRIGger<n>\[:SEQuence\]:SOURce](#) on page 913

Trigger Level

Defines the trigger level as a numeric value.

In the trigger mode "Time", this softkey is not available.

Remote command:

[TRIGger<n>\[:SEQuence\]:LEVel:IFPower](#) on page 911

[TRIGger<n>\[:SEQuence\]:LEVel:VIDeo](#) on page 912

For digital input via the R&S Digital I/Q Interface, R&S FSV-B17:

[TRIGger<n>\[:SEQuence\]:LEVel:BBPower](#) on page 910

Trigger Polarity

Sets the polarity of the trigger source.

The sweep starts after a positive or negative edge of the trigger signal. The default setting is "Pos". The setting applies to all modes with the exception of the "Free Run" and "Time" mode.

"Pos" Level triggering: the sweep is stopped by the logic "0" signal and restarted by the logical "1" signal after the gate delay time has elapsed.

"Neg" Edge triggering: the sweep is continued on a "0" to "1" transition for the gate length duration after the gate delay time has elapsed.

Remote command:

[TRIGger<n>\[:SEQuence\]:SLOPe](#) on page 913

[\[SENSe:\]SWEep:EGATe:POLarity](#) on page 868

Trigger Offset

Opens an edit dialog box to enter the time offset between the trigger signal and the start of the sweep. The time may be entered in multiples of 125 ns in the range -13 s to 13 s (default 0 s).

offset > 0:	start of the sweep is delayed
offset < 0:	<p>sweep starts earlier (pre-trigger)</p> <p>only possible for span = 0 and gated trigger switched off</p> <p>not possible if RMS or average detector activated</p> <p>maximum allowed range and the maximum resolution limited by the sweep time:</p> <ul style="list-style-type: none"> • $\text{range}_{\text{max}} = -499/500 \times \text{sweep time}$ • $\text{resolution}_{\text{max}} = \text{sweep time}/500$

In the trigger mode **Time**, this softkey is not available.

For details on the relation between demodulation bandwidth and trigger offset refer to [chapter 5.1.8, "Sample Rate, Measurement Time and Trigger Offset"](#), on page 325.

Remote command:

[TRIGger<n>\[:SEquence\]:HOLDoff\[:TIME\]](#) on page 908

Repetition Interval

Opens an edit dialog box to define a repetition interval in which the measurement is triggered. The shortest interval is 2 ms. This softkey is only available if the trigger source "Time" is selected (see **"Time"** on page 112).

Remote command:

[TRIGger<n>\[:SEquence\]:TIME:RINterval](#) on page 915

Trigger Hysteresis

Defines the value for the trigger hysteresis for "IF power" or "RF Power" trigger sources. The hysteresis in dB is the value the input signal must stay below the power trigger level in order to allow a trigger to start the measurement. The range of the value is between 3 dB and 50 dB with a step width of 1 dB.

Remote command:

[TRIGger<n>\[:SEquence\]:IFPower:HYSteresis](#) on page 909

Trigger Holdoff

Defines the value for the trigger holdoff. The holdoff value in s is the time which must pass before triggering, in case another trigger event happens.

This softkey is only available if "IFPower", "RF Power" or "BBPower" is the selected trigger source.

Remote command:

[TRIGger<n>\[:SEquence\]:IFPower:HOLDoff](#) on page 909

For digital input via the R&S Digital I/Q Interface, R&S FSV-B17:

[TRIGger<n>\[:SEquence\]:BBPower:HOLDoff](#) on page 909

5.2.10 Softkeys of the Marker Menu – MKR key (analog demodulation)

The following table shows all softkeys available in the "Marker" menu in "Analog Demodulation" mode (MKR key). It is possible that your instrument configuration does not provide all softkeys. If a softkey is only available with a special option, model or

(measurement) mode, this information is provided in the corresponding softkey description.

Marker 1 / Marker 2 / Marker 3 / ... Marker 16,/ Marker Norm/Delta.....	375
More Markers.....	375
Marker to Trace.....	375
Marker Wizard.....	376
L All Marker Off.....	377
All Marker Off.....	377
Marker Table.....	377
Marker Stepsize.....	377
L Stepsize Standard.....	377
L Stepsize Sweep Points.....	378
Marker Zoom (span > 0).....	378
Link Mkr1 and Delta1.....	378
Link Time Marker.....	378
Link AF Spectrum Marker.....	379

Marker 1 / Marker 2 / Marker 3 / ... Marker 16,/ Marker Norm/Delta

The "Marker X" softkey activates the corresponding marker and opens an edit dialog box to enter a value for the marker to be set to. Pressing the softkey again deactivates the selected marker.

If a marker value is changed using the rotary knob, the step size is defined via the [Stepsize Standard](#) or [Stepsize Sweep Points](#) softkeys.

Marker 1 is always the reference marker for relative measurements. If activated, markers 2 to 16 are delta markers that refer to marker 1. These markers can be converted into markers with absolute value display using the "Marker Norm/Delta" softkey. If marker 1 is the active marker, pressing the "Marker Norm/Delta" softkey switches on an additional delta marker.

Remote command:

[CALCulate<n>:MARKer<m>\[:STATe\]](#) on page 608

[CALCulate<n>:MARKer<m>:X](#) on page 618

[CALCulate<n>:MARKer<m>:Y](#) on page 620

[CALCulate<n>:DELTAmarker<m>\[:STATe\]](#) on page 557

[CALCulate<n>:DELTAmarker<m>:X](#) on page 568

[CALCulate<n>:DELTAmarker<m>:X:RELative?](#) on page 569

[CALCulate<n>:DELTAmarker<m>:Y](#) on page 569

More Markers

Opens a sub-menu to select one of up to 16 available markers. See "[Marker 1 / Marker 2 / Marker 3 / ... Marker 16,/ Marker Norm/Delta](#)" on page 120.

Marker to Trace

Opens an edit dialog box to enter the number of the trace on which the marker is to be placed.

Remote command:

[CALCulate<n>:MARKer<m>:TRACe](#) on page 617

[CALCulate<n>:DELTAmarker<m>:TRACe](#) on page 567

Marker Wizard

Opens a configuration dialog for markers. The marker wizard allows you to configure and activate up to 16 different markers in one dialog. The first 8 markers are displayed on one tab, the last 8 markers on a second tab. For each marker, the following settings are available:



"Selected/State" When you press the "Selected" or "State" field the corresponding marker is activated and the marker row is highlighted.

"Normal/Delta" Defines whether it is a normal marker or delta marker. For delta markers you can define a reference marker.

"Ref. Marker" Reference marker for delta markers. The marker values for the delta marker are indicated relative to the specified reference marker. The reference marker can either be another active marker, or a fixed reference marker ("FXD", see ["Ref Fixed"](#) on page 131).

"Trace" Trace for which the marker is to be set.

Remote command:

[CALCulate<n>:MARKer<m>\[:STATe\]](#) on page 608

[CALCulate<n>:DELTAmarker<m>\[:STATe\]](#) on page 557

[CALCulate<n>:MARKer<m>:TRACe](#) on page 617

[CALCulate<n>:DELTAmarker<m>:TRACe](#) on page 567

[CALCulate<n>:DELTAmarker<m>:MREF](#) on page 567

All Marker Off ← Marker Wizard

Switches all markers off. It also switches off all functions and displays that are associated with the markers/delta markers.

Remote command:

`CALCulate<n>:MARKer<m>:AOFF` on page 608

All Marker Off

Switches all markers off. It also switches off all functions and displays that are associated with the markers/delta markers.

Remote command:

`CALCulate<n>:MARKer<m>:AOFF` on page 608

Marker Table

Defines how the marker information is displayed.

For more information, see "Displayed Marker Information" in the description of the base unit.

For more information, see [Displayed Marker Information](#).

"On" Displays the marker information in a table in a separate area beneath the diagram.

"Off" Displays the marker information within the diagram area.

"Aut" (Default) The marker table is displayed automatically if more than 2 markers are active, and removed if only 1 or 2 markers are active. This helps keep the information in the display clear.

Remote command:

`DISPlay:MTABLE` on page 710

Marker Stepsize

Opens a submenu to set the step size of all markers and delta markers.

Default value for the marker step size is [Stepsize Sweep Points](#).

Stepsize Standard ← Marker Stepsize

Moves the marker or delta marker from one measurement point to the next, if the marker or delta marker value is changed via the rotary knob ("Marker 1 / Marker 2 / Marker 3 / ... Marker 16, / Marker Norm/Delta" softkeys, see "[Marker 1 / Marker 2 / Marker 3 / ... Marker 16, / Marker Norm/Delta](#)" on page 120). If more measured values than measurement points exist, it is not possible to read out all measured values. In this case, use the [Stepsize Sweep Points](#) softkey.

Remote command:

`CALC:MARK:X:SSIZ STAN` (see `CALCulate<n>:MARKer<m>:X:SSIZe` on page 620)

Stepsize Sweep Points ← Marker Stepsize

Moves the marker or delta marker from one measured value to the next, if the marker or delta marker value is changed via the rotary knob ("Marker 1 / Marker 2 / Marker 3 / ... Marker 16,/ Marker Norm/Delta" softkeys, see "[Marker 1 / Marker 2 / Marker 3 / ... Marker 16,/ Marker Norm/Delta](#)" on page 120). If more measured values than measurement points exist, every single measured value is accessible and its value is displayed in the marker field.

The number of measured values is defined in the ""Sweep"" menu via the [Sweep Points](#) softkey.

This functionality is available for all base unit measurements with the exception of statistics ("APD" and "CCDF" softkeys in the "Measurement" menu).

Remote command:

`CALC:MARK:X:SSIZ POIN` (see [CALCulate<n>:MARKer<m>:X:SSIZe](#) on page 620)

Marker Zoom (span > 0)

Opens an edit dialog box to enter a display range for the zoom. The area around marker 1 is expanded accordingly and more details of the result can be seen. If no marker is activated, marker 1 is switched on and set on the largest signal.

The following sweep is stopped at the position of the reference marker. The frequency of the signal is counted and the measured frequency becomes the new center frequency. The zoomed display range is then configured and the new settings are used by the R&S FSVR for further measurements.

If the display has not yet been switched to the new frequency display range and you press the softkey, the procedure is aborted. If an instrument setting is changed during this operation, the procedure is also aborted.

This function is not available in I/Q Analyzer mode.

Remote command:

`CALCulate<n>:MARKer<m>:FUNCTION:ZOOM` on page 640

Link Mkr1 and Delta1

The delta marker 1 is linked to marker 1, so if the x-axis value of the marker 1 is changed, the delta marker 1 will follow on the same x-position. The link is off by default.

You can set the two markers on different traces to measure the difference (e.g. between a max hold trace and a min hold trace or between a measurement and a reference trace).

Remote command:

`CALCulate<n>:DELTAmarker<m>:LINK` on page 563

Link Time Marker

Links the markers in all time domain diagrams.

Remote command:

`CALCulate<n>:MARKer<m>:LINK` on page 610

Link AF Spectrum Marker

Links the markers in all AF spectrum displays.

Remote command:

`CALCulate<n>:MARKer<m>:LINK` on page 610

5.2.11 Softkeys of the Marker Function Menu – MKR FUNC Key (analog demodulation)

The following table shows all softkeys available in the "Marker Function" menu.

Select Marker (No).....	379
Phase Noise.....	379
Ref Fixed.....	379
L Ref. Fixed On/Off.....	380
L Ref Point Level.....	380
L Ref Point Frequency (span > 0)/Ref Point Time (zero span).....	380
L Peak Search.....	380
n dB down.....	380
Marker Peak List.....	381
L Peak List On/Off.....	381
L Sort Mode Freq/Lvl.....	381
L Max Peak Count.....	382
L Peak Excursion.....	382
L Left Limit.....	382
L Right Limit.....	382
L Threshold.....	382
L ASCII File Export.....	382
L Decim Sep.....	383
L Marker Number.....	383

Select Marker (No)

Opens a submenu to select one of 16 markers and define whether the marker is a normal or a delta marker (see "Marker 1 / Marker 2 / Marker 3 / ... Marker 16, / Marker Norm/Delta" on page 120). "(No)" indicates the number of the currently active marker.

See "Marker 1 / Marker 2 / Marker 3 / ... Marker 16, / Marker Norm/Delta" on page 120.

Phase Noise

For AF spectrum displays, the Phase Noise marker is a normal marker with a special display value.

Remote command:

`CALCulate<n>:MARKer<m>:FUNCTION:PNOise:RESult?` on page 637

`CALCulate<n>:MARKer<m>:FUNCTION:PNOise:RESult?` on page 637

Ref Fixed

Opens a submenu to set all values of a reference point. Instead of using the current values of the reference marker (marker 1) as reference point for the delta markers, level and frequency or time are set to fixed values and used as reference point.

Ref. Fixed On/Off ← Ref Fixed

Switches the relative measurement to a fixed reference value on or off. The level and frequency or time values of marker 1 immediately become the reference point, but can be altered using the corresponding softkeys ("Ref Point Level" on page 130, "Ref Point Frequency (span > 0)/Ref Point Time (zero span)" on page 130 and "Peak Search" on page 130).

When set to ON, all delta markers which previously referenced marker 1 are automatically set to reference the fixed marker.

The reference marker assignment can be changed using the "Marker Wizard" (see "Marker Wizard" on page 121).

Remote command:

`CALCulate<n>:DELTAmarker<m>:FUNCTION:FIXed[:STATe]` on page 559

Ref Point Level ← Ref Fixed

Opens an edit dialog box to enter a reference level value. All relative level values of the delta markers refer to this reference level.

Remote command:

`CALCulate<n>:DELTAmarker<m>:FUNCTION:FIXed:RPOINT:Y` on page 561

Ref Point Frequency (span > 0)/Ref Point Time (zero span) ← Ref Fixed

Opens an edit dialog box to enter a frequency reference or time value. All relative frequency or time values of the delta markers refer to this frequency reference. For phase noise measurement, input of reference time is not possible.

Remote command:

`CALCulate<n>:DELTAmarker<m>:FUNCTION:FIXed:RPOINT:X` on page 560

Peak Search ← Ref Fixed

Sets the maximum value of the selected trace as the reference point.

Remote command:

`CALCulate<n>:DELTAmarker<m>:FUNCTION:FIXed:RPOINT:MAXimum[:PEAK]` on page 560

n dB down

Opens an edit dialog box to enter a value to define the level spacing of the two temporary markers to the right and left of marker 1 (default setting: 3 dB). Activates the temporary markers T1 and T2. The values of the temporary markers (T1, T2) and the entered value (ndB) are displayed in the marker field.

If a positive value is entered, the markers T1 and T2 are placed below the active reference marker. If a negative value (e.g. for notch filter measurements) is entered, the markers T1 and T2 are placed above the active reference marker. Marker T1 is placed to the left and marker T2 to the right of the reference marker.

In the marker table, the following results are displayed:

Span setting	Parameter name	Description
span > 0	Bw	frequency spacing of the two temporary markers
	Q factor	quality of the displayed bandwidth value (Bw)
span = 0	PWid	pulse width between the two temporary markers

If it is not possible to form the frequency spacing for the n dB value (e.g. because of noise display), dashes instead of a measured value are displayed.

Remote command:

CALC:MARK1:FUNC:NDBD:STAT ON, see [CALCulate<n>:MARKer<m>:FUNCTION:NDBDown:STATe](#) on page 635

CALC:MARK1:FUNC:NDBD 3dB, see [CALCulate<n>:MARKer<m>:FUNCTION:NDBDown](#) on page 633

CALC:MARK1:FUNC:NDBD:RES? , see [CALCulate<n>:MARKer<m>:FUNCTION:NDBDown:RESult?](#) on page 635

CALC:MARK:FUNC:NDBD:QFAC?, see [CALCulate<n>:MARKer<m>:FUNCTION:NDBDown:QFACTOR](#) on page 634

CALC:MARK1:FUNC:NDBD:FREQ? (span > 0), see [CALCulate<n>:MARKer<m>:FUNCTION:NDBDown:FREQUENCY?](#) on page 634

CALC:MARK1:FUNC:NDBD:TIME? (span = 0), see [CALCulate<n>:MARKer<m>:FUNCTION:NDBDown:TIME?](#) on page 636

Marker Peak List

Opens the "Peak List" submenu to define criteria for the sort order and the contents of the peak list. For each listed peak the frequency ("Stimulus") and level ("Response") values are given. In addition, the peaks are indicated in the trace display. A maximum of 50 entries are listed.

Remote command:

[CALCulate<n>:MARKer<m>:FUNCTION:FPEaks:COUNT?](#) on page 629

[CALCulate<n>:MARKer<m>:FUNCTION:FPEaks:X](#) on page 630

[CALCulate<n>:MARKer<m>:FUNCTION:FPEaks:Y?](#) on page 631

Peak List On/Off ← Marker Peak List

Activates/deactivates the marker peak list. If activated, the peak list is displayed and the peaks are indicated in the trace display.

Remote command:

[CALCulate<n>:MARKer<m>:FUNCTION:FPEaks:STAT](#) on page 630

Sort Mode Freq/Lvl ← Marker Peak List

Defines the criteria for sorting:

"Freq" sorting in ascending order of frequency values (span > 0) or time values (span = 0)

"Lvl" sorting in ascending order of the level

Remote command:

[CALCulate<n>:MARKer<m>:FUNCTION:FPEaks:SORT](#) on page 630

Max Peak Count ← Marker Peak List

Defines the maximum number of peaks to be determined and displayed.

Remote command:

`CALCulate<n>:MARKer<m>:FUNCTION:FPEaks:LIST:SIZE` on page 629

Peak Excursion ← Marker Peak List

Opens an edit dialog box for level measurements to enter the minimum level value by which a signal must rise or fall so that it will be identified as a maximum or a minimum by the search functions. Entries from 0 dB to 80 dB are allowed; the resolution is 0.1 dB. The default setting for the peak excursion is 6 dB.

For more information see "Specifying the suitable peak excursion" and "Effect of different peak excursion settings".

Remote command:

`CALCulate<n>:MARKer<m>:PEXCursion` on page 616

Left Limit ← Marker Peak List

Opens an edit dialog box to enter a value for the lower limit (left vertical line: S1 for span > 0; T1 for zero span). The search is performed between the lines of the left and right limit (see also [Right Limit](#) softkey).

Remote command:

`CALCulate<n>:MARKer<m>:X:SLIMits:LEFT` on page 618

Right Limit ← Marker Peak List

Opens an edit dialog box to enter a value for the upper limit (left vertical line: S2 for span > 0; T2 for zero span). The search is performed between the lines of the left and right limit (see also [Left Limit](#) softkey). If no value is set, the upper limit corresponds to the stop frequency.

Remote command:

`CALCulate<n>:MARKer<m>:X:SLIMits:RIGHT` on page 619

Threshold ← Marker Peak List

Opens an edit dialog box to define the threshold line. The threshold line represents the lower level limit for a "Peak" search and the upper level limit for a "Min" search.

Remote command:

`CALCulate<n>:THReshold:STATe` on page 703

`CALCulate<n>:THReshold` on page 702

ASCII File Export ← Marker Peak List

Opens the "ASCII File Export Name" dialog box and saves the active peak list in ASCII format to the specified file and directory.

The file consists of the header containing important scaling parameters and a data section containing the marker data. For details on an ASCII file see [chapter 4.1.8.7, "ASCII File Export Format"](#), on page 107.

This format can be processed by spreadsheet calculation programs, e.g. MS-Excel. It is necessary to define ';' as a separator for the data import. Different language versions of evaluation programs may require a different handling of the decimal point. It is therefore possible to select between separators '.' (decimal point) and ',' (comma) using the "Decim Sep" softkey (see "Decim Sep" on page 100).

An example of an output file for Spectrum Emission Mask measurements is given in "ASCII File Export Format (Spectrum Emission Mask)" on page 210.

Remote command:

`FORMat:DEXPort:DSEPARATOR` on page 728

`MMEMemory:STORE<n>:LIST` on page 742

Decim Sep ← Marker Peak List

Selects the decimal separator with floating-point numerals for the ASCII Trace export to support evaluation programs (e.g. MS-Excel) in different languages. The values '.' (decimal point) and ',' (comma) can be set.

Remote command:

`FORMat:DEXPort:DSEPARATOR` on page 728

Marker Number ← Marker Peak List

If enabled, the determined peaks are indicated by their corresponding marker number in the trace display.

Remote command:

`CALCulate<n>:MARKer<m>:FUNCTION:FPEaks:ANN:LAB:STAT` on page 628

5.2.12 Softkeys of the Input/Output Menu

The following table shows all softkeys available in the "Input/Output" menu. It is possible that your instrument configuration does not provide all softkeys. If a softkey is only available with a special option, model or (measurement) mode, this information is provided in the corresponding softkey description.

Input (AC/DC).....	384
Noise Source.....	384
Video Output.....	384
Power Sensor.....	384
Trigger Out.....	385
External Mixer.....	385
Probe Config.....	385
Signal Source.....	385
L Input Path.....	385
L Connected Device.....	385
L Input Sample Rate.....	385
L Full Scale Level.....	386
L Level Unit.....	386
L Adjust Reference Level to Full Scale Level.....	386
EXIQ.....	386
L TX Settings.....	386
L RX Settings.....	386

L Send To	386
L Firmware Update	387
L R&S Support	387
L DiglConf	387
Digital Output	387
Digital IQ Info	388

Input (AC/DC)

Toggles the RF input of the R&S FSVR between AC and DC coupling.

This function is not available for input from the R&S Digital I/Q Interface (option R&S FSV-B17).

Remote command:

[INPut:COUPling](#) on page 732

Noise Source

Switches the supply voltage for an external noise source on or off. For details on connectors refer to the R&S FSVR Quick Start Guide, "Front and Rear Panel" chapter.

Remote command:

[DIAGnostic<n>:SERVice:NSOource](#) on page 928

Video Output

Turns output on the IF / Video output available with option R&S FSV-B5 on and off.

When you turn on the output, you can select to output either the intermediate frequency or the video signal.

Note: Video output does not return valid values in IQ or FFT mode.

Remote command:

[OUTPut:IF VID](#) , see [OUTPut:IF\[:SOURce\]](#) on page 959

Power Sensor

For precise power measurement a power sensor can be connected to the instrument via the front panel (USB connector) or the rear panel (power sensor, option R&S FSV-B5). The Power Sensor Support firmware option (R&S FSV-K9) provides the power measurement functions for this test setup.

This softkey is only available if the R&S FSVR option Power Sensor (R&S FSV-K9) is installed.

For details see [chapter 4.5, "Instrument Functions - Power Sensor \(R&S FSV-K9\)"](#), on page 304.

For details see the chapter "Instrument Functions Power Sensor (K9)" in the base unit description.

This softkey is available for RF measurements.

Trigger Out

Sets the Trigger Out port in the Additional Interfaces (option R&S FSV-B5 only) to low or high. Thus, you can trigger an additional device via the external trigger port, for example.

Remote command:

`OUTPut:TRIGger` on page 959

External Mixer

Opens the submenu for the external mixer.

For details see the base unit description.

Probe Config

Opens an edit dialog box to activate and configure a connected probe which is to provide an input signal. It is only available if a probe is connected to the instrument's RF INPUT and USB connectors.

For details see [chapter 4.2.8.2, "Using Active Probes for Input"](#), on page 273.

For details see the base unit Operating Manual.

Remote command:

`PROBe[:STATe]` on page 748

`PROBe:SETup:MODE` on page 747

Signal Source

Opens a dialog box to select the signal source.

For "Digital Baseband (I/Q)", the source can also be configured here.

Input Path ← Signal Source

Defines whether the "RF Radio Frequency" or the "Digital IQ" input path is used for measurements. "Digital IQ" is only available if option R&S FSV-B17 (R&S Digital I/Q Interface) is installed.

Note: Note that the input path defines the characteristics of the signal, which differ significantly between the RF input and digital input.

Remote command:

`INPut:SElect` on page 738

Connected Device ← Signal Source

Displays the name of the device connected to the optional R&S Digital I/Q Interface (R&S FSV-B17) to provide Digital IQ input. The device name cannot be changed here.

The device name is unknown.

Remote command:

`INPut:DIQ:CDEvice` on page 733

Input Sample Rate ← Signal Source

Defines the sample rate of the digital I/Q signal source. This sample rate must correspond with the sample rate provided by the connected device, e.g. a generator.

Remote command:

`INPut:DIQ:SRATe` on page 735

Full Scale Level ← Signal Source

The "Full Scale Level" defines the level that should correspond to an I/Q sample with the magnitude "1".

The level can be defined either in dBm or Volt.

Remote command:

`INPut:DIQ:RANGe[:UPPer]` on page 734

Level Unit ← Signal Source

Defines the unit used for the full scale level.

Remote command:

`INPut:DIQ:RANGe[:UPPer]:UNIT` on page 735

Adjust Reference Level to Full Scale Level ← Signal Source

If enabled, the reference level is adjusted to the full scale level automatically if any change occurs.

(See the [Auto Level](#) softkey).

Remote command:

`INPut:DIQ:RANGe:COUPling` on page 734

EXIQ

Opens a configuration dialog box for an optionally connected R&S EX-IQ-BOX and a submenu to access the main settings quickly.

Note: The EX-IQ-Box functionality is not supported for R&S FSVR models 1321.3008Kxx.

If the optional R&S DigIConf software is installed, the submenu consists only of one key to access the software. **Note that R&S DigIConf requires a USB connection (not LAN!) from the R&S FSVR to the R&S EX-IQ-BOX in addition to the R&S Digital I/Q Interface connection. R&S DigIConf version 2.10 or higher is required.**

For typical applications of the R&S EX-IQ-BOX see also the description of the R&S Digital I/Q Interface (R&S FSV-B17) in the base unit manual.

For details on configuration see the "R&S®Ex I/Q Box - External Signal Interface Module Manual".

For details on installation and operation of the R&S DigIConf software, see the "R&S®EX-IQ-BOX Digital Interface Module R&S®DigIConf Software Operating Manual".

TX Settings ← EXIQ

Opens the "EX-IQ-BOX Settings" dialog box to configure the R&S FSVR for digital output to a connected device ("Transmitter" Type).

RX Settings ← EXIQ

Opens the "EX-IQ-BOX Settings" dialog box to configure the R&S FSVR for digital input from a connected device ("Receiver" Type).

Send To ← EXIQ

The configuration settings defined in the dialog box are transferred to the R&S EX-IQ-BOX.

Firmware Update ← EXIQ

If a firmware update for the R&S EX-IQ-BOX is delivered with the R&S FSVR firmware, this function is available. In this case, when you select the softkey, the firmware update is performed.

R&S Support ← EXIQ

Stores useful information for troubleshooting in case of errors.

This data is stored in the `C:\R_S\Instr\user\Support` directory on the instrument.

If you contact the Rohde&Schwarz support to get help for a certain problem, send these files to the support in order to identify and solve the problem faster.

DigIConf ← EXIQ

Starts the optional R&S DigIConf application. This softkey is only available if the optional software is installed.

To return to the R&S FSVR application, press any key on the front panel. The application is displayed with the "EXIQ" menu, regardless of which key was pressed.

For details on the R&S DigIConf application, see the "R&S®EX-IQ-BOX Digital Interface Module R&S®DigIConf Software Operating Manual".

Note: If you close the R&S DigIConf window using the "Close" icon, the window is minimized, not closed.

If you select the "File > Exit" menu item in the R&S DigIConf window, the application is closed. Note that in this case the settings are lost and the EX-IQ-BOX functionality is no longer available until you restart the application using the "DigIConf" softkey in the R&S FSVR once again.

Remote command:

Remote commands for the R&S DigIConf software always begin with `SOURCE:EBOX`. Such commands are passed on from the R&S FSVR to the R&S DigIConf automatically which then configures the R&S EX-IQ-BOX via the USB connection.

All remote commands available for configuration via the R&S DigIConf software are described in the "R&S®EX-IQ-BOX Digital Interface Module R&S®DigIConf Software Operating Manual".

Example 1:

```
SOURCE:EBOX:*RST
```

```
SOURCE:EBOX:*IDN?
```

Result:

```
"Rohde&Schwarz,DigIConf,02.05.436 Build 47"
```

Example 2:

```
SOURCE:EBOX:USER:CLOCK:REFERENCE:FREQUENCY 5MHZ
```

Defines the frequency value of the reference clock.

Digital Output

Opens a dialog box to enable a digital output stream to the optional R&S Digital I/Q Interface (R&S FSV-B17), if available.

The displayed sample rate is identical to the sample rate defined under [Data Acquisition](#) (I/Q Analyzer) and is not editable here.

For details see "Digital Output" in the description of the R&S Digital I/Q Interface for the base unit.

Remote command:

[OUTPut:DIQ](#) on page 744

Digital IQ Info

Displays a dialog box with information on the digital I/Q input and output connection via the optional R&S Digital I/Q Interface (R&S FSV-B17), if available. The information includes:

- Device identification
- Used port
- (Maximum) digital input/output sample rates and maximum digital input/output transfer rates
- Status of the connection protocol
- Status of the PRBS descewing test

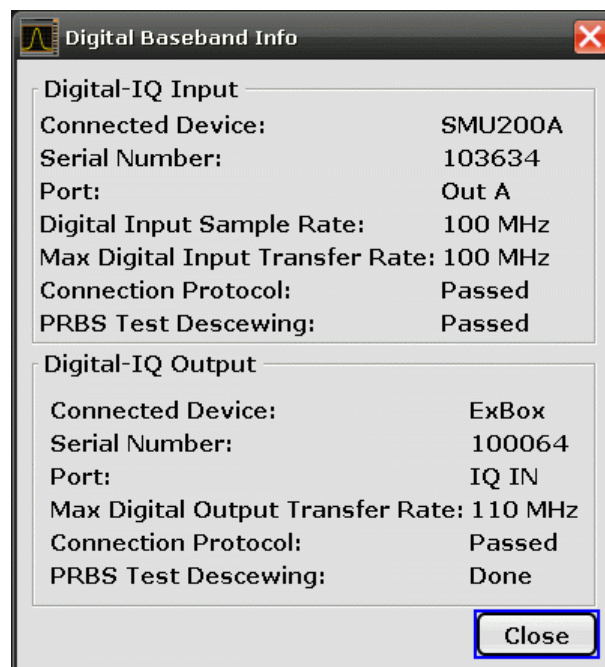

For details see "Interface Status Information" in "Instrument Functions - R&S Digital I/Q Interface (Option R&S FSV-B17)" in the description of the base unit.

Remote command:

[INPut:DIQ:CDEvice](#) on page 733

5.3 Functions of the Stereo FM Demodulator

This section provides information on the Stereo FM demodulation parameters and settings and its softkey menus. All menus not described here are provided as described for the base unit.

5.3.1 Softkeys of the FM Stereo Menu - MEAS key (K7S)

This section describes all softkeys available in the "FM Stereo" menu.

Left.....	390
L Display Config.....	390
L Screen A-D.....	390
L Predefined.....	391
L Add.....	391
L Apply.....	391
L Remove.....	391
L Restore.....	392
L Close.....	392
L Result Summary Setup.....	392
L Detector.....	393
L Mode.....	393
L Coupled.....	393
L Meas To Ref.....	394
L Meas Time.....	394
L AF Filter.....	394
L High Pass.....	394
L Low Pass.....	395
L Weighting.....	395
L None.....	396
L CCITT.....	396
L CCIR Unweighted.....	396
L CCIR Weighted.....	396
L A Weighted.....	396
L Deemphasis.....	397
L Coupled.....	397
L All AF Filter Off.....	397
L AF Range.....	398
L Dev per Division.....	398
L Reference Position.....	398
L Reference Value.....	398
L AF Coupling AC/DC.....	399
L Deviation Lin/Log.....	399
L Unit.....	399
L Phase Unit (Rad/Deg).....	399
L THD Unit (% / DB).....	399
L Abs. Dev Unit (kHz/dBm).....	399
L Rel. Dev Unit (dB / %).....	400
L Time Domain Zoom.....	400
L State On / Off.....	400
L Start.....	400
L Length Manual.....	400
L Length Auto.....	400
L Time per Division.....	400
L Squelch.....	401
L Squelch Level.....	401

Right.....	401
MPX.....	401
Mono.....	401
Stereo.....	401
RDS.....	401
Pilot.....	402
RF Power.....	402
Display Config.....	402

Left

Displays the left signal of the FM stereo input and the "Left" submenu.

Remote command:

CALCulate<n>:FEED on page 705

Display Config ← Left

You configure the display settings for the results in the "Display Configuration" dialog box. This dialog box contains the following tabs:

- "Screen A-D": a separate tab for each of the four available screens
- "Predefined": for predefined display configurations

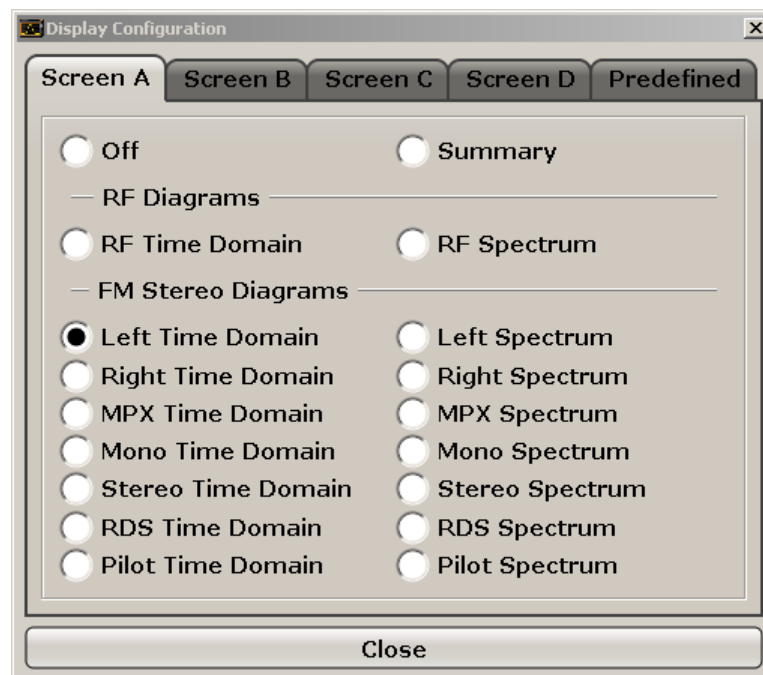
**Screen A-D ← Display Config ← Left**

For each of the four available screens you can configure what is to be displayed. To define the Display Configuration for a screen, select the corresponding tab. For each screen you can define:

- "Off": Whether it is displayed or not
- "Summary": Whether a summary of the evaluation lists from all screens is displayed instead of a diagram
- "RF Diagrams": Which type of diagram is displayed; this is the standard analog demodulation diagram type

For details on the result diagram types, see [chapter 5.1.9, "Measurement Result Display"](#), on page 327.

- "FM Stereo Diagrams": Which type of FM stereo diagram is displayed; each measurement type can be displayed either in the time domain or as a spectrum

Note: Summaries that take up the entire width of the screen are displayed as tables; if only half the screen width is available (2 windows next to each other), the summary is displayed as a list. Thus, the factory-set predefined screen configurations contain only 3 screens: 2 for diagrams and one full-width screen for the summary.

Remote command:

[INSTRument\[:SElect\]](#) on page 739

Activates stereo fm demodulation.

[CALCulate<n>:FEED](#) on page 705

Defines the display configuration.

Predefined ← Display Config ← Left

You can store and load predefined screen configurations. All available configurations are displayed in the "Predefined" tab. The current screen configuration is indicated under "Current" at the top of the list.

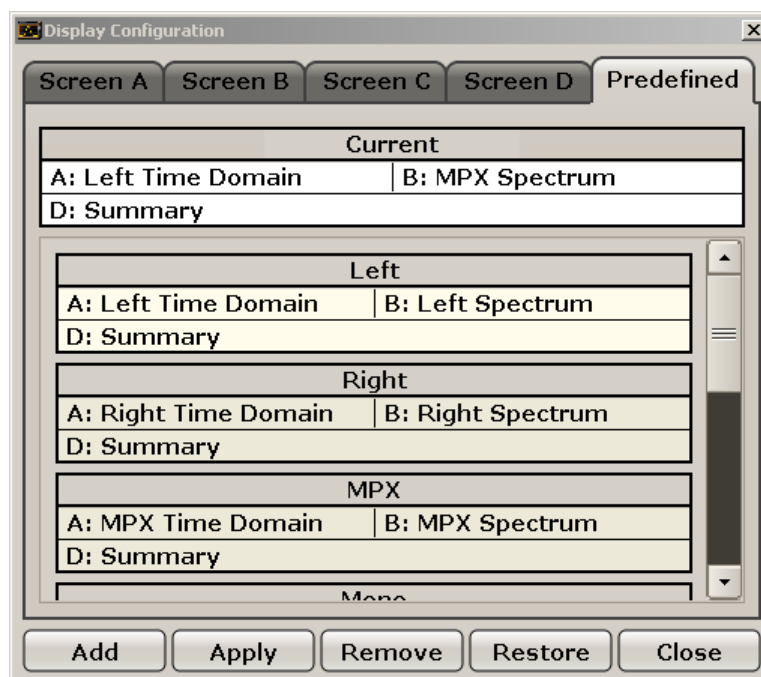

Add ← Predefined ← Display Config ← Left

Opens an edit dialog box to enter a name for the current screen configuration. The configuration is then stored and added to the list.

Apply ← Predefined ← Display Config ← Left

Applies the currently selected configuration from the list to the current display.

Remove ← Predefined ← Display Config ← Left

Removes the currently selected configuration from the list.

Restore ← Predefined ← Display Config ← Left

Restores the default display configuration. Existing configurations with the default names are replaced.

Close ← Predefined ← Display Config ← Left

Closes the displays settings dialog box.

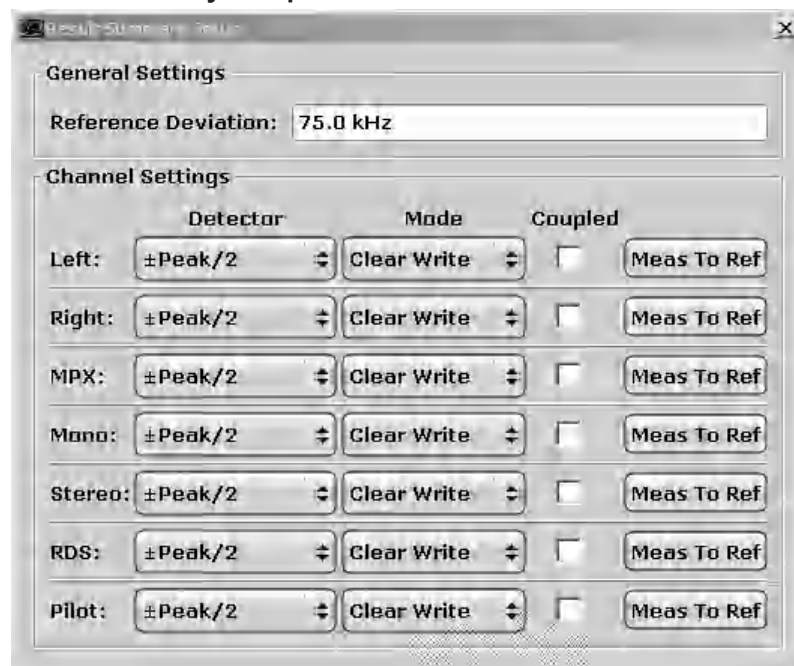
Result Summary Setup ← Left

The result summary table displays the results of all channel measurements in a table. It is configured in the "Result Summary Setup" dialog box. This function is only available for screens for which an FM stereo measurement is selected in the "Display Settings" (see "Display Config" on page 390).

B Result Summary							
Carrier Power: -200.97 dBm		Carrier Freq: 15.0 GHz		Mod Depth: 0.0 %			
	Detector	Result Mode	Dev.	Rel. to Ref.	Mod. Freq.	SINAD	THD
Left	±Peak/2	Clear Write	0.000 Hz	---	---	---	---
Right	±Peak/2	Clear Write	0.000 Hz	---	---	---	---
MPX	±Peak/2	Clear Write	0.000 Hz	---	---	---	---
Mono	±Peak/2	Clear Write	0.000 Hz	---	---	---	---
Stereo	±Peak/2	Clear Write	0.000 Hz	---	---	---	---
RDS	±Peak/2	Clear Write	0.000 Hz	---	---	---	---
Pilot	±Peak/2	Clear Write	0.000 Hz	---	---	---	---

Fig. 5-2: Result summary for an FM stereo measurement

In the "General Settings" area you define the "Reference Deviation" for all summaries manually. Alternatively, you can determine the reference deviation from one of the channel measurements by selecting "Meas To Ref" (see "Meas To Ref" on page 394).

For each FM stereo channel you can define individual channel settings:

- "Detector" on page 393
- "Mode" on page 393

- "Coupled" on page 393
- "Meas To Ref" on page 394

Remote command:

[SENSe:] SFM:REFeRence on page 856

[SENSe:] SFM:<ChannelType>:RSUMmary:DETeCtor[:FUNctIon] on page 863

[SENSe:] SFM:<ChannelType>:RSUMmary:MODe on page 864

[SENSe:] SFM:<ChannelType>:RSUMmary:COUPling on page 862

[SENSe:] SFM:<ChannelType>:RSUMmary:REFeRence[:AUto] ONCE
on page 864

Detector ← Result Summary Setup ← Left

Defines the detector used for the deviation measurement.

- "RMS"
- "RMS*SQRT2"
- "Pos Peak"
- "Neg Peak"
- "±Peak/2"
- "QP CCIR"
- "QP*SQRT2"

Note: To ensure correct measurements with QP detectors, it is recommended that you set the measurement time to its maximum value (see "Meas Time" on page 338 and chapter 5.1.8, "Sample Rate, Measurement Time and Trigger Offset", on page 325).

Remote command:

[SENSe:] SFM:<ChannelType>:RSUMmary:DETeCtor[:FUNctIon] on page 863

Mode ← Result Summary Setup ← Left

Defines the result summary mode for the absolute deviation and the deviation relative to the reference.

"Clear Write" Overwrite mode: the summary is overwritten by each sweep. This is the default setting.

"Peak Hold" The peak values are determined over several sweeps and displayed.

"Average" The average is formed over several sweeps.

Remote command:

[SENSe:] SFM:<ChannelType>:RSUMmary:MODe on page 864

Coupled ← Result Summary Setup ← Left

All channels for which this option is enabled are configured identically, i.e. the channel settings are coupled. If you change the settings for one coupled channel, the settings are changed for all other coupled channels, as well. The settings are taken from the first channel for which coupling is enabled.

Remote command:

[SENSe:] SFM:<ChannelType>:RSUMmary:COUPling on page 862

Meas To Ref ← Result Summary Setup ← Left

Determines the "Reference Deviation" from the current channel measurement.

Remote command:

[SENSe:]SFM:<ChannelType>:RSUMmary:REFErence[:AUTO] ONCE

on page 864

Meas Time ← Left

Opens an editor for entering the measurement time of the analog demodulation. For details on the measurement time values refer to [chapter 5.1.8, "Sample Rate, Measurement Time and Trigger Offset"](#), on page 325.

Note: For FM Stereo measurements (option K7S), the minimum measurement time is 2 ms.

Remote command:

[SENSe:]ADEMod:MTIME on page 764

AF Filter ← Left

Opens a dialog to select the appropriate filters.

The bandwidth of the demodulated signal can be reduced by high pass or low pass filters and also a weighting or de-emphasis can be switched on. You can define different filter settings for each channel.

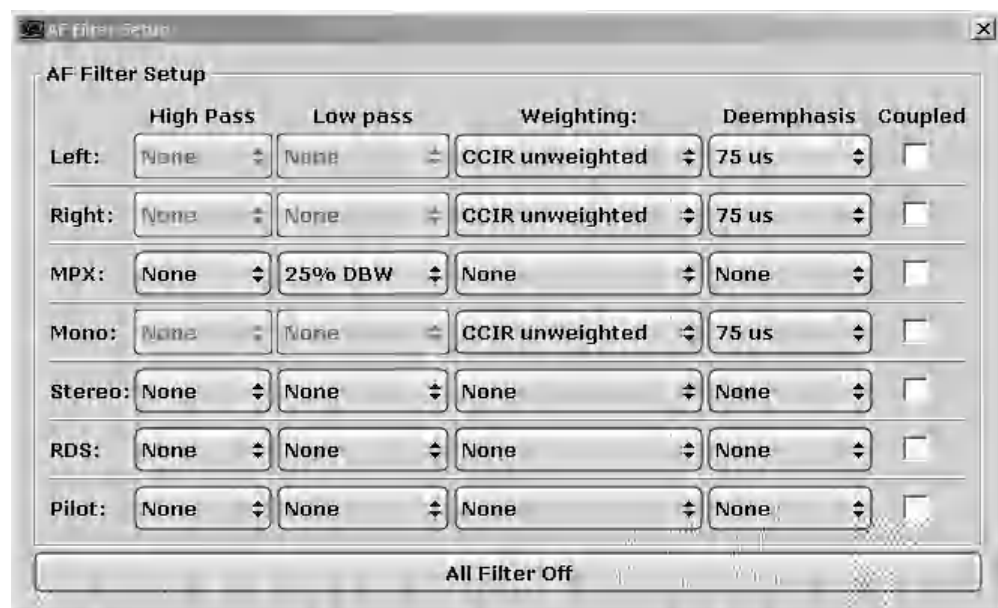
**High Pass ← AF Filter ← Left**

Opens the "High Pass" selection list to switch on a high pass filter with the given limit to separate the DC component. The filters are indicated by the 3 dB cutoff frequency. The 50 Hz and 300 Hz filters are designed as 2nd-order Butterworth filter (12 dB/octave). The 20 Hz filter is designed as 3rd-order Butterworth filter (18 dB/octave).

"None" deactivates the AF high pass filter. Default is "None".

The high pass filters are active in the following demodulation bandwidth range:

20 Hz	100 Hz ≤ demodulation bandwidth ≤ 1.6 MHz
50 Hz:	200 Hz ≤ demodulation bandwidth ≤ 3 MHz
300 Hz:	800 Hz ≤ demodulation bandwidth ≤ 8 MHz
Note: for FM stereo (K7S), all filters are active at all times, as the demodulation range is always 400 kHz	

Remote command:

[SENSe:] FILTer<n>:HPASs[:STATe] on page 805

[SENSe:] FILTer<n>:HPASs:FREQuency on page 806

Low Pass ← AF Filter ← Left

Opens the "Low Pass" selection list to select the filter type. Relative and absolute low pass filter are available.

- Absolute low pass filters:
The 3 kHz, 15 kHz; 23 kHz and 150 kHz softkeys switch on a absolute low pass filter. The filters are indicated by the 3 dB cutoff frequency. The 3 kHz, 15 kHz and 23 kHz filters are designed as 5th-order Butterworth filters (30 dB/octave). The 150 kHz filter is designed as 8th-order Butterworth filter (48 dB/octave).
The absolute low pass filters are active in the following demodulation bandwidth range:

3 kHz:	6.4 kHz ≤ demodulation bandwidth ≤ 3 MHz
15 kHz:	50 kHz ≤ demodulation bandwidth ≤ 8 MHz
23 kHz	50 kHz ≤ demodulation bandwidth ≤ 18 MHz
150 kHz:	400 kHz ≤ demodulation bandwidth ≤ 8 MHz
Note: for FM stereo (K7S), all filters are active at all times, as the demodulation range is always 400 kHz	

- Relative low pass filters:
The filters (3 dB) can be selected in % of the demodulation bandwidth. The filters are designed as 5th-order Butterworth filter (30 dB/octave) and active for all demodulation bandwidths.
- "None" deactivates the AF low pass filter. Default is "None".

Remote command:

[SENSe:] FILTer<n>:LPASs[:STATe] on page 806

[SENSe:] FILTer<n>:LPASs:FREQuency[:ABSolute] on page 807

[SENSe:] FILTer<n>:LPASs:FREQuency:RELative on page 807

SFM:

[SENSe:] SFM:<ChannelType>:FILTer:LPASs:STATe on page 861

[SENSe:] SFM:<ChannelType>:FILTer:LPASs:FREQuency on page 861

Weighting ← AF Filter ← Left

Opens the "Weighting" selection list to select the weighting AF filter.

None ← Weighting ← AF Filter ← Left

Deactivates the weighting filter. This is the default setting.

Remote command:

`[SENSe:] FILTer<n>:HPASs[:STATe]` on page 805

CCITT ← Weighting ← AF Filter ← Left

Switches on a CCITT P.53 weighting filter. The weighting filter is active in the following demodulation bandwidth range:

$20 \text{ kHz} \leq \text{demodulation bandwidth} \leq 3 \text{ MHz}$

For FM stereo (K7S), the filter is active at all times, as the demodulation range is always 400 kHz.

Remote command:

`[SENSe:] FILTer<n>:CCIT` on page 803

SFM:

`[SENSe:] SFM:<ChannelType>:FILTer:CCITt:STATe` on page 858

CCIR Unweighted ← Weighting ← AF Filter ← Left

Switches on the CCIR unweighted filter, which is the combination of the 20 Hz high-pass and 23 kHz low pass filter. The weighting filter is active in the following demodulation bandwidth range:

$50 \text{ kHz} \leq \text{demodulation bandwidth} \leq 1.6 \text{ MHz}$

For FM stereo (K7S), the filter is active at all times, as the demodulation range is always 400 kHz.

Remote command:

`[SENSe:] FILTer<n>:CCIR[:UNWeighted][:STATe]` on page 804

SFM:

`[SENSe:] SFM:<ChannelType>:FILTer:CCIR[:UNWeighted][:STATe]`
on page 858

CCIR Weighted ← Weighting ← AF Filter ← Left

Switches on the CCIR weighted filter. The weighting filter is active in the following demodulation bandwidth range:

$100 \text{ kHz} \leq \text{demodulation bandwidth} \leq 3.0 \text{ MHz}$

For FM stereo (K7S), the filter is active at all times, as the demodulation range is always 400 kHz.

Remote command:

`[SENSe:] FILTer<n>:CCIR:WEIGhted[:STATe]` on page 804

SFM:

`[SENSe:] SFM:<ChannelType>:FILTer:CCIR:WEIGhted[:STATe]` on page 859

A Weighted ← Weighting ← AF Filter ← Left

Switches on the A weighted filter. The weighting filter is active in the following demodulation bandwidth range:

100 kHz ≤ demodulation bandwidth ≤ 800 kHz

Remote command:

[SENSe:]FILTer<n>:AWEighted[:STATe] on page 803

SFM:

[SENSe:]SFM:<ChannelType>:FILTer:AWEighted[:STATe] on page 858

Deemphasis ← AF Filter ← Left

Opens the "Deemphasis" selection list to switch on a deemphasis with the given time constant.

The deemphasis is active in the following demodulation bandwidth range:

Note: For FM stereo measurements (K7S), the demodulation bandwidth is always 400 kHz, thus the deemphasis is always active.

25 µs:	25 kHz ≤ demodulation bandwidth ≤ 40 MHz
50 µs:	6.4 kHz ≤ demodulation bandwidth ≤ 18 MHz
75 µs:	6.4 kHz ≤ demodulation bandwidth ≤ 18 MHz
750 µs:	800 Hz ≤ demodulation bandwidth ≤ 3 MHz

The following table shows the required demodulation bandwidth for an error less than 0.5 dB up to a maximum AF frequency.

deemphasis	25 µs	50 µs	75 µs	750 µs
max. AF frequency	25 kHz	12 kHz	8 kHz	800 Hz
required demodulation bandwidth	≥ 200 kHz	≥ 100 kHz	≥ 50 kHz	≥ 6.4 kHz

For higher AF frequencies the demodulation bandwidth must be increased.

Remote command:

[SENSe:]FILTer<n>:DEMPHasis[:STATe] on page 805

[SENSe:]FILTer<n>:DEMPHasis:TCONstant on page 805

SFM:

[SENSe:]SFM:<ChannelType>:FILTer:DEMPHasis:STATe on page 859

[SENSe:]SFM:<ChannelType>:FILTer:DEMPHasis:TCONstant on page 860

Coupled ← AF Filter ← Left

All channels for which this option is enabled are configured identically, i.e. the channel settings are coupled. If you change the settings for one coupled channel, the settings are changed for all other coupled channels, as well. The settings are taken from the first channel for which coupling is enabled.

Remote command:

[SENSe:]SFM:<ChannelType>:RSUMmary:COUPling on page 862

All AF Filter Off ← AF Filter ← Left

Disables all specified AF Filters.

Remote command:

[SENSe:]FILTer<n>:AOFF on page 803

AF Range ← Left

Opens a submenu to define the diagram scaling for AF displays.

Dev per Division ← AF Range ← Left

Opens an edit dialog box to set the modulation depth or the phase deviation (analog demodulation only), or frequency deviation per division:

AM display:	0.0001 % to 1000 %
FM display:	1 Hz/div to 100 MHz/div
PM display:	0.0001 rad/div to 1000 rad/div

The softkey is not available if logarithmic display is set ("Deviation Lin/Log" softkey).

Remote command:

[DISPlay\[:WINDow<n>\]:TRACe<t>:MODE:HCONTinuous](#) on page 719

Reference Position ← AF Range ← Left

Determines the position of the reference line for the modulation depth or the phase deviation (analog demodulation only) or frequency deviation on the y-axis of the diagram. By default, this line is set to 0.

The position is entered as a percentage of the diagram height with 100 % corresponding to the upper diagram border. The default setting is 50 % (diagram center) for the display of the AM, FM, or PM signal, and 100 % (upper diagram border) for the AF spectrum display of the AM, FM, or PM signal.

Remote command:

[DISPlay\[:WINDow<n>\]:TRACe<t>:Y\[:SCALe\]:RPOSition](#) on page 720

Reference Value ← AF Range ← Left

Determines the modulation depth or the phase deviation (analog demodulation only) or the frequency deviation at the reference line of the y-axis. The reference value is set separately for each display of the AM, FM, and PM signal and the AF spectrum of the AM, FM, and PM signal.

- AM/FM/PM signal display
The trace display takes individual frequency/phase offsets into account (in contrast, the [AF Coupling AC/DC](#) softkey permits automatic correction by the average frequency/phase offset of the signal, and can therefore not be activated simultaneously).
Possible values: 0 and ± 10000 % (AM), 0 and ± 10 MHz (FM), 0 and ± 10000 rad (PM).
- AF spectrum display of the AM/FM/PM signal
In the default setting, the reference value defines the modulation depth or the FM/PM deviation at the upper diagram border.
Possible values: 0 and 10000 % (AM), 0 and 10 MHz (FM), 0 and 10000 rad (PM).

Remote command:

[DISPlay\[:WINDow<n>\]:TRACe<t>:Y\[:SCALe\]:RVALue](#) on page 721

AF Coupling AC/DC ← AF Range ← Left

Controls the automatic correction of the frequency offset and phase offset of the input signal:

(**Note:** This function is not available with the AF spectrum display of the FM or PM signal.)

- FM signal display
 - If DC is selected, the absolute frequency is displayed, i.e. an input signal with an offset relative to the center frequency is not displayed symmetrically with respect to the zero line.
 - If AC is selected, the frequency offset is automatically corrected, i.e. the trace is always symmetric with respect to the zero line.
- PM signal display
 - If DC is selected, the phase runs according to the existing frequency offset. In addition, the DC signal contains a phase offset of $\pm \pi$.
 - If AC is selected, the frequency offset and phase offset are automatically corrected, i.e. the trace is always symmetric with respect to the zero line.

Remote command:

[\[SENSe:\]ADEMod<n>:AF:COUPling](#) on page 752

Deviation Lin/Log ← AF Range ← Left

Switches between logarithmic and linear display of the modulation depth or the phase deviation (analog demodulation only) or the frequency deviation.

Remote command:

[DISPlay\[:WINDow<n>\]:TRACe<t>:Y:SPACing](#) on page 717

Unit ← AF Range ← Left

Opens a submenu to define the modulation unit.

Phase Unit (Rad/Deg) ← Unit ← AF Range ← Left

Sets the phase unit to rad or deg for displaying PM signals.

Remote command:

[UNIT:THD](#) on page 921

THD Unit (% / DB) ← Unit ← AF Range ← Left

Sets the unit to percent or DB for THD measurements.

Remote command:

[UNIT:THD](#) on page 921

Abs. Dev Unit (kHz/dBm) ← Unit ← AF Range ← Left

Sets the unit for absolute deviation to kHz or dBm. This softkey is only available with the FM Stereo option K7S.

Remote command:

[UNIT:ADEV](#) on page 921

Rel. Dev Unit (dB / %) ← Unit ← AF Range ← Left

Sets the unit for relative deviation to dB or percent. This softkey is only available with the FM Stereo option K7S.

Remote command:

`UNIT:RDEV` on page 922

Time Domain Zoom ← Left

Opens a submenu to activate and configure the zoom function.

State On / Off ← Time Domain Zoom ← Left

Activates or deactivates the time domain zoom according to the defined settings.

"ON" Activates the time domain zoom. The zoom area is defined using the "Start" ["Start"](#) on page 344 and "Length Manual" ["Length Manual"](#) on page 344 / "Length Auto" ["Length Auto"](#) on page 344 softkeys.

"OFF" If more measured values than measurement points are available, several measured values are combined in one measurement point according to the method of the selected trace detector. For details on detectors refer to [chapter 4.1.8.6, "Detector Overview"](#), on page 106.

Remote command:

`[SENSe:]ADEMod<n>:ZOOM[:STATe]` on page 774

Start ← Time Domain Zoom ← Left

Opens an edit dialog box to define the start time for the zoom area.

Remote command:

`[SENSe:]ADEMod<n>:ZOOM:START` on page 775

Length Manual ← Time Domain Zoom ← Left

Opens an edit dialog box to define the length of the zoom area (as a time value) manually.

Remote command:

`[SENSe:]ADEMod<n>:ZOOM:LENGTh` on page 775

Length Auto ← Time Domain Zoom ← Left

Automatically sets the length of the zoom area to the number of sweep points (see ["Sweep Points"](#) on page 91).

Remote command:

`[SENSe:]ADEMod<n>:ZOOM:LENGTh:MODE` on page 776

Time per Division ← Left

This function enables the "Time Domain Zoom" function and defines the zoom area length in one step. The width of the zoom display is divided into 10 divisions; thus, by entering the time that is displayed in each division, you indirectly define the zoom area length ("Time per Division" * 10). The starting point of the zoom area is determined automatically. To specify the starting point manually, use the "Start" function in the "Time Domain Zoom" submenu.

For details see "Time Domain Zoom".

Squelch ← Left

Activates the squelch function, i.e. if the signal falls below a defined threshold, the demodulated data is automatically set to 0. This is useful, for example, to avoid demodulation noise during transmission breaks.

Remote command:

`[SENSe:]ADEMod:SQUelch[:STATe]` on page 773

Squelch Level ← Left

Defines the level threshold below which the demodulated data is set to 0 if squelching is enabled. The squelch level is an absolute value.

Remote command:

`[SENSe:]ADEMod:SQUelch:LEVel` on page 773

Right

Displays the right signal of the FM stereo input and the "Right" submenu, which is identical to the "Left" submenu, see "Left" on page 390.

Remote command:

`CALCulate<n>:FEED` on page 705

MPX

Displays the MPX signal of the FM stereo input and the "MPX" submenu, which is identical to the "Left" submenu, see "Left" on page 390.

Remote command:

`CALCulate<n>:FEED` on page 705

Mono

Displays the mono signal of the FM stereo input (= Left channel + Right channel) and the "Mono" submenu, which is identical to the "Left" submenu, see "Left" on page 390.

Remote command:

`CALCulate<n>:FEED` on page 705

Stereo

Displays the stereo signal of the FM stereo input (= Left channel - Right channel) and the "Stereo" submenu, which is identical to the "Left" submenu, see "Left" on page 390.

Remote command:

`CALCulate<n>:FEED` on page 705

RDS

Displays the RDS signal of the FM stereo input and the "RDS" submenu, which is identical to the "Left" submenu, see "Left" on page 390.

Remote command:

`CALCulate<n>:FEED` on page 705

Pilot

Displays the pilot signal of the FM stereo input and the "Pilot" submenu, which is identical to the "Left" submenu, see "Left" on page 390.

Remote command:

CALCulate<n>:FEED on page 705

RF Power

Selects RF power as the modulation type, changes the signal display, and opens a submenu to set the measurement configuration. For details see the Analog Demodulation option K7 ("RF Power" on page 346).

Remote command:

CALCulate<n>:FEED on page 705

Display Config

See "Display Config" on page 390

5.3.2 Softkeys of the Amplitude Menu – AMPT Key (R&S FSV–K7S)

The following table shows all softkeys available in the "Amplitude" menu in "FM stereo" mode (AMPT key).

Ref Level.....	403
AF Range.....	403
L Dev per Division.....	403
L Reference Position.....	403
L Reference Value.....	403
L AF Coupling AC/DC.....	404
L Deviation Lin/Log.....	404
L Unit.....	404
L Phase Unit (Rad/Deg).....	404
L THD Unit (% / DB).....	404
L Abs. Dev Unit (kHz/dBm).....	405
L Rel. Dev Unit (dB / %).....	405
Unit.....	405
L Phase Unit (Rad/Deg).....	405
L THD Unit (% / DB).....	405
L Abs. Dev Unit (kHz/dBm).....	405
L Rel. Dev Unit (dB / %).....	405
Preamp On/Off.....	405
RF Atten Manual/Mech Att Manual.....	406
RF Atten Auto/Mech Att Auto.....	406
EI Atten On/Off.....	406
EI Atten Mode (Auto/Man).....	407
Ref Level Offset.....	407
Input (AC/DC).....	407
Input 50 Ω/75 Ω.....	408

Ref Level

Opens an edit dialog box to enter the reference level in the current unit (dBm, dBμV, etc).

The reference level is the maximum value the AD converter can handle without distortion of the measured value. Signal levels above this value will not be measured correctly, which is indicated by the "IFOVL" status display.

Remote command:

`DISPlay[:WINDow<n>]:TRACe<t>:Y[:SCALe]:RLEVel` on page 720

AF Range

Opens a submenu to define the diagram scaling for AF displays.

Dev per Division ← AF Range

Opens an edit dialog box to set the modulation depth or the phase deviation (analog demodulation only), or frequency deviation per division:

AM display:	0.0001 % to 1000 %
FM display:	1 Hz/div to 100 MHz/div
PM display:	0.0001 rad/div to 1000 rad/div

The softkey is not available if logarithmic display is set ("Deviation Lin/Log" softkey).

Remote command:

`DISPlay[:WINDow<n>]:TRACe<t>:MODE:HCONtinuous` on page 719

Reference Position ← AF Range

Determines the position of the reference line for the modulation depth or the phase deviation (analog demodulation only) or frequency deviation on the y-axis of the diagram. By default, this line is set to 0.

The position is entered as a percentage of the diagram height with 100 % corresponding to the upper diagram border. The default setting is 50 % (diagram center) for the display of the AM, FM, or PM signal, and 100 % (upper diagram border) for the AF spectrum display of the AM, FM, or PM signal.

Remote command:

`DISPlay[:WINDow<n>]:TRACe<t>:Y[:SCALe]:RPOSition` on page 720

Reference Value ← AF Range

Determines the modulation depth or the phase deviation (analog demodulation only) or the frequency deviation at the reference line of the y-axis. The reference value is set separately for each display of the AM, FM, and PM signal and the AF spectrum of the AM, FM, and PM signal.

- AM/FM/PM signal display

The trace display takes individual frequency/phase offsets into account (in contrast, the **AF Coupling AC/DC** softkey permits automatic correction by the average frequency/phase offset of the signal, and can therefore not be activated simultaneously).

Possible values: 0 and ± 10000 % (AM), 0 and ± 10 MHz (FM), 0 and ± 10000 rad (PM).

- AF spectrum display of the AM/FM/PM signal
In the default setting, the reference value defines the modulation depth or the FM/PM deviation at the upper diagram border.
Possible values: 0 and 10000 % (AM), 0 and 10 MHz (FM), 0 and 10000 rad (PM).

Remote command:

`DISPlay[:WINDow<n>]:TRACe<t>:Y[:SCALe]:RVALue` on page 721

AF Coupling AC/DC ← AF Range

Controls the automatic correction of the frequency offset and phase offset of the input signal:

(**Note:** This function is not available with the AF spectrum display of the FM or PM signal.)

- FM signal display
If DC is selected, the absolute frequency is displayed, i.e. an input signal with an offset relative to the center frequency is not displayed symmetrically with respect to the zero line.
If AC is selected, the frequency offset is automatically corrected, i.e. the trace is always symmetric with respect to the zero line.
- PM signal display
If DC is selected, the phase runs according to the existing frequency offset. In addition, the DC signal contains a phase offset of $\pm \pi$.
If AC is selected, the frequency offset and phase offset are automatically corrected, i.e. the trace is always symmetric with respect to the zero line.

Remote command:

`[SENSe:]ADEMod<n>:AF:COUPLing` on page 752

Deviation Lin/Log ← AF Range

Switches between logarithmic and linear display of the modulation depth or the phase deviation (analog demodulation only) or the frequency deviation.

Remote command:

`DISPlay[:WINDow<n>]:TRACe<t>:Y:SPACing` on page 717

Unit ← AF Range

Opens a submenu to define the modulation unit.

Phase Unit (Rad/Deg) ← Unit ← AF Range

Sets the phase unit to rad or deg for displaying PM signals.

Remote command:

`UNIT:THD` on page 921

THD Unit (% / DB) ← Unit ← AF Range

Sets the unit to percent or DB for THD measurements.

Remote command:

`UNIT:THD` on page 921

Abs. Dev Unit (kHz/dBm) ← Unit ← AF Range

Sets the unit for absolute deviation to kHz or dBm. This softkey is only available with the FM Stereo option K7S.

Remote command:

[UNIT:ADEV](#) on page 921

Rel. Dev Unit (dB / %) ← Unit ← AF Range

Sets the unit for relative deviation to dB or percent. This softkey is only available with the FM Stereo option K7S.

Remote command:

[UNIT:RDEV](#) on page 922

Unit

Opens a submenu to define the modulation unit.

Phase Unit (Rad/Deg) ← Unit

Sets the phase unit to rad or deg for displaying PM signals.

Remote command:

[UNIT:THD](#) on page 921

THD Unit (% / DB) ← Unit

Sets the unit to percent or DB for THD measurements.

Remote command:

[UNIT:THD](#) on page 921

Abs. Dev Unit (kHz/dBm) ← Unit

Sets the unit for absolute deviation to kHz or dBm. This softkey is only available with the FM Stereo option K7S.

Remote command:

[UNIT:ADEV](#) on page 921

Rel. Dev Unit (dB / %) ← Unit

Sets the unit for relative deviation to dB or percent. This softkey is only available with the FM Stereo option K7S.

Remote command:

[UNIT:RDEV](#) on page 922

Preamp On/Off

Switches the preamplifier on and off.

If option R&S FSV-B22 is installed, the preamplifier is only active below 7 GHz.

If option R&S FSV-B24 is installed, the preamplifier is active for all frequencies.

When measuring Spurious Emissions, using this softkey automatically opens the "Sweep List" dialog, see "[Sweep List dialog box](#)" on page 219.

This function is not available for input from the R&S Digital I/Q Interface (option R&S FSV-B17).

Remote command:

`INPut:GAIN:STATe` on page 737

RF Atten Manual/Mech Att Manual

Opens an edit dialog box to enter the attenuation, irrespective of the reference level. If electronic attenuation is activated (option R&S FSV-B25 only; "EI Atten Mode Auto" softkey), this setting defines the mechanical attenuation.

The mechanical attenuation can be set in 10 dB steps.

The RF attenuation can be set in 5 dB steps (with option R&S FSV-B25: 1 dB steps).

The range is specified in the data sheet. If the current reference level cannot be set for the set RF attenuation, the reference level is adjusted accordingly.

This function is not available for input from the R&S Digital I/Q Interface (option R&S FSV-B17).

The RF attenuation defines the level at the input mixer according to the formula:

$$\text{level}_{\text{mixer}} = \text{level}_{\text{input}} - \text{RF attenuation}$$

Note: As of firmware version 1.63, the maximum mixer level allowed is **0 dBm**. Mixer levels above this value may lead to incorrect measurement results, which are indicated by the "OVLD" status display. The increased mixer level allows for an improved signal, but also increases the risk of overloading the instrument!

When measuring spurious emissions, using this softkey automatically opens the "Sweep List" dialog box, see "[Sweep List dialog box](#)" on page 219.

Remote command:

`INPut:ATTenuation` on page 732

RF Atten Auto/Mech Att Auto

Sets the RF attenuation automatically as a function of the selected reference level. This ensures that the optimum RF attenuation is always used. It is the default setting.

When measuring spurious emissions, using this softkey automatically opens the "Sweep List" dialog, see "[Sweep List dialog box](#)" on page 219.

This function is not available for input from the R&S Digital I/Q Interface (option R&S FSV-B17).

Remote command:

`INPut:ATTenuation:AUTO` on page 732

EI Atten On/Off

This softkey switches the electronic attenuator on or off. This softkey is only available with option R&S FSV-B25.

When the electronic attenuator is activated, the mechanical and electronic attenuation can be defined separately. Note however, that both parts must be defined in the same mode, i.e. either both manually, or both automatically.

This function is not available for input from the R&S Digital I/Q Interface (option R&S FSV-B17).

- To define the mechanical attenuation, use the [RF Atten Manual/Mech Att Manual](#) or [RF Atten Auto/Mech Att Auto](#) softkeys.
- To define the electronic attenuation, use the [EI Atten Mode \(Auto/Man\)](#) softkey.

Note: This function is not available for stop frequencies (or center frequencies in zero span) >7 GHz. In this case, the electronic and mechanical attenuation are summarized and the electronic attenuation can no longer be defined individually. As soon as the stop or center frequency is reduced below 7 GHz, this function is available again. When the electronic attenuator is switched off, the corresponding RF attenuation mode (auto/manual) is automatically activated.

Remote command:

[INPut:EATT:AUTO](#) on page 736

EI Atten Mode (Auto/Man)

This softkey defines whether the electronic attenuator value is to be set automatically or manually. If manual mode is selected, an edit dialog box is opened to enter the value. This softkey is only available with option R&S FSV-B25, and only if the electronic attenuator has been activated via the [EI Atten On/Off](#) softkey.

Note: This function is not available for stop frequencies (or center frequencies in zero span) >7 GHz. In this case, the electronic and mechanical attenuation are summarized and the electronic attenuation can no longer be defined individually. As soon as the stop or center frequency is reduced below 7 GHz, electronic attenuation is available again. If the electronic attenuation was defined manually, it must be re-defined.

The attenuation can be varied in 1 dB steps from 0 to 30 dB. Other entries are rounded to the next lower integer value.

To re-open the edit dialog box for manual value definition, select the "Man" mode again.

If the defined reference level cannot be set for the given RF attenuation, the reference level is adjusted accordingly and the warning "Limit reached" is output.

Remote command:

[INPut:EATT:AUTO](#) on page 736

[INPut:EATT](#) on page 736

Ref Level Offset

Opens an edit dialog box to enter the arithmetic level offset. This offset is added to the measured level irrespective of the selected unit. The scaling of the y-axis is changed accordingly. The setting range is ± 200 dB in 0.1 dB steps.

Remote command:

[DISPlay\[:WINDow<n>\]:TRACe<t>:Y\[:SCALe\]:RLEVel:OFFSet](#) on page 720

Input (AC/DC)

Toggles the RF input of the R&S FSVR between AC and DC coupling.

This function is not available for input from the R&S Digital I/Q Interface (option R&S FSV-B17).

Remote command:

[INPut:COUPling](#) on page 732

Input 50 Ω/75 Ω

Uses 50 Ω or 75 Ω as reference impedance for the measured levels. Default setting is 50 Ω.

The setting 75 Ω should be selected if the 50 Ω input impedance is transformed to a higher impedance using a 75 Ω adapter of the RAZ type (= 25 Ω in series to the input impedance of the instrument). The correction value in this case is 1.76 dB = 10 log (75 Ω/50 Ω).

All levels specified in this Operating Manual refer to the default setting of the instrument (50 Ω).

This function is not available for input from the R&S Digital I/Q Interface (option R&S FSV-B17).

Remote command:

`INPut:IMPedance` on page 737

5.3.3 Softkeys of the Bandwidth Menu – BW Key (R&S FSV–K7S)

The following table shows all softkeys available in the "Bandwidth" menu in FM Stereo mode (BW key).

<code>Res BW (span > 0)</code>	408
<code>Meas Time</code>	408
<code>AF Filter</code>	409
L <code>High Pass</code>	409
L <code>Low Pass</code>	409
L <code>Weighting</code>	410
L <code>None</code>	410
L <code>CCITT</code>	410
L <code>CCIR Unweighted</code>	410
L <code>CCIR Weighted</code>	410
L <code>A Weighted</code>	411
L <code>Deemphasis</code>	411
L <code>All AF Filter Off</code>	412

Res BW (span > 0)

Opens an edit dialog box to enter a value for the resolution bandwidth. The range is specified in the data sheet.

This softkey is only available for spectrum measurements (see [chapter 5.1.9, "Measurement Result Display"](#), on page 327).

Remote command:

`[SENSe:]ADEMod:SPECTrum:BANDwidth|BWIDth[:RESolution]` on page 771

Meas Time

Opens an editor for entering the measurement time of the analog demodulation. For details on the measurement time values refer to [chapter 5.1.8, "Sample Rate, Measurement Time and Trigger Offset"](#), on page 325.

Note: For FM Stereo measurements (option K7S), the minimum measurement time is 2 ms.

Remote command:

[SENSe:] ADEMod:MTIME on page 764

AF Filter

The bandwidth of the demodulated signal can be reduced by high pass or low pass filters and also a de-emphasis can be switched on. The selected filters are used for AM, FM and PM demodulation in common. Individual settings are not possible.

High Pass ← AF Filter

Opens the "High Pass" selection list to switch on a high pass filter with the given limit to separate the DC component. The filters are indicated by the 3 dB cutoff frequency. The 50 Hz and 300 Hz filters are designed as 2nd-order Butterworth filter (12 dB/octave). The 20 Hz filter is designed as 3rd-order Butterworth filter (18 dB/octave).

"None" deactivates the AF high pass filter. Default is "None".

The high pass filters are active in the following demodulation bandwidth range:

20 Hz	100 Hz ≤ demodulation bandwidth ≤ 1.6 MHz
50 Hz:	200 Hz ≤ demodulation bandwidth ≤ 3 MHz
300 Hz:	800 Hz ≤ demodulation bandwidth ≤ 8 MHz
Note: for FM stereo (K7S), all filters are active at all times, as the demodulation range is always 400 kHz	

Remote command:

[SENSe:] FILTER<n>:HPASs[:STATe] on page 805

[SENSe:] FILTER<n>:HPASs:FREQUENCY on page 806

Low Pass ← AF Filter

Opens the "Low Pass" selection list to select the filter type. Relative and absolute low pass filter are available.

- Absolute low pass filters:
The 3 kHz, 15 kHz; 23 kHz and 150 kHz softkeys switch on a absolute low pass filter. The filters are indicated by the 3 dB cutoff frequency. The 3 kHz, 15 kHz and 23 kHz filters are designed as 5th-order Butterworth filters (30 dB/octave). The 150 kHz filter is designed as 8th-order Butterworth filter (48 dB/octave).
The absolute low pass filters are active in the following demodulation bandwidth range:

3 kHz:	6.4 kHz ≤ demodulation bandwidth ≤ 3 MHz
15 kHz:	50 kHz ≤ demodulation bandwidth ≤ 8 MHz
23 kHz	50 kHz ≤ demodulation bandwidth ≤ 18 MHz
150 kHz:	400 kHz ≤ demodulation bandwidth ≤ 8 MHz
Note: for FM stereo (K7S), all filters are active at all times, as the demodulation range is always 400 kHz	

- Relative low pass filters:

The filters (3 dB) can be selected in % of the demodulation bandwidth. The filters are designed as 5th-order Butterworth filter (30 dB/octave) and active for all demodulation bandwidths.

- "None" deactivates the AF low pass filter. Default is "None".

Remote command:

[SENSe:] FILTER<n>:LPASs[:STATe] on page 806

[SENSe:] FILTER<n>:LPASs:FREQuency[:ABSolute] on page 807

[SENSe:] FILTER<n>:LPASs:FREQuency:RELative on page 807

SFM:

[SENSe:] SFM:<ChannelType>:FILTer:LPASs:STATe on page 861

[SENSe:] SFM:<ChannelType>:FILTer:LPASs:FREQuency on page 861

Weighting ← AF Filter

Opens the "Weighting" selection list to select the weighting AF filter.

None ← Weighting ← AF Filter

Deactivates the weighting filter. This is the default setting.

Remote command:

[SENSe:] FILTER<n>:HPASs[:STATe] on page 805

CCITT ← Weighting ← AF Filter

Switches on a CCITT P.53 weighting filter. The weighting filter is active in the following demodulation bandwidth range:

20 kHz ≤ demodulation bandwidth ≤ 3 MHz

For FM stereo (K7S), the filter is active at all times, as the demodulation range is always 400 kHz.

Remote command:

[SENSe:] FILTER<n>:CCIT on page 803

SFM:

[SENSe:] SFM:<ChannelType>:FILTer:CCITt:STATe on page 858

CCIR Unweighted ← Weighting ← AF Filter

Switches on the CCIR unweighted filter, which is the combination of the 20 Hz high-pass and 23 kHz low pass filter. The weighting filter is active in the following demodulation bandwidth range:

50 kHz ≤ demodulation bandwidth ≤ 1.6 MHz

For FM stereo (K7S), the filter is active at all times, as the demodulation range is always 400 kHz.

Remote command:

[SENSe:] FILTER<n>:CCIR[:UNWeighted] [:STATe] on page 804

SFM:

[SENSe:] SFM:<ChannelType>:FILTer:CCIR[:UNWeighted] [:STATe]
on page 858

CCIR Weighted ← Weighting ← AF Filter

Switches on the CCIR weighted filter. The weighting filter is active in the following demodulation bandwidth range:

100 kHz ≤ demodulation bandwidth ≤ 3.0 MHz

For FM stereo (K7S), the filter is active at all times, as the demodulation range is always 400 kHz.

Remote command:

[SENSe:] FILTer<n>:CCIR:WEIGhted[:STATe] on page 804

SFM:

[SENSe:] SFM:<ChannelType>:FILTer:CCIR:WEIGhted[:STATe] on page 859

A Weighted ← Weighting ← AF Filter

Switches on the A weighted filter. The weighting filter is active in the following demodulation bandwidth range:

100 kHz ≤ demodulation bandwidth ≤ 800 kHz

Remote command:

[SENSe:] FILTer<n>:AWEIGhted[:STATe] on page 803

SFM:

[SENSe:] SFM:<ChannelType>:FILTer:AWEIGhted[:STATe] on page 858

Deemphasis ← AF Filter

Opens the "Deemphasis" selection list to switch on a deemphasis with the given time constant.

The deemphasis is active in the following demodulation bandwidth range:

Note: For FM stereo measurements (K7S), the demodulation bandwidth is always 400 kHz, thus the deemphasis is always active.

25 μs:	25 kHz ≤ demodulation bandwidth ≤ 40 MHz
50 μs:	6.4 kHz ≤ demodulation bandwidth ≤ 18 MHz
75 μs:	6.4 kHz ≤ demodulation bandwidth ≤ 18 MHz
750 μs:	800 Hz ≤ demodulation bandwidth ≤ 3 MHz

The following table shows the required demodulation bandwidth for an error less than 0.5 dB up to a maximum AF frequency.

deemphasis	25 μs	50 μs	75 μs	750 μs
max. AF frequency	25 kHz	12 kHz	8 kHz	800 Hz
required demodulation bandwidth	≥ 200 kHz	≥ 100 kHz	≥ 50 kHz	≥ 6.4 kHz

For higher AF frequencies the demodulation bandwidth must be increased.

Remote command:

[SENSe:] FILTer<n>:DEMPHasis[:STATe] on page 805

[SENSe:] FILTer<n>:DEMPHasis:TCONstant on page 805

SFM:

[SENSe:] SFM:<ChannelType>:FILTer:DEMPHasis:STATe on page 859

[SENSe:] SFM:<ChannelType>:FILTer:DEMPHasis:TCONstant on page 860

All AF Filter Off ← AF Filter

Disables all specified AF Filters.

Remote command:

[SENSe:] FILTer<n>:AOFF on page 803

5.3.4 Softkeys of the Trigger Menu – TRIG Key (R&S FSV–K7S)

The following table shows all softkeys available in the "Trigger" menu in "FM Stereo" mode (TRIG key). It is possible that your instrument configuration does not provide all softkeys. If a softkey is only available with a special option, model or (measurement) mode, this information is delivered in the corresponding softkey description.

Trigger Source.....	412
L Left.....	413
L Right.....	413
L MPX.....	413
L Mono.....	413
L Stereo.....	413
L RDS.....	413
L Pilot.....	413
L RF.....	413
L Time.....	414
Trigger Level.....	414
Trigger Polarity.....	414
Trigger Offset.....	414
Repetition Interval.....	415
Trigger Hysteresis.....	415
Trigger Holdoff.....	415

Trigger Source

Opens the "Trg Source" submenu to select the trigger source.

In "FM Stereo" mode, the next measurement is triggered if the selected input signal exceeds the threshold specified using the "Trigger Level" on page 294 softkey. A periodic signal modulated onto the carrier frequency can be displayed in this way. It is recommended that the measurement time covers at least five periods of the audio signal.

For triggering to be successful, the measurement time must cover at least 5 periods of the audio signal.

For more information on trigger sources also available in the Spectrum application refer to the following topics:

- "Free Run" on page 110
- "External" on page 110
- "RF Power" on page 110
- "IF Power/BB Power" on page 111
- "Time" on page 112

Remote command:

TRIGger<n> [:SEquence] :SOURce on page 913

Left ← Trigger Source

Triggers on the specified frequency level of the left FM signal.

Remote command:

`TRIGger<n>[:SEquence]:LEVel:SFM:LEFT` on page 916

Right ← Trigger Source

Triggers on the specified frequency level of the right FM signal.

Remote command:

`TRIGger<n>[:SEquence]:LEVel:SFM:RIGHT` on page 916

MPX ← Trigger Source

Triggers on the specified frequency level of the MPX FM signal.

Remote command:

`TRIGger<n>[:SEquence]:LEVel:SFM:MPX` on page 916

Mono ← Trigger Source

Triggers on the specified frequency level of the mono FM signal.

Remote command:

`TRIGger<n>[:SEquence]:LEVel:SFM:MONO` on page 917

Stereo ← Trigger Source

Triggers on the specified frequency level of the stereo FM signal.

Remote command:

`TRIGger<n>[:SEquence]:LEVel:SFM:STEReo` on page 917

RDS ← Trigger Source

Triggers on the specified frequency level of the RDS FM signal.

Remote command:

`TRIGger<n>[:SEquence]:LEVel:SFM:RDS` on page 918

Pilot ← Trigger Source

Triggers on the specified frequency level of the pilot FM signal.

Remote command:

`TRIGger<n>[:SEquence]:LEVel:SFM:PILot` on page 918

RF ← Trigger Source

Triggers on the specified level of the RF signal.

Note: The RF **offline** trigger is based on the I/Q data of the demodulated signal, in a very limited bandwidth. For a wider trigger bandwidth and triggering based on the currently measured RF input signal, use the more powerful **RF Power** trigger.

Remote command:

`TRIGger<n>[:SEquence]:LEVel:AM[:ABSolute]` on page 910

Time ← Trigger Source

Opens an edit dialog box to define a repetition interval in which the measurement is triggered. The shortest interval is 2 ms.

Remote command:

TRIG:SOUR TIME:TRIGger<n>[:SEquence]:SOURce on page 913

Trigger Level

Defines the trigger level as a numeric value.

In the trigger mode "Time", this softkey is not available.

Remote command:

TRIGger<n>[:SEquence]:LEVel:IFPower on page 911

TRIGger<n>[:SEquence]:LEVel:VIDeo on page 912

For digital input via the R&S Digital I/Q Interface, R&S FSV-B17:

TRIGger<n>[:SEquence]:LEVel:BBPower on page 910

Trigger Polarity

Sets the polarity of the trigger source.

The sweep starts after a positive or negative edge of the trigger signal. The default setting is "Pos". The setting applies to all modes with the exception of the "Free Run" and "Time" mode.

"Pos" Level triggering: the sweep is stopped by the logic "0" signal and restarted by the logical "1" signal after the gate delay time has elapsed.

"Neg" Edge triggering: the sweep is continued on a "0" to "1" transition for the gate length duration after the gate delay time has elapsed.

Remote command:

TRIGger<n>[:SEquence]:SLOPe on page 913

[SENSe:]SWEep:EGATe:POLarity on page 868

Trigger Offset

Opens an edit dialog box to enter the time offset between the trigger signal and the start of the sweep.

offset > 0:	Start of the sweep is delayed
offset < 0:	<p>Sweep starts earlier (pre-trigger)</p> <p>Only possible for span = 0 (e.g. I/Q Analyzer mode) and gated trigger switched off</p> <p>Maximum allowed range limited by the sweep time: $\text{pretrigger}_{\text{max}} = \text{sweep time}$</p> <p>When using the R&S Digital I/Q Interface (R&S FSV-B17) with I/Q Analyzer mode, the maximum range is limited by the number of pretrigger samples.</p> <p>See table 7-2.</p> <p>See the R&S Digital I/Q Interface(R&S FSV-B17) description in the base unit.</p>

In the "External" or "IF Power" trigger mode, a common input signal is used for both trigger and gate. Therefore, changes to the gate delay will affect the trigger delay (trigger offset) as well.

Tip: To determine the trigger point in the sample (for "External" or "IF Power" trigger mode), use the `TRACe<n>:IQ:TPISample?` command.

In the "Time" trigger mode, this softkey is not available.

Remote command:

`TRIGger<n>[:SEquence]:HOLDoFF[:TIME]` on page 908

Repetition Interval

Opens an edit dialog box to define a repetition interval in which the measurement is triggered. The shortest interval is 2 ms. This softkey is only available if the trigger source "Time" is selected (see "Time" on page 112).

Remote command:

`TRIGger<n>[:SEquence]:TIME:RINTerval` on page 915

Trigger Hysteresis

Defines the value for the trigger hysteresis for "IF power" or "RF Power" trigger sources. The hysteresis in dB is the value the input signal must stay below the power trigger level in order to allow a trigger to start the measurement. The range of the value is between 3 dB and 50 dB with a step width of 1 dB.

Remote command:

`TRIGger<n>[:SEquence]:IFPower:HYSteresis` on page 909

Trigger Holdoff

Defines the value for the trigger holdoff. The holdoff value in s is the time which must pass before triggering, in case another trigger event happens.

This softkey is only available if "IFPower", "RF Power" or "BBPower" is the selected trigger source.

Remote command:

`TRIGger<n>[:SEquence]:IFPower:HOLDoFF` on page 909

For digital input via the R&S Digital I/Q Interface, R&S FSV-B17:

`TRIGger<n>[:SEquence]:BBPower:HOLDoFF` on page 909

5.3.5 Softkeys of the Marker Function Menu – MKR FUNC Key (R&S FSV-K7S)

The MKR FUNC menu provides the following functions.

Select Marker (No).....	416
Ref Fixed.....	416
L Ref. Fixed On/Off.....	416
L Ref Point Level.....	416
L Ref Point Frequency (span > 0)/Ref Point Time (zero span).....	417
L Peak Search.....	417
Diff.Freq.Distortion.....	417
L Diff.Freq.Distortion (On/Off).....	418

L Unit (% / DB).....	418
L Search Signals.....	418
Intermod. Distortion.....	418
L Intermod.Distortion (On/Off).....	419
L Unit (% / DB).....	419
L Search Signals.....	420
n dB down.....	420
Marker Peak List.....	421
L Peak List On/Off.....	421
L Sort Mode Freq/Lvl.....	421
L Max Peak Count.....	421
L Peak Excursion.....	421
L Left Limit.....	421
L Right Limit.....	422
L Threshold.....	422
L ASCII File Export.....	422
L Decim Sep.....	422
L Marker Number.....	422

Select Marker (No)

Opens a submenu to select one of 16 markers and define whether the marker is a normal or a delta marker (see "[Marker 1 / Marker 2 / Marker 3 / ... Marker 16, / Marker Norm/Delta](#)" on page 120). "(No)" indicates the number of the currently active marker.

See "[Marker 1 / Marker 2 / Marker 3 / ... Marker 16, / Marker Norm/Delta](#)" on page 120.

Ref Fixed

Opens a submenu to set all values of a reference point. Instead of using the current values of the reference marker (marker 1) as reference point for the delta markers, level and frequency or time are set to fixed values and used as reference point.

Ref. Fixed On/Off ← Ref Fixed

Switches the relative measurement to a fixed reference value on or off. The level and frequency or time values of marker 1 immediately become the reference point, but can be altered using the corresponding softkeys ("[Ref Point Level](#)" on page 130, "[Ref Point Frequency \(span > 0\)/Ref Point Time \(zero span\)](#)" on page 130 and "[Peak Search](#)" on page 130).

When set to ON, all delta markers which previously referenced marker 1 are automatically set to reference the fixed marker.

The reference marker assignment can be changed using the "Marker Wizard" (see "[Marker Wizard](#)" on page 121).

Remote command:

`CALCulate<n>:DELTAmarker<m>:FUNction:FIXed[:STATe]` on page 559

Ref Point Level ← Ref Fixed

Opens an edit dialog box to enter a reference level value. All relative level values of the delta markers refer to this reference level.

Remote command:

`CALCulate<n>:DELTAmarker<m>:FUNction:FIXed:RPoint:Y` on page 561

Ref Point Frequency (span > 0)/Ref Point Time (zero span) ← Ref Fixed

Opens an edit dialog box to enter a frequency reference or time value. All relative frequency or time values of the delta markers refer to this frequency reference. For phase noise measurement, input of reference time is not possible.

Remote command:

`CALCulate<n>:DELTAmarker<m>:FUNCTION:FIXed:RPoint:X` on page 560

Peak Search ← Ref Fixed

Sets the maximum value of the selected trace as the reference point.

Remote command:

`CALCulate<n>:DELTAmarker<m>:FUNCTION:FIXed:RPoint:MAXimum[:PEAK]`
on page 560

Diff.Freq.Distortion

Opens a submenu to enable and configure difference frequency distortion measurement. This function is only available for AF spectrum measurements.

Definition of the difference frequency distortion:

f_1 and f_2 represent the frequencies of two sine-wave signals with the same level. Their frequencies should preferably differ by 80 Hz. The difference frequency distortion factors of 2nd and 3rd order (dd_2 , dd_3) are defined as follows:

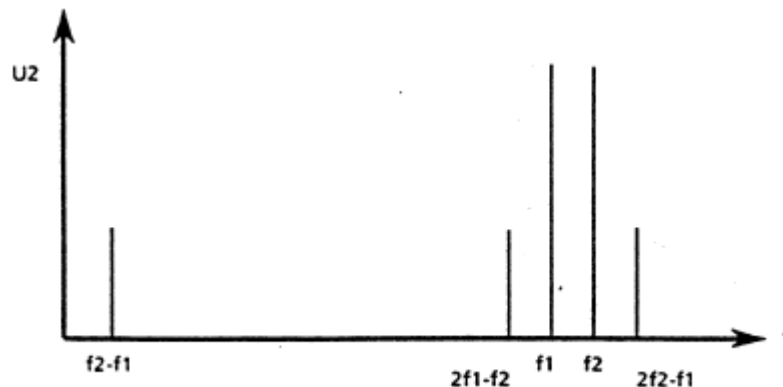

$$d_{d2} = \frac{U_2(f_2 - f_1)}{2 * U_2(f_2)} * 100\%$$

for percentage indication or

$$d_{d2} = 20 * \lg\left(\frac{U_2(f_2 - f_1)}{2 * U_2(f_2)} \right)$$

for indication in dB

$$d_{d3} = \frac{U_2(2 * f_2 - f_1) + U_2(2 * f_1 - f_2)}{2 * U_2(f_2)}$$

for percentage indication or

$$d_{d3} = 20 * \lg\left(\frac{U_2(2 * f_2 - f_1) + U_2(2 * f_1 - f_2)}{2 * U_2(f_2)} \right)$$

for indication in dB

Diff.Freq.Distortion (On/Off) ← Diff.Freq.Distortion

Enables difference frequency distortion. The results are displayed in the summary table with the function "DiffDist 2/3". The markers are indicated as "DFD2, DFD3".

Remote command:

`CALCulate<n>:MARKer:FUNction:DFD[:STATe]` on page 678

Unit (% / DB) ← Diff.Freq.Distortion

Sets the unit to percent or DB for differential frequency distortion.

Remote command:

`CALCulate<n>:MARKer:FUNction:DFD:UNIT` on page 679

Search Signals ← Diff.Freq.Distortion

Starts the search of the signals required for the difference frequency distortion measurement.

Remote command:

`CALCulate<n>:MARKer:FUNction:DFD:SEARchsignal ONCE` on page 679

Intermod. Distortion

Opens a submenu to enable and configure intermodulation distortion measurement. This function is only available for AF spectrum measurements.

Definition of the intermodulation distortion:

f1 and f2 represent the frequencies of two sine-wave signals. f2 should be at least 8*f1. The level of f2 should be 1/4th of the level of f1. The modulation factors of 2nd and 3rd order (dm2, dm3) are defined as follows:

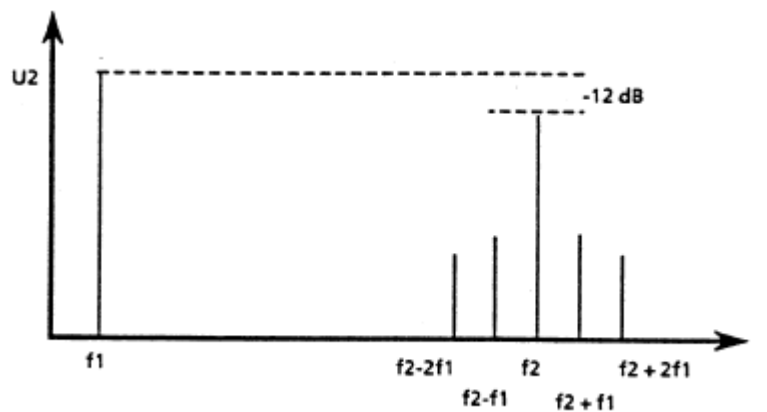

$$d_{m2} = \frac{U_2(f_2 + f_1) + U_2(f_2 - f_1)}{U_2(f_2)} \cdot 100\%$$

for percentage indication or

$$d_{m2} = 20 \cdot \lg\left(\frac{U_2(f_2 + f_1) + U_2(f_2 - f_1)}{U_2(f_2)} \right)$$

for indication in dB

$$d_{m3} = \frac{U_2(f_2 + 2f_1) + U_2(f_2 - 2f_1)}{U_2(f_2)} \cdot 100\%$$

for percentage indication

$$d_{m3} = 20 \cdot \lg\left(\frac{U_2(f_2 + 2f_1) + U_2(f_2 - 2f_1)}{U_2(f_2)} \right)$$

for indication in dB

Intermod.Distortion (On/Off) ← Intermod. Distortion

Enables intermodulation distortion. The results are displayed in the summary table with the function "IModDist 2/3". The markers are indicated as "IMD2, IMD3".

Remote command:

`CALCulate<n>:MARKer:FUNction:IMD[:STATe]` on page 680

Unit (% / DB) ← Intermod. Distortion

Sets the unit to percent or DB for intermodulation distortion.

Remote command:

`CALCulate<n>:MARKer:FUNction:IMD:UNIT` on page 680

Search Signals ← Intermod. Distortion

Starts the search of the signals required for the intermodulation distortion measurement.

Remote command:

`CALCulate<n>:MARKer:FUNction:IMD:SEARChsignal ONCE` on page 681

n dB down

Opens an edit dialog box to enter a value to define the level spacing of the two temporary markers to the right and left of marker 1 (default setting: 3 dB). Activates the temporary markers T1 and T2. The values of the temporary markers (T1, T2) and the entered value (ndB) are displayed in the marker field.

If a positive value is entered, the markers T1 and T2 are placed below the active reference marker. If a negative value (e.g. for notch filter measurements) is entered, the markers T1 and T2 are placed above the active reference marker. Marker T1 is placed to the left and marker T2 to the right of the reference marker.

In the marker table, the following results are displayed:

Span setting	Parameter name	Description
span > 0	Bw	frequency spacing of the two temporary markers
	Q factor	quality of the displayed bandwidth value (Bw)
span = 0	PWid	pulse width between the two temporary markers

If it is not possible to form the frequency spacing for the n dB value (e.g. because of noise display), dashes instead of a measured value are displayed.

Remote command:

`CALC:MARK1:FUNC:NDBD:STAT ON`, see `CALCulate<n>:MARKer<m>:FUNction:NDBDown:STATe` on page 635

`CALC:MARK1:FUNC:NDBD 3dB`, see `CALCulate<n>:MARKer<m>:FUNction:NDBDown` on page 633

`CALC:MARK1:FUNC:NDBD:RES?`, see `CALCulate<n>:MARKer<m>:FUNction:NDBDown:RESult?` on page 635

`CALC:MARK:FUNC:NDBD:QFAC?`, see `CALCulate<n>:MARKer<m>:FUNction:NDBDown:QFACTOR` on page 634

`CALC:MARK1:FUNC:NDBD:FREQ?` (span > 0), see `CALCulate<n>:MARKer<m>:FUNction:NDBDown:FREQuency?` on page 634

`CALC:MARK1:FUNC:NDBD:TIME?` (span = 0), see `CALCulate<n>:MARKer<m>:FUNction:NDBDown:TIME?` on page 636

Marker Peak List

Opens the "Peak List" submenu to define criteria for the sort order and the contents of the peak list. For each listed peak the frequency ("Stimulus") and level ("Response") values are given. In addition, the peaks are indicated in the trace display. A maximum of 50 entries are listed.

Remote command:

[CALCulate<n>:MARKer<m>:FUNction:FPEaks:COUNT?](#) on page 629

[CALCulate<n>:MARKer<m>:FUNction:FPEaks:X](#) on page 630

[CALCulate<n>:MARKer<m>:FUNction:FPEaks:Y?](#) on page 631

Peak List On/Off ← Marker Peak List

Activates/deactivates the marker peak list. If activated, the peak list is displayed and the peaks are indicated in the trace display.

Remote command:

[CALCulate<n>:MARKer<m>:FUNction:FPEaks:STAT](#) on page 630

Sort Mode Freq/Lvl ← Marker Peak List

Defines the criteria for sorting:

"Freq" sorting in ascending order of frequency values (span > 0) or time values (span = 0)

"Lvl" sorting in ascending order of the level

Remote command:

[CALCulate<n>:MARKer<m>:FUNction:FPEaks:SORT](#) on page 630

Max Peak Count ← Marker Peak List

Defines the maximum number of peaks to be determined and displayed.

Remote command:

[CALCulate<n>:MARKer<m>:FUNction:FPEaks:LIST:SIZE](#) on page 629

Peak Excursion ← Marker Peak List

Opens an edit dialog box for level measurements to enter the minimum level value by which a signal must rise or fall so that it will be identified as a maximum or a minimum by the search functions. Entries from 0 dB to 80 dB are allowed; the resolution is 0.1 dB. The default setting for the peak excursion is 6 dB.

For more information see "Specifying the suitable peak excursion" and "Effect of different peak excursion settings".

Remote command:

[CALCulate<n>:MARKer<m>:PEXCursion](#) on page 616

Left Limit ← Marker Peak List

Opens an edit dialog box to enter a value for the lower limit (left vertical line: S1 for span > 0; T1 for zero span). The search is performed between the lines of the left and right limit (see also [Right Limit](#) softkey).

Remote command:

[CALCulate<n>:MARKer<m>:X:SLIMits:LEFT](#) on page 618

Right Limit ← Marker Peak List

Opens an edit dialog box to enter a value for the upper limit (left vertical line: S2 for span > 0; T2 for zero span). The search is performed between the lines of the left and right limit (see also [Left Limit](#) softkey). If no value is set, the upper limit corresponds to the stop frequency.

Remote command:

[CALCulate<n>:MARKer<m>:X:SLIMits:RIGHT](#) on page 619

Threshold ← Marker Peak List

Opens an edit dialog box to define the threshold line. The threshold line represents the lower level limit for a "Peak" search and the upper level limit for a "Min" search.

Remote command:

[CALCulate<n>:THReshold:STATe](#) on page 703

[CALCulate<n>:THReshold](#) on page 702

ASCII File Export ← Marker Peak List

Opens the "ASCII File Export Name" dialog box and saves the active peak list in ASCII format to the specified file and directory.

The file consists of the header containing important scaling parameters and a data section containing the marker data. For details on an ASCII file see [chapter 4.1.8.7, "ASCII File Export Format"](#), on page 107.

This format can be processed by spreadsheet calculation programs, e.g. MS-Excel. It is necessary to define ';' as a separator for the data import. Different language versions of evaluation programs may require a different handling of the decimal point. It is therefore possible to select between separators '.' (decimal point) and ',' (comma) using the "Decim Sep" softkey (see ["Decim Sep"](#) on page 100).

An example of an output file for Spectrum Emission Mask measurements is given in ["ASCII File Export Format \(Spectrum Emission Mask\)"](#) on page 210.

Remote command:

[FORMat:DEXPort:DSEParator](#) on page 728

[MMEMory:STORe<n>:LIST](#) on page 742

Decim Sep ← Marker Peak List

Selects the decimal separator with floating-point numerals for the ASCII Trace export to support evaluation programs (e.g. MS-Excel) in different languages. The values '.' (decimal point) and ',' (comma) can be set.

Remote command:

[FORMat:DEXPort:DSEParator](#) on page 728

Marker Number ← Marker Peak List

If enabled, the determined peaks are indicated by their corresponding marker number in the trace display.

Remote command:

[CALCulate<n>:MARKer<m>:FUNCTion:FPEaks:ANN:LAB:STAT](#) on page 628

5.4 Information on Remote Control Commands

This chapter includes additional information on remote operation of the analog demodulator.

5.4.1 Trace Mode Result Types

The following result types can be set:

WRITE	The current trace results will be obtained
AVERage	The trace results will be averaged over the given # of measurements
MAXHold	The maximum trace result values will be obtained over the given # of measurements
MINHold	The minimum trace result values will be obtained over the given # of measurements
VIEW	The trace results are frozen and displayed, i.e. they are not calculated for subsequent measurements. Traces in this mode cannot be queried.
OFF	The result type will not be used.



It is not possible to query trace data when result type VIEW is selected.

Each value besides OFF can only be assigned to one result type at a time.

If all result types are set to OFF, the AM, FM, or PM demodulator will be deactivated.

5.4.2 Formats for Returned Values: ASCII Format and Binary Format

- ASCII Format (FORMat ASCII):
The command reads out a list of comma separated values (CSV) of the measured values in floating point format.
- Binary Format (FORMat REAL,32):
The command reads out binary data (Definite Length Block Data according to IEEE 488.2), each measurement value being formatted in 32 Bit IEEE 754 Floating-Point-Format. The schematics of the result string will be as follows:
#41024<value1><value2>...<value n> with

#4	number of digits (= 4 in the example) of the following number of data bytes
1024	number of following data bytes (= 1024 in the example)
<value>	4-byte floating point value

5.4.3 Sample Rate and Maximum Usable Bandwidth (RF Input)



Information on sample rates and maximum usable bandwidths for Digital I/Q input is described in [table 7-1](#).

Information on sample rates and maximum usable bandwidths for Digital I/Q input is described in the base unit manual.

Definitions

- **Input sample rate (ISR):** the sample rate of the useful data provided by the connected instrument to the R&S FSVR input
- (User, Output) **Sample rate (SR):** the sample rate that is defined by the user (e.g. in the "Data Acquisition" dialog box in the "I/Q Analyzer" application) and which is used as the basis for analysis or output
- **Usable I/Q (Analysis) bandwidth:** the bandwidth range in which the signal remains undistorted in regard to amplitude characteristic and group delay; this range can be used for accurate analysis by the R&S FSVR

For the I/Q data acquisition, digital decimation filters are used internally. The passband of these digital filters determines the *maximum usable I/Q bandwidth*. In consequence, signals within the usable I/Q bandwidth (passband) remain unchanged, while signals outside the usable I/Q bandwidth (passband) are suppressed. Usually, the suppressed signals are noise, artifacts, and the second IF side band. If frequencies of interest to you are also suppressed, you should try to increase the output sample rate, since this increases the maximum usable I/Q bandwidth.

Relationship between sample rate and usable bandwidth

The diagram [figure 4-24](#) shows the maximum usable I/Q bandwidths depending on the user sample rates.

As a rule, the usable bandwidth is proportional to the output sample. Yet, when the I/Q bandwidth reaches the bandwidth of the analog IF filter (at very high sample rates), the curve breaks.

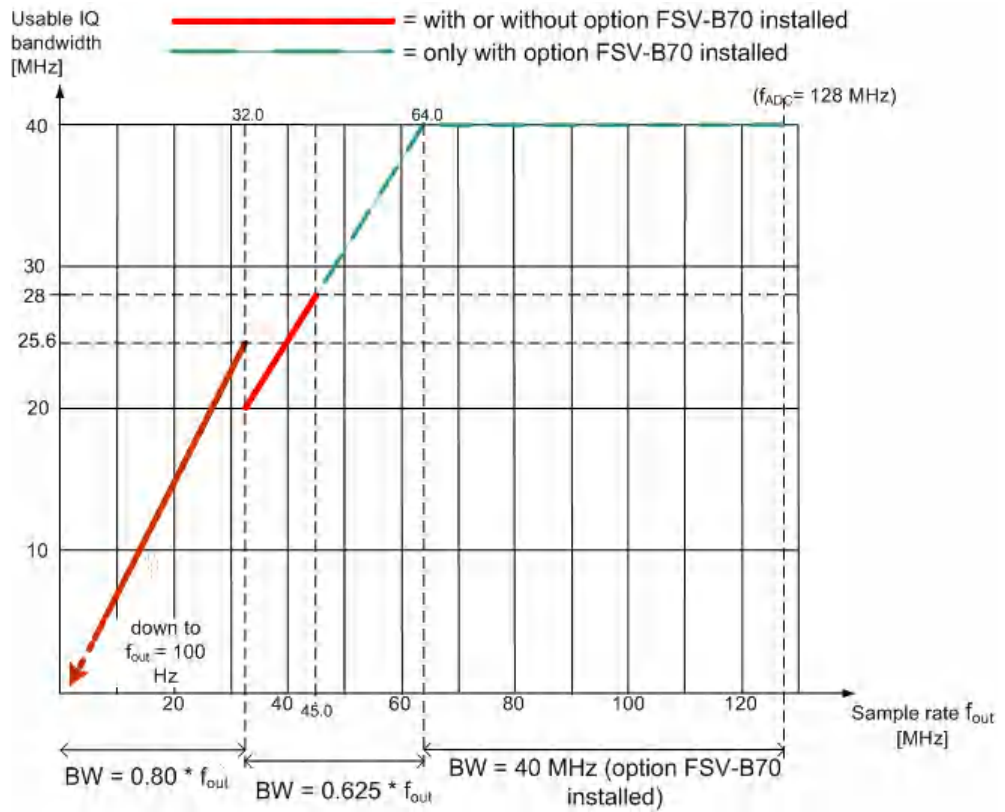

Fig. 5-3: Relation between maximum usable bandwidth and sample rate (RF input)

6 General Setup of the R&S FSVR

The R&S FSVR provides various global functions like display settings or printer settings that allow you to customize it to your needs and your personal preferences. This category also includes data management on the R&S FSVR. These functions are valid over all measurement modes of the R&S FSVR.

6.1 Instrument Setup and Interface Configuration – SETUP Key

The SETUP key is used to set or display the default settings of the instrument: reference frequency, noise source, level correction values, date, time, LAN interface, firmware update and enabling of options, information about instrument configuration and service support functions. For further details refer also to the Quick Start Guide, chapter 2 "Preparing for Use".

To open the Setup menu

- ▶ Press the SETUP key.
The "Setup" menu is displayed.

Menu and softkey description

- [chapter 6.1.1, "Softkeys of the Setup Menu"](#), on page 426

Further information

- [chapter 6.1.3, "LXI Class C Functionality"](#), on page 449

Tasks

- [chapter 6.1.2, "Activating or Deactivating the LXI Class C Functionality"](#), on page 448

6.1.1 Softkeys of the Setup Menu

The following table shows all softkeys available in the "Setup" menu. It is possible that your instrument configuration does not provide all softkeys. If a softkey is only available with a special option, model or (measurement) mode, this information is delivered in the corresponding softkey description.

Reference Int/Ext.....	428
Handle missing Ext. Ref.....	429
L Show Error Flag.....	429
L Auto select Reference.....	429
Transducer.....	429

L Active (On/Off).....	430
L Edit.....	430
L Edit Name.....	430
L Edit Unit.....	431
L Edit Value.....	431
L Insert Value.....	431
L Delete Value.....	431
L Interpolation Lin/Log.....	431
L Save Factor.....	431
L New.....	431
L Copy to.....	432
L Delete.....	432
L Ref Level Adjust (Man/Auto).....	432
L Show Directory.....	432
Alignment.....	432
L Self Alignment.....	433
L Show Align Results.....	433
L Touch Screen Alignment.....	433
General Setup.....	433
L Configure Network.....	433
L Network Address.....	434
L Computer Name.....	434
L IP Address.....	434
L Subnet Mask.....	434
L DHCP (On/Off).....	434
L LXI.....	434
L Info.....	434
L Password.....	435
L Description.....	435
L LAN Reset.....	435
L GPIB.....	435
L GPIB Address.....	435
L ID String Factory.....	435
L ID String User.....	436
L Compatibility Mode.....	436
L Mode Default.....	436
L Mode R&S FSP.....	436
L Mode R&S FSU.....	436
L GPIB Language.....	436
L IF Gain (Norm/Puls).....	437
L Sweep Repeat (On/Off).....	438
L Coupling (FSx/HP).....	438
L REV String Factory.....	438
L REV String User.....	438
L Display Update (On/Off).....	438
L GPIB Terminator LFEIOI/EOI.....	438
L *IDN Format Leg./New.....	439
L I/O Logging (On/Off).....	439
L Time+Date.....	439
L Configure Monitor.....	439

L Soft Frontpanel.....	439
Display Setup.....	440
L Tool Bar State (On/Off).....	441
L Status Bar.....	441
L Screen Title (On/Off).....	441
L Time+Date (On/Off).....	441
L Time+Date Format (US/DE).....	441
L Print Logo (On/Off).....	441
L Annotation (On/Off).....	441
L Theme Selection.....	442
L Screen Colors.....	442
L Select Screen Color Set.....	442
L Color (On/Off).....	442
L Select Object.....	442
L Predefined Colors.....	443
L User Defined Colors.....	443
L Set to Default.....	443
L Print Colors.....	443
L Select Print Color Set.....	443
L Color (On/Off).....	444
L Display Pwr Save (On/Off).....	444
System Info.....	444
L Hardware Info.....	444
L Versions+Options.....	445
L System Messages.....	445
L Clear All Messages.....	445
Firmware Update.....	446
Option Licenses.....	446
L Install Option.....	446
L Install Option by XML.....	446
Application Setup Recovery.....	446
Service.....	447
L Input Source.....	447
L RF.....	447
L Calibration Frequency RF.....	447
L Calibration Frequency MW.....	447
L Reset Password.....	448
L Selftest.....	448
L Selftest Results.....	448
L Password.....	448
L Service Function.....	448

Reference Int/Ext

Switches between the internal and external reference signal source. The default setting is internal reference. It is important that the external reference signal is deactivated when switching from external to internal reference to avoid interactions. When an external reference is used, "EXT REF" is displayed in the status bar.

If the reference signal is missing after switching to an external reference, the message "NO REF" is displayed to indicate that no synchronization is performed.

The R&S FSVR can use the internal reference source or an external reference source as frequency standard from which all internal oscillators are derived. A 10 MHz crystal oscillator is used as internal reference source. In the external reference setting, all internal oscillators of the R&S FSVR are synchronized to the external reference frequency, which can be set from 1–20 MHz in 100 kHz steps. For details on connectors refer to the Quick Start Guide, chapter 1 "Front and Rear Panel".

Note: Optional internal reference sources.

Alternatively to the standard internal reference source, an optional OCXO reference (option R&S FSV-B4) is available. This option generates a very precise 10 MHz reference signal with an output level of ≥ 0 dBm, which can also be used to synchronize other connected devices via the REF OUT connector.

If installed, and if no external signal is used, the OCXO signal is used as an internal reference.

Remote command:

`[SENSe:]ROSCillator:SOURce` on page 964

Handle missing Ext. Ref

If an external reference is selected but none is available, there are different ways the instrument can react. This command opens a submenu to select the preferred method of handling a missing external reference. By default, an error flag is displayed in the status bar of the display.

The submenu contains the following commands:

- "Show Error Flag" on page 429
- "Auto select Reference" on page 429

Show Error Flag ← Handle missing Ext. Ref

If this option is selected, an error flag is displayed in the status bar of the display when an external reference is selected but none is available.

Remote command:

`[SENSe:]ROSCillator:SOURce` on page 964

Auto select Reference ← Handle missing Ext. Ref

If this option is selected, the instrument automatically switches back to the internal reference if no external reference is available. Note that you must re-activate the external reference if it becomes available again at a later time.

Remote command:

`[SENSe:]ROSCillator:SOURce` on page 964

Transducer

Opens the "Select Transducer" dialog box and a submenu to activate or deactivate defined transducer factors, to generate new transducer factors or to edit existing ones.

In the "Select Transducer" dialog box, a transducer factor can be edited, deleted or copied, if selected, using the corresponding softkeys. The default directory in which the transducer factors are saved is displayed (C:\R_S\INSTR\TRD; the extension of transducer factor files is *.TDF). Subdirectories can be added or deleted via the file manager. They are displayed or hidden using the arrow keys or the [Show Directory](#) softkey / "Hide Directory" button.

Two different directory views are possible: If the "Show all" option is activated, all transducer factors in the directory are displayed. If the "Show compatible" option is activated, only the compatible transducer factors in the directory are displayed.

The submenu contains the following commands:

- "Active (On/Off)" on page 430
- "Edit" on page 430 >
- "New" on page 431
- "Copy to" on page 432
- "Delete" on page 432
- "Ref Level Adjust (Man/Auto)" on page 432
- "Show Directory" on page 432

Remote command:

[SENSe:]CORRection:TRANsdUCer:SElect on page 962

Active (On/Off) ← Transducer

Activates or deactivates the selected transducer factor. A maximum of 8 transducer factors can be activated at the same time. Each time an additional transducer factor is activated, its unit compatibility is checked. If one factor has a different unit than dB, all the other activated factors must have the unit dB.

Remote command:

[SENSe:]CORRection:TRANsdUCer:SElect on page 962

[SENSe:]CORRection:TRANsdUCer[:STATe] on page 962

Edit ← Transducer

Opens the "Edit Transducer" dialog box with the data of the selected factor, as well as a submenu. During editing, a transducer factor remains stored in the background until the factor is saved using the [Save Factor](#) softkey.

A transducer factor can contain up to 625 values. By defining up to 8 adjacent factors, a transducer system with up to 5000 values can be implemented.

The submenu contains the following commands:

- "Edit Name" on page 430
- "Edit Unit" on page 431
- "Edit Value" on page 431
- "Insert Value" on page 431
- "Delete Value" on page 431
- "Interpolation Lin/Log" on page 431
- "Save Factor" on page 431

Remote command:

[SENSe:]CORRection:TRANsdUCer:COMMeNt on page 960

Edit Name ← Edit ← Transducer

Sets the focus on the "Name" field to enter a file name. The extension is added automatically.

Remote command:

[SENSe:]CORRection:TRANsdUCer:SElect on page 962

Edit Unit ← Edit ← Transducer

Sets the focus on the "Unit" field to select the unit.

Note: If one factor has a different unit than "dB", all the other activated factors must have the unit "dB".

Remote command:

[\[SENSe:\]CORRection:TRANsducer:UNIT](#) on page 962

Edit Value ← Edit ← Transducer

Sets the focus to enter positions and values as frequency/level pairs. The entered data is also displayed graphically. Using the "Shift x" or "Shift y" button, all entered values can be shifted in x or y direction.

The valid transducer value range is: -200 dB < value < 200 dB

Remote command:

[\[SENSe:\]CORRection:TRANsducer:DATA](#) on page 961

Insert Value ← Edit ← Transducer

Inserts an empty line above the selected reference value to enter a new reference value. When entering a new reference value in the line, the ascending order of frequencies must be taken into consideration, however.

Each transducer factor may contain a maximum of 625 values. The valid transducer value range is: -200 dB < value < 200 dB

Delete Value ← Edit ← Transducer

Deletes the selected reference value (complete line). The reference values that follow move one line up.

Interpolation Lin/Log ← Edit ← Transducer

Sets the scaling of the x-axis to linear or logarithmic.

Remote command:

[\[SENSe:\]CORRection:TRANsducer:SCALing](#) on page 961

Save Factor ← Edit ← Transducer

Saves the changed factor to a file on the internal flash disk. If a transducer factor with the same name already exists, a confirmation query is displayed. If the new factor is active, the new values are immediately applied.

In remote control, the save operation is performed automatically after the definition of the reference values.

New ← Transducer

Opens the "Edit Transducer" dialog box to enter data for a new factor.

This dialog box contains the same contents as the [Edit](#) softkey.

The submenu contains the following commands:

- ["Edit Name"](#) on page 430
- ["Edit Unit"](#) on page 431
- ["Edit Value"](#) on page 431
- ["Insert Value"](#) on page 431
- ["Delete Value"](#) on page 431

- ["Interpolation Lin/Log"](#) on page 431
- ["Save Factor"](#) on page 431

Copy to ← Transducer

Opens the "Edit Transducer" dialog box to copy the selected factor.

This dialog box contains the same contents as the ["Edit"](#) on page 430 softkey.

The submenu contains the following commands:

- ["Edit Name"](#) on page 430
- ["Edit Unit"](#) on page 431
- ["Edit Value"](#) on page 431
- ["Insert Value"](#) on page 431
- ["Delete Value"](#) on page 431
- ["Interpolation Lin/Log"](#) on page 431
- ["Save Factor"](#) on page 431

Delete ← Transducer

Deletes the selected factor after confirmation.

Remote command:

[\[SENSe:\]CORRection:TRANsducer:DELeTe](#) on page 961

Ref Level Adjust (Man/Auto) ← Transducer

Activates or deactivates the automatic adjustment of the reference level to the selected transducer factor.

If a transducer factor is used (active), the trace is moved by a calculated shift. However, an upward shift reduces the dynamic range for the displayed values.

- | | |
|--------|--|
| "Auto" | Activates the automatic adjustment. The original dynamic range is restored by also shifting the reference level by the maximum value of the transducer factor. |
| "Man" | Deactivates the automatic adjustment. Adjust the reference level via the "Amplitude" menu. |

Remote command:

[\[SENSe:\]CORRection:TRANsducer:ADJust:RLEVel\[:STATe\]](#) on page 960

Show Directory ← Transducer

Displays the subdirectory of the selected directory.

Alignment

Opens a submenu with the available functions for recording, displaying and activating the data for self alignment.

The correction data and characteristics required for the alignment are determined by comparison of the results at different settings with the known characteristics of the high-precision calibration signal source at 65.83 MHz. The correction data are stored as a file on flash disk and can be displayed using the ["Show Align Results"](#) on page 433 softkey.

The submenu contains the following commands:

- ["Self Alignment"](#) on page 433

- ["Show Align Results"](#) on page 433
- ["Touch Screen Alignment"](#) on page 433

Self Alignment ← Alignment

Starts the recording of correction data of the instrument. If the correction data acquisition has failed or if the correction values are deactivated, a corresponding message is displayed in the status field.

As long as the self alignment data is collected the procedure can be cancelled using the "Abort" button.

Remote command:

[*CAL?](#) on page 551

Show Align Results ← Alignment

Opens a dialog box that displays the correction data of the alignment:

- date and time of last correction data record
- overall results of correction data record
- list of found correction values according to function/module

The results are classified as follows:

PASSED	calibration successful without any restrictions
CHECK	deviation of correction value larger than expected, correction could however be performed
FAILED	deviations of correction value too large, no correction was possible. The found correction data are not applicable.

Remote command:

[CALibration:RESult?](#) on page 925

Touch Screen Alignment ← Alignment

Displays a touch screen alignment dialog.

When the device is delivered, the touch screen is initially aligned. However, it may become necessary to adjust the alignment later, e.g. after an image update or after exchanging a hard disk. If you notice that touching a specific point on the screen does not achieve the correct response, you may try adjusting the alignment, as well. .

Using a finger or any other pointing device, press the 4 markers on the screen.

The touch screen is aligned according to the executed pointing operations.

General Setup

Opens a submenu for all general settings such as IP address and LAN settings, date and time, remote control (optional) and measurement display.

Configure Network ← General Setup

Opens the "Network Connections" dialog box to change the LAN settings. For details refer to the Quick Start Guide, chapter 2 "Preparing for Use" and appendix B "LAN Interface".

Network Address ← General Setup

Opens a submenu to configure the internet protocol properties and the computer name.

Computer Name ← Network Address ← General Setup

Opens an edit dialog box to enter the computer name via the keypad. The naming conventions of Windows apply. If too many characters and/or numbers are entered, in the status line, an according message is displayed. For step-by-step instructions refer to the Quick Start Guide, appendix B "LAN Interface".

IP Address ← Network Address ← General Setup

Opens an edit dialog box to enter the IP address via the keypad. The TCP/IP protocol is preinstalled with the IP address 10.0.0.10. If the DHCP server is available ("DHCP On"), the dialog box entry is read-only.

The IP address consists of four number blocks separated by dots. Each block contains 3 numbers in maximum (e.g. 100.100.100.100), but also one or two numbers are allowed in a block (as an example see the preinstalled address). For step-by-step instructions refer to the Quick Start Guide, chapter 2 "Preparing for Use".

Subnet Mask ← Network Address ← General Setup

Opens an edit dialog box to enter the subnet mask via the keypad. The TCP/IP protocol is preinstalled with the subnet mask 255.255.255.0. If the DHCP server is available ("DHCP On"), the dialog box entry is read-only.

The subnet mask consists of four number blocks separated by dots. Each block contains 3 numbers in maximum (e.g. 100.100.100.100), but also one or two numbers are allowed in a block (as an example see the preinstalled address). For step-by-step instructions refer to the Quick Start Guide, chapter 2 "Preparing for Use".

DHCP (On/Off) ← Network Address ← General Setup

Switches between DHCP server available (On) or not available (Off). If a DHCP server is available in the network, the IP address and subnet mask of the instrument are obtained automatically from the DHCP server. For further details refer to the Quick Start Guide, chapter 2 "Preparing for Use".

LXI ← General Setup

Opens the LXI submenu containing the following softkeys:

- "Info" on page 434
- "Password" on page 435
- "Description" on page 435
- "LAN Reset" on page 435

LXI functionality is available only for user accounts with administrator rights.

Info ← LXI ← General Setup

Shows the current parameters of LXI class C, including the current version, class and various computer parameters like the computer name or IP address.

While active, the dialog is not updated.

LXI functionality is available only for user accounts with administrator rights.

Remote command:

`SYSTem:LXI:INFo?` on page 977

Password ← LXI ← General Setup

Shows the currently set password. You can also change the current password using this softkey.

The password is required to change settings via the web browser (e.g. IP parameter). An empty password is not valid, i.e. you must enter a password.

By default, the password is *LxiWebIfc*.

LXI functionality is available only for user accounts with administrator rights.

Remote command:

`SYSTem:LXI:PASSword` on page 977

Description ← LXI ← General Setup

Opens a dialog box to view or change the LXI instrument description. This description is used on some of the LXI web sites.

By default, the description is "Signal Analyzer".

LXI functionality is available only for user accounts with administrator rights.

Remote command:

`SYSTem:LXI:MDEscription` on page 977

LAN Reset ← LXI ← General Setup

Resets the LAN configuration to a state required by the LXI standard. For example, the TCP/IP mode is set to DHCP and Dynamic DNS and ICMP Ping are enabled. In addition, the R&S FSVR sets the password and the instrument description to their initial states (see "Password" on page 435 and "Description" on page 435 softkeys).

Only user accounts with administrator rights can reset the LAN configuration.

Remote command:

`SYSTem:LXI:LANReset` on page 977

GPIB ← General Setup

Opens a submenu to set the parameters of the remote control interface.

GPIB Address ← GPIB ← General Setup

Opens an edit dialog box to enter the GPIB address. Values from 0 to 30 are allowed. The default address is 20.

Remote command:

`SYSTem:COMMunicate:GPIB[:SELF]:ADDRess` on page 970

ID String Factory ← GPIB ← General Setup

Selects the default response to the *IDN? query.

Remote command:

`SYSTem:IDENtify:FACTory` on page 975

ID String User ← GPIB ← General Setup

Opens an edit dialog box to enter a user-defined response to the *IDN? query. Max. 36 characters are allowed.

Remote command:

`SYSTem:IDENtify[:STRing]` on page 975

Compatibility Mode ← GPIB ← General Setup

Sets the R&S FSVR in a state compatible to previous R&S devices, enabling the usage of existing external control applications. In particular, the number of measurement points and available bandwidths are adjusted to those of other devices.

Furthermore, some special GPIB settings are available in order to emulate HP models (see [chapter 8.2.5, "GPIB Commands of HP Models 856xE, 8566A/B, 8568A/B and 8594E"](#), on page 981):

- "GPIB Language" on page 436
- "IF Gain (Norm/Puls)" on page 437
- "Sweep Repeat (On/Off)" on page 438
- "Coupling (FSx/HP)" on page 438

"Default" Standard R&S FSVR operation, see "Mode Default" on page 436

"R&S FSP" Compatible to R&S FSP, see "Mode R&S FSP" on page 436

"R&S FSU" Compatible to R&S FSU, see "Mode R&S FSU" on page 436

Remote command:

`SYSTem:COMPAtible` on page 972

Mode Default ← Compatibility Mode ← GPIB ← General Setup

Resets the number of measurement points and available bandwidths to default R&S FSVR values.

Remote command:

`SYST:COMP DEF`, see `SYSTem:COMPAtible` on page 972

Mode R&S FSP ← Compatibility Mode ← GPIB ← General Setup

Sets the number of measurement points and available bandwidths as in R&S FSP devices.

Remote command:

`SYST:COMP FSP`, see `SYSTem:COMPAtible` on page 972

Mode R&S FSU ← Compatibility Mode ← GPIB ← General Setup

Sets the number of measurement points and available bandwidths as in R&S FSU devices.

Remote command:

`SYST:COMP FSU`, see `SYSTem:COMPAtible` on page 972

GPIB Language ← Compatibility Mode ← GPIB ← General Setup

Opens a list of selectable remote-control languages:

Language	Comment
SCPI	
71100C	Compatible to 8566A/B
71200C	Compatible to 8566A/B
71209A	Compatible to 8566A/B
8560E	
8561E	
8562E	
8563E	
8564E	
8565E	
8566A	Command sets A and B are available. Command sets A and B differ in the rules regarding the command structure.
8566B	
8568A	Command sets A and B are available. Command sets A and B differ in the rules regarding the command structure.
8568A_DC	Uses DC input coupling by default if supported by the instrument
8568B	Command sets A and B are available. Command sets A and B differ in the rules regarding the command structure.
8568B_DC	Uses DC input coupling by default if supported by the instrument
8591E	Compatible to 8594E
8594E	Command sets A and B are available. Command sets A and B differ in the rules regarding the command structure.

For details on the GPIB languages, see [chapter 8.2.5, "GPIB Commands of HP Models 856xE, 8566A/B, 8568A/B and 8594E"](#), on page 981.

Remote command:

[SYSTem:LANGuage](#) on page 976

IF Gain (Norm/Puls) ← Compatibility Mode ← GPIB ← General Setup

Configures the internal IF gain settings in HP emulation mode due to the application needs. This setting is only taken into account for resolution bandwidth < 300 kHz.

NORM	Optimized for high dynamic range, overload limit is close to reference level.
PULS	Optimized for pulsed signals, overload limit up to 10 dB above reference level.

This softkey is only available if a HP language is selected via the "GPIB Language" softkey (see ["GPIB Language"](#) on page 436).

Remote command:

[SYSTem:IFGain:MODE](#) on page 976

Sweep Repeat (On/Off) ← Compatibility Mode ← GPIB ← General Setup

Controls a repeated sweep of the E1 and MKPK HI/HL HP model commands (for details on the commands refer to "GPIB Language" on page 436). If the repeated sweep is OFF, the marker is set without sweeping before.

Note: In single sweep mode, switch off this softkey before you set the marker via the E1 and MKPK HI/HL commands in order to avoid sweeping again.

This softkey is only available if a HP language is selected via the "GPIB Language" softkey (see "GPIB Language" on page 436).

Remote command:

`SYSTem:RSW` on page 980

Coupling (FSx/HP) ← Compatibility Mode ← GPIB ← General Setup

Controls the default coupling ratios in the HP emulation mode for:

- span and resolution bandwidth (Span/RBW) and
- resolution bandwidth and video bandwidth (RBW/VBW)

For FSP(=FSV), the standard parameter coupling of the instrument is used. As a result, in most cases a shorter sweeptime is used than in case of HP.

This softkey is only available if a HP language is selected via the "GPIB Language" softkey (see "GPIB Language" on page 436).

Remote command:

`SYSTem:HPCoupling` on page 974

REV String Factory ← Compatibility Mode ← GPIB ← General Setup

Selects the default response to the `REV?` query for the revision number (HP emulation only, see chapter 8.2.5, "GPIB Commands of HP Models 856xE, 8566A/B, 8568A/B and 8594E", on page 981).

Remote command:

`SYSTem:REVision:FACTory` on page 979

REV String User ← Compatibility Mode ← GPIB ← General Setup

Opens an edit dialog box to enter a user-defined revision number in response to the `REV?` query (HP emulation only, see chapter 8.2.5, "GPIB Commands of HP Models 856xE, 8566A/B, 8568A/B and 8594E", on page 981). Max. 36 characters are allowed.

Remote command:

`SYSTem:REVision[:STRing]` on page 979

Display Update (On/Off) ← GPIB ← General Setup

Defines whether the instrument display is switched off when changing from manual operation to remote control. In remote control mode, this softkey is displayed in the local menu.

Remote command:

`SYSTem:DISPlay:UPDate` on page 973

GPIB Terminator LFEOI/EOI ← GPIB ← General Setup

Changes the GPIB receive terminator.

According to the standard, the terminator in ASCII is <LF> and/or <EOI>. For binary data transfers (e.g. trace data) from the control computer to the instrument, the binary code used for <LF> might be included in the binary data block, and therefore should not be interpreted as a terminator in this particular case. This can be avoided by changing the receive terminator to EOI.

Remote command:

`SYSTem:COMMunicate:GPIB[:SELF]:RTERminator` on page 970

***IDN Format Leg./New ← GPIB ← General Setup**

Defines the response format to the *IDN? remote command (see *IDN? on page 552). This function is intended for re-use of existing control programs together with the R&S FSVR.

"Leg"	Legacy format, compatible to the R&S FSP/FSU/FSQ family e.g. Rohde&Schwarz, FSV-7, 100005/007, 1.61
"New"	R&S FSVR format e.g. Rohde&Schwarz, FSV-7, 1307.9002K07/100005, 1.61

Remote command:

`SYSTem:FORMat:IDENT` on page 974

I/O Logging (On/Off) ← GPIB ← General Setup

Activates or deactivates the SCPI log function. All remote control commands received by the R&S FSVR are recorded in the following log file:

`C:\R_S\Instr\scpi\logging\ScpiLog.txt`

Logging the commands may be extremely useful for debug purposes, e.g. in order to find misspelled keywords in control programs.

Remote command:

`SYSTem:CLOGging` on page 969

Time+Date ← General Setup

Opens an edit dialog box to enter time and date for the internal real time clock. For details refer to the Quick Start Guide, chapter 2 "Preparing for Use".

Remote command:

`SYSTem:TIME` on page 980

`SYSTem:DATE` on page 972

Configure Monitor ← General Setup

Determines and displays the configuration of a connected external monitor, if available. In the configuration dialog box, you can switch from the internal monitor (laptop icon) to the external monitor (monitor icon), or both (double monitor icon). For external, the R&S FSVR display is disabled (turns dark). The screen content formerly displayed on the R&S FSVR is displayed on the external screen.

For further details refer to the Quick Start Guide, chapter 2 "Preparing for Use".

Soft Frontpanel ← General Setup

Activates or deactivates the display of the instrument emulation.

deactivated	Only the measurement screen is displayed. This is the setting for working at the R&S FSVR.
activated	In addition to the measurement screen, the whole front panel is displayed, i.e. the hardkeys and other hardware controls of the device are simulated on the screen. This is the setting for working at a computer with XP Remote Desktop or at an external monitor.

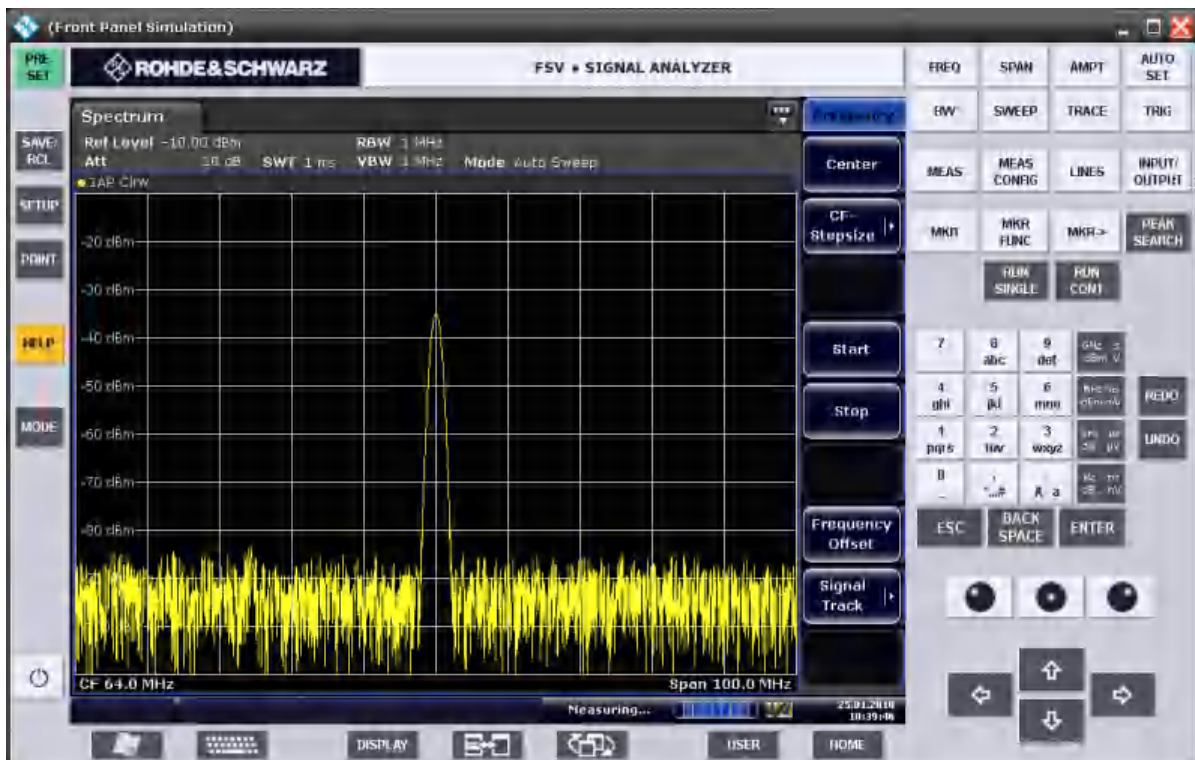

Fig. 6-1: Soft Frontpanel

Alternatively to this softkey, you can use the F6 key.

Remote command:

[SYSTem:DISPlay:FPANel](#) on page 972

Display Setup

Opens a submenu to define the display settings.

The following display settings are available:

- ["Tool Bar State \(On/Off\)"](#) on page 441
- ["Screen Title \(On/Off\)"](#) on page 441
- ["Time+Date \(On/Off\)"](#) on page 441
- ["Time+Date Format \(US/DE\)"](#) on page 441
- ["Print Logo \(On/Off\)"](#) on page 441
- ["Annotation \(On/Off\)"](#) on page 441
- ["Theme Selection"](#) on page 442
- ["Screen Colors"](#) on page 442
- ["Print Colors"](#) on page 443
- ["Display Pwr Save \(On/Off\)"](#) on page 444

Tool Bar State (On/Off) ← Display Setup

Displays or removes the tool bar above the diagram.

This setting is stored in instrument settings files.

Remote command:

`DISPlay:TBAR[STATe]` on page 935

Status Bar ← Display Setup

Displays or removes the status bar beneath the diagram.

The status bar indicates the global instrument settings, the instrument status and any irregularities during measurement or display.

This setting is stored in instrument settings files.

Remote command:

`DISPlay:SBAR[:STATe]` on page 935

Screen Title (On/Off) ← Display Setup

Activates/deactivates the display of a diagram title (if available) and opens an edit dialog box to enter a new title for the active diagram. Max. 20 characters are allowed.

Remote command:

`DISPlay[:WINDow<n>]:TEXT[:DATA]` on page 936

`DISPlay[:WINDow<n>]:TIME` on page 936

Time+Date (On/Off) ← Display Setup

Activates/deactivates the display of date and time beneath the diagram.

This setting is stored in instrument settings files.

Remote command:

`DISPlay[:WINDow<n>]:TIME` on page 936

Time+Date Format (US/DE) ← Display Setup

Switches the time and date display on the screen between US and German (DE).

This setting is stored in instrument settings files.

Remote command:

`DISPlay[:WINDow<n>]:TIME:FORMat` on page 937

Print Logo (On/Off) ← Display Setup

Activates/deactivates the display of the Rohde & Schwarz company logo in the upper left corner.

Remote command:

`DISPlay:LOGO` on page 934

Annotation (On/Off) ← Display Setup

Activates/deactivates the display of the frequency information in the diagram footer.

For example to protect confidential data it can be useful to hide the frequency information.

Remote command:

`DISPlay:ANNotation:FREQuency` on page 932

Theme Selection ← Display Setup

Opens a selection list of available themes for the screen display. The theme defines the colors used for keys and screen elements, for example. The default theme is "Blue-Ocean".

Remote command:

`DISPlay:THEME:SElect` on page 935

Screen Colors ← Display Setup

Opens a submenu to configure the screen colors. For details on screen colors refer to the Quick Start Guide, chapter 2 "Preparing for Use".

The submenu contains the following commands:

- "Select Screen Color Set" on page 442
- "Color (On/Off)" on page 442
- "Select Object" on page 442
- "Predefined Colors" on page 443
- "User Defined Colors" on page 443
- "Set to Default" on page 443

Remote command:

`DISPlay:CMAP<item>:HSL` on page 933

Select Screen Color Set ← Screen Colors ← Display Setup

Opens the "Select Screen Color Set" dialog box to select default or user defined color settings.

If one of the default settings is selected ("Default Colors 1"/"2"), the default settings for brightness, color tint and color saturation for all display screen elements are restored. The default color schemes provide optimum visibility of all picture elements at an angle of vision from above or below. Default setting is "Default Colors 1".

If "User Defined Colors" is selected, a user-defined color set can be defined. For step-by-step instruction refer to the Quick Start Guide, chapter 2 "Preparing for Use".

Remote command:

`DISPlay:CMAP<item>:DEFault` on page 932

Color (On/Off) ← Screen Colors ← Display Setup

Switches from color display to black-and-white display and back. The default setting is color display.

Select Object ← Screen Colors ← Display Setup

Opens the "Color Setup" dialog box to select the color settings for a selected object.

The "Selected Object" list is displayed to select the object. For setting the color the predefined colors are displayed.

Remote command:

`DISPlay:CMAP<item>:HSL` on page 933

`HCOPY:CMAP<item>:HSL` on page 940

Predefined Colors ← Screen Colors ← Display Setup

In the "Color Setup" dialog box, displays the "Predefined Colors" (alternatively to the "Predefined Colors" button). This softkey is only available if, in the "Select Color Set" dialog box, the "User Defined Colors" option is selected or the "Color Setup" dialog box is displayed. For further details refer to the Quick Start Guide, chapter 2 "Preparing for Use".

Remote command:

`DISPlay:CMAP<item>:PDEFined` on page 933

`HCOPY:CMAP<item>:PDEFined` on page 941

User Defined Colors ← Screen Colors ← Display Setup

In the "Color Setup" dialog box, displays the "User Defined Colors" (alternatively to the "User Defined Colors" button). This softkey is only available if, in the "Select Color Set" dialog box, the "User Defined Colors" option is selected or the "Color Setup" dialog box is displayed. For further details refer to the Quick Start Guide, chapter 2 "Preparing for Use".

Remote command:

`DISPlay:CMAP<item>:HSL` on page 933

`HCOPY:CMAP<item>:HSL` on page 940

Set to Default ← Screen Colors ← Display Setup

Opens the "Set to Default" dialog box to select one of the factory default color settings.

Remote command:

`DISPlay:CMAP<item>:DEFault` on page 932

`HCOPY:CMAP<item>:DEFault` on page 940

Print Colors ← Display Setup

Opens a submenu to select the colors for the printout. To facilitate color selection, the selected color combination is displayed when the menu is entered. The previous colors are restored when the menu is exited. For details on screen colors refer to the Quick Start Guide, chapter 2 "Preparing for Use".

The submenu contains the following commands:

- "Select Print Color Set" on page 443
- "Color (On/Off)" on page 444
- "Select Object" on page 466
- "Predefined Colors" on page 466
- "User Defined Colors" on page 466
- "Set to Default" on page 466

Remote command:

`HCOPY:CMAP<item>:HSL` on page 940

Select Print Color Set ← Print Colors ← Display Setup

Opens the "Select Print Color Set" dialog box to select the color settings for printout.

Screen Colors (Print)	Selects the current screen colors for the printout. The background is always printed in white and the grid in black.
Screen Colors (Hardcopy)	Selects the current screen colors without any changes for a hardcopy. The output format is set via the "Device Setup" on page 466 softkey in the "Print" menu.
Optimized Colors	Selects an optimized color setting for the printout to improve the visibility of the colors (default setting). Trace 1 is blue, trace 2 black, trace 3 green, and the markers are turquoise. The background is always printed in white and the grid in black.
User Defined Colors	Enables the softkeys to define colors for the printout.

Remote command:

[HCOPY:CMAP<item>:DEFault](#) on page 940

Color (On/Off) ← Print Colors ← Display Setup

Switches from color printout to black-and-white printout and back. All colored areas are printed in white and all colored lines in black. This improves the contrast. The default setting is color printout, provided that the selected printer can produce color printouts.

Remote command:

[HCOPY:DEVIce:COLor](#) on page 942

Display Pwr Save (On/Off) ← Display Setup

Switches the power-save mode for the display (On/Off) and opens an edit dialog box to enter the time for the power-save function to respond. After the elapse of this time the display is completely switched off, i.e. including backlighting. This mode is recommended when the instrument is exclusively operated in remote control.

For details on the power-save mode for the display refer to the Quick Start Guide, chapter 2 "Preparing for Use".

Remote command:

[DISPlay:PSAVe\[:STATe\]](#) on page 934

[DISPlay:PSAVe:HOLDoff](#) on page 934

System Info

Opens a submenu to display detailed information on module data, device statistics and system messages.

The submenu contains the following commands:

- ["Hardware Info"](#) on page 444
- ["Versions+Options"](#) on page 445
- ["System Messages"](#) on page 445
- ["Clear All Messages"](#) on page 445

Hardware Info ← System Info

Opens a dialog box that displays hardware information, e.g. on the frontend and motherboard. Every listed component is described by its serial number, order number, model information, hardware code, and hardware revision.

Remote command:

[DIAGnostic<n>:SERVice:HWINfo?](#) on page 927

Versions+Options ← System Info

Opens a dialog box that displays a list of hardware and firmware information, including:

Label	Description
Device ID	Unique ID of the device
Instrument Firmware	Installed firmware version
BIOS	Installed BIOS version
CPLD	CPLD version
MB-FPGA	Motherboard FPGA version
Data Sheet Version	Data sheet version of the basic device
<option>	Installed hardware and firmware options

For details on options refer to the Quick Start Guide, chapter 2 "Checking the Supplied Items".

Remote command:

*IDN? on page 552

*OPT? on page 552

SYSTem:DEvice:ID?/SYSTem:DID? on page 972

System Messages ← System Info

Opens the "System Messages" dialog box that displays the generated system messages in the order of their occurrence. The most recent messages are placed at the top of the list. Messages that have occurred since the last display of system messages menu are marked with an asterisk '*'. The following information is available:

No	device-specific error code
Message	brief description of the message
Component	hardware messages: name of the affected module
	software messages: name of the affected software
Date/Time	date and time of the occurrence of the message

If the number of error messages exceeds the capacity of the error buffer, "Message buffer overflow" is displayed. To delete messages see "[Clear All Messages](#)" on page 445 softkey.

Remote command:

SYSTem:ERRor:LIST? on page 973

Clear All Messages ← System Info

Deletes all system messages. The softkey is only available if the "System Messages" dialog box is displayed.

Remote command:

SYSTem:ERRor:CLEar:ALL on page 973

Firmware Update

Opens the "Firmware Update" dialog box.

Enter the name of or browse for the firmware installation file and press the "Execute" button. For details on installation refer to the Quick Start Guide, chapter 3 "Firmware Update and Installation of Firmware Options".

Only user accounts with administrator rights can perform a firmware update.

Remote command:

[SYSTem:FIRMware:UPDate](#) on page 974

Option Licenses

Opens a submenu to install options. For details on options refer to the Quick Start Guide, chapter 3 "Firmware Update and Installation of Firmware Options".

The submenu contains the following commands:

- ["Install Option"](#) on page 446
- ["Install Option by XML"](#) on page 446

Only user accounts with administrator rights are able to install options.

Install Option ← Option Licenses

Opens an edit dialog box to enter the license key for the option that you want to install.

If an option is about to expire, a message box is displayed to inform you. You can then use this softkey to enter a new license key.

If an option has already expired, a message box appears for you to confirm. In this case, all instrument functions are unavailable (including remote control) until the R&S FSVR is rebooted. You must then use the "Install Option" softkey to enter the new license key.

For more information about the option in question refer to the [System Info](#) softkey in the "Setup" menu.

Only user accounts with administrator rights are able to install options.

Install Option by XML ← Option Licenses

Opens an edit dialog to install an additional option to the R&S FSVR using an XML file. Enter or browse for the name of an XML file on the instrument that contains the option key and press "Select".

Only user accounts with administrator rights are able to install options.

Application Setup Recovery

Controls instrument behavior when switching between measurement applications, e.g. from "Spectrum" to "Analog Demod" and back.

If this softkey is activated, the current instrument settings are stored when you switch to a different application. When you switch back to the previous application, the corresponding instrument settings are restored. Thus, the settings of the individual applications are independent of each other.

If the softkey is deactivated (default), only a few parameters of the current instrument setting are passed between applications (e.g. center frequency, level settings).

Note that this setting is not deactivated during a preset operation, i.e. you must deactivate it manually, if necessary.

Remote command:

[SYSTem:APPLication:SRECovery\[:STATe\]](#) on page 969

Service

Opens a submenu that contains additional functions for maintenance and/or troubleshooting.

NOTICE! Risk of incorrect operation due to Service functions. The service functions are not necessary for normal measurement operation. However, incorrect use can affect correct operation and/or data integrity of the R&S FSVR.

Therefore, many of the functions can only be used after entering a password. They are described in the instrument service manual.

The submenu contains the following commands:

- ["Input Source"](#) on page 447
- ["Reset Password"](#) on page 448
- ["Selftest"](#) on page 448
- ["Selftest Results"](#) on page 448
- ["Password"](#) on page 448
- ["Service Function"](#) on page 448

Only user accounts with administrator rights are able to use service functions.

Input Source ← Service

Opens a submenu to select the input source for measurement.

The submenu contains the following options:

- ["RF"](#) on page 447
- ["Calibration Frequency RF"](#) on page 447
- ["Calibration Frequency MW"](#) on page 447

RF ← Input Source ← Service

Switches the input of the R&S FSVR to the RF input connector (normal position). This is the default setting.

Remote command:

[DIAGnostic<n>:SERvice:INPut\[:SElect\]](#) on page 928

Calibration Frequency RF ← Input Source ← Service

Opens an edit dialog box to set the generator frequency for the internal calibration.

Remote command:

[DIAGnostic<n>:SERvice:INPut:PULSed:CFrequency](#) on page 927

Calibration Frequency MW ← Input Source ← Service

Opens an edit dialog box to set the calibration frequency for frequencies greater than 7 GHz (for R&S FSVR 13 and 30 only).

Remote command:

[DIAGnostic<n>:SERvice:INPut:PULSed:MCFrequency](#) on page 928

Reset Password ← Service

Deactivates all set passwords.

Remote command:

[SYSTem:PASSword:RESet](#) on page 978

Selftest ← Service

Initiates the self test of the instrument modules to identify a defective module in case of failure. All modules are checked consecutively and the test result is displayed.

Remote command:

[*TST?](#) on page 554

Selftest Results ← Service

Opens the "Selftest Result" dialog box that contains the test results. In case of failure a short description of the failed test, the defective module, the associated value range and the corresponding test results are indicated.

Remote command:

[DIAGnostic<n>:SERvice:STEST:RESult?](#) on page 930

Password ← Service

Opens an edit dialog box to enter the password. This ensures that the service functions are only used by authorized personnel.

Remote command:

[SYSTem:PASSword\[:CENable\]](#) on page 978

Service Function ← Service

Opens the "Service Function" dialog box to start special service functions. For further information refer to the service manual.

Remote command:

[DIAGnostic<n>:SERvice:SFUNction](#) on page 929

6.1.2 Activating or Deactivating the LXI Class C Functionality

1. In the Windows XP "Start" menu, select the "LXI" entry and press the ENTER key. An LXI configuration dialog box is displayed.

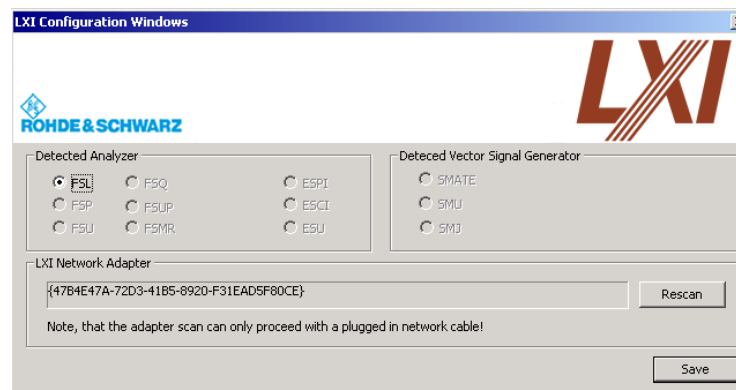

2. Press the "Rescan" button.
3. Press the "Save" button.
The instrument reboots and after the reboot LXI is active.
4. To deactivate the LXI Class C functionality perform step 1 and 2 again.
An LXI configuration dialog box is displayed.

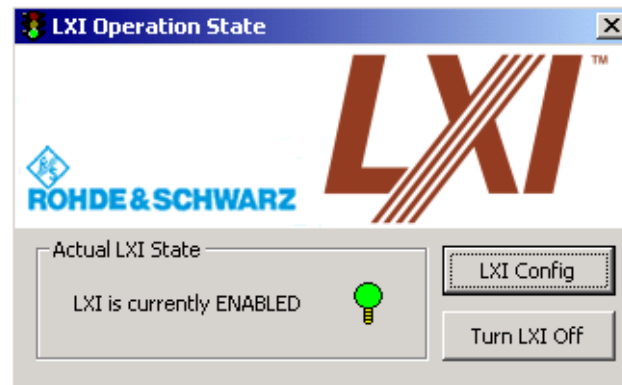

5. Press the "Turn LXI Off" button.

6.1.3 LXI Class C Functionality

If the LXI Class C functionality is installed and enabled (default state is off; see [chapter 6.1.1, "Softkeys of the Setup Menu"](#), on page 426), the instrument can be accessed via any web browser (e.g. the Microsoft Internet Explorer) to perform the following tasks:

- modifying network configurations
- modifying device configurations
- monitoring connections from the device to other devices

To change settings, in the web browser, open the "http://<instrument-hostname>" or "http://<instrument-ip-address>" page. The password to change LAN configurations is *LxiWeb*.

6.2 Saving and Recalling Settings Files – SAVE/RCL Key

The SAVE/RCL key is used to store and recall an instrument configuration.

The "Save/Recall" menu enables the user to save or recall the configuration file from the instrument's internal storage, a memory stick or a network drive. The file can also include various settings used by the options installed on the instrument. Measurement results can also be stored; however, it is strongly recommended that you use the "Print Screen" or "Trace Export" functions instead.



When recalling a saved configuration file, the following restrictions apply:

- Configuration files cannot be transferred from an R&S FSVR with a larger frequency range to one with a smaller frequency range
- Configuration files created on a R&S FSVR with certain options in use will not work on an R&S FSVR without these options
- Files created with newer firmware versions may not work with a previous version

To open the Save/Recall menu

- ▶ Press the SAVE/RCL key.
The "Save/Recall" menu is displayed.

Menu and softkey description

- [chapter 6.2.1, "Softkeys of the SAVE/RCL Menu"](#), on page 450

Further information

- [chapter 6.2.2, "File Selection Dialog Boxes"](#), on page 456
- [chapter 6.2.3, "Importing and Exporting I/Q Data"](#), on page 459

6.2.1 Softkeys of the SAVE/RCL Menu

The following table shows all softkeys available in the "Save/Recall" menu.

Save.....	451
L Save File / Recall File.....	451
L Select Path.....	451
L Select File.....	451
L Edit File Name.....	451
L Edit Comment.....	452
L Select Items.....	452
L Select Items.....	452
L Enable all Items.....	452
L Disable all Items.....	452
L Delete File.....	452
Recall.....	452
Startup Recall.....	453
L Startup Recall (On/Off).....	453
L Select Dataset.....	453
ScreenShot.....	453
Export.....	453
L ASCII Trace Export.....	453
L Decim Sep.....	454
L IQ Export.....	454
Import.....	454
L IQ Import.....	454
File Manager.....	454

L Edit Path.....	454
L New Folder.....	455
L Copy.....	455
L Rename.....	455
L Cut.....	455
L Paste.....	455
L Delete.....	455
L Sort Mode.....	455
L Name.....	455
L Date.....	455
L Extension.....	455
L Size.....	455
L File Lists (1/2).....	456
L Current File List (1/2).....	456
L Network Drive.....	456
L Map Network Drive.....	456
L Disconnect Network Drive.....	456

Save

Opens the "Save" dialog box to define which measurement settings and results to store. To navigate in the dialog box and define/enter data, use the corresponding soft-keys.

For details see also [chapter 6.2.2, "File Selection Dialog Boxes"](#), on page 456.

Save File / Recall File ← Save

Saves the settings file with the defined file name ("Save" dialog box), or recalls the selected settings file ("Recall" dialog box).

You can assign stored settings files to user-definable softkeys in the "User" menu for easy access, see [chapter 6.5, "User-Defined Menu – USER key"](#), on page 467 .

Remote command:

[MMEMemory:STORe<n>:STATe](#) on page 957

[MMEMemory:STORe<n>:STATe:NEXT](#) on page 958

[MMEMemory:LOAD:STATe](#) on page 951

Select Path ← Save

Opens the directory list to select the drive and folder for the settings file to be stored or loaded. The default path is `C:\r_s\instr\user`.

Select File ← Save

Sets the focus on the "Files" list.

Remote command:

[MMEMemory:CATalog?](#) on page 946

Edit File Name ← Save

Sets the focus on the "File Name" field.

Edit Comment ← Save

Sets the focus on the "Comment" field to enter a comment for the settings file. Max. 60 characters are allowed.

Select Items ← Save

Displays the submenu for selecting the items to be stored or loaded.

Select Items ← Select Items ← Save

Sets the focus on the items list. Which items are available depends on the installed options.

In the "Save" dialog box, all items that can be saved are displayed.

In the "Recall" dialog box, the items saved in the selected file are displayed.

Remote command:

[MMEMory:SELEct\[:ITEM\]:HWSettings](#) on page 956

[MMEMory:SELEct\[:ITEM\]:LINes:ALL](#) on page 956

[MMEMory:SELEct\[:ITEM\]:TRACe\[:ACTive\]](#) on page 957

[MMEMory:SELEct\[:ITEM\]:TRANsducer:ALL](#) on page 957

Enable all Items ← Select Items ← Save

Selects all items for saving or loading.

Remote command:

[MMEMory:SELEct\[:ITEM\]:ALL](#) on page 955

Disable all Items ← Select Items ← Save

Selects none of the items for saving or loading.

Remote command:

[MMEMory:SELEct\[:ITEM\]:NONE](#) on page 956

Delete File ← Save

Deletes the selected settings file.

Remote command:

[MMEMory:CLEAr:STATe 1](#), on page 948

Recall

Opens the "Recall" dialog box to load a settings file. To navigate in the dialog box, use the corresponding softkeys.

For details see also [chapter 6.2.2, "File Selection Dialog Boxes"](#), on page 456.

Path	Directory from which the settings file is loaded. The default path for user settings files is C:\r_s\instr\user
Files	List of stored settings files
File Name	Name of settings file
Comment	Comment of the settings file
[Items]	Items saved in the settings file

Note: After you use the "Recall" function, the history of previous actions is deleted, i.e. any actions performed previously cannot be undone or redone using the UNDO/REDO keys.

Remote command:

[MMEMoRY:LOAD:STATe](#) on page 951

Startup Recall

Opens a submenu to activate or deactivate and set up the startup recall function.

Startup Recall (On/Off) ← Startup Recall

Activates or deactivates the startup recall function. If activated, the settings stored in the file selected via the [Select Dataset](#) softkey are loaded when booting or for preset. If deactivated, the default settings are loaded.

Remote command:

[MMEMoRY:LOAD:AUTO](#) on page 951

Select Dataset ← Startup Recall

Opens the "Startup Recall" dialog box to select the settings file for the startup recall function.

ScreenShot

Saves the current measurement screen as a file (screenshot). This function can also be performed via the "Screenshot" icon in the toolbar, if available.

Remote command:

[HCOPY\[:IMMediate<1|2>\]](#) on page 943

Export

Opens a submenu to configure data export.

ASCII Trace Export ← Export

Opens the "ASCII Trace Export Name" dialog box and saves the active trace in ASCII format to the specified file and directory.

The file consists of the header containing important scaling parameters and a data section containing the trace data. For details on an ASCII file see [chapter 4.1.8.7, "ASCII File Export Format"](#), on page 107.

This format can be processed by spreadsheet calculation programs, e.g. MS-Excel. It is necessary to define ';' as a separator for the data import. Different language versions of evaluation programs may require a different handling of the decimal point. It is therefore possible to select between separators '.' (decimal point) and ',' (comma) using the "Decim Sep" softkey (see ["Decim Sep"](#) on page 100).

Remote command:

[FORMat:DEXPort:DSEParator](#) on page 728

[MMEMoRY:STORe<n>:TRACe](#) on page 744

[MMEMoRY:STORe:SGRam](#) on page 743

Decim Sep ← Export

Selects the decimal separator with floating-point numerals for the ASCII Trace export to support evaluation programs (e.g. MS-Excel) in different languages. The values '.' (decimal point) and ',' (comma) can be set.

Remote command:

[FORMat:DEXPort:DSEParator](#) on page 728

IQ Export ← Export

Opens a file selection dialog box to select an export file to which the IQ data will be stored. This function is only available in single sweep mode.

For details see [chapter 6.2.3, "Importing and Exporting I/Q Data"](#), on page 459.

Remote command:

[MMEMory:STORe:IQ:STATe](#) on page 742

[MMEMory:STORe:IQ:COMM](#) on page 742

Import

Provides functions to import data.

IQ Import ← Import

Opens a file selection dialog box to select an import file that contains IQ data. This function is only available in single sweep mode.

For details see [chapter 6.2.3, "Importing and Exporting I/Q Data"](#), on page 459.

Remote command:

[MMEMory:LOAD:IQ:STATe](#) on page 741

File Manager

Opens the "File Manager" dialog box and a submenu to manage mass storage media and files. In the upper left corner, the current drive is displayed. Below the folders and subfolders of the current directory are displayed.

For details on navigation see also [chapter 6.2.2, "File Selection Dialog Boxes"](#), on page 456.

The following tasks can be performed:

- copying files from flash disk to other media
- copying files into another directory
- renaming and deleting files

Edit Path ← File Manager

Opens the directory list to select the drive and folder for the file to be stored or loaded. The default path is `C:\r_s\instr\user`.

Remote command:

[MMEMory:MSIS](#) on page 953

[MMEMory:CDIRectory](#) on page 948

New Folder ← File Manager

Creates a new folder and opens an edit dialog box to enter name and path (absolute or relative to the current directory) of the new folder.

Remote command:

[MMEMoRY:MDIRectory](#) on page 952

Copy ← File Manager

Copies the selected item to the clipboard. The item can be copied later using the [Paste](#) softkey.

Remote command:

[MMEMoRY:CoPY](#) on page 949

Rename ← File Manager

Opens an edit dialog box to enter a new file or folder name.

Remote command:

[MMEMoRY:MoVE](#) on page 952

Cut ← File Manager

Copies the selected file to the clipboard. If the file is later copied to a different directory using the [Paste](#) softkey, it is deleted in the current directory.

Paste ← File Manager

Copies a file from the clipboard to the currently selected directory.

Delete ← File Manager

Deletes the selected item after confirmation.

Remote command:

[MMEMoRY:DELeTe](#) on page 950

[MMEMoRY:RDIRectory](#) on page 955

Sort Mode ← File Manager

Opens a submenu to select the sorting mode for the displayed files. The entry for the next higher directory level ("..") and the folders are always located at the top of the list.

Name ← Sort Mode ← File Manager

Sorts the displayed files in alphabetical order of the file names.

Date ← Sort Mode ← File Manager

Sorts the displayed files in respect to the date.

Extension ← Sort Mode ← File Manager

Sorts the displayed files in respect to the extension.

Size ← Sort Mode ← File Manager

Sorts the displayed files in respect to the size.

File Lists (1/2) ← File Manager

Splits the screen to copy files from one directory to the other. The focus between the two panes is switched using the FIELD RIGHT and FIELD LEFT keys.

Current File List (1/2) ← File Manager

Changes the focus to the selected file list.

Network Drive ← File Manager

Opens the "Map Network Drive" dialog box and submenu.

Map Network Drive ← Network Drive ← File Manager

Sets the focus on the "Drive" list.

Remote command:

[MMEMory:NETWork:MAP](#) on page 954

[MMEMory:NETWork:USEDdrives?](#) on page 955

[MMEMory:NETWork:UNUSeddrives?](#) on page 954

Disconnect Network Drive ← Network Drive ← File Manager

Opens the "Disconnect Network Drive" dialog box. In the "Drive" list, select the drive you want to disconnect and confirm with "OK".

Remote command:

[MMEMory:NETWork:DISConnect](#) on page 954

6.2.2 File Selection Dialog Boxes

The "Save" and "Recall" dialog boxes are used to save and recall settings and data files. The "File Manager" allows you to copy, delete or rename data files on the R&S FSVR. These and other file selection dialog boxes are very similar.

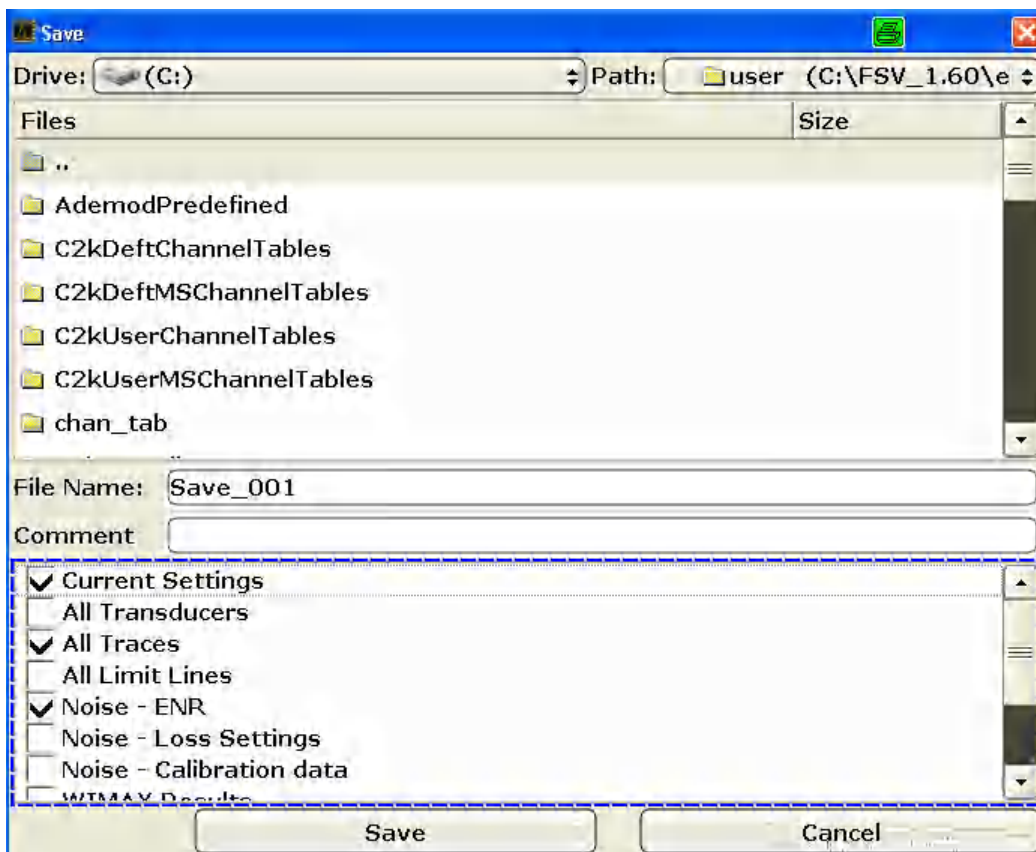

Drive

The data is stored on the internal flash disk or, if selected, on a memory stick or network drive. The mass media are assigned to the volume names as follows:

Drive	Designation	Comment
C	operating system, firmware and stored instrument settings	for customer data
A	USB floppy drive	if connected
D	USB memory stick or USB CD-ROM	if connected
E ...Z	additional USB mass storage devices or mounted LAN volumes	if connected

Path

The current path contains the drive and the complete file path to the currently selected folder.

To set the focus on the "Path" list, press the [Select Path/ Edit Path](#) softkey.

Files

This list contains the files and folders contained in the currently selected path.

To set the focus on the "Files" list, press the [Select File](#) softkey.

File Name

The "File Name" field contains the name of the data file without the path or extension.

To set the focus on "File Name" field, press the [Edit File Name](#) softkey.

In the "Save" dialog box, the field already contains a suggestion for a new name: the file name used in the last saving process is used, extended by an index. For example, if the name last used was `test_004`, the new name `test_005` is suggested, but only if this name is not in use. You can change the suggested name as you like.

By default, the name of a settings file consists of a base name followed by an underscore and three numbers, e.g. `limit_lines_005`. In the example, the base name is `limit_lines`. The base name can contain characters, numbers and underscores. The file extension `df1` is added automatically.

Comment

The comment is optional and may contain a description for the data file.

To set the focus on the "Comment" field, press the [Edit Comment](#) softkey.

Items

When saving data files you can select which data and settings are stored; when recalling such files, this field indicates which items were included during storage. In the "File Manager", this field is not available.

Which items are available depends on the installed options. The following items may be included:

Item	Description
Current Settings	Current measurement settings
All Transducers	Transducer factors for all active transducers.
All Traces	All active traces; R&S FSV-K30 only: also calibration data
All Limit Lines	All limit lines (Note: information on which limit lines are active is stored with the "Current Settings")
Spectrograms	Spectrogram trace data (only available if spectrogram display is currently active, R&S FSV-K14 only)
Noise - ENR	Data in "ENR Settings" dialog box (R&S FSV-K30 only)
Noise - Loss Settings	Data in "Loss Settings" dialog box (R&S FSV-K30 only)
Noise - Calibration data	Results from calibration measurement (R&S FSV-K30 only)
K40 Results	All current phase noise trace results (R&S FSV-K40 only)
WLAN Results	Stores the trace and table results for WLAN measurements (R&S FSV-K91 only)
WLAN IQ Data	Stores the measured I/Q data (R&S FSV-K91 only)

Item	Description
WLAN User Limits	Stores any limit values modified in the table of results for WLAN measurements (R&S FSV-K91 only)
WiMAX Results	Stores the trace and table results for WiMAX measurements (R&S FSV-K93 only)

6.2.3 Importing and Exporting I/Q Data

In addition to instrument settings and displayed traces, also captured I/Q data can be exported to a file on the R&S FSVR. The stored data can then be imported again at a later time, also by different applications, for further processing. For example, you can capture I/Q data using the I/Q Analyzer (see [chapter 4.4, "Instrument Functions - I/Q Analyzer"](#), on page 277) and then perform vector signal analysis on that data using the R&S FSV-K70 option, if available.

As opposed to storing trace data, which may be averaged or restricted to peak values, I/Q data is stored as it was captured, without further processing. The data is stored as complex values in 32-bit floating-point format. The I/Q data is stored in a packed format with the file extension `.iq.tar`.

The [IQ Import](#) and [IQ Export](#) functions are available from the "Save/Recall" menu, which is displayed when you press the SAVE/RCL key on the front panel.

They can also be performed remotely using the following commands:

`MMEMory:STORe:IQ:STATe` on page 742

`MMEMory:LOAD:IQ:STATe` on page 741

6.2.3.1 iq-tar File Format Specification

I/Q data is stored in a compressed format with the file extension `.iq.tar`.

An `.iq.tar` file contains I/Q data in binary format together with meta information that describes the nature and the source of data, e.g. the sample rate. The objective of the `.iq.tar` file format is to separate I/Q data from the meta information while still having both inside one file. In addition, the file format allows you to preview the I/Q data in a web browser, and allows you to include user-specific data.

Contained files

An `iq-tar` file must contain the following files:

- **I/Q parameter XML file**, e.g. `xyz.xml`
Contains meta information about the I/Q data (e.g. sample rate). The filename can be defined freely, but there must be only one single I/Q parameter XML file inside an `iq-tar` file.
- **I/Q data binary file**, e.g. `xyz.complex.float32`
Contains the binary I/Q data of all channels. There must be only one single I/Q data binary file inside an `iq-tar` file.

Optionally, an `iq-tar` file can contain the following file:

- **I/Q preview XSLT file**, e.g. `open_IqTar_xml_file_in_web_browser.xslt`
Contains a stylesheet to display the I/Q parameter XML file and a preview of the I/Q data in a web browser.

I/Q Parameter XML File Specification



The content of the I/Q parameter XML file must comply with the XML schema `RsIqTar.xsd` available at: <http://www.rohde-schwarz.com/file/RsIqTar.xsd>.

In particular, the order of the XML elements must be respected, i.e. `iq-tar` uses an "ordered XML schema". For your own implementation of the `iq-tar` file format make sure to validate your XML file against the given schema.

The following example shows an I/Q parameter XML file. The XML elements and attributes are explained in the following sections.

Sample I/Q parameter XML file: `xyz.xml`

```
<?xml version="1.0" encoding="UTF-8"?>
<?xml-stylesheet type="text/xsl"
href="open_IqTar_xml_file_in_web_browser.xslt"?>
<RS_IQ_TAR_FileFormat fileFormatVersion="1"
xsi:noNamespaceSchemaLocation="RsIqTar.xsd"
xmlns:xsi="http://www.w3.org/2001/XMLSchema-instance">
  <Name>FSV-K10</Name>
  <Comment>Here is a comment</Comment>
  <DateTime>2011-01-24T14:02:49</DateTime>
  <Samples>68751</Samples>
  <Clock unit="Hz">6.5e+006</Clock>
  <Format>complex</Format>
  <DataType>float32</DataType>
  <ScalingFactor unit="V">1</ScalingFactor>
  <NumberOfChannels>1</NumberOfChannels>
  <DataFilename>xyz.complex.float32</DataFilename>
  <UserData>
    <UserDefinedElement>Example</UserDefinedElement>
  </UserData>
  <PreviewData>...</PreviewData>
</RS_IQ_TAR_FileFormat>
```

Element	Description
<code>RS_IQ_TAR_FileFormat</code>	The root element of the XML file. It must contain the attribute <code>fileFormatVersion</code> that contains the number of the file format definition. Currently, <code>fileFormatVersion</code> "2" is used.
<code>Name</code>	Optional: describes the device or application that created the file.
<code>Comment</code>	Optional: contains text that further describes the contents of the file.

Saving and Recalling Settings Files – SAVE/RCL Key

Element	Description
DateTime	Contains the date and time of the creation of the file. Its type is <code>xs:dateTime</code> (see <code>RsIqTar.xsd</code>).
Samples	Contains the number of samples of the I/Q data. For multi-channel signals all channels have the same number of samples. One sample can be: <ul style="list-style-type: none"> • A complex number represented as a pair of I and Q values • A complex number represented as a pair of magnitude and phase values • A real number represented as a single real value See also <code>Format</code> element.
Clock	Contains the clock frequency in Hz, i.e. the sample rate of the I/Q data. A signal generator typically outputs the I/Q data at a rate that equals the clock frequency. If the I/Q data was captured with a signal analyzer, the signal analyzer used the clock frequency as the sample rate. The attribute <code>unit</code> must be set to "Hz".
Format	Specifies how the binary data is saved in the I/Q data binary file (see <code>DataFilename</code> element). Every sample must be in the same format. The format can be one of the following: <ul style="list-style-type: none"> • Complex: Complex number in cartesian format, i.e. I and Q values interleaved. I and Q are unitless • Real: Real number (unitless) • Polar: Complex number in polar format, i.e. magnitude (unitless) and phase (rad) values interleaved. Requires <code>DataType = float32</code> or <code>float64</code>
DataType	Specifies the binary format used for samples in the I/Q data binary file (see <code>DataFilename</code> element and " I/Q Data Binary File " on page 463). The following data types are allowed: <ul style="list-style-type: none"> • <code>int8</code>: 8 bit signed integer data • <code>int16</code>: 16 bit signed integer data • <code>int32</code>: 32 bit signed integer data • <code>float32</code>: 32 bit floating point data (IEEE 754) • <code>float64</code>: 64 bit floating point data (IEEE 754)
ScalingFactor	Optional: describes how the binary data can be transformed into values in the unit Volt. The binary I/Q data itself has no unit. To get an I/Q sample in the unit Volt the saved samples have to be multiplied by the value of the <code>ScalingFactor</code> . For polar data only the magnitude value has to be multiplied. For multi-channel signals the <code>ScalingFactor</code> must be applied to all channels. The <code>ScalingFactor</code> must be > 0 . If the <code>ScalingFactor</code> element is not defined, a value of 1 V is assumed.
NumberOfChannels	Optional: specifies the number of channels, e.g. of a MIMO signal, contained in the I/Q data binary file. For multi-channels, the I/Q samples of the channels are expected to be interleaved within the I/Q data file (see " I/Q Data Binary File " on page 463). If the <code>NumberOfChannels</code> element is not defined, one channel is assumed.
DataFilename	Contains the filename of the I/Q data binary file that is part of the <code>iq-tar</code> file. It is recommended that the filename uses the following convention: <code><xyz>.<Format>.<Channels>ch.<Type></code> <ul style="list-style-type: none"> • <code><xyz></code> = a valid Windows file name • <code><Format></code> = complex, polar or real (see <code>Format</code> element) • <code><Channels></code> = Number of channels (see <code>NumberOfChannels</code> element) • <code><Type></code> = <code>float32</code>, <code>float64</code>, <code>int8</code>, <code>int16</code>, <code>int32</code> or <code>int64</code> (see <code>DataType</code> element) Examples: <ul style="list-style-type: none"> • <code>xyz.complex.1ch.float32</code> • <code>xyz.polar.1ch.float64</code> • <code>xyz.real.1ch.int16</code> • <code>xyz.complex.16ch.int8</code>

Element	Description
UserData	Optional: contains user, application or device-specific XML data which is not part of the <code>iq-tar</code> specification. This element can be used to store additional information, e.g. the hardware configuration. It is recommended that you add user data as XML content.
PreviewData	Optional: contains further XML elements that provide a preview of the I/Q data. The preview data is determined by the routine that saves an <code>iq-tar</code> file (e.g. R&S FSVR). For the definition of this element refer to the <code>RsIqTar.xsd</code> schema. Note that the preview can be only displayed by current web browsers that have JavaScript enabled and if the XSLT stylesheet <code>open_IqTar_xml_file_in_web_browser.xslt</code> is available.

Example: ScalingFactor

Data stored as `int16` and a desired full scale voltage of 1 V

$$\text{ScalingFactor} = 1 \text{ V} / \text{maximum int16 value} = 1 \text{ V} / 2^{15} = 3.0517578125e-5 \text{ V}$$

	Numerical value	Numerical value x ScalingFactor
Minimum (negative) int16 value	$-2^{15} = -32768$	-1 V
Maximum (positive) int16 value	$2^{15}-1 = 32767$	0.999969482421875 V

Example: PreviewData in XML

```
<PreviewData>
  <ArrayOfChannel length="1">
    <Channel>
      <PowerVsTime>
        <Min>
          <ArrayOfFloat length="256">
            <float>-95</float>
            <float>-94</float>
            ...
            <float>-93</float>
          </ArrayOfFloat>
        </Min>
        <Max>
          <ArrayOfFloat length="256">
            <float>0</float>
            <float>-41</float>
            ...
            <float>0</float>
          </ArrayOfFloat>
        </Max>
      </PowerVsTime>
      <Spectrum>
        <Min>
          <ArrayOfFloat length="256">
            <float>-107</float>
            <float>-96</float>
```

```

...
    <float>-94</float>
  </ArrayOfFloat>
</Min>
<Max>
  <ArrayOfFloat length="256">
    <float>-25</float>
    <float>1</float>
    ...
    <float>1</float>
  </ArrayOfFloat>
</Max>
</Spectrum>
</Channel>
</ArrayOfChannel>
</PreviewData>

```

I/Q Data Binary File

The I/Q data is saved in binary format according to the format and data type specified in the XML file (see `Format` element and `DataType` element). To allow reading and writing of streamed I/Q data all data is interleaved, i.e. complex values are interleaved pairs of I and Q values and multi-channel signals contain interleaved (complex) samples for channel 1, channel 2, channel 3 etc.

Example: NumberOfChannels - Element ordering for complex cartesian data

Complex data: I[channel no][time index], Q[channel no][time index]

```

I[0][0], Q[0][0],           // Channel 0, Complex sample 0
I[1][0], Q[1][0],           // Channel 1, Complex sample 0
I[2][0], Q[2][0],           // Channel 2, Complex sample 0

I[0][1], Q[0][1],           // Channel 0, Complex sample 1
I[1][1], Q[1][1],           // Channel 1, Complex sample 1
I[2][1], Q[2][1],           // Channel 2, Complex sample 1

I[0][2], Q[0][2],           // Channel 0, Complex sample 2
I[1][2], Q[1][2],           // Channel 1, Complex sample 2
I[2][2], Q[2][2],           // Channel 2, Complex sample 2

I[0][3], Q[0][3],           // Channel 0, Complex sample 3
I[1][3], Q[1][3],           // Channel 1, Complex sample 3
I[2][3], Q[2][3],           // Channel 2, Complex sample 3

...

```

6.3 Manual Operation – Local Menu

When switched on, the instrument is always in the manual measurement mode and can be operated via the front panel. As soon as the instrument receives a remote command, it is switched to the remote control mode.

In remote control mode, all keys of the instrument except the PRESET key are disabled, see [chapter 6.1, "Instrument Setup and Interface Configuration – SETUP Key"](#), on page 426. The "LOCAL" softkey and the [Display Update \(On/Off\)](#) softkey are displayed. Depending on the setting of the [Display Update \(On/Off\)](#) softkey, the diagrams, traces and display fields are displayed or hidden. For further details on the [Display Update \(On/Off\)](#) softkey refer to [chapter 6.1, "Instrument Setup and Interface Configuration – SETUP Key"](#), on page 426.

For details on remote control refer to chapter 5 "Remote Control – Basics".

The change to manual operation consists of:

- Enabling the Front Panel Keys
Returning to manual mode enables all inactive keys. The main softkey menu of the current mode is displayed.
- Displaying the measurement diagrams again.
The diagrams, traces and display fields are displayed again.
- Generating the "OPERATION COMPLETE" message
If, at the time of pressing the "LOCAL" softkey, the synchronization mechanism via *OPC, *OPC? or *WAI is active, the currently running measurement procedure is aborted and synchronization is achieved by setting the corresponding bits in the registers of the status reporting system.
- Setting Bit 6 (User Request) of the Event Status Register
With a corresponding configuration of the status reporting system, this bit immediately causes the generation of a service request (SRQ) to inform the control software that the user wishes to return to front panel control. For example this can be used to interrupt the control program and to correct instrument settings manually. This bit is set each time the "LOCAL" softkey is pressed.

To return to manual operation

- ▶ Press the "LOCAL" softkey.

The instrument switches from remote to manual operation, but only if the local lock-out function has not been activated in the remote control mode.

6.4 Measurement Documentation – PRINT Key

The PRINT key is used to select and configure the printer and to customize the screen printout. For detailed information on printer selection and installation refer to the R&S FSVR Quick Start Guide.

To open the Print menu

- ▶ Press the PRINT key.
The "Print" menu is displayed.

Softkeys of the Print Menu

The following table shows all softkeys available in the "Print" menu. It is possible that your instrument configuration does not provide all softkeys. If a softkey is only available with a special option, model or (measurement) mode, this information is delivered in the corresponding softkey description.

Print Screen.....	465
Device Setup.....	466
Device (1/2).....	466
Colors.....	466
L Select Print Color Set.....	466
L Color (On/Off).....	466
L Select Object.....	466
L Predefined Colors.....	466
L User Defined Colors.....	466
L Set to Default.....	466
Comment.....	467
Install Printer.....	467

Print Screen

Starts to printout all test results displayed on the screen: diagrams, traces, markers, marker lists, limit lines etc. Comments, title, date, and time are included at the bottom margin of the printout. All displayed items belonging to the instrument software (softkeys, tables, dialog boxes) are not printed out.

The output is defined via the "Device Setup" on page 466 softkey. If the output is saved in a file, the file name used in the last saving process is counted up to the next unused name. If you use a file name that already exists, upon saving, a message is displayed. Selecting "Yes" overwrites the existing file, selecting "No" aborts the saving process. For further details on the file name and an example, refer to the "Save/Recall" menu, "Edit File Name" on page 451 softkey.

Path	Directory in which the file is stored. The default path is C:\r_s\instruser
Files	List of the existing files in the same format
File Name	Name of the file

Remote command:

HCOPY[:IMMEDIATE<1|2>] on page 943

HCOPY[:IMMEDIATE<1|2>]:NEXT on page 943

HCOPY:ITEM:ALL on page 944

Device Setup

Opens the "Hardcopy Setup" dialog box to define the output: image file, clipboard, or the printer. The dialog box consists of two tabs which are selected via the "[Device \(1/2\)](#)" on page 466 softkey.

For further information refer to the R&S FSVR Quick Start Guide.

Remote command:

[HCOPY:DEVICE:LANGUAGE<1|2>](#) on page 942

[HCOPY:DESTINATION<1|2>](#) on page 941

[HCOPY:PAGE:ORIENTATION<1|2>](#) on page 945

[HCOPY:TDSTAMP:STATE<1|2>](#) on page 945

[SYSTEM:COMMUNICATE:PRINTER:ENUMERATE:FIRST?](#) on page 970

[SYSTEM:COMMUNICATE:PRINTER:ENUMERATE\[:NEXT\]?](#) on page 971

Device (1/2)

Selects the tab of the device in the "Device Setup" dialog box. The analyzer is able to manage two print settings independently of each other. For each device the print setting is displayed on the corresponding tab of the "Device Setup" dialog box ("[Device Setup](#)" on page 466 softkey).

For further information refer to the R&S FSVR Quick Start Guide.

Colors

Opens a submenu to define the colors to be used. For details see "[Print Colors](#)" on page 443 softkey of the "Setup" menu.

The submenu contains the following commands:

- "[Select Print Color Set](#)" on page 466
- "[Color \(On/Off\)](#)" on page 466
- "[Select Object](#)" on page 466
- "[Predefined Colors](#)" on page 466
- "[User Defined Colors](#)" on page 466
- "[Set to Default](#)" on page 466

Select Print Color Set ← Colors

For details see "[Select Print Color Set](#)" on page 443 softkey of the "Setup" menu.

Color (On/Off) ← Colors

For details see "[Color \(On/Off\)](#)" on page 442 softkey of the "Setup" menu.

Select Object ← Colors

For details see "[Select Object](#)" on page 442 softkey of the "Setup" menu.

Predefined Colors ← Colors

For details see "[Predefined Colors](#)" on page 443 softkey of the "Setup" menu.

User Defined Colors ← Colors

For details see "[User Defined Colors](#)" on page 443 softkey of the "Setup" menu.

Set to Default ← Colors

For details see "[Set to Default](#)" on page 443 softkey of the "Setup" menu.

Comment

Opens dialog box to enter a comment. Max. 120 characters are allowed. 60 characters fit in one line. In the first line, at any point a manual line-feed can be forced by entering "@".

Date and time are inserted automatically. The comment is printed below the diagram area, but not displayed on the screen. If a comment should not be printed, it must be deleted.

For details on the alphanumeric entries refer to the R&S FSVR Quick Start Guide, "Basic Operations".

Remote command:

[HCOPY:ITEM:WINDOW:TEXT](#) on page 944

Install Printer

Opens the "Printers and Faxes" window to install a new printer. All printers that are already installed are displayed.

For further information refer to the R&S FSVR Quick Start Guide, appendix 1, "Printer Interface".

Only user accounts with administrator rights can install a printer.

6.5 User-Defined Menu – USER key

The USER key displays a user-defined menu. The softkeys displayed here can be labelled and assigned to user-defined settings files as required.

To open the user-defined menu

- ▶ Press the USER key.
The "User" menu is displayed.

Softkeys of the User menu

The "User" menu contains 8 user-definable softkeys as well as a "[User Preference Setup](#)" softkey that allows you to define them. Pressing one of the user-definable softkeys has the same effect as the [Save File / Recall File](#) function for a pre-defined settings file. The definitions for these softkeys remain unchanged even after a reset function and after updating the firmware.

"User Preference Setup" softkey

Opens an "ApplicationManager" dialog to set up the user-defined softkeys.

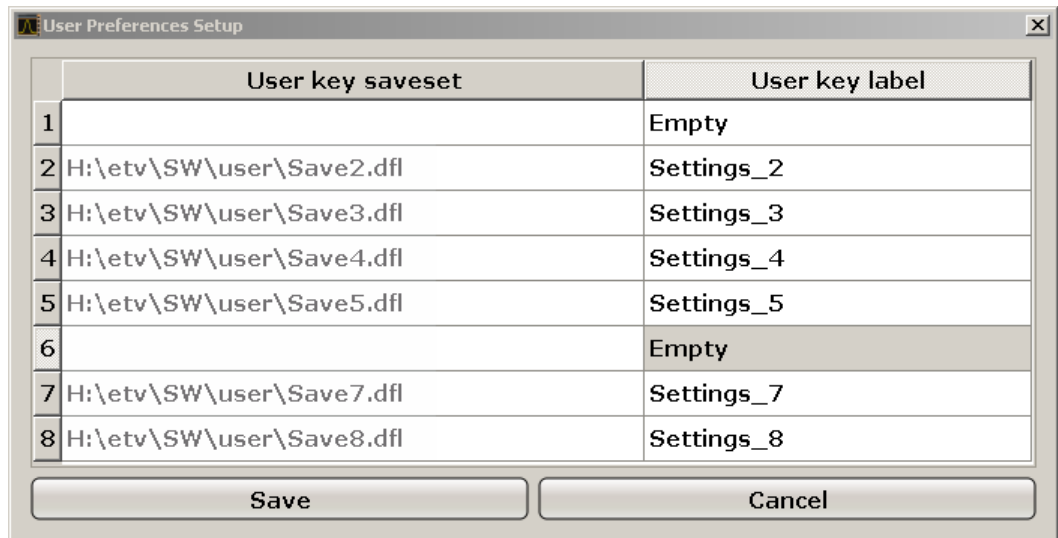

For each user-definable softkey (1–8), you can define a key label and assign a settings file that is to be loaded when the softkey is selected.

SCPI command:

[MMEMory:USER<Softkey>](#) on page 958

To define the key label

1. Click into the table entry for the corresponding softkey.
2. Enter a label for the softkey.
3. Press ENTER.

To assign a settings file

1. Click into the table entry for the corresponding softkey.
2. In the file selection dialog, select a stored settings file to be recalled when the softkey is selected.
3. Click "Select".
The selected file is displayed in the "ApplicationManager" dialog.

To store the softkey settings

- ▶ Click "Save" to store the user-defined softkey definitions.

7 R&S FSVR Options

This chapter provides a description of all hardware options available for the R&S FSVR.

7.1 Instrument Functions - R&S Digital I/Q Interface (Option R&S FSV-B17)

In the standard configuration, the R&S FSVR provides an internal I/Q memory in order to capture and evaluate I/Q data, which can be output via GPIB or the LAN interface. If the R&S FSVR R&S Digital I/Q Interface option (R&S FSV-B17) is installed, an online digital I/Q data interface is provided on the rear panel of the instrument for input and output.

Using the R&S Digital I/Q Interface for input, the digital baseband signal from the digital interface is used for measurement, rather than the digitalized IF signal. If the digital output is enabled, the I/Q data is continuously output at the connector at the rear of the instrument.



Alternatively, the I/Q data can be exported to a file (see [chapter 6.2.3, "Importing and Exporting I/Q Data"](#), on page 459).

In the base unit, the input and output I/Q data can be evaluated using the I/Q Analyzer, for example (see [chapter 4.4, "Instrument Functions - I/Q Analyzer"](#), on page 277). Other applications (e.g. VSA, R&S FSV-K70) also support digital input, see the descriptions of the individual firmware options for details.

The digital input and output can be enabled in the base unit or in one of the applications (where available). Alternatively, I/Q data can also be captured via remote control. The required commands are contained in the following subsystems:

- [chapter 8.2.3.9, "INPut Subsystem"](#), on page 731
- ["TRACe:IQ Subsystem"](#) on page 893
- [chapter 8.2.3.12, "OUTPut Subsystem"](#), on page 744

Information on the `STATus:QUESTionable:DIQ` register can be found in ["STATus:QUESTionable:DIQ Register"](#) on page 537.

7.1.1	Typical Applications for the R&S Digital I/Q Interface.....	470
7.1.2	Digital Input.....	471
7.1.3	Digital Output.....	477
7.1.4	Softkeys and Parameters of the R&S Digital I/Q Interface.....	478
7.1.5	Interface Status Information.....	482
7.1.6	Description of the LVDS Connector.....	485

7.1.1 Typical Applications for the R&S Digital I/Q Interface

The following typical applications use the R&S Digital I/Q Interface:

- Capturing and evaluating digital I/Q data in the I/Q Analyzer mode of the R&S FSVR base unit or other (optional) applications, e.g. R&S FSV-K70 (VSA). See [chapter 4.4, "Instrument Functions - I/Q Analyzer"](#), on page 277 or the description of the individual firmware options.



- Output of digital I/Q data to a selected receiver, e.g. to implement fading (simulating mobile radio communication participants) using a generator.

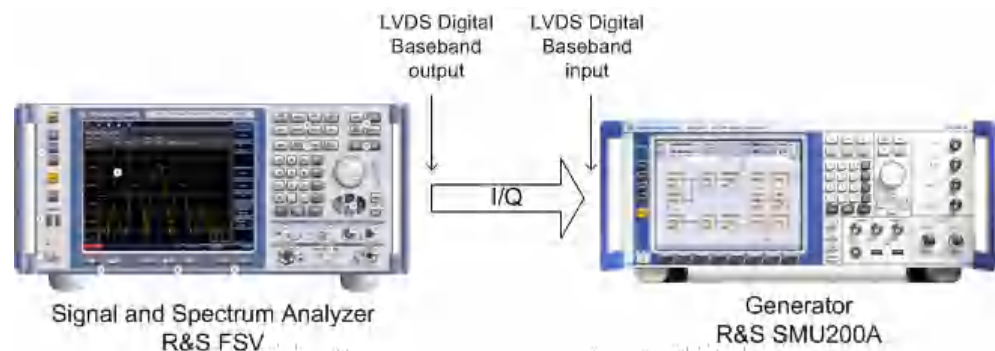

- Output of digital I/Q data to a device with a user-specific interface using an R&S EX-IQ-BOX (see the "R&S®EX-IQ-BOX - External Signal Interface Module Manual". The EX-IQ-Box functionality is not supported for R&S FSVR models 1321.3008Kxx.)

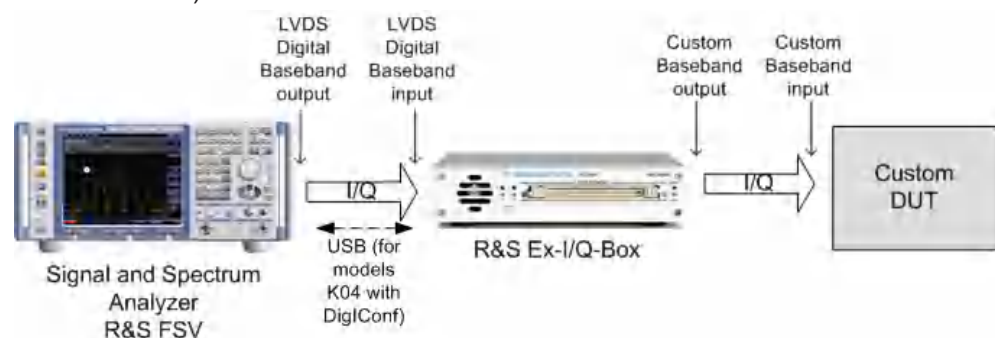

- Capturing and evaluating digital I/Q data from a device with a user-specific interface using an R&S EX-IQ-BOX (see the "R&S®EX-IQ-BOX - External Signal Interface Module Manual". The EX-IQ-Box functionality is not supported for R&S FSVR models 1321.3008Kxx.)

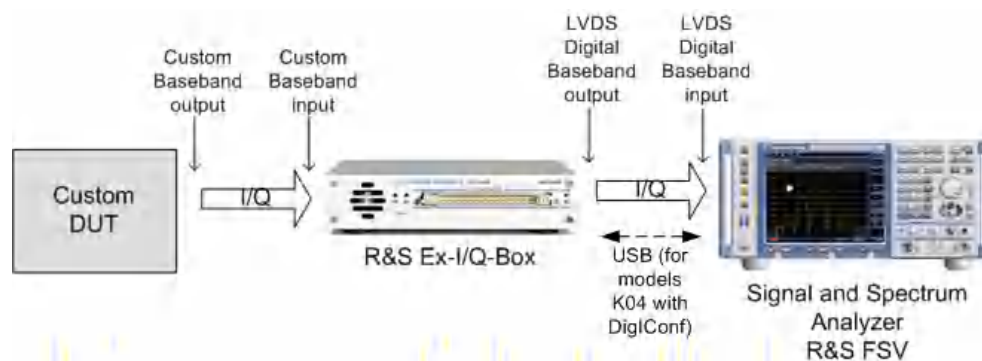

R&S EX-IQ-BOX and R&S DigIConf

The R&S EX-IQ-BOX is a configurable interface module that converts signal properties and the transmission protocol of the R&S instruments into user-defined or standardized signal formats and vice versa.

The EX-IQ-Box functionality is **not supported** for R&S FSVR models **1321.3008Kxx**.

The latest R&S EX-IQ-BOX (model 1409.5505K04) provides the configuration software R&S DigIConf which can be installed directly on the R&S FSVR. The software R&S DigIConf (Digital Interface Configurator for the R&S EX-IQ-BOX, version 2.10 or higher) controls the protocol, data and clock settings of the R&S EX-IQ-BOX independently from the connected R&S instrument. Besides basic functions of the user-defined protocols, this software utility supports the settings for standardized protocols, as e.g. CPRI, OBSAI or DigRF. **Note that R&S DigIConf requires a USB connection (not LAN!) to the R&S FSVR in addition to the R&S Digital I/Q Interface connection.**

Remote control is possible and very simple. Remote commands for the R&S DigIConf software always begin with `SOURCE: EBOX`. Such commands are passed on from the R&S FSVR to the R&S EX-IQ-BOX automatically via the USB connection.

A setup file, included in delivery, consists of an installation wizard, the executable program and all necessary program and data files. The latest software versions can be downloaded free of charge from the R&S website: www.rohde-schwarz.com/en/products/test_and_measurement/signal_generation/EX-IQ-Box. Simply execute the Setup file and follow the instructions in the installation wizard.

For details on installation and operation of the R&S DigIConf software, see the "R&S®EX-IQ-BOX Digital Interface Module R&S®DigIConf Software Operating Manual".

7.1.2 Digital Input

Digital input is enabled by selecting the "Digital Baseband (I/Q)" input path in the "Signal Source" dialog box (available either in the "Measurement" menu of the "I/Q Analyzer" mode, or in the "Input/Output" menu of the base unit and some applications, see "Signal Source" on page 270).



The digital input and output cannot be used simultaneously.

Signal Source

The device that provides digital input must be connected to the R&S Digital I/Q Interface at the rear of the R&S FSVR. The signal source is then configured in the "Signal Source" dialog box.

In the "Signal Source" dialog box the detected input device is indicated. For "Digital Baseband (I/Q)" sources, you can configure the basic connection settings, e.g. the input sample rate. Each time the device is disconnected or the configuration is changed, a connection protocol is executed, and before the first measurement, a PRBS desewing test is performed. Information on the connection status and the results of the connection tests are provided in the "Digital IQ Info" dialog box, see [chapter 7.1.5, "Interface Status Information"](#), on page 482.

Note that if you are using an R&S FSV as signal source, and turn it off while the R&S FSVR is still running, you have to synchronize the R&S FSVR again. To synchronize the R&S FSVR, reconnect the cables to the R&S FSVR while the R&S FSV is running.

Measurement Settings

The "Full Scale Level" defines the level that should correspond to an I/Q sample with the magnitude "1" and can be defined either in dBm or Volt (see ["Full Scale Level"](#) on page 270). When converting the measured power into dBm, an impedance of 50 Ω is assumed.

Processing digital input

The digital input signal is brought to the desired sample rate using a downsampling filter and fractional resampling. The word length of the data is 18 bits fixed point for each I and Q. The resulting data can be processed by the selected application (see [chapter 7.1.1, "Typical Applications for the R&S Digital I/Q Interface"](#), on page 470). As illustrated in [figure 7-1](#), the sample rate is dependant on the input sample rate.

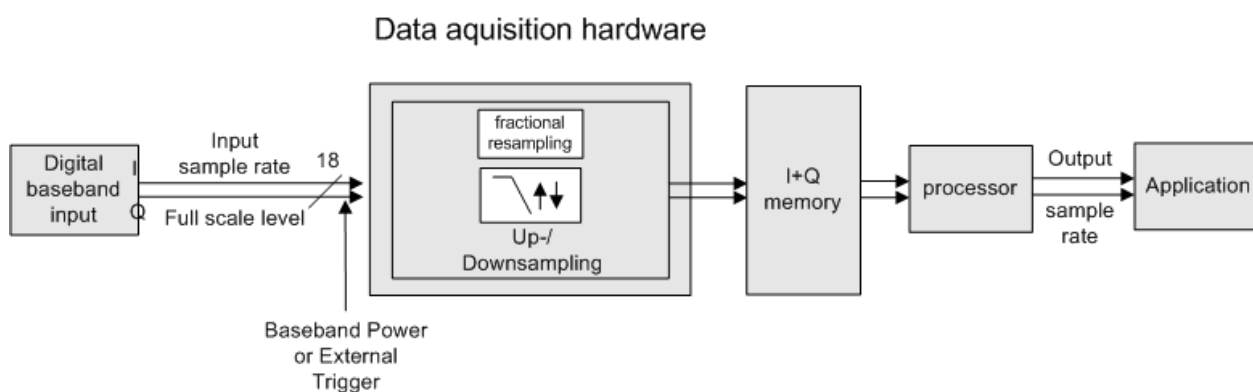

Fig. 7-1: Signal path using digital input

Sample rates, bandwidths and other limitations

The calculation of the usable I/Q bandwidth for active digital input is described in [table 7-1](#).



Abbreviations

The following abbreviations are used in this section:

- **SR**: sample rate: the sample rate that is defined by the user (e.g. in the "Data Acquisition" dialog box in the "I/Q Analyzer" mode, see ["Sample Rate"](#) on page 283)
- **ISR**: Input sample rate: the sample rate of the data provided by the connected device to the digital input
- **Ms**: 1 Ms = 1024 * 1024 samples

Table 7-1: Calculation of the usable I/Q bandwidth for active digital input

Precondition	Bandwidth
$\frac{SR}{ISR} < 0.95$	0.8 * SR
$0.95 \leq \frac{SR}{ISR}$	0.76 * ISR



Unfiltered I/Q data input

The values in [table 7-1](#) apply for the default data processing using the decimation filter and resampler. If the filter is deactivated (see ["No Filter"](#) on page 283), the sample rate is identical to the input sample rate. In this case, the usable I/Q bandwidth is not restricted by the R&S FSVR.

The following table describes the dependencies for digital in- and output:

Table 7-2: Dependencies for digital in- and output

Type of Limit	Precondition	Range / Value
Input sample rate (ISR)		100 Hz ... 10 GHz (*)
Minimum sample rate (SR)		100 Hz (*)
Maximum sample rate (SR)	Digital input active	45 MHz (without R&S FSV-B70) (*) 254 * ISR, max. 10 GHz (with R&S FSV-B70) (*)
	Digital output active	45 MHz (without R&S FSV-B70) 100 MHz (with R&S FSV-B70)
(*) Note the relationship between the sample rate and the input sample rate, which may restrict the value ranges further: $ISR_{min} = SR/254$ $ISR_{max} = SR * 2 * 1048576$		

Type of Limit	Precondition	Range / Value
Maximum number of samples		$\text{Min}\left(100Ms, 100Ms \cdot \frac{SR}{ISR}\right) - \text{group delay in samples}$ <p>Note: the internal filter settling time depends on the relation:</p> $\frac{SR}{ISR}$ <p>Some R&S FSVR applications limit the maximum number of samples to reasonable values.</p> <p>In I/Q Analyzer mode (Eval mode, see TRACe<n>: IQ: EVAL on page 902), the maximum number of samples is restricted to:</p> $\text{Min}\left(10Mio, 100Ms \cdot \frac{SR}{ISR}\right) - \text{group delay in samples}$
Maximum number of I/Q pretrigger samples		-(MaxNoOfSamples-1) to + (MaxNoOfSamples-1)
<p>(*) Note the relationship between the sample rate and the input sample rate, which may restrict the value ranges further:</p> $ISR_{\min} = SR/254$ $ISR_{\max} = SR \cdot 2 \cdot 1048576$		

Table 7-3: Typical values for the maximum number of samples depending on the SR/ISR relation

SR/ISR	Max number of samples
100	104857600
10	104857600
1	104857600
1/10	10485686
1/100	1048508



SlowIQ measurements

"SlowIQ" measurements are measurements where the sample rate exceeds the rate used to transfer valid samples. In the R&S FSVR, the sample rate may exceed 100 MHz for "SlowIQ" measurements. This happens, for example, when an analog signal is sampled by external hardware, e.g. an oscilloscope, with a sample rate > 100 MHz, is stored there in a memory temporarily and then read from the memory and transmitted to the R&S FSVR. In this case, make sure the source sample rate is defined correspondingly for the connected device (see ["Input Sample Rate"](#) on page 270).

Bandwidths

Depending on the sample rate, the following bandwidths are available:

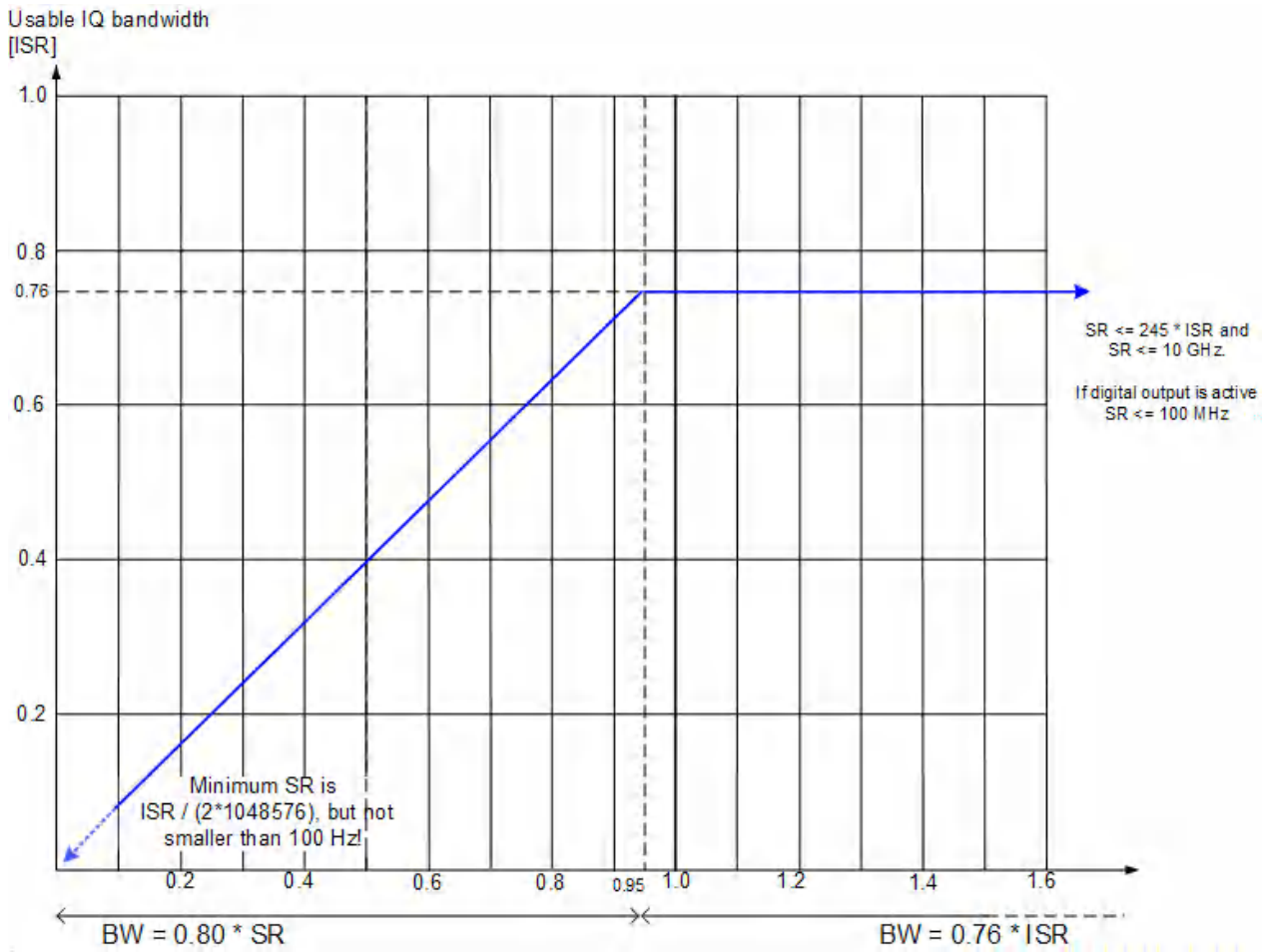

Fig. 7-2: Bandwidths depending on sample rate for active digital input

Table 7-4: Bandwidths depending on sample rate for active digital input (with B70)

Exemplary digital input sample rates	Possible output sample rates and the corresponding IQ bandwidths			
	Linear increase from the minimum possible output sample rate up to break point		Constant IQ bandwidth from break point up to the maximum possible output sample rate	
	minimum	break point	break point	maximum
Minimum: ISR = 100 Hz	Not allowed		SR = 100 Hz ¹⁾ BW = 0.76 * ISR = 76 Hz	SR = 254 * ISR = 25.64 kHz BW = 0.76 * ISR = 76 Hz
Example ISR = 30 MHz	SR = 100 Hz ¹⁾ BW = 0.8 * SR = 80 Hz	SR = 0.95*ISR = 28.5 MHz BW = 0.8 * SR = 22.8 MHz	SR = 0.95*ISR = 28.5 MHz BW = 0.76 * ISR = 22.8 MHz	SR = 254 * ISR = 7.62 GHz BW = 0.76 * ISR = 22.8 Hz
¹⁾ max(ISR/(2*1048576), 100 Hz) ²⁾ min(254*ISR, 10GHz)				

Exemplary digital input sample rates	Possible output sample rates and the corresponding IQ bandwidths			
	Linear increase from the minimum possible output sample rate up to break point		Constant IQ bandwidth from break point up to the maximum possible output sample rate	
	minimum	break point	break point	maximum
Example ISR = 50 MHz	SR = 100 Hz ¹⁾ BW = 0.8 * SR = 80 Hz	SR = 0.95*ISR = 47.5 MHz BW = 0.8 * SR = 38 MHz	SR = 0.95*ISR = 47.5 MHz BW = 0.76 * ISR = 38 MHz	SR = 10 GHz ²⁾ BW = 0.76 * ISR = 38 MHz
Example ISR = 500 MHz	SR = ISR/ (2*1048576) = 239 Hz BW = 0.8 * SR = 191.2 Hz	SR = 0.95*ISR = 475 MHz BW = 0.8 * SR = 380 MHz	SR = 0.95*ISR = 475 MHz BW = 0.76 * ISR = 380 MHz	SR = 10 GHz ²⁾ BW = 0.76 * ISR = 380 MHz
Maximum: ISR = 10 GHz	SR = ISR/ (2*1048576) = 4.769 kHz BW = 0.8 * SR = 3.8152 kHz	SR = 0.95*ISR = 9.5 GHz BW = 0.8 * SR = 7.6 GHz	SR = 0.95*ISR = 9.5 GHz BW = 0.76 * ISR = 7.6 GHz	SR = 10 GHz ²⁾ BW = 0.76 * ISR = 7.6 GHz
¹⁾ max(ISR/(2*1048576), 100 Hz) ²⁾ min(254*ISR, 10GHz)				

Table 7-5: Bandwidths depending on sample rate for active digital input (without B70)

Exemplary digital input sample rates	Possible output sample rates and the corresponding IQ bandwidths			
	Linear increase from the minimum possible output sample rate up to break point		Constant IQ bandwidth from break point up to the maximum possible output sample rate	
	minimum	break point	break point	maximum
Minimum: ISR = 100 Hz	Not allowed		SR = 100 Hz ¹⁾ BW = 0.76 * ISR = 76 Hz	SR = 254 * ISR = 25.64 kHz BW = 0.76 * ISR = 76 Hz
Example ISR = 30 MHz	SR = 100 Hz ¹⁾ BW = 0.8 * SR = 80 Hz	SR = 0.95*ISR = 28.5 MHz BW = 0.8 * SR = 22.8 MHz	SR = 0.95*ISR = 28.5 MHz BW = 0.76 * ISR = 22.8 MHz	SR = 45 MHz ²⁾ BW = 0.76 * ISR = 22.8 MHz
Example ISR = 50 MHz	SR = 100 Hz ¹⁾ BW = 0.8 * SR = 80 Hz	SR = 45 MHz ²⁾ BW = 0.8 * SR = 36 MHz	Not allowed	
¹⁾ max(ISR/(2*1048576), 100 Hz) ²⁾ min(254*ISR, 45 MHz)				

Exemplary digital input sample rates	Possible output sample rates and the corresponding IQ bandwidths			
	Linear increase from the minimum possible output sample rate up to break point		Constant IQ bandwidth from break point up to the maximum possible output sample rate	
	minimum	break point	break point	maximum
Example ISR = 500 MHz	SR = ISR/ (2*1048576) = 239 Hz BW = 0.8 * SR = 191.2 Hz	SR = 45 MHz ²⁾ BW = 0.8 * SR = 36 MHz	Not allowed	
Maximum: ISR = 10 GHz	SR = ISR/ (2*1048576) = 4.769 kHz BW = 0.8 * SR = 3.8152 kHz	SR = 45 MHz ²⁾ BW = 0.8 * SR = 36 MHz	Not allowed	
¹⁾ max(ISR/(2*1048576), 100 Hz) ²⁾ min(254*ISR, 45 MHz)				

Triggering

The following trigger modes are supported:

- External (see ["External"](#) on page 110)
- BB Power (see ["IF Power/BB Power"](#) on page 111)
- Time (see ["Time"](#) on page 112)

If external triggering is used, the external trigger must be applied via the connector on the rear panel of the instrument (as for analog input).



Gating

Gating is not supported for digital input.

7.1.3 Digital Output

Digital output is enabled in the I/Q Analyzer mode (see [chapter 4.4, "Instrument Functions - I/Q Analyzer"](#), on page 277).



The digital input and output cannot be used simultaneously.

Processing digital output

Digital output is processed almost identically to RF input in I/Q mode (see [chapter 4.4.6, "Working with I/Q Data"](#), on page 301). I/Q data is sampled blockwise, according to the defined sample rate, and stored in the I/Q memory. From the memory,

the I/Q data is processed in the I/Q Analyzer mode. Simultaneously, the data is written to the R&S Digital I/Q Interface continuously. Using this interface, the I/Q data can be processed in an external device as an alternative to internal processing in the R&S FSVR.



The sample rate at the digital output corresponds to the user-defined sample rate (maximum 100 MHz, see "Sample Rate" on page 283). The current sample rate is displayed in the "Digital Output" dialog box (read-only) when the digital output is enabled (see "Digital Output" on page 272).

For digital output, the full scale level corresponds to the defined reference level (without the reference level offset and transducer; see also "Full Scale Level" on page 270 and "Reference Level" on page 282).

The data rate for digital output via the R&S Digital I/Q Interface is 100 MHz, i.e. any connected device must be capable of processing digital input at a data rate of 100 MHz.

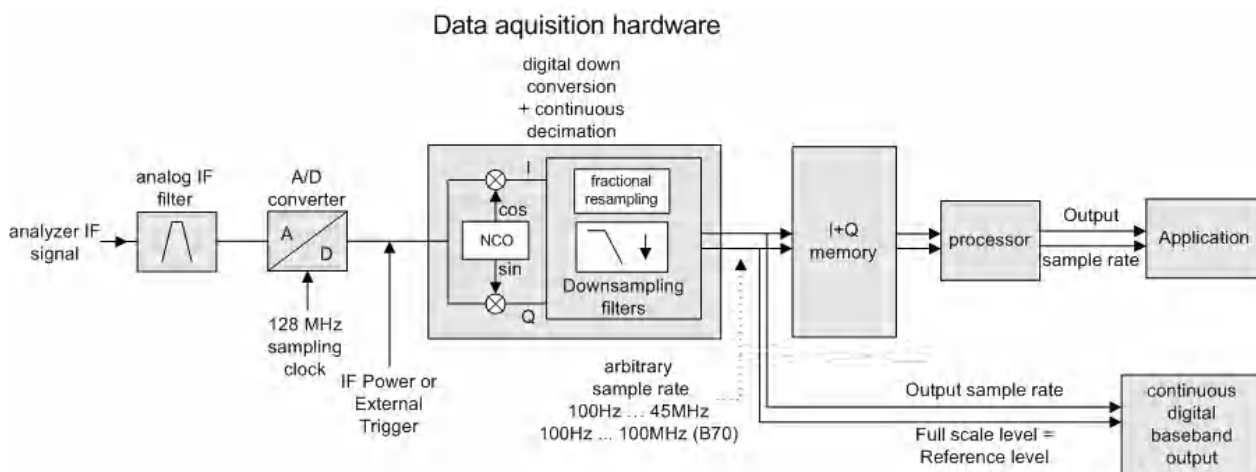

Fig. 7-3: Signal path using the digital output

7.1.4 Softkeys and Parameters of the R&S Digital I/Q Interface

The following softkeys and parameters are available for the R&S Digital I/Q Interface in the applications that support it.

Signal Source.....	479
L Input Path.....	479
L Connected Device.....	479
L Input Sample Rate.....	479
L Full Scale Level.....	479
L Level Unit.....	479
L Adjust Reference Level to Full Scale Level.....	480
Digital Output.....	480
Digital IQ Info.....	480
EXIQ.....	481

L TX Settings.....	481
L RX Settings.....	481
L Send To.....	481
L Firmware Update.....	481
L R&S Support.....	481
L DigIConf.....	482

Signal Source

Opens a dialog box to select the signal source.

For "Digital Baseband (I/Q)", the source can also be configured here.

Input Path ← Signal Source

Defines whether the "RF Radio Frequency" or the "Digital IQ" input path is used for measurements. "Digital IQ" is only available if option R&S FSV-B17 (R&S Digital I/Q Interface) is installed.

Note: Note that the input path defines the characteristics of the signal, which differ significantly between the RF input and digital input.

Remote command:

[INPut:SElect](#) on page 738

Connected Device ← Signal Source

Displays the name of the device connected to the optional R&S Digital I/Q Interface (R&S FSV-B17) to provide Digital IQ input. The device name cannot be changed here.

The device name is unknown.

Remote command:

[INPut:DIQ:CDEvice](#) on page 733

Input Sample Rate ← Signal Source

Defines the sample rate of the digital I/Q signal source. This sample rate must correspond with the sample rate provided by the connected device, e.g. a generator.

Remote command:

[INPut:DIQ:SRATe](#) on page 735

Full Scale Level ← Signal Source

The "Full Scale Level" defines the level that should correspond to an I/Q sample with the magnitude "1".

The level can be defined either in dBm or Volt.

Remote command:

[INPut:DIQ:RANGe\[:UPPer\]](#) on page 734

Level Unit ← Signal Source

Defines the unit used for the full scale level.

Remote command:

[INPut:DIQ:RANGe\[:UPPer\]:UNIT](#) on page 735

Adjust Reference Level to Full Scale Level ← Signal Source

If enabled, the reference level is adjusted to the full scale level automatically if any change occurs.

(See the [Auto Level](#) softkey).

Remote command:

`INPut:DIQ:RANGe:COUPling` on page 734

Digital Output

Opens a dialog box to enable a digital output stream to the optional R&S Digital I/Q Interface (R&S FSV-B17), if available.

The displayed sample rate is identical to the sample rate defined under [Data Acquisition](#) (I/Q Analyzer) and is not editable here.

For details see "Digital Output" in the description of the R&S Digital I/Q Interface for the base unit.

Remote command:

`OUTPut:DIQ` on page 744

Digital IQ Info

Displays a dialog box with information on the digital I/Q input and output connection via the optional R&S Digital I/Q Interface (R&S FSV-B17), if available. The information includes:

- Device identification
- Used port
- (Maximum) digital input/output sample rates and maximum digital input/output transfer rates
- Status of the connection protocol
- Status of the PRBS descewing test

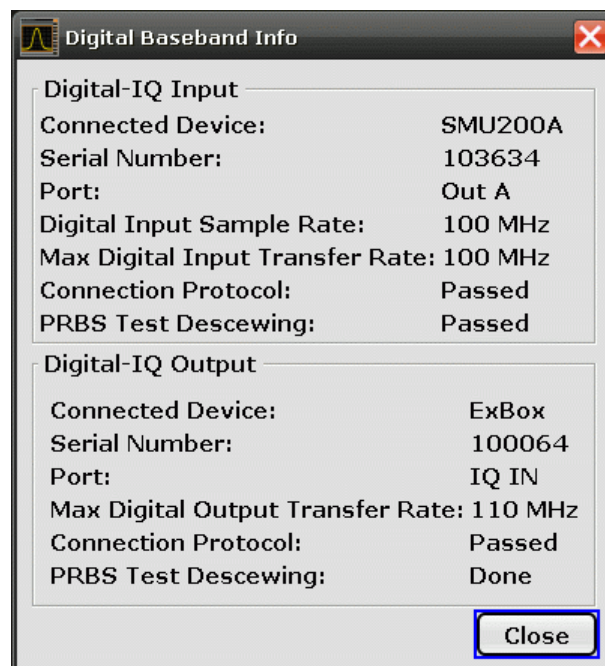

For details see "Interface Status Information" in "Instrument Functions - R&S Digital I/Q Interface (Option R&S FSV-B17)" in the description of the base unit.

Remote command:

[INPut:DIQ:CDEvice](#) on page 733

EXIQ

Opens a configuration dialog box for an optionally connected R&S EX-IQ-BOX and a submenu to access the main settings quickly.

Note: The EX-IQ-Box functionality is not supported for R&S FSVR models 1321.3008Kxx.

If the optional R&S DigIConf software is installed, the submenu consists only of one key to access the software. **Note that R&S DigIConf requires a USB connection (not LAN!) from the R&S FSVR to the R&S EX-IQ-BOX in addition to the R&S Digital I/Q Interface connection. R&S DigIConf version 2.10 or higher is required.**

For typical applications of the R&S EX-IQ-BOX see also the description of the R&S Digital I/Q Interface (R&S FSV-B17) in the base unit manual.

For details on configuration see the "R&S@Ex I/Q Box - External Signal Interface Module Manual".

For details on installation and operation of the R&S DigIConf software, see the "R&S@EX-IQ-BOX Digital Interface Module R&S@DigIConf Software Operating Manual".

TX Settings ← EXIQ

Opens the "EX-IQ-BOX Settings" dialog box to configure the R&S FSVR for digital output to a connected device ("Transmitter" Type).

RX Settings ← EXIQ

Opens the "EX-IQ-BOX Settings" dialog box to configure the R&S FSVR for digital input from a connected device ("Receiver" Type).

Send To ← EXIQ

The configuration settings defined in the dialog box are transferred to the R&S EX-IQ-BOX.

Firmware Update ← EXIQ

If a firmware update for the R&S EX-IQ-BOX is delivered with the R&S FSVR firmware, this function is available. In this case, when you select the softkey, the firmware update is performed.

R&S Support ← EXIQ

Stores useful information for troubleshooting in case of errors.

This data is stored in the `C:\R_S\Instr\user\Support` directory on the instrument.

If you contact the Rohde&Schwarz support to get help for a certain problem, send these files to the support in order to identify and solve the problem faster.

DigIConf ← EXIQ

Starts the optional R&S DigIConf application. This softkey is only available if the optional software is installed.

To return to the R&S FSVR application, press any key on the front panel. The application is displayed with the "EXIQ" menu, regardless of which key was pressed.

For details on the R&S DigIConf application, see the "R&S®EX-IQ-BOX Digital Interface Module R&S®DigIConf Software Operating Manual".

Note: If you close the R&S DigIConf window using the "Close" icon, the window is minimized, not closed.

If you select the "File > Exit" menu item in the R&S DigIConf window, the application is closed. Note that in this case the settings are lost and the EX-IQ-BOX functionality is no longer available until you restart the application using the "DigIConf" softkey in the R&S FSVR once again.

Remote command:

Remote commands for the R&S DigIConf software always begin with `SOURce:EBOX`. Such commands are passed on from the R&S FSVR to the R&S DigIConf automatically which then configures the R&S EX-IQ-BOX via the USB connection.

All remote commands available for configuration via the R&S DigIConf software are described in the "R&S®EX-IQ-BOX Digital Interface Module R&S®DigIConf Software Operating Manual".

Example 1:

```
SOURce:EBOX:*RST
SOURce:EBOX:*IDN?
```

Result:

```
"Rohde&Schwarz,DigIConf,02.05.436 Build 47"
```

Example 2:

```
SOURce:EBOX:USER:CLOCK:REFERENCE:FREQUENCY 5MHZ
```

Defines the frequency value of the reference clock.

7.1.5 Interface Status Information

When a digital input or output device is connected to the R&S Digital I/Q Interface, a dialog box and status icons in the status bar provide information on the status of the connection. To display the dialog box, select the "Digital IQ Info" softkey in the "Input/Output" menu (see "Digital IQ Info" on page 273).

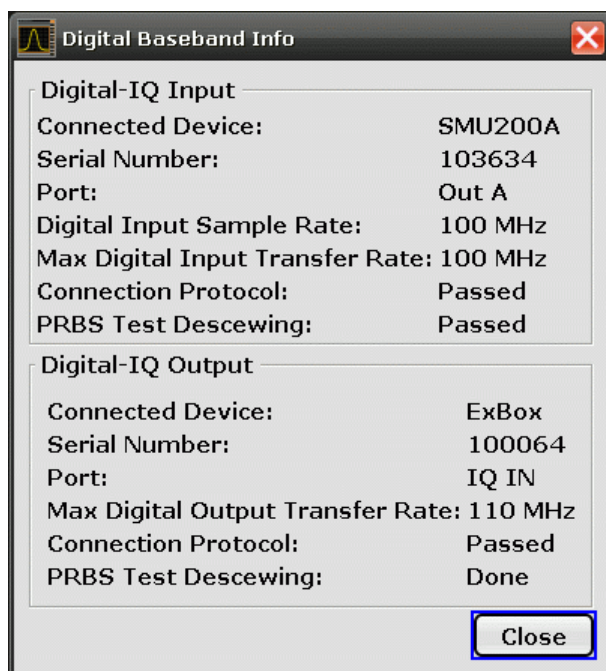

The following information is displayed:

Table 7-6: Displayed Information for Digital Baseband Connections

Label	Description
Digital I/Q input connection	
Digital-I/Q Input	Device connected to R&S FSVR input interface
Serial Number	Serial number of the connected device
Port	Port name used by the connected device
(Max.) Digital Output Sample Rate	Maximum possible or currently used sample rate of the connected device; depends on the used connection protocol version (see "<SampleRate-Type>" parameter described in INPut:DIQ:CDEvice on page 733)
Max. Digital Output Transfer Rate	Maximum data transfer rate of the connected device in Hz
Connection Protocol	State of the connection protocol which is used to identify the connected device
PRBS Test Descewing	State of the PRBS test
Digital I/Q output connection	
Digital-I/Q Output	Device connected to R&S FSVR output interface
Serial Number	Serial number of the connected device
Port	Port name used by the connected device
Max. Digital Input Transfer Rate	Maximum input data transfer rate that can be processed by the connected device

Label	Description
Connection Protocol	State of the connection protocol which is used to identify the connected device
PRBS Test Descewing	State of the PRBS test



You can query the information in this dialog box using remote commands, see [INPut:DIQ:CDEvice](#) on page 733.

Connection tests

Each time a device is (re-)connected to the R&S FSVR, a connection protocol is executed. This test identifies the connected device. This test may take 2 seconds to complete. If a connection cannot be established within 30 seconds, the test is aborted and an error is indicated in the dialog box and the status bar.







Before the first measurement is started after a device has been (re-)connected to the R&S FSVR, a PRBS Descewing test is performed to identify the properties of the used cable. The state of this test is also indicated in the dialog box and the status bar.







If either of the tests fail, check the cable to the connected device as a first step. Also make sure the data rate of the R&S FSVR and the connected device comply with the specification.

Status icons

The status of the connection tests are indicated in the "Digital IQ Info" dialog box and as icons in the status bar. The status icons have the following meaning:

Table 7-7: Status information for digital baseband connections

Icon	Status
Digital input	
	Connection established, protocol not yet started
	Connection protocol in progress
	Connection protocol passed
	PRBS test in progress
	PRBS test passed
	Connection protocol failed
	PRBS test failed

Icon	Status
	No cable connected although "Signal Source" = "DigIQ"
Digital output	
	Connection established, protocol not yet started
	Connection protocol in progress
	Connection protocol passed
	Connection protocol failed
	No cable connected although "Digital Output" enabled.

Error messages

If errors occur, a message is displayed in the status bar. The following table describes the most common errors and possible solutions.

Message	Possible solutions
"Dig. Input Sample Rate too high!"	<ul style="list-style-type: none"> • Increase the sample rate • Reduce the input sample rate
"Dig. Input Sample Rate too low!"	<ul style="list-style-type: none"> • Reduce the sample rate • Increase the input sample rate
"Output Sample Rate too high!"	<ul style="list-style-type: none"> • Reduce the sample rate • Increase the input sample rate
"Number of I/Q Capture Samples too high!"	<ul style="list-style-type: none"> • Reduce the number of I/Q samples • Reduce the ratio input sample rate / sample rate by increasing the sample rate or decreasing the input sample rate
Keyword: "FIFO OVL"	Reduce the input sample rate

7.1.6 Description of the LVDS Connector

The R&S Digital I/Q Interface is a proprietary LVDS serial interface. For adaption to industrial standard interfaces use the R&S EX-IQ-BOX (see the "R&S®EX-IQ-BOX - External Signal Interface Module Manual". The EX-IQ-Box functionality is not supported for R&S FSVR models 1321.3008Kxx.).

The LVDS Connector is a 26 pin female 0.050" Mini D Ribbon connector (e.g.: 3M 102XX-1210VE series).



For the connection, use the cables provided with the R&S EX-IQ-BOX or an R&S@SMU-Z6 cable (order no.: 1415.0201.02).

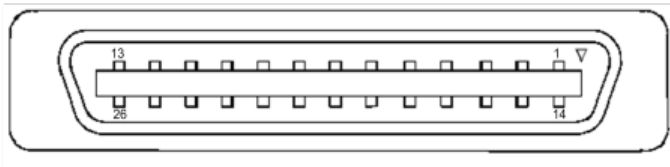

Fig. 7-4: LVDS connector on the R&S FSVR rear panel, connector front view

The [table 7-8](#) shows the multiplexed data at the output of the LVDS transmitter.

Table 7-8: LVDS connector pin description

Pin	Signal	Level	
1			reserved for future use
2	GND	0V	Ground, shield of pair 1-14, for future use
3	SDAT0_P	LVDS	Serial data channel 0 positive pin; carries the bits VALID, ENABLE, MARKER_1 (GP4), Reserve_1 (GP2), RE_0, RE_1
4	SDAT1_P	LVDS	Serial data channel 1 positive pin; carries the bits RE_2, RE_3, RE_4, RE_5, RE_6, RE_7
5	SDAT2_P	LVDS	Serial data channel 2 positive pin; carries the bits RE_8, RE_9, RE_10, RE_11, RE_12, RE_13
6	CLK1_P	LVDS	Clock 1 positive pin; clock for transmission on LVDS link
7	S_CLK	TTL	(for future use)
8	+5VD	+5.0V	Supply voltage (for future use)
9	SDAT3_P	LVDS	Serial data channel 3 positive pin; carries the bits RE_14, RE_15, RE_16, RE_17, RE_18, RE_19
10	SDAT4_P	LVDS	Serial data channel 4 positive pin; carries the bits TRIGGER_1 (GP0), TRIGGER_2 (GP1), MARKER_2 (GP5), Reserve_2 (GP3), IM_0, IM_1
11	SDAT5_P	LVDS	Serial data channel 5 positive pin; carries the bits IM_2, IM_3, IM_4, IM_5, IM_6, IM_7
12	SDAT6_P	LVDS	Serial data channel 6 positive pin; carries the bits IM_8, IM_9, IM_10, IM_11, IM_12, IM_13
13	SDAT7_P	LVDS	Serial data channel 7 positive pin; carries the bits IM_14, IM_15, IM_16, IM_17, IM_18, IM_19
14			reserved for future use
15	SDAT0_M	LVDS	Serial data channel 0 negative pin
16	SDAT1_M	LVDS	Serial data channel 1 negative pin
17	SDAT2_M	LVDS	Serial data channel 2 negative pin
18	CLK1_M	LVDS	Clock 1 negative pin
19	DGND	0V	Power ground; ground return for 5V supply voltage (for future use)

Pin	Signal	Level	
20	S_DATA	TTL	(for future use)
21	SDAT3_M	LVDS	Serial data channel 3 negative pin
22	SDAT4_M	LVDS	Serial data channel 4 negative pin
23	SDAT5_M	LVDS	Serial data channel 5 negative pin
24	SDAT6_M	LVDS	Serial data channel 6 negative pin
25	SDAT7_M	LVDS	Serial data channel 7 negative pin
26	GND	0V	LVDS ground; shielding of transmission lines and shielding of cable

7.2 Instrument Functions – External Mixer (Option R&S FSV-B21)

If the R&S FSVR External Mixer option (R&S FSV-B21) is installed, an external mixer can be connected to the R&S FSVR to increase the available frequency range.



External mixers - once activated - are available for all instrument applications. (De-)Activation is only possible in the base unit, i.e. in "Spectrum" mode.

Connecting External Mixers

How to connect external mixers is described in the R&S FSVR Quick Start Guide, "Optional Front Panel Connectors".

General information

Some general information on working with external mixers can be found in [chapter 7.2.1, "General Information on External Mixers"](#), on page 488.

Menu and softkey description

The "External Mixer" menu is displayed when you select the "External Mixer" softkey in the "Home" menu of the "Spectrum" mode.

For details see [chapter 7.2.2, "Softkeys of the External Mixer \(Option B21\)"](#), on page 493.

Measurement Example

An introductory example of operating an external mixer is provided in [chapter 7.2.3, "Introductory Example of Operation"](#), on page 504.

- [General Information on External Mixers](#).....488
- [Softkeys of the External Mixer \(Option B21\)](#).....493
- [Introductory Example of Operation](#)..... 504

7.2.1 General Information on External Mixers

This section contains some general information on external mixers and their application.

7.2.1.1	Frequency Range.....	488
7.2.1.2	Bias Current.....	489
7.2.1.3	Conversion Loss Tables.....	489
7.2.1.4	Full Screen Level.....	490
7.2.1.5	Remarks on Signal Identification with Auto ID.....	491

7.2.1.1 Frequency Range

The frequency of the input signal can be expressed as a function of the LO frequency and the selected harmonic of the first LO as follows:

$$f_{in} = n * f_{LO} + f_{IF}$$

where:

f_{in} : frequency of input signal

n : order of harmonic used for conversion

f_{LO} : frequency of first LO: 7.73 GHz to 15.23 GHz

f_{IF} : intermediate frequency 729.9 MHz

For pre-defined bands, the resulting frequency ranges are as follows:

Table 7-9: Frequency ranges for pre-defined bands

Band	Frequency start [GHz]	Frequency stop [GHz]
K	18.0	26.5
KA (A) *	26.5	40.0
Q	33.0	50.0
U	40.0	60.0
V	50.0	75.0
E	60.0	90.0
W	75.0	110.0
F	90.0	140.0
D	110.0	170.0
G	140.0	220.0
J	220.0	325.0
*) The band formerly referred to as "A" is now named "KA".		

Band	Frequency start [GHz]	Frequency stop [GHz]
Y	325.0	500.0
USER	31.65 (default)	60.1901 (default)

*) The band formerly referred to as "A" is now named "KA".

7.2.1.2 Bias Current

Single-diode mixers generally require a DC voltage which is applied via the LO line. This DC voltage is to be tuned to the minimum conversion loss versus frequency. Such a DC voltage can be set via the "BIAS" function using the D/A converter of the R&S FSVR. The value to be entered is not the voltage but the short-circuit current. The current is defined in the "Bias Settings" or set to the value of the conversion loss table (see "Bias Settings" on page 502 and "Bias" on page 499).

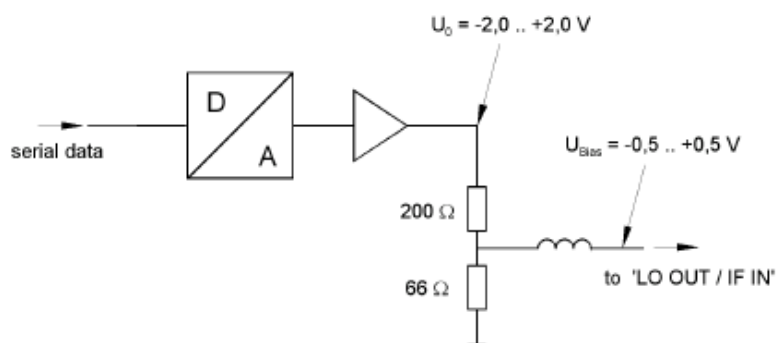

Fig. 7-5: Bias circuit of the R&S FSVR

The voltage U_0 at the output of the operational amplifier can be set in the range -2.0 to $+2.0$ V. An open-circuit voltage V_{bias} of -0.5 to $+0.5$ V is obtained accordingly at the output of the voltage divider. A short-circuit current of $I_{\text{short}} = V_0 / 200 \Omega = 10$ mA to $+10$ mA is obtained for a short circuit at the output of the voltage divider. For using biasing it is not important to know exactly the current flowing through the diode since the conversion loss must be set to minimum with the frequency. It therefore makes no difference whether the setting is performed by an open-circuit voltage or by a short-circuit current. A DC return path is ensured via the 66Ω resistor, which is an advantage in some mixers.

7.2.1.3 Conversion Loss Tables

Conversion loss tables consist of value pairs that describe the correction values for conversion loss at certain frequencies. Correction values for frequencies between the reference values are obtained by interpolation. Linear interpolation is performed if the table contains only two values. If it contains more than two reference values, spline interpolation is carried out. Outside the frequency range covered by the table the con-

version loss is assumed to be the same (see [figure 7-6](#)) as that for the first and last reference value.

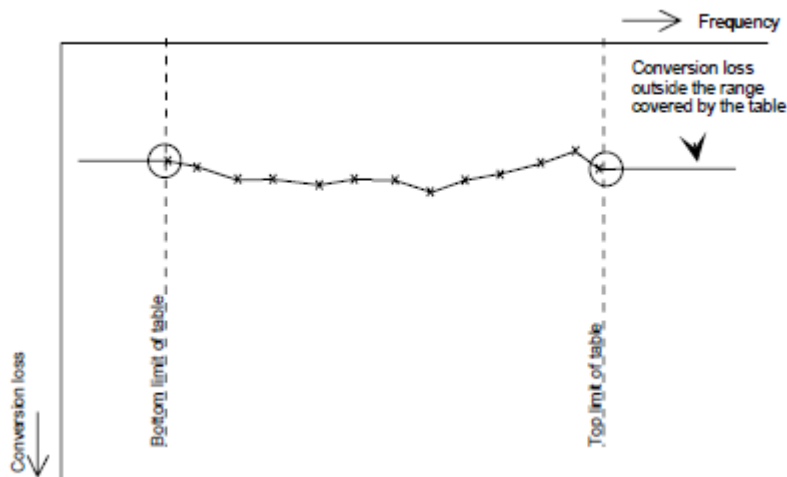

Fig. 7-6: Conversion loss outside the band's frequency range

Predefined conversion loss tables are often provided with the external mixer and can be imported to the R&S FSVR. Alternatively, you can define your own conversion loss tables. Conversion loss tables are configured and managed in the "Conversion Loss Table Setup" tab of the "External Mixer Configuration" dialog box (see ["Conversion Loss Table Setup"](#) on page 497).

The conversion loss table to be used for a particular range is defined in the "External Mixer Configuration" dialog box. All tables stored on the instrument in the `C:\r_s\instr\user\cvl\` directory are offered for selection. A validation check is then performed on the selected table to ensure that it complies with the settings. In particular, the following is checked:

- the assigned band name
- the harmonic order
- the mixer type
- the table must contain at least one frequency that lies within the frequency range for the band

7.2.1.4 Full Screen Level

The maximum possible reference level depends on the maximum used conversion loss value. Thus, the reference level can be adjusted for each range according to the used conversion loss table or average conversion loss value. If a conversion loss value is used which exceeds the maximum reference level, the reference level is adjusted to the maximum value permitted by the firmware.

7.2.1.5 Remarks on Signal Identification with Auto ID

Test sweep and reference sweep

Depending on which of the automatic signal identification functions are used, the traces are used to display either the test sweep (the upper side-band sweep) or the reference sweep (lower side-band sweep).

Function	Trace 1	Trace 2	Trace 3
Signal ID	Signal ID upper side-band	Signal ID lower side-band	-
Auto ID	Auto ID	-	-
Signal ID + Auto ID	Signal ID upper side-band	Signal ID lower side-band	Auto ID

Type of signal

The automatic comparison of the test sweep and reference sweep with the "Auto ID" function can only be usefully applied for signals with time-constant spectrum since the two sweeps are always required to determine the actual spectrum.

Tolerance for the comparison of test sweep and reference

Since the LO frequency is displaced downwards in the reference sweep, the conversion loss of the mixer may differ from that of the test sweep. The reasons for this are the LO output power of the R&S FSV varying with the frequency and the non-ideal characteristics of the mixer. A certain tolerance should therefore be permitted for the comparison of the signal levels in the test sweep and reference sweep. The user can set this tolerance using the "AUTO ID THRESHOLD" function. If the tolerance is defined too narrow, the signal collected with the reference sweep may be displayed even for the identification of real signals.

Mixer products with low S/N ratio

If the S/N ratio of a mixer product is less than the tolerance set with "AUTO ID THRESHOLD", the level difference between the test sweep and reference sweep at the frequency of this mixer product is always within limits, even if the signal occurs in one of the sweeps only. Such mixer products cannot be identified by "AUTO ID". It is therefore recommended to perform a visual comparison of the test sweep and reference sweep using the function "SIGNAL ID".

An unwanted signal with a S/N ratio that corresponds approximately to the tolerance set with "AUTO ID THRESHOLD" may not be blanked out permanently. Due to the fact that the noise display varies from one sweep to another, the S/N ratio changes and thus the level difference between the test sweep and reference sweep measured at a frequency changes as well. As a result, the criterion for detecting unwanted signals is not fulfilled. To blank out unwanted signals permanently, an almost constant noise indication is therefore required. This can be achieved by reducing the video bandwidth. Since the average noise indication lies well below the generated noise peak values, the minimum level diminishes. For identification using "AUTO ID" signals should have this minimum level.

Examining unwanted mixer products with small span

With large spans in which non-modulated sinewave signals are represented as single lines, unwanted mixer products are generally completely blanked out. However, if you examine the frequency range containing a blanked signal in detail using a small span, e.g. an image-frequency response, part of the signal may nevertheless be displayed. This happens when the displayed components of a blanked signal have a level difference which is smaller than the tolerance predefined with "AUTO ID THRESHOLD" when compared with the noise floor. These components are therefore not blanked out.

Display of mixer products at the same frequency

If the input signal consists of a very large number of spectral components, it will become more and more probable that two different unwanted mixer products will be displayed at the same frequency in the test sweep and reference sweep.

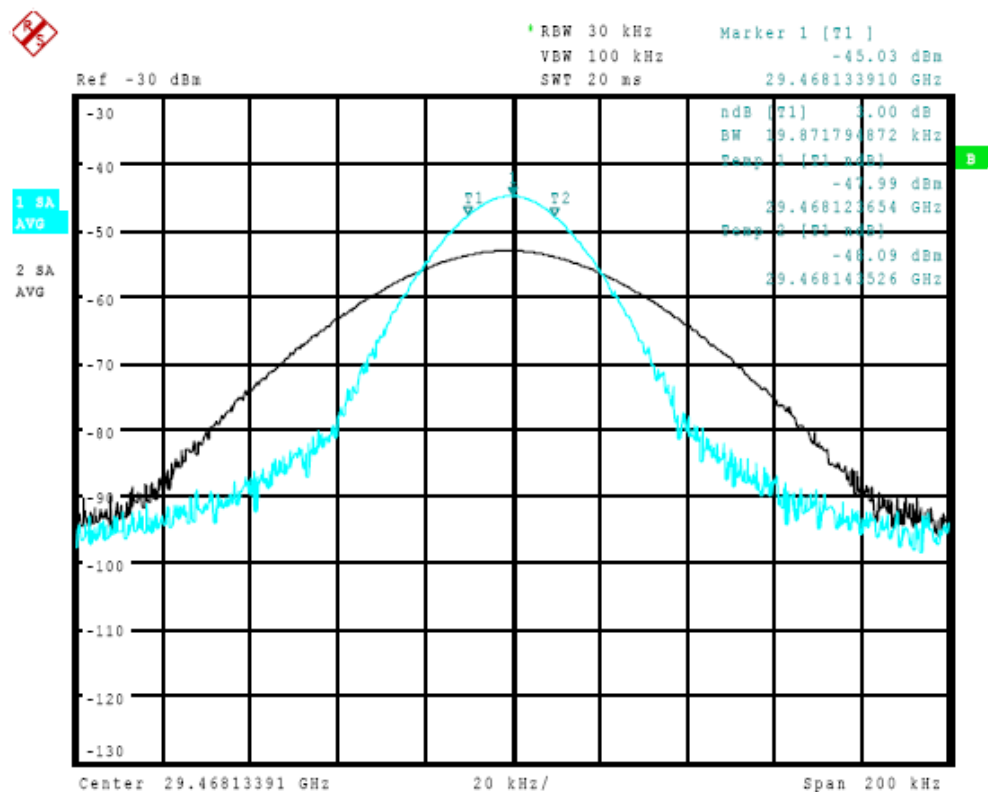

Fig. 7-7: Different mixer products displayed at the same frequency in the test sweep and reference sweep

The external mixer has been working using 2nd order harmonic. The signal recorded in the test sweep is displayed by trace 1. The IF filter of the R&S FSVR is represented at a 3 dB bandwidth of 20 kHz, the real IF bandwidth being 30 kHz. If, however, the 3 dB bandwidth (trace 2) of the signal recorded in the reference sweep is examined, it will be found to be larger exactly by a factor of 2. This shows that the two products were generated by mixing with LO harmonics of different orders. The signal recorded in the test sweep was generated by mixing with 3rd order harmonic. Since the frequency axis

scaling is based on the 2nd order, the mixer product or the resulting diagram of the IF filter is compressed by a factor of 2/3. The signal recorded in the reference sweep was generated by mixing with the fundamental of the LO signal. Since the frequency axis scaling is based on the 2nd order, the mixer product or the resulting diagram of the IF filter is expanded by a factor of 2.

Automatic identification with a large span is not possible since the two mixer products are displayed at the same frequency. The diagram shown in figure 7-8 is obtained when examining products with a narrow span using "AUTO ID". You can easily recognize unwanted mixer products from the clear diagram obtained using "AUTO ID" or "SIGNAL ID".

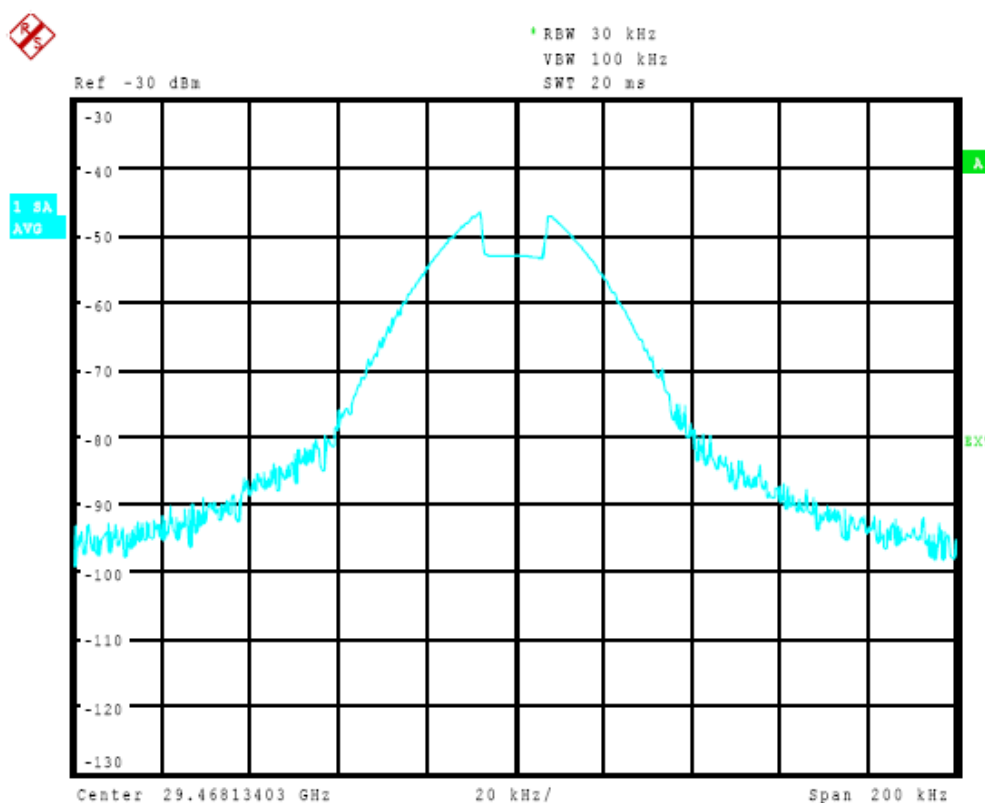

Fig. 7-8: Signal as in Screen A: Unwanted mixer product with the use of AUTO ID

7.2.2 Softkeys of the External Mixer (Option B21)

External Mixer.....	494
L External Mixer (On/Off).....	494
L External Mixer Config.....	494
L External Mixer Setup.....	495
L RF Start.....	495
L RF Stop.....	495
L Handover Freq.....	495
L Band.....	495

L RF Overrange.....	496
L Preset Band.....	496
L Mixer Type.....	496
L Harmonic Type.....	496
L Range 1/2.....	496
L Harmonic Order.....	496
L Conversion Loss.....	497
L Conversion Loss Table Setup.....	497
L New Table.....	498
L File Name.....	499
L Comment.....	499
L Band.....	499
L Harmonic Order.....	499
L Bias.....	499
L Mixer Name.....	499
L Mixer S/N.....	500
L Mixer Type.....	500
L Position/Value.....	500
L Insert.....	501
L Delete.....	501
L Shift x.....	501
L Shift y.....	501
L Save.....	501
L Edit Table.....	501
L Delete Table.....	501
L Import Table.....	501
L Bias Settings.....	502
L Write to <CVL table name>.....	502
L LO Level.....	502
L Signal ID (On/Off).....	502
L Auto ID (On/Off).....	503
L Auto ID Threshold.....	504

External Mixer

Opens the submenu for the external mixer.

External Mixer (On/Off) ← External Mixer

Switches the external mixer on or off. Once activated, the external mixer is available for all applications on the instrument.

Remote command:

[SENSe:]MIXer[:STATe] on page 826

External Mixer Config ← External Mixer

Opens the "External Mixer Configuration" dialog box that contains two tabs:

- "External Mixer Setup" on page 495
- "Conversion Loss Table Setup" on page 497

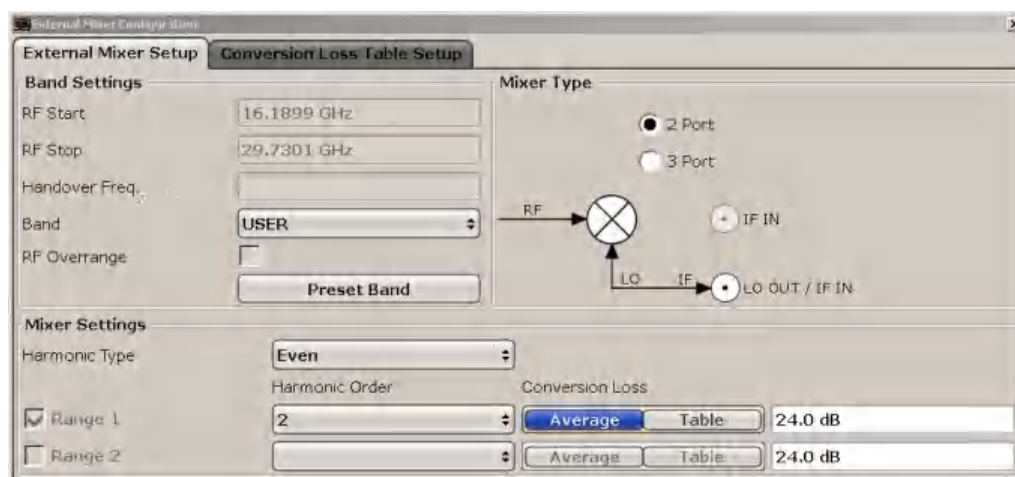

External Mixer Setup ← External Mixer Config ← External Mixer

In this tab you configure the band and mixer settings.

RF Start ← External Mixer Setup ← External Mixer Config ← External Mixer

Displays the start frequency of the selected band. For pre-defined bands, the frequency range is set automatically (see [table 7-9](#)).

Remote command:

[\[SENSe:\]MIXer:FREQuency:START?](#) on page 828

RF Stop ← External Mixer Setup ← External Mixer Config ← External Mixer

Displays the stop frequency of the selected band. For pre-defined bands, the frequency range is set automatically (see [table 7-9](#)).

Remote command:

[\[SENSe:\]MIXer:FREQuency:STOP?](#) on page 828

Handover Freq. ← External Mixer Setup ← External Mixer Config ← External Mixer

Defines the frequency at which the mixer switches from one range to the next (if two different ranges are selected). The handover frequency can be selected freely within the overlapping frequency range.

Remote command:

[\[SENSe:\]MIXer:FREQuency:HANDOver](#) on page 828

Band ← External Mixer Setup ← External Mixer Config ← External Mixer

Defines the waveguide band or user-defined band to be used by the mixer.

The start and stop frequencies of the selected band are displayed in the "RF Start" and "RF Stop" fields.

For a definition of the frequency range for the pre-defined bands, see [table 7-9](#).

The mixer settings for the user-defined band can be selected freely. The frequency range for the user band is defined via the harmonics configuration (see "[Range 1/2](#)" on page 496).

Note: The band formerly referred to as "A" is now named "KA".

Remote command:

[SENSe:]MIXer:HARMonic:BAND on page 828

RF Overrange ← **External Mixer Setup** ← **External Mixer Config** ← **External Mixer**
Specifies whether the band limits are extended beyond "RF Start" and "RF Stop" due to the capabilities of the used harmonics.

Remote command:

[SENSe:]MIXer:RFOVerrange[:STATe] on page 827

Preset Band ← **External Mixer Setup** ← **External Mixer Config** ← **External Mixer**
Restores the presettings for the selected band.

Note: changes to the band and mixer settings are maintained even after using the PRESET function. This function allows you to restore the original band settings.

Remote command:

[SENSe:]MIXer:HARMonic:BAND:PRESet on page 829

Mixer Type ← **External Mixer Setup** ← **External Mixer Config** ← **External Mixer**
The R&S FSVR option B21 allows for the following external mixer types:

"2 Port" LO and IF data uses the same port

"3 Port" LO and IF data uses separate ports

Remote command:

[SENSe:]MIXer:PORTs on page 832

Harmonic Type ← **External Mixer Setup** ← **External Mixer Config** ← **External Mixer**

Defines if only even, only odd, or even and odd harmonics can be used for conversion. Depending on this selection, the order of harmonic to be used for conversion changes (see "Harmonic Order" on page 496).

Remote command:

[SENSe:]MIXer:HARMonic:TYPE on page 830

Range 1/2 ← **External Mixer Setup** ← **External Mixer Config** ← **External Mixer**
Enables the use of a second harmonic to cover the band's frequency range.

For each range you can define which harmonic to use and how the [Conversion Loss](#) is handled.

Remote command:

[SENSe:]MIXer:HARMonic:HIGH:STATe on page 829

Harmonic Order ← **Range 1/2** ← **External Mixer Setup** ← **External Mixer Config** ← **External Mixer**

Defines which of the available harmonic orders are used to cover the frequency range.

By default, the lowest order of the specified harmonic type is selected that allows conversion of input signals in the whole band. If due to the LO frequency the conversion is not possible using one harmonic, the band is splitted.

For the band "USER", the order of harmonic is defined by the user. The order of harmonic can be between 2 and 100, the lowest usable frequency being 26,5 GHz.

Remote command:

[SENSe:]MIXer:HARMonic[:LOW] on page 830

[SENSe:]MIXer:HARMonic:HIGH[:VALue] on page 829

Conversion Loss ← Range 1/2 ← External Mixer Setup ← External Mixer Config ← External Mixer

Defines how the conversion loss is handled. The following possibilities are available:

"Average"	Defines the average conversion loss for the entire range in dB.
"Table"	Defines the conversion loss via the table selected from the list. Pre-defined conversion loss tables are often provided with the external mixer and can be imported to the R&S FSVR. Alternatively, you can define your own conversion loss tables. Conversion loss tables are configured and managed in the Conversion Loss Table Setup tab. For details on conversion loss tables, see chapter 7.2.1.3, "Conversion Loss Tables" , on page 489. For details on importing tables, see "Import Table" on page 501.

All tables stored on the instrument in the

C:\r_s\instr\user\cv1\ directory are offered for selection. A validation check is then performed on the selected table to ensure that it complies with the settings. In particular, the following is checked:

- the assigned band name
- the harmonic order
- the mixer type
- the table must contain at least one frequency that lies within the frequency range for the band

Remote command:

[SENSe:]MIXer:LOSS[:LOW] on page 831

Average for range 1

[SENSe:]MIXer:LOSS:TABLE[:LOW] on page 831

Table for range 1

[SENSe:]MIXer:LOSS:HIGH on page 831

Average for range 2

[SENSe:]MIXer:LOSS:TABLE:HIGH on page 831

Table for range 2

Conversion Loss Table Setup ← External Mixer Config ← External Mixer

In this tab you configure and manage conversion loss tables. Conversion loss tables consist of value pairs that describe the correction values for conversion loss at certain frequencies. The correction values for frequencies between the reference points are obtained via interpolation.

The currently selected table for each range is displayed at the top of the dialog box.

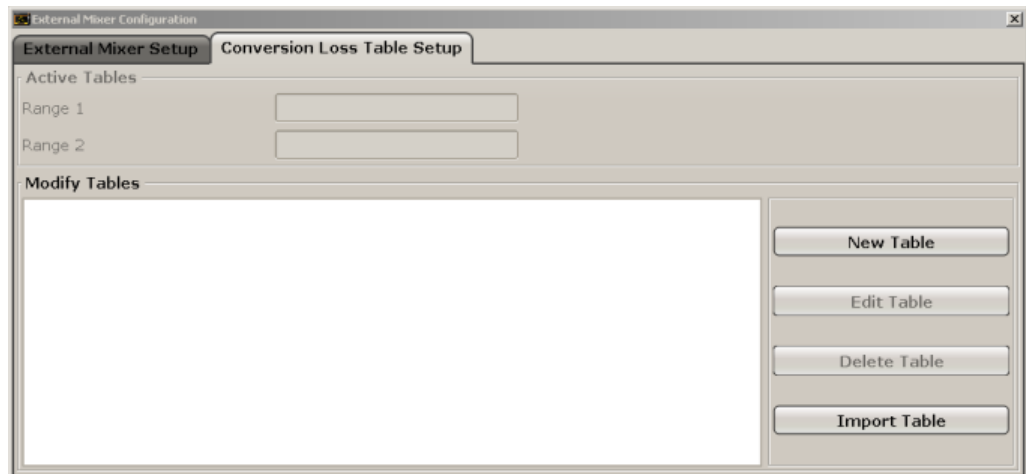

New Table ← Conversion Loss Table Setup ← External Mixer Config ← External Mixer

Opens the "Edit Conversion Loss Table" dialog box to configure a new conversion loss table.

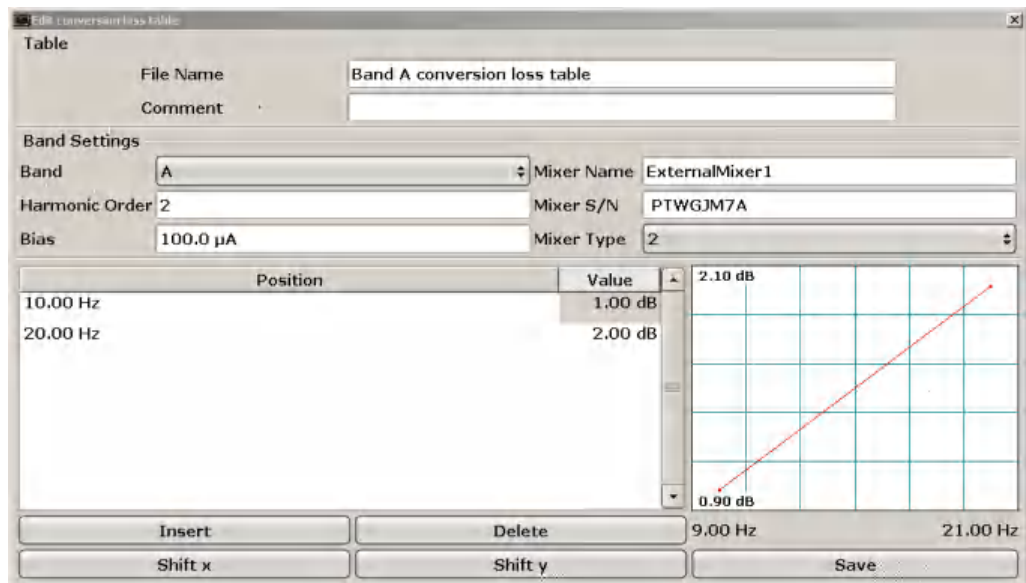

A preview pane displays the current configuration of the conversion loss function as described by the Position/Value entries.

Remote command:

[\[SENSe:\]CORRection:CVL:SElect](#) on page 786

File Name ← New Table ← Conversion Loss Table Setup ← External Mixer Config ← External Mixer

Defines the name under which the table is stored in the C:\r_s\instr\user\cvl\ directory on the instrument. The name of the table is identical with the name of the file (without extension) in which the table is stored. The entry in this field is mandatory. The .ACL extension is automatically appended during storage.

Remote command:

[SENSe:]CORRection:CVL:SElect on page 786

Comment ← New Table ← Conversion Loss Table Setup ← External Mixer Config ← External Mixer

An optional comment that describes the conversion loss table. The comment can be freely defined by the user.

Remote command:

[SENSe:]CORRection:CVL:COMMeNt on page 788

Band ← New Table ← Conversion Loss Table Setup ← External Mixer Config ← External Mixer

The waveguide or user-defined band for which the table is to be applied.

For a definition of the frequency range for the pre-defined bands, see [table 7-9](#)).

Remote command:

[SENSe:]CORRection:CVL:BAND on page 786

Harmonic Order ← New Table ← Conversion Loss Table Setup ← External Mixer Config ← External Mixer

The harmonic order for which the table is to be applied.

Remote command:

[SENSe:]CORRection:CVL:HARMonic on page 787

Bias ← New Table ← Conversion Loss Table Setup ← External Mixer Config ← External Mixer

The bias current which is required to set the mixer to its optimum operating point. It corresponds to the short-circuit current. The bias current can range from -10 mA to 10 mA. The actual bias current is lower because of the forward voltage of the mixer diode(s).

Tip: You can also define the bias interactively while a preview of the trace with the changed setting is displayed, see "[Bias Settings](#)" on page 502.

Remote command:

[SENSe:]CORRection:CVL:BIAS on page 788

Mixer Name ← New Table ← Conversion Loss Table Setup ← External Mixer Config ← External Mixer

Specifies the name of the external mixer for which the table is to be applied.

Remote command:

[SENSe:]CORRection:CVL:MIXer on page 787

Mixer S/N ← New Table ← Conversion Loss Table Setup ← External Mixer Config ← External Mixer

Specifies the serial number of the external mixer for which the table is to be applied.

Remote command:

`[SENSe:]CORRection:CVL:SNUMber` on page 787

Mixer Type ← New Table ← Conversion Loss Table Setup ← External Mixer Config ← External Mixer

Specifies whether the external mixer for which the table is to be applied is a two-port or three-port type.

Remote command:

`[SENSe:]CORRection:CVL:PORTs` on page 788

Position/Value ← New Table ← Conversion Loss Table Setup ← External Mixer Config ← External Mixer

Each position/value pair defines the correction value for conversion loss for a specific frequency. The reference values must be entered in order of increasing frequencies. A maximum of 50 reference values can be entered.

Correction values for frequencies between the reference values are obtained by interpolation. Linear interpolation is performed if the table contains only two values. If it contains more than two reference values, spline interpolation is carried out. Outside the frequency range covered by the table the conversion loss is assumed to be the same (see figure 7-6) as that for the first and last reference value.

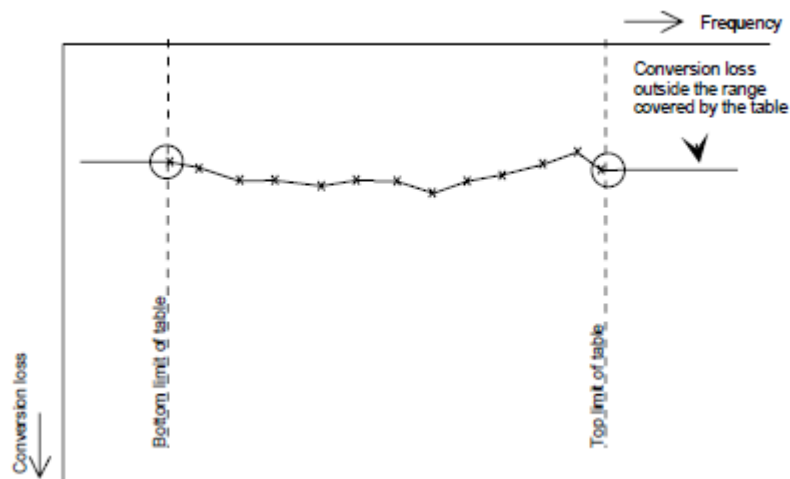

Fig. 7-9: Conversion loss outside the band's frequency range

The current configuration of the conversion loss function as described by the Position/Value entries is displayed in the preview pane to the right of the table.

The following functions are available to define the table:

- [Insert an entry](#)
- [Delete an entry](#)
- [Shift all positions by a specific value \(shift x\)](#)

- [Shift all conversion loss values by a specific value \(shift y\)](#)

Remote command:

[\[SENSe:\]CORRection:CVL:DATA](#) on page 789

Insert ← **New Table** ← **Conversion Loss Table Setup** ← **External Mixer Config** ← **External Mixer**

Inserts a new position/value entry in the table.

If the table is empty, a new entry at 0 Hz is inserted.

If entries already exist, a new entry is inserted above the selected entry. The position of the new entry is selected such that it divides the span to the previous entry in half.

Delete ← **New Table** ← **Conversion Loss Table Setup** ← **External Mixer Config** ← **External Mixer**

Deletes the currently selected position/value entry.

Shift x ← **New Table** ← **Conversion Loss Table Setup** ← **External Mixer Config** ← **External Mixer**

Shifts all positions in the table by a specific value. The value can be entered in the edit dialog box. The conversion loss function in the preview pane is shifted along the x-axis.

Shift y ← **New Table** ← **Conversion Loss Table Setup** ← **External Mixer Config** ← **External Mixer**

Shifts all conversion loss values by a specific value. The value can be entered in the edit dialog box. The conversion loss function in the preview pane is shifted along the y-axis.

Save ← **New Table** ← **Conversion Loss Table Setup** ← **External Mixer Config** ← **External Mixer**

The conversion loss table is stored under the specified name in the `C:\r_s\instr\user\cvl\` directory of the instrument.

Edit Table ← **Conversion Loss Table Setup** ← **External Mixer Config** ← **External Mixer**

Opens the "Edit Conversion Loss Table" dialog box to edit the selected conversion loss table. For details on table configuration see "[New Table](#)" on page 498.

Remote command:

[\[SENSe:\]CORRection:CVL:SElect](#) on page 786

Delete Table ← **Conversion Loss Table Setup** ← **External Mixer Config** ← **External Mixer**

Deletes the currently selected conversion loss table after you confirm the action.

Remote command:

[\[SENSe:\]CORRection:CVL:CLEar](#) on page 789

Import Table ← **Conversion Loss Table Setup** ← **External Mixer Config** ← **External Mixer**

Imports a stored conversion loss table from any directory to the instrument's `C:\r_s\instr\user\cvl\` directory.

Bias Settings ← External Mixer

Opens a dialog box to define the bias current for each range, which is required to set the mixer to its optimum operating point. It corresponds to the short-circuit current. The bias current can range from -10 mA to 10 mA. The actual bias current is lower because of the forward voltage of the mixer diode(s).

The trace is adapted to the settings immediately so you can check the results. To store the bias setting in the currently selected conversion loss table, select the [Write to <CVL table name>](#) button.

Remote command:

[\[SENSe:\]MIXer:BIAS:LOW](#) on page 827

[\[SENSe:\]MIXer:BIAS:HIGH](#) on page 826

Write to <CVL table name> ← Bias Settings ← External Mixer

Stores the bias setting in the currently selected "Conversion Loss Table" for the range (see "[Conversion Loss Table Setup](#)" on page 497).

Remote command:

[\[SENSe:\]CORRection:CVL:BIAS](#) on page 788

LO Level ← External Mixer

Opens an edit dialog box to change the LO level of the external mixer's LO port from 13.0 dBm to 17.0 dBm in 0.1 dB steps. Default value is 15.5 dB.

Remote command:

[\[SENSe:\]MIXer:LOPower](#) on page 830

Signal ID (On/Off) ← External Mixer

The SIGNAL ID softkey activates or deactivates visual signal identification. Two sweeps are performed alternately. Trace 1 shows the trace measured on the upper side band (USB) of the LO (the test sweep), trace 2 shows the trace measured on the lower side band (LSB), i.e. the reference sweep. (See also [chapter 7.2.1.5, "Remarks on Signal Identification with Auto ID"](#), on page 491).

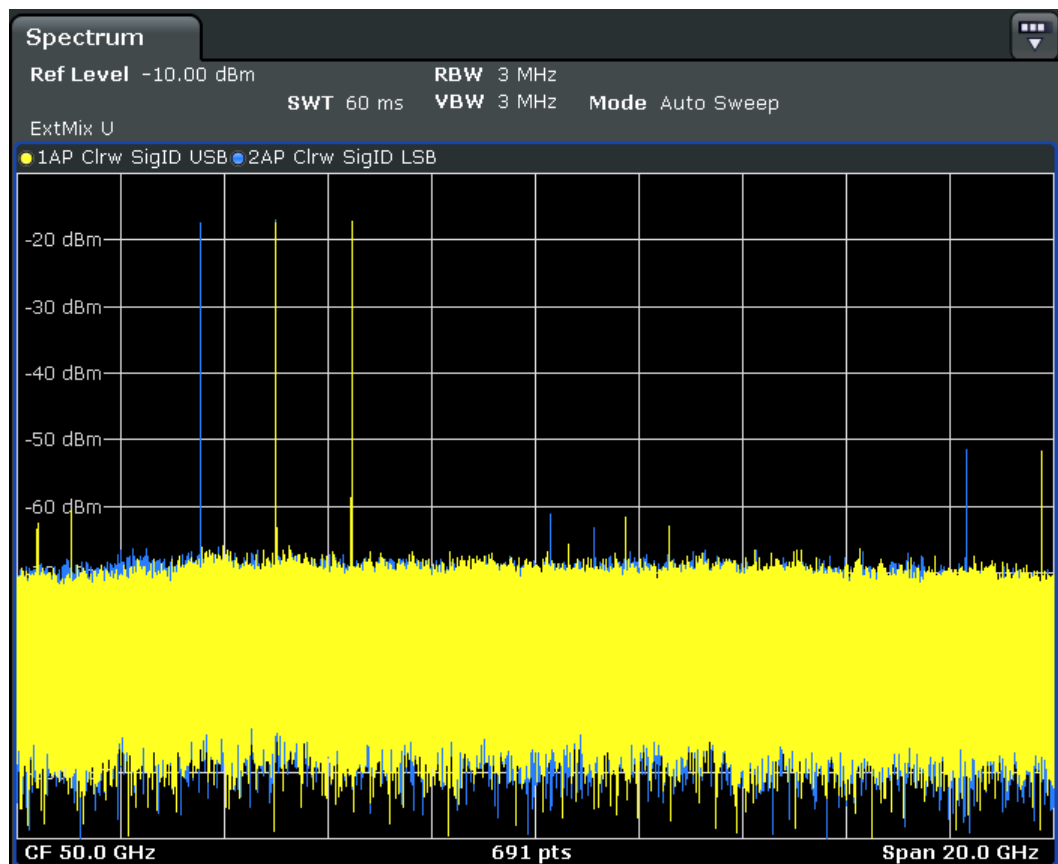

The reference sweep is performed using a LO setting shifted downwards by $2 \cdot \text{IF} / \langle \text{Harmonic order} \rangle$. Input signals in the wanted sideband that are converted using the specified harmonic are displayed in both traces at the same position on the frequency axis. Image signals and mixer products caused by other harmonics are displayed in both traces at different positions. The user identifies the signals visually by comparing the two traces.

Since the LO frequency is displaced downwards in the reference sweep, the conversion loss of the mixer may differ from the test sweep. Therefore the level should only be measured in the test sweep (trace 1).

Mathematical functions with traces and trace copy cannot be used with the Signal ID function.

Remote command:

`[SENSe:]MIXer:SIGNal` on page 832

Auto ID (On/Off) ← External Mixer

Activates or deactivates automatic signal identification.

Auto ID basically functions like [Signal ID \(On/Off\)](#). However, the test and reference sweeps are converted into a single trace by a comparison of maximum peak values of each sweep point. The result of this comparison is displayed in trace 3 if "Signal ID" is active at the same time. If "Signal ID" is not active, the result can be displayed in any of the traces 1 to 3. Unwanted mixer products are suppressed in this calculated trace. (See also [chapter 7.2.1.5, "Remarks on Signal Identification with Auto ID"](#), on page 491).

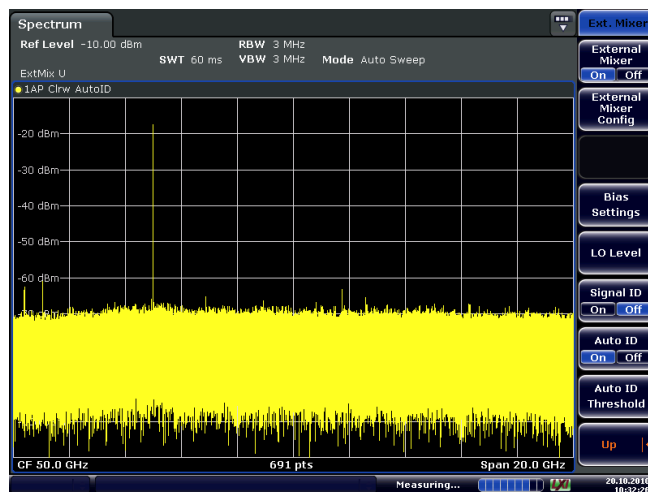

Real input signals are displayed at the same frequency in the test and reference sweeps, i.e. theoretically identical signal levels are expected in the two sweeps at the frequency of the real mixer product. If the level difference is lower than the tolerance set with [Auto ID Threshold](#), the signal obtained in the test sweep is displayed. If a signal occurs only in the test sweep or reference sweep, it is an unwanted mixer product. The level of this signal is compared to the noise floor in the other sweep. If the S/N ratio is sufficiently large, the tolerance limit for the maximum permissible level difference is exceeded. This means that the signal with the lower level, i.e. noise in this case, is displayed.

Note that "Auto ID" functions according to the fail-safe principle, i.e. unwanted mixer products may not be detected as such but signals which are in fact real input signals are not blanked out. See also [chapter 7.2.1.5, "Remarks on Signal Identification with Auto ID"](#), on page 491.

Remote command:

`[SENSe:]MIXer:SIGNal` on page 832

Auto ID Threshold ← External Mixer

Allows the maximum permissible level difference between test sweep and reference sweep to be corrected during automatic comparison ([Auto ID](#) function). The input range is between 0.1 dB and 100 dB. Values of about 10 dB (i.e. default setting) generally yield satisfactory results. See also [chapter 7.2.1.5, "Remarks on Signal Identification with Auto ID"](#), on page 491.

Remote command:

`[SENSe:]MIXer:THReshold` on page 833

7.2.3 Introductory Example of Operation

The following example gives an example of the operation of external mixers as well as the required settings: A sine wave signal with $f = 14.5$ GHz is applied to the input of a multiplier. The spectrum at the multiplier output is to be recorded in the range of 52 to 60 GHz using a 2-port mixer for the V band. The mixer used is a double-diode mixer. The example of operation is described in the following steps:

- Test Setup
- Activating the External Mixer and Selecting the Mode
- Default Settings
- Level Correction
- Frequency-dependant Level Correction
- Level Correction with an Average Value
- Taking into Account the Cable Loss in the IF Path
- Functions for Signal Identification

Test Setup

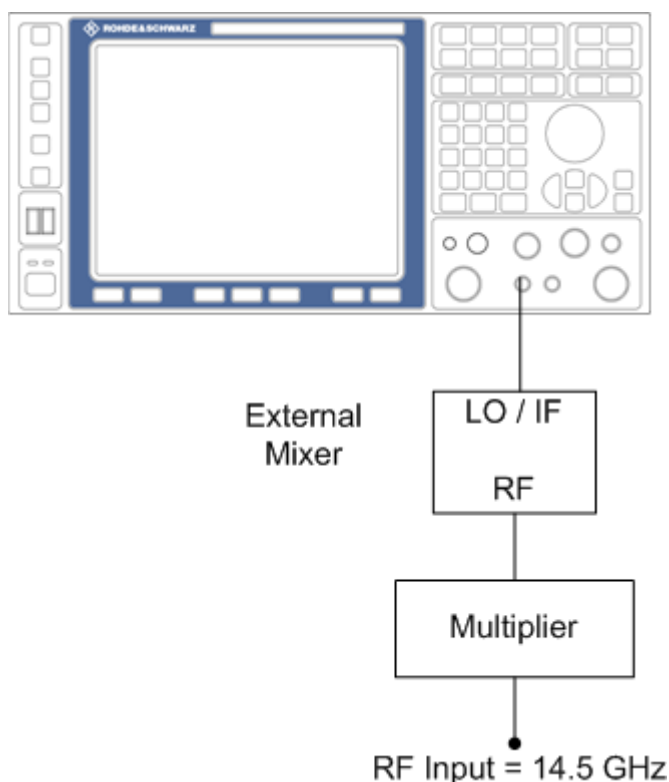

Fig. 7-10: External mixer test setup

1. Connect the "LO OUT / IF IN" output of the R&S FSVR to the LO/IF port of the external mixer.
2. Connect the multiplier to the external mixer.
3. Apply a sine wave signal with $f = 14.5 \text{ GHz}$ to the input of the multiplier.

Activating the External Mixer and Selecting the Mode

- ▶ Activate the external mixing for all applications by selecting "FREQ > External Mixer > External Mixer ON" in Spectrum mode.

Default Settings

Prior to the measurement select the required band (in this case the V band).

1. Select "FREQ > External Mixer > External Mixer Config".
2. From the "Band" selection list, select the "V" band.

Level Correction

The conversion loss of the mixer can be taken into account either as a function of frequency (table with reference values) or using an average value. The frequency-dependent level correction is used in this example in order to obtain a higher precision. As an alternative, level correction based on average value can be used (see below).

1. Select "FREQ > External Mixer > External Mixer Config".
2. For Range 1, select "Table".
3. From the selection list, select a conversion loss table stored on the instrument.
If the selected table is not valid for the selected band, an error message is displayed.

7.2.3.1 Frequency-dependent Level Correction

1. Open the external mixer configuration settings by selecting "FREQ > External Mixer > External Mixer Config".
2. Select the required "Band".
3. For "Range 1", select "Table".
4. From the selection list, select a conversion loss table stored on the instrument. No further settings are necessary since the selected file contains all required parameters. If the selected table is not valid for the selected band, an error message is displayed.
If no conversion loss table is available yet, create a new table first (in the "Conversion Loss Table Setup" tab, see ["New Table"](#) on page 498).
5. A span is automatically set which covers the whole V band (50 to 75 GHz).
6. Set the frequency range to be examined by selecting "FREQ > Frequency Start"=*52 GHz* and "FREQ > Frequency Stop"=*60 GHz*.
7. Reduce the video bandwidth by selecting "BW > Video Bandwidth Manual"=*1 MHz*. This allows for correct signal identification using "AUTO ID" (see also [chapter 7.2.1.5, "Remarks on Signal Identification with Auto ID"](#), on page 491).

7.2.3.2 Level Correction with an Average Value

To take an average value into account instead of the frequency-dependent level correction, enter the following parameters for the selected band in the external mixer configuration settings:

1. Open the external mixer configuration settings by selecting "FREQ > External Mixer > External Mixer Config".
2. Select the required "Band".
3. For "Range 1", select "Average".
4. Enter the average of the conversion loss.

The entered average value is taken into account for the spectrum display irrespective of the frequency. The precision that can be obtained depends on the frequency response of the mixer. With this type of level correction, measurements can be easily performed at single frequencies.

7.2.3.3 Taking into Account the Cable Loss in the IF Path

On performing level correction, the conversion loss of the mixer and also the insertion loss a_0 of the cable used to tap off the IF signal are to be taken into account. This additional loss is frequency-dependent.

1. Determine the insertion of the cable at the intermediate frequency $f_{IF} = 729.9 \text{ MHz}$.
2. For level correction with average value, add the cable insertion loss to the average conversion loss.

For frequency-dependent level correction, increase each reference value by the insertion loss to the same extent. To do so, you can enter the cable loss using a transducer table. Such a table should only contain two reference values (band start and end) for which a_0 is specified.

8 Remote Operation of the R&S FSVR

The following part of the documentation deals with remote operation of the R&S FSVR.

In its first chapters, it provides general information on handling and programming remote control operation. Then, it lists all available remote commands for the R&S FSVR.

8.1 Remote Control - Basics

This chapter provides basic information on operating an instrument via remote control.



The computer that is used for remote operation is called "controller" here.

8.1.1 Remote Control Interfaces and Protocols

The instrument supports different interfaces for remote control. The following table gives an overview.

Table 8-1: Remote control interfaces and protocols

Interface	Protocols, VISA ^{*)} address string	Remarks
Local Area Network (LAN)	Protocols: <ul style="list-style-type: none"> • HiSLIP High-Speed LAN Instrument Protocol (IVI-6.1) TCPIP:: host address:: hislip0[:: INSTR] • VXI-11 • socket communication (Raw Ethernet, simple Telnet) TCPIP:: host address[:: LAN device name]: :<port>::SOCKET Library: VISA or socketcontroller • RSIB • simple telnet (Raw Ethernet) VISA ^{*)} address string: TCPIP::host address[::LAN device name][::INSTR]	A LAN connector is located on the rear panel of the instrument. The interface is based on TCP/IP and supports various protocols. For a description of the protocols refer to: <ul style="list-style-type: none"> • HiSLIP Protocol • "VXI-11 Protocol" on page 512 • Socket Communication • "RSIB Protocol" on page 513 • "Telnet Protocol" on page 514
GPIB (IEC/IEEE Bus Interface)	VISA ^{*)} address string: GPIB::primary address[::INSTR] (no secondary address)	A GPIB bus interface according to the IEC 625.1/IEEE 488.1 standard is located on the rear panel of the instrument. For a description of the interface refer to chapter 8.1.1.4, "GPIB Interface (IEC 625/IEEE 418 Bus Interface)" , on page 514.
^{*)} VISA is a standardized software interface library providing input and output functions to communicate with instruments. A VISA installation on the controller is a prerequisite for remote control using the indicated interfaces (see also chapter 8.1.1.1, "VISA Libraries" , on page 510).		



Within this interface description, the term GPIB is used as a synonym for the IEC/IEEE bus interface.

SCPI (Standard Commands for Programmable Instruments)

SCPI commands - messages - are used for remote control. Commands that are not taken from the SCPI standard follow the SCPI syntax rules. The instrument supports the SCPI version 1999. The SCPI standard is based on standard IEEE 488.2 and aims at the standardization of device-specific commands, error handling and the status registers. The tutorial "Automatic Measurement Control - A tutorial on SCPI and IEEE 488.2" from John M. Pieper (R&S order number 0002.3536.00) offers detailed information on concepts and definitions of SCPI.

The requirements that the SCPI standard places on command syntax, error handling and configuration of the status registers are explained in detail in the following sec-

tions. Tables provide a fast overview of the bit assignment in the status registers. The tables are supplemented by a comprehensive description of the status registers.

8.1.1.1 VISA Libraries

VISA is a standardized software interface library providing input and output functions to communicate with instruments. The I/O channel (LAN or TCP/IP, USB, GPIB,...) is selected at initialization time by means of the channel-specific address string ("VISA resource string") indicated in [table 8-1](#), or by an appropriately defined VISA alias (short name). A VISA installation is a prerequisite for remote control using the VXI-11, raw socket, RSIB or the newer HiSLIP protocol. The necessary VISA library is available as a separate product. For details contact your local R&S sales representative.

For more information on VISA refer to the user documentation.

8.1.1.2 Messages

The messages transferred on the data lines are divided into the following categories:

- **Interface messages**
Interface messages are transmitted to the instrument on the data lines, with the attention line being active (LOW). They are used to communicate between the controller and the instrument. Interface messages can only be sent by instruments that have GPIB bus functionality. For details see the sections for the required interface.
- **Instrument messages**
Instrument messages are employed in the same way for all interfaces, if not indicated otherwise in the description. Structure and syntax of the instrument messages are described in [chapter 8.1.4, "SCPI Command Structure"](#), on page 519. A detailed description of all messages available for the instrument is provided in the chapter "Remote Control Commands".
There are different types of instrument messages, depending on the direction they are sent:
 - Commands
 - Instrument responses

Commands

Commands (program messages) are messages the controller sends to the instrument. They operate the instrument functions and request information. The commands are subdivided according to two criteria:

- According to the effect they have on the instrument:
 - **Setting commands** cause instrument settings such as a reset of the instrument or setting the frequency.
 - **Queries** cause data to be provided for remote control, e.g. for identification of the instrument or polling a parameter value. Queries are formed by directly appending a question mark to the command header.
- According to their definition in standards:
 - **Common commands**: their function and syntax are precisely defined in standard IEEE 488.2. They are employed identically on all instruments (if implemen-

ted). They refer to functions such as management of the standardized status registers, reset and self test.

- **Instrument control commands** refer to functions depending on the features of the instrument such as frequency settings. Many of these commands have also been standardized by the SCPI committee. These commands are marked as "SCPI confirmed" in the command reference chapters. Commands without this SCPI label are device-specific; however, their syntax follows SCPI rules as permitted by the standard.

Instrument responses

Instrument responses (response messages and service requests) are messages the instrument sends to the controller after a query. They can contain measurement results, instrument settings and information on the instrument status.

8.1.1.3 LAN Interface

To be integrated in a LAN, the instrument is equipped with a LAN interface, consisting of a connector, a network interface card and protocols. The network card can be operated with a 10 MHz Ethernet IEEE 802.3 or a 100 MHz Ethernet IEEE 802.3u interface. For remote control via a network, the PC and the instrument must be connected via the LAN interface to a common network with TCP/IP network protocol. They are connected using a commercial RJ45 cable (shielded or unshielded twisted pair category 5). The TCP/IP network protocol and the associated network services are preconfigured on the instrument. Software for instrument control and the VISA program library must be installed on the controller.

VISA library

Instrument access via VXI-11 or RSIB protocols is usually achieved from high level programming platforms using VISA as an intermediate abstraction layer. VISA encapsulates the low level VXI, RSIB or even GPIB function calls and thus makes the transport interface transparent for the user. See [chapter 8.1.1.1, "VISA Libraries"](#), on page 510 for details.

IP address

Only the IP address or a valid DNS host name is required to set up the connection. The host address is part of the "VISA resource string" used by the programs to identify and control the instrument.

The VISA resource string has the form:

```
TCPIP::host address[::LAN device name][::INSTR]
```

or

```
TCPIP::host address::port::SOCKET
```

where:

- **TCPIP** designates the network protocol used
- **host address** is the IP address or host name of the device

- **LAN device name** defines the protocol and the instance number of a sub-instrument;
 - `inst0` selects the VXI-11 protocol (default)
 - `hislip0` selects the newer HiSLIP protocol
- **INSTR** indicates the instrument resource class (optional)
- **port** determines the used port number
- **SOCKET** indicates the raw network socket resource class

Example:

- Instrument has the IP address `192.1.2.3`; the valid resource string using VXI-11 protocol is:
`TCPIP::192.1.2.3::INSTR`
- The instrument name is `RSFSV`; the valid resource string is:
`TCPIP::RSFSV::INSTR`
- A raw socket connection can be established using:
`TCPIP::192.1.2.3::5025::SOCKET`
- The DNS host name name is `FSV-123456`; the valid resource string using HiSLIP is:
`TCPIP::FSV-123456::hislip0`

**Identifying instruments in a network**

If several instruments are connected to the network, each instrument has its own IP address and associated resource string. The controller identifies these instruments by means of the resource string.

For details on configuring the LAN connection, see "Setting Up a Network (LAN) Connection" in the R&S FSVR Quick Start Guide.

VXI-11 Protocol

The VXI-11 standard is based on the ONC RPC (Open Network Computing Remote Procedure Call) protocol which in turn relies on TCP/IP as the network/transport layer. The TCP/IP network protocol and the associated network services are preconfigured. TCP/IP ensures connection-oriented communication, where the order of the exchanged messages is adhered to and interrupted links are identified. With this protocol, messages cannot be lost.

HiSLIP Protocol

The HiSLIP (**H**igh **S**peed **L**AN **I**nstrument **P**rotocol) is the successor protocol for VXI-11 for TCP-based instruments specified by the IVI foundation. The protocol uses two TCP sockets for a single connection - one for fast data transfer, the other for non-sequential control commands (e.g. `Device Clear` or `SRQ`).

HiSLIP has the following characteristics:

- High performance as with raw socket network connections

- Compatible IEEE 488.2 support for Message Exchange Protocol, Device Clear, Serial Poll, Remote/Local, Trigger, and Service Request
- Uses a single IANA registered port (4880), which simplifies the configuration of firewalls
- Supports simultaneous access of multiple users by providing versatile locking mechanisms
- Usable for IPv6 or IPv4 networks



Note that HiSLIP data is sent to the device using the "fire and forget" method with immediate return, as opposed to VXI-11, where each operation is blocked until a VXI-11 device handshake returns. Thus, a successful return of a VISA operation such as `viWrite()` does not guarantee that the instrument has finished or started the requested command, but is delivered to the TCP/IP buffers.

For more information see also the application note at: <http://www.rohde-schwarz.com/appnote/1MA208>.

Socket Communication

An alternative way for remote control of the software is to establish a simple network communication using sockets. The socket communication, also referred to as "Raw Ethernet communication", does not necessarily require a VISA installation on the remote controller side. It is available by default on all operating systems.

The simplest way to establish socket communication is to use the built-in telnet program. The telnet program is part of every operating system and supports a communication with the software on a command-by-command basis. For more convenience and to enable automation by means of programs, user-defined sockets can be programmed.

Socket connections are established on a specially defined port. The socket address is a combination of the IP address or the host name of the instrument and the number of the port configured for remote-control. All R&S FSVR use port number 5025 for this purpose. The port is configured for communication on a command-to-command basis and for remote control from a program.

RSIB Protocol

The R&S defined RSIB protocol uses the TCP/IP protocol for communication with the instrument. Remote control over RSIB is done on a message level basis using the SCPI command set of the instrument. The RSIB protocol allows you to control the instrument for example via Visual C++- and Visual Basic programs, via the Windows applications Word and Excel, as well as via National Instruments LabView, LabWindows/CVI, Agilent VEE and others. The control applications run on an external computer in the network.

RSIB Interface Functions

The library functions are adapted to the interface functions of National Instruments for GPIB programming. The functions supported by the libraries are listed in the following table.

Function	Description
RSDLLibfind()	Provides a handle for access to a device.
RSDLLibwrt()	Sends a zero-terminated string to a device.
RSDLLiwrft()	Sends a certain number of bytes to a device.
RSDLLibwrtf()	Sends the contents of a file to a device.
RSDLLibrd()	Reads data from a device into a string.
RSDLLiird()	Reads a certain number of bytes from a device.
RSDLLibrdf()	Reads data from a device into a file.
RSDLLibtmo()	Sets timeout for RSIB functions.
RSDLLibsre()	Switches a device to the local or remote state.
RSDLLibloc()	Temporarily switches a device to the local state.
RSDLLibeot()	Enables/disables the END message for write operations.
RSDLLibrsp()	Performs a serial poll and provides the status byte.
RSDLLibonl()	Sets the device online/offline.
RSDLLTestSrq()	Checks whether a device has generated an SRQ.
RSDLLWaitSrq()	Waits until a device generates an SRQ.
RSDLLSwapBytes	Swaps the byte sequence for binary numericdisplay (only required for non-Intel platforms).

Telnet Protocol

As an alternative to remote control the instrument can use a simple telnet protocol (port 5025). Unlike using the VXI-11 protocol, no VISA installation is necessary on the remote controller side. This protocol is sometimes also referred to as "socket communication" or "Raw Ethernet mode". To control the instrument, only a Telnet program is required. The Telnet program is part of every operating system.

8.1.1.4 GPIB Interface (IEC 625/IEEE 418 Bus Interface)

To be able to control the instrument via the GPIB bus, the instrument and the controller must be linked by a GPIB bus cable. A GPIB bus card, the card drivers and the program libraries for the programming language used must be provided in the controller. The controller must address the instrument with the GPIB bus address (see "[GPIB Instrument Address](#)" on page 517).

Notes and Conditions

In connection with the GPIB interface, note the following:

- Up to 15 instruments can be connected
- The total cable length is restricted to a maximum of 15 m or 2 m times the number of devices, whichever is less; the cable length between two instruments should not exceed 2 m.

- A wired "OR"-connection is used if several instruments are connected in parallel.
- Any connected IEC-bus cables should be terminated by an instrument or controller.

GPIB Interface Messages

Interface messages are transmitted to the instrument on the data lines, with the attention line (ATN) being active (LOW). They are used for communication between the controller and the instrument and can only be sent by a computer which has the function of a GPIB bus controller. GPIB interface messages can be further subdivided into:

- **Universal commands:** act on all instruments connected to the GPIB bus without previous addressing
- **Addressed commands:** only act on instruments previously addressed as listeners

The following figure provides an overview of the available communication lines used by the GPIB interface.

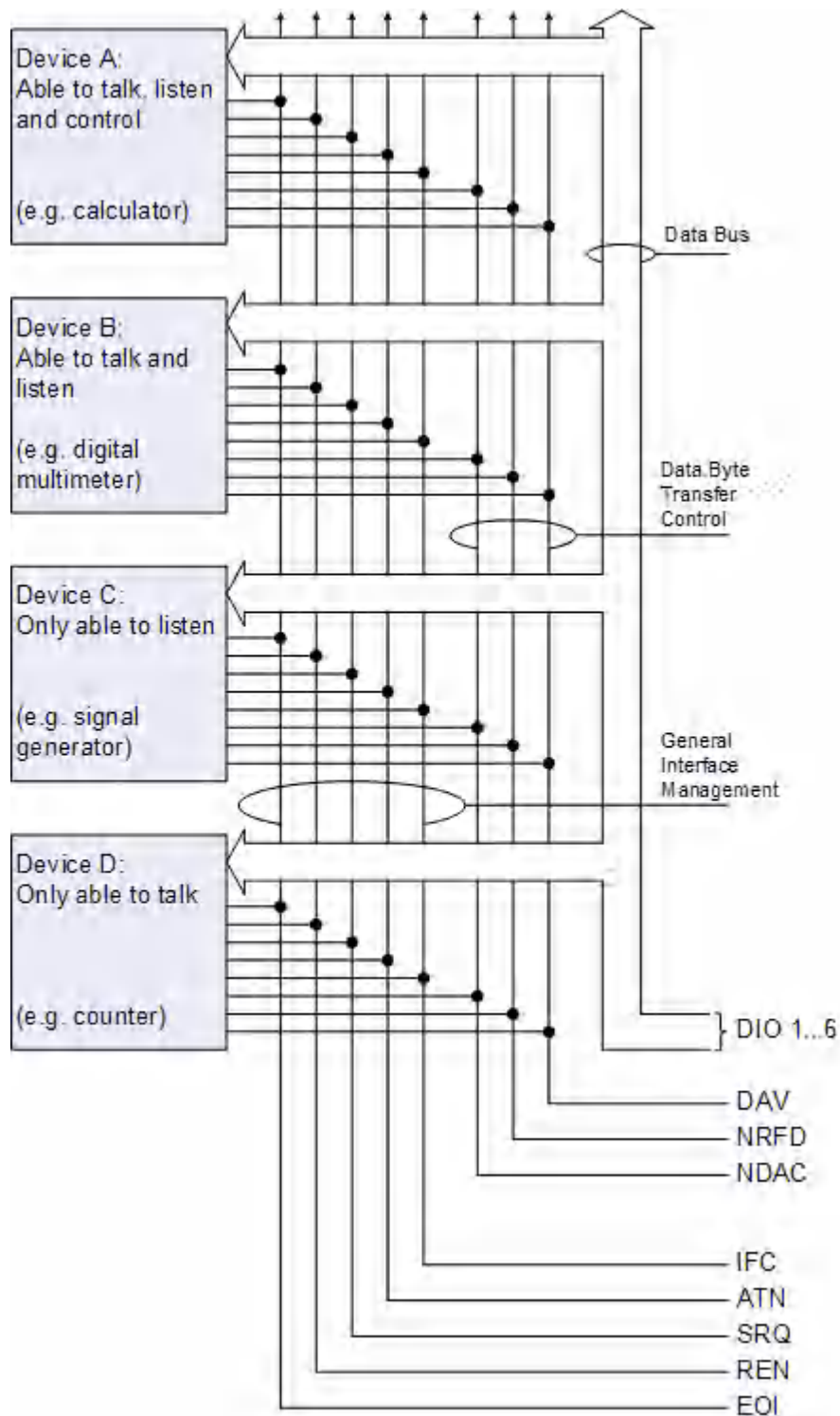

Fig. 8-1: Communication lines used by the GPIB interface

Universal Commands

Universal commands are encoded in the range 10 through 1F hex. They affect all instruments connected to the bus and do not require addressing.

Command	Effect on the instrument
DCL (Device Clear)	Aborts the processing of the commands just received and sets the command processing software to a defined initial state. Does not change the instrument settings.
IFC (Interface Clear) *)	Resets the interfaces to the default setting.
LLO (Local Lockout)	The LOC/IEC ADDR key is disabled.
SPE (Serial Poll Enable)	Ready for serial poll.
SPD (Serial Poll Disable)	End of serial poll.
PPU (Parallel Poll Unconfigure)	End of the parallel-poll state.
*) IFC is not a real universal command, it is sent via a separate line; however, it also affects all instruments connected to the bus and does not require addressing	

Addressed Commands

Addressed commands are encoded in the range 00 through 0F hex. They only affect instruments addressed as listeners.

Command	Effect on the instrument
GET (Group Execute Trigger)	Triggers a previously active instrument function (e.g. a sweep). The effect of the command is the same as with that of a pulse at the external trigger signal input.
GTL (Go to Local)	Transition to the "local" state (manual control).
	Transition to the "remote" state (remote control).
PPC (Parallel Poll Configure)	Configures the instrument for parallel poll.
SDC (Selected Device Clear)	Aborts the processing of the commands just received and sets the command processing software to a defined initial state. Does not change the instrument setting.

GPIB Instrument Address

In order to operate the instrument via remote control, it must be addressed using the GPIB address. The remote control address is factory-set to 20, but it can be changed if it does not fit in the network environment. For remote control, addresses 0 through 30 are allowed. The GPIB address is maintained after a reset of the instrument settings.

Setting the GPIB address

1. On the R&S FSVR, press the SETUP key.
2. Press the "General Setup" softkey.
3. Press the "GPIB" softkey.

The submenu for setting the parameters of the remote control interface is displayed.

4. Press the "GPIB Address" softkey.

The edit dialog box for the GPIB address is displayed.

5. Enter a value between 0 and 30.

Remote command: `SYST:COMM:GPIB:ADDR 18`

8.1.2 Starting a Remote Control Session

When you switch on the instrument, it is always in manual operation state ("local" state) and can be operated via the front panel.

Starting remote control

1. Send an addressed command (`GTR` - Go to Remote) from a controller to the instrument.

The instrument is switched to remote control ("remote" state). Operation via the front panel is disabled. Only the "Local" softkey is displayed to return to manual operation. The instrument remains in the remote state until it is reset to the manual state via the instrument or via remote control interfaces. Switching from manual operation to remote control and vice versa does not affect the other instrument settings.

2. During program execution, send the `SYSTem:DISPlay:UPDate ON` command to activate the display of results.

The changes in the device settings and the recorded measurement values are displayed on the instrument screen.

3. To obtain optimum performance during remote control, send the `SYSTem:DISPlay:UPDate OFF` command to hide the display of results and diagrams again (default setting in remote control).

4. To prevent unintentional return to manual operation, disable the keys of the instrument using the universal command `LLO`.

Switching to manual mode is only possible via remote control then. This function is only available for the GPIB interface.

5. To enable the keys of the R&S FSVR again, switch the instrument to local mode (`GTL` - Go to Local), i.e. deactivate the `REN` line of the remote control interface.



If the instrument is operated exclusively in remote control, it is recommended that you switch on the power-save mode for the display. For more details on this mode refer to the R&S FSVR Quick Start Guide.

8.1.3 Returning to Manual Operation

Before you switch back to manual operation, all remote command processing must be completed. Otherwise, the instrument will switch back to remote control immediately.

- ▶ Press the "Local" softkey or the PRESET key, or use the following GPIB command:

```
status = viGpibControlREN(vi, VI_GPIB_REN_ADDRESS_GTL)
```

8.1.4 SCPI Command Structure

SCPI commands consist of a so-called header and, in most cases, one or more parameters. The header and the parameters are separated by a "white space" (ASCII code 0 to 9, 11 to 32 decimal, e.g. blank). The headers may consist of several mnemonics (keywords). Queries are formed by appending a question mark directly to the header.

The commands can be either device-specific or device-independent (common commands). Common and device-specific commands differ in their syntax.

8.1.4.1 Syntax for Common Commands

Common (=device-independent) commands consist of a header preceded by an asterisk (*) and possibly one or more parameters.

Examples:

*RST	RESET	Resets the instrument.
*ESE	EVENT STATUS ENABLE	Sets the bits of the event status enable registers.
*ESR?	EVENT STATUS QUERY	Queries the contents of the event status register.
*IDN?	IDENTIFICATION QUERY	Queries the instrument identification string.

8.1.4.2 Syntax for Device-Specific Commands



Not all commands used in the following examples are necessarily implemented in the instrument.

For demonstration purposes only, assume the existence of the following commands for this section:

- DISPLAY[:WINDow<1...4>]:MAXimize <Boolean>
- FORMat:READings:DATA <type>[,<length>]
- HCOpy:DEvice:COLor <Boolean>
- HCOpy:DEvice:CMAP:COLor:RGB <red>,<green>,<blue>
- HCOpy[:IMMediate]
- HCOpy:ITEM:ALL
- HCOpy:ITEM:LABel <string>
- HCOpy:PAGE:DIMensions:QUADrant [<N>]
- HCOpy:PAGE:ORientation LANDscape | PORTrait
- HCOpy:PAGE:SCALE <numeric value>
- MMEMory:COpy <file_source>,<file_destination>
- SENSE:BANDwidth|BWIDth[:RESolution] <numeric_value>
- SENSE:FREQuency:STOP <numeric value>
- SENSE:LIST:FREQuency <numeric_value>{,<numeric_value>}

Long and short form

The mnemonics feature a long form and a short form. The short form is marked by upper case letters, the long form corresponds to the complete word. Either the short form or the long form can be entered; other abbreviations are not permitted.

Example:

HCOpy:DEvice:COLor ON is equivalent to HCOP:DEV:COL ON.



Case-insensitivity

Upper case and lower case notation only serves to distinguish the two forms in the manual, the instrument itself is case-insensitive.

Numeric suffixes

If a command can be applied to multiple instances of an object, e.g. specific channels or sources, the required instances can be specified by a suffix added to the command. Numeric suffixes are indicated by angular brackets (<1...4>, <n>, <i>) and are replaced by a single value in the command. Entries without a suffix are interpreted as having the suffix 1.

Example:

Definition: `HCOPY:PAGE:DIMensions:QUADrant [<N>]`

Command: `HCOP:PAGE:DIM:QUAD2`

This command refers to the quadrant 2.

**Different numbering in remote control**

For remote control, the suffix may differ from the number of the corresponding selection used in manual operation. SCPI prescribes that suffix counting starts with 1. Suffix 1 is the default state and used when no specific suffix is specified.

Some standards define a fixed numbering, starting with 0. If the numbering differs in manual operation and remote control, it is indicated for the corresponding command.

Optional mnemonics

Some command systems permit certain mnemonics to be inserted into the header or omitted. These mnemonics are marked by square brackets in the description. The instrument must recognize the long command to comply with the SCPI standard. Some commands are considerably shortened by these optional mnemonics.

Example:

Definition: `HCOPY[:IMMEDIATE]`

Command: `HCOP:IMM` is equivalent to `HCOP`

**Optional mnemonics with numeric suffixes**

Do not omit an optional mnemonic if it includes a numeric suffix that is relevant for the effect of the command.

Example:

Definition: `DISPlay[:WINDow<1...4>]:MAXimize <Boolean>`

Command: `DISP:MAX ON` refers to window 1.

In order to refer to a window other than 1, you must include the optional `WINDow` parameter with the suffix for the required window.

`DISP:WIND2:MAX ON` refers to window 2.

Parameters

Parameters must be separated from the header by a "white space". If several parameters are specified in a command, they are separated by a comma (.). For a description of the parameter types, refer to [chapter 8.1.4.3, "SCPI Parameters"](#), on page 522.

Example:

Definition: `HCOPY:DEvice:CMAP:COLor:RGB <red>, <green>, <blue>`

Command: `HCOP:DEV:CMAP:COL:RGB 3, 32, 44`

Special characters

	<p>Parameters</p> <p>A vertical stroke in parameter definitions indicates alternative possibilities in the sense of "or". The effect of the command differs, depending on which parameter is used.</p> <p>Example:</p> <p>Definition:HCOPY:PAGE:ORIENTATION LANDscape PORTRait</p> <p>Command HCOP:PAGE:ORI LAND specifies landscape orientation</p> <p>Command HCOP:PAGE:ORI PORT specifies portrait orientation</p> <p>Mnemonics</p> <p>A selection of mnemonics with an identical effect exists for several commands. These mnemonics are indicated in the same line; they are separated by a vertical stroke. Only one of these mnemonics needs to be included in the header of the command. The effect of the command is independent of which of the mnemonics is used.</p> <p>Example:</p> <p>DefinitionSENSE:BANDwidth BWIDTH[:RESolution] <numeric_value></p> <p>The two following commands with identical meaning can be created:</p> <p>SENS:BAND:RES 1</p> <p>SENS:BWID:RES 1</p>
[]	<p>Mnemonics in square brackets are optional and may be inserted into the header or omitted.</p> <p>Example: HCOPI[:IMMEDIATE]</p> <p>HCOP:IMM is equivalent to HCOP</p>
{ }	<p>Parameters in curly brackets are optional and can be inserted once or several times, or omitted.</p> <p>Example: SENSE:LIST:FREQUENCY <numeric_value>{,<numeric_value>}</p> <p>The following are valid commands:</p> <p>SENS:LIST:FREQ 10</p> <p>SENS:LIST:FREQ 10,20</p> <p>SENS:LIST:FREQ 10,20,30,40</p>

8.1.4.3 SCPI Parameters

Many commands are supplemented by a parameter or a list of parameters. The parameters must be separated from the header by a "white space" (ASCII code 0 to 9, 11 to 32 decimal, e.g. blank). Allowed parameters are:

- Numeric values
- Special numeric values
- Boolean parameters
- Text
- Character strings
- Block data

The parameters required for each command and the allowed range of values are specified in the command description.

Numeric values

Numeric values can be entered in any form, i.e. with sign, decimal point and exponent. Values exceeding the resolution of the instrument are rounded up or down. The mantissa may comprise up to 255 characters, the exponent must lie inside the value range -32000 to 32000. The exponent is introduced by an "E" or "e". Entry of the exponent alone is not allowed. In the case of physical quantities, the unit can be entered. Allowed unit prefixes are G (giga), MA (mega), MOHM and MHZ (are also allowed), K (kilo), M (milli), U (micro) and N (nano). If the unit is missing, the basic unit is used.

Example: `SENS:FREQ:STOP 1.5GHz = SENS:FREQ:STOP 1.5E9`

Units

For physical quantities, the unit can be entered. Allowed unit prefixes are:

- G (giga)
- MA (mega), MOHM, MHZ
- K (kilo)
- M (milli)
- U (micro)
- N (nano)

If the unit is missing, the basic unit is used.

Example:

`SENSe:FREQ:STOP 1.5GHz = SENSe:FREQ:STOP 1.5E9`

Some settings allow relative values to be stated in percent. According to SCPI, this unit is represented by the `PCT` string.

Example:

`HCOP:PAGE:SCAL 90PCT`

Special numeric values

The texts listed below are interpreted as special numeric values. In the case of a query, the numeric value is provided.

- **MIN/MAX**
MINimum and MAXimum denote the minimum and maximum value.
- **DEF**
DEFault denotes a preset value which has been stored in the EPROM. This value conforms to the default setting, as it is called by the `*RST` command.
- **UP/DOWN**
UP, DOWN increases or reduces the numeric value by one step. The step width can be specified via an allocated step command for each parameter which can be set via UP, DOWN.
- **INF/NINF**

INFinity, Negative INFinity (NINF) represent the numeric values 9.9E37 or -9.9E37, respectively. INF and NINF are only sent as instrument responses.

- **NAN**

Not A Number (NAN) represents the value 9.91E37. NAN is only sent as a instrument response. This value is not defined. Possible causes are the division of zero by zero, the subtraction of infinite from infinite and the representation of missing values.

Example:

Setting command: `SENSe:LIST:FREQ MAXimum`

Query: `SENS:LIST:FREQ?`, Response: `3.5E9`



Queries for special numeric values

The numeric values associated to `MAXimum`/`MINimum`/`DEFault` can be queried by adding the corresponding mnemonics to the command. They must be entered following the quotation mark.

Example: `SENSe:LIST:FREQ? MAXimum`

Returns the maximum numeric value as a result.

Boolean Parameters

Boolean parameters represent two states. The "ON" state (logically true) is represented by "ON" or a numeric value 1. The "OFF" state (logically untrue) is represented by "OFF" or the numeric value 0. The numeric values are provided as the response for a query.

Example:

Setting command: `HCOpy:DEV:COL ON`

Query: `HCOpy:DEV:COL?`

Response: `1`

Text parameters

Text parameters observe the syntactic rules for mnemonics, i.e. they can be entered using a short or long form. Like any parameter, they have to be separated from the header by a white space. In the case of a query, the short form of the text is provided.

Example:

Setting command: `HCOpy:PAGE:ORientation LANDscape`

Query: `HCOp:PAGE:ORI?`

Response: `LAND`

Character strings

Strings must always be entered in quotation marks (' or ").

Example:

```
HCOP:ITEM:LABel "Test1" or HCOP:ITEM:LABel 'Test1'
```

Block data

Block data is a format which is suitable for the transmission of large amounts of data. A command using a block data parameter has the following structure:

Example:

```
FORMat:READings:DATA #45168xxxxxxxx
```

The ASCII character # introduces the data block. The next number indicates how many of the following digits describe the length of the data block. In the example the 4 following digits indicate the length to be 5168 bytes. The data bytes follow. During the transmission of these data bytes all end or other control signs are ignored until all bytes are transmitted.

#0 specifies a data block of indefinite length. The use of the indefinite format requires a `NL^END` message to terminate the data block. This format is useful when the length of the transmission is not known or if speed or other considerations prevent segmentation of the data into blocks of definite length.

8.1.4.4 Overview of Syntax Elements

The following table provides an overview of the syntax elements:

:	The colon separates the mnemonics of a command. In a command line the separating semicolon marks the uppermost command level.
;	The semicolon separates two commands of a command line. It does not alter the path.
,	The comma separates several parameters of a command.
?	The question mark forms a query.
*	The asterisk marks a common command.
''	Quotation marks introduce a string and terminate it (both single and double quotation marks are possible).
#	The hash symbol introduces binary, octal, hexadecimal and block data. <ul style="list-style-type: none"> • Binary: #B10110 • Octal: #O7612 • Hexa: #HF3A7 • Block: #21312
	A "white space" (ASCII-Code 0 to 9, 11 to 32 decimal, e.g. blank) separates the header from the parameters.

8.1.4.5 Structure of a command line

A command line may consist of one or several commands. It is terminated by one of the following:

- a <New Line>
- a <New Line> with EOI
- an EOI together with the last data byte

Several commands in a command line must be separated by a semicolon ";". If the next command belongs to a different command system, the semicolon is followed by a colon.

Example:

```
MMEM: COPY "Test1", "MeasurementXY"; :HCOP: ITEM ALL
```

This command line contains two commands. The first command belongs to the MMEM system, the second command belongs to the HCOP system.

If the successive commands belong to the same system, having one or several levels in common, the command line can be abbreviated. To this end, the second command after the semicolon starts with the level that lies below the common levels. The colon following the semicolon must be omitted in this case.

Example:

```
HCOP: ITEM ALL; :HCOP: IMM
```

This command line contains two commands. Both commands are part of the HCOP command system, i.e. they have one level in common.

When abbreviating the command line, the second command begins with the level below HCOP. The colon after the semicolon is omitted. The abbreviated form of the command line reads as follows:

```
HCOP: ITEM ALL; IMM
```

A new command line always begins with the complete path.

Example:

```
HCOP: ITEM ALL
```

```
HCOP: IMM
```

8.1.4.6 Responses to Queries

A query is defined for each setting command unless explicitly specified otherwise. It is formed by adding a question mark to the associated setting command. According to SCPI, the responses to queries are partly subject to stricter rules than in standard IEEE 488.2.

- The requested parameter is transmitted without a header.
Example: `HCOP: PAGE: ORI?`, **Response:** `LAND`
- Maximum values, minimum values and all other quantities that are requested via a special text parameter are returned as numeric values.
Example: `SENSe: FREQuency: STOP? MAX`, **Response:** `3.5E9`

- Numeric values are output without a unit. Physical quantities are referred to the basic units or to the units set using the `Unit` command. The response `3.5E9` in the previous example stands for 3.5 GHz.
- Truth values (Boolean values) are returned as 0 (for OFF) and 1 (for ON).

Example:

Setting command: `HCOPY:DEV:COL ON`

Query: `HCOPY:DEV:COL?`

Response: 1

- Text (character data) is returned in a short form.

Example:

Setting command: `HCOPY:PAGE:ORIENTATION LANDscape`

Query: `HCOPY:PAGE:ORI?`

Response: LAND

8.1.5 Command Sequence and Synchronization

IEEE 488.2 defines a distinction between overlapped and sequential commands:

- A **sequential command** is one which finishes executing before the next command starts executing. Commands that are processed quickly are usually implemented as sequential commands.
- An **overlapping command** is one which does not automatically finish executing before the next command starts executing. Usually, overlapping commands take longer to process and allow the program to do other tasks while being executed. If overlapping commands do have to be executed in a defined order, e.g. in order to avoid wrong measurement results, they must be serviced sequentially. This is called synchronization between the controller and the instrument.

Setting commands within one command line, even though they may be implemented as sequential commands, are not necessarily serviced in the order in which they have been received. In order to make sure that commands are actually carried out in a certain order, each command must be sent in a separate command line.

Example: Commands and queries in one message

The response to a query combined in a program message with commands that affect the queried value is not predictable.

The following commands always return the specified result:

```
:FREQ:STAR 1GHZ;SPAN 100 :FREQ:STAR?
```

Result:

```
1000000000 (1 GHz)
```

Whereas the result for the following commands is not specified by SCPI:

```
:FREQ:STAR 1GHz;STAR?;SPAN 1000000
```

The result could be the value of `STARt` before the command was sent since the instrument might defer executing the individual commands until a program message terminator is received. The result could also be 1 GHz if the instrument executes commands as they are received.



As a general rule, send commands and queries in different program messages.

Example: Overlapping command with *OPC

The instrument implements `INITiate[:IMMEDIATE]` as an overlapped command. Assuming that `INITiate[:IMMEDIATE]` takes longer to execute than `*OPC`, sending the following command sequence results in initiating a sweep and, after some time, setting the `OPC` bit in the `ESR`:

```
INIT; *OPC.
```

Sending the following commands still initiates a sweep:

```
INIT; *OPC; *CLS
```

However, since the operation is still pending when the instrument executes `*CLS`, forcing it into the "Operation Complete Command Idle" State (OCIS), `*OPC` is effectively skipped. The `OPC` bit is not set until the instrument executes another `*OPC` command.

The following list includes the commands for which a synchronization via `*OPC`, `*OPC?` or `*WAI` is mandatory:

Command	Purpose
INIT	start measurement
INIT:CONM	continue measurement
CALC:MARK:FUNC:ZOOM	zoom frequency range around marker 1
CALC:STAT:SCAL:AUTO ONCE	optimize level settings for signal statistic measurement functions
[SENS:]POW:ACH:PRES:RLEV	optimize level settings for adjacent channel power measurements

8.1.5.1 Preventing Overlapping Execution

To prevent an overlapping execution of commands, one of the commands `*OPC`, `*OPC?` or `*WAI` can be used. All three commands cause a certain action only to be carried out after the hardware has been set. By suitable programming, the controller can be forced to wait for the corresponding action to occur.

Table 8-2: Synchronization using *OPC, *OPC? and *WAI

Command	Action	Programming the controller
*OPC	Sets the Operation Complete bit in the ESR after all previous commands have been executed.	<ul style="list-style-type: none"> Setting bit 0 in the ESE Setting bit 5 in the SRE Waiting for service request (SRQ)
*OPC?	Stops command processing until 1 is returned. This is only the case after the Operation Complete bit has been set in the ESR. This bit indicates that the previous setting has been completed.	Sending *OPC? directly after the command whose processing should be terminated before other commands can be executed.
*WAI	Stops further command processing until all commands sent before *WAI have been executed.	Sending *WAI directly after the command whose processing should be terminated before other commands are executed.

Command synchronization using *WAI or *OPC? appended to an overlapped command is a good choice if the overlapped command takes only little time to process. The two synchronization techniques simply block overlapped execution of the command.

For time consuming overlapped commands it is usually desirable to allow the controller or the instrument to do other useful work while waiting for command execution. Use one of the following methods:

***OPC with a service request**

1. Set the OPC mask bit (bit no. 0) in the ESE: *ESE 1
2. Set bit no. 5 in the SRE: *SRE 32 to enable ESB service request.
3. Send the overlapped command with *OPC
4. Wait for a service request

The service request indicates that the overlapped command has finished.

***OPC? with a service request**

1. Set bit no. 4 in the SRE: *SRE 16 to enable MAV service request.
2. Send the overlapped command with *OPC?
3. Wait for a service request

The service request indicates that the overlapped command has finished.

Event Status Register (ESE)

1. Set the OPC mask bit (bit no. 0) in the ESE: *ESE 1
2. Send the overlapped command without *OPC, *OPC? or *WAI
3. Poll the operation complete state periodically (by means of a timer) using the sequence: *OPC; *ESR?

A return value (LSB) of 1 indicates that the overlapped command has finished.

***OPC? with short timeout**

1. Send the overlapped command without *OPC, *OPC? or *WAI
2. Poll the operation complete state periodically (by means of a timer) using the sequence: <short timeout>; *OPC?
3. A return value (LSB) of 1 indicates that the overlapped command has finished. In case of a timeout, the operation is ongoing.
4. Reset timeout to former value
5. Clear the error queue with `SYStem:ERRor?` to remove the "-410, Query interrupted" entries.

Using several threads in the controller application

As an alternative, provided the programming environment of the controller application supports threads, separate threads can be used for the application GUI and for controlling the instrument(s) via SCPI.

A thread waiting for a *OPC? thus will not block the GUI or the communication with other instruments.

8.1.6 Status Reporting System

The status reporting system stores all information on the current operating state of the instrument, and on errors which have occurred. This information is stored in the status registers and in the error queue. Both can be queried via GPIB bus or LAN interface (`STATus...` commands).

8.1.6.1 Hierarchy of Status Registers

- **STB, SRE**
The `STatus Byte (STB)` register and its associated mask register `Service Request Enable (SRE)` form the highest level of the status reporting system. The `STB` provides a rough overview of the instrument status, collecting the information of the lower-level registers.
- **ESR, SCPI registers**
The `STB` receives its information from the following registers:
 - The `Event Status Register (ESR)` with the associated mask register `standard Event Status Enable (ESE)`
 - The `STATus:OPERation` and `STATus:QUEStionable` registers which are defined by SCPI and contain detailed information on the instrument
- **IST, PPE**
The `IST` flag ("Individual `STatus`"), like the `SRQ`, combines the entire instrument status in a single bit. The `PPE` fulfills the same function for the `IST` flag as the `SRE` for the service request.
- **Output buffer**

The output buffer contains the messages the instrument returns to the controller. It is not part of the status reporting system but determines the value of the `MAV` bit in the `STB` and thus is represented in the overview.

All status registers have the same internal structure.



SRE, ESE

The service request enable register `SRE` can be used as `ENABLE` part of the `STB` if the `STB` is structured according to SCPI. By analogy, the `ESE` can be used as the `ENABLE` part of the `ESR`.

8.1.6.2 Structure of a SCPI Status Register

Each standard SCPI register consists of 5 parts. Each part has a width of 16 bits and has different functions. The individual bits are independent of each other, i.e. each hardware status is assigned a bit number which is valid for all five parts. Bit 15 (the most significant bit) is set to zero for all parts. Thus the contents of the register parts can be processed by the controller as positive integers.

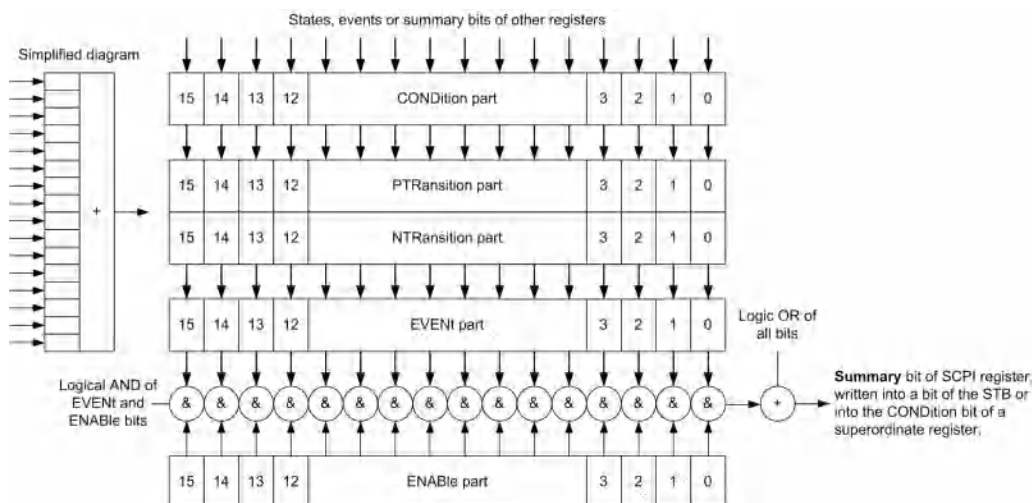

Fig. 8-2: The status-register model

Description of the five status register parts

The five parts of a SCPI register have different properties and functions:

- CONDITION**
 The `CONDition` part is written into directly by the hardware or the sum bit of the next lower register. Its contents reflect the current instrument status. This register part can only be read, but not written into or cleared. Its contents are not affected by reading.
- PTRANSITION / NTRANSITION**
 The two transition register parts define which state transition of the `CONDition` part (none, 0 to 1, 1 to 0 or both) is stored in the `EVENT` part.

The **Positive-TRansition** part acts as a transition filter. When a bit of the `CONDition` part is changed from 0 to 1, the associated `PTR` bit decides whether the `EVENT` bit is set to 1.

- `PTR` bit =1: the `EVENT` bit is set.
- `PTR` bit =0: the `EVENT` bit is not set.

This part can be written into and read as required. Its contents are not affected by reading.

The **Negative-TRansition** part also acts as a transition filter. When a bit of the `CONDition` part is changed from 1 to 0, the associated `NTR` bit decides whether the `EVENT` bit is set to 1.

- `NTR` bit =1: the `EVENT` bit is set.
- `NTR` bit =0: the `EVENT` bit is not set.

This part can be written into and read as required. Its contents are not affected by reading.

- **EVENT**

The `EVENT` part indicates whether an event has occurred since the last reading, it is the "memory" of the condition part. It only indicates events passed on by the transition filters. It is permanently updated by the instrument. This part can only be read by the user. Reading the register clears it. This part is often equated with the entire register.

- **ENABLE**

The `ENABLE` part determines whether the associated `EVENT` bit contributes to the sum bit (see below). Each bit of the `EVENT` part is "ANDed" with the associated `ENABLE` bit (symbol '&'). The results of all logical operations of this part are passed on to the sum bit via an "OR" function (symbol '+').

`ENABLE` bit = 0: the associated `EVENT` bit does not contribute to the sum bit

`ENABLE` bit = 1: if the associated `EVENT` bit is "1", the sum bit is set to "1" as well.

This part can be written into and read by the user as required. Its contents are not affected by reading.

Sum bit

The sum bit is obtained from the `EVENT` and `ENABLE` part for each register. The result is then entered into a bit of the `CONDition` part of the higher-order register.

The instrument automatically generates the sum bit for each register. Thus an event can lead to a service request throughout all levels of the hierarchy.

8.1.6.3 Contents of the Status Register

This chapter provides information on the contents of each status register the meaning for all bits that are used available for each operating mode.

Status Register in Realtime Mode

This chapter contains the description of the registers and bits available in realtime mode.

The figure below shows the status registers available in realtime mode.

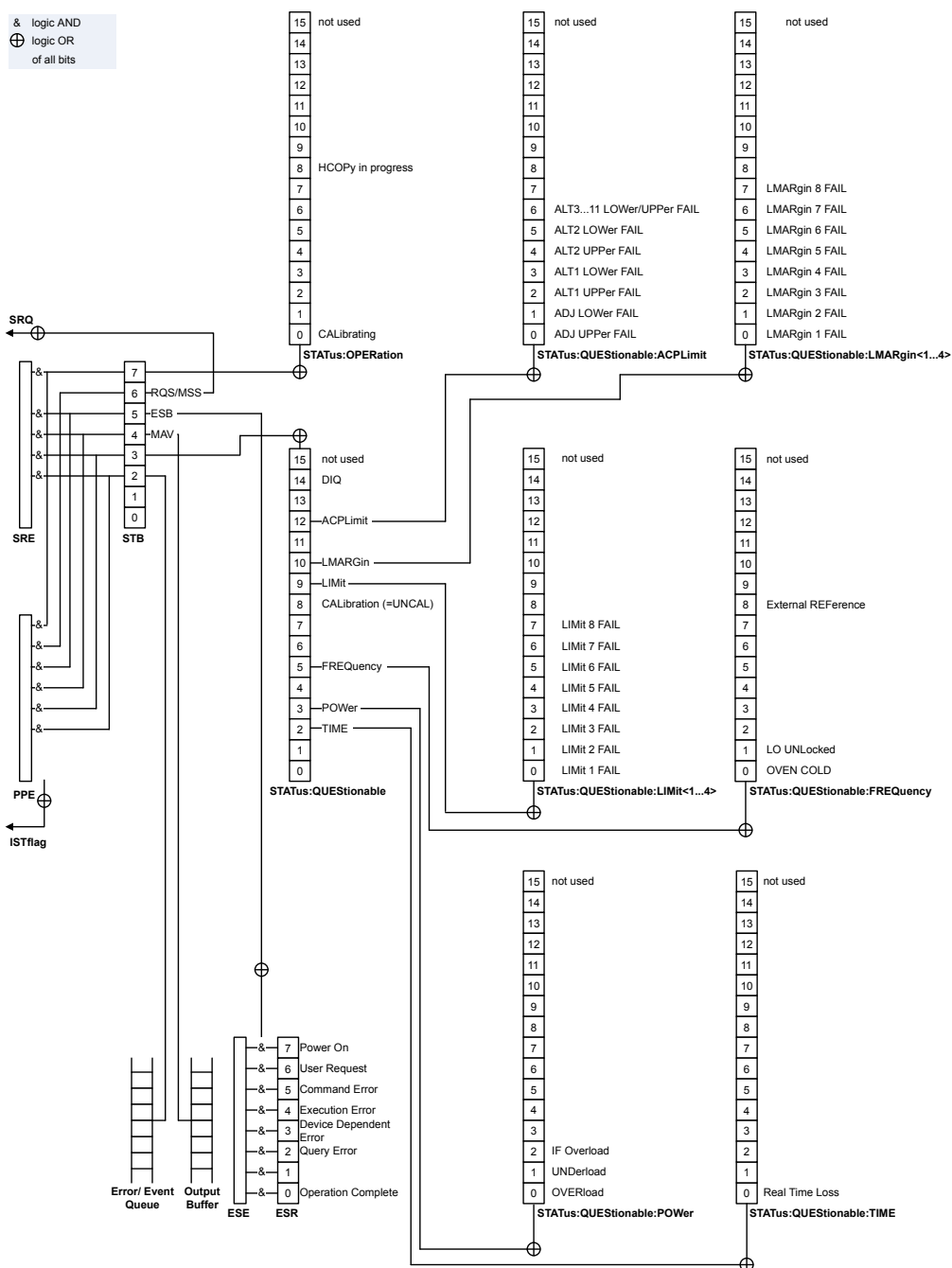

Fig. 8-3: Overview of status registers in realtime mode

Status Byte (STB) and Service Request Enable Register (SRE)

The **STatus Byte (STB)** is already defined in IEEE 488.2. It provides a rough overview of the instrument status by collecting the pieces of information of the lower registers. A special feature is that bit 6 acts as the sum bit of the remaining bits of the status byte.

The STB can thus be compared with the `CONDition` part of an SCPI register and assumes the highest level within the SCPI hierarchy.

The STB is read using the command `*STB?` or a serial poll.

The `STatus Byte` (STB) is linked to the `Service Request Enable` (SRE) register. Each bit of the STB is assigned a bit in the SRE. Bit 6 of the SRE is ignored. If a bit is set in the SRE and the associated bit in the STB changes from 0 to 1, a service request (SRQ) is generated. The SRE can be set using the command `*SRE` and read using the command `*SRE?`.

Table 8-3: Meaning of the bits used in the status byte

Bit No.	Meaning
0...1	Not used
2	Error Queue not empty The bit is set when an entry is made in the error queue. If this bit is enabled by the SRE, each entry of the error queue generates a service request. Thus an error can be recognized and specified in greater detail by polling the error queue. The poll provides an informative error message. This procedure is to be recommended since it considerably reduces the problems involved with remote control.
3	QUESTIONable status register summary bit The bit is set if an <code>EVENT</code> bit is set in the <code>QUESTIONable</code> status register and the associated <code>ENABLE</code> bit is set to 1. A set bit indicates a questionable instrument status, which can be specified in greater detail by querying the <code>STATUS:QUESTIONable</code> status register.
4	MAV bit (message available) The bit is set if a message is available in the output queue which can be read. This bit can be used to enable data to be automatically read from the instrument to the controller.
5	ESB bit Sum bit of the event status register. It is set if one of the bits in the event status register is set and enabled in the event status enable register. Setting of this bit indicates a serious error which can be specified in greater detail by polling the event status register.
6	MSS bit (master status summary bit) The bit is set if the instrument triggers a service request. This is the case if one of the other bits of this registers is set together with its mask bit in the service request enable register SRE.
7	<code>STATUS:OPERation</code> status register summary bit The bit is set if an <code>EVENT</code> bit is set in the <code>OPERation</code> status register and the associated <code>ENABLE</code> bit is set to 1. A set bit indicates that the instrument is just performing an action. The type of action can be determined by querying the <code>STATUS:OPERation</code> status register.

IST Flag and Parallel Poll Enable Register (PPE)

As with the SRQ, the IST flag combines the entire status information in a single bit. It can be read by means of a parallel poll (see "[Parallel Poll](#)" on page 543) or using the command `*IST?`.

The parallel poll enable register (PPE) determines which bits of the STB contribute to the IST flag. The bits of the STB are "ANDed" with the corresponding bits of the PPE, with bit 6 being used as well in contrast to the SRE. The IST flag results from the "ORing" of all results. The PPE can be set using commands `*PRE` and read using command `*PRE?`.

Event Status Register (ESR) and Event Status Enable Register (ESE)

The Event Status Register (ESR) is the source for the registers on the highest levels and is similar to the `EVENTt` part of a SCPI register. It is defined by IEEE 488.2. You can read out the ESR with `*ESR?`.

The corresponding `ENABLE` part of the ESR is the Event Status Enable mask register (ESE). The ESE is directly linked to the ESR. You can control the ESE with `*ESE`.

Table 8-4: Meaning of the bits used in the event status register

Bit No.	Meaning
0	Operation Complete This bit is set on receipt of the command <code>*OPC</code> exactly when all previous commands have been executed.
1	Unused
2	Query Error This bit is set if either the controller wants to read data from the instrument without having sent a query, or if it does not fetch requested data and sends new instructions to the instrument instead. The cause is often a query which is faulty and hence cannot be executed.
3	Device-dependent Error This bit is set if a device-dependent error occurs. The R&S FSVR adds a number to the error queue. The number is either in the range between -300 and -399 or greater than 0. If the number is positive, it indicates the error type in greater detail.
4	Execution Error This bit is set if a received command is syntactically correct but cannot be performed for other reasons. An error message with a number between -200 and -300, which denotes the error in greater detail, is entered into the error queue.
5	Command Error This bit is set if a remote command is undefined or has a incorrect syntax. The R&S FSVR adds a number to the error queue. The number is in the range between -100 and -200 and indicates the error type in greater detail.
6	User Request This bit is set when you press the "Local" softkey.
7	Power On (supply voltage on) This bit is set when you turn on the instrument.

STATus:OPERation Register

The `STATus:OPERation` register contains information about actions the R&S FSVR is currently executing. It also contains information about the actions the R&S FSVR has executed since the last reading.

You can read out the state of the register with `STATus:OPERation:CONDition` or `STATus:OPERation[:EVENT]`.

Table 8-5: Meaning of the bits used in the STATus:OPERation register

Bit No.	Meaning
0	CALibrating This bit is set as long as the instrument is performing a calibration.
1 to 7	Not used
8	HardCOpy in progress This bit is set while the instrument is printing a hardcopy.
9 to 14	Not used
15	This bit is always 0.

STATus:QUEStionable Register

The STATus:QUEStionable register contains information about states that may occur if the R&S FSVR is operated without meeting the specifications.

You can read out the state of the register with `STATus:QUEStionable:CONDition` and `STATus:QUEStionable[:EVENT]?`.

Table 8-6: Meaning of the bits used in the STATus:QUEStionable register

Bit No.	Meaning
0 - 2	These bits are not used
2	TIME This bit is set if a
3	POWer This bit is set if a questionable power occurs (see the <code>STATus:QUEStionable:POWer</code> register in the manual of the R&S FSVR).
4	TEMPerature This bit is set if a questionable temperature occurs.
5	FREQuency The bit is set if a frequency is questionable (see the <code>STATus:QUEStionable:FREQuency</code> register in the manual of the R&S FSVR).
6 - 7	Not used
8	CALibration The bit is set if a measurement is performed unaligned ("UNCAL" display)
9	LIMit (device-specific) This bit is set if a limit value is violated (see the <code>STATus:QUEStionable:LIMit</code> register in the manual of the R&S FSVR)
10	LMARgin (device-specific) This bit is set if a margin is violated (see the <code>STATus:QUEStionable:LMARgin</code> register in the manual of the R&S FSVR)
11	SYNC (device-specific) This bit is set if, in measurements or pre-measurements, synchronization to midamble fails or no burst is found. This bit is also set if, in pre-measurements mode, the result differs too strongly from the expected value.

Bit No.	Meaning
12	ACPLimit (device-specific) This bit is set if a limit for the adjacent channel power measurement is violated (see " STATus:QUEStionable:ACPLimit Register " on page 537)
13	Not used
14	DIQ This bit is set if there is any information about the digital input or output. It is only available with option R&S FSV-B17.
15	This bit is always 0.

STATus:QUEStionable:ACPLimit Register

The STATus:QUEStionable:ACPLimit register contains information about the results of a limit check during ACLR measurements.

You can read out the register with [STATus:QUEStionable:ACPLimit:CONDition?](#) or [STATus:QUEStionable:ACPLimit\[:EVENT\]?](#)

Table 8-7: Meaning of the bits used in the STATus:QUEStionable:ACPLimit register

Bit No.	Meaning
0	ADJ UPPer FAIL This bit is set if the limit is exceeded in the upper adjacent channel
1	ADJ LOWer FAIL This bit is set if the limit is exceeded in the lower adjacent channel.
2	ALT1 UPPer FAIL This bit is set if the limit is exceeded in the upper 1st alternate channel.
3	ALT1 LOWer FAIL This bit is set if the limit is exceeded in the lower 1st alternate channel.
4	ALT2 UPPer FAIL This bit is set if the limit is exceeded in the upper 2nd alternate channel.
5	ALT2 LOWer FAIL This bit is set if the limit is exceeded in the lower 2nd alternate channel.
6	ALT3 ... 11 LOWer/UPPer FAIL This bit is set if the limit is exceeded in one of the lower or upper alternate channels 3 ... 11.
7 to 14	Unused
15	This bit is always 0.

STATus:QUEStionable:DIQ Register

This register contains information about the state of the digital I/Q input and output. This register is available with option R&S FSV-B17.

You can read out the state of the register with [STATus:QUEStionable:DIQ:CONDition?](#) on page 877 and [STATus:QUEStionable:DIQ\[:EVENT\]?](#) on page 877.

Bit No.	Meaning
0	Digital I/Q Input Device connected This bit is set if a device is recognized and connected to the R&S Digital I/Q Interface of the analyzer.
1	Digital I/Q Input Connection Protocol in progress This bit is set while the connection between analyzer and digital baseband data signal source (e.g. R&S SMU, R&S Ex-I/Q-Box) is established.
2	Digital I/Q Input Connection Protocol error This bit is set if an error occurred during establishing of the connect between analyzer and digital I/Q data signal source (e.g. R&S SMU, R&S Ex-I/Q-Box) is established.
3-5	not used
6	Digital I/Q Input FIFO Overload This bit is set if the input transfer rate is too high. The R&S FSVR can process a maximum transfer rate of 128MHz.
7	not used
8	Digital I/Q Output Device connected This bit is set if a device is recognized and connected to the Digital I/Q Output.
9	Digital I/Q Output Connection Protocol in progress This bit is set while the connection between analyzer and digital I/Q data signal sink (e.g. R&S SMU, R&S Ex-I/Q-Box) is established.
10	Digital I/Q Output Connection Protocol error This bit is set if an error occurred while the connection between analyzer and digital I/Q data signal sink (e.g. R&S SMU, R&S Ex-I/Q-Box) is established.
11-14	not used
15	This bit is always set to 0.

STATus:QUEStionable:FREQuency Register

The STATus:QUEStionable:FREQuency register contains information about the condition of the local oscillator and the reference frequency.

You can read out the register with `STATus:QUEStionable:FREQuency:CONDition?` or `STATus:QUEStionable:FREQuency[:EVENT]?`.

Table 8-8: Meaning of the bits used in the STATus:QUEStionable:FREQuency register

Bit No.	Meaning
0	OVEN COLD This bit is set if the reference oscillator has not yet attained its operating temperature. "OCXO" is displayed.
1	LO UNLocked This bit is set if the local oscillator no longer locks. "LOUNL" is displayed.
2 to 7	Unused

Bit No.	Meaning
8	EXTernalREFerence This bit is set if you have selected an external reference oscillator but did not connect a useable external reference source. In that case the synthesizer can not lock. The frequency in all probability is not accurate.
9 to 14	Unused
15	This bit is always 0.

STATus:QUEStionable:LIMit Register

The STATus:QUEStionable:LIMit register contains information about the results of a limit check when you are working with limit lines.

The number of LIMit registers depends on the number of measurement windows available in any operating mode.

You can read out the register with `STATus:QUEStionable:LIMit<m>:CONDition?` or `STATus:QUEStionable:LIMit<m>:CONDition?`.

Table 8-9: Meaning of the bits used in the STATus:QUEStionable:LIMit register

Bit No.	Meaning
0	LIMit 1 FAIL This bit is set if limit line 1 is violated.
1	LIMit 2 FAIL This bit is set if limit line 2 is violated.
2	LIMit 3 FAIL This bit is set if limit line 3 is violated.
3	LIMit 4 FAIL This bit is set if limit line 4 is violated.
4	LIMit 5 FAIL This bit is set if limit line 5 is violated.
5	LIMit 6 FAIL This bit is set if limit line 6 is violated.
6	LIMit 7 FAIL This bit is set if limit line 7 is violated.
7	LIMit 8 FAIL This bit is set if limit line 8 is violated.
8 to 14	Unused
15	This bit is always 0.

STATus:QUEStionable:LMARgin Register

This register contains information about the observance of limit margins.

Depending on the measurement mode, there is a varying number of `STATUS:QUESTIONable:LMARgin` registers that you can select by adding a numeric suffix at `LIMit`. In realtime mode, e.g., there are up to four measurement windows, so there are also 4 `STATUS:QUESTIONable:LMARgin` registers that you can select by adding 1 to 4 to `LMARgin`.

It can be read using the commands

`STATUS:QUESTIONable:LMARgin:CONDition?` and
`STATUS:QUESTIONable:LMARgin[:EVENT]?`.

Table 8-10: Meaning of the bits used in the `STATUS:QUESTIONable:LMARgin` register

Bit No.	Meaning
0	LMARgin 1 FAIL This bit is set if limit margin 1 is violated.
1	LMARgin 2 FAIL This bit is set if limit margin 2 is violated.
2	LMARgin 3 FAIL This bit is set if limit margin 3 is violated.
3	LMARgin 4 FAIL This bit is set if limit margin 4 is violated.
4	LMARgin 5 FAIL This bit is set if limit margin 5 is violated.
5	LMARgin 6 FAIL This bit is set if limit margin 6 is violated.
6	LMARgin 7 FAIL This bit is set if limit margin 7 is violated.
7	LMARgin 8 FAIL This bit is set if limit margin 8 is violated.
8 to 14	Not used
15	This bit is always 0.

STATUS:QUESTIONable:POWER Register

The `STATUS:QUESTIONable:POWER` register contains information about possible overload situations that may occur during operation of the R&S FSVR.

You can read out the register with `STATUS:QUESTIONable:POWER:CONDition?` or `STATUS:QUESTIONable:POWER[:EVENT]?`

Table 8-11: Meaning of the bits used in the STATus:QUEStionable:POWer register

Bit No.	Meaning
0	OVERload This bit is set if an overload occurs at the RF input. The R&S FSVR displays the enhancement label "OVLD".
1	UNDerload This bit is set if an underload occurs at the RF input. The R&S FSVR displays the enhancement label "UNLD".
2	IF_OVERload This bit is set if an overload occurs in the IF path. The R&S FSVR displays the enhancement label "IFOVL".
3 to 14	Unused
15	This bit is always 0.

STATus:QUEStionable:TIME Register

The STATus:QUEStionable:TIME register contains information about possible errors in realtime mode.

You can read out the register with `STATus:QUEStionable:TIME:CONDition?` or `STATus:QUEStionable:TIME[:EVENT]?`.

Table 8-12: Meaning of the bits used in the STATus:QUEStionable:TIME register

Bit No.	Meaning
0	Real Time Data Loss This bit is set if the R&S FSVR loses data during the measurement and measurements are no longer possible in realtime.
1 to 14	Unused
15	This bit is always 0.

Status Registers in Spectrum Mode

This chapter contains the description of the registers and bits specific to spectrum mode. For a comprehensive description of the other status registers see "[Status Register in Realtime Mode](#)" on page 532.

The figure below shows the status registers in spectrum mode.

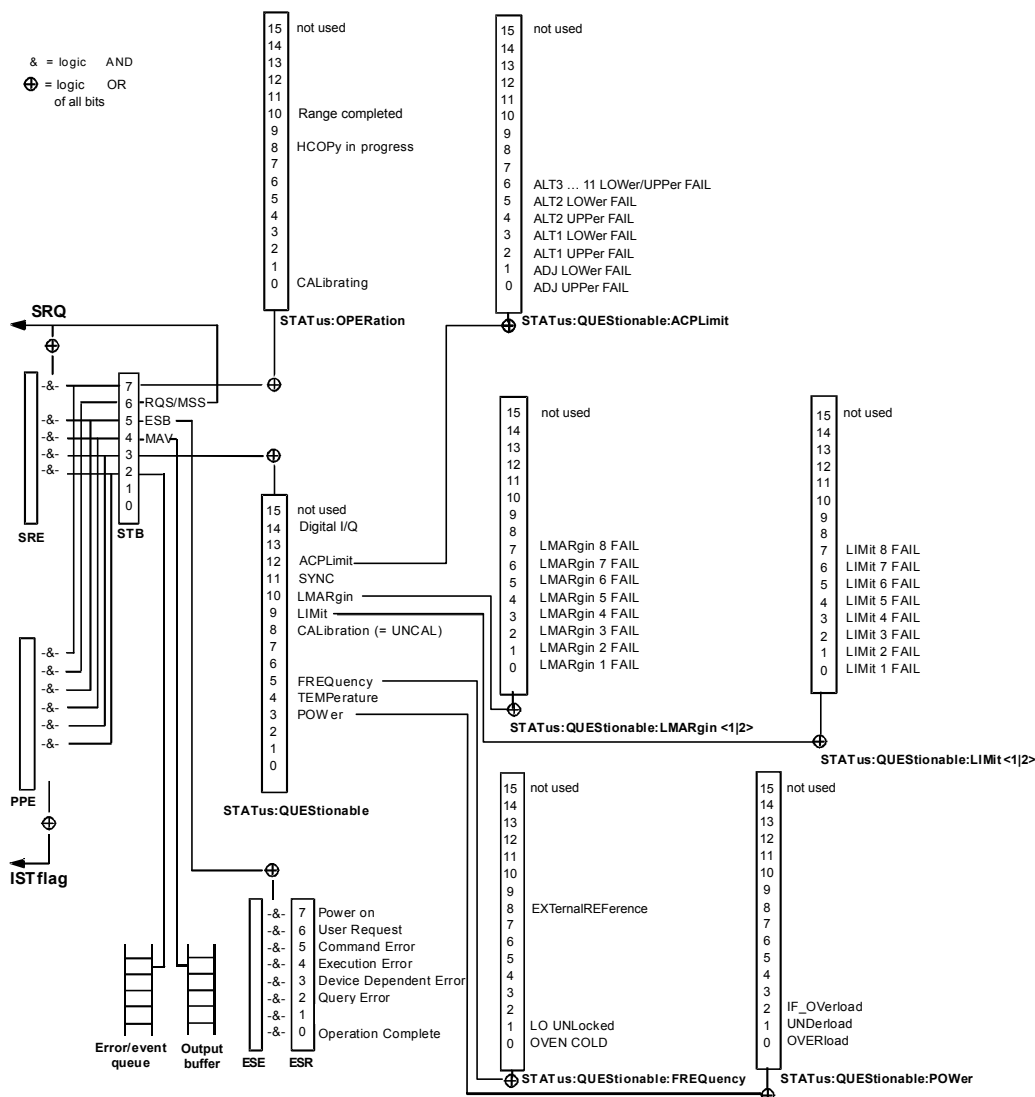

Fig. 8-4: Overview of status registers in spectrum mode

8.1.6.4 Application of the Status Reporting System

The purpose of the status reporting system is to monitor the status of one or several devices in a measuring system. To do this and react appropriately, the controller must receive and evaluate the information of all devices. The following standard methods are used:

- **Service request (SRQ)** initiated by the instrument
- **Serial poll** of all devices in the bus system, initiated by the controller in order to find out who sent a SRQ and why
- **Parallel poll** of all devices
- Query of a **specific instrument status** by means of commands
- Query of the **error queue**

Service Request

Under certain circumstances, the instrument can send a service request (SRQ) to the controller. Usually this service request initiates an interrupt at the controller, to which the control program can react appropriately. As evident from [figure 8-3](#), an SRQ is always initiated if one or several of bits 2, 3, 4, 5 or 7 of the status byte are set and enabled in the SRE. Each of these bits combines the information of a further register, the error queue or the output buffer. The `ENABLe` parts of the status registers can be set such that arbitrary bits in an arbitrary status register initiate an SRQ. In order to make use of the possibilities of the service request effectively, all bits should be set to "1" in enable registers SRE and ESE.

Use of the command `*OPC` to generate an SRQ at the end of a sweep

1. `CALL InstrWrite(analyzer, "**ESE 1")` 'Set bit 0 in the ESE (Operation Complete)
2. `CALL InstrWrite(analyzer, "**SRE 32")` 'Set bit 5 in the SRE (ESB)
3. `CALL InstrWrite(analyzer, "**INIT;*OPC")` ' Generate an SRQ after operation complete

After its settings have been completed, the instrument generates an SRQ.

The SRQ is the only possibility for the instrument to become active on its own. Each controller program should cause the instrument to initiate a service request if errors occur. The program should react appropriately to the service request.

A detailed example for a service request routine can be found in [chapter 8.3.1, "Service Request"](#), on page 1017.

A detailed example for a service request routine can be found in the programming examples for the base unit.

Serial Poll

In a serial poll, just as with command `*STB`, the status byte of an instrument is queried. However, the query is realized via interface messages and is thus clearly faster.

The serial poll method is defined in IEEE 488.1 and used to be the only standard possibility for different instruments to poll the status byte. The method also works for instruments which do not adhere to SCPI or IEEE 488.2.

The serial poll is mainly used to obtain a fast overview of the state of several instruments connected to the controller.

Parallel Poll

In a parallel poll, up to eight instruments are simultaneously requested by the controller using a single command to transmit 1 bit of information each on the data lines, i.e., to set the data line allocated to each instrument to a logical "0" or "1".

In addition to the SRE register, which determines the conditions under which an SRQ is generated, there is a Parallel Poll Enable register (PPE) which is ANDed with the STB bit by bit, considering bit 6 as well. This register is ANDed with the STB bit by bit,

considering bit 6 as well. The results are ORed, the result is possibly inverted and then sent as a response to the parallel poll of the controller. The result can also be queried without parallel poll using the command `*IST?`.

The instrument first has to be set for the parallel poll using the command `PPC`. This command allocates a data line to the instrument and determines whether the response is to be inverted. The parallel poll itself is executed using `PPE`.

The parallel poll method is mainly used to find out quickly which one of the instruments connected to the controller has sent a service request. To this effect, `SRE` and `PPE` must be set to the same value.

Query of an instrument status

Each part of any status register can be read using queries. There are two types of commands:

- The common commands `*ESR?`, `*IDN?`, `*IST?`, `*STB?` query the higher-level registers.
- The commands of the `STATUS` system query the SCPI registers (`STATUS:QUESTIONABLE...`)

The returned value is always a decimal number that represents the bit pattern of the queried register. This number is evaluated by the controller program.

Queries are usually used after an `SRQ` in order to obtain more detailed information on the cause of the `SRQ`.

Decimal representation of a bit pattern

The `STB` and `ESR` registers contain 8 bits, the `SCPI` registers 16 bits. The contents of a status register are specified and transferred as a single decimal number. To make this possible, each bit is assigned a weighted value. The decimal number is calculated as the sum of the weighted values of all bits in the register that are set to 1.

Bits	0	1	2	3	4	5	6	7	...
Weight	1	2	4	8	16	32	64	128	...

Example:

The decimal value $40 = 32 + 8$ indicates that bits no. 3 and 5 in the status register (e.g. the `QUESTIONABLE` status summary bit and the `ESB` bit in the `STATUS` Byte) are set.

Error Queue

Each error state in the instrument leads to an entry in the error queue. The entries of the error queue are detailed plain text error messages that can be looked up in the Error Log or queried via remote control using `SYSTEM:ERROR[:NEXT]?` or `SYSTEM:ERROR:ALL?`. Each call of `SYSTEM:ERROR[:NEXT]?` provides one entry

from the error queue. If no error messages are stored there any more, the instrument responds with 0, "No error".

The error queue should be queried after every SRQ in the controller program as the entries describe the cause of an error more precisely than the status registers. Especially in the test phase of a controller program the error queue should be queried regularly since faulty commands from the controller to the instrument are recorded there as well.

8.1.6.5 Reset Values of the Status Reporting System

The following table contains the different commands and events causing the status reporting system to be reset. None of the commands, except *RST and SYSTem:PRESet, influence the functional instrument settings. In particular, DCL does not change the instrument settings.

Table 8-13: Resetting the status reporting system

Event	Switching on supply voltage Power-On-Status-Clear		DCL, SDC (Device Clear, Selected Device Clear)	*RST or SYS- Tem:PRE- Set	STA- Tus:PRE- Set	*CLS
	0	1				
Clear STB, ESR	-	yes	-	-	-	yes
Clear SRE, ESE	-	yes	-	-	-	-
Clear PPE	-	yes	-	-	-	-
Clear EVENT parts of the registers	-	yes	-	-	-	yes
Clear ENABLE parts of all OPERation and QUESTionable registers; Fill ENABLE parts of all other registers with "1".	-	yes	-	-	yes	-
Fill PTRansition parts with "1"; Clear NTRansition parts	-	yes	-	-	yes	-
Clear error queue	yes	yes	-	-	-	yes
Clear output buffer	yes	yes	yes	1)	1)	1)
Clear command processing and input buffer	yes	yes	yes	-	-	-

1) The first command in a command line that immediately follows a <PROGRAM MESSAGE TERMINATOR> clears the output buffer.

8.1.7 General Programming Recommendations

Initial instrument status before changing settings

Manual operation is designed for maximum possible operating convenience. In contrast, the priority of remote control is the "predictability" of the instrument status. Thus, when a command attempts to define incompatible settings, the command is ignored and the instrument status remains unchanged, i.e. other settings are not automatically adapted. Therefore, control programs should always define an initial instrument status (e.g. using the *RST command) and then implement the required settings.

Command sequence

As a general rule, send commands and queries in different program messages. Otherwise, the result of the query may vary depending on which operation is performed first (see also Preventing Overlapping Execution).

Reacting to malfunctions

The service request is the only possibility for the instrument to become active on its own. Each controller program should instruct the instrument to initiate a service request in case of malfunction. The program should react appropriately to the service request.

Error queues

The error queue should be queried after every service request in the controller program as the entries describe the cause of an error more precisely than the status registers. Especially in the test phase of a controller program the error queue should be queried regularly since faulty commands from the controller to the instrument are recorded there as well.

8.1.8 The IECWIN Tool

The R&S FSVR is delivered with *IECWIN* installed, an auxiliary tool provided free of charge by R&S. IECWIN is a program to send SCPI commands to a measuring instrument either interactively or from a command script.



The R&S IECWIN32 tool is provided free of charge. The functionality may change in a future version without notice.

IECWIN offers the following features:

- Connection to instrument via several interfaces/protocols (GPIB, VISA, named pipe (if IECWIN is run on the instrument itself), RSIB)
- Interactive command entry
- Browsing available commands on the instrument
- Error checking following every command

- Execution of command scripts
- Storing binary data to a file
- Reading binary data from a file
- Generation of a log file

For command scripts, IECWIN offers the following features:

- Synchronization with the instrument on every command
- Checking expected result for query commands (as string or numeric value)
- Checking for expected errors codes
- Optional pause on error
- Nested command scripts
- Single step mode
- Conditional execution, based on the *IDN and *OPT strings



You can use the IECWIN to try out the programming examples provided in the R&S FSVR User Manuals.

Starting IECWIN

IECWIN is available from the Windows task bar on the R&S FSVR, or by executing the following file:

You can also copy the program to any Windows PC or laptop. Simply copy the `iecwin32.exe`, `iecwin.chm` and `rsib32.dll` files from the location above to the same folder on the target computer.

When the tool is started, a "Connection settings" dialog box is displayed. Define the connection from the computer the IECWIN tool is installed on to the R&S FSVR you want to control. If you are using the tool directly on the R&S FSVR, you can use an NT Pipe (COM Parser) connection, which requires no further configuration. For help on setting up other connection types, check the tool's online help (by clicking the "Help" button in the dialog box).



The IECWIN offers an online help with extensive information on how to work with the tool.

8.2 Remote Control – Commands

This chapter describes all remote control commands for the "Spectrum" mode (Analyzer) functions, and the basic measurement-mode independent functions of the R&S FSVR in detail.

Each subsystem starts with a list of commands, which provides quick access to all commands of the subsystem. Be aware, that for one subsystem more than one SCPI command lists can exist, depending on the functionality (analyzer and basic functions,

and possibly firmware-option specific functions). For details on the notation refer to [chapter 8.2.1, "Notation"](#), on page 548.

Remote commands of the base unit firmware

- [chapter 8.2.3, "Remote Control – Description of Analyzer Commands"](#), on page 554
- [chapter 8.2.4, "Remote Control – Description of Measurement-Independent Commands"](#), on page 924

8.2.1 Notation

In the following sections, all commands implemented in the instrument are first listed and then described in detail, arranged according to the command subsystems. The notation is adapted to the SCPI standard. The SCPI conformity information is included in the individual description of the commands.

Individual Description

The individual description contains the complete notation of the command. An example for each command, the *RST value and the SCPI information are included as well.

The options and operating modes for which a command can be used are indicated by the following abbreviations:

Abbreviation	Description
A	spectrum analysis
A-F	spectrum analysis – span > 0 only (frequency mode)
A-T	spectrum analysis – zero span only (time mode)
ADEMODO	analog demodulation (option R&S FSV-K7)
BT	Bluetooth (option R&S FSV-K8)
CDMA	CDMA 2000 base station measurements (option R&S FSV-K82)
EVDO	1xEV-DO base station analysis (option R&S FSV-K84)
GSM	GSM/Edge measurements (option R&S FSV-K10)
IQ	IQ Analyzer mode
OFDM	WiMAX IEEE 802.16 OFDM measurements (option R&S FSV-K93)
OFDMA/WiBro	WiMAX IEEE 802.16e OFDMA/WiBro measurements (option R&S FSV-K93)
NF	Noise Figure measurements (R&S FSV-K30)
PHN	Phase Noise measurements (R&S FSV-K40)
PSM	Power Sensor measurements (option R&S FSV-K9)
RT	Realtime mode
SFM	Stereo FM measurements (option R&S FSV-K7S)

SPECM	Spectrogram mode (option R&S FSV-K14)
TDS	TD-SCDMA base station / UE measurements (option R&S FSV-K76/K77)
VSA	Vector Signal Analysis (option R&S FSV-K70)
WCDMA	3GPP Base Station measurements (option R&S FSV-K72), 3GPP UE measurements (option R&S FSV-K73)
WLAN	WLAN TX measurements (option R&S FSV-K91)



The spectrum analysis mode is implemented in the basic unit. For the other modes, the corresponding options are required.

Upper/Lower Case Notation

Upper/lower case letters are used to mark the long or short form of the key words of a command in the description. The instrument itself does not distinguish between upper and lower case letters.

Special Characters

	A selection of key words with an identical effect exists for several commands. These keywords are indicated in the same line; they are separated by a vertical stroke. Only one of these keywords needs to be included in the header of the command. The effect of the command is independent of which of the keywords is used.
--	---

Example:

```
SENSe:FREQuency:CW|:FIXed
```

The two following commands with identical meaning can be created. They set the frequency of the fixed frequency signal to 1 kHz:

```
SENSe:FREQuency:CW 1E3
```

```
SENSe:FREQuency:FIXed 1E3
```

A vertical stroke in parameter indications marks alternative possibilities in the sense of "or". The effect of the command differs, depending on which parameter is used.

Example: Selection of the parameters for the command

```
[SENSe<1...4>:]AVERage<1...4>:TYPE VIDEo | LINear
```

[]	Key words in square brackets can be omitted when composing the header. The full command length must be accepted by the instrument for reasons of compatibility with the SCPI standards. Parameters in square brackets can be incorporated optionally in the command or omitted as well.
----	---

{}	Parameters in braces can be incorporated optionally in the command, either not at all, once or several times.
----	---

Description of Parameters

Due to the standardization, the parameter section of SCPI commands consists always of the same syntactical elements. SCPI has therefore specified a series of definitions, which are used in the tables of commands. In the tables, these established definitions are indicated in angled brackets (<...>) and is briefly explained in the following.

For details see [chapter 8.1.4.3, "SCPI Parameters"](#), on page 522.

For details see the chapter "SCPI Command Structure" in the base unit description.

<Boolean>

This keyword refers to parameters which can adopt two states, "on" and "off". The "off" state may either be indicated by the keyword OFF or by the numeric value 0, the "on" state is indicated by ON or any numeric value other than zero. Parameter queries are always returned the numeric value 0 or 1.

<numeric_value> <num>

These keywords mark parameters which may be entered as numeric values or be set using specific keywords (character data). The following keywords given below are permitted:

- **MAXimum**: This keyword sets the parameter to the largest possible value.
- **MINimum**: This keyword sets the parameter to the smallest possible value.
- **DEFault**: This keyword is used to reset the parameter to its default value.
- **UP**: This keyword increments the parameter value.
- **DOWN**: This keyword decrements the parameter value.

The numeric values associated to MAXimum/MINimum/DEFault can be queried by adding the corresponding keywords to the command. They must be entered following the quotation mark.

Example:

```
SENSe:FREQuency:CENTer? MAXimum
```

Returns the maximum possible numeric value of the center frequency as result.

<arbitrary block program data>

This keyword is provided for commands the parameters of which consist of a binary data block.

8.2.2 Common Commands

Common commands are described in the IEEE 488.2 (IEC 625-2) standard. These commands have the same effect and are employed in the same way on different devices. The headers of these commands consist of "*" followed by three letters. Many common commands are related to the Status Reporting System.

Available common commands:

*CAL?	551
*CLS	551
*ESE	551
*ESR?	551
*IDN?	552
*IST?	552
*OPC	552
*OPT?	552
*PCB	552
*PRE	553
*PSC	553
*RST	553
*SRE	553
*STB?	554
*TRG	554
*TST?	554
*WAI	554

***CAL?**

Calibration query

Initiates a calibration of the instrument and subsequently queries the calibration status. Responses > 0 indicate errors.

Usage: Query only**Manual operation:** See "[Self Alignment](#)" on page 433

***CLS**

Clear status

Sets the status byte (STB), the standard event register (ESR) and the `EVENT` part of the `QUESTIONABLE` and the `OPERATION` registers to zero. The command does not alter the mask and transition parts of the registers. It clears the output buffer.

Usage: Setting only

***ESE <Value>**

Event status enable

Sets the event status enable register to the specified value. The query returns the contents of the event status enable register in decimal form.

Parameters:**<Value>** Range: 0 to 255

***ESR?**

Event status read

Returns the contents of the event status register in decimal form and subsequently sets the register to zero.

Return values:

<Contents> Range: 0 to 255

Usage: Query only

***IDN?**

Identification

Returns the instrument identification.

Usage: Query only

Manual operation: See "[*IDN Format Leg./New](#)" on page 439
 See "[Versions+Options](#)" on page 445

***IST?**

Individual status query

Returns the contents of the IST flag in decimal form. The IST flag is the status bit which is sent during a parallel poll.

Return values:

<ISTflag> 0 | 1

Usage: Query only

***OPC**

Operation complete

Sets bit 0 in the event status register when all preceding commands have been executed. This bit can be used to initiate a service request. The query form writes a "1" into the output buffer as soon as all preceding commands have been executed. This is used for command synchronization.

***OPT?**

Option identification query

Queries the options included in the instrument. For a list of all available options and their description refer to the data sheet.

Usage: Query only

Manual operation: See "[Versions+Options](#)" on page 445

***PCB <Address>**

Pass control back

Indicates the controller address to which remote control is returned after termination of the triggered action.

Setting parameters:

<Address> Range: 0 to 30

Usage: Setting only

***PRE <Value>**

Parallel poll register enable

Sets parallel poll enable register to the indicated value. The query returns the contents of the parallel poll enable register in decimal form.

Parameters:

<Value> Range: 0 to 255

***PSC <Action>**

Power on status clear

Determines whether the contents of the `ENABLE` registers are preserved or reset when the instrument is switched on. Thus a service request can be triggered when the instrument is switched on, if the status registers ESE and SRE are suitably configured. The query reads out the contents of the "power-on-status-clear" flag.

Parameters:

<Action> 0 | 1

0

The contents of the status registers are preserved.

1

Resets the status registers.

***RST**

Reset

Sets the instrument to a defined default status. The default settings are indicated in the description of commands.

The command is equivalent to `SYSTEM:PRESet`.

Usage: Setting only

***SRE <Contents>**

Service request enable

Sets the service request enable register to the indicated value. This command determines under which conditions a service request is triggered.

Parameters:

<Contents> Contents of the service request enable register in decimal form.
Bit 6 (MSS mask bit) is always 0.
Range: 0 to 255

***STB?**

Status byte query

Reads the contents of the status byte in decimal form.

Usage: Query only

***TRG**

Trigger

Triggers all actions waiting for a trigger event. In particular, *TRG generates a manual trigger signal. This common command complements the commands of the TRIGger subsystem.

Usage: Event

***TST?**

Self test query

Initiates selftests of the instrument and returns an error code in decimal form (see Service Manual supplied with the instrument). "0" indicates no errors occurred.

Usage: Query only

Manual operation: See "[Selftest](#)" on page 448

***WAI**

Wait to continue

Prevents servicing of the subsequent commands until all preceding commands have been executed and all signals have settled (see also command synchronization and [*OPC](#)).

Usage: Event

8.2.3 Remote Control – Description of Analyzer Commands

In this section all remote control commands for "Spectrum" mode functions are described in detail. For details on commands that are independent of a particular measurement mode refer to [chapter 8.2.4, "Remote Control – Description of Measurement-Independent Commands"](#), on page 924.

Subsystems of the analyzer

• ABORt Subsystem.....	555
• CALCulate Subsystem.....	555
• CALibration:PMETER Subsystem (Power Sensor, R&S FSV-K9).....	709
• DISPlay Subsystem.....	709
• DISPlay:WINDow:PSPectrum and DISPlay:WINDow:SPECtrogram Subsystems	724
• FETCh:PMETER Subsystem (Power Sensor, R&S FSV-K9).....	727
• FORMat Subsystem.....	728
• INITiate Subsystem.....	728
• INPut Subsystem.....	731
• INSTrument Subsystem.....	739
• MMEMory Subsystem.....	741
• OUTPut Subsystem.....	744
• PROBe subsystem.....	746
• READ:PMETER Subsystem.....	748
• SENSE Subsystem.....	748
• STATus:QUESTionable Subsystem.....	875
• SYSTem Subsystem.....	887
• TRACe Subsystem.....	889
• TRIGger Subsystem.....	907
• TRIGger Subsystem for Stereo FM Measurements.....	915
• UNIT Subsystem.....	920
• UNIT Subsystem for Stereo FM Measurements.....	921
• Formats for Returned Values: ASCII Format and Binary Format.....	923

8.2.3.1 ABORt Subsystem

The ABORt subsystem contains the commands for aborting triggered actions. An action can be triggered again immediately after being aborted. All commands trigger events, and therefore they have no *RST value.

ABORt

This command aborts a current measurement and resets the trigger system.

Example: ABOR; INIT: IMM

Mode: all

Manual operation: See "Meas Start/Stop" on page 197

8.2.3.2 CALCulate Subsystem

The CALCulate subsystem contains commands for converting instrument data, transforming and carrying out corrections. These functions are carried out subsequent to data acquisition, i.e. following the SENSE subsystem.



Some applications offer up to four measurement windows. For those, the suffix <n> for CALCulate selects the measurement window. For all other applications, the suffix is irrelevant.

• CALCulate:DELTamarker Subsystem.....	556
• CALCulate:DELTamarker:SGRam subsystem.....	571
• CALCulate:DLINe Subsystem.....	577
• CALCulate:ESPECTrum Subsystem.....	578
• CALCulate:FLINe Subsystem.....	579
• CALCulate:LIMit Subsystem.....	580
• CALCulate:LIMit:ACPower Subsystem.....	585
• CALCulate:LIMit:CONTRol Subsystem.....	593
• CALCulate:LIMit:ESPECTrum subsystem.....	596
• CALCulate:LIMit:LOWer Subsystem.....	600
• CALCulate:LIMit:UPPer Subsystem.....	603
• CALCulate:MARKer Subsystem.....	607
• CALCulate:MARKer:FUNCTion Subsystem.....	622
• CALCulate:MARKer:FUNCTion:ADEMod Subsystem (Analog Demodulation, analog demodulation).....	641
• CALCulate:MARKer:FUNCTion:HARMONics Subsystem.....	646
• CALCulate:MARKer:FUNCTion:POWER Subsystem.....	649
• CALCulate:MARKer:SGRam subsystem.....	656
• Predefined CP/ACLR Standards.....	663
• CALCulate:MARKer:FUNCTion:STRack Subsystem.....	663
• CALCulate:MARKer:FUNCTion:SUMMary Subsystem.....	665
• CALCulate:MARKer:FUNCTion Subsystem for Stereo FM Measurements.....	678
• CALCulate:MASK Subsystem.....	683
• CALCulate:MATH Subsystem.....	688
• CALCulate:PMETer Subsystem (Power Sensor, R&S FSV-K9).....	690
• CALCulate:PSEarch PEAKsearch Subsystem.....	691
• CALCulate:SGRam Subsystem.....	693
• CALCulate:STATistics Subsystem.....	697
• CALCulate:THReshold Subsystem.....	702
• CALCulate:TLINE Subsystem.....	703
• CALCulate:UNIT Subsystem.....	704
• Other commands in the Calculate subsystem.....	705

CALCulate:DELTamarker Subsystem

The CALCulate:DELTamarker subsystem controls the delta marker functions of the instrument.

Commands of the CALCulate:DELTamarker Subsystem

CALCulate<n>:DELTamarker<m>[:STATe].....	557
CALCulate<n>:DELTamarker<m>:AOFF.....	557
CALCulate<n>:DELTamarker<m>:FUNCTion:BPOWER:MODE.....	558
CALCulate<n>:DELTamarker<m>:FUNCTion:BPOWER:RESult?.....	558
CALCulate<n>:DELTamarker<m>:FUNCTion:BPOWER:SPAN.....	559
CALCulate<n>:DELTamarker<m>:FUNCTion:BPOWER[:STATe].....	559

CALCulate<n>:DELTamarker<m>:FUNction:FIXed[:STATe].....	559
CALCulate<n>:DELTamarker<m>:FUNction:FIXed:RPOint:MAXimum[:PEAK].....	560
CALCulate<n>:DELTamarker<m>:FUNction:FIXed:RPOint:X.....	560
CALCulate<n>:DELTamarker<m>:FUNction:FIXed:RPOint:Y.....	561
CALCulate<n>:DELTamarker<m>:FUNction:FIXed:RPOint:Y:OFFSet.....	561
CALCulate<n>:DELTamarker<m>:FUNction:PNOise[:STATe].....	561
CALCulate<n>:DELTamarker<m>:FUNction:PNOise:AUTO.....	562
CALCulate<n>:DELTamarker<m>:FUNction:PNOise:RESult?.....	562
CALCulate<n>:DELTamarker<m>:LINK.....	563
CALCulate<n>:DELTamarker<m>:MODE.....	563
CALCulate<n>:DELTamarker<m>:MAXimum[:PEAK].....	564
CALCulate<n>:DELTamarker<m>:MAXimum:LEFT.....	564
CALCulate<n>:DELTamarker<m>:MAXimum:NEXT.....	564
CALCulate<n>:DELTamarker<m>:MAXimum:RIGHT.....	565
CALCulate<n>:DELTamarker<m>:MINimum[:PEAK].....	565
CALCulate<n>:DELTamarker<m>:MINimum:LEFT.....	566
CALCulate<n>:DELTamarker<m>:MINimum:RIGHT.....	566
CALCulate<n>:DELTamarker<m>:MINimum:NEXT.....	567
CALCulate<n>:DELTamarker<m>:MREF.....	567
CALCulate<n>:DELTamarker<m>:TRACe.....	567
CALCulate<n>:DELTamarker<m>:X.....	568
CALCulate<n>:DELTamarker<m>:X:RELative?.....	569
CALCulate<n>:DELTamarker<m>:Y.....	569
CALCulate<n>:DELTamarker<m>:Z?.....	571

CALCulate<n>:DELTamarker<m>[:STATe] <State>

This command turns delta markers on and off.

If the corresponding marker was a normal marker, it is turned into a delta marker.

No suffix at DELTmarker turns on delta marker 1.

Suffix:

<n>	Selects the measurement window.
<m>	Selects the marker.

Parameters:

<State>	ON OFF
	*RST: OFF

Example:

```
CALC:DELT1 ON
Switches marker 1 to delta marker mode.
```

Manual operation: See "[Marker 1 / Marker 2 / Marker 3 / ... Marker 16, / Marker Norm/Delta](#)" on page 120
See "[Marker Wizard](#)" on page 121

CALCulate<n>:DELTamarker<m>:AOFF

This command turns all active delta markers off.

Suffix:
 <n> Selects the measurement window.
 <m> Selects the marker.
Example: `CALC:DELT:AOFF`
 Switches off all delta markers.

CALCulate<n>:DELTamarker<m>:FUNCTION:BPOWer:MODE <Mode>

This command selects the way the results for a band power delta marker are displayed.

Suffix:
 <n> irrelevant
 <m> irrelevant
Parameters:
 <Mode> **POWer**
 Result is displayed as a power in dBm.
DENSity
 Result is displayed as a density in dBm/Hz.
 *RST: POW

Example: `CALC:DELT:BPOW:MODE DENS`

CALCulate<n>:DELTamarker<m>:FUNCTION:BPOWer:RESult?

This command queries the results of the band power measurement.

Suffix:
 <n> irrelevant
 <m> irrelevant
Return values:
 <Power> Signal power over the delta marker bandwidth.
Example: Activate the delta band power marker:
`CALC:DELT:BPOW:STAT ON`
 Select the density mode for the result:
`CALC:DELT:BPOW:MODE DENS`
 Query the result:
`CALC:DELT:BPOW:RES?`
 Response:
 20dBm/Hz
Usage: Query only

**CALCulate<n>:DELTamarker<m>:FUNCTioN:BPOWer:SPAN **

This command defines the bandwidth around the delta marker position. The span is indicated by lines in the diagram.

Suffix:

<n> irrelevant

<m> irrelevant

Parameters:

 Numeric value that defines the span in Hz.
The maximum span depends on the marker position and R&S FSVR model.

*RST: 5% of current span

Example: CALC:DELT:BPOW:SPAN 20

CALCulate<n>:DELTamarker<m>:FUNCTioN:BPOWer[:STATe] <State>

This command turns delta markers for band power measurements on and off.

If necessary, the command also turns on a reference marker.

For details see [chapter 4.2.3.8, "Performing Band Power Measurements"](#), on page 140.

Suffix:

<n> irrelevant

<m> irrelevant

Parameters:

<State> **ON | OFF**
When switched to on, if no marker is active yet, marker 1 is activated. Otherwise, the currently active marker is used as a delta band power marker (all other marker functions for this marker are deactivated).

*RST: OFF

Example: CALC:DELT:BPOW:STAT ON

CALCulate<n>:DELTamarker<m>:FUNCTioN:FIXed[:STATe] <State>

This command switches the relative measurement to a fixed reference value on or off. Marker 1 is activated previously and a peak search is performed, if necessary. If marker 1 is activated, its position becomes the reference point for the measurement.

The reference point can then be modified with the [CALCulate<n>:DELTamarker<m>:FUNCTioN:FIXed:RPOint:X](#) commands and [CALCulate<n>:DELTamarker<m>:FUNCTioN:FIXed:RPOint:Y](#) independently of the position of marker 1 and of a trace. It applies to all delta markers as long as the function is active.

Suffix:

<n> Selects the measurement window.

<m> Selects the marker.

Parameters:

<State> ON | OFF

*RST: OFF

Example:

```
CALC:DELT:FUNC:FIX ON
```

Switches on the measurement with fixed reference value for all delta markers.

```
CALC:DELT:FUNC:FIX:RPO:X 128 MHZ
```

Sets the frequency reference to 128 MHz.

```
CALC:DELT:FUNC:FIX:RPO:Y 30 DBM
```

Sets the reference level to +30 dBm.

Manual operation: See "[Ref. Fixed On/Off](#)" on page 131

CALCulate<n>:DELTamarker<m>:FUNCtion:FIXed:RPOint:MAXimum[:PEAK]

This command moves the fixed reference marker to the peak power.

When measuring the phase noise, the command defines a new reference point level for delta marker 2.

Suffix:

<n> Selects the measurement window.

<m> Selects the marker.

Example:

```
CALC:DELT:FUNC:FIX:RPO:MAX
```

Sets the reference point level for delta markers to the peak of the selected trace.

Usage: Event

Manual operation: See "[Peak Search](#)" on page 130

CALCulate<n>:DELTamarker<m>:FUNCtion:FIXed:RPOint:X <Reference>

This command defines the horizontal position of the fixed delta marker reference point. The coordinates of the reference may be anywhere in the diagram.

When measuring the phase noise, the command defines the frequency reference for delta marker 2.

Suffix:

<n> Selects the measurement window.

<m> Selects the marker.

Parameters:

<Reference> Numeric value that defines the horizontal position of the reference.

For frequency domain measurements, it is a frequency in Hz.

For time domain measurements, it is a point in time in s.

*RST: Fixed reference: OFF

Example: `CALC:DELTA:FUNC:FIX:RPO:X 128 MHz`
Sets the frequency reference to 128 MHz.

Manual operation: See ["Ref Point Frequency \(span > 0\)/Ref Point Time \(zero span\)"](#) on page 130

CALCulate<n>:DELTAmarker<m>:FUNCTION:FIXed:RPOint:Y <RefPointLevel>

This command defines the vertical position of the fixed delta marker reference point. The coordinates of the reference may be anywhere in the diagram.

When measuring the phase noise, the command defines the level reference for delta marker 2.

Suffix:

<n> Selects the measurement window.

<m> Selects the marker.

Parameters:

<RefPointLevel> Numeric value that defines the vertical position of the reference. The unit and value range is variable.

*RST: Fixed reference: OFF

Example: `CALC:DELTA:FUNC:FIX:RPO:Y -10dBm`
Sets the reference point level for delta markers to -10 dBm.

Manual operation: See ["Ref Point Level"](#) on page 130

CALCulate<n>:DELTAmarker<m>:FUNCTION:FIXed:RPOint:Y:OFFSet <Offset>

This command defines a level offset for the fixed delta marker reference point.

When measuring the phase noise, the command defines an additional level offset for delta marker 2.

Suffix:

<n> Selects the measurement window.

<m> Selects the marker.

Parameters:

<Offset> Level offset that is added to the display of all delta markers.

*RST: 0 dB

Example: `CALC:DELTA:FUNC:FIX:RPO:Y:OFFS 10dB`
Sets the level offset for the measurement with fixed reference value or the phase-noise measurement to 10 dB.

CALCulate<n>:DELTAmarker<m>:FUNCTION:PNOise[:STATE] <State>

This command turns the phase noise measurement at the delta marker position on and off.

The correction values for the bandwidth and the log amplifier are taken into account in the measurement.

The reference marker for phase noise measurements is either a normal marker or a fixed reference. If necessary, the command turns on the reference marker

A fixed reference point can be modified with the `CALCulate<n>:DELTamarker<m>:FUNCTION:FIXed:RPOint:X` and `CALCulate<n>:DELTamarker<m>:FUNCTION:FIXed:RPOint:Y` commands independent of the position of marker 1 and of a trace.

Suffix:

<n> Selects the measurement window.

<m> irrelevant

Note: marker 2 is always the deltamarker for phase noise measurement results.

Parameters:

<State> ON | OFF

*RST: OFF

Example:

`CALC:DELT:FUNC:PNO ON`

Switches on the phase-noise measurement with all delta markers.

`CALC:DELT:FUNC:FIX:RPO:X 128 MHZ`

Sets the frequency reference to 128 MHz.

`CALC:DELT:FUNC:FIX:RPO:Y 30 DBM`

Sets the reference level to +30 dBm

Manual operation: See "Phase Noise On/Off" on page 130

CALCulate<n>:DELTamarker<m>:FUNCTION:PNOise:AUTO <State>

This command turns an automatic peak search for the fixed reference marker at the end of a sweep on and off.

Suffix:

<n> Selects the measurement window.

<m> irrelevant

Parameters:

<State> ON | OFF

*RST: OFF

Example:

`CALC:DELT:FUNC:PNO:AUTO ON`

Activates an automatic peak search for the reference marker in a phase-noise measurement.

Manual operation: See "Ph. Noise Auto Peak Search" on page 130

CALCulate<n>:DELTamarker<m>:FUNCTION:PNOise:RESult?

This command queries the result of the phase noise measurement.

If necessary, the command activates the measurement first..

Suffix:

<n> Selects the measurement window.

<m> 2
Marker 2 is always the deltamarker for phase noise measurements.

Example:

```
CALC:DELT2:FUNC:PNO:RES?
```

Outputs the result of phase-noise measurement of the delta-marker 2.

Usage:

Query only

Manual operation: See "[Phase Noise On/Off](#)" on page 130

CALCulate<n>:DELTamarker<m>:LINK <State>

This command links delta marker 1 to marker 1.

If you change the horizontal position of the marker, so does the delta marker.

Suffix:

<n> Selects the measurement window.

<m> 1
irrelevant

Parameters:

<State> ON | OFF
*RST: OFF

Example:

```
CALC:DELT:LINK ON
```

Manual operation: See "[Link Mkr1 and Delta1](#)" on page 124

CALCulate<n>:DELTamarker<m>:MODE <Mode>

This command selects the delta marker mode.

Suffix:

<n> Selects the measurement window.

<m> Selects the marker.

Parameters:

<Mode> **ABSolute**
Delta marker position in absolute terms.

RELative
Delta marker position in relation to a reference marker.

*RST: REL

Example:

```
CALC:DELT:MODE ABS
```

Absolute delta marker position.

CALCulate<n>:DELTamarker<m>:MAXimum[:PEAK]

This command positions the delta marker to the current trace maximum. If necessary, the corresponding delta marker is activated first.

In "Spectrogram" mode, this command positions the specified delta marker on the current peak level of the x-axis. The search is performed within the current frame. It does not change the position of the deltamarker on the y-axis.

Suffix:

<n> Selects the measurement window.

<m> Selects the marker.

Example:

`CALC:DELT3:MAX`

Sets delta marker 3 to the maximum value of the associated trace.

Manual operation: See ["Peak"](#) on page 143
See ["Marker Search Type"](#) on page 147

CALCulate<n>:DELTamarker<m>:MAXimum:LEFT

This command positions the delta marker to the next smaller trace maximum on the left of the current value (i.e. descending X values). The corresponding delta marker is activated first, if necessary.

If no next higher minimum value is found on the trace (level spacing to adjacent values < peak excursion), an execution error (error code: -200) is produced.

In "Spectrogram" mode, this command positions the specified delta marker on the next peak level of the x-axis. The search includes only the data to the left of the current marker position in the current frame. It does not change the position of the deltamarker on the y-axis.

Suffix:

<n> Selects the measurement window.

<m> Selects the marker.

Example:

`CALC:DELT:MAX:LEFT`

Sets delta marker 1 to the next smaller maximum value to the left of the current value.

Manual operation: See ["Next Mode"](#) on page 145

CALCulate<n>:DELTamarker<m>:MAXimum:NEXT

This command positions the delta marker to the next smaller trace maximum. The corresponding delta marker is activated first, if necessary.

If no next higher minimum value is found on the trace (level spacing to adjacent values < peak excursion), an execution error (error code: -200) is produced.

In "Spectrogram" mode, this command positions the specified delta marker on the next peak level of the x-axis. The search includes the data in both directions of the current marker position in the current frame. It does not change the position of the delta marker on the y-axis.

Suffix:

<n> Selects the measurement window.

<m> Selects the marker.

Example:

```
CALC:DELT2:MAX:NEXT
```

Sets delta marker 2 to the next smaller maximum value.

Manual operation:

See "Next Peak" on page 143

See "Next Mode" on page 145

CALCulate<n>:DELTamarker<m>:MAXimum:RIGHT

This command positions the delta marker to the next smaller trace maximum on the right of the current value (i.e. ascending X values). The corresponding delta marker is activated first, if necessary.

If no next higher minimum value is found on the trace (level spacing to adjacent values < peak excursion), an execution error (error code: -200) is produced.

In "Spectrogram" mode, this command positions the specified delta marker on the next peak level of the x-axis. The search includes only the data to the right of the current marker position in the current frame. It does not change the position of the delta marker on the y-axis.

Suffix:

<n> Selects the measurement window.

<m> Selects the marker.

Example:

```
CALC:DELT:MAX:RIGH
```

Sets delta marker 1 to the next smaller maximum value to the right of the current value.

Manual operation:

See "Next Mode" on page 145

CALCulate<n>:DELTamarker<m>:MINimum[:PEAK]

This command positions the delta marker to the current trace minimum. The corresponding delta marker is activated first, if necessary.

In "Spectrogram" mode, this command positions the specified delta marker on the current minimum level of the x-axis. The search is performed within a specific frame. It does not change the position of the deltamarker on the y-axis.

Suffix:

<n> Selects the measurement window.

<m> Selects the marker.

Example: `CALC:DELT3:MIN`
Sets delta marker 3 to the minimum value of the associated trace.

Manual operation: See ["Min"](#) on page 144
See ["Marker Search Type"](#) on page 147

CALCulate<n>:DELTamarker<m>:MINimum:LEFT

This command positions the delta marker to the next higher trace minimum on the left of the current value (i.e. descending X values). The corresponding delta marker is activated first, if necessary.

If no next higher minimum value is found on the trace (level spacing to adjacent values < peak excursion), an execution error (error code: -200) is produced.

In "Spectrogram" mode, this command positions the specified delta marker on the next minimum level of the x-axis. The search includes only the data to the left of the current marker position in the current frame. It does not change the position of the delta marker on the y-axis.

Suffix:

<n> Selects the measurement window.

<m> Selects the marker.

Example: `CALC:DELT:MIN:LEFT`
Sets delta marker 1 to the next higher minimum to the left of the current value.

Manual operation: See ["Next Mode"](#) on page 145

CALCulate<n>:DELTamarker<m>:MINimum:RIGHT

This command positions the delta marker to the next higher trace minimum on the right of the current value (i.e. ascending X values). The corresponding delta marker is activated first, if necessary.

If no next higher minimum value is found on the trace (level spacing to adjacent values < peak excursion), an execution error (error code: -200) is produced.

In "Spectrogram" mode, this command positions the specified delta marker on the next minimum level of the x-axis. The search includes only the data to the right of the current marker position in the current frame. It does not change the position of the delta marker on the y-axis.

Suffix:

<n> Selects the measurement window.

<m> Selects the marker.

Example: `CALC:DELT:MIN:RIGHT`
Sets delta marker 1 to the next higher minimum value to the right of the current value.

Manual operation: See "Next Mode" on page 145

CALCulate<n>:DELTamarker<m>:MINimum:NEXT

This command positions the delta marker to the next higher trace minimum. The corresponding delta marker is activated first, if necessary.

If no next higher minimum value is found on the trace (level spacing to adjacent values < peak excursion), an execution error (error code: -200) is produced.

In "Spectrogram" mode, this command positions the specified delta marker on the next minimum level of the x-axis. The search includes the data in both directions of the current marker position in the current frame. It does not change the position of the delta marker on the y-axis.

Suffix:

<n> Selects the measurement window.

<m> Selects the marker.

Example:

`CALC:DELT2:MIN:NEXT`

Sets delta marker 2 to the next higher minimum value.

Manual operation: See "Next Min" on page 144
See "Next Mode" on page 145

CALCulate<n>:DELTamarker<m>:MREF <RefMarkerNo>

This command defines the reference marker for a delta marker other than marker 1.

The reference may be another marker or the fixed reference.

Suffix:

<n> Selects the measurement window.

<m> Selects the marker.

Parameters:

<RefMarkerNo> **1 ... 16**

Selects markers 1 to 16 as the reference.

FIXed

Selects the fixed reference as the reference.

Example:

`CALC:DELT3:MREF 2`

Specifies that the values of delta marker 3 are relative to marker 2.

Manual operation: See "Marker Wizard" on page 121

CALCulate<n>:DELTamarker<m>:TRACe <TraceNumber>

This command selects the trace a delta marker is positioned on.

The corresponding trace must have a trace mode other than "Blank".

In the persistence spectrum result display, the command also defines if the delta marker is positioned on the persistence trace or the maxhold trace.

Suffix:

<n> Selects the measurement window.

<m> Selects the marker.

Parameters:

<TraceNumber> **1 ... 6**
Trace number the marker is positioned on.

MAXHold

Defines the maxhold trace as the trace to put the delta marker on.

This parameter is available only for the persistence spectrum result display.

WRITE

Defines the persistence trace as the trace to put the delta marker on.

This parameter is available only for the persistence spectrum result display.

Example:

`CALC:DELT3:TRAC 2`

Assigns delta marker 3 to trace 2.

Manual operation:

See "[Marker to Trace](#)" on page 121

See "[Marker Wizard](#)" on page 121

CALCulate<n>:DELTamarker<m>:X <Position>

This command positions a delta marker on a particular coordinate on the x-axis.

The position is an absolute value.

You can enter a relative value, if you activate relative entry first with `CALCulate<n>:DELTamarker<m>:MODE`.

If fixed reference is active, the position is relative to the fixed reference (`CALCulate<n>:DELTamarker<m>:FUNCTION:FIXed[:STATE]` is ON). A query always returns the absolute position.

Suffix:

<n> Selects the measurement window.

<m> Selects the marker.

Parameters:

<Position> 0 to maximum frequency or sweep time

Example:

`CALC:DELT:X?`

Outputs the absolute frequency/time of delta marker 1.

Manual operation:

See "[Marker 1 / Marker 2 / Marker 3 / ... Marker 16, / Marker Norm/Delta](#)" on page 120

CALCulate<n>:DELTamarker<m>:X:RELative?

This command queries the x-value of the selected delta marker relative to marker 1 or to the reference position (for `CALC:DELT:FUNC:FIX:STAT ON`). The command activates the corresponding delta marker, if necessary.

Suffix:

<n> Selects the measurement window.
 <m> Selects the marker.

Example:

`CALC:DELT3:X:REL?`

Outputs the frequency of delta marker 3 relative to marker 1 or relative to the reference position.

Usage: Query only

Manual operation: See "[Marker 1 / Marker 2 / Marker 3 / ... Marker 16, / Marker Norm/Delta](#)" on page 120

CALCulate<n>:DELTamarker<m>:Y

This command queries the measured value of a delta marker. The corresponding delta marker is activated, if necessary. The output is always a relative value referred to marker 1 or to the reference position (reference fixed active).

In the persistence spectrum result display of the realtime analyzer, it is also possible to set the delta marker with this command. You can either set the delta marker on an absolute position or a position relative to the marker, depending on the marker mode (`CALCulate<n>:DELTamarker<m>:MODE` on page 563). The query, however, always returns the relative position. You can select whether to query the results of the persistence trace or the maxhold trace with `CALCulate<n>:DELTamarker<m>:TRACe` on page 567.

To get a valid result, you have to perform a complete measurement with synchronization to the end of the measurement before reading out the result. This is only possible for single sweeps.

Depending on the unit defined with `CALC:UNIT:POW` or on the activated measuring functions, the query result is output in the units below:

Table 8-14: Base unit

Parameter, measuring function or result display	Output unit
DBM DBPW DBUV DBMV DBUA	dB (lin/log)
WATT VOLT AMPere	dB (lin), % (log)
statistics function (APD or CCDF) on	dimensionless output

Table 8-15: Analog demodulation measurements

Parameter, measuring function or result display	Output unit
AM result display (R&S FSV-K7)	% (lin) dB (log)
FM result display (R&S FSV-K7)	Hz (lin) dB (log)
PM result display (R&S FSV-K7)	rad deg (lin) dB (log)
RF result display (R&S FSV-K7)	dB (Range Log or Range Linear %) % (Range Linear %)

Table 8-16: Bluetooth measurements

Parameter, measuring function or result display	Output unit
OUTPUT POWER result display (R&S FSV-K8)	dB
TX SPECTRUM ACP result display (R&S FSV-K8)	dB
MODULATION CHARACTERISTICS result display (R&S FSV-K8)	Hz
INITIAL CARR FREQ TOL result display (R&S FSV-K8)	Hz
CARRIER FREQ DRIFT result display (R&S FSV-K8)	Hz
RELATIVE TX POWER (R&S FSV-K8)	dB
IN-BAND SPURIOUS EMISSIONS (R&S FSV-K8)	dB
CARRIER FREQUENCY STABILITY (R&S FSV-K8)	–
DIFF PHASE ENCODING (R&S FSV-K8)	–

Suffix:

<n> Selects the measurement window.

<m> Selects the marker.

Example:

```
INIT:CONT OFF
Switches to single sweep mode.
INIT;*WAI
Starts a sweep and waits for its end.
CALC:DELT2 ON
Switches on delta marker 2.
CALC:DELT2:Y?
Outputs measurement value of delta marker 2.
```

Manual operation: See "[Marker 1 / Marker 2 / Marker 3 / ... Marker 16, / Marker Norm/Delta](#)" on page 120

CALCulate<n>:DELTamarker<m>:Z?

This command queries the z-axis value of the indicated delta marker in the persistence spectrum result display.

You can select whether to query the results of the persistence trace or the maxhold trace with `CALCulate<n>:DELTamarker<m>:TRACe` on page 567.

Return values:

<percentage> The return value is the percentage of hits on the marker position.

Usage: Query only

Mode: RT

CALCulate:DELTamarker:SGRam subsystem

The following commands control the deltamarkers when you are using the spectrogram.

The spectrogram is available in realtime mode and for option R&S FSV-K14.

<code>CALCulate<n>:DELTamarker<m>:SGRam:FRAMe</code>	571
<code>CALCulate<n>:DELTamarker<m>:SGRam:SARea</code>	572
<code>CALCulate<n>:DELTamarker<m>:SGRam:XY:MAXimum[:PEAK]</code>	572
<code>CALCulate<n>:DELTamarker<m>:SGRam:XY:MINimum[:PEAK]</code>	573
<code>CALCulate<n>:DELTamarker<m>:SGRam:Y:MAXimum:ABOVe</code>	573
<code>CALCulate<n>:DELTamarker<m>:SGRam:Y:MAXimum:BELow</code>	574
<code>CALCulate<n>:DELTamarker<m>:SGRam:Y:MAXimum:NEXT</code>	574
<code>CALCulate<n>:DELTamarker<m>:SGRam:Y:MAXimum[:PEAK]</code>	575
<code>CALCulate<n>:DELTamarker<m>:SGRam:Y:MINimum:ABOVe</code>	575
<code>CALCulate<n>:DELTamarker<m>:SGRam:Y:MINimum:BELow</code>	576
<code>CALCulate<n>:DELTamarker<m>:SGRam:Y:MINimum:NEXT</code>	576
<code>CALCulate<n>:DELTamarker<m>:SGRam:Y:MINimum[:PEAK]</code>	577
<code>CALCulate<n>:MARKer<m>:SGRam:Y:TRIGger</code>	577

CALCulate<n>:DELTamarker<m>:SGRam:FRAMe <Frame> | <Time>

This command positions the delta marker on a particular frame. The frame is relative to the position of marker 1.

The command is available for the spectrogram.

Suffix:

<n> 1...4
Selects the measurement window.

<m> 1...16
Selects the marker.

Parameters:

<Frame> | <Time> **<Frame> (if time stamp is off)**
 Defines the distance of the deltamarker in frames and in relation to the position of marker 1.

<time> (if time stamp is on)
 Defines the distance of the deltamarker in seconds and in relation to the position of marker 1. The reference is the time stamp of marker 1.

Example:

`CALC:DELTA4:SGR:FRAM -20`
 Sets fourth deltamarker 20 frames below marker 1.

`CALC:DELTA4:SGR:FRAM 2 s`
 Sets fourth deltamarker 2 seconds above the position of marker 1.

CALCulate<n>:DELTamarker<m>:SGRam:SARea <SearchArea>

This command defines the deltamarker search area.

The command is available for the spectrogram.

Suffix:

<n> 1...4
 Selects the measurement window.

<m> 1...16
 Selects the marker.

Parameters:

<SearchArea> **VISible**
 Performs a search in the visible frames.
 Note that VISible is ignored if Spectrogram is not visible for any reason (e.g. if the Spectrum Analyzer is in full screen mode or display update is inactive).

MEMory

Performs a search over all frames in the memory.

*RST: VISible

Example:

`CALC:DELTA:SGR:SARea MEM`
 Performs a search over all frames in the memory.

Manual operation: See "[Marker Search Area](#)" on page 148

CALCulate<n>:DELTamarker<m>:SGRam:XY:MAXimum[:PEAK]

This command positions the specified delta marker on the current peak level of the spectrogram. The possible position depends on the deltamarker search area.

The command is available for the spectrogram.

For more information, see [CALCulate<n>:DELTamarker<m>:SGRam:SARea](#) on page 572.

Suffix:

<n> 1...4
Selects the measurement window.

<m> 1...16
Selects the marker.

Example:

```
CALC:DELT2:SGR:SAR VIS
CALC:DELT2:SGR:XY:MAX
```

Activates and positions delta marker 2 on the peak level in the visible Spectrogram.

Usage: Event

Manual operation: See "[Marker Search Type](#)" on page 147

CALCulate<n>:DELTamarker<m>:SGRam:XY:MINimum[:PEAK]

This command positions the specified delta marker on the current minimum level of the spectrogram. The possible position depends on the deltamarker search area.

The command is available for the spectrogram.

For more information, see [CALCulate<n>:DELTamarker<m>:SGRam:SARea](#) on page 572.

Suffix:

<n> 1...4
Selects the measurement window.

<m> 1...16
Selects the marker.

Example:

```
CALC:DELT3:SGR:SAR VIS
CALC:DELT3:SGR:XY:MIN
```

Activates and positions delta marker 3 on the minimum level in the visible Spectrogram.

Usage: Event

Manual operation: See "[Marker Search Type](#)" on page 147

CALCulate<n>:DELTamarker<m>:SGRam:Y:MAXimum:ABOVE

This command positions the specified delta marker on the next peak level of the vertical axis. The search includes only frames above the current marker position. It does not change the horizontal position of the delta marker.

The command is available for the spectrogram.

Suffix:

<n> 1...4
Selects the measurement window.

<m> 1...16
Selects the marker.

- Example:** `CALC:DELT2:SGR:Y:MAX`
 Activates and positions delta marker 2 on the peak level of the y-axis.
`CALC:DELT2:SGR:Y:MAX:ABOV`
 Positions delta marker 2 on the next higher level found in the diagram area above the current marker position.
- Usage:** Event
- Manual operation:** See "[Search Mode for Next Peak in Y Direction](#)" on page 147

CALCulate<n>:DELTamarker<m>:SGRam:Y:MAXimum:BELOW

This command positions the specified delta marker on the next peak level of the vertical axis. The search includes only frames below the current marker position. It does not change the horizontal position of the delta marker.

The command is available for the spectrogram.

Suffix:

- <n> 1...4
 Selects the measurement window.
- <m> 1...16
 Selects the marker.

- Example:** `CALC:DELT2:SGR:Y:MAX`
 Activates and positions delta marker 2 on the peak level of the y-axis.
`CALC:DELT2:SGR:Y:MAX:BEL`
 Positions delta marker 2 on the next higher level found in the diagram area below the current marker position.

- Usage:** Event
- Manual operation:** See "[Search Mode for Next Peak in Y Direction](#)" on page 147

CALCulate<n>:DELTamarker<m>:SGRam:Y:MAXimum:NEXT

This command positions the specified delta marker on the next peak level of the vertical axis. The search includes frames above and below the current marker position. It does not change the horizontal position of the delta marker.

The command is available for the spectrogram.

Suffix:

- <n> 1...4
 Selects the measurement window.
- <m> 1...16
 Selects the marker.

- Example:** `CALC:DELT2:SGR:Y:MAX`
 Activates and positions delta marker 2 on the peak level of the y-axis.
`CALC:DELT2:SGR:Y:MAX:NEXT`
 Positions delta marker 2 on the next higher level.
- Usage:** Event
- Manual operation:** See "[Search Mode for Next Peak in Y Direction](#)" on page 147

CALCulate<n>:DELTamarker<m>:SGRam:Y:MAXimum[:PEAK]

This command positions the specified delta marker on the current peak level of the vertical axis. The search is performed over all frames. It does not change the horizontal position of the deltamarker.

The command is available for the spectrogram.

Suffix:

- <n> 1...4
 Selects the measurement window.
- <m> 1...16
 Selects the marker.

- Example:** `CALC:DELT2:SGR:Y:MAX`
 Activates and positions delta marker 2 on the peak level of the y-axis.
- Usage:** Event
- Manual operation:** See "[Marker Search Type](#)" on page 147

CALCulate<n>:DELTamarker<m>:SGRam:Y:MINimum:ABOVE

This command positions the specified delta marker on the next minimum level of the vertical axis. The search includes only frames above the current marker position. It does not change the horizontal position of the delta marker.

The command is available for the spectrogram.

Suffix:

- <n> 1...4
 Selects the measurement window.
- <m> 1...16
 Selects the marker.

- Example:** `CALC:DELT2:SGR:Y:MIN`
 Activates and positions delta marker 2 on the minimum level of the y-axis.
`CALC:DELT2:SGR:Y:MIN:ABOV`
 Positions delta marker 2 on the next minimum level found in the diagram area above the current marker position.

Usage: Event

Manual operation: See ["Search Mode for Next Peak in Y Direction"](#) on page 147

CALCulate<n>:DELTamarker<m>:SGRam:Y:MINimum:BELOW

This command positions the specified delta marker on the next minimum level of the vertical axis. The search includes only frames below the current marker position. It does not change the horizontal position of the delta marker.

The command is available for the spectrogram.

Suffix:

<n> 1...4
Selects the measurement window.

<m> 1...16
Selects the marker.

Example:

`CALC:DELT2:SGR:Y:MIN`

Activates and positions delta marker 2 on the minimum level of the y-axis.

`CALC:DELT2:SGR:Y:MAX:BEL`

Positions delta marker 2 on the next minimum level found in the diagram area below the current marker position.

Usage: Event

Manual operation: See ["Search Mode for Next Peak in Y Direction"](#) on page 147

CALCulate<n>:DELTamarker<m>:SGRam:Y:MINimum:NEXT

This command positions the specified delta marker on the next minimum level of the vertical axis. The search includes frames above and below the current marker position. It does not change the horizontal position of the delta marker.

The command is available for the spectrogram.

Suffix:

<n> 1...4
Selects the measurement window.

<m> 1...16
Selects the marker.

Example:

`CALC:DELT2:SGR:Y:MIN`

Activates and positions delta marker 2 on the minimum level of the y-axis.

`CALC:DELT2:SGR:Y:MIN:NEXT`

Positions delta marker 2 on the next minimum level.

Usage: Event

Manual operation: See ["Search Mode for Next Peak in Y Direction"](#) on page 147

CALCulate<n>:DELTaMarker<m>:SGRam:Y:MINimum[:PEAK]

This command positions the specified delta marker on the current minimum level of the vertical axis. The search is performed over all captured frames. It does not change the horizontal position of the delta marker.

The command is available for the spectrogram.

Suffix:

<n> 1...4
Selects the measurement window.

<m> 1...16
Selects the marker.

Example:

CALC:DELT2:SGR:Y:MIN

Activates and positions delta marker 2 on the minimum level of the y-axis.

Usage: Event

Manual operation: See "[Marker Search Type](#)" on page 147

CALCulate<n>:MARKer<m>:SGRam:Y:TRIGger

This command positions a marker in the spectrogram on the most recent trigger event.

Suffix:

<n> 1...4
Selects the measurement window.

Usage: Event

CALCulate:DLINe Subsystem

The CALCulate:DLINe subsystem defines the position of the display lines.

[CALCulate<n>:DLINe<k>](#).....577
[CALCulate<n>:DLINe<k>:STATe](#).....578

CALCulate<n>:DLINe<k> <Position>

This command defines the (vertical) position of a display line.

Suffix:

<n> Selects the measurement window.

<k> 1 | 2
Selects the display line.

Parameters:

<Position> The value range is variable.
The unit depends on [CALCulate<n>:UNIT:POWer](#).

*RST: (state is OFF)

Example: CALC:DLIN -20dBm

Manual operation: See "Display Line 1 / Display Line 2" on page 260

CALCulate<n>:DLINe<k>:STATe <State>

This command turns a display line on and off.

Suffix:

<n> Selects the measurement window.
 <k> 1 | 2
 Selects the display line.

Parameters:

<State> ON | OFF
 *RST: OFF

Example: CALC:DLIN2:STAT OFF

Manual operation: See "Display Line 1 / Display Line 2" on page 260

CALCulate:ESPectrum Subsystem

The CALCulate:ESPectrum subsystem contains the remote commands for Spectrum Emission Mask (SEM) measurements. Both groups of commands (PSEarch and PEAKsearch) perform the same functions.

CALCulate<n>:ESPectrum:PSEarch]:PEAKsearch:[IMMediate].....	578
CALCulate<n>:ESPectrum:PSEarch]:PEAKsearch:AUTO.....	578
CALCulate<n>:ESPectrum:PSEarch]:PEAKsearch:MARGin.....	579
CALCulate<n>:ESPectrum:PSEarch]:PEAKsearch:PSHow.....	579

CALCulate<n>:ESPectrum:PSEarch]:PEAKsearch:[IMMediate]

This command starts the list evaluation.

Suffix:

<n> Selects the measurement window.

Example: CALC:ESP:PSE

Usage: Event

CALCulate<n>:ESPectrum:PSEarch]:PEAKsearch:AUTO <State>

This command activates or deactivates the list evaluation.

Suffix:

<n> Selects the measurement window.

Parameters:

<State> ON | OFF
 *RST: ON

Example: `CALC:ESP:PSE:AUTO OFF`
Deactivates the list evaluation.

CALCulate<n>:ESpectrum:PSEarch|:PEAKsearch:MARGIN <Margin>

This command sets the margin used for the limit check/peak search.

Suffix:
<n> Selects the measurement window.

Parameters:
<Margin> -200 to 200 dB
*RST: 200 dB

Example: `CALC:ESP:PSE:MARG 100`
Sets the margin to 100 dB.

CALCulate<n>:ESpectrum:PSEarch|:PEAKsearch:PSHOW <State>

This command marks all peaks with blue squares in the diagram.

Suffix:
<n> Selects the measurement window.

Parameters:
<State> ON | OFF
*RST: OFF

Example: `CALC:ESP:PSE:PSH ON`
Marks all peaks with blue squares.

Manual operation: See "Show Peaks" on page 194

CALCulate:FLINE Subsystem

The CALCulate:FLINE subsystem defines the position of the frequency lines.

<code>CALCulate<n>:FLINE<k></code>	579
<code>CALCulate<n>:FLINE<k>:STATE</code>	580

CALCulate<n>:FLINE<k> <Frequency>

This command defines the position of a frequency line.

Suffix:
<n> Selects the measurement window.
<k> 1 | 2
Selects the frequency line.

Parameters:
<Frequency> Range: 0 Hz to fmax
*RST: (STATE to OFF)

Example: `CALC:FLIN2 120MHz`

Manual operation: See "[Frequency Line 1 / Frequency Line 2](#)" on page 261

CALCulate<n>:FLINe<k>:STATe <State>

This command turns a frequency line on and off.

Suffix:

<n> Selects the measurement window.

<k> 1 | 2
Selects the frequency line.

Parameters:

<State> ON | OFF

*RST: OFF

Example: `CALC:FLIN2:STAT ON`

Manual operation: See "[Frequency Line 1 / Frequency Line 2](#)" on page 261

CALCulate:LIMit Subsystem

The CALCulate:LIMit subsystem contains commands for the limit lines and the corresponding limit checks. Limit lines can be defined as upper or lower limit lines. The individual Y values of the limit lines correspond to the values of the x-axis (CONTROL). The number of X and Y values must be identical. For details on limit lines refer to [chapter 4.2.7, "Using Limit Lines and Display Lines – LINES Key"](#), on page 256.

Further information

- [chapter 8.3.3, "Limit Lines and Limit Test"](#), on page 1026

CALCulate<n>:LIMit<k>:ACTive?	580
CALCulate<n>:LIMit<k>:CLEar[IMMEDIATE]	581
CALCulate<n>:LIMit<k>:COMMeNT	581
CALCulate<n>:LIMit<k>:COpy	581
CALCulate<n>:LIMit<k>:DELeTe	582
CALCulate<n>:LIMit<k>:FAIL?	582
CALCulate<n>:LIMit<k>:NAME	583
CALCulate<n>:LIMit<k>:STATe	583
CALCulate<n>:LIMit<k>:UNIT	584
CALCulate<n>:LIMit<k>:TRACe	584

CALCulate<n>:LIMit<k>:ACTive?

This command queries the names of all active limit lines.

Suffix:

<n> irrelevant

<k> irrelevant

Return values:

<LimitLines> String containing the names of all active limit lines in alphabetical order.

Example:

`CALC:LIM:ACT?`

Queries the names of all active limit lines.

Usage:

Query only

CALCulate<n>:LIMit<k>:CLEar[:IMMEDIATE]

This command deletes the result of the current limit check for all limit lines in all windows.

Suffix:

<n> irrelevant

<k> irrelevant

Example:

`CALC:LIM:CLE`

Deletes the result of the limit check.

Usage:

Event

CALCulate<n>:LIMit<k>:COMMent <Comment>

This command defines a comment for the selected limit line in all windows.

Suffix:

<n> irrelevant

<k> Selects the limit line.

Parameters:

<Comment> String containing the comment. The maximum number of characters the string may contain is 40.

Example:

`CALC:LIM5:COMM 'Upper limit for spectrum'`

Defines the comment for limit line 5.

Manual operation:

See "[Edit Comment](#)" on page 258

CALCulate<n>:LIMit<k>:COPY <Line>

This command copies a limit line.

Suffix:

<n> irrelevant

<k> Selects the limit line.

Parameters:

<Line> **1 to 8**
 number of the new limit line

<name>
 String containing the name of the limit line.

Example:

```
CALC:LIM1:COPY 2
Copies limit line 1 to line 2.
CALC:LIM1:COPY 'FM2'
Copies limit line 1 to a new line named FM2.
```

Manual operation: See "[Copy to](#)" on page 259

CALCulate<n>:LIMit<k>:DELeTe

This command deletes a limit line.

Suffix:

<n> irrelevant

<k> Selects the limit line.

Example:

```
CALC:LIM1:DEL
Deletes limit line 1.
```

Usage: Event

Manual operation: See "[Delete](#)" on page 260

CALCulate<n>:LIMit<k>:FAIL?

This command queries the result of a limit check.

Note that for SEM measurements, the limit line suffix <k> is irrelevant, as only one specific SEM limit line is checked for the currently relevant power class.

To get a valid result, you have to perform a complete measurement with synchronization to the end of the measurement before reading out the result. This is only possible for single sweeps.

Suffix:

<n> irrelevant

<k> limit line
 For option WLAN TX Measurements, R&S FSV-K91/91n, see table below

Return values:

<Result> **0**
 PASS

1
 FAIL

- Example:** `INIT; *WAI`
 Starts a new sweep and waits for its end.
 `CALC:LIM3:FAIL?`
 Queries the result of the check for limit line 3.
- Usage:** Query only
- Manual operation:** See "[Limit Check 1-4](#)" on page 191
 See "[Limit Check 1-4](#)" on page 221

For option WLAN TX Measurements, R&S FSV-K91/91n, the numeric suffix <k> specifies the limit lines as follows:

Suffix	Limit
1 to 2	These indexes are not used
3	ETSI Spectrum Mask limit line
4	Spectrum Flatness (Upper) limit line
5	Spectrum Flatness (Lower) limit line
6	IEEE Spectrum Mask limit line
7	PVT Rising Edge max limit
8	PVT Rising Edge mean limit
9	PVT Falling Edge max limit
10	PVT Falling Edge mean limit

CALCulate<n>:LIMit<k>:NAME <Name>

This command selects a limit line that already exists or defines a name for a new limit line.

Suffix:

- <n> irrelevant
- <k> 1...8 (NF: 1...6)
 Selects the limit line.

Parameters:

- <Name> String containing the limit line name.
 *RST: REM1 to REM8 for lines 1 to 8

- Example:** `CALC:LIM1:NAME 'FM1'`
 Assigns the name FM1 to limit line 1.

CALCulate<n>:LIMit<k>:STATe <State>

This command turns the limit check on and off.

To query the limit check result, use `CALCulate<n>:LIMit<k>:FAIL?`.

Suffix:

<n> irrelevant
 <k> Selects the limit line.

Parameters:

<State> ON | OFF
 *RST: OFF

Example:

CALC:LIM:STAT ON
 Switches on the limit check for limit line 1.

Manual operation: See ["Select Traces to check"](#) on page 258
 See ["Deselect All"](#) on page 258

CALCulate<n>:LIMit<k>:UNIT <Unit>

This command defines the unit of a limit line.

Upon selection of the unit DB the limit line is automatically switched to the relative mode. For units different from DB the limit line is automatically switched to absolute mode.

Suffix:

<n> irrelevant
 <k> Selects the limit line.

Parameters:

<Unit> DBM | DBPW | WATT | DBUV | DBMV | VOLT | DBUA |
 AMPere | DB | DBUV_M | DBUA_M | DEG | RAD | S | HZ |
 PCT | (unitless)

If you select dB as the limit line unit, the command automatically turns the limit line into a relative limit line.

In spectrum mode, units deg, rad, s, Hz and PCT are unavailable.

*RST: DBM

Example:

CALC:LIM4:UNIT DBUV
 Sets the unit of limit line 4 to dB μ V.

CALCulate<n>:LIMit<k>:TRACe <TraceNumber>

This command links a limit line to one or more traces.

Suffix:

<n> irrelevant
 <k> Selects the limit line.

Parameters:

<TraceNumber> Range: 1 to 6
 *RST: 1

Example: `CALC:LIM2:TRAC 3`
Assigns limit line 2 to trace 3.

Manual operation: See "[Select Traces to check](#)" on page 258

CALCulate:LIMit:ACPower Subsystem

The CALCulate:LIMit:ACPower subsystem defines the limit check for adjacent channel power measurement.

<code>CALCulate<n>:LIMit<k>:ACPower[:STATe]</code>	585
<code>CALCulate<n>:LIMit<k>:ACPower:ACHannel[:RELative]</code>	585
<code>CALCulate<n>:LIMit<k>:ACPower:ACHannel[:RELative]:STATe</code>	586
<code>CALCulate<n>:LIMit<k>:ACPower:ACHannel:ABSolute</code>	587
<code>CALCulate<n>:LIMit<k>:ACPower:ACHannel:ABSolute:STATe</code>	587
<code>CALCulate<n>:LIMit<k>:ACPower:ACHannel:RESult</code>	588
<code>CALCulate<n>:LIMit<k>:ACPower:ALternate<channel>[:RELative]</code>	589
<code>CALCulate<n>:LIMit<k>:ACPower:ALternate<Channel>[:RELative]:STATe</code>	590
<code>CALCulate<n>:LIMit<k>:ACPower:ALternate<Channel>:ABSolute</code>	590
<code>CALCulate<n>:LIMit<k>:ACPower:ALternate<Channel>:ABSolute:STATe</code>	591
<code>CALCulate<n>:LIMit<k>:ACPower:ALternate<Channel>:RESult?</code>	592

CALCulate<n>:LIMit<k>:ACPower[:STATe] <State>

This command switches on and off the limit check for adjacent-channel power measurements. The commands `CALCulate<n>:LIMit<k>:ACPower:ACHannel[:RELative]:STATe` or `CALCulate<n>:LIMit<k>:ACPower:ALternate<Channel>[:RELative]:STATe` must be used in addition to specify whether the limit check is to be performed for the upper/lower adjacent channel or for the alternate adjacent channels.

Suffix:

<n> Selects the measurement window.
<k> irrelevant

Parameters:

<State> ON | OFF
*RST: OFF

Example: `CALC:LIM:ACP ON`
Switches on the ACLR limit check.

Manual operation: See "[Limit Checking](#)" on page 171
See "[Relative Limit](#)" on page 172
See "[Absolute Limit](#)" on page 172

CALCulate<n>:LIMit<k>:ACPower:ACHannel[:RELative] <LowerLimit>, <UpperLimit>

This command defines the relative limit of the upper/lower adjacent channel for adjacent-channel power measurements. The reference value for the relative limit value is the measured channel power.

It should be noted that the relative limit value has no effect on the limit check as soon as it is below the absolute limit value defined with the `CALCulate<n>:LIMit<k>:ACPower:ACHannel:ABSolute` command. This mechanism allows automatic checking of the absolute basic values of adjacent-channel power as defined in mobile radio standards.

Suffix:

<n> Selects the measurement window.
 <k> irrelevant

Parameters:

<LowerLimit>, 0 to 100dB; the value for the lower limit must be lower than the
 <UpperLimit> value for the upper limit
 *RST: 0 dB

Example:

```
CALC:LIM:ACP:ACH 30DB, 30DB
```

Sets the relative limit value for the power in the lower and upper adjacent channel to 30 dB below the channel power.

CALCulate<n>:LIMit<k>:ACPower:ACHannel[:RELative]:STATe <State>

This command activates the limit check for the relative limit value of the adjacent channel when adjacent-channel power measurement is performed. Before this command, the limit check must be activated using `CALCulate<n>:LIMit<k>:ACPower[:STATe]`.

The result can be queried with `CALCulate<n>:LIMit<k>:ACPower:ACHannel:RESult`. Note that a complete measurement must be performed between switching on the limit check and the result query, since otherwise no correct results are available.

Suffix:

<n> Selects the measurement window.
 <k> irrelevant

Parameters:

<State> ON | OFF
 *RST: OFF

Example:

```
CALC:LIM:ACP:ACH 30DB, 30DB
```

Sets the relative limit value for the power in the lower and upper adjacent channel to 30 dB below the channel power.

```
CALC:LIM:ACP:ACH:ABS -35DBM, -35DBM
```

Sets the absolute limit value for the power in the lower and upper adjacent channel to -35 dBm.

```
CALC:LIM:ACP ON
```

Switches on globally the limit check for the channel/adjacent channel measurement.

```
CALC:LIM:ACP:ACH:STAT ON
```

Switches on the check of the relative limit values for adjacent channels.

```
CALC:LIM:ACP:ACH:ABS:STAT ON
```

Switches on the check of absolute limit values for the adjacent channels.

```
INIT;*WAI
```

Starts a new measurement and waits for the sweep end.

```
CALC:LIM:ACP:ACH:RES?
```

Queries the limit check result in the adjacent channels.

CALCulate<n>:LIMit<k>:ACPpower:ACHannel:ABSolute <LowerLimit>, <UpperLimit>

This command defines the absolute limit value for the lower/upper adjacent channel during adjacent-channel power measurement (Adjacent Channel Power).

Note that the absolute limit value has no effect on the limit check as soon as it is below the relative limit value defined with `CALCulate<n>:LIMit<k>:ACPpower:ACHannel[:RELative]`. This mechanism allows automatic checking of the absolute basic values of adjacent-channel power as defined in mobile radio standards.

Suffix:

<n> Selects the measurement window.

<k> irrelevant

Parameters:

<LowerLimit>, first value: -200DBM to 200DBM; limit for the lower and the upper adjacent channel

<UpperLimit> *RST: -200DBM

Example:

```
CALC:LIM:ACP:ACH:ABS -35DBM, -35DBM
```

Sets the absolute limit value for the power in the lower and upper adjacent channel to -35 dBm.

CALCulate<n>:LIMit<k>:ACPpower:ACHannel:ABSolute:STATe <State>

This command activates the limit check for the adjacent channel when adjacent-channel power measurement (Adjacent Channel Power) is performed. Before the command, the limit check for the channel/adjacent-channel measurement must be globally switched on using `CALCulate<n>:LIMit<k>:ACPpower[:STATe]`.

The result can be queried with `CALCulate<n>:LIMit<k>:ACPpower:ACHannel:RESult`. It should be noted that a complete measurement must be performed between switching on the limit check and the result query, since otherwise no correct results are available.

Suffix:

<n> Selects the measurement window.

<k> irrelevant

Parameters:

<State> ON | OFF

*RST: OFF

Example:

```
CALC:LIM:ACP:ACH 30DB, 30DB
```

Sets the relative limit value for the power in the lower and upper adjacent channel to 30 dB below the channel power.

```
CALC:LIM:ACP:ACH:ABS -35DBM, -35DBM
```

Sets the absolute limit value for the power in the lower and upper adjacent channel to -35 dBm.

```
CALC:LIM:ACP ON
```

Switches on globally the limit check for the channel/adjacent-channel measurement.

```
CALC:LIM:ACP:ACH:REL:STAT ON
```

Switches on the check of the relative limit values for adjacent channels.

```
CALC:LIM:ACP:ACH:ABS:STAT ON
```

Switches on the check of absolute limit values for the adjacent channels.

```
INIT;*WAI
```

Starts a new measurement and waits for the sweep end.

```
CALC:LIM:ACP:ACH:RES?
```

Queries the limit check result in the adjacent channels.

Manual operation: See "[Absolute Limit](#)" on page 172

CALCulate<n>:LIMit<k>:ACPpower:ACHannel:RESult

This command queries the result of the limit check for the upper/lower adjacent channel when adjacent channel power measurement is performed.

If the power measurement of the adjacent channel is switched off, the command produces a query error.

Suffix:

<n> Selects the measurement window.

<k> irrelevant

Return values:

Result The result is returned in the form <result>, <result> where <result> = PASSED | FAILED, and where the first returned value denotes the lower, the second denotes the upper adjacent channel.

Example:

```
CALC:LIM:ACP:ACH 30DB, 30DB
```

Sets the relative limit value for the power in the lower and upper adjacent channel to 30 dB below the channel power.

```
CALC:LIM:ACP:ACH:ABS -35DBM, -35DBM
```

Sets the absolute limit value for the power in the lower and upper adjacent channel to -35 dB.

```
CALC:LIM:ACP ON
```

Switches on globally the limit check for the channel/adjacent channel measurement.

```
CALC:LIM:ACP:ACH:STAT ON
```

Switches on the limit check for the adjacent channels.

```
INIT;*WAI
```

Starts a new measurement and waits for the sweep end.

```
CALC:LIM:ACP:ACH:RES?
```

Queries the limit check result in the adjacent channels.

Manual operation: See "[Limit Checking](#)" on page 171

CALCulate<n>:LIMit<k>:ACPpower:ALTernate<channel>[:RELative] <LowerLimit>, <UpperLimit>

This command defines the limit for the alternate adjacent channels for adjacent channel power measurements. The reference value for the relative limit value is the measured channel power.

Note that the relative limit value has no effect on the limit check as soon as it is below the absolute limit defined with `CALCulate<n>:LIMit<k>:ACPpower:ALTernate<Channel>:ABSolute`. This mechanism allows automatic checking of the absolute basic values of adjacent-channel power as defined in mobile radio standards.

Suffix:

<n>	Selects the measurement window.
<k>	irrelevant
<Channel>	1...11 the alternate channel

Parameters:

<LowerLimit>, <UpperLimit>	first value: 0 to 100dB; limit for the lower and the upper alternate adjacent channel *RST: 0 DB
----------------------------	---

Example:

```
CALC:LIM:ACP:ALT2 30DB, 30DB
```

Sets the relative limit value for the power in the lower and upper second alternate adjacent channel to 30 dB below the channel power.

Manual operation: See "[Limit Checking](#)" on page 171

CALCulate<n>:LIMit<k>:ACPpower:ALTErnate<Channel>[:RELative]:STATe
 <State>

This command activates the limit check for the alternate adjacent channels for adjacent channel power measurements. Before the command, the limit check must be activated using `CALCulate<n>:LIMit<k>:ACPpower[:STATe]`.

The result can be queried with `CALCulate<n>:LIMit<k>:ACPpower:ALTErnate<channel>[:RELative]`. Note that a complete measurement must be performed between switching on the limit check and the result query, since otherwise no correct results are obtained.

Suffix:

<n>	Selects the measurement window.
<k>	irrelevant
<Channel>	1...11 the alternate channel

Parameters:

<State>	ON OFF
*RST:	OFF

Example:

```
CALC:LIM:ACP:ALT2 30DB, 30DB
```

Sets the relative limit value for the power in the lower and upper second alternate adjacent channel to 30 dB below the channel power.

```
CALC:LIM:ACP:ALT2:ABS -35DBM, -35DBM
```

Sets the absolute limit value for the power in the lower and upper second alternate adjacent channel to -35 dBm.

```
CALC:LIM:ACP ON
```

Switches on globally the limit check for the channel/adjacent channel measurement.

```
CALC:LIM:ACP:ALT2:STAT ON
```

Switches on the check of the relative limit values for the lower and upper second alternate adjacent channel.

```
CALC:LIM:ACP:ALT2:ABS:STAT ON
```

Switches on the check of absolute limit values for the lower and upper second alternate adjacent channel.

```
INIT;*WAI
```

Starts a new measurement and waits for the sweep end.

```
CALC:LIM:ACP:ALT2:RES?
```

Queries the limit check result in the second alternate adjacent channels.

CALCulate<n>:LIMit<k>:ACPpower:ALTErnate<Channel>:ABSolute <LowerLimit>
 <UpperLimit>

This command defines the absolute limit value for the lower/upper alternate adjacent-channel power measurement (Adjacent Channel Power).

Note that the absolute limit value for the limit check has no effect as soon as it is below the relative limit value defined with `CALCulate<n>:LIMit<k>:ACPower:ACHannel[:RELative]`. This mechanism allows automatic checking of the absolute basic values defined in mobile radio standards for the power in adjacent channels.

Suffix:

<n>	Selects the measurement window.
<k>	irrelevant
<Channel>	1...11 the alternate channel

Parameters:

<LowerLimit>, <UpperLimit>	first value: -200DBM to 200DBM; limit for the lower and the upper alternate adjacent channel
*RST:	-200DBM

Example:

```
CALC:LIM:ACP:ALT2:ABS -35DBM, -35DBM
```

Sets the absolute limit value for the power in the lower and upper second alternate adjacent channel to -35 dBm.

CALCulate<n>:LIMit<k>:ACPower:ALTErnate<Channel>:ABSolute:STATe
 <State>

This command activates the limit check for the alternate adjacent channels for adjacent-channel power measurement (Adjacent Channel Power).

Before the command, the limit check must be globally switched on for the channel/ adjacent-channel power with the `CALCulate<n>:LIMit<k>:ACPower[:STATe]` command.

The result can be queried with `CALCulate<n>:LIMit<k>:ACPower:ALTErnate<channel>[:RELative]`. Note that a complete measurement must be performed between switching on the limit check and the result query, since otherwise no correct results are available.

Suffix:

<n>	Selects the measurement window.
<k>	irrelevant
<Channel>	1...11 the alternate channel

Parameters:

<State>	ON OFF
*RST:	OFF

Example:

```
CALC:LIM:ACP:ALT2 30DB, 30DB
```

Sets the relative limit value for the power in the lower and upper second alternate adjacent channel to 30 dB below the channel power.

```
CALC:LIM:ACP:ALT2:ABS -35DBM, -35DBM
```

Sets the absolute limit value for the power in the lower and upper second alternate adjacent channel to -35 dBm.

```
CALC:LIM:ACP ON
```

Switches on globally the limit check for the channel/adjacent channel measurement.

```
CALC:LIM:ACP:ALT2:STAT ON
```

Switches on the check of the relative limit values for the lower and upper second alternative adjacent channels.

```
CALC:LIM:ACP:ALT2:ABS:STAT ON
```

Switches on the check of absolute limit values for the lower and upper second alternative adjacent channels.

```
INIT;*WAI
```

Starts a new measurement and waits for the sweep end.

```
CALC:LIM:ACP:ALT2:RES?
```

Queries the limit check result in the second alternate adjacent channels.

CALCulate<n>:LIMit<k>:ACPpower:ALTErnate<Channel>:RESult?

This command queries the result of the limit check for the alternate adjacent channels for adjacent channel power measurements.

If the power measurement of the adjacent channel is switched off, the command produces a query error.

Suffix:

<n>	Selects the measurement window.
<k>	irrelevant
<Channel>	1...11 the alternate channel

Parameters:

The result is returned in the form <result>, <result> where <result> = PASSED | FAILED and where the first (second) returned value denotes the lower (upper) alternate adjacent channel.

Example:

```
CALC:LIM:ACP:ALT2 30DB, 30DB
```

Sets the relative limit value for the power in the lower and upper second alternate adjacent channel to 30 dB below the channel power.

```
CALC:LIM:ACP:ALT2:ABS -35DBM, -35DBM
```

Sets the absolute limit value for the power in the lower and upper second alternate adjacent channel to -35 dBm.

```
CALC:LIM:ACP ON
```

Switches on globally the limit check for the channel/adjacent channel measurement.

```
CALC:LIM:ACP:ALT2:STAT ON
```

Switches on the limit check for the lower and upper second adjacent channel.

```
INIT;*WAI
```

Starts a new measurement and waits for the sweep end.

```
CALC:LIM:ACP:ALT2:RES?
```

Queries the limit check result in the second alternate adjacent channels.

Usage:

Query only

CALCulate:LIMit:CONTrol Subsystem

The CALCulate:LIMit:CONTrol subsystem defines the x-axis (CONTrol axis).

CALCulate<n>:LIMit<k>:CONTrol[:DATA].....	593
CALCulate<n>:LIMit<k>:CONTrol:DOMain.....	594
CALCulate<n>:LIMit<k>:CONTrol:MODE.....	594
CALCulate<n>:LIMit<k>:CONTrol:OFFSet.....	594
CALCulate<n>:LIMit<k>:CONTrol:SHIFt.....	595
CALCulate<n>:LIMit<k>:CONTrol:SPACing.....	595

CALCulate<n>:LIMit<k>:CONTrol[:DATA] <LimitLinePoints>

This command defines the horizontal definition points of a lower limit line.

Suffix:

<n>	Selects the measurement window.
<k>	1...8 Selects the limit line.

Parameters:

<LimitLinePoints> Variable number of x-axis values.
Note that the number of horizontal values has to be the same as the number of vertical values set with `CALCulate<n>:LIMit<k>:LOWer[:DATA]` or `CALCulate<n>:LIMit<k>:UPPer[:DATA]`. If not, the R&S FSVR either adds missing values or ignores surplus values.
The unit is Hz or s, depending on `CALCulate<n>:LIMit<k>:CONTrol:DOMain`.

*RST: - (CALC:LIM is set to OFF)

Example: `CALC:LIM2:CONT 1 MHz,30 MHz,100 MHz,300 MHz,1 GHz`
 Defines 5 reference values for the x-axis of limit line 2.
`CALC:LIM2:CONT?`
 Outputs the reference values for the x-axis of limit line 2 separated by a comma.

Manual operation: See "Edit Value" on page 259

CALCulate<n>:LIMit<k>:CONTrol:DOMain <SpanSetting>

This command selects the domain of the limit line.

Suffix:

<n> Selects the measurement window.
 <k> 1...8
 Selects the limit line.

Parameters:

<SpanSetting> FREQUENCY | TIME
 *RST: FREQUENCY

Example: `CALC:LIM2:CONT:DOM TIME`
 Defines zero span for the x-axis of limit line 2.

CALCulate<n>:LIMit<k>:CONTrol:MODE <Mode>

This command selects the horizontal limit line scaling.

Suffix:

<n> Selects the measurement window.
 <k> 1...8
 Selects the limit line.

Parameters:

<Mode> **ABSolute**
 Limit line is defined by absolute physical values (Hz or s).
RELative
 Limit line is defined by relative values related to the center frequency (frequency domain) or the left diagram border (time domain).
 *RST: ABSolute

Example: `CALC:LIM2:CONT:MODE REL`
 Defines the x-axis of limit line 2 as relatively scaled.

CALCulate<n>:LIMit<k>:CONTrol:OFFSet <Offset>

This command defines an offset for a complete limit line.

Compared to shifting the limit line, an offset does not actually change the limit line definition points.

Suffix:

<n> Selects the measurement window.
 <k> 1...8
 Selects the limit line.

Parameters:

<Offset> Numeric value that defines the offset.
 The unit of the offset depends on the scale of the x-axis.
 *RST: 0

Example:

`CALC:LIM2:CONT:OFFS 100us`

Sets the X offset for limit line 2 (defined in zero span) to 100µs.

Manual operation: See "[X Offset](#)" on page 260

CALCulate<n>:LIMit<k>:CONTrol:SHIFt <Distance>

This command moves a complete limit line horizontally.

Compared to defining an offset, this command actually changes the limit line definition points by the value you define.

Suffix:

<n> Selects the measurement window.
 <k> Selects the limit line.

Parameters:

<Distance> Numeric value that defines the distance of the shift.
 The unit depends on the scale of the x-axis.

Example:

`CALC:LIM2:CONT:SHIF 50KHZ`

Shifts all reference values of limit line 2 by 50 kHz.

CALCulate<n>:LIMit<k>:CONTrol:SPACing <InterpolMode>

This command selects linear or logarithmic interpolation for the calculation of limit lines from frequency points.

Suffix:

<n> Selects the measurement window.
 <k> 1...8
 Selects the limit line.

Parameters:

<InterpolMode> LINear | LOGarithmic
 *RST: LIN

Example:

`CALC:LIM:CONT:SPAC LIN`

CALCulate:LIMit:ESpectrum subsystem

The CALCulate:LIMit:ESpectrum subsystem defines the limit check for the Spectrum Emission Mask.

CALCulate<n>:LIMit<k>:ESpectrum:LIMits.....	596
CALCulate<n>:LIMit<k>:ESpectrum:MODE.....	596
CALCulate<n>:LIMit<k>:ESpectrum:PClass<Class>[:EXCLusive].....	597
CALCulate<n>:LIMit<k>:ESpectrum:PClass<Class>:COUNT.....	597
CALCulate<n>:LIMit<k>:ESpectrum:PClass<Class>:LIMit[:STATe].....	598
CALCulate<n>:LIMit<k>:ESpectrum:PClass<Class>:MAXimum.....	598
CALCulate<n>:LIMit<k>:ESpectrum:PClass<Class>:MINimum.....	599
CALCulate<n>:LIMit<k>:ESpectrum:RESTore.....	599
CALCulate<n>:LIMit<k>:ESpectrum:VALue.....	599

CALCulate<n>:LIMit<k>:ESpectrum:LIMits <Limits>

This command sets or queries up to 4 power classes in one step.

Suffix:

<n>	irrelevant
<k>	irrelevant

Parameters:

<Limits>	1–3 numeric values between -200 and 200, separated by commas -200, <0-3 numeric values between -200 and 200, in ascending order, separated by commas>, 200
----------	---

Example:

```
CALC:LIM:ESP:LIM -50,50,70
Defines the following power classes:
<-200, -50>
<-50, 50>
<50, 70>
<70, 200>
Query:
CALC:LIM:ESP:LIM?
Response:
-200,-50,50,70,200
```

CALCulate<n>:LIMit<k>:ESpectrum:MODE <Mode>

This command activates or deactivates the automatic selection of the limit line in the Spectrum Emission Mask measurement.

Suffix:

<n>	1...4 window
<k>	irrelevant

Parameters:

<Mode> AUTO | MANUAL

AUTO

The limit line depends on the measured channel power.

MANUAL

One of the three specified limit lines is set. The selection is made with the "[CALCulate:LIMit:ESpectrum subsystem](#)" on page 596 command.

*RST: AUTO

Example:

CALC:LIM:ESP:MODE AUTO

Activates automatic selection of the limit line.

CALCulate<n>:LIMit<k>:ESpectrum:PCLass<Class>[:EXCLusive] <State>

This command sets the power classes used in the spectrum emission mask measurement. It is only possible to use power classes for which limits are defined. Also, either only one power class at a time or all power classes together can be selected.

Suffix:

<n> irrelevant

<k> irrelevant

<Class> 1...4
the power class to be evaluated

Parameters:

<State> ON | OFF

*RST: OFF

Example:

CALC:LIM:ESP:PCL1 ON

Activates the first defined power class.

Manual operation: See "[Used Power Classes](#)" on page 196
See "[Add/Remove](#)" on page 197

CALCulate<n>:LIMit<k>:ESpectrum:PCLass<Class>:COUNT <NoPowerClasses>

This command sets the number of power classes to be defined.

Suffix:

<n> irrelevant

<k> irrelevant

<Class> irrelevant

Parameters:

<NoPowerClasses> 1 to 4

*RST: 1

Example:

CALC:LIM:ESP:PCL:COUN 2

Two power classes can be defined.

CALCulate<n>:LIMit<k>:ESPectrum:PCLass<Class>:LIMit[:STATe] <State>

This command defines which limits are evaluated in the measurement.

Suffix:

<n>	irrelevant
<k>	irrelevant
<Class>	1...4 the power class to be evaluated

Parameters:

<State> ABSolute | RELative | AND | OR

ABSolute

Evaluates only limit lines with absolute power values

RELative

Evaluates only limit lines with relative power values

AND

Evaluates limit lines with relative and absolute power values. A negative result is returned if both limits fail.

OR

Evaluates limit lines with relative and absolute power values. A negative result is returned if at least one limit failed.

*RST: REL

Example:

CALC:LIM:ESP:PCL:LIM ABS

Manual operation: See "[Used Power Classes](#)" on page 196

CALCulate<n>:LIMit<k>:ESPectrum:PCLass<Class>:MAXimum <Level>

This command sets the upper limit level for one power class. The unit is dBm. The limit always ends at + 200 dBm, i.e. the upper limit of the last power class can not be set. If more than one power class is in use, the upper limit must equal the lower limit of the next power class.

Suffix:

<n>	irrelevant
<k>	irrelevant
<Class>	1...4 the power class to be evaluated

Parameters:

<Level> <numeric value>

*RST: +200

Example:

CALC:LIM:ESP:PCL1:MAX -40 dBm

Sets the maximum power value of the first power class to -40 dBm.

Manual operation: See "[PMin/PMax](#)" on page 196

CALCulate<n>:LIMit<k>:ESPectrum:PCLass<Class>:MINimum <Level>

This command sets the minimum lower level limit for one power class. The unit is dBm. The limit always start at – 200 dBm, i.e. the first lower limit can not be set. If more than one power class is in use, the lower limit must equal the upper limit of the previous power class.

Suffix:

<n>	irrelevant
<k>	irrelevant
<Class>	1...4 the power class to be evaluated

Parameters:

<Level>	<numeric_value> *RST: -200 for class1, otherwise +200
---------	---

Example:

`CALC:LIM:ESP:PCL2:MIN -40 dBm`
Sets the minimum power value of the second power class to -40 dBm.

Manual operation: See "[PMin/PMax](#)" on page 196

CALCulate<n>:LIMit<k>:ESPectrum:RESTore

This command restores the predefined limit lines for the Spectrum Emission Mask measurement. All modifications made to the predefined limit lines are lost and the factory-set values are restored.

Suffix:

<n>	1...4 window
<k>	irrelevant

Example:

`CALC:LIM:ESP:REST`
Resets the limit lines for the Spectrum Emission Mask to the default setting.

CALCulate<n>:LIMit<k>:ESPectrum:VALue <Power>

This command activates the manual limit line selection and specifies the expected power as a value. Depending on the entered value, one of the predefined limit lines is selected.

Suffix:

<n>	1...4 window
<k>	irrelevant

Parameters:

<Power> 33 | 28 | 0

33
P ≥ 33

28
28 < P < 33

0
P < 28

*RST: 0

Example:

```
CALC:LIM:ESP:VAL 33
```

Activates manual selection of the limit line and selects the limit line for P = 33.

CALCulate:LIMit:LOWer Subsystem

The CALCulate:LIMit:LOWer subsystem defines the lower limit line.

CALCulate<n>:LIMit<k>:LOWer[:DATA].....	600
CALCulate<n>:LIMit<k>:LOWer:MARGin.....	601
CALCulate<n>:LIMit<k>:LOWer:MODE.....	601
CALCulate<n>:LIMit<k>:LOWer:OFFSet.....	601
CALCulate<n>:LIMit<k>:LOWer:SHIFt.....	602
CALCulate<n>:LIMit<k>:LOWer:SPACing.....	602
CALCulate<n>:LIMit<k>:LOWer:STATe.....	603
CALCulate<n>:LIMit<k>:LOWer:THReshold.....	603

CALCulate<n>:LIMit<k>:LOWer[:DATA] <LimitLinePoints>

This command defines the vertical definition points of a lower limit line.

If the measured values are smaller than the LOWER limit line, the limit check is violated.

The units DEG, RAD, S, HZ, PCT are not available in the "Spectrum" mode.

Suffix:

<n> irrelevant

<k> 1...8
Selects the limit line.

Parameters:

<LimitLinePoints> Variable number of x-axis values.
Note that the number of horizontal values has to be the same as the number of vertical values set with `CALCulate<n>:LIMit<k>:CONTrol[:DATA]`. If not, the R&S FSVR either adds missing values or ignores surplus values.
The unit depends on `CALCulate<n>:LIMit<k>:UNIT`.

*RST: (LIMit:STATe is set to OFF)

Example: `CALC:LIM2:LOW -30,-40,-10,-40,-30`
 Defines 5 lower limit values for limit line 2 in the preset unit.
`CALC:LIM2:LOW?`
 Outputs the lower limit values of limit line 2 separated by a comma.

Manual operation: See "Edit Value" on page 259

CALCulate<n>:LIMit<k>:LOWer:MARGin <Margin>

This command defines an area around a lower limit line where limit check violations are still tolerated.

Suffix:

<n> irrelevant
 <k> 1...8
 Selects the limit line.

Parameters:

<Margin> Numeric value that defines the margin.
 In spectrum mode, the unit is always dB.
 *RST: 0

Example: `CALC:LIM:LOW:MARG 10dB`

CALCulate<n>:LIMit<k>:LOWer:MODE <Mode>

This command selects the vertical limit line scaling.

Suffix:

<n> irrelevant
 <k> 1...8
 Selects the limit line.

Parameters:

<Mode> **ABSolute**
 Limit line is defined by absolute physical values. The unit is variable.
RELative
 Limit line is defined by values relative to the reference level (dB).
 *RST: ABSolute

Example: `CALC:LIM:LOW:MODE REL`
 Defines the y-axis of limit line 2 as relative scaled.

Manual operation: See "Edit Name" on page 258

CALCulate<n>:LIMit<k>:LOWer:OFFSet <Offset>

This command defines an offset for a complete lower limit line.

Compared to shifting the limit line, an offset does not actually change the limit line definition points.

Suffix:

<n> irrelevant
 <k> 1...8
 Selects the limit line.

Parameters:

<Offset> Numeric value that defines the offset.
 *RST: 0

Example:

CALC:LIM2:LOW:OFFS 3dB
 Shifts limit line 2 by 3 dB upwards.

Manual operation: See "Y Offset" on page 260

CALCulate<n>:LIMit<k>:LOWer:SHIFt <Distance>

This command moves a complete lower limit line vertically.

Compared to defining an offset, this command actually changes the limit line definition points by the value you define.

Suffix:

<n> irrelevant
 <k> Selects the limit line.

Parameters:

<Distance> Numeric value that defines the distance of the shift.
 The unit depends on CALCulate<n>:LIMit<k>:UNIT on page 584.

Example:

CALC:LIM3:LOW:SHIF 20DB
 Shifts all Y values of limit line 3 by 20 dB.

CALCulate<n>:LIMit<k>:LOWer:SPACing <InterpolType>

This command selects linear or logarithmic interpolation for the lower limit line.

Suffix:

<n> irrelevant
 <k> 1...8
 Selects the limit line.

Parameters:

<InterpolType> LINear | LOGarithmic
 *RST: LIN

Example:

CALC:LIM:LOW:SPAC LIN

CALCulate<n>:LIMit<k>:LOWer:STATe <State>

This command turns a lower limit line on and off.

Before you can use this command, you have to select a limit line with

[CALCulate<n>:LIMit<k>:NAME](#).

The limit check is activated separately with [CALCulate<n>:LIMit<k>:STATe](#). The result of the limit check can be queried with [CALCulate<n>:LIMit<k>:FAIL?](#).

Suffix:

<n> irrelevant
 <k> 1...8
 Selects the limit line.

Parameters:

<State> ON | OFF
 *RST: OFF

Example:

`CALC:LIM4:LOW:STAT ON`
 Switches on limit line 4 (lower limit).

CALCulate<n>:LIMit<k>:LOWer:THReshold <Threshold>

This command defines a threshold for relative limit lines.

The R&S FSVR uses the threshold for the limit check, if the limit line violates the threshold.

Suffix:

<n> irrelevant
 <k> 1...8
 Selects the limit line.

Parameters:

<Threshold> Numeric value that defines the threshold.
 The unit depends on [CALCulate<n>:LIMit<k>:UNIT](#).
 *RST: -200 dBm

Example:

`CALC:LIM2:LOW:THR -35DBM`
 Defines an absolute threshold value for limit line 2.

CALCulate:LIMit:UPPer Subsystem

The `CALCulate:LIMit:UPPer` subsystem defines the upper limit line.

CALCulate<n>:LIMit<k>:UPPer[:DATA]	604
CALCulate<n>:LIMit<k>:UPPer:MARGin	604
CALCulate<n>:LIMit<k>:UPPer:MODE	605
CALCulate<n>:LIMit<k>:UPPer:OFFSet	605
CALCulate<n>:LIMit<k>:UPPer:SHIFt	605

CALCulate<n>:LIMit<k>:UPPer:SPACing.....	606
CALCulate<n>:LIMit<k>:UPPer:STATe.....	606
CALCulate<n>:LIMit<k>:UPPer:THReshold.....	606

CALCulate<n>:LIMit<k>:UPPer[:DATA] <LimitLinePoints>

This command defines the vertical definition points of an upper limit line.

If the measured values exceed the UPPer limit line, the limit is violated.

Suffix:

<n>	irrelevant
<k>	1...8 Selects the limit line.

Parameters:

<LimitLinePoints>	Variable number of x-axis values. Note that the number of horizontal values has to be the same as the number of vertical values set with <code>CALCulate<n>:LIMit<k>:CONTRol[:DATA]</code> . If not, the R&S FSVR either adds missing values or ignores surplus values. The unit depends on <code>CALCulate<n>:LIMit<k>:UNIT</code> . *RST: (LIMit:STATe is set to OFF)
-------------------	--

Example:

```
CALC:LIM2:UPP -10,0,0,-10,-5
```

Defines 5 upper limit values for limit line 2 in the preset unit.

```
CALC:LIM2:UPP?
```

Outputs the upper limit values for limit line 2 separated by a comma.

Manual operation: See "Edit Value" on page 259

CALCulate<n>:LIMit<k>:UPPer:MARGin <Margin>

This command defines an area around a upper limit line where limit check violations are still tolerated.

Suffix:

<n>	irrelevant
<k>	1...8 Selects the limit line.

Parameters:

<Margin>	Numeric value that defines the margin. In spectrum mode, the unit is always dB. *RST: 0
----------	---

Example:

```
CALC:LIM2:UPP:MARG 10dB
```

Defines the margin of limit line 2 to 10 dB below the limit value.

CALCulate<n>:LIMit<k>:UPPer:MODE <Mode>

This command selects the vertical limit line scaling.

Suffix:

<n>	irrelevant
<k>	1...8 Selects the limit line.

Parameters:

<Mode>	ABSolute Limit line is defined by absolute physical values. The unit is variable.
	RELative Limit line is defined by values relative to the reference level (dB).
*RST:	ABSolute

Example:

```
CALC:LIM2:UPP:MODE REL
```

Defines the y-axis of limit line 2 as relative scaled.

CALCulate<n>:LIMit<k>:UPPer:OFFSet <Offset>

This command defines an offset for a complete upper limit line.

Compared to shifting the limit line, an offset does not actually change the limit line definition points.

Suffix:

<n>	irrelevant
<k>	1...8 Selects the limit line.

Parameters:

<Offset>	Numeric value that defines the offset.
*RST:	0

Example:

```
CALC:LIM2:UPP:OFFS 3dB
```

Shifts limit line 2 by 3 dB upwards.

Manual operation: See "[Y Offset](#)" on page 260

CALCulate<n>:LIMit<k>:UPPer:SHIFt <Value>

This command moves a complete upper limit line vertically.

Compared to defining an offset, this command actually changes the limit line definition points by the value you define.

Suffix:

<n>	irrelevant
<k>	1...8 Selects the limit line.

Parameters:

<Distance> Numeric value that defines the distance of the shift.
The unit depends on [CALCulate<n>:LIMit<k>:UNIT](#)
on page 584.

Example:

`CALC:LIM3:UPP:SHIF 20`
Shifts all Y values of limit line 3 by 20 limit line units, e.g. dB.

Usage:

Event

CALCulate<n>:LIMit<k>:UPPer:SPACing <InterpolType>

This command selects linear or logarithmic interpolation for the upper limit line.

Suffix:

<n> irrelevant
<k> 1...8
Selects the limit line.

Parameters:

<InterpolType> LINear | LOGarithmic
*RST: LIN

Example:

`CALC:LIM:UPP:SPAC LIN`

CALCulate<n>:LIMit<k>:UPPer:STATe <State>

This command turns a lower limit line on and off.

Before you can use this command, you have to select a limit line with
[CALCulate<n>:LIMit<k>:NAME](#).

The limit check is activated separately with [CALCulate<n>:LIMit<k>:STATe](#). The
result of the limit check can be queried with [CALCulate<n>:LIMit<k>:FAIL?](#).

Suffix:

<n> irrelevant
<k> 1...8
Selects the limit line.

Parameters:

<State> ON | OFF
*RST: OFF

Example:

`CALC:LIM4:UPP:STAT ON`
Switches on limit line 4 (upper limit).

CALCulate<n>:LIMit<k>:UPPer:THReshold <Threshold>

This command defines a threshold for relative limit lines.

The R&S FSVR uses the threshold for the limit check, if the limit line violates the threshold.

Suffix:

<n>	irrelevant
<k>	1...8 Selects the limit line.

Parameters:

<Threshold>	Numeric value that defines the threshold. The unit depends on <code>CALCulate<n>:LIMit<k>:UNIT</code> .
*RST:	-200 dBm

Example:

```
CALC:LIM2:UPP:THR -35DBM
Defines an absolute threshold value for limit line 2.
```

CALCulate:MARKer Subsystem

The CALCulate:MARKer subsystem checks the marker functions of the instrument.

CALCulate<n>:MARKer<m>[:STATe].....	608
CALCulate<n>:MARKer<m>:AOFF.....	608
CALCulate<n>:MARKer<m>:COUNT.....	608
CALCulate<n>:MARKer<m>:COUNT:FREQuency?.....	609
CALCulate<n>:MARKer<m>:COUNT:RESolution.....	610
CALCulate<n>:MARKer<m>:LINK.....	610
CALCulate<n>:MARKer<m>:LOEXclude.....	610
CALCulate<n>:MARKer<m>:MAXimum[:PEAK].....	611
CALCulate<n>:MARKer<m>:MAXimum:AUTO.....	611
CALCulate<n>:MARKer<m>:MAXimum:LEFT.....	612
CALCulate<n>:MARKer<m>:MAXimum:NEXT.....	612
CALCulate<n>:MARKer<m>:MAXimum:RIGHT.....	613
CALCulate<n>:MARKer<m>:MINimum[:PEAK].....	613
CALCulate<n>:MARKer<m>:MINimum:AUTO.....	614
CALCulate<n>:MARKer<m>:MINimum:LEFT.....	614
CALCulate<n>:MARKer<m>:MINimum:NEXT.....	615
CALCulate<n>:MARKer<m>:MINimum:RIGHT.....	615
CALCulate<n>:MARKer<m>:PEXCursion.....	616
CALCulate<n>:MARKer<m>:SEARCh.....	616
CALCulate<n>:MARKer<m>:TRACe.....	617
CALCulate<n>:MARKer<m>:X.....	618
CALCulate<n>:MARKer<m>:X:SLIMits[:STATe].....	618
CALCulate<n>:MARKer<m>:X:SLIMits:LEFT.....	618
CALCulate<n>:MARKer<m>:X:SLIMits:RIGHT.....	619
CALCulate<n>:MARKer<m>:X:SLIMits:ZOOM.....	620
CALCulate<n>:MARKer<m>:X:SSize.....	620
CALCulate<n>:MARKer<m>:Y.....	620
CALCulate<n>:MARKer<m>:Y:PERCent.....	622
CALCulate<n>:MARKer<m>:Z?.....	622

CALCulate<n>:MARKer<m>[:STATe] <State>

This command turns markers on and off.

If the corresponding marker number is currently active as a deltamarker, it is turned into a normal marker.

Suffix:

<n>	Selects the measurement window.
<m>	depends on mode Selects the marker.

Parameters:

<State>	ON OFF
*RST:	OFF

Example:

CALC:MARK3 ON
Switches on marker 3 or switches to marker mode.

Manual operation: See "[Marker 1 / Marker 2 / Marker 3 / ... Marker 16, / Marker Norm/Delta](#)" on page 120
See "[Marker Wizard](#)" on page 121

CALCulate<n>:MARKer<m>:AOFF

This command all markers off, including delta markers and marker measurement functions.

Suffix:

<n>	Selects the measurement window.
<m>	depends on mode irrelevant

Example:

CALC:MARK:AOFF
Switches off all markers.

Usage:

Event

Manual operation: See "[All Marker Off](#)" on page 122

CALCulate<n>:MARKer<m>:COUNT <State>

This command turns the frequency counter at the marker position for marker 1 on and off.

The count result is queried with `CALCulate<n>:MARKer<m>:COUNT:FREQuency?`.

The frequency counter works for one marker only. If you perform a frequency count with another marker, the R&S FSVR deactivates the frequency count of the first marker.

To get a valid result, you have to perform a complete measurement with synchronization to the end of the measurement before reading out the result. This is only possible for single sweeps.

Suffix:
 <n> Selects the measurement window.
 <m> irrelevant

Parameters:
 <State> ON | OFF
 *RST: OFF

Example:
 INIT:CONT OFF
 Switches to single sweep mode.
 CALC:MARK ON
 Switches on marker 1.
 CALC:MARK:COUN ON
 Switches on the frequency counter for marker 1.
 INIT;*WAI
 Starts a sweep and waits for the end.
 CALC:MARK:COUN:FREQ?
 Outputs the measured value.

Manual operation: See "[Signal Count](#)" on page 129

CALCulate<n>:MARKer<m>:COUNT:FREQUency?

This command queries the result of the frequency counter for marker 1.

To get a valid result, you have to perform a complete measurement with synchronization to the end of the measurement before reading out the result. This is only possible for single sweeps.

Suffix:
 <n> Selects the measurement window.
 <m> irrelevant

Return values:
 <Frequency> Frequency at the marker position.

Example:
 INIT:CONT OFF
 Switches to single sweep mode.
 CALC:MARK ON
 Switches on marker 2.
 CALC:MARK:COUN ON
 Activates the frequency counter for marker 1.
 INIT;*WAI
 Starts a sweep and waits for the end.
 CALC:MARK:COUN:FREQ?
 Outputs the measured value of marker 1.

Usage: Query only

Manual operation: See "[Signal Count](#)" on page 129

CALCulate<n>:MARKer<m>:COUNT:RESolution <Resolution>

This command specifies the resolution of the frequency counter (marker 1).

Suffix:

<n> Selects the measurement window.
 <m> irrelevant

Parameters:

<Resolution> 0.001 | 0.01 | 0.1 | 1 | 10 | 100 | 1000 | 10000 Hz
 *RST: 0.1 Hz

Example:

CALC:MARK:COUN:RES 1kHz
 Sets the resolution of the frequency counter to 1 kHz.

CALCulate<n>:MARKer<m>:LINK <DisplayType>

Links the markers in all displays of the specified type.

Suffix:

<n> 1...4
 window
 <m> 1...16
 marker

Parameters:

<DisplayType> TIME | SPECTrum | BOTH | NONE

TIME

Links the markers in all time domain diagrams

SPECTrum

Links the markers in all AF Spectrum displays

BOTH

Links the markers both in the time domain diagrams and in the AF Spectrum displays

NONE

Markers are not linked.

*RST: NONE

Example:

CALC1:MARK1:LINK TIME
 Links the marker 1 in all time domain diagrams in screen A.

Mode:

ADEMOD

Manual operation:

See "[Link Time Marker](#)" on page 378
 See "[Link AF Spectrum Marker](#)" on page 379

CALCulate<n>:MARKer<m>:LOEXclude <State>

This command turns the local oscillator suppression during a peak search on or off.

Suffix:

<n> Selects the measurement window.

<m> irrelevant

Parameters:

<State> ON | OFF

*RST: ON

Example:

CALC:MARK:LOEX ON

Manual operation: See ["Exclude LO"](#) on page 146

CALCulate<n>:MARKer<m>:MAXimum[:PEAK]

This command positions the marker on the current trace maximum.

The corresponding marker is activated first or switched to the marker mode.

If no maximum value is found on the trace (level spacing to adjacent values < peak excursion), an execution error (error code: -200) is produced.

In "Spectrogram" mode, this command positions the specified marker on the current peak level of the x-axis. The search is performed within the current frame. It does not change the position of the marker on the y-axis.

Suffix:

<n> Selects the measurement window.

<m> depends on mode
Selects the marker.

Example:

CALC:MARK2:MAX

Positions marker 2 to the maximum value of the trace.

Usage:

Event

Manual operation:

See ["Peak"](#) on page 143

See ["Marker Search Type"](#) on page 147

CALCulate<n>:MARKer<m>:MAXimum:AUTO <State>

This command turns an automatic marker peak search for a trace maximum on and off. The command performs the peak search after each sweep.

An automatic peak search may be used during adjustments of a device under test to keep track of the actual peak marker position and level.

If no maximum value is found on the trace (level spacing to adjacent values < peak excursion), an execution error (error code: -200) is produced.

Suffix:

<n> Selects the measurement window.

<m> Selects the marker.

Parameters:

<State> ON | OFF
 *RST: OFF

Example:

CALC:MARK:MAX:AUTO ON
 Activates the automatic peak search function for marker 1 at the end of each particular sweep.

Usage: Event

Manual operation: See ["Auto Max Peak/Auto Min Peak"](#) on page 144

CALCulate<n>:MARKer<m>:MAXimum:LEFT

This command positions a marker to the next smaller trace maximum on the left of the current position (i.e. in descending X values).

If no next smaller maximum value is found on the trace (level spacing to adjacent values < peak excursion), an execution error (error code: -200) is produced.

In "Spectrogram" mode, this command positions the specified marker on the next peak level of the x-axis. The search includes only the data to the left of the current marker position in the current frame. It does not change the position of the marker on the y-axis.

Suffix:

<n> Selects the measurement window.
 <m> Selects the marker.

Example:

CALC:MARK2:MAX:LEFT
 Positions marker 2 to the next lower maximum value to the left of the current value.

Usage: Event

Manual operation: See ["Next Mode"](#) on page 145
 See ["Search Mode for Next Peak in X Direction"](#) on page 146

CALCulate<n>:MARKer<m>:MAXimum:NEXT

This command positions the marker to the next smaller trace maximum.

If no next smaller maximum value is found on the trace (level spacing to adjacent values < peak excursion), an execution error (error code: -200) is produced.

In "Spectrogram" mode, this command positions the specified marker on the next peak level of the x-axis. The search includes the data in both directions of the current marker position in the current frame. It does not change the position of the marker on the y-axis.

Suffix:

<n> Selects the measurement window.
 <m> Selects the marker.

Example:	<code>CALC:MARK2:MAX:NEXT</code> Positions marker 2 to the next lower maximum value.
Usage:	Event
Manual operation:	See "Next Peak" on page 143 See "Next Mode" on page 145 See "Search Mode for Next Peak in X Direction" on page 146

CALCulate<n>:MARKer<m>:MAXimum:RIGHT

This command positions a marker to the next smaller trace maximum on the right of the current value (i.e. in ascending X values).

If no next smaller maximum value is found on the trace (level spacing to adjacent values < peak excursion), an execution error (error code: -200) is produced.

In "Spectrogram" mode, this command positions the specified marker on the next peak level of the x-axis. The search includes only the data to the right of the current marker position in the current frame. It does not change the position of the delta marker on the y-axis.

Suffix:

<n>	Selects the measurement window.
<m>	Selects the marker.

Example:	<code>CALC:MARK2:MAX:RIGHT</code> Positions marker 2 to the next lower maximum value to the right of the current value.
-----------------	--

Usage:	Event
---------------	-------

Manual operation:	See "Next Mode" on page 145 See "Search Mode for Next Peak in X Direction" on page 146
--------------------------	---

CALCulate<n>:MARKer<m>:MINimum[:PEAK]

This command positions the marker on the current trace minimum.

The corresponding marker is activated first or switched to marker mode, if necessary.

If no minimum value is found on the trace (level spacing to adjacent values < peak excursion), an execution error (error code: -200) is produced.

In "Spectrogram" mode, this command positions the specified marker on the current minimum level of the x-axis. The search is performed within the current frame. It does not change the position of the marker on the y-axis / frames.

Suffix:

<n>	Selects the measurement window.
<m>	depends on mode Selects the marker.

Example:	<code>CALC:MARK2:MIN</code> Positions marker 2 to the minimum value of the trace.
Usage:	Event
Manual operation:	See " Min " on page 144 See " Marker Search Type " on page 147

CALCulate<n>:MARKer<m>:MINimum:AUTO <State>

This command turns an automatic marker peak search for a trace maximum on and off. The command performs the peak search after each sweep.

An automatic peak search may be used during adjustments of a device under test to keep track of the actual peak marker position and level.

If no maximum value is found on the trace (level spacing to adjacent values < peak excursion), an execution error (error code: -200) is produced.

Suffix:

<n> Selects the measurement window.

<m> Selects the marker.

Parameters:

<State> ON | OFF

*RST: OFF

Example: `CALC:MARK:MIN:AUTO ON`
Activates the automatic minimum value search function for marker 1 at the end of each particular sweep.

Manual operation: See "[Auto Max Peak/Auto Min Peak](#)" on page 144

CALCulate<n>:MARKer<m>:MINimum:LEFT

This command positions a marker to the next higher trace minimum on the left of the current value (i.e. in descending X direction).

If no next higher minimum value is found on the trace (level spacing to adjacent values < peak excursion), an execution error (error code: -200) is produced.

In "Spectrogram" mode, this command positions the specified marker on the next minimum level of the x-axis. The search includes only the data to the left of the current marker position in the current frame. It does not change the position of the marker on the y-axis.

Suffix:

<n> Selects the measurement window.

<m> Selects the marker.

- Example:** `CALC:MARK2:MIN`
Positions marker 2 to the minimum value of the trace.
`CALC:MARK2:MIN:LEFT`
Positions marker 2 to the next higher minimum value to the left of the current value.
- Usage:** Event
- Manual operation:** See ["Next Mode"](#) on page 145
See ["Search Mode for Next Peak in X Direction"](#) on page 146

CALCulate<n>:MARKer<m>:MINimum:NEXT

This command positions a marker to the next higher trace minimum.

If no next higher minimum value is found on the trace (level spacing to adjacent values < peak excursion), an execution error (error code: -200) is produced.

In "Spectrogram" mode, this command positions the specified marker on the next minimum level of the x-axis. The search includes the data in both directions of the current marker position in the current frame. It does not change the position of the marker on the y-axis.

Suffix:

- <n> Selects the measurement window.
- <m> Selects the marker.

- Example:** `CALC:MARK2:MIN`
Positions marker 2 to the minimum value of the trace.
`CALC:MARK2:MIN:NEXT`
Positions marker 2 to the next higher maximum value.

Usage: Event

- Manual operation:** See ["Next Min"](#) on page 144
See ["Next Mode"](#) on page 145
See ["Search Mode for Next Peak in X Direction"](#) on page 146

CALCulate<n>:MARKer<m>:MINimum:RIGHT

This command positions a marker to the next higher trace minimum on the right of the current value (i.e. in ascending X direction).

If no next higher minimum value is found on the trace (level spacing to adjacent values < peak excursion), an execution error (error code: -200) is produced.

In "Spectrogram" mode, this command positions the specified marker on the current peak level of the x-axis. The search is performed within the current frame. It does not change the position of the marker on the y-axis.

Suffix:

- <n> Selects the measurement window.
- <m> Selects the marker.

- Example:** `CALC:MARK2:MIN`
 Positions marker 2 to the minimum value of the trace.
 `CALC:MARK2:MIN:RIGH`
 Positions marker 2 to the next higher minimum value to the right
 of the current value.
- Usage:** Event
- Manual operation:** See ["Next Mode"](#) on page 145
 See ["Search Mode for Next Peak in X Direction"](#) on page 146

CALCulate<n>:MARKer<m>:PEXCursion <Excursion>

This command defines the peak excursion

The peak excursion sets the requirements for a peak to be detected during a peak search.

The unit depends on the selected operating mode and measurement.

Mode/Display mode	Unit
Spectrum	dB
ADEMOD, RF display	dB
ADEMOD, AM display	PCT
ADEMOD, FM display	kHz
ADEMOD, PM display	RAD

Suffix:

- <n> Selects the measurement window.
- <m> irrelevant

Parameters:

- <Excursion> The peak excursion is the distance to a trace maximum that must be attained before a new maximum is recognized, or the distance to a trace minimum that must be attained before a new minimum is recognized
- *RST: 6dB in "Spectrum" mode and RF displays; 5 PCT in AM displays, 50 kHz in FM displays, (0.5 RAD in PM displays

- Example:** `CALC:MARK:PEXC 10dB`
 Defines peak excursion 10 dB.

- Manual operation:** See ["Peak Excursion"](#) on page 134

CALCulate<n>:MARKer<m>:SEARch <MarkReallmag>

This command selects the trace type a marker search is performed on.

Suffix:

<n> Selects the measurement window.

<m> Selects the marker.

Parameters:

<MarkReallmag>

REAL

Marker search functions are performed on the real trace of the "I/Q" measurement.

IMAG

Marker search functions are performed on the imaginary trace of the "I/Q" measurement.

MAGN

Marker search functions are performed on the magnitude of the I and Q data.

*RST: REAL

Example:

CALC4:MARK:SEAR IMAG

CALCulate<n>:MARKer<m>:TRACe <Trace>

This command selects the trace a marker is positioned on.

The corresponding trace must have a trace mode other than "Blank".

If necessary, the corresponding marker is switched on prior to the assignment.

In the persistence spectrum result display, the command also defines if the marker is positioned on the persistence trace or the maxhold trace.

Suffix:

<n> Selects the measurement window.

<m> depends on mode
Selects the marker.

Parameters:

<Trace>

1 ... 6

Trace number the marker is positioned on.

MAXHold

Defines the maxhold trace as the trace to put the delta marker on.

This parameter is available only for the persistence spectrum result display.

WRITe

Defines the persistence trace as the trace to put the delta marker on.

This parameter is available only for the persistence spectrum result display.

Example:

CALC:MARK3:TRAC 2

Assigns marker 3 to trace 2.

Manual operation: See ["Marker to Trace"](#) on page 121
See ["Marker Wizard"](#) on page 121

CALCulate<n>:MARKer<m>:X <Position>

This command positions a marker on a particular coordinate on the x-axis.

If marker 2, 3 or 4 is selected and used as delta marker, it is switched to marker mode.

Suffix:

<n> Selects the measurement window.

<m> Selects the marker.

Parameters:

<Position> Numeric value that defines the marker position on the x-axis.
The unit is either Hz (frequency domain) or s (time domain) or dB (statistics).

Range: The range depends on the current x-axis range.

Example:

`CALC:MARK2:X 1.7MHz`

Positions marker 2 to frequency 1.7 MHz.

Manual operation: See ["Marker 1 / Marker 2 / Marker 3 / ... Marker 16,/ Marker Norm/Delta"](#) on page 120

CALCulate<n>:MARKer<m>:X:SLIMits[:STATe] <State>

This command turns marker search limits on and off.

If the power measurement in zero span is active, this command limits the evaluation range on the trace.

Suffix:

<n> Selects the measurement window.

<m> marker

Parameters:

<State> ON | OFF

*RST: OFF

Example:

`CALC:MARK:X:SLIM ON`

Switches on search limitation.

Manual operation: See ["Search Limits"](#) on page 144
See ["Search Lim Off"](#) on page 145
See ["Limits \(On/Off\)"](#) on page 226

CALCulate<n>:MARKer<m>:X:SLIMits:LEFT <Limit>

This command sets the left limit of the marker search range.

If the power measurement in zero span is active, this command limits the evaluation range to the trace.

Note: The function is only available if the search limit for marker and delta marker is switched on (see `CALCulate<n>:MARKer<m>:X:SLIMits[:STATe]`).

Suffix:

<n> Selects the measurement window.
 <m> irrelevant

Parameters:

<Limit> The value range depends on the span or sweep time.
 The unit is Hz for frequency domain measurements and s for
 time domain measurements.
 Range: 0 to MAX
 *RST: left diagram border

Example:

```
CALC:MARK:X:SLIM ON
Switches the search limit function on.
CALC:MARK:X:SLIM:LEFT 10MHz
Sets the left limit of the search range to 10 MHz.
```

Manual operation: See "[Left Limit](#)" on page 134
 See "[Left Limit](#)" on page 227

CALCulate<n>:MARKer<m>:X:SLIMits:RIGHT <Limit>

This command sets the right limit of the marker search range.

If the power measurement in zero span is active, this command limits the evaluation range to the trace.

Note: The function is only available if the search limit for marker and delta marker is switched on (`CALCulate<n>:MARKer<m>:X:SLIMits[:STATe]`).

Suffix:

<n> Selects the measurement window.
 <m> irrelevant

Parameters:

<Limit> The value range depends on the span or sweep time.
 The unit is Hz for frequency domain measurements and s for
 time domain measurements.
 Range: 0 to MAX
 *RST: left diagram border

Example:

```
CALC:MARK:X:SLIM ON
Switches the search limit function on.
CALC:MARK:X:SLIM:RIGH 20MHz
Sets the right limit of the search range to 20 MHz.
```

Manual operation: See "[Right Limit](#)" on page 135
 See "[Right Limit](#)" on page 227

CALCulate<n>:MARKer<m>:X:SLIMits:ZOOM <State>

This command sets the limits of the marker search range to the zoom area.

Note: The function is only available if the search limit for marker and delta marker is switched on (see `CALCulate<n>:MARKer<m>:X:SLIMits[:STATe]`).

Suffix:

<n> irrelevant

<m> irrelevant

Parameters:

<State> ON | OFF

*RST: OFF

Example:

`CALC:MARK:X:SLIM:ZOOM ON`

Switches the search limit function on.

`CALC:MARK:X:SLIM:RIGH 20MHz`

Sets the right limit of the search range to 20 MHz.

Manual operation: See "Use Zoom Limits" on page 145

CALCulate<n>:MARKer<m>:X:SSIZe <StepSize>

This command defines the step size of the rotary knob for marker or delta marker value changes. It only takes effect in manual operation.

The marker step size is unavailable for statistical measurements.

Suffix:

<n> irrelevant

<m> irrelevant

Parameters:

<StepSize>

STANDARD

step size corresponds to space between two pixels

POINTS

step size corresponds to space between two measured values (number of measured values is defined via the

`[SENSe<n>:]SWEep:POINTs` command, see `[SENSe:]SWEep:POINTs` on page 872)

*RST: POINTs

Example:

`CALC:MARK:X:SSIZ STAN`

Sets the measured value step size.

Manual operation: See "Stepsize Standard" on page 123
See "Stepsize Sweep Points" on page 123

CALCulate<n>:MARKer<m>:Y <MarkerPosition>

This command queries the measured value of a marker.

If necessary, the command activates the marker or turns a delta marker into a normal marker.

In the persistence spectrum result display of the realtime analyzer, it is also possible to set the marker with this command. You can select whether to query the results of the persistence trace or the maxhold trace with `CALCulate<n>:DELTAmarker<m>:TRACe` on page 567.

To get a valid result, you have to perform a complete measurement with synchronization to the end of the measurement before reading out the result. This is only possible for single sweeps.

In the default setting, the output is made depending on the unit determined with `CALCulate<n>:UNIT:POWer`; only with linear level scaling the output is in %.

If the analog demodulator (option Analog Demodulation, R&S FSVR–K7) is activated, the query result is output in the following units in the window specified by the suffix <1...4>:

Result display	Output unit
AM	%
FM	Hz
PM	rad/deg (defined with <code>CALCulate<n>:UNIT:ANGLe</code> on page 704)
RF	dB (Range Log or Range Linear %) % (Range Linear dB)

Suffix:

<n> Selects the measurement window.

<m> Selects the marker.

Parameters:

<MarkerPosition> Defines the vertical marker position in the persistence spectrum result display.

Return values:

<Result> The measured value of the selected marker is returned. In I/Q Analyzer mode, if the result display configuration "Real/Imag (I/Q)" is selected, this query returns the Real (Q) value of the marker first, then the Imag (I) value.

Example:

```
INIT:CONT OFF
Switches to single sweep mode.
CALC:MARK2 ON
Switches marker 2.
INIT;*WAI
Starts a sweep and waits for the end.
CALC:MARK2:Y?
Outputs the measured value of marker 2.
In I/Q Analyzer mode, for "Real/Imag (I/Q)", for example:
1.852719887E-011,0
```

Manual operation: See "[Marker 1 / Marker 2 / Marker 3 / ... Marker 16, / Marker Norm/Delta](#)" on page 120

CALCulate<n>:MARKer<m>:Y:PERCent <Probability>

This command positions the selected marker to the given probability.

If you use the command in combination with a delta marker, that delta marker is turned into a normal marker.

Note: The command is only available for CCDF measurements. You can query the associated level value with [CALCulate<n>:MARKer<m>:X](#).

Suffix:

<n> Selects the measurement window.

<m> Selects the marker.

Parameters:

<Probability> Range: 0 to 100
Default unit: PCT

Example: `CALC1:MARK:Y:PERC 95PCT`
Positions marker 1 to a probability of 95 %.

Manual operation: See "[Percent Marker](#)" on page 237

CALCulate<n>:MARKer<m>:Z?

This command queries the z-axis value of the indicated marker in the persistence spectrum result display.

You can select whether to query the results of the persistence trace or the maxhold trace with [CALCulate<n>:DELTAmarker<m>:TRACe](#) on page 567.

Return values:

<percentage> The return value is the percentage of hits on the marker position.

Usage: Query only

Mode: RT

CALCulate:MARKer:FUNCTION Subsystem

The CALCulate:MARKer<m>:FUNCTION subsystem checks the marker functions in the instrument.

CALCulate<n>:MARKer<m>:FUNCTION:BPOWER:MODE	623
CALCulate<n>:MARKer<m>:FUNCTION:BPOWER:RESult?	624
CALCulate<n>:MARKer<m>:FUNCTION:BPOWER:SPAN	624
CALCulate<n>:MARKer<m>:FUNCTION:BPOWER[.STATe]	624
CALCulate<n>:MARKer<m>:FUNCTION:CENTer	625
CALCulate<n>:MARKer<m>:FUNCTION:CSTep	625
CALCulate<n>:MARKer<m>:FUNCTION:DEModulation:CONTInuous	625
CALCulate<n>:MARKer<m>:FUNCTION:DEModulation:HOLDoff	626

CALCulate<n>:MARKer<m>:FUNCTion:DEModulation:SElect.....	626
CALCulate<n>:MARKer<m>:FUNCTion:DEModulation[:STATe].....	627
CALCulate<n>:MARKer<m>:FUNCTion:FPEaks[:IMMediate].....	627
CALCulate<n>:MARKer<m>:FUNCTion:FPEaks:ANN:LAB:STAT.....	628
CALCulate<n>:MARKer<m>:FUNCTion:FPEaks:COUNT?.....	629
CALCulate<n>:MARKer<m>:FUNCTion:FPEaks:LIST:SIZE.....	629
CALCulate<n>:MARKer<m>:FUNCTion:FPEaks:SEAR:AUTO.....	629
CALCulate<n>:MARKer<m>:FUNCTion:FPEaks:SORT.....	630
CALCulate<n>:MARKer<m>:FUNCTion:FPEaks:STAT.....	630
CALCulate<n>:MARKer<m>:FUNCTion:FPEaks:X.....	630
CALCulate<n>:MARKer<m>:FUNCTion:FPEaks:Y?.....	631
CALCulate<n>:MARKer<m>:FUNCTion:MDEPth:RESult?.....	632
CALCulate<n>:MARKer<m>:FUNCTion:MDEPth:SEARChsignal ONCE.....	632
CALCulate<n>:MARKer<m>:FUNCTion:MDEPth[:STATe].....	632
CALCulate<n>:MARKer<m>:FUNCTion:NDBDown.....	633
CALCulate<n>:MARKer<m>:FUNCTion:NDBDown:FREQuency?.....	634
CALCulate<n>:MARKer<m>:FUNCTion:NDBDown:QFACtor.....	634
CALCulate<n>:MARKer<m>:FUNCTion:NDBDown:RESult?.....	635
CALCulate<n>:MARKer<m>:FUNCTion:NDBDown:STATe.....	635
CALCulate<n>:MARKer<m>:FUNCTion:NDBDown:TIME?.....	636
CALCulate<n>:MARKer<m>:FUNCTion:NOISe[:STATe].....	636
CALCulate<n>:MARKer<m>:FUNCTion:NOISe:RESult.....	637
CALCulate<n>:MARKer<m>:FUNCTion:PNOise:RESult?.....	637
CALCulate<n>:MARKer<m>:FUNCTion:PNOise.....	638
CALCulate<n>:MARKer<m>:FUNCTion:REFerence.....	638
CALCulate<n>:MARKer<m>:FUNCTion:TOI:RESult?.....	639
CALCulate<n>:MARKer<m>:FUNCTion:TOI:SEARChsignal ONCE.....	639
CALCulate<n>:MARKer<m>:FUNCTion:TOI[:STATe].....	640
CALCulate<n>:MARKer<m>:FUNCTion:ZOOM.....	640

CALCulate<n>:MARKer<m>:FUNCTion:BPOWER:MODE <Mode>

This command selects the way the results for a band power marker are displayed.

Suffix:

<n>	irrelevant
<m>	irrelevant

Parameters:

<Mode>	POWER Result is displayed as a power in dBm.
	DENSity Result is displayed as a density in dBm/Hz.
*RST:	POW

Example:

CALC:MARK:FUNC:BPOW:MODE DENS

Manual operation:

See "Power" on page 136
See "Density" on page 136

CALCulate<n>:MARKer<m>:FUNCTION:BPOWER:RESult?

This command queries the results of the band power measurement.

Suffix:

<n> irrelevant
<m> irrelevant

Return values:

<Power> Signal power over the marker bandwidth.

Example:

Activate the band power marker:

```
CALC:MARK:FUNC:BPOW:STAT ON
```

Select the density mode for the result:

```
CALC:MARK:FUNC:BPOW:MODE DENS
```

Query the result:

```
CALC:MARK:FUNC:BPOW:RES?
```

Response:

```
20dBm/Hz
```

Usage: Query only

Manual operation: See "Power" on page 136
See "Density" on page 136

**CALCulate<n>:MARKer<m>:FUNCTION:BPOWER:SPAN **

This command defines the bandwidth around the marker position.

Suffix:

<n> irrelevant
<m> irrelevant

Parameters:

 Numeric value that defines the span in Hz.
The maximum span depends on the marker position and R&S FSVR model.

*RST: 5% of current span

Example:

```
CALC:MARK:FUNC:BPOW:SPAN 20
```

Manual operation: See "Span" on page 136

CALCulate<n>:MARKer<m>:FUNCTION:BPOWER[:STATe] <State>

This command turns markers for band power measurements on and off.

If necessary, the command also turns on a marker. If a marker is already on, the currently active marker is used as the band power marker (all other marker functions for this marker are deactivated).

For details see [chapter 4.2.3.8, "Performing Band Power Measurements"](#), on page 140.

Suffix:

<n> irrelevant

<m> irrelevant

Parameters:

<State> **ON | OFF**

*RST: OFF

Example:

CALC:MARK:FUNC:BPOW:STAT ON

Manual operation: See ["Band Power On/Off"](#) on page 136

CALCulate<n>:MARKer<m>:FUNCtion:CENTer

This command matches the center frequency to the frequency of a marker.

If you use the command in combination with a delta marker, that delta marker is turned into a normal marker.

Suffix:

<n> Selects the measurement window.

<m> Selects the marker.

Example:

CALC:MARK2:FUNC:CENT

Sets the center frequency to the frequency of marker 2.

Manual operation: See ["Center =Mkr Freq \(span > 0\)"](#) on page 143

CALCulate<n>:MARKer<m>:FUNCtion:CSTep

This command matches the center frequency step size to the current marker frequency.

The command turns delta markers into normal markers.

Suffix:

<n> Selects the measurement window.

<m> Selects the marker.

Example:

CALC:MARK3:FUNC:CST

Sets the center frequency to the same value as the frequency of marker 3.

Usage:

Event

CALCulate<n>:MARKer<m>:FUNCtion:DEModulation:CONTInuous <State>

This command turns continuous demodulation of the signal at the marker position in the frequency domain on and off.

Thus acoustic monitoring of the signals can be performed.

In the time domain continuous demodulation is always on.

This command is only available if the R&S FSVR option B3 (Audio Demodulator) is installed.

Suffix:

<n> Selects the measurement window.

<m> Selects the marker.

Parameters:

<State> ON | OFF

*RST: OFF

Example:

CALC2:MARK3:FUNC:DEM:CONT ON

Switches on the continuous ' demodulation.

Manual operation: See "[Continuous Demod \(span > 0\)](#)" on page 132

CALCulate<n>:MARKer<m>:FUNctioN:DEMOdulation:HOLDoff <Duration>

This command defines for how long the the signal at the marker position is demodulated.

This command is only available if the R&S FSVR option B3 (Audio Demodulator) is installed.

Suffix:

<n> Selects the measurement window.

<m> Selects the marker.

Parameters:

<Duration> Range: 10 ms to 1000 s

*RST: Marker demodulation = OFF

Example:

CALC:MARK:FUNC:DEM:HOLD 3s

Manual operation: See "[Mkr Stop Time](#)" on page 132

CALCulate<n>:MARKer<m>:FUNctioN:DEMOdulation:SElect <DemodMode>

This command selects the demodulation mode for the audio demodulator.

This command is only available if the R&S FSVR option B3 (Audio Demodulator) is installed.

Suffix:

<n> Selects the measurement window.

<m> irrelevant

Parameters:

<DemodMode> AM | FM

*RST: AM

Example:

CALC:MARK:FUNC:DEM:SEL FM

Manual operation: See "AM" on page 132
See "FM" on page 132

CALCulate<n>:MARKer<m>:FUNction:DEModulation[:STATe] <State>

This command turns the audio demodulator on and off when the measurement reaches a marker position.

In the frequency domain, the hold time can be defined at the corresponding marker position with `CALCulate<n>:MARKer<m>:FUNction:DEModulation:HOLDOff`.

In the time domain continuous demodulation is always on.

This command is only available if the R&S FSVR option B3 (Audio Demodulator) is installed.

Suffix:

<n> Selects the measurement window.

<m> Selects the marker.

Parameters:

<State> ON | OFF
*RST: OFF

Example: `CALC:MARK3:FUNC:DEM ON`
Switches on the demodulation for marker 3.

Manual operation: See "Mkr Demod On/Off" on page 132

CALCulate<n>:MARKer<m>:FUNction:FPEaks[:IMMediate] <NoMaxima>

This command initiates a peak search.

The results can be queried with:

- Position of a peak on the x-axis: `CALCulate<n>:MARKer<m>:FUNction:FPEaks:X`
- Position of a peak on the y-axis: `CALCulate<n>:MARKer<m>:FUNction:FPEaks:Y?`
- Number of peaks in the list: `CALCulate<n>:MARKer<m>:FUNction:FPEaks:COUNT?`

The order the results are returned in is selected with `CALCulate<n>:MARKer<m>:FUNction:FPEaks:SORT`.

The trace the peaks search is performed on is selected with `CALCulate<n>:MARKer<m>:TRACe`.

Number of found maxima

The number of maxima found depends on the waveform and value set for the Peak Excursion parameter (see `CALCulate<n>:MARKer<m>:PEXCursion`), however, a maximum number of 200 maxima are determined. Only the signals which exceed their surrounding values at least by the value indicated by the peak excursion parameter are recognized as maxima. Therefore, the number of maxima found is not automatically the same as the number of maxima desired.

Suffix:

<n> Selects the measurement window.

<m> Selects the marker.

Parameters:

<NoMaxima> Range: 1 to 200

Example:

```
INIT:CONT OFF
```

Switches to single sweep mode

```
INIT;*WAI
```

Starts measurement and synchronizes to end

```
CALC:MARK:TRAC 1
```

Sets marker 1 to trace 1

```
CALC:MARK:FUNC:FPE:SORT X
```

Sets the sort mode to increasing X values

```
CALC:MARK:FUNC:FPE 3;*WAI
```

Searches the 3 highest maxima for trace 1 and synchronizes to end

```
CALC:MARK:FUNC:FPE:COUN?
```

Queries the number of maxima found

```
CALC:MARK:FUNC:FPE:Y?
```

Queries the level of maxima found

```
CALC:MARK:FUNC:FPE:X?
```

Queries the frequencies (span <> 0) or time (span = 0) of maxima found.

CALCulate<n>:MARKer<m>:FUNCTION:FPEaks:ANN:LAB:STAT <State>

This command turns labels for peaks found during a peak search on and off.

The labels correspond to the marker number in the marker peak list.

Suffix:

<n> Selects the measurement window.

<m> Selects the marker.

Parameters:

<State> **ON | OFF**

```
*RST: ON
```

Example:

```
CALC:MARK:FUNC:FPE:ANN:LAB:STAT OFF
```

Removes the peak labels from the diagram

Manual operation: See "[Marker Number](#)" on page 135

CALCulate<n>:MARKer<m>:FUNCTion:FPEaks:COUNT?

This command queries the number of peaks that have been found during a peak search.

Suffix:

<n> irrelevant
<m> Selects the marker.

Return values:

<NumberOfPeaks>

Example:

```
CALC:MARK:FUNC:FPE 3
Searches the 3 highest maxima for trace 1
CALC:MARK:FUNC:FPE:COUN?
Queries the number of maxima found
```

Usage: Query only

Manual operation: See "[Marker Peak List](#)" on page 134

CALCulate<n>:MARKer<m>:FUNCTion:FPEaks:LIST:SIZE <MaxNoPeaks>

This command defines the maximum number of peaks the marker peak list may contain.

Suffix:

<n> Selects the measurement window.
<m> Selects the marker.

Parameters:

<MaxNoPeaks> Maximum number of peaks to be determined.
*RST: 50

Example:

```
CALC:MARK:FUNC:FPE:LIST:SIZE 10
The marker peak list will contain a maximum of 10 peaks.
```

Manual operation: See "[Max Peak Count](#)" on page 134

CALCulate<n>:MARKer<m>:FUNCTion:FPEaks:SEAR:AUTO <State>

This command turns the marker peak search on and off.

This command is retained for compatibility with R&S FSP only. Use [CALCulate<n>:MARKer<m>:FUNCTion:FPEaks:STAT](#) instead.

Suffix:

<n> Selects the measurement window.
<m> Selects the marker.

Parameters:

<State> ON | OFF
*RST: OFF

Example: `CALC:MARK:FUNC:FPE:SEAR:AUTO ON`
 Activates marker peak search

CALCulate<n>:MARKer<m>:FUNction:FPEaks:SORT <SortMode>

This command selects the order in which the results of a peak search are returned.

Suffix:

<n> Selects the measurement window.

<m> Selects the marker.

Parameters:

<SortMode> **X**
 Sorts the peaks according to increasing position on the x-axis.
Y
 Sorts the peaks according to decreasing position on the y-axis.

Example: `CALC:MARK:FUNC:FPE:SORT Y`
 Sets the sort mode to decreasing y values

Manual operation: See "[Sort Mode Freq/Lvl](#)" on page 134

CALCulate<n>:MARKer<m>:FUNction:FPEaks:STAT <State>

This command turns a peak search on and off.

Suffix:

<n> Selects the measurement window.

<m> Selects the marker.

Parameters:

<State> ON | OFF
 *RST: OFF

Example: `CALC:MARK:FUNC:FPE:STAT ON`
 Activates marker peak search

Manual operation: See "[Peak List On/Off](#)" on page 134

CALCulate<n>:MARKer<m>:FUNction:FPEaks:X

This command queries the position of the peaks on the x-axis.

The order depends on the sort order that has been set with `CALCulate<n>:MARKer<m>:FUNction:FPEaks:SORT` on page 630.

The number of peaks on the number that has been set with `CALCulate<n>:MARKer<m>:FUNction:FPEaks:COUNT?`.

Suffix:

<n> Selects the measurement window.

<m> Selects the marker.

Return values:

<PeakPosition> Position of the peaks on the x-axis. The unit depends on the measurement.

Example:

```
CALC:MARK:FUNC:FPE:SORT Y
```

Sets the sort mode to decreasing y values

```
CALC:MARK:FUNC:FPE 3
```

Searches the 3 highest maxima for trace 1

```
CALC:MARK:FUNC:FPE:COUN?
```

Queries the number of maxima found

```
CALC:MARK:FUNC:FPE:X?
```

Queries the frequencies (span <> 0) or. time (span = 0) of the maxima found

```
107.5E6,153.8E6,187.9E6
```

frequencies in increasing order

```
2.05E-3,2.37E-3, 3.71e-3
```

times in increasing order

Manual operation: See "[Marker Peak List](#)" on page 134

CALCulate<n>:MARKer<m>:FUNction:FPEaks:Y?

This command queries the position of the peaks on the y-axis.

The order depends on the sort order that has been set with [CALCulate<n>:MARKer<m>:FUNction:FPEaks:SORT](#) on page 630.

The number of peaks on the number that has been set with [CALCulate<n>:MARKer<m>:FUNction:FPEaks:COUNT?](#).

Suffix:

<n> Selects the measurement window.

<m> Selects the marker.

Return values:

<PeakPosition> Position of the peaks on the y-axis. The unit depends on the measurement.

Example:

```
CALC:MARK:FUNC:FPE:SORT Y
```

Sets the sort mode to decreasing y values

```
CALC:MARK:FUNC:FPE 3
```

Searches the 3 highest maxima for trace 1

```
CALC:MARK:FUNC:FPE:COUN?
```

Queries the number of maxima found

```
CALC:MARK:FUNC:FPE:Y?
```

Queries the levels of the maxima found

Usage:

Query only

Manual operation: See "[Marker Peak List](#)" on page 134

CALCulate<n>:MARKer<m>:FUNction:MDEPth:RESult?

This command queries the results of the AM modulation depth measurement..

To get a valid result, you have to perform a complete measurement with synchronization to the end of the measurement before reading out the result. This is only possible for single sweeps.

Suffix:

<n> Selects the measurement window.

<m> irrelevant

Example:

```
INIT:CONT OFF
```

Switches to single sweep mode.

```
CALC:MARK:X 10MHZ
```

Sets the reference marker (marker 1) to the carrier signal at 10 MHz.

```
CALC:MARK:FUNC:MDEP ON
```

Switches on the modulation depth measurement.

```
INIT;*WAI
```

Starts a sweep and waits for the end.

```
CALC:MARK:FUNC:MDEP:RES?
```

Outputs the measured value.

Usage: Query only

Manual operation: See ["AM Mod Depth"](#) on page 154
See ["AM Mod Depth"](#) on page 251

CALCulate<n>:MARKer<m>:FUNction:MDEPth:SEARChsignal ONCE

This command initiates a search for the signals required for the AM depth measurement.

Note that the command does not perform a new measurement, but looks for the signals on the current trace.

Suffix:

<n> Selects the measurement window.

<m> irrelevant

Example:

```
CALC:MARK:FUNC:MDEP:SEAR ONCE
```

Executes the search of an AM modulated signal at the currently available trace.

Usage: Event
SCPI confirmed

Manual operation: See ["Search Signals"](#) on page 252

CALCulate<n>:MARKer<m>:FUNction:MDEPth[:STATe] <State>

This command turns the AM Modulation Depth measurement on and off.

To work correctly, the measurement requires an AM modulated signal.

If necessary, the command positions marker 1 on the signal with the highest level.

The level value of marker 1 is regarded as the carrier level. On activating the function, marker 2 and marker 3 are automatically set as delta markers symmetrically to the carrier to the adjacent maxima of the trace.

If the position of delta marker 2 is changed, delta marker 3 is moved symmetrically with respect to the reference marker (marker 1). If the position of delta marker 3 is changed, fine adjustment can be performed independently of delta marker 2.

The power at the marker positions is calculated from the measured levels.

The AM modulation depth is calculated from the ratio of power values at the reference marker and the delta markers. If the two AM sidebands differ in power, the average value of the two power values is used for calculating the AM modulation depth.

Suffix:

<n> Selects the measurement window.

<m> irrelevant

Parameters:

<State> ON | OFF

*RST: OFF

Example:

CALC:MARK:X 10MHZ

Sets the reference marker (marker 1) to the carrier signal at 10 MHz.

CALC:MARK:FUNC:MDEP ON

Switches on the modulation depth measurement.

CALC:DELT2:X 10KHZ

Sets delta markers 2 and 3 to the signals at 10 kHz from the carrier signal.

CALC:DELT3:X 9.999KHZ

Corrects the position of delta marker 3 relative to delta marker 2.

Manual operation: See "AM Mod Depth" on page 154

See "AM Mod Depth" on page 251

CALCulate<n>:MARKer<m>:FUNction:NDBDown <Distance>

This command defines the distance of the n dB down markers to the reference marker.

The temporary markers T1 and T2 are positioned n dB below the active reference marker. The frequency and time position of these markers can be queried with [CALCulate<n>:MARKer<m>:FUNction:NDBDown:FREQuency?](#) and [CALCulate<n>:MARKer<m>:FUNction:NDBDown:TIME?](#). The bandwidth between the markers can be queried with [CALCulate<n>:MARKer<m>:FUNction:NDBDown:RESult?](#).

Suffix:

<n> Selects the measurement window.

<m> irrelevant

Parameters:

<Distance> Distance of the temporary markers to the reference marker in dB.

*RST: 6dB

Example:

CALC:MARK:FUNC:NDBD 3dB

Sets the level spacing to 3 dB.

Manual operation: See "[n dB down](#)" on page 133

CALCulate<n>:MARKer<m>:FUNction:NDBDown:FREQuency?

This command queries the position of the n dB down markers on the x-axis when measuring in the frequency domain.

To get a valid result, you have to perform a complete measurement with synchronization to the end of the measurement before reading out the result. This is only possible for single sweeps.

Suffix:

<n> Selects the measurement window.

<m> irrelevant

Return values:

<Frequency>

<frequency 1>

absolute frequency of the n dB marker to the left of the reference marker in Hz

<frequency 2>

absolute frequency of the n dB marker to the right of the reference marker in Hz

Example:

INIT:CONT OFF

Switches to single sweep mode.

CALC:MARK:FUNC:NDBD ON

Switches on the n dB down function.

INIT;*WAI

Starts a sweep and waits for the end.

CALC:MARK:FUNC:NDBD:FREQ?

Outputs the frequencies of the temporary markers.

Usage: Query only

Manual operation: See "[n dB down](#)" on page 133

CALCulate<n>:MARKer<m>:FUNction:NDBDown:QFACTOR

This command queries the Q factor (quality) of n dB down measurements.

Suffix:

<n> Selects the measurement window.

<m> Selects the marker.

Example: INIT:CONT OFF
Switches to single sweep mode.
CALC:MARK:FUNC:NDBD ON
Switches on the n dB down function.
INIT;*WAI
Starts a sweep and waits for the end.
CALC:MARK:FUNC:NDBD:QFAC?
Queries the Q factor of the measured bandwidth.

Manual operation: See "n dB down" on page 133

CALCulate<n>:MARKer<m>:FUNCTion:NDBDown:RESult?

This command queries the distance of the n dB down markers from each other.

To get a valid result, you have to perform a complete measurement with synchronization to the end of the measurement before reading out the result. This is only possible for single sweeps.

Suffix:

<n> Selects the measurement window.

<m> irrelevant

Parameters:

<Distance> The result depends on the span.
In case of frequency domain measurements, the command returns the bandwidth between the two n dB down markers in Hz. In case of time domain measurements, the command returns the pulse width between the two n dB down markers in seconds.

Example: INIT:CONT OFF
Switches to single sweep mode.
CALC:MARK:FUNC:NDBD ON
Switches on the n dB down function.
INIT;*WAI
Starts a sweep and waits for the end.
CALC:MARK:FUNC:NDBD:RES?
Outputs the measured value.

Usage: Query only

Manual operation: See "n dB down" on page 133

CALCulate<n>:MARKer<m>:FUNCTion:NDBDown:STATe <State>

This command turns the n dB Down marker function on and off.

Suffix:

<n> Selects the measurement window.

<m> irrelevant

Parameters:

<State> ON | OFF
*RST: OFF

Example: CALC:MARK:FUNC:NDBD:STAT ON
Switches on the "N dB Down" function.

Manual operation: See "[n dB down](#)" on page 133

CALCulate<n>:MARKer<m>:FUNCtion:NDBDown:TIME?

This command queries the position of the n dB down markers on the x-axis when measuring in the time domain.

To get a valid result, you have to perform a complete measurement with synchronization to the end of the measurement before reading out the result. This is only possible for single sweeps.

Suffix:

<n> Selects the measurement window.

<m> irrelevant

Return values:

<Time> **<time 1>**
absolute position in time of the n dB marker to the left of the reference marker in seconds
<time 2>
absolute position in time of the n dB marker to the right of the reference marker in seconds

Example: INIT:CONT OFF
Switches to single sweep mode
CALC:MARK:FUNC:NDBD ON
Switches on the n dB down function.
INIT;*WAI
Starts a sweep and waits for the end.
CALC:MARK:FUNC:NDBD:TIME?
Outputs the time values of the temporary markers.

Usage: Query only

Manual operation: See "[n dB down](#)" on page 133

CALCulate<n>:MARKer<m>:FUNCtion:NOISe[:STATe] <State>

This command turns the noise measurement for all markers on or off.

If on, the R&S FSVR measures the noise power density at the marker position.

The result can be queried with [CALCulate<n>:MARKer<m>:FUNCtion:NOISe:RESult](#).

Suffix:

<n> Selects the measurement window.

<m> Selects the marker.

Parameters:

<State> ON | OFF

*RST: OFF

Example:

```
CALC:MARK:FUNC:NOIS ON
```

Switches on the noise measurement.

Manual operation: See "Noise Meas On/Off" on page 129

CALCulate<n>:MARKer<m>:FUNCtion:NOISe:RESult

This command queries the result of the noise measurement.

To get a valid result, you have to perform a complete measurement with synchronization to the end of the measurement before reading out the result. This is only possible for single sweeps.

Suffix:

<n> Selects the measurement window.

<m> Selects the marker.

Example:

```
INIT:CONT OFF
```

Switches to single sweep mode.

```
CALC:MARK2 ON
```

Switches on marker 2.

```
CALC:MARK:FUNC:NOIS ON
```

Switches on noise measurement.

```
INIT;*WAI
```

Starts a sweep and waits for the end.

```
CALC:MARK2:NOIS:RES?
```

Outputs the noise result of marker 2.

Manual operation: See "Noise Meas On/Off" on page 129

CALCulate<n>:MARKer<m>:FUNCtion:PNOise:RESult?

This command queries the result of the phase noise measurement at the specified marker in the specified window.

A complete sweep with synchronization to the sweep end must be performed between switching on the function and querying the measured value in order to obtain a correct query result. This is only possible in single sweep mode.

Suffix:

<n> 1...4
window

<m> 1...16
marker

Example:	<pre>INIT:CONT OFF Switches to single sweep mode. CALC:MARK2 ON Switches on marker 2. CALC:MARK2:FUNC:PNO ON Switches on the phase noise marker 2. INIT;*WAI Starts a sweep and waits for the end. CALC:MARK2:PNO:RES? Outputs the phase noise result of marker 2.</pre>
Usage:	Query only
Mode:	ADEMOD
Manual operation:	See "Phase Noise" on page 379

CALCulate<n>:MARKer<m>:FUNCTion:PNOise <State>

This command switches the phase noise measurement for the specified marker on or off in the specified window. The phase noise power density is measured at the position of the markers. The result can be queried with [CALCulate<n>:MARKer<m>:FUNCTion:PNOise:RESult?](#) on page 637.

Suffix:

<n>	1...4 window
<m>	1...16 marker

Parameters:

<State>	ON OFF
	*RST: OFF

Example:

```
CALC:MARK2:FUNC:PNO ON
```

Switches on the phase noise marker 2.

Mode: ADEMOD

CALCulate<n>:MARKer<m>:FUNCTion:REFerence

This command sets the reference level to the power measured by a marker.

If you use the command in combination with a delta marker, that delta marker is turned into a normal marker.

Suffix:

<n>	Selects the measurement window.
<m>	Selects the marker.

Example:

```
CALC:MARK2:FUNC:REF
```

Sets the reference level to the level of marker 2.

Manual operation: See "[Ref Lvl =Mkr Lvl](#)" on page 143

CALCulate<n>:MARKer<m>:FUNCtion:TOI:RESult?

This command queries the results for the third order intercept point measurement.

To get a valid result, you have to perform a complete measurement with synchronization to the end of the measurement before reading out the result. This is only possible for single sweeps.

Suffix:

<n> Selects the measurement window.

<m> irrelevant

Return values:

<TOI> Third order intercept point.

Example:

```
INIT:CONT OFF
```

Switches to single sweep mode.

```
CALC:MARK:FUNC:TOI ON
```

Switches the intercept measurement.

```
INIT;*WAI
```

Starts a sweep and waits for the end.

```
CALC:MARK:FUNC:TOI:RES?
```

Outputs the measured value.

Usage: Query only

Manual operation: See "[TOI](#)" on page 154

See "[TOI](#)" on page 250

CALCulate<n>:MARKer<m>:FUNCtion:TOI:SEARchsignal ONCE

This command initiates a search for signals in the current trace to determine the third intercept point.

No new measurement is performed. Only the currently available trace selected for the TOI measurement is used.

Suffix:

<n> Selects the measurement window.

<m> Selects the marker.

Example:

```
CALC:MARK:FUNC:TOI:SEAR ONCE
```

Executes the search for 2 signals and their intermodulation product at the currently available trace.

Usage: Event
SCPI confirmed

Manual operation: See "[Search Signals](#)" on page 250

CALCulate<n>:MARKer<m>:FUNCTION:TOI[:STATe] <State>

This command initiates a measurement to determine the third intercept point.

A two-tone signal with equal carrier levels is expected at the RF input of the instrument. Marker 1 and marker 2 (both normal markers) are set to the maximum of the two signals. Delta marker 3 and delta marker 4 are positioned to the intermodulation products. The delta markers can be modified separately afterwards with `CALCulate<n>:DELTamarker<m>:X`.

The third-order intercept is calculated from the level spacing between the normal markers and the delta markers.

Suffix:

<n> Selects the measurement window.
 <m> irrelevant

Parameters:

<State> ON | OFF
 *RST: OFF

Example:

`CALC:MARK:FUNC:TOI ON`
 Switches on the measurement of the third-order intercept.

Manual operation: See "TOI" on page 154
 See "TOI" on page 250

CALCulate<n>:MARKer<m>:FUNCTION:ZOOM <Range>

This command defines the range to be zoomed around marker 1. Marker 1 is activated first, if necessary.

The subsequent frequency sweep is stopped at the marker position and the frequency of the signal is counted. This frequency becomes the new center frequency, and the zoomed span is set.

Note that you should perform a complete measurement with synchronization to the end of the measurement. This is only possible for single sweeps.

Suffix:

<n> Selects the measurement window.
 <m> Selects the marker.

Parameters:

<Range> <numeric_value>

Example:

`INIT:CONT OFF`
 Switches to single sweep mode
`CALC:MARK:FUNC:ZOOM 1kHz; *WAI`
 Activates zooming and waits for its end.

Manual operation: See "Marker Zoom (span > 0)" on page 124

CALCulate:MARKer:FUNCTION:ADEMod Subsystem (Analog Demodulation, analog demodulation)

The CALCulate:MARKer:FUNCTION:ADEMod subsystem contains the marker functions for the Analog Demodulation mode.

Commands of the CALCulate:MARKer:FUNCTION:ADEMod Subsystem

CALCulate<n>:MARKer:FUNCTION:ADEMod:AFRequency[:RESult<t>]?	641
CALCulate<n>:MARKer:FUNCTION:ADEMod:AM[:RESult<t>]?	641
CALCulate<n>:MARKer:FUNCTION:ADEMod:CARRier[:RESult<t>]?	642
CALCulate<n>:MARKer:FUNCTION:ADEMod:FERRor[:RESult<t>]?	643
CALCulate<n>:MARKer:FUNCTION:ADEMod:FM[:RESult<t>]?	643
CALCulate<n>:MARKer:FUNCTION:ADEMod:PM[:RESult<t>]?	644
CALCulate<n>:MARKer:FUNCTION:ADEMod:SINad:RESult<t>?	645
CALCulate<n>:MARKer:FUNCTION:ADEMod:THD:RESult<t>?	645

CALCulate<n>:MARKer:FUNCTION:ADEMod:AFRequency[:RESult<t>]?

This command queries the audio frequency with analog demodulation in the specified window.

If several demodulation modes are activated simultaneously (e.g. with the [SENSe:]ADEMod[:TDOMain] [:TYPE] command, the audio frequency of the display mode selected with CALCulate<n>:FEED on page 705 is returned.

Suffix:

<n>	1 window
<t>	1...6 irrelevant

Example:

ADEM ON, see [SENSe:]ADEMod[:STATE] on page 752
Switches on analog demodulator
CALC:FEED 'XTIM:AM:TDOM', see CALCulate<n>:FEED on page 705
Switches on AM result display.
DISP:TRAC ON, see DISPlay[:WINDow<n>]:TRACe<t>[:STATE] on page 715
Switches the trace on.
CALC:MARK:FUNC:ADEM:AFR?
Queries the audio frequency.

Usage: Query only

Mode: ADEMOD

CALCulate<n>:MARKer:FUNCTION:ADEMod:AM[:RESult<t>]? <Result>
CALCulate<n>:MARKer:FUNCTION:ADEMod:AM[:RESult<t>]?? <MeasType>

This command queries the results of the AM modulation measurement.

Suffix:

<n>	1...4 irrelevant
<t>	1...6 trace 1, 2, 3, 4, 5 or 6

Parameters:

<Result> The result of the selected measurement type is returned.

Query parameters:

<MeasType> PPEak | MPEak | MIDDLE | RMS

PPEak

Measurement with detector Pluspeak (+PK)

MPEak

Measurement with detector MinusPeak (-PK)

MIDDLE

Averaging $\pm PK/2$

RMS

RMS measurement

Example:

ADEM ON (see [SENSe:]ADEMod[:STATe] on page 752)

Switches on the analog demodulator.

CALC:FEED 'XTIM:AM:TDOM', see CALCulate<n>:FEED on page 705

Switches on the AM result display.

DISP:TRAC ON, see DISPlay[:WINDow<n>]:TRACe<t>[:STATe] on page 715

Switches on the trace.

CALC:MARK:FUNC:ADEM:AM? PPE

Queries the peak value.

Usage: Query only

Mode: ADEM0D

CALCulate<n>:MARKer:FUNCTION:ADEMod:CARRier[:RESult<t>]?

This command queries the carrier power.

With RF Power result display, the carrier power is determined from trace 1 to 6 indicated in the suffix. With all other result displays, the carrier power is determined from the current trace data (CLR/WRITE trace).

Suffix:

<n>	1...4 irrelevant
<t>	1...6 irrelevant

Example: ADEM ON (see [SENSe:]ADEMod[:STATe] on page 752)
Switches on analog demodulator
CALC:FEED 'XTIM:RFP', see CALCulate<n>:FEED
on page 705
Switches on RF power result display
CALC:MARK:FUNC:ADEM:CARR?
Queries the carrier power

Usage: Query only

Mode: ADEMOD

CALCulate<n>:MARKer:FUNCTION:ADEMod:FERRor[:RESult<t>]?

This command queries the frequency error with FM and PM demodulation. The frequency error is determined from the current measurement data (CLR/WRITE trace).

The offset thus determined differs from that calculated in the [SENSe:]ADEMod:FM:OFFSet on page 763 command since, for determination of the frequency deviation, the modulation is removed by means of low pass filtering, producing results that are different from those obtained by averaging with the SENSe command.

Suffix:

<n> 1...4
irrelevant

<t> 1...6
irrelevant

Example: ADEM ON (see [SENSe:]ADEMod[:STATe] on page 752)
Switches on analog demodulator
CALC:FEED 'XTIM:FM:TDOM', see CALCulate<n>:FEED
on page 705
Switches on FM result display
CALC:MARK:FUNC:ADEM:FERR?
Queries the frequency error of trace 1

Usage: Query only

Mode: ADEMOD

CALCulate<n>:MARKer:FUNCTION:ADEMod:FM[:RESult<t>]? <Result> CALCulate<n>:MARKer:FUNCTION:ADEMod:FM[:RESult<t>]?? <MeasType>

This command queries the results of FM modulation measurement.

Suffix:

<n> 1...4
irrelevant

<t> 1...6
trace 1, 2, 3, 4, 5 or 6

Parameters:

<Result> The result of the selected measurement type is returned.

Query parameters:

<MeasType> PPEak | MPEak | MIDDLE | RMS

PPEak

Measurement with detector Pluspeak (+PK)

MPEak

Measurement with detector MinusPeak (-PK)

MIDDLE

Averaging \pm PK/2

RMS

RMS measurement

Example:

ADEM ON (see [SENSe:]ADEMod[:STATe] on page 752)

Switches on the analog demodulator.

CALC:FEED 'XTIM:FM:TDOM', see CALCulate<n>:FEED on page 705

Switches on the FM result display.

CALC:MARK:FUNC:ADEM:FM? PPE

Queries the peak value.

Usage:

Query only

Mode:

ADEMOD

CALCulate<n>:MARKer:FUNCTION:ADEMod:PM[:RESult<t>]? <Result>

CALCulate<n>:MARKer:FUNCTION:ADEMod:PM[:RESult<t>]?? <MeasType>

This command queries the results of PM modulation measurement of analog demodulation.

Suffix:

<t> 1...6
trace 1, 2, 3, 4, 5 or 6

<n> 1...4
irrelevant

Parameters:

<Result> The result of the selected measurement type is returned.

Query parameters:

<MeasType>	PPEak MPEak MIDDLE RMS
	PPEak Measurement with detector Pluspeak (+PK)
	MPEak Measurement with detector MinusPeak (-PK)
	MIDDLE Averaging \pm PK/2
	RMS RMS measurement

Example:

ADEM ON (see [SENSe:]ADEMod[:STATe] on page 752)
Switches on the analog demodulator.
CALC:FEED 'XTIM:FM:TDOM', see CALCulate<n>:FEED
on page 705
Switches on the FM result display.
CALC:MARK:FUNC:ADEM:PM? PPE
Queries the peak value.

Usage: Query only

Mode: ADEMOD

CALCulate<n>:MARKer:FUNCTION:ADEMod:SINad:RESult<t>?

This command queries the result of the SINAD measurement in the specified window.

Suffix:

<n>	1...4 window
<t>	1...6 trace 1, 2, 3, 4, 5 or 6

Example:

ADEM ON (see [SENSe:]ADEMod[:STATe] on page 752)
Switches on analog demodulator
CALC:FEED 'XTIM:FM:AFSP', see CALCulate<n>:FEED
on page 705
Switches on AF spectrum of FM
CALC:MARK:FUNC:ADEM:SIN:RES?
Queries SINAD value

Usage: Query only

Mode: ADEMOD

CALCulate<n>:MARKer:FUNCTION:ADEMod:THD:RESult<t>?

This command queries the result of the THD measurement in the specified window.

Suffix:	
<n>	1...4 window
<t>	1...6 trace 1, 2, 3, 4, 5 or 6
Example:	ADEM ON (see [SENSe:]ADEMod[:STATe] on page 752) Switches on analog demodulator CALC:FEED 'XTIM:FM:AFSP', see CALCulate<n>:FEED on page 705 Switches on AF spectrum of FM DISP:TRAC ON, see DISPlay[:WINDow<n>]:TRACe<t>[: STATe] on page 715 Switches on the trace CALC:MARK:FUNC:ADEM:THD:RES? Queries THD result
Usage:	Query only
Mode:	ADEMOD

CALCulate:MARKer:FUNCTION:HARMonics Subsystem

The CALCulate:MARKer<m>:FUNCTION:HARMonics subsystem contains the commands to define the settings for harmonics measurement.

CALCulate<n>:MARKer<m>:FUNCTION:HARMonics:BANDwidth:AUTO.....	646
CALCulate<n>:MARKer<m>:FUNCTION:HARMonics:DISTortion?.....	647
CALCulate<n>:MARKer<m>:FUNCTION:HARMonics:LIST?.....	647
CALCulate<n>:MARKer<m>:FUNCTION:HARMonics:NHARmonics.....	648
CALCulate<n>:MARKer<m>:FUNCTION:HARMonics:PRESet.....	648
CALCulate<n>:MARKer<m>:FUNCTION:HARMonics[:STATe].....	649

CALCulate<n>:MARKer<m>:FUNCTION:HARMonics:BANDwidth:AUTO <State>

This command selects the resolution bandwidth of the harmonic in respect to the bandwidth of the first harmonic.

For details refer to "Harmonic RBW Auto" on page 256.

Suffix:	
<n>	Selects the measurement window.
<m>	irrelevant
Parameters:	
<State>	OFF ON OFF identical ON a multiple *RST: ON

Example: `CALC:MARK:FUNC:HARM:BAND:AUTO OFF`
Deactivates the automatic bandwidth enlargement.

Manual operation: See "[Harmonic RBW Auto](#)" on page 256

CALCulate<n>:MARKer<m>:FUNCTion:HARMonics:DISToRTion?

This command queries the total harmonic distortion of the signal.

To get a valid result, you have to perform a complete measurement with synchronization to the end of the measurement before reading out the result. This is only possible for single sweeps.

Suffix:

<n> Selects the measurement window.

<m> irrelevant

Parameters:

TOTAL

Return values:

<Result> **<Distortion_%>,<Distortion_dB>**
Pair of values, one showing the THD in %, one in dB.

Example:

```
INIT:CONT OFF
Switches to single sweep mode.
CALC:MARK:FUNC:HARM:NHARM 3
Sets the number of harmonics to be measured to 3.
CALC:MARK:FUNC:HARM ON
Activates the harmonic distortion measurement.
INIT;*WAI
Starts a sweep and waits for the end of the sweep.
CALC:MARK:FUNC:HARM:DIS? TOT
Returns the total distortion in % and dB.
```

Usage: Query only

Manual operation: See "[Harmonic Distortion](#)" on page 155
See "[Harmonic Distortion](#)" on page 255

CALCulate<n>:MARKer<m>:FUNCTion:HARMonics:LIST?

This command queries the position of the harmonics.

To get a valid result, you have to perform a complete measurement with synchronization to the end of the measurement before reading out the result. This is only possible for single sweeps.

Suffix:

<n> Selects the measurement window.

<m> Selects the marker.

Parameters:

<Harmonics> Returns one value for every harmonic. The first value is the absolute power of the first harmonic. The unit is variable. The other values are power levels relative to the first harmonic. The unit for these is dB.

Example:

```
INIT:CONT OFF
```

Switches to single sweep mode.

```
CALC:MARK:FUNC:HARM:NHARM 3
```

Sets the number of harmonics to be measured to 3.

```
CALC:MARK:FUNC:HARM ON
```

Activates the harmonic distortion measurement.

```
INIT;*WAI
```

Starts a sweep and waits for the end of the sweep.

```
CALC:MARK:FUNC:HARM:LIST?
```

Returns the values for the 3 measured harmonics.

Usage:

Query only

Manual operation:

See "[Harmonic Distortion](#)" on page 155

See "[Harmonic Distortion](#)" on page 255

CALCulate<n>:MARKer<m>:FUNCTION:HARMonics:NHARmonics <NoHarmonics>

This command sets the number of harmonics to be measured.

Suffix:

<n> Selects the measurement window.

<m> irrelevant

Parameters:

<NoHarmonics> Range: 1 to 26
*RST: 10

Example:

```
CALC:MARK:FUNC:HARM:NHARM 3
```

Sets the number of harmonics to be measured to 3.

Manual operation:

See "[No. of Harmonics](#)" on page 256

CALCulate<n>:MARKer<m>:FUNCTION:HARMonics:PRESet

This command initiates a measurement to determine the ideal configuration for the harmonic distortion measurement.

The method depends on the span.

- Frequency domain (span > 0)
Frequency and level of the first harmonic are determined and used for the measurement list.
- Time domain (span = 0)
The level of the first harmonic is determined. The frequency remains unchanged.

Suffix:	
<n>	Selects the measurement window.
<m>	irrelevant
Example:	CALC:MARK:FUNC:HARM:PRES Optimizes the device settings for the harmonic measurement.
Usage:	Event
Manual operation:	See "Adjust Settings" on page 256

CALCulate<n>:MARKer<m>:FUNCTion:HARMonics[:STATe] <State>

This command turns the harmonic distortion measurement on and off.

Note the following:

- If you perform the measurement in the frequency domain, the search range for the frequency of the first harmonic, whose power is determined, is defined by the last span.
- If you perform the measurement in the time domain, the current center frequency is used as the frequency of the first harmonic. Thus, the frequency search is bypassed. The first harmonic frequency is set by a specific center frequency in zero span before the harmonic measurement is started.

Suffix:	
<n>	Selects the measurement window.
<m>	irrelevant
Parameters:	
<State>	ON OFF
	*RST: OFF
Example:	CALC:MARK:FUNC:HARM ON Activates the harmonic distortion measurement.
Manual operation:	See "Harmonic Distortion" on page 155 See "Harmonic Distortion" on page 255

CALCulate:MARKer:FUNCTion:POWER Subsystem

The CALCulate:MARKer<m>:FUNCTion:POWER subsystem contains the commands for control of power measurement.

Further information

- ["Predefined CP/ACLR Standards"](#) on page 663

CALCulate<n>:MARKer<m>:FUNCTion:POWER:MODE.....	650
CALCulate<n>:MARKer<m>:FUNCTion:POWER:PRESet.....	650
CALCulate<n>:MARKer<m>:FUNCTion:POWER:RESult?.....	651
CALCulate<n>:MARKer<m>:FUNCTion:POWER:RESult:PHZ.....	654
CALCulate<n>:MARKer<m>:FUNCTion:POWER:SElect.....	654

CALCulate<n>:MARKer<m>:FUNctioN:POWer[:STATe].....	655
CALCulate<n>:MARKer<m>:FUNctioN:POWer:STANdard:CATalog?.....	656
CALCulate<n>:MARKer<m>:FUNctioN:POWer:STANdard:DELete.....	656
CALCulate<n>:MARKer<m>:FUNctioN:POWer:STANdard:SAVE.....	656

CALCulate<n>:MARKer<m>:FUNctioN:POWer:MODE <Mode>

This commands defines the method by which the channel power values are calculated from the current trace in the window specified by the suffix <n>.

Suffix:

<n>	Selects the measurement window.
<m>	Selects the marker.

Parameters:

<Mode> WRITe | MAXHold

WRITe

The channel power and the adjacent channel powers are calculated directly from the current trace

MAXHold

The power values are calculated from the current trace and compared with the previous power value using a maximum algorithm.

Example:

CALC:MARK:FUNC:POW:MODE MAXH
Sets the Maxhold channel power mode.

Manual operation: See "[Clear/Write](#)" on page 173
See "[Max Hold](#)" on page 173

CALCulate<n>:MARKer<m>:FUNctioN:POWer:PRESet <Standard> | <UserStandard>

This command selects the power measurement setting for a standard and switches on the corresponding measurement, if required.

The configuration for a standard comprises of the parameters weighting filter, channel bandwidth and spacing, resolution and video bandwidth, as well as detector and sweep time.

The settings for standards IS95A and C differ as far as the calculation method of channel spacings is concerned. For IS95A and J-STD008 the spacing is calculated from the center of the main channel to the center of the corresponding adjacent channel, for IS95C from the center of the main channel to the nearest border of the adjacent channel.

Suffix:

<n>	Selects the measurement window.
<m>	Selects the marker.

Setting parameters:

<Standard> Note that predefined standards go without quotes, while user standards have to be in quotes ('user standard').

<Predefined standard>
Predefine standard according to table in "[Predefined CP/ACLR Standards](#)" on page 663.

'<string>'
User-defined standard with <string> being the name of the user standard.

Return values:

<Standard> <Predefined standard> | USER | NONE

<Predefined standard>
Predefine standard according to table in "[Predefined CP/ACLR Standards](#)" on page 663.

USER
User-defined standard is set

NONE
not yet defined

with <string> being the name of a user standard. Note that predefined standards go without quotes, while user standards have to be in quotes ('user standard').
For further details refer to "[Predefined CP/ACLR Standards](#)" on page 663.

Example: `CALC:MARK:FUNC:POW:PRES TETRA`
Selects the standard setting for TETRA

Example: `CALC:MARK:FUNC:POW:PRES 'my_aclr_standard'`
Selects the user standard my_aclr_standard

Manual operation: See "[CP/ACLR Standard](#)" on page 166
See "[Load](#)" on page 175

CALCulate<n>:MARKer<m>:FUNctioN:POWer:RESult? <ResultType>

This command queries the result of the performed power measurement in the window specified by the suffix <n>. If necessary, the measurement is switched on prior to the query.

The channel spacings and channel bandwidths are configured in the `SENSe:POWer` subsystem.

To obtain a correct result, a complete sweep with synchronization to the end of the sweep must be performed before a query is output. Synchronization is possible only in the single sweep mode.

Suffix:

<n> Selects the measurement window.

<m> Selects the marker.

Parameters:

<ResultType>

ACPower | AOBW | CN | CN0 | CPOWer | PPOWer |
MCACpower | OBANdwidth | OBWidth | BANDwidth**ACPower**

Adjacent-channel power measurement

Results are output in the following sequence, separated by commas:

Power of transmission channel

Power of lower adjacent channel

Power of upper adjacent channel

Power of lower alternate channel 1

Power of upper alternate channel 1

Power of lower alternate channel 2

Power of upper alternate channel 2

The number of measured values returned depends on the number of adjacent/alternate channels selected with `[SENSe:]POWer:ACHannel:ACPairs`.With logarithmic scaling (RANGE "LOG"), the power is output in the currently selected level unit; with linear scaling (RANGE "LIN dB" or "LIN %"), the power is output in W. If `[SENSe:]POWer:ACHannel:MODE` is set to "REL", the adjacent/alternate-channel power is output in dB.**AOBW (AllOccupiedBandWidth)**

Returns the occupied bandwidth, as well as the position and level of the temporary markers T1 and T2 used to calculate the occupied bandwidth.

The syntax of the result is:

<Occupied bandwidth>,<T1 x-value>,<T1 y-value>,<T2 x-value>,<T2 y-value>

CN

Measurement of carrier-to-noise ratio

The carrier-to-noise ratio in dB is returned.

CN0

Measurement of carrier-to-noise ratio referenced to 1 Hz bandwidth.

The carrier-to-noise ratio in dB/Hz is returned.

CPOWer

Channel power measurement

In a Spectrum Emission Mask measurement, the query returns the power result for the reference range, if this power reference type is selected.

With logarithmic scaling (RANGE LOG), the channel power is output in the currently selected level unit; with linear scaling (RANGE LIN dB or LIN %), the channel power is output in W.

PPOWer

Power of the highest peak

In a Spectrum Emission Mask measurement, the query returns the power result for the reference range, if this power reference type is selected.

MCACpower

Channel/adjacent-channel power measurement with several carrier signals

Results are output in the following sequence, separated by commas:

Power of carrier signal 1 to 18s in ascending order

Total power of all carrier signals

Power of lower adjacent channel

Power of upper adjacent channel

Power of lower alternate channel 1

Power of upper alternate channel 1

Power of lower alternate channel 2

Power of upper alternate channel 2

The number of measured values returned depends on the number of carrier signals and adjacent/alternate channels selected with `[SENSe:]POWer:ACHannel:TXChannel:COUNT` and `[SENSe:]POWer:ACHannel:ACPairs`.

If only one carrier signal is measured, the total value of all carrier signals is not output.

With logarithmic scaling (RANGE LOG), the power is output in dBm; with linear scaling (RANGE LIN dB or LIN %), the power is output in W. If `[SENSe:]POWer:ACHannel:MODE` is set to "REL", the adjacent/alternate-channel power is output in dB.

OBANdwidth | OBWidth

Measurement of occupied bandwidth

The occupied bandwidth in Hz is returned.

Example:

For an example of channel/adjacent-channel power measurement see [chapter 8.3.4, "Measuring the Channel and Adjacent Channel Power"](#), on page 1028.

Example of occupied bandwidth measurement

```
POW:BAND 90PCT
```

Defines 90 % as the percentage of the power to be contained in the bandwidth range to be measured.

```
INIT:CONT OFF
```

Switches over to single sweep mode.

```
INIT;*WAI
```

Starts a sweep and waits for the end of the sweep.

```
CALC:MARK:FUNC:POW:RES? OBW
```

Queries the occupied bandwidth measured.

Manual operation:

See ["Ch Power ACLR"](#) on page 153

See ["OBW \(span > 0\)"](#) on page 153

See ["Ch Power ACLR"](#) on page 166

See ["C/N"](#) on page 181

See ["C/No"](#) on page 181

See ["OBW"](#) on page 184

CALCulate<n>:MARKer<m>:FUNCTION:POWer:RESult:PHZ <State>

This command switches the query response of the power measurement results between output of absolute values and output referred to the measurement bandwidth.

The measurement results are output with the [CALCulate<n>:MARKer<m>:FUNCTION:POWer:RESult?](#) command.

Suffix:

<n> Selects the measurement window.
 <m> Selects the marker.

Parameters:

<State> ON | OFF
ON
 Results output: channel power density in dBm/Hz
OFF
 Results output: channel power is displayed in dBm
 *RST: OFF

Example:

`CALC:MARK:FUNC:POW:RES:PHZ ON`
 Output of results referred to the channel bandwidth.
 For details on a complete measurement example refer to [CALCulate<n>:MARKer<m>:FUNCTION:POWer:RESult?](#) on page 651.

Manual operation: See "[Chan Pwr/Hz](#)" on page 172

CALCulate<n>:MARKer<m>:FUNCTION:POWer:SElect <MeasType>

This command selects – and switches on – the specified power measurement type in the window specified by the suffix <n>.

The channel spacings and channel bandwidths are configured in the `SENSe:POWer` subsystem.

Note: If CPOWER is selected, the number of adjacent channels ([\[SENSe:\]POWer:ACHannel:ACPairs](#)) is set to 0. If ACPower is selected, the number of adjacent channels is set to 1, unless adjacent-channel power measurement is switched on already.

The channel/adjacent-channel power measurement is performed for the trace selected with [\[SENSe:\]POWer:TRACe](#).

The occupied bandwidth measurement is performed for the trace on which marker 1 is positioned. To select another trace for the measurement, marker 1 is to be positioned on the desired trace by means of [CALCulate<n>:MARKer<m>:TRACe](#).

Suffix:

<n> Selects the measurement window.
 <m> Selects the marker.

Parameters:

<MeasType>

ACPower | CPOWer | MCACpower | OBANdwidth | OBWidth | CN | CNO

ACPower

Adjacent-channel power measurement with a single carrier signal

CPOWer

Channel power measurement with a single carrier signal (equivalent to adjacent-channel power measurement with "NO. OF ADJ CHAN" = 0)

MCACpower

Channel/adjacent-channel power measurement with several carrier signals

OBANdwidth | OBWidth

Measurement of occupied bandwidth

CN

Measurement of carrier-to-noise ratio

CNO

Measurement of carrier-to-noise ratio referenced to 1 Hz bandwidth

Example:

CALC:MARK:FUNC:POW:SEL ACP

Switches on adjacent-channel power measurement.

Manual operation:

See "Ch Power ACLR" on page 153

See "OBW (span > 0)" on page 153

See "Ch Power ACLR" on page 166

See "C/N" on page 181

See "C/No" on page 181

See "OBW" on page 184

CALCulate<n>:MARKer<m>:FUNCtion:POWer[:STATe] <State>

This command switches off the power measurement in the window specified by the suffix <n>.

Suffix:

<n>

Selects the measurement window.

<m>

Selects the marker.

Parameters:

<State>

OFF

Example:

CALC:MARK:FUNC:POW OFF

Switches off the power measurement.

Usage:

Event

Manual operation: See "Ch Power ACLR" on page 153
 See "OBW (span > 0)" on page 153
 See "Ch Power ACLR" on page 166
 See "C/N" on page 181
 See "C/No" on page 181
 See "OBW" on page 184

CALCulate<n>:MARKer<m>:FUNCTION:POWer:STANdard:CATalog?

This command queries all available standards, including user standards.

The numeric suffix at MARKer is irrelevant.

Example: `CALC:MARK:FUNC:POW:STAN:CAT?`
 Queries the available standards.

Usage: Query only

Manual operation: See "Load" on page 175

CALCulate<n>:MARKer<m>:FUNCTION:POWer:STANdard:DELeTe <Standard>

This command deletes an ACLR standard.

The numeric suffix at MARKer is irrelevant.

Parameters:
 <Standard> Name of the standard you want to delete.

Example: `CALC:MARK:FUNC:POW:STAN:DEL 'CDMA2000'`
 Deletes the CDMA2000 standard.

Manual operation: See "Delete" on page 175

CALCulate<n>:MARKer<m>:FUNCTION:POWer:STANdard:SAVE <Standard>

This command saves a customized ACLR standard.

The numeric suffix at MARKer is irrelevant.

Parameters:
 <Standard> Specifies the name of the user standard.

Example: `CALC:MARK:FUNC:POW:STAN:SAVE 'CDMA2000'`
 Saves the user standard with the name CDMA2000.

Manual operation: See "Save" on page 175

CALCulate:MARKer:SGRam subsystem

The following commands control the markers when you are using the spectrogram.

The spectrogram is available in realtime mode and for option R&S FSV-K14.

CALCulate<n>:MARKer<m>:SGRam:FRAMe.....	657
CALCulate<n>:MARKer<m>:SGRam:SARea.....	657
CALCulate<n>:MARKer<m>:SGRam:XY:MAXimum[:PEAK].....	658
CALCulate<n>:MARKer<m>:SGRam:XY:MINimum[:PEAK].....	658
CALCulate<n>:MARKer<m>:SGRam:Y:MAXimum:ABOVe.....	659
CALCulate<n>:MARKer<m>:SGRam:Y:MAXimum:BELOW.....	659
CALCulate<n>:MARKer<m>:SGRam:Y:MAXimum:NEXT.....	660
CALCulate<n>:MARKer<m>:SGRam:Y:MAXimum[:PEAK].....	660
CALCulate<n>:MARKer<m>:SGRam:Y:MINimum:ABOVe.....	660
CALCulate<n>:MARKer<m>:SGRam:Y:MINimum:BELOW.....	661
CALCulate<n>:MARKer<m>:SGRam:Y:MINimum:NEXT.....	661
CALCulate<n>:MARKer<m>:SGRam:Y:MINimum[:PEAK].....	662
CALCulate<n>:MARKer<m>:SGRam:Y:TRIGger.....	662

CALCulate<n>:MARKer<m>:SGRam:FRAMe <Frame> | <Time>

This command positions the marker on a particular frame.

The command is available for the spectrogram.

Suffix:

<n>	1...4 Selects the measurement window.
<m>	1...16 Selects the marker.

Parameters:

<Frame> <Time>	<Frame> (if time stamp is off) Defines the frame to place the marker on. The range is {0...number of recorded frames-1}
	<time> (if time stamp is on) Defines the distance of the marker in seconds to the last measured frame (frame 0).

Example:

```
CALC:MARK:SGR:FRAM -20
Sets the marker on the 20th frame before the present.
CALC:MARK2:SGR:FRAM 2 s
Sets second marker on the frame 2 seconds ago.
```

CALCulate<n>:MARKer<m>:SGRam:SARea <SearchArea>

This command defines the marker search area.

The command is available for the spectrogram.

Suffix:

<n>	1...4 Selects the measurement window.
<m>	1...16 Selects the marker.

Parameters:

<SearchArea>

VISible

Performs a search in the visible frames.

Note that VISible is ignored if Spectrogram is not visible for any reason (e.g. if the Spectrum Analyzer is in full screen mode or display update is inactive).

MEMory

Performs a search over all frames in the memory.

*RST: VISible

Example:

CALC:DELT:SGR:SAR MEM

Performs a search over all frames in the memory.

Manual operation: See "[Marker Search Area](#)" on page 148**CALCulate<n>:MARKer<m>:SGRam:XY:MAXimum[:PEAK]**

This command positions the specified marker on the current peak level of the spectrogram. The possible position depends on the marker search area.

The command is available for the spectrogram.

For more information, see [CALCulate<n>:MARKer<m>:SGRam:SARea](#) on page 657.

Suffix:

<n>

1...4

Selects the measurement window.

<m>

1...16

Selects the marker.

Example:

CALC:MARK2:SGR:SAR VIS

CALC:MARK2:SGR:XY:MAX

Activates and positions marker 2 on the peak level in the visible Spectrogram.

Usage:

Event

Manual operation: See "[Marker Search Type](#)" on page 147**CALCulate<n>:MARKer<m>:SGRam:XY:MINimum[:PEAK]**

This command positions the specified marker on the current minimum level of the spectrogram. The possible position depends on the marker search area.

The command is available for the spectrogram.

For more information, see [CALCulate<n>:MARKer<m>:SGRam:SARea](#) on page 657 .

Suffix:

<n>

1...4

Selects the measurement window.

<m>

1...16

Selects the marker.

Example: `CALC:MARK3:SGR:SAR VIS`
 `CALC:MARK3:SGR:XY:MIN`
 Activates and positions marker 3 on the minimum level in the visible Spectrogram.

Usage: Event

Manual operation: See "[Marker Search Type](#)" on page 147

CALCulate<n>:MARKer<m>:SGRam:Y:MAXimum:ABOVE

This command positions the specified marker on the next peak level of the vertical axis. The search includes only frames above the current marker position. It does not change the horizontal position of the marker.

The command is available for the spectrogram.

Suffix:

<n> 1...4
 Selects the measurement window.

<m> 1...16
 Selects the marker.

Example: `CALC:MARK2:SGR:Y:MAX`
 Activates and positions marker 2 on the peak level of the y-axis.
 `CALC:MARK2:SGR:Y:MAX:ABV`
 Positions marker 2 on the next higher level found in the diagram area above the current marker position.

Usage: Event

Manual operation: See "[Search Mode for Next Peak in Y Direction](#)" on page 147

CALCulate<n>:MARKer<m>:SGRam:Y:MAXimum:BELOW

This command positions the specified marker on the next peak level of the vertical axis. The search includes only frames below the current marker position. It does not change the horizontal position of the marker.

The command is available for the spectrogram.

Suffix:

<n> 1...4
 Selects the measurement window.

<m> 1...16
 Selects the marker.

Example: `CALC:MARK2:SGR:Y:MAX`
 Activates and positions marker 2 on the peak level of the y-axis.
 `CALC:MARK2:SGR:Y:MAX:BEL`
 Positions marker 2 on the next higher level found in the diagram area below the current marker position.

Usage: Event

Manual operation: See "[Search Mode for Next Peak in Y Direction](#)" on page 147

CALCulate<n>:MARKer<m>:SGRam:Y:MAXimum:NEXT

This command positions the specified marker on the next peak level of the vertical axis. The search includes frames above and below the current marker position. It does not change the horizontal position of the marker.

The command is available for the spectrogram.

Suffix:

<n> 1...4
Selects the measurement window.

<m> 1...16
Selects the marker.

Example: `CALC:MARK2:SGR:Y:MAX`
Activates and positions marker 2 on the peak level of the y-axis.
`CALC:MARK2:SGR:Y:MAX:NEXT`
Positions marker 2 on the next higher level.

Usage: Event

Manual operation: See "[Search Mode for Next Peak in Y Direction](#)" on page 147

CALCulate<n>:MARKer<m>:SGRam:Y:MAXimum[:PEAK]

This command positions the specified marker on the current peak level of the vertical axis. The search is performed over all frames. It does not change the horizontal position of the marker.

The command is available for the spectrogram.

Suffix:

<n> 1...4
Selects the measurement window.

<m> 1...16
Selects the marker.

Example: `CALC:MARK2:SGR:Y:MAX`
Activates and positions marker 2 on the peak level of the y-axis.

Usage: Event

Manual operation: See "[Marker Search Type](#)" on page 147

CALCulate<n>:MARKer<m>:SGRam:Y:MINimum:ABOVE

This command positions the specified marker on the next minimum level of the vertical axis. The search includes only frames above the current marker position. It does not change the horizontal position of the marker.

The command is available for the spectrogram.

Suffix:

<n> 1...4
Selects the measurement window.

<m> 1...16
Selects the marker.

Example:

`CALC:MARK2:SGR:Y:MIN`

Activates and positions marker 2 on the minimum level of the y-axis.

`CALC:MARK2:SGR:Y:MIN:ABOV`

Positions marker 2 on the next minimum level found in the diagram area above the current marker position.

Usage: Event

Manual operation: See "[Search Mode for Next Peak in Y Direction](#)" on page 147

CALCulate<n>:MARKer<m>:SGRam:Y:MINimum:BELOW

This command positions the specified marker on the next minimum level of the vertical axis. The search includes only frames below the current marker position. It does not change the horizontal position of the marker.

The command is available for the spectrogram.

Suffix:

<n> 1...4
Selects the measurement window.

<m> 1...16
Selects the marker.

Example:

`CALC:MARK2:SGR:Y:MIN`

Activates and positions marker 2 on the minimum level of the y-axis.

`CALC:MARK2:SGR:Y:MAX:BEL`

Positions marker 2 on the next minimum level found in the diagram area below the current marker position.

Usage: Event

Manual operation: See "[Search Mode for Next Peak in Y Direction](#)" on page 147

CALCulate<n>:MARKer<m>:SGRam:Y:MINimum:NEXT

This command positions the specified marker on the next minimum level of the vertical axis. The search includes frames above and below the current marker position. It does not change the horizontal position of the marker.

The command is available for the spectrogram.

Suffix:

<n> 1...4
Selects the measurement window.

<m> 1...16
Selects the marker.

Example:

```
CALC:MARK2:SGR:Y:MIN
```

Activates and positions marker 2 on the minimum level of the y-axis.

```
CALC:MARK2:SGR:Y:MIN:NEXT
```

Positions marker 2 on the next minimum level.

Usage: Event

Manual operation: See ["Search Mode for Next Peak in Y Direction"](#) on page 147

CALCulate<n>:MARKer<m>:SGRam:Y:MINimum[:PEAK]

This command positions the specified marker on the current minimum level of the vertical axis. The search is performed over all captured frames. It does not change the horizontal position of the delta marker.

The command is available for the spectrogram.

Suffix:

<n> 1...4
Selects the measurement window.

<m> 1...16
Selects the marker.

Example:

```
CALC:MARK2:SGR:Y:MIN
```

Activates and positions marker 2 on the minimum level of the y-axis.

Usage: Event

Manual operation: See ["Marker Search Type"](#) on page 147

CALCulate<n>:MARKer<m>:SGRam:Y:TRIGger

This command positions a marker in the spectrogram on the most recent trigger event.

Suffix:

<n> 1...4
Selects the measurement window.

Usage: Event

Predefined CP/ACLR Standards

Parameter	Standard
W-CDMA 3GPP FWD	W-CDMA 3.84 MHz forward
W-CDMA 3GPP REV	W-CDMA 3.84 MHz reverse
CDMA IS95A FWD	CDMA IS95A forward
CDMA IS95A REV	CDMA IS95A reverse
CDMA IS95C Class 0 FWD	CDMA IS95C Class 0 forward
CDMA IS95C Class 0 REV	CDMA IS95C Class 0 reverse
CDMA J-STD008 FWD	CDMA J-STD008 forward
CDMA J-STD008 REV	CDMA J-STD008 reverse
CDMA IS95C Class 1 FWD	CDMA IS95C Class 1 forward
CDMA IS95C Class 1 REV	CDMA IS95C Class 1 reverse
CDMA 2000	CDMA 2000
TD SCDMA FWD	TD-SCDMA forward
TD SCDMA REV	TD-SCDMA reverse
WLAN 802.11A	WLAN 802.11A
WLAN 802.11B	WLAN 802.11B
WiMAX	WiMAX
WiBRO	WiBRO
RFID 14443	RFID 14443
EUTRa	EUTRA/LTE Square
REUTra	EUTRA/LTE Square/RRC
TETRA	TETRA
PDC	PDC
PHS	PHS
CDPD	CDPD
GSM	GSM

CALCulate:MARKer:FUNCTION:STRack Subsystem

The CALCulate:MARKer<m>:FUNCTION:STRack subsystem defines the settings of the signal track.

CALCulate<n>:MARKer<m>:FUNCTION:STRack:BANDwidth BWIDTH.....	664
CALCulate<n>:MARKer<m>:FUNCTION:STRack:THReshold.....	664
CALCulate<n>:MARKer<m>:FUNCTION:STRack:TRACe.....	664
CALCulate<n>:MARKer<m>:FUNCTION:STRack[:STATe].....	665

CALCulate<n>:MARKer<m>:FUNCTion:STRack:BANDwidth|BWIDth <Bandwidth>

This command defines the bandwidth around the center frequency that is included in the signal tracking process.

Note that you have to turn on signal tracking before you can use the command (`CALCulate<n>:MARKer<m>:FUNCTion:STRack[:STATe]`).

Suffix:

<n> Selects the measurement window.
 <m> Selects the marker.

Parameters:

<Bandwidth> 10 Hz to MAX (span)
 *RST: (= span/10 on activating the function)

Example:

`CALC:MARK:FUNC:STR:BAND 1 MHZ`
 Sets the search bandwidth to 1 MHz.
`CALC:MARK:FUNC:STR:BWID 1 MHZ`
 Alternative command for the same function.

Manual operation: See "[Track BW \(span > 0\)](#)" on page 63

CALCulate<n>:MARKer<m>:FUNCTion:STRack:THReshold <Level>

This command defines a threshold above which the signal is tracked.

Note that you have to turn on signal tracking before you can use the command (`CALCulate<n>:MARKer<m>:FUNCTion:STRack[:STATe]`).

The unit depends on `CALCulate<n>:UNIT:POWer`.

Suffix:

<n> Selects the measurement window.
 <m> Selects the marker.

Parameters:

<Level> Range: -130 dBm to 30 dBm
 *RST: -120 dBm
 Default unit: dBm

Example:

`CALC:MARK:FUNC:STR:THR -50DBM`
 Sets the threshold for signal tracking to -50 dBm.

Manual operation: See "[Track Threshold \(span > 0\)](#)" on page 63

CALCulate<n>:MARKer<m>:FUNCTion:STRack:TRACe <TraceNumber>

This command defines the trace on which the signal is tracked.

Suffix:

<n> Selects the measurement window.
 <m> Selects the marker.

Parameters:

<TraceNumber> Range: 1 to 6
*RST: 1

Example:

CALC:MARK:FUNC:STR:TRAC 3
Defines trace 3 as the trace for signal tracking.

Manual operation: See "Select Trace (span > 0)" on page 63

CALCulate<n>:MARKer<m>:FUNCTion:STRack[:STATe] <State>

This command turns signal tracking on and off.

When signal tracking is on, the R&S FSVR determines the maximum signal after each frequency sweep. The center frequency is then set to the frequency of this signal. Thus, the center frequency follows the frequency when you measure drifting signals.

Suffix:

<n> Selects the measurement window.
<m> Selects the marker.

Parameters:

<State> ON | OFF
*RST: OFF

Example:

CALC:MARK:FUNC:STR ON
Switches on the signal track function.

Manual operation: See "Track On/Off (span > 0)" on page 63

CALCulate:MARKer:FUNCTion:SUMMary Subsystem

This subsystem contains the control commands for the power functions in zero span.

CALCulate<n>:MARKer<m>:FUNCTion:MSUMmary?	666
CALCulate<n>:MARKer<m>:FUNCTion:SUMMary:AOff	667
CALCulate<n>:MARKer<m>:FUNCTion:SUMMary:AVERage	667
CALCulate<n>:MARKer<m>:FUNCTion:SUMMary:MEAN:AVERage:RESult?	668
CALCulate<n>:MARKer<m>:FUNCTion:SUMMary:MEAN:PHOLd:RESult?	669
CALCulate<n>:MARKer<m>:FUNCTion:SUMMary:MEAN:RESult?	669
CALCulate<n>:MARKer<m>:FUNCTion:SUMMary:MEAN[:STATe]	670
CALCulate<n>:MARKer<m>:FUNCTion:SUMMary:MODE	670
CALCulate<n>:MARKer<m>:FUNCTion:SUMMary:PHOLd	670
CALCulate<n>:MARKer<m>:FUNCTion:SUMMary:PPEak:AVERage:RESult?	671
CALCulate<n>:MARKer<m>:FUNCTion:SUMMary:PPEak:PHOLd:RESult?	671
CALCulate<n>:MARKer<m>:FUNCTion:SUMMary:PPEak:RESult?	672
CALCulate<n>:MARKer<m>:FUNCTion:SUMMary:PPEak[:STATe]	672
CALCulate<n>:MARKer<m>:FUNCTion:SUMMary:REFerence:AUTO ONCE	673
CALCulate<n>:MARKer<m>:FUNCTion:SUMMary:RMS:AVERage:RESult?	673
CALCulate<n>:MARKer<m>:FUNCTion:SUMMary:RMS:PHOLd:RESult?	674
CALCulate<n>:MARKer<m>:FUNCTion:SUMMary:RMS:RESult?	674
CALCulate<n>:MARKer<m>:FUNCTion:SUMMary:RMS[:STATe]	675
CALCulate<n>:MARKer<m>:FUNCTion:SUMMary:SDEViation:AVERage:RESult?	675

CALCulate<n>:MARKer<m>:FUNction:SUMMery:SDEVIation:PHOLd:RESult?.....	676
CALCulate<n>:MARKer<m>:FUNction:SUMMery:SDEVIation:RESult?.....	677
CALCulate<n>:MARKer<m>:FUNction:SUMMery:SDEVIation[:STATe].....	677
CALCulate<n>:MARKer<m>:FUNction:SUMMery[:STATe].....	678

CALCulate<n>:MARKer<m>:FUNction:MSUMmary?

The commands of this subsystem are used to determine the power of a sequence of signal pulses that have the same interval in the window specified by the suffix <n>, as for example the slots of a GSM signal typically do. The number of pulses to be measured as well as the measurement time and the period can be set. To define the position of the first pulse in the trace, a suitable offset can be entered.

The evaluation is performed on the measurement data of a previously recorded trace. The data recorded during the set measurement time is combined to a measured value for each pulse according to the detector specified and the indicated number of results is output as a list.

Trace 1 is always used by the function.

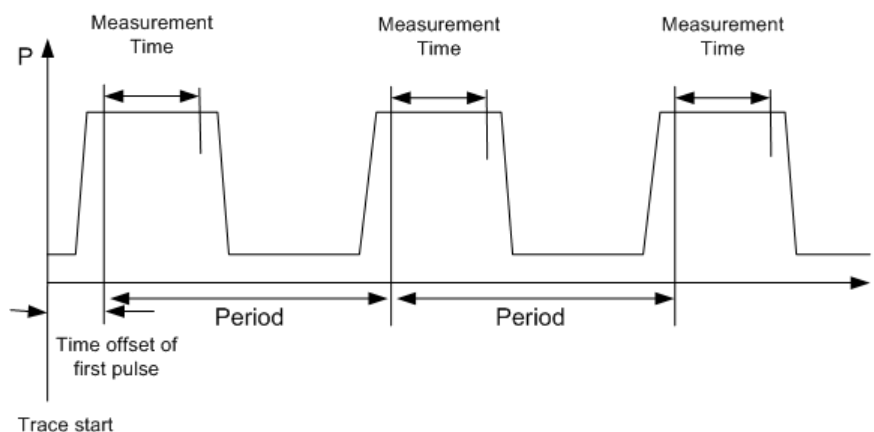

Suffix:

<n> Selects the measurement window.

<m> Selects the marker.

Parameters:

<time offset of first pulse>, <measurement time>, <period>, < # of pulses to measure>

Example:	<pre>DISP:WIND:TRAC:Y:RLEV -10dBm Sets the reference level to 10 dB INP:ATT 30 dB Sets the input attenuation to 30 dB FREQ:CENT 935.2MHz;SPAN 0 Hz Sets the receive frequency to 935.2 MHz and the span to 0 Hz BAND:RES 1 MHz;VID 3 MHz Sets the resolution bandwidth to 1 MHz and the video bandwidth to 3 MHz DET RMS Sets the RMS detector TRIG:SOUR VID;LEV:VID 50 PCT Selects the trigger source VIDEO and sets the level of the video trigger source to 50 PCT SWE:TIME 50 ms Sets the sweep time to 50 ms INIT;*WAI Starts the measurement with synchronization CALC:MARK:FUNC:MSUM? 50US,450US,576.9US,8 Queries 8 bursts with an offset of 50 µs, a test time of 450 µs and a period of 576.9 µs</pre>
Usage:	Query only

CALCulate<n>:MARKer<m>:FUNCTion:SUMMery:AOff

This command turns all time domain power measurements off.

Suffix:

<n>	Selects the measurement window.
<m>	Selects the marker.

Example:	<pre>CALC:MARK:FUNC:SUMM:AOff</pre> <p>Switches off the functions for power measurement in zero span.</p>
-----------------	---

Usage:	Event
---------------	-------

CALCulate<n>:MARKer<m>:FUNCTion:SUMMery:AVERage <State>

This command turns averaging for the active power measurement in zero span on and off.

Averaging is reset by switching it off and on again.

The number of results required for the calculation of average is defined with [\[SENSe:\]AVERage<n>:COUNT](#).

To get a valid result, you have to perform a complete measurement with synchronization to the end of the measurement before reading out the result. This is only possible for single sweeps.

Suffix:	
<n>	Selects the measurement window.
<m>	Selects the marker.
Parameters:	
<State>	ON OFF
	*RST: OFF
Example:	<pre>INIT:CONT OFF</pre> <p>Switches to single sweep mode.</p> <pre>CALC:MARK:FUNC:SUMM:AVER ON</pre> <p>Switches on the calculation of average.</p> <pre>AVER:COUN 200</pre> <p>Sets the measurement counter to 200.</p> <pre>INIT;*WAI</pre> <p>Starts a sweep and waits for the end.</p>

CALCulate<n>:MARKer<m>:FUNCTION:SUMMery:MEAN:AVERAge:RESult?

This command queries the average mean time domain power. The query is only possible if averaging has been activated previously using `CALCulate<n>:MARKer<m>:FUNCTION:SUMMery:AVERAge`.

To get a valid result, you have to perform a complete measurement with synchronization to the end of the measurement before reading out the result. This is only possible for single sweeps.

Suffix:	
<n>	Selects the measurement window.
<m>	Selects the marker.
Return values:	
<MeanPower>	Mean power of the signal during the measurement time.
Example:	<pre>INIT:CONT OFF</pre> <p>Switches to single sweep mode.</p> <pre>CALC:MARK:FUNC:SUMM:MEAN ON</pre> <p>Switches on the function.</p> <pre>CALC:MARK:FUNC:SUMM:AVER ON</pre> <p>Switches on the average value calculation.</p> <pre>INIT;*WAI</pre> <p>Starts a sweep and waits for the end.</p> <pre>CALC:MARK:FUNC:SUMM:MEAN:AVER:RES?</pre> <p>Outputs the result.</p>
Usage:	Query only

CALCulate<n>:MARKer<m>:FUNction:SUMMery:MEAN:PHOLd:RESult?

This command queries the maximum mean time domain power. The query is only possible if the peak hold function has been activated previously using `CALCulate<n>:MARKer<m>:FUNction:SUMMery:PHOLd`.

To get a valid result, you have to perform a complete measurement with synchronization to the end of the measurement before reading out the result. This is only possible for single sweeps.

Suffix:

<n> Selects the measurement window.

<m> Selects the marker.

Return values:

<MeanPower> Mean power of the signal during the measurement time.

Example:

```
INIT:CONT OFF
Switches to single sweep mode.
CALC:MARK:FUNC:SUMM:MEAN ON
Switches on the function.
CALC:MARK:FUNC:SUMM:PHOL ON
Switches on the peak value measurement.
INIT;*WAI
Starts a sweep and waits for the end.
CALC:MARK:FUNC:SUMM:MEAN:PHOL:RES?
Outputs the result.
```

Usage: Query only

CALCulate<n>:MARKer<m>:FUNction:SUMMery:MEAN:RESult?

This command queries the mean time domain power.

To get a valid result, you have to perform a complete measurement with synchronization to the end of the measurement before reading out the result. This is only possible for single sweeps.

Suffix:

<n> Selects the measurement window.

<m> Selects the marker.

Return values:

<MeanPower> Mean power of the signal during the measurement time.

Example:

```
INIT:CONT OFF
Switches to single sweep mode.
CALC:MARK:FUNC:SUMM:MEAN ON
Switches on the function.
INIT;*WAI
Starts a sweep and waits for the end.
CALC:MARK:FUNC:SUMM:MEAN:RES?
Outputs the result.
```

Usage: Query only
Manual operation: See "Mean" on page 226

CALCulate<n>:MARKer<m>:FUNction:SUMMery:MEAN[:STATe] <State>

This command turns the measurement of the mean time domain power on and off.

Note: The measurement is performed on the trace marker 1 is positioned. In order to evaluate another trace, marker 1 must be positioned on another trace with `CALCulate<n>:MARKer<m>:TRACe`.

Suffix:

<n> Selects the measurement window.
 <m> Selects the marker.

Parameters:

<State> ON | OFF
 *RST: OFF

Example: `CALC:MARK:FUNC:SUMM:MEAN ON`
 Switches on the function.

Manual operation: See "Mean" on page 226

CALCulate<n>:MARKer<m>:FUNction:SUMMery:MODE <Mode>

This command selects absolute or relative power measurement in zero span.

The reference power for relative measurement is defined with `CALCulate<n>:MARKer<m>:FUNction:SUMMery:REFERENCE:AUTO ONCE`. If the reference power is not defined, the value 0 dBm is used.

Suffix:

<n> Selects the measurement window.
 <m> irrelevant

Parameters:

<Mode> ABSolute | RELative
 *RST: ABSolute

Example: `CALC:MARK:FUNC:SUMM:MODE REL`
 Switches the power measurement in zero span to relative.

CALCulate<n>:MARKer<m>:FUNction:SUMMery:PHOLD <State>

This command turns the peak hold function for the active power measurement in zero span on and off.

If on, the measurement results show only the maximum power that has been measured for each sweep point.

The peak hold function is reset by switching it off and on again.

Suffix:

<n> Selects the measurement window.

<m> Selects the marker.

Parameters:

<State> ON | OFF

*RST: OFF

Example:

CALC:MARK:FUNC:SUMM:PHOL ON
Switches on the function.

CALCulate<n>:MARKer<m>:FUNCTION:SUMMARY:PPEak:AVERage:RESult?

This command queries the average positive peak time domain power. The query is only possible if averaging has been activated previously using [CALCulate<n>:MARKer<m>:FUNCTION:SUMMARY:AVERage](#).

To get a valid result, you have to perform a complete measurement with synchronization to the end of the measurement before reading out the result. This is only possible for single sweeps.

Suffix:

<n> Selects the measurement window.

<m> Selects the marker.

Return values:

<PeakPower> Peak power of the signal during the measurement time.

Example:

INIT:CONT OFF
Switches to single sweep mode.
CALC:MARK:FUNC:SUMM:PPE ON
Switches on the function.
CALC:MARK:FUNC:SUMM:AVER ON
Switches on the calculation of average.
INIT;*WAI
Starts a sweep and waits for the end.
CALC:MARK:FUNC:SUMM:PPE:AVER:RES?
Outputs the result.

Usage: Query only

CALCulate<n>:MARKer<m>:FUNCTION:SUMMARY:PPEak:PHOLd:RESult?

This command queries the maximum positive peak time domain power. The query is only possible if the peak hold function has been activated previously using [CALCulate<n>:MARKer<m>:FUNCTION:SUMMARY:PHOLd](#).

To get a valid result, you have to perform a complete measurement with synchronization to the end of the measurement before reading out the result. This is only possible for single sweeps.

Suffix:	
<n>	Selects the measurement window.
<m>	Selects the marker.
Return values:	
<PeakPower>	Peak power of the signal during the measurement time.
Example:	<pre>INIT:CONT OFF Switches to single sweep mode. CALC:MARK:FUNC:SUMM:PPE ON Switches on the function. CALC:MARK:FUNC:SUMM:PHOL ON Switches on the measurement of the peak value. INIT;*WAI Starts a sweep and waits for the end. CALC:MARK:FUNC:SUMM:PPE:PHOL:RES? Outputs the result.</pre>
Usage:	Query only

CALCulate<n>:MARKer<m>:FUNCtion:SUMMary:PPEak:RESult?

This command queries the positive peak time domain power.

To get a valid result, you have to perform a complete measurement with synchronization to the end of the measurement before reading out the result. This is only possible for single sweeps.

Suffix:	
<n>	Selects the measurement window.
<m>	Selects the marker.
Return values:	
<PeakPower>	Peak power of the signal during the measurement time.
Example:	<pre>INIT:CONT OFF Switches to single sweep mode. CALC:MARK:FUNC:SUMM:PPE ON Switches on the function. INIT;*WAI Starts a sweep and waits for the end. CALC:MARK:FUNC:SUMM:PPE:RES? Outputs the result.</pre>
Usage:	Query only
Manual operation:	See " Peak " on page 226

CALCulate<n>:MARKer<m>:FUNCtion:SUMMary:PPEak[:STATe] <State>

This command turns the measurement of the positive peak time domain power on and off.

Note: The measurement is performed on the trace marker 1 is positioned. In order to evaluate another trace, marker 1 must be positioned on another trace with `CALCulate<n>:MARKer<m>:TRACe`.

Suffix:

<n> Selects the measurement window.
 <m> Selects the marker.

Parameters:

<State> ON | OFF
 *RST: OFF

Example: `CALC:MARK:FUNC:SUMM:PPE ON`
 Switches on the function.

Manual operation: See "Peak" on page 226

CALCulate<n>:MARKer<m>:FUNCTION:SUMMARY:REFERENCE:AUTO ONCE

This command sets the currently measured average value (`CALCulate<n>:MARKer<m>:FUNCTION:SUMMARY:MEAN[:STATE]`) and RMS value (`CALCulate<n>:MARKer<m>:FUNCTION:SUMMARY:RMS[:STATE]`) as reference values for relative measurements in zero span.

If the measurement of RMS value and average is not activated, the reference value 0 dBm is used.

If the function `CALCulate<n>:MARKer<m>:FUNCTION:SUMMARY:AVERAGE` or `CALCulate<n>:MARKer<m>:FUNCTION:SUMMARY:PHOLD` is switched on, the current value is the accumulated measurement value at the time considered.

Suffix:

<n> Selects the measurement window.
 <m> irrelevant

Example: `CALC:MARK:FUNC:SUMM:REF:AUTO ONCE`
 Takes the currently measured power as reference value for the relative power measurement in zero span.

Usage: Event

CALCulate<n>:MARKer<m>:FUNCTION:SUMMARY:RMS:AVERAGE:RESULT?

This command queries the average RMS time domain power. The query is only possible if averaging has been activated previously using `CALCulate<n>:MARKer<m>:FUNCTION:SUMMARY:AVERAGE`.

To get a valid result, you have to perform a complete measurement with synchronization to the end of the measurement before reading out the result. This is only possible for single sweeps.

Suffix:

<n> Selects the measurement window.

<m>	Selects the marker.
Return values:	
<RMSPower>	RMS power of the signal during the measurement time.
Example:	<pre>INIT:CONT OFF Switches to single sweep mode. CALC:MARK:FUNC:SUMM:RMS ON Switches on the function. CALC:MARK:FUNC:SUMM:AVER ON Switches on the average value calculation. INIT;*WAI Starts a sweep and waits for the end. CALC:MARK:FUNC:SUMM:RMS:AVER:RES? Outputs the result.</pre>
Usage:	Query only

CALCulate<n>:MARKer<m>:FUNction:SUMMary:RMS:PHOLd:RESult?

This command queries the maximum RMS time domain power. The query is only possible if the peak hold function has been activated previously using [CALCulate<n>:MARKer<m>:FUNction:SUMMary:PHOLd](#).

To get a valid result, you have to perform a complete measurement with synchronization to the end of the measurement before reading out the result. This is only possible for single sweeps.

Suffix:	
<n>	Selects the measurement window.
<m>	Selects the marker.
Return values:	
<RMSPower>	RMS power of the signal during the measurement time.
Example:	<pre>INIT:CONT OFF Switches to single sweep mode. CALC:MARK:FUNC:SUMM:RMS ON Switches on the function. CALC:MARK:FUNC:SUMM:PHOL ON Switches on the peak value measurement. INIT;*WAI Starts a sweep and waits for the end. CALC:MARK:FUNC:SUMM:RMS:PHOL:RES? Outputs the result.</pre>
Usage:	Query only

CALCulate<n>:MARKer<m>:FUNction:SUMMary:RMS:RESult?

This command queries the RMS time domain power.

To get a valid result, you have to perform a complete measurement with synchronization to the end of the measurement before reading out the result. This is only possible for single sweeps.

Suffix:

<n> Selects the measurement window.
 <m> Selects the marker.

Return values:

<RMSPower> RMS power of the signal during the measurement time.

Example:

```
INIT:CONT OFF
Switches to single sweep mode.
CALC:MARK:FUNC:SUMM:RMS ON
Switches on the function.
INIT;*WAI
Starts a sweep and waits for the end.
CALC:MARK:FUNC:SUMM:RMS:RES?
Outputs the result.
```

Usage: Query only

Manual operation: See "RMS" on page 226

CALCulate<n>:MARKer<m>:FUNCTION:SUMMARY:RMS[:STATE] <State>

This command turns the measurement of the RMS time domain power on and off.

Note: The measurement is performed on the trace marker 1 is positioned. In order to evaluate another trace, marker 1 must be positioned on another trace with [CALCulate<n>:MARKer<m>:TRACe](#).

Suffix:

<n> Selects the measurement window.
 <m> Selects the marker.

Parameters:

<State> ON | OFF
 *RST: OFF

Example:

```
CALC:MARK:FUNC:SUM:RMS ON
```

Switches on the function.

Manual operation: See "RMS" on page 226

CALCulate<n>:MARKer<m>:FUNCTION:SUMMARY:SDEVIation:AVERage:RESult?

This command queries the average standard deviation of the time domain power. The query is only possible if averaging has been activated previously using [CALCulate<n>:MARKer<m>:FUNCTION:SUMMARY:AVERage](#).

To get a valid result, you have to perform a complete measurement with synchronization to the end of the measurement before reading out the result. This is only possible for single sweeps.

Suffix:

<n> Selects the measurement window.
 <m> Selects the marker.

Return values:

<StandardDeviation> Standard deviation of the signal during the measurement time.

Example:

```
INIT:CONT OFF
Switches to single sweep mode.
CALC:MARK:FUNC:SUMM:SDEV ON
Switches on the function.
CALC:MARK:FUNC:SUMM:AVER ON
Switches on the calculation of average.
INIT;*WAI
Starts a sweep and waits for the end.
CALC:MARK:FUNC:SUMM:MEAN:SDEV:RES?
Outputs the result.
```

Usage: Query only

CALCulate<n>:MARKer<m>:FUNCTion:SUMMery:SDEViation:PHOLd:RESult?

This command queries the maximum standard deviation of the time domain power. The query is only possible if the peak hold function has been activated previously using [CALCulate<n>:MARKer<m>:FUNCTion:SUMMery:PHOLd](#).

To get a valid result, you have to perform a complete measurement with synchronization to the end of the measurement before reading out the result. This is only possible for single sweeps.

Suffix:

<n> Selects the measurement window.
 <m> Selects the marker.

Return values:

<StandardDeviation> Standard deviation of the signal during the measurement time.

Example:

```
INIT:CONT OFF
Switches to single sweep mode.
CALC:MARK:FUNC:SUMM:SDEV ON
Switches on the function.
CALC:MARK:FUNC:SUMM:PHOL ON
Switches on the peak value measurement.
INIT;*WAI
Starts a sweep and waits for the end.
CALC:MARK:FUNC:SUMM:SDEV:PHOL:RES?
Outputs the result.
```

Usage: Query only

CALCulate<n>:MARKer<m>:FUNction:SUMMary:SDEViation:RESult?

This command queries the standard deviation of the time domain power.

To get a valid result, you have to perform a complete measurement with synchronization to the end of the measurement before reading out the result. This is only possible for single sweeps.

Suffix:

<n> Selects the measurement window.
 <m> Selects the marker.

Return values:

<StandardDeviation> Standard deviation of the signal during the measurement time.

Example:

```
INIT:CONT OFF
Switches to single sweep mode.
CALC:MARK:FUNC:SUMM:SDEV ON
Switches on the function.
INIT;*WAI
Starts a sweep and waits for the end.
CALC:MARK:FUNC:SUMM:SDEV:RES?
Outputs the result.
```

Usage: Query only

Manual operation: See "[Std Dev](#)" on page 226

CALCulate<n>:MARKer<m>:FUNction:SUMMary:SDEViation[:STATe] <State>

This command turns the measurement of the standard deviation of the time domain power on and off.

Note: The measurement is performed on the trace marker 1 is positioned. In order to evaluate another trace, marker 1 must be positioned on another trace with [CALCulate<n>:MARKer<m>:TRACe](#).

Suffix:

<n> Selects the measurement window.
 <m> Selects the marker.

Parameters:

<State> ON | OFF
 *RST: OFF

Example:

```
CALC:MARK:FUNC:SUMM:SDEV ON
Switches on the measurement of the standard deviation.
```

Manual operation: See "[Std Dev](#)" on page 226

CALCulate<n>:MARKer<m>:FUNCTION:SUMMARY[:STATe] <State>

This command turns time domain power measurements on and off. This measurement is only available in zero span.

Thus one or several measurements can be first selected and then switched on and off together using this command.

Suffix:

<n> Selects the measurement window.
 <m> Selects the marker.

Parameters:

<State> ON | OFF
 *RST: OFF

Example: CALC:MARK:FUNC:SUMM:STAT ON

Manual operation: See ["Time Domain Power \(zero span\)"](#) on page 154
 See ["Time Domain Power"](#) on page 226

CALCulate:MARKer:FUNCTION Subsystem for Stereo FM Measurements

The CALCulate:MARKer:FUNCTION subsystem contains the marker functions for the option FM Stereo, R&S FSV-K7S.

CALCulate<n>:MARKer:FUNCTION:DFD[:STATe].....	678
CALCulate<n>:MARKer:FUNCTION:DFD:UNIT.....	679
CALCulate<n>:MARKer:FUNCTION:DFD[:RESult<m>]?.....	679
CALCulate<n>:MARKer:FUNCTION:DFD:SEARChsignal ONCE.....	679
CALCulate<n>:MARKer:FUNCTION:IMD[:STATe].....	680
CALCulate<n>:MARKer:FUNCTION:IMD:UNIT.....	680
CALCulate<n>:MARKer:FUNCTION:IMD[:RESult<m>]?.....	680
CALCulate<n>:MARKer:FUNCTION:IMD:SEARChsignal ONCE.....	681
CALCulate<n>:MARKer:FUNCTION:SFM[:RESult<m>]?.....	681
CALCulate<n>:MARKer:FUNCTION:SFM:<ChannelType>[:RESult<m>]?.....	682

CALCulate<n>:MARKer:FUNCTION:DFD[:STATe] <State>

This command activates difference frequency distortion measurement in the specified window.

Suffix:

<n> 1...4
 window

Parameters:

<State> ON | OFF
 *RST: OFF

Example: CALC:MARK:FUNC:DFD:ON

Mode: SFM

Manual operation: See "[Diff.Freq.Distortion \(On/Off\)](#)" on page 418

CALCulate<n>:MARKer:FUNCTION:DFD:UNIT <ResultUnit>

This command defines the unit for the difference frequency distortion measurement results.

Suffix:
 <n> 1...4
 irrelevant

Parameters:
 <ResultUnit> **PCT | DB**
 *RST: PCT

Example: CALC:MARK:FUNC:DFD:UNIT DB

Mode: SFM

Manual operation: See "[Unit \(% / DB\)](#)" on page 418

CALCulate<n>:MARKer:FUNCTION:DFD[:RESult<m>]?

This command queries the result of the difference frequency distortion measurement in the specified window.

Suffix:
 <n> 1...4
 window
 <m> 1...6
 irrelevant

Return values:
 <Result> <dd2>,<dd3>
 The difference frequency distortion factors of 2nd and 3rd order (see "[Diff.Freq.Distortion](#)" on page 417)

Example: CALC:MARK:FUNC:DFD:RES?

Usage: Query only

Mode: SFM

CALCulate<n>:MARKer:FUNCTION:DFD:SEARChsignal ONCE

This command starts the search of the signals required for the difference frequency distortion measurement in the specified window.

Suffix:
 <n> 1...4
 window

Example: CALC:MARK:FUNC:DFD:SEAR ONCE

Usage: Event
Mode: SFM
Manual operation: See "[Search Signals](#)" on page 418

CALCulate<n>:MARKer:FUNCtion:IMD[:STATe] <State>

This command activates intermodulation distortion measurement in the specified window.

Suffix:
 <n> 1...4
 window

Parameters:
 <State> **ON | OFF**
 *RST: OFF

Example: CALC:MARK:FUNC:IMD:ON

Mode: SFM

Manual operation: See "[Intermod.Distortion \(On/Off\)](#)" on page 419

CALCulate<n>:MARKer:FUNCtion:IMD:UNIT <ResultUnit>

This command defines the unit for the intermodulation distortion measurement results.

Suffix:
 <n> 1...4
 irrelevant

Parameters:
 <ResultUnit> **PCT | DB**
 *RST: PCT

Example: CALC:MARK:FUNC:IMD:UNIT DB

Mode: SFM

Manual operation: See "[Unit \(% / DB\)](#)" on page 419

CALCulate<n>:MARKer:FUNCtion:IMD[:RESult<m>]?

This command queries the result of the intermodulation distortion measurement in the specified window.

Suffix:
 <n> 1...4
 window
 <m> 1...6
 irrelevant

Return values:

<Result> <dm2>, <dm3>
The modulation factors of 2nd and 3rd order

Example: CALC:MARK:FUNC:IMD:RES?

Usage: Query only

Mode: SFM

CALCulate<n>:MARKer:FUNCtion:IMD:SEARChsignal ONCE

This command starts the search of the signals required for the intermodulation distortion measurement in the specified window.

Suffix:

<n> 1...4
window

Example: CALC:MARK:FUNC:IMD:SEAR ONCE

Usage: Event

Mode: SFM

Manual operation: See "[Search Signals](#)" on page 420

CALCulate<n>:MARKer:FUNCtion:SFM[:RESult<m>]? <ResultType>

This command queries the results of the stereo measurement.

Suffix:

<n> 1...4
window

Query parameters:

<ResultType> **SUMMARY**
Returns all results of the measurement.
FCARRIER
Returns only the carrier frequency.

Return values:

<SUMMARY> <Absolute deviation>, <Relative deviation>, <SINAD>, <THD>, <Modulation frequency>

The results consist of the described 5 values for each channel, separated by commas.

Note: if one of the result values is not available, $9.91E+37$ is inserted for the missing value.

To obtain the results for an individual channel, or only individual results, use the specific commands:

CALCulate<n>:MARKer:FUNCtion:SFM:
<ChannelType>[:RESult<m>]? on page 682

<FCARRIER> The carrier frequency is returned.

Example: CALC1:MARK:FUNC:SFM:RES?
Usage: Query only
Mode: SFM

**CALCulate<n>:MARKer:FUNCtion:SFM:<ChannelType>[:RESult<m>]?
 <MeasType>**

This command queries the results of the measurement type for the selected channel in the specified window.

Suffix:

<n> 1...4
 window

<ChannelType> LEFT | RIGHT | MPX | MONO | STEReo | RDS | PILot
 Channel type for which the command is performed.

Query parameters:

<MeasType> ALL | ADEV | RDEV | SINad | THD | AFRequency | XTALk

ALL

All available measurement values

ADEV

The absolute deviation

RDEV

The relative deviation

SINad

The signal-to-noise-and-distortion value

THD

Total harmonic distortion

AFRequency

Audio frequency

XTALk

Crosstalk between left and right channels in dB:

$-20|\log(\text{Left [kHz]} / \text{Right[kHz]})|$ dB

*RST: ALL

Return values:

<Result> Measurement value according to the specified measurement type.
Note: if the specified result value is not available, a "Query Error" is returned. If all result values are queried (query parameter "ALL"), and one of them is not available, $9.91E+37$ is inserted for the missing value.

Example: CALC1:MARK:FUNC:SFM:LEFT? THD
 Queries the total harmonic distortion for the left stereo channel.

Usage: Query only
Mode: SFM

CALCulate:MASK Subsystem

The commands of the CALCulate:MASK subsystem configure the frequency mask trigger.

Programming example

```

TRIG:SOUR MASK
//Selects the frequency mask as a trigger source.
MMEM:MDIR 'C:\R_S\instr\freqmask\MyMasks'
CALC:MASK:CDIR 'MyMasks'
//Creates a directory on C:\ called 'FreqMasks' and selects it as the frequency
//mask directory.
//Defining the shape of a lower frequency mask
CALC:MASK:NAME 'MyMask'
//Creates or loads a frequency mask called 'MyMask'.
CALC:MASK:COMM 'Customized Frequency Mask'
//Adds a comment to the frequency mask.
TRIG:MASK:COND ENT
//Triggers the measurement when the signal enters the frequency mask.
CALC:MASK:MODE ABS
//Selects absolute power level values.
CALC:MASK:LOW -10MHZ,-10,-4MHZ,-10,-4MHZ,-20,4MHZ,-20,4MHZ,-10,10MHZ,-10
//Defines a lower frequency mask with 6 data points.
//The first data point position is at -10 MHz from the center frequency
//and at -10 dBm, the second at -4 MHz from the center frequency etc.
CALC:MASK:LOW:SHIF:X 1MHZ
CALC:MASK:LOW:SHIF:Y 10
//Shifts the lower frequency mask by 1 MHz to the right and 10 dB up.
CALC:MASK:LOW:STAT ON
//Turns the lower frequency mask on.

//Defining the shape of an upper frequency mask
CALC:MASK:NAME 'AnotherMask'
//Creates or loads a frequency mask called 'AnotherMask'
CALC:MASK:MODE ABS
//Selects absolute power level values.
CALC:MASK:UPP -10MHZ,-10,-4MHZ,-10,-4MHZ,-20,4MHZ,-20,4MHZ,-10,10MHZ,-10
//Defines an upper frequency mask with 6 data points.
CALC:MASK:UPP:SHIF:X -1MHZ
CALC:MASK:UPP:SHIF 10
//Shift the upper frequency mask 1 MHz to the left and 10 dB up.
CALC:MASK:UPP:STAT ON
//Turns the upper frequency mask on.
//Alternatively, you can create an upper frequency mask automatically.
CALC:MASK:UPP:AUTO
//Automatically defines the shape of an upper frequency mask.

CALC:MASK:DEL
//Deletes the frequency mask called 'MyMask' in C:\FreqMasks.

```



Before making any changes to a frequency mask, you have to select one by name with `CALCulate<n>:MASK:NAME` on page 686.

Compared to manual configuration of frequency masks, any changes made to a frequency mask via remote control are saved after the corresponding command has been sent.

<code>CALCulate<n>:MASK:CDIRectory</code>	684
<code>CALCulate<n>:MASK:COMMeNt</code>	684
<code>CALCulate<n>:MASK:DELeTe</code>	685
<code>CALCulate<n>:MASK:LOWer:SHIFt:X</code>	685
<code>CALCulate<n>:MASK:LOWer:SHIFt:Y</code>	685
<code>CALCulate<n>:MASK:LOWer[:STATe]</code>	685
<code>CALCulate<n>:MASK:LOWer[:DATA]</code>	686
<code>CALCulate<n>:MASK:MODE</code>	686
<code>CALCulate<n>:MASK:NAME</code>	686
<code>CALCulate<n>:MASK:SPAN</code>	687
<code>CALCulate<n>:MASK:UPPer:AUTO</code>	687
<code>CALCulate<n>:MASK:UPPer:SHIFt:X</code>	687
<code>CALCulate<n>:MASK:UPPer:SHIFt:Y</code>	687
<code>CALCulate<n>:MASK:UPPer[:STATe]</code>	688
<code>CALCulate<n>:MASK:UPPer[:DATA]</code>	688

CALCulate<n>:MASK:CDIRectory <Subdirectory>

This command selects the directory the R&S FSVR stores frequency masks in.

The directory must exist already for the command to work. You can create a new directory with `MMEMoRY:MDIRectory` on page 952.

Parameters:

<Subdirectory> String containing the path to the directory. The directory has to be a subdirectory of the default directory. Thus the path is always relative to the default directory (C:\R_S\INSTR\FREQ-MASK).
An empty string selects the default directory.

Example: See "`CALCulate:MASK Subsystem`" on page 683.

Manual operation: See "`Load Mask`" on page 53

CALCulate<n>:MASK:COMMeNt <Comment>

This command defines a comment for the frequency mask that you have selected with `CALCulate<n>:MASK:NAME` on page 686.

Parameters:

<Comment> String containing the comment for the frequency mask.

Example: See "`CALCulate:MASK Subsystem`" on page 683.

Manual operation: See "`Labelling a frequency mask`" on page 50

CALCulate<n>:MASK:DELeTe

This command deletes the currently selected frequency mask.

Before making any changes to a frequency mask, you have to select one by name with [CALCulate<n>:MASK:NAME](#) on page 686.

Example: See "[CALCulate:MASK Subsystem](#)" on page 683.

Usage: Event

Manual operation: See "[Delete Mask](#)" on page 53

CALCulate<n>:MASK:LOWer:SHIFt:X <Frequency>

This command shifts the lower frequency mask horizontally by a specified distance. Positive values move the mask to the right, negative values shift the mask to the left.

Before making any changes to a frequency mask, you have to select one by name with [CALCulate<n>:MASK:NAME](#) on page 686.

Parameters:

<Frequency> Defines the distance of the shift.
Default unit: Hz

Example: See "[CALCulate:MASK Subsystem](#)" on page 683.

Manual operation: See "[Shifting mask points as a whole](#)" on page 52

CALCulate<n>:MASK:LOWer:SHIFt:Y <Level>

This command shifts the lower frequency mask vertically by a specified distance. Positive values move the mask upwards, negative values shift the mask downwards.

Before making any changes to a frequency mask, you have to select one by name with [CALCulate<n>:MASK:NAME](#) on page 686.

Parameters:

<Level> Defines the distance of the shift. The shift is relative to the current position.
Default unit: dB

Example: See "[CALCulate:MASK Subsystem](#)" on page 683.

Manual operation: See "[Shifting mask points as a whole](#)" on page 52

CALCulate<n>:MASK:LOWer[:STATe] <State>

This command turns the lower frequency mask on and off.

Before making any changes to a frequency mask, you have to select one by name with [CALCulate<n>:MASK:NAME](#) on page 686.

Parameters:

<State> **ON | OFF**

Example: See "[CALCulate:MASK Subsystem](#)" on page 683.

Manual operation: See "[Working with upper and lower lines](#)" on page 51

CALCulate<n>:MASK:LOWer[:DATA] <Frequency>,<Level>,...

This command defines the shape of the lower frequency mask.

Before making any changes to a frequency mask, you have to select one by name with [CALCulate<n>:MASK:NAME](#) on page 686.

The unit of the power levels depends on [CALCulate<n>:MASK:MODE](#) on page 686.

If you are using the command with the vector network analysis option (R&S FSV-K70), you can only use this command as a query.

Parameters:

<Frequency>, [N] pairs of numerical values. [N] is the number of data points
<Level> the mask consists of.
Each data point is defined by the frequency (in Hz) and the level (in dB or dBm). All values are separated by commas.
Note that the data points have to be inside the current span.

Example: See "[CALCulate:MASK Subsystem](#)" on page 683.

Manual operation: See "[Positioning data points](#)" on page 52

CALCulate<n>:MASK:MODE <Mode>

This command defines the scaling of the level axis for frequency masks.

Parameters:

<Mode> **ABSolute**
absolute scaling of the level axis.
RELative
relative scaling of the level axis.
*RST: RELative

CALCulate<n>:MASK:NAME <Name>

This command creates or selects a frequency mask with the name that you specify by the parameter. When you use it as a query, the command returns the name of the mask currently in use.

Parameters:

<Name> String containing the name of the mask.
Note that an empty string does not select a frequency mask.

Manual operation: See "[Labelling a frequency mask](#)" on page 50

See "[Load Mask](#)" on page 53

**CALCulate<n>:MASK:SPAN **

This command defines the frequency span of the frequency mask.

Parameters:

 Range: 100 Hz to 40 MHz
 *RST: 40 MHz

Example: CALC:MASK:SPAN 10 MHz
 Defines a span of 10 MHz.

Manual operation: See ["Defining the frequency mask span"](#) on page 51

CALCulate<n>:MASK:UPPer:AUTO

This command automatically defines the shape of an upper frequency mask according to the spectrum that is currently measured.

Example: See ["CALCulate:MASK Subsystem"](#) on page 683.

Usage: Event

CALCulate<n>:MASK:UPPer:SHIFt:X <Frequency>

This command shifts the lower frequency mask horizontally by a specified distance. Positive values move the mask to the right, negative values shift the mask to the left.

You have to select a mask before you can use this command with [CALCulate<n>:MASK:NAME](#) on page 686.

Parameters:

<Frequency> Defines the distance of the shift.

Example: See ["CALCulate:MASK Subsystem"](#) on page 683.

Manual operation: See ["Shifting mask points as a whole"](#) on page 52

CALCulate<n>:MASK:UPPer:SHIFt:Y <Level>

This command shifts the upper frequency mask vertically by a specified distance. Positive values move the mask upwards, negative values shift the mask downwards.

You have to select a mask before you can use this command with [CALCulate<n>:MASK:NAME](#) on page 686.

Parameters:

<Level> Defines the distance of the shift. The shift is relative to the current position.

Default unit: dB

Example: See ["CALCulate:MASK Subsystem"](#) on page 683.

Manual operation: See ["Shifting mask points as a whole"](#) on page 52

CALCulate<n>:MASK:UPPer[:STATe] <State>

This command turns the upper frequency mask on and off.

Before making any changes to a frequency mask, you have to select one by name with [CALCulate<n>:MASK:NAME](#) on page 686.

Parameters:

<State> **ON | OFF**

Example: See "[CALCulate:MASK Subsystem](#)" on page 683.

Manual operation: See "[Working with upper and lower lines](#)" on page 51

CALCulate<n>:MASK:UPPer[:DATA] <Frequency>,<Level>,...

This command activates and defines the shape of the upper frequency mask trigger mask.

You have to select a mask before you can use this command with [CALCulate<n>:MASK:NAME](#) on page 686.

The unit of the power levels depends on [CALCulate<n>:MASK:MODE](#) on page 686.

If you are using the command with the vector network analysis option (R&S FSV-K70), you can only use this command as a query.

Parameters:

<Frequency>, [N] pairs of numerical values. [N] is the number of data points
<Level> the mask consists of.
Each data point is defined by the frequency (in Hz) and the
amplitude (in dB or dBm). All values are separated by commas.
Note that the data points have to be inside the current span.

Example: See "[CALCulate:MASK Subsystem](#)" on page 683.

Manual operation: See "[Positioning data points](#)" on page 52
See "[Automatic alignment of the frequency mask](#)" on page 53

CALCulate:MATH Subsystem

The CALCulate:MATH subsystem allows data from the SENSE-subsystem to be processed in numeric expressions.

CALCulate<n>:MATH[:EXpression][:DEFine]	688
CALCulate<n>:MATH:POSition	689
CALCulate<n>:MATH:STATe	689
CALCulate<n>:MATH:MODE	690

CALCulate<n>:MATH[:EXpression][:DEFine] <Expression>

This command defines the mathematical expression for relating traces to trace1.

Suffix:

<n> irrelevant

Parameters:

<Expression> (TRACe1-TRACe2) | (TRACe1-TRACe3) | (TRACe1-TRACe4) |
(TRACe1-TRACe5) | (TRACe1-TRACe6)

(TRACe1-TRACe2)

Subtracts trace 2 from trace 1.

(TRACe1-TRACe3)

Subtracts trace 3 from trace 1.

(TRACe1-TRACe4)

Subtracts trace 4 from trace 1.

(TRACe1-TRACe5)

Subtracts trace 5 from trace 1.

(TRACe1-TRACe6)

Subtracts trace 6 from trace 1.

Example:

CALC1:MATH (TRACe1 - TRACe2)

Selects the subtraction of trace 2 from trace 1.

Manual operation: See "[Trace Math](#)" on page 100

CALCulate<n>:MATH:POSition <Position>

This command defines the position of the result of the trace mathematics. The indication is in % of the screen height, with 100 % corresponding to the upper diagram border.

Suffix:

<n> Selects the measurement window.

Parameters:

<Position> -100PCT to 200PCT

*RST: 50PCT

Example:

CALC:MATH:POS 50PCT

Sets the position to the horizontal diagram center.

Manual operation: See "[Trace Math Position](#)" on page 101

CALCulate<n>:MATH:STATe <State>

This command switches the mathematical relation of traces on or off.

Suffix:

<n> irrelevant

Parameters:

<State> ON | OFF

*RST: OFF

Example:

CALC:MATH:STAT ON

Switches on the trace mathematics.

Manual operation: See ["Trace Math"](#) on page 100
See ["Trace Math Off"](#) on page 101

CALCulate<n>:MATH:MODE <Method>

This command selects the method for the trace math calculations.

For details see ["Trace Math Mode"](#) on page 100.

Suffix:

<n> irrelevant

Parameters:

<Method> LINear | LOGarithmic | POWer

*RST: LOG

Example:

CALC:MATH:MODE LIN

Selects linear averaging for trace math calculations.

Manual operation: See ["Lin"](#) on page 100
See ["Log"](#) on page 101
See ["Power"](#) on page 101

CALCulate:PMETer Subsystem (Power Sensor, R&S FSV-K9)

This subsystem controls the instrument settings for power sensor measurements. It is only available if the R&S FSV-K9 Power Sensor option is installed.

For details see [chapter 4.5, "Instrument Functions - Power Sensor \(R&S FSV-K9\)"](#), on page 304.

[CALCulate<n>:PMETer<p>:RELative\[:MAGNitude\]](#)..... 690

[CALCulate<n>:PMETer<p>:RELative\[:MAGNitude\]:AUTO ONCE](#)..... 691

[CALCulate<n>:PMETer<p>:RELative:STATe](#)..... 691

CALCulate<n>:PMETer<p>:RELative[:MAGNitude] <Value>

This command sets the reference value for relative measurements for the selected power sensor.

Suffix:

<n> irrelevant

<p> 1...4
Power sensor index

Parameters:

<Value> -200 to 200

*RST: 0

Example:

CALC:PMET2:REL -30

Sets the reference value for relative measurements to -30 dBm for power sensor 2.

Mode: PSM

Manual operation: See "Reference Value" on page 315

CALCulate<n>:PMETer<p>:RELative[:MAGNitude]:AUTO ONCE

This command takes the current measurement value as reference value for relative measurements for the selected power sensor.

Suffix:

<n> irrelevant
 <p> 1...4
 Power sensor index

Example:

`CALC:PMET2:REL:AUTO ONCE`

Takes the current measurement value as reference value for relative measurements for power sensor 2.

Mode: PSM

Manual operation: See "Meas -> Ref" on page 315

CALCulate<n>:PMETer<p>:RELative:STATe <State>

This command switches between relative and absolute display of the measured power for the selected power sensor.

Suffix:

<n> irrelevant
 <p> 1...4
 Power sensor index

Parameters:

<State> ON | OFF
 *RST: OFF

Example:

`CALC:PMET2:REL:STAT ON`

Activates the relative display of the measured value for power sensor 2.

Mode: PSM

CALCulate:PSEarch|PEAKsearch Subsystem

The CALCulate:PSEarch|PEAKsearch subsystem contains the remote commands for Spurious Emissions measurements. Both groups of commands (PSEarch and PEAKsearch) perform the same functions.

CALCulate<n>:PEAKsearch PSEarch[:IMMediate]	692
CALCulate<n>:PEAKsearch PSEarch:AUTO	692
CALCulate<n>:PEAKsearch PSEarch:MARGin	692
CALCulate<n>:PEAKsearch PSEarch:PSHow	692
CALCulate<n>:PEAKsearch PSEarch:SUBRanges	693

CALCulate<n>:PEAKsearch|PSEarch[:IMMEDIATE]

This command switches the spurious limit check off.

If you want to read out the values peak values including the delta to a limit, you have to switch on the limit again.

This command is only for FSP compatibility, and not necessary to use on the R&S FSVR.

Suffix:

<n> irrelevant

Example:

CALC:PSE
Starts to determine the list.

CALCulate<n>:PEAKsearch|PSEarch:AUTO <State>

This command activates or deactivates the list evaluation.

Suffix:

<n> Selects the measurement window.

Parameters:

<State> ON | OFF
*RST: ON

Example:

CALC:ESP:PSE:AUTO OFF
Deactivates the list evaluation.

Manual operation: See "[List Evaluation \(On/Off\)](#)" on page 194
See "[List Evaluation \(On/Off\)](#)" on page 223

CALCulate<n>:PEAKsearch|PSEarch:MARGIN <Margin>

This command sets the margin used for the limit check/peak search.

Suffix:

<n> Selects the measurement window.

Parameters:

<Margin> -200 to 200 dB
*RST: 200 dB

Example:

CALC:ESP:PSE:MARG 100
Sets the margin to 100 dB.

Manual operation: See "[Margin](#)" on page 194
See "[Margin](#)" on page 223

CALCulate<n>:PEAKsearch|PSEarch:PSHOW

This command marks all peaks with blue squares in the diagram.

Suffix:
 <n> Selects the measurement window.

Parameters:
 <State> ON | OFF
 *RST: OFF

Example: CALC:ESP:PSE:PSH ON
 Marks all peaks with blue squares.

Manual operation: See "Show Peaks" on page 223

CALCulate<n>:PEAKsearch|PSEarch:SUBRanges <NumberPeaks>

This command sets the number of peaks per range that are stored in the list. Once the selected number of peaks has been reached, the peak search is stopped in the current range and continued in the next range.

Suffix:
 <n> irrelevant

Parameters:
 <NumberPeaks> 1 to 50
 *RST: 25

Example: CALC:PSE:SUBR 10
 Sets 10 peaks per range to be stored in the list.

Manual operation: See "Peaks per Range" on page 223

CALCulate:SGRam Subsystem

These commands are only available if the "Spectrogram" measurements option R&S FSV-K14 is installed.

CALCulate<n>:SGRam:CLEAr[:IMMediate].....	693
CALCulate<n>:SGRam:COLor.....	694
CALCulate<n>:SGRam:CONT.....	694
CALCulate<n>:SGRam:FRAME:COUNT.....	694
CALCulate<n>:SGRam:FRAME:SElect.....	695
CALCulate<n>:SGRam:HDEPth.....	695
CALCulate<n>:SGRam[:STATe].....	696
CALCulate<n>:SGRam:TSTamp[:STATe].....	696
CALCulate<n>:SGRam:TSTamp:DATA?.....	696
CALCulate<n>:SGRam:X:DATA?.....	697

CALCulate<n>:SGRam:CLEAr[:IMMediate]

This command resets the Spectrogram result display and clears the history buffer.

Suffix:
 <n> 1...4
 Selects the measurement window.

Example: `CALC:SGR:CLE`
Resets the result display and clears the memory.

Usage: Event

CALCulate<n>:SGRam:COLor <Color>

This command selects the color scheme of the spectrogram result display.

Suffix:

<n> 1...4
Selects the measurement window.

Parameters:

<Color> **COLor**
RGB colors
RADar
black - green - white
GRAYscale
black and white
***RST:** COLor

Example: `CALC:SGR:COL GRAY`
Selects black and white color scheme.

CALCulate<n>:SGRam:CONT <State>

This command determines whether the results of the last measurement are deleted before starting a new measurement in single sweep mode.

Suffix:

<n> 1...4
Selects the measurement window.

Parameters:

<State> **ON | OFF**
***RST:** OFF

Example: `INIT:CONT OFF`
Selects single sweep mode.
`INIT;*WAI`
Starts the sweep and waits for the end of the sweep.
`CALC:SGR:CONT ON`
Repeats the single sweep measurement without deleting the results of the last measurement.

CALCulate<n>:SGRam:FRAME:COUNT <Frames>

This command sets the number of frames to be recorded in a single sweep.

Suffix:

<n> 1...4
Selects the measurement window.

Parameters:

<Frames> The maximum number of frames depends on the `.CALCulate<n>:SGRam:HDEPth` on page 695
Range: 1 to depends on history depth
Increment: 1
*RST: 1

Example:

```
INIT:CONT OFF
Selects single sweep mode.
CALC:SGR:FRAM:COUN 200
Sets the number of frames to 200.
```

CALCulate<n>:SGRam:FRAME:SElect <Frame>

This command selects a specific frame for further analysis. The command is available only if no measurement is running or after a single sweep has ended.

Suffix:

<n> 1...4
Selects the measurement window.

Parameters:

<Frame> **<frame_number> (if time stamp is off)**
Selects the frame. The range is {0...number of recorded frames-1}
<time> (if time stamp is on)
Time distance in seconds. It selects the frame that is x seconds away from frame 0.

Example:

```
INIT:CONT OFF
Stop the continuous sweep.
CALC:SGR:FRAM:SEL -25
Selects frame number -25.
```

CALCulate<n>:SGRam:HDEPth <HistoryDepth>

This command sets the number of frames to be stored in the R&S FSVR's memory.

Suffix:

<n> 1...4
Selects the measurement window.

Parameters:

<HistoryDepth> The maximum number of frames depends on the number of sweep points.
Range: 781 to 20000
Increment: 1
*RST: 3000

Example: `CALC:SGR:HDEP 1500`
Sets the history depth to 1500.

CALCulate<n>:SGRam[:STATe] <State>

This command turns the spectrogram result display on and off.

Alternatively, you can turn on the spectrogram with `CALCulate<n>:FEED` on page 705.

Suffix:
<n> 1...4
Selects the measurement window.

Parameters:
<State> **ON | OFF**
*RST: OFF

Example: `CALC:SGR ON`
Activates the Spectrogram result display.

CALCulate<n>:SGRam:TSTamp[:STATe] <State>

This command activates and deactivates the time stamp.

If the time stamp is active, some commands do not address frames as numbers, but as (relative) time values:

- `CALCulate<n>:DELTamarker<m>:SGRam:FRAMe` on page 571
- `CALCulate<n>:MARKer<m>:SGRam:FRAMe` on page 657
- `CALCulate<n>:SGRam:FRAMe:SELeCt` on page 695

Suffix:
<n> 1...4
Selects the measurement window.

Parameters:
<State> **ON | OFF**
*RST: OFF

Example: `CALC:SGR:TST ON`
Activates the time stamp.

CALCulate<n>:SGRam:TSTamp:DATA? <Mode>

This command queries the time stamp of the frames.

All available frame results are returned via the `TRACe<n>[:DATA]?` command.

Suffix:
<n> 1...4
Selects the measurement window.

Query parameters:

<Mode>

CURRent

Returns the time stamp of the current frame.

ALL

Returns the time stamps of all frames. The result are sorted in descending order, beginning with the current frame.

Return values:

<TimeStamp>

The return values consist of four values for each frame.

The first value is the date of the measurement in seconds that have passed since 01.01.1970 in seconds. For a better resolution the second value shows the additional milliseconds. This value is also displayed on screen.

These numbers are appropriate for relative uses, but you can also calculate the absolute date and time as displayed on the screen.

The third and fourth value are reserved for future uses.

If the Spectrogram is empty, the command returns '0,0,0,0'

Example:

CALC:SGR:TST ON

Activates the time stamp.

CALC:SGR:TST:DATA? ALL

Returns the time stamp of all frames sorted in a descending order.

Usage:

Query only

CALCulate<n>:SGRam:X:DATA? <Data>

This command queries the scaling of the x-axis in the spectrogram.

Parameters:

<Data>

CURRent

Scaling of the current spectrogram frame.

ALL

Scaling of all frames in the history of the spectrogram.

Usage:

Query only

CALCulate:STATistics Subsystem

The CALCulate:STATistics subsystem controls the statistical measurement functions in the instrument.

CALCulate<n>:STATistics:APD[:STATe].....	698
CALCulate<n>:STATistics:CCDF[:STATe].....	698
CALCulate<n>:STATistics:CCDF:X<Trace>.....	698
CALCulate<n>:STATistics:NSAMples.....	699
CALCulate<n>:STATistics:PRESet.....	699
CALCulate<n>:STATistics:RESult<Trace>.....	700
CALCulate<n>:STATistics:SCALe:AUTO ONCE.....	700
CALCulate<n>:STATistics:SCALe:X:RANGe.....	701

CALCulate<n>:STATistics:SCALe:X:RLEVel.....	701
CALCulate<n>:STATistics:SCALe:Y:LOWer.....	701
CALCulate<n>:STATistics:SCALe:Y:UNIT.....	702
CALCulate<n>:STATistics:SCALe:Y:UPPer.....	702

CALCulate<n>:STATistics:APD[:STATe] <State>

This command switches on or off the measurement of amplitude distribution (APD). On activating this function, the CCDF measurement is switched off.

Suffix:

<n> irrelevant

Parameters:

<State> ON | OFF
*RST: OFF

Example:

CALC:STAT:APD ON
Switches on the APD measurement.

Manual operation: See "APD" on page 154
See "APD" on page 231

CALCulate<n>:STATistics:CCDF[:STATe] <State>

This command switches on or off the measurement of the complementary cumulative distribution function (CCDF). On activating this function, the APD measurement is switched off.

Suffix:

<n> irrelevant

Parameters:

<State> ON | OFF
*RST: OFF

Example:

CALC:STAT:CCDF ON
Switches on the CCDF measurement.

Manual operation: See "CCDF" on page 154
See "CCDF" on page 237

CALCulate<n>:STATistics:CCDF:X<Trace> <Probability>

This command queries the results of the complementary cumulative distribution function (CCDF) for the specified probability (corresponding to the "Percent Marker" in the display, see "Percent Marker" on page 237). The suffix of X defines the trace number.

Suffix:

<n> irrelevant

<Trace> 1...6
trace

Parameters:

<Probability> P0_01: Level value for 0.01 % probability
 P0_1: Level value for 0.1 % probability
 P1: Level value for 1 % probability
 P10: Level value for 10 % probability

Example:

CALC:STAT:CCDF:X1? P10

Returns the level values that are over 10 % above the mean value.

Manual operation: See "[CCDF](#)" on page 237

CALCulate<n>:STATistics:NSAMples <NoMeasPoints>

This command sets the number of measurement points to be acquired for the statistical measurement functions.

Suffix:

<n> irrelevant

Parameters:

<NoMeasPoints> 100 to 1E9
 *RST: 100000

Example:

CALC:STAT:NSAM 500

Sets the number of measurement points to be acquired to 500.

Manual operation: See "[# of Samples](#)" on page 232

CALCulate<n>:STATistics:PRESet

This command resets the scaling of the X and Y axes in a statistical measurement. The following values are set:

x-axis ref level:	-20 dBm
x-axis range APD:	100 dB
x-axis range CCDF:	20 dB
y-axis upper limit:	1.0
y-axis lower limit:	1E-6

Suffix:

<n> irrelevant

Example:

CALC:STAT:PRESet

Resets the scaling for statistical functions

Manual operation: See "[Default Settings](#)" on page 235

CALCulate<n>:STATistics:RESult<Trace> <ResultType>

This command reads out the results of statistical measurements of a recorded trace.

Suffix:

<n>	irrelevant
<Trace>	1...6 trace

Parameters:

<ResultType> MEAN | PEAK | CFACtor | ALL

MEAN

Average (=RMS) power in dBm measured during the measurement time.

PEAK

Peak power in dBm measured during the measurement time.

CFACtor

Determined CREST factor (= ratio of peak power to average power) in dB.

ALL

Results of all three measurements mentioned before, separated by commas: <mean power>,<peak power>,<crest factor>

The required result is selected via the following parameters:

Example:

```
CALC:STAT:RES2? ALL
```

Reads out the three measurement results of trace 2. Example of answer string: 5.56,19.25,13.69 i.e. mean power: 5.56 dBm, peak power 19.25 dBm, CREST factor 13.69 dB

CALCulate<n>:STATistics:SCALE:AUTO ONCE

This command optimizes the level setting of the instrument depending on the measured peak power, in order to obtain maximum instrument sensitivity.

To obtain maximum resolution, the level range is set as a function of the measured spacing between peak power and the minimum power for the APD measurement and of the spacing between peak power and mean power for the CCDF measurement. In addition, the probability scale for the number of test points is adapted.

Subsequent commands have to be synchronized with *WAI, *OPC or *OPC? to the end of the auto range process which would otherwise be aborted.

Suffix:

<n>	irrelevant
-----	------------

Example:

```
CALC:STAT:SCALE:AUTO ONCE; *WAI
```

Adapts the level setting for statistical measurements.

Manual operation: See "[Adjust Settings](#)" on page 235

CALCulate<n>:STATistics:SCALE:X:RANGe <Value>

This command defines the level range for the x-axis of the measurement diagram. The setting is identical to the level range setting defined with the `DISPlay[:WINDow<n>]:TRACe<t>:Y[:SCALE]` command.

Suffix:

<n> irrelevant

Parameters:

<Value> 10dB to 200dB

*RST: 100dB

Example: `CALC:STAT:SCAL:X:RANG 20dB`

Manual operation: See "[x-Axis Range](#)" on page 232

CALCulate<n>:STATistics:SCALE:X:RLEVEl <Value>

This command defines the reference level for the x-axis of the measurement diagram. The setting is identical to the reference level setting using the `DISPlay[:WINDow<n>]:TRACe<t>:Y[:SCALE]:RLEVEl` command.

With the reference level offset <> 0 the indicated value range of the reference level is modified by the offset.

The unit depends on the setting performed with `CALCulate<n>:UNIT:POWer`.

Suffix:

<n> irrelevant

Parameters:

<Value> -120dBm to 20dBm

*RST: -20dBm

Example: `CALC:STAT:SCAL:X:RLEV -60dBm`

Manual operation: See "[x-Axis Ref Level](#)" on page 232

CALCulate<n>:STATistics:SCALE:Y:LOWer <Value>

This command defines the lower limit for the y-axis of the diagram in statistical measurements. Since probabilities are specified on the y-axis, the entered numeric values are dimensionless.

Suffix:

<n> selects the screen

Parameters:

<Value> 1E-9 to 0.1

*RST: 1E-6

Example: `CALC:STAT:SCAL:Y:LOW 0.001`

Manual operation: See "[y-Axis Min Value](#)" on page 234

CALCulate<n>:STATistics:SCALE:Y:UNIT <Unit>

This command defines the scaling type of the y-axis.

Suffix:

<n> selects the screen

Parameters:

<Unit> PCT | ABS

*RST: ABS

Example:

CALC:STAT:SCAL:Y:UNIT PCT

Sets the percentage scale.

Manual operation: See "y-Unit % / Abs" on page 235

CALCulate<n>:STATistics:SCALE:Y:UPPer <Value>

This command defines the upper limit for the y-axis of the diagram in statistical measurements. Since probabilities are specified on the y-axis, the entered numeric values are dimensionless.

Suffix:

<n> irrelevant

Parameters:

<Value> 1E-8 to 1.0

*RST: 1.0

Example:

CALC:STAT:SCAL:Y:UPP 0.01

Manual operation: See "y-Axis Max Value" on page 234

CALCulate:THReshold Subsystem

The CALCulate:THReshold subsystem controls the threshold value for the maximum/minimum search of markers.

CALCulate<n>:THReshold.....702

CALCulate<n>:THReshold:STATe.....703

CALCulate<n>:THReshold <Threshold>

This command defines a threshold value for the marker peak search.

A threshold line is automatically turned on.

Suffix:

<n> irrelevant

Parameters:

<Threshold> The unit depends on CALCulate<n>:UNIT:POWer.

*RST: (STATe to OFF)

Example: `CALC:THR -82DBM`
Sets the threshold value to -82 dBm.

Manual operation: See ["Threshold"](#) on page 135

CALCulate<n>:THReshold:STATe <State>

This command turns the threshold line for the marker peak search on and off.

Suffix:
<n> irrelevant

Parameters:
<State> ON | OFF
*RST: OFF

Example: `CALC:THR:STAT ON`
Switches on the threshold line.

Manual operation: See ["Threshold"](#) on page 135
See ["Search Lim Off"](#) on page 145

CALCulate:TLINe Subsystem

The CALCulate:TLINe subsystem defines the position of the time lines.

[CALCulate<n>:TLINe<Line>](#)..... 703
[CALCulate<n>:TLINe<Line>:STATe](#)..... 703

CALCulate<n>:TLINe<Line> <Time>

This command defines the position of a time line.

Suffix:
<n> irrelevant
<Line> 1 | 2
Selects the time line.

Parameters:
<Time> Range: 0 to 1000
*RST: (STATe to OFF)
Default unit: s

Example: `CALC:TLIN 10ms`

Manual operation: See ["Time Line 1 / Time Line 2"](#) on page 261

CALCulate<n>:TLINe<Line>:STATe <State>

This command turns a time line on and off.

Suffix:
<n> irrelevant

<Line> 1 | 2
Selects the time line.

Parameters:

<State> ON | OFF
*RST: OFF

Example: CALC:TLIN2:STAT ON

Manual operation: See "[Time Line 1 / Time Line 2](#)" on page 261

CALCulate:UNIT Subsystem

The CALCulate:UNIT subsystem defines the units for the parameters that can be set and the measurement results.

CALCulate<n>:UNIT:ANGLE <Unit>

This command selects the unit for angles.

The unit is defined globally for all windows.

Suffix:

<n> irrelevant

Parameters:

<Unit> DEG | RAD
*RST: RAD

Example: CALC:UNIT:ANGL DEG

Mode: ADEMOD

CALCulate<n>:UNIT:POWER <Unit>

This command selects the unit of the y-axis.

The unit applies to all measurement windows.

Suffix:

<n> irrelevant

Parameters:

<Unit> DBM | V | A | W | DBPW | WATT | DBUV | DBMV | VOLT |
DBUA | AMPere
*RST: dBm

Example: CALC:UNIT:POW DBM
Sets the power unit to dBm.

Manual operation: See "[Unit](#)" on page 69

Other commands in the Calculate subsystem

CALCulate<n>:FEED <ResultDisplay>

This command selects the result display in realtime mode.

Parameters:

<ResultDisplay>	'XFRequency:RFPower[:SPEctrum]'
	'XFRequency[:SPEctrum]'
	Selects the realtime spectrum result display.
	'XFRequency:RFPower:SGRam'
	'XFRequency:SGRam'
	Selects the spectrogram result display.
	'XFRequency:RFPower:PSpectrum'
	'XFRequency:PSpectrum'
	Selects the persistence spectrum result display.
	'XTIME:RFPower[:TDOMain]'
	'XTIME[:TDOMain]'
	Selects the power vs time result display.
	'XTIME:RFPower:SGRam'
	'XTIME:SGRam'
	Selects the power vs time waterfall diagram.
	*RST: SPEctrum

Example:

```
CALC:FEED 'XFR:PSP'
```

Starts the persistence spectrum result display.

CALCulate<n>:FEED <Evaluation>

This command selects the evaluation method of the measured data that is to be displayed in the specified window.

The suffix <1...6> indicates which of the traces is evaluated in the result summary. Note that all result summaries are identical, as the results of all evaluations are included in the summary.

Suffix:

<n>	1...4
	window

Parameters:

<Evaluation>

XTIM:AM:RELative[:TDOMain] |
 XTIM:AM:RELative:AFSPectrum<1...6> |
 XTIM:AM[:ABSolute][:TDOMain] | XTIM:RFPower[:TDOMain] |
 XTIM:FM[:TDOMain] | XTIM:FM:AFSPectrum<1...6> |
 XTIM:PM[:TDOMain] | XTIM:PM:AFSPectrum<1...6> |
 XTIM:AMSummary<1...6>[:ABSolute] |
 XTIM:AMSummary<1...6>:RELative |
 XTIM:FMSummary<1...6> | XTIM:PMSummary<1...6> |
 XTIM:SPECTrum | XTIM:SUMMARY<1...6> |
 XTIM:RFPower[:TDOMain] | XTIM:SPECTrum |
 XTIM:SUMMARY<1...6> | XFRrequency:SFM:LEFT |
 XFRrequency:SFM:RIGHT | XFRrequency:SFM:MPX |
 XFRrequency:SFM:MONO | XFRrequency:SFM:STEReo |
 XFRrequency:SFM:RDS | XFRrequency:SFM:PILot |
 XTIme:SFM:LEFT | XTIme:SFM:RIGHT | XTIme:SFM:MPX |
 XTIme:SFM:MONO | XTIme:SFM:STEReo | XTIme:SFM:RDS |
 XTIme:SFM:PILot

XTIM:AM:RELative[:TDOMain]

Demodulated AM signal in time domain

XTIM:AM:RELative:AFSPectrum<1...6>

AF spectrum of the demodulated AM signal

XTIM:AM[:ABSolute][:TDOMain]

RF signal in time domain (RF power)

Same as 'XTIM:RFPower'

XTIM:RFPower[:TDOMain]

RF power of the signal (RF signal in time domain)

XTIM:FM[:TDOMain]

Demodulated FM signal in time domain

XTIM:FM:AFSPectrum<1...6>

AF spectrum of the demodulated FM signal

XTIM:PM[:TDOMain]

Demodulated PM signal in time domain

XTIM:PM:AFSPectrum<1...6>

AF spectrum of the demodulated PM signal

XTIM:AMSummary<1...6>[:ABSolute]

Result summary for RF signal

XTIM:AMSummary<1...6>:RELative

Result summary for demodulated AM signal

XTIM:FMSummary<1...6>

Result summary for demodulated FM signal

XTIM:PMSummary<1...6>

Result summary for demodulated PM signal

XTIM:SPECTrum

RF spectrum of the signal determined from the measured data via FFT

XTIM:SUMMary<1...6>

Summary of all evaluation lists

XFrequency:SFM:LEFT

Left channel spectrum of FM stereo signal

XFrequency:SFM:RIGHT

Right channel spectrum of FM stereo signal

XFrequency:SFM:MPX

MPX channel spectrum of FM stereo signal

XFrequency:SFM:MONO

Mono channel spectrum of FM stereo signal

XFrequency:SFM:STEReo

Stereo channel spectrum of FM stereo signal

XFrequency:SFM:RDS

RDS channel spectrum of FM stereo signal

XFrequency:SFM:PILot

Pilot channel spectrum of FM stereo signal

XTime:SFM:LEFT

Left channel of FM stereo signal in time domain

XTime:SFM:RIGHT

Right channel of FM stereo signal in time domain

XTime:SFM:MPX

MPX channel of FM stereo signal in time domain

XTime:SFM:MONO

Mono channel of FM stereo signal in time domain

XTime:SFM:STEReo

Stereo channel of FM stereo signal in time domain

XTime:SFM:RDS

RDS channel of FM stereo signal in time domain

XTime:SFM:PILot

Pilot channel of FM stereo signal in time domain

Example:

`INST:SEL ADEM`

Activates analog demodulator.

`CALC:FEED 'XTIM:FM'`

Selects the display of the FM signal.

Usage:

SCPI confirmed

Mode:

ADEMODO, SFM

Manual operation: See "AM" on page 336
 See "Screen A-D" on page 336
 See "FM" on page 344
 See "PM" on page 345
 See "RF Power" on page 346
 See "Left" on page 390
 See "Screen A-D" on page 390
 See "Right" on page 401
 See "MPX" on page 401
 See "Mono" on page 401
 See "Stereo" on page 401
 See "RDS" on page 401
 See "Pilot" on page 402
 See "RF Power" on page 402

CALCulate<n>:FORMat <Limitation>

This command activates the limitation to $\pm 180^\circ$.

Suffix:

<n> 1...4
 irrelevant

Parameters:

<Limitation> PHASe | UPHase
PHASe
 Limitation to $\pm 180^\circ$
UPHase
 Unwrapped
 *RST: UPHase

Example:

CALC:FORM PHAS
 Activates the limitation to $\pm 180^\circ$.

Usage: SCPI confirmed

Mode: ADEMOD

Manual operation: See "Phase Wrap On/Off" on page 346

CALCulate<n>:FORMat <Format>

This command defines the display type of the IQ data.

Suffix:

<n> irrelevant

Parameters:

<Format>	RIMag IQ data
	MAGNitude Magnitude
	FREQuency Spectrum
	VECTor IQ-Vector

Manual operation: See "I/Q Analyzer" on page 279
See "Display Config" on page 284

8.2.3.3 CALibration:PMETer Subsystem (Power Sensor, R&S FSV-K9)

The CALibration:PMETer Subsystem determines the error correction data for measurements in the power meter mode. It is only available if the R&S FSV-K9 Power Sensor option is installed.

For details see [chapter 4.5, "Instrument Functions - Power Sensor \(R&S FSV-K9\)"](#), on page 304.

CALibration:PMETer<p>:ZERO:AUTO ONCE.....709

CALibration:PMETer<p>:ZERO:AUTO ONCE

This command starts zeroing of the selected power sensor.

Note: Before starting the zeroing process disconnect all signals from the input of the power sensor.

Suffix:

<p>	1...4 Power sensor index
-----	-----------------------------

Example:

```
CAL:PMET2:ZERO:AUTO ONCE;*WAI
```

Starts zeroing the power sensor 2 and delays the execution of further commands until zeroing is concluded.

Mode: PSM

Manual operation: See "Zeroing Power Sensor" on page 313

8.2.3.4 DISPlay Subsystem

The DISPLay subsystem controls the selection and presentation of textual and graphic information as well as of measurement data on the display.



Some applications offer up to four measurement windows. For those, the suffix <1...4> for WINDow selects the measurement window. For all other applications, the suffix is irrelevant.

DISPlay:MTABLE.....	710
DISPlay[:WINDow<n>]:MINFo:STATe.....	711
DISPlay[:WINDow<n>][:SUBWindow<m>]:SIZE.....	711
DISPlay[:WINDow<n>][:SUBWindow<m>]:SELEct.....	712
DISPlay:WINDow[:SUBWindow]:TRACe:MAXHold:RESEt.....	712
DISPlay:WINDow<n>[:SUBWindow<m>]:TRACe<t>:MAXHold[:INTensity].....	713
DISPlay:WINDow<n>[:SUBWindow<m>]:TRACe:MAXHold[:STATe].....	713
DISPlay:WINDow<n>[:SUBWindow<m>]:TRACe<t>:PERSiStence:DURation.....	713
DISPlay:WINDow[:SUBWindow]:TRACe:PERSiStence:GRANularity.....	714
DISPlay:WINDow<n>[:SUBWindow<m>]:TRACe<t>:PERSiStence[:STATe].....	714
DISPlay:WINDow<n>[:SUBWindow<m>]:TRACe<t>:SYMBol.....	714
DISPlay:WINDow[:SUBWindow]:ZOOM:AREA.....	714
DISPlay:WINDow[:SUBWindow]:ZOOM:STATe.....	715
DISPlay[:WINDow<n>]:TRACe<t>[:STATe].....	715
DISPlay[:WINDow<n>]:TRACe<t>:MODE.....	716
DISPlay[:WINDow<n>]:TRACe<t>:MODE:HCONtinuous.....	716
DISPlay[:WINDow<n>]:TRACe<t>:X:SPACing.....	717
DISPlay[:WINDow<n>]:TRACe<t>:Y:SPACing.....	717
DISPlay[:WINDow<n>]:TRACe<t>:Y[:SCALE].....	718
DISPlay[:WINDow<n>]:TRACe<t>:Y[:SCALE]:MODE.....	719
DISPlay[:WINDow<n>]:TRACe<t>:MODE:HCONtinuous.....	719
DISPlay[:WINDow<n>]:TRACe<t>:Y[:SCALE]:RLEVel.....	720
DISPlay[:WINDow<n>]:TRACe<t>:Y[:SCALE]:RLEVel:OFFSEt.....	720
DISPlay[:WINDow<n>]:TRACe<t>:Y[:SCALE]:RPOSiTion.....	720
DISPlay[:WINDow<n>]:TRACe<t>:Y[:SCALE]:RVALue.....	721
DISPlay[:WINDow<n>]:TRACe<t>:Y[:SCALE]:RVALue.....	721
DISPlay[:WINDow<n>]:STATe.....	721
DISPlay[:WINDow<n>]:SSELEct?.....	722
DISPlay[:WINDow<n>][:SUBWindow<1 2>]:SELEct.....	722
DISPlay:WSELEct?.....	723
DISPlay[:WINDow<n>]:ZOOM:AREA.....	723
DISPlay[:WINDow<n>]:ZOOM:STATe.....	724

DISPlay:MTABLE <DisplayMode>

This command turns the marker table on and off.

Parameters:

<DisplayMode>	ON	Marker table is displayed.
	OFF	Marker table is not displayed.
	AUTO	Marker table is only displayed if 2 or more markers are active.
*RST:	AUTO	

Example: To activate the table display:
 DISP:MTAB ON
 To query the current state of the marker table display:
 DISP:MTAB?

Manual operation: See "[Marker Table](#)" on page 123

DISPlay[:WINDow<n>]:MINFo:STATe <State>

This command turns the marker info field in the diagram on and off.

Parameters:

<State> ON | OFF
 *RST: ON

Example: DISP:MINF:STAT ON
 Turns the marker info field on.

Manual operation: See "[Marker Info \(On Off\)](#)" on page 124

DISPlay[:WINDow<n>][:SUBWIndow<m>]:SIZE <Size>

This command configures the measurement display.

Suffix:

<n> 1 | 2
 window;
 Channel and adjacent-channel power measurements: Only "1" is allowed as a suffix for the window.
 Spectrum Emission Mask and Spurious Emissions measurements:
 selects the window that is displayed in full size (if no suffix is defined, "1" is used):
 1: diagram/result list
 2: marker table

<m> 1 | 2
 selects the item in the window to be displayed in full size:
 1: diagram
 2: result list

Parameters:**<Size>** LARGe | SMALI**LARGe**

Channel and adjacent-channel power measurements: diagram in full screen.

Spectrum Emission Mask and Spurious Emissions measurements: diagram or list in full screen, depending on the value of the suffix.

SMALI

split screen (diagram and list and table)

***RST:** SMALI**Example:**

DISP:SIZE LARG

Displays the measurement diagram in full screen size.

DISP:WIND1:SUBW2:SIZE LARG

Displays the result list in full screen size.

DISP:WIND2:SIZE LARG

Displays the marker table in full screen size.

Mode:

all

DISPlay[:WINDow<n>][:SUBWindow<m>]:SElect

This command selects which window (screen) is active for applications with more than one measurement window. For measurements with additional subwindows (e.g. SEM, ACLR), the subwindow can also be selected.

Suffix:**<n>** 1...4

window; For applications that do not have more than 1 measurement window, the suffix <n> is irrelevant.

<m>

1...2

1: graphic

2: table

For applications that do not have subwindows, the suffix <m> is irrelevant.

Parameters:***RST:** 1**Example:**

DISP:WIND1:SEL

Sets the window 1 active.

DISP:WIND1:SUBW2:SEL

Sets the focus on the table of window 1.

DISPlay:WINDow[:SUBWindow]:TRACe:MAXHold:RESet

This command resets the maxhold trace in the persistence spectrum result display.

Usage:

Event

Mode: RT

DISPlay:WINDow<n>[:SUBWindow<m>]:TRACe<t>:MAXHold[:INTensity]
 <intensity> | RESet

This command defines the color intensity of the maxhold persistence spectrum.

Parameters:

<intensity> Sets the color intensity of the maxhold trace.
 Setting an intensity of 0 turns the maxhold off.

Range: 0 to 254

Increment: 1

*RST: 100

RESet Resets the maxhold trace.

Example:

DISP:WIND:TRAC:MAXH 120

Sets the color intensity of the maxhold trace to 120.

DISP:WIND:TRAC:MAXH RES

Resets the maxhold trace.

Mode: RT

DISPlay:WINDow<n>[:SUBWindow<m>]:TRACe:MAXHold[:STATe] <boolean>

This command switches the maxhold trace in the persistence spectrum on and off.

Parameters:

<boolean> **ON | OFF**

*RST: On

Mode: RT

DISPlay:WINDow<n>[:SUBWindow<m>]:TRACe<t>:PERSistence:DURation
 <persistence>

This command sets the duration of the persistence.

Setting the persistence to 0 turns it off.

Parameters:

<persistence> Persistence in seconds.

Range: 0 to 8

Increment: 0.001

*RST: 1 seconds

Default unit: seconds

Example:

DISP:WIND:TRAC:PERS:DUR 4.3

Sets the persistence to 4.3 seconds.

Mode: RT

DISPlay:WINDow[:SUBWindow]:TRACe:PERSistence:GRANularity <Granularity>

This command sets the persistence granularity

Parameters:

<Granularity> Amount of data the R&S FSVR uses to build the persistence spectrum in seconds.
*RST: RST value

Mode: RT

DISPlay:WINDow<n>[:SUBWindow<m>]:TRACe<t>:PERSistence[:STATe]
<boolean>

This command switches persistence in the persistence spectrum on and off.

Parameters:

<boolean> ON | OFF
*RST: On

Mode: RT

DISPlay:WINDow<n>[:SUBWindow<m>]:TRACe<t>:SYMBOL <style>

This command sets the display style of the persistence spectrum.

Parameters:

<style> **DOTS**
Displays the data as dots. The result is a persistence spectrum made up out of dots.
VECTor
Interpolates the measurement points. The result is an uninterrupted persistence spectrum.
*RST: VECTor

Example:

```
CALC3:FEED 'XFR:HIST'
```

Activates the persistence spectrum in screen 3 with a vectorial display of the results.

```
DISP:WIND3:TRAC:SYMB DOTS
```

Displays the persistence spectrum in the third measurement screen as dots.

Mode: RT

DISPlay:WINDow[:SUBWindow]:ZOOM:AREA <StartFrequency>, <StartTime>, <StopFrequency>, <StopTime>

This command defines the zoom area.

Before you can use this command, you have to turn the zoom on with [DISPlay:WINDow\[:SUBWindow\]:ZOOM:STATe](#) on page 715.

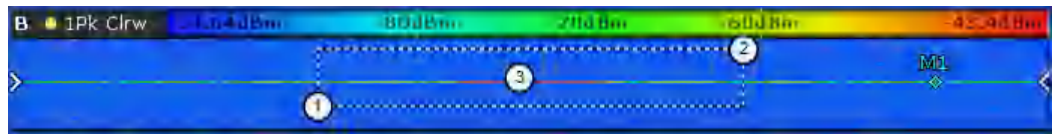

1 = Start frequency and time
 2 = Stop frequency and time
 3 = Zoom area

Parameters:

<StartFrequency> Defines the start frequency of the zoom area.
 The range depends on the span of the unzoomed spectrogram.

<StartTime> Defines the start time of the zoom area.
 Time information in seconds is relative to the present frame.
 The range corresponds to the visible spectrogram.

<StopFrequency> Defines the stop frequency of the zoom area.
 The range depends on the span of the unzoomed spectrogram.

<StopTime> Defines the stop time of the zoom area.
 Time information in seconds is relative to the present frame.
 The range corresponds to the visible spectrogram.

Example:

`DISP:WIND:ZOOM:AREA 95MHZ,-2s,105MHZ,-1s`
 Defines a zoom area between 95 and 105 MHz and between -1 and -2 seconds ago.

Mode: RT

DISPlay:WINDow[:SUBWindow]:ZOOM:STATE <State>

This command turns the spectrogram zoom on and off.

The spectrogram has to be active for the command to work.

Parameters:

<State> ON | OFF

Example:

`DISP:WIND:ZOOM:STAT ON`
 Turns the zoom on.

DISPlay[:WINDow<n>]:TRACe<t>[:STATe] <State>

This command switches on or off the display of the corresponding trace. The other measurements are not aborted but continue running in the background.

Suffix:

<n> window; For applications that do not have more than 1 measurement window, the suffix <n> is irrelevant.

<t> trace

Parameters:

<State> ON | OFF

*RST: ON for TRACe1, OFF for TRACe2 to 6

Example: DISP:TRAC3 ON

Manual operation: See "Blank" on page 95

DISPlay[:WINDow<n>]:TRACe<t>:MODE <Mode>

This command defines the type of display and the evaluation of the traces. WRITE corresponds to the Clr/Write mode of manual operation. The trace is switched off (= BLANK in manual operation) with `DISPlay[:WINDow<n>]:TRACe<t>[:STATe]`.

The number of measurements for AVERage, MAXHold and MINHold is defined with the `[SENSe:]AVERage<n>:COUNT` or `[SENSe:]SWEep:COUNT` commands. It should be noted that synchronization to the end of the indicated number of measurements is only possible in single sweep mode.

If calculation of average values is active, selection between logarithmic and linear averaging is possible. For more detail see `[SENSe:]AVERage<n>:TYPE` on page 780.

Suffix:

<n> window; For applications that do not have more than 1 measurement window, the suffix <n> is irrelevant.

<t> trace

Parameters:

<Mode> WRITE | VIEW | AVERage | MAXHold | MINHold | BLANK
 *RST: WRITE for TRACe1, STATe OFF for
 TRACe2/3/4/5/6

For details on trace modes refer to [chapter 4.1.8.4, "Trace Mode Overview"](#), on page 104.

Example:

INIT:CONT OFF

Switching to single sweep mode.

SWE:COUN 16

Sets the number of measurements to 16.

DISP:TRAC3:MODE MAXH

Switches on the calculation of the maximum peak for trace 3.

INIT;*WAI

Starts the measurement and waits for the end of the 16 sweeps.

Manual operation: See "Clear Write" on page 94
 See "Max Hold" on page 94
 See "Min Hold" on page 95
 See "Average" on page 95
 See "View" on page 95

DISPlay[:WINDow<n>]:TRACe<t>:MODE:HCONTinuous <State>

This command defines whether traces in Min Hold, Max Hold and Average mode (see `DISPlay[:WINDow<n>]:TRACe<t>:MODE` on page 716) are reset after a parameter is changed.

Normally, the measurement is started anew after parameter changes, before the measurement results are evaluated (e.g. using a marker). In all cases that require a new measurement after parameter changes, the trace is reset automatically to avoid false results (e.g. with span changes). For applications that require no reset after parameter changes, the automatic reset can be switched off.

Suffix:

<n> window; For applications that do not have more than 1 measurement window, the suffix <n> is irrelevant.

<t> trace

Parameters:

<State>

ON

The automatic reset is switched off.

OFF

After certain parameter changes the traces are reset.

*RST: OFF

Example:

DISP:WIND:TRAC3:MODE:HCON ON

Switches off the reset function.

Manual operation: See "[Hold/Cont](#)" on page 95

DISPlay[:WINDow<n>]:TRACe<t>:X:SPACing <ScalingType>

This command toggles between linear and logarithmic display of the x-axis.

Suffix:

<n> window; For applications that do not have more than 1 measurement window, the suffix <n> is irrelevant.

<t> irrelevant

Parameters:

<ScalingType>

LOGarithmic | LINear

LOGarithmic

Selects logarithmic scaling.

LINear

Selects linear scaling.

*RST: LINear

Example:

DISP:TRAC:X:SPAC LOG

Mode:

A, ADEMOD

DISPlay[:WINDow<n>]:TRACe<t>:Y:SPACing <ScalingType>

This command selects the scaling of the y-axis.

For AF spectrum displays, only the parameters "LINear" and "LOGarithmic" are permitted.

Suffix:

<n> Selects the measurement window.

<t> irrelevant

Parameters:

<ScalingType>

LOGarithmic

Logarithmic scaling.

LINear

Linear scaling in %.

LDB

Linear scaling in dB.

*RST: LOGarithmic

Example:

```
DISP:TRAC:Y:SPAC LIN
```

Select a linear scale.

Manual operation:

See ["Range Log 100 dB"](#) on page 68

See ["Range Log 50 dB"](#) on page 68

See ["Range Log 10 dB"](#) on page 68

See ["Range Log 5 dB"](#) on page 68

See ["Range Log 1 dB"](#) on page 69

See ["Range Log Manual"](#) on page 69

See ["Range Linear %"](#) on page 69

See ["Range Lin. Unit"](#) on page 69

See ["Deviation Lin/Log"](#) on page 343

DISPlay[:WINDow<n>]:TRACe<t>:Y[:SCALe] <Range>

This command defines the display range of the y-axis with logarithmic scaling.

The command works only for a logarithmic scaling. You can select the scaling with [DISPlay\[:WINDow<n>\]:TRACe<t>:Y:SPACing](#) on page 717.

Suffix:

<n> window; For applications that do not have more than 1 measurement window, the suffix <n> is irrelevant.

<t> irrelevant

Parameters:

<Range> Range: 10 to 200

*RST: 100

Default unit: dB

Example:

```
DISP:TRAC:Y 110dB
```

Manual operation:

See ["Range Log 100 dB"](#) on page 68

See ["Range Log 50 dB"](#) on page 68

See ["Range Log 10 dB"](#) on page 68

See ["Range Log 5 dB"](#) on page 68

See ["Range Log 1 dB"](#) on page 69

See ["Range Log Manual"](#) on page 69

DISPlay[:WINDow<n>]:TRACe<t>:Y[:SCALe]:MODE <Mode>

This command selects the type of scaling of the y-axis.

When `SYSTem:DISPlay:UPDate` is turned off, this command has no immediate effect on the screen.

Suffix:

<n> window; For applications that do not have more than 1 measurement window, the suffix <n> is irrelevant.

<t> irrelevant

Parameters:

<Mode> **ABSolute**
absolute scaling of the y-axis

RELative
relative scaling of the y-axis

*RST: ABS

Example: DISP:TRAC:Y:MODE REL

Manual operation: See "Grid Abs/Rel " on page 72

DISPlay[:WINDow<n>]:TRACe<t>:MODE:HCONTinuous <State>

This command defines whether traces in Min Hold, Max Hold and Average mode are reset in the window specified by the suffix <n> after parameter change or not.

Normally, the measurement is started anew after parameter changes, before the measurement results are evaluated (e.g. using a marker). In all cases that require a new measurement after parameter changes, the trace is reset automatically to avoid false results (e.g. with span changes). For applications that require no reset after parameter changes, the automatic reset can be switched off.

Suffix:

<n> window; For applications that do not have more than 1 measurement window, the suffix <n> is irrelevant.

<t> trace

Parameters:

<State> OFF | ON

OFF

After certain parameter changes the traces are reset.

ON

The automatic reset is switched off.

*RST: OFF

Example: DISP:WIND:TRAC3:MODE:HCON ON
Switches off the reset function.

Mode: A

Manual operation: See "Dev per Division" on page 341

DISPlay[:WINDow<n>]:TRACe<t>:Y[:SCALe]:RLEVel <ReferenceLevel>

This command defines the reference level.

With the reference level offset $\neq 0$, the value range of the reference level is modified by the offset.

The unit depends on the setting defined with `CALCulate<n>:UNIT:POWer`.

Suffix:

<n> irrelevant.

<t> irrelevant

Parameters:

<ReferenceLevel> The unit is variable.
 Range: see datasheet
 *RST: -10dBm

Example: `DISP:TRAC:Y:RLEV -60dBm`

Manual operation: See "[Ref Level](#)" on page 67

DISPlay[:WINDow<n>]:TRACe<t>:Y[:SCALe]:RLEVel:OFFSet <Value>

This command defines a reference level offset.

Suffix:

<n> irrelevant.

<t> irrelevant

Parameters:

<Value> Range: -200 to 200
 *RST: 0
 Default unit: dB

Example: `DISP:TRAC:Y:RLEV:OFFS -10dB`

Manual operation: See "[Ref Level Offset](#)" on page 72

DISPlay[:WINDow<n>]:TRACe<t>:Y[:SCALe]:RPOSition <Position>

This command defines the position of the reference level on the display grid..

Suffix:

<n> Selects the measurement window.

<t> irrelevant

Parameters:

<Position> 0 PCT corresponds to the lower display border, 100% corresponds to the upper display border.
 Range: 0 to 100
 *RST: Spectrum mode: 100 PCT
 Default unit: PCT

Example: `DISP:TRAC:Y:RPOS 50PCT`

Manual operation: See ["Ref Level Position"](#) on page 72
See ["Reference Position"](#) on page 341

DISPlay[:WINDow<n>]:TRACe<t>:Y[:SCALe]:RVALue <Value>

The command defines the power value assigned to the reference position in the grid.

Suffix:

<n> irrelevant

<t> irrelevant

Parameters:

<Value> *RST: 0 dB, coupled to reference level

Example: `DISP:TRAC:Y:RVAL -20dBm`
Defines a reference position of -20 dBm.

Manual operation: See ["Reference Level"](#) on page 282

DISPlay[:WINDow<n>]:TRACe<t>:Y[:SCALe]:RVALue <Value>

This command defines the reference value assigned to the reference position in the specified window. Separate reference values are maintained for the various displays.

Suffix:

<n> 1...4
window

<t> irrelevant

Parameters:

<Value> *RST: 0 PCT = AM display, (0 Hz = FM display), (0 rad = PM display), (100 PCT = AF spectrum display of AM signal), (250 kHz = AF spectrum display of FM signal), (10 rad = AF spectrum display of PM signal)

Example: `DISP:TRAC:Y:RVAL 0`
Sets the value assigned to the reference position to 0 Hz (analog demodulation)

Manual operation: See ["Reference Value"](#) on page 342

DISPlay[:WINDow<n>]:STATe <State>

This command activates the measurement specified window.

Suffix:

<n> 1...4
window

Parameters:**<State>** ON | OFF**Example:**

DISP:WIND2:STAT ON

Displays a second window (Screen B).

Usage:

SCPI confirmed

Mode:

ADEMOD

Manual operation: See "Screen A-D" on page 336**DISPlay[:WINDow<n>]:SSElect?**

Queries the currently selected subwindow.

Suffix:**<n>** 1...4
window**Return values:****<Result>** 1 | 2
1
Diagram
2
Result list**Example:**

DISP:WIND2:SUBW2:SEL

Switches the focus area to the result list in screen B.

DISP:WIND2:SSEL?

Result: 2

Usage:Query only
SCPI confirmed**Mode:**

ADEMOD

DISPlay[:WINDow<n>][:SUBWIndow<1|2>]:SElect

Moves the focus area to the selected window and subwindow.

Suffix:**<n>** 1
window**Example:**

DISP:WIND2:STAT ON

Displays a second window (Screen B).

CALC2:FEED 'XTIME:FM:AFSPektrum1'

Displays an AF spectrum diagram of the demodulated FM signal from trace 1 in screen B.

DISP:WIND2:SEL

Switches the focus area to the evaluation list of the AF spectrum diagram in screen B.

Usage: SCPI confirmed
Mode: ADEMOD

DISPlay:WSElect?

Queries the currently selected window.

Example: `DISP:WIND2:SEL`
 Switches the focus area to screen B.
`DISP:WSEL?`
 Result: 2

Usage: Query only
 SCPI confirmed

Mode: ADEMOD

DISPlay[:WINDow<n>]:ZOOM:AREA <x1>, <y1>, <x2>, <y2>

This command defines the zoom area.

Before you can define a zoom area, you first have to turn the zoom on.

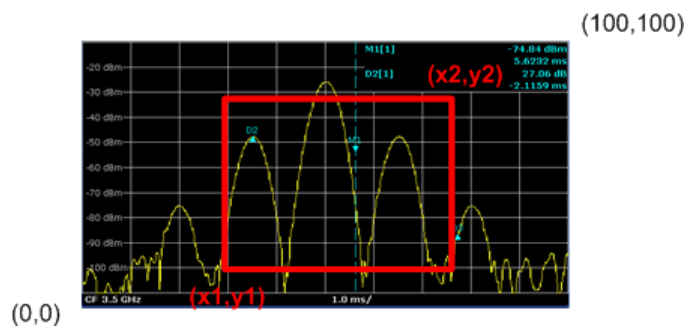

Suffix: <n> window; For applications that do not have more than 1 measurement window, the suffix <n> is irrelevant.

Parameters: <x1>, <y1>, <x2>, <y2>
 Diagram coordinates in % of the complete diagram that define the zoom area.
 The lower left corner is the origin of coordinate system. The upper right corner is the end point of the system.
 Range: 0 to 100
 Default unit: PCT

Example: `DISP:ZOOM ON`
 Activates the zoom mode.
`DISP:ZOOM:AREA 5,30,20,100`
 Enlarges the display of the measurement results in the area defined by the coordinates (5,30) and (20,100).

DISPlay[:WINDow<n>]:ZOOM:STATe <State>

This command turns the zoom on and off.

Suffix:

<n> Selects the measurement window.

Parameters:

<State> ON | OFF
*RST: OFF

Example:

DISP:ZOOM ON
Activates the zoom mode.

8.2.3.5 DISPlay:WINDow:PSPectrum and DISPlay:WINDow:SPECTrogram Subsystems

The commands in the DISPlay:WINDow:PSPectrum and DISPlay:WINDow:SPECTrogram subsystems define the color settings of the persistence spectrum and spectrogram result display of the realtime analyzer.

| | |
|--|-----|
| DISPlay:WINDow:PSPectrum:COLor:DEFault..... | 724 |
| DISPlay:WINDow:PSPectrum:COLor:LOWer..... | 724 |
| DISPlay:WINDow:PSPectrum:COLor:SHAPE..... | 725 |
| DISPlay:WINDow:PSPectrum:COLor[:STYLE]..... | 725 |
| DISPlay:WINDow:PSPectrum:COLor:TRUNcate..... | 725 |
| DISPlay:WINDow:PSPectrum:COLor:UPPer..... | 725 |
| DISPlay:WINDow:SGRam:COLor:DEFault..... | 726 |
| DISPlay:WINDow:SGRam:COLor:LOWer..... | 726 |
| DISPlay:WINDow:SGRam:COLor:SHAPE..... | 726 |
| DISPlay:WINDow:SGRam:COLor[:STYLE]..... | 726 |
| DISPlay:WINDow:SGRam:COLor:UPPer..... | 727 |

DISPlay:WINDow:PSPectrum:COLor:DEFault

This command sets the color settings for the persistence spectrum result display to its default state.

Usage: Event

DISPlay:WINDow:PSPectrum:COLor:LOWer <Percentage>

This command sets the lower percentage boundary of the persistence spectrum.

Parameters:

<Percentage> Statistical frequency percentage.
Range: 0 to 65,6
*RST: 0
Default unit: %

Example:

DISP:WIND:HIST:COL:LOW 10
Sets the start of the color map to 10%.

DISPlay:WINDow:PSPectrum:COLor:SHAPE <Shape>

This command defines the shape and focus of the color curve for the persistence spectrum result display.

Parameters:

<Shape> Shape of the color curve.
 Range: -1 to 1
 *RST: 0

DISPlay:WINDow:PSPectrum:COLor[:STYLE] <ColorScheme>

This command sets the color scheme for the persistence spectrum.

Parameters:

<ColorScheme> **HOT**
 COLD
 RADar
 GREYscale
 *RST: HOT

Example:

DISP:WIND:HIST:COL GREY
 Changes the color scheme of the persistence spectrum to black and white.

DISPlay:WINDow:PSPectrum:COLor:TRUNcate <State>

This command reduces the range of the color map of the persistence spectrum if there are no hits at the start or end of the value range.

Parameters:

<State> **ON**
 OFF
 *RST: OFF

Example:

DISP:WIND:PSP:COL:TRUN ON
 Activates truncation of the color map.

DISPlay:WINDow:PSPectrum:COLor:UPPer <Percentage>

This command sets the upper percentage boundary of the persistence spectrum.

Parameters:

<Percentage> Statistical frequency percentage.
 Range: 0 to 66
 *RST: 0
 Default unit: %

Example:

DISP:WIND:HIST:COL:UPP 95
 Sets the start of the color map to 95%.

DISPlay:WINDow:SGRam:COLor:DEFault

This command sets the color settings for the spectrogram result display to its default state.

Usage: Event

DISPlay:WINDow:SGRam:COLor:LOWer <Percentage>

This command sets the lower percentage boundary of the spectrogram.

Parameters:

<Percentage> Statistical frequency percentage.
Range: 0 to 66
*RST: 0
Default unit: %

Example:

DISP:WIND:SGR:COL:LOW 10
Sets the start of the color map to 10%.

DISPlay:WINDow:SGRam:COLor:SHAPE <Shape>

This command defines the shape and focus of the color curve for the spectrogram result display.

Parameters:

<Shape> Shape of the color curve.
Range: -1 to 1
*RST: 0

DISPlay:WINDow:SGRam:COLor[:STYLE] <ColorScheme>

This command sets the color scheme for the spectrogram.

Parameters:

<ColorScheme>

HOT

Uses a color range from blue to red. Blue colors indicate low levels, red colors indicate high ones.

COLD

Uses a color range from red to blue. Red colors indicate low levels, blue colors indicate high ones.

COLor

In realtime mode, this parameter selects the HOT color scheme. In spectrum mode, it selects the color scheme Color.

RADar

Uses a color range from black over green to light turquoise with shades of green in between. Dark colors indicate low levels, light colors indicate high ones.

GRAYscale

Shows the results in shades of gray. Dark gray indicates low levels, light gray indicates high ones.

*RST: HOT

Example:

```
DISP:WIND:SGR:COL GRAY
```

Changes the color scheme of the spectrogram to black and white.

DISPlay:WINDow:SGRam:COLor:UPPer <Percentage>

This command sets the upper percentage boundary of the spectrogram.

Parameters:

<Percentage>

Statistical frequency percentage.

Range: 0 to 66

*RST: 0

Default unit: %

Example:

```
DISP:WIND:SGR:COL:UPP 95
```

Sets the start of the color map to 95%.

8.2.3.6 FETCh:PMETer Subsystem (Power Sensor, R&S FSV-K9)

The FETCh:PMETer subsystem contains commands to read measurement results of power sensor measurements without starting the measurement itself. It is only available if the R&S FSV-K9 Power Sensor option is installed.

For details see [chapter 4.5, "Instrument Functions - Power Sensor \(R&S FSV-K9\)"](#), on page 304.

FETCh<n>:PMETer<p>?..... 728

FETCH<n>:PMETER<p>?

This command reads the result of the power sensor measurement for the selected power sensor. These results are also displayed in the marker table.

If no measurement has been performed, this command will lead to a query error.

Suffix:

| | |
|-----|-----------------------------|
| <n> | irrelevant |
| <p> | 1...4
Power sensor index |

Example:

```
FETCH:PMET2?
```

Reads the result of the power sensor measurement for the power sensor 2.

Usage:

Query only

Mode:

PSM

8.2.3.7 FORMat Subsystem

The FORMat subsystem specifies the data format of the data transmitted from and to the instrument.

[FORMat:DEXPort:DSEPARATOR.....](#) 728

FORMat:DEXPort:DSEPARATOR <Separator>

This command defines which decimal separator (decimal point or comma) is to be used for outputting measurement data to the file in ASCII format. Different languages of evaluation programs (e.g. MS-Excel) can thus be supported.

Parameters:

| | |
|-------------|--|
| <Separator> | POINT COMMA |
| *RST: | (factory setting is POINT; *RST does not affect setting) |

Example:

```
FORM:DEXP:DSEP POIN
```

Sets the decimal point as separator.

Manual operation:

See "[ASCII Trace Export](#)" on page 99

See "[Decim Sep](#)" on page 100

See "[ASCII File Export](#)" on page 135

8.2.3.8 INITiate Subsystem

The INITiate subsystem is used to control the init-measurement function.

[INITiate<n>\[:IMMEDIATE\].....](#) 729

[INITiate<n>:CONMeas.....](#) 729

[INITiate<n>:CONTInuous.....](#) 730

| | |
|----------------------------|-----|
| INITiate<n>:DISPlay..... | 730 |
| INITiate<n>:ESpectrum..... | 731 |
| INITiate<n>:SPURious..... | 731 |

INITiate<n>[:IMMEDIATE]

The command initiates a new measurement sequence.

With sweep count > 0 or average count > 0, this means a restart of the indicated number of measurements. With trace functions MAXHold, MINHold and AVERage, the previous results are reset on restarting the measurement.

In single sweep mode, you can synchronize to the end of the measurement with *OPC, *OPC? or *WAI. In continuous sweep mode, synchronization to the end of the measurement is not possible. Thus, it is not recommended that you use continuous sweep mode in remote control, as results like trace data or markers are only valid after a single sweep end synchronization.

Suffix:

<n> irrelevant

Example:

```
INIT:CONT OFF
```

Switches to single sweep mode.

```
DISP:WIND:TRAC:MODE AVER
```

Switches on trace averaging.

```
SWE:COUN 20
```

Setting the sweep counter to 20 sweeps.

```
INIT;*WAI
```

Starts the measurement and waits for the end of the 20 sweeps.

Mode: all

INITiate<n>:CONMeas

This command restarts a measurement that has been stopped in single sweep mode.

The measurement is restarted at the first sweep point.

As opposed to `INITiate<n>[:IMMEDIATE]`, this command does not reset traces in maxhold, minhold or average mode. Therefore it can be used to continue measurements using max hold or averaging functions.

In single sweep mode, you can synchronize to the end of the measurement with *OPC, *OPC? or *WAI. In continuous sweep mode, synchronization to the end of the measurement is not possible. Thus, it is not recommended that you use continuous sweep mode in remote control, as results like trace data or markers are only valid after a single sweep end synchronization.

Suffix:

<n> irrelevant

Example:

```
INIT:CONT OFF
Switches to single sweep mode.
DISP:WIND:TRAC:MODE AVER
Switches on trace averaging.
SWE:COUN 20
Setting the sweep counter to 20 sweeps.
INIT;*WAI
Starts the measurement and waits for the end of the 20 sweeps.
INIT:CONM;*WAI
Continues the measurement (next 20 sequences) and waits for
the end.
```

Manual operation: See ["Continue Single Sweep"](#) on page 89

INITiate<n>:CONTInuous <State>

This command determines whether the trigger system is continuously initiated (continuous) or performs single measurements (single).

The sweep is started immediately.

In the "Spectrum" mode, this setting refers to the sweep sequence (switching between continuous/single sweep).

In single sweep mode, you can synchronize to the end of the measurement with *OPC, *OPC? or *WAI. In continuous sweep mode, synchronization to the end of the measurement is not possible. Thus, it is not recommended that you use continuous sweep mode in remote control, as results like trace data or markers are only valid after a single sweep end synchronization.

Suffix:

<n> irrelevant

Parameters:

<State> ON | OFF
*RST: ON

Example:

```
INIT:CONT OFF
Switches the sequence to single sweep.
INIT:CONT ON
Switches the sequence to continuous sweep.
```

Mode: all

Manual operation: See ["Continuous Sweep"](#) on page 89
See ["Single Sweep"](#) on page 89

INITiate<n>:DISPly <State>

This command turns the display during a single sweep measurement on or off.

Suffix:

<n> irrelevant

Parameters:

<State> ON | OFF
 *RST: ON

Example:

```
INIT:CONT OFF
Switches to single sweep mode
INIT:DISP OFF
Sets the display behavior to OFF
INIT;*WAI
Starts the measurement with display switched off.
```

INITiate<n>:ESPectrum

This command starts a Spectrum Emission Mask measurement.

Suffix:

<n> irrelevant

Example:

```
INIT:ESP
Starts a Spectrum Emission Mask measurement.
```

Manual operation: See "[Meas Start/Stop](#)" on page 197

INITiate<n>:SPURious

This command initiates a Spurious Emissions measurement.

Suffix:

<n> irrelevant

Example:

```
INIT:SPUR
Starts a Spurious Emissions measurement.
```

Usage: Event

8.2.3.9 INPut Subsystem

The INPut subsystem controls the input characteristics of the RF inputs of the instrument.

| | |
|-----------------------------------|-----|
| INPut:ATTenuation..... | 732 |
| INPut:ATTenuation:AUTO..... | 732 |
| INPut:COUPling..... | 732 |
| INPut:DIQ:CDEVice..... | 733 |
| INPut:DIQ:RANGe:COUPling..... | 734 |
| INPut:DIQ:RANGe[:UPPer]..... | 734 |
| INPut:DIQ:RANGe[:UPPer]:UNIT..... | 735 |
| INPut:DIQ:SRATe..... | 735 |
| INPut:EATT..... | 736 |
| INPut:EATT:AUTO..... | 736 |
| INPut:EATT:STATe..... | 736 |
| INPut:FILTer:YIG[:STATe]..... | 737 |

| | |
|------------------------|-----|
| INPut:GAIN:STATe | 737 |
| INPut:IMPedance..... | 737 |
| INPut:SElect..... | 738 |
| INPut:UPORt?..... | 738 |
| INPut:UPORt:STATe..... | 738 |

INPut:ATTenuation <Value>

This command programs the input attenuator. To protect the input mixer against damage from overloads, the setting 0 dB can be obtained by entering numerals, not by using the DOWN command.

The attenuation can be set in 5 dB steps (with option R&S FSV-B25: 1 dB steps). If the defined reference level cannot be set for the set RF attenuation, the reference level is adjusted accordingly.

In the default state with "Spectrum" mode, the attenuation set on the step attenuator is coupled to the reference level of the instrument. If the attenuation is programmed directly, the coupling to the reference level is switched off.

This function is not available if the R&S Digital I/Q Interface (R&S FSV-B17) is active.

Parameters:

<Value> *RST: 10 dB (AUTO is set to ON)

Example:

INP:ATT 30dB

Sets the attenuation on the attenuator to 30 dB and switches off the coupling to the reference level.

Mode: all

Manual operation: See "[RF Atten Manual/Mech Att Manual](#)" on page 70

INPut:ATTenuation:AUTO <State>

This command automatically couples the input attenuation to the reference level (state ON) or switches the input attenuation to manual entry (state OFF).

This function is not available if the R&S Digital I/Q Interface (R&S FSV-B17) is active.

Parameters:

<State> ON | OFF

*RST: ON

Example:

INP:ATT:AUTO ON

Couples the attenuation set on the attenuator to the reference level.

Manual operation: See "[RF Atten Auto/Mech Att Auto](#)" on page 71

INPut:COUPling <CouplingType>

Toggles the RF input of the R&S FSVR between AC and DC coupling.

This function is not available if the R&S Digital I/Q Interface (R&S FSV-B17) is active.

Parameters:

<CouplingType> AC | DC
 *RST: AC

Example:

INP:COUP DC

Manual operation: See "[Input \(AC/DC\)](#)" on page 73

INPut:DIQ:CDEvice

This command queries the current configuration and the status of the digital baseband input from the optional R&S Digital I/Q Interface (option R&S FSV-B17).

For details see the section "Interface Status Information" for the R&S Digital I/Q Interface (R&S FSV-B17) in the description of the base unit.

Return values:

<ConnState> Defines whether a device is connected or not.
0
 No device is connected.
1
 A device is connected.

<DeviceName> Device ID of the connected device

<SerialNumber> Serial number of the connected device

<PortName> Port name used by the connected device

<SampleRate> Maximum or currently used sampling rate of the connected device in Hz (depends on the used connection protocol version; indicated by <SampleRateType> parameter)

<MaxTransferRate> Maximum data transfer rate of the connected device in Hz

<ConnProtState> State of the connection protocol which is used to identify the connected device.
Not Started
Has to be Started
Started
Passed
Failed
Done

<PRBSTestState> State of the PRBS test.
Not Started
Has to be Started
Started
Passed
Failed
Done

| | |
|--------------------------|---|
| <SampleRateType> | 0
Maximum sampling rate is displayed |
| | 1
Current sampling rate is displayed |
| <Placeholder> | for future use; currently "0" |
| Example: | INP:DIQ:CDEV?
Result:
1, SMU200A, 103634, Out
A, 70000000, 100000000, Passed, Not Started, 0, 0 |
| Mode: | IQ, VSA, EVDO, CDMA, WCDMA, GSM, ADEMOD, TDS |
| Manual operation: | See " Connected Device " on page 270
See " Digital IQ Info " on page 273 |

INPut:DIQ:RANGe:COUPling <State>

If enabled, the reference level for digital input is adjusted to the full scale level automatically if the fullscale level changes.

(See the [Auto Level](#) softkey).

This command is only available if the optional R&S Digital I/Q Interface (option R&S FSV-B17) is installed.

For details see the R&S Digital I/Q Interface (R&S FSV-B17) description of the base unit.

Parameters:

<State> ON | OFF
*RST: OFF

Example: INP:DIQ:RANG:COUP OFF

Mode: IQ, VSA, EVDO, CDMA, WCDMA, GSM, ADEMOD, TDS

Manual operation: See "[Adjust Reference Level to Full Scale Level](#)" on page 271
See "[Auto Level](#)" on page 282

INPut:DIQ:RANGe[:UPPer] <Level>

Defines or queries the "Full Scale Level", i.e. the level that should correspond to an I/Q sample with the magnitude "1".

It can be defined either in dBm or Volt (see "[Full Scale Level](#)" on page 270).

This command is only available if the optional R&S Digital I/Q Interface (option R&S FSV-B17) is installed.

For details see [chapter 7.1.5, "Interface Status Information"](#), on page 482.

For details see the R&S Digital I/Q Interface (R&S FSV-B17) description of the base unit.

Parameters:

<Level> <numeric value>
 Range: 70.711 nV to 7.071 V
 *RST: 1 V

Example: INP:DIQ:RANG 1V

Mode: A, IQ, NF, TDS, VSA, CDMA, EVDO, WCDMA, ADEMOD, GSM, OFDM, OFDMA/WiBro, WLAN

Manual operation: See "[Full Scale Level](#)" on page 270

INPut:DIQ:RANGe[:UPPer]:UNIT <Unit>

Defines the unit of the full scale level (see "[Level Unit](#)" on page 271). The availability of units depends on the measurement application you are using.

This command is only available if the optional R&S Digital I/Q Interface (option R&S FSV-B17) is installed.

For details see the R&S Digital I/Q Interface (R&S FSV-B17) description of the base unit.

Parameters:

<Level> V | dBm | dBpW | W | dBmV | dBuV | dBuA | A
 *RST: Volt

Example: INP:DIQ:RANG:UNIT A

Mode: IQ, VSA, EVDO, CDMA, WCDMA, GSM, ADEMOD, TDS

Manual operation: See "[Level Unit](#)" on page 271

INPut:DIQ:SRATe <SampleRate>

This command specifies or queries the sample rate of the input signal from the R&S Digital I/Q Interface (see "[Input Sample Rate](#)" on page 270).

Note: the final user sample rate of the R&S FSVR may differ and is defined using TRAC:IQ:SRAT (see [TRACe<n>:IQ:SRATe](#) on page 906).

Note: the final user sample rate of the R&S FSVR may differ and is defined using SENSE:ADEM:SRATe (see [\[SENSE:\]ADEMod:SRATe?](#) on page 774).

This command is only available if the optional R&S Digital I/Q Interface (option R&S FSV-B17) is installed.

For details see the R&S Digital I/Q Interface (R&S FSV-B17) description of the base unit.

Parameters:

<SampleRate> Range: 1 Hz to 10 GHz
 *RST: 32 MHz

Example: INP:DIQ:SRAT 200 MHz

Mode: A, IQ, NF, TDS, VSA, CDMA, EVDO, WCDMA, ADEMOD, GSM, OFDM, OFDMA/WiBro, WLAN

Manual operation: See ["Input Sample Rate"](#) on page 270

INPut:EATT <Attenuation>

This command defines the electronic attenuation.

If necessary, the command also turns the electronic attenuator on.

This command is only available with option R&S FSV-B25, but not if R&S FSV-B17 is active.

The attenuation can be varied in 1 dB steps from 0 to 25 dB. Other entries are rounded to the next lower integer value.

If the defined reference level cannot be set for the given RF attenuation, the reference level is adjusted accordingly and the warning "Limit reached" is output.

Parameters:

<Attenuation> 0...25
*RST: 0 dB (OFF)

Example: INP1:EATT 10 dB

Mode: all

Manual operation: See ["EI Atten Mode \(Auto/Man\)"](#) on page 71

INPut:EATT:AUTO <State>

This command switches the automatic behaviour of the electronic attenuator on or off. If activated, electronic attenuation is used to reduce the operation of the mechanical attenuation whenever possible.

This command is only available with option R&S FSV-B25, but not if R&S FSV-B17 is active.

Parameters:

<State> ON | OFF
*RST: ON

Example: INP1:EATT:AUTO OFF

Mode: all

Manual operation: See ["EI Atten On/Off"](#) on page 71
See ["EI Atten Mode \(Auto/Man\)"](#) on page 71

INPut:EATT:STATe <State>

This command turns the electronic attenuator on or off.

This command is only available with option R&S FSV-B25, but not if R&S FSV-B17 is active.

Parameters:

<State> ON | OFF
 *RST: OFF

Example:

INP:EATT:STAT ON
 Switches the electronic attenuator into the signal path.

INPut:FILTer:YIG[:STATe] <State>

This command activates and deactivates the YIG filter.

Parameters:

<State> ON
 OFF
 *RST: ON

Example:

INP:FILT:YIG OFF
 Deactivates the YIG filter.

Mode: RT

Manual operation: See "[YIG Filter \(On Off\)](#)" on page 73

INPut:GAIN:STATe <State>

This command turns the 20 dB preamplifier on and off.

With option R&S FSV-B22, the preamplifier only has an effect below 7 GHz.

With option R&S FSV-B24, the amplifier applies to the entire frequency range.

This command is not available when using R&S Digital I/Q Interface (R&S FSV-B17).

Parameters:

<State> ON | OFF
 *RST: OFF

Example:

INP:GAIN:STAT ON
 Turns the preamplifier on.

Manual operation: See "[Preamp On/Off](#)" on page 70

INPut:IMPedance <Impedance>

This command selects the nominal input impedance.

75 Ω should be selected if the 50 Ω input impedance is transformed to a higher impedance using a 75 Ω adapter of the RAZ type (= 25 Ω in series to the input impedance of the instrument). The correction value in this case is 1.76 dB = 10 log (75Ω/50Ω).

This function is not available if the R&S Digital I/Q Interface (R&S FSV-B17) is active.

Parameters:

<Impedance> 50 | 75
 *RST: 50 Ω

Example: INP:IMP 75

Manual operation: See "[Input 50 Ω/75 Ω](#)" on page 73

INPut:SElect <Source>

This command selects the signal source for measurements.

Parameters:

<Source> RF | DIQ
RF
 Radio Frequency ("RF INPUT" connector)
DIQ
 Digital IQ (only available with R&S Digital I/Q Interface, option R&S FSV-B17)
 *RST: RF

Example: INP:SEL RF

Mode: A, IQ, NF, TDS, VSA, CDMA, EVDO, WCDMA, ADEMOD, GSM, OFDM, OFDMA/WiBro, WLAN

Manual operation: See "[Input Path](#)" on page 270

INPut:UPORt?

This command queries the control lines of the user ports.

Example: INP:UPOR?

Usage: Query only

INPut:UPORt:STATe <State>

This command selects if the user port control lines are used as a input or as a output.

Parameters:

<State> **ON**
 User port is used as a input.
OFF
 User port is used as a output.
 *RST: ON

Example: INP:UPOR:STAT ON

8.2.3.10 INSTRument Subsystem

The INSTRument subsystem selects the operating mode of the unit either via text parameters or fixed numbers.

INSTRument[:SElect] <Mode> | <ChannelName>

This command selects the measurement mode by means of text parameters.

In case you are working with more than one spectrum display, the command also selects the spectrum display (or channel) you need.

Note: To select an **I/Q Analyzer** channel in simple mode, you have to use `TRACe<n>:IQ[:STATe]`.

Also see

- `INSTRument:CREate[:NEW]` on page 740
- Remote program example: [chapter 8.3.16, "Usage of Four Spectrum Instances"](#), on page 1055

Parameters:

<Mode> values see [table 8-17](#)
 *RST: SANalyzer

Example:

```
INST SAN
Switches the instrument to "Spectrum" mode.
```

Usage: SCPI confirmed

Manual operation: See ["Screen A-D"](#) on page 390

Table 8-17: Instrument mode parameters

| Mode | Text parameter (INST:SEL) | Numeric parameter (INST:NSEL) | Option number |
|--|--|-------------------------------|---------------|
| Spectrum | SANalyzer | 1 | |
| Additional spectrum mode.
The first spectrum mode is always active (SANalyzer). | Spectrum 2
Spectrum 3
Spectrum 4 | | |
| IQ Analyzer (eval mode) | IQ | - | |
| Realtime | RTIM | 26 | |
| Analog demodulation | ADEMod | 3 | |
| FM Stereo | SFM | 7 | R&S FSV-K7S |
| Bluetooth | BTOoth | 12 | R&S FSV-K8 |
| GSM | GSM
(Query: MGSM.) | 5 | R&S FSV-K10 |
| Noise Figure Measurements | NOISe | 19 | R&S FSV-K30 |
| Phase Noise mode | PNOise | 20 | R&S FSV-K40 |
| VSA | DDEM | 2 | R&S FSV-K70 |

| Mode | Text parameter (INST:SEL) | Numeric parameter (INST:NSEL) | Option number |
|---------------------------|---------------------------|-------------------------------|--------------------------------------|
| 3G FDD BTS mode | BWCD | 8 | R&S FSV-K72 |
| 3G FDD UE mode | MWCD | 9 | R&S FSV-K73 |
| TD-SCDMA BTS mode | BTDS | 17 | R&S FSV-K76 |
| TD-SCDMA UE mode | MTDS | 18 | R&S FSV-K77 |
| CDMA2000 BS Analysis | BCK2 | 10 | R&S FSV-K82 |
| CDMA2000 MS | MC2K | 11 | |
| 1xEV-DO BS Analysis | BDO | 14 | R&S FSV-K84 |
| 1xEV-DO MS | MDO | 15 | |
| WLAN TX | WLAN | 16 | R&S FSV-K91/91n |
| WiMax | WiMAX | 23 | R&S FSV-K93 |
| LTE (uplink and downlink) | LTE | 100 | R&S FSV-K101/K102/K103/K104/
K105 |

INSTrument:CREate[:NEW] <ChannelType>, <ChannelName>

This command adds an additional spectrum display. You can add up to three additional spectrum displays.

Also see

- [INSTrument\[:SElect\]](#) on page 739
- [INSTrument:DELeTe](#) on page 740
- Remote program example: [chapter 8.3.16, "Usage of Four Spectrum Instances"](#), on page 1055

Parameters:

<ChannelType>

SANalyzer

The channel type is always `SANalyzer` to indicate that you add a new spectrum display.

<ChannelName>

Sets the name of the additional spectrum display.

Spectrum 2 | Spectrum 3 | Spectrum 4

The names of the spectrum displays you add have to be `Spectrum 2` for the second spectrum display, `Spectrum 3` for the third and `Spectrum 4` for the fourth.

Example:

```
INST:CRE SAN, Spectrum 2
```

Adds a second spectrum display.

INSTrument:DELeTe <ChannelName>

This command deletes a spectrum display.

Also see

- [INSTrument:CREate\[:NEW\]](#) on page 740
- Remote program example: [chapter 8.3.16, "Usage of Four Spectrum Instances"](#), on page 1055

Parameters:

<ChannelName> Selects the spectrum display you want to delete.

Spectrum 2 | Spectrum 3 | Spectrum 4

A spectrum display must exist in order to be able delete it.

Example:

```
INST:DEL Spectrum 4
```

Deletes the fourth spectrum display.

INSTrument:NSElect <Mode>

This command selects the operating mode by means of numbers (see [table 8-17](#)).

Parameters:

<Mode> *RST: 1

Example:

```
INST:NSEL 1
```

Switches the instrument to "Spectrum" mode.

Usage:

SCPI confirmed

Mode:

all

8.2.3.11 MMEMory Subsystem

The MMEMory (mass memory) subsystem provides commands which allow for access to the storage media of the instrument and for storing and loading various instrument settings.

In this section all MMEMory commands for "Spectrum" mode are described in detail. For details on commands that are independant of a particular measurement mode and information on the MMEMory subsystem in general, see [chapter 8.2.4.7, "MMEMory Subsystem"](#), on page 945.

| | |
|---|-----|
| MMEMory:LOAD:IQ:STATe | 741 |
| MMEMory:STORE:IQ:STATe | 742 |
| MMEMory:STORE:IQ:COMM | 742 |
| MMEMory:STORE<n>:LIST | 742 |
| MMEMory:STORE<n>:PEAK | 743 |
| MMEMory:STORE:SGRam | 743 |
| MMEMory:STORE<n>:SPURious | 743 |
| MMEMory:STORE<n>:TRACe | 744 |

MMEMory:LOAD:IQ:STATe 1, <FileName>

This command loads the I/Q data from the specified `.iq.tar` file.

Note: switch to single sweep mode (`INIT:CONT OFF`) before importing I/Q data as otherwise the instrument will continue to measure data and display the current results rather than the imported data.

Parameters:

<FileName> Complete file name including the path

Example:

```
MMEM:LOAD:IQ:STAT 1, 'C:
\R_S\Instr\user\data.iq.tar'
```

Loads I/Q data from the specified file.

Usage:

Setting only

Manual operation: See ["IQ Import"](#) on page 454

MMEMory:STORe:IQ:STATe 1, <FileName>

This command stores the complex I/Q data to the specified `.iq.tar` file in 32-bit floating point format.

Parameters:

<FileName> Complete file name including the path

Example:

```
MMEM:STOR:IQ:STAT 1, 'C:
\R_S\Instr\user\data.iq.tar'
```

Stores I/Q data to the specified file.

Manual operation: See ["IQ Export"](#) on page 454

MMEMory:STORe:IQ:COMM <Description>

Defines a description of the export file which is stored with the data and also displayed in the file selection dialog box for I/Q data import and export.

Parameters:

<Description>

Example:

```
MMEM:STOR:IQ:COMM 'Device test 1b'
```

Creates a description for the export file.

```
MMEM:STOR:IQ:STAT 1, 'C:
\R_S\Instr\user\data.iq.tar'
```

Stores I/Q data and the comment to the specified file.

Manual operation: See ["IQ Export"](#) on page 454

MMEMory:STORe<n>:LIST <FileName>

This command stores the current list evaluation results in a `<file name>.dat` file. The file consists of a data section containing the list evaluation results.

Suffix:

<n> irrelevant

Parameters:

<FileName> <file name>

Example:

```
MME:STOR:LIST 'test'
```

Stores the current list evaluation results in the `test.dat` file.

Manual operation:

See ["ASCII File Export"](#) on page 135

See ["Save Evaluation List"](#) on page 194

See ["Save Evaluation List"](#) on page 223

See ["ASCII File Export"](#) on page 223

MME:STOR:n>:PEAK <FileName>

This command exports the marker peak list to a *.dat file.

Suffix:

<n> Selects the measurement window.

Parameters:

<FileName> String containing the path and name of the target file.

Example:

```
MME:STOR:PEAK 'test'
```

Saves the current marker peak list in the file `test.dat`.

Usage:

Event

MME:STOR:SGRam <File>

This command exports the spectrogram data to a ASCII file.

The file contains the data for every frame in the history buffer. The data corresponding to a particular frame begins with information about the frame number and the time that frame was recorded.

Note that, depending on the size of the history buffer, the process of exporting the data can take a while.

Parameters:

<File> string containing the file name of the destination file

Example:

```
MME:STOR:SGR
```

Copies the spectrogram data to a file.

Manual operation: See ["ASCII Trace Export"](#) on page 99

MME:STOR:n>:SPURious <FileName>

This command exports the marker peak list available for spurious emission measurements to a file.

Suffix:

<n> irrelevant

Parameters:

<FileName> String containing the path and name of the target file.

Example: `MMEM:STOR:SPUR 'test'`
Saves the current marker peak list in the file test.dat.

Usage: Event

MMEMory:STORe<n>:TRACe <Trace>, <FileName>

This command stores the selected trace in the specified window in a file with ASCII format. The file format is described in [chapter 4.1.8.7, "ASCII File Export Format"](#), on page 107

The decimal separator (decimal point or comma) for floating-point numerals contained in the file is defined with the `FORMat:DEXPort:DSEParator` command (see [FORMat:DEXPort:DSEParator](#) on page 728).

Suffix:

<n> window; For applications that do not have more than 1 measurement window, the suffix <n> is irrelevant.

Parameters:

<Trace> 1 to 6
selected measurement trace

<FileName> DOS file name
The file name includes indication of the path and the drive name. Indication of the path complies with DOS conventions.

Example: `MMEM:STOR:TRAC 3, 'TEST.ASC'`
Stores trace 3 in the file TEST.ASC.

Manual operation: See ["ASCII Trace Export"](#) on page 99

8.2.3.12 OUTPut Subsystem

The OUTPut subsystem controls the output-related features of the instrument.

| | |
|--|-----|
| OUTPut:DIQ | 744 |
| OUTPut:DIQ:CDEvice | 745 |
| OUTPut:UPORt | 746 |
| OUTPut:UPORt:STATe | 746 |

OUTPut:DIQ <State>

If enabled, the captured IQ data is output to the R&S Digital I/Q Interface in a continuous stream. This function requires the LVDS interface option (R&S FSV-B17).

Digital input and digital output cannot be used simultaneously.

Parameters:

<State> **ON | OFF**
***RST:** OFF

Example: `OUTP:DIQ ON`

Mode: ADEMODO, IQ, VSA

Manual operation: See "Digital Output" on page 272

OUTPut:DIQ:CDEvice

This command queries the current configuration and the status of the digital baseband output to the optional R&S Digital I/Q Interface (option R&S FSV-B17).

For details see the R&S Digital I/Q Interface description for the base unit.

Return values:

| | |
|-------------------|---|
| <ConnState> | Defines whether a device is connected or not.
0
No device is connected.
1
A device is connected. |
| <DeviceName> | Device ID of the connected device |
| <SerialNumber> | Serial number of the connected device |
| <PortName> | Port name used by the connected device |
| <NotUsed> | to be ignored |
| <MaxTransferRate> | Maximum data transfer rate of the connected device in Hz |
| <ConnProtState> | State of the connection protocol which is used to identify the connected device.
Not Started
Has to be Started
Started
Passed
Failed
Done |
| <PRBSTestState> | State of the PRBS test.
Not Started
Has to be Started
Started
Passed
Failed
Done |
| <NotUsed> | to be ignored |
| <Placeholder> | for future use; currently "0" |

Example: `OUTP:DIQ:CDEV?`
Result:
`1,SMU200A,103634,Out`
`A,70000000,100000000,Passed,Not Started,0,0`

Mode: `IQ, VSA`

OUTPut:UPORt <Value>

This command defines the control lines of the user ports.

The assignment of the pin numbers to the bits is as follows:

| Bit | 7 | 6 | 5 | 4 | 3 | 2 | 1 | 0 |
|-----|-----|-----|---|---|---|---|---|---|
| Pin | N/A | N/A | 5 | 3 | 4 | 7 | 6 | 2 |

Bits 7 and 6 are not assigned to pins and must always be 0.

The user port is written to with the given binary pattern. If the user port is programmed to input instead of output (see [INPut:UPORt:STATe](#) on page 738), the output value is temporarily stored.

Parameters:

<Value> `#B00000000 to #B00111111`

Example: `OUTP:UPOR #B00100100`
 Sets pins 5 and 7 to 5 V.

OUTPut:UPORt:STATe <State>

This command selects if the user port control lines are used as a input or as a output.

This command switches the control line of the user ports between INPut and OUTPut. The user port is switched to OUTPut with parameter ON, to INPut with OFF.

Parameters:

<State> **ON**
 User port is used as a input.

ON
 User port is used as a output.

*RST: **ON**

Example: `OUTP:UPOR:STAT ON`

8.2.3.13 PROBe subsystem

With firmware R&S FSVR 1.61SP2 or newer, active probes are supported (via an adapter). The following commands activate and configure a connected probe which is to provide an input signal. They are only available if a probe is connected to the instrument's RF INPUT and USB connectors.

For details see [chapter 4.2.8.2, "Using Active Probes for Input"](#), on page 273.

For details see the base unit description.

PROBe:ID:PARTnumber?

This command returns the material part number of the connected probe.

Example: `PROB:ID:PART?`

Usage: Query only

Manual operation: See "[Part number](#)" on page 276

PROBe:ID:SRNumber?

This command returns the serial number of the connected probe.

Example: `PROB:ID:SRN?`

Usage: Query only

Manual operation: See "[Serial Number](#)" on page 276

PROBe:SETup:MODE <Mode>

This command defines which action is taken when the probe's micro button is pressed.

Parameters:

<Mode>

RSINgLe

A single sweep is performed.

NOACtion

No action is taken.

*RST: OFF

Example: `PROB:SET:STAT ON`

Manual operation: See "[Probe Config](#)" on page 270
See "[Micro Button Action](#)" on page 276

PROBe:SETup:NAME?

This command returns the name of the connected probe.

Example: `PROB:SET:NAME?`

Usage: Query only

Manual operation: See "[Name](#)" on page 276

PROBe:SETup:STATe?

This command queries whether a probe is connected to the instrument's RF INPUT and USB connectors and was recognized by the R&S FSVR.

Example: `PROB:SET:STAT ON`

Usage: Query only

PROBe[:STATe] <State>

This command activates a connected probe. Use this command to switch off the probe and measure the digital input without considering the transducer factor of the probe.

Parameters:

<State> **ON | OFF**
 *RST: OFF

Example: PROB:STAT ON

Manual operation: See "Probe Config" on page 270
 See "State" on page 276

8.2.3.14 READ:PMETer Subsystem

This subsystem contains commands to start power sensor measurements and to read the results after the measurement is concluded. It is only available if the R&S FSV-K9 Power Sensor option is installed.

For details see [chapter 4.5, "Instrument Functions - Power Sensor \(R&S FSV-K9\)"](#), on page 304.

READ<n>:PMETer<p>?748

READ<n>:PMETer<p>?

This command starts a power sensor measurement and reads the result for the selected power sensor after the measurement is concluded. These results are also displayed in the marker table.

Suffix:

<n> irrelevant
 <p> 1...4
 Power sensor index

Example: READ:PMET3?
 Starts a measurement and reads the result.

Usage: Query only

Mode: PSM

8.2.3.15 SENSE Subsystem

The SENSE subsystem is organized in several subsystems. The commands of these subsystems directly control device-specific settings, they do not refer to the signal characteristics of the measurement signal.

The SENSE subsystem controls the essential parameters of the analyzer. In accordance with the SCPI standard, the keyword "SENSE" is optional for this reason, which means that it is not necessary to include the SENSE node in command sequences.

| | |
|--|-----|
| SENSE:ADEMod Subsystem (Analog Demodulation, analog demodulation)..... | 749 |
| SENSE:ADJust Subsystem..... | 776 |
| SENSE:AVERage Subsystem..... | 779 |
| SENSE:BANDwidth Subsystem..... | 781 |
| SENSE:CORRection Subsystem..... | 785 |
| SENSE:DEMod Subsystem..... | 790 |
| SENSE:ESpectrum Subsystem..... | 790 |
| SENSE:FILTer Subsystem (Analog Demodulation, analog demodulation)..... | 802 |
| SENSE:FREQuency Subsystem..... | 808 |
| SENSE:LIST Subsystem..... | 812 |
| SENSE:LIST:RANGe Subsystem..... | 818 |
| SENSE:MIXer Subsystem..... | 826 |
| SENSE:MPOWer Subsystem..... | 833 |
| SENSE:PMETer<p> Subsystem (Power Sensor, R&S FSV-K9)..... | 837 |
| SENSE:POWer Subsystem..... | 844 |
| SENSE:SFM Subsystem..... | 855 |
| SENSE:SWEep Subsystem..... | 866 |
| SENSE:[WINDow:]DETEctor Subsystem..... | 874 |

SENSE:ADEMod Subsystem (Analog Demodulation, analog demodulation)

The SENSE:ADEMod Subsystem contains commands to set up the instrument for the measurement of analog demodulated signals and query the result at the end of the measurement.

Further information

- [chapter 5.4.1, "Trace Mode Result Types"](#), on page 423
- [chapter 5.4.2, "Formats for Returned Values: ASCII Format and Binary Format"](#), on page 423

| | |
|-------------------------------------|-----|
| [SENSE:]ADEMod:CAPTure:DOFFset..... | 750 |
| [SENSE:]ADEMod:CAPTure:TIME..... | 751 |
| [SENSE:]ADEMod:CAPTure[:MODE]..... | 751 |
| [SENSE:]ADEMod[:STATe]..... | 752 |
| [SENSE:]ADEMod<n>:AF:CENTer..... | 752 |
| [SENSE:]ADEMod<n>:AF:COUPling..... | 752 |
| [SENSE:]ADEMod<n>:AF:SPAN..... | 753 |
| [SENSE:]ADEMod<n>:AF:SPAN:FULL..... | 753 |

| | |
|--|-----|
| [SENSe:]ADEMod<n>:AF:START..... | 754 |
| [SENSe:]ADEMod<n>:AF:STOP..... | 754 |
| [SENSe:]ADEMod:AM[:ABSolute][:TDOMain]:RESult? | 755 |
| [SENSe:]ADEMod:AM[:ABSolute][:TDOMain][:TYPE]..... | 756 |
| [SENSe:]ADEMod:AM:RELative[:TDOMain][:TYPE]..... | 756 |
| [SENSe:]ADEMod:AM:RELative[:TDOMain]:RESult? | 757 |
| [SENSe:]ADEMod:AM:RELative:AFSPectrum[:TYPE]..... | 758 |
| [SENSe:]ADEMod:AM:RELative:AFSPectrum:RESult? | 759 |
| [SENSe:]ADEMod:BANDwidth BWIDth:DEModulation..... | 760 |
| [SENSe:]ADEMod:BANDwidth BWIDth:DEModulation:TYPE..... | 760 |
| [SENSe:]ADEMod:FM[:TDOMain][:TYPE]..... | 760 |
| [SENSe:]ADEMod:FM[:TDOMain]:RESult..... | 761 |
| [SENSe:]ADEMod:FM:AFSPectrum[:TYPE]..... | 762 |
| [SENSe:]ADEMod:FM:AFSPectrum:RESult..... | 762 |
| [SENSe:]ADEMod:FM:OFFSet..... | 763 |
| [SENSe:]ADEMod:MTIME..... | 764 |
| [SENSe:]ADEMod:PM[:TDOMain][:TYPE]..... | 765 |
| [SENSe:]ADEMod:PM[:TDOMain]:RESult..... | 765 |
| [SENSe:]ADEMod:PM:AFSPectrum[:TYPE]..... | 766 |
| [SENSe:]ADEMod:PM:AFSPectrum:RESult..... | 767 |
| [SENSe:]ADEMod:PM:RPOint[:X]..... | 768 |
| [SENSe:]ADEMod:RLENgth?..... | 769 |
| [SENSe:]ADEMod:SET..... | 769 |
| [SENSe:]ADEMod:SPECtrum[:TYPE]..... | 770 |
| [SENSe:]ADEMod:SPECtrum:BANDwidth BWIDth[:RESolution]..... | 771 |
| [SENSe:]ADEMod:SPECtrum:RESult..... | 771 |
| [SENSe:]ADEMod:SPECtrum:SPAN[:MAXimum]..... | 772 |
| [SENSe:]ADEMod:SPECtrum:SPAN:ZOOM..... | 773 |
| [SENSe:]ADEMod:SQUelch[:STATe]..... | 773 |
| [SENSe:]ADEMod:SQUelch:LEVel..... | 773 |
| [SENSe:]ADEMod:SRATe?..... | 774 |
| [SENSe:]ADEMod<n>:ZOOM[:STATe]..... | 774 |
| [SENSe:]ADEMod<n>:ZOOM:START..... | 775 |
| [SENSe:]ADEMod<n>:ZOOM:LENgth..... | 775 |
| [SENSe:]ADEMod<n>:ZOOM:LENgth:MODE..... | 776 |

[SENSe:]ADEMod:CAPTure:DOFFset <Time>

This command defines an offset of the defined measurement time from the beginning of the capture buffer for analog demodulation if [SENSe:]ADEMod:CAPTure[:MODE] is set to manual mode.

All results are recalculated automatically based on the new data.

Parameters:

<Time> *RST: 0

Example: ADEM:CAPT MAN
 Activates the manual capture buffer processing mode.
 ADEM:CAPT:TIME 500 us
 Sets the size of the capture buffer to 500 us.
 ADEM:CAPT:DOFF 10us
 Results are recalculated for the data in the capture buffer starting at 10us.

Mode: ADEMOD

Manual operation: See "[Demod Offset](#)" on page 366

[SENSe:]ADEMod:CAPTure:TIME <Time>

This command defines the size of the capture buffer for analog demodulation if [SENSe:]ADEMod:CAPTure[:MODE] is set to manual mode.

Parameters:

<Time> Range: 0 to 7.5 MSamples (time depends on DBW)
 *RST: 62.5us

Example: ADEM:CAPT MAN
 Activates the manual capture buffer processing mode.
 ADEM:CAPT:TIME 500 us

Mode: ADEMOD

Manual operation: See "[Capture Time](#)" on page 365

[SENSe:]ADEMod:CAPTure[:MODE] <Mode>

This command defines how the size of the the capture buffer is defined for analog demodulation.

Parameters:

<Mode> **AUTO**
 The capture buffer size is identical to the defined measurement time (see [SENSe:]ADEMod:MTIME).

MANual

The size of the capture buffer is defined manually using the [SENSe:]ADEMod:CAPTure:TIME command.

*RST: **AUTO**

Example: ADEM:CAPT MAN
 Activates the manual capture buffer processing mode.

Mode: ADEMOD

Manual operation: See "[Capture Mode](#)" on page 365

[SENSe:]ADEMod[:STATe] <State>

This command activates the analog demodulator of the instrument. The instrument will be set to zero span at the current center frequency.

Parameters:

<State> ON | OFF
*RST: OFF

Example: ADEM ON
Switches the analog demodulator on.

Mode: ADEMOD

[SENSe:]ADEMod<n>:AF:CENTer <Frequency>

This command sets the center frequency for AF spectrum result display.

Suffix:

<n> 1...4
irrelevant

Parameters:

<Frequency> *RST: 1.25 MHz

Example: ADEM ON, see [CALCulate<n>:FEED](#) on page 705
Switches on the analog demodulator
CALC:FEED 'XTIM:FM:AFSP', see [CALCulate<n>:FEED](#)
on page 705
Switches on AF spectrum result display of FM
ADEM:BAND 5 MHz, see [\[SENSe:\]ADEMod:
BANDwidth|BWIDth:DEModulation](#) on page 760
Sets the measurement bandwidth
ADEM:AF:CENT 500kHz, see [\[SENSe:\]ADEMod<n>:AF:
CENTer](#) on page 752
Sets the AF center frequency
ADEM:AF:SPAN 200kHz, see [\[SENSe:\]ADEMod<n>:AF:
SPAN](#) on page 753
Sets the AF span

Mode: ADEMOD

Manual operation: See "[AF Center \(AF Spectrum\)](#)" on page 349

[SENSe:]ADEMod<n>:AF:COUPLing <Coupling>

This command selects the coupling of the AF path of the analyzer in the specified window.

Suffix:

<n> 1...4
window

Parameters:

<Coupling> AC | DC
 *RST: AC (PM); DC (FM)

Example:

ADEM:AF:COUP DC
 Switches on DC coupling.

Mode:

ADEMOD

Manual operation: See "AF Coupling AC/DC" on page 342

**[SENSe:]ADEMod<n>:AF:SPAN **

This command sets the span for AF spectrum result display.

The span is limited to half the measurement bandwidth of analog demodulation ([SENSe:]ADEMod:BANDwidth|BWIDth:DEModulation on page 760).

Suffix:

<n> 1...4
 irrelevant

Parameters:

 *RST: 2.5 MHz

Example:

ADEM ON, see [SENSe:]ADEMod[:STATE] on page 752
 Switches on the analog demodulator
 CALC:FEED 'XTIM:FM:AFSP', see CALCulate<n>:FEED on page 705
 Switches on AF spectrum result display of FM
 ADEM:BAND 5 MHz, see [SENSe:]ADEMod:BANDwidth|BWIDth:DEModulation on page 760
 Sets the measurement bandwidth
 ADEM:AF:CENT 500kHz, see [SENSe:]ADEMod<n>:AF:CENTer on page 752
 ADEM:AF:SPAN 200 kHz
 Sets the AF span to 200 kHz

Mode:

ADEMOD

Manual operation: See "AF Span Manual (AF Spectrum)" on page 350

[SENSe:]ADEMod<n>:AF:SPAN:FULL

This command sets the maximum span for AF spectrum result display.

The maximum span corresponds to half the measurement bandwidth of analog demodulation ([SENSe:]ADEMod:BANDwidth|BWIDth:DEModulation on page 760).

Suffix:

<n> 1...4
 irrelevant

| | |
|--------------------------|--|
| Example: | ADEM ON, see [SENSe:]ADEMod[:STATe] on page 752
Switches on the analog demodulator
CALC:FEED 'XTIM:FM:AFSP', see CALCulate<n>:FEED
on page 705
Switches on AF spectrum result display of FM
ADEM:BAND 5 MHz, see [SENSe:]ADEMod:
BANDwidth BWIDth:DEModulation on page 760
Sets the measurement bandwidth to 5 MHz
ADEM:AF:SPAN:FULL
Sets the AF span to 2.5 MHz |
| Mode: | ADEMOD |
| Manual operation: | See " AF Full Span (AF Spectrum) " on page 350 |

[SENSe:]ADEMod<n>:AF:STARt <Frequency>

This command sets the start frequency for AF spectrum result display.

Suffix:

| | |
|-----|---------------------|
| <n> | 1...4
irrelevant |
|-----|---------------------|

Parameters:

| | |
|-------------|-------------|
| <Frequency> | *RST: 0 MHz |
|-------------|-------------|

| | |
|--------------------------|--|
| Example: | ADEM ON, see [SENSe:]ADEMod[:STATe] on page 752
Switches on the analog demodulator
CALC:FEED 'XTIM:FM:AFSP', see CALCulate<n>:FEED
on page 705
Switches on AF spectrum result display of FM
ADEM:BAND 5 MHz, see [SENSe:]ADEMod:
BANDwidth BWIDth:DEModulation on page 760
Sets the measurement bandwidth to 5 MHz
ADEM:AF:STAR 0 kHz
Sets the AF start frequency to 0 kHz
[SENSe:]ADEMod<n>:AF:STOP on page 754
Sets the AF stop frequency to 500 kHz |
| Mode: | ADEMOD |
| Manual operation: | See " AF Start " on page 349 |

[SENSe:]ADEMod<n>:AF:STOP <Frequency>

This command sets the stop frequency for AF spectrum result display.

The stop frequency is limited to half the measurement bandwidth of analog demodulation ([\[SENSe:\]ADEMod:BANDwidth|BWIDth:DEModulation](#) on page 760).

Suffix:

| | |
|-----|---------------------|
| <n> | 1...4
irrelevant |
|-----|---------------------|

Parameters:

<Frequency> *RST: 2.5 MHz

Example:

ADEM ON, see [\[SENSe:\]ADEMod\[:STATe\]](#) on page 752
 Switches on the analog demodulator
 CALC:FEED 'XTIM:FM:AFSP', see [CALCulate<n>:FEED](#)
 on page 705
 Switches on AF spectrum result display of FM
 ADEM:BAND 5 MHz, see [\[SENSe:\]ADEMod:
 BANDwidth|BWIDth:DEModulation](#) on page 760
 Sets the measurement bandwidth to 5 MHz
[\[SENSe:\]ADEMod<n>:AF:START](#) on page 754
 Sets the AF start frequency to 0 kHz
 ADEM:AF:STOP 500 kHz
 Sets the AF stop frequency to 500 kHz

Mode: ADEMOD

Manual operation: See "[AF Stop](#)" on page 349

[SENSe:]ADEMod:AM[:ABSolute][:TDOMain]:RESult? <TraceMode>

This command reads the result data of the RF signal in zero span in the specified trace mode. The data format of the output data block is defined by the [FORMAT](#) command (see [chapter 5.4.2, "Formats for Returned Values: ASCII Format and Binary Format"](#), on page 423).

The output unit is dBm (logarithmic display) or V (linear display).

Query parameters:

<TraceMode> WRITe | AVERage | MAXHold | MINHold | VIEW

The specified trace mode must be one of those configured by [\[SENSe:\]ADEMod:AM\[:ABSolute\]\[:TDOMain\]\[:TYPE\]](#) on page 756. Otherwise a query error is generated. For details on trace modes see [chapter 5.4.1, "Trace Mode Result Types"](#), on page 423.

Example: ADEM:SET 8MHz,32000,EXT,POS,-500,30
 Sets up demodulator parameters
 ADEM:AM AVER,MAXH,MINH
 Sets up AM results to be measured
 ADEM ON
 Switches on demodulator
 INIT; *WAI
 Starts measurement and waits for sync
 FORM ASC
 Selects output format
 ADEM:AM:RES? AVER
 Reads AM average results
 ADEM:AM:RES? MAXH
 Reads AM max hold results
 ADEM:AM:RES? MINH
 Reads AM min hold results

Usage: Query only

Mode: ADEMOD

[SENSe:]ADEMod:AM[:ABSolute][:TDOMain][:TYPE] <TraceMode>

This command selects the trace modes of the RF signal to be measured simultaneously in zero span. For each of the six available traces a mode can be defined.

Parameters:

<TraceMode> <TraceMode1>, <TraceMode2>, <TraceMode3>, <TraceMode4>, <TraceMode5>, <TraceMode6>

WRITe | AVERage | MAXHold | MINHold | VIEW | OFF

For details on trace modes see [chapter 5.4.1, "Trace Mode Result Types"](#), on page 423.

*RST: WRITe,OFF,OFF,OFF,OFF,OFF (FM-Stereo:OFF,OFF,OFF,OFF,OFF,OFF)

Example: ADEM:AM AVER,MAXH,MINH,OFF,OFF,OFF
 Determines average, max hold and min hold values simultaneously for the traces 1-3.
 ADEM:AM WRIT,OFF,OFF,OFF,OFF,OFF
 Determines only the current measurement values for trace 1.
 ADEM:AM OFF,OFF,OFF,OFF,OFF,OFF
 Switches AM demodulation off.

Mode: ADEMOD

[SENSe:]ADEMod:AM:RELative[:TDOMain][:TYPE] <TraceMode>

This command selects the result types to be measured simultaneously by AM demodulation.

Parameters for setting and query:

<TraceMode> <TraceMode1>, <TraceMode2>, <TraceMode3>, <TraceMode4>, <TraceMode5>, <TraceMode6>

WRITE | AVERAGE | MAXHOLD | MINHOLD | VIEW | OFF

For details on trace modes see [chapter 5.4.1, "Trace Mode Result Types"](#), on page 423.

*RST: WRITE,OFF,OFF,OFF,OFF,OFF (FM-Stereo:OFF,OFF,OFF,OFF,OFF,OFF)

Example:

ADEM:AM:REL AVER,MAXH,MINH

Determines average, max hold and min hold values simultaneously.

ADEM:AM:REL WRIT,OFF,OFF

Determines only the current measurement values.

ADEM:AM:REL OFF,OFF,OFF

Switches AM demodulation off.

Mode: ADEMOD

[SENSe:]ADEMod:AM:RELative[:TDOMain]:RESult? <TraceMode>

This command reads the result data obtained by AM demodulation for the specified result type. The data format of the output data block is defined by the FORMat command (see [chapter 5.4.2, "Formats for Returned Values: ASCII Format and Binary Format"](#), on page 423).

The output unit is %.

Query parameters:

<TraceMode> WRITE | AVERAGE | MAXHOLD | MINHOLD | VIEW

The specified trace mode must be one of those configured by [\[SENSe:\]ADEMod:AM\[:ABSolute\]\[:TDOMain\]\[:TYPE\]](#) on page 756. Otherwise a query error is generated.

For details on trace modes see [chapter 5.4.1, "Trace Mode Result Types"](#), on page 423.

Example: ADEM:SET 8MHz,32000,EXT,POS,-500,30
 Sets up demodulator parameters
 ADEM:FM AVER,MAXH,MINH
 Selects FM results to be measured
 ADEM:AM:REL WRIT,OFF,OFF
 Selects AM results to be measured
 ADEM ON
 Switches on demodulator
 INIT; WAI
 Starts measurement and waits for sync
 FORM ASC
 Selects output format
 ADEM:FM:RES? AVER
 Reads FM average results
 ADEM:FM:RES? MAXH
 Reads FM max hold results
 ADEM:FM:RES? MINH
 Reads FM min hold results
 ADEM:AM:REL:RES? WRIT
 Reads current AM result data

Usage: Query only

Mode: ADEMOD

[SENSe:]ADEMod:AM:RELative:AFSPectrum[:TYPE] <TraceMode>

This command selects the AF spectrum result types of the AM-demodulated signal to be measured simultaneously.

Note: in FM stereo mode (option K7S), only those traces can be measured that are currently displayed in at least one screen.

Parameters:

<TraceMode> <TraceMode1>, <TraceMode2>, <TraceMode3>, <Trace-
 Mode4>, <TraceMode5>, <TraceMode6>

WRITE | AVERage | MAXHold | MINHold | VIEW | OFF

For details on trace modes see [chapter 5.4.1, "Trace Mode Result Types"](#), on page 423.

*RST: WRITE,OFF,OFF,OFF,OFF,OFF (FM-
 Stereo:OFF,OFF,OFF,OFF,OFF,OFF)

Example: ADEM:AM:REL:AFSP AVER,MAXH,MINH
 Determines average, maximum and minimum value simultane-
 ously
 ADEM:AM:REL:AFSP WRIT,OFF,OFF
 Determines only current measurement results
 ADEM:AM:REL:AFSP OFF,OFF,OFF
 Switches off calculation of the AF spectrum

Mode: ADEMOD

[SENSe:]ADEMod:AM:RELative:AFSPectrum:RESult? <TraceMode>

This command reads out the AF spectrum result data of the AM-demodulated signal for the specified result type. The data format of the output data is determined with the FORMat command (see [chapter 5.4.2, "Formats for Returned Values: ASCII Format and Binary Format"](#), on page 423).

The output unit is dB (logarithmic display) or % (linear display).

Query parameters:

<TraceMode>

WRITe | AVERAge | MAXHold | MINHold | VIEW

The specified trace mode must be one of those configured by [\[SENSe:\]ADEMod:AM\[:ABSolute\]\[:TDOMain\]\[:TYPE\]](#) on page 756. Otherwise a query error is generated. For details on trace modes see [chapter 5.4.1, "Trace Mode Result Types"](#), on page 423.

Example:

ADEM:SET 8MHz,32000,EXT,POS,-500,30

Sets the demodulator

ADEM:FM AVER,MAXH,MINH

Selects the FM results to be measured

ADEM:AM:REL WRIT,OFF,OFF

Selects the AM results to be measured

ADEM:AM:REL:AFSP WRIT,OFF,OFF

Selects the AF spectrum results of the demodulated AM signal to be measured

ADEM ON

Switches on the demodulator

INIT; WAI

Starts the measurement and waits for the termination

FORM ASC

Selects the output format

ADEM:FM:RES? AVER

Reads the FM average result data

ADEM:FM:RES? MAXH

Reads the FM Maxhold result data

ADEM:FM:RES? MINH

Reads the FM Minhold result data

ADEM:AM:REL:RES? WRIT

Reads the current AM result data

ADEM:AM:REL:AFSP:RES? WRIT

Reads the current AF spectrum result data of the demodulated AM signal

Usage: Query only**Mode:** ADEMOD

[SENSe:]ADEMod:BANDwidth|BWIDTH:DEModulation <Bandwidth>

This command defines the demodulation bandwidth used for analog demodulation. The required sampling rate is automatically set depending on the selected demodulation bandwidth. The available demodulation bandwidths are determined by the existing sampling rates. For details on the relation between demodulation bandwidth and sampling rate refer to [chapter 5.1.8, "Sample Rate, Measurement Time and Trigger Offset"](#), on page 325.

Parameters:

<Bandwidth>

*RST: 5 MHz

For details on the correlation of bandwidth and sample rate refer to chapter "Instrument Functions", section "Analog Demodulation (Option K7)" – [chapter 5.1.8, "Sample Rate, Measurement Time and Trigger Offset"](#), on page 325.

Example:

ADEM:BAND:DEM 1MHz

Sets the demodulation bandwidth to 1 MHz.

Mode:

ADEMOD

[SENSe:]ADEMod:BANDwidth|BWIDTH:DEModulation:TYPE <FilterType>

This command defines the type of demodulation filter to be used.

Parameters:

<FilterType>

FLAT

Standard flat demodulation filter

GAUSS

Gaussian filter for optimized settling behaviour

*RST: FLAT

Example:

BAND:DEM:TYPE GAUS

Selects the Gaussian filter.

Mode:

ADEMOD

[SENSe:]ADEMod:FM[:TDOMain][:TYPE] <Type>

This command selects the result types to be measured simultaneously by FM demodulation.

Parameters:

<Type>

*RST: WRITe,OFF,OFF

<result type 1|2|3|4|5|6>: WRITe, AVERage, MAXHold, MINHold, VIEW, OFF; for details see [chapter 5.4.1, "Trace Mode Result Types"](#), on page 423 .

Example: `[SENSe:]ADEMod:FM[:TDOMain] [:TYPE]` on page 760
 "Creates average, max hold and min hold values simultaneously
`DEM:FM WRIT,OFF,OFF`
 Only creates the current measurement values
`ADEM:FM OFF,OFF,OFF`
 Switches analog demodulator off

Mode: ADEMODO

`[SENSe:]ADEMod:FM[:TDOMain]:RESult <Type>`

This command reads the result data obtained by analog demodulation for the specified result type. The data format of the output data block is defined by the FORMat command.

Return values:

`<Type>` `<result type>`: WRITe, AVERAge, MAXHold, MINHold; for details see [chapter 5.4.1, "Trace Mode Result Types"](#), on page 423. The result type indicated must be one of those configured by `[SENSe:]ADEMod:FM[:TDOMain] [:TYPE]` on page 760. Otherwise a query error will be generated.

Return values ASCII Format (FORMat ASCII) or Binary Format (FORMat REAL,32); for details see [chapter 5.4.2, "Formats for Returned Values: ASCII Format and Binary Format"](#), on page 423 .

Default unit: Hz

Example:

`ADEM:SET 8MHz,32000,EXT,POS,-500,30`, see `[SENSe:]ADEMod:SET` on page 769

Sets up demodulator parameters

`ADEM:FM AVER,MAXH,MINH`, see `[SENSe:]ADEMod:FM[:TDOMain] [:TYPE]` on page 760

Selects FM results to be measured

`ADEM:AM WRIT,OFF,OFF`

Selects AM results to be measured

`ADEM ON`, see `[SENSe:]ADEMod[:STATe]` on page 752

Switches on demodulator

`INIT; WAI`

Starts measurement and waits for sync

`FORM ASC`, see `FORMat[:DATA]` on page 939

Selects output format

`ADEM:FM:RES? AVER`

Reads FM average results

`ADEM:FM:RES? MAXH`

Reads FM max hold results

`ADEM:FM:RES? MINH`

Reads FM min hold results

`ADEM:AM:RES? WRIT`

Reads current AM results

Mode: ADEMODO

[SENSe:]ADEMod:FM:AFSPectrum[:TYPE] <Type>

This command selects the AF spectrum result types of the FM demodulated signal to be measured simultaneously.

Parameters:

<Type> *RST: OFF,OFF,OFF
 <result type 1|2|3|4|5|6>: WRITe, AVERAge, MAXHold, MINHold, VIEW, OFF; for details see [chapter 5.4.1, "Trace Mode Result Types"](#), on page 423.
 The result type "AF spectrum of the FM demodulated signal" cannot be activated at the same time as "AF spectrum of AM or PM demodulated signal".

Example:

ADEMod:FM:AFSP AVER,MAXH,MINH

Determines average, maximum and minimum value simultaneously

ADEMod:FM:AFSP WRIT,OFF,OFF

Determines only current measurement results

ADEMod:FM:AFSP OFF,OFF,OFF

Switches calculation of AF spectrum off

Mode: ADEMOD

[SENSe:]ADEMod:FM:AFSPectrum:RESult <Type>

This command reads out the AF spectrum result data of the FM demodulated signal for the specified result type. The data format of the output data is determined with the FORMat command.

Return values:

<Type> <result type>: WRITe, AVERAge, MAXHold, MINHold; for details see [chapter 5.4.1, "Trace Mode Result Types"](#), on page 423.
 The specified result type must be one of those configured with the `[SENSe:]ADEMod:FM:AFSPectrum[:TYPE]` command. Otherwise a query error will be generated.

Return values ASCII Format (FORMat ASCII) or Binary Format (FORMat REAL,32); for details see [chapter 5.4.2, "Formats for Returned Values: ASCII Format and Binary Format"](#), on page 423.
 Default unit: dB (logarithmic display) or Hz (linear display)

| | |
|-----------------|---|
| Example: | <p>ADEM:SET 8MHz,32000,EXT,POS,-500,30, see [SENSe:]ADEMod:SET on page 769</p> <p>Sets demodulator</p> <p>ADEM:FM AVER,MAXH,MINH, see [SENSe:]ADEMod:FM[:TDOMain][:TYPE] on page 760</p> <p>Selects the FM results to be measured</p> <p>ADEM:AM:REL WRIT,OFF,OFF, see [SENSe:]ADEMod:FM:AFSPectrum[:TYPE] on page 762</p> <p>Selects the AM results to be measured</p> <p>ADEM:FM:AFSP WRIT,OFF,OFF, see [SENSe:]ADEMod:FM:AFSPectrum[:TYPE] on page 762</p> <p>Selects the AF spectrum results of the demodulated FM signal to be measured</p> <p>ADEM ON, see [SENSe:]ADEMod[:STATe] on page 752</p> <p>Switches the demodulator on</p> <p>INIT; WAI</p> <p>Starts the measurement and waits for termination</p> <p>FORM ASC, see FORMat[:DATA] on page 939</p> <p>Selects output format</p> <p>ADEM:FM:RES? AVER, see [SENSe:]ADEMod:FM[:TDOMain]:RESult on page 761</p> <p>Reads FM average result data</p> <p>ADEM:FM:RES? MAXH, see [SENSe:]ADEMod:FM[:TDOMain]:RESult on page 761</p> <p>Reads FM maxhold result data</p> <p>ADEM:FM:RES? MINH, see [SENSe:]ADEMod:FM[:TDOMain]:RESult on page 761</p> <p>Reads FM minhold result data</p> <p>ADEM:AM:RES? WRIT, see [SENSe:]ADEMod:AM[:ABSolute][:TDOMain]:RESult? on page 755</p> <p>Reads current AM result data</p> <p>ADEM:FM:AFSP:RES? WRIT</p> <p>Reads current AF spectrum result data of demodulated FM signal</p> |
| Mode: | ADEMOD |

[SENSe:]ADEMod:FM:OFFSet <Type>

This command calculates the FM offset of the currently available measurement data set.

If averaging has been activated before acquiring the data set (using [SENSe:]ADEMod:FM[:TDOMain][:TYPE] on page 760, the averaged FM offset over several measurements can also be obtained by setting <result type> = AVERage.

The offset thus determined differs from the one calculated by the `CALCulate<n>:MARKer:FUNCTION:ADEMod:FERRor[:RESult<t>]?` on page 643 command since, for determination of the frequency deviation, the modulation is removed by means of low pass filtering, producing results that are different from those obtained by averaging.

Parameters:

<Type> <result type> | IMMEDIATE | AVERAGE

IMMEDIATE

The current measurement results will be used for calculating the FM offset

AVERAGE

The measurement results that were averaged over the given # of measurements will be used for calculating the FM offset

If no average measurement was active during the last measurement sequence only the `[SENSe:]ADEMod:FM:OFFSet IMMEDIATE` command (see `[SENSe:]ADEMod:FM:OFFSet` on page 763) will return a correct result (data to calculate the offset are taken from the last measured data set).

`[SENSe:]ADEMod:FM:OFFSet AVERAGE` will cause a query error in this case.

Example:

`ADEM:SET 8MHz,32000,EXT,POS,-500,30`, see `[SENSe:]ADEMod:SET` on page 769

Sets up demodulator parameters to execute 30 measurements

`ADEM:FM AVER,OFF,OFF`

Selects FM results to perform averaging

`ADEM:AM OFF,OFF,OFF`

Switches off AM demodulation

`ADEM ON`, see `[SENSe:]ADEMod[:STATe]` on page 752

Switches on analog demodulator

`INIT; WAI`

Starts measurement and waits for sync

`ADEM:FM:OFFS? IMM`

Reads FM offset of last measurement of the sequence of 30

`ADEM:FM:OFFS? AVER`

Reads FM offset averaged over 30 measurements

Mode: ADEMOD

[SENSe:]ADEMod:MTIME <Time>

This command defines the measurement time for analog demodulation.

Parameters:

<Time> *RST: 62.5us

Example:

`ADEM:MTIM 62.5us`

Sets the measurement time to 62.5 µs.

Mode: ADEMOD

Manual operation: See "Meas Time" on page 338

[SENSe:]ADEMod:PM[:TDOMain][:TYPE] <Type>

This command selects the result types of the PM-demodulated signal to be created simultaneously.

Parameters:

<Type> *RST: OFF,OFF,OFF
 <result type 1|2|3|4|5|6>: WRITe, AVERAge, MAXHold, MINHold, VIEW; for details see [chapter 5.4.1, "Trace Mode Result Types"](#), on page 423.

Example:

ADEM:PM AVER,MAXH,MINH, see [\[SENSe:\]ADEMod:PM\[:TDOMain\]\[:TYPE\]](#) on page 765
 Determines average, maximum and minimum value simultaneously
 ADEM:PM WRIT,OFF,OFF
 Determines only current measurement results
 ADEM:PM OFF,OFF,OFF
 Switches the PM demodulator off.

Mode: ADEMOD

[SENSe:]ADEMod:PM[:TDOMain]:RESult <Type>

This command reads the result data of the PM demodulation for the specified result type. The data format of the output data is determined with the FORMat command.

Return values:

<Type> <result type>: WRITe, AVERAge, MAXHold, MINHold; for details see [chapter 5.4.1, "Trace Mode Result Types"](#), on page 423.
 The specified result type must be one of those configured with the [\[SENSe:\]ADEMod:PM\[:TDOMain\]\[:TYPE\]](#) command.
 Otherwise a query error will be generated.

Return values

ASCII Format (FORMat ASCII) or Binary Format (FORMat REAL,32); for details see [chapter 5.4.2, "Formats for Returned Values: ASCII Format and Binary Format"](#), on page 423 .
 Default unit: dB (logarithmic display) or RAD or DEG (linear display)

Example: ADEM:SET 8MHz,32000,EXT,POS,-500,30, see [SENSe:]ADEMod:SET on page 769
Sets the demodulator parameters.
ADEM:PM AVER,MAXH,MINH, see [SENSe:]ADEMod:PM[:TDOMain][:TYPE] on page 765
Selects the PM results to be measured.
ADEM:AM WRIT,OFF,OFF
Selects the AM results to be measured.
ADEM ON, see [SENSe:]ADEMod[:STATe] on page 752
Switches on the demodulator.
INIT; WAI
Starts the measurement and waits for termination.
FORM ASC, see FORMAt[:DATA] on page 939
Selects the output format.
ADEM:PM:RES? AVER
Reads the PM average result data.
ADEM:PM:RES? MAXH
Reads the PM maxhold result data.
ADEM:PM:RES? MINH
Reads the PM minhold result data.
ADEM:AM:RES? WRIT
Reads the current AM result data.

Mode: ADEMOD

[SENSe:]ADEMod:PM:AFSPectrum[:TYPE] <Type>

This command selects the AF spectrum result types of the PM-demodulated signal to be measured simultaneously.

Parameters:

<Type> *RST: OFF,OFF,OFF
<result type 1|2|3|4|5|6>: WRITe, AVERAge, MAXHold, MINHold, VIEW; for details see [chapter 5.4.1, "Trace Mode Result Types"](#), on page 423.
The result type "AF spectrum of the PM demodulated signal" cannot be activated at the same time as "AF spectrum of AM or FM demodulated signal".

Example: ADEM:PM:AFSP AVER,MAXH,MINH
Determines average, maximum and minimum value simultaneously
ADEM:PM:AFSP WRIT,OFF,OFF
Determines only current measurement results
ADEM:PM:AFSP OFF,OFF,OFF
Switches calculation of AF spectrum off

Mode: ADEMOD

[SENSe:]ADEMod:PM:AFSPectrum:RESult <Type>

This command reads out the AF spectrum result data of the PM-demodulated signal for the specified result type. The data format of the output data is determined with the FORMat command.

Return values:

<Type>

<result type>: WRITe, AVERAge, MAXHold, MINHold; for details see [chapter 5.4.1, "Trace Mode Result Types"](#), on page 423 .

The specified result type must be one of those configured with the `[SENSe:]ADEMod:PM:AFSPectrum[:TYPE]` on page 766 command. Otherwise a query error will be generated.

Return values

ASCII Format (FORMat ASCII) or Binary Format (FORMat REAL,32); for details see [chapter 5.4.2, "Formats for Returned Values: ASCII Format and Binary Format"](#), on page 423 .

Default unit: dB (logarithmic display) or RAD or DEG (linear display)

Example: ADEM:SET 8MHz,32000,EXT,POS,-500,30, see [SENSe:]ADEMod:SET on page 769
 Sets demodulator
 ADEM:PM AVER,MAXH,MINH, see [SENSe:]ADEMod:PM[:TDOMain][:TYPE] on page 765
 Selects the PM results to be measured
 ADEM:AM:REL WRIT,OFF,OFF, see [SENSe:]ADEMod:FM:AFSPpectrum[:TYPE] on page 762
 Selects the AM results to be measured
 ADEM:PM:AFSP WRIT,OFF,OFF, see [SENSe:]ADEMod:PM:AFSPpectrum[:TYPE] on page 766
 Selects the AF spectrum results of the demodulated PM signal to be measured
 ADEM ON, see [SENSe:]ADEMod[:STATe] on page 752
 Switches the demodulator on
 INIT; WAI
 Starts the measurement and waits for termination
 FORM ASC, see FORMat[:DATA] on page 939
 Selects output format
 ADEM:PM:RES? AVER, see [SENSe:]ADEMod:PM:AFSPpectrum:RESult on page 767
 Reads PM average result data
 ADEM:PM:RES? MAXH, see [SENSe:]ADEMod:PM:AFSPpectrum:RESult on page 767
 Reads PM maxhold result data
 ADEM:PM:RES? MINH, see [SENSe:]ADEMod:PM:AFSPpectrum:RESult on page 767
 Reads PM minhold result data
 ADEM:AM:RES? WRIT, see [SENSe:]ADEMod:PM:AFSPpectrum:RESult on page 767
 Reads current AM result data
 ADEM:PM:AFSP:RES? WRIT
 Reads current AF spectrum result data of demodulated PM signal

Mode: ADEMOD

[SENSe:]ADEMod:PM:RPOint[:X] <Time>

This command determines the position where the phase of the PM-demodulated signal is set to 0 rad. The maximum possible value depends on the measurement time selected in the instrument; this value is output in response to the query

ADEM:PM:RPO:X? MAX.

Parameters:

<Time> 0 s to measurement time
 *RST: 0 s

Example: ADEM:PM:RPO 500us
 Sets the position where the phase to 0 rad setting to 500 µs.

| | |
|--------------------------|--|
| Usage: | SCPI confirmed |
| Mode: | ADEMOD |
| Manual operation: | See " Zero Phase Reference Point " on page 346 |

[SENSe:]ADEMod:RLEnGth?

This command returns the record length set up for the current analog demodulation measurement.

Example: ADEM:RLEN?
Returns the current record length.

Usage: Query only
Mode: ADEMOD

[SENSe:]ADEMod:SET <sample rate> | <record length> | <trigger source> | <trigger slope> | <offset samples> | <# of meas>

This command configures the analog demodulator of the instrument.

Parameters:

| | |
|------------------|---|
| <sample rate> | numeric value
The frequency at which measurement values are taken from the A/D-converter and stored in I/Q memory.
Allowed range: refer to Sample Rate, Measurement Time and Trigger Offset .
Note: for FM stereo measurements (K7S option), the sample rate is always 500 kHz (as the demodulation bandwidth is permanently set to 400 kHz). Thus, this parameter is ignored in this case.
*RST: 8 MHz |
| <record length> | Number of samples to be stored in I/Q memory.
Range: 1 to 400001 with AF filter or AF trigger active, 1 to 480001 with both AF filter and AF trigger deactive
*RST: 501) |
| <trigger source> | Selection of the trigger source to use for the demodulator.
IMMediate EXTernal IFPower RFPower AF AM AMRelative FM PM
Note: After selecting IF Power, the trigger threshold can be set with the TRIGger<n>[:SEquence]:LEVel:IFPower command.
*RST: IMMediate |

| | |
|------------------|---|
| <trigger slope> | POSitive NEGative
Used slope of the trigger signal.
The value indicated here will be ignored for <trigger source> = IMMEDIATE.
*RST: POSitive |
| <offset samples> | Number of samples to be used as an offset to the trigger signal.
For details refer to chapter 5.1.8, "Sample Rate, Measurement Time and Trigger Offset" , on page 325.
The value indicated here is ignored for <trigger source> = "IMMEDIATE".
*RST: 0 |
| <# of meas> | Number of repetitions of the measurement to be executed. The value indicated here is especially necessary for the average/maxhold/minhold function.
Range: 0 to 32767
*RST: 0 |
| Example: | ADEM:SET 8MHz, 32000, EXT, POS, -500, 30
Performs a measurement at:
sample rate = 8 MHz
record length = 32000
trigger source = EXTERNAL
trigger slope = POSitive
offset samples = -500 (500 samples before trigger occurred)
of meas = 30 |
| Mode: | ADEMOD |

[SENSe:]ADEMod:SPECTrum[:TYPE] <Type>

This command selects the result types to be created in parallel by the RF spectrum measurement with active analog demodulation.

Parameters:

<Type> *RST: OFF,OFF,OFF
<result type 1|2|3|4|5|6>: WRITe, AVERAge, MAXHold, MINHold, VIEW, OFF; for details see [chapter 5.4.1, "Trace Mode Result Types"](#), on page 423.

Example:

```
ADEM:SPEC AVER,MAXH,MINH
Creates average, max hold and min hold values at a time
ADEM:SPEC WRIT,OFF,OFF
Only creates the current measurement values
ADEM:SPEC OFF,OFF,OFF
Switches analog demodulator off
```

Mode: ADEMOD

[SENSe:]ADEMod:SPECTrum:BANDwidth|BWIDth[:RESolution] <Bandwidth>

This command sets the resolution bandwidth for the spectrum representation that was determined from the analog demodulation data.

The recording time required is calculated from the sampling rate indirectly set via [\[SENSe:\]ADEMod:SPECTrum:SPAN\[:MAXimum\]](#) on page 772 or [\[SENSe:\]ADEMod:BANDwidth|BWIDth:DEModulation](#) on page 760. If the available recording time is not sufficient for the given bandwidth, the recording time is set to its maximum and the resolution bandwidth is enlarged to the resulting bandwidth.

Parameters:

<Bandwidth> refer to data sheet
*RST: 61.2 kHz

Example:

ADEM ON, see [\[SENSe:\]ADEMod\[:STATe\]](#) on page 752
Switches on the analog demodulator
CALC:FEED 'XTIM:SPEC', see [CALCulate<n>:FEED](#)
on page 705
Switches on the RF spectrum result display
or
CALC:FEED 'XTIM:FM:AFSP', see [CALCulate<n>:FEED](#)
on page 705
Switches on the AF spectrum result display of FM signal
ADEM:SPEC:BAND 61.2kHz
Sets the resolution bandwidth to 61.2 kHz.

Mode: AEMOD

Manual operation: See "[Res BW \(span > 0\)](#)" on page 359

[SENSe:]ADEMod:SPECTrum:RESult <Type>

This command reads out the RF spectrum result data for the specified result type. The data format of the output data block is defined by the [FORMat](#) command.

Return values:

<Type> <result type>: WRITe, AVERAge, MAXHold, MINHold; for details see [chapter 5.4.1, "Trace Mode Result Types"](#), on page 423. The result type indicated must be one of those configured by [\[SENSe:\]ADEMod:SPECTrum\[:TYPE\]](#) on page 770. Otherwise a query error will be generated.

Return values ASCII Format ([FORMat ASCII](#)) or Binary Format ([FORMat REAL,32](#)); for details see [chapter 5.4.2, "Formats for Returned Values: ASCII Format and Binary Format"](#), on page 423. The output units are described in [CALCulate<n>:MARKer<m>:PEXCursion](#) on page 616.

| | |
|-----------------|---|
| Example: | <p>ADEM:SET 8MHz,32000,EXT,POS,-500,30, see [SENSe:]ADEMod:SET on page 769</p> <p>Sets demodulator</p> <p>ADEM:SPEC AVER,MAXH,MINH</p> <p>Selects RF spectrum results to be measured</p> <p>ADEM:SPEC WRIT,OFF,OFF</p> <p>Selects the AM results to be measured</p> <p>ADEM ON, see [SENSe:]ADEMod[:STATE] on page 752</p> <p>Switches the demodulator on</p> <p>INIT; WAI</p> <p>Starts the measurement and waits for termination</p> <p>FORM ASC, see FORMat[:DATA] on page 939</p> <p>Selects output format</p> <p>ADEM:SPEC:RES? AVER</p> <p>Reads RF spectrum average results</p> <p>ADEM:SPEC:RES? MAXH</p> <p>Reads RF spectrum max hold results</p> <p>ADEM:SPEC:RES? MINH</p> <p>Reads RF spectrum min hold results</p> <p>ADEM:SPEC:RES? WRIT</p> <p>Reads spectrum current results</p> |
| Mode: | AEMOD |

[SENSe:]ADEMod:SPECTrum:SPAN[:MAXimum] <FreqRange>

This command sets the maximum frequency range for displaying the RF spectrum that was determined from the FM demodulation data. The maximum span corresponds to the measurement bandwidth of analog demodulation (for details refer to [SENSe:]ADEMod:BANDwidth|BWIDth:DEModulation on page 760).

For details refer on the relation of bandwidth and sample rate refer to [Sample Rate, Measurement Time and Trigger Offset](#).

Parameters:

<FreqRange> *RST: 5 MHz

| | |
|-----------------|---|
| Example: | <p>ADEM ON, see [SENSe:]ADEMod[:STATE] on page 752</p> <p>Switches on the analog demodulator</p> <p>CALC:FEED 'XTIM:SPEC', see CALCulate<n>:FEED on page 705</p> <p>Switches on RF spectrum result display.</p> <p>ADEM:SPEC:SPAN:MAX 5 MHz</p> <p>Sets the max. span to 5 MHz</p> <p>ADEM:SPEC:SPAN:ZOOM 1 MHz</p> <p>Sets the displayed span to 1 MHz</p> |
|-----------------|---|

Mode: AEMOD

[SENSe:]ADEMod:SPECTrum:SPAN:ZOOM <FreqRange>

This command sets the frequency range for the RF spectrum result display determined from analog demodulation data. The frequency range for result display is limited to the maximum span ([SENSe:]ADEMod:SPECTrum:SPAN[:MAXimum] on page 772) or to the measurement bandwidth of analog demodulation ([SENSe:]ADEMod:BANDwidth|BWIDth:DEModulation on page 760).

Parameters:

<FreqRange> *RST: 5 MHz

Example:

ADEM ON, see [SENSe:]ADEMod[:STATe] on page 752
Switches on the analog demodulator
CALC:FEED 'XTIM:SPEC', see CALCulate<n>:FEED
on page 705
Switches on RF spectrum result display.
ADEM:SPEC:SPAN:MAX 5 MHz, see [SENSe:]ADEMod:
SPECTrum:SPAN[:MAXimum] on page 772
Sets the maximum span to 5 MHz
ADEM:SPEC:SPAN:ZOOM 1 MHz
Sets displayed span to 1 MHz

Mode: ADEMOD

Manual operation: See "Span Manual (RF Spectrum)" on page 350
See "Full Span (RF Spectrum)" on page 350

[SENSe:]ADEMod:SQUelch[:STATe] <State>

This command activates the squelch function, i.e. if the signal falls below a defined threshold (see [SENSe:]ADEMod:SQUelch:LEVel on page 773), the demodulated data is automatically set to 0.

Parameters:

<State> ON | OFF
*RST: OFF

Example:

DEM:SQU ON
Signals below the level threshold are squelched.

Usage: SCPI confirmed

Mode: A, ADEMOD, SFM

Manual operation: See "Squelch" on page 344

[SENSe:]ADEMod:SQUelch:LEVel <Threshold>

This command defines the level threshold below which the demodulated data is set to 0 if squelching is enabled (see [SENSe:]ADEMod:SQUelch[:STATe] on page 773).

Parameters:

<Threshold> numeric value
 The absolute threshold level
 Range: -150 dBm to 30 dBm
 *RST: -40 dBm

Example:

DEM:SQU:LEV -80
 If the signal drops below -80 dBm, the demodulated data is set to 0.

Usage: SCPI confirmed

Mode: ADEMOD, SFM

Manual operation: See "[Squelch Level](#)" on page 344

[SENSe:]ADEMod:SRATe?

This command returns the sample rate set up for the current analog demodulation measurement.

Example:

ADEM:SRAT?
 Returns the current sample rate.

Usage: Query only

Mode: ADEMOD

[SENSe:]ADEMod<n>:ZOOM[:STATe] <State>

The command enables or disables the zoom function for the analog-demodulated measurement data in the specified window. Depending on the selected measurement time and the demodulation bandwidth, the number of recorded test points may be greater than that shown on the display.

If the zoom function is enabled, the default number of sweep points in "Spectrum" mode of the result memory are displayed from the specified start time with [\[SENSe:\]ADEMod<n>:ZOOM:START](#) on page 775.

If the zoom function is disabled, data reduction is used to adapt the test points to the number of points available on the display.

Suffix:

<n> 1...4
 window

Parameters:

<State> ON | OFF
 *RST: OFF

Example:

ADEM:ZOOM ON
 Switches on the zoom function

Mode: ADEMOD

Manual operation: See "State On / Off" on page 343

[SENSe:]ADEMod<n>:ZOOM:START <Time>

The command selects the start time for the display of individual measured values of the analog demodulation in the specified window. The maximum possible value depends on the measurement time, which is set in the instrument and can be queried with the [SENSe:]ADEMod:MTIME on page 764 command.

If the zoom function is enabled, the default number of sweep points in "Spectrum" mode of the result memory are displayed from the specified start time with [SENSe:]ADEMod<n>:ZOOM:START on page 775.

Suffix:

<n> 1...4
 window

Parameters:

<Time> *RST: 0 s
 0 s to measurement time – (default number of sweep points in "Spectrum" mode – 1 * 1/sample rate)

Example: ADEM:ZOOM:STAT ON (see [SENSe:]ADEMod<n>:ZOOM[:STATe] on page 774)

Switches on the zoom function

ADEM:ZOOM:STAR 500us

Sets the starting point of the display to 500 µs.

Mode: ADEMOD

Manual operation: See "Start" on page 344

[SENSe:]ADEMod<n>:ZOOM:LENGTH <Length>

The command allows you to define the length of the zoom area for the analog-demodulated measurement data in the specified window manually. If the length is defined manually using this command, the zoom mode is also set to manual.

Suffix:

<n> 1...4
 window

Parameters:

<Length> *RST: sweep time
 Length of the zoom area in seconds.

Example: ADEM:ZOOM:LENG 2s
Zoom mode is set to manual and the zoom length to 2 seconds.

Mode: ADEMOD

Manual operation: See "Length Manual" on page 344

[SENSe:]ADEMod<n>:ZOOM:LENGth:MODE <Mode>

The command defines whether the length of the zoom area for the analog-demodulated measurement data is defined automatically or manually in the specified window. By default and in automatic mode, the number of sweep points is used as the zoom length. If the zoom length was already entered using `[SENSe:]ADEMod<n>:ZOOM:LENGth` on page 775, manual zoom mode is set automatically.

Suffix:

<n> 1...4
window

Parameters:

<Mode> AUTO | MAN
*RST: AUTO

Example:

ADEM:ZOOM:LENG:MODE MAN
Zoom function uses the length defined manually.

Mode: ADEMOD

Manual operation: See "Length Auto" on page 344

SENSe:ADJust Subsystem

The ADJust subsystem controls automatic definition of frequency and level settings.

| | |
|---|-----|
| <code>[SENSe:]ADJust:ALL</code> | 776 |
| <code>[SENSe:]ADJust:FREQuency</code> | 776 |
| <code>[SENSe:]ADJust:LEVel</code> | 777 |
| <code>[SENSe:]ADJust:CONFigure:LEVel:DURation</code> | 777 |
| <code>[SENSe:]ADJust:CONFigure:LEVel:DURation:MODE</code> | 777 |
| <code>[SENSe:]ADJust:CONFigure:HYSTeresis:LOWer</code> | 777 |
| <code>[SENSe:]ADJust:CONFigure:HYSTeresis:UPPer</code> | 778 |
| <code>[SENSe:]ADJust:CONFigure:TRIG</code> | 778 |
| <code>[SENSe:]ADJust:SCALe:Y:AUTO[:CONTInuous]</code> | 778 |

[SENSe:]ADJust:ALL

This command determines the ideal frequency and level configuration for the current measurement.

Example: ADJ:ALL

Manual operation: See "Auto All" on page 76

[SENSe:]ADJust:FREQuency

This command defines the center frequency and the reference level automatically by determining the highest level in the frequency span.

Example: ADJ:FREQ

Manual operation: See "Auto Freq" on page 76

[SENSe:]ADJust:LEVel

This command automatically sets the optimal reference level for the current measurement.

You can define a threshold that the signal must exceed before the reference level is adjusted, see [\[SENSe:\]ADJust:CONFIguration:HYSTeresis:UPPer](#) and [\[SENSe:\]ADJust:CONFIguration:HYSTeresis:LOWer](#).

Example: ADJ:LEV

Manual operation: See "Auto Level" on page 77

[SENSe:]ADJust:CONFIgure:LEVel:DURation <Duration>

This command defines the duration of the level measurement used to determine the optimal reference level automatically (for `SENS:ADJ:LEV ON`).

Parameters:

<Duration> <numeric value> in seconds
 Range: 0.001 to 16000.0
 *RST: 0.001
 Default unit: s

Example: ADJ:CONF:LEV:DUR:5

Manual operation: See "Meas Time Manual" on page 77

[SENSe:]ADJust:CONFIgure:LEVel:DURation:MODE <Mode>

This command selects the way the R&S FSVR determines the length of the measurement that is performed while determining the ideal reference level.

Parameters:

<Mode> **AUTO**
 Automatically determines the measurement length.
 MANual
 Manual definition of the measurement length.
 *RST: AUTO

Example: ADJ:CONF:LEV:DUR:MODE MAN
 Specifies manual definition of the measurement duration.
 ADJ:CONF:LEV:DUR:5
 Specifies the duration manually.

[SENSe:]ADJust:CONFIguration:HYSTeresis:LOWer <Threshold>

This command defines a lower threshold the signal must drop below before the reference level is automatically adjusted when the "Auto Level" function is performed.

For more information see [\[SENSe:\]ADJust:LEVel](#).

Parameters:

<Threshold> Range: 0 to 200
 *RST: +1 dB
 Default unit: dB

Example: SENS:ADJ:CONF:HYST:LOW 2

Example: For an input signal level of currently 20 dBm, the reference level will only be adjusted when the signal level falls below 18 dBm.

Manual operation: See "[Lower Level Hysteresis](#)" on page 77

[SENSe:]ADJust:CONFIguration:HYSTeresis:UPPer <Threshold>

This command defines an upper threshold the signal must exceed before the reference level is automatically adjusted when the "Auto Level" function is performed.

For more information see [[SENSe:\]ADJust:LEVel](#)).

Parameters:

<Threshold> Range: 0 to 200
 *RST: +1 dB
 Default unit: dB

Example: SENS:ADJ:CONF:HYST:UPP 2

For an input signal level of currently 20 dBm, the reference level will only be adjusted when the signal level rises above 22 dBm.

Manual operation: See "[Upper Level Hysteresis](#)" on page 77

[SENSe:]ADJust:CONFIgure:TRIG <State>

This command defines the behaviour of the measurement when adjusting a setting automatically (using SENS:ADJ:LEV ON, for example).

For more information see "[Adjusting settings automatically during triggered measurements](#)" on page 76.

Parameters:

<State> **ON**
 The measurement for automatic adjustment waits for the trigger.

OFF
 The measurement for automatic adjustment is performed immediately, without waiting for a trigger.

 *RST: ON

Example: ADJ:CONF:TRIG OFF

[SENSe:]ADJust:SCALe:Y:AUTO[:CONTInuous] <state>

Activates automatic scaling of the y-axis. Currently auto-scaling is only available for AF measurements. RF power and RF spectrum measurements are not affected by the auto-scaling.

Parameters:

<state> ON | OFF
 *RST: OFF

Example:

SENS1:ADJ:SCAL:Y:AUTO ON

Mode:

ADEMODO, SFM

Manual operation: See "AF Auto Scale" on page 359

SENSe:AVERage Subsystem

The SENSe:AVERage subsystem calculates the average of the acquired data. A new test result is obtained from several successive measurements.

There are two types of average calculation: logarithmic and linear. In case of logarithmic average calculation (denoted with VIDEo), the average value of the measured logarithmic power is calculated and in case of linear average calculation, the linear power is averaged before the logarithm is applied.

| | |
|--|-----|
| [SENSe:]AVERage<n>[:STATe<Trace>]..... | 779 |
| [SENSe:]AVERage<n>:COUNT..... | 779 |
| [SENSe:]AVERage<n>:TYPE..... | 780 |

[SENSe:]AVERage<n>[:STATe<Trace>] <State>

This command turns averaging for a particular trace in a particular window on and off.

Suffix:

<n> Selects the measurement window.
 <Trace> 1...6
 Selects the trace.

Parameters:

<State> ON | OFF
 *RST: OFF

Example:

AVER OFF
 Switches off the average calculation for trace 1.
 AVER:STAT3 ON
 Switches on the average calculation for trace 3.

[SENSe:]AVERage<n>:COUNT <NoMeasurements>

This command defines the number of measurements which contribute to the average value.

Note that continuous averaging is performed after the indicated number has been reached in continuous sweep mode.

In single sweep mode, the sweep is stopped as soon as the indicated number of measurements (sweeps) is reached. Synchronization to the end of the indicated number of measurements is only possible in single sweep mode.

This command has the same effect as the `[SENSe<source>:]SWEep:COUNT` command. In both cases, the number of measurements is defined whether the average calculation is active or not.

The number of measurements applies to all traces in the window.

Suffix:

<n> Selects the measurement window.

Parameters:

<NoMeasurements> 0 to 32767

*RST: 0

Example:

SWE:CONT OFF

Switching to single sweep mode.

AVER:COUN 16

Sets the number of measurements to 16.

AVER:STAT ON

Switches on the calculation of average.

INIT;*WAI

Starts the measurement and waits for the end of the 16 sweeps.

[SENSe:]AVERage<n>:TYPE <FunctionType>

This command selects the type of average function.

Suffix:

<n> Selects the measurement window.

Parameters:

<FunctionType> VIDEo | LINear | POWer

VIDEo

The logarithmic power values are averaged.

LINear

The power values are averaged before they are converted to logarithmic values.

POWer

The power level values are converted into unit Watt prior to averaging. After the averaging, the data is converted back into its original unit.

*RST: VIDEo

Example:

AVER:TYPE LIN

Switches to linear average calculation.

Manual operation:

See "[Lin](#)" on page 99

See "[Log](#)" on page 99

See "[Power](#)" on page 99

SENSe:BANDwidth Subsystem

This subsystem controls the setting of the instruments filter bandwidths. Both groups of commands (BANDwidth and BWIDth) perform the same functions.

| | |
|--|-----|
| [SENSe:]BANDwidth BWIDth:DEMod..... | 781 |
| [SENSe:]BANDwidth:DEMod:TYPE..... | 781 |
| [SENSe:]BANDwidth BWIDth[:RESolution]..... | 782 |
| [SENSe:]BANDwidth BWIDth[:RESolution]:AUTO..... | 782 |
| [SENSe:]BANDwidth BWIDth[:RESolution]:FFT..... | 782 |
| [SENSe:]BANDwidth BWIDth[:RESolution]:RATio..... | 783 |
| [SENSe:]BANDwidth BWIDth[:RESolution]:TYPE..... | 783 |
| [SENSe:]BANDwidth BWIDth:VIDeo..... | 784 |
| [SENSe:]BANDwidth BWIDth:VIDeo:AUTO..... | 784 |
| [SENSe:]BANDwidth BWIDth:VIDeo:RATio..... | 784 |
| [SENSe:]BANDwidth BWIDth:VIDeo:TYPE..... | 785 |

[SENSe:]BANDwidth|BWIDth:DEMod <Bandwidth>

This command sets the bandwidth for analog demodulation. Depending on the selected demodulation bandwidth, the instrument selects the required sampling rate.

The available values of the demodulation bandwidths are determined by the sampling rates. For details on the correlation between demodulation bandwidth and sampling rate refer to [chapter 5.1.8, "Sample Rate, Measurement Time and Trigger Offset"](#), on page 325.

Parameters:

<Bandwidth> *RST: 5 MHz

Example:

BAND:DEM 1MHz
Sets test bandwidth to 1 MHz

Mode: A-F, ADEMOM

Manual operation: See "[Demod BW](#)" on page 338

[SENSe:]BANDwidth:DEMod:TYPE <FilterType>

This command defines the type of demodulation filter to be used.

Parameters:

<FilterType> **FLAT**
Standard flat demodulation filter

GAUSs
Gaussian filter for optimized settling behaviour

*RST: FLAT

Example:

BAND:DEM:TYPE GAUS
Selects the Gaussian filter.

Mode: ADEMOM

Manual operation: See "[Demod Filter](#)" on page 363

[SENSe:]BANDwidth|BWIDth[:RESolution] <Bandwidth>

This command defines the resolution bandwidth.

The available resolution bandwidths are specified in the data sheet. For details on the correlation between resolution bandwidth and filter type refer to [chapter 4.1.6.3, "Selecting the Appropriate Filter Type"](#), on page 85.

In realtime mode, the resolution bandwidth is always coupled to the span. In all other modes, a change of the resolution bandwidth automatically turns the coupling to the span off.

Parameters:

<Bandwidth> refer to data sheet
*RST: (AUTO is set to ON)

Example:

BAND 1 MHz
Sets the resolution bandwidth to 1 MHz

Manual operation: See ["Res BW Manual"](#) on page 80
See ["Res BW"](#) on page 231

[SENSe:]BANDwidth|BWIDth[:RESolution]:AUTO <State>

This command couples and decouples the resolution bandwidth to the span.

The automatic coupling adapts the resolution bandwidth to the current frequency span according to the relationship between frequency span and resolution bandwidth.

Use `[SENSe:]BANDwidth|BWIDth[:RESolution]:RATio` to define the ratio RBW/span.

Parameters:

<State> ON | OFF
*RST: ON

Example:

BAND:AUTO OFF
Switches off the coupling of the resolution bandwidth to the span.

Manual operation: See ["Res BW Manual"](#) on page 80
See ["Res BW Auto"](#) on page 80
See ["Default Coupling"](#) on page 85

[SENSe:]BANDwidth|BWIDth[:RESolution]:FFT <FilterMode>

This command defines the filter mode of FFT filters by defining the partial span size. The partial span is the span which is covered by one FFT analysis.

This command is only available for sweep type "FFT".

Parameters:

<FilterMode>

AUTO

The firmware determines whether to use wide or narrow filters to obtain the best measurement results.

NARROW

The FFT filters with the smaller partial span are used. This allows you to perform measurements near a carrier with a reduced reference level due to a narrower analog prefilter.

*RST: AUTO

Example:

BAND:TYPE FFT

Select FFT filter.

Example:

BAND:FFT NARR

Select narrow partial span for FFT filter.

Manual operation:

See "Auto" on page 78

See "Narrow" on page 79

[SENSe:]BANDwidth|BWIDth[:RESolution]:RATio <Ratio>

This command defines the ratio between the resolution bandwidth (Hz) and the span (Hz).

Note that the ratio defined with the remote command (RBW/span) is reciprocal to that of the manual operation (span/RBW).

Parameters:

<Ratio>

Range: 0.0001 to 1

*RST: 0.01

Example:

BAND:RAT 0.01

Manual operation:

See "Span/RBW Manual" on page 84

[SENSe:]BANDwidth|BWIDth[:RESolution]:TYPE <FilterType>

This command selects the type of resolution filter.

For detailed information on filters see [chapter 4.1.6.3, "Selecting the Appropriate Filter Type"](#), on page 85 and [chapter 4.1.6.4, "List of Available RRC and Channel Filters"](#), on page 86.

When changing the filter type, the next larger filter bandwidth is selected if the same filter bandwidth is not available for the new filter type.

5 Pole filters are not available when using the sweep type "FFT".

Parameters:

<FilterType> **NORMal**
 Gaussian filters

CFILter
 channel filters

RRC
 RRC filters

P5
 5 Pole filters

*RST: **NORMal**

Example: BAND:TYPE NORM

Manual operation: See "[Filter Type](#)" on page 85

[SENSe:]BANDwidth|BWIDth:VIDeo <Bandwidth>

This command defines the video bandwidth. The available video bandwidths are specified in the data sheet.

Parameters:

<Bandwidth> refer to data sheet

*RST: (AUTO is set to ON)

Example: BAND:VID 10 kHz

Manual operation: See "[Video BW Manual](#)" on page 80

[SENSe:]BANDwidth|BWIDth:VIDeo:AUTO <State>

This command couples and decouples the VBW to the RBW.

Use [\[SENSe:\]BANDwidth|BWIDth:VIDeo:RATio](#) to define the ratio VBW/RBW.

Parameters:

<State> ON | OFF

*RST: ON

Example: BAND:VID:AUTO OFF

Manual operation: See "[Video BW Manual](#)" on page 80
 See "[Video BW Auto](#)" on page 81
 See "[Default Coupling](#)" on page 85

[SENSe:]BANDwidth|BWIDth:VIDeo:RATio <Ratio>

This command defines the ratio between video bandwidth (Hz) and resolution bandwidth (Hz).

Note that the ratio defined with the remote command (VBW/RBW) is reciprocal to that of the manual operation (RBW/VBW).

Parameters:

<Ratio> Range: 0.01 to 1000
 *RST: 3

Example:

BAND:VID:RAT 3
 Sets the coupling of video bandwidth to video bandwidth =
 3*resolution bandwidth

Manual operation:

See "[RBW/VBW Sine \[1/1\]](#)" on page 83
 See "[RBW/VBW Pulse \[.1\]](#)" on page 83
 See "[RBW/VBW Noise \[10\]](#)" on page 84
 See "[RBW/VBW Manual](#)" on page 84
 See "[Span/RBW Auto \[100\]](#)" on page 84

[SENSe:]BANDwidth|BWIDth:VIDeo:TYPE <Mode>

This command selects the position of the video filter in the signal path.

Changing the video filter position is possible only if the resolution bandwidth is ≤ 100 kHz.

Parameters:

<Mode>

LINear

The video filter is applied in front of the logarithmic amplifier. In linear mode, measurements with a logarithmic level scale result in flatter falling edges compared to logarithmic mode. The reason is the conversion of linear power values into logarithmic level values: if you halve the linear power, the logarithmic level decreases by 3 dB.

LOGarithmic

The video filter is applied after the logarithmic amplifier.

*RST: LINear

Example:

BAND:VID:TYPE LIN
 Video filter ahead of the logarithmic amplifier

SENSe:CORRection Subsystem

This subsystem controls the configuration of conversion loss tables for external mixers (option B21) is performed using these commands.

| | |
|---|-----|
| [SENSe:]CORRection:CVL:BAND | 786 |
| [SENSe:]CORRection:CVL:CATalog? | 786 |
| [SENSe:]CORRection:CVL:SElect | 786 |
| [SENSe:]CORRection:CVL:MIXer | 787 |
| [SENSe:]CORRection:CVL:SNUMber | 787 |
| [SENSe:]CORRection:CVL:HARMonic | 787 |
| [SENSe:]CORRection:CVL:PORTs | 788 |
| [SENSe:]CORRection:CVL:BIAS | 788 |
| [SENSe:]CORRection:CVL:COMMent | 788 |
| [SENSe:]CORRection:CVL:DATA | 789 |
| [SENSe:]CORRection:CVL:CLEar | 789 |

[SENSe:]CORRection:CVL:BAND <Type>

This command defines the waveguide band in the conversion loss table. Before this command can be performed, the conversion loss table must be selected (see [\[SENSe:\]CORRection:CVL:SElect](#) on page 786).

This command is only available with option B21 (External Mixer) installed.

Parameters:**<Band>**

K | A | KA | Q | U | V | E | W | F | D | G | Y | J | USER

Standard waveguide band or user-defined band.

Note: The band formerly referred to as "A" is now named "KA"; the input parameter "A" is still available and refers to the same band as "KA".

For a definition of the frequency range for the pre-defined bands, see [table 7-9](#)).

*RST: F (90 GHz - 140 GHz)

Example:

CORR:CVL:SEL 'LOSS_TAB_4'

Selects the conversion loss table.

CORR:CVL:BAND KA

Sets the band to KA (26.5 GHz - 40 GHz).

Mode: all**Manual operation:** See "[Band](#)" on page 499**[SENSe:]CORRection:CVL:CATalog?**

This command queries all available conversion loss tables saved in the C:\r_s\instr\user\cvl\ directory on the instrument.

This command is only available with option B21 (External Mixer) installed.

Example: CORR:CVL:CAT?**Usage:** Query only**Mode:** all**[SENSe:]CORRection:CVL:SElect <FileName>**

This command selects the conversion loss table with the specified file name. If <file_name> is not available, a new conversion loss table is created.

This command is only available with option B21 (External Mixer) installed.

Parameters:**<FileName>**

'<File name>'

Example:

CORR:CVL:SEL 'LOSS_TAB_4'

Mode: all

Manual operation: See "New Table" on page 498
 See "File Name" on page 499
 See "Edit Table" on page 501

[SENSe:]CORRection:CVL:MIXer <Type>

This command defines the mixer name in the conversion loss table. Before this command can be performed, the conversion loss table must be selected (see [SENSe:]CORRection:CVL:SElect on page 786).

This command is only available with option B21 (External Mixer) installed.

Parameters:

<Type> Name of mixer with a maximum of 16 characters

Example:

```
CORR:CVL:SEL 'LOSS_TAB_4'
Selects the conversion loss table.
CORR:CVL:MIX 'FS_Z60'
```

Mode: all

Manual operation: See "Mixer Name" on page 499

[SENSe:]CORRection:CVL:SNUMber <SerialNo>

This command defines the serial number of the mixer in the conversion loss table. Before this command can be performed, the conversion loss table must be selected (see [SENSe:]CORRection:CVL:SElect on page 786).

This command is only available with option B21 (External Mixer) installed.

Parameters:

<SerialNo> Serial number with a maximum of 16 characters

Example:

```
CORR:CVL:SEL 'LOSS_TAB_4'
Selects the conversion loss table.
CORR:CVL:MIX '123.4567'
```

Mode: all

Manual operation: See "Mixer S/N" on page 500

[SENSe:]CORRection:CVL:HARMonic <HarmOrder>

This command defines the harmonic order used in the conversion loss table. Before this command can be performed, the conversion loss table must be selected (see [SENSe:]CORRection:CVL:SElect on page 786).

This command is only available with option B21 (External Mixer) installed.

Parameters:

<HarmOrder> **<numeric value>**
 Range: 2 to 65

Example: CORR:CVL:SEL 'LOSS_TAB_4'
Selects the conversion loss table.
CORR:CVL:HARM 3

Mode: all

Manual operation: See "[Harmonic Order](#)" on page 499

[SENSe:]CORRection:CVL:PORTs <PortNo>

This command defines the mixer type in the conversion loss table. Before this command can be performed, the conversion loss table must be selected (see [\[SENSe:\]CORRection:CVL:SElect](#) on page 786).

This command is only available with option B21 (External Mixer) installed.

Parameters:

<PortType> **2 | 3**
*RST: 2

Example: CORR:CVL:SEL 'LOSS_TAB_4'
Selects the conversion loss table.
CORR:CVL:PORT 3

Mode: all

Manual operation: See "[Mixer Type](#)" on page 500

[SENSe:]CORRection:CVL:BIAS <BiasSetting>

This command defines the bias setting in the conversion loss table. Before this command can be performed, the conversion loss table must be selected (see [\[SENSe:\]CORRection:CVL:SElect](#) on page 786).

This command is only available with option B21 (External Mixer) installed.

Parameters:

<BiasSetting> *RST: 0.0 A
Default unit: A

Example: CORR:CVL:SEL 'LOSS_TAB_4'
Selects the conversion loss table.
CORR:CVL:BIAS 3A

Mode: all

Manual operation: See "[Bias](#)" on page 499
See "[Write to <CVL table name>](#)" on page 502

[SENSe:]CORRection:CVL:COMMeNt <Text>

This command defines a comment in the conversion loss table. Before this command can be performed, the conversion loss table must be selected (see [\[SENSe:\]CORRection:CVL:SElect](#) on page 786).

This command is only available with option B21 (External Mixer) installed.

Parameters:

<Text>

Example: CORR:CVL:SEL 'LOSS_TAB_4'
Selects the conversion loss table.
CORR:CVL:COMM 'Conversion loss table for
FS_Z60'

Mode: all

Manual operation: See "[Comment](#)" on page 499

[SENSe:]CORRection:CVL:DATA <Freq>,<Level>

This command defines the reference values of the selected conversion loss tables. The values are entered as a set of frequency/level pairs. A maximum of 50 pairs of frequency/level may be entered. Before this command can be performed, the conversion loss table must be selected (see [\[SENSe:\]CORRection:CVL:SElect](#) on page 786).

This command is only available with option B21 (External Mixer) installed.

Parameters:

<Freq> The frequencies have to be sent in ascending order.

<Level>

Example: CORR:CVL:SEL 'LOSS_TAB_4'
Selects the conversion loss table.
CORR:CVL:DATA 1MHZ,-30DB,2MHZ,-40DB

Mode: all

Manual operation: See "[Position/Value](#)" on page 500

[SENSe:]CORRection:CVL:CLEar

This command deletes the selected conversion loss table. Before this command can be performed, the conversion loss table must be selected (see [\[SENSe:\]CORRection:CVL:SElect](#) on page 786).

This command is only available with option B21 (External Mixer) installed.

Example: CORR:CVL:SEL 'LOSS_TAB_4'
Selects the conversion loss table.
CORR:CVL:CLE

Usage: Event

Mode: all

Manual operation: See "[Delete Table](#)" on page 501

SENSe:DEMod Subsystem

This subsystem controls demodulation of audible AF signals.

| | |
|------------------------------------|-----|
| [SENSe:]DEMod:SQUelch:LEVel..... | 790 |
| [SENSe:]DEMod:SQUelch[:STATe]..... | 790 |

[SENSe:]DEMod:SQUelch:LEVel <Threshold>

This command defines the threshold for selective demodulation. Squelching must be active for this command to work (see [SENSe:]DEMod:SQUelch[:STATe]).

All signals below the threshold are not demodulated.

This command is only available if the R&S FSVR option B3 (Audio Demodulation) is installed.

Parameters:

<Threshold> The threshold level as a percentage of the display height.
 Range: 0 to 100
 *RST: 60

Example: DEM:SQU:LEV 80
 Sets the squelch level to 80% of the displayed signal.

Usage: SCPI confirmed

Manual operation: See "Squelch Level" on page 133

[SENSe:]DEMod:SQUelch[:STATe] <State>

This command turns selective demodulation at the marker position on and off.

A video trigger is automatically activated with the same level as the squelch level, any other trigger or gate settings are deactivated.

This command is only available if the R&S FSVR option B3 (Audio Demodulation) is installed.

Parameters:

<State> ON | OFF
 *RST: OFF

Example: DEM:SQU ON
 Signals below the level threshold are not sent to the audio output.

Usage: SCPI confirmed

Manual operation: See "Squelch" on page 132

SENSe:ESpectrum Subsystem

The SENSe:ESpectrum subsystem contains the remote commands to configure Spectrum Emission Mask (SEM) measurements.



The sweep list cannot be configured using remote commands during an on-going sweep operation.

| | |
|--|-----|
| [SENSe:]ESpectrum:BWID..... | 791 |
| [SENSe:]ESpectrum:FILTer[:RRC][:STATe]..... | 792 |
| [SENSe:]ESpectrum:FILTer[:RRC]:ALPHa..... | 792 |
| [SENSe:]ESpectrum:HighSPeed..... | 792 |
| [SENSe:]ESpectrum:PRESet[:STANdard]..... | 793 |
| [SENSe:]ESpectrum:PRESet:REStore..... | 793 |
| [SENSe:]ESpectrum:PRESet:StORe..... | 794 |
| [SENSe:]ESpectrum:RANGe<range>:BANDwidth[:RESolution]..... | 794 |
| [SENSe:]ESpectrum:RANGe<range>:BANDwidth:VIDeo..... | 794 |
| [SENSe:]ESpectrum:RANGe<range>:COUnT..... | 795 |
| [SENSe:]ESpectrum:RANGe<range>:DELeTe..... | 795 |
| [SENSe:]ESpectrum:RANGe<range>:FILTer:TYPE..... | 795 |
| [SENSe:]ESpectrum:RANGe<range>[:FREQuency]:StARt..... | 796 |
| [SENSe:]ESpectrum:RANGe<range>[:FREQuency]:StOP..... | 796 |
| [SENSe:]ESpectrum:RANGe<range>:INPut:ATTenuation..... | 797 |
| [SENSe:]ESpectrum:RANGe<range>:INPut:ATTenuation:AUTO..... | 797 |
| [SENSe:]ESpectrum:RANGe<range>:INPut:GAIN:STATe..... | 797 |
| [SENSe:]ESpectrum:RANGe<range>:INStert..... | 798 |
| [SENSe:]ESpectrum:RANGe<range>:LIMit<source>:ABSolute:StARt..... | 798 |
| [SENSe:]ESpectrum:RANGe<range>:LIMit<source>:ABSolute:StOP..... | 798 |
| [SENSe:]ESpectrum:RANGe<range>:LIMit<source>:RELative:StARt..... | 799 |
| [SENSe:]ESpectrum:RANGe<range>:LIMit<source>:RELative:StOP..... | 799 |
| [SENSe:]ESpectrum:RANGe<range>:LIMit<source>:STATe..... | 800 |
| [SENSe:]ESpectrum:RANGe<range>:RLEVel..... | 800 |
| [SENSe:]ESpectrum:RANGe<range>:SWEep:TIME..... | 800 |
| [SENSe:]ESpectrum:RANGe<range>:SWEep:TIME:AUTO..... | 801 |
| [SENSe:]ESpectrum:RANGe<range>:TRANsducer..... | 801 |
| [SENSe:]ESpectrum:RRANGe..... | 802 |
| [SENSe:]ESpectrum:RTYPE..... | 802 |

[SENSe:]ESpectrum:BWID <Bandwidth>

This command defines the bandwidth used for measuring the channel power (reference range). This setting takes only effect if channel power is selected as power reference type (see [SENSe:]ESpectrum:RTYPE on page 802).

Parameters:

<Bandwidth> minimum span ≤ value ≤ span of reference range
 *RST: 3.84 MHz

Example:

```
ESP:RTYP CPOW
Sets the power reference type to channel power.
ESP:BWID 1 MHZ
Sets the Tx bandwidth to 1 MHz.
```

Manual operation: See "Edit Reference Range" on page 193

[SENSe:]ESpectrum:FILTer[:RRC][:STATe] <State>

This command activates or deactivates the use of an RRC filter. This setting only takes effect if channel power is selected as power reference type (see [SENSe:]ESpectrum:RTYPE on page 802).

Parameters:

<State> ON | OFF
*RST: ON

Example:

```
ESP:RTYP CPOW
Sets the power reference type to channel power.
ESP:FILT OFF
Deactivates the use of an RRC filter.
```

Manual operation: See "Edit Reference Range" on page 193

[SENSe:]ESpectrum:FILTer[:RRC]:ALPHa <Value>

This command sets the alpha value of the RRC filter. This setting takes only effect if channel power is selected as power reference type ([SENSe:]ESpectrum:RTYPE command) and if the RRC filter is activated ([SENSe:]ESpectrum:FILTer[:RRC] [:STATe] command).

Parameters:

<Value> 0 to 1
*RST: 0.22

Example:

```
ESP:RTYP CPOW
Sets the power reference type to channel power.
ESP:FILT ON
Activates the use of an RRC filter.
ESP:FILT:ALPH 0.5
Sets the alpha value of the RRC filter to 0.5.
```

Manual operation: See "Edit Reference Range" on page 193

[SENSe:]ESpectrum:HighSPeed <State>

This command activates Fast SEM mode to accelerate spurious emission mask measurements. For details see "Fast Spectrum Emission Mask Measurements" on page 211.

Note that in Fast SEM mode, the following parameters cannot be changed in all ranges:

- Filter type, see [SENSe:]ESpectrum:RANGe<range>:FILTer:TYPE on page 795
- RBW, see [SENSe:]ESpectrum:RANGe<range>:BANDwidth[:RESolution] on page 794
- VBW, see [SENSe:]ESpectrum:RANGe<range>:BANDwidth:VIDeo on page 794

- Sweep Time Mode, see `[SENSe:]ESpectrum:RANGe<range>:SWEep:TIME:AUTO` on page 801
- Sweep Time, see `[SENSe:]ESpectrum:RANGe<range>:SWEep:TIME` on page 800
- Reference level, see `[SENSe:]ESpectrum:RANGe<range>:RLEVel` on page 800
- RF Att Mode, see `[SENSe:]ESpectrum:RANGe<range>:INPut:ATTenuation:AUTO` on page 797
- Rf Attenuation, see `[SENSe:]ESpectrum:RANGe<range>:INPut:ATTenuation` on page 797
- Preamp, see `[SENSe:]ESpectrum:RANGe<range>:INPut:GAIN:STATE` on page 797

Parameters:

<State> ON | OFF
 *RST: OFF

Example: ESP:HSP ON

Manual operation: See "[Fast SEM](#)" on page 189

[SENSe:]ESpectrum:PRESet[:STANdard]

This command selects the specified XML file under `C:\r_s\instr\sem_std`. If the file is stored in a subdirectory, include the relative path.

Example: ESP:PRES 'WCDMA\3GPP\DL\PowerClass_31_39.xml'
 Selects the `PowerClass_31_39.xml` XML file in the `C:\R_S\instr\sem_std\WCDMA\3GPP\DL` directory.
 ESP:PRES?
 W-CDMA 3GPP DL (31,39)dBm
 The query returns information about the selected standard, the link direction and the power class. If no standard has been selected, the query returns None.

Manual operation: See "[Load Standard](#)" on page 197

[SENSe:]ESpectrum:PRESet:RESTore

This command copies the XML files from the `C:\R_S\instr\sem_backup` folder to the `C:\R_S\instr\sem_std` folder. Files of the same name are overwritten.

Example: ESP:PRES:REST
 Restores the originally provided XML files.

Manual operation: See "[Restore Standard Files](#)" on page 197

[SENSe:]ESPectrum:PRESet:STORE <FileName>

This command stores the current settings as presets in the specified XML file under C:\r_s\instr\sem_backup.

Parameters:
<FileName>

Example: ESP:PRE:STOR
 'WCDMA\3GPP\DL\PowerClass_31_39.xml'
Stores the settings in the PowerClass_31_39.xml file in the C:\R_S\instr\sem_std\WCDMA\3GPP\DL directory.

Manual operation: See "Save As Standard" on page 197

[SENSe:]ESPectrum:RANGe<range>:BANDwidth[:RESolution] <Value>

This command sets the RBW value for the specified range.

Note that this parameter can not be set for all ranges if "Fast SEM" mode is activated (see [SENSe:]ESPectrum:HighSPeed on page 792).

Suffix:
<range> 1...20
 range

Parameters:
<Value> Refer to the data sheet.
*RST: 30.0 kHz

Example: ESP:RANG2:BAND:RES 5000
Sets the RBW for range 2 to 5 kHz.

Manual operation: See "RBW" on page 189

[SENSe:]ESPectrum:RANGe<range>:BANDwidth:VIDeo <Value>

This command sets the VBW value for the specified range.

Note that this parameter can not be set for all ranges if "Fast SEM" mode is activated (see [SENSe:]ESPectrum:HighSPeed on page 792).

Suffix:
<range> 1...20
 range

Parameters:
<Value> Refer to the data sheet.
*RST: 10.0 MHz

Example: ESP:RANG1:BAND:VID 5000000
Sets the VBW for range 1 to 5 MHz.

Manual operation: See "VBW" on page 190

[SENSe:]ESpectrum:RANGe<range>:COUNT

This command returns the number of defined ranges.

Suffix:

<range> 1...20
range

Example:

ESP:RANG:COUNT?
Returns the number of defined ranges.

[SENSe:]ESpectrum:RANGe<range>:DELEte

This command deletes the specified range. The range numbers are updated accordingly. The reference range cannot be deleted. A minimum of three ranges is mandatory.

Suffix:

<range> 1...20
range

Example:

ESP:RANG4:DEL
Deletes range 4.

Manual operation: See "[Delete Range](#)" on page 192

[SENSe:]ESpectrum:RANGe<range>:FILTer:TYPE <Type>

This command sets the filter type for the specified range.

Note that this parameter can not be set for all ranges if "Fast SEM" mode is activated (see [\[SENSe:\]ESpectrum:HighSPeed](#) on page 792).

Suffix:

<range> 1...20
range

Parameters:

<Type> **NORMal**
Gaussian filters
CFILter
channel filters
RRC
RRC filters
P5
5 Pole filters
*RST: NORM
The available bandwidths of the filters are specified in the data sheet.

Example:

ESP:RANG1:FILT:TYPE RRC
Sets the RRC filter type for range 1.

Manual operation: See ["Filter Type"](#) on page 189

[SENSe:]ESpectrum:RANGe<range>[:FREQUENCY]:START <Frequency>

This command sets the start frequency for the specified range.

In order to change the start/stop frequency of the first/last range, select the appropriate span. If you set a span that is smaller than the overall span of the ranges, the measurement includes only the ranges that lie within the defined span and have a minimum span of 20 Hz. The first and last range are adapted to the given span as long as the minimum span of 20 Hz is not violated.

Note the rules for the <Frequency> parameter specified in ["Ranges and Range Settings"](#) on page 199.

Suffix:

<range> 1...20
range

Parameters:

<Frequency> numeric value
*RST: -250.0 MHz (range 1), -2.52 MHz (range 2), 2.52 MHz (range 3)

Example:

ESP:RANG1:STAR 100000000
Sets the start frequency for range 1 to 100 MHz.

Manual operation: See ["Range Start / Range Stop"](#) on page 189

[SENSe:]ESpectrum:RANGe<range>[:FREQUENCY]:STOP <Frequency>

This command sets the stop frequency for the specified range. For further details refer to the [\[SENSe:\]ESpectrum:RANGe<range>\[:FREQUENCY\]:START](#) command.

Note the rules for the <Frequency> parameter specified in ["Ranges and Range Settings"](#) on page 199.

Suffix:

<range> 1...20
range

Parameters:

<Frequency> numeric value
*RST: -2.52 MHz (range 1), 2.52 MHz (range 2), 250.0 MHz (range 3)

Example:

ESP:RANG3:STOP 10000000
Sets the stop frequency for range 2 to 10 MHz.

Manual operation: See ["Range Start / Range Stop"](#) on page 189

[SENSe:]ESpectrum:RANGe<range>:INPut:ATTenuation <Value>

This command sets the attenuation for the specified range.

Note that this parameter can not be set for all ranges if "Fast SEM" mode is activated (see [SENSe:]ESpectrum:HighSpeed on page 792).

Suffix:

<range> 1...20
range

Parameters:

<Value> Refer to the data sheet.
*RST: 0 dB

Example:

ESP:RANG3:INP:ATT 10
Sets the attenuation of range 3 to 10 dB.

Manual operation: See "RF Attenuator" on page 190

[SENSe:]ESpectrum:RANGe<range>:INPut:ATTenuation:AUTO <State>

This command activates or deactivates the automatic RF attenuation setting for the specified range.

Note that this parameter can not be set for all ranges if "Fast SEM" mode is activated (see [SENSe:]ESpectrum:HighSpeed on page 792).

Suffix:

<range> 1...20
range

Parameters:

<State> ON | OFF
*RST: ON

Example:

ESP:RANG2:INP:ATT:AUTO OFF
Deactivates the RF attenuation auto mode for range 2.

Manual operation: See "RF Att. Mode" on page 190

[SENSe:]ESpectrum:RANGe<range>:INPut:GAIN:STATe <State>

This command switches the preamplifier on or off for the specified range.

Note that this parameter can not be set for all ranges if "Fast SEM" mode is activated (see [SENSe:]ESpectrum:HighSpeed on page 792).

Suffix:

<range> 1...20
range

Parameters:

<State> ON | OFF
*RST: OFF

Example: `ESP:RANG3:INP:GAIN:STATe ON`
Switches the preamplifier for range 3 on or off.

Manual operation: See ["Preamp"](#) on page 190

[SENSe:]ESpectrum:RANGe<range>:INSert <Mode>

This command inserts a new range before or after the specified range. The range numbers are updated accordingly.

Suffix:
<range> 1...20
 range

Parameters:
<Mode> AFTer | BEFore

Example: `ESP:RANG3:INS BEF`
Inserts a new range before range 3.
`ESP:RANG1:INS AFT`
Inserts a new range after range 1.

Manual operation: See ["Insert before Range"](#) on page 192
See ["Insert after Range"](#) on page 192

[SENSe:]ESpectrum:RANGe<range>:LIMit<source>:ABSolute:STARt <Level>

This command sets an absolute limit value at the start frequency of the specified range. Different from manual operation, this setting is independently of the defined limit check type.

Suffix:
<range> 1...20
 range

Parameters:
<Level> -400 to in 400 dBm
 *RST: 13 dBm

Example: `ESP:RANG1:LIM:ABS:STAR 10`
Sets an absolute limit of 10 dBm at the start frequency of the range.

Manual operation: See ["Abs Limit Start"](#) on page 191

[SENSe:]ESpectrum:RANGe<range>:LIMit<source>:ABSolute:STOP <Level>

This command sets an absolute limit value at the stop frequency of the specified range. Different from manual operation, this setting is independent of the defined limit check type.

| | |
|--------------------------|---|
| Suffix: | |
| <range> | 1...20
range |
| Parameters: | |
| <Level> | -400 to in 400 dBm
*RST: 13 dBm |
| Example: | ESP:RANG1:LIM:ABS:STOP 20
Sets an absolute limit of 20 dBm at the stop frequency of the range. |
| Manual operation: | See " Abs Limit Stop " on page 191 |

[SENSe:]ESpectrum:RANGe<range>:LIMit<source>:RELative:STARt <Limit>

This command sets a relative limit value at the start frequency of the specified range. Different from manual operation, this setting is independent of the defined limit check type.

| | |
|--------------------------|---|
| Suffix: | |
| <range> | 1...20
range |
| Parameters: | |
| <Limit> | -400 to in 400 dBc
*RST: -50 dBc |
| Example: | ESP:RANG3:LIM:REL:STAR -20
Sets a relative limit of -20 dBc at the start frequency of the range. |
| Manual operation: | See " Rel Limit Start " on page 191 |

[SENSe:]ESpectrum:RANGe<range>:LIMit<source>:RELative:STOP <Limit>

This command sets a relative limit value at the stop frequency of the specified range. Different from manual operation, this setting is independently of the defined limit check type.

| | |
|--------------------------|--|
| Suffix: | |
| <range> | 1...20
range |
| Parameters: | |
| <Limit> | -400 to in 400 dBc
*RST: -50 dBc |
| Example: | ESP:RANG3:LIM:REL:STOP 20
Sets a relative limit of 20 dBc at the stop frequency of the range. |
| Manual operation: | See " Rel Limit Stop " on page 191 |

[SENSe:]ESpectrum:RANGe<range>:LIMit<source>:STATe <State>

This command sets the type of limit check for all ranges.

Suffix:

<range> irrelevant

Parameters:

<State> ABSolute | RELative | AND | OR

ABSolute

Checks only the absolute limits defined.

RELative

Checks only the relative limits. Relative limits are defined as relative to the measured power in the reference range.

AND

Combines the absolute and relative limit. The limit check fails when both limits are violated.

OR

Combines the absolute and relative limit. The limit check fails when one of the limits is violated.

*RST: REL

Example:

ESP:RANG3:LIM:STAT AND

Sets for all ranges the combined absolute/relative limit check.

Manual operation: See "[Limit Check 1-4](#)" on page 191

[SENSe:]ESpectrum:RANGe<range>:RLEVel <Value>

This command sets the reference level for the specified range.

Note that this parameter can not be set for all ranges if "Fast SEM" mode is activated (see [\[SENSe:\]ESpectrum:HighSpeed](#) on page 792).

Suffix:

<range> 1...20
range

Parameters:

<Value> Refer to the data sheet.

*RST: -20 dBm

Example:

ESP:RANG2:RLEV 0

Sets the reference level of range 2 to 0 dBm.

Manual operation: See "[Ref. Level](#)" on page 190

[SENSe:]ESpectrum:RANGe<range>:SWEep:TIME <SweepTime>

This command sets the sweep time for the specified range.

Note that this parameter can not be set for all ranges if "Fast SEM" mode is activated (see [\[SENSe:\]ESpectrum:HighSPeEd](#) on page 792).

Suffix:

<range> 1...20
range

Parameters:

<SweepTime> Allowed values depend on the ratio of span to RBW and RBW to VBW. For details refer to the data sheet.

*RST: 0.27 s

Example:

ESP:RANG1:SWE:TIME 1

Sets the sweep time for range 1 to 1 s.

Manual operation: See "[Sweep Time](#)" on page 190

[SENSe:]ESpectrum:RANGe<range>:SWEep:TIME:AUTO <State>

This command activates or deactivates the automatic sweep time setting for the specified range.

Note that this parameter can not be set for all ranges if "Fast SEM" mode is activated (see [\[SENSe:\]ESpectrum:HighSPeEd](#) on page 792).

Suffix:

<range> 1...20
range

Parameters:

<State> ON | OFF

*RST: ON

Example:

ESP:RANG3:SWE:TIME:AUTO OFF

Deactivates the sweep time auto mode for range 3.

Manual operation: See "[Sweep Time Mode](#)" on page 190

[SENSe:]ESpectrum:RANGe<range>:TRANsducer <TransducerName>

This command sets a transducer for the specified range. You can only choose a transducer that fulfills the following conditions:

- The transducer overlaps or equals the span of the range.
- The x-axis is linear.
- The unit is dB.

Suffix:

<range> 1...20
range

Parameters:

<TransducerName> 'string' = name of the transducer

Example: `ESP:RANG1:TRAN 'test'`
Sets the transducer called test for range 1.

Manual operation: See "[Transd. Factor](#)" on page 190

[SENSe:]ESpectrum:RRANge

This command returns the current position (number) of the reference range.

Example: `ESP:RRAN?`
Returns the current position (number) of the reference range.

[SENSe:]ESpectrum:RTYPE <Type>

This command sets the power reference type.

Parameters:

<Type> PEAK | CPOWer

PEAK

Measures the highest peak within the reference range.

CPOWer

Measures the channel power within the reference range (integral bandwidth method).

*RST: CPOWer

Example: `ESP:RTYP PEAK`
Sets the peak power reference type.

Manual operation: See "[Edit Reference Range](#)" on page 193

SENSe:FILTer Subsystem (Analog Demodulation, analog demodulation)

The SENSe:FILTer subsystem selects the filters to reduce the bandwidth of the demodulated signal. The selected filters are used for AM, FM and PM demodulation in common.



Using the commands in the SENSe:FILTer subsystem you can define filter settings for each window individually. Note, however, that if the same modulation type is used in several windows, the settings defined for that modulation are used in all the corresponding windows.

Commands of the SENSe:FILTer subsystem

| | |
|--|-----|
| [SENSe:]FILTer<n>:AOFF..... | 803 |
| [SENSe:]FILTer<n>:AWEighted[:STATe]..... | 803 |
| [SENSe:]FILTer<n>:CCIT..... | 803 |
| [SENSe:]FILTer<n>:CCIR[:UNWeighted][:STATe]..... | 804 |
| [SENSe:]FILTer<n>:CCIR:WEIGhted[:STATe]..... | 804 |
| [SENSe:]FILTer<n>:DEMPHasis[:STATe]..... | 805 |
| [SENSe:]FILTer<n>:DEMPHasis:TCONstant..... | 805 |

| | |
|---|-----|
| [SENSe:]FILTer<n>:HPASs[:STATe]..... | 805 |
| [SENSe:]FILTer<n>:HPASs:FREQuency..... | 806 |
| [SENSe:]FILTer<n>:LPASs[:STATe]..... | 806 |
| [SENSe:]FILTer<n>:LPASs:FREQuency[:ABSolute]..... | 807 |
| [SENSe:]FILTer<n>:LPASs:FREQuency:RELative..... | 807 |

[SENSe:]FILTer<n>:AOFF

This command switches all AF filters in the specified window off.

Suffix:

<n> 1...4
 window

Example: SENS:FILT:AOff

Usage: Event

Mode: ADEMOD, SFM

Manual operation: See "[All AF Filter Off](#)" on page 341

[SENSe:]FILTer<n>:AWEighted[:STATe] <State>

This command activates/deactivates the "A" weighting filter in the specified window.

For details on the A weighted filter see "[A Weighted](#)" on page 340.

Suffix:

<n> 1...4
 window

Parameters:

<State> ON | OFF
 *RST: OFF

Example: FILT:AWE ON
 Activates the A weighting filter.

Mode: ADEMOD

Manual operation: See "[A Weighted](#)" on page 340

[SENSe:]FILTer<n>:CCIT <State>

This command activates/deactivates the CCITT (CCITT P.53) weighting filter in the specified window.

For details on the CCITT filter see "[CCITT](#)" on page 339.

Suffix:

<n> 1...4
 window

Parameters:

<State> ON | OFF
 *RST: OFF

Example:

FILT:CCIT ON
 Activates the CCITT weighting filter.

Mode: ADEMOD

Manual operation: See "[CCITT](#)" on page 339

[SENSe:]FILTeR<n>:CCIR[:UNWeighted][:STATe] <State>

This command activates/deactivates the unweighted CCIR filter in the specified window.

For details on the unweighted CCIR filter see "[CCIR Unweighted](#)" on page 340.

Suffix:

<n> 1...4
 window

Parameters:

<State> ON | OFF
 *RST: OFF

Example:

FILT:CCIR:UNW ON
 Activates the unweighted CCIR filter.

Mode: ADEMOD

Manual operation: See "[CCIR Unweighted](#)" on page 340

[SENSe:]FILTeR<n>:CCIR:WEIGhted[:STATe] <State>

This command activates/deactivates the weighted CCIR filter in the specified window.

For details on the weighted CCIR filter see "[CCIR Weighted](#)" on page 340.

Suffix:

<n> 1...4
 window

Parameters:

<State> ON | OFF
 *RST: OFF

Example:

FILT:CCIR:WEIG ON
 Activates the weighted CCIR filter.

Mode: ADEMOD

Manual operation: See "[CCIR Weighted](#)" on page 340

[SENSe:]FILTer<n>:DEMPHasis[:STATe] <State>

This command activates/deactivates the selected deemphasis in the specified window.

For details about deemphasis refer to "Deemphasis" on page 340.

Suffix:

<n> 1...4
window

Parameters:

<State> ON | OFF
*RST: OFF

Example:

FILT:DEMP ON
Activates the selected deemphasis.

Mode: ADEMODO

Manual operation: See "Deemphasis" on page 340

[SENSe:]FILTer<n>:DEMPHasis:TCONstant

This command selects the deemphasis in the specified window.

For details on deemphasis refer to "Deemphasis" on page 340.

For details on the demodulation bandwidth range refer to "Demod BW" on page 338.

Suffix:

<n> 1...4
window

Parameters:

25 us | 50 us | 75 us | 750 us
*RST: 50 us

Example:

FILT:DEMP:TCON 750us
Selects the deemphasis for the demodulation bandwidth range from 800 Hz to 4 MHz with a time constant of 750 μ s.

Mode: ADEMODO

Manual operation: See "Deemphasis" on page 340

[SENSe:]FILTer<n>:HPASs[:STATe] <State>

This command activates/deactivates the selected high pass filter in the specified window.

For details on the high pass filter refer to "High Pass" on page 338.

Suffix:

<n> 1...4
window

Parameters:

<State> ON | OFF
 *RST: OFF

Example:

FILT:HPAS ON
 Activates the selected high pass filter.

Mode:

ADEMODO

Manual operation:

See "High Pass" on page 338
 See "None" on page 339

[SENSE:]FILTEr<n>:HPASs:FREQuency <FilterType>

This command selects the high pass filter type in the specified window. For details on filters refer to "High Pass" on page 338.

For details about the demodulation bandwidth range refer to "Demod BW" on page 338.

Suffix:

<n> 1...4
 window

Parameters:

<FilterType> Range: 50 to 300
 *RST: 300Hz
 Default unit: Hz

Example:

FILT:HPAS:FREQ 300Hz
 Selects the high pass filter for the demodulation bandwidth range from 800 Hz to 16 MHz.

Mode:

ADEMODO

Manual operation:

See "High Pass" on page 338

[SENSE:]FILTEr<n>:LPASs[:STATe] <State>

This command activates/deactivates the selected low pass filter in the specified window.

For details on the low pass filter refer to "Low Pass" on page 339.

Suffix:

<n> 1...4
 window

Parameters:

<State> ON | OFF
 *RST: OFF

Example:

FILT:LPAS ON
 Activates the selected low pass filter.

Mode: ADEMODO

Manual operation: See "Low Pass" on page 339

[SENSe:]FILTer<n>:LPASs:FREQuency[:ABSolute] <FilterType>

This command selects the absolute low pass filter type in the specified window. For details on filters refer to "Low Pass" on page 339.

For details about the demodulation bandwidth range refer to "Demod BW" on page 338.

Suffix:

<n> 1...4
window

Parameters:

<FilterType> 3kHz | 15kHz | 150kHz
*RST: 15kHz

Example:

FILT:LPAS:FREQ 150kHz
Selects the low pass filter for the demodulation bandwidth range from 400 kHz to 16 MHz.

Mode: ADEMODO

Manual operation: See "Low Pass" on page 339

[SENSe:]FILTer<n>:LPASs:FREQuency:RELative <FilterType>

This command selects the relative low pass filter type in the specified window. For details on filters refer to Low Pass softkey.

For details about the demodulation bandwidth range refer to "Demod BW" on page 338.

Suffix:

<n> 1...4
window

Parameters:

<FilterType> 5PCT | 10PCT | 25PCT
*RST: 25PCT

Example:

FILT:LPAS:FREQ 25PCT
Selects the low pass filter as 25 % of the demodulation bandwidth.

Mode: ADEMODO

Manual operation: See "Low Pass" on page 339

SENSe:FREQuency Subsystem

The SENSe:FREQuency subsystem defines the frequency axis of the active display. The frequency axis can either be defined via the start/stop frequency or via the center frequency and span.

| | |
|--|-----|
| [SENSe:]FREQuency:CENTer..... | 808 |
| [SENSe:]FREQuency:CENTer:STEP..... | 808 |
| [SENSe:]FREQuency:CENTer:STEP:AUTO..... | 808 |
| [SENSe:]FREQuency:CENTer:STEP:LINK..... | 809 |
| [SENSe:]FREQuency:CENTer:STEP:LINK:FACTOR..... | 809 |
| [SENSe:]FREQuency:MODE..... | 810 |
| [SENSe:]FREQuency:OFFSet..... | 811 |
| [SENSe:]FREQuency:SPAN..... | 811 |
| [SENSe:]FREQuency:SPAN:FULL..... | 811 |
| [SENSe:]FREQuency:START..... | 811 |
| [SENSe:]FREQuency:STOP..... | 811 |

[SENSe:]FREQuency:CENTer <Frequency>

This command defines the center frequency (frequency domain) or measuring frequency (time domain).

Parameters:

<Frequency> Range: 0 to f_{max}
 *RST: f_{max}/2
 Default unit: Hz
 f_{max} is specified in the data sheet. min span is 10 Hz
 (SEM and Spurious: min span = 20 Hz)

Example: `FREQ:CENT 100 MHz`

Manual operation: See "[Center](#)" on page 60

[SENSe:]FREQuency:CENTer:STEP <StepSize>

This command defines the center frequency step size.

Parameters:

<StepSize> Range: 1 to f_{max}
 *RST: 0.1 x
 Default unit: Hz

Example: `FREQ:CENT:STEP 120 MHz`

Manual operation: See "[Manual](#)" on page 62

[SENSe:]FREQuency:CENTer:STEP:AUTO <State>

This command couples the step size of the center frequency to the span (ON) or sets the value of the center frequency entered via `[SENSe:]FREQuency:CENTer` (OFF).

Parameters:

<State> ON | OFF
 *RST: ON

Example:

FREQ:CENT:STEP:AUTO ON
 Activates the coupling of the step size to the span.

[SENSe:]FREQuency:CENTer:STEP:LINK <CouplingType>

This command couples and decouples the center frequency step size to the span or the resolution bandwidth.

Parameters:

<CouplingType> **SPAN**
 Couples the step size to the span. Available for measurements in the frequency domain.
 (for RF spectrum result display)

RBW
 Couples the step size to the resolution bandwidth. Available for measurements in the time domain.
 (for all result displays except RF spectrum)

OFF
 Decouples the step size (manual input).
 *RST: SPAN

Example:

FREQ:CENT:STEP:LINK SPAN

Manual operation:

See "[0.1*Span \(span > 0\)](#)" on page 61
 See "[0.1*RBW \(span > 0\)](#)" on page 61
 See "[0.5*Span \(span > 0\)](#)" on page 61
 See "[0.5*RBW \(span > 0\)](#)" on page 61
 See "[x*Span \(span > 0\)](#)" on page 61
 See "[x*RBW \(span > 0\)](#)" on page 62
 See "[0.1*Span \(RF Spectrum\)](#)" on page 348
 See "[0.1*Demod BW \(AF/RF Time Domain, AF Spectrum\)](#)" on page 348
 See "[0.5*Span \(RF Spectrum\)](#)" on page 348
 See "[0.5*Demod BW \(AF/RF Time Domain, AF Spectrum\)](#)" on page 348
 See "[x*Span \(RF Spectrum\)](#)" on page 348
 See "[x*Demod BW \(AF/RF Time Domain, AF Spectrum\)](#)" on page 349

[SENSe:]FREQuency:CENTer:STEP:LINK:FACTOR <Factor>

This command defines a step size factor if the center frequency step size is coupled to the span or the resolution bandwidth.

Parameters:

<Factor> Range: 1 to 100
 *RST: 10
 Default unit: PCT

Example:

FREQ:CENT:STEP:LINK:FACT 20PCT

Manual operation:

See "0.1*Span (span > 0)" on page 61
 See "0.1*RBW (span > 0)" on page 61
 See "0.5*Span (span > 0)" on page 61
 See "0.5*RBW (span > 0)" on page 61
 See "0.1*Span (RF Spectrum)" on page 348
 See "0.1*Demod BW (AF/RF Time Domain, AF Spectrum)"
 on page 348
 See "0.5*Span (RF Spectrum)" on page 348
 See "0.5*Demod BW (AF/RF Time Domain, AF Spectrum)"
 on page 348
 See "x*Span (RF Spectrum)" on page 348
 See "x*Demod BW (AF/RF Time Domain, AF Spectrum)"
 on page 349

[SENSe:]FREQuency:MODE <Mode>

This command selects the frequency mode.

between span > 0 and zero span in the "Spectrum" mode.

Parameters:

<Mode>

CW

Selects the time domain (span = 0).

In the time domain, define the measurement frequency with
[\[SENSe:\]FREQuency:CENTer](#).

FIXed

Selects the time domain (span = 0).

In the time domain, define the measurement frequency with
[\[SENSe:\]FREQuency:CENTer](#).

SWEep

Selects the frequency domain (span > 0).

In the frequency domain, define the frequency characteristics
 with the following commands:

- [\[SENSe:\]FREQuency:START](#)
- [\[SENSe:\]FREQuency:STOP](#)
- [\[SENSe:\]FREQuency:SPAN](#)
- [\[SENSe:\]FREQuency:CENTer](#)

*RST: SWEep

Example:

FREQ:MODE SWE

Selects the frequency domain.

Usage:

SCPI confirmed

[SENSe:]FREQUENCY:OFFSet <Offset>

This command defines the frequency offset.

Parameters:

<Offset> Range: -100 GHz to 100 GHz
 *RST: 0 Hz
 Default unit: Hz

Example: `FREQ:OFFS 1GHZ`

Manual operation: See "[Frequency Offset](#)" on page 62

**[SENSe:]FREQUENCY:SPAN **

This command defines the frequency span.

Parameters:

 In analyzer mode, the span range is 10 Hz to f_{max} . For SEM and Spurious Emission measurements, the minimum span 20 Hz.
 *RST: fmax

Example: `FREQ:SPAN 10MHz`

Manual operation: See "[Span Manual](#)" on page 66
 See "[Zero Span](#)" on page 66

[SENSe:]FREQUENCY:SPAN:FULL

This command sets the frequency span to its maximum.

Example: `FREQ:SPAN:FULL`

Manual operation: See "[Full Span](#)" on page 66

[SENSe:]FREQUENCY:START <Frequency>

This command defines the start frequency for measurements in the frequency domain.

Parameters:

<Frequency> 0 to (fmax - min span)
 In analyzer mode, the span range is 10 Hz to f_{max} . For SEM and Spurious Emission measurements, the minimum span 20 Hz.
 *RST: 0

Example: `FREQ:STAR 20MHz`

Manual operation: See "[Start](#)" on page 62

[SENSe:]FREQUENCY:STOP <Frequency>

This command defines the stop frequency for measurements in the frequency domain.

Parameters:

<Frequency> min span to fmax
 In analyzer mode, the span range is 10 Hz to f_{max} . For SEM and Spurious Emission measurements, the minimum span 20 Hz.
 *RST: fmax

Example: `FREQ:STOP 2000 MHz`

Manual operation: See "[Stop](#)" on page 62

SENSe:LIST Subsystem

The commands of this subsystem are used for measuring the power at a list of frequency points with different device settings. The measurement is always performed in zero span. A new trigger event is required for each test point (exception: trigger "FREE RUN").

The results are output as a list in the order of the entered frequency points. The number of results per test point depends on the number of concurrently active measurements (peak/RMS/average). The number of frequencies is limited to 200 entries.

Selection of concurrently active measurements and setting of parameters that are constant for the whole measurement is performed via a configuration command ([\[SENSe:JLIST:POWer:SET\]](#)). This also includes the setting for trigger and gate parameters.



Settings that are not directly included in commands of this subsystem can be configured by sending the corresponding commands prior to the [SENSe:LIST Subsystem](#) commands.

Please note that changes to the trigger level have to be executed in zero span in order to take effect for the [SENSe:LIST Subsystem](#) commands.

The sweep list cannot be configured using remote commands during an on-going sweep operation.

The following subsystem is included:

["SENSe:LIST:RANGe Subsystem"](#) on page 818

Further information

- ["SENSe:LIST Subsystem"](#) on page 812

More details on the SENSe:LIST Subsystem

The following setting parameters can be selected independently for each frequency point:

- analyzer frequency
- reference level
- resolution filter
- resolution bandwidth
- video bandwidth

- measurement time
- detector

The commands of this subsystem can be used in two different ways:

- Instrument setup, measurement and querying of the results in a single command line. With this method, there is the least delay between the measurement and the result output. However, it requires the control computer to wait for the response from the instrument.
- Instrument setup and querying of the result list at the end of the measurement: With this method, the control computer may be used for other activities while the measurement is being performed. However, more time is needed for synchronization via service request.

| | |
|------------------------------------|-----|
| [SENSe:]LIST:POWer:RESult?..... | 813 |
| [SENSe:]LIST:POWer[:SEQuence]..... | 814 |
| [SENSe:]LIST:POWer:SET..... | 817 |
| [SENSe:]LIST:POWer:STATe..... | 818 |

[SENSe:]LIST:POWer:RESult?

This command queries the results of the list evaluation.

This command may be used to obtain measurement results in an asynchronous way, using the service request mechanism for synchronization to the end of the measurement.

If there are no results, the command returns an error.

Return values:

<PowerLevel> Power level for each frequency included in the measurement. The command returns up to 3 power levels for each frequency, depending on the number of evaluation modes you have turned on with [SENSe:]LIST:POWer:SET on page 817. The result is a list of floating point values separated by commas. The unit depends on [SENSe:]LIST:POWer[:SEQuence].

Example: *ESE 1
 *SRE 32
 Configuration of the status reporting system for the generation of
 an SRQ on operation complete
 SENSE:LIST:POWer
 935.2 MHz, -20dBm, 10dB, OFF, NORM, 1 MHz, 3 MHz,
 434us, 0,
 935.4 MHz, -20dBm, 10dB, 10dB, NORM, 30 kHz, 100 kHz,
 434us, 0,
 935.6 MHz, -20dBm, 10dB, 20dB, NORM, 30 kHz, 100 kHz,
 434us, 0;
 *OPC
 Configuring and starting the measurement
 ...
 Further actions of the control computer during measurement
 On SRQ:
 SENSE:LIST:POWer:RESult?
 Response to service request

Usage: Query only

[SENSe:]LIST:POWer[:SEquence]

<Frequency>, <RefLevel>, <RfAtt>, <EIAtt>, <FilterType>, <RBW>, <VBW>, <Meas
 Time>, <TriggerLevel>

This command configures and initiates the List Evaluation measurement.

The list can contain up to 200 entries (frequencies). You can define a different instrument setup for each frequency that is in the list.

If you synchronize the measurement with *OPC, the R&S FSVR produces a service request when all frequencies have been measured and the number of individual measurements has been performed.

To reduce the setting time, all indicated parameters are set up simultaneously at each test point.

The measurement is performed in zero span and therefore the span is set to 0 Hz. If the span > 0 is set, the function is automatically switched off.

The measurement is not compatible with other measurements, especially as far as marker, adjacent channel power measurement or statistics are concerned. The corresponding commands thus automatically deactivate the function.

The function is only available in REMOTE operation. It is deactivated when switching the instrument back to LOCAL.

Note that using the command as a query initiates the measurement and returns the results if all frequencies have been measured. For more information on querying the results see [SENSe:]LIST:POWer:RESult? on page 813 .

The following parameters are the settings for an individual frequency point. They are repeated for each frequency point.

Setting parameters:

- <Frequency> Defines the receive frequency. Each frequency corresponds to one list entry.
Range: 0 Hz to fmax
- <RefLevel> Defines the reference level for a list entry.
Range: -130 dBm to 30 dBm
Increment: 0.01 dBm
- <RfAtt> Defines the RF attenuation for a list entry.
Range: 0 dB to 70 dB (75 dB with option R&S FSV-B25)
Increment: 5 dB (1 dB with option R&S FSV-B25)
- <EIAtt> Defines the electronic attenuation for a list entry.
Requires option R&S FSV-B25;
OFF
Turns electronic attenuation off.
<AttenuationLevel>
Numeric value that defines the attenuation level.
Range: 0 dB to 30 dB
Increment: 1 dB
- <FilterType> Selects the filter type for a list entry. For more information see [\[SENSe:\]BANDwidth|BWIDth\[:RESolution\]:TYPE](#) on page 783.
- <RBW> Defines the resolution bandwidth for a list entry.
For the range of values refer to "Res BW Manual" on page 80.
Refer to [chapter 4.1.6.3, "Selecting the Appropriate Filter Type"](#), on page 85 for possible combinations of filter type and filter bandwidth for the <filter type> = CFILter and <filter type> = RRC.
- <VBW> Defines the video bandwidth for a list entry.
The value is ignored for <filter type> = "CFILter" or "RRC"
Range: 1 Hz to 10 MHz in 1, 3, 10 steps
- <MeasTime> Defines the measurement time for a list entry.
For details refer to "[SweepTime Manual](#)" on page 81.
Range: 1 µs to 16000 s
- <TriggerLevel> The trigger level must be 0.
- Return values:**
- <PowerLevel> Power level for each frequency included in the measurement.
The command returns up to 3 power levels for each frequency, depending on the number of evaluation modes you have turned on with [\[SENSe:\]LIST:POWer:SET](#) on page 817.
The result is a list of floating point values separated by commas.
The unit depends on [CALCulate<n>:UNIT:POWer](#).

- Example:** `SENSE:LIST:POWer?`
`935.2 MHz,0 dBm,10 dB,OFF,NORM,1 MHz,3 MHz,`
`440us,0,`
`935.4 MHz,0dBm,10dB,10dB,NORM,30 kHz,100 kHz,`
`440us,0,`
`935.6 MHz,0dBm,10dB,20dB,NORM,30 kHz,100 kHz,`
`440us,0`
Result list:
-28.3,-30.6,-38.1
- Example:** `SENSE:LIST:POWer:SET ON,ON,ON,IMM,POS,0,0`
Activates the power measurement of the peak, RMS and average values.
`SENSE:LIST:POWer?`
`935.2 MHz,0dBm,10dB,OFF,NORM,1 MHz,3 MHz,440us,`
`0,`
`935.4 MHz,0dBm,10dB,10dB,NORM,30 kHz,100 kHz,`
`440us,0,`
`935.6 MHz,0dBm,10dB,20dB,NORM,30 kHz,100 kHz,`
`440us,0`
Result list (3 results per frequency point):
-28.3, -29.6, 1.5, -30.6, -31.9, 0.9, -38.1, -40.0, 2.3
- Example:** `SENSE:LIST:POWer`
`935.2 MHz,0dBm,10dB,OFF,NORM,1 MHz,3 MHz,440us,`
`0,`
`935.4 MHz,0dBm,10dB,10dB,CFIL,30 kHz,100 kHz,`
`440us,0,`
`935.6 MHz,0dBm,10dB,20dB,CFIL,30 kHz,100 kHz,`
`440us,0`
Performs a measurement sequence with the settings described in [table 8-18](#).
`SENSE:LIST:POWer?`
`935.2 MHz,0dBm,10dB,OFF,NORM,1 MHz,3 MHz,440us,`
`0,`
`935.4 MHz,0dBm,10dB,10dB,CFIL,30 kHz,100 kHz,`
`440us,0,`
`935.6 MHz,0dBm,10dB,20dB,CFIL,30 kHz,100 kHz,`
`440us,0`
Performs the same measurement and returns the result list immediately after the last frequency point.

Table 8-18: Settings for power list example

| Step | Freq. [MHz] | Ref Level [dBm] | RF Att [dB] | eI Att [dB] | Filter type | RBW | VBW | Meas Time [us] | TRG Level (reserved) |
|------|-------------|-----------------|-------------|-------------|-------------|--------|---------|----------------|----------------------|
| 1 | 935.2 | 0 | 10 | OFF | Normal | 1 MHz | 3 MHz | 440 | 0 |
| 2 | 935.4 | 0 | 10 | 10 | Channel | 30 kHz | 100 kHz | 440 | 0 |
| 3 | 935.6 | 0 | 10 | 20 | Channel | 30 kHz | 100 kHz | 440 | 0 |

[SENSe:]LIST:POWer:SET

<PeakPower>, <RMSPower>, <AVGPower>, <TriggerSource>, <TriggerSlope>, <TriggerOffset>, <GateLength>

This command defines global List Evaluation parameters.

These parameters are valid for every frequency you want to measure.

The state of the first three parameters (<PeakPower>, <RMSPower> and <AVGPower>) define the number of results for each frequency in the list.

Note that you have to set the trigger level *after* sending this command.

Parameters:

| | |
|-----------------|---|
| <PeakPower> | ON OFF
Turns peak power evaluation on and off.
*RST: ON |
| <RMSPower> | ON OFF
Turns RMS power evaluation on and off.
*RST: OFF |
| <AVGPower> | ON OFF
Turns average power evaluation on and off.
*RST: OFF |
| <TriggerSource> | IMMEDIATE EXTERNAL VIDEO IFPOWER RFPower
Selects a trigger source.
For more information see " Trg/Gate Source " on page 109.
*RST: IMM |
| <TriggerSlope> | NEGATIVE POSITIVE
Selects the trigger slope.
*RST: POS |
| <TriggerOffset> | Defines the trigger delay. The trigger delay is the time between the detection of the trigger signal and the start of the measurement at the next frequency point.
Range: span = 0 Hz: (-sweep time) to 30 s; span > 10 Hz: 31.25 ns to 30 s
*RST: 0 s |
| <GateLength> | Defines the gate length for gated measurements.
Setting 0 seconds turns gated measurements off. Other values activate the gated trigger function.
To perform gated measurements, the trigger source must be different from IMMEDIATE.
Range: 31.25 ns to 30 s
*RST: 0 s |

Example:

```
SENSe:LIST:POWer:SET ON,OFF,OFF,EXT,POS,10US,434US
```

[SENSe:]LIST:POWer:STATe <State>

This command turns the List Evaluation off.

Parameters:

<State> OFF

Example: SENS:LIST:POW:STAT OFF

SENSe:LIST:RANGe Subsystem

The `SENSe:LIST:RANGe` Subsystem contains the remote commands to configure Spurious Emissions measurements.

| | |
|---|-----|
| [SENSe:]LIST:RANGe<range>:BANDwidth[:RESolution]..... | 818 |
| [SENSe:]LIST:RANGe<range>:BANDwidth:VIDeo..... | 819 |
| [SENSe:]LIST:RANGe<range>:BREak..... | 819 |
| [SENSe:]LIST:RANGe<range>:COUNT..... | 819 |
| [SENSe:]LIST:RANGe<range>:DELeTe..... | 820 |
| [SENSe:]LIST:RANGe<range>:DETEctor..... | 820 |
| [SENSe:]LIST:RANGe<range>[:FREQuency]:START..... | 820 |
| [SENSe:]LIST:RANGe<range>[:FREQuency]:STOP..... | 821 |
| [SENSe:]LIST:RANGe<range>:FILTer:TYPE..... | 821 |
| [SENSe:]LIST:RANGe<range>:INPut:ATTenuation..... | 822 |
| [SENSe:]LIST:RANGe<range>:INPut:ATTenuation:AUTO..... | 822 |
| [SENSe:]LIST:RANGe<range>:INPut:GAIN:STATe..... | 823 |
| [SENSe:]LIST:RANGe<range>:LIMit:START..... | 823 |
| [SENSe:]LIST:RANGe<range>:LIMit:STATe..... | 823 |
| [SENSe:]LIST:RANGe<range>:LIMit:STOP..... | 824 |
| [SENSe:]LIST:RANGe<range>:POINts..... | 824 |
| [SENSe:]LIST:RANGe<range>:RLEVel..... | 824 |
| [SENSe:]LIST:RANGe<range>:SWEep:TIME..... | 825 |
| [SENSe:]LIST:RANGe<range>:SWEep:TIME:AUTO..... | 825 |
| [SENSe:]LIST:RANGe<range>:TRANsducer..... | 825 |

[SENSe:]LIST:RANGe<range>:BANDwidth[:RESolution] <Value>

This command sets the RBW value for the specified range.

Suffix:

<range> 1...20
range

Parameters:

<Value> Refer to the data sheet.
*RST: 30.0 kHz

Example: LIST:RANG2:BAND:RES 5000
Sets the RBW for range 2 to 5 kHz.

Manual operation: See "RBW" on page 220

[SENSe:]LIST:RANGe<range>:BANDwidth:VIDeo

This command sets the VBW value for the specified range.

Suffix:

<range> 1...20
 range

Parameters:

<Value> Refer to the data sheet.
*RST: 10.0 MHz

Example: LIST:RANG1:BAND:VID 5000000
 Sets the VBW for range 1 to 5 MHz.

Manual operation: See "[VBW](#)" on page 220

[SENSe:]LIST:RANGe<range>:BREak <State>

This command configures the sweep behavior.

The suffixes are irrelevant.

Suffix:

<range> 1...20
 range

Parameters:

<State> **ON**
 The R&S FSVR stops after one range is swept and continues only if you confirm (a message box is displayed).

OFF

The R&S FSVR sweeps all ranges in one go.

*RST: OFF

Example: LIST:RANG:BRE ON
 Configures a stop after each range.

Manual operation: See "[Stop After Sweep](#)" on page 221

[SENSe:]LIST:RANGe<range>:COUNT

This command returns the number of defined ranges.

Suffix:

<range> 1...20
 range

Example: LIST:RANG:COUNT?
 Returns the number of defined ranges.

[SENSe:]LIST:RANGe<range>:DELeTe

This command deletes the specified range. The range numbers are updated accordingly. The reference range cannot be deleted. A minimum of three ranges is mandatory.

Suffix:

<range> 1...20
range

Example:

LIST:RANG4:DEL
Deletes range 4.

Manual operation: See "[Delete Range](#)" on page 222

[SENSe:]LIST:RANGe<range>:DETector <Detector>

This command sets the detector for the specified range. For details refer to "[Detector](#)" on page 220.

Suffix:

<range> 1...20
range

Parameters:

<Detector> NEGative | POSitive | SAMPlE | RMS | AVERage
NEGative
minimum peak detector
POSitive
peak detector
SAMPlE
sample detector
RMS
RMS detector
AVERage
average detector
*RST: RMS

Example:

LIST:RANGe3:DET SAMP
Sets the sample detector for range 3.

Manual operation: See "[Detector](#)" on page 220

[SENSe:]LIST:RANGe<range>[:FREQuency]:STARt <Frequency>

This command sets the start frequency for the specified range.

In order to change the start/stop frequency of the first/last range, select the appropriate span. If you set a span that is smaller than the overall span of the ranges, the measurement includes only the ranges that lie within the defined span and have a minimum span of 20 Hz. The first and last range are adapted to the given span as long as the minimum span of 20 Hz is not violated.

Suffix:

<range> 1...20
range

Parameters:

<Frequency> see rules in chapter 4, "Ranges and settings"
*RST: -250.0 MHz (range 1), -2.52 MHz (range 2), 2.52
MHz (range 3)

Example:

LIST:RANG1:STAR 100000000
Sets the start frequency for range 1 to 100 MHz.

Manual operation: See "[Range Start / Range Stop](#)" on page 219

[SENSe:]LIST:RANGe<range>[:FREQUENCY]:STOP <Frequency>

This command sets the stop frequency for the specified range. See also [\[SENSe:\]LIST:RANGe<range>\[:FREQUENCY\]:START](#) on page 820.

Suffix:

<range> 1...20
range

Parameters:

<Frequency> see rules in chapter 4, "Ranges and settings"
*RST: -2.52 MHz (range 1), 2.52 MHz (range 2), 250.0
MHz (range 3)

Example:

LIST:RANG3:STOP 100000000
Sets the stop frequency for range 2 to 10 MHz.

Manual operation: See "[Range Start / Range Stop](#)" on page 219

[SENSe:]LIST:RANGe<range>:FILTer:TYPE <Type>

This command sets the filter type for the specified range.

Suffix:

<range> 1...20
range

Parameters:

<Type>

NORMAL

Gaussian filters

CFILter

channel filters

RRC

RRC filters

P5

5 Pole filters

*RST: NORM

The available bandwidths of the filters are specified in the data sheet.

Example:

LIST:RANG1:FILT:TYPE RRC

Sets the RRC filter type for range 1.

Manual operation: See ["Filter Type"](#) on page 220**[SENSe:]LIST:RANGe<range>:INPut:ATTenuation <Value>**

This command sets the attenuation for the specified range.

Suffix:

<range>

1...20

range

Parameters:

<Value>

Refer to the data sheet.

*RST: 0 dB

Example:

LIST:RANG3:INP:ATT 10

Sets the attenuation of range 3 to 10 dB.

Manual operation: See ["RF Attenuator"](#) on page 220**[SENSe:]LIST:RANGe<range>:INPut:ATTenuation:AUTO <State>**

This command activates or deactivates the automatic RF attenuation setting for the specified range.

Suffix:

<range>

1...20

range

Parameters:

<State>

ON | OFF

*RST: ON

Example:

LIST:RANG2:INP:ATT:AUTO OFF

Deactivates the RF attenuation auto mode for range 2.

Manual operation: See ["RF Att. Mode"](#) on page 220

[SENSe:]LIST:RANGe<range>:INPut:GAIN:STATe <State>

This command switches the preamplifier on or off for the specified range.

Suffix:

<range> 1...20
range

Parameters:

<State> ON | OFF
*RST: OFF

Example: LIST:RANG3:INP:GAIN:STATe ON
Switches the preamplifier for range 3 on or off.

Manual operation: See "[Preamp](#)" on page 221

[SENSe:]LIST:RANGe<range>:LIMit:STARt <Limit>

This command sets an absolute limit value at the start frequency of the specified range. Different from manual operation, this setting is independent of the defined limit check type.

Suffix:

<range> 1...20
range

Parameters:

<Limit> -400 to in 400 dBm
*RST: 13 dBm

Example: LIST:RANG1:LIM:ABS:STAR 10
Sets an absolute limit of 10 dBm at the start frequency of the range.

Manual operation: See "[Abs Limit Start](#)" on page 221

[SENSe:]LIST:RANGe<range>:LIMit:STATe

This command activates or deactivates the limit check for all ranges.

Suffix:

<range> irrelevant

Parameters:

<State> ON | OFF
*RST: OFF

Example: LIST:RANG3:LIM:STAT ON
Activates a limit check for all ranges.

Manual operation: See "[Limit Check 1-4](#)" on page 221

[SENSe:]LIST:RANGe<range>:LIMit:STOP <Limit>

This command sets an absolute limit value at the stop frequency of the specified range. Different from manual operation, this setting is independent of the defined limit check type.

Suffix:

<range> 1...20
range

Parameters:

<Limit> -400 to in 400 dBm
*RST: 13 dBm

Example:

LIST:RANG1:LIM:STOP 20

Sets an absolute limit of 20 dBm at the stop frequency of the range.

Manual operation: See "[Abs Limit Stop](#)" on page 222

[SENSe:]LIST:RANGe<range>:POINTs <Value>

This command sets the number of sweep points for the specified range.

Suffix:

<range> 1...20
range

Parameters:

<Value> For details on possible values refer to chapter 4, **Sweep Points** softkey of the "Sweep" menu.

*RST: 691

Example:

LIST:RANG3:POIN 601

Sets 601 sweep points for range 3.

Manual operation: See "[Sweep Points](#)" on page 221

[SENSe:]LIST:RANGe<range>:RLEVel <Value>

This command sets the reference level for the specified range.

Suffix:

<range> 1...20
range

Parameters:

<Value> Refer to the data sheet.

*RST: -20 dBm

Example:

LIST:RANG2:RLEV 0

Sets the reference level of range 2 to 0 dBm.

Manual operation: See "[Ref. Level](#)" on page 220

[SENSe:]LIST:RANGe<range>:SWEep:TIME

This command sets the sweep time for the specified range.

Suffix:

<range> 1...20
range

Parameters:

<SweepTime> Allowed values depend on the ratio of span to RBW and RBW to VBW. For details refer to the data sheet.

*RST: 0.27 s

Example:

LIST:RANG1:SWE:TIME 1

Sets the sweep time for range 1 to 1 s.

Manual operation: See "[Sweep Time](#)" on page 220

[SENSe:]LIST:RANGe<range>:SWEep:TIME:AUTO

This command activates or deactivates the automatic sweep time setting for the specified range.

Suffix:

<range> 1...20
range

Parameters:

<State> ON | OFF

*RST: ON

Example:

LIST:RANG3:SWE:TIME:AUTO OFF

Deactivates the sweep time auto mode for range 3.

Manual operation: See "[Sweep Time Mode](#)" on page 220

[SENSe:]LIST:RANGe<range>:TRANsducer <TransducerName>

This command sets a transducer for the specified range. You can only choose a transducer that fulfills the following conditions:

- The transducer overlaps or equals the span of the range.
- The x-axis is linear.
- The unit is dB.

Suffix:

<range> 1...20
range

Parameters:

<TransducerName> 'string' = name of the transducer

Example:

SENS:LIST:RANG1:TRAN 'test'

Sets the transducer called "test" for range 1.

Manual operation: See "Transd. Factor" on page 221

SENSe:MIXer Subsystem

The MIXer subsystem controls the external mixer settings. These commands are only available if the R&S FSV-B21 (Exeternal Mixer) option is installed.

| | |
|--|-----|
| [SENSe:]MIXer[:STATe]..... | 826 |
| [SENSe:]MIXer:BIAS:HIGH..... | 826 |
| [SENSe:]MIXer:BIAS:LOW..... | 827 |
| [SENSe:]MIXer:RFOVerrange[:STATe]..... | 827 |
| [SENSe:]MIXer:FREQuency:HANdOver..... | 828 |
| [SENSe:]MIXer:FREQuency:STARt?..... | 828 |
| [SENSe:]MIXer:FREQuency:STOP?..... | 828 |
| [SENSe:]MIXer:HARMonic:BAND..... | 828 |
| [SENSe:]MIXer:HARMonic:BAND:PRESet..... | 829 |
| [SENSe:]MIXer:HARMonic:HIGH:STATe..... | 829 |
| [SENSe:]MIXer:HARMonic:HIGH[:VALue]..... | 829 |
| [SENSe:]MIXer:HARMonic[:LOW]..... | 830 |
| [SENSe:]MIXer:HARMonic:TYPE..... | 830 |
| [SENSe:]MIXer:LOPower..... | 830 |
| [SENSe:]MIXer:LOSS:HIGH..... | 831 |
| [SENSe:]MIXer:LOSS:TABLE:HIGH..... | 831 |
| [SENSe:]MIXer:LOSS:TABLE[:LOW]..... | 831 |
| [SENSe:]MIXer:LOSS[:LOW]..... | 831 |
| [SENSe:]MIXer:PORTs..... | 832 |
| [SENSe:]MIXer:SIGNal..... | 832 |
| [SENSe:]MIXer:THReshold..... | 833 |

[SENSe:]MIXer[:STATe] <State>

This command activates the external mixer.

Parameters:

<State> **ON | OFF**
 *RST: OFF

Example: MIX ON

Mode: all

Manual operation: See "External Mixer (On/Off)" on page 494

[SENSe:]MIXer:BIAS:HIGH <BiasSetting>

This command defines the bias current for the high range (see also [chapter 7.2.1.2, "Bias Current"](#), on page 489).

This command is only available if the external mixer is active (see [\[SENSe:\]MIXer\[:STATe\]](#) on page 826).

Parameters:

<BiasSetting> *RST: 0.0 A
 Default unit: A

Example:

MIX ON
 Activates the external mixer.
 MIX:BIAS:HIGH 2A
 Sets the bias for the high range to 2 A.

Mode: all

Manual operation: See "[Bias Settings](#)" on page 502

[SENSe:]MIXer:BIAS:LOW <BiasSetting>

This command defines the bias current for the low range (see also [chapter 7.2.1.2, "Bias Current"](#), on page 489).

This command is only available if the external mixer is active (see [\[SENSe:\]MIXer\[:STATe\]](#) on page 826).

Parameters:

<BiasSetting> *RST: 0.0 A
 Default unit: A

Example:

MIX ON
 Activates the external mixer.
 MIX:BIAS:LOW 2A
 Sets the bias for the low range to 2 A.

Mode: all

Manual operation: See "[Bias Settings](#)" on page 502

[SENSe:]MIXer:RFOVerrange[:STATe] <State>

This command specifies whether the frequencies beyond the defined band limits are to be used.

This command is only available if the external mixer is active (see [\[SENSe:\]MIXer\[:STATe\]](#) on page 826).

Parameters:

<State> **ON | OFF**
 *RST: OFF

Example:

MIX:RFOV ON

Mode: all

Manual operation: See "[RF Overrange](#)" on page 496

[SENSe:]MIXer:FREQUency:HANdOver <Frequency>

This command defines the frequency at which the mixer switches from one range to the next (if two different ranges are selected). The handover frequency for each band can be selected freely within the overlapping frequency range.

This command is only available if the external mixer is active (see [\[SENSe:\]MIXer\[:STATe\]](#) on page 826).

Parameters:

<Frequency>

Example:

```
MIX ON
```

Activates the external mixer.

```
MIX:FREQ:HAND 78.0299GHz
```

Sets the handover frequency to 78.0299 GHz.

Mode: all

Manual operation: See "[Handover Freq.](#)" on page 495

[SENSe:]MIXer:FREQUency:STARt?

This command queries the frequency at which the external mixer band starts.

Example:

```
MIX:FREQ:STAR?
```

Queries the start frequency of the band.

Usage: Query only

Mode: all

Manual operation: See "[RF Start](#)" on page 495

[SENSe:]MIXer:FREQUency:STOP?

This command queries the frequency at which the external mixer band stops.

Example:

```
MIX:FREQ:STOP?
```

Queries the stop frequency of the band.

Usage: Query only

Mode: all

Manual operation: See "[RF Stop](#)" on page 495

[SENSe:]MIXer:HARMonic:BAND <Band>

This command selects the external mixer band. The query returns the currently selected band.

This command is only available if the external mixer is active (see [\[SENSe:\]MIXer\[:STATe\]](#) on page 826).

Parameters:

<Band>

A | KA | Q | U | V | E | W | F | D | G | Y | J | USER

Standard waveguide band or user-defined band.

Note: The band formerly referred to as "A" is now named "KA"; the input parameter "A" is still available and refers to the same band as "KA".For a definition of the frequency range for the pre-defined bands, see [table 7-9](#)).

*RST: F (90 GHz - 140 GHz)

Example:

MIX ON

Activates the external mixer.

MIX:HARM:BAND A

Sets the band to A (26.5 GHz - 40 GHz).

Mode:

all

Manual operation: See "[Band](#)" on page 495**[SENSe:]MIXer:HARMonic:BAND:PRESet**

This command restores the preset frequency ranges for the standard waveguide bands.

Example:

MIX:HARM:BAND:PRES

Presets the waveguide bands.

Usage:

Event

Mode:

all

Manual operation: See "[Preset Band](#)" on page 496**[SENSe:]MIXer:HARMonic:HIGH:STATe <State>**

This command specifies whether a second (high) harmonic is to be used to cover the band's frequency range.

Parameters:

<State>

ON | OFF

*RST: OFF

Example:

MIX:HARM:HIGH:STAT ON

Mode:

all

Manual operation: See "[Range 1/2](#)" on page 496**[SENSe:]MIXer:HARMonic:HIGH[:VALue] <HarmOrder>**

This command specifies the harmonic order to be used for the high range.

Parameters:

<HarmOrder> <numeric value>
 Range: 2 to 100 (USER band); for other bands: see band definition

Example: MIX:HARM:HIGH 2

Mode: all

Manual operation: See "[Harmonic Order](#)" on page 496

[SENSe:]MIXer:HARMonic:LOW] <HarmOrder>

This command specifies the harmonic order to be used for the LOW range.

Parameters:

<HarmOrder> <numeric value>
 Range: 2 to 100 (USER band); for other bands: see band definition
 *RST: 2 (for band F)

Example: MIX:HARM 3

Mode: all

Manual operation: See "[Harmonic Order](#)" on page 496

[SENSe:]MIXer:HARMonic:TYPE <OddEven>

This command specifies whether the harmonic order to be used should be odd, even, or both.

Parameters:

<OddEven> **ODD | EVEN | EODD**
 *RST: EVEN

Example: MIX:HARM:TYPE ODD

Mode: all

Manual operation: See "[Harmonic Type](#)" on page 496

[SENSe:]MIXer:LOPower <Level>

This command specifies the LO level of the external mixer's LO port.

Parameters:

<Level> <numeric value>
 Range: 13.0 dBm to 17.0 dBm
 Increment: 0.1 dB
 *RST: 15.5 dBm

Example: MIX:LOP 16.0dBm

Mode: all
Manual operation: See "[LO Level](#)" on page 502

[SENSe:]MIXer:LOSS:HIGH <Average>

This command defines the average conversion loss to be used for the entire high range.

Parameters:
 <Average> <numeric value>
 Range: 0 to 100
 *RST: 40.0 dB
 Default unit: dB

Example: MIX:LOSS:HIGH 20dB

Mode: all
Manual operation: See "[Conversion Loss](#)" on page 497

[SENSe:]MIXer:LOSS:TABLE:HIGH <FileName>

This command defines the file name of the conversion loss table to be used for the high range.

Parameters:
 <FileName> <file name>

Example: MIX:LOSS:HIGH 20dB

Mode: all
Manual operation: See "[Conversion Loss](#)" on page 497

[SENSe:]MIXer:LOSS:TABLE[:LOW] <FileName>

This command defines the file name of the conversion loss table to be used for the low range.

Parameters:
 <FileName> <file name>

Example: MIX:LOSS:TABL mix_1_4
 Specifies the conversion loss table *mix_1_4*.

Mode: all
Manual operation: See "[Conversion Loss](#)" on page 497

[SENSe:]MIXer:LOSS[:LOW] <Average>

This command defines the average conversion loss to be used for the entire low range.

Parameters:

<Average> <numeric value>
 Range: 0 to 100
 *RST: 40.0 dB
 Default unit: dB

Example: MIX:LOSS 20dB

Mode: all

Manual operation: See "[Conversion Loss](#)" on page 497

[SENSe:]MIXer:PORTs <PortType>

This command specifies whether the mixer is a 2-port or 3-port type.

Parameters:

<PortType> **2 | 3**
 *RST: 2

Example: MIX:PORT 3

Mode: all

Manual operation: See "[Mixer Type](#)" on page 496

[SENSe:]MIXer:SIGNal <State>

This command specifies whether automatic signal detection is active or not.

Parameters:

<State> **OFF | ON | AUTO | ALL**
OFF
 No automatic signal detection is active.
ON
 Automatic signal detection (Signal ID) is active.
AUTO
 Automatic signal detection (Auto ID) is active.
ALL
 Both automatic signal detection functions (Signal ID+Auto ID) are active.
 *RST: OFF

Example: MIX:SIGN AUTO

Mode: all

Manual operation: See "[Signal ID \(On/Off\)](#)" on page 502
 See "[Auto ID \(On/Off\)](#)" on page 503

[SENSe:]MIXer:THReshold <Value>

This command defines the maximum permissible level difference between test sweep and reference sweep to be corrected during automatic comparison (see [SENSe:]MIXer:SIGNal on page 832).

Parameters:

<Value> <numeric value>
 Range: 30 dBm to -130 dBm
 *RST: 0.0 dBm

Example: MIX:PORT 3

Mode: all

Manual operation: See "Auto ID Threshold" on page 504

SENSe:MPOWER Subsystem

The commands of this subsystem are used to determine the mean burst power or peak burst power for a given number of signal bursts, and for outputting the results in a list. Since all the settings required for a measurement are combined in a single command, the measurement speed is considerably higher than when using individual commands.

For measuring the signal bursts, the gated sweep function is used in zero span. The gate is controlled either by an external trigger signal or by the video signal. An individual trigger event is required for each burst to be measured. If an external trigger signal is used, the threshold is fixed to TTL level, while with a video signal the threshold can be set as desired.

More Details on the SENSe:MPOWER Subsystem

The following graphics shows the relation between trigger time, trigger offset (for delayed gate opening) and measurement time.

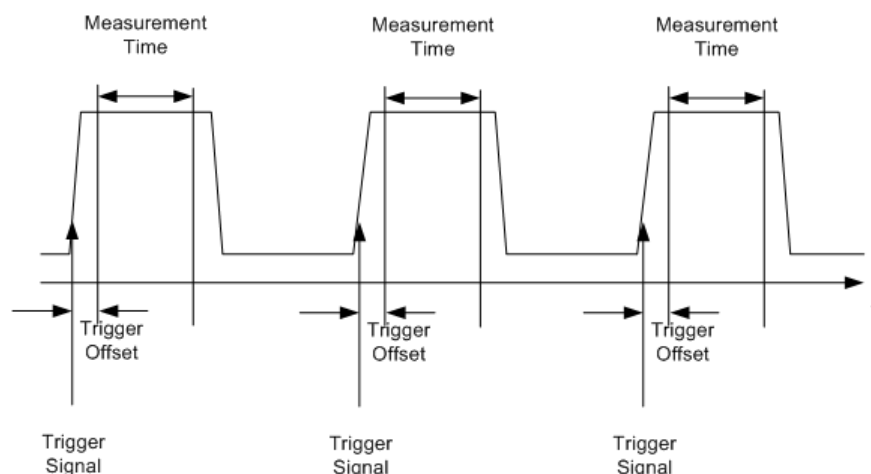

Depending on the settings made, the measurements are performed with the RMS detector for RMS power or the PEAK detector for peak power. For all these measurements, trace 1 of the selected system is used.

The setting parameters for this measurement are:

- analyzer frequency
- resolution bandwidth
- measurement time used for a single burst
- trigger source
- trigger level
- trigger offset
- type of power measurement (PEAK, MEAN)
- number of bursts to be measured

The commands of this subsystem can be used in two different ways:

- Setting up the instrument and at the same time querying the result list: This method ensures the smallest delay between measurement and the output of the measured values, but requires the control computer to wait actively for the response of the instrument.
- Setting up the instrument and querying the result list after synchronization to the end of measurement: With this method the control computer can be used for other activities while the instrument is performing the measurement at the cost of additional time needed for synchronization via service request.

| | |
|------------------------------------|-----|
| [SENSe:]MPOWer:FTYPE..... | 834 |
| [SENSe:]MPOWer:RESult[:LIST]?..... | 834 |
| [SENSe:]MPOWer:RESult:MIN?..... | 835 |
| [SENSe:]MPOWer[:SEquence]..... | 835 |

[SENSe:]MPOWer:FTYPE <FilterType>

This command selects the filter type for pulse power measurements.

Parameters:

<FilterType> NORMal | CFILter | RRC

Example:

SENSe:MPOWer:FTYPE CFILter

[SENSe:]MPOWer:RESult[:LIST]?

This command queries the results of the pulse power measurement.

This command may be used to obtain measurement results in an asynchronous way, using the service request mechanism for synchronization to the end of the measurement.

If there are no results, the command returns an error.

Parameters:

<PulsePower> List of pulse powers.
 The number of values depends on the number of pulses you have been measuring.
 The unit is dBm.

Example: *ESE 1
 *SRE 32
 Configuration of status reporting systems for the generation of
 an SRQ on operation complete
 SENSE:MPOWer 935.2MHz,1MHz,434us,VIDEO,50PCT,
 5us,MEAN,20;*OPC
 Configuring and starting the measurement
 ...
 Further actions of the control computer during measurement
 On SRQ:
 Response to service request
 SENSE:MPOWer:RESult?

Usage: Query only

[SENSe:]MPOWer:RESult:MIN?

This command queries the lowest pulse power that has been measured during a pulse power measurement.

If there are no results, the command returns an error.

Return values:

<PulsePower> Lowest power level of the pulse power measurement.
 The unit is dBm.

Example: *ESE 1
 *SRE 32
 Configuration of status reporting systems for the generation of
 an SRQ on operation complete
 SENSE:MPOWer 935.2MHz,1MHz,434us,VIDEO,50PCT,
 5us,MEAN,20;*OPC
 Configuring and starting the measurement
 ...
 Further actions of the control computer during measurement
 On SRQ:
 Response to service request
 SENSE:MPOWer:RESult:MIN?

Usage: Query only

[SENSe:]MPOWer[:SEQuence] <Frequency>, <RBW>, <MeasTime>, <TriggerSource>, <TriggerLevel>, <TriggerOffset>, <Detector>, <#OfPulses>

This command configures and initiates the pulse power measurement.

The R&S FSVR caches all measurement parameters that you can set with this command. If you use the command repeatedly, the R&S FSVR only changes those settings that you have actually changed before initiating the measurement. Thus, measurement times are kept as low as possible.

If you synchronize the measurement with *OPC, the R&S FSVR produces a service request when all frequencies have been measured and the number of individual measurements has been performed.

Note that using the command as a query initiates the measurement and returns the results if all frequencies have been measured. For more information on querying the results see .

To reduce the setting time, the setup is performed simultaneously for all selected parameters.

The query adapts the instrument settings, performs the defined number of measurements and outputs the measurement results list.

This measurement is not compatible with other measurements, especially as far as marker functions, adjacent-channel measurement or statistics are concerned. The corresponding functions are therefore automatically switched off. In return, incompatible commands automatically deactivate the multi burst power function.

The function is only available in the REMOTE operation. It is deactivated on switching back to LOCAL.

Parameters:

| | |
|-----------------|---|
| <Frequency> | Defines the pulse frequency.
Range: 0 Hz to fmax |
| <RBW> | Defines the resolution bandwidth.
Range: 10 Hz to 10 MHz in steps of 1, 3, 10 |
| <MeasTime> | Defines the measurement time.
Range: 1 µs to 30 s |
| <TriggerSource> | Selects a trigger source.
EXternal
The trigger signal is fed from the "Ext. Trigger/Gate" input on the rear of the unit.
VIDeo
The internal video signal is used as trigger signal. |
| <TriggerLevel> | Defines a trigger level.
The trigger level is available for the video trigger. In that case, the level is a percentage of the diagram height.
In case of an external trigger, the R&S FSVR uses a fix TTL level.
Range: 0 PCT to 100 PCT |
| <TriggerOffset> | Defines the trigger delay. The trigger delay is the time between the detection of the trigger signal and the start of the measurement.
Range: see data sheet |

| | |
|-----------------------|---|
| <Detector> | Selects the detector and therefore the way the measurement is evaluated.
MEAN
Calculates the RMS pulse power.
PEAK
Calculates the peak pulse power. |
| <#OfPulses> | Defines the number of pulses included in the measurement.
Range: 1 to 32001 |
| Return values: | |
| <PowerLevel> | Pulse power level.
The result is a list of floating point values separated by commas.
The unit is dBm. |
| Example: | Sample setting:
SENSE:MPOWer 935.2MHz, 1MHz, 434us, VIDEO, 50PCT, 5us, MEAN, 20
Performs a measurement sequence with the following settings:
Frequency = 935.2 MHz,
Resolution bandwidth = 1 MHz
Measurement time = 434 µs
Trigger source = VIDEO
Trigger threshold = 50 %
Trigger offset = 5 µs
Type of measurement = MEAN power
No. of measurements = 20
Sample query:
SENSE:MPOWer? 935.2MHz, 1MHz, 434us, VIDEO, 50PCT, 5us, MEAN, 20
Performs the same measurement and in addition returns the results list immediately after completion of the last measurement.
Sample result:
18.3,18.6,18.1,18.0,17.9,18.3,18.6,18.1,18.0,17.9,18.3,18.6,18.1,18.0,17.9,18.3,18.6,18.1,18.0,17.9,18.3,18.6,18.1,18.0,17.9 |

SENSe:PMETer<p> Subsystem (Power Sensor, R&S FSV-K9)

This subsystem controls the device settings for power sensor measurements. It is only available if the R&S FSV-K9 Power Sensor option is installed.

For details see [chapter 4.5, "Instrument Functions - Power Sensor \(R&S FSV-K9\)"](#), on page 304.

| | |
|--|-----|
| [SENSe:]PMETer<p>[:STATe]..... | 838 |
| [SENSe:]PMETer<p>:DCYClE:STATe..... | 838 |
| [SENSe:]PMETer<p>:DCYClE:VALue..... | 839 |
| [SENSe:]PMETer<p>:FREQUency..... | 839 |
| [SENSe:]PMETer<p>:FREQUency:LINK..... | 839 |
| [SENSe:]PMETer<p>:MTIME..... | 840 |
| [SENSe:]PMETer<p>:MTIME:AVERAge[:STATe]..... | 840 |

| | |
|--|-----|
| [SENSe:]PMETer<p>:MTIME:AVERage:COUNT..... | 841 |
| [SENSe:]PMETer<p>:ROFFset[:STATe]..... | 841 |
| [SENSe:]PMETer<p>:TRIGger[:STATe]..... | 842 |
| [SENSe:]PMETer<p>:TRIGger:DTIME..... | 842 |
| [SENSe:]PMETer<p>:TRIGger:HOLDoff..... | 842 |
| [SENSe:]PMETer<p>:TRIGger:HYSTeresis..... | 843 |
| [SENSe:]PMETer<p>:TRIGger:LEVel..... | 843 |
| [SENSe:]PMETer<p>:TRIGger:SLOPe..... | 844 |
| [SENSe:]PMETer<p>:UPDate[:STATe]..... | 844 |

[SENSe:]PMETer<p>[:STATe] <State>

This command switches the power sensor measurement for the selected power sensor on or off.

Suffix:

<p> 1...4
Power sensor index

Parameters:

<State> ON | OFF
*RST: OFF

Example:

PMET1 ON
Switches the power sensor measurements on.

Mode: PSM

Manual operation: See "[Power Sensor On/Off](#)" on page 311
See "[Select](#)" on page 313

[SENSe:]PMETer<p>:DCYClE:STATe <State>

This command activates the duty cycle correction for the selected power sensor.

Suffix:

<p> 1...4
Power sensor index

Parameters:

<State> ON | OFF
*RST: OFF

Example:

PMET2:DCYC:STAT ON

Mode: PSM

Manual operation: See "[Duty Cycle](#)" on page 314

[SENSe:]PMETer<p>:DCYClE:VALue <Percentage>

This command sets the duty cycle for the selected power sensor to a percent value for the correction of pulse modulated signals. With the correction activated, the sensor calculates the signal pulse power from this value and the mean power.

Suffix:

<p> 1...4
Power sensor index

Parameters:

<Percentage> Range: 0.001 to 99.999
*RST: 99.999
Default unit: %

Example:

```
PMET2:DCYC:STAT ON
Activates the duty cycle correction.
PMET2:DCYC:VAL 0.5
Sets the correction value to 0.5%.
```

Mode: PSM

Manual operation: See "[Duty Cycle](#)" on page 314

[SENSe:]PMETer<p>:FREQUency <Frequency>

This command sets the frequency of the selected power sensor. The limits f_{\min} and f_{\max} are defined by the power sensor.

Suffix:

<p> 1...4
Power sensor index

Parameters:

<Frequency> fmin ... fmax
*RST: 50 MHz

Example:

```
PMET2:FREQ 1GHZ
Sets the frequency of the power sensor to 1 GHz.
```

Mode: PSM

Manual operation: See "[Frequency Manual](#)" on page 314

[SENSe:]PMETer<p>:FREQUency:LINK <Coupling>

This command sets the frequency coupling of the selected power sensor.

Suffix:

<p> 1...4
Power sensor index

Parameters:

<Coupling>

CENTER

Couples the frequency to the center frequency of the analyzer

MARKer1

couples the frequency to the position of marker 1

OFF

switches the frequency coupling off

*RST: CENT

Example:

PMET2:FREQ:LINK CENT

Couples the frequency to the center frequency of the analyzer

Mode:

PSM

Manual operation: See "[Frequency Coupling](#)" on page 314**[SENSe:]PMETer<p>:MTIME <Duration>**

This command sets the measurement duration of the selected power sensor.

Suffix:

<p>

1...4

Power sensor index

Parameters:

<Duration>

SHORT | NORMal | LONG

*RST: NORM

Example:

PMET2:MTIM SHOR

Sets a short measurement duration for measurements of stationary high power signals for the selected power sensor.

Mode:

PSM

Manual operation: See "[Meas Time / Average](#)" on page 314**[SENSe:]PMETer<p>:MTIME:AVERage[:STATe] <State>**This command activates or deactivates manual averaging for the selected power sensor. The average count is set with the [\[SENSe:\]PMETer<p>:MTIME:AVERage:COUNT](#) command.**Suffix:**

<p>

1...4

Power sensor index

Parameters:

<State>

ON | OFF

*RST: OFF

Example:

PMET2:MTIM:AVER ON

Activates manual averaging.

Mode:

PSM

Manual operation: See "[Meas Time / Average](#)" on page 314

[SENSe:]PMETer<p>:MTIME:AVERage:COUNT <NumberReadings>

This command defines the number of readings (averagings) to be performed after a single sweep has been started for the selected power sensor. This command is only available if the `[SENSe:]PMETer<p>:MTIME:AVERage[:STATe]` command is set to ON.

Results become more stable with extended average, particularly if signals with low power are measured. This setting can be used to minimize the influence of noise in the power meter measurement.

Suffix:

<p> 1...4
Power sensor index

Parameters:

<NumberReadings> 0 to 256 in binary steps (1, 2, 4, 8,...)
For average count = 0 or 1, one reading is performed.

Example:

```
PMET2:MTIM:AVER ON
Activates manual averaging.
PMET2:MTIM:AVER:COUN 8
Sets the number of readings to 8.
```

Mode: PSM

Manual operation: See "[Number of Readings](#)" on page 315

[SENSe:]PMETer<p>:ROFFset[:STATe] <State>

This command defines whether the reference level offset set for the analyzer is taken into account for the measured power or not for the selected power sensor.

Suffix:

<p> 1...4
Power sensor index

Parameters:

<State> **ON**
Adds the offset defined by the `DISPlay[:WINDow<n>]:TRACE<t>:Y[:SCALE]:RLEVEL:OFFSet` command to the measured level.

OFF
Takes no offset into account.

*RST: ON

Example:

```
PMET2:ROFF OFF
Takes no offset into account for the measured power.
```

Mode: PSM

Manual operation: See "[Use Ref Level Offset](#)" on page 315

[SENSe:]PMETer<p>:TRIGger[:STATe] <State>

This command switches the external power trigger on or off for the selected power sensor.

For details on configuring an external power trigger, see [chapter 4.5.3, "Configuring an External Power Trigger"](#), on page 309.

This command is only available in conjunction with a NRP-Z81 power sensor.

Suffix:

<p> 1...4
Power sensor index

Parameters:

<State> ON | OFF
*RST: OFF

Example:

PMET2:TRIG ON
Switches the external power trigger on

Mode: PSM

Manual operation: See ["External Power Trigger"](#) on page 315

[SENSe:]PMETer<p>:TRIGger:DTIME <Value>

Defines the time the input signal must stay below the IF power trigger level in order to allow a trigger to start the measurement.

Suffix:

<p> 1...4
Power sensor index

Parameters:

<Value> 0 to 1 s
Increment: 100 ns
*RST: 100 µs

Example:

PMET2:TRIG:DTIME 0.001

Mode: PSM

Manual operation: See ["Dropout"](#) on page 316

[SENSe:]PMETer<p>:TRIGger:HOLDoff <Value>

Defines the holdoff value in s, which is the time which must pass before triggering, in case another trigger event happens.

For details see [figure 4-26](#).

Suffix:

<p> 1...4
Power sensor index

Parameters:

<Value> 0 to 1 s
 Increment: 100 ns
 *RST: 0 s

Example:

PMET2:TRIG:HOLD 0.1
 Sets the holdoff time of the trigger to 100 ms

Mode: PSM

Manual operation: See "[Holdoff](#)" on page 316

[SENSe:]PMETer<p>:TRIGger:HYSTeresis <Value>

Defines the value for the trigger hysteresis of an external power trigger. The hysteresis in dB is the value the input signal must stay below the IF power trigger level in order to allow a trigger to start the measurement.

For details see [figure 4-26](#).

Suffix:

<p> 1...4
 Power sensor index

Parameters:

<Value> 3 to 50 dB
 Increment: 1 dB
 *RST: 0 dB

Example:

PMET2:TRIG:HYST 10
 Sets the hysteresis of the trigger to 10 dB.

Mode: PSM

Manual operation: See "[Hysteresis](#)" on page 316

[SENSe:]PMETer<p>:TRIGger:LEVel <Value>

This command sets the power level for the external power trigger for the selected power sensor.

This command is only available in conjunction with a NRP-Z81 power sensor.

For details see [figure 4-26](#).

Suffix:

<p> 1...4
 Power sensor index

Parameters:

<Value> -20 to +20 dBm
 *RST: -10 dBm

Example:

PMET2:TRIG:LEV -10 dBm
 Sets the level of the trigger

Mode: PSM

Manual operation: See ["External Trigger Level"](#) on page 316

[SENSe:]PMETer<p>:TRIGger:SLOPe <Edge>

Defines whether the sweep starts after a positive or negative edge of the trigger signal.

For details see [figure 4-26](#).

Suffix:

<p> 1...4
Power sensor index

Parameters:

<Edge> POSitive | NEGative
*RST: POS

Example: PMET2:TRIG:SLOP NEG

Mode: PSM

Manual operation: See ["Slope"](#) on page 316

[SENSe:]PMETer<p>:UPDate[:STATe] <State>

This command switches the continuous update of the power sensor measurement for the selected power sensor on or off. If activated, even after a single sweep has been completed, the data from the power sensor is updated.

Suffix:

<p> 1...4
Power sensor index

Parameters:

<State> ON | OFF
*RST: OFF

Example: PMET1:UPD ON
The data from power sensor 1 is updated continuously.

Mode: PSM

Manual operation: See ["Continuous Value Update"](#) on page 312

SENSe:POWer Subsystem

This subsystem controls the setting of the instruments channel and adjacent channel power measurements.

| | |
|---|-----|
| [SENSe:]POWer:ACHannel:ACPairs..... | 845 |
| [SENSe:]POWer:ACHannel:BANDwidth BWIDth[:CHANnel<channel>]..... | 845 |
| [SENSe:]POWer:ACHannel:BANDwidth BWIDth:ACHannel..... | 846 |
| [SENSe:]POWer:ACHannel:BANDwidth BWIDth:ALTErnate<channel>..... | 846 |
| [SENSe:]POWer:ACHannel:FILTer:ALPHa:ACHannel..... | 847 |

| | |
|---|-----|
| [SENSe:]POWer:ACHannel:FILTer:ALPHa[:ALL]..... | 847 |
| [SENSe:]POWer:ACHannel:FILTer:ALPHa:ALTerNate<channel>..... | 847 |
| [SENSe:]POWer:ACHannel:FILTer:ALPHa:CHANnel<channel>..... | 847 |
| [SENSe:]POWer:ACHannel:FILTer[:STATe]:ALL..... | 848 |
| [SENSe:]POWer:ACHannel:FILTer[:STATe]:ACHannel..... | 848 |
| [SENSe:]POWer:ACHannel:FILTer[:STATe]:ALTerNate<channel>..... | 848 |
| [SENSe:]POWer:ACHannel:FILTer[:STATe]:CHANnel<channel>..... | 848 |
| [SENSe:]POWer:ACHannel:MODE..... | 849 |
| [SENSe:]POWer:ACHannel:NAME:ACHannel..... | 849 |
| [SENSe:]POWer:ACHannel:NAME:ALTerNate<channel>..... | 850 |
| [SENSe:]POWer:ACHannel:NAME:CHANnel<channel>..... | 850 |
| [SENSe:]POWer:ACHannel:PRESet..... | 850 |
| [SENSe:]POWer:ACHannel:PRESet:RLEVel..... | 851 |
| [SENSe:]POWer:ACHannel:REFerence:AUTO ONCE..... | 851 |
| [SENSe:]POWer:ACHannel:REFerence:TXCHannel:AUTO..... | 851 |
| [SENSe:]POWer:ACHannel:REFerence:TXCHannel:MANual..... | 852 |
| [SENSe:]POWer:ACHannel:SPACing[:ACHannel]..... | 852 |
| [SENSe:]POWer:ACHannel:SPACing:ALTerNate<channel>..... | 853 |
| [SENSe:]POWer:ACHannel:SPACing:CHANnel<channel>..... | 853 |
| [SENSe:]POWer:ACHannel:TXCHannel:COUNT..... | 853 |
| [SENSe:]POWer:BANDwidth BWIDth..... | 854 |
| [SENSe:]POWer:HSPeed..... | 854 |
| [SENSe:]POWer:NCORrection..... | 854 |
| [SENSe:]POWer:TRACe..... | 855 |

[SENSe:]POWer:ACHannel:ACPairs <ChannelPairs>

This command sets the number of adjacent channels (upper and lower channel in pairs). The figure 0 stands for pure channel power measurement.

Parameters:

<ChannelPairs> 0 to 12
*RST: 1

Example:

POW:ACH:ACP 3

Sets the number of adjacent channels to 3, i.e. the adjacent channel and alternate adjacent channels 1 and 2 are switched on.

Manual operation: See "# of Adj Chan" on page 167
See "Channel Bandwidth" on page 181

[SENSe:]POWer:ACHannel:BANDwidth|BWIDth[:CHANnel<channel>] <Bandwidth>

This command sets the channel bandwidth of the specified TX channel in the radio communication system. The bandwidths of adjacent channels are not influenced by this modification.

With [SENSe<source>:] POWer:HSPEED set to ON, steep-edged channel filters are available. For further information on filters refer to [chapter 4.1.6.4, "List of Available RRC and Channel Filters"](#), on page 86.

Parameters:

<Bandwidth> 100 Hz to 40 GHz
*RST: 14 kHz

Example:

POW:ACH:BWID:CHAN2 30 kHz
Sets the bandwidth of the TX channel 2 to 30 kHz.

Manual operation:

See "[Bandwidth](#)" on page 168
See "[Channel Bandwidth \(span > 0\)](#)" on page 185

[SENSe:]POWER:ACHannel:BANDwidth|BWIDth:ACHannel <Bandwidth>

This command defines the channel bandwidth of the adjacent channel of the radio transmission system. If the bandwidth of the adjacent channel is changed, the bandwidths of all alternate adjacent channels are automatically set to the same value.

With [SENSe<source>:] POWer:HSPEED set to ON, steep-edged channel filters are available. For further information on filters refer to [chapter 4.1.6.4, "List of Available RRC and Channel Filters"](#), on page 86 .

Parameters:

<Bandwidth> 100 Hz to 40 GHz
*RST: 14 kHz

Example:

POW:ACH:BWID:ACH 30 kHz
Sets the bandwidth of all adjacent channels to 30 kHz.

Manual operation:

See "[Bandwidth](#)" on page 168

**[SENSe:]POWER:ACHannel:BANDwidth|BWIDth:ALTernate<channel>
<Bandwidth>**

This command defines the channel bandwidth of the specified alternate adjacent channels of the radio transmission system. If the channel bandwidth of one alternate adjacent channel is changed (e.g. channel 3), the bandwidth of all subsequent alternate adjacent channels (e.g. 4–11) is automatically set to the same value.

With [SENSe<source>:] POWer:HSPEED set to ON, steep-edged channel filters are available. For further information on filters refer to [chapter 4.1.6.4, "List of Available RRC and Channel Filters"](#), on page 86 .

Suffix:

<channel> 1...11
the alternate adjacent channel

Parameters:

<Bandwidth> 100 Hz to 40 GHz
*RST: 14 kHz

Example:

POW:ACH:BWID:ALT2 30 kHz

Manual operation: See "[Bandwidth](#)" on page 168

[SENSe:]POWer:ACHannel:FILTer:ALPHa:ACHannel <Alpha>

This command defines the roll-off factor for the weighting filter of the adjacent channel.

Parameters:

<Alpha> <numeric value>
*RST: 0,22

Example: POW:ACH:FILT:ALPH:ACH 0,35

Manual operation: See "[Weighting Filter](#)" on page 170

[SENSe:]POWer:ACHannel:FILTer:ALPHa[:ALL] <Alpha>

This command defines the roll-off factor for the weighting filter of all channels.

Parameters:

<Alpha> <numeric value>
*RST: 0,22

Example: POW:ACH:FILT:ALPH:ALL 0,35

[SENSe:]POWer:ACHannel:FILTer:ALPHa:ALTErnate<channel> <Alpha>

This command defines the roll-off factor for the weighting filter of the specified alternate channel.

Suffix:

<channel> 1...11
the alternate channel

Parameters:

<Alpha> <numeric value>
*RST: 0,22

Example: POW:ACH:FILT:ALPH:ALT3 0,35
Sets the alpha value for the weighting filter for the alternate channel 3 to 0,35.

Manual operation: See "[Weighting Filter](#)" on page 170

[SENSe:]POWer:ACHannel:FILTer:ALPHa:CHANnel<channel> <Alpha>

This command defines the roll-off factor for the weighting filter of the specified TX channel.

Suffix:

<channel> 1...11
the TX channel

Parameters:

<Alpha> <numeric value>
 *RST: 0,22

Example:

POW:ACH:FILT:ALPH:CHAN3 0,35
 Sets the alpha value for the weighting filter for the TX channel 3 to 0,35.

Manual operation: See "[Weighting Filter](#)" on page 170

[SENSe:]POWer:ACHannel:FILTer[:STATe]:ALL <State>

This command activates the weighting filter for all channels.

Parameters:

<State> ON | OFF
 *RST: OFF

Example:

POW:ACH:FILT ON

[SENSe:]POWer:ACHannel:FILTer[:STATe]:ACHannel <State>

This command activates the weighting filter for the adjacent channel.

Parameters:

<State> ON | OFF
 *RST: OFF

Example:

POW:ACH:FILT:ACH ON

Manual operation: See "[Weighting Filter](#)" on page 170

[SENSe:]POWer:ACHannel:FILTer[:STATe]:ALTErnate<channel> <State>

This command activates the weighting filter for the specified alternate channel.

Suffix:

<channel> 1...11
 the alternate adjacent channel

Parameters:

<State> ON | OFF
 *RST: OFF

Example:

POW:ACH:FILT:ALT3 ON
 Activates the weighting filter for alternate channel 3.

Manual operation: See "[Weighting Filter](#)" on page 170

[SENSe:]POWer:ACHannel:FILTer[:STATe]:CHANnel<channel> <State>

This command activates the weighting filter for the specified TX channel.

Suffix:
 <channel> 1...18
 the TX channel

Parameters:
 <State> ON | OFF
 *RST: OFF

Example: POW:ACH:FILT:CHA3 ON
 Activates the weighting filter for TX channel 3.

Manual operation: See "[Weighting Filter](#)" on page 170

[SENSe:]POWer:ACHannel:MODE <Mode>

This command switches between absolute and relative adjacent channel measurement. The command is only available with span > 0 and if the number of adjacent channels is greater than 0.

For the relative measurement the reference value is set to the currently measured channel power using the command [SENSe:]POWer:ACHannel:REference: [AUTO ONCE](#).

Parameters:
 <Mode> ABSolute | RELative

ABSolute
 absolute adjacent channel measurement

RELative
 relative adjacent channel measurement

*RST: RELative

Example: POW:ACH:MODE REL
 Sets the adjacent channel measurement mode to relative.

Manual operation: See "[ACLR \(Abs/Rel\)](#)" on page 173

[SENSe:]POWer:ACHannel:NAME:ACHannel <Name>

This command defines a name for the adjacent channel. The name is displayed in the result diagram and the result table.

Parameters:
 <Name> *RST: Adj

Example: POW:ACH:NAME:ACH 'XYZ'
 Defines the name of the adjacent channel as 'XYZ'.

Manual operation: See "[Names](#)" on page 170

[SENSe:]POWer:ACHannel:NAME:ALternate<channel> <Name>

This command defines a name for the specified alternate channel. The name is displayed in the result diagram and the result table.

Suffix:

<channel> 1...11
the alternate channel

Parameters:

<Name> *RST: ALT<1...11>

Example:

POW:ACH:NAME:ALT3 'XYZ'

Defines the name of the third alternate channel as 'XYZ'.

Manual operation: See "[Names](#)" on page 170

[SENSe:]POWer:ACHannel:NAME:CHANnel<channel> <Name>

This command defines a name for the specified TX channel. The name is displayed in the result diagram and the result table.

Suffix:

<channel> 1...12
the TX channel

Parameters:

<Name> *RST: TX<1...12>

Example:

POW:ACH:NAME:CHAN3 'XYZ'

Defines the name of the third transmission channel as 'XYZ'.

Manual operation: See "[Names](#)" on page 170

[SENSe:]POWer:ACHannel:PRESet <Setting>

This command adjusts the frequency span, the measurement bandwidths and the detector as required for the number of channels, the channel bandwidths and the channel spacings selected in the active power measurement. If necessary, adjacent-channel power measurement is switched on prior to the adjustment.

To obtain correct results, a complete sweep with synchronization to the end of the sweep must be performed after the adjustment. Synchronization is possible only in the single sweep mode.

The result is queried with the [CALCulate<n>:MARKer<m>:FUNction:POWer:RESult?](#) command.

Parameters:

<Setting> ACPower | CPOWer | MCACpower | OBANdwidth | OBWidth |
CN | CN0

- Example:** `POW:ACH:PRES ACP`
Sets the frequency span, the measurement bandwidths and the detector as required for the ACLR measurement.
- `INIT:CONT OFF`
Switches over to single sweep mode.
- `INIT;*WAI`
Starts a sweep and waits for the end of the sweep.
- `CALC:MARK:FUNC:POW:RES? ACP`
Queries the result of the adjacent-channel power measurement.
- Manual operation:** See ["Adjust Settings"](#) on page 173
See ["Adjust Settings "](#) on page 182

[SENSe:]POWer:ACHannel:PRESet:RLEVel

This command adapts the reference level to the measured channel power and – if required – switches on previously the adjacent channel power measurement. This ensures that the signal path of the instrument is not overloaded. Since the measurement bandwidth is significantly smaller than the signal bandwidth in channel power measurements, the signal path can be overloaded although the trace is still significantly below the reference level. If the measured channel power equals the reference level, the signal path is not overloaded.

Subsequent commands have to be synchronized with *WAI, *OPC or *OPC? to the end of the auto range process which would otherwise be aborted.

- Example:** `POW:ACH:PRESet:RLEV;*WAI`
Adapts the reference level to the measured channel power.

- Manual operation:** See ["Adjust Ref Lvl"](#) on page 176
See ["Adjust Ref Lvl \(span > 0\)"](#) on page 185
See ["Adjust Ref Lvl \(span > 0\)"](#) on page 222
See ["Adjust Ref Lvl \(span > 0\)"](#) on page 224

[SENSe:]POWer:ACHannel:REFerence:AUTO ONCE

This command sets the reference value to the currently measured channel power for the relative measurement.

- Example:** `POW:ACH:REF:AUTO ONCE`

- Manual operation:** See ["Set CP Reference"](#) on page 174

[SENSe:]POWer:ACHannel:REFerence:TXCHannel:AUTO <Channel>

This command activates the automatic selection of a transmission channel to be used as a reference channel in relative adjacent-channel power measurements.

The transmission channel with the highest power, the transmission channel with the lowest power, or the transmission channel nearest to the adjacent channels can be defined as a reference channel.

The command is available only for multicarrier channel and adjacent-channel power measurements with span > 0 ([CALCulate<n>:MARKer<m>:FUNction:POWer:SElect](#) on page 654).

Parameters:

<Channel> MINimum | MAXimum | LHIGhest

MINimum
Transmission channel with the lowest power

MAXimum
Transmission channel with the highest power

LHIGhest
Lowermost transmission channel for the lower adjacent channels, uppermost transmission channel for the upper adjacent channels

Example:

```
POW:ACH:REF:TXCH:AUTO MAX
```

The transmission channel with the highest power is used as a reference channel.

Manual operation: See "[ACLR Reference](#)" on page 169

[SENSe:]POWer:ACHannel:REFerence:TXCHannel:MANual <ChannelNumber>

This command selects a transmission channel to be used as a reference channel in relative adjacent-channel power measurements.

The command is available only for multicarrier channel and adjacent-channel power measurements with span > 0 ([CALCulate<n>:MARKer<m>:FUNction:POWer:SElect](#) on page 654).

Parameters:

<ChannelNumber> 1 to 18

*RST: 1

Example:

```
POW:ACH:REF:TXCH:MAN 3
```

Transmission channel 3 is used as a reference channel.

Manual operation: See "[ACLR Reference](#)" on page 169

[SENSe:]POWer:ACHannel:SPACing[:ACHannel] <Spacing>

This command defines the spacing between the carrier signal and the adjacent channel (ADJ). The modification of the adjacent-channel spacing (ADJ) causes a change in all higher adjacent-channel spacings (ALT1, ALT2, ...): they are all multiplied by the same factor (new spacing value/old spacing value).

Parameters:

<Spacing> 100 Hz to 20 GHz

*RST: 14 kHz

Example: `POW:ACH:SPAC 33kHz`
 Sets the spacing between the carrier signal and the adjacent channel to 33 kHz, the alternate adjacent channel 1 to 66 kHz, the alternate adjacent channel 2 to 99 kHz, and so on.

Manual operation: See "[Spacing](#)" on page 169

[SENSe:]POWer:ACHannel:SPACing:ALTErnate<channel> <Spacing>

This command defines the spacing between the alternate adjacent channels and the TX channel (ALT1, ALT2, ...). A modification of a higher adjacent-channel spacing causes a change by the same factor (new spacing value/old spacing value) in all higher adjacent-channel spacings, while the lower adjacent-channel spacings remain unchanged.

Suffix:
 <channel> 1...11
 the alternate adjacent channel

Parameters:
 <Spacing> 100 Hz to 20 GHz
 *RST: 40 kHz (ALT1), 60 kHz (ALT2), 80 kHz (ALT3), ...

Example: `POW:ACH:SPAC:ALT1 100 kHz`
 Sets the spacing between TX channel and alternate adjacent channel 1 (ALT1) from 40 kHz to 100 kHz. In consequence, the spacing between the TX channel and all higher alternate adjacent channels is increased by the factor $100/40 = 2.5$: ALT2 = 150 kHz, ALT3 = 200 kHz, ALT4 = 250 kHz.

Manual operation: See "[Spacing](#)" on page 169

[SENSe:]POWer:ACHannel:SPACing:CHANnel<channel> <Spacing>

This command defines the channel spacing for the carrier signals.

Suffix:
 <channel> 1...11
 the TX channel

Parameters:
 <Spacing> 14 kHz to 20 GHz
 *RST: 20 kHz

Example: `POW:ACH:SPAC:CHAN 25kHz`

Manual operation: See "[Spacing](#)" on page 169

[SENSe:]POWer:ACHannel:TXChannel:COUNt <Number>

This command selects the number of carrier signals.

The command is available only for multicarrier channel and adjacent-channel power measurements with span > 0 (see [CALCulate<n>:MARKer<m>:FUNCTION:POWER:SElect](#) on page 654).

Parameters:

<Number> 1 to 18
*RST: 1

Example: POW:ACH:TXCH:COUN 3

Manual operation: See "[# of TX Chan](#)" on page 167

[SENSe:]POWER:BANDwidth|BWIDth <Percentage>

This command defines the percentage of the power with respect to the total power.

This value is the basis for the occupied bandwidth measurement (see [\[SENSe:\]POWER:ACHannel:PRESet](#) on page 850).

Parameters:

<Percentage> 10 to 99.9PCT
*RST: 99PCT

Example: POW:BWID 95PCT

Manual operation: See "[% Power Bandwidth \(span > 0\)](#)" on page 185

[SENSe:]POWER:HSPeed <State>

This command switches on or off the high-speed channel/adjacent channel power measurement. The measurement itself is performed in zero span on the center frequencies of the individual channels. The command automatically switches to zero span and back.

Depending on the selected mobile radio standard, weighting filters with characteristic or very steep-sided channel filters are used for band limitation.

Parameters:

<State> ON | OFF
*RST: OFF

Example: POW:HSP ON

Manual operation: See "[Fast ACLR \(On/Off\)](#)" on page 174

[SENSe:]POWER:NCORrection <Mode>

This command turns noise cancellation on and off.

If noise cancellation is on, the R&S FSVR performs a reference measurement to determine its inherent noise and subtracts the result from the channel power measurement result (first active trace only).

The inherent noise of the instrument depends on the selected center frequency, resolution bandwidth and level setting. Therefore, the correction function is disabled whenever one of these parameters is changed. A corresponding message is displayed on the screen. Noise correction must be turned on again manually after the change.

Parameters:

<Mode>

ON

Performs noise correction.

OFF

Performs no noise correction.

AUTO

Performs noise correction.

After a parameter change, noise correction is restarted automatically and a new correction measurement is performed.

*RST: OFF

Example:

POW:NCOR ON

Manual operation: See ["Noise Correction"](#) on page 72**[SENSe:]POWer:TRACe <TraceNumber>**

This command assigns the channel/adjacent channel power measurement to the indicated trace. The corresponding trace must be active, i.e. its state must be different from blank.

Note: The measurement of the occupied bandwidth (OBW) is performed on the trace on which marker 1 is positioned. To evaluate another trace, marker 1 must be positioned to another trace with [CALCulate<n>:MARKer<m>:TRACe](#).

Parameters:

<TraceNumber>

1 to 6

Example:

POW:TRAC 2

Assigns the measurement to trace 2.

Manual operation: See ["Select Trace"](#) on page 173**SENSe:SFM Subsystem**

The [SENSe:]SFM subsystem contains commands for the definition of frequency and level settings when measuring the specific channels of FM stereo signals.

| | |
|--|-----|
| [SENSe:]SFM:FILTer<n>:AOFF | 856 |
| [SENSe:]SFM:STATe | 856 |
| [SENSe:]SFM:REFerence | 856 |
| [SENSe:]SFM:<ChannelType>:AFSPectrum:TYPE | 857 |
| [SENSe:]SFM:<ChannelType>:AFSPectrum:RESult? | 857 |
| [SENSe:]SFM:<ChannelType>:FILTer:AWEighted[:STATe] | 858 |
| [SENSe:]SFM:<ChannelType>:FILTer:CCITt:STATe | 858 |
| [SENSe:]SFM:<ChannelType>:FILTer:CCIR[:UNWeighted][:STATe] | 858 |
| [SENSe:]SFM:<ChannelType>:FILTer:CCIR:WEIGhted[:STATe] | 859 |
| [SENSe:]SFM:<ChannelType>:FILTer:COUPling | 859 |

| | |
|---|-----|
| [SENSe:]SFM:<ChannelType>:FILTer:DEMPHasis:STATe..... | 859 |
| [SENSe:]SFM:<ChannelType>:FILTer:DEMPHasis:TCONstant..... | 860 |
| [SENSe:]SFM:<ChannelType>:FILTer:HPASs:STATe..... | 860 |
| [SENSe:]SFM:<ChannelType>:FILTer:HPASs:FREQUency..... | 861 |
| [SENSe:]SFM:<ChannelType>:FILTer:LPASs:STATe..... | 861 |
| [SENSe:]SFM:<ChannelType>:FILTer:LPASs:FREQUency..... | 861 |
| [SENSe:]SFM:<ChannelType>:FILTer:LPASs:FREQUency[ABSolute]..... | 862 |
| [SENSe:]SFM:<ChannelType>:FILTer:LPASs:FREQUency:RELative..... | 862 |
| [SENSe:]SFM:<ChannelType>:RSUMmary:COUPLing..... | 862 |
| [SENSe:]SFM:<ChannelType>:RSUMmary:DETECTOR[:FUNCTion]..... | 863 |
| [SENSe:]SFM:<ChannelType>:RSUMmary:MODE..... | 864 |
| [SENSe:]SFM:<ChannelType>:RSUMmary:REFerence[:AUTO] ONCE..... | 864 |
| [SENSe:]SFM:<ChannelType>:TDOmain:RESult?..... | 865 |
| [SENSe:]SFM:<ChannelType>:TDOmain:TYPE..... | 865 |

[SENSe:]SFM:FILTer<n>:AOFF

This command switches all AF filters off.

Suffix:

<n> 1...4
 window

Example: SENS:SFM:FILT:AOFF

Usage: Event

Mode: SFM

[SENSe:]SFM:STATe <State>

This command switches between Stereo FM and Spectrum mode.

Parameters:

<State> **ON | OFF**
 *RST: OFF

Example: SFM:STAT ON

Mode: SFM

[SENSe:]SFM:REFerence <Level>

This command defines the reference deviation required for relative deviation measurements. Alternatively, it can be defined automatically, see e.g. [SENSe:]SFM:<ChannelType>:RSUMmary:REFerence[:AUTO] ONCE on page 864.

Parameters:

<Level> **<numeric value> in Hz or dBm**
 *RST: -10.0 dBm

Example: SFM:REF 2Hz

Mode: SFM

Manual operation: See ["Result Summary Setup"](#) on page 392

[SENSe:]SFM:<ChannelType>:AFSPectrum:TYPE <TraceMode>

This command selects the trace modes of the FM stereo AF spectrum to be measured simultaneously. For each trace a mode can be defined, however only if the specified channel is currently displayed in one of the four screens. If a trace mode is set for a channel that is not displayed, a query error is generated.

Suffix:

<ChannelType> LEFT | RIGHT | MPX | MONO | STEReo | RDS | PILot
Channel type for which the command is performed.

Parameters:

<TraceMode> <TraceMode1>, <TraceMode2>, <TraceMode3>, <TraceMode4>, <TraceMode5>, <TraceMode6>

WRITE | AVERage | MAXHold | MINHold | VIEW | OFF

For details on trace modes see [chapter 5.4.1, "Trace Mode Result Types"](#), on page 423.

*RST: OFF,OFF,OFF,OFF,OFF,OFF

Example:

SFM:LEFT:AFSP:TYPE WRIT,OFF,AVER

Mode: SFM

[SENSe:]SFM:<ChannelType>:AFSPectrum:RESult? <TraceMode>

This command reads the AF spectrum result data of the FM stereo signal in the specified trace mode. The data format of the output data block is defined by the FORMat command (see [chapter 5.4.2, "Formats for Returned Values: ASCII Format and Binary Format"](#), on page 423).

The output units are described in [CALCulate<n>:MARKer<m>:PEXCursion](#) on page 616.

Suffix:

<ChannelType> LEFT | RIGHT | MPX | MONO | STEReo | RDS | PILot
Channel type for which the command is performed.

Query parameters:

<TraceMode> WRITE

At least one screen must display a channel with the specified channel type that has the trace mode "Write" specified using [\[SENSe:\]ADEMod:AM\[:ABSolute\] \[:TDOMain\] \[:TYPE\]](#) on page 756. Otherwise a query error is generated.

Example:

SFM:LEFT:AFSP:RES MINH

Returns the minimum value in the left channel after a series of measurements.

Usage: Query only

Mode: SFM

[SENSe:]SFM:<ChannelType>:FILTer:AWeighted[:STATe] <State>

This command activates/deactivates the weighted CCIR filter for the specified channel type.

For details on the weighted "A" filter see "[A Weighted](#)" on page 340.

Suffix:

<ChannelType> LEFT | RIGHT | MPX | MONO | STEReo | RDS | PILot
Channel type for which the command is performed.

Parameters:

<State> ON | OFF
*RST: OFF

Example: SFM:LEFT:FILT:AWEI ON

Mode: SFM

Manual operation: See "[A Weighted](#)" on page 340

[SENSe:]SFM:<ChannelType>:FILTer:CCITt:STATe <State>

This command activates/deactivates the CCIT (CCIT P.53) weighting filter for the specified channel type.

For details on the CCIT filter see "[CCITT](#)" on page 339.

Suffix:

<ChannelType> LEFT | RIGHT | MPX | MONO | STEReo | RDS | PILot
Channel type for which the command is performed.

Parameters:

<State> ON | OFF
*RST: OFF

Example: SFM:LEFT:FILT:CCIT:STAT ON

Mode: SFM

Manual operation: See "[CCITT](#)" on page 339

[SENSe:]SFM:<ChannelType>:FILTer:CCIR[:UNWeighted][:STATe] <State>

This command activates/deactivates the unweighted CCIR filter for the specified channel type.

For details on the unweighted CCIR filter see "[CCIR Unweighted](#)" on page 340.

Suffix:

<ChannelType> LEFT | RIGHT | MPX | MONO | STEReo | RDS | PILot
Channel type for which the command is performed.

Parameters:

<State> **ON | OFF**
 *RST: OFF

Example:

SFM:LEFT:FILT:CCIR ON

Mode:

SFM

Manual operation: See "[CCIR Unweighted](#)" on page 340

[SENSe:]SFM:<ChannelType>:FILTer:CCIR:WEIGhted[:STATe] <State>

This command activates/deactivates the weighted CCIR filter for the specified channel type.

For details on the weighted CCIR filter see "[CCIR Weighted](#)" on page 340.

Suffix:

<ChannelType> LEFT | RIGHT | MPX | MONO | STEReo | RDS | PILot
 Channel type for which the command is performed.

Parameters:

<State> **ON | OFF**
 *RST: OFF

Example:

SFM:LEFT:FILT:CCIR:WEIG ON

Mode:

SFM

Manual operation: See "[CCIR Weighted](#)" on page 340

[SENSe:]SFM:<ChannelType>:FILTer:COUPling <State>

This command couples the filter settings for the specified channel type to other channels. The filter settings for all channels for which this setting is set to "ON" are defined identically.

Suffix:

<ChannelType> LEFT | RIGHT | MPX | MONO | STEReo | RDS | PILot
 Channel type for which the command is performed.

Parameters:

<State> **ON | OFF**
 *RST: OFF

Example:

SFM:LEFT:FILT:COUP ON

Mode:

SFM

[SENSe:]SFM:<ChannelType>:FILTer:DEMPhasis:STATe <State>

This command activates/deactivates the selected deemphasis for the specified channel type.

Suffix:
 <ChannelType> LEFT | RIGHT | MPX | MONO | STEReo | RDS | PILot
 Channel type for which the command is performed.

Parameters:
 <State> ON | OFF
 *RST: OFF

Example: SFM:LEFT:FILT:DEMP:STAT ON

Mode: SFM

Manual operation: See "[Deemphasis](#)" on page 340

[SENSe:]SFM:<ChannelType>:FILTer:DEMPHasis:TCONstant <Value>

This command selects the deemphasis for the specified channel type. For details on deemphasis refer to "[Deemphasis](#)" on page 340.

Suffix:
 <ChannelType> LEFT | RIGHT | MPX | MONO | STEReo | RDS | PILot
 Channel type for which the command is performed.

Parameters:
 <Value> 25 us | 50 us | 75 us | 750 us
 *RST: 50 us

Example: SFM:LEFT:FILT:DEMP:TCON 75us

Mode: SFM

Manual operation: See "[Deemphasis](#)" on page 340

[SENSe:]SFM:<ChannelType>:FILTer:HPASs:STATE <State>

This command activates/deactivates the selected high pass filter for the specified channel type.

For details on the high pass filter refer to "[High Pass](#)" on page 338.

Suffix:
 <ChannelType> LEFT | RIGHT | MPX | MONO | STEReo | RDS | PILot
 Channel type for which the command is performed.

Parameters:
 <State> ON | OFF
 *RST: OFF

Example: SFM:LEFT:FILT:HPAS:STAT ON

Mode: SFM

[SENSe:]SFM:<ChannelType>:FILTer:HPASs:FREQuency <FilterType>

This command selects the high pass filter type for the specified channel type. For details on filters refer to "[Deemphasis](#)" on page 340.

Suffix:

<ChannelType> LEFT | RIGHT | MPX | MONO | STEReo | RDS | PILot
Channel type for which the command is performed.

Parameters:

<FilterType> Range: 50 to 300
*RST: 300Hz
Default unit: Hz

Example: SFM:LEFT:FILT:HPAS:FREQ 300Hz

Mode: SFM

[SENSe:]SFM:<ChannelType>:FILTer:LPASs:STATe <State>

This command activates the low pass filter for the specified channel type.

For details on the low pass filter refer to "[Low Pass](#)" on page 339.

Suffix:

<ChannelType> LEFT | RIGHT | MPX | MONO | STEReo | RDS | PILot
Channel type for which the command is performed.

Parameters:

<State> ON | OFF
*RST: OFF

Example: SFM:LEFT:FILT:LPAS:STAT ON

Mode: SFM

Manual operation: See "[Low Pass](#)" on page 339

[SENSe:]SFM:<ChannelType>:FILTer:LPASs:FREQuency <Level>

This command activates/deactivates the selected low pass filter for the specified channel type.

For details on the low pass filter refer to "[Low Pass](#)" on page 339.

Suffix:

<ChannelType> LEFT | RIGHT | MPX | MONO | STEReo | RDS | PILot
Channel type for which the command is performed.

Parameters:

<Level> <numeric value>
*RST: RST value

Example: SFM:LEFT:FILT:LPAS:FREQ 10

Mode: SFM

Manual operation: See "[Low Pass](#)" on page 339

[SENSe:]SFM:<ChannelType>:FILTer:LPASs:FREQuency[:ABSolute] <FilterType>

This command selects the absolute low pass filter type in the specified window. For details on filters refer to "[Low Pass](#)" on page 339.

For details about the demodulation bandwidth range refer to "[Demod BW](#)" on page 338.

Suffix:

<n> 1...4
 window

Parameters:

<FilterType> 3kHz | 15kHz | 150kHz
 *RST: 15kHz

Example:

SFM:LEFT:FILT:LPAS:FREQ 150kHz
Selects the low pass filter for the demodulation bandwidth range from 400 kHz to 16 MHz.

Mode: SFM

[SENSe:]SFM:<ChannelType>:FILTer:LPASs:FREQuency:RELative <FilterType>

This command selects the relative low pass filter type in the specified window. For details on filters refer to [Low Pass](#) softkey.

For details about the demodulation bandwidth range refer to "[Demod BW](#)" on page 338.

Suffix:

<n> 1...4
 window

Parameters:

<FilterType> 5PCT | 10PCT | 25PCT
 *RST: 25PCT

Example:

SFM:LEFT:FILT:LPAS:FREQ 25PCT
Selects the low pass filter as 25 % of the demodulation bandwidth.

Mode: SFM

[SENSe:]SFM:<ChannelType>:RSUMmary:COUPling <State>

This command couples the channel settings to other channels, i.e. channels for which this command is set to "ON" are configured identically.

Suffix:
 <ChannelType> LEFT | RIGHT | MPX | MONO | STEReo | RDS | PILot
 Channel type for which the command is performed.

Parameters:
 <State> ON | OFF
 *RST: OFF

Example: SFM:LEFT:RSUM:COUP ON

Mode: SFM

Manual operation: See "Result Summary Setup" on page 392
 See "Coupled" on page 393

[SENSe:]SFM:<ChannelType>:RSUMmary:DETEctor[:FUNCTion] <Detector>

This command defines the detector used to determine the deviation value of the left channel of the FM stereo signal in the result summary.

Suffix:
 <ChannelType> LEFT | RIGHT | MPX | MONO | STEReo | RDS | PILot
 Channel type for which the command is performed.

Parameters:
 <Detector> RMS | SRMS | PPEak | NPEak | PAverage | QPEak | SQPeak
RMS
 RMS
SRMS
 RMS*SQRT2
PPEak
 Positive peak
NPEak
 Negative peak
PAverage
 \pm Peak/2
QPEak
 Quasipeak CCIR
SQPeak
 Quasipeak*SQRT2
 *RST: PAverage

Example: SFM:LEFT:RSUM:DET PPE
 Sets the detector for the left channel to positive peak.

Mode: SFM

Manual operation: See "Result Summary Setup" on page 392
 See "Detector" on page 393

[SENSe:]SFM:<ChannelType>:RSUMmary:MODE <Mode>

This command defines the result summary mode for the absolute and relative deviation. It does not affect the trace mode.

Suffix:

<ChannelType> LEFT | RIGHT | MPX | MONO | STEReo | RDS | PILot
Channel type for which the command is performed.

Parameters:

<Mode> WRITe | AVERAge | PHOLd

WRITe

Clear Write: Overwrite mode; the summary is overwritten by each sweep.

AVERAge

The average is formed over several sweeps. The number of sweeps is defined by the sweep count (see [SENSe:]SWEep:COUNT on page 866 or [SENSe:]AVERAge<n>:COUNT on page 779).

PHOLd

Peak hold: The maximum values are determined over several sweeps and displayed. The number of sweeps is defined by the sweep count (see [SENSe:]SWEep:COUNT on page 866 or [SENSe:]AVERAge<n>:COUNT on page 779).

*RST: WRITe

Example:

AVER:COUN 16

Sets the number of measurements to 16.

SFM:LEFT:RSUM:MODE PHOL

Sets the result summary mode for the left channel to peak hold. The maximum value during 16 measurements is displayed in the result summary.

Mode: SFM

Manual operation: See "Result Summary Setup" on page 392
See "Mode" on page 393

[SENSe:]SFM:<ChannelType>:RSUMmary:REFerence[:AUTO] ONCE

This command determines the reference deviation from the current channel measurement.

Suffix:

<ChannelType> LEFT | RIGHT | MPX | MONO | STEReo | RDS | PILot
Channel type for which the command is performed.

Example: SFM:LEFT:RSUM:REF ONCE

Mode: SFM

Manual operation: See "Result Summary Setup" on page 392
See "Meas To Ref" on page 394

[SENSe:]SFM:<ChannelType>:TDOMain:RESult? <TraceMode>

This command reads the result data of the FM stereo signal in zero span in the specified trace mode. The data format of the output data block is defined by the FORMat command (see [chapter 5.4.2, "Formats for Returned Values: ASCII Format and Binary Format"](#), on page 423).

The output units are described in [CALCulate<n>:MARKer<m>:PEXCursion](#) on page 616.

Suffix:

<ChannelType> LEFT | RIGHT | MPX | MONO | STEReo | RDS | PILot
Channel type for which the command is performed.

Query parameters:

<TraceMode> WRITe

At least one screen must display a left channel that has the trace mode "Write" specified using [\[SENSe:\]ADEMod:AM\[:ABSolute\]\[:TDOMain\]\[:TYPE\]](#) on page 756. Otherwise a query error is generated.

Example:

SFM:LEFT:TDOM:RES WRIT

Returns the current trace results in the left channel.

Usage:

Query only

Mode:

SFM

[SENSe:]SFM:<ChannelType>:TDOMain:TYPE <TraceMode>

This command selects the trace modes of the FM stereo signal to be measured simultaneously in zero span. For each trace a mode can be defined, however only if the specified channel is currently displayed in one of the four screens. If a trace mode is set for a channel that is not displayed, a query error is generated.

Suffix:

<ChannelType> LEFT | RIGHT | MPX | MONO | STEReo | RDS | PILot
Channel type for which the command is performed.

Parameters:

<TraceMode> <TraceMode1>, <TraceMode2>, <TraceMode3>, <TraceMode4>, <TraceMode5>, <TraceMode6>

WRITe | AVERAge | MAXHold | MINHold | VIEW | OFF

For details on trace modes see [chapter 5.4.1, "Trace Mode Result Types"](#), on page 423.

*RST: OFF,OFF,OFF,OFF,OFF,OFF

Example:

SFM:LEFT:TDOM:TYPE WRIT,OFF,AVER

Mode:

SFM

SENSe:SWEEp Subsystem

The SENSe:SWEEp subsystem controls the sweep parameters.

| | |
|--|-----|
| [SENSe:]SWEEp:COUNT..... | 866 |
| [SENSe:]SWEEp:COUNT:CURRent?..... | 866 |
| [SENSe:]SWEEp:EGATe..... | 867 |
| [SENSe:]SWEEp:EGATe:HOLDoff..... | 867 |
| [SENSe:]SWEEp:EGATe:LENGth..... | 868 |
| [SENSe:]SWEEp:EGATe:POLarity..... | 868 |
| [SENSe:]SWEEp:EGATe:SOURce..... | 868 |
| [SENSe:]SWEEp:EGATe:TRACe<k>:COMMeNt..... | 869 |
| [SENSe:]SWEEp:EGATe:TRACe<k>[:STATe<range>]..... | 869 |
| [SENSe:]SWEEp:EGATe:TRACe<k>:STARt<range>..... | 869 |
| [SENSe:]SWEEp:EGATe:TRACe<k>:STOP<range>..... | 870 |
| [SENSe:]SWEEp:EGATe:TRACe<k>:PERiod..... | 870 |
| [SENSe:]SWEEp:EGATe:TYPE..... | 871 |
| [SENSe<n>]:SWEEp:FFT:WINDow:TYPE..... | 871 |
| [SENSe:]SWEEp:MODE..... | 872 |
| [SENSe:]SWEEp:POINts..... | 872 |
| [SENSe:]SWEEp:TIME..... | 872 |
| [SENSe:]SWEEp:TIME:AUTO..... | 873 |
| [SENSe:]SWEEp:TYPE..... | 873 |
| [SENSe:]SWEEp:TYPE:USED?..... | 873 |

[SENSe:]SWEEp:COUNT <NumberSweeps>

This command defines the number of sweeps started with single sweep, which are used for calculating the average or maximum value. If the values 0 or 1 are set, one sweep is performed.

Parameters:

<NumberSweeps> 0 to 32767
 *RST: 0 (GSM: 200, PHN:1)

Example:

```
SWEE:COUN 64
Sets the number of sweeps to 64.
INIT:CONT OFF
Switches to single sweep mode.
INIT;*WAI
Starts a sweep and waits for its end.
```

Manual operation: See "[Sweep Count](#)" on page 91

[SENSe:]SWEEp:COUNT:CURRent?

This query command returns the current number of started sweeps. A sweep count value should be set and the device should be in single sweep mode.

Example: SWE:COUNT 64
 Sets sweep count to 64
 INIT:CONT OFF
 Switches to single sweep mode
 INIT
 Starts a sweep (without waiting for the sweep end!)

Usage: Query only

[SENSe:]SWEep:EGATe <State>

This command switches on/off the sweep control by an external gate signal. If the external gate is selected the trigger source is automatically switched to EXTERNAL as well.

In case of measurement with external gate, the measured values are recorded as long as the gate is opened. During a sweep the gate can be opened and closed several times. The synchronization mechanisms with *OPC, *OPC? and *WAI remain completely unaffected.

The sweep end is detected when the required number of measurement points (691 in "Spectrum" mode) has been recorded.

Parameters:

<State> ON | OFF
 *RST: OFF

Example: SWE:EGAT ON
 Switches on the external gate mode.
 SWE:EGAT:TYPE EDGE
 Switches on the edge-triggered mode.
 SWE:EGAT:HOLD 100US
 Sets the gate delay to 100 µs.
 SWE:EGAT:LEN 500US
 Sets the gate opening time to 500 µs.
 INIT;*WAI
 Starts a sweep and waits for its end.

Manual operation: See ["Gated Trigger"](#) on page 114
 See ["Gated Trigger \(On/Off\)"](#) on page 235
 See ["Gate Ranges"](#) on page 235

[SENSe:]SWEep:EGATe:HOLDoff <DelayTime>

This command defines the delay time between the external gate signal and the continuation of the sweep.

Note: Using gate mode "level" (see [SENSe:]SWEep:EGATe:TYPE on page 871) and an IFP trigger (see TRIGger<n>[:SEQuence]:SOURce on page 913), the holdoff time for the IFP trigger is ignored for frequency sweep, FFT sweep, zero span and IQ mode measurements.

Parameters:

<DelayTime> 0 s to 30 s
 *RST: 0s

Example:

SWE:EGAT:HOLD 100us

Manual operation: See "Gate Delay" on page 115

[SENSe:]SWEep:EGATe:LENGth <TimeInterval>

This command defines a gate length.

Parameters:

<TimeInterval> 125 ns to 30 s
 *RST: 400µs

Example:

SWE:EGAT:LENG 10ms

Manual operation: See "Gate Length (Gate Mode Edge)" on page 115

[SENSe:]SWEep:EGATe:POLarity <Polarity>

This command determines the polarity of the external gate signal. The setting applies both to the edge of an edge-triggered signal and the level of a level-triggered signal.

Parameters:

<Polarity> POSitive | NEGative
 *RST: POSitive

Example:

SWE:EGAT:POL POS

Manual operation: See "Trg/Gate Polarity" on page 112
 See "Trigger Polarity" on page 295

[SENSe:]SWEep:EGATe:SOURce <Source>

This command selects the signal source for gated measurements.

If an IF power signal is used, the gate is opened as soon as a signal at > -20 dBm is detected within the IF path bandwidth (10 MHz).

For details see the "Trg/Gate Source" on page 109 softkey.

For details see the "Trigger Source" on page 372 softkey.

Parameters:

<Source> EXTernal | IFPower | VIDeo | RFPower | PSEN
 *RST: IFPower

Example: `SWE:EGAT:SOUR IFP`
Switches the gate source to IF power.

Manual operation: See ["Trg/Gate Source"](#) on page 109
See ["External"](#) on page 110
See ["Video"](#) on page 110
See ["RF Power"](#) on page 110
See ["IF Power/BB Power"](#) on page 111
See ["Power Sensor"](#) on page 111
See ["Gated Trigger"](#) on page 114
See ["Gated Trigger \(On/Off\)"](#) on page 235

[SENSe:]SWEep:EGATe:TRACe<k>:COMMeNt <Comment>

Defines a comment for one of the traces for gated triggering.

Suffix:
<k> 1...6
trace

Parameters:
<Comment>

Example: `SWE:EGAT:TRAC1:COMM "SlotA"`

Manual operation: See ["Gate Ranges"](#) on page 235

[SENSe:]SWEep:EGATe:TRACe<k>[:STATe<range>] <State>

This command activates or deactivates tracing for a specific range using gated triggering.

Suffix:
<k> 1...6
trace

<range> 1...3
range

Parameters:
<State> ON | OFF
*RST: OFF

Example: `SWE:EGAT:TRAC1:STAT1 ON`
Activates tracing for range 1 of trace 1.

Manual operation: See ["Gate Ranges"](#) on page 235

[SENSe:]SWEep:EGATe:TRACe<k>:STARt<range> <Value>

This command defines the starting point for the range to be traced using gated triggering.

Suffix:

<k> 1...6
trace

<range> 1...3
range

Parameters:

<Value> <numeric value>
*RST: OFF

Example:

SWE:EGAT:TRAC1:STAR1 3ms
Sets the Starting point for range 1 on trace 1 at 3 ms.

Manual operation: See "[Gate Ranges](#)" on page 235

[SENSe:]SWEep:EGATe:TRACe<k>: STOP<range> <Value>

This command defines the stopping point for the range to be traced using gated triggering

Suffix:

<k> 1...6
trace

<range> 1...3
range

Parameters:

<Value> <numeric value>
*RST: 1 μ s

Example:

SWE:EGAT:TRAC1:STOP1 5ms
Sets the stopping point for range 1 on trace 1 at 5 ms.

Manual operation: See "[Gate Ranges](#)" on page 235

[SENSe:]SWEep:EGATe:TRACe<k>: PERiod <Value>

This command defines the length of the period to be traced using gated triggering.

Suffix:

<k> 1...6
trace

Parameters:

<Value> <numeric value>
*RST: 0 s

Example:

SWE:EGAT:TRAC1:PER 5ms
Defines the period for gated triggering to 5 ms.

Manual operation: See "[Gate Ranges](#)" on page 235

[SENSe:]SWEep:EGATe:TYPE <Type>

This command sets the type of triggering by the external gate signal.

A delay between applying the gate signal and the start of recording measured values can be defined, see `[SENSe:]SWEep:EGATe:HOLDoff` on page 867.

Parameters:

<Type>

LEVel | EDGE

LEVel

The gate is level-triggered:

After detection of the gate signal, the gate remains open until the gate signal disappears. The gate opening time cannot be defined with the command `[SENSe:]SWEep:EGATe:HOLDoff`.

Note: Using gating with gate mode "level" and an IFP trigger (see `TRIGger<n>[:SEQuence]:SOURce` on page 913), the holdoff time for the IFP trigger is ignored for frequency sweep, FFT sweep, zero span and IQ mode measurements.

EDGE

The gate is edge-triggered:

After detection of the set gate signal edge, the gate remains open until the gate delay (`[SENSe:]SWEep:EGATe:HOLDoff`) has expired.

*RST: EDGE

Example:

`SWE:EGAT:TYPE EDGE`

Manual operation: See "Gate Mode (Lvl/Edge)" on page 114

[SENSe<n>]:SWEep:FFT:WINDow:TYPE <FFTWindow>

This command selects the type of FFT window that you want to use in realtime mode.

Parameters:

<FFTWindow>

BLACKharris

FLATtop

GAUSSian

HANNing

KAISerbessel

RECTangular

*RST: BLACKharris

Example:

`SWE:FFT:WIND:TYPE HANN`

Selects the Hanning FFT window.

Mode:

RT

[SENSe:]SWEep:MODE <Mode>

This command selects the spurious emission and spectrum emission mask measurements.

Parameters:

<Mode> AUTO | ESpectrum | LIST

AUTO

Switches to "Spectrum" measurement mode or stays in the current mode if it is not ESP/LIST

ESpectrum

"Spectrum Emission Mask" measurement mode

LIST

"Spurious Emissions" measurement mode

*RST: AUTO

Example:

SWE:MODE ESP

Sets the Spectrum Emission Mask measurement mode.

Manual operation: See ["Spectrum Emission Mask"](#) on page 153
 See ["Spurious Emissions"](#) on page 153
 See ["Spectrum Emission Mask"](#) on page 188
 See ["Spurious Emissions"](#) on page 219

[SENSe:]SWEep:POINTS <NumberPoints>

This command defines the number of measurement points to be collected during one sweep.

Note: For Spurious Emissions measurements the maximum number of sweep points in all ranges is limited to 100001.

Parameters:

<NumberPoints> Range: 101 to 32001

*RST: 691

Example:

SWE:POIN 251

Manual operation: See ["Sweep Points"](#) on page 91

[SENSe:]SWEep:TIME <Time>

This command defines the sweep time.

The range depends on the frequency span.

If this command is used in "Spectrum" mode, automatic coupling to resolution bandwidth and video bandwidth is switched off.

Parameters:

<Time> refer to data sheet

*RST: (automatic)

Example: `SWE:TIME 10s`

Manual operation: See ["Sweeptime Manual"](#) on page 81
 See ["Sweep Time"](#) on page 173
 See ["Meas Time"](#) on page 283

[SENSe:]SWEep:TIME:AUTO <State>

In realtime mode, this command automatically sets the sweep time to 32 ms.

In analyzer mode, this command controls the automatic coupling of the sweep time to the frequency span and bandwidth settings. If `[SENSe:]SWEep:TIME` is used, automatic coupling is switched off.

Parameters:

<State> ON | OFF
 *RST: ON

Example: `SWE:TIME:AUTO ON`
 Activates automatic sweep time.

Manual operation: See ["Sweeptime Manual"](#) on page 81
 See ["Sweeptime Auto"](#) on page 82
 See ["Default Coupling"](#) on page 85

[SENSe:]SWEep:TYPE <Type>

This command selects the sweep type.

Parameters:

<Type> **SWE**
 Selects analog frequency sweeps.
AUTO
 Automatically selects the sweep type (FFT or analog frequency sweep).
FFT
 Selects FFT sweeps.
 *RST: AUTO

Example: `SWE:TYPE FFT`
 Selects FFT sweeps.

Manual operation: See ["Sweep"](#) on page 78
 See ["FFT"](#) on page 78
 See ["Auto"](#) on page 78

[SENSe:]SWEep:TYPE:USED?

This command queries the sweep type if you have turned on automatic selection of the sweep type.

Return values:

<Type> SWE | FFT
SWE
 Normal sweep
FFT
 FFT mode
 *RST: SWE

Example: SWE:TYPE:USED?

Usage: Query only

SENSe:[WINDow:]DETECTOR Subsystem

The SENSE:DETECTOR subsystem controls the acquisition of measurement data via the selection of the detector for the corresponding trace.

[SENSe:][WINDow:]DETECTOR<trace>[:FUNCTION].....874
 [SENSe:][WINDow:]DETECTOR<trace>[:FUNCTION]:AUTO.....875

[SENSe:][WINDow:]DETECTOR<trace>[:FUNCTION] <Function>

This command selects the detector for the data acquisition in the selected trace.

Suffix:

<trace> 1...6
 Selects the trace.
 <trace> 1...6
 trace

Parameters:

<Function> APEak | NEGative | POSitive | SAMPlE | RMS | AVERAge |
 QPEak | CAVERage | CRMS
 *RST: APEak

Example: DET POS
 Sets the detector to "positive peak".

Manual operation: See "Auto Peak" on page 97
 See "Positive Peak" on page 97
 See "Negative Peak" on page 97
 See "Sample" on page 97
 See "RMS" on page 97
 See "Average" on page 97
 See "Quasipeak" on page 97
 See "CISPR Average" on page 97
 See "RMS Average" on page 98

[SENSe:][WINDow:]DETEctor<trace>[:FUNction]:AUTO <State>

This command either couples the detector to the current trace setting or turns coupling off.

Suffix:

<trace> 1...6
 trace

Parameters:

<State> ON | OFF
 *RST: ON

Example: DET:AUTO OFF

Manual operation: See "Auto Select" on page 96

8.2.3.16 STATus:QUEStionable Subsystem

The STATus subsystem contains the commands for the status reporting system (for details refer to [chapter 8.1.6, "Status Reporting System"](#), on page 530). *RST does not influence the status registers.

The STATus:QUEStionable subsystem contains information about the observance of limits during adjacent power measurements, the reference and local oscillator, the observance of limit lines and limit margins and possible overloads of the unit.

| | |
|---|-----|
| STATus:QUEStionable:ACPLimit[:EVENT]?..... | 876 |
| STATus:QUEStionable:ACPLimit:CONDition?..... | 876 |
| STATus:QUEStionable:ACPLimit:ENABle..... | 876 |
| STATus:QUEStionable:ACPLimit:NTRansition..... | 877 |
| STATus:QUEStionable:ACPLimit:PTRansition..... | 877 |
| STATus:QUEStionable:DIQ:CONDition?..... | 877 |
| STATus:QUEStionable:DIQ[:EVENT]?..... | 877 |
| STATus:QUEStionable:DIQ:ENABle..... | 878 |
| STATus:QUEStionable:DIQ:NTRansition..... | 878 |
| STATus:QUEStionable:DIQ:PTRansition..... | 878 |
| STATus:QUEStionable:FREQuency:CONDition?..... | 878 |
| STATus:QUEStionable:FREQuency:ENABle..... | 878 |
| STATus:QUEStionable:FREQuency[:EVENT]?..... | 879 |
| STATus:QUEStionable:FREQuency:NTRansition..... | 879 |
| STATus:QUEStionable:FREQuency:PTRansition..... | 879 |
| STATus:QUEStionable:LIMit<m> [:EVENT]?..... | 879 |
| STATus:QUEStionable:LIMit<m>:CONDition?..... | 880 |
| STATus:QUEStionable:LIMit<m>:ENABle..... | 880 |
| STATus:QUEStionable:LIMit<m>:NTRansition..... | 880 |
| STATus:QUEStionable:LIMit<m>:PTRansition..... | 881 |
| STATus:QUEStionable:LMARgin<m>[:EVENT]?..... | 881 |
| STATus:QUEStionable:LMARgin<m>:CONDition?..... | 881 |
| STATus:QUEStionable:LMARgin<m>:ENABle..... | 882 |
| STATus:QUEStionable:LMARgin<m>:NTRansition..... | 882 |
| STATus:QUEStionable:LMARgin<m>:PTRansition..... | 883 |

| | |
|--|-----|
| <code>STATus:QUEStionable:POWer[:EVENT]?</code> | 883 |
| <code>STATus:QUEStionable:POWer:CONDition?</code> | 883 |
| <code>STATus:QUEStionable:POWer:ENABle</code> | 883 |
| <code>STATus:QUEStionable:POWer:NTRansition</code> | 884 |
| <code>STATus:QUEStionable:POWer:PTRansition</code> | 884 |
| <code>STATus:QUEStionable:SYNC[:EVENT]?</code> | 884 |
| <code>STATus:QUEStionable:SYNC:CONDition?</code> | 884 |
| <code>STATus:QUEStionable:SYNC:ENABle</code> | 885 |
| <code>STATus:QUEStionable:SYNC:NTRansition</code> | 885 |
| <code>STATus:QUEStionable:SYNC:PTRansition</code> | 885 |
| <code>STATus:QUEStionable:TIME:CONDition?</code> | 885 |
| <code>STATus:QUEStionable:TIME:ENABle</code> | 886 |
| <code>STATus:QUEStionable:TIME[:EVENT]?</code> | 886 |
| <code>STATus:QUEStionable:TIME:NTRansition</code> | 886 |
| <code>STATus:QUEStionable:TIME:PTRansition</code> | 886 |

STATus:QUEStionable:ACPLimit[:EVENT]?

This command queries the contents of the "EVENT" part of the `STATus:QUEStionable:ACPLimit` register. Readout deletes the contents of the "EVENT" part.

Example: `STAT:QUES:ACPL?`

Usage: Query only

Mode: all

STATus:QUEStionable:ACPLimit:CONDition?

This command queries the contents of the "CONDition" part of the `STATus:QUEStionable:ACPLimit` register (see "[STATus:QUEStionable:ACPLimit Register](#)" on page 537). Readout does not delete the contents of the "CONDition" part.

Example: `STAT:QUES:ACPL:COND?`

Usage: Query only

Mode: all

STATus:QUEStionable:ACPLimit:ENABle <BitDefinition>

This command sets the bits of the "ENABle" part of the `STATus:QUEStionable:ACPLimit` register. The "ENABle" register selectively enables the individual events of the associated "EVENT" part for the summary bit.

Parameters:

<BitDefinition> 0 to 65535

Example: `STAT:QUES:ACPL:ENAB 65535`

Mode: all

STATus:QUESTionable:ACPLimit:NTRansition <BitDefinition>

This command sets the edge detectors of all bits of the `STATus:QUESTionable:ACPLimit` register from 1 to 0 for the transitions of the "CONDition" bit.

Parameters:

<BitDefinition> 0 to 65535

Example:

`STAT:QUES:ACPL:NTR 65535`

Mode:

all

STATus:QUESTionable:ACPLimit:PTRansition <BitDefinition>

This command sets the edge detectors of all bits of the `STATus:QUESTionable:ACPLimit` register from 0 to 1 for the transitions of the "CONDition" bit.

Parameters:

<BitDefinition> 0 to 65535

Example:

`STAT:QUES:ACPL:PTR 65535`

Mode:

all

STATus:QUESTionable:DIQ:CONDition?

This command queries the contents of the "CONDition" part of the `STATus:QUESTionable:DIQ` register for IQ measurements (see "[STATus:QUESTionable:DIQ Register](#)" on page 537). Readout does not delete the contents of the "CONDition" part.

Example:

`STAT:QUES:DIQ:COND?`

Usage:

Query only

Mode:

IQ

STATus:QUESTionable:DIQ[:EVENT]?

This command queries the contents of the "EVENT" part of the `STATus:QUESTionable:DIQ` register for IQ measurements.

Readout deletes the contents of the "EVENT" part.

Example:

`STAT:QUES:DIQ?`

Usage:

Query only

Mode:

IQ

STATus:QUESTionable:DIQ:ENABLE <Enable>**Setting parameters:**

<Enable> numeric value

Usage: SCPI confirmed**Mode:** all

STATus:QUESTionable:DIQ:NTRansition <NTransition>**Setting parameters:**

<NTransition> numeric value

Usage: SCPI confirmed**Mode:** all

STATus:QUESTionable:DIQ:PTRansition <PTransition>**Setting parameters:**

<PTransition> numeric value

Usage: SCPI confirmed**Mode:** all

STATus:QUESTionable:FREQuency:CONDition?

This command queries the contents of the "CONDition" part of the `STATus:QUESTionable:FREQuency` register (see "[STATus:QUESTionable:FRE-Quency Register](#)" on page 538). Readout does not delete the contents of the "CONDition" part.

Example: `STAT:QUES:FREQ:COND?`**Usage:** Query only**Mode:** all

STATus:QUESTionable:FREQuency:ENABLE <BitDefinition>

This command sets the bits of the "ENABLE" part of the `STATus:QUESTionable:FREQuency` register. The "ENABLE" register selectively enables the individual events of the associated "EVENT" part for the summary bit.

Parameters:

<BitDefinition> 0 to 65535

Example: `STAT:QUES:FREQ:ENAB 65535`**Mode:** all

STATus:QUESTionable:FREQuency[:EVENT]?

This command queries the contents of the "EVENT" part of the `STATus:QUESTionable:FREQuency` register.

Readout deletes the contents of the "EVENT" part.

Example: `STAT:QUES:FREQ?`

Usage: Query only

Mode: all

STATus:QUESTionable:FREQuency:NTRansition <BitDefinition>

This command sets the edge detectors of all bits of the `STATus:QUESTionable:FREQuency` register from 1 to 0 for the transitions of the "CONDition" bit.

Parameters:

<BitDefinition> 0 to 65535

Example: `STAT:QUES:FREQ:NTR 65535`

Mode: all, except NF

STATus:QUESTionable:FREQuency:PTRansition <BitDefinition>

This command sets the edge detectors of all bits of the `STATus:QUESTionable:FREQuency` register from 0 to 1 for the transitions of the "CONDition" bit.

Parameters:

<BitDefinition> 0 to 65535

Example: `STAT:QUES:FREQ:PTR 65535`

Mode: all, except NF

STATus:QUESTionable:LIMit<m> [:EVENT]?

This command queries the contents of the "EVENT" part of the `STATus:QUESTionable:LIMit` register. Readout deletes the contents of the "EVENT" part.

Suffix:

<m> 1...4
window

For applications that do not have more than one measurement window, the suffix <1...4> is irrelevant.

Example: `STAT:QUES:LIM?`

Usage: Query only

Mode: all

STATus:QUESTionable:LIMit<m>:CONDition?

This command queries the contents of the "CONDition" part of the `STATus:QUESTionable:LIMit` register (see "[STATus:QUESTionable:LIMit Register](#)" on page 539).

Readout does not delete the contents of the "CONDition" part.

Suffix:

<m> 1...4
window
For applications that do not have more than one measurement window, the suffix <1...4> is irrelevant.

Example: `STAT:QUES:LIM:COND?`

Usage: Query only

Mode: all

STATus:QUESTionable:LIMit<m>:ENABLE <BitDefinition>

This command sets the bits of the "ENABLE" part of the `STATus:QUESTionable` register. The "ENABLE" register selectively enables the individual events of the associated "EVENT" part for the summary bit.

Suffix:

<m> 1...4
window
For applications that do not have more than one measurement window, the suffix <1...4> is irrelevant.

Parameters:

<BitDefinition> 0 to 65535

Example: `STAT:QUES:LIM:ENAB 65535`

Mode: all

STATus:QUESTionable:LIMit<m>:NTRansition <BitDefinition>

This command sets the edge detectors of all bits of the `STATus:QUESTionable:LIMit` register from 1 to 0 for the transitions of the "CONDition" bit.

Suffix:

<m> 1...4
window
For applications that do not have more than one measurement window, the suffix is irrelevant.

Parameters:**<BitDefinition>** 0 to 65535**Example:**

STAT:QUES:LIM:NTR 65535

Mode:

all, except NF

STATus:QUESTionable:LIMit<m>:PTRansition <BitDefinition>

This command sets the edge detectors of all bits of the

STATus:QUESTionable:LIMit register from 0 to 1 for the transitions of the "CONDition" bit.

Suffix:

<m> 1...4
window

For applications that do not have more than one measurement window, the suffix is irrelevant.

Parameters:**<BitDefinition>** 0 to 65535**Example:**

STAT:QUES:LIM:PTR 65535

Mode:

all, except NF

STATus:QUESTionable:LMARgin<m>[:EVENT]?

This command queries the contents of the "EVENT" part of the

STATus:QUESTionable:LMARgin register. Readout deletes the contents of the "EVENT" part.

Suffix:

<m> 1...4
window

For applications that do not have more than one measurement window, the suffix is irrelevant.

Example:

STAT:QUES:LMAR?

Usage:

Query only

Mode:

all

STATus:QUESTionable:LMARgin<m>:CONDition?

This command queries the contents of the "CONDition" part of the

STATus:QUESTionable:LMARgin register (see "[STATus:QUESTionable:LMARgin Register](#)" on page 539). Readout does not delete the contents of the "CONDition" part.

| | |
|-----------------|--|
| Suffix: | |
| <m> | 1...4
window
For applications that do not have more than one measurement window, the suffix is irrelevant. |
| Example: | STAT:QUES:LMAR:COND? |
| Usage: | Query only |
| Mode: | all |

STATus:QUESTionable:LMARgin<m>:ENABLE <BitDefinition>

This command sets the bits of the "ENABLE" part of the STATus:QUESTionable:LMARgin register. The "ENABLE" register selectively enables the individual events of the associated "EVENT" part for the summary bit.

| | |
|--------------------|--|
| Suffix: | |
| <m> | 1...4
window
For applications that do not have more than one measurement window, the suffix is irrelevant. |
| Parameters: | |
| <BitDefinition> | 0 to 65535 |
| Example: | STAT:QUES:LMAR:ENAB 65535 |
| Mode: | all |

STATus:QUESTionable:LMARgin<m>:NTRansition <BitDefinition>

This command sets the edge detectors of all bits of the STATus:QUESTionable:LMARgin register from 1 to 0 for the transitions of the "CONDition" bit.

| | |
|--------------------|--|
| Suffix: | |
| <m> | 1...4
window
For applications that do not have more than one measurement window, the suffix is irrelevant. |
| Parameters: | |
| <BitDefinition> | 0 to 65535 |
| Example: | STAT:QUES:LMAR:NTR 65535 |
| Mode: | all |

STATus:QUESTionable:LMARgin<m>:PTRansition <BitDefinition>

This command sets the edge detectors of all bits of the `STATus:QUESTionable:LMARgin` register from 0 to 1 for the transitions of the "CONDition" bit.

Suffix:

<m> 1...4
window
For applications that do not have more than one measurement window, the suffix is irrelevant.

Parameters:

<BitDefinition> 0 to 65535

Example: `STAT:QUES:LMAR:PTR 65535`

Mode: all

STATus:QUESTionable:POWER[:EVENT]?

This command queries the contents of the "EVENT" part of the `STATus:QUESTionable:POWER` register. Readout deletes the contents of the "EVENT" part.

Example: `STAT:QUES:POW?`

Usage: Query only
SCPI confirmed

Mode: all

STATus:QUESTionable:POWER:CONDition?

This command queries the contents of the "CONDition" part of the `STATus:QUESTionable:POWER` register (see ["STATus:QUESTionable:POWER Register"](#) on page 540). Readout does not delete the contents of the "CONDition" part.

Example: `STAT:QUES:POW:COND?`

Usage: Query only
SCPI confirmed

Mode: all

STATus:QUESTionable:POWER:ENABLE <BitDefinition>

This command sets the bits of the "ENABLE" part of the `STATus:QUESTionable:POWER` register. The "ENABLE" register selectively enables the individual events of the associated "EVENT" part for the summary bit.

Parameters:

<BitDefinition> 0 to 65535

Example: STAT:QUES:POW:ENAB 65535
Usage: SCPI confirmed
Mode: all

STATus:QUESTionable:POWer:NTRansition <BitDefinition>

This command sets the edge detectors of all bits of the STATus:QUESTionable:POWer register from 1 to 0 for the transitions of the "CONDition" bit.

Parameters:
 <BitDefinition> 0 to 65535
Example: STAT:QUE:POWS:NTR 65535
Usage: SCPI confirmed
Mode: all

STATus:QUESTionable:POWer:PTRansition <BitDefinition>

This command sets the edge detectors of all bits of the STATus:QUESTionable:POWer register from 0 to 1 for the transitions of the "CONDition" bit.

Parameters:
 <BitDefinition> 0 to 65535
Example: STAT:QUES:POW:PTR 65535
Usage: SCPI confirmed
Mode: all

STATus:QUESTionable:SYNC[:EVENT]?

This command queries the contents of the "EVENT" part of the STATus:QUESTionable:SYNC register. For details see the description for the individual firmware applications.

Readout deletes the contents of the "EVENT" part.

Example: STAT:QUES:SYNC?
Usage: Query only
Mode: This command is required by the firmware applications only.

STATus:QUESTionable:SYNC:CONDition?

This command queries the contents of the "CONDition" part of the STATus:QUESTionable:SYNC register. For details see the description for the individual firmware applications.

Readout does not delete the contents of the "CONDition" part.

Example: STAT:QUES:SYNC:COND?

Usage: Query only

Mode: This command is required by the firmware applications only.

STATus:QUESTionable:SYNC:ENABLE <BitDefinition>

This command sets the bits of the "ENABle" part of the STATus:QUESTionable:SYNC register. The "ENABle" register selectively enables the individual events of the associated "EVENT" part for the summary bit.

Parameters:

<BitDefinition> 0 to 65535

Example: STAT:QUES:SYNC:ENAB 65535

Mode: This command is required by the firmware applications only.

STATus:QUESTionable:SYNC:NTRansition <BitDefinition>

This command sets the edge detectors of all bits of the STATus:QUESTionable:SYNC register from 1 to 0 for the transitions of the "CONDition" bit.

Parameters:

<BitDefinition> 0 to 65535

Example: STAT:QUES:SYNC:NTR 65535

Mode: This command is required by the firmware applications only.

STATus:QUESTionable:SYNC:PTRansition <BitDefinition>

This command sets the edge detectors of all bits of the STATus:QUESTionable:SYNC register from 0 to 1 for the transitions of the "CONDition" bit.

Parameters:

<BitDefinition> 0 to 65535

Example: STAT:QUES:SYNC:PTR 65535

Mode: This command is required by the firmware applications only.

STATus:QUESTionable:TIME:CONDition?

This command queries the contents of the STATus:QUESTionable:TIME register.

A readout does not delete the contents of the "CONDition" section.

Usage: Query only

Mode: RT

STATus:QUESTionable:TIME:ENABLE <BitDefinition>

This command sets the bits of the "ENABLE" section of the STATus:QUESTionable:TIME register.

The "ENABLE" register selectively enables the individual events of the associated "EVENT" section for the summary bit.

Parameters:

<BitDefinition> 0 to 65535

Mode: RT

STATus:QUESTionable:TIME[:EVENT]?

This command queries the contents of the "EVENT" section of the STATus:QUESTionable:TIME register.

A readout deletes the contents of the "EVENT" section.

Usage: Query only

Mode: RT

STATus:QUESTionable:TIME:NTRansition <BitDefinition>

This command sets the edge detectors of all bits of the STATus:QUESTionable:TIME register from 1 to 0 for the transitions of the "CONDition" bit.

Parameters:

<BitDefinition> 0 to 65535

Mode: RT

STATus:QUESTionable:TIME:PTRansition <BitDefinition>

This command sets the edge detectors of all bits of the STATus:QUESTionable:TIME register from 0 to 1 for the transitions of the "CONDition" bit.

Parameters:

<BitDefinition> 0 to 65535

Mode: RT

8.2.3.17 SYSTem Subsystem

| | |
|--|-----|
| SYSTem:COMMunicate:RDEvice:PMETer<p>:DEFine..... | 887 |
| SYSTem:COMMunicate:RDEvice:PMETer<p>:CONFigure:AUTO[:STATe]..... | 888 |
| SYSTem:COMMunicate:RDEvice:PMETer<p>:COUNT?..... | 888 |
| SYSTem:SPEaker:VOLume..... | 888 |
| SYSTem:TIME:TSTamp?..... | 888 |

SYSTem:COMMunicate:RDEvice:PMETer<p>:DEFine <Placeholder>, <Type>, <Interface>, <SerialNo>

This command assigns the power sensor with the specified serial number to the selected power sensor index (configuration).

The query returns the power sensor type and serial number of the sensor assigned to the specified index.

Suffix:

<p> 1...4
Power sensor index

Setting parameters:

<Placeholder> Currently not evaluated
<SerialNo> Serial number of a connected power sensor

Query parameters:

<Type> The power sensor type, e.g. "NRP-Z81".
<Interface> Currently not evaluated

Return values:

<Placeholder> Currently not used
<Type> Detected power sensor type, e.g. "NRP-Z81".
<Interface> Interface the power sensor is connected to; always "USB"
<SerialNo> Serial number of the power sensor assigned to the specified index

Example:

```
SYST:COMM:RDEV:PMET2:DEF ' ', 'NRP-Z81', ' ', '123456'
```

Assigns the power sensor with the serial number '123456' to the configuration "Power Sensor 2".

```
SYST:COMM:RDEV:PMET2:DEF?
```

Queries the sensor assigned to "Power Sensor 2".

Result:

```
' ', 'NRP-Z81', 'USB', '123456'
```

The NRP-Z81 power sensor with the serial number '123456' is assigned to the "Power Sensor 2".

Mode: all

Manual operation: See ["Power Sensor Assignment"](#) on page 312

SYSTem:COMMunicate:RDEvice:PMETer<p>:CONFigure:AUTO[:STATe] <State>

This command defines whether the selected power sensor index is automatically assigned to a subsequently connected power sensor. See also "[Power Sensor Assignment](#)" on page 312.

Suffix:

<p> 1...4
Power sensor index

Parameters:

<State> **ON | OFF**
*RST: ON

Example: SYST:COMM:RDEV:PMET:CONF:AUTO OFF

Mode: ALL

Manual operation: See "[Power Sensor Assignment](#)" on page 312

SYSTem:COMMunicate:RDEvice:PMETer<p>:COUNT?

This command queries the number of power sensors currently connected to the R&S FSVR.

Suffix:

<p> 1...4
irrelevant

Example: SYST:COMM:RDEV:PMET:COUN?

Usage: Query only

Mode: ALL

Manual operation: See "[Power Sensor Assignment](#)" on page 312

SYSTem:SPEaker:VOLume <Volume>

This command defines the volume of the built-in loudspeaker for demodulated signals.

The command is available with the audio demodulator (option R&S FSV-B3) and in the time domain in Spectrum mode.

Parameters:

<Volume> Range: 0 to 1
*RST: 0.5

Example: SYST:SPE:VOL 0
Switches the loudspeaker to mute.

SYSTem:TIME:TSTamp?

This command queries the time and date from the internal real time clock.

Return values:

<TimeStamp>

Example:

SYST:TIME:TSTamp?

Usage:

Query only

8.2.3.18 TRACe Subsystem

The TRACe subsystem controls access to the instruments internal trace memory.



Some applications offer up to four measurement windows. For those, the suffix <n> for TRACe selects the measurement window. For all other applications, the suffix is irrelevant.

The TRACe subsystem contains the following subsystem:

- ["TRACe:IQ Subsystem"](#) on page 893

Some further information on working with IQ data is provided here:

- [chapter 4.4.6, "Working with I/Q Data"](#), on page 301
- ["I/Q Gating"](#) on page 906

| | |
|--------------------------------------|-----|
| Commands of the TRACe subsystem..... | 889 |
| TRACe:IQ Subsystem..... | 893 |
| I/Q Gating..... | 906 |

Commands of the TRACe subsystem

TRACe<n>:COPY <TraceNumber>, <TraceNumber>

This command copies data from one trace to another.

Suffix:

<n> window; For applications that do not have more than 1 measurement window, the suffix <n> is irrelevant.

Parameters:

<TraceNumber>, TRACE1 | TRACE2 | TRACE3 | TRACE4 | TRACE5 | TRACE6,
 <TraceNumber> TRACE1 | TRACE2 | TRACE3 | TRACE4 | TRACE5 | TRACE6
 The first argument is the destination of the data to be copied, the second argument describes the source.

Example:

TRAC:COPY TRACE1,TRACE2

Manual operation: See ["Copy Trace"](#) on page 98

TRACe<n>[:DATA]? <ResultType>

This command returns the current trace data or measurement results. In case of several result displays, you have to use specific parameters to query the results.

The data format is variable. You can set it with `FORMat [: DATA]` on page 939. For more information on data formats see [chapter 8.2.3.23, "Formats for Returned Values: ASCII Format and Binary Format"](#), on page 923.

For details on saving and recalling data refer to [chapter 8.2.4.7, "MMEMory Subsystem"](#), on page 945.

For details on saving and recalling data refer to the `MMEMory` subsystem in the description of the base unit.

Suffix:

<n> 1...4
window; For applications that have only one measurement screen, the suffix is irrelevant.

Query parameters:

<ResultType> TRACE1 | TRACE2 | TRACE3 | TRACE4 | TRACE5 | TRACE6 |
SPECTrogram | SGRam | LIST | SPURious | TRACE1 |
TRACE2 | TRACE3 | TRACE4 | TRACE5 | TRACE6

Selects the type of result to be returned.

TRACE1 | ... | TRACE6

The query returns a list of results with one value for each sweep point in the currently set level unit.

For details see [table 8-19](#)

LIST

Returns the results of the list evaluation of the Spectrum Emission Mask and Spurious Emissions measurement (Spectrum mode only). For a description of the syntax see [table 8-20](#) below.

SPURious

Returns the peak list of the Spurious Emissions measurement (Spectrum mode only)

SPECTrogram | SGRam

Returns the results of the spectrogram result display. For every frame in the spectrogram, the command returns 801 power levels, one for each horizontal pixel on the display. The power level unit depends on the unit you have currently set. The number of frames depends on the history depth.

The data format is either binary or ASCII.

PSPpectrum

Returns the results of the persistence spectrum result display. The command returns 801*600 percentages, one for each pixel in the histogram from .

The data format is either binary or ASCII.

HMAXhold

Returns the results of the maxhold trace in the persistence spectrum result display. The command returns 801*600 percentages, one for each pixel in the maxhold trace.

The data format is either binary or ASCII.

| | |
|--------------------------|--|
| Example: | TRAC? TRACE1
Returns the trace data for Trace 1. |
| Usage: | Query only |
| Mode: | A, ADEMOD, BT, NF, PHN, TDS |
| Manual operation: | See "List Evaluation (On/Off)" on page 194
See "List Evaluation (On/Off)" on page 223 |

Table 8-19: Results for <TRACe...> ResultTypes

| |
|--|
| <p>The query returns a list of results with one value for each sweep point in the currently set level unit. By default, the list contains 691 values. The currently used number of sweep points can be determined using SWE:POIN?, see [SENSe:]SWEep:POINts on page 872.</p> <p>FORMat REAL, 32 is used as format for binary transmission, and FORMat ASCii for ASCII transmission.</p> <p>For details on formats refer to chapter 8.2.3.23, "Formats for Returned Values: ASCII Format and Binary Format", on page 923.</p> <p>With the auto peak detector, only positive peak values can be read out.</p> <p>In IQ Analyzer mode, if the result display configuration "Real/Imag (I/Q)" is selected, this query returns the I values of each trace point first, then the Q values:</p> <p><result>= I₁,I₂,...,I_n, Q₁,Q₂,...,Q_n</p> <p>In realtime mode, this parameter queries the results of the realtime spectrum result display.</p> |
|--|

Table 8-20: Results for <LIST> ResultType

| | |
|--|---|
| <p>Using the LIST parameter, the query returns the results of the list evaluation of the Spectrum Emission Mask and Spurious Emissions measurement (Spectrum mode only) with the following syntax:</p> <p><no>, <start>, <stop>, <rbw>, <freq>, <power abs>, <power rel>, <delta>, <limit check>, <unused1>, <unused2></p> <p>where:</p> | |
| <no>: | peak number |
| <start>: | start frequency of range |
| <stop>: | stop frequency of range |
| <rbw>: | resolution bandwidth of range |
| <freq>: | frequency of peak |
| <power abs>: | absolute power in dBm of peak |
| <power rel>: | relative power in dBc (related to the channel power) of peak |
| <delta>: | distance to the limit line in dB (positive indicates value above the limit, fail) |
| <limit check>: | limit fail (pass = 0, fail =1) |
| <unused1>: | reserved (0.0) |
| <unused2>: | reserved (0.0) |

Table 8-21: Results for Spectrogram measurements

For spectrogram measurements, the query returns the complete spectrogram trace data (requires R&S FSV-K14 option). For each frame, the trace data is returned as a comma-separated list in the following order:

```
<TraceDataFrame0>, <TraceDataFrame1>, ...<TraceDataFrameMinX>
```

where <FrameMinX> is determined by [CALC:SGR:FRAM:SEL MIN](#) (see also example below)

The trace data for each frame corresponds to the syntax described for the <TRACe> result type.

To calculate the amount of returned values for <SPECTrogram> results:

```
CALC:SGR:FRAM:SEL MIN
```

```
CALC:SGR:FRAM:SEL? //returns value <FrameMinX>, e.g. -34
```

```
SWE:POIN? //returns number of sweep points, e.g. 691
```

```
TRACE:DATA? SGR
```

```
//returns 34*691 = 25494 comma separated values for the spectrogram
```

TRACe<n>[:DATA] <Trace>, <Data>

The command transfers trace data from a control computer to the R&S FSVR. The transfer of trace data into the R&S FSVR memory is available only in spectrum analyzer mode.

The data format is variable. You can set it with [FORMat \[: DATA\]](#) on page 939. For more information on data formats see [chapter 8.2.3.23, "Formats for Returned Values: ASCII Format and Binary Format"](#), on page 923.

For details on saving and recalling data refer to [chapter 8.2.4.7, "MMEMory Subsystem"](#), on page 945.

For details on saving and recalling data refer to the [MMEMory](#) subsystem in the description of the base unit.

Suffix:

<n> Sets the screen number you want to apply the command to. For applications that have only one measurement screen, the suffix is irrelevant.

Parameters:

<Trace> TRACE1 | TRACE2 | TRACE3 | TRACE4 | TRACE5 | TRACE6
Selects the trace you want to write data to.

Setting parameters:

<Data> Defines the data you want to transfer.

Example:

```
TRAC TRACe1, +A$
```

A\$ is a placeholder for the data list in the current format.

Usage:

Setting only

Mode:

A

TRACe<n>[:DATA]:MEMory? <Trace>,<OffsSwPoint>,<NoOfSwPoints>

This command queries the previously acquired trace data for the specified trace from the memory. As an offset and number of sweep points to be retrieved can be specified, the trace data can be retrieved in smaller portions, making the command faster than the `TRAC:DATA?` command. This is useful if only specific parts of the trace data are of interest.

If no parameters are specified with the command, the entire trace data is retrieved; in this case, the command is identical to `TRAC:DATA? TRACE1`

Suffix:

<n> 1...4
Selects the measurement window.

Query parameters:

<Trace> TRACE1 | TRACE2 | TRACE3 | TRACE4 | TRACE5 | TRACE6

<OffsSwPoint> The offset in sweep points related to the start of the measurement at which data retrieval is to start.

<NoOfSwPoints> Number of sweep points to be retrieved from the trace.

Example:

`TRAC:DATA:MEM? TRACE1,25,100`

Retrieves 100 sweep points from trace 1, starting at sweep point 25.

Usage: Query only

TRACe<n>[:DATA]:X? <TraceNumber>

This command reads the x-values of the selected trace.

Suffix:

<n> 1...4
window; For applications that have only one measurement screen, the suffix is irrelevant.

Query parameters:

<TraceNumber> TRACE1 | TRACE2 | TRACE3 | TRACE4 | TRACE5 | TRACE6
Trace number

Example:

`TRACe:DATA:X? TRACE1`

Returns the x-values for trace 1.

Usage: Query only

TRACe:IQ Subsystem

The commands of this subsystem are used for acquisition and output of measured IQ data.

Some further information on working with IQ data is provided here:

- [chapter 4.4.6, "Working with I/Q Data"](#), on page 301

- ["I/Q Gating"](#) on page 906



Different remote modes available

In remote control, two different modes for the I/Q analyzer functions are available. A quick mode for pure data acquisition, and a more sophisticated mode for acquisition and evaluation. The sophisticated evaluation mode can be enabled by a special command (see [TRACe<n>:IQ:EVAL](#) on page 902). In the quick data acquisition mode, which is activated by default with the [TRACe<n>:IQ\[:STATe\]](#) command, the new visualization functions are not available; however, performance is slightly improved.

The measurement results are output in the form of a list, three different formats can be selected for this list ([TRACe<n>:IQ:DATA:FORMat](#) command).

The [FORMat](#) command can be used to select between binary output (32 bit IEEE 754 floating-point values) and output in ASCII format.

For details on formats refer to [Formats for Returned Values: ASCII Format and Binary Format](#).

Different procedures

The commands of this subsystem can be used in two ways:

- Measurement and result query with one command:
This method causes the least delay between measurement and output of the result data, but it requires the control computer to wait actively for the response data.
- Setting up the instrument, start of the measurement via INIT and query of the result list at the end of the measurement:
With this method, the control computer can be used for other activities during the measurement. However, the additional time needed for synchronization via service request must be taken into account.

| | |
|--|-----|
| TRACe<n>:IQ[:STATe] | 895 |
| TRACe<n>:IQ:AVERAge:COUNT | 895 |
| TRACe<n>:IQ:AVERAge[:STATe] | 895 |
| TRACe<n>:IQ:BWIDth | 896 |
| TRACe<n>:IQ:DATA | 896 |
| TRACe<n>:IQ:DATA:FORMat | 897 |
| TRACe<n>:IQ:DATA:MEMory? | 899 |
| TRACe<n>:IQ:DIQFilter | 900 |
| TRACe<n>:IQ:EGATe | 901 |
| TRACe<n>:IQ:EGATe:GAP | 901 |
| TRACe<n>:IQ:EGATe:LENGth | 901 |
| TRACe<n>:IQ:EGATe:NOFgateperiods | 902 |
| TRACe<n>:IQ:EGATe:TYPE | 902 |
| TRACe<n>:IQ:EVAL | 902 |
| TRACe<n>:IQ:RLENGth | 903 |
| TRACe<n>:IQ:SET | 904 |
| TRACe<n>:IQ:SRATe | 906 |
| TRACe<n>:IQ:TPISample? | 906 |

TRACe<n>:IQ:STATe] <State>

This command switches the I/Q data acquisition on or off.

I/Q data acquisition is not compatible with other measurement functions. Therefore, all other measurement functions are switched off as soon as the I/Q measurement function is switched on. The trace display is also switched off by this command. Therefore, all traces are set to "BLANK".

To switch trace display back on, use the `TRACe<n>:IQ:EVAL` command.

Note: to enable the evaluation functions of the IQ Analyzer, you must also execute the command `TRACe<n>:IQ:EVAL`.

Suffix:

<n> irrelevant

Parameters:

<State> ON | OFF

*RST: OFF

Example:

`TRAC:IQ ON`

Switches on I/Q data acquisition

Manual operation: See "I/Q Analyzer" on page 279

TRACe<n>:IQ:AVERAge:COUNT <NumberSets>

This command defines the number of I/Q data sets that are to serve as a basis for averaging.

Suffix:

<n> irrelevant

Parameters:

<NumberSets> 0 to 32767

*RST: 0

Example:

`TRAC:IQ ON`

Switches on acquisition of I/Q data.

`TRAC:IQ:AVER ON`

Enables averaging of the I/Q measurement data

`TRAC:IQ:AVER:COUN 10`

Selects averaging over 10 data sets

`TRAC:IQ:DATA?`

Starts the measurement and reads out the averaged data.

Usage:

SCPI confirmed

TRACe<n>:IQ:AVERAge[:STATe] <State>

The command enables averaging of the recorded I/Q data, provided that I/Q data acquisition was previously enabled with `TRACe<n>:IQ[:STATe]` on page 895.

With I/Q data averaging enabled, the maximum amount of I/Q data is limited to 512kS (524288 complex samples).

Suffix:

<n> irrelevant

Parameters:

<State> ON | OFF

*RST: OFF

Example:

TRAC:IQ ON

Switches on acquisition of I/Q data.

TRAC:IQ:AVER ON

Enables averaging of the I/Q measurement data.

TRAC:IQ:AVER:COUN 10

Selects averaging over 10 data sets.

TRAC:IQ:DATA?

Starts the measurement and reads out the averaged data.

TRACe<n>:IQ:BWIDth

This command queries the flat, usable filter bandwidth of the final I/Q data.

The bandwidth depends on the defined user sample rate and the defined signal source (RF/Digital IQ), see also [figure 7-2](#). This value can not be changed by the user.

This command queries the flat, usable filter bandwidth of the final I/Q data, which is dependent on the defined user sample rate and the defined signal source (RF/Digital IQ), see also "Sample rates, bandwidths and other limitations" in the description of the Digital Baseband Interface (B17) for the base unit. This value can not be changed by the user.

Suffix:

<n> irrelevant

Example:

TRAC:IQ:BWID?

Manual operation: See "[Filter BW](#)" on page 283

TRACe<n>:IQ:DATA

This command starts a measurement with the settings defined via [TRACe<n>:IQ:SET](#) and returns the list of measurement results (I/Q samples) immediately after they are corrected in terms of frequency response. The number of measurement results depends on the settings defined with [TRACe<n>:IQ:SET](#), the output format depends on the settings of the FORMat subsystem. The format of the data list is defined by the command [TRACe<n>:IQ:DATA:FORMat](#).

The command requires all response data to be read out completely before the instrument accepts further commands.

The result values are scaled linearly in Volts and correspond to the voltage at the RF or digital input of the instrument. The number of the returned values is 2 * the number of samples.

Note: Using the command with the *RST values for the `TRACe<n>:IQ:SET` command, the following minimum buffer sizes for the response data are recommended:

ASCII format: 10 kBytes

Binary format: 2 kBytes

Suffix:

<n> irrelevant

Example:

```
TRAC:IQ:STAT ON
```

Enables acquisition of I/Q data

```
TRAC:IQ:SET NORM,10MHz,32MHz,EXT,POS,0,4096
```

Measurement configuration:

Sample Rate = 32 MHz

Trigger Source = External

Trigger Slope = Positive

Pretrigger Samples = 0

Number of Samples = 4096

```
FORMat REAL,32
```

Selects format of response data

```
TRAC:IQ:DATA?
```

Starts measurement and reads results

TRACe<n>:IQ:DATA:FORMat <Format>

This command defines the transfer format of the I/Q data.

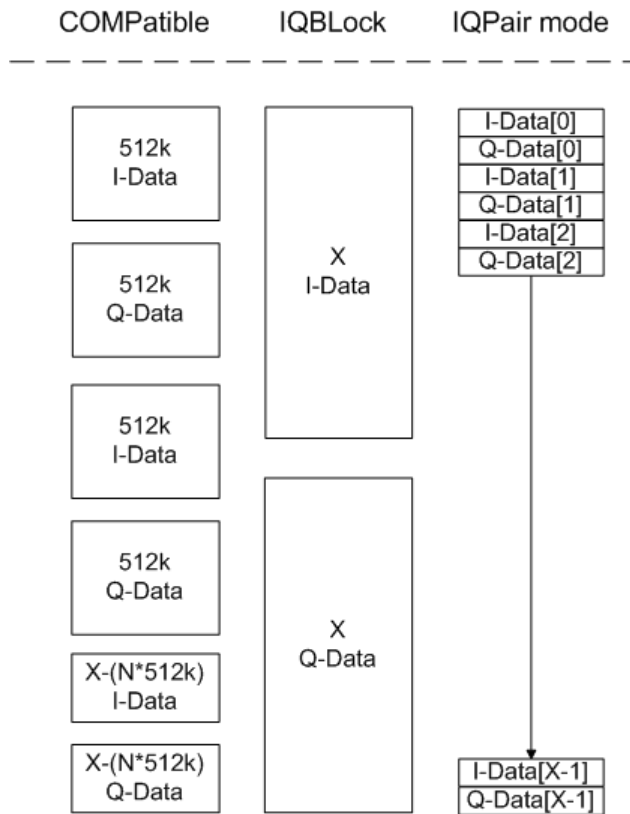

Fig. 8-5: IQ data formats

Note: 512k corresponds to 524288 samples

$$\# \text{ of } I\text{-Data} = \# \text{ of } Q\text{-Data} = \frac{\# \text{ of } DataBytes}{8}$$

$$Q\text{-Data - Offset} = \frac{(\# \text{ of } DataBytes)}{2} + LengthIndicatorDigits$$

Suffix:

<n> irrelevant

Parameters:

<Format> COMPAtible | IQBLock | IQPair

*RST: IQBL

For maximum performance, the formats "Compatible" or "IQPair" should be used. Furthermore, for large amounts of data, the data should be in binary format to improve performance.

For further details on formats refer to [chapter 8.2.3.23, "Formats for Returned Values: ASCII Format and Binary Format"](#), on page 923 .

TRACe<n>:IQ:DATA:MEMory? <OffsetSamples>,<NoOfSamples>

This command reads out previously acquired (and frequency response corrected) I/Q data from the memory. Furthermore, the offset related to the start of measurement and the number of I/Q samples are given. Thus, a previously acquired data set can be read out in smaller portions. If no parameters are given, all data is read from the memory. The maximum amount of available data depends on the settings of the [TRACe<n>:IQ:SET](#) command, the output format on the settings in the FORMat subsystem.

The returned values are scaled linear in unit Volt and correspond to the voltage at the RF or digital input of the instrument.

The format of the output buffer corresponds to the [TRACe<n>:IQ:DATA](#) command.

The command requires all response data to be read out completely before the instrument accepts further commands.

If no I/Q data is available in memory because the corresponding measurement was not started, the command causes a query error.

Suffix:

<n> irrelevant

Parameters:

| | |
|-----------------|---|
| <OffsetSamples> | Offset of the values to be read, in relation to the start of the acquired data.
Range: 0 to <# of samples> – 1, with <# of samples> being the value set by the "TRACe:IQ:SET" command
*RST: 0 |
| <NoOfSamples> | Number of measurement values to be read.
Range: 1 to <# of samples> - <offset samples> with <# of samples> being the value set by the "TRACe:IQ:SET" command
*RST: <# of samples> |

Example:

```
TRAC:IQ:STAT ON
```

Enables acquisition of I/Q data

```
TRAC:IQ:SET NORM,10MHz,32MHz,EXT,POS,100,4096
```

Measurement configuration:

Sample Rate = 32 MHz

Trigger Source = External

Trigger Slope = Positive

Pretrigger Samples = 100

Number of Samples = 4096

```
INIT;*WAI
```

Starts measurement and wait for sync

```
FORMat REAL,32
```

Determines output format

To read the results:

```
TRAC:IQ:DATA:MEM?
```

Reads all 4096 I/Q data

```
TRAC:IQ:DATA:MEM? 0,2048
```

Reads 2048 I/Q data starting at the beginning of data acquisition

```
TRAC:IQ:DATA:MEM? 2048,1024
```

Reads 1024 I/Q data from half of the recorded data

```
TRAC:IQ:DATA:MEM? 100,512
```

Reads 512 I/Q data starting at the trigger point (<Pretrigger Samples> was 100)

Usage:

Query only

TRACe<n>:IQ:DIQFilter <State>

This command is only available when using the Digital Baseband Interface (R&S FSVR-B17).

By default, a decimation filter is used during data acquisition to reduce the sample rate to the value defined using [TRACe<n>:IQ:SRATe](#).

If the filter is bypassed, the sample rate is identical to the input sample rate configured for the Digital I/Q input source (see [INPut:DIQ:SRATe](#) on page 735).

Suffix:

<n> irrelevant

Parameters:

<State> ON | OFF

ON

The digital I/Q filter bypass is on, i.e. no filter or resampler is used during I/Q data acquisition.

OFF

The filter bypass is off, i.e. decimation filter and resampler are used during I/Q data acquisition.

```
*RST: OFF
```

Example:

```
TRAC:IQ:DIQF ON
```

Mode: IQ

Manual operation: See "No Filter" on page 283

TRACe<n>:IQ:EGATe <State>

Activates or deactivates the gate function for IQ data measurements. This command is only valid for TRAC:IQ ON and trigger modes "EXT" and "IFP". The gate trigger is specified using TRACe<n>:IQ:SET on page 904. For details see "I/Q Gating" on page 906.

This function is not available if the R&S Digital I/Q Interface (R&S FSV-B17) is active.

Suffix:

<n> irrelevant

Parameters:

<State> ON | OFF

*RST: OFF

Example: TRAC:IQ:EGAT: ON

TRACe<n>:IQ:EGATe:GAP <Samples>

Defines the interval between several gate periods in samples. For details see "I/Q Gating" on page 906.

This function is not available if the R&S Digital I/Q Interface (R&S FSV-B17) is active.

Suffix:

<n> irrelevant

Parameters:

<Samples> <numeric value>

Max = MaxPreTriggerSamples * 128 MHz/sample rate
pretrigger samples defined by TRACe<n>:IQ:SET;
sample rate defined by TRACe<n>:IQ:SRATe)

Range: 1...Max (samples)

*RST: 100

Example: TRAC:IQ:EGAT:GAP 2

TRACe<n>:IQ:EGATe:LENGth <GateLength>

Defines the gate length in samples in edge mode. For details see "I/Q Gating" on page 906.

This function is not available if the R&S Digital I/Q Interface (R&S FSV-B17) is active.

Suffix:

<n> irrelevant

Parameters:

<GateLength> <numeric value>
 Max = MaxPreTriggerSamples * 128 MHz/sample rate
 pretrigger samples defined by [TRACe<n>:IQ:SET](#);
 sample rate defined by [TRACe<n>:IQ:SRATe](#))
 Range: 1...Max (samples)
 *RST: 100

Example: TRAC:IQ:EGAT:LENG 2000

TRACe<n>:IQ:EGAT:NOFgateperiods <Number>

Defines the number of gate periods after a trigger signal. For details see "[I/Q Gating](#)" on page 906.

This function is not available if the R&S Digital I/Q Interface (R&S FSV-B17) is active.

Suffix:

<n> irrelevant

Parameters:

<Number> 1...1023
 *RST: 1

Example: TRAC:IQ:EGAT:NOF 2

TRACe<n>:IQ:EGAT:TYPE <Type>

Specifies the gate trigger type used for data collection. For details see "[I/Q Gating](#)" on page 906.

Note: Using gating with gate mode "level" and an IFP trigger ([TRIGger<n>\[:SEQUence\]:SOURCE](#)), the holdoff time for the IFP trigger (see [TRIGger<n>\[:SEQUence\]:IFPower:HOLDoff](#) on page 909) is ignored.

This function is not available if the R&S Digital I/Q Interface (R&S FSV-B17) is active.

Suffix:

<n> irrelevant

Parameters:

<Type> LEVEL | EDGE
 *RST: EDGE

Example: TRAC:IQ:EGAT:TYPE LEV

TRACe<n>:IQ:EVAL <State>

This command enables or disables the IQ data evaluation mode and is a prerequisite for the IQ Analyzer functions.

Before this command can be executed, IQ data acquisition must be enabled (see [TRACe<n>:IQ\[:STATe\]](#) on page 895). This command automatically disables the IQ data evaluation mode to provide optimum performance for IQ-data acquisition.

If you start the IQ Analyzer manually by selecting the "IQ Analyzer" mode in the R&S FSVR, or use the [CALCulate<n>:FORMat](#) command, the IQ data evaluation mode is automatically activated.

The maximum number of samples for RF input is 200 MS. For details see [chapter 4.4.6, "Working with I/Q Data"](#), on page 301.

For digital input see [table 7-2](#).

For digital input see "Sample rates, bandwidths and other limitations" in the description of the Digital Baseband Interface (B17) for the base unit.

Suffix:

<n> irrelevant

Parameters:

<State> ON | OFF

ON

all functions of the IQ Analyzer are available

OFF

no traces or marker operations are available; IQ data can only be captured, but with a better performance than in active IQ data evaluation mode

*RST: OFF

Example:

TRAC:IQ ON

Enables IQ data acquisition

TRAC:IQ:EVAL ON

Enables the IQ data evaluation mode.

Manual operation: See "[I/Q Analyzer](#)" on page 279

TRACe<n>:IQ:RLENgth <NoOfSamples>

This command sets the record length for the acquired I/Q data. Increasing the record length automatically also increases the measurement time.

Note: Alternatively, you can define the measurement time using the [SENS:SWE:TIME](#) command.

Suffix:

<n> irrelevant

Parameters:

<NoOfSamples> Number of measurement values to record.
 For digital input via the R&S Digital I/Q Interface (R&S FSVRB17) the valid number of samples is described in [table 7-2](#).
 For digital input via the R&S Digital I/Q Interface (R&S FSVRB17) the valid number of samples is described in "Sample rates, bandwidths and other limitations" in the base unit.
 Range: 1 ... 209715200(= 200*1024*1024);
 *RST: 691

Example: TRAC:IQ:RLEN 256

Manual operation: See "[Record Length](#)" on page 283

TRACe<n>:IQ:SET NORM,<Placeholder>, <SampleRate>, <TriggerMode>, <TriggerSlope>, <PretriggerSamp>, <NumberSamples>

This command defines the settings of the R&S FSVR hardware for the measurement of I/Q data. This allows setting the sample rate, trigger conditions and the record length.

If this command is omitted, the current instrument settings are used for the corresponding parameters.

This command switches to IQ mode automatically (see also [TRACe<n>:IQ\[:STATe\]](#) on page 895).

The trigger level can be set using the [TRIGger<n>\[:SEquence\]:SOURce](#) command.

Note: When using the default settings with the [TRACe<n>:IQ:DATA](#) command, the following minimum buffer sizes for the response data are recommended: ASCII format 10 kBytes, Binary format 2 kBytes.

Tip: To determine the trigger point in the sample (for "External" or "IF Power" trigger mode), use the [TRACe<n>:IQ:TPISample?](#) on page 906 command.

Parameters:

NORM is not evaluated, but must be inserted
 <Placeholder> numeric value
 is not evaluated, but must be inserted

| | |
|------------------|---|
| <SampleRate> | <p>Sample rate of the I/Q data (user sample rate).
For digital input via the R&S Digital I/Q Interface (R&S FSVRB17) the valid sample rates are described in table 7-2
For digital input via the R&S Digital I/Q Interface (R&S FSVRB17) the valid sample rates are described in "Sample rates, bandwidths and other limitations" in the base unit.</p> <p>Range: 100 Hz to 45 MHz (for option B70: 10 GHz, for R&S FSV40 model 1307.9002K39: 12.5 MHz), continuously adjustable;</p> <p>*RST: 32MHz (for R&S FSV40 model 1307.9002K39: 12.5 MHz)</p> |
| <TriggerMode> | <p>IMMEDIATE EXTERNAL IFPOWER BBPOWER PSE</p> <p>Selection of the trigger source used for the measurement.
For IMM mode, gating is automatically deactivated.</p> <p>*RST: IMM</p> |
| <TriggerSlope> | <p>POSITIVE NEGATIVE</p> <p>Used trigger slope.</p> <p>*RST: POS</p> |
| <PretriggerSamp> | <p>Defines the trigger offset in terms of pretrigger samples. Negative values correspond to a trigger delay.
This value also defines the interval between the trigger signal and the gate edge in samples.</p> <p>Range:
RF input without gating: 0 to (200 MS - 1)
RF input with gating: 0 to [(200 MS * SR/128 MHz)-1]</p> <p>Range: 0 to (MaxPreTriggerSamples * 128 MHz/sample rate).</p> <p>*RST: 0</p> |
| <NumberSamples> | <p>Number of measurement values to record (including the pretrigger samples).</p> <p>Range: 1 ... 209715200(= 200*1024*1024);</p> <p>*RST: 128</p> |
| Example: | <p>TRAC:IQ:SET NORM,10 MHz,32 MHz,EXT,POS,0,2048
Reads 2048 I/Q-values starting at the trigger point.
sample rate = 32 MHz
trigger = External
slope = Positive</p> <p>TRAC:IQ:SET NORM,10 MHz,4 MHz,EXT,POS,1024,512
Reads 512 I/Q-values from 1024 measurement points before the trigger point.
sample rate = 4 MHz
trigger = External
slope = Positive</p> |

Manual operation: See ["Power Sensor"](#) on page 111
See ["Record Length"](#) on page 283

TRACe<n>:IQ:SRATe <SampleRate>

This command sets the final user sample rate for the acquired I/Q data. Thus, the sample rate can be modified without affecting the other settings.

Note: The smaller the user sample rate, the smaller the usable I/Q bandwidth, see [TRACe<n>:IQ:BWIDth](#) on page 896.

Suffix:

<n> irrelevant

Parameters:

<SampleRate> For digital input via the R&S Digital I/Q Interface (R&S FSVRB17) the valid sample rates are described in "Sample rates, bandwidths and other limitations" in the description of the B17 option in the base unit.

Range: 100 Hz to 45 MHz

*RST: 32 MHz

Example: TRAC:IQ:SRAT 4 MHz

Manual operation: See ["Sample Rate"](#) on page 283

TRACe<n>:IQ:TPISample?

This command determines the time offset of the trigger in the sample (trigger position in sample = TPIS). This value can only be determined in triggered measurements using external or IFPower triggers, otherwise the value is 0. The value is not user-definable.

This command is not available if the R&S Digital I/Q Interface (R&S FSV-B17 option) is active.

Suffix:

<n> irrelevant

Example: TRAC:IQ:TPIS?

Usage: Query only

Manual operation: See ["Trigger Offset"](#) on page 113

I/Q Gating

Sometimes in spectrum analysis, measurements are based on a certain length of time called the gate area. With I/Q gating, you can define the gate area using the gate length, the distance between the periods and the number of periods. The gate length and the distance between the capture periods are specified in samples.



I/Q gating is only available using remote commands; manual configuration is not possible.

Using I/Q gating, the gate area can be defined using the following methods:

- Edge triggered recording
After a trigger signal, the gate period is defined by a gate length and a gate distance. All data in the gate period is recorded until the required number of samples has been recorded.

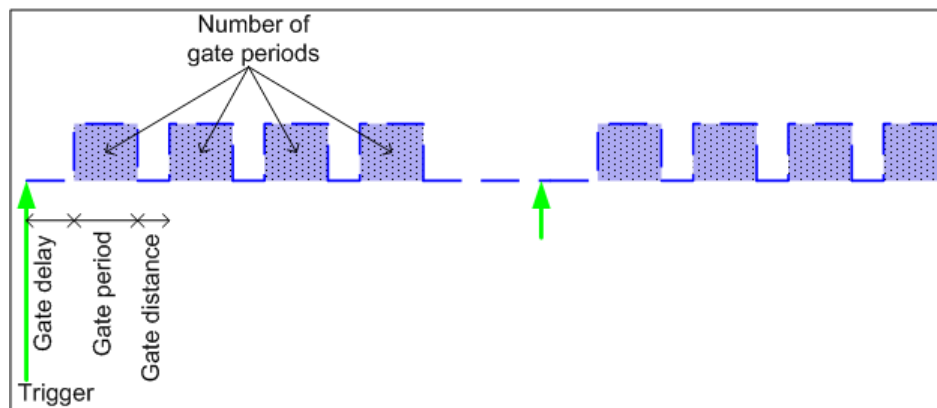

SCPI command: `TRACE:IQ:EGATE:TYPE EDGE`, see [TRACe<n>:IQ:EGATE:TYPE](#) on page 902

- Level triggered recording
After a trigger signal, all data is recorded in which the gate signal is set to 1, which means it has exceeded a level. In this case, the gate signal can be generated by the IFP trigger, for example: each time the IFP level is exceeded, the IFP trigger signal is set to 1 and the samples in this area are recorded as gate samples.

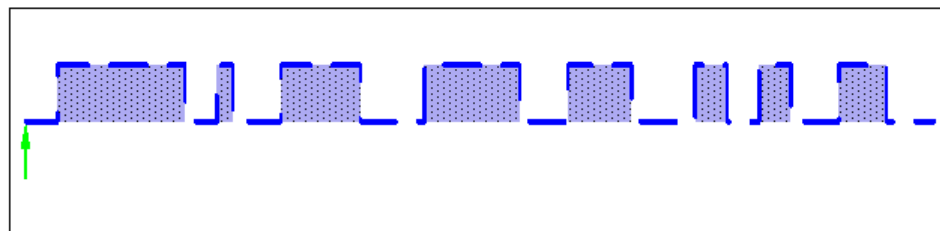

The number of complex samples to be recorded prior to the trigger event can be selected (see [TRACe<n>:IQ:SET](#) on page 904) for all available trigger sources, except for "Free Run".

SCPI command: `TRACE:IQ:EGATE:TYPE LEV`, see [TRACe<n>:IQ:EGATE:TYPE](#) on page 902

8.2.3.19 TRIGger Subsystem

The TRIGger subsystem is used to synchronize instrument actions with events. It is thus possible to control and synchronize the start of a sweep.

| | |
|--|-----|
| TRIGger:MODE..... | 908 |
| TRIGger<n>[:SEQuence]:HOLDoff[:TIME]..... | 908 |
| TRIGger<n>[:SEQuence]:BBPower:HOLDoff..... | 909 |
| TRIGger<n>[:SEQuence]:IFPower:HOLDoff..... | 909 |
| TRIGger<n>[:SEQuence]:IFPower:HYSteresis..... | 909 |
| TRIGger<n>[:SEQuence]:LEVel:AM:RELative..... | 910 |
| TRIGger<n>[:SEQuence]:LEVel:AM[:ABSolute]..... | 910 |
| TRIGger<n>[:SEQuence]:LEVel:BBPower..... | 910 |
| TRIGger<n>[:SEQuence]:LEVel[:EXTernal]..... | 911 |
| TRIGger<n>[:SEQuence]:LEVel:FM..... | 911 |
| TRIGger<n>[:SEQuence]:LEVel:IFPower..... | 911 |
| TRIGger<n>[:SEQuence]:LEVel:PM..... | 912 |
| TRIGger<n>[:SEQuence]:LEVel:RFPower..... | 912 |
| TRIGger<n>[:SEQuence]:LEVel:VIDeo..... | 912 |
| TRIGger<n>[:SEQuence]:MASK:CONDition..... | 913 |
| TRIGger<n>[:SEQuence]:SLOPe..... | 913 |
| TRIGger<n>[:SEQuence]:SOURce..... | 913 |
| TRIGger<n>[:SEQuence]:TDTRigger:LEVel..... | 915 |
| TRIGger<n>[:SEQuence]:TIME:RINTerval..... | 915 |

TRIGger:MODE <Mode>

This command turns continuous triggering on and off.

Parameters:

| | |
|--------|--|
| <Mode> | CONTInuous
Continuous measurement |
| | STOP
Measurement stops after the trigger event is done |
| *RST: | CONTInuous |

Mode: RT

TRIGger<n>[:SEQuence]:HOLDoff[:TIME] <Delay>

This command defines the length of the trigger delay.

A negative delay time (pretrigger) can be set in zero span only.

Suffix:

| | |
|-----|------------|
| <n> | irrelevant |
|-----|------------|

Parameters:

| | |
|---------|--|
| <Delay> | Range: zero span: -sweptime (see data sheet) to 30 s;
span: 0 to 30 s |
| *RST: | 0 s |

Example: TRIG:HOLD 500us

Manual operation: See "Trigger Offset" on page 113
See "Trigger Offset" on page 373

TRIGger<n>[:SEQuence]:BBPower:HOLDoff <Value>

This command sets the holding time before the next BB power trigger event (for digital input via the R&S Digital I/Q Interface, R&S FSV-B17).

Suffix:

<n> irrelevant

Parameters:

<Value> *RST: 150 ns

Example:

TRIG:SOUR BBP

Sets the baseband power trigger source.

TRIG:BBP:HOLD 200 ns

Sets the holding time to 200 ns.

Mode: all

Manual operation: See "[Trigger Holdoff](#)" on page 113

TRIGger<n>[:SEQuence]:IFPower:HOLDoff <Value>

This command sets the holding time before the next IF power trigger event.

Note: Using gating with gate mode "level" (see [TRACe<n>:IQ:EGATE:TYPE](#) on page 902) and an IFP trigger (see [TRIGger<n>\[:SEQuence\]:LEVel:IFPower](#) on page 911), the holdoff time for the IFP trigger is ignored for frequency sweep, FFT sweep, zero span and IQ mode measurements.

Suffix:

<n> irrelevant

Parameters:

<Value> *RST: 150 ns

Example:

TRIG:SOUR IFP

Sets the IF power trigger source.

TRIG:IFP:HOLD 200 ns

Sets the holding time to 200 ns.

Manual operation: See "[Trigger Holdoff](#)" on page 113

TRIGger<n>[:SEQuence]:IFPower:HYSTeresis <Value>

This command sets the limit that the hysteresis value for the IF power trigger has to fall below in order to trigger the next measurement.

Suffix:

<n> irrelevant

Parameters:

<Value> *RST: 3 dB

Example: TRIG:SOUR IFP
Sets the IF power trigger source.
TRIG:IFP:HYST 10DB
Sets the hysteresis limit value.

Manual operation: See "[Trigger Hysteresis](#)" on page 113

TRIGger<n>[:SEQUENCE]:LEVEL:AM:RELative <Level>

The command sets the level when AM-modulated signals are used as trigger source.

For triggering with AF, AM, AMRelative, FM, and PM trigger sources to be successful, the measurement time must cover at least 5 periods of the audio signal.

Suffix:

n irrelevant

Parameters:

<Level> Range: -100 to +100
*RST: 0 %
Default unit: %

Example: TRIG:LEV:AM:REL -20 %
Sets the AM trigger threshold to -20 %

Mode: ADEMOD

TRIGger<n>[:SEQUENCE]:LEVEL:AM[:ABSolute] <Level>

The command sets the level when RF power signals are used as trigger source.

For triggering with AF, AM, AMRelative, FM, and PM trigger sources to be successful, the measurement time must cover at least 5 periods of the audio signal.

Suffix:

n irrelevant

Parameters:

<Level> Range: -100 to +30
*RST: -20 dBm
Default unit: dBm

Example: TRIG:LEV:AM -30 dBm
Sets the RF power signal trigger threshold to -30 dBm

Mode: ADEMOD

Manual operation: See "[RF](#)" on page 413

TRIGger<n>[:SEQUENCE]:LEVEL:BBPower <Level>

This command sets the level of the baseband power trigger source (for digital input via the R&S Digital I/Q Interface, R&S FSV-B17).

Suffix:
<n> irrelevant

Parameters:
<Level> Range: -50 dBm to +20 dBm
*RST: -20 DBM

Example: TRIG:LEV:BB -30DBM

Mode: All

Manual operation: See "Trigger Level" on page 294

TRIGger<n>[:SEQuence]:LEVel[:EXtErnal] <TriggerLevel>

This command sets the level of the external trigger source in Volt.

Suffix:
<n> irrelevant

Parameters:
<TriggerLevel> Range: 0.5 V to 3.5 V
*RST: 1.4 V

Example: TRIG:LEV 2V

TRIGger<n>[:SEQuence]:LEVel:FM <Level>

The command sets the level when FM-modulated signals are used as trigger source.

For triggering with AF, AM, AMRelative, FM, and PM trigger sources to be successful, the measurement time must cover at least 5 periods of the audio signal.

Suffix:
n irrelevant

Parameters:
<Level> Range: -10 to +10
*RST: 0 Hz
Default unit: MHz

Example: TRIG:LEV:FM 10 kHz
Sets the FM trigger threshold to 10 kHz

Mode: ADEMODO

TRIGger<n>[:SEQuence]:LEVel:IFPower <TriggerLevel>

This command defines the power level at the third intermediate frequency that must be exceeded to cause a trigger event. Note that any RF attenuation or preamplification is considered when the trigger level is analyzed. If defined, a reference level offset is also considered.

Suffix:
<n> irrelevant

Parameters:

<TriggerLevel> *RST: -20 dBm

Example:

TRIG:LEV:IFP -30DBM

Manual operation:

See "Trg/Gate Level" on page 112

See "Trigger Level" on page 294

TRIGger<n>[:SEQuence]:LEVel:PM <Level>

The command sets the level when PM-modulated signals are used as trigger source.

For triggering with AF, AM, AMRelative, FM, and PM trigger sources to be successful, the measurement time must cover at least 5 periods of the audio signal.

Suffix:

n irrelevant

Parameters:

<Level> Range: -1000 to +1000
*RST: 0 RAD
Default unit: RAD | DEG

Example:

TRIG:LEV:PM 1.2 RAD

Sets the PM trigger threshold to 1.2 rad

Mode:

ADEMODO

TRIGger<n>[:SEQuence]:LEVel:RFPower <TriggerLevel>

This command defines the power level at the third intermediate frequency that must be exceeded to cause a trigger event. Note that any RF attenuation or preamplification is considered when the trigger level is analyzed. If defined, a reference level offset is also considered.

Suffix:

<n> irrelevant

Parameters:

<TriggerLevel> *RST: -20 dBm

Example:

TRIG:LEV:RFP -30dBm

TRIGger<n>[:SEQuence]:LEVel:VIDeo <Value>

This command sets the level of the video trigger source.

Suffix:

<n> irrelevant

Parameters:

<Value> 0 to 100 PCT
*RST: 50 PCT

Example:

TRIG:LEV:VID 50PCT

Manual operation: See ["Trg/Gate Level"](#) on page 112
See ["Trigger Level"](#) on page 294

TRIGger<n>[:SEQuence]:MASK:CONDition <Condition>

This command sets the condition that activates the frequency mask trigger.

Parameters:

<Condition>

ENTer

Triggers on entering the frequency mask.

LEAVing

Triggers on leaving the frequency mask.

INSide

The trigger is active as long as the signal is inside the frequency mask.

OUTSide

The trigger is active as long as the signal is outside the frequency mask.

*RST: INSide

Example: See ["CALCulate:MASK Subsystem"](#) on page 683.

Manual operation: See ["Setting the trigger condition"](#) on page 51

TRIGger<n>[:SEQuence]:SLOPe <Type>

This command selects the slope of the trigger signal. The selected trigger slope applies to all trigger signal sources.

Suffix:

<n> irrelevant

Parameters:

<Type>

POSitive | NEGative

*RST: POSitive

Example: TRIG:SLOP NEG

Manual operation: See ["Trg/Gate Polarity"](#) on page 112

See ["Trigger Polarity"](#) on page 295

TRIGger<n>[:SEQuence]:SOURce <Source>

This command selects the trigger source.

Note: Using gating with gate mode "level" ([TRACe<n>:IQ:EGATe:TYPE](#) on page 902/ [\[SENSe:\]SWEep:EGATe:TYPE](#)) and an IFP trigger, the holdoff time for the IFP trigger (see [TRIGger<n>\[:SEQuence\]:HOLDoff\[:TIME\]](#) on page 908) is ignored for frequency sweep, FFT sweep, zero span and IQ mode measurements.

For triggering with AF, AM, AMRelative, FM, and PM trigger sources to be successful, the measurement time must cover at least 5 periods of the audio signal. For details on trigger modes refer to the [Trigger Source](#) softkey.

When triggering or gating is activated, the squelch function is automatically disabled (see `[SENSe:]DEMod:SQUelch[:STATe]`).

For details on trigger modes refer to "[Trg/Gate Source](#)" on page 109.

For details on trigger modes refer to the "Trg/Gate Source" softkey in the base unit description.

Suffix:

<n> irrelevant

Parameters:

<Source>

EXTernal | IFPower | IMMEDIATE | MASK | TIME | VIDEO | additional trigger modes for analog demodulation (R&S FSV-K7) and FM stereo (R&S FSV-K7S) measurements: AF | FM | AM | AMRelative | PM

Note that the availability of the trigger source depends on the measurement you are in.

EXTernal

Selects an external trigger.

IFPower

Selects the power trigger on the second intermediate frequency.

IMMEDIATE

Selects the free run mode (= no trigger).

MASK

Selects the frequency mask trigger.

TDTRigger

Selects the time domain trigger.

TIME

Selects the time trigger.

VIDEO

Selects the video trigger. The video trigger is available for time domain measurements.

AF

AF power signal

FM

FM power signal

AM

corresponds to the RF power signal

AMRelative

corresponds to the AM signal

PM

PM power signal

*RST: IMMEDIATE

| | |
|--------------------------|---|
| Example: | TRIG:SOUR EXT
Selects the external trigger input as source of the trigger signal |
| Manual operation: | See " Trg/Gate Source " on page 109
See " Free Run " on page 110
See " External " on page 110
See " Video " on page 110
See " RF Power " on page 110
See " IF Power/BB Power " on page 111
See " Power Sensor " on page 111
See " Time " on page 112
See " Trigger Source " on page 372
See " FM " on page 372
See " AM " on page 372
See " PM " on page 373
See " RF " on page 373
See " Trigger Source " on page 412 |

TRIGger<n>[:SEQuence]:TDTRigger:LEVel <TriggerLevel>

This command sets the trigger level for the time domain trigger.

Parameters:

<TriggerLevel> Default unit: dBm

Example: TRIG:TDTR:LEV 0
Sets a trigger level of 0 dBm.

Mode: RT

TRIGger<n>[:SEQuence]:TIME:RINTerval <Interval>

This command sets the repetition interval for the time trigger source.

Suffix:

<n> irrelevant

Parameters:

<Interval> 2.0 ms to 5000
*RST: 1.0

Example: TRIG:SOUR TIME
Selects the time trigger input for triggering.
TRIG:TIME:RINT 50
The sweep starts every 50 s.

Mode: All

Manual operation: See "[Repetition Interval](#)" on page 113

8.2.3.20 TRIGger Subsystem for Stereo FM Measurements

The TRIGger subsystem controls the trigger for the stereo FM demodulator.

Commands of the TRIGger Subsystem

| | |
|---|-----|
| TRIGger<n>[:SEQuence]:LEVel:SFM:LEFT..... | 916 |
| TRIGger<n>[:SEQuence]:LEVel:SFM:RIGHT..... | 916 |
| TRIGger<n>[:SEQuence]:LEVel:SFM:MPX..... | 916 |
| TRIGger<n>[:SEQuence]:LEVel:SFM:MONO..... | 917 |
| TRIGger<n>[:SEQuence]:LEVel:SFM:STEReo..... | 917 |
| TRIGger<n>[:SEQuence]:LEVel:SFM:RDS..... | 918 |
| TRIGger<n>[:SEQuence]:LEVel:SFM:PILot..... | 918 |
| TRIGger<n>[:SEQuence]:SOURce..... | 918 |

TRIGger<n>[:SEQuence]:LEVel:SFM:LEFT <Level>

The command sets the level when the left stereo channel is used as trigger source.

Suffix:

<n> 1...4
 irrelevant

Parameters:

<Level> Range: -10 to +10
 *RST: 0 Hz
 Default unit: MHz

Example:

TRIG:LEV:SFM:LEFT 2Hz
Sets the left stereo signal trigger threshold to 2 Hz.

Mode: SFM

Manual operation: See "[Left](#)" on page 413

TRIGger<n>[:SEQuence]:LEVel:SFM:RIGHT <Level>

The command sets the level when the right stereo channel is used as trigger source.

Suffix:

<n> 1...4
 irrelevant

Parameters:

<Level> Range: -10 to +10
 *RST: 0 Hz
 Default unit: MHz

Example:

TRIG:LEV:SFM:RIGHT 2Hz
Sets the trigger threshold of the right stereo signal to 2 Hz.

Mode: SFM

Manual operation: See "[Right](#)" on page 413

TRIGger<n>[:SEQuence]:LEVel:SFM:MPX <Level>

The command sets the level when the MPX stereo channel is used as trigger source.

Suffix:

<n> 1...4
irrelevant

Parameters:

<Level> Range: -10 to +10
*RST: 0 Hz
Default unit: MHz

Example:

TRIG:LEV:SFM:MPX 2Hz
Sets the trigger threshold of the MPX stereo signal to 2 Hz.

Mode: SFM

Manual operation: See "MPX" on page 413

TRIGger<n>[:SEQUENCE]:LEVel:SFM:MONO <Level>

The command sets the level when the mono channel of a FM stereo signal is used as trigger source.

Suffix:

<n> 1...4
irrelevant

Parameters:

<Level> Range: -10 to +10
*RST: 0 Hz
Default unit: MHz

Example:

TRIG:LEV:SFM:MONO 2Hz
Sets the trigger threshold of the mono stereo signal to 2 Hz.

Mode: SFM

Manual operation: See "Mono" on page 413

TRIGger<n>[:SEQUENCE]:LEVel:SFM:STEReo <Level>

The command sets the level when the stereo channel is used as trigger source.

Suffix:

<n> 1...4
irrelevant

Parameters:

<Level> Range: -10 to +10
*RST: 0 Hz
Default unit: MHz

Example:

TRIG:LEV:SFM:STER 2Hz
Sets the trigger threshold of the stereo signal to 2 Hz.

Mode: SFM

Manual operation: See "Stereo" on page 413

TRIGger<n>[:SEQuence]:LEVel:SFM:RDS <Level>

The command sets the level when the RDS stereo channel is used as trigger source.

Suffix:

<n> 1...4
 irrelevant

Parameters:

<Level> Range: -10 to +10
 *RST: 0 Hz
 Default unit: MHz

Example:

TRIG:LEV:SFM:RDS 2Hz
Sets the trigger threshold of the RDS stereo signal to 2 Hz.

Mode: SFM

Manual operation: See "RDS" on page 413

TRIGger<n>[:SEQuence]:LEVel:SFM:PILot <Level>

The command sets the level when the pilot stereo channel is used as trigger source.

Suffix:

<n> 1...4
 irrelevant

Parameters:

<Level> Range: -10 to +10
 *RST: 0 Hz
 Default unit: MHz

Example:

TRIG:LEV:SFM:PIL 2Hz
Sets the trigger threshold of the pilot stereo signal to 2 Hz.

Mode: SFM

Manual operation: See "Pilot" on page 413

TRIGger<n>[:SEQuence]:SOURce <Source>

This command selects the trigger source for the start of a sweep.

Suffix:

<n> 1...4
 irrelevant

Parameters:

<Source>

IMMediate | EXTern | IFPower | AF | FM | AM | AMRelative |
 PM | TIME | SLEFt | SRIGHt | SMPX | SMONo | SSTereo |
 SRDS | SPILot

For details on trigger sources refer to the "[Trigger Source](#)"
 on page 412 softkey.

For triggering with AF, AM, AMRelative, FM, and PM trigger
 sources to be successful, the measurement time must cover at
 least 5 periods of the audio signal.

IMMediate

Free Run (no trigger)

EXTern

External trigger

IFPower

Triggering via signals which are outside the measurement chan-
 nel

AF

Audio frequency trigger

FM

Triggering via FM frequency level

AM

Triggering via RF power signal

AMRelative

Triggering via AM signal

PM

Triggering via PM frequency level

TIME

Triggering according to repetition interval

SLEFt

Triggering via left stereo signal

SRIGHt

Triggering via right stereo signal

SMPX

Triggering via MPX stereo signal

SMONo

Triggering via mono stereo signal

SSTereo

Triggering via stereo FM signal

SRDS

Triggering via RDS stereo signal

SPILot

Triggering via pilot stereo signal

*RST: IMM

Example:

TRIG:SEQ:SOUR:SRDS

Defines triggering on the RDS stereo signal.

Mode: SFM

8.2.3.21 UNIT Subsystem

The UNIT subsystem sets the basic unit of the setting parameters.

UNIT<n>:POWer <Unit>

This command selects the default unit.

The unit is the same for all measurement windows.

Parameters:

<Unit> DBM | V | A | W | DBPW | WATT | DBPT | DBUV | DBMV |
VOLT | DBUA | AMPere
*RST: DBM

Example: UNIT:POW DBUV
Sets the power unit to dBm.

Usage: SCPI confirmed

UNIT<n>:PMETer<p>:POWer <Unit>

This command selects the unit for absolute power sensor measurement for the selected sensor.

Suffix:

<n> irrelevant
<p> 1...4
Power sensor index

Parameters:

<Unit> DBM | WATT | W
*RST: DBM

Example: UNIT:PMET:POW DBM

Usage: SCPI confirmed

Mode: PSM

Manual operation: See "Unit / Scale" on page 314

UNIT<n>:PMETer<p>:POWer:RATio <Unit>

This command selects the unit for relative power sensor measurement for the selected sensor.

Suffix:

<n> irrelevant
<p> 1...4
Power sensor index

Parameters:

<Unit> DB | PCT
 *RST: DB

Example:

UNIT:PMET:POW:RAT DB

Usage:

SCPI confirmed

Mode:

PSM

Manual operation: See "[Unit / Scale](#)" on page 314

UNIT:THD <Mode>

Selects the unit for THD measurements.

Parameters:

<Mode> DB | PCT
 *RST: DB

Example:

UNIT:THD PCT

Mode:

ADEMOD, SFM

Manual operation: See "[Phase Unit \(Rad/Deg\)](#)" on page 343
 See "[THD Unit \(% / DB\)](#)" on page 343

8.2.3.22 UNIT Subsystem for Stereo FM Measurements

This chapter contains all commands of the UNIT subsystem that control stereo FM measurements.

UNIT:ADEV <Unit>

Selects the unit for absolute deviation measurements.

Parameters:

<Unit> HZ | DBM
 *RST: HZ

Example:

UNIT:ADEV DBM

Mode:

SFM

Manual operation: See "[Abs. Dev Unit \(kHz/dBm\)](#)" on page 343

UNIT:ANGLE <Unit>

This command selects the unit for angles (e.g. for PM display).

The unit is defined globally for all windows.

Suffix:

<n> irrelevant

Parameters:

<Unit> DEG | RAD
 *RST: RAD

Example: UNIT:ANGL DEG

Mode: ADEMOD, SFM

UNIT:POW <Unit>

This command selects the unit for power.

The unit is defined globally for all windows.

Suffix:

<n> irrelevant

Parameters:

<Unit> DBM | V | A | W | DBPW | WATT | DBUV | DBMV | VOLT |
 DBUA | AMPere
 *RST: dBm

Example: UNIT:POW DBM
 Sets the power unit to dBm.

Mode: A, ADEMOD, SFM, SPECM

UNIT:RDEV <Unit>

Selects the unit for relative deviation measurements.

Parameters:

<Unit> DB | PCT
 *RST: HZ

Example: UNIT:RDEV PCT

Mode: SFM

Manual operation: See "[Rel. Dev Unit \(dB / %\)](#)" on page 343

UNIT:THD <Mode>

Selects the unit for THD measurements.

Parameters:

<Mode> DB | PCT
 *RST: DB

Example: UNIT:THD PCT

Mode: ADEMOD, SFM

Manual operation: See "[Phase Unit \(Rad/Deg\)](#)" on page 343
 See "[THD Unit \(% / DB\)](#)" on page 343

8.2.3.23 Formats for Returned Values: ASCII Format and Binary Format

ASCII Format (FORMat ASCII)

The command reads out a list of comma separated values (CSV) of the measured values in floating point format.



Reading out data in binary format is quicker than in ASCII format. Thus, binary format is recommended for large amounts of data.

Binary Format (FORMat REAL,32)

The command reads out binary data (Definite Length Block Data according to IEEE 488.2), each measurement value being formatted in 32 Bit IEEE 754 Floating-Point-Format.

Depending on the number of samples to be transferred, 2 different kinds of syntax are used:

For 10^{10} samples:

The schema of the result string is as follows:

#<NoOfDigits><NoOfDataBytes><value1><value2>...<value n>, with

| | |
|-----------------|---|
| # | Header prefix, 1 byte |
| <NoOfDigits> | Number of digits of the following number of data bytes (= 4 in the example), 1 byte |
| <NoOfDataBytes> | Number of following data bytes in decimal form (= 1024 in the example), 1...9 bytes |
| <Value> | Data values, each one is a 4-byte floating point value |

Example:

#41024<value1><value2>...<value 256>

4: the following number of data bytes has 4 digits

1024: 1024 Bytes of following data; float: 4 Bytes / value => 1024 / 4 = 256 values (128 I and 128 Q values)

<value x>: 4 Byte values, must be interpreted as float

For $\geq 10^{10}$ samples:

The schema of the result string is as follows:

(<NoOfDataBytes>) <value1><value2>...<value n>, with

| | |
|-----------------|--|
| # | Header prefix, 1 byte |
| (| 1 byte |
| <NoOfDataBytes> | number of following data bytes (= 1024 in the example), 10 bytes |

| | |
|---------|--|
|) | 1 byte |
| <Value> | Data values, each one is a 4-byte floating point value |

Example:

```
#(1677721600)<value 1><value 2> ... <value 419430400>
```

(1677721600): 1677721600 Bytes of following data; float: 4 Bytes / value ==>
1677721600 / 4 = 419430400 values (200Ms I and 200Ms Q values)

<value x>: 4 Byte values, must be interpreted as float

8.2.4 Remote Control – Description of Measurement-Independent Commands

In this section all remote control commands that are independent of a particular measurement mode are described in detail. For details on specific "Spectrum" mode commands refer to [chapter 8.2.3, "Remote Control – Description of Analyzer Commands"](#), on page 554.

| | | |
|----------|--|-----|
| 8.2.4.1 | CALibration Subsystem..... | 924 |
| 8.2.4.2 | DIAGnostic Subsystem..... | 926 |
| 8.2.4.3 | DISPlay Subsystem..... | 932 |
| 8.2.4.4 | CMAP Suffix Assignment..... | 937 |
| 8.2.4.5 | FORMat Subsystem..... | 939 |
| 8.2.4.6 | HCOPY Subsystem..... | 939 |
| 8.2.4.7 | MMEMory Subsystem..... | 945 |
| 8.2.4.8 | OUTPut Subsystem (Option Additional Interfaces, B5)..... | 959 |
| 8.2.4.9 | SENSE Subsystem..... | 959 |
| | SENSE:CORRection Subsystem..... | 960 |
| | SENSE:ROSCillator Subsystem..... | 963 |
| 8.2.4.10 | SOURce Subsystem..... | 964 |
| | SOURce:TEMPerature Subsystem..... | 964 |
| 8.2.4.11 | STATus Subsystem..... | 965 |
| 8.2.4.12 | SYSTem Subsystem..... | 968 |

8.2.4.1 CALibration Subsystem

The commands of the CALibration subsystem determine the data for system error correction in the instrument.

| | |
|------------------------|-----|
| CALibration:ABORt..... | 925 |
| CALibration[:ALL]? | 925 |
| CALibration:RESult? | 925 |
| CALibration:STATe..... | 926 |

CALibration:ABORt

This command aborts the current calibration routine.

Example: CAL:ABORt
 Aborts calibration.

Usage: Event
 SCPI confirmed

CALibration[:ALL]?

This command initiates a calibration routine and queries if calibration was successful.

During the acquisition of correction data the instrument does not accept any remote control commands.

In order to recognize when the acquisition of correction data is completed, the MAV bit in the status byte can be used. If the associated bit is set in the Service Request Enable Register, the instrument generates a service request after the acquisition of correction data has been completed.

Return values:
<CalibrationState> **0**
 The command returns a '0' if calibration was successful.

Example: *CLS
 Resets the status management.
 *SRE 16
 Enables MAV bit in the Service Request Enable Register.
 *CAL?
 Starts the correction data recording, and then a service request is generated.

Usage: Query only
 SCPI confirmed

CALibration:RESult?

This command returns the results collected during calibration.

Return values:
<CalibrationData> String containing the calibration data.

| | |
|--------------------------|---|
| Example: | CAL:RES?
would return, e.g.
Total Calibration Status:
PASSED, Date (dd/mm/yyyy): 12/07/2004,
Time: 16:24:54, Runtime: 00.06 |
| Usage: | Query only |
| Manual operation: | See " Show Align Results " on page 433 |

CALibration:STATe <State>

This command includes or excludes calibration data in the actual measurement.

Parameters:

<State> ON | OFF

Example: CAL:STAT OFF
Sets up the instrument to ignore the calibration data.

Usage: SCPI confirmed

8.2.4.2 DIAGnostic Subsystem

The DIAGnostic subsystem contains the commands which support instrument diagnostics for maintenance, service and repair. In accordance with the SCPI standard, all of these commands are device-specific.

| | |
|---|-----|
| DIAGnostic<n>:SERVice:BIOSinfo?..... | 926 |
| DIAGnostic<n>:SERVice:HWInfo?..... | 927 |
| DIAGnostic<n>:SERVice:INPut:PULSed:CFrequency..... | 927 |
| DIAGnostic<n>:SERVice:INPut:PULSed:MCFrequency..... | 928 |
| DIAGnostic<n>:SERVice:INPut[:SElect]..... | 928 |
| DIAGnostic<n>:SERVice:NSource..... | 928 |
| DIAGnostic<n>:SERVice:SFUNction..... | 929 |
| DIAGnostic<n>:SERVice:SFUNction:LASTresult?..... | 929 |
| DIAGnostic<n>:SERVice:SFUNction:RESults:DElete..... | 929 |
| DIAGnostic<n>:SERVice:SFUNction:RESults:SAVE..... | 930 |
| DIAGnostic<n>:SERVice:STESt:RESult?..... | 930 |
| DIAGnostic<n>:SERVice:TEMPerature:FRONt?..... | 930 |
| DIAGnostic<n>:SERVice:VERSinfo?..... | 930 |

DIAGnostic<n>:SERVice:BIOSinfo?

This command queries the CPU board BIOS version.

Suffix:

<n> irrelevant

Return values:

<Version> ASCII string containing the BIOS version, e.g. 47.11.

Example: `DIAG:SERV:BIOS?`
Returns the BIOS version.

Usage: Query only

DIAGnostic<n>:SERVice:HWInfo?

This command queries the hardware information.

Suffix:
<n> irrelevant

Return values:
<HardwareInfo> "<component 1>|<serial #>|<order #>|<model>| <hardware code>|<revision>|<subrevision>",
"<component 2>|<serial #>|<order #>|<model>| <hardware code>|<revision>|<subrevision>",
...
Table lines are output as string data and are separated by commas. The individual columns of the table are separated from each other by |.

Example: `DIAG:SERV:HWIN?`
Queries the hardware information.
"FRONTEND|100001/003|1300.3009|03|01|00|00",
"MOTHERBOARD|123456/002|1300.3080|02|00|00|00",
...

Usage: Query only

Manual operation: See "[Hardware Info](#)" on page 444

DIAGnostic<n>:SERVice:INPut:PULSed:CFrequency <Frequency>

This command defines the frequency of the calibration signal.

Before you can use the command, you have to feed in a calibration signal with [DIAGnostic<n>:SERVice:INPut\[:SElect\]](#) on page 928.

Suffix:
<n> irrelevant

Parameters:
<Frequency> Possible frequencies of the calibration signal are fixed. If you define a frequency that is not available, the R&S FSVR uses the next available frequency. Example: a frequency of 20 MHz is rounded up to the next available frequency (21.33 MHz).

*RST: 64 MHz

Example: `DIAG:SERV:INP:PULS:CFR 128 MHz`
Defines a calibration signal frequency of 128 MHz.

Usage: SCPI confirmed

Manual operation: See "Calibration Frequency RF" on page 447

DIAGnostic<n>:SERVice:INPut:PULSed:MCFRequency <Frequency>

This command sets the calibration frequency for frequencies greater than 7 GHz. This command only takes effect if a microwave calibration signal is selected for input (`DIAGnostic<n>:SERVice:INPut[:SELect]` on page 928).

Suffix:

<n> irrelevant

Parameters:

<Frequency> **<numeric value>**
 *RST: 7 GHz

Example: DIAG:SERV:INP:PULS:MCFR 7,1 GHz

Usage: SCPI confirmed

Manual operation: See "Calibration Frequency MW" on page 447

DIAGnostic<n>:SERVice:INPut[:SELect] <Signal>

This command selects the source of the signal.

You can feed in a signal from the RF input or the calibration signal.

Suffix:

<n> irrelevant

Parameters:

<Signal> **CALibration**
 Calibration
MCALibration
 Microwave calibration (for R&S FSVR 13 and 30 only)
RF
 RF input
 *RST: RF

Example: DIAG:SERV:INP CAL
 Selects the calibration signal as the input signal

Manual operation: See "RF" on page 447

DIAGnostic<n>:SERVice:NSOource <State>

This command switches the 28 V supply of the noise source on the front panel on or off.

Suffix:

<n> irrelevant

Parameters:

<State> ON | OFF
 *RST: OFF

Example: DIAG:SERV:NSO ON

Manual operation: See "[Noise Source](#)" on page 269

DIAGnostic<n>:SERVice:SFUNction <ServiceFunction>

This command starts a service function.

The service functions are available after you have entered the level 1 or level 2 system password.

Suffix:

<n> irrelevant

Parameters:

<ServiceFunction> String containing the ID of the service function.
 The ID of the service function is made up out of five numbers, separated by a point.

- function group number
- board number
- function number
- parameter 1 (see the Service Manual)
- parameter 2 (see the Service Manual)

Example: DIAG:SERV:SFUN '2.0.2.12.1'

Usage: Event

Manual operation: See "[Service Function](#)" on page 448

DIAGnostic<n>:SERVice:SFUNction:LASTresult?

This command queries the results of the most recent service function you have used.

Suffix:

<n> irrelevant

Example: DIAG:SERV:SFUN:LAST?

Usage: Query only

DIAGnostic<n>:SERVice:SFUNction:RESults:DELeTe

This command deletes the results of the most recent service function you have used.

Suffix:

<n> irrelevant

Example: DIAG:SERV:SFUN:RES:DEL

Usage: Event

DIAGnostic<n>:SERVice:SFUNction:RESults:SAVE <FileName>

This command saves the results of the most recent service function you have used in a file.

Suffix:

<n> irrelevant

Parameters:

<FileName> String containing the file name.

Example:

DIAG:SERV:SFUN:RES:SAVE "C:\diag"

DIAGnostic<n>:SERVice:STESt:RESult?

This command queries the self test results.

Suffix:

<n> irrelevant

Parameters:

<Results> String of data containing the results.
The rows of the self test result table are separated by commas.

Example:

DIAG:SERV:STES:RES?
would return, e.g.:
"Total Selftest Status:
PASSED", "Date (dd/mm/yyyy): 09/07/2004 TIME:
16:24:54", "Runtime: 00:06", "..."

Usage:

Query only

Manual operation: See "[Selftest Results](#)" on page 448

DIAGnostic<n>:SERVice:TEMPerature:FRONt?

This command queries the temperature of the frontend.

Parameters:

<Temperature> Temperature of the frontend.

Example:

DIAG:SERV:TEMP:FRON?

Usage:

Query only

DIAGnostic<n>:SERVice:VERSinfo?

This command queries information about the hardware and software components.

Suffix:

<n> irrelevant

Return values:

<Information>

String containing the version of hardware and software components including the types of licenses for installed firmware options.

Example:

```
DIAG:SERV:VERS?
```

Queries the version information.

Response:

```
Instrument Firmware |1.63
BIOS |7.0.4.62.2
Image Version |3.28
PCI-FPGA |2.001
SA-FPGA |4.070
ADCI-FPGA |1.005
RTSA-FPGA |2.013
MB-FPGA |1.0.7.0
Data Sheet Version |01.00
Time Control Management |inactive
Audio Demodulator B3 ||
OCXO Reference B4 ||
Additional Interfaces B5 ||
Digital Baseband I/O B17 ||
RF Preamplifier B22| |permanent
Electronic Attenuator B25| |permanent
Frequency Extension 20 Hz B29| |permanent
40 MHz Bandwidth B70| |permanent
Analog Demod K7| |permanent
FM Stereo K7S| |permanent
Bluetooth K8| |permanent
Power Sensor Support K9| |permanent
Spectrogram K14| |permanent
Vector Signal Analysis K70|1.63|permanent
3GPP Base Station K72|1.63|permanent
3GPP Mobile Station K73|1.63|permanent
TD-SCDMA Base Station K76|1.63|permanent
TD-SCDMA Mobile Station K77|1.63|permanent
CDMA2000 Base Station K82|1.63|permanent
CDMA2000 Mobile Station K83|1.63|permanent
1xEV-DO Base Station K84|1.63|permanent
1xEV-DO Mobile Station K85|1.63|permanent
OFDM-VSA K96| |permanent
LTE FDD Downlink K100| |permanent
LTE FDD Uplink K101| |permanent
LTE Downlink MIMO K102| |permanent
LTE TDD Downlink K104| |permanent
LTE TDD Uplink K105| |permanent
```

Usage:

Query only
SCPI confirmed

8.2.4.3 DISPlay Subsystem

The DISPLay subsystem controls the selection and presentation of textual and graphic information as well as of measurement data on the display.



Some applications offer up to four measurement windows. For those, the suffix <1...4> for WINDow selects the measurement window. For all other applications, the suffix is irrelevant.

Further Information

- [chapter 8.2.4.4, "CMAP Suffix Assignment"](#), on page 937

| | |
|--------------------------------------|-----|
| DISPlay:ANNotation:FREQuency..... | 932 |
| DISPlay:CMAP<item>:DEFault..... | 932 |
| DISPlay:CMAP<item>:HSL..... | 933 |
| DISPlay:CMAP<item>:PDEFined..... | 933 |
| DISPlay:LOGO..... | 934 |
| DISPlay:PSAVe:HOLDoff..... | 934 |
| DISPlay:PSAVe[:STATe]..... | 934 |
| DISPlay:SBAR[:STATe]..... | 935 |
| DISPlay:SKEYs[:STATe]..... | 935 |
| DISPlay:TBAR[:STATe]..... | 935 |
| DISPlay:THEMe:CATalog?..... | 935 |
| DISPlay:THEMe:SElect..... | 935 |
| DISPlay:TOUChscreen:STATe..... | 936 |
| DISPlay[:WINDow<n>]:TEXT[:DATA]..... | 936 |
| DISPlay[:WINDow<n>]:TEXT:STATe..... | 936 |
| DISPlay[:WINDow<n>]:TIME..... | 936 |
| DISPlay[:WINDow<n>]:TIME:FORMat..... | 937 |

DISPlay:ANNotation:FREQuency <State>

This command switches the x-axis annotation on or off.

Parameters:

<State> ON | OFF
 *RST: ON

Example: DISP:ANN:FREQ OFF

Usage: SCPI confirmed

Manual operation: See "[Annotation \(On/Off\)](#)" on page 441

DISPlay:CMAP<item>:DEFault <Setting>

This command resets the screen colors of all display items to their default settings.

Suffix:

<item> irrelevant

Parameters:

<Setting> 1 | 2
Default settings DEFault1 and DEFault2

Example:

DISP:CMAP:DEF2
Selects default setting 2 for setting the colors.

Usage:

Event
SCPI confirmed

Manual operation:

See ["Select Screen Color Set"](#) on page 442
See ["Set to Default"](#) on page 443

DISPlay:CMAP<item>:HSL <ColorTable>

This command defines the color table of the instrument.

The set values are not changed by *RST.

Suffix:

<item> Selects the display item. For more information see [chapter 8.2.4.4, "CMAP Suffix Assignment"](#), on page 937.

Parameters:

<ColorTable> hue | sat | lum

hue

TINT

sat

SATURATION

lum

BRIGHTNESS

The value range is 0 to 1 for all parameters.

Example:

DISP:CMAP2:HSL 0.3,0.8,1.0
Changes the grid color.

Usage:

SCPI confirmed

Manual operation:

See ["Screen Colors"](#) on page 442
See ["Select Object"](#) on page 442
See ["User Defined Colors"](#) on page 443

DISPlay:CMAP<item>:PDEFined <Color>

This command defines the color table of the instrument using predefined color values. Each suffix of CMAP is assigned to one or several graphical elements which can be modified by varying the corresponding color setting.

The values set are not changed by *RST.

Suffix:

<item> Selects the display item. For more information see [chapter 8.2.4.4, "CMAP Suffix Assignment"](#), on page 937.

Parameters:

<Color> BLACK | BLUE | BROWn | GREen | CYAN | RED | MAGenta |
 YELLow | WHITe | DGRAY | LGRAY | LBLUe | LGREen |
 LCYan | LRED | LMAGenta

Example:

DISP:CMAP2:PDEF GRE

Usage:

SCPI confirmed

Manual operation: See ["Predefined Colors"](#) on page 443

DISPlay:LOGO <State>

This command switches the company logo on the screen on or off.

Parameters:

<State> ON | OFF
 *RST: ON

Example:

DISP:LOGO OFF

Manual operation: See ["Print Logo \(On/Off\)"](#) on page 441

DISPlay:PSAVe:HOLDoff <Minutes>

This command sets the holdoff time for the power-save mode of the display. The available value range is 1 to 60 minutes, the resolution 1 minute. The entry is dimensionless.

Parameters:

<Minutes> 1 to 60
 *RST: 15

Example:

DISP:PSAV:HOLD 30

Manual operation: See ["Display Pwr Save \(On/Off\)"](#) on page 444

DISPlay:PSAVe[:STATe] <State>

This command switches on or off the power-save mode of the display. With the power-save mode activated the display including backlight is completely switched off after the elapse of the response time (see [DISPlay:PSAVe:HOLDoff](#) command).

This mode is recommended to protect the display, especially if the instrument is operated exclusively via remote control.

Parameters:

<State> ON | OFF
 *RST: OFF

Example:

DISP:PSAVe ON
 Switches on the power-save mode.

Manual operation: See ["Display Pwr Save \(On/Off\)"](#) on page 444

DISPlay:SBAR[:STATe] <State>

This command turns the status bar in the display on and off.

Parameters:

<State> ON | OFF
*RST: ON

Example: DISP:SBAR OFF

Manual operation: See "[Status Bar](#)" on page 441

DISPlay:SKEYs[:STATe] <State>

This command turns the softkey bar in the display on and off.

Parameters:

<State> ON | OFF
*RST: ON

Example: DISP:SKEY OFF

DISPlay:TBAR[STATe] <State>

This command turns the toolbar in the display on or off.

Parameters:

<State> ON | OFF
*RST: OFF

Example: DISP:TOOL ON

Manual operation: See "[Tool Bar State \(On/Off\)](#)" on page 441

DISPlay:THEMe:CATalog?

This command queries the available themes for the display.

Example: DISP:THEMe:CAT?

Usage: Query only

DISPlay:THEMe:SElect <Theme>

This command selects a theme for the screen display. The theme defines the colors used for keys and screen elements, for example.

Parameters:

<Theme> String containing the name of the theme.
*RST: SPL

Example: DISP:THEM:SEL "OceanBlue"

Manual operation: See "[Theme Selection](#)" on page 442

DISPlay:TOUCHscreen:STATe <State>

This command turns the touch screen functionality on, off, or partially on.

Parameters:

<State> ON | OFF | FRAME

ON
Touch screen function is active for entire screen

OFF
Touch screen is deactivated for entire screen

FRAME
Touch screen is deactivated for the diagram area of the screen, but active for the surrounding Softkeys, toolbars and menus.

*RST: ON

Example: DISP:TOUC:STAT ON

DISPlay[:WINDow<n>]:TEXT[:DATA] <Comment>

This command defines a comment (max. 20 characters) which can be displayed in one of the measurement windows.

Suffix:

<n> Selects the measurement window.

Parameters:

<Comment> *RST: (empty)

Example: DISP:WIND:TEXT 'Noise Measurement'
Defines the screen title.

Manual operation: See "[Screen Title \(On/Off\)](#)" on page 441

DISPlay[:WINDow<n>]:TEXT:STATe <State>

This command turns the display of the comment (screen title) on and off.

Suffix:

<n> Selects the measurement window.

Parameters:

<State> ON | OFF

*RST: OFF

Example: DISP:TEXT:STAT ON
Switches on the title.

DISPlay[:WINDow<n>]:TIME <State>

This command turns the display of date and time on and off.

| | |
|--------------------------|---|
| Suffix: | |
| <n> | irrelevant |
| Parameters: | |
| <State> | ON OFF |
| | *RST: OFF |
| Example: | DISP:TIME ON |
| Manual operation: | See "Screen Title (On/Off)" on page 441
See "Time+Date (On/Off)" on page 441 |

DISPlay[:WINDow<n>]:TIME:FORMat <Format>

This command selects the time and date display format.

| | |
|--------------------------|---|
| Suffix: | |
| <n> | irrelevant |
| Parameters: | |
| <Format> | US DE |
| | *RST: DE |
| Example: | DISP:TIME ON
Switches the screen display of date and time on.
DISP:TIME:FORM US
Switches the date and time format to US. |
| Manual operation: | See "Time+Date Format (US/DE)" on page 441 |

8.2.4.4 CMAP Suffix Assignment

Each suffix of CMAP is assigned one or several graphical elements which can be modified by varying the corresponding color setting. The following assignment applies:

| Suffix | Description |
|----------|--------------------|
| CMAP1 | Background |
| CMAP2 | Grid |
| CMAP3 *) | Common Text |
| CMAP4 *) | Check Status OK |
| CMAP5 *) | Check Status Error |
| CMAP6 *) | Text Special 1 |
| CMAP7 *) | Text Special 2 |
| CMAP8 | Trace 1 |
| CMAP9 | Trace 2 |
| CMAP10 | Trace 3 |
| CMAP11 | Marker Info Text |

| Suffix | Description |
|-----------|-----------------------------------|
| CMAP12 | Limit Lines |
| CMAP13 | Limit and Margin Check – "Pass" |
| CMAP14 | Limit and Margin Check – "Fail" |
| CMAP15 *) | Softkey Text |
| CMAP16 *) | Softkey Background |
| CMAP17 *) | Selected Field Text |
| CMAP18 *) | Selected Field Background |
| CMAP19 *) | Softkey 3D Bright Part |
| CMAP20 *) | Softkey 3D Dark Part |
| CMAP21 *) | Softkey State "On" |
| CMAP22 *) | Softkey State "Dialog open" |
| CMAP23 *) | Softkey Text Disabled |
| CMAP24 | Logo |
| CMAP25 | Trace 4 |
| CMAP26 | Grid – Minorlines |
| CMAP27 | Marker |
| CMAP28 | Display Lines |
| CMAP29 *) | Sweepcount – Text |
| CMAP30 | Limit and Margin Check – Text |
| CMAP31 | Limit and Margin Check – "Margin" |
| CMAP32 *) | Table Overall – Title Text |
| CMAP33 *) | Table Overall – Title Background |
| CMAP34 *) | Table Overall – Text |
| CMAP35 *) | Table Overall – Background |
| CMAP36 *) | Table Value – Title Text |
| CMAP37 *) | Table Value – Title Background |
| CMAP38 *) | Table Value – Text |
| CMAP39 *) | Table Value – Background |
| CMAP40 | Trace 5 |
| CMAP41 | Trace 6 |

*) these settings can only be defined via the theme, see [chapter 8.2.4.3, "DISPlay Sub-system"](#), on page 932, and are thus ignored in the SCPI command

8.2.4.5 FORMat Subsystem

The FORMat subsystem specifies the data format of the data transmitted from and to the instrument.

FORMat[:DATA] <Format>

This command selects the data format for the data transmitted from the R&S FSVR to the controlling computer. It is used for the transmission of trace data. The data format of trace data received by the instrument is automatically recognized, regardless of the format which is programmed.

In the "Spectrum" mode, the format setting REAL, 32 is used for the binary transmission of trace data.

Parameters:

<Format>

ASCIi

ASCII data are transmitted in plain text, separated by commas.

REAL

REAL data are transmitted as 32-bit IEEE 754 floating-point numbers in the "definite length block format".

*RST: ASCII

Example:

```
FORM REAL, 32
```

```
FORM ASC
```

8.2.4.6 HCOPy Subsystem

The HCOPy subsystem controls the output of display information for documentation purposes on output devices or files. The instrument allows two independent printer configurations which can be set separately with the suffix <1|2>.

| | |
|------------------------------------|-----|
| HCOPy:ABORt..... | 939 |
| HCOPy:CMAP<item>:DEFault..... | 940 |
| HCOPy:CMAP<item>:HSL..... | 940 |
| HCOPy:CMAP<item>:PDEFined..... | 941 |
| HCOPy:DESTination<1 2>..... | 941 |
| HCOPy:DEVice:COLor..... | 942 |
| HCOPy:DEVice:LANGuage<1 2>..... | 942 |
| HCOPy[:IMMediate<1 2>]..... | 943 |
| HCOPy[:IMMediate<1 2>]:NEXT..... | 943 |
| HCOPy:ITEM:ALL..... | 944 |
| HCOPy:ITEM:WINDow:TABLe:STATe..... | 944 |
| HCOPy:ITEM:WINDow:TEXT..... | 944 |
| HCOPy:PAGE:ORientation<1 2>..... | 945 |
| HCOPy:TDSTamp:STATe<1 2>..... | 945 |

HCOPy:ABORt

This command aborts a running hardcopy output.

Example:

```
HCOP:ABOR
```

Usage: Event
SCPI confirmed

HCOPY:CMAP<item>:DEFault <ColorSet>

This command defines the color scheme for print jobs.

Suffix:
<item> Selects the item for which the color scheme is to be defined. For details on the CMAP assignment refer to [chapter 8.2.4.4, "CMAP Suffix Assignment"](#), on page 937.

Parameters:
<ColorSet> 1 | 2 | 3 | 4

1
current screen colors with the background in white and the grid in black.

2
optimized color set

3
user defined color set

4
current screen colors without any changes (setting for hardcopies)

Example: HCOPY:CMAP:DEF2
Selects the optimized color set for the color settings of a printout or a hardcopy.

Usage: Event
SCPI confirmed

Manual operation: See ["Set to Default"](#) on page 443
See ["Select Print Color Set"](#) on page 443

HCOPY:CMAP<item>:HSL

This command selects the color for various screen elements in print jobs.

The values set are not changed by *RST.

Suffix:
<item> Selects the item for which the color scheme is to be defined. For details on the CMAP assignment refer to [chapter 8.2.4.4, "CMAP Suffix Assignment"](#), on page 937.

Parameters:

hue | sat | lum

hue

tint

sat

saturation

lum

brightness

The value range is 0 to 1 for all parameters.

Example:

HCOP:CMAP2:HSL 0.3,0.8,1.0

Changes the grid color

Usage:

SCPI confirmed

Manual operation:See "[Select Object](#)" on page 442See "[User Defined Colors](#)" on page 443See "[Print Colors](#)" on page 443**HCOPY:CMAP<item>:PDEFined <Color>**

This command selects a predefined color for various screen elements in print jobs.

The values set are not changed by *RST.

Suffix:

<item>

Selects the item for which the color scheme is to be defined.
For details on the CMAP assignment refer to [chapter 8.2.4.4, "CMAP Suffix Assignment"](#), on page 937.**Parameters:**

<Color>

BLACK | BLUE | BROWn | GREen | CYAN | RED | MAGenta |
YELLow | WHITE | DGRAY | LGRAY | LBLUe | LGREEN |
LCYan | LRED | LMAGenta**Example:**

HCOP:CMAP2:PDEF GRE

Usage:

SCPI confirmed

Manual operation:See "[Predefined Colors](#)" on page 443**HCOPY:DESTination<1|2> <Medium>**

This command selects the destination of a print job.

The type of instrument is selected with `SYSTEM:COMMunicate:PRINter:SElect <1|2>`, which automatically selects a default output medium. Therefore `HCOPY:DESTination` should always be sent after setting the device type.

The suffix <1|2> selects the printing device.

Parameters:

<Medium>

'MMEM'

Sends the hardcopy to a file.

You can select the file name with `MMEMory:NAME`You can select the file format with `HCOPY:DEVIce:``LANGUage<1|2>`.**'SYST:COMM:PRIN'**

Sends the hardcopy to the printer.

You can select the printer with `SYSTem:COMMunicate:``PRINter:SElect <1|2>`.**'SYST:COMM:CLIP'**

Sends the hardcopy to the clipboard.

The format should be WEMF.

`*RST: SYST:COMM:CLIP`**Example:**`SYST:COMM:PRIN:SEL2 'LASER on LPT1'`

Selects the printer and output medium for device 2.

`HCOP:DEST2 'SYST:COMM:PRIN'`

Selects the printer interface as device 2.

Usage:

SCPI confirmed

Manual operation: See "[Device Setup](#)" on page 466**HCOPY:DEVIce:COLor <State>**

This command turns color printing on and off.

Parameters:

<State>

ON | OFF

ON

Color output

OFF

Black and white output

`*RST: OFF`**Example:**`HCOP:DEV:COL ON`**Usage:**

SCPI confirmed

Manual operation: See "[Color \(On/Off\)](#)" on page 444**HCOPY:DEVIce:LANGUage<1|2> <Format>**

This command selects the file format for a print job.

The suffix <1|2> selects the printing device.

Parameters:

<Format>

GDI

Graphics Device Interface:

Default format for the output to a printer configured under Windows. Must be selected for the output to the printer interface.

Can be used for the output to a file. The printer driver configured under Windows is used in this case and a printer-specific file format is thus generated.

(see also [HCOPY:DESTination<1|2>](#) command)**WMF | EWMF**

WINDOWS Metafile and Enhanced Metafile Format:

Data formats for output files which can be integrated in corresponding programs for documentation purposes at a later time. WMF can only be used for output to a file and EWMF also for the output to the clipboard.

(see also [HCOPY:DESTination<1|2>](#) command)**BMP | JPG | PNG**

Data format for output to files only.

Example:

HCOP:DEV:LANG WMF

Usage:

SCPI confirmed

Manual operation: See "[Device Setup](#)" on page 466**HCOPY[:IMMEDIATE<1|2>]**

This command initiates a print job.

If you are printing to a file, the file name depends on [MMEMORY:NAME](#).

The suffix <1|2> selects the printing device.

Example:

HCOP:DEV:LANG BMP

Selects the data format.

HCOP:DEST 'MMEM'

Directs the hardcopy to a file.

MMEM:NAME 'C:\R_S\instr\user\Print.bmp'

Selects the file name. If the file Print.bmp already exists, it is replaced.

HCOP

Saves the hardcopy output into the file Print.bmp.

Usage:

Event

SCPI confirmed

Manual operation: See "[ScreenShot](#)" on page 453See "[Print Screen](#)" on page 465**HCOPY[:IMMEDIATE<1|2>]:NEXT**

This command initiates a print job.

If you are printing to a file, the file name depends on `MMEMory:NAME`. This command adds a consecutive number to the file name.

The suffix `<1|2>` selects the printing device.

Example:

```
HCOP:DEV:LANG BMP
Selects the data format.
HCOP:DEST 'MMEM'
Directs the hardcopy to a file.
MMEM:NAME 'C:\R_S\instr\user\Print.bmp'
Selects the file name.
HCOP
Saves the hardcopy output into the file Print.bmp.
HCOP:NEXT
Saves the hardcopy output into the file Print_001.bmp.
HCOP:NEXT
Saves the hardcopy output into the file Print_002.bmp.
```

Usage: Event
SCPI confirmed

Manual operation: See "[Print Screen](#)" on page 465

HCOPY:ITEM:ALL

This command includes all screen elements in the printout.

The screen elements include comments, title, time and date.

Example: `HCOPY:ITEM:ALL`

Usage: Event
SCPI confirmed

Manual operation: See "[Print Screen](#)" on page 465

HCOPY:ITEM:WINDOW:TABLE:STATE <State>

This command turns printing of the currently active table on and off.

Parameters:

<State> ON | OFF
*RST: OFF

Example: `HCOPY:ITEM:WINDOW:TABLE:STAT ON`

HCOPY:ITEM:WINDOW:TEXT <Comment>

This command defines a comment added to the printout.

Parameters:

<Comment> String containing the comment with a maximum of 100 characters. The line feed is by means of the characters `@`.

Example: HCOP:ITEM:WIND:TEXT 'comment'

Manual operation: See ["Comment"](#) on page 467

HCOPY:PAGE:ORIENTATION<1|2> <Orientation>

The command selects the format of the printout.

The command is only available if the output device is a printer (see [HCOPY:DESTINATION<1|2>](#) on page 941).

Parameters:

<Orientation> LANDscape | PORTRait
*RST: PORT

Example: HCOP:PAGE:ORI LAND

Usage: SCPI confirmed

Manual operation: See ["Device Setup"](#) on page 466

HCOPY:TDSTAMP:STATE<1|2> <State>

This command includes or excludes the time and date in the printout.

The suffix <1|2> selects the printing device.

Parameters:

<State> ON | OFF
*RST: OFF

Example: HCOP:TDST:STAT OFF

Manual operation: See ["Device Setup"](#) on page 466

8.2.4.7 MMEORY Subsystem

The MMEORY (mass memory) subsystem provides commands which allow for access to the storage media of the instrument and for storing and loading various instrument settings.

The various drives can be addressed via the "mass storage unit specifier" <msus> using the conventional DOS syntax. The internal hard disk is addressed by "C:". For details on drives refer to [chapter 6.2, "Saving and Recalling Settings Files – SAVE/RCL Key"](#), on page 449.

The file names <file_name> are indicated as string parameters with the commands being enclosed in quotation marks. They also comply with DOS conventions.

DOS file names consist of max. 8 ASCII characters and an extension of up to three characters separated from the file name by a dot "." Both, the dot and the extension are optional. The dot is not part of the file name. DOS file names do not distinguish between uppercase and lowercase notation. All letters and digits are permitted as well as the special characters "_", "^", "\$", "~", "!", "#", "%", "&", "-", "{", "}", "(", ")", "@" and

"". Reserved file names are CLOCK\$, CON, AUX, COM1 to COM4, LPT1 to LPT3, NUL and PRN.

The two characters "*" and "?" have the function of so-called "wildcards", i.e., they are variables for selection of several files. The question mark "?" replaces exactly one character, the asterisk means any of the remaining characters in the file name. "*. *" thus means all files in a directory.

In this section all MMEMory commands that are independant of a particular measurement mode are described in detail. For details on specific "Spectrum" mode commands refer to [chapter 8.2.3.11, "MMEMory Subsystem"](#), on page 741.

| | |
|--------------------------------------|-----|
| MMEMory:CATalog? | 946 |
| MMEMory:CATalog:LONG? | 947 |
| MMEMory:CDIRectory | 948 |
| MMEMory:CLEar:ALL | 948 |
| MMEMory:CLEar:STATe 1, | 948 |
| MMEMory:COMMeNt | 949 |
| MMEMory:COpy | 949 |
| MMEMory:DATA | 950 |
| MMEMory:DELeTe | 950 |
| MMEMory:LOAD:AUTO | 951 |
| MMEMory:LOAD:STATe | 951 |
| MMEMory:MDIRectory | 952 |
| MMEMory:MOVE | 952 |
| MMEMory:MSIS | 953 |
| MMEMory:NAME | 953 |
| MMEMory:NETWork:DISConnect | 954 |
| MMEMory:NETWork:MAP | 954 |
| MMEMory:NETWork:UNUSeddrives? | 954 |
| MMEMory:NETWork:USEDdrives? | 955 |
| MMEMory:RDIRectory | 955 |
| MMEMory:SELeCt[:ITEM]:ALL | 955 |
| MMEMory:SELeCt[:ITEM]:DEFault | 955 |
| MMEMory:SELeCt[:ITEM]:HWSettings | 956 |
| MMEMory:SELeCt[:ITEM]:LINES:ALL | 956 |
| MMEMory:SELeCt[:ITEM]:NONE | 956 |
| MMEMory:SELeCt[:ITEM]:SGRam | 956 |
| MMEMory:SELeCt[:ITEM]:TRACe[:ACTive] | 957 |
| MMEMory:SELeCt[:ITEM]:TRANSDucer:ALL | 957 |
| MMEMory:STORe<n>:STATe | 957 |
| MMEMory:STORe<n>:STATe:NEXT | 958 |
| MMEMory:USER<Softkey> | 958 |

MMEMory:CATalog?

This command reads the indicated directory.

Query parameters:**<Path>** <path>

DOS Path name

The path name should conform to DOS conventions and may also include the drive name. According to DOS convention, wildcard characters can be entered in order to query e.g. a list of all files of a certain type.

Return values:**Result** List of file names in the form of strings separated by commas**Example:**

MMEM:CAT? 'C:\R_S\Instr\user*.DFL'

Returns all files in C:\R_S\Instr\user with extension ".DFL"

MMEM:CAT? 'C:\R_S\Instr\user\SPOOL?.WMF'

Returns all files in C:\R_S\Instr\user whose names start with SPOOL, have 6 letters and the extension ".WMF".

SPOOL1.WMF, SPOOL2.WMF, SPOOL3.WMF

Usage:

Query only

SCPI confirmed

Manual operation: See ["Select File"](#) on page 451**MMEMory:CATalog:LONG?**

Corresponds to [MMEMory:CATalog?](#) on page 946, but displays extended information on the files contained in the current or specified directory.

This command is an event and therefore has no *RST value and no query.

Query parameters:**<Path>** <path>

DOS Path name

The path name should be in conformance with DOS conventions and may also include the drive name.

Following this value, for each file, a string is listed according to the following syntax:

```
"<File name>, <suffix>, <Length of file in bytes>"
```

Return values:

Result <total number of bytes the directory contains>,"<File name1>, <suffix1>, <Length of file 2 in bytes>","<File name 2>, <suffix2>, <Length of file2 in bytes>","...",<File name n>, <suffix n>, <Length of file n in bytes>"

The response value consists of a list of strings, separated by commas. It begins with the total number of bytes the directory contains. Then the information for each file is returned.

The <suffix> may be:

- ASCii
- BINary
- STAT

Example: MMEM:CAT:LONG? 'C:\R_S\Instr\user'
 Returns all files in C:\R_S\Instr\user:
 1776,3331993600, "autolog.txt,ASC,1520",
 "autologin.reg,BIN,144", "no_autologin.reg,BIN,
 112"
 Query for the current directory:
 MMEM:CDIR?
 Response:
 C:\R_S\Instr\user
 MMEM:CAT:LONG?
 Returns all files in C:\R_S\Instr\user.

Usage: Query only
 SCPI confirmed

MMEMory:CDIRectory <Directory>

This command changes the current directory.

Parameters:

<Directory> <directory_name>
<directory_name>
 DOS path name

In addition to the path name, the indication of the directory may contain the drive name. The path name complies with the DOS conventions.

Example: MMEM:CDIR 'C:\R_S\Instr\user'
 Selects the directory C:\R_S\Instr\user.

Usage: SCPI confirmed

Manual operation: See ["Edit Path"](#) on page 454

MMEMory:CLEar:ALL

This command deletes all instrument configuration files in the current directory.

You can select the directory with [MMEMory:CDIRectory](#) on page 948. The default directory is C:\R_S\Instr\user.

Example: MMEM:CLEAR:ALL

Usage: Event

MMEMory:CLEar:STATe 1, <FileName>

This command deletes the instrument settings file selected by <file_name>. All associated files on the mass memory storage are cleared.

Parameters:

<FileName> 1,<file_name>
 with <file_name> = DOS file name without extension
 The file name includes indication of the path and may also include the drive. The path name complies with DOS conventions.

Example: MMEM:CLE:STAT 1, 'TEST'

Usage: Event

Manual operation: See "[Delete File](#)" on page 452

MMEMory:COMMeNt <Comment>

This command defines a comment for the stored settings.

Parameters:

<Comment>

Example: MMEMory:COMMeNt "ACP measurement with Standard Tetra from 23.05."
 MMEMory::MMEMory:STORE1:STATE 1, "ACP_T"
 As a result, in the selection list for recall settings, the comment "ACP measurement with Standard Tetra from 23.05." is added to the ACP entry.

Usage: SCPI confirmed

MMEMory:COpy <FileSource>,<FileDestination>

This command copies the files indicated in <file_source> to the destination directory indicated with <file_destination> or to the destination file indicated by <file_destination> if <file_source> is just a file.

Parameters:

<FileSource>,<FileDestination>,<file_source>,<file_destination> = <file_name>
 <file_source>,<file_destination> = <file_name>
 DOS file name

The indication of the file name may include the path and the drive name. The file names and path information must be in accordance with the DOS conventions.

Example: MMEM:COpy 'C:\R_S\Instr\user\SETUP.CFG', 'E:'

Usage: Event
 SCPI confirmed

Manual operation: See "[Copy](#)" on page 455

MMEMory:DATA <FileName>, [<Block>]

This command writes the block data contained in <block> into the file characterized by <file_name>. The delimiter must be set to EOI to obtain error-free data transfer.

The associated query command reads the indicated file from the mass memory and transfers it to the remote control computer. It should be noted that the buffer memory of the control computer should be large enough to store the file. The setting of the delimiter is irrelevant in this case.

The command is useful for reading stored settings files or trace data from the instrument or for transferring them to the instrument.

Parameters:

| | |
|------------|--|
| <FileName> | '<file name>' (file name in single quotes)
selects the file to be transferred |
| <Block> | binary data block with the following structure: #<digit for the length of the length information><length information (number of bytes) for the binary data><binary data> |

Example:

```
MMEM:DATA 'TEST01.HCP',#216 This is the file
where:
```

#2: the next 2 characters are the length indication

16: number of subsequent binary data bytes

This is the file: 16 bytes stored as binary data in the file

```
TEST01.HCP
```

```
MMEM:DATA? 'TEST01.HCP'
```

Transfers the file TEST01.HCP from the instrument to the control computer.

Usage: SCPI confirmed

MMEMory:DELeTe <FileName>

This command deletes the indicated files.

Parameters:

| | |
|------------|---|
| <FileName> | <file_name> = DOS file name
The indication of the file name contains the path and, optionally, the drive name. Indication of the path complies with DOS conventions. |
|------------|---|

Example:

```
MMEM:DEL 'TEST01.HCP'
```

The file TEST01.HCP is deleted.

Usage: SCPI confirmed

Manual operation: See ["Delete"](#) on page 455

MMEMory:LOAD:AUTO <Mode>

This command defines which settings file is automatically loaded after the device is switched on. The contents of the file are read after switching on the device and used to define the new device state.

The settings file defined as auto recall set can also be restored by the **RST* on page 553 command.

Parameters:

<Mode> 1,'FACTORY' | 1,'<file_name>' | with <file_name>
1,'FACTORY'
 deactivates the startup recall function
1,'<file_name>'
 activates the startup recall function and defines the settings file to be loaded
with <file_name>
 DOS file name with or without extension
 The file name includes indication of the path and may also include the drive name. The path name complies with DOS conventions.

Example: MMEM:LOAD:AUTO 1, 'C:\R_S\Instr\user\TEST'

Usage: Event

Manual operation: See "[Startup Recall \(On/Off\)](#)" on page 453

MMEMory:LOAD:STATe 1, <FileName>

This command restores and activates an instrument configuration stored in a *.dfl file.

Note that files with other formats cannot be loaded with this command.

The contents that are reloaded from the file are defined by the last selection made either in the "Save/Recall" dialogs (manual operation) or through the `MMEMory:SElect[:ITEM]` commands (remote operation; the settings are identical in both cases).

By default, the selection is limited to the user settings ("User Settings" selection in the dialogs, `HWSettings` in SCPI). The selection is not reset by PRESET or **RST*.

As a consequence, the results of a SCPI script using the `MMEMory:LOAD:STATe` command without a previous `MMEMory:SElect[:ITEM]` command may vary, depending on previous actions in the GUI or in previous scripts, even if the script starts with the **RST* command.

It is therefore recommended that you use the appropriate `MMEMory:SElect[:ITEM]` command before using `MMEMory:LOAD:STATe`.

Parameters:

1

<FileName> DOS file name with or without extension
 The file name includes indication of the path and may also include the drive name. The path name complies with DOS conventions.

Example:

```
MMEM:SEL:ALL
//Save all items (User Settings, All Traces, All Limit Lines) from
the R&S FSVR.
MMEM:LOAD:STAT 1, 'C:\R_S\Instr\user\TEST01'
//Reloads all items
In the "Recall" dialog, select only "User Settings" and "All Limit
Lines".
MMEM:LOAD:STAT 1, 'C:\R_S\Instr\user\TEST01'
//Reloads user settings and all limit lines.
*RST
//Reset instrument.
MMEM:LOAD:STAT 1, 'C:\R_S\Instr\user\TEST01'
//Selected items are retained. Reloads user settings and all limit
lines.
Restart the instrument (using the ON/OFF key on the front
panel).
MMEM:LOAD:STAT 1, 'C:\R_S\Instr\user\TEST01'
// Selected items are set to default. Reloads only the user set-
tings.
```

Usage: SCPI confirmed

Manual operation: See ["Save File / Recall File"](#) on page 451
 See ["Recall"](#) on page 452

MMEMory:MDIRectory <Directory>

This command creates a new directory. The file name includes indication of the path and may also include the drive name. The path name complies with DOS conventions.

Parameters:

<Directory> <directory_name> = DOS path name

Example: MMEM:MDIR 'C:\R_S\Instr\user'

Usage: Event

Manual operation: See ["New Folder"](#) on page 455

MMEMory:MOVE <FileSource>,<FileDestination>

This command renames existing files, if <file_destination> contains no path indication. Otherwise the file is moved to the indicated path and stored under the file name specified there, if any.

Parameters:

<FileSource>, <FileDestination>, <file_destination> = <file_name> = DOS file name

The file name includes indication of the path and may also include the drive. The path name complies with DOS conventions.

Example:

```
MMEM:MOVE 'C:\TEST01.CFG', 'SETUP.CFG'
```

Renames TEST01.CFG in SETUP.CFG in directory C:\.

```
MMEM:MOVE 'C:\TEST01.CFG', 'C:\R_S\Instr\user
```

Moves TEST01.CFG from C:\ to C:\R_S\Instr\user.

```
MMEM:MOVE 'C:\TEST01.CFG', 'C:
```

```
\R_S\Instr\user\SETUP.CFG'
```

Moves TEST01.CFG from C:\ to C:\R_S\Instr\user and renames the file in SETUP.CFG.

Usage:

Event

SCPI confirmed

Manual operation: See ["Rename"](#) on page 455

MMEMory:MSIS <Device>

This command changes to the drive indicated. The drive may be the internal hard disk C:.

Parameters:

<Device> <device> = A: | C: ... Z:

```
*RST: "C:
```

The path name complies with DOS conventions.

Example:

```
MMEM:MSIS 'C: '
```

Usage:

SCPI confirmed

Manual operation: See ["Edit Path"](#) on page 454

MMEMory:NAME <FileName>

This command defines a destination file for the printout started with the [HCOPY\[: IMMEDIATE<1|2>\]](#) on page 943 command. In this case the printer output must be routed to a file as destination.

Parameters:

<FileName> <file_name> = DOS file name

The file name includes indication of the path and may also include the drive name. The file name and path information comply with DOS conventions.

Example:

```
MMEM:NAME 'C:\R_S\instr\user\PRINT1.BMP'
```

Selects the file name.

Usage:

Event

SCPI confirmed

MMEMory:NETWork:DISConnect <Drive>

This command disconnects the selected drive.

Parameters:

<Drive>

Example: MMEM:NETW:DISC 'T: '
Disconnects network drive T:

Usage: Event

Manual operation: See "[Disconnect Network Drive](#)" on page 456

MMEMory:NETWork:MAP <Drive>, <HostName> [, <UserName>, <Password>][, <Reconnect>]

This command maps a drive to a server or server directory of the network.

Note that you have to allow sharing for a server or folder in Microsoft networks first.

Parameters:

<Drive> String containing the drive name or path of the directory you want to map.

<HostName> String containing the host name of the computer or the IP address and the share name of the drive.
'<host name or IP address\share name>'

<UserName> String containing a user name in the network.
The user name is optional.

<Password> String containing the password corresponding to the <User-Name>.
The password is optional.

<Reconnect> ON | OFF
ON
Reconnects at logon with the same user name.
OFF
Does not reconnect at logon.

Usage: Event

Manual operation: See "[Map Network Drive](#)" on page 456

MMEMory:NETWork:UNUSeddrives?

This command lists all unused network drive names.

This command is only a query and therefore has no *RST value.

Example: MMEM:NETW:UNUS?
Lists all unused network drive names.

Usage: Query only

Manual operation: See ["Map Network Drive"](#) on page 456

MMEMory:NETWork:USEDdrives? <ResultType>

This command lists all mapped network drives.

Query parameters:

<ResultType> **ON**
 Lists all mapped network drives including the folder information.

OFF
 Lists all mapped network drive names.

*RST: OFF

Example: MMEM:NETW:USED? ON
 Lists all mapped network drives including the folder information.

Usage: Query only

Manual operation: See ["Map Network Drive"](#) on page 456

MMEMory:RDIRECTory <Directory>

This command deletes the indicated directory. The directory name includes indication of the path and may also include the drive name. The path name complies with DOS conventions.

Parameters:

<Directory> <directory_name> = DOS path name

Example: MMEM:RDIR 'C:\TEST'

Usage: Event

Manual operation: See ["Delete"](#) on page 455

MMEMory:SElect[:ITEM]:ALL

This command includes all data subsets in the list of device settings to be stored/loaded.

Example: MMEM:SEL:ALL

Usage: Event

Manual operation: See ["Enable all Items"](#) on page 452

MMEMory:SElect[:ITEM]:DEFault

This command includes the default list in the settings file to be stored/loaded. For details on hardware settings refer to the [MMEMory:SElect\[:ITEM\]:HWSettings](#) on page 956 command.

Example: MMEM:SEL:DEFault

MMEMory:SElect[:ITEM]:HWSettings <State>

This command includes the hardware settings in the settings file to be stored/loaded. The hardware settings include:

- current configuration of general device parameters (general setup)
- current setting of the measurement hardware including markers
- activated limit lines:

A settings file may include 8 limit lines at maximum. This number includes the activated limit lines and, if available, the de-activated limit lines last used.

Therefore the combination of the non-activated restored limit lines depends on the sequence of use with the **MMEMory:LOAD:STATE** on page 951 command.

- user-defined color setting
- configuration for the hardcopy output

Parameters:

<State> ON | OFF
 *RST: ON

Example: MMEM:SEL:HWS ON

Manual operation: See "[Select Items](#)" on page 452

MMEMory:SElect[:ITEM]:LINES:ALL <State>

This command includes all limit lines (activated and de-activated) in the settings file to be stored/loaded.

Parameters:

<State> ON | OFF
 *RST: OFF

Example: MMEM:SEL:LIN:ALL ON

Manual operation: See "[Select Items](#)" on page 452

MMEMory:SElect[:ITEM]:NONE

This command excludes all items from the settings file to be stored/loaded.

Example: MMEM:SEL:NONE

Usage: Event

Manual operation: See "[Disable all Items](#)" on page 452

MMEMory:SElect[:ITEM]:SGRam <boolean>

This command adds the spectrogram data to the list of data subsets of a save/recall device setting.

Parameters:

<boolean> **ON | OFF**
 *RST: OFF

Example:

MEM:SEL:SGR ON
 Adds the spectrogram data to the list of data subsets.

Mode: SPECM

MMEMory:SElect[:ITEM]:TRACe[:ACTive] <State>

This command includes the active traces in the settings file to be stored/loaded. Active traces are all traces whose state is not blank.

Parameters:

<State> ON | OFF
 *RST: OFF, i.e. no traces is stored

Example:

MMEM:SEL:TRAC ON

Manual operation: See "[Select Items](#)" on page 452

MMEMory:SElect[:ITEM]:TRANsducer:ALL <State>

This command includes all transducer factors and sets in the settings file to be stored/loaded.

Parameters:

<State> ON | OFF
 *RST: OFF

Example:

MMEM:SEL:TRAN:ALL ON

Manual operation: See "[Select Items](#)" on page 452

MMEMory:STORe<n>:STATe <State>

This command stores the current device settings in a *.dfl file.

Suffix:

<n> irrelevant

Parameters:

<State> 1,<file_name>
with <file_name>
 DOS file name with or without extension
 The file name includes the indication of the path and may also include the drive name. The path name complies with DOS conventions.

Example:

MMEM:STOR:STAT 1, 'Save'
 Saves the current device settings in the file Save.dfl.

Usage: Event
SCPI confirmed

Manual operation: See ["Save File / Recall File"](#) on page 451

MMEMory:STORe<n>:STATe:NEXT

This command stores the current device settings in a *.df1 file. The file name used in the last saving process is automatically counted up to the next unused name.

Suffix:
<n> irrelevant

Example: `MMEM:STOR:STAT 1, 'Save '`
Saves the current device settings in the file `Save.dfl`.
`MMEM:STOR:STAT:NEXT`
Saves the current device settings in the file `Save_001.dfl`
`MMEM:STOR:STAT:NEXT`
Saves the current device settings in the file `Save_002.dfl`

Usage: Event

Manual operation: See ["Save File / Recall File"](#) on page 451

MMEMory:USER<Softkey> <Filename>, <Label>

This command defines the settings file to be loaded when the specified user-definable softkey is selected. The settings file must exist, otherwise an error occurs.

Suffix:
<Softkey> 1 | 2 | 3 | 4 | 5 | 6 | 7 | 8
Number of the softkey in the "User" menu.

Parameters:
<Filename> string
This parameter defines the path and file name of the settings to be loaded.

<Label> string
This parameter defines the label of the user-definable softkey.

*RST: User<Softkey_number>

Example: `MMEM:USER1 'C:\MySaveSets\Set1', 'Set1'`
Loads settings file `Set1` when the "Set1" softkey in the "User" menu is selected.

Example: `MMEM:USER3 'C:\MySaveSets\Set3', ''`
Loads settings file `Set3` when the "User3" softkey in the "User" menu is selected.

8.2.4.8 OUTPut Subsystem (Option Additional Interfaces, B5)

The OUTPut subsystem controls the output features of the instrument.

| | |
|-------------------------|-----|
| OUTPut:IF[:SOURce]..... | 959 |
| OUTPut:TRIGger..... | 959 |

OUTPut:IF[:SOURce] <Source>

This command selects the source of the IF output.

Parameters:

| | |
|----------|--|
| <Source> | IF
Outputs the intermediate frequency. |
| | OFF
Turns off the output of a signal. |
| | VIDeo
Outputs the video signal (200 mV). |
| *RST: | IF |

Example: OUTP:IF VID
Selects the video signal for the IF output connector.

Manual operation: See "[Video Output](#)" on page 269

OUTPut:TRIGger <PortLevel>

This command selects level of the Trigger Out port. Thus, you can trigger an additional device via the external trigger port, for example.

Parameters:

| | |
|-------------|------------|
| <PortLevel> | LOW HIGH |
| *RST: | LOW |

Example: OUTP:TRIG HIGH

Manual operation: See "[Trigger Out](#)" on page 269

8.2.4.9 SENSE Subsystem

The SENSE subsystem is organized in several subsystems. The commands of these subsystems directly control device-specific settings; they do not refer to the signal characteristics of the measurement signal.

The SENSE subsystem controls the essential parameters of the analyzer. In accordance with the SCPI standard, the keyword "SENSE" is optional for this reason, which means that it is not necessary to include the SENSE node in command sequences.

| | |
|----------------------------------|-----|
| SENSE:CORRection Subsystem..... | 960 |
| SENSE:ROSCillator Subsystem..... | 963 |

SENSe:CORRection Subsystem

This subsystem controls calibration and normalization.

| | |
|--|-----|
| [SENSe:]CORRection:TRANsducer:ADJust:RLEVel[:STATe]..... | 960 |
| [SENSe:]CORRection:TRANsducer:COMMeNt..... | 960 |
| [SENSe:]CORRection:TRANsducer:DATA..... | 961 |
| [SENSe:]CORRection:TRANsducer:DELeTe..... | 961 |
| [SENSe:]CORRection:TRANsducer:SCALing..... | 961 |
| [SENSe:]CORRection:TRANsducer:SELeCt..... | 962 |
| [SENSe:]CORRection:TRANsducer[:STATe]..... | 962 |
| [SENSe:]CORRection:TRANsducer:UNIT..... | 962 |
| [SENSe:]CORRection:TRANsducer:VIEW..... | 963 |

[SENSe:]CORRection:TRANsducer:ADJust:RLEVel[:STATe] <State>

This command turns automatic adjustment of the reference level regarding the transducer factor characteristics on and off.

Before you can use the command, you have to select a transducer factor with

[SENSe:]CORRection:TRANsducer:SELeCt.

Parameters:

<State>

ON

Automatically adjusts the reference level with respect to the transducer factor characteristics.

OFF

Manual adjustment of the reference level with respect to the transducer factor characteristics is necessary.

*RST: OFF

Example:

```
CORR:TRAN:SEL 'FACTOR'
```

```
CORR:TRAN:STAT ON
```

Selects and turns on a transducer factor.

```
CORR:TRAN:ADJ:RLEV ON
```

Adjusts the reference level to the characteristics of the transducer.

Manual operation: See "Ref Level Adjust (Man/Auto)" on page 432

[SENSe:]CORRection:TRANsducer:COMMeNt <Comment>

This command defines a comment for a transducer factor.

Before you can use the command, you have to select a transducer factor with

[SENSe:]CORRection:TRANsducer:SELeCt on page 962.

Parameters:

<Comment>

String containing the comment.

*RST: (empty comment)

Example: CORR:TRAN:SEL 'FACTOR'
 CORR:TRAN:STAT ON
 Selects and turns on a transducer factor.
 CORR:TRAN:COMM 'FACTOR FOR ANTENNA'
 Defines a comment for the selected transducer factor.

Manual operation: See "Edit" on page 430

[SENSe:]CORRection:TRANsducer:DATA <Frequency>,<Level>

This command defines the shape of the transducer factor.

A transducer factor may contain up to 625 reference values. Each reference value is a combination of a frequency and a level value.

Before you can use this command, you have to select a transducer factor with [\[SENSe:\]CORRection:TRANsducer:SElect](#) on page 962.

Parameters:

<Frequency> Numeric value in Hz.
 The frequency values have to be in ascending order.

<Level> The unit depends on [\[SENSe:\]CORRection:TRANsducer:UNIT](#) on page 962. By default, it is dB.

Example: SENS:CORR:TRAN:SEL 'TRAN_1'
 Selects the transducer factor
 CORR:TRAN:UNIT 'DB'
 Selects the unit for the transducer.
 CORR:TRAN:DATA 1MHZ,-30,2MHZ,-40
 Defines the frequency/level pairs 1 MHz, -30 dB and 2 MHz, -40 dB.

Manual operation: See "Edit Value" on page 431

[SENSe:]CORRection:TRANsducer:DElete

This command deletes a transducer factor.

Before you can use the command, you have to select a transducer factor with [\[SENSe:\]CORRection:TRANsducer:SElect](#).

Example: CORR:TRAN:SEL 'Transducer 1'
 CORR:TRAN:DEL
 Deletes the selected transducer.

Usage: Event

Manual operation: See "Delete" on page 432

[SENSe:]CORRection:TRANsducer:SCALing <Scale>

This command selects the scale of the transducer factor.

Before you can use the command, you have to select a transducer factor with [\[SENSe:\]CORRection:TRANsdUcer:SElect](#) on page 962R&S FSVR.

Parameters:

<Scale> LINear | LOGarithmic
*RST: LINear

Example:

```
CORR:TRAN:SEL 'FACTOR'
CORR:TRAN:SCAL LOG
Selects a transducer and scales it logarithmically.
```

Manual operation: See ["Interpolation Lin/Log"](#) on page 431

[SENSe:]CORRection:TRANsdUcer:SElect <FileName>

This command creates or selects a transducer factor.

Parameters:

<FileName> String containing the name of the transducer factor.
If the name does not exist yet, the R&S FSVR creates a transducer factor by that name.

Example:

```
CORR:TRAN:SEL 'Transducer 1'
Selects the corresponding transducer factor.
```

Manual operation: See ["Transducer"](#) on page 429
See ["Active \(On/Off\)"](#) on page 430
See ["Edit Name"](#) on page 430

[SENSe:]CORRection:TRANsdUcer[:STATe] <State>

This command turns a transducer factor on and off.

Before you can use the command, you have to select a transducer factor with [\[SENSe:\]CORRection:TRANsdUcer:SElect](#).

You can turn on up to 8 transducer factors at the same time.

Parameters:

<State> ON | OFF
*RST: OFF

Example:

```
CORR:TRAN:SEL 'Transducer 1'
CORR:TRAN ON
Turns the transducer factor on.
```

Manual operation: See ["Active \(On/Off\)"](#) on page 430

[SENSe:]CORRection:TRANsdUcer:UNIT <Unit>

This command selects the unit of a transducer factor.

Before you can use the command, you have to select a transducer factor with [\[SENSe:\]CORRection:TRANsdUcer:SElect](#).

Note that the unit of all active transducer factors must be the same or in relative terms (dB).

Parameters:

<Unit> String containing one of the following units:
 DB | DBM | DBMV | DBUV | DBUV/M | DBUA DBUA/M | DBPW |
 DBPT
 *RST: DB

Example:

```
CORR:TRAN:SEL 'FACTOR'
CORR:TRAN:UNIT 'DBUV'
Selects a transducer based on the unit dBµV.
```

Manual operation: See "Edit Unit" on page 431

[SENSe:]CORRection:TRANsducer:VIEW <State>

This command includes or excludes a figure of a transducer factor in the diagram.

Before you can use the command, you have to select a transducer factor with
[\[SENSe:\]CORRection:TRANsducer:SElect](#).

Parameters:

<State> ON | OFF
 *RST: OFF

Example:

```
CORR:TRAN:SEL 'FACTOR'
CORR:TRAN:VIEW ON
Selects and displays a transducer factor.
```

SENSe:ROSCillator Subsystem

This subsystem controls the reference oscillator. The suffix in SENSe is irrelevant for the commands of this subsystem.

| | |
|--|-----|
| SOURce:EXTernal<1 2>:ROSCillator: EXTernal:FREQUENCY | 963 |
| [SENSe:]ROSCillator:EXTernal:FREQUENCY | 963 |
| [SENSe:]ROSCillator:SOURce | 964 |
| [SENSe:]ROSCillator:SOURce:EAUTO? | 964 |

SOURce:EXTernal<1|2>:ROSCillator: EXTernal:FREQUENCY**[SENSe:]ROSCillator:EXTernal:FREQUENCY <Frequency>**

This command defines the frequency of the external reference oscillator.

If the external reference oscillator is selected, the reference signal must be connected to the rear panel of the instrument.

Parameters:

<Frequency> Range: 1 MHz to 20 MHz

Example:

```
ROSC:EXT:FREQ 13
Sets the frequency to 13 MHz.
SOUR:EXT:ROSC:EXT:FREQ 13
```

Usage: SCPI confirmed

[SENSe:]ROSCillator:SOURce <Source>

This command selects the reference oscillator.

If the external reference oscillator is selected, the reference signal must be connected to the rear panel of the instrument.

Parameters:

<Source>

INTernal

The internal reference is used (10 MHz)

EXTernal

The external reference is used; if none is available, an error flag is displayed in the status bar

EAUTO

The external reference is used as long as it is available, then the instrument switches to the internal reference

Example: ROSC:SOUR EXT

Usage: SCPI confirmed

Manual operation: See ["Reference Int/Ext"](#) on page 428
 See ["Show Error Flag"](#) on page 429
 See ["Auto select Reference"](#) on page 429

[SENSe:]ROSCillator:SOURce:EAUTO?

This command queries the current reference type in case you have activated an automatic switch to the internal reference if the external reference is missing.

Return values:

<Reference>

INT

internal reference

EXT

external reference

Example: SENS:ROSC:SOUR:EAUT?
 Queries the currently available reference type.

Usage: Query only

8.2.4.10 SOURce Subsystem

The SOURce subsystem controls the output signals of the instrument.

SOURce:TEMPerature Subsystem

SOURce<n>:TEMPerature:APRobe

This command queries the sensor temperature.

| | | |
|--------------------|------------------|--|
| Suffix: | <n> | irrelevant |
| Parameters: | | 1 (CPU) |
| Example: | SOUR:TEMP:APR? 1 | Queries the temperature of the CPU sensor. |
| Mode: | | all |

8.2.4.11 STATus Subsystem

The STATus subsystem contains the commands for the status reporting system (see the Operating Manual on CD-ROM, chapter 5 "Remote Control – Basics"). *RST does not influence the status registers.

| | |
|---------------------------------|-----|
| STATus:OPERation[:EVENT] | 965 |
| STATus:OPERation:CONDition | 965 |
| STATus:OPERation:ENABLE | 966 |
| STATus:OPERation:PTRansition | 966 |
| STATus:OPERation:NTRansition | 966 |
| STATus:PRESet | 966 |
| STATus:QUESTionable:CONDition | 967 |
| STATus:QUESTionable[:EVENT]? | 967 |
| STATus:QUESTionable:ENABLE | 967 |
| STATus:QUESTionable:PTRansition | 967 |
| STATus:QUESTionable:NTRansition | 968 |
| STATus:QUEue[:NEXT]? | 968 |

STATus:OPERation[:EVENT]

This command queries the contents of the EVENT part of the STATus:OPERation register. The contents of the EVENT part are deleted after readout.

| | |
|-----------------|------------|
| Example: | STAT:OPER? |
| Mode: | all |

STATus:OPERation:CONDition

This command queries the CONDition part of the STATus:OPERation register (see the base unit description of status registers in the Remote Control Basics chapter).

Readout does not delete the contents of the CONDition part. The value returned reflects the current hardware status.

| | |
|-----------------|-----------------|
| Example: | STAT:OPER:COND? |
| Mode: | all |

STATus:OPERation:ENABLE

This command sets the bits of the ENABLE section of the STATus:OPERation register. The ENABLE register selectively enables the individual events of the associated EVENT section for the summary bit in the status byte.

Parameters:

0 to 65535

Example:

STAT:OPER:ENAB 65535

Usage:

SCPI confirmed

Mode:

all

STATus:OPERation:PTRansition

This command sets the edge detectors of all bits of the STATus:OPERation register from 0 to 1 for the transitions of the CONDition bit.

Parameters:

0 to 65535

Example:

STAT:OPER:PTR 65535

Usage:

SCPI confirmed

Mode:

all

STATus:OPERation:NTRansition

This command sets the edge detectors of all bits of the STATus:OPERation register from 1 to 0 for the transitions of the CONDition bit.

Parameters:

0 to 65535

Example:

STAT:OPER:NTR 65535

Usage:

SCPI confirmed

Mode:

all

STATus:PRESet

This command resets the edge detectors and ENABLE parts of all registers to a defined value. All PTRansition parts are set to FFFFh, i.e. all transitions from 0 to 1 are detected. All NTRansition parts are set to 0, i.e. a transition from 1 to 0 in a CONDition bit is not detected. The ENABLE part of the STATus:OPERation and STATus:QUEStionable registers are set to 0, i.e. all events in these registers are not passed on.

Example:

STAT:PRES

Usage:

SCPI confirmed

Mode:

all

STATus:QUEStionable:CONDition

This command queries the CONDition part of the "STATus:QUEStionable" register. This part contains the sum bit of the next lower register. This register part can only be read, but not written into or cleared. Readout does not delete the contents of the CONDition part.

Example: STAT:QUES:COND?

Mode: all

STATus:QUEStionable[:EVENT]?

This command queries the contents of the EVENT part of the STATus:QUEStionable register. The EVENT part indicates whether an event has occurred since the last reading, it is the "memory" of the condition part. It only indicates events passed on by the transition filters. It is permanently updated by the instrument. This part can only be read by the user. Reading the register clears it.

Example: STAT:QUES?

Usage: Query only

Mode: all

STATus:QUEStionable:ENABLE

This command sets the bits of the ENABLE section of the STATus:QUEStionable register. The ENABLE register selectively enables the individual events of the associated EVENT section for the summary bit in the status byte.

Parameters:

0 to 65535

Example: STAT:QUES:ENAB 65535

Usage: SCPI confirmed

Mode: all

STATus:QUEStionable:PTRansition

This command sets the edge detectors of all bits of the STATus:QUEStionable register from 0 to 1 for the transitions of the CONDition bit.

Parameters:

0 to 65535

Example: STAT:QUES:PTR 65535

Usage: SCPI confirmed

Mode: all

STATus:QUEStionable:NTRansition

This command sets the edge detectors of all bits of the STATus:OPERation register from 1 to 0 for the transitions of the CONDition bit.

Parameters:

0 to 65535

Example:

STAT:QUES:NTR 65535

Usage:

SCPI confirmed

Mode:

all

STATus:QUEue[:NEXT?]?

This command queries the earliest error queue entry and deletes it.

Positive error numbers indicate device-specific errors, negative error numbers are error messages defined by SCPI. If the error queue is empty, the error number 0, "No error", is returned. This command is identical to the `SYSTEM:ERROR[:NEXT]?` command.

Example:

STAT:QUES?

Usage:Query only
SCPI confirmed**Mode:**

all

8.2.4.12 SYSTEM Subsystem

This subsystem contains a series of commands for general functions.

| | |
|---|-----|
| SYSTEM:APPLication:SRECovery[:STATe]..... | 969 |
| SYSTEM:CLOGging..... | 969 |
| SYSTEM:COMMunicate:GPIB[:SELF]:ADDRess..... | 970 |
| SYSTEM:COMMunicate:GPIB[:SELF]:RTERminator..... | 970 |
| SYSTEM:COMMunicate:PRINter:ENUMerate:FIRSt?..... | 970 |
| SYSTEM:COMMunicate:PRINter:ENUMerate[:NEXT]?..... | 971 |
| SYSTEM:COMMunicate:PRINter:SElect <1 2>..... | 971 |
| SYSTEM:COMMunicate:TCPip:CONTRol?..... | 971 |
| SYSTEM:COMPatible..... | 972 |
| SYSTEM:DATE..... | 972 |
| SYSTEM:DEVice:ID?/SYSTEM:DID?..... | 972 |
| SYSTEM:DISPlay:FPANel..... | 972 |
| SYSTEM:DISPlay:UPDate..... | 973 |
| SYSTEM:ERRor:CLEar:ALL..... | 973 |
| SYSTEM:ERRor:LIST?..... | 973 |
| SYSTEM:ERRor[:NEXT]?..... | 973 |
| SYSTEM:FIRMware:UPDate..... | 974 |
| SYSTEM:FORMat:IDENT..... | 974 |
| SYSTEM:HPCoupling..... | 974 |
| SYSTEM:IDENTify:FACTory..... | 975 |

| | |
|--------------------------------|-----|
| SYSTem:IDENtify[:STRing]..... | 975 |
| SYSTem:IFGain:MODE..... | 976 |
| SYSTem:KLOCK..... | 976 |
| SYSTem:LANGuage..... | 976 |
| SYSTem:LXI:INFo?..... | 977 |
| SYSTem:LXI:LANReset..... | 977 |
| SYSTem:LXI:MDEscription..... | 977 |
| SYSTem:LXI:PASSword..... | 977 |
| SYSTem:PASSword[:CENable]..... | 978 |
| SYSTem:PASSword:RESet..... | 978 |
| SYSTem:PRESet..... | 978 |
| SYSTem:PSA:WIDeband..... | 978 |
| SYSTem:REBoot..... | 979 |
| SYSTem:REVIsion:FACTory..... | 979 |
| SYSTem:REVIsion[:STRing]..... | 979 |
| SYSTem:RSW..... | 980 |
| SYSTem:SHUTdown..... | 980 |
| SYSTem:TIME..... | 980 |
| SYSTem:VERSion?..... | 981 |

SYSTem:APPLication:SRECOVERY[:STATE] <State>

Controls instrument behavior when switching between measurement applications, e.g. from "Spectrum" to "Analog Demod" and back.

If activated, the current instrument settings are stored when you switch to a different application. When you switch back to the previous application, the corresponding instrument settings are restored. Thus, the settings of the individual applications are independent of each other.

If deactivated (default), only a few parameters of the current instrument setting are passed between applications (e.g. center frequency, level settings).

Note that although the default value is "OFF", this parameter is not reset using the PRESET key. Thus it must be deactivated manually, if necessary.

Parameters:

<State> ON | OFF
 *RST: OFF (not restored using the "PRESET" function)

Example: SYST:APPL:SREC ON

Manual operation: See ["Application Setup Recovery"](#) on page 446

SYSTem:CLOGging <State>

This command turns logging of remote commands on and off.

Parameters:

<State> **ON**
 Writes all remote commands that have been sent to a file.
 The destination is C :
 \R_S\instr\ScpiLogging\ScpiLog.txt.

OFF
 *RST: OFF

Manual operation: See "[I/O Logging \(On/Off\)](#)" on page 439

SYSTem:COMMunicate:GPIB[:SELF]:ADDRess <Address>

This command changes the GPIB address of the unit.

Parameters:

<Address> 0 to 30
 *RST: (no influence on this parameter, factory default 20)

Example: SYST:COMM:GPIB:ADDR 18

Usage: SCPI confirmed

Manual operation: See "[GPIB Address](#)" on page 435

SYSTem:COMMunicate:GPIB[:SELF]:RTERminator <Terminator>

This command changes the GPIB receive terminator.

According to the standard the terminator in ASCII is <LF> and/or <EOI>. For binary data transfers (e.g. trace data) from the control computer to the instrument, the binary code (0AH) used for <LF> might be included in the binary data block, and therefore should not be interpreted as a terminator in this particular case. This can be avoided by changing the receive terminator to EOI.

Output of binary data from the instrument to the control computer does not require such a terminator change.

Parameters:

<Terminator> LFEOI | EOI
 *RST: (no influence on this parameter, factory default LFEOI)

Example: SYST:COMM:GPIB:RTER EOI

Manual operation: See "[GPIB Terminator LFEOI/EOI](#)" on page 438

SYSTem:COMMunicate:PRINter:ENUMerate:FIRSt?

This command queries the name of the first printer (in the list of printers) available under Windows XP.

The names of other installed printers can be queried with the `SYSTem:COMMunicate:PRINter:ENUMerate[:NEXT]?` command.

If no printer is configured an empty string is output.

Parameters:

*RST: NONE

Example:

SYST:COMM:PRIN:ENUM:FIRS?

Usage:

Query only

Manual operation: See "Device Setup" on page 466

SYSTem:COMMunicate:PRINter:ENUMerate[:NEXT]?

This command queries the name of the next printer installed under Windows XP. After all available printer names have been output, an empty string enclosed by quotation marks ("") is output for the next query. Further queries are answered by a query error.

The `SYSTem:COMMunicate:PRINter:ENUMerate:FIRSt?` command should be sent previously to return to the beginning of the printer list and query the name of the first printer.

Example:

SYST:COMM:PRIN:ENUM?

Usage:

Query only

Manual operation: See "Device Setup" on page 466

SYSTem:COMMunicate:PRINter:SELEct <1|2> <PrinterName>

This command selects one of the printers configured under Windows XP including the associated output destination.

The specified printer name must be a string (entered in quotes) as returned by the commands

`SYSTem:COMMunicate:PRINter:ENUMerate:FIRSt?` or

`SYSTem:COMMunicate:PRINter:ENUMerate[:NEXT]?`

The `HCOPY:DESTination<1|2>` on page 941 command is used to select an output medium other than the default one.

Parameters:

<PrinterName> "<printer_name>"

*RST: NONE

Example:

SYST:COMM:PRIN:SEL "LASER on LPT1"

SYSTem:COMMunicate:TCPIP:CONTrol?

This command outputs the control port for the LAN socket connection. An error indicates that the socket connection is not supported.

Example:

SYST:COMM:TCP:CONT?

Usage:

Query only

SYSTem:COMPAtible <Mode>

Sets the device in a state compatible to previous R&S signal analyzers, e.g. regarding the number of sweep points.

Parameters:

<Mode> DEFault | FSU | FSP

Example: SYST:COMP FSP

Usage: SCPI confirmed

Manual operation: See "[Compatibility Mode](#)" on page 436
 See "[Mode Default](#)" on page 436
 See "[Mode R&S FSP](#)" on page 436
 See "[Mode R&S FSU](#)" on page 436

SYSTem:DATE <Date>

This command is used to enter the date for the internal calendar.

The sequence of entry is year, month, day.

Only user accounts with administrator rights can set the date.

Parameters:

<Date> 1980 to 2099, 1 to 12, 1 to 31

Example: SYST:DATE 2000, 6, 1

Usage: SCPI confirmed

Manual operation: See "[Time+Date](#)" on page 439

SYSTem:DEVice:ID?/SYSTem:DID?

.Both commands are identical and return the unique ID of the R&S FSVR device.

Example: SYST:DEV:ID?
 1307.9002K07-100123-aZ

Usage: Query only
 SCPI confirmed

Manual operation: See "[Versions+Options](#)" on page 445

SYSTem:DISPlay:FPANel <State>

This command activates or deactivates the display of the front panel keys on the screen.

With the display activated, the instrument can be operated on the screen using the mouse by pressing the corresponding buttons.

Parameters:

<State> ON | OFF
 *RST: OFF

Example: SYST:DISP:FPAN ON

Manual operation: See "[Soft Frontpanel](#)" on page 439

SYSTem:DISPlay:UPDate <State>

In remote control mode, this command switches on or off the instrument display. If switched on, only the diagrams, traces and display fields are displayed and updated.

The best performance is obtained if the display output is switched off during remote control.

Parameters:

<State> ON | OFF
 *RST: OFF

Example: SYST:DISP:UPD ON

Manual operation: See "[Display Update \(On/Off\)](#)" on page 438

SYSTem:ERRor:CLEar:ALL

This command deletes all entries in the table SYSTEM MESSAGES.

Example: SYST:ERR:CLE:ALL

Usage: Event

Manual operation: See "[Clear All Messages](#)" on page 445

SYSTem:ERRor:LIST?

This command reads all system messages and returns a list of comma separated strings. Each string corresponds to an entry in the table SYSTEM MESSAGES.

If the error list is empty, an empty string " is returned.

This command is a query and therefore has no *RST value.

Example: SYST:ERR:LIST?

Usage: Query only

Manual operation: See "[System Messages](#)" on page 445

SYSTem:ERRor[:NEXT]?

This command queries the earliest error queue entry and deletes it.

Positive error numbers indicate device-specific errors, negative error numbers are error messages defined by SCPI. If the error queue is empty, the error number 0, "No error", is returned.

This command is a query and therefore has no *RST value.

Example: STAT:ERR?

Usage: Query only
SCPI confirmed

SYSTem:FIRMware:UPDate

This command starts a firmware update using the *.msi files in the selected directory. The default path is D:\FW_UPDATE. The path is changed via the [MMEMory:COMMeNt](#) command. To store the update files the [MMEMory:DATA](#) command is used.

Only user accounts with administrator rights can perform a firmware update.

Example: SYST:FIRM:UPD 'D:\FW_UPDATE'
Starts the firmware update from directory "D:\FW_UPDATE".

Usage: Event

Manual operation: See "[Firmware Update](#)" on page 446

SYSTem:FORMat:IDENT

This command defines the response format to the [*IDN?](#) on page 552 command. This function is intended for re-use of existing control programs together with the R&S FSVR.

Parameters:

FSL | LEGacy | NEW

LEGacy

Format is compatible to the R&S FSP/FSU/FSQ family

NEW

R&S FSVR format

FSL

Format is compatible to the R&S FSL family

*RST: not reset!

Example: SYST:FORM:IDEN LEG
Adapts the return value of *IDN? to the R&S FSP/FSU/FSQ family.

Manual operation: See "[*IDN Format Leg./New](#)" on page 439

SYSTem:HPCoupling <CouplingType>

Controls the default coupling ratios in the HP emulation mode for:

- span and resolution bandwidth (Span/RBW) and

- resolution bandwidth and video bandwidth (RBW/VBW)

For FSP (=FSV), the standard parameter coupling of the instrument is used. As a result, in most cases a shorter sweep time is used than in case of HP.

This command is only available if a HP language is selected using [SYSTem:LANGuage](#).

Parameters:

<CouplingType> HP | FSP
*RST: FSP

Example: SYSTem:HPC HP

Usage: SCPI confirmed

Manual operation: See "[Coupling \(FSx/HP\)](#)" on page 438

SYSTem:IDENtify:FACTory

Resets the response to the *IDN? query to the default value, e.g. after a user string was defined using the [ID String User](#) softkey.

Example: SYST:IDEN:FACT
*IDN?
Response:
Rohde&Schwarz, R&S FSVR-7,
1307.9002K07/101768,1.05

Usage: Event
SCPI confirmed

Manual operation: See "[ID String Factory](#)" on page 435

SYSTem:IDENtify[:STRing] <String>

Sets the response to the *IDN? query to the defined string, e.g. after the default value was reset using the [ID String Factory](#) softkey.

Parameters:

<String>

Example: Set the response to 'MyDevice':
SYST:IDEN:STR 'MyDevice'
Query the response:
SYST:IDEN:STR?
Response:
MyDevice

Usage: SCPI confirmed

Manual operation: See "[ID String User](#)" on page 436

SYSTem:IFGain:MODE <Mode>

Configures the internal IF gain settings in HP emulation mode due to the application needs. This setting is only taken into account for resolution bandwidth < 300 kHz and is only available if a HP language is selected using [SYSTem:LANGuage](#).

Parameters:

<Mode> NORM | PULS

NORM

Optimized for high dynamic range, overload limit is close to reference level.

PULS

Optimized for pulsed signals, overload limit up to 10 dB above reference level.

*RST: NORM

Example: SYST:IFG:MODE PULS

Usage: SCPI confirmed

Manual operation: See "[IF Gain \(Norm/Puls\)](#)" on page 437

SYSTem:KLOCK <State>

This command activates the local lockout (remote control) or returns to the local mode.

Parameters:

<State> **ON**
LLO (local lockout)

OFF

GTL (go to local)

*RST: OFF

Example: SYST:KLOK ON
Activates LLO (remote control)

SYSTem:LANGuage <Language>

This command defines the system language. Default is SCPI which defines the standard remote control behavior of the instrument. The other parameters are to simulate the corresponding HP analyzer. The parameter "PSA89600" sets the device in a state in which it can be used for IQ capturing from the 89600 vector signal analyzer software.

Parameters:

<Language> "SCPI" | "8560E" | "8561E" | "8562E" | "8563E" | "8564E" |
"8565E" | "8566A" | "8566B" | "8568A" | "8568A_DC" | "8568B" |
"8568B_DC" | "8591E" | "8594E" | "71100C" | "71200C" |
"71209A" | "PSA89600"

*RST: SCPI

Example: `SYST:LANG '8560E'`
Sets the system language to 8560E to simulate the HP analyzer.

Manual operation: See "[GPIB Language](#)" on page 436

SYSTem:LXI:INFo?

This query returns the current parameters of the LXI class C.

Only user accounts with administrator rights are able to use LXI functionality.

Return values:

Return values `<current version> | <LXI class> | <Computername> |`
(example) `<MAC adress> | <IP adress> | <Auto MDIX>`

Usage: Query only

Manual operation: See "[Info](#)" on page 434

SYSTem:LXI:LANReset

This command resets the LAN configuration to the values required by the LXI standard. In addition, the password is reset to its initial state as well as the LXI instrument description.

Only user accounts with administrator rights are able to use LXI functionality.

Example: `SYST:LXI:LANR`

Usage: Event

Manual operation: See "[LAN Reset](#)" on page 435

SYSTem:LXI:MDEscription <String>

This command shows the LXI instrument description. Also, the instrument description can be changed using this command.

Only user accounts with administrator rights are able to use LXI functionality.

Parameters:

<String>

Example: `SYST:LXI:MDES`

Manual operation: See "[Description](#)" on page 435

SYSTem:LXI:PASSword <Password>

This command shows or changes the LXI password.

Only user accounts with administrator rights are able to use LXI functionality.

Parameters:

<Password> <password>

Example: `SYST:LXI:PASS`

Manual operation: See "Password" on page 435

SYSTem:PASSword[:CENable] <Password>

This command enables access to the service functions by means of the password.

Parameters:

<Password> <password>

Example: `SYST:PASS XXXX`

Usage: Event
 SCPI confirmed

Manual operation: See "Password" on page 448

SYSTem:PASSword:RESet

This command resets the service password.

Example: `SYST:PASS:RES`

Usage: Event
 SCPI confirmed

Manual operation: See "Reset Password" on page 448

SYSTem:PRESet

This command initiates an instrument reset.

The effect of this command corresponds to that of the **PRESET** key with manual operation or to the `*RST` command. For details on preset settings refer to [chapter 4.1.1, "Initializing the Configuration – PRESET Key"](#), on page 57.

Example: `SYST:PRES`

Usage: SCPI confirmed

SYSTem:PSA:WIDeband <State>

This command defines which option is returned when the `*OPT?` query is executed, depending on the state of the wideband option.

It is only available for PSA89600 emulation.

Parameters:

<State> ON | OFF | HIGH

OFF
The option is indicated as "B7J"

ON
The 40 MHz wideband is used.
The option is indicated as "B7J, 140".

HIGH
The 80 MHz wideband is used.
The option is indicated as "B7J, 122".

*RST: OFF

SYSTem:REBoot

This command reboots the instrument, including the operating system.

Usage: Event

SYSTem:REVision:FACTory

Resets the response to the REV? query to the default value, e.g. after a user string was defined using the `SYSTem:REVision[:STRing]` command. (REV? query available for HP emulation only, see [chapter 8.2.5, "GPIB Commands of HP Models 856xE, 8566A/B, 8568A/B and 8594E"](#), on page 981.)

Example: Define the system language:
`SYST:LANG '8563E'`

Set the response back to factory setting:
`SYS:REV:FACT`

Query the revision:
`REV?`

Response:
920528

Usage: Event
SCPI confirmed

Manual operation: See ["REV String Factory"](#) on page 438

SYSTem:REVision[:STRing] <Name>

Sets the response to the REV? query to the defined string (HP emulation only, see [chapter 8.2.5, "GPIB Commands of HP Models 856xE, 8566A/B, 8568A/B and 8594E"](#), on page 981).

Parameters:

<Name>

Example: Define the system language:
 SYST:LANG '8563E'
 Query the revision:
 REV?
 Response:
 920528
 Set the response to 'NewRevision':
 SYST:REV:STR 'NewRevision'
 Query the response:
 SYST:REV:STR?
 Response:
 NewRevision

Manual operation: See "[REV String User](#)" on page 438

SYSTem:RSW <State>

Controls a repeated sweep of the E1 and MKPK HI/HL HP model commands (for details on the commands refer to [chapter 8.2.5, "GPIB Commands of HP Models 856xE, 8566A/B, 8568A/B and 8594E"](#), on page 981). If the repeated sweep is OFF, the marker is set without sweeping before.

This command is only available if a HP language is selected using [SYSTem:LANGuage](#).

Parameters:

<State> ON | OFF
 *RST: OFF

Example: SYSTem:RSW ON

Usage: SCPI confirmed

Manual operation: See "[Sweep Repeat \(On/Off\)](#)" on page 438

SYSTem:SHUTdown

This command shuts down the instrument.

Usage: Event

SYSTem:TIME <Time>

This command sets the internal clock. The sequence of entry is hour, minute, second.

Only user accounts with administrator rights are able to set the time.

Parameters:

<Time> 0 to 23, 0 to 59, 0 to 59

Example: SYST:TIME 12,30,30

Usage: SCPI confirmed

Manual operation: See "Time+Date" on page 439

SYSTem:VERSion?

This command queries the number of the SCPI version, which is relevant for the instrument.

This command is a query and therefore has no *RST value.

Example: SYST:VERS?

Usage: Query only
 SCPI confirmed

8.2.5 GPIB Commands of HP Models 856xE, 8566A/B, 8568A/B and 8594E

The R&S FSVR analyzer family supports a subset of the GPIB commands of HP models 8560E, 8561E, 8562E, 8563E, 8564E, 8565E, 8566A, 8566B, 8568A, 8568B and 8594E.

Despite the differences in system architecture and device features, the supported commands have been implemented in a way to ensure a sufficiently high degree of correspondence with the original.

This includes the support of syntax rules for not only newer device families (B and E models) but for the previous A family as well.

In many cases the selection of commands supported by the R&S FSVR is sufficient to run an existing GPIB program without adaptation.

After the introduction, this section includes the following topics:

| | | |
|---------|---|------|
| 8.2.5.1 | GPIB Languages..... | 982 |
| 8.2.5.2 | Command Set of Models 8560E, 8561E, 8562E, 8563E, 8564E, 8565E, 8566A/B, 8568A/B, 8591E, 8594E, 71100C, 71200C, and 71209A..... | 983 |
| 8.2.5.3 | Special Features of the Syntax Parsing Algorithms for 8566A and 8568A Models.. | 1007 |
| 8.2.5.4 | Special Behavior of Commands..... | 1008 |
| 8.2.5.5 | Model-Dependent Default Settings..... | 1009 |
| 8.2.5.6 | Data Output Formats..... | 1010 |
| 8.2.5.7 | Trace Data Output Formats..... | 1010 |
| 8.2.5.8 | Trace Data Input Formats..... | 1011 |
| 8.2.5.9 | GPIB Status Reporting..... | 1011 |

8.2.5.1 GPIB Languages

The R&S FSVR analyzer family supports a subset of the GPIB commands used by other devices. Thus it can emulate other devices in order to use existing remote control programs.

The device model to be emulated is selected manually using the key sequence "SETUP > General Setup > GPIB > Compatible Mode > GPIB Language". Via the GPIB interface using the command.

In order to emulate device models that are not part of the selection list of the GPIB "Language" setting, you can modify the identification string received in response to the ID command ("Identification String" setting). Thus, any device model whose command set is compatible with one of the supported device models can be emulated.

Supported languages

| Language | Comment |
|----------|---|
| SCPI | |
| 71100C | Compatible to 8566A/B |
| 71200C | Compatible to 8566A/B |
| 71209A | Compatible to 8566A/B |
| 8560E | |
| 8561E | |
| 8562E | |
| 8563E | |
| 8564E | |
| 8565E | |
| 8566A | Command sets A and B are available. Command sets A and B differ in the rules regarding the command structure. |
| 8566B | |
| 8568A | Command sets A and B are available. Command sets A and B differ in the rules regarding the command structure. |
| 8568A_DC | Uses DC input coupling by default if supported by the instrument |
| 8568B | Command sets A and B are available. Command sets A and B differ in the rules regarding the command structure. |
| 8568B_DC | Uses DC input coupling by default if supported by the instrument |
| 8591E | Compatible to 8594E |
| 8594E | Command sets A and B are available. Command sets A and B differ in the rules regarding the command structure. |
| PSA89600 | |

Notes:

- If you select a language other than "SCPI", the GPIB address is set to 18 if it was 20 before.
- The Start/stop frequency, reference level and number of sweep points are adapted to the selected instrument model.
- When you switch between remote control languages, the following settings or changes are made:
SCPI:
 The instrument performs a PRESET.
8566A/B, 8568A/B, 8594E; FSEA, FSEB, FSEM; FSEK:
 - The instrument performs a PRESET.
 - The following instrument settings are changed:

Table 8-22: Instrument settings for emulation of 8566A/B, 8568A/B, 8594E; FSEA, FSEB, FSEM; FSEK instruments

| Model | # of Trace Points | Start Freq. | Stop Freq. | Ref Level | Input Coupling |
|---------|-------------------|-------------|------------|-----------|----------------|
| 8566A/B | 1001 | 2 GHz | 22 GHz | 0 dBm | AC |
| 8568A/B | 1001 | 0 Hz | 1.5 GHz | 0 dBm | AC |
| 8560E | 601 | 0 Hz | 2.9 GHz | 0 dBm | AC |
| 8561E | 601 | 0 Hz | 6.5 GHz | 0 dBm | AC |
| 8562E | 601 | 0 Hz | 13.2 GHz | 0 dBm | AC |
| 8563E | 601 | 0 Hz | 26.5 GHz | 0 dBm | AC |
| 8564E | 601 | 0 Hz | 40 GHz | 0 dBm | AC |
| 8565E | 601 | 0 Hz | 50 GHz | 0 dBm | AC |
| 8594E | 401 | 0 Hz | 3 GHz | 0 dBm | AC |

Note: The stop frequency indicated in the table may be limited to the corresponding frequency of the R&S FSVR, if required.

8.2.5.2 Command Set of Models 8560E, 8561E, 8562E, 8563E, 8564E, 8565E, 8566A/B, 8568A/B, 8591E, 8594E, 71100C, 71200C, and 71209A

As with the original units, the R&S FSVR includes the command set of the A models in the command set of the B models.



The HP model 8591E is compatible to HP model 8594E, the HP models 71100C, 71200C, and 71209A are compatible to HP models 8566A/B.

| Command | Supported subset | Function | Corresp. HP-Models | Status |
|----------------------|-------------------------------------|------------------------|---|-----------|
| A1 | A1 | Clear/Write A | HP 8566A/
HP 8568A | available |
| A2 | A2 | Max Hold A | HP 8566A/
HP 8568A | available |
| A3 | A3 | View A | HP 8566A/
HP 8568A | available |
| A4 | A4 | Blank A | HP 8566A/
HP 8568A | available |
| ABORT ¹⁾ | ABORT | Stop previous function | HP 856xE/
HP 8566B/HP
8568B/HP
8594E | available |
| ADD | | Add | HP 8566B/
HP 8568B/
HP 8594E | available |
| ADJALL | ADJALL | Adjust all | HP 856xE/
HP 8566B/
HP 8568B/
HP 8594E | available |
| ADJCRT ²⁾ | ADJCRT | Adjust CRT | HP 856xE/
HP 8566B/
HP 8568B/
HP 8594E | available |
| ADJIF ²⁾ | ADJIF | Auto adjust IF | HP 856xE/
HP 8566B/
HP 8568B/
HP 8594E | available |
| AMB | AMB ON OFF
AMB 1 0
AMB? | Trace A – B -> Trace A | HP 856xE/
HP 8594E | available |
| AMBPL | AMBPL ON OFF
AMBPL 1 0
AMBPL? | | HP 856xE/
HP 8566B/
HP 8568B/
HP 8594E | available |
| ANNOT | ANNOT ON OFF
ANNOT 1 0
ANNOT? | Annotation | HP 856xE/
HP 8566B/
HP 8568B/
HP 8594E | available |

| Command | Supported subset | Function | Corresp. HP-Models | Status |
|---------|---|---------------------------------------|---|-----------|
| APB | APB | Trace A + B -> Trace A | HP 856xE/
HP 8566B/
HP 8568B/
HP 8594E | available |
| AT | AT <numeric_value> DB
 DM
AT DN
AT UP
AT AUTO
AT? | Attenuation | HP 8566A/
HP 8568A/
HP 856xE/
HP 8566B/
HP 8568B/
HP 8594E | available |
| AUNITS | AUNITS DBM DBMV
DBUV
AUNITS? | Amplitude Units | HP 856xE/
HP 8566B/
HP 8568B/
HP 8594E | available |
| AUTOCP | AUTOCP | Coupling default | HP 856xE/
HP 8566B/
HP 8568B/
HP 8594E | available |
| AXB | AXB | Exchange trace A and B | HP 856xE/
HP 8566B/
HP 8568B/
HP 8594E | available |
| B1 | B1 | Clear/Write B | HP 8566A/
HP 8568A | available |
| B2 | B2 | Max Hold B | HP 8566A/
HP 8568A | available |
| B3 | B3 | View B | HP 8566A/
HP 8568A | available |
| B4 | B4 | Blank B | HP 8566A/
HP 8568A | available |
| BL | BL | Trace B – Display Line -
> Trace B | HP 8566A/
HP 8568A | available |
| BML | BML | Trace B – Display Line -
> Trace B | HP 856xE/
HP8594E | available |
| BTC | BTC | Transfer Trace B -> C | HP 856xE/
HP 8566B/
HP 8568B/
HP 8594E | available |

| Command | Supported subset | Function | Corresp. HP-Models | Status |
|-------------------|---|-------------------------------|---|-----------|
| BXC | BXC | Exchange Trace B and C | HP 856xE/
HP 8566B/
HP 8568B/
HP 8594E | available |
| BLANK | BLANK TRA TRB TRC | Blank Trace | HP 856xE/
HP 8566B/
HP 8568B/
HP 8594E | available |
| C1 | C1 | A-B off | HP 8566A/
HP 8568A | available |
| C2 | C2 | A-B -> A | HP 8566A/
HP 8568A | available |
| CA | CA | Couple Attenuation | HP 8566A/
HP 8568A | available |
| CAL ¹⁾ | CAL ALL
CAL ON
CAL OFF | Start analyzer self alignment | HP 856xE/
HP 8566B/
HP 8568B/
HP 8594E | available |
| CF | CF <numeric_value>
HZ KHZ MHZ GHZ
CF UP
CF DN
CF? | Center Frequency | HP 8566A/
HP 8568A/
HP 856xE/
HP 8566B/
HP 8568B/
HP 8594E | available |
| CHANPWR | CHANPWR TRA TRB,
<numeric_value>,<?> | Channel Power Measurement | HP 856xE/
HP 8594E | available |
| CHPWRBW | CHPWRBW
<numeric_value> HZ
KHZ MHZ GHZ | Channel Power Bandwidth | HP 856xE/
HP 8594E | available |
| CLRW | CLRW TRA TRB TRC | Clear/Write Trace | HP 856xE/
HP 8566B/
HP 8568B/
HP 8594E | available |
| CLS ¹⁾ | CLS | Clear all status bits | HP 856xE/
HP 8566B/
HP 8568B/
HP 8594E | available |

| Command | Supported subset | Function | Corresp. HP-Models | Status |
|-------------------------|---|---------------------------|---|-----------|
| CONTS | CONTS | | HP 856xE/
HP 8566B/
HP 8568B/
HP 8594E | available |
| COUPLE | COUPLE AC DC | Input coupling | HP 856xE/
HP 8566B/
HP 8568B/
HP 8594E | available |
| CR | CR | Couple RBW | HP 8566A/
HP 8568A | available |
| CS | CS | Couple Step Size | HP 8566A/
HP 8568A | available |
| CT | CT | Couple SWT | HP 8566A/
HP 8568A | available |
| CTA | | Convert to absolute units | HP 8566B/
HP 8568B/
HP 8594E | available |
| CV | CV | Couple VBW | HP 8566A/
HP 8568A | available |
| D1 ²⁾ | D1 | Display Size normal | HP 8566A/
HP 8568A | available |
| DA ²⁾ | DA | Display address | | available |
| DEMODO ¹⁾ | DEMODO ON OFF AM
FM | AF Demodulator | HP 856xE/
HP 8566B/
HP 8568B/
HP 8594E | available |
| DEMODOAGC ²⁾ | DEMODOAGC ON OFF 1
0
DEMODOAGC? | Demodulation AGC | HP 856xE/
HP 8566B/
HP 8568B/
HP 8594E | available |
| DEMODT | DEMODT
<numeric_value> S MS
US SC
DEMODT UP DN
DEMODT? | Demodulation time | HP 856xE/
HP 8566B/
HP 8568B/
HP 8594E | available |
| DET | DET POS SMP NEG
DET? | Detector | HP 856xE/
HP 8566B/
HP 8568B/
HP 8594E | available |

| Command | Supported subset | Function | Corresp. HP-Models | Status |
|-----------------------|---|---|---|-----------|
| DISPOSE ²⁾ | ONEOS TRMATH
ONSWP ALL
<numeric_value> | | | available |
| DIV | | Divide | HP 8566B/
HP 8568B/
HP 8594E | available |
| DL | DL <numeric_value>
DB DM
DL DN
DL UP
DL ON
DL OFF
DL? | Display Line | HP 856xE/
HP 8566B/
HP 8568B/
HP 8594E | available |
| DLE | DLE ON OFF | Display Line enable | HP 856xE/
HP 8566B/
HP 8568B/
HP 8594E | available |
| DONE | DONE
DONE? | Done query | HP 856xE/
HP 8566B/
HP 8568B/
HP 8594E | available |
| DW ²⁾ | DW | Write to display and
increment address | | available |
| E1 | E1 | Peak Search | HP 8566A/
HP 8568A | available |
| E2 | E2 | Marker to Center Freq. | HP 8566A/
HP 8568A | available |
| E3 | E3 | Deltamarker Step Size | HP 8566A/
HP 8568A | available |
| E4 | E4 | Marker to Ref. Level | available | available |
| EDITDONE | | limit line edit done | HP 856xE | available |
| EDITLIML | | edit limit line | HP 856xE | available |

| Command | Supported subset | Function | Corresp. HP-Models | Status |
|-----------------------|---|--|---|-------------------|
| ERR | ERR 250 cal level error
ERR 300 LO unlock
ERR 472 cal error digital filter
ERR 473 cal error analog filter
ERR 552 cal error log amp
ERR 902 unscale tracking generator
ERR 906 oven cold
ERR 117 numeric unit error
ERR 112 Unrecognized Command | Now some FSx errors are mapped to HP errors. | HP8568A
HP856xE | not yet available |
| ERR? | ERR? | Error queue query | HP 856xE/
HP 8566B/
HP 8568B/
HP 8594E | not yet available |
| EX | EX | Exchange trace A and B | HP 8566A/
HP 8568A | available |
| FA | FA <numeric_value> HZ
KHZ MHZ GHZ
FA UP
FA DN
FA? | Start Frequency | HP 8566A/
HP 8568A/
HP 856xE/
HP 8566B/
HP 8568B/
HP 8594E | available |
| FB | FB <numeric_value> HZ
KHZ MHZ GHZ
FB UP
FB DN
FB? | Stop Frequency | HP 8566A/
HP 8568A/
HP 856xE/
HP 8566B/
HP 8568B/
HP 8594E | available |
| FDSP | | Frequency display off | 8560E
8561E
8562E
8563E
8564E
8565E | available |
| FOFFSET ¹⁾ | FOFFSET
<numeric_value> HZ
KHZ MHZ GHZ
FOFFSET? | Frequency Offset | HP 856xE/
HP 8566B/
HP 8568B/
HP 8594E | available |

| Command | Supported subset | Function | Corresp. HP-Models | Status |
|-----------------------|---|---|---|-----------|
| FREF | FREF INT EXT | Reference Frequency | HP 856xE/
HP 8566B/
HP 8568B/
HP 8594E | available |
| FS | FS | Full Span | HP 8566A/
HP 8568A | available |
| FUNCDEF | | Define Function Function must be in one line between delimiters @ | HP 8594E/
HP 856xE/
HP 8566B | available |
| GATE ¹⁾ | GATE ON OFF
GATE 1 0 | | HP 856xE/
HP 8566B/
HP 8568B/
HP 8594E | available |
| GATECTL ¹⁾ | GATECTL EDGE LEVEL
GATECTL? | | HP 856xE/
HP 8566B/
HP 8568B/
HP 8594E | available |
| GD ¹⁾ | GD <numeric_value>
US MS SC
GD DN
GD UP
GD? | | HP 856xE/
HP 8566B/
HP 8568B/
HP 8594E | available |
| GL ¹⁾ | GL <numeric_value>
US MS SC
GL DN
GL UP
GL? | | HP 856xE/
HP 8566B/
HP 8568B/
HP 8594E | available |
| GP ¹⁾ | GP POS NEG
GP? | | HP 856xE/
HP 8566B/
HP 8568B/
HP 8594E | available |
| GRAT ²⁾ | GRAT
ON OFF | Graticule | HP 856xE/
HP 8566B/
HP 8568B/
HP 8594E | available |
| I1 | I1 | | HP 8566A/
HP 8568A | available |
| I2 | I2 | | HP 8566A/
HP 8568A | available |

| Command | Supported subset | Function | Corresp. HP-Models | Status |
|-------------------|---|-------------------------------------|---|-----------|
| ID | ID
ID? | Identify | HP 8566A/
HP 8568A/
HP 856xE/
HP 8566B/
HP 8568B/
HP 8594E | available |
| INZ ¹⁾ | INZ 75
INZ 50
INZ? | Input Impedance | HP 856xE/
HP 8566B/
HP 8568B/
HP 8594E | available |
| IP | IP | Instrument preset | HP 8566A/
HP 8568A | available |
| KEYDEF | KEYDEF | Key definition | HP 8566B/
HP 856xE/
HP 859xE | available |
| KEYEXEC | KEYEXEC | Key execute | HP 8566B | available |
| KS= | KS= <numeric_value>
HZ KHZ MHZ GHZ
KS= DN
KS= UP
KS=? | Marker Frequency Counter Resolution | HP 8566A/
HP 8568A | available |
| KS/ | KS/ | Manual Peaking | HP 8566A/
HP 8568A | available |
| KS(| KS(| Lock register | HP 8566A/
HP 8568A | available |
| KS) | KS) | Unlock register | HP 8566A/
HP 8568A | available |
| KS91 | KS91 | Read Amplitude Error | HP 8566A/
HP 8568A | available |
| KSA | KSA | Amplitude Units in dBm | HP 8566A/
HP 8568A | available |
| KSB | KSB | Amplitude Units in dBmV | HP 8566A/
HP 8568A | available |
| KSC | KSC | Amplitude Units in dBuV | HP 8566A/
HP 8568A | available |
| KSD | KSD | Amplitude Units in V | HP 8566A/
HP 8568A | available |
| KSE | KSE <numeric_value>
<char data>@ | Title mode | HP 8566A/
HP 8568A | available |

| Command | Supported subset | Function | Corresp. HP-Models | Status |
|-------------------|---|--------------------------|-----------------------|-----------|
| KSG | KSG
KSG ON
KSG <numeric_value> | Video Averaging on | HP 8566A/
HP 8568A | available |
| KSH | KSH | Video Averaging Off | HP 8566A/
HP 8568A | available |
| KSK | | Marker to Next Peak | HP 8566A/
HP 8568A | available |
| KSL | | Marker Noise off | HP 8566A/
HP 8568A | available |
| KSM | | Marker Noise on | HP 8566A/
HP 8568A | available |
| KSO | KSO | Deltamarker to span | HP 8566A/
HP 8568A | available |
| KSP | KSP <numeric_value> | HPIB address | HP 8566A/
HP 8568A | available |
| KSQ ²⁾ | KSQ | Band lock off | HP 8566A/
HP 8568A | available |
| KST | KST | Fast Preset | HP 8566A/
HP 8568A | available |
| KSV | KSV <numeric_value>
HZ KHZ MHZ GHZ
KSV? | Frequency Offset | HP 8566A/
HP 8568A | available |
| KSW | KSW | Error Correction Routine | HP 8566A/
HP 8568A | available |
| KSX | KSX | Correction Values On | HP 8566A/
HP 8568A | available |
| KSY | KSY | Correction Values Off | HP 8566A/
HP 8568A | available |
| KSZ | KSZ <numeric_value>
DB
KSZ? | Reference Value Offset | HP 8566A/
HP 8568A | available |
| KSa | KSa | Normal Detection | HP 8566A/
HP 8568A | available |
| KSb | KSb | Pos Peak Detection | HP 8566A/
HP 8568A | available |
| KSd | KSd | Neg Peak Detection | HP 8566A/
HP 8568A | available |

| Command | Supported subset | Function | Corresp. HP-Models | Status |
|-------------------|-------------------------------------|--------------------------------|-----------------------|-----------|
| KSe | KSe | Sample Detection | HP 8566A/
HP 8568A | available |
| KSg | | CRT beam off | | available |
| KSh | | CRT beam on | | available |
| KSj | KSj | View Trace C | HP 8566A/
HP 8568A | available |
| KSk | KSk | Blank Trace C | HP 8566A/
HP 8568A | available |
| KSl | KSl | Transfer B to C | HP 8566A/
HP 8568A | available |
| KSm | KSm | Graticule off | HP 8566A/
HP 8568A | available |
| KSn ²⁾ | KSn | Grid on | HP 8566A/
HP 8568A | available |
| KSo | KSn | Character display off | HP 8566A/
HP 8568A | available |
| KSp | KSp | Character display on | HP 8566A/
HP 8568A | available |
| KSr | KSr | Create service request | HP 8566A/
HP 8568A | available |
| KSt ²⁾ | KSt | Band lock on | HP 8566A/
HP 8568A | available |
| KV ²⁾ | KVv | Signal ident on | HP 8566A/
HP 8568A | available |
| L0 | L0 | Display line off | HP 8566A/
HP 8568A | available |
| LB | LB <numeric_value>
<char data>@ | Label | HP 8566A/
HP 8568A | available |
| LF | LF | Low frequency band pre-
set | HP 8566A/
HP 8568A | available |
| LIMD | | limit line delta | HP 856xE | available |
| LIMF | | limit line frequency | HP 856xE | available |
| LIMIFAIL | | limit fail query | HP 856xE | available |
| LIMIPURGE | | purge limit line | HP 856xE | available |
| LIMIRCL | | recall limit line | HP 856xE | available |
| LIMIREL | | relative limit line | HP 856xE | available |

| Command | Supported subset | Function | Corresp. HP-Models | Status |
|------------------|---|--------------------------|---|-----------|
| LIMISAV | | save limit line | HP 856xE | available |
| LIMITEST | | limit line test | HP 856xE | available |
| LIML | | lower limit line value | HP 856xE | available |
| LIMM | | middle limit line value | HP 856xE | available |
| LIMTFL | | flat limit line segment | HP 856xE | available |
| LIMITSL | | slope limit line segment | HP 856xE | available |
| LIMU | | upper limit line value | HP 856xE | available |
| LG | LG <numeric_value> DB
 DM
LG? | Amplitude Scale Log | HP 856xE/
HP 8566B/
HP 8568B/
HP 8594E | available |
| LL ²⁾ | LL | Plot command | HP 8566A/
HP 8568A | available |
| LN | LN | Amplitude Scale Lin | HP 856xE/
HP 8566B/
HP 8568B/
HP 8594E | available |
| M1 | M1 | Marker Off | HP 8566A/
HP 8568A | available |
| M2 | M2
M2 <numeric_value>
HZ KHZ MHZ GHZ
M2 DN
M2 UP
M2? | Marker Normal | HP 8566A/
HP 8568A | available |
| M3 | M3
M3 <numeric_value>
HZ KHZ MHZ GHZ
M3 DN
M3 UP
M3? | Delta Marker | HP 8566A/
HP 8568A | available |
| M4 | M4 <numeric_value>
HZ KHZ MHZ GHZ | Marker Zoom | HP 8566A/
HP 8568A | available |
| MA | MA | Marker Amplitude | HP 8566A/
HP 8568A | available |
| MC0 | MC0 | Marker Count off | HP 8566A/
HP 8568A | available |

| Command | Supported subset | Function | Corresp. HP-Models | Status |
|--------------------|---|--------------------------|---|---------------|
| MC1 | MC1 | Marker Count on | HP 8566A/
HP 8568A | available |
| MDS | MDS | Measurement data size | HP 8566B | available |
| MEAS | | Measurement status | HP 856xE | available |
| MF | MF
MF? | Marker Frequency | HP 8566A/
HP 8568A/
HP 856xE/
HP 8566B/
HP 8568B/
HP 8594E | available |
| MINH ¹⁾ | MINH TRC | Minimum Hold | HP 856xE/
HP 8566B/
HP 8568B/
HP 8594E | available |
| MKA | MKA <numeric_value>
MKA? | Marker Amplitude | HP 856xE/
HP 8566B/
HP 8568B/
HP 8594E | available |
| MKACT | MKACT 1
MKACT? | Select the active marker | HP 856xE/
HP 8566B/
HP 8568B/
HP 8594E | not available |
| MKBW ¹⁾ | MKBW <numeric_value>
MKBW ON
MKBW OFF | N dB Down | HP 856xE/
HP 8566B/
HP 8568B/
HP 8594E | available |
| MKD | MKD
MKD <numeric_value>
HZ KHZ
MHZ GHZ
MKD DN
MKD UP
MKD ON
MKD OFF
MKD? | Delta Marker | HP 856xE/
HP 8566B/
HP 8568B/
HP 8594E | available |
| MKDR | MKDR <numeric_value>
HZ KHZ
MHZ GHZ
S SC MS MSEC
USMKDR? | Delta Marker reverse | HP 856xE/
HP 8566B/
HP 8568B/
HP 8594E | available |

| Command | Supported subset | Function | Corresp. HP-Models | Status |
|---------------------|---|------------------------------|---|-----------|
| MKDR? | | Delta Marker reverse query | | available |
| MKF | MKF <numeric_value>
HZ KHZ MHZ GHZ
MKF? | Set Marker Frequency | HP 856xE/
HP 8566B/
HP 8568B/
HP 8594E | available |
| MKFC | MKFC ON OFF | Frequency Counter on/off | HP 856xE/
HP 8566B/
HP 8568B/
HP 8594E | available |
| MKFCR ¹⁾ | MKFCR <numeric_value>
HZ KHZ MHZ GHZ
MKFCR DN
MKFCR UP
MKFCR? | Frequency Counter Resolution | HP 856xE/
HP 8566B/
HP 8568B/
HP 8594E | available |
| MKMIN | MKMIN | Marker -> Min | HP 856xE/
HP 8566B/
HP 8568B/
HP 8594E | available |
| MKN | MKN
MKN <numeric_value>
HZ KHZ MHZ GHZ
MKN DN
MKN UP
MKN ON
MKN OFF
MKN? | Normal Marker | HP 856xE/
HP 8566B/
HP 8568B/
HP 8594E | available |
| MKNOISE | MKNOISE ON OFF
MKNOISE 1 0
MKNOISE? | Noise Measurement | HP 856xE/
HP 8566B/
HP 8568B/
HP 8594E | available |
| MKOFF | MKOFF
MKOFF ALL | Marker off | HP 856xE/
HP 8566B/
HP 8568B/
HP 8594E | available |
| MKP | MKP <numeric_value>
MKP? | Marker position | HP 856xE/
HP 8566B/
HP 8568B/
HP 8594E | available |

| Command | Supported subset | Function | Corresp. HP-Models | Status |
|---------|---|---------------------------------|---|-----------|
| MKPK | MKPK
MKPK HI
MKPK NH
MKPK NR
MKPK NL | Marker Search | HP 856xE/
HP 8566B/
HP 8568B/
HP 8594E | available |
| MKPT | MKPT
MKPT HI
MKPT NH
MKPT NR
MKPT NL | Marker Peak Threshold | HP 856xE/
HP 8566B/
HP 8568B/
HP 8594E | available |
| MKPX | MKPX <numeric_value>
DB
MKPX DN
MKPX UP
MKPX? | Peak Excursion | HP 856xE/
HP 8566B/
HP 8568B/
HP 8594E | available |
| MKRL | MKRL | Ref Level = Marker Level | HP 856xE/
HP 8566B/
HP 8568B/
HP 8594E | available |
| MKSP | MKSP | Deltamarker to span | HP 856xE/
HP 8566B/
HP 8568B/
HP 8594E | available |
| MKSS | MKSS | CF Stepsize = Marker Freq | HP 856xE/
HP 8566B/
HP 8568B/
HP 8594E | available |
| MKT | MKT <numeric_value>
S MS US SC
MKT? | MKF = fstart + MKT/
SWT*Span | HP 856xE/
HP 8594E | available |
| MKTRACE | MKTRACE TRA TRB
TRC | Marker to Trace | HP 856xE/
HP 8566B/
HP 8568B/
HP 8594E | available |
| MKTRACK | MKTRACK ON OFF
MKTRACK 1 0
MKTRACK? | Signal Track | HP 856xE/
HP 8566B/
HP 8568B/
HP 8594E | available |

| Command | Supported subset | Function | Corresp. HP-Models | Status |
|-------------------|--|------------------------------------|---|----------------------------|
| MKTYPE | MKTYPE AMP
MK TYPE? | Marker type | HP 856xE/
HP 8566B/
HP 8568B/
HP 8594E | available |
| ML | | Mixer level | HP 856xE | available |
| MOV | MOV TRA TRB TRC,
TRA TRB T RC | Move Trace Contents | HP 856xE/
HP 8566B/
HP 8568B/
HP 8594E | available |
| MPY | | Multiply | HP 8566B/
HP 8568B/
HP 8594E | available |
| MT0 | MT0 | Marker Track Off | HP 8566A/
HP 8568A | available |
| MT1 | MT1 | Marker Track On | HP 8566A/
HP 8568A | available |
| MXMH | MXMH TRA TRB | Maximum Hold | HP 856xE/
HP 8566B/
HP 8568B/
HP 8594E | available |
| NORMALIZE | NORMALIZE | Normalize trace | HP 856xE/
HP 8566B/
HP 8568B/
HP 8594E | not available
available |
| NRL ¹⁾ | NRL <numeric_value>
DB DM
NRL? | Normalized Reference Level | HP 856xE/
HP 8566B/
HP 8568B/
HP 8594E | available |
| NRPOS | NRPOS
<numeric_value>
NRL? | Normalize position | HP 856xE/
HP 8566B/
HP 8568B/
HP 8594E | available |
| O1 | O1 | Format ASCII, Values 0 to 4095 | HP 8566A/
HP 8568A | available |
| O2 | O2 | Format Binary,
Values 0 to 4095 | HP 8566A/
HP 8568A | available |
| O3 | O3 | Format ASCII | HP 8566A/
HP 8568A | available |

| Command | Supported subset | Function | Corresp. HP-Models | Status |
|----------|---------------------------------------|--|-----------------------|-----------|
| OA | OA | Output All | HP 8566A/
HP 8568A | available |
| OL | OL <80 characters>
OL? | Output Learn String | HP 8566A/
HP 8568A | available |
| OT | OT | Output Trace Annotations | HP 8566A/
HP 8568A | available |
| PA | PA <numeric_value>,
<numeric_value | Plot command | HP 8566A/
HP 8568A | available |
| PD | PD <numeric_value>,
<numeric_value | Plot command | HP 8566A/
HP 8568A | available |
| PH_MKF | | Spot frequency in Hz | HP 856xE | available |
| PH_FMIN | | Min offset frequency to be measured | HP 856xE | available |
| PH_FMAX | | Max offset frequency to be measured | HP 856xE | available |
| PH_MKA | | Queries amplitude at the spot frequency | HP 856xE | available |
| PH_DRIFT | | 0: for stable signals, 1: for drifty | HP 856xE | available |
| PH_RLVL | | Reference level for the log plot | HP 856xE | available |
| PH_SMTHV | | Trace smoothing | HP 856xE | available |
| PH_VBR | | Filtering | HP 856xE | available |
| PH_RMSPT | | Amount of data points to skip when doing the integration | HP 856xE | available |
| PH_RMSFL | | Lower integration frequency in Hz | HP 856xE | available |
| PH_RMSFU | | Upper integration frequency in Hz | HP 856xE | available |
| PH_EXIT | | Quits phase noise | HP 856xE | available |
| PH_F_UDT | | Updates internal frequency variables | HP 856xE | available |
| PH_LMT_L | | Apply limits to PH_FMIN and PH_FMAX | HP 856xE | available |
| PH_MEAS | | Generates log frequency plot | HP 856xE | available |
| PH_MKF_D | | Updates the spot frequency | HP 856xE | available |

| Command | Supported subset | Function | Corresp. HP-Models | Status |
|-----------------------|--|---|---|-----------|
| PH_RMS | | Requests the rms phase noise | HP 856xE | available |
| PH_RMSFT | | Updates internal frequency variables | HP 856xE | available |
| PH_RMSX | | Calculates the rms phase noise | HP 856xE | available |
| PH_SPOTF | | Executes the spot frequency measurement | HP 856xE | available |
| PLOTORG ²⁾ | PLOTORG DSP GRT | Plot command | HP 856xE/
HP 8566B/
HP 8568B/
HP 8594E | available |
| PLOTSRC ²⁾ | PLOTSRC ANNT GRT
TRB TRA ALLDSP GRT | Plot command | HP 856xE/
HP 8566B/
HP 8568B/
HP 8594E | available |
| PP | PP | Preselector Peaking | HP 8566A/
HP 8568A | available |
| PRINT ¹⁾ | PRINT
PRINT 1 0 | Hardcopy | HP 856xE/
HP 8566B/
HP 8568B/
HP 8594E | available |
| PSDAC ²⁾ | PSDAC
<numeric_value>
PSDAC UP DN | Preselector DAC value | HP 856xE/
HP 8566B/
HP 8568B/
HP 8594E | available |
| PSTATE ²⁾ | PSTATE ON OFF 1 0 | Protect State | HP 856xE/
HP 8566B/
HP 8568B/
HP 8594E | available |
| PU | PU | Pen Up | HP 8566A/
HP 8568A | available |
| PWRBW | PWRBW | Power Bandwidth | HP 8566B/
HP 859x/
HP 856xE | available |
| R1 | R1 | Set Status Bit Enable | HP 8566A/
HP 8568A | available |
| R2 | R2 | Set Status Bit Enable | HP 8566A/
HP 8568A | available |

| Command | Supported subset | Function | Corresp. HP-Models | Status |
|---------|--|-----------------------------|---|-----------|
| R3 | R3 | Set Status Bit Enable | HP 8566A/
HP 8568A | available |
| R4 | R4 | Set Status Bit Enable | HP 8566A/
HP 8568A | available |
| RB | RB <numeric_value>
HZ KHZ MHZ GHZ
RB DN
RB UP
RB AUTO
RB? | Resolution Bandwidth | HP 856xE/
HP 8566B/
HP 8568B/
HP 8594E | available |
| RBR | RBR <numeric_value>
RBR DN
RBR UP
RBR? | Resolution Bandwidth Ratio | HP 856xE/
HP 8566B/
HP 8568B/
HP 8594E | available |
| RC1...6 | RC1...6 | Recall Last State | HP 8566A/
HP 8568A | available |
| RCLS | RCLS <numeric_value> | Recall State Register | HP 856xE/
HP 8566B/
HP 8568B/
HP 8594E | available |
| RCLT | RCLT TRA TRB, <number> | Recall Trace | HP856xE/
HP8594E | available |
| RESET | RESET | Instrument preset | HP 856xE/
HP 8566B/
HP 8568B/
HP 8594E | available |
| REV | REV
REV? | Firmware revision | HP 856xE/
HP 8566B/
HP 8568B/
HP 8594E | available |
| RL | RL <numeric_value>
DB DM
RL DN
RL UP
RL? | Reference Level | HP 856xE/
HP 8566B/
HP 8568B/
HP 8594E | available |
| RLCAL | RLCAL
<numeric_value>
RL? | Reference Level Calibration | HP 856xE/
HP 8566B/
HP 8568B/
HP 8594E | available |

| Command | Supported subset | Function | Corresp. HP-Models | Status |
|---------------------|--|---------------------------|---|---------------|
| RCLOSCAL | RCLOSCAL | Recall Open/Short Average | HP 856xE/
HP 8594E | not available |
| RCLTHRU | RCLTHRU | Recall Thru | HP 856xE/
HP 8594E | not available |
| RLPOS ¹⁾ | RLPOS
<numeric_value>
RLPOS DN
RLPOS UP
RLPOS? | Reference Level Position | HP 856xE/
HP 8566B/
HP 8568B/
HP 8594E | available |
| ROFFSET | ROFFSET
<numeric_value> DB
DM
ROFFSET? | Reference Level Offset | HP 856xE/
HP 8566B/
HP 8568B/
HP 8594E | available |
| RQS | RQS | Service Request Bit mask | HP 856xE/
HP 8566B/
HP 8568B/
HP 8594E | available |
| S1 | S1 | Continuous Sweep | HP 8566A/
HP 8568A | available |
| S2 | S2 | Single Sweep | HP 8566A/
HP 8568A | available |
| SADD | | add a limit line segment | HP 856xE | available |
| SAVES | SAVES
<numeric_value> | Save State Register | HP 856xE/
HP 8566B/
HP 8568B/
HP 8594E | available |
| SAVET | SAVET TRA TRB,<number> | Save Trace | HP856xE/
HP8594E | available |
| SDEL | | delete limit line segment | HP 856xE | available |
| SDON | | limit line segment done | HP 856xE | available |
| SEDI | | edit limit line segment | HP 856xE | available |
| SMOOTH | SMOOTH TRA TRB
TRC, <number of
points> | Smooth Trace | HP 856xE/
HP 8566B/
HP 8568B/
HP 8594E | available |
| SNGLS | SNGLS | Single Sweep | HP 856xE/
HP 8566B/
HP 8568B/
HP 8594E | available |

| Command | Supported subset | Function | Corresp. HP-Models | Status |
|-----------------------|--|----------------------|---|---------------|
| SQUELCH ²⁾ | SQUELCH
<numeric_value>
DM DB
SQUELCH UP DN
SQUELCH ON OFF | Squelch | HP 856xE/
HP 8566B/
HP 8568B/
HP 8594E | available |
| SP | SP <numeric_value>
HZ KHZ MHZ GHZ
SP DN
SP UP
SP? | Span | HP 8566A/
HP 8568A/
HP 856xE/
HP 8566B/
HP 8568B/
HP 8594E | available |
| SRCNORM ¹⁾ | SRCNORM ON OFF
SRCNORM 1 0 | Source Normalization | HP 856xE/
HP 8566B/
HP 8568B/
HP 8594E | not available |
| SRCPOFS ¹⁾ | SRCPOFS
<numeric_value> DB
DM
SRCPOFS DN
SRCPOFS UP
SRCPOFS? | Source Power Offset | HP 856xE/
HP 8566B/
HP 8568B/
HP 8594E | not available |
| SRCPWR ¹⁾ | SRCPWR
<numeric_value> DB
DM
SRCPWR DN
SRCPWR UP
SRCPWR ON
SRCPWR OFF
SRCPWR? | Source Power | HP 856xE/
HP 8566B/
HP 8568B/
HP 8594E | not available |
| SS | SS <numeric_value>
HZ KHZ MHZ GHZ
SS DN
SS UP
SS AUTO
SS? | CF Step Size | HP 8566A/
HP 8568A/
HP 856xE/
HP 8566B/
HP 8568B/
HP 8594E | available |
| ST | ST <numeric_value>
US MS SC
ST DN
ST UP
ST AUTO
ST? | Sweep Time | HP 8566A/
HP 8568A/
HP 856xE/
HP 8566B/
HP 8568B/
HP 8594E | available |

| Command | Supported subset | Function | Corresp. HP-Models | Status |
|----------------------|-------------------------------------|-------------------------|---|---------------|
| STB | STB | Status byte query | HP 856xE/
HP 8566B/
HP 8568B/
HP 8594E | available |
| STOREOPEN | STOREOPEN | Store Open | HP 856xE/
HP 8594E | not available |
| STORESHORT | STORESHORT | Store Short | HP 856xE/
HP 8594E | not available |
| STORETHRU | STORETHRU | Store Thru | HP 856xE/
HP 8594E | not available |
| SUB | | Subtract | HP 8566B/
HP 8568B/
HP 8594E | available |
| SUM | | sum of trace amplitudes | HP 8566B/
HP 8568B/
HP 8594E | available |
| SV1...6 | SV1...6 | Save State | HP 8566A/
HP 8568A | available |
| SWPCPL ²⁾ | SWPCPL SA SR
SWPCPL? | Sweep Couple | HP 856xE/
HP 8566B/
HP 8568B/
HP 8594E | available |
| SWPOUT ²⁾ | SWPOUT FAV FAVA
RAMP
SWPOUT? | Sweep Output | HP 856xE/
HP 8566B/
HP 8568B/
HP 8594E | available |
| T0 | T0 | Threshold off | HP 8566A/
HP 8568A | available |
| T1 | T1 | Free Run Trigger | HP 8566A/
HP 8568A | available |
| T2 ²⁾ | T2 | Line Trigger | HP 8566A/
HP 8568A | available |
| T3 | T3 | External Trigger | HP 8566A/
HP 8568A | available |
| T4 | T4 | Video Trigger | HP 8566A/
HP 8568A | available |
| TA | TA | Transfer A | HP 8566A/
HP 8568A | available |

| Command | Supported subset | Function | Corresp. HP-Models | Status |
|-----------------------|--|---|---|---------------|
| TACL | TACL? | Returns instantaneous measurement results.
See TRACe<trace #>:IMMEDIATE:LEVel? for full description. | | not available |
| TBCL | TBCL? | | | |
| TCCL | TCCL? | | | |
| TACR | TACR? | Returns instantaneous measurement results.
See TRACe<trace #>:IMMEDIATE:LEVel? for full description. | | not available |
| TBCR | TBCR? | | | |
| TCCR | TCCR? | | | |
| TB | TB | Transfer B | HP 8566A/
HP 8568A | available |
| TDF | TDF P
TDF M
TDF B
TDF A
TDF I | Trace Data Format | HP 856xE/
HP 8566B/
HP 8568B/
HP 8594E | available |
| TH | TH <numeric_value>
DB DM
TH DN
TH UP
TH ON
TH OFF
TH AUTO
TH? | Threshold | HP 856xE/
HP 8566B/
HP 8568B/
HP 8594E | available |
| THE | THE ON OFF | Threshold Line enable | HP 856xE/
HP 8566B/
HP 8568B/
HP 8594E | available |
| TIMEDSP ¹⁾ | TIMEDSP ON OFF
TIMEDSP 1 0
TIMEDSP? | Time Display | HP 856xE/
HP 8566B/
HP 8568B/
HP 8594E | available |
| TM | TM FREE VID EXT
LINE ²⁾
TM? | Trigger Mode | HP 856xE/
HP 8566B/
HP 8568B/
HP 8594E | available |
| TM LINE ²⁾ | TM LINE | Trigger Line | HP 8566B | available |

| Command | Supported subset | Function | Corresp. HP-Models | Status |
|-------------------|--|--|---|-----------|
| TRA | TRA B
TRA A
TRA I | Transfer A | HP 856xE/
HP 8566B/
HP 8568B/
HP 8594E | available |
| TRB | TRB B
TRB A
TRB I | Transfer B | HP 856xE/
HP 8566B/
HP 8568B/
HP 8594E | available |
| TRSTAT | TRSTAT? | Trace State Query | HP 856xE/
HP 8566B/
HP 8568B/
HP 8594E | available |
| TS | TS | Take Sweep | HP 856xE/
HP 8566B/
HP 8568B/
HP 8594E | available |
| UR ²⁾ | UR | Plot Command | HP 8566A/
HP 8568A | available |
| VARDEF | VARDEF | Variable definition,
arrays are not supported | HP 8566B/
HP 8568B/
HP 8594E | available |
| VAVG | VAVG
VAVG TRA TRB TRC | Video Averaging | HP 856xE/
HP 8566B/
HP 8568B/
HP 8594E | available |
| VB | VB <numeric_value>
HZ KHZ MHZ GHZ
VB DN
VB UP
VB AUTO
VB? | Video Bandwidth | HP 856xE/
HP 8566B/
HP 8568B/
HP 8594E | available |
| VBR ¹⁾ | VBR <numeric_value>
VBR DN
VBR UP
VBR? | Video Bandwidth Ratio | HP 856xE/
HP 8566B/
HP 8568B/
HP 8594E | available |
| VIEW | VIEW TRA TRB TRC | | HP 856xE/
HP 8566B/
HP 8568B/
HP 8594E | available |

| Command | Supported subset | Function | Corresp. HP-Models | Status |
|--|--|---------------------|-----------------------|---------------|
| VTL | VTL <numeric_value>
DB DM
VTL DN
VTL UP
VTL? | Video Trigger Level | HP 856xE/
HP 8594E | not available |
| 1) HP 8594E only | | | | |
| 2) Command is accepted without error message, but is ignored | | | | |

8.2.5.3 Special Features of the Syntax Parsing Algorithms for 8566A and 8568A Models

The command syntax is very different for models A and B. Different names are assigned to identical instrument functions, and the command structure likewise differs considerably between models A and models B.

The command structure for models A is as follows:

```
<command> ::= <command
code> [<SPC>] [<data>|<step>] [<SPC>] [<delimiter>] [<command
code>]...<delimiter>
```

```
<data> ::= <Value> [<SPC>] [<units
code>] [<SPC>] [<delimiter>] [<SPC>] [<data>]...
```

```
<step> ::= UP|DN
```

where

```
<command code> = see Table "Supported Commands"
```

```
<Value> = integer or floating-point numerical value
```

```
<units code> = DM | -DM | DB | HZ | KZ | MZ | GZ | MV | UV | SC | MS | US
```

```
<delimiter> = <CR> | <LF> | <,> | <;> | <ETX>
```

```
<SPC> = 3210
```

```
<ETX> = 310
```

Command sections given in [] are optional.

The R&S FSVR GPIB hardware differs from that used in the HP analyzers. Therefore, the following constraint exists:

<LF>| <EOI> are still used as delimiters since the GPIB hardware is able to identify them. The other delimiters are identified and evaluated during syntax analysis.

8.2.5.4 Special Behavior of Commands

| Command | Known Differences |
|---------|--|
| ABORT | Does not automatically set the command complete bit (bit 4) in the status byte. An additional DONE is required for that purpose. |
| ANNOT | Only frequency axis annotation is affected. |
| AT | AT DN/UP: Step size |
| CAL | The CAL commands do not automatically set the command complete bit (bit 4) in the status byte. An additional DONE command is required for that purpose. |
| CF | Default value, range, step size |
| CR | Default ratio Span/RBW |
| CT | Formula for coupled sweep time |
| CV | Default ratio RBW/VBW |
| DEMOD | requires option R&S FSV-B3 |
| DET | DET? returns SAMP instead of SMP on the R&S FSVR.
DET not automatically set the command complete bit (bit 4) in the status byte. An additional DONE is required for that purpose. |
| ERR? | Deletes the error bit in the status register but always returns a '0' in response. |
| FA | Default value, range, step size |
| FB | Default value, range, step size |
| ID | |
| M2 | Default value, range, step size |
| M3 | Default value, range, step size |
| MKACT | Only marker 1 is supported as the active marker. |
| MKBW | Default value |
| MKPT | Step size |
| MKPX | Step size |
| OL? | Storage of instrument settings:
80 characters are returned as information on the instrument settings.
The contents of the 80 characters returned does not correspond to the original data contents of the 8566A/8568A family. |
| OL | Readout of instrument settings:
The 80 characters read by means of OL? are accepted as information on the corresponding instrument settings.
The contents of the 80 characters read does not correspond to the original data contents of the 8566A/8568A family. |
| RB | Default value, range, step size |
| RL | Default value, step size |

| Command | Known Differences |
|---------|---|
| RLPOS | Adapts the position of the reference level even if the tracking generator normalization is not active. |
| RQS | Supported bits:
1 (Units key pressed)
2 (End of Sweep)
3 (Device error)
4 (Command complete)
5 (Illegal command) |

| | |
|-----|--|
| SP | Default value, range, step size |
| SS | Default value, range, step size |
| ST | Default value, range, step size |
| STB | The status bits are mapped as described with command RQS.
Note: Bit 2 and 4 are always set in parallel if "Command Complete" or "End of Sweep" are recognized. The R&S FSVR cannot distinguish between these conditions. Additionally these bits are not suitable for synchronization on the end of sweep in continuous sweep operation. |
| TA | Output of 1001 trace points of trace A in O1 or O3 format. |
| TB | Output of 1001 trace points of trace B in O1 or O3 format. |
| TH | Default value |
| VB | Range |
| VBR | Default value |

8.2.5.5 Model-Dependent Default Settings

If the GPIB language is switched over to an 85xx model, the GPIB address is automatically switched over to 18 provided that the default address of the R&S FSVR (20) is still set. If a different value is set, this value is maintained. Upon return to SCPI, this address remains unchanged.

The following table shows the default settings obtained after a change of the GPIB language and for the commands IP, KST and RESET:

| Model | # of Trace Points | Start Freq. | Stop Freq. | Ref Level | Input Coupling |
|---------|-------------------|-------------|------------|-----------|----------------|
| 8566A/B | 1001 | 2 GHz | 22 GHz | 0 dBm | AC |
| 8568A/B | 1001 | 0 Hz | 1.5 GHz | 0 dBm | AC |
| 8560E | 601 | 0 Hz | 2.9 GHz | 0 dBm | AC |
| 8561E | 601 | 0 Hz | 6.5 GHz | 0 dBm | AC |
| 8562E | 601 | 0 Hz | 13.2 GHz | 0 dBm | AC |
| 8563E | 601 | 0 Hz | 26.5 GHz | 0 dBm | AC |

| Model | # of Trace Points | Start Freq. | Stop Freq. | Ref Level | Input Coupling |
|-------|-------------------|-------------|------------|-----------|----------------|
| 8564E | 601 | 0 Hz | 40 GHz | 0 dBm | AC |
| 8565E | 601 | 0 Hz | 50 GHz | 0 dBm | AC |
| 8594E | 401 | 0 Hz | 3 GHz | 0 dBm | AC |



Stop frequency

The stop frequency given in the table may be limited to the corresponding frequency range of the R&S FSVR.

Command LF sets the stop frequency for 8566A/B to a maximum value of 2 GHz.

Test points (trace points)

The number of trace points is switched over only upon transition to the REMOTE state.

8.2.5.6 Data Output Formats

In the case of the SCPI and IEEE488.2 standards, the output formats for numerical data are flexible to a large extent. The output format for the HP units, by contrast, is accurately defined with respect to the number of digits. The memory areas for reading instrument data have therefore been adapted accordingly in the remote-control programs for instruments of this series.

Therefore, in response to a query, the R&S FSVR returns data of the same structure as that used by the original instruments; this applies in particular to the number of characters returned.

Two formats are currently supported when trace data is output: Display Units (command O1) and physical values (command O2, O3 or TDF P). As to the "Display Units" format, the level data of the R&S FSVR is converted to match the value range and the resolution of the 8566/8568 series. Upon transition to the **REMOTE** state, the R&S FSVR is reconfigured such that the number of test points (trace points) corresponds to that of the 85xx families (1001 for 8566A/B and 8568A/B, 601 for 8560E to 8565E, 401 for 8594E).

8.2.5.7 Trace Data Output Formats

All formats are supported for trace data output: display units (command O1), display units in two byte binary data (command O2 or TDF B and MDS W), display units in one byte binary data (command O4 or TDF B and MDS B) and physical values (commands O3 or TDF P). With format "display units" the level data is converted into value range and resolution of the 8566/8568 models. On transition to REMOTE state the number of trace points are reconfigured in order to be conform to the selected instrument model (1001 for 8566A/B and 8568 A/B, 601 for 8560E to 8565E, 401 for 8594E).

8.2.5.8 Trace Data Input Formats

Trace data input is only supported for binary date (TDF B, TDF A, TDF I, MDS W, MDS B).

8.2.5.9 GPIB Status Reporting

The assignment of status bits by commands R1, R2, R3, R4, RQS is supported.

The STB command and the serial poll respond with an 8-bit value with the following assignment:

| Bit enabled by RQS | Description |
|--------------------|--------------------|
| 0 | not used (value 0) |
| 1 | Units key pressed |
| 2 | End of Sweep |
| 3 | Device Error |
| 4 | Command Complete |
| 5 | Illegal Command |
| 6 | Service Request |
| 7 | not used (value 0) |

Bits 0 and 7 are not used and always have the value 0.

Please note that the R&S FSVR reports any key pressed on the front panel rather than only the unit keys if bit 1 was enabled.

Another difference is the behavior of bit 6 when using the STB? query. On the HP analyzers this bit monitors the state of the SRQ line on the bus. On the R&S FSVR this is not possible. Therefore this bit is set, as soon as one of the bits 1 to 5 is set. It won't be reset by performing a serial poll.

8.2.6 Reference: Command Set of Emulated PSA Models

The R&S FSVR analyzer family supports a subset of the GPIB commands of PSA89600 instruments.

Despite the differences in system architecture and device features, the supported commands have been implemented in a way to ensure a sufficiently high degree of correspondence with the original.

In many cases the selection of commands supported by the R&S FSVR is sufficient to run an existing GPIB program without adaptation.

| Supported 89600 commands |
|---|
| *CAL? |
| *CLS |
| *ESE |
| *ESR? |
| *IDN? |
| *IST? |
| *OPC |
| *OPT? |
| *PCB |
| *PRE |
| *PSC |
| *RST |
| *SRE |
| *STB? |
| *TRG |
| *TST? |
| *WAI |
| :CALibration:AUTO OFF ON ALERT |
| :CALibration:TCORrections AUTO ON OFF |
| :CONFigure:WAVeform |
| :DIAGnostic:EABY ON OFF |
| :DIAGnostic:LATCh:VALue <numeric> |
| :DIAGnostic:LATCh:SElect <string> |
| :DISPlay:ANNotation:TITLe:DATA <string> |
| :DISPlay:ENABle OFF ON |
| :DISPlay:WINDow:TRACe:Y:[SCALe]:PDIVision <numeric> |
| :DISPlay:WINDow:TRACe:Y:[SCALe]:RLEVel <numeric> |
| :DISPlay:WINDow:TRACe:Y:[SCALe]:RLEVel:OFFSet <numeric> |
| :FORMat:BORDer NORMAl SWAPped |
| :FORMat[:DATA] ASCii REAL UINT MATLAB,<numeric> |
| :INITiate:CONTInuous OFF ON |
| :INITiate[:IMMEDIATE] |
| :INSTrument:CATalog? |

| Supported 89600 commands |
|---|
| :INSTrument:NSElect <numeric> |
| :MMEMory:CATalog? <dir_name> |
| :MMEMory:COpy <'file_name1'>,<'file_name2'> |
| :MMEMory:DATA <'file_name'>,<definite_length_block> |
| :MMEMory:DELeTe <'file_name'> |
| :MMEMory:LOAD:STATe 1,<'file_name'> |
| :MMEMory:LOAD:TRACe 1,<'file_name'> |
| :MMEMory:MDIRectory <'dir_name'> |
| :MMEMory:MOVE <'file_name1'>,<'file_name2'> |
| :MMEMory:STORE:STATe 1,<'file_name'> |
| :MMEMory:STORE:TRACe <numeric>,<'file_name'> |
| :READ:WAVform? |
| [.SENSe]:FREQuency:CENTer <numeric> |
| [.SENSe]:FREQuency:STARt <numeric> |
| [.SENSe]:FREQuency:STOP <numeric> |
| [.SENSe]:FREQuency:SPAN <numeric> |
| [.SENSe]:POWer:ATTenuation <numeric> |
| [.SENSe]:ROSCillator:EXTernal:FREQuency <numeric> |
| [.SENSe]:ROSCillator:OUTPut OFF ON |
| [.SENSe]:ROSCillator:SOURce INTernal EXTernal EAUto |
| [.SENSe]:SPECtrum:TRIGger:SOURce EXTernal<1 2> IF IMMediate |
| [.SENSe]:WAVeform:ADC:RANGe P6 |
| [.SENSe]:WAVeform:APER? |
| [.SENSe]:WAVeform:AVERage:TACount <numeric> |
| [.SENSe]:WAVeform:BWIDth:ACTive? |
| [.SENSe]:WAVeform:BWIDth:TYPE FLAT GAUSSian |
| [.SENSe]:WAVeform:IFGain <numeric> |
| [.SENSe]:WAVeform:IFPath NARRow WIDE |
| [.SENSe]:WAVeform:NCPTTrace ON OFF |
| [.SENSe]:WAVeform:PDIT ON OFF |
| [.SENSe]:WAVeform:SRATe <numeric> |
| [.SENSe]:WAVeform:SWEp:TIME <numeric> |
| [.SENSe]:WAVeform:TRIGger:EOFFset? |

| Supported 89600 commands |
|---|
| [:SENSe]:WAVEform:TRIGger:INTerpolation ON OFF |
| [:SENSe]:WAVEform:TRIGger:SOURce EXTernal<1 2> IF IMMediate |
| :STATus:QUEStionable:CONDition? |
| :STATus:QUEStionable:ENABle <number> |
| :STATus:QUEStionable:NTRansition <number> |
| :STATus:QUEStionable:PTRansition <number> |
| :STATus:QUEStionable[:EVENT]? |
| :STATus:QUEStionable:CALibration:CONDition? |
| :STATus:QUEStionable:CALibration:ENABle <number> |
| :STATus:QUEStionable:CALibration:NTRansition <number> |
| :STATus:QUEStionable:CALibration:PTRansition <number> |
| :STATus:QUEStionable:CALibration[:EVENT]? |
| :STATus:QUEStionable:FREQuency:CONDition? |
| :STATus:QUEStionable:FREQuency:ENABle <number> |
| :STATus:QUEStionable:FREQuency:NTRansition <number> |
| :STATus:QUEStionable:FREQuency:PTRansition <number> |
| :STATus:QUEStionable:FREQuency[:EVENT]? |
| :STATus:QUEStionable:INTegrity:CONDition? |
| :STATus:QUEStionable:INTegrity:ENABle <number> |
| :STATus:QUEStionable:INTegrity:NTRansition <number> |
| :STATus:QUEStionable:INTegrity:PTRansition <number> |
| :STATus:QUEStionable:INTegrity[:EVENT]? |
| :STATus:OPERation:CONDition? |
| :STATus:OPERation:ENABle <integer> |
| :STATus:OPERation:NTRansition <integer> |
| :STATus:OPERation:PTRansition <integer> |
| :STATus:OPERation[:EVENT]? |
| :SYSTem:COMMunicate:GPIB[:SELF]:ADDRess <integer> |
| :SYSTem:DATE <year>,<month>,<day> |
| :SYSTem:ERRor[:NEXT]? |
| :SYSTem:KLOCK? |
| :SYSTem:MESSAge <string> |
| :SYSTem:PRESet |

| Supported 89600 commands |
|---|
| :SYSTem:TIME <hour>,<minute>,<second> |
| :SYSTem:VERSion? |
| :TRACe:COPIY <src_trace>,<dest_trace> |
| :TRACe[:DATA] TRACE1 TRACE2 TRACE3 TRACE4 TRACE5 TRACE6, <definite_length_block> <comma_separated_ASCII_data> |
| :TRACe:MODE WRITe MAXHold MINHold VIEW BLANK |
| :TRIGger[:SEQuence]:DELay <numeric> |
| :TRIGger[:SEQuence]:DELay:STATe OFF ON 0 1 |
| :TRIGger[:SEQuence]:EXTernal:DELay <numeric> |
| :TRIGger[:SEQuence]:EXTernal:LEVel <numeric> |
| :TRIGger[:SEQuence]:EXTernal:SLOPe POSitive NEGative |
| :TRIGger[:SEQuence]:HOLDoff <numeric> |
| :TRIGger[:SEQuence]:IF:DELay <numeric> |
| :TRIGger[:SEQuence]:IF:LEVel <numeric> |
| :TRIGger[:SEQuence]:IF:SLOPe POSitive NEGative |
| :TRIGger[:SEQuence]:SLOPe POSitive NEGative |
| :TRIGger[:SEQuence]:SOURce IMMEDIATE VIDeo EXTernal<1 2> |
| :TRIGger[:SEQuence]:VIDeo:LEVel <numeric> |
| :TRIGger[:SEQuence]:VIDeo:LEVel:FREQuency <freq> |

8.3 Remote Control – Programming Examples

In this chapter, more complex programming examples are given. In the R&S FSVR Quick Start Guide, basic steps in remote control programming are provided.

The following programming examples have a hierarchical structure, i.e. subsequent examples are based on previous ones. It is thus possible to compile an operational program from the modules of the given examples very easily. VISUAL BASIC has been used as programming language. However, the programs can be translated into other languages.



In programming languages as C, C++ or programs as MATLAB, NI Interactive Control, a backslash starts an escape sequence (e.g. "\n" is used to start a new line). In these programming languages and programs, two backslashes instead of one must be used in remote commands (for an example refer to the R&S FSVR Quick Start Guide.)

| | | |
|----------|---|------|
| 8.3.1 | Service Request..... | 1017 |
| 8.3.1.1 | Initiate Service Request..... | 1017 |
| 8.3.1.2 | Waiting for the Arrival of a Service Request..... | 1017 |
| 8.3.1.3 | Waiting Without Blocking the Keyboard and Mouse..... | 1019 |
| 8.3.1.4 | Service Request Routine..... | 1020 |
| 8.3.1.5 | Reading Out the Output Buffer..... | 1021 |
| 8.3.1.6 | Reading Error Messages..... | 1021 |
| 8.3.1.7 | Evaluation of SCPI Status Registers..... | 1022 |
| 8.3.1.8 | Evaluation of Event Status Register..... | 1022 |
| 8.3.2 | Using Marker and Delta Marker..... | 1024 |
| 8.3.2.1 | Shape Factor Measurement (using n dB down)..... | 1024 |
| 8.3.2.2 | Measuring the Third Order Intercept Point..... | 1025 |
| 8.3.2.3 | Measuring the AM Modulation Depth..... | 1026 |
| 8.3.3 | Limit Lines and Limit Test..... | 1026 |
| 8.3.4 | Measuring the Channel and Adjacent Channel Power..... | 1028 |
| 8.3.5 | Occupied Bandwidth Measurement..... | 1031 |
| 8.3.6 | Time Domain Power Measurement..... | 1032 |
| 8.3.7 | Fast Power Measurement on Power Ramps..... | 1033 |
| 8.3.7.1 | Power Measurement with Multi-Summary Marker..... | 1033 |
| 8.3.7.2 | Multi-Burst Power Measurement..... | 1035 |
| 8.3.8 | Fast Level Measurement Using Frequency Lists..... | 1036 |
| 8.3.9 | Level Correction of Transducers..... | 1038 |
| 8.3.10 | Measuring the Magnitude and Phase of a Signal..... | 1039 |
| 8.3.11 | Reading and Writing Files..... | 1041 |
| 8.3.11.1 | Reading a File from the Instrument..... | 1041 |
| 8.3.11.2 | Creating a File on the Instrument..... | 1042 |
| 8.3.12 | Spectrum Emission Mask Measurement..... | 1042 |
| 8.3.12.1 | Using Predefined Standard Wibro..... | 1043 |
| 8.3.12.2 | Defining 5 Ranges with all Parameters..... | 1043 |
| 8.3.13 | Spurious Emissions Measurement..... | 1046 |
| 8.3.14 | Averaging I/Q Data..... | 1049 |
| 8.3.15 | Using IQ Gating..... | 1050 |
| 8.3.16 | Usage of Four Spectrum Instances..... | 1055 |

8.3.1 Service Request

The service request routine requires an extended initialization of the instrument in which the relevant bits of the transition and enable registers are set. In addition the service request event must be enabled in the VISA session.

8.3.1.1 Initiate Service Request

```

REM ---- Example of initialization of the SRQ in the case
' of errors -----
PUBLIC SUB SetupSRQ()
CALL InstrWrite (analyzer, "*CLS") 'Reset status reporting system
CALL InstrWrite (analyzer, "*SRE 168") 'Enable service request for
'STAT:OPER, STAT:QUES and ESR
'register
CALL InstrWrite (analyzer, "*ESE 60") 'Set event enable bit for
'command, execution, device-
'dependent and query error
CALL InstrWrite (analyzer, "STAT:OPER:ENAB 32767")
'Set OPERATION enable bit for
'all events
CALL InstrWrite (analyzer, "STAT:OPER:PTR 32767")
'Set appropriate OPERATION
'Ptransition bits
CALL InstrWrite (analyzer, "STAT:QUES:ENAB 32767")
'Set questionable enable bits
'for all events
CALL InstrWrite (analyzer, "STAT:QUES:PTR 32767")
'Set appropriate questionable
'Ptransition bits
CALL viEnableEvent(analyzer, VI_EVENT_SERVICE_REQ, VI_QUEUE, 0)
'Enable the event for service
'request
Status = viWaitOnEvent(analyzer, VI_EVENT_SERVICE_REQ, SRQWaitTimeout, VI_NULL,
VI_NULL)
IF (status = VI_SUCCESS) THEN CALL Srq
'If SRQ is recognized =>
'subroutine for evaluation
END SUB
REM *****

```

8.3.1.2 Waiting for the Arrival of a Service Request

There are basically two methods of waiting for the arrival of a service request:

Blocking (user inputs not possible):

This method is appropriate if the waiting time until the event to be signaled by an SRQ is short (shorter than the selected timeout), if no response to user inputs is required

during the waiting time, and if – as the main criterion – the event is absolutely certain to occur.

Reason:

From the time the `viWaitOnEvent()` function is called until the occurrence of the expected event, it does not allow the program to respond to mouse clicks or key entries during the waiting time. Moreover, it returns an error if the SRQ event does not occur within the predefined timeout period.

The method is, therefore, in many cases not suitable for waiting for measurement results, especially when using triggered measurements.

The following function calls are required:

```
Status = viWaitOnEvent(analyzer, VI_EVENT_SERVICE_REQ, SRQWaitTimeout, VI_NULL,
    VI_NULL)
'Wait for service request user
'inputs are not possible during
'the waiting time!
IF (status = VI_SUCCESS) THEN CALL Srq
'If SRQ is recognized =>
'subroutine for evaluation

'----- Sweep in first Spectrum Tab and query marker -----
Dim Status = mbSession.WaitOnEvent( _
MessageBasedSessionEventType.ServiceRequest, SRQWaitTimeout)
'Wait for service request user inputs are not possible
'during the waiting time!
If (Status.EventType() = MessageBasedSessionEventType.ServiceRequest) Then
'If SRQ is recognized => subroutine for evaluation
    Srq()
End If
```

Non-blocking (user inputs possible):

This method is recommended if the waiting time until the event to be signaled by an SRQ is long (longer than the selected timeout), and user inputs should be possible during the waiting time, or if the event is not certain to occur. This method is, therefore, the preferable choice for waiting for the end of measurements, i.e. the output of results, especially in the case of triggered measurements.

The method necessitates a waiting loop that checks the status of the SRQ line at regular intervals and returns control to the operating system during the time the expected event has not yet occurred. In this way, the system can respond to user inputs (mouse clicks, key entries) during the waiting time.

It is advisable to employ the `Hold()` auxiliary function, which returns control to the operating system for a selectable waiting time (see section [Waiting Without Blocking the Keyboard and Mouse](#)), so enabling user inputs during the waiting time.

```
result% = 0
For i = 1 To 10 'Abort after max. 10 loop
'iterations
```

```

Status = viWaitOnEvent(analyzer, VI_EVENT_SERVICE_REQ, VI_TMO_IMMEDIATE, VI_NULL,
    VI_NULL)
'Check event queue
If (status = VI_SUCCESS) Then
result% = 1
CALL Srq 'If SRQ is recognized =>
'subroutine for evaluation
Else
CALL Hold(20) 'Call hold function with
'20 ms 'waiting time. User inputs
'are possible.
Endif
Next i
If result% = 0 Then
Debug.Print "Timeout Error; Program aborted" 'Output error message
STOP 'Stop software
Endif

```

8.3.1.3 Waiting Without Blocking the Keyboard and Mouse

A frequent problem with remote control programs using Visual Basic is to insert waiting times without blocking the keyboard and the mouse.

If the program is to respond to user inputs also during a waiting time, control over the program events during this time must be returned to the operating system. In Visual Basic, this is done by calling the `DoEvents` function. This function causes keyboard-or mouse-triggered events to be executed by the associated elements. For example, it allows the operation of buttons and input fields while the user waits for an instrument setting to be completed.

The following programming example describes the `Hold()` function, which returns control to the operating system for the period of the waiting time selectable in milliseconds.

```

Rem *****
Rem The waiting function below expects the transfer of the desired
Rem waiting time in milliseconds. The keyboard and the mouse remain
Rem operative during the waiting period, thus allowing desired elements
Rem to be controlled
Rem *****
Public Sub Hold(delayTime As Single)
Start = Timer 'Save timer count on calling the
'function
Do While Timer < Start + delayTime/1000 'Check timer count
DoEvents 'Return control to operating
'system to enable control of
'desired elements as long as
'timer has not elapsed
Loop
End Sub
Rem *****

```

The waiting procedure is activated simply by calling Hold(<Waiting time in milliseconds>).

8.3.1.4 Service Request Routine

A service request is processed in the service request routine.



The variables userN% and userM% must be pre-assigned usefully!

```

REM ----- Service request routine -----
Public SUB Srq()
ON ERROR GOTO noDevice 'No user existing
CALL viReadSTB(analyzer, STB%) 'Serial poll, read status byte
IF STB% > 0 THEN 'This instrument has bits set in
'the STB
SRQFOUND% = 1
IF (STB% AND 16) > 0 THEN CALL Outputqueue
IF (STB% AND 4) > 0 THEN CALL ErrorQueueHandler
IF (STB% AND 8) > 0 THEN CALL Questionablestatus
IF (STB% AND 128) > 0 THEN CALL Operationstatus
IF (STB% AND 32) > 0 THEN CALL Esrread
END IF
noDevice:
END SUB 'End of SRQ routine
REM *****

REM ----- Subroutine for evaluation Service Request Routine -----

Public Sub Srq()
    Try
        Dim mySTB As Short = mbSession.ReadStatusByte()
        'Serial poll, read status byte
        Console.WriteLine("Reading Service Request Routine:" + mySTB.ToString())
        If mySTB > 0 Then 'This instrument has bits set in the STB
            If (mySTB And 16) > 0 Then Call Outputqueue()
            If (mySTB And 4) > 0 Then Call ErrorQueueHandler()
            If (mySTB And 8) > 0 Then Call Questionablestatus()
            If (mySTB And 128) > 0 Then Call Operationstatus()
            If (mySTB And 32) > 0 Then Call Esrread()
        End If
    Catch exp As Exception
        Console.WriteLine(exp.Message)
    End Try
End Sub 'End of SRQ routine

```

Reading out the status event registers, the output buffer and the error/event queue is effected in subroutines.

8.3.1.5 Reading Out the Output Buffer

```

REM ----- Subroutine for the individual STB bits -----
Public SUB Outputqueue() 'Reading the output buffer
result$ = SPACE$(100) 'Make space for response
CALL InstrRead(analyzer, result$)
Debug.Print "Contents of Output Queue:"; result$
END SUB
REM *****

REM ----- Subroutine for the output queue -----
Public Sub Outputqueue() 'Reading the output buffer
    Try
        Dim result As String = mbSession.ReadString()
        Console.WriteLine("Contents of Output Queue:" + result)
    Catch exp As Exception
        Console.WriteLine(exp.Message)
    End Try
End Sub

```

8.3.1.6 Reading Error Messages

```

REM ----- Subroutine for reading the error queue -----
Public SUB ErrorQueueHandler()
ERROR$ = SPACE$(100) 'Make space for error variable
CALL InstrWrite (analyzer, "SYSTEM:ERROR?")
CALL InstrRead(analyzer, ERROR$)
Debug.Print "Error Description:"; ERROR$
END SUB
REM *****

REM ----- Subroutine for reading the error queue -----
Sub ErrorQueueHandler()
    Dim result As String
    Dim hasErr As Boolean = True
    Do
        mbSession.Write("SYST:ERR?")
        result = mbSession.ReadString()
        Dim parts As String() = result.Split(",")
        If parts(0) = 0 Then
            hasErr = False
            Console.WriteLine(result)
        Else
            Console.WriteLine(result)
        End If
    Loop While hasErr
End Sub

```

8.3.1.7 Evaluation of SCPI Status Registers

```

REM ----- Subroutine for evaluating Questionable Status Register -----
Public SUB Questionablestatus()
Ques$ = SPACE$(20)
'Preallocate blanks to text
'variable
CALL InstrWrite (analyzer, "STATus:QUEStionable:EVENT?")
CALL InstrRead(analyzer, Ques$)
Debug.Print "Questionable Status: "; Ques$
END SUB
REM *****
REM ----- Subroutine for evaluating Operation Status Register -----
Public SUB Operationstatus()
Oper$ = SPACE$(20) 'Preallocate blanks to text
'variable
CALL InstrWrite (analyzer, "STATus:OPERation:EVENT?")
CALL InstrRead(analyzer, Oper$)
Debug.Print "Operation Status: "; Oper$
END SUB
REM *****

REM ----- Subroutine for evaluating Questionable Status Register -----
Public Sub Questionablestatus()
    Dim myQSR As String = Nothing
    Try
        myQSR = mbSession.Query("STATus:QUEStionable:EVENT?") 'Read QSR
        Console.WriteLine("Questionable Status:" + myQSR)
    Catch exp As Exception
        Console.WriteLine(exp.Message)
    End Try
End Sub

REM ----- Subroutine for evaluating Operation Status Register -----
Public Sub Operationstatus()
    Dim myOSR As String = Nothing
    Try
        myOSR = mbSession.Query("STATus:OPERation:EVENT?") 'Read OSR
        Console.WriteLine("Operation Status:" + myOSR)
    Catch exp As Exception
        Console.WriteLine(exp.Message)
    End Try
End Sub

```

8.3.1.8 Evaluation of Event Status Register

```

REM ----- Subroutine for evaluating the Event Status Register -----
Public SUB Esrread()
Esr$ = SPACE$(20) 'Preallocate blanks to text
'variable

```

```

CALL InstrWrite (analyzer, "*ESR?") 'Read ESR
CALL InstrRead(analyzer, Esr$)
IF (VAL(Esr$) AND 1) > 0 THEN Debug.Print "Operation complete"
IF (VAL(Esr$) AND 2) > 0 THEN Debug.Print "Request Control"
IF (VAL(Esr$) AND 4) > 0
THEN Debug.Print "Query Error"
IF (VAL(Esr$) AND 8) > 0
THEN Debug.Print "Device dependent error"
IF (VAL(Esr$) AND 16) > 0
THEN Debug.Print "Execution Error; Program aborted" 'Output error message
STOP 'Stop software
END IF
IF (VAL(Esr$) AND 32) > 0
THEN Debug.Print "Command Error; Program aborted" 'Output error message
STOP 'Stop software
END IF
IF (VAL(Esr$) AND 64) > 0 THEN Debug.Print "User request"
IF (VAL(Esr$) AND 128) > 0 THEN Debug.Print "Power on"END SUB
REM *****

REM ----- Subroutine for evaluating the Event Status Register -----
Public Sub Esrread()
    Try
        Dim myESR As Short = mbSession.Query("*ESR?") 'Read ESR
        If (myESR And 1) > 0 Then Console.WriteLine("Operation complete")
        If (myESR And 2) > 0 Then Console.WriteLine("Request Control")
        If (myESR And 4) > 0 Then Console.WriteLine("Query Error")
        If (myESR And 8) > 0 Then Console.WriteLine("Device dependent error")
        If (myESR And 16) > 0 Then
            Console.WriteLine("Execution Error; Program aborted") 'Output error message
            Stop 'Stop software
        End If
        If (myESR And 32) > 0 Then
            Console.WriteLine("Command Error; Program aborted") 'Output error message
            Stop 'Stop software
        End If
        If (myESR And 64) > 0 Then Console.WriteLine("User request")
        If (myESR And 128) > 0 Then Console.WriteLine("Power on")
    Catch exp As Exception
        Console.WriteLine(exp.Message)
    End Try
End Sub

```

8.3.2 Using Marker and Delta Marker

8.3.2.1 Shape Factor Measurement (using n dB down)

The n-dB-down function of the R&S FSVR is used twice to determine the shape factor of a filter (ratio of bandwidths at 60 dB and 3 dB below the filter maximum).

The following example is again based on a signal with a level of -30 dBm at 100 MHz. The shape factor is determined for the 30 kHz resolution bandwidth. The default setting of the R&S FSVR is used for measurements (SetupInstrument).

```

REM *****
Public Sub ShapeFactor()
result$ = Space$(100)
'----- R&S FSV default setting -----
CALL SetupInstrument 'Default setting
CALL InstrWrite (analyzer, "INIT:CONT OFF") 'Single sweep
'----- Set frequency -----
CALL InstrWrite (analyzer, "FREQ:SPAN 1 MHz")
'Span
CALL InstrWrite (analyzer, "BAND:RES 30 kHz")
'Resolution bandwidth
CALL InstrWrite (analyzer, "INIT;*WAI") 'Perform sweep with sync
'----- Measure 60 dB value -----
CALL InstrWrite (analyzer, "CALC:MARK:PEXC 6 DB")
'Peak excursion
CALL InstrWrite (analyzer, "CALC:MARK:STAT ON")
'Marker1 on
CALL InstrWrite (analyzer, "CALC:MARK:TRAC 1")
'Assign marker1 to trace1
CALL InstrWrite (analyzer, "CALC:MARK:MAX") 'Set marker1 to 100 MHz
CALL InstrWrite (analyzer, "CALC:MARK:FUNC:NDBD 45 dB")
'Read out bandwidth measured at
'45 dB
CALL InstrWrite (analyzer, "CALC:MARK:FUNC:NDBD:RES?")
CALL InstrRead(analyzer, result$)
result60 = Val(result$)
'----- Measure 3 dB down value-----
CALL InstrWrite (analyzer, "CALC:MARK:FUNC:NDBD 3 dB")
'Read out bandwidth measured at
'3 dB
CALL InstrWrite (analyzer, "CALC:MARK:FUNC:NDBD:RES?")
CALL InstrRead(analyzer, result$)
result3 = Val(result$)
'----- Read out shape factor-----
Print "Shapefaktor 60 dB/3 dB:";result60/result3
END SUB
REM *****

```

8.3.2.2 Measuring the Third Order Intercept Point

The third order intercept point (TOI) is the (virtual) level of two adjacent useful signals at which the intermodulation products of third order have the same level as the useful signals.

The intermodulation product at f_{s2} is obtained by mixing the first harmonic of the useful signal P_{N2} with signal P_{N1} , the intermodulation product at f_{s1} by mixing the first harmonic of the useful signal P_{N1} with signal P_{N2} .

$$f_{s1} = 2 \times f_{n1} - f_{n2} \quad (1)$$

$$f_{s2} = 2 \times f_{n2} - f_{n1} \quad (2)$$

The following example is based on two adjacent signals with a level of -30 dBm at 100 MHz and 110 MHz. The intermodulation products lie at 90 MHz and 120 MHz according to the above formula. The frequency is set so that the examined mixture products are displayed in the diagram. Otherwise, the default setting of the R&S FSVR is used for measurements (SetupInstrument).

```

REM *****
Public Sub TOI()
result$ = Space$(100)
'----- R&S FSV default setting -----
CALL SetupStatusReg 'Set status registers
CALL InstrWrite (analyzer, "*RST") 'Reset instrument
CALL InstrWrite (analyzer, "INIT:CONT OFF") 'Single sweep
CALL InstrWrite (analyzer, "SYST:DISP:UPD ON")
'ON: display on'OFF: off
'----- Set frequency -----
CALL InstrWrite (analyzer, "FREQ:START 85 MHz;STOP 125 MHz")
'Span
'----- Set level -----
CALL InstrWrite (analyzer, "DISP:WIND:TRAC:Y:RLEV -20 dBm")
'Reference level
CALL InstrWrite (analyzer, "INIT;*WAI") 'Perform sweep with sync
'----- TOI measurement -----
CALL InstrWrite (analyzer, "CALC:MARK:PEXC 6 DB")
'Peak excursion
CALL InstrWrite (analyzer, "CALC:MARK:FUNC:TOI ON")
'Switch on TOI measurement
CALL InstrWrite (analyzer, "CALC:MARK:FUNC:TOI:RES?")
'and read out results
CALL InstrRead(analyzer, result$)
'----- Read out result -----
Print "TOI [dBm]:";result$
END SUB
REM *****

```

8.3.2.3 Measuring the AM Modulation Depth

The example below is based on an AM-modulated signal at 100 MHz with the following characteristics:

| | |
|----------------------|---------|
| Carrier signal level | -30 dBm |
| AF frequency | 100 kHz |
| Modulation depth | 50 % |

The default setting of the analyzer for measurements can be used for the measurements described below (SetupInstrument).

```

REM *****
Public Sub AMMod()
result$ = Space$(100)
CALL SetupInstrument 'Default setting
CALL InstrWrite (analyzer, "BAND:RES 30 kHz") 'Set appropriate RBW
'----- Peak search -----
CALL InstrWrite (analyzer, "INIT:CONT OFF") 'Single sweep
CALL InstrWrite (analyzer, "INIT;*WAI") 'Perform sweep with sync
CALL InstrWrite (analyzer, "CALC:MARK:PEXC 6 DB")
'Peak excursion
CALL InstrWrite (analyzer, "CALC:MARK:STAT ON")
'Marker 1 on
CALL InstrWrite (analyzer, "CALC:MARK:TRAC 1")
'Assign marker1 to trace1
'----- Measure modulation depth -----
CALL InstrWrite (analyzer, "CALC:MARK:MAX;FUNC:MDEP ON")
'Marker to Peak;
CALL InstrWrite (analyzer, "CALC:MARK:FUNC:MDEP:RES?")
'Measure mod. depth
CALL InstrRead(analyzer, result$) 'Read out result
'----- Read out result -----
Print "AM Mod Depth [%]:";result$
END SUB
REM *****

```

8.3.3 Limit Lines and Limit Test

The example below shows the definition and use of a new limit line 5 for trace 1 with the following characteristics:

- Upper limit line
- Absolute x-axis in the frequency range
- 7 reference values:
 - 120 MHz/-70 dB,
 - 126 MHz/-40 dB,
 - 127 MHz/-40 dB,

- 128 MHz/-10 dB,
- 129 MHz/-40 dB,
- 130 MHz/-40 dB,
- 136 MHz/-70 dB
- Relative y-axis with unit dB
- Absolute threshold at –75 dBm
- No margin

The signal of the integrated calibration source (128 MHz, -30 dBm) is used to check the limit test.

```

REM *****
Public Sub LimitLine()
result$ = Space$(100)
'----- R&S FSV default setting -----
CALL SetupInstrument 'Default setting
CALL InstrWrite (analyzer, "FREQUENCY:CENTER 128 MHz;Span 10 MHz")
'Span
CALL InstrWrite (analyzer, "Diag:Serv:Inp Cal")
'Cal signal on
'----- Definition of limit lines -----
CALL InstrWrite (analyzer, "CALC:LIM5:NAME 'TEST1'")
'Define name
CALL InstrWrite (analyzer, "CALC:LIM5:COMM 'Upper limit'")
'Define comment
CALL InstrWrite (analyzer, "CALC:LIM5:TRAC 1")
'Assign trace
CALL InstrWrite (analyzer, "CALC:LIM5:CONT:DOM FREQ")
'Define x-axis range
CALL InstrWrite (analyzer, "CALC:LIM5:CONT:MODE ABS")
'Define x-axis scaling
CALL InstrWrite (analyzer, "CALC:LIM5:UNIT DB")
'Define y-axis unit
CALL InstrWrite (analyzer, "CALC:LIM5:UPP:MODE REL")
'Define y-axis scaling
'----- Definition of data points and threshold -----
xlimit$ = "CALC:LIM5:CONT 120 MHz,126 MHz,127 MHz,128 MHz,129 MHz,130 MHz,136 MHz"
CALL InstrWrite (analyzer, xlimit$) 'Set values for x-axis
CALL InstrWrite (analyzer, "CALC:LIM5:UPP -70,-40,-40,-20,-40,-40,-70")
'Set values for y-axis
CALL InstrWrite (analyzer, "CALC:LIM5:UPP:THR -75 DBM")
'Set y threshold (only
'possible for relative
'y-axis)
'----- Definition of margin or x/y offset-----
'A margin or an x/y offset can be defined here.
'----- Activate and evaluate the limit line -----
CALL InstrWrite (analyzer, "CALC:LIM5:UPP:STAT ON")
'Activate line 5

```

```

CALL InstrWrite (analyzer, "CALC:LIM5:STAT ON")
'Activate limit check
CALL InstrWrite (analyzer, "INIT;*WAI") 'Perform sweep with sync
CALL InstrWrite (analyzer, "CALC:LIM5:FAIL?")
'Query result of limit check
CALL InstrRead(analyzer, result$) 'Result: 1 (= FAIL)
'----- Read out result -----
Print "Limit Result Line 5: ";result$
'----- Evaluate limit line by means of status register -----
CALL InstrWrite (analyzer, "*CLS") 'Reset status register
'----- Measure -----
CALL InstrWrite (analyzer, "INIT;*OPC") 'Perform sweep with sync
CALL viEnableEvent(analyzer, VI_EVENT_SERVICE_REQ, VI_QUEUE, 0)
Status = viWaitOnEvent(analyzer, VI_EVENT_SERVICE_REQ, SRQWaitTimeout, VI_NULL, VI_NULL)
IF (status = VI_SUCCESS) THEN CALL Srq 'If SRQ is recognized =>
'subroutine for evaluation
'----- Read out result -----
IF (status% = 1) THEN
CALL InstrWrite (analyzer, "STAT:QUES:LIM1:COND?")
'Read out STAT:QUES:LIMit
'register
CALL InstrRead(analyzer, result$)
IF ((Val(result$) And 16) <> 0) THEN
Print "Limit5 failed"ELSE
Print "Limit5 passed"END IF
END IF
END SUB
REM *****

```

8.3.4 Measuring the Channel and Adjacent Channel Power

In the following example, the channel and adjacent channel power is first measured on a signal with a level of 0 dBm at 800 MHz to IS95. Then the channel and adjacent channel power is measured on a GSM signal at 935.2 MHz with fast ACP measurement (FAST ACP).

In addition, the limit test is activated.

```

REM *****
Public Sub ACP()
result$ = Space$(100)
'----- R&S FSV default setting -----
CALL SetupStatusReg 'Set status register
CALL InstrWrite (analyzer, "*RST") 'Reset instrument
CALL InstrWrite (analyzer, "INIT:CONT OFF") 'Single sweep
CALL InstrWrite (analyzer, "SYST:DISP:UPD ON")
'ON: display on
'OFF: off
'----- Set frequency -----
CALL InstrWrite (analyzer, "FREQ:CENT 800 MHz")

```

```

'Set frequency
'----- Set level -----
CALL InstrWrite (analyzer, "DISP:WIND:TRAC:Y:RLEV 10 dBm")
'Reference level
'----- Example 1: Configure CP/ACP for CDMA-----
CALL InstrWrite (analyzer, "CALC:MARK:FUNC:POW:SEL ACP")
'ACP measurement on
CALL InstrWrite (analyzer, "CALC:MARK:FUNC:POW:PRES F8CDMA")
'Select CDMA800 FWD
CALL InstrWrite (analyzer, "SENS:POW:ACH:ACP 2")
'Select 2 adjacent channels
CALL InstrWrite (analyzer, "SENS:POW:ACH:PRES ACP")
'Optimize settings
CALL InstrWrite (analyzer, "SENS:POW:ACH:PRES:RLEV")
'Optimize reference level
CALL InstrWrite (analyzer, "SENS:POW:ACH:MODE ABS")
'Absolute measurement
CALL InstrWrite (analyzer, "SENS:POW:HSP ON")
'Fast ACP measurement
'----- Perform measurement and query results -----
CALL InstrWrite (analyzer, "INIT;*WAI") 'Perform sweep with sync
CALL InstrWrite (analyzer, "CALC:MARK:FUNC:POW:RES? ACP")
'Query result CALL InstrRead(analyzer, result$)
'----- Read out result -----
Print "Result (CP, ACP low, ACP up, Alt low, Alt up):"Print result$
'----- Example 2: Configure CP/ACP manually for GSM-----
result$ = Space$(100)
CALL InstrWrite (analyzer, "FREQ:CENT 935.2 MHz")
'Set frequency
CALL InstrWrite (analyzer, "CALC:MARK:FUNC:POW:SEL ACP")
'ACP measurement on
CALL InstrWrite (analyzer, "SENS:POW:ACH:ACP 1")
'1 adjacent channel
CALL InstrWrite (analyzer, "SENS:POW:ACH:BAND 200 KHZ")
'Channel bandw. 200 kHz
CALL InstrWrite (analyzer, "SENS:POW:ACH:BAND:ACH 200 KHZ")
'Adjacent channel band-
'width 200 kHz
CALL InstrWrite (analyzer, "SENS:POW:ACH:SPAC 200 KHZ")
'Channel spacing 200 kHz
CALL InstrWrite (analyzer, "SENS:POW:ACH:PRES ACP")
'Optimize settings
CALL InstrWrite (analyzer, "SENS:POW:ACH:PRES:RLEV")
'Optimize reference level
CALL InstrWrite (analyzer, "SENS:POW:ACH:MODE ABS")
'Absolute measurement
'----- Start measurement and query result -----
CALL InstrWrite (analyzer, "INIT;*WAI") 'Perform sweep with sync
CALL InstrWrite (analyzer, "CALC:MARK:FUNC:POW:RES? ACP")
'Query result

```

```

CALL InstrRead(analyzer, result$)
'----- Read out result -----
Print "Result (CP, ACP low, ACP up):"Print result$
'----- Active limit check -----
result$ = Space$(100)
CALL InstrWrite (analyzer, "CALC:LIM:ACP:ACH 30 DB, 30 DB")
'Set relative limit
CALL InstrWrite (analyzer, "CALC:LIM:ACP:ACH:ABS -35 DBM,-35 DBM")
'Set absolute limit
CALL InstrWrite (analyzer, "CALC:LIM:ACP:ACH:STAT ON")
'Rel. limit check on
CALL InstrWrite (analyzer, "CALC:LIM:ACP:ACH:ABS:STAT ON")
'Abs. limit check on
CALL InstrWrite (analyzer, "CALC:LIM:ACP ON")
'Limit check on
'----- Start measurement and query result -----
CALL InstrWrite (analyzer, "INIT;*WAI") 'Perform sweep with sync
CALL InstrWrite (analyzer, "CALC:LIM:ACP:ACH:RES?")
'Query result of limit check
CALL InstrRead(analyzer, result$)
'----- Read out result -----
Print "Result Limit Check:";result$
END SUB
REM *****

```

Example of channel/adjacent-channel power measurement

```
POW:ACH:ACP 3
```

Sets the number of adjacent/alternate channels to 3.

```
POW:ACH:BAND 30 KHZ
```

Sets the bandwidth of the transmission channel to 30 kHz.

```
POW:ACH:BAND:ACH 40 KHZ
```

Sets the bandwidth of each adjacent channel to 40 kHz.

```
POW:ACH:BAND:ALT1 50 KHZ
```

Sets the bandwidth of each alternate channel to 50 kHz.

```
POW:ACH:BAND:ALT2 60 KHZ
```

Sets the bandwidth of alternate channel 2 to 60 kHz.

```
POW:ACH:SPAC 30 KHZ
```

Sets the spacing between the transmission channel and the adjacent channel to 30 kHz, the spacing between the transmission channel and alternate channel 1 to 60 kHz, and the spacing between the transmission channel and alternate channel 2 to 90 kHz.

```
POW:ACH:SPAC:ALT1 100 KHZ
```

Sets the spacing between the alternate adjacent channels and the TX channel. For details refer to [\[SENSe:\]POWer:ACHannel:SPACing:ALternate<channel>](#) on page 853.

```
POW:ACH:SPAC:ALT2 140 KHZ
```

Sets the spacing between the transmission channel and alternate channel 2 to 140 kHz.

```
POW:ACH:MODE ABS
```

Switches on absolute power measurement.

```
CALC:MARK:FUNC:POW:SEL ACP
```

Switches on the adjacent-channel power measurement.

```
INIT:CONT OFF
```

Switches over to single sweep mode.

```
INIT;*WAI
```

Starts a sweep and waits for the end of the sweep.

```
CALC:MARK:FUNC:POW:RES? ACP
```

Queries the result of adjacent-channel power measurement.

```
POW:ACH:REF:AUTO ONCE
```

Defines the measured channel power as the reference value for relative power measurements.

If the channel power only is to be measured, all commands relating to adjacent/alternate channel bandwidth and channel spacings are omitted. The number of adjacent/alternate channels is set to 0 with [\[SENSe:\]POWer:ACHannel:ACPairs](#) on page 845.

8.3.5 Occupied Bandwidth Measurement

In the following example, the bandwidth is to be found in which 95 % of the power of a GSM signal is contained. Signal frequency is 935.2 MHz; channel bandwidth is 200 kHz.

```
REM *****
Public Sub OBW()
result$ = Space$(100)
'----- R&S FSV default setting -----
CALL SetupStatusReg 'Set status register
CALL InstrWrite (analyzer, "*RST") 'Reset instrument
CALL InstrWrite (analyzer, "INIT:CONT OFF") 'Single sweep
CALL InstrWrite (analyzer, "SYST:DISP:UPD ON")
'ON: display on
'OFF: off
'----- Configure R&S FSV for OBW for GSM-----
CALL InstrWrite (analyzer, "FREQ:CENT 935.2 MHz")
```

```

'Set frequency
CALL InstrWrite (analyzer, "CALC:MARK:FUNC:POW:SEL OBW")
'OBW measurement on
CALL InstrWrite (analyzer, "SENS:POW:ACH:BAND 200 KHZ")
'Channel bandw. 200 kHz
CALL InstrWrite (analyzer, "SENS:POW:BWID 95PCT")
'Percentage of power
CALL InstrWrite (analyzer, "SENS:POW:ACH:PRES OBW")
'Set frequency and optimize reference level
CALL InstrWrite (analyzer, "SENS:POW:ACH:PRES:RLEV")
CALL InstrWrite (analyzer, "SENS:POW:NCOR OFF")
'Noise correction
'OFF: switch off
'ON: switch on
'----- Perform measurement and query results -----
CALL InstrWrite (analyzer, "INIT;*WAI") 'Perform sweep with sync
CALL InstrWrite (analyzer, "CALC:MARK:FUNC:POW:RES? OBW")
'Query result
CALL InstrRead(analyzer, result$)
Print result$
END SUB
REM *****

```

8.3.6 Time Domain Power Measurement

In the following example, the mean carrier power of a signal with 300 kHz bandwidth at 100 MHz is to be determined. In addition, the peak power, the rms value and the standard deviation are measured. To do this, the time-domain-power measurement functions are used.

```

REM *****
Public Sub TimeDomainPower()
result$ = Space$(100)
'----- R&S FSV default setting -----
CALL SetupStatusReg 'Set status register
CALL InstrWrite (analyzer, "*RST") 'Reset instrument
CALL InstrWrite (analyzer, "INIT:CONT OFF") 'Single sweep
CALL InstrWrite (analyzer, "SYST:DISP:UPD ON")
'ON: display on
'OFF: off
'----- Configure R&S FSV for time domain power measurement -----
CALL InstrWrite (analyzer, "FREQ:CENT 100 MHz;SPAN 0Hz")
'Set frequency
CALL InstrWrite (analyzer, "BAND:RES 300 kHz")
'Resolution bandwidth
CALL InstrWrite (analyzer, "SWE:TIME 200US") 'Sweep time
CALL InstrWrite (analyzer, "CALC:MARK:FUNC:SUMM:PPE ON")
'Peak measurement on
CALL InstrWrite (analyzer, "CALC:MARK:FUNC:SUMM:MEAN ON")

```



```

'Mean measurement on
CALL InstrWrite (analyzer, "CALC:MARK:FUNC:SUMM:RMS ON")
'RMS measurement on
CALL InstrWrite (analyzer, "CALC:MARK:FUNC:SUMM:SDEV ON")
'Standard deviation on
'----- Perform measurement and query results -----
CALL InstrWrite (analyzer, "INIT;*WAI") 'Perform sweep with sync
'Query results:
query$ = "CALC:MARK:FUNC:SUMM:PPE:RES?;" 'Peak measurement
query$ = query$ + ":CALC:MARK:FUNC:SUMM:MEAN:RES?;" 'Mean measurement
query$ = query$ + ":CALC:MARK:FUNC:SUMM:RMS:RES?;" 'RMS measurement
query$ = query$ + ":CALC:MARK:FUNC:SUMM:SDEV:RES?" 'Standard deviation
CALL InstrWrite (analyzer, query$)
CALL InstrRead(analyzer, result$)
Print result$
END SUB
REM *****

```

8.3.7 Fast Power Measurement on Power Ramps

A frequent task in mobile radio tests is measurement of a DUT at various power control levels at the highest possible speed. The R&S FSVR offers two test functions for this task, which can be used depending on the signal characteristics.

In the following, the two methods are presented by means of two examples.

8.3.7.1 Power Measurement with Multi-Summary Marker

The multi-summary marker function is suitable for measuring the power of a sequence of pulses with the following characteristics:

- The pulses occur at identical time intervals, which is typical of GSM transmission in slots, for example.
- The level of the first signal is reliably above threshold.
- The subsequent pulses may have any levels.
- The function uses the first pulse as a trigger signal. The power of the subsequent pulses is determined exclusively via the timing pattern selected for the pulse sequence. The function is, therefore, suitable for adjustments where the DUT output power varies considerably and is not reliably above the trigger threshold.
- The measurement accuracy is determined by the ratio of pulse duration to total measurement time; this should not be below 1:50.
- The function always uses TRACE 1.

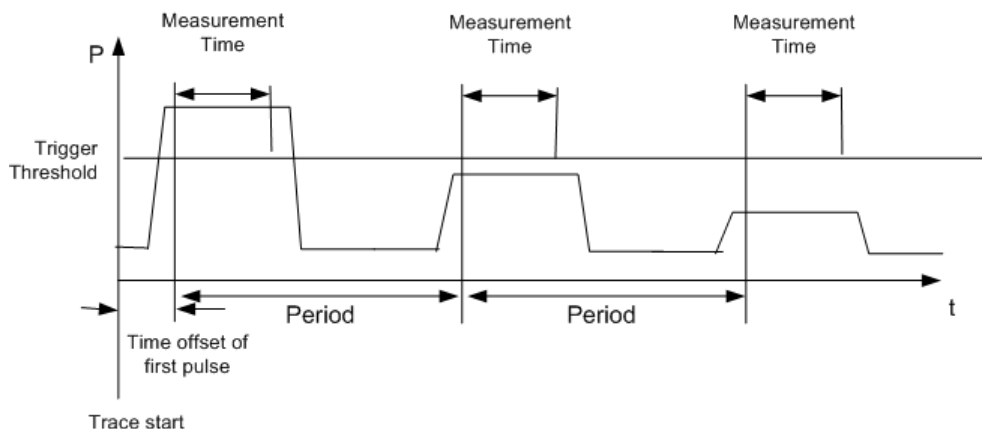

Fig. 8-6: Block diagram illustrating signal processing in analyzer

In the example below, a GSM pulse sequence of 8 pulses is measured with an offset of 50 μs of the first pulse, 450 μs measurement time/pulse and 576.9 μs pulse period.

```

REM *****
Public Sub MultiSumMarker()
result$ = Space$(200)
'----- R&S FSV default setting-----
CALL SetupStatusReg 'Configure status register
CALL InstrWrite (analyzer, "*RST") 'Reset instrument
CALL InstrWrite (analyzer, "INIT:CONT OFF") 'Single sweep mode
CALL InstrWrite (analyzer, "SYST:DISP:UPD ON")
'ON: switch display on
'OFF: switch display off
'----- Configure R&S FSV for power measurement in time domain -----
CALL InstrWrite (analyzer, "FREQ:CENT 935.2 MHz;SPAN 0Hz")
'Frequency setting
CALL InstrWrite (analyzer, "DISP:WIND:TRAC:Y:RLEV 10 dBm")
'Set reference level to 10 dB
CALL InstrWrite (analyzer, "INP:ATT 30 dB") 'Set input attenuation to 30 dB
CALL InstrWrite (analyzer, "BAND:RES 1 MHz;VID 3 MHz")
'Bandwidth setting
CALL InstrWrite (analyzer, "DET RMS") 'Select RMS detector
CALL InstrWrite (analyzer, "TRIG:SOUR VID") 'Trigger source: video
CALL InstrWrite (analyzer, "TRIG:LEV:VID 50 PCT")
'Trigger threshold: 50 %
CALL InstrWrite (analyzer, "SWE:TIME 50ms") 'Sweep time  $\geq$  1 frame
'----- Perform measurement and query results -----
CALL InstrWrite (analyzer, "INIT;*WAI") 'Perform sweep with sync
'Query results:
cmd$ = "CALC:MARK:FUNC:MSUM?"cmd$ = cmd$ + "50US," 'Offset of first pulse
cmd$ = cmd$ + "450US," 'Measurement time
cmd$ = cmd$ + "576.9US," 'Pulse period
cmd$ = cmd$ + "8" 'Number of bursts
CALL InstrWrite (analyzer, cmd$)
CALL InstrRead(analyzer, result$) 'Read results

```

```
Print result$
END SUB
REM *****
```

8.3.7.2 Multi-Burst Power Measurement

The multi-burst power measurement function is suitable for measuring the power of a sequence of pulses with the following characteristics:

- The pulses occur at variable time intervals.
- The levels of all pulses of the sequence are reliably above the trigger threshold, or an external trigger signal is used.
- The function requires one trigger event per pulse. This means that if the video trigger or the IF power trigger is used, the levels of all pulses must be above the trigger threshold.
- The function is, therefore, particularly suitable for re-measuring DUTs already adjusted and whose output power is within the specified range. The measurement is optimized for minimum overhead relative to the actual measurement time.

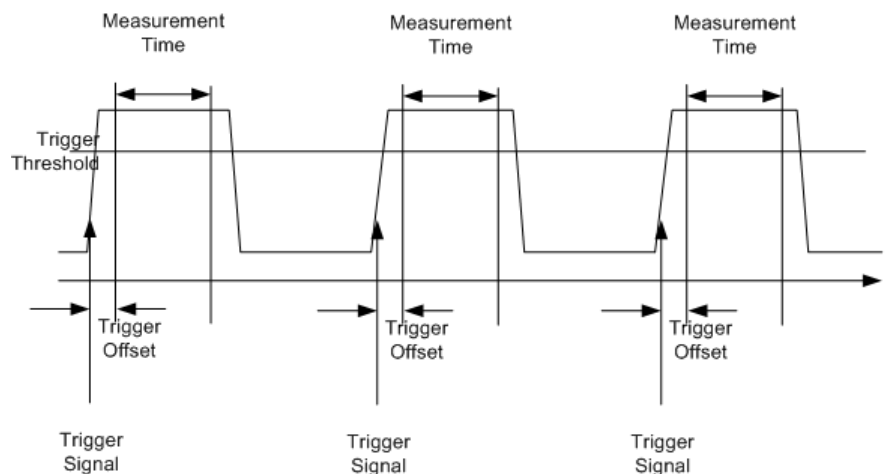

Fig. 8-7: Block diagram illustrating signal processing in analyzer

Either the root-mean-square power or the peak power is measured, depending on whether the RMS detector or the PEAK detector is selected. The function always uses TRACE 1.

The following parameters are to be set for this measurement:

- Analyzer frequency
- Resolution bandwidth
- Measurement time per single pulse
- Trigger source
- Trigger threshold
- Trigger offset
- Type of power measurement (PEAK, MEAN)

- Number of pulses to be measured

During the measurement, each pulse is mapped into a pixel of the screen, i.e. any change of the trace can be detected only at the left-hand edge of the screen. Maximum measurement speed is as usual achieved with the display switched off.

In the example below, a GSM pulse sequence of 8 pulses is measured with 5 μ s trigger offset, 434 μ s measurement time/pulse, video trigger with 50 % trigger threshold, and peak detection:

```
REM *****
Public Sub MultiBurstPower()
result$ = Space$(200)
'----- R&S FSV default setting -----
CALL SetupStatusReg 'Configure status register
CALL InstrWrite (analyzer, "*RST") 'Reset instrument
CALL InstrWrite (analyzer, "INIT:CONT OFF") 'Single sweep mode
CALL InstrWrite (analyzer, "SYST:DISP:UPD OFF")
'OFF: display off
'----- Perform measurement and query results -----
cmd$ = "MPOW? "cmd$ = cmd$ + "935.2 MHZ," 'Center frequency
cmd$ = cmd$ + "1 MHZ," 'Resolution bandwidth
cmd$ = cmd$ + "434US," 'Measurement time
cmd$ = cmd$ + "VID," 'Trigger source
cmd$ = cmd$ + "50PCT," 'Trigger threshold
cmd$ = cmd$ + "1US," 'Trigger offset
cmd$ = cmd$ + "PEAK," 'Peak detector
cmd$ = cmd$ + "8" 'Number of bursts
CALL InstrWrite (analyzer, cmd$)
CALL InstrRead(analyzer, result$) 'Read results
Print result$
END SUB
REM *****
```

8.3.8 Fast Level Measurement Using Frequency Lists

A typical task for the R&S FSVR is power measurement at a number of frequency points, e.g. at multiples of the fundamental (harmonics measurement), or at frequencies defined by a mobile radio standard (e.g. spectrum due to transients at ± 200 kHz, ± 400 kHz, etc about the carrier frequency of a GSM signal). In many cases, different level and/or bandwidth settings are required for the different frequency points to match the channel spacing and meet the requirements of dynamic range.

Especially for this application, the R&S FSVR offers a number of remote-control functions (commands available in SENSE:LIST subsystem) that allow level measurement based on a frequency list with different instrument settings assigned to different frequencies. Not only the frequency list can be programmed, but also the measurement types (PEAK, RMS, AVG) to be performed simultaneously can be selected.

The example below describes a harmonics measurement on a dual-band amplifier. The harmonics level in general decreases as the frequency increases. To boost mea-

surement sensitivity, therefore, the reference level is lowered by 10 dB from the third harmonic.

The following settings are used:

| | |
|-------------------------|---|
| Reference level: | 10.00 dBm up to first harmonic, 0 dBm from 2nd harmonic |
| RF attenuation: | 20 dB |
| Electronic attenuation: | 0 dB (OFF) |
| Filter type: | NORMal |
| RBW: | 1 MHz |
| VBW: | 3 MHz |
| Measurement time: | 300 µs |
| Trigger delay: | 100 µs |
| Trigger: | video, 45 % |

| Frequency | Type |
|------------|-----------------------------------|
| 935.2 MHz | GSM 900 fundamental |
| 1805.2 MHz | GSM 1800 fundamental |
| 1870.4 MHz | GSM 900 2 nd harmonic |
| 2805.6 MHz | GSM 900 3 rd harmonic |
| 3610.4 MHz | GSM 1800 2 nd harmonic |
| 3740.8 MHz | GSM 900 4 th harmonic |
| 5815.6 MHz | GSM 1800 3 rd Harmonic |

The frequencies are selected in ascending order to minimize system-inherent waiting times resulting from frequency changes.

At each frequency point the peak power and the rms power are measured. The peak power and the rms power values are stored alternately in the results memory.

```

REM *****
Public Sub FrequencyList()
result$ = Space$(500)
'----- R&S FSV default setting -----
CALL SetupStatusReg 'Configure status register
CALL InstrWrite (analyzer, "*RST") 'Reset instrument
CALL InstrWrite (analyzer, "INIT:CONT OFF") 'Single sweep mode
CALL InstrWrite (analyzer, "SYST:DISP:UPD OFF") 'Display off
'-----Configure R&S FSV for power measurement based on frequency list -
CALL InstrWrite (analyzer, "TRIG:LEV:IFP -20 dBm")
'Set IF power trigger level
CALL InstrWrite (analyzer, "LIST:POWER:SET ON,ON,OFF,IFP,POS,100us,0")
'----- Perform measurement and query results -----
    
```

```

cmd$ = "LIST:POWer?"cmd$ = cmd$ + "935.2 MHz, 10 dBm, 20 dB,OFF,NORM,1 MHz,3 MHz,
300 us, 0, "
cmd$ = cmd$ + "1805.2 MHz, 10 dBm, 20 dB,OFF,NORM,1 MHz,3 MHz,300 us, 0, "
cmd$ = cmd$ + "1870.4 MHz, 10 dBm, 20 dB,OFF,NORM,1 MHz,3 MHz,300 us, 0, "
cmd$ = cmd$ + "2805.6 MHz, 0 dBm, 20 dB,OFF,NORM,1 MHz,3 MHz,300 us, 0, "
cmd$ = cmd$ + "3610.4 MHz, 10 dBm,20 dB,OFF,NORM,1 MHz,3 MHz,300 us, 0, "
cmd$ = cmd$ + "3740.8 MHz, 0 dBm, 20 dB, OFF, NORM, 1 MHz,3 MHz,300 us, 0, "
cmd$ = cmd$ + "5815.6 MHz, 0 dBm, 20 dB, OFF, NORM, 1 MHz, 3 MHz, 300 us, 0"
CALL InstrWrite (analyzer, cmd$)
CALL InstrRead(analyzer, result$)
Print result$
END SUB
REM *****

```

8.3.9 Level Correction of Transducers

In more complex test systems, the frequency response of the test setup must be taken into account in all power measurements to avoid any measurement errors being introduced from sources other than the DUT.

The R&S FSVR offers the possibility of defining a frequency-dependent attenuation correction factor (transducer factor).

In the example below, a factor with the following characteristics is defined:

| | |
|-----------|----------------------------|
| Name: | Transtest |
| Unit: | dB |
| Scaling: | lin |
| Comment: | simulated cable correction |
| Frequency | Level |
| 10 MHz | 0 dB |
| 100 MHz | 3 dB |
| 1 GHz | 7 dB |
| 3 GHz | 10 dB |

The factor is defined and can be activated as required.

```

REM *****
Public Sub TransducerFactor()
'----- Define transducer factor -----
CALL InstrWrite (analyzer, "CORR:TRAN:SEL 'TRANSTEST'")
'Define "Transtest" transducer factor
CALL InstrWrite (analyzer, "CORR:TRAN:UNIT 'DB'")
'Unit 'dB'
CALL InstrWrite (analyzer, "CORR:TRAN:SCAL LIN")
'Linear frequency-axis
CALL InstrWrite (analyzer, "CORR:TRAN:COMM 'Simulated cable correction'")

```

```

cmd$ = "CORR:TRAN:DATA" 'Enter frequency and level
cmd$ = cmd$ + "10 MHz, 0," 'values. Level values without
cmd$ = cmd$ + "100 MHz, 3," 'unit!
cmd$ = cmd$ + "1GHz, 7,"cmd$ = cmd$ + "3GHz, 10"
CALL InstrWrite (analyzer,cmd$) 'Enter frequency and level values
'----- Activate transducer -----
CALL InstrWrite (analyzer, "CORR:TRAN:STAT ON")
'Activate transducer factor
END SUB
REM *****

```

8.3.10 Measuring the Magnitude and Phase of a Signal

Due to the R&S FSVR's internal architecture, it is capable of measuring and outputting the magnitude and phase of a signal in addition to its power values. This opens up a variety of possibilities for more in-depth analysis (FFT, demodulation, etc).

I/Q data is stored in memory areas each containing 512 k words. Hardware triggering controls the memory.

The following example shows the steps necessary to collect data at a predefined sampling rate and read it from the I/Q memory.

1. Data is output in the form of voltage values referred to the analyzer input. Data can be read in binary or ASCII format.
 - In binary format, the length information carried in the message header is evaluated and used for calculating the x-axis values.
 - In ASCII format, only a list of voltage values is output.
2. Binary data is read in three steps:
3. The number of digits carrying the length information is read.
4. The length information itself is read.
5. The trace data is read.

This procedure is necessary with programming languages like Visual Basic which support only structures of identical data types (arrays), whereas the binary data format uses different data types in the header and the data section.



The arrays for measured data are dimensioned in such a way that they can accommodate the I/Q data of the R&S FSVR (2 × 512 k).

```

REM *****
Public Sub ReadIQData()
'----- Create variables -----
Dim IData(131072) As Single 'Buffer for floating-point
'I data (= 512*1024 bytes)
Dim QData(131072) As Single 'Buffer for floating-point

```

```

'Q data (= 512*1024 bytes)
'Note:
'Visual Basic cannot read in
'data volumes larger than
'512 k words!
Dim digits As Byte 'No. of digits as length
Dim IQBytes As Long 'Length of trace data in bytes
Dim IQValues As Long 'No. of meas. values in buffer
Dim retCount As Integer 'Return count from read
asciiResult$ = Space$(6553600) 'Buffer for ASCII I/Q data
' (= 25*2*1024 bytes)
result$ = Space$(100) 'Buffer for simple results
'----- Default setting -----
CALL SetupInstrument 'Default setting
CALL InstrWrite (analyzer, "TRAC:IQ:STAT ON")
'Activate I/Q data
'acquisition mode; must be
'done before TRAC:IQ:SET !
'Select number of test points
' (= 512 * 1024 - 512) at
'RBW 10 MHz, 'sample rate 32 MHz,
'trigger free run, pos. trigger
'edge and 0 s trigger delay.
CALL InstrWrite (analyzer, "TRAC:IQ:SET NORM,10 MHz,32 MHz,IMM,POS,0,130560")
'----- Read-out in binary format-----
CALL InstrWrite (analyzer, "FORMAT REAL,32")
'Set binary format
CALL InstrWrite (analyzer, "TRAC:IQ:DATA?")
'Measure + read out I/Q data
CALL viRead(analyzer, result$, 2, retCount)
'Read and store length for
digits = Val(Mid$(result$, 2, 1)) 'number of digits
result$ = Space$(100) 'Re-initialize buffer
CALL viRead(analyzer, result$, digits, retCount)
'Read and store length
IQBytes = Val(Left$(result$, digits))
IQBytes = IQBytes/2 'Divide no. per buffer in half
CALL viRead(analyzer, IData(0), IQBytes, retCount)
'Read I data in buffer
CALL viRead(analyzer, QData(0), IQBytes, retCount)
'Read Q data in buffer
CALL viRead(analyzer, result$, 1, retCount)
'Read in end character <NL>
'----- Output of binary data as frequency/level pair -----
IQValues = IQBytes/4 'Single Precision = 4 Bytes
For i = 0 To IQValues - 1
Print "I-Value["; i; "] = "; IData(i)
Print "Q-Value["; i; "] = "; QData(i)
Next i
'----- Read-out in ASCII format -----

```



```

CALL InstrWrite (analyzer, "FORMAT ASCII") 'Set ASCII format
CALL InstrWrite (analyzer, "TRAC:IQ:DATA?")
'Re-measure and read out
'I/Q data
CALL InstrRead(analyzer, asciiResult$)
CALL InstrWrite (analyzer, "TRAC:IQ:STAT OFF")
'Stop I/Q data acquisition
'mode if no further
'measurements are to be
'done
END SUB
REM *****

```

8.3.11 Reading and Writing Files

8.3.11.1 Reading a File from the Instrument

In the following example, the TEST1.R&S FSVR.DFL file stored under C:\R_S\Instr\user is read from the instrument and stored in the controller.

```

REM *****
Public Sub ReadFile()
'----- Generate variables -----
Dim digits As Byte 'Number of digits of
'length information
Dim fileBytes As Long 'Length of file with trace data
'in bytes
result$ = Space$(100) 'Buffer for simple results
'----- Default setting of status register -----
CALL SetupStatusReg 'Configure status register
'----- Read out file -----
CALL InstrWrite (analyzer, "MMEM:DATA? 'C:\R_S\Instr\user\TEST1.R&S FSV.DFL'")
'Select file
CALL ilrd(analyzer, result$, 2) 'Read and store number of
digits = Val(Mid$(result$, 2, 1)) 'digits of length information
CALL ilrd(analyzer, result$, digits) 'Read and store length
fileBytes = Val(Left$(result$, digits)) 'information
FileBuffer$ = Space$(fileBytes) 'Buffer for file
CALL ilrd(analyzer, FileBuffer, fileBytes)
'Read file into buffer
CALL ilrd(analyzer, result$, 1) 'Read terminator <NL>
'----- Store file to controller -----
Open "TEST1.R&S FSV.DFL" For Output As #1
Print #1, FileBuffer; '; to avoid linefeed at
'end of file
Close #1

```

```

END SUB
REM *****

```

8.3.11.2 Creating a File on the Instrument

In the following example, the TEST1.R&S FSVR.DFL file available on the controller is stored in the instrument under C :

```

\R_S\Instr\user\DUPLICAT.R&S FSVR.DFL.

```

```

REM *****
Public Sub WriteFile()
'----- Generate variables -----
FileBuffer$ = Space$(100000) 'Buffer for file
Dim digits As Long 'Number of digits of
'length information
Dim fileBytes As Long 'Length of file in bytes
fileSize$ = Space$(100) 'Length of file as a string
result$ = Space$(100) 'Buffer for simple results
'----- Default setting of status register -----
CALL SetupStatusReg 'Configure status register
'----- Prepare the definite length block data -----
fileBytes = FileLen("H:\work\vb\TEST1.R&S FSV.DFL")
'Determine length of file
fileSize$ = Str$(fileBytes)
digits = Len(fileSize$) - 1 'Determine number of digits of
fileSize$ = Right$(fileSize$, digits) 'length information
FileBuffer$ = "#" + Right$(Str$(digits), 1) + fileSize$
'Store length information in
'file buffer
'----- Read file from controller -----
Open "H:\work\vb\TEST1.R&S FSV.DFL" For Binary As #1
FileBuffer$ = FileBuffer$ + Left$(Input(fileBytes, #1), fileBytes)
Close #1
'----- Write file -----
CALL InstrWrite (analyzer, "SYST:COMM:PIB:RTER EOI") 'Set receive
'terminator on the
'instrument
CALL InstrWrite (analyzer, "MMEM:DATA
'DUPLICAT.R&S FSV.DFL', " + FileBuffer$)
'Select file
END SUB
REM *****

```

8.3.12 Spectrum Emission Mask Measurement

You can configure Spectrum Emission Mask measurements via XML files provided for different standards or by defining ranges and parameters. For both ways an example is given.

8.3.12.1 Using Predefined Standard Wibro

In the following example, the Spectrum Emission Mask measurement is configured using a predefined standard XML file.

```

REM *****
'----- General settings of the instrument -----
CALL InstrWrite (analyzer, "*RST") 'Reset instrument
CALL InstrWrite (analyzer, "INIT:CONT OFF") 'Switch to single sweep
CALL InstrWrite (analyzer, "INIT:IMM;*WAI") 'Make sure no sweep is running
CALL InstrWrite (analyzer, ":SENSel:SWEep:MODE ESpectrum")
'Set measurement mode
Rem After preset 3 ranges are available where the middle one is
Rem the reference range for calculating the TX power
CALL InstrWrite (analyzer, ":SENSel:FREQuency:CENTer 2.2 GHz")
'Center frequency 2.2 GHz
CALL InstrWrite (analyzer, ":SENSel:DETEctor1 RMS")
'Set RMS detector
'----- Setting up the gated trigger -----
CALL InstrWrite (analyzer, ":SENSel:SWEep:EGATE ON")
'Switch on the external gate mode
CALL InstrWrite (analyzer, ":SENSel:SWEep:EGATE:SOURce EXTernal")
'Set enternal gate source
CALL InstrWrite (analyzer, ":SENSel:SWEep:EGATE:HOLDoff 0s")
'Set delay time to 0 s
CALL InstrWrite (analyzer, ":SENSel:SWEep:EGATE:LENGth 200 US")
'Set time interval
'----- Setting the standard -----
CALL InstrWrite (analyzer, "SENSel:ESpectrum:PRESet:STANDARD
'WIBRO\DL\PowerClass_29_40.xml")
'Set WiBro standard
'----- Measuring -----
CALL InstrWrite (analyzer, "INIT;*WAI") 'Perform sweep, wait for sweep
'end
'----- Reading out results -----
CALL InstrWrite (analyzer, ":TRACel:DATA? LIST")
'Query list results
CALL InstrWrite (analyzer, ":CALCulate:LIMit:FAIL?")
'Query result of limit check
CALL InstrRead(analyzer, result$)
REM *****

```

8.3.12.2 Defining 5 Ranges with all Parameters

In the following example, the Spectrum Emission Mask measurement is configured by defining ranges and parameters.

```

REM *****
'----- General settings of the instrument -----
CALL InstrWrite (analyzer, "*RST") 'Reset instrument

```

```

CALL InstrWrite (analyzer, "INIT:CONT OFF") 'Switch to single sweep
CALL InstrWrite (analyzer, "INIT:IMM;*WAI") 'Make sure no sweep is running
CALL InstrWrite (analyzer, ":SENSE1:SWEep:MODE ESpectrum")
'Set measurement mode
Rem After preset 3 ranges are available where the middle one is
Rem the reference range for calculating the TX power
CALL InstrWrite (analyzer, ":SENSE1:FREQuency:CENTer 2.2GHz")
'Center frequency 2.2 GHz
CALL InstrWrite (analyzer, ":SENSE1:DETEctor1 RMS")
'Set RMS detector
CALL InstrWrite (analyzer, ":TRIGger1:SEQUence:SOURce IMMEDIATE")
'Trigger setup
'----- Setting up the gated trigger -----
Rem If a free run trigger is not appropriate a gated trigger can
Rem the be set up (just comment in the following lines).
Rem CALL InstrWrite (analyzer, ":SENSE1:SWEep:EGATE ON")
Rem Switch on the external gate mode
Rem CALL InstrWrite (analyzer, ":SENSE1:SWEep:EGATE:SOURce EXTERNAL")
Rem Set external gate source
Rem CALL InstrWrite (analyzer, ":SENSE1:SWEep:EGATE:HOLDoff 0s")
Rem Set delay time to 0 s
Rem CALL InstrWrite (analyzer, ":SENSE1:SWEep:EGATE:LENGth 200 US")
Rem Set time interval
'----- Setting the span -----
CALL InstrWrite (analyzer, ":SENSE1:FREQuency:SPAN 8 MHz")
'Set the span to 8 MHz
'----- Inserting new ranges -----
Rem Enlarge number of ranges to 5 by adding one at the end
Rem and one at the beginnig. This ensures that the reference range
Rem remains in the middle
CALL InstrWrite (analyzer, ":SENSE1:ESpectrum:RANGe2:INSert AFter")
'Insert a range after range 2
CALL InstrWrite (analyzer, ":SENSE1:ESpectrum:RANGe1:INSert BEFore")
'Insert a range before range 1
'----- Defining the limit check for all ranges -----
CALL InstrWrite (analyzer, ":SENSE1:ESpectrum:RANGe:LIMit:STATe AND")
'Set check for absolute and 'relative limit
'----- Defining the reference range settings -----
Rem The bandwidth of the reference range limits the minimum span
Rem of the reference range definition later in the script.
CALL InstrWrite (analyzer, ":SENSE1:ESpectrum:RTYPE CPOWer")
'Set power reference type
CALL InstrWrite (analyzer, ":SENSE1:ESpectrum:BWID 2 MHz")
'Set bandwidth
'----- Defining the settings of range 1 -----
CALL InstrWrite (analyzer, ":SENSE1:ESpectrum:RANGe1:FREQuency:STARt -4 MHz")
'Set the start frequency
CALL InstrWrite (analyzer, ":SENSE1:ESpectrum:RANGe1:FREQuency:STOP -2 MHz")
'Set the stop frequency
CALL InstrWrite (analyzer, ":SENSE1:ESpectrum:RANGe1:BANDwidth:RESolution 1 MHz")

```

```

'Set the resolution bandwidth
CALL InstrWrite (analyzer, ":SENSe1:ESpectrum:RANGe1:FILTer:TYPE CFILTer")
'Set the channel filters
CALL InstrWrite (analyzer, ":SENSe1:ESpectrum:RANGe1:BANDwidth:VIDeo 3 MHz")
'Set the video bandwidth to 3 MHz
CALL InstrWrite (analyzer, ":SENSe1:ESpectrum:RANGe1:SWEep:TIME 20 ms")
'Set the sweep time to 20 ms
CALL InstrWrite (analyzer, ":SENSe1:ESpectrum:RANGe1:RLEVel 5 DBM")
'Set the reference level to 5 dBm
CALL InstrWrite (analyzer, ":SENSe1:ESpectrum:RANGe1:INPut:ATTenuation 20 DB")
'Set the attenuation to 20 dB
CALL InstrWrite (analyzer, ":SENSe1:ESpectrum:RANGe1:LIMit:ABSolute:STARt -50")
'Set an absolute limit of -50 dBm
CALL InstrWrite (analyzer, ":SENSe1:ESpectrum:RANGe1:LIMit:ABSolute:STOP -50")
'Set an absolute limit of -50 dBm
CALL InstrWrite (analyzer, ":SENSe1:ESpectrum:RANGe1:LIMit:RELative:STARt -70")
'Set a relative limit of -70 dBc
CALL InstrWrite (analyzer, ":SENSe1:ESpectrum:RANGe1:LIMit:RELative:STOP -60")
'Set a relative limit of -60 dBc
'----- Defining the settings of range 2 -----
CALL InstrWrite (analyzer, ":SENSe1:ESpectrum:RANGe2:FREQuency:STARt -2 MHz")
CALL InstrWrite (analyzer, ":SENSe1:ESpectrum:RANGe2:FREQuency:STOP -1 MHz")
CALL InstrWrite (analyzer, ":SENSe1:ESpectrum:RANGe2:BANDwidth:RESolution
100 kHz")
CALL InstrWrite (analyzer, ":SENSe1:ESpectrum:RANGe2:FILTer:TYPE NORM")
CALL InstrWrite (analyzer, ":SENSe1:ESpectrum:RANGe2:BANDwidth:VIDeo 300 kHz")
CALL InstrWrite (analyzer, ":SENSe1:ESpectrum:RANGe2:SWEep:TIME 50 ms")
CALL InstrWrite (analyzer, ":SENSe1:ESpectrum:RANGe2:RLEVel 10 DBM")
CALL InstrWrite (analyzer, ":SENSe1:ESpectrum:RANGe2:INPut:ATTenuation 30 DB")
CALL InstrWrite (analyzer, ":SENSe1:ESpectrum:RANGe2:LIMit:ABSolute:STARt
-40")
CALL InstrWrite (analyzer, ":SENSe1:ESpectrum:RANGe2:LIMit:RELative:STARt
-60")
CALL InstrWrite (analyzer, ":SENSe1:ESpectrum:RANGe2:LIMit:ABSolute:STOP -40")
CALL InstrWrite (analyzer, ":SENSe1:ESpectrum:RANGe2:LIMit:RELative:STOP -40")
'----- Defining the settings of range 3 -----
CALL InstrWrite (analyzer, ":SENSe1:ESpectrum:RANGe3:FREQuency:STARt -1 MHz")
CALL InstrWrite (analyzer, ":SENSe1:ESpectrum:RANGe3:FREQuency:STOP 1 MHz")
CALL InstrWrite (analyzer, ":SENSe1:ESpectrum:RANGe3:BANDwidth:RESolution
30 kHz")
CALL InstrWrite (analyzer, ":SENSe1:ESpectrum:RANGe3:FILTer:TYPE NORM")
CALL InstrWrite (analyzer, ":SENSe1:ESpectrum:RANGe3:BANDwidth:VIDeo 100 kHz")
CALL InstrWrite (analyzer, ":SENSe1:ESpectrum:RANGe3:SWEep:TIME 5 ms")
CALL InstrWrite (analyzer, ":SENSe1:ESpectrum:RANGe3:RLEVel 20 DBM")
CALL InstrWrite (analyzer, ":SENSe1:ESpectrum:RANGe3:INPut:ATTenuation 30 DB")
CALL InstrWrite (analyzer, ":SENSe1:ESpectrum:RANGe3:LIMit:ABSolute:STARt 200")
CALL InstrWrite (analyzer, ":SENSe1:ESpectrum:RANGe3:LIMit:ABSolute:STOP 200")
CALL InstrWrite (analyzer, ":SENSe1:ESpectrum:RANGe3:LIMit:RELative:STARt 200")
CALL InstrWrite (analyzer, ":SENSe1:ESpectrum:RANGe3:LIMit:RELative:STOP 200")
'----- Defining the settings of range 4 -----

```

```

CALL InstrWrite (analyzer, ":SENSE1:ESpectrum:RANGE4:FREQuency:STARt 1 MHz")
CALL InstrWrite (analyzer, ":SENSE1:ESpectrum:RANGE4:FREQuency:STOP 2 MHz")
CALL InstrWrite (analyzer, ":SENSE1:ESpectrum:RANGE4:BANDwidth:RESolution
100 kHz")
CALL InstrWrite (analyzer, ":SENSE1:ESpectrum:RANGE4:FILTer:TYPE NORM")
CALL InstrWrite (analyzer, ":SENSE1:ESpectrum:RANGE4:BANDwidth:VIDeo 300 kHz")
CALL InstrWrite (analyzer, ":SENSE1:ESpectrum:RANGE4:SWEep:TIME 50 ms")
CALL InstrWrite (analyzer, ":SENSE1:ESpectrum:RANGE4:RLEVel 10 DBM")
CALL InstrWrite (analyzer, ":SENSE1:ESpectrum:RANGE4:INPut:ATTenuation 30 DB")
CALL InstrWrite (analyzer, ":SENSE1:ESpectrum:RANGE4:LIMit:ABSolute:STARt
-40")
CALL InstrWrite (analyzer, ":SENSE1:ESpectrum:RANGE4:LIMit:ABSolute:STOP -40")
CALL InstrWrite (analyzer, ":SENSE1:ESpectrum:RANGE4:LIMit:RELative:STARt
-40")
CALL InstrWrite (analyzer, ":SENSE1:ESpectrum:RANGE4:LIMit:RELative:STOP -60")
'----- Defining the settings of range 5 -----
CALL InstrWrite (analyzer, ":SENSE1:ESpectrum:RANGE5:FREQuency:STARt 2 MHz")
CALL InstrWrite (analyzer, ":SENSE1:ESpectrum:RANGE5:FREQuency:STOP 4 MHz")
CALL InstrWrite (analyzer, ":SENSE1:ESpectrum:RANGE5:BANDwidth:RESolution 1 MHz")
CALL InstrWrite (analyzer, ":SENSE1:ESpectrum:RANGE5:FILTer:TYPE CFILter")
CALL InstrWrite (analyzer, ":SENSE1:ESpectrum:RANGE5:BANDwidth:VIDeo 3 MHz")
CALL InstrWrite (analyzer, ":SENSE1:ESpectrum:RANGE5:SWEep:TIME 20 ms")
CALL InstrWrite (analyzer, ":SENSE1:ESpectrum:RANGE5:RLEVel 5 DBM")
CALL InstrWrite (analyzer, ":SENSE1:ESpectrum:RANGE5:INPut:ATTenuation 20 DB")
CALL InstrWrite (analyzer, ":SENSE1:ESpectrum:RANGE5:LIMit:ABSolute:STARt
-50")
CALL InstrWrite (analyzer, ":SENSE1:ESpectrum:RANGE5:LIMit:ABSolute:STOP -50")
CALL InstrWrite (analyzer, ":SENSE1:ESpectrum:RANGE5:LIMit:RELative:STARt -60")
CALL InstrWrite (analyzer, ":SENSE1:ESpectrum:RANGE5:LIMit:RELative:STOP -70")
'----- Measuring -----
CALL InstrWrite (analyzer, "INIT;*WAI") 'Perform sweep, wait for sweep
'end
'----- Reading out results -----
CALL InstrWrite (analyzer, ":TRACe1:DATA? LIST")
'Query list results
CALL InstrWrite (analyzer, ":CALCulate:LIMit:FAIL?")
'Query result of limit check
CALL InstrRead(analyzer, result$)
REM *****

```

8.3.13 Spurious Emissions Measurement

In the following example, the Spurious Emissions measurement is configured by defining ranges and parameters.

```

REM *****
'----- General settings of the instrument -----
CALL InstrWrite (analyzer, "*RST") 'Reset instrument
Rem After preset 4 ranges are available. Range settings can be questioned

```

```

Rem independent from the set measurement mode.
'----- Deleting all ranges -----
Rem Delete all ranges to prepare for setting up a new measurement
CALL InstrWrite (analyzer, "SENSe1:LIST:RANGe4:DELeTe")
'Delete range 4
CALL InstrWrite (analyzer, "SENSe1:LIST:RANGe3:DELeTe")
CALL InstrWrite (analyzer, "SENSe1:LIST:RANGe2:DELeTe")
CALL InstrWrite (analyzer, "SENSe1:LIST:RANGe1:DELeTe")
'----- Defining the start frequency for all ranges -----
CALL InstrWrite (analyzer, "SENSe1:LIST:RANGe1:FREQuency:START 1000000")
Rem Setting the start frequency of range 1 will create the ranges and
Rem every other range value will be set to the default value.
CALL InstrWrite (analyzer, "SENSe1:LIST:RANGe2:FREQuency:START 2000000")
CALL InstrWrite (analyzer, "SENSe1:LIST:RANGe3:FREQuency:START 3000000")
CALL InstrWrite (analyzer, "SENSe1:LIST:RANGe4:FREQuency:START 4000000")
CALL InstrWrite (analyzer, "SENSe1:LIST:RANGe5:FREQuency:START 5000000")
CALL InstrWrite (analyzer, "SENSe1:LIST:RANGe:COUNT?")
'Queries the number of defined
'ranges
'----- Querying the parameters of range 1 -----
CALL InstrWrite (analyzer, "SENSe1:LIST:RANGe1:FREQuency:START?")
CALL InstrWrite (analyzer, "SENSe1:LIST:RANGe1:FREQuency:STOP?")
CALL InstrWrite (analyzer, "SENSe1:LIST:RANGe1:FILTeR:TYPe?")
CALL InstrWrite (analyzer, "SENSe1:LIST:RANGe1:BANdwidth:RESolution?")
CALL InstrWrite (analyzer, "SENSe1:LIST:RANGe1:BANdwidth:VIDeo?")
CALL InstrWrite (analyzer, "SENSe1:LIST:RANGe1:SWEep:TIME:AUTO?")
CALL InstrWrite (analyzer, "SENSe1:LIST:RANGe1:DETeCtor?")
CALL InstrWrite (analyzer, "SENSe1:LIST:RANGe1:RLEVel?")
CALL InstrWrite (analyzer, "SENSe1:LIST:RANGe1:INPut:ATTenuation:AUTO?")
CALL InstrWrite (analyzer, "SENSe1:LIST:RANGe1:INPut:GAIN:STATe?")
CALL InstrWrite (analyzer, "SENSe1:LIST:RANGe1:BReAk?")
CALL InstrWrite (analyzer, "SENSe1:LIST:RANGe1:TRANsducer?")
CALL InstrWrite (analyzer, "SENSe1:LIST:RANGe1:SWEep:TIME?")
CALL InstrWrite (analyzer, "SENSe1:LIST:RANGe1:INPut:ATTenuation?")
CALL InstrWrite (analyzer, "SENSe1:LIST:RANGe1:POINts?")
CALL InstrWrite (analyzer, "SENSe1:LIST:RANGe1:LIMit:START?")
CALL InstrWrite (analyzer, "SENSe1:LIST:RANGe1:LIMit:STOP?")
CALL InstrWrite (analyzer, "SENSe1:LIST:RANGe1:LIMit:STATe?")
'----- Changing into the Spurious Emissions measurement mode -----
CALL InstrWrite (analyzer, ":SENSe1:SWEEP:MODE LIST")
Rem In continuous sweep mode, editing the ranges is not allowed.
Rem You have to stop the measurement first.
Rem In single sweep mode, you can edit the ranges at the end of the sweep.
'----- Single sweep version -----
CALL InstrWrite (analyzer, "INIT:CONT OFF") 'Switch to single sweep
CALL InstrWrite (analyzer, "SENSe1:LIST:RANGe1:FREQuency:START 500000")
'Change the start frequency
CALL InstrWrite (analyzer, "INIT;*WAI") 'Perform sweep, wait for sweep
'end
'----- Continuous sweep version -----

```

Remote Control – Programming Examples

```

CALL InstrWrite (analyzer, "INIT:CONT ON") 'Switch to continuous sweep
CALL InstrWrite (analyzer, "ABORT") 'Stop the measurement
CALL InstrWrite (analyzer, "SENSE1:LIST:RANGE1:FREQUENCY:START 500000")
'Change the start frequency
CALL InstrWrite (analyzer, ":INITiate1:SPURious") 'Restart the measurement
'----- Defining the range settings in single sweep mode -----
CALL InstrWrite (analyzer, "INIT:CONT OFF") 'Switch to single sweep
CALL InstrWrite (analyzer, "INIT;*WAI") 'Perform sweep, wait for sweep
'end

Rem Edit one range at a time. Make sure to edit the ranges in a correct
Rem order to prevent limit violations. Ranges cannot overlap.
Rem The best way is to start with range 1.
CALL InstrWrite (analyzer, "SENSE1:LIST:RANGE1:FREQUENCY:START 500000")
CALL InstrWrite (analyzer, "SENSE1:LIST:RANGE1:FREQUENCY:STOP 550000")
CALL InstrWrite (analyzer, "SENSE1:LIST:RANGE1:FILTer:TYPE NORM")
CALL InstrWrite (analyzer, "SENSE1:LIST:RANGE1:BANDwidth:RESolution 3000000")
CALL InstrWrite (analyzer, "SENSE1:LIST:RANGE1:BANDwidth:VIDeo 10000000")
CALL InstrWrite (analyzer, "SENSE1:LIST:RANGE1:SWEep:TIME:AUTO ON")
CALL InstrWrite (analyzer, "SENSE1:LIST:RANGE1:DETECTOR RMS")
CALL InstrWrite (analyzer, "SENSE1:LIST:RANGE1:RLEVel -10")
CALL InstrWrite (analyzer, "SENSE1:LIST:RANGE1:INPut:ATTenuation:AUTO ON")
CALL InstrWrite (analyzer, "SENSE1:LIST:RANGE1:POINts 8001")
CALL InstrWrite (analyzer, "SENSE1:LIST:RANGE1:INPut:GAIN:STATE OFF")
CALL InstrWrite (analyzer, "SENSE1:LIST:RANGE1:BREak OFF")
CALL InstrWrite (analyzer, "SENSE1:LIST:RANGE1:LIMit:START -20")
CALL InstrWrite (analyzer, "SENSE1:LIST:RANGE1:LIMit:STOP -20")
CALL InstrWrite (analyzer, "SENSE1:LIST:RANGE1:LIMit:STATE ON")
Rem Proceed with range 2.
CALL InstrWrite (analyzer, "SENSE1:LIST:RANGE2:FREQUENCY:START 1000000")
CALL InstrWrite (analyzer, "SENSE1:LIST:RANGE2:FREQUENCY:STOP 200000000")
CALL InstrWrite (analyzer, "SENSE1:LIST:RANGE2:FILTer:TYPE CFILter")
CALL InstrWrite (analyzer, "SENSE1:LIST:RANGE2:BANDwidth:RESolution 5000000")
CALL InstrWrite (analyzer, "SENSE1:LIST:RANGE2:DETECTOR POS")
CALL InstrWrite (analyzer, "SENSE1:LIST:RANGE2:RLEVel -20")
CALL InstrWrite (analyzer, "SENSE1:LIST:RANGE2:INPut:ATTenuation 0")
CALL InstrWrite (analyzer, "SENSE1:LIST:RANGE2:POINts 32001")
CALL InstrWrite (analyzer, "SENSE1:LIST:RANGE2:INPut:GAIN:STATE ON")
Rem Proceed with range 3.
CALL InstrWrite (analyzer, "SENSE1:LIST:RANGE3:FREQUENCY:START 250000000")
CALL InstrWrite (analyzer, "SENSE1:LIST:RANGE3:FREQUENCY:STOP 1000000000")
CALL InstrWrite (analyzer, "SENSE1:LIST:RANGE3:FILTer:TYPE RRC")
CALL InstrWrite (analyzer, "SENSE1:LIST:RANGE3:POINts 32001")
Rem Proceed with range 4.
CALL InstrWrite (analyzer, "SENSE1:LIST:RANGE4:FREQUENCY:START 1200000000")
CALL InstrWrite (analyzer, "SENSE1:LIST:RANGE4:FREQUENCY:STOP 4000000000")
CALL InstrWrite (analyzer, "SENSE1:LIST:RANGE4:FILTer:TYPE PULSe")
CALL InstrWrite (analyzer, "SENSE1:LIST:RANGE4:POINts 251")
Rem Proceed with range 5.
CALL InstrWrite (analyzer, "SENSE1:LIST:RANGE5:FREQUENCY:START 5000000000")
CALL InstrWrite (analyzer, "SENSE1:LIST:RANGE5:FREQUENCY:STOP 6000000000")

```



```

CALL InstrWrite (analyzer, "SENSE1:LIST:RANGe5:POINTs 7001")
'----- Defining the limit check for all ranges -----
CALL InstrWrite (analyzer, "SENSE1:LIST:RANGe1:LIMit:STATe ON")
'Activate the limit check
'----- Setting the span to include all ranges -----
CALL InstrWrite (analyzer, ":SENSE1:FREQuency:STARt 500000")
CALL InstrWrite (analyzer, ":SENSE1:FREQuency:STOP 6000000000")
'----- Measuring -----
CALL InstrWrite (analyzer, "INIT;*WAI") 'Perform sweep, wait for sweep
'end
'----- Reading out results -----
CALL InstrWrite (analyzer, ":TRACe1:DATA? LIST")
'Query list results
CALL InstrWrite (analyzer, ":CALCulate1:PSEarch[:IMMediate]")
'Deactivate limit line and
'just look for peaks
Rem Or set margin to 200 in order to find all peaks
CALL InstrWrite (analyzer, ":TRACe1:DATA? SPUR")
'Query just the peaks
CALL InstrWrite (analyzer, ":CALCulate:LIMit:FAIL?")
'Query result of limit check
CALL InstrRead(analyzer, result$)
REM *****

```

8.3.14 Averaging I/Q Data

The R&S FSVR has averaging capability also for I/Q measurements, i.e. I/Q data can be averaged over several test runs. This is subject to the following conditions:

- An external trigger signal must be available for data measurement, and the trigger signal must be phase-locked to the signal measured.
- The same reference-frequency signal must be used for the DUT and the R&S FSVR.
- Internal I/Q data averaging is supported up to 512 k I/Q samples.

If all of the above conditions are fulfilled, no phase shift will occur between consecutive test runs. Phase shift may falsify the measured average so that in extreme cases a value of 0 is obtained.

The default setting of the instrument for data measurement without averaging has to be changed as follows:

```

REM *****
'----- R&S FSV default setting -----
CALL SetupInstrument 'Default setting
CALL InstrWrite (analyzer, "TRAC:IQ:STAT ON")
'Activate I/Q data acquisition
'mode; this must be
'done before TRAC:IQ:SET!
'Select max. number of test points (= 512 * 1024) at 10 MHz RBW,

```

```
'32 MHz sampling rate, external
'trigger, pos. trigger edge and
'0 s trigger delay.
CALL InstrWrite (analyzer, "TRAC:IQ:SET NORM,10 MHz,32 MHz,EXT,POS,0,524288")
CALL InstrWrite (analyzer, "TRAC:IQ:AVER ON") 'Switch on I/Q averaging
CALL InstrWrite (analyzer, "TRAC:IQ:AVER:COUN 10") 'Set 10 test runs
'----- Read data in binary format -----
...
REM *****
```

8.3.15 Using IQ Gating

IQ gating refers to recording IQ samples in certain time intervals – the gate areas. There are different modes to define the gate areas:

- Edge triggered recording
- Level triggered recording

For more information, see "IQ Gating" in the "Remote Commands" chapter under "Trace:IQ" subsystem.

Measurement example: Level mode

With IQ gating in level mode, the area in which the gate signal is active is recorded. In this example, the gate signal is generated by the IFP trigger. The [figure 8-8](#) shows the signal (triggered externally) in IQ mode. The following sample program records the signal in level mode with an external trigger.

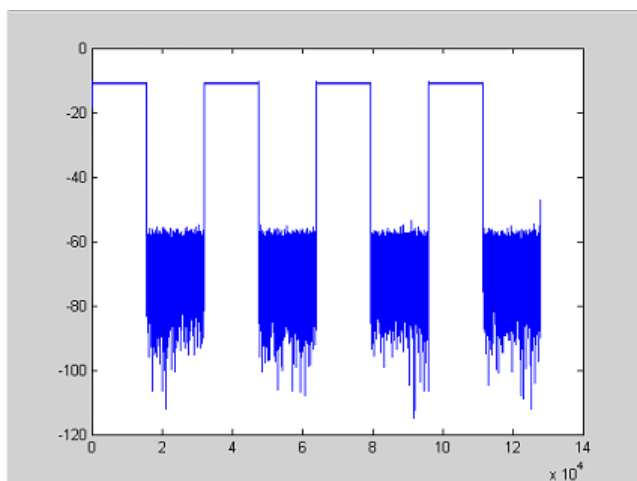

Fig. 8-8: Signal to be recorded in IQ mode

Used values

sample rate: 32 MHz

number of IQ samples: 128000

trigger mode: IFP

Program

```
:TRACel:IQ ON
Trace:iq:set NORM,0,3200000,IFP,POS,0,128000
:TRIGger1:SEQuence:LEVel:IFPower -20
:TRACel:IQ:EGATe ON
:TRACel:IQ:EGATe:TYPE LEVel
```

Result

In [figure 8-9](#), the recorded signal using IQ gating in level mode is displayed. Edges are only visible around the IFP trigger point, otherwise only the signal level is recorded.

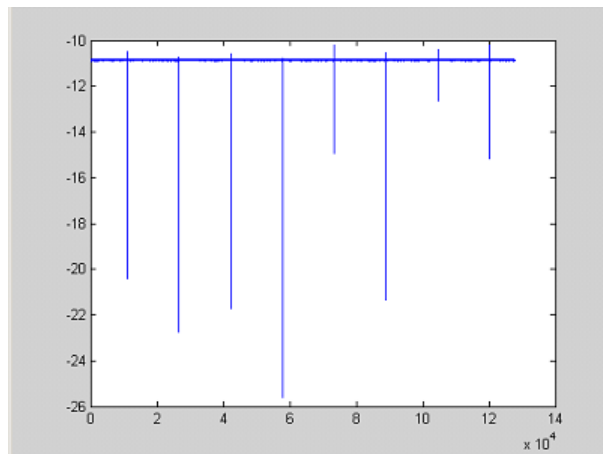

Fig. 8-9: Recorded signal using IQ gating in level mode

Measurement example: Edge mode

In edge mode, the gate area is defined by:

- delay (pretrigger samples)
- length
- number of periods
- gap between the periods

The gate starting point can be defined using an IFP or external trigger.

The [figure 8-10](#) shows the signal to be recorded in IQ mode.

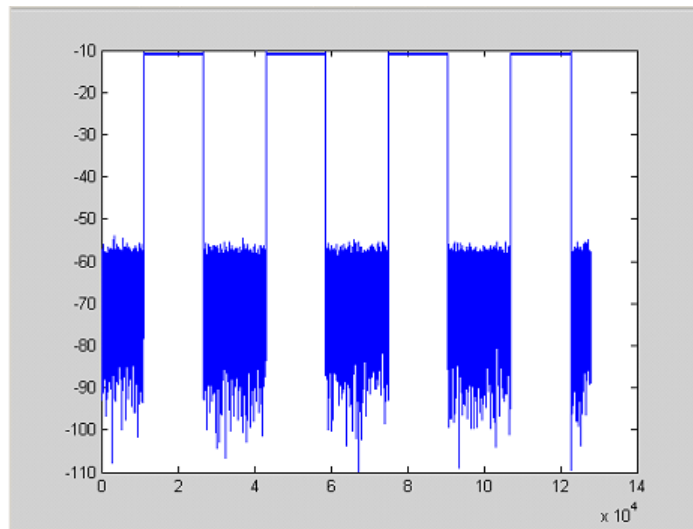

Fig. 8-10: Signal to be recorded in IQ mode

Example 1: Signal only

The following sample program records the signal in edge mode and displays only the signal, without gaps and noise.

Used values

sample rate: 32 MHz

number of IQ samples: 128000

delay = 11020 samples

length = 15500 samples

trigger mode: EXT

Program

```
:TRACel:IQ ON
Trace:iq:set NORM,0,32000000,EXT,POS, 11020,128000
:TRACel:IQ:EGATe ON
:TRACel:IQ:EGATe:TYPE EDGE
:TRACel:IQ:EGATe:LENGth 15500
```

Result

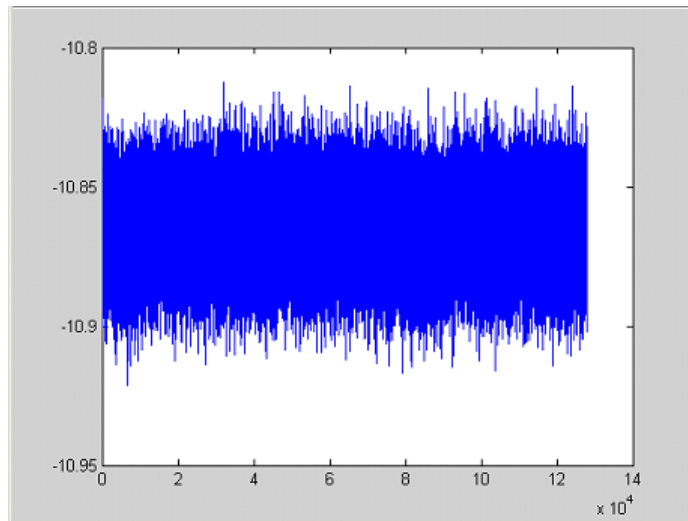

Fig. 8-11: Result: signal only (no gaps, no noise)

Example 2: Noise only

The following sample program records the signal in edge mode and displays only the noise.

Used values

sample rate: 32 MHz

number of IQ samples: 128000

delay = 0 samples

length = 9000 samples

trigger mode: EXT

Program

```
:TRACel:IQ ON  
  
Trace:iq:set NORM,0,32000000,EXT,POS, 0,128000  
  
:TRACel:IQ:EGATE ON  
  
:TRACel:IQ:EGATE:TYPE EDGE  
  
:TRACel:IQ:EGATE:LENGTH 9000
```

Result

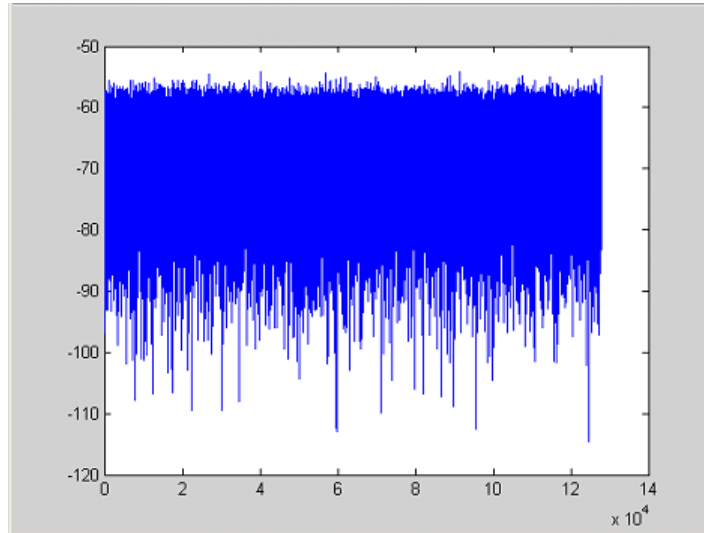

Fig. 8-12: Result: noise only

Measurement example: Periodic signal intervals in edge mode

The gate area can also be defined by a number of gate periods and the distance between two periods (gap). In this example, a power ramp is recorded, triggered by the IFP on the highest edge (see [figure 8-13](#)). As a result, only the levels of the individual ramp areas of the first 3 periods are displayed (see [figure 8-14](#)).

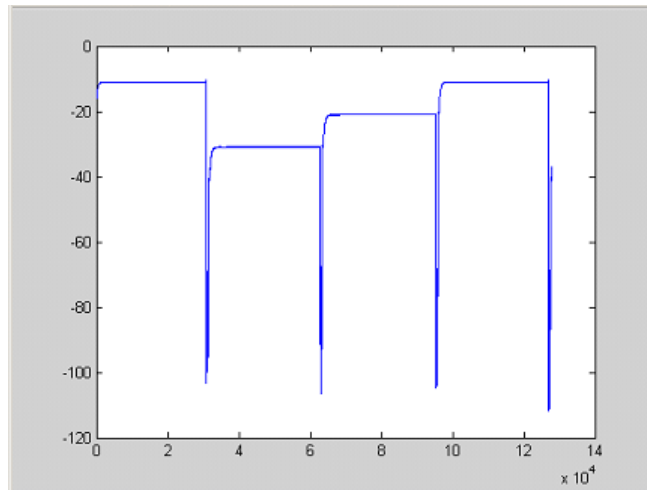

Fig. 8-13: Periodic signal recording in edge mode

Used values:

sample rate: 3,2 MHz

number of IQ samples: 228000

trigger mode: IFP

length: 28800

number of periods: 3

gap: 3800 samples

Program

```
:TRACel:IQ ON
trace:iq:set NORM,0,3200000,IFP,POS,0,228000
:TRIGger1:SEQuence:LEVel:IFPower -20
:TRACel:IQ:EGATe ON
:TRACel:IQ:EGATe:TYPE EDGE
:TRACel:IQ:EGATe:LENGth 28800
:TRACel:IQ:EGATe:NOF 3
:TRACel:IQ:EGATe:GAP 3800
```

Result

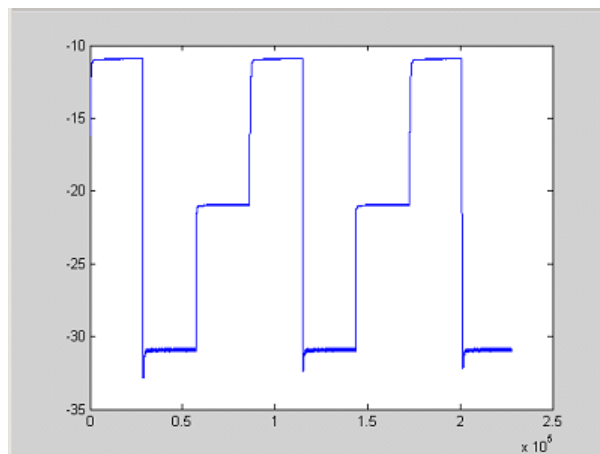

Fig. 8-14: Result: periodic power ramp levels

8.3.16 Usage of Four Spectrum Instances

As of R&S FSVR firmware version 1.50, you can open up to four tabs for spectrum mode with the softkey "New Spectrum" in the "MODE" menu. The following remote example shows how to set up four tabs with four different measurements on a WCDMA signal.

```
REM *****
Public Sub 4SpectrumTabs()
result$ = Space$(100)

'----- R&S FSV default setting -----
CALL SetupStatusReg           'Set status registers
```

Remote Control – Programming Examples

```

CALL InstrWrite(analyzer,"*RST")          'Reset instrument
CALL InstrWrite(analyzer,"INIT:CONT OFF")  'Single sweep

'----- Setup the first Spectrum tab (Spectrum Overview Measurement) -----
CALL InstrWrite(analyzer,"INIT:CONT OFF")  'Single sweep
CALL InstrWrite(analyzer,"DISP:WIND:TRAC:Y:SCAL:RLEV 10 dBm")'Reference level
CALL InstrWrite(analyzer,"FREQ:START 100MHz;STOP 6 GHz")    'Span

'----- Setup the Spectrum 2 Tab (ACLR measurement) -----
CALL InstrWrite(analyzer,"INST:CRE SAN,'Spectrum 2'")      'Create Tab 2

'--- After creation the tab is in standard preset setup ---
CALL InstrWrite(analyzer,"INIT:CONT OFF")  'Single sweep
CALL InstrWrite(analyzer,"DISP:WIND:TRAC:Y:SCAL:RLEV 10 dBm")'Reference level
CALL InstrWrite(analyzer,"FREQ:CENT 2.1175GHz")            'different CF
CALL InstrWrite(analyzer,"CALC:MARK:FUNC:POW:SEL ACP")     'select ACLR meas
CALL InstrWrite(analyzer,"CALC:MARK:FUNC:POW:PRES FW3Gppcdma")
      'select WCDMA BTS standard

'----- Setup the Spectrum 3 Tab (OBW measurement) -----
CALL InstrWrite(analyzer,"INST:CRE SAN,'Spectrum 3'")      'Create Tab 3
CALL InstrWrite(analyzer,"INIT:CONT OFF")  'Single sweep
CALL InstrWrite(analyzer,"DISP:WIND:TRAC:Y:SCAL:RLEV 10 dBm")'Reference level
CALL InstrWrite(analyzer,"FREQ:CENT 2.1175GHz")            'different CF
CALL InstrWrite(analyzer,"CALC:MARK:FUNC:POW:SEL OBW")     'select OBW meas
CALL InstrWrite(analyzer,"CALC:MARK:FUNC:POW:PRES FW3Gppcdma")
      ' select WCDMA BTS standard

'----- Setup the Spectrum 4 Tab (CCDF measurement) -----
CALL InstrWrite(analyzer,"INST:CRE SAN,'Spectrum 4'")      'Create Tab 4
CALL InstrWrite(analyzer,"INIT:CONT OFF")  'Single sweep
CALL InstrWrite(analyzer,"DISP:WIND:TRAC:Y:SCAL:RLEV 10 dBm")'Reference level
CALL InstrWrite(analyzer,"FREQ:CENT 2.1175GHz")            'different CF
CALL InstrWrite(analyzer," CALC:STAT:CCDF ON")              'select CCDF meas

'----- Sweep in first Spectrum Tab and query marker -----
CALL InstrWrite(analyzer,"INST:SEL SAN")                    'Select Tab 1
CALL InstrWrite(analyzer,"INIT;*WAI")                      'Perform sweep with sync
CALL InstrWrite(analyzer,"CALC:MARK1:MAX")                  'Marker to peak
CALL InstrWrite(analyzer,"CALC:MARK1:X?")                  'Query Marker x value
CALL InstrRead(analyzer,result$)
Print "Spectrum 1 Marker x [Hz]: ";result$
CALL InstrWrite(analyzer,"CALC:MARK1:Y?")                  'Query Marker y value
CALL InstrRead(analyzer,result$)
Print "Spectrum 1 Marker y [dBm]: ";result$

'----- Sweep in Spectrum 2 Tab and query ACLR results -----
CALL InstrWrite(analyzer," INST:SEL 'Spectrum 2'")          'Select Tab 2
CALL InstrWrite(analyzer,"INIT;*WAI")                      'Perform sweep with sync
CALL InstrWrite(analyzer,"CALC:MARK:FUNC:POW:RES? ACP")    'Query ACLR results
CALL InstrRead(analyzer,result$)
Print "Spectrum 2 ACRL results : ";result$

'----- Sweep in Spectrum 3 Tab and query OBW results -----
CALL InstrWrite(analyzer," INST:SEL 'Spectrum 3'")          'Select Tab 3

```



```
CALL InstrWrite(analyzer,"INIT;*WAI")          'Perform sweep with sync
CALL InstrWrite(analyzer,"CALC:MARK:FUNC:POW:RES? OBW")'Query OBW results
CALL InstrRead(analyzer,result$)
Print "Spectrum 3 OBW results : ";result$

'----- Sweep in Spectrum 4 Tab and query CCDF results -----
CALL InstrWrite(analyzer," INST:SEL 'Spectrum 4'") 'Select Tab 4
CALL InstrWrite(analyzer,"INIT;*WAI")          'Perform sweep with sync
CALL InstrWrite(analyzer,"CALC:STAT:RES1? ALL")'Query CCDF results
CALL InstrRead(analyzer,result$)
Print "Spectrum 4 CCDF results : ";result$
'----- Now the sweep part can be redone without the need of -----
'----- doing the setup of all 4 measurements again. -----
END SUB
REM *****
```

9 Maintenance

The following chapter contains information on the maintenance of the R&S FSVR. The instrument does not need a periodic maintenance. What is necessary is essentially the cleaning of the instrument. However, it is recommended to check the rated data from time to time.

Follow the instructions in the service manual and the safety instructions when exchanging modules or ordering spares. The order no. for spare parts is included in the service manual. The service manual includes further information particularly on troubleshooting, repair, exchange of modules (including battery exchange, adjustment of the OCXO oscillator) and alignment.

The address of our support center and a list of all Rohde & Schwarz service centers can be found at the beginning of this manual.

9.1 Storing and Packing

The storage temperature range of the instrument is given in the data sheet. If the instrument is to be stored for a longer period of time, it must be protected against dust.

Repack the instrument as it was originally packed when transporting or shipping. The two protective foam plastic parts prevent the control elements and connectors from being damaged. The antistatic packing foil avoids any undesired electrostatic charging to occur.

If you do not use the original packaging, provide for sufficient padding to prevent the instrument from slipping inside the package. Wrap antistatic packing foil around the instrument to protect it from electrostatic charging.

9.2 List of Available Power Cables

Table 9-1: List of power cables available

| Stock No. | Earthed-contact connector | Preferably used in |
|----------------|--|--------------------|
| DS 006.7013.00 | BS1363: 1967' complying with
IEC 83: 1975 standard B2 | Great Britain |
| DS 006.7020.00 | Type 12 complying with SEV-regulation 1011.1059, standard sheet S 24 507 | Switzerland |
| DS 006.7036.00 | Type 498/13 complying with US-regulation UL 498, or with IEC 83 | USA/Canada |
| DS 006.7107.00 | Type SAA3 10 A, 250 V, complying with AS C112-1964 Ap. | Australia |

List of Available Power Cables

| Stock No. | Earthed-contact connector | Preferably used in |
|-----------------|-----------------------------------|-----------------------------|
| DS 0025.2365.00 | DIN 49 441, 10 A, 250 V, angular | Europe (except Switzerland) |
| DS 0099.1456.00 | DIN 49 441, 10 A, 250 V, straight | |

10 Error Messages

Error messages are entered in the error/event queue of the status reporting system in the remote control mode and can be queried with the command `SYSTem:ERRor?`. The answer format of R&S FSVR to the command is as follows:

```
<error code>, "<error text with queue query>;
<remote control command concerned>"
```

The indication of the remote control command with prefixed semicolon is optional.

Example:

The command "TEST:COMMAND" generates the following answer to the query `SYSTem:ERRor?`

```
-113, "Undefined header;TEST:COMMAND"
```

There are two types of error messages:

- Error messages defined by SCPI are marked by negative error codes. These messages are defined and described in the SCPI standard and not listed here.
- Device-specific error messages use positive error codes. These messages are listed below.

The right-hand column in the following tables contains the error text in bold which is entered in the error/event queue and can be read out by means of query `SYSTem:ERRor?`. A short explanation of the error cause is given. The left-hand column contains the associated error code.

Additionally, option-specific warnings and error messages displayed in the status bar are explained.

Table 10-1: Device-specific error messages

| Error code | Error text in the case of queue poll
Error explanation |
|------------|---|
| 1052 | Frontend LO is Unlocked
This message is displayed when the phase regulation of the local oscillator fails in the RF front-end. |
| 1060 | Trigger-Block Gate Delay Error- gate length < Gate Delay
This message is displayed when the gate signal length is not sufficient for the pull-in delay with a predefined gate delay. |
| 1064 | Tracking LO is Unlocked
This message is displayed when the phase regulation of the local oscillator fails on the tracking generator module. |
| 2028 | Hardcopy not possible during measurement sequence
This message is displayed when a printout is started during scan sequences that cannot be interrupted. Such sequences are for example: <ul style="list-style-type: none"> • Recording the system error correction data (alignment) • Instrument self test In such cases synchronization to the end of the scan sequence should be performed prior to starting the printout. |

| Error code | Error text in the case of queue poll
Error explanation |
|------------|--|
| 2033 | Printer Not Available
This message is displayed when the selected printer is not included in the list of available output devices. A possible cause is that the required printer driver is missing or incorrectly installed. |
| 2034 | CPU Temperature is too high
This message is displayed when the temperature of the processor exceeds 70 °C. |

List of Commands

| | |
|--|-----|
| [SENSe:] [WINDow:] DETector<trace>[:FUNction] | 874 |
| [SENSe:] [WINDow:] DETector<trace>[:FUNction]:AUTO | 875 |
| [SENSe:] ADEMod:AM:RELative:AFSPectrum:RESult? | 759 |
| [SENSe:] ADEMod:AM:RELative:AFSPectrum[:TYPE] | 758 |
| [SENSe:] ADEMod:AM:RELative[:TDOMain]:RESult? | 757 |
| [SENSe:] ADEMod:AM:RELative[:TDOMain][:TYPE] | 756 |
| [SENSe:] ADEMod:AM[:ABSolute][:TDOMain]:RESult? | 755 |
| [SENSe:] ADEMod:AM[:ABSolute][:TDOMain][:TYPE] | 756 |
| [SENSe:] ADEMod:BANDwidth BWIDth:DEModulation | 760 |
| [SENSe:] ADEMod:BANDwidth BWIDth:DEModulation:TYPE | 760 |
| [SENSe:] ADEMod:CAPTure:DOFFset | 750 |
| [SENSe:] ADEMod:CAPTure:TIME | 751 |
| [SENSe:] ADEMod:CAPTure[:MODE] | 751 |
| [SENSe:] ADEMod:FM:AFSPectrum:RESult | 762 |
| [SENSe:] ADEMod:FM:AFSPectrum[:TYPE] | 762 |
| [SENSe:] ADEMod:FM:OFFSet | 763 |
| [SENSe:] ADEMod:FM[:TDOMain]:RESult | 761 |
| [SENSe:] ADEMod:FM[:TDOMain][:TYPE] | 760 |
| [SENSe:] ADEMod:MTIME | 764 |
| [SENSe:] ADEMod:PM:AFSPectrum:RESult | 767 |
| [SENSe:] ADEMod:PM:AFSPectrum[:TYPE] | 766 |
| [SENSe:] ADEMod:PM:RPOint[:X] | 768 |
| [SENSe:] ADEMod:PM[:TDOMain]:RESult | 765 |
| [SENSe:] ADEMod:PM[:TDOMain][:TYPE] | 765 |
| [SENSe:] ADEMod:RLENgth? | 769 |
| [SENSe:] ADEMod:SET | 769 |
| [SENSe:] ADEMod:SPECTrum:BANDwidth BWIDth[:RESolution] | 771 |
| [SENSe:] ADEMod:SPECTrum:RESult | 771 |
| [SENSe:] ADEMod:SPECTrum:SPAN:ZOOM | 773 |
| [SENSe:] ADEMod:SPECTrum:SPAN[:MAXimum] | 772 |
| [SENSe:] ADEMod:SPECTrum[:TYPE] | 770 |
| [SENSe:] ADEMod:SQUelch:LEVel | 773 |
| [SENSe:] ADEMod:SQUelch[:STATe] | 773 |
| [SENSe:] ADEMod:SRATe? | 774 |
| [SENSe:] ADEMod[:STATe] | 752 |
| [SENSe:] ADEMod<n>:AF:CENTer | 752 |
| [SENSe:] ADEMod<n>:AF:COUPling | 752 |
| [SENSe:] ADEMod<n>:AF:SPAN | 753 |
| [SENSe:] ADEMod<n>:AF:SPAN:FULL | 753 |
| [SENSe:] ADEMod<n>:AF:START | 754 |
| [SENSe:] ADEMod<n>:AF:STOP | 754 |
| [SENSe:] ADEMod<n>:ZOOM:LENgth | 775 |
| [SENSe:] ADEMod<n>:ZOOM:LENgth:MODE | 776 |
| [SENSe:] ADEMod<n>:ZOOM:START | 775 |
| [SENSe:] ADEMod<n>:ZOOM[:STATe] | 774 |
| [SENSe:] ADJust:ALL | 776 |
| [SENSe:] ADJust:CONFIguration:HYSTeresis:LOWer | 777 |

| | |
|--|-----|
| [SENSe:]ADJust:CONFIguration:HYSteresis:UPPer..... | 778 |
| [SENSe:]ADJust:CONFIgure:LEVel:DURation..... | 777 |
| [SENSe:]ADJust:CONFIgure:LEVel:DURation:MODE..... | 777 |
| [SENSe:]ADJust:CONFIgure:TRIG..... | 778 |
| [SENSe:]ADJust:FREQUency..... | 776 |
| [SENSe:]ADJust:LEVel..... | 777 |
| [SENSe:]ADJust:SCALe:Y:AUTO[:CONTInuous]..... | 778 |
| [SENSe:]AVERAge<n>:COUNT..... | 779 |
| [SENSe:]AVERAge<n>:TYPE..... | 780 |
| [SENSe:]AVERAge<n>[:STATe<Trace>]..... | 779 |
| [SENSe:]BANDwidth:DEMod:TYPE..... | 781 |
| [SENSe:]BANDwidth BWIDth:DEMod..... | 781 |
| [SENSe:]BANDwidth BWIDth:VIDeo..... | 784 |
| [SENSe:]BANDwidth BWIDth:VIDeo:AUTO..... | 784 |
| [SENSe:]BANDwidth BWIDth:VIDeo:RATio..... | 784 |
| [SENSe:]BANDwidth BWIDth:VIDeo:TYPE..... | 785 |
| [SENSe:]BANDwidth BWIDth[:RESolution]..... | 782 |
| [SENSe:]BANDwidth BWIDth[:RESolution]:AUTO..... | 782 |
| [SENSe:]BANDwidth BWIDth[:RESolution]:FFT..... | 782 |
| [SENSe:]BANDwidth BWIDth[:RESolution]:RATio..... | 783 |
| [SENSe:]BANDwidth BWIDth[:RESolution]:TYPE..... | 783 |
| [SENSe:]CORRection:CVL:BAND..... | 786 |
| [SENSe:]CORRection:CVL:BIAS..... | 788 |
| [SENSe:]CORRection:CVL:CATalog?..... | 786 |
| [SENSe:]CORRection:CVL:CLear..... | 789 |
| [SENSe:]CORRection:CVL:COMMeNt..... | 788 |
| [SENSe:]CORRection:CVL:DATA..... | 789 |
| [SENSe:]CORRection:CVL:HARMonic..... | 787 |
| [SENSe:]CORRection:CVL:MIXer..... | 787 |
| [SENSe:]CORRection:CVL:PORTs..... | 788 |
| [SENSe:]CORRection:CVL:SELEct..... | 786 |
| [SENSe:]CORRection:CVL:SNUMber..... | 787 |
| [SENSe:]CORRection:TRANsdUcer:ADJust:RLEVel[:STATe]..... | 960 |
| [SENSe:]CORRection:TRANsdUcer:COMMeNt..... | 960 |
| [SENSe:]CORRection:TRANsdUcer:DATA..... | 961 |
| [SENSe:]CORRection:TRANsdUcer:DELEte..... | 961 |
| [SENSe:]CORRection:TRANsdUcer:SCALing..... | 961 |
| [SENSe:]CORRection:TRANsdUcer:SELEct..... | 962 |
| [SENSe:]CORRection:TRANsdUcer:UNIT..... | 962 |
| [SENSe:]CORRection:TRANsdUcer:VIEW..... | 963 |
| [SENSe:]CORRection:TRANsdUcer[:STATe]..... | 962 |
| [SENSe:]DEMod:SQUelch:LEVel..... | 790 |
| [SENSe:]DEMod:SQUelch[:STATe]..... | 790 |
| [SENSe:]ESPEctrum:BWID..... | 791 |
| [SENSe:]ESPEctrum:FILTer[:RRC]:ALPHa..... | 792 |
| [SENSe:]ESPEctrum:FILTer[:RRC][:STATe]..... | 792 |
| [SENSe:]ESPEctrum:HighSPeed..... | 792 |
| [SENSe:]ESPEctrum:PRESet:REStore..... | 793 |
| [SENSe:]ESPEctrum:PRESet:StORE..... | 794 |
| [SENSe:]ESPEctrum:PRESet[:STANdard]..... | 793 |

| | |
|--|-----|
| [SENSe:]ESpectrum:RANGe<range>:BANDwidth:VIDeo..... | 794 |
| [SENSe:]ESpectrum:RANGe<range>:BANDwidth[:RESolution]..... | 794 |
| [SENSe:]ESpectrum:RANGe<range>:COUNT..... | 795 |
| [SENSe:]ESpectrum:RANGe<range>:DELEte..... | 795 |
| [SENSe:]ESpectrum:RANGe<range>:FILTer:TYPE..... | 795 |
| [SENSe:]ESpectrum:RANGe<range>:INPut:ATTenuation..... | 797 |
| [SENSe:]ESpectrum:RANGe<range>:INPut:ATTenuation:AUTO..... | 797 |
| [SENSe:]ESpectrum:RANGe<range>:INPut:GAIN:STATE..... | 797 |
| [SENSe:]ESpectrum:RANGe<range>:INSert..... | 798 |
| [SENSe:]ESpectrum:RANGe<range>:LIMit<source>:ABSolute:START..... | 798 |
| [SENSe:]ESpectrum:RANGe<range>:LIMit<source>:ABSolute:STOP..... | 798 |
| [SENSe:]ESpectrum:RANGe<range>:LIMit<source>:RELative:START..... | 799 |
| [SENSe:]ESpectrum:RANGe<range>:LIMit<source>:RELative:STOP..... | 799 |
| [SENSe:]ESpectrum:RANGe<range>:LIMit<source>:STATE..... | 800 |
| [SENSe:]ESpectrum:RANGe<range>:RLEVel..... | 800 |
| [SENSe:]ESpectrum:RANGe<range>:SWEep:TIME..... | 800 |
| [SENSe:]ESpectrum:RANGe<range>:SWEep:TIME:AUTO..... | 801 |
| [SENSe:]ESpectrum:RANGe<range>:TRANsducer..... | 801 |
| [SENSe:]ESpectrum:RANGe<range>[:FREQuency]:START..... | 796 |
| [SENSe:]ESpectrum:RANGe<range>[:FREQuency]:STOP..... | 796 |
| [SENSe:]ESpectrum:RRANGe..... | 802 |
| [SENSe:]ESpectrum:RTYPE..... | 802 |
| [SENSe:]FILTer<n>:AOFF..... | 803 |
| [SENSe:]FILTer<n>:AWEighted[:STATE]..... | 803 |
| [SENSe:]FILTer<n>:CCIR:WEIGhted[:STATE]..... | 804 |
| [SENSe:]FILTer<n>:CCIR[:UNWeighted][:STATE]..... | 804 |
| [SENSe:]FILTer<n>:CCIT..... | 803 |
| [SENSe:]FILTer<n>:DEMPHasis:TCONstant..... | 805 |
| [SENSe:]FILTer<n>:DEMPHasis[:STATE]..... | 805 |
| [SENSe:]FILTer<n>:HPASs:FREQuency..... | 806 |
| [SENSe:]FILTer<n>:HPASs[:STATE]..... | 805 |
| [SENSe:]FILTer<n>:LPASs:FREQuency:RELative..... | 807 |
| [SENSe:]FILTer<n>:LPASs:FREQuency[:ABSolute]..... | 807 |
| [SENSe:]FILTer<n>:LPASs[:STATE]..... | 806 |
| [SENSe:]FREQuency:CENTer..... | 808 |
| [SENSe:]FREQuency:CENTer:STEP..... | 808 |
| [SENSe:]FREQuency:CENTer:STEP:AUTO..... | 808 |
| [SENSe:]FREQuency:CENTer:STEP:LINK..... | 809 |
| [SENSe:]FREQuency:CENTer:STEP:LINK:FACTOR..... | 809 |
| [SENSe:]FREQuency:MODE..... | 810 |
| [SENSe:]FREQuency:OFFSet..... | 811 |
| [SENSe:]FREQuency:SPAN..... | 811 |
| [SENSe:]FREQuency:SPAN:FULL..... | 811 |
| [SENSe:]FREQuency:START..... | 811 |
| [SENSe:]FREQuency:STOP..... | 811 |
| [SENSe:]LIST:POWer:RESult?..... | 813 |
| [SENSe:]LIST:POWer:SET..... | 817 |
| [SENSe:]LIST:POWer:STATE..... | 818 |
| [SENSe:]LIST:POWer[:SEQuence]..... | 814 |
| [SENSe:]LIST:RANGe<range>:BANDwidth:VIDeo..... | 819 |

| | |
|---|-----|
| [SENSe:]LIST:RANGe<range>:BANDwidth[:RESolution]..... | 818 |
| [SENSe:]LIST:RANGe<range>:BREak..... | 819 |
| [SENSe:]LIST:RANGe<range>:COUNt..... | 819 |
| [SENSe:]LIST:RANGe<range>:DELeTe..... | 820 |
| [SENSe:]LIST:RANGe<range>:DETEctor..... | 820 |
| [SENSe:]LIST:RANGe<range>:FILTer:TYPE..... | 821 |
| [SENSe:]LIST:RANGe<range>:INPut:ATTenuation..... | 822 |
| [SENSe:]LIST:RANGe<range>:INPut:ATTenuation:AUTO..... | 822 |
| [SENSe:]LIST:RANGe<range>:INPut:GAIN:STATe..... | 823 |
| [SENSe:]LIST:RANGe<range>:LIMit:START..... | 823 |
| [SENSe:]LIST:RANGe<range>:LIMit:STATe..... | 823 |
| [SENSe:]LIST:RANGe<range>:LIMit:STOP..... | 824 |
| [SENSe:]LIST:RANGe<range>:POINts..... | 824 |
| [SENSe:]LIST:RANGe<range>:RLEVel..... | 824 |
| [SENSe:]LIST:RANGe<range>:SWEep:TIME..... | 825 |
| [SENSe:]LIST:RANGe<range>:SWEep:TIME:AUTO..... | 825 |
| [SENSe:]LIST:RANGe<range>:TRANsducer..... | 825 |
| [SENSe:]LIST:RANGe<range>[:FREQuency]:START..... | 820 |
| [SENSe:]LIST:RANGe<range>[:FREQuency]:STOP..... | 821 |
| [SENSe:]MIXer:BIAS:HIGH..... | 826 |
| [SENSe:]MIXer:BIAS:LOW..... | 827 |
| [SENSe:]MIXer:FREQuency:HANDover..... | 828 |
| [SENSe:]MIXer:FREQuency:START?..... | 828 |
| [SENSe:]MIXer:FREQuency:STOP?..... | 828 |
| [SENSe:]MIXer:HARMonic:BAND..... | 828 |
| [SENSe:]MIXer:HARMonic:BAND:PRESet..... | 829 |
| [SENSe:]MIXer:HARMonic:HIGH:STATe..... | 829 |
| [SENSe:]MIXer:HARMonic:HIGH[:VALue]..... | 829 |
| [SENSe:]MIXer:HARMonic:TYPE..... | 830 |
| [SENSe:]MIXer:HARMonic[:LOW]..... | 830 |
| [SENSe:]MIXer:LOPower..... | 830 |
| [SENSe:]MIXer:LOSS:HIGH..... | 831 |
| [SENSe:]MIXer:LOSS:TABLE:HIGH..... | 831 |
| [SENSe:]MIXer:LOSS:TABLE[:LOW]..... | 831 |
| [SENSe:]MIXer:LOSS[:LOW]..... | 831 |
| [SENSe:]MIXer:PORTs..... | 832 |
| [SENSe:]MIXer:RFOVerrange[:STATe]..... | 827 |
| [SENSe:]MIXer:SIGNAL..... | 832 |
| [SENSe:]MIXer:THReshold..... | 833 |
| [SENSe:]MIXer[:STATe]..... | 826 |
| [SENSe:]MPOWER:FTYPE..... | 834 |
| [SENSe:]MPOWER:RESult:MIN?..... | 835 |
| [SENSe:]MPOWER:RESult[:LIST]?..... | 834 |
| [SENSe:]MPOWER[:SEQUence]..... | 835 |
| [SENSe:]PMETer<p>:DCYClE:STATe..... | 838 |
| [SENSe:]PMETer<p>:DCYClE:VALue..... | 839 |
| [SENSe:]PMETer<p>:FREQuency..... | 839 |
| [SENSe:]PMETer<p>:FREQuency:LINK..... | 839 |
| [SENSe:]PMETer<p>:MTIME..... | 840 |
| [SENSe:]PMETer<p>:MTIME:AVERAge:COUNt..... | 841 |

| | |
|---|-----|
| [SENSe:]PMETer<p>:MTIME:AVERAge[:STATe]..... | 840 |
| [SENSe:]PMETer<p>:ROFFset[:STATe]..... | 841 |
| [SENSe:]PMETer<p>:TRIGger:DTIME..... | 842 |
| [SENSe:]PMETer<p>:TRIGger:HOLDoff..... | 842 |
| [SENSe:]PMETer<p>:TRIGger:HYSTeresis..... | 843 |
| [SENSe:]PMETer<p>:TRIGger:LEVel..... | 843 |
| [SENSe:]PMETer<p>:TRIGger:SLOPe..... | 844 |
| [SENSe:]PMETer<p>:TRIGger[:STATe]..... | 842 |
| [SENSe:]PMETer<p>:UPDate[:STATe]..... | 844 |
| [SENSe:]PMETer<p>[:STATe]..... | 838 |
| [SENSe:]POWer:ACHannel:ACPairs..... | 845 |
| [SENSe:]POWer:ACHannel:BANDwidth BWIDth:ACHannel..... | 846 |
| [SENSe:]POWer:ACHannel:BANDwidth BWIDth:ALTErnate<channel>..... | 846 |
| [SENSe:]POWer:ACHannel:BANDwidth BWIDth[:CHANnel<channel>]..... | 845 |
| [SENSe:]POWer:ACHannel:FILTer:ALPHa:ACHannel..... | 847 |
| [SENSe:]POWer:ACHannel:FILTer:ALPHa:ALTErnate<channel>..... | 847 |
| [SENSe:]POWer:ACHannel:FILTer:ALPHa:CHANnel<channel>..... | 847 |
| [SENSe:]POWer:ACHannel:FILTer:ALPHa[:ALL]..... | 847 |
| [SENSe:]POWer:ACHannel:FILTer[:STATe]:ACHannel..... | 848 |
| [SENSe:]POWer:ACHannel:FILTer[:STATe]:ALL..... | 848 |
| [SENSe:]POWer:ACHannel:FILTer[:STATe]:ALTErnate<channel>..... | 848 |
| [SENSe:]POWer:ACHannel:FILTer[:STATe]:CHANnel<channel>..... | 848 |
| [SENSe:]POWer:ACHannel:MODE..... | 849 |
| [SENSe:]POWer:ACHannel:NAME:ACHannel..... | 849 |
| [SENSe:]POWer:ACHannel:NAME:ALTErnate<channel>..... | 850 |
| [SENSe:]POWer:ACHannel:NAME:CHANnel<channel>..... | 850 |
| [SENSe:]POWer:ACHannel:PRESet..... | 850 |
| [SENSe:]POWer:ACHannel:PRESet:RLEVel..... | 851 |
| [SENSe:]POWer:ACHannel:REFerence:AUTO ONCE..... | 851 |
| [SENSe:]POWer:ACHannel:REFerence:TXCHannel:AUTO..... | 851 |
| [SENSe:]POWer:ACHannel:REFerence:TXCHannel:MANual..... | 852 |
| [SENSe:]POWer:ACHannel:SPACing:ALTErnate<channel>..... | 853 |
| [SENSe:]POWer:ACHannel:SPACing:CHANnel<channel>..... | 853 |
| [SENSe:]POWer:ACHannel:SPACing[:ACHannel]..... | 852 |
| [SENSe:]POWer:ACHannel:TXCHannel:COUNT..... | 853 |
| [SENSe:]POWer:BANDwidth BWIDth..... | 854 |
| [SENSe:]POWer:HSPeed..... | 854 |
| [SENSe:]POWer:NCORrection..... | 854 |
| [SENSe:]POWer:TRACe..... | 855 |
| [SENSe:]ROSCillator:EXTernal:FREQuency..... | 963 |
| [SENSe:]ROSCillator:SOURce..... | 964 |
| [SENSe:]ROSCillator:SOURce:EAUTO?..... | 964 |
| [SENSe:]SFM:<ChannelType>:AFSPectrum:RESult?..... | 857 |
| [SENSe:]SFM:<ChannelType>:AFSPectrum:TYPE..... | 857 |
| [SENSe:]SFM:<ChannelType>:FILTer:AWEighted[:STATe]..... | 858 |
| [SENSe:]SFM:<ChannelType>:FILTer:CCIR:WEIGhted[:STATe]..... | 859 |
| [SENSe:]SFM:<ChannelType>:FILTer:CCIR[:UNWeighted][:STATe]..... | 858 |
| [SENSe:]SFM:<ChannelType>:FILTer:CCIT:STATe..... | 858 |
| [SENSe:]SFM:<ChannelType>:FILTer:COUPLing..... | 859 |
| [SENSe:]SFM:<ChannelType>:FILTer:DEMPhasis:STATe..... | 859 |

| | |
|--|-----|
| [SENSe:]SFM:<ChannelType>:FILTer:DEMPHasis:TCONstant..... | 860 |
| [SENSe:]SFM:<ChannelType>:FILTer:HPASs:FREQUency..... | 861 |
| [SENSe:]SFM:<ChannelType>:FILTer:HPASs:STATe..... | 860 |
| [SENSe:]SFM:<ChannelType>:FILTer:LPASs:FREQUency..... | 861 |
| [SENSe:]SFM:<ChannelType>:FILTer:LPASs:FREQUency:RELative..... | 862 |
| [SENSe:]SFM:<ChannelType>:FILTer:LPASs:FREQUency[:ABSolute]..... | 862 |
| [SENSe:]SFM:<ChannelType>:FILTer:LPASs:STATe..... | 861 |
| [SENSe:]SFM:<ChannelType>:RSUMmary:COUPLing..... | 862 |
| [SENSe:]SFM:<ChannelType>:RSUMmary:DETEctor[:FUNction]..... | 863 |
| [SENSe:]SFM:<ChannelType>:RSUMmary:MODE..... | 864 |
| [SENSe:]SFM:<ChannelType>:RSUMmary:REFereNce[:AUTO] ONCE..... | 864 |
| [SENSe:]SFM:<ChannelType>:TDOmain:RESult?..... | 865 |
| [SENSe:]SFM:<ChannelType>:TDOmain:TYPE..... | 865 |
| [SENSe:]SFM:FILTer<n>:AOFF..... | 856 |
| [SENSe:]SFM:REFereNce..... | 856 |
| [SENSe:]SFM:STATe..... | 856 |
| [SENSe:]SWEep:COUNT..... | 866 |
| [SENSe:]SWEep:COUNT:CURRent?..... | 866 |
| [SENSe:]SWEep:EGATE..... | 867 |
| [SENSe:]SWEep:EGATE:HOLDoff..... | 867 |
| [SENSe:]SWEep:EGATE:LENGth..... | 868 |
| [SENSe:]SWEep:EGATE:POLarity..... | 868 |
| [SENSe:]SWEep:EGATE:SOURce..... | 868 |
| [SENSe:]SWEep:EGATE:TRACe<k>: PERiod..... | 870 |
| [SENSe:]SWEep:EGATE:TRACe<k>: STOP<range>..... | 870 |
| [SENSe:]SWEep:EGATE:TRACe<k>:COMMeNt..... | 869 |
| [SENSe:]SWEep:EGATE:TRACe<k>:STARt<range>..... | 869 |
| [SENSe:]SWEep:EGATE:TRACe<k>[:STATe<range>]..... | 869 |
| [SENSe:]SWEep:EGATE:TYPE..... | 871 |
| [SENSe:]SWEep:MODE..... | 872 |
| [SENSe:]SWEep:POINts..... | 872 |
| [SENSe:]SWEep:TIME..... | 872 |
| [SENSe:]SWEep:TIME:AUTO..... | 873 |
| [SENSe:]SWEep:TYPE..... | 873 |
| [SENSe:]SWEep:TYPE:USED?..... | 873 |
| [SENSe<n>]:SWEep:FFT:WINDow:TYPE..... | 871 |
| *CAL?..... | 551 |
| *CLS..... | 551 |
| *ESE..... | 551 |
| *ESR?..... | 551 |
| *IDN?..... | 552 |
| *IST?..... | 552 |
| *OPC..... | 552 |
| *OPT?..... | 552 |
| *PCB..... | 552 |
| *PRE..... | 553 |
| *PSC..... | 553 |
| *RST..... | 553 |
| *SRE..... | 553 |
| *STB?..... | 554 |

| | |
|---|-----|
| *TRG..... | 554 |
| *TST?..... | 554 |
| *WAI..... | 554 |
| ABORT..... | 555 |
| CALCulate<n>:DELTamarker<m>:AOFF..... | 557 |
| CALCulate<n>:DELTamarker<m>:FUNction:BPOWer:MODE..... | 558 |
| CALCulate<n>:DELTamarker<m>:FUNction:BPOWer:RESult?..... | 558 |
| CALCulate<n>:DELTamarker<m>:FUNction:BPOWer:SPAN..... | 559 |
| CALCulate<n>:DELTamarker<m>:FUNction:BPOWer[:STATe]..... | 559 |
| CALCulate<n>:DELTamarker<m>:FUNction:FIXed:RPOint:MAXimum[:PEAK]..... | 560 |
| CALCulate<n>:DELTamarker<m>:FUNction:FIXed:RPOint:X..... | 560 |
| CALCulate<n>:DELTamarker<m>:FUNction:FIXed:RPOint:Y..... | 561 |
| CALCulate<n>:DELTamarker<m>:FUNction:FIXed:RPOint:Y:OFFSet..... | 561 |
| CALCulate<n>:DELTamarker<m>:FUNction:FIXed[:STATe]..... | 559 |
| CALCulate<n>:DELTamarker<m>:FUNction:PNOise:AUTO..... | 562 |
| CALCulate<n>:DELTamarker<m>:FUNction:PNOise:RESult?..... | 562 |
| CALCulate<n>:DELTamarker<m>:FUNction:PNOise[:STATe]..... | 561 |
| CALCulate<n>:DELTamarker<m>:LINK..... | 563 |
| CALCulate<n>:DELTamarker<m>:MAXimum:LEFT..... | 564 |
| CALCulate<n>:DELTamarker<m>:MAXimum:NEXT..... | 564 |
| CALCulate<n>:DELTamarker<m>:MAXimum:RIGHT..... | 565 |
| CALCulate<n>:DELTamarker<m>:MAXimum[:PEAK]..... | 564 |
| CALCulate<n>:DELTamarker<m>:MINimum:LEFT..... | 566 |
| CALCulate<n>:DELTamarker<m>:MINimum:NEXT..... | 567 |
| CALCulate<n>:DELTamarker<m>:MINimum:RIGHT..... | 566 |
| CALCulate<n>:DELTamarker<m>:MINimum[:PEAK]..... | 565 |
| CALCulate<n>:DELTamarker<m>:MODE..... | 563 |
| CALCulate<n>:DELTamarker<m>:MREF..... | 567 |
| CALCulate<n>:DELTamarker<m>:SGRam:FRAMe..... | 571 |
| CALCulate<n>:DELTamarker<m>:SGRam:SARea..... | 572 |
| CALCulate<n>:DELTamarker<m>:SGRam:XY:MAXimum[:PEAK]..... | 572 |
| CALCulate<n>:DELTamarker<m>:SGRam:XY:MINimum[:PEAK]..... | 573 |
| CALCulate<n>:DELTamarker<m>:SGRam:Y:MAXimum:ABOVe..... | 573 |
| CALCulate<n>:DELTamarker<m>:SGRam:Y:MAXimum:BELOW..... | 574 |
| CALCulate<n>:DELTamarker<m>:SGRam:Y:MAXimum:NEXT..... | 574 |
| CALCulate<n>:DELTamarker<m>:SGRam:Y:MAXimum[:PEAK]..... | 575 |
| CALCulate<n>:DELTamarker<m>:SGRam:Y:MINimum:ABOVe..... | 575 |
| CALCulate<n>:DELTamarker<m>:SGRam:Y:MINimum:BELOW..... | 576 |
| CALCulate<n>:DELTamarker<m>:SGRam:Y:MINimum:NEXT..... | 576 |
| CALCulate<n>:DELTamarker<m>:SGRam:Y:MINimum[:PEAK]..... | 577 |
| CALCulate<n>:DELTamarker<m>:TRACe..... | 567 |
| CALCulate<n>:DELTamarker<m>:X..... | 568 |
| CALCulate<n>:DELTamarker<m>:X:RELative?..... | 569 |
| CALCulate<n>:DELTamarker<m>:Y..... | 569 |
| CALCulate<n>:DELTamarker<m>:Z?..... | 571 |
| CALCulate<n>:DELTamarker<m>[:STATe]..... | 557 |
| CALCulate<n>:DLINe<k>..... | 577 |
| CALCulate<n>:DLINe<k>:STATe..... | 578 |
| CALCulate<n>:ESPectrum:PSEarch[:PEAKsearch[:IMMEdiate]..... | 578 |
| CALCulate<n>:ESPectrum:PSEarch[:PEAKsearch:AUTO..... | 578 |

| | |
|--|-----|
| CALCulate<n>:ESpectrum:PSEarch :PEAKsearch:MARGin..... | 579 |
| CALCulate<n>:ESpectrum:PSEarch :PEAKsearch:PSHow..... | 579 |
| CALCulate<n>:FEED..... | 705 |
| CALCulate<n>:FEED..... | 705 |
| CALCulate<n>:FLINe<k>..... | 579 |
| CALCulate<n>:FLINe<k>:STATe..... | 580 |
| CALCulate<n>:FORMat..... | 708 |
| CALCulate<n>:FORMat..... | 708 |
| CALCulate<n>:LIMit<k>:ACPowEr:ACHannel:ABSolute..... | 587 |
| CALCulate<n>:LIMit<k>:ACPowEr:ACHannel:ABSolute:STATe..... | 587 |
| CALCulate<n>:LIMit<k>:ACPowEr:ACHannel:RESult..... | 588 |
| CALCulate<n>:LIMit<k>:ACPowEr:ACHannel[:RELative]..... | 585 |
| CALCulate<n>:LIMit<k>:ACPowEr:ACHannel[:RELative]:STATe..... | 586 |
| CALCulate<n>:LIMit<k>:ACPowEr:ALTernate<Channel>:ABSolute..... | 590 |
| CALCulate<n>:LIMit<k>:ACPowEr:ALTernate<Channel>:ABSolute:STATe..... | 591 |
| CALCulate<n>:LIMit<k>:ACPowEr:ALTernate<Channel>:RESult?..... | 592 |
| CALCulate<n>:LIMit<k>:ACPowEr:ALTernate<channel>[:RELative]..... | 589 |
| CALCulate<n>:LIMit<k>:ACPowEr:ALTernate<Channel>[:RELative]:STATe..... | 590 |
| CALCulate<n>:LIMit<k>:ACPowEr[:STATe]..... | 585 |
| CALCulate<n>:LIMit<k>:ACTive?..... | 580 |
| CALCulate<n>:LIMit<k>:CLEar[:IMMediate]..... | 581 |
| CALCulate<n>:LIMit<k>:COMMeNt..... | 581 |
| CALCulate<n>:LIMit<k>:CONTRol:DOMain..... | 594 |
| CALCulate<n>:LIMit<k>:CONTRol:MODE..... | 594 |
| CALCulate<n>:LIMit<k>:CONTRol:OFFSet..... | 594 |
| CALCulate<n>:LIMit<k>:CONTRol:SHIFt..... | 595 |
| CALCulate<n>:LIMit<k>:CONTRol:SPACing..... | 595 |
| CALCulate<n>:LIMit<k>:CONTRol[:DATA]..... | 593 |
| CALCulate<n>:LIMit<k>:COPY..... | 581 |
| CALCulate<n>:LIMit<k>:DELeTe..... | 582 |
| CALCulate<n>:LIMit<k>:ESpectrum:LIMits..... | 596 |
| CALCulate<n>:LIMit<k>:ESpectrum:MODE..... | 596 |
| CALCulate<n>:LIMit<k>:ESpectrum:PCLass<Class>:COUNT..... | 597 |
| CALCulate<n>:LIMit<k>:ESpectrum:PCLass<Class>:LIMit[:STATe]..... | 598 |
| CALCulate<n>:LIMit<k>:ESpectrum:PCLass<Class>:MAXimum..... | 598 |
| CALCulate<n>:LIMit<k>:ESpectrum:PCLass<Class>:MINimum..... | 599 |
| CALCulate<n>:LIMit<k>:ESpectrum:PCLass<Class>[:EXCLusive]..... | 597 |
| CALCulate<n>:LIMit<k>:ESpectrum:RESTore..... | 599 |
| CALCulate<n>:LIMit<k>:ESpectrum:VALue..... | 599 |
| CALCulate<n>:LIMit<k>:FAIL?..... | 582 |
| CALCulate<n>:LIMit<k>:LOWer:MARGin..... | 601 |
| CALCulate<n>:LIMit<k>:LOWer:MODE..... | 601 |
| CALCulate<n>:LIMit<k>:LOWer:OFFSet..... | 601 |
| CALCulate<n>:LIMit<k>:LOWer:SHIFt..... | 602 |
| CALCulate<n>:LIMit<k>:LOWer:SPACing..... | 602 |
| CALCulate<n>:LIMit<k>:LOWer:STATe..... | 603 |
| CALCulate<n>:LIMit<k>:LOWer:THReShold..... | 603 |
| CALCulate<n>:LIMit<k>:LOWer[:DATA]..... | 600 |
| CALCulate<n>:LIMit<k>:NAME..... | 583 |
| CALCulate<n>:LIMit<k>:STATe..... | 583 |

| | |
|--|-----|
| CALCulate<n>:LIMit<k>:TRACe..... | 584 |
| CALCulate<n>:LIMit<k>:UNIT..... | 584 |
| CALCulate<n>:LIMit<k>:UPPer:MARGIn..... | 604 |
| CALCulate<n>:LIMit<k>:UPPer:MODE..... | 605 |
| CALCulate<n>:LIMit<k>:UPPer:OFFSet..... | 605 |
| CALCulate<n>:LIMit<k>:UPPer:SHIFt..... | 605 |
| CALCulate<n>:LIMit<k>:UPPer:SPACIng..... | 606 |
| CALCulate<n>:LIMit<k>:UPPer:STATe..... | 606 |
| CALCulate<n>:LIMit<k>:UPPer:THReshold..... | 606 |
| CALCulate<n>:LIMit<k>:UPPer[:DATA]..... | 604 |
| CALCulate<n>:MARKer:FUNCTion:ADEMod:AFRequency[:RESult<t>]?..... | 641 |
| CALCulate<n>:MARKer:FUNCTion:ADEMod:AM[:RESult<t>]?..... | 641 |
| CALCulate<n>:MARKer:FUNCTion:ADEMod:CARRier[:RESult<t>]?..... | 642 |
| CALCulate<n>:MARKer:FUNCTion:ADEMod:FERRor[:RESult<t>]?..... | 643 |
| CALCulate<n>:MARKer:FUNCTion:ADEMod:FM[:RESult<t>]?..... | 643 |
| CALCulate<n>:MARKer:FUNCTion:ADEMod:PM[:RESult<t>]?..... | 644 |
| CALCulate<n>:MARKer:FUNCTion:ADEMod:SINad:RESult<t>?..... | 645 |
| CALCulate<n>:MARKer:FUNCTion:ADEMod:THD:RESult<t>?..... | 645 |
| CALCulate<n>:MARKer:FUNCTion:DFD:SEARChsignal ONCE..... | 679 |
| CALCulate<n>:MARKer:FUNCTion:DFD:UNIT..... | 679 |
| CALCulate<n>:MARKer:FUNCTion:DFD[:RESult<m>]?..... | 679 |
| CALCulate<n>:MARKer:FUNCTion:DFD[:STATe]..... | 678 |
| CALCulate<n>:MARKer:FUNCTion:IMD:SEARChsignal ONCE..... | 681 |
| CALCulate<n>:MARKer:FUNCTion:IMD:UNIT..... | 680 |
| CALCulate<n>:MARKer:FUNCTion:IMD[:RESult<m>]?..... | 680 |
| CALCulate<n>:MARKer:FUNCTion:IMD[:STATe]..... | 680 |
| CALCulate<n>:MARKer:FUNCTion:SFM:<ChannelType>[:RESult<m>]?..... | 682 |
| CALCulate<n>:MARKer:FUNCTion:SFM[:RESult<m>]?..... | 681 |
| CALCulate<n>:MARKer<m>:AOFF..... | 608 |
| CALCulate<n>:MARKer<m>:COUNT..... | 608 |
| CALCulate<n>:MARKer<m>:COUNT:FREQuency?..... | 609 |
| CALCulate<n>:MARKer<m>:COUNT:RESolution..... | 610 |
| CALCulate<n>:MARKer<m>:FUNCTion:BPOWer:MODE..... | 623 |
| CALCulate<n>:MARKer<m>:FUNCTion:BPOWer:RESult?..... | 624 |
| CALCulate<n>:MARKer<m>:FUNCTion:BPOWer:SPAN..... | 624 |
| CALCulate<n>:MARKer<m>:FUNCTion:BPOWer[:STATe]..... | 624 |
| CALCulate<n>:MARKer<m>:FUNCTion:CENTer..... | 625 |
| CALCulate<n>:MARKer<m>:FUNCTion:CSTep..... | 625 |
| CALCulate<n>:MARKer<m>:FUNCTion:DEModulation:CONTInuous..... | 625 |
| CALCulate<n>:MARKer<m>:FUNCTion:DEModulation:HOLDoff..... | 626 |
| CALCulate<n>:MARKer<m>:FUNCTion:DEModulation:SElect..... | 626 |
| CALCulate<n>:MARKer<m>:FUNCTion:DEModulation[:STATe]..... | 627 |
| CALCulate<n>:MARKer<m>:FUNCTion:FPEaks:ANN:LAB:STAT..... | 628 |
| CALCulate<n>:MARKer<m>:FUNCTion:FPEaks:COUNT?..... | 629 |
| CALCulate<n>:MARKer<m>:FUNCTion:FPEaks:LIST:SIZE..... | 629 |
| CALCulate<n>:MARKer<m>:FUNCTion:FPEaks:SEAR:AUTO..... | 629 |
| CALCulate<n>:MARKer<m>:FUNCTion:FPEaks:SORT..... | 630 |
| CALCulate<n>:MARKer<m>:FUNCTion:FPEaks:STAT..... | 630 |
| CALCulate<n>:MARKer<m>:FUNCTion:FPEaks:X..... | 630 |
| CALCulate<n>:MARKer<m>:FUNCTion:FPEaks:Y?..... | 631 |

| | |
|--|-----|
| CALCulate<n>:MARKer<m>:FUNction:FPEaks[:IMMediate]..... | 627 |
| CALCulate<n>:MARKer<m>:FUNction:HARMonics:BANDwidth:AUTO..... | 646 |
| CALCulate<n>:MARKer<m>:FUNction:HARMonics:DISToRtion?..... | 647 |
| CALCulate<n>:MARKer<m>:FUNction:HARMonics:LIST?..... | 647 |
| CALCulate<n>:MARKer<m>:FUNction:HARMonics:NHARmonics..... | 648 |
| CALCulate<n>:MARKer<m>:FUNction:HARMonics:PRESet..... | 648 |
| CALCulate<n>:MARKer<m>:FUNction:HARMonics[:STATe]..... | 649 |
| CALCulate<n>:MARKer<m>:FUNction:MDEPth:RESult?..... | 632 |
| CALCulate<n>:MARKer<m>:FUNction:MDEPth:SEARChsignal ONCE..... | 632 |
| CALCulate<n>:MARKer<m>:FUNction:MDEPth[:STATe]..... | 632 |
| CALCulate<n>:MARKer<m>:FUNction:MSUMmary?..... | 666 |
| CALCulate<n>:MARKer<m>:FUNction:NDBDown..... | 633 |
| CALCulate<n>:MARKer<m>:FUNction:NDBDown:FREQuency?..... | 634 |
| CALCulate<n>:MARKer<m>:FUNction:NDBDown:QFACtor..... | 634 |
| CALCulate<n>:MARKer<m>:FUNction:NDBDown:RESult?..... | 635 |
| CALCulate<n>:MARKer<m>:FUNction:NDBDown:STATe..... | 635 |
| CALCulate<n>:MARKer<m>:FUNction:NDBDown:TIME?..... | 636 |
| CALCulate<n>:MARKer<m>:FUNction:NOISe:RESult..... | 637 |
| CALCulate<n>:MARKer<m>:FUNction:NOISe[:STATe]..... | 636 |
| CALCulate<n>:MARKer<m>:FUNction:PNOise..... | 638 |
| CALCulate<n>:MARKer<m>:FUNction:PNOise:RESult?..... | 637 |
| CALCulate<n>:MARKer<m>:FUNction:POWer:MODE..... | 650 |
| CALCulate<n>:MARKer<m>:FUNction:POWer:PRESet..... | 650 |
| CALCulate<n>:MARKer<m>:FUNction:POWer:RESult:PHZ..... | 654 |
| CALCulate<n>:MARKer<m>:FUNction:POWer:RESult?..... | 651 |
| CALCulate<n>:MARKer<m>:FUNction:POWer:SELEct..... | 654 |
| CALCulate<n>:MARKer<m>:FUNction:POWer:STANdard:CATalog?..... | 656 |
| CALCulate<n>:MARKer<m>:FUNction:POWer:STANdard:DELEte..... | 656 |
| CALCulate<n>:MARKer<m>:FUNction:POWer:STANdard:SAVE..... | 656 |
| CALCulate<n>:MARKer<m>:FUNction:POWer[:STATe]..... | 655 |
| CALCulate<n>:MARKer<m>:FUNction:REFerence..... | 638 |
| CALCulate<n>:MARKer<m>:FUNction:STRack:BANDwidth BWIDTH..... | 664 |
| CALCulate<n>:MARKer<m>:FUNction:STRack:THREShold..... | 664 |
| CALCulate<n>:MARKer<m>:FUNction:STRack:TRACe..... | 664 |
| CALCulate<n>:MARKer<m>:FUNction:STRack[:STATe]..... | 665 |
| CALCulate<n>:MARKer<m>:FUNction:SUMMary:AOFF..... | 667 |
| CALCulate<n>:MARKer<m>:FUNction:SUMMary:AVERAge..... | 667 |
| CALCulate<n>:MARKer<m>:FUNction:SUMMary:MEAN:AVERAge:RESult?..... | 668 |
| CALCulate<n>:MARKer<m>:FUNction:SUMMary:MEAN:PHOLd:RESult?..... | 669 |
| CALCulate<n>:MARKer<m>:FUNction:SUMMary:MEAN:RESult?..... | 669 |
| CALCulate<n>:MARKer<m>:FUNction:SUMMary:MEAN[:STATe]..... | 670 |
| CALCulate<n>:MARKer<m>:FUNction:SUMMary:MODE..... | 670 |
| CALCulate<n>:MARKer<m>:FUNction:SUMMary:PHOLd..... | 670 |
| CALCulate<n>:MARKer<m>:FUNction:SUMMary:PPEak:AVERAge:RESult?..... | 671 |
| CALCulate<n>:MARKer<m>:FUNction:SUMMary:PPEak:PHOLd:RESult?..... | 671 |
| CALCulate<n>:MARKer<m>:FUNction:SUMMary:PPEak:RESult?..... | 672 |
| CALCulate<n>:MARKer<m>:FUNction:SUMMary:PPEak[:STATe]..... | 672 |
| CALCulate<n>:MARKer<m>:FUNction:SUMMary:REFerence:AUTO ONCE..... | 673 |
| CALCulate<n>:MARKer<m>:FUNction:SUMMary:RMS:AVERAge:RESult?..... | 673 |
| CALCulate<n>:MARKer<m>:FUNction:SUMMary:RMS:PHOLd:RESult?..... | 674 |

| | |
|---|-----|
| CALCulate<n>:MARKer<m>:FUNction:SUMMary:RMS:RESult?..... | 674 |
| CALCulate<n>:MARKer<m>:FUNction:SUMMary:RMS[:STATe]..... | 675 |
| CALCulate<n>:MARKer<m>:FUNction:SUMMary:SDEVIation:AVERAge:RESult?..... | 675 |
| CALCulate<n>:MARKer<m>:FUNction:SUMMary:SDEVIation:PHOLd:RESult?..... | 676 |
| CALCulate<n>:MARKer<m>:FUNction:SUMMary:SDEVIation:RESult?..... | 677 |
| CALCulate<n>:MARKer<m>:FUNction:SUMMary:SDEVIation[:STATe]..... | 677 |
| CALCulate<n>:MARKer<m>:FUNction:SUMMary[:STATe]..... | 678 |
| CALCulate<n>:MARKer<m>:FUNction:TOI:RESult?..... | 639 |
| CALCulate<n>:MARKer<m>:FUNction:TOI:SEARChsignal ONCE..... | 639 |
| CALCulate<n>:MARKer<m>:FUNction:TOI[:STATe]..... | 640 |
| CALCulate<n>:MARKer<m>:FUNction:ZOOM..... | 640 |
| CALCulate<n>:MARKer<m>:LINK..... | 610 |
| CALCulate<n>:MARKer<m>:LOEXclude..... | 610 |
| CALCulate<n>:MARKer<m>:MAXimum:AUTO..... | 611 |
| CALCulate<n>:MARKer<m>:MAXimum:LEFT..... | 612 |
| CALCulate<n>:MARKer<m>:MAXimum:NEXT..... | 612 |
| CALCulate<n>:MARKer<m>:MAXimum:RIGHT..... | 613 |
| CALCulate<n>:MARKer<m>:MAXimum[:PEAK]..... | 611 |
| CALCulate<n>:MARKer<m>:MINimum:AUTO..... | 614 |
| CALCulate<n>:MARKer<m>:MINimum:LEFT..... | 614 |
| CALCulate<n>:MARKer<m>:MINimum:NEXT..... | 615 |
| CALCulate<n>:MARKer<m>:MINimum:RIGHT..... | 615 |
| CALCulate<n>:MARKer<m>:MINimum[:PEAK]..... | 613 |
| CALCulate<n>:MARKer<m>:PEXCursion..... | 616 |
| CALCulate<n>:MARKer<m>:SEARCh..... | 616 |
| CALCulate<n>:MARKer<m>:SGRam:FRAMe..... | 657 |
| CALCulate<n>:MARKer<m>:SGRam:SARea..... | 657 |
| CALCulate<n>:MARKer<m>:SGRam:XY:MAXimum[:PEAK]..... | 658 |
| CALCulate<n>:MARKer<m>:SGRam:XY:MINimum[:PEAK]..... | 658 |
| CALCulate<n>:MARKer<m>:SGRam:Y:MAXimum:ABOVE..... | 659 |
| CALCulate<n>:MARKer<m>:SGRam:Y:MAXimum:BELOW..... | 659 |
| CALCulate<n>:MARKer<m>:SGRam:Y:MAXimum:NEXT..... | 660 |
| CALCulate<n>:MARKer<m>:SGRam:Y:MAXimum[:PEAK]..... | 660 |
| CALCulate<n>:MARKer<m>:SGRam:Y:MINimum:ABOVE..... | 660 |
| CALCulate<n>:MARKer<m>:SGRam:Y:MINimum:BELOW..... | 661 |
| CALCulate<n>:MARKer<m>:SGRam:Y:MINimum:NEXT..... | 661 |
| CALCulate<n>:MARKer<m>:SGRam:Y:MINimum[:PEAK]..... | 662 |
| CALCulate<n>:MARKer<m>:SGRam:Y:TRIGger..... | 577 |
| CALCulate<n>:MARKer<m>:SGRam:Y:TRIGger..... | 662 |
| CALCulate<n>:MARKer<m>:TRACe..... | 617 |
| CALCulate<n>:MARKer<m>:X..... | 618 |
| CALCulate<n>:MARKer<m>:X:SLIMits:LEFT..... | 618 |
| CALCulate<n>:MARKer<m>:X:SLIMits:RIGHT..... | 619 |
| CALCulate<n>:MARKer<m>:X:SLIMits:ZOOM..... | 620 |
| CALCulate<n>:MARKer<m>:X:SLIMits[:STATe]..... | 618 |
| CALCulate<n>:MARKer<m>:X:SSIZe..... | 620 |
| CALCulate<n>:MARKer<m>:Y..... | 620 |
| CALCulate<n>:MARKer<m>:Y:PERCent..... | 622 |
| CALCulate<n>:MARKer<m>:Z?..... | 622 |
| CALCulate<n>:MARKer<m>[:STATe]..... | 608 |

| | |
|--|-----|
| CALCulate<n>:MASK:CDIRectory..... | 684 |
| CALCulate<n>:MASK:COMment..... | 684 |
| CALCulate<n>:MASK:DELeTe..... | 685 |
| CALCulate<n>:MASK:LOWer:SHIFt:X..... | 685 |
| CALCulate<n>:MASK:LOWer:SHIFt:Y..... | 685 |
| CALCulate<n>:MASK:LOWer[:DATA]..... | 686 |
| CALCulate<n>:MASK:LOWer[:STATe]..... | 685 |
| CALCulate<n>:MASK:MODE..... | 686 |
| CALCulate<n>:MASK:NAME..... | 686 |
| CALCulate<n>:MASK:SPAN..... | 687 |
| CALCulate<n>:MASK:UPPer:AUTO..... | 687 |
| CALCulate<n>:MASK:UPPer:SHIFt:X..... | 687 |
| CALCulate<n>:MASK:UPPer:SHIFt:Y..... | 687 |
| CALCulate<n>:MASK:UPPer[:DATA]..... | 688 |
| CALCulate<n>:MASK:UPPer[:STATe]..... | 688 |
| CALCulate<n>:MATH:MODE..... | 690 |
| CALCulate<n>:MATH:POSition..... | 689 |
| CALCulate<n>:MATH:STATe..... | 689 |
| CALCulate<n>:MATH[:EXPRession][:DEFine]..... | 688 |
| CALCulate<n>:PEAKsearch PSEarch:AUTO..... | 692 |
| CALCulate<n>:PEAKsearch PSEarch:MARGin..... | 692 |
| CALCulate<n>:PEAKsearch PSEarch:PSHow..... | 692 |
| CALCulate<n>:PEAKsearch PSEarch:SUBRanges..... | 693 |
| CALCulate<n>:PEAKsearch PSEarch[:IMMediate]..... | 692 |
| CALCulate<n>:PMETer<p>:RELative:STATe..... | 691 |
| CALCulate<n>:PMETer<p>:RELative[:MAGNitude]..... | 690 |
| CALCulate<n>:PMETer<p>:RELative[:MAGNitude]:AUTO ONCE..... | 691 |
| CALCulate<n>:SGRam:CLEAr[:IMMediate]..... | 693 |
| CALCulate<n>:SGRam:COLor..... | 694 |
| CALCulate<n>:SGRam:CONT..... | 694 |
| CALCulate<n>:SGRam:FRAMe:COUNT..... | 694 |
| CALCulate<n>:SGRam:FRAMe:SELeCt..... | 695 |
| CALCulate<n>:SGRam:HDEPth..... | 695 |
| CALCulate<n>:SGRam:TSTamp:DATA?..... | 696 |
| CALCulate<n>:SGRam:TSTamp[:STATe]..... | 696 |
| CALCulate<n>:SGRam:X:DATA?..... | 697 |
| CALCulate<n>:SGRam[:STATe]..... | 696 |
| CALCulate<n>:STATistics:APD[:STATe]..... | 698 |
| CALCulate<n>:STATistics:CCDF:X<Trace>..... | 698 |
| CALCulate<n>:STATistics:CCDF[:STATe]..... | 698 |
| CALCulate<n>:STATistics:NSAMples..... | 699 |
| CALCulate<n>:STATistics:PRESet..... | 699 |
| CALCulate<n>:STATistics:RESult<Trace>..... | 700 |
| CALCulate<n>:STATistics:SCALe:AUTO ONCE..... | 700 |
| CALCulate<n>:STATistics:SCALe:X:RANGe..... | 701 |
| CALCulate<n>:STATistics:SCALe:X:RLEVel..... | 701 |
| CALCulate<n>:STATistics:SCALe:Y:LOWer..... | 701 |
| CALCulate<n>:STATistics:SCALe:Y:UNIT..... | 702 |
| CALCulate<n>:STATistics:SCALe:Y:UPPer..... | 702 |
| CALCulate<n>:THReshold..... | 702 |

| | |
|---|-----|
| CALCulate<n>:THReshold:STATe..... | 703 |
| CALCulate<n>:TLINe<Line>..... | 703 |
| CALCulate<n>:TLINe<Line>:STATe..... | 703 |
| CALCulate<n>:UNIT:ANGLE..... | 704 |
| CALCulate<n>:UNIT:POWer..... | 704 |
| CALibration:ABORT..... | 925 |
| CALibration:PMETer<p>:ZERO:AUTO ONCE..... | 709 |
| CALibration:RESult?..... | 925 |
| CALibration:STATe..... | 926 |
| CALibration[:ALL]?..... | 925 |
| DIAGnostic<n>:SERVice:BIOSinfo?..... | 926 |
| DIAGnostic<n>:SERVice:HWINfo?..... | 927 |
| DIAGnostic<n>:SERVice:INPut:PULSed:CFRequency..... | 927 |
| DIAGnostic<n>:SERVice:INPut:PULSed:MCFRequency..... | 928 |
| DIAGnostic<n>:SERVice:INPut[:SELeCt]..... | 928 |
| DIAGnostic<n>:SERVice:NSource..... | 928 |
| DIAGnostic<n>:SERVice:SFUNction..... | 929 |
| DIAGnostic<n>:SERVice:SFUNction:LASTresult?..... | 929 |
| DIAGnostic<n>:SERVice:SFUNction:RESults:DELeTe..... | 929 |
| DIAGnostic<n>:SERVice:SFUNction:RESults:SAVE..... | 930 |
| DIAGnostic<n>:SERVice:STESt:RESult?..... | 930 |
| DIAGnostic<n>:SERVice:TEMPerature:FRONT?..... | 930 |
| DIAGnostic<n>:SERVice:VERSinfo?..... | 930 |
| DISPlay:ANNotation:FREquency..... | 932 |
| DISPlay:CMAP<item>:DEFault..... | 932 |
| DISPlay:CMAP<item>:HSL..... | 933 |
| DISPlay:CMAP<item>:PDEFined..... | 933 |
| DISPlay:LOGO..... | 934 |
| DISPlay:MTABLE..... | 710 |
| DISPlay:PSAVe:HOLDoff..... | 934 |
| DISPlay:PSAVe[:STATe]..... | 934 |
| DISPlay:SBAR[:STATe]..... | 935 |
| DISPlay:SKEYs[:STATe]..... | 935 |
| DISPlay:TBAR[STATe]..... | 935 |
| DISPlay:THEMe:CATalog?..... | 935 |
| DISPlay:THEMe:SELeCt..... | 935 |
| DISPlay:TOUCHscreen:STATe..... | 936 |
| DISPlay:WINDow:PSPectrum:COLor:DEFault..... | 724 |
| DISPlay:WINDow:PSPectrum:COLor:LOWer..... | 724 |
| DISPlay:WINDow:PSPectrum:COLor:SHAPE..... | 725 |
| DISPlay:WINDow:PSPectrum:COLor:TRUNcate..... | 725 |
| DISPlay:WINDow:PSPectrum:COLor:UPPer..... | 725 |
| DISPlay:WINDow:PSPectrum:COLor[:STYLe]..... | 725 |
| DISPlay:WINDow:SGRam:COLor:DEFault..... | 726 |
| DISPlay:WINDow:SGRam:COLor:LOWer..... | 726 |
| DISPlay:WINDow:SGRam:COLor:SHAPE..... | 726 |
| DISPlay:WINDow:SGRam:COLor:UPPer..... | 727 |
| DISPlay:WINDow:SGRam:COLor[:STYLe]..... | 726 |
| DISPlay:WINDow[:SUBWindow]:TRACe:MAXHold:RESet..... | 712 |
| DISPlay:WINDow[:SUBWindow]:TRACe:PERSiStence:GRANularity..... | 714 |

| | |
|---|-----|
| DISPlay:WINDow[:SUBWindow]:ZOOM:AREA..... | 714 |
| DISPlay:WINDow[:SUBWindow]:ZOOM:STATe | 715 |
| DISPlay:WINDow<n>[:SUBWindow<m>]:TRACe<t>:MAXHold[:STATe]..... | 713 |
| DISPlay:WINDow<n>[:SUBWindow<m>]:TRACe<t>:MAXHold[:INTensity]..... | 713 |
| DISPlay:WINDow<n>[:SUBWindow<m>]:TRACe<t>:PERSistence:DURation..... | 713 |
| DISPlay:WINDow<n>[:SUBWindow<m>]:TRACe<t>:PERSistence[:STATe]..... | 714 |
| DISPlay:WINDow<n>[:SUBWindow<m>]:TRACe<t>:SYMBOL..... | 714 |
| DISPlay:WSElect?..... | 723 |
| DISPlay[:WINDow<n>]:MINFo:STATe..... | 711 |
| DISPlay[:WINDow<n>]:SSElect?..... | 722 |
| DISPlay[:WINDow<n>]:STATe..... | 721 |
| DISPlay[:WINDow<n>]:TEXT:STATe..... | 936 |
| DISPlay[:WINDow<n>]:TEXT[:DATA]..... | 936 |
| DISPlay[:WINDow<n>]:TIME..... | 936 |
| DISPlay[:WINDow<n>]:TIME:FORMat..... | 937 |
| DISPlay[:WINDow<n>]:TRACe<t>:MODE..... | 716 |
| DISPlay[:WINDow<n>]:TRACe<t>:MODE:HCONTinuous..... | 716 |
| DISPlay[:WINDow<n>]:TRACe<t>:MODE:HCONTinuous..... | 719 |
| DISPlay[:WINDow<n>]:TRACe<t>:X:SPACing..... | 717 |
| DISPlay[:WINDow<n>]:TRACe<t>:Y:SPACing..... | 717 |
| DISPlay[:WINDow<n>]:TRACe<t>:Y[:SCALE]..... | 718 |
| DISPlay[:WINDow<n>]:TRACe<t>:Y[:SCALE]:MODE..... | 719 |
| DISPlay[:WINDow<n>]:TRACe<t>:Y[:SCALE]:RLEVel..... | 720 |
| DISPlay[:WINDow<n>]:TRACe<t>:Y[:SCALE]:RLEVel:OFFSet..... | 720 |
| DISPlay[:WINDow<n>]:TRACe<t>:Y[:SCALE]:RPOSition..... | 720 |
| DISPlay[:WINDow<n>]:TRACe<t>:Y[:SCALE]:RVALue..... | 721 |
| DISPlay[:WINDow<n>]:TRACe<t>:Y[:SCALE]:RVALue..... | 721 |
| DISPlay[:WINDow<n>]:TRACe<t>[:STATe]..... | 715 |
| DISPlay[:WINDow<n>]:ZOOM:AREA..... | 723 |
| DISPlay[:WINDow<n>]:ZOOM:STATe..... | 724 |
| DISPlay[:WINDow<n>][:SUBWindow<1 2>]:SElect..... | 722 |
| DISPlay[:WINDow<n>][:SUBWindow<m>]:SElect..... | 712 |
| DISPlay[:WINDow<n>][:SUBWindow<m>]:SIZE..... | 711 |
| FETCh<n>:PMETer<p>?..... | 728 |
| FORMat:DEXPort:DSEParator..... | 728 |
| FORMat[:DATA]..... | 939 |
| HCOPY:ABORt..... | 939 |
| HCOPY:CMAP<item>:DEFault..... | 940 |
| HCOPY:CMAP<item>:HSL..... | 940 |
| HCOPY:CMAP<item>:PDEFined..... | 941 |
| HCOPY:DEStination<1 2>..... | 941 |
| HCOPY:DEVice:COLor..... | 942 |
| HCOPY:DEVice:LANGUage<1 2>..... | 942 |
| HCOPY:ITEM:ALL..... | 944 |
| HCOPY:ITEM:WINDow:TABLe:STATe..... | 944 |
| HCOPY:ITEM:WINDow:TEXT..... | 944 |
| HCOPY:PAGE:ORlentation<1 2>..... | 945 |
| HCOPY:TDSamp:STATe<1 2>..... | 945 |
| HCOPY[:IMMEDIATE<1 2>]..... | 943 |
| HCOPY[:IMMEDIATE<1 2>]:NEXT..... | 943 |

| | |
|------------------------------------|-----|
| INITiate<n>:CONMeas..... | 729 |
| INITiate<n>:CONTinuous..... | 730 |
| INITiate<n>:DISPlay..... | 730 |
| INITiate<n>:ESpectrum..... | 731 |
| INITiate<n>:SPURious..... | 731 |
| INITiate<n>[:IMMEDIATE]..... | 729 |
| INPut:ATTenuation..... | 732 |
| INPut:ATTenuation:AUTO..... | 732 |
| INPut:COUPling..... | 732 |
| INPut:DIQ:CDEvice..... | 733 |
| INPut:DIQ:RANGe:COUPling..... | 734 |
| INPut:DIQ:RANGe[:UPPer]..... | 734 |
| INPut:DIQ:RANGe[:UPPer]:UNIT..... | 735 |
| INPut:DIQ:SRATe..... | 735 |
| INPut:EATT..... | 736 |
| INPut:EATT:AUTO..... | 736 |
| INPut:EATT:STATe..... | 736 |
| INPut:FILTer:YIG[:STATe]..... | 737 |
| INPut:GAIN:STATe..... | 737 |
| INPut:IMPedance..... | 737 |
| INPut:SElect..... | 738 |
| INPut:UPORt:STATe..... | 738 |
| INPut:UPORt?..... | 738 |
| INSTRument:CREate[:NEW]..... | 740 |
| INSTRument:DELeTe..... | 740 |
| INSTRument:NSElect..... | 741 |
| INSTRument[:SElect]..... | 739 |
| MMEMory:CATalog:LONG?..... | 947 |
| MMEMory:CATalog?..... | 946 |
| MMEMory:CDIRectory..... | 948 |
| MMEMory:CLEar:ALL..... | 948 |
| MMEMory:CLEar:STATe 1..... | 948 |
| MMEMory:COMMeNt..... | 949 |
| MMEMory:COpy..... | 949 |
| MMEMory:DATA..... | 950 |
| MMEMory:DELeTe..... | 950 |
| MMEMory:LOAD:AUTO..... | 951 |
| MMEMory:LOAD:IQ:STATe..... | 741 |
| MMEMory:LOAD:STATe..... | 951 |
| MMEMory:MDIRectory..... | 952 |
| MMEMory:MOVE..... | 952 |
| MMEMory:MSIS..... | 953 |
| MMEMory:NAME..... | 953 |
| MMEMory:NETWork:DISConnect..... | 954 |
| MMEMory:NETWork:MAP..... | 954 |
| MMEMory:NETWork:UNUSeddrives?..... | 954 |
| MMEMory:NETWork:USEDdrives?..... | 955 |
| MMEMory:RDIRectory..... | 955 |
| MMEMory:SElect[:ITEM]:ALL..... | 955 |
| MMEMory:SElect[:ITEM]:DEFault..... | 955 |

| | |
|---|-----|
| MMEMory:SElect[:ITEM]:HWSettings..... | 956 |
| MMEMory:SElect[:ITEM]:LINES:ALL..... | 956 |
| MMEMory:SElect[:ITEM]:NONE..... | 956 |
| MMEMory:SElect[:ITEM]:SGRam..... | 956 |
| MMEMory:SElect[:ITEM]:TRACe[:ACTive]..... | 957 |
| MMEMory:SElect[:ITEM]:TRANsducer:ALL..... | 957 |
| MMEMory:STORe:IQ:COMM..... | 742 |
| MMEMory:STORe:IQ:STATe..... | 742 |
| MMEMory:STORe:SGRam..... | 743 |
| MMEMory:STORe<n>:LIST..... | 742 |
| MMEMory:STORe<n>:PEAK..... | 743 |
| MMEMory:STORe<n>:SPURious..... | 743 |
| MMEMory:STORe<n>:STATe..... | 957 |
| MMEMory:STORe<n>:STATe:NEXT..... | 958 |
| MMEMory:STORe<n>:TRACe..... | 744 |
| MMEMory:USER<Softkey>..... | 958 |
| OUTPut:DIQ..... | 744 |
| OUTPut:DIQ:CDEvice..... | 745 |
| OUTPut:IF[:SOURce]..... | 959 |
| OUTPut:TRIGger..... | 959 |
| OUTPut:UPORt..... | 746 |
| OUTPut:UPORt:STATe..... | 746 |
| PROBe:ID:PARTnumber?..... | 747 |
| PROBe:ID:SRNumber?..... | 747 |
| PROBe:SETup:MODE..... | 747 |
| PROBe:SETup:NAME?..... | 747 |
| PROBe:SETup:STATe?..... | 747 |
| PROBe[:STATe]..... | 748 |
| READ<n>:PMETer<p>?..... | 748 |
| SOURce:EXTErnal<1 2>:ROSCillator: EXTErnal:FREQUency..... | 963 |
| SOURce<n>:TEMPerature:APRObe..... | 964 |
| STATus:OPERation:CONDition..... | 965 |
| STATus:OPERation:ENABLE..... | 966 |
| STATus:OPERation:NTRansition..... | 966 |
| STATus:OPERation:PTRansition..... | 966 |
| STATus:OPERation[:EVENT]..... | 965 |
| STATus:PRESet..... | 966 |
| STATus:QUEStionable:ACPLimit:CONDition?..... | 876 |
| STATus:QUEStionable:ACPLimit:ENABLE..... | 876 |
| STATus:QUEStionable:ACPLimit:NTRansition..... | 877 |
| STATus:QUEStionable:ACPLimit:PTRansition..... | 877 |
| STATus:QUEStionable:ACPLimit[:EVENT]?..... | 876 |
| STATus:QUEStionable:CONDition..... | 967 |
| STATus:QUEStionable:DIQ:CONDition?..... | 877 |
| STATus:QUEStionable:DIQ:ENABLE..... | 878 |
| STATus:QUEStionable:DIQ:NTRansition..... | 878 |
| STATus:QUEStionable:DIQ:PTRansition..... | 878 |
| STATus:QUEStionable:DIQ[:EVENT]?..... | 877 |
| STATus:QUEStionable:ENABLE..... | 967 |
| STATus:QUEStionable:FREQUency:CONDition?..... | 878 |

| | |
|--|-----|
| STATus:QUESTionable:FREQuency:ENABle..... | 878 |
| STATus:QUESTionable:FREQuency:NTRansition..... | 879 |
| STATus:QUESTionable:FREQuency:PTRansition..... | 879 |
| STATus:QUESTionable:FREQuency[:EVENT]? | 879 |
| STATus:QUESTionable:LIMit<m> [:EVENT]? | 879 |
| STATus:QUESTionable:LIMit<m>:CONDition? | 880 |
| STATus:QUESTionable:LIMit<m>:ENABle..... | 880 |
| STATus:QUESTionable:LIMit<m>:NTRansition..... | 880 |
| STATus:QUESTionable:LIMit<m>:PTRansition..... | 881 |
| STATus:QUESTionable:LMARgin<m>:CONDition? | 881 |
| STATus:QUESTionable:LMARgin<m>:ENABle..... | 882 |
| STATus:QUESTionable:LMARgin<m>:NTRansition..... | 882 |
| STATus:QUESTionable:LMARgin<m>:PTRansition..... | 883 |
| STATus:QUESTionable:LMARgin<m>[:EVENT]? | 881 |
| STATus:QUESTionable:NTRansition..... | 968 |
| STATus:QUESTionable:POWer:CONDition? | 883 |
| STATus:QUESTionable:POWer:ENABle..... | 883 |
| STATus:QUESTionable:POWer:NTRansition..... | 884 |
| STATus:QUESTionable:POWer:PTRansition..... | 884 |
| STATus:QUESTionable:POWer[:EVENT]? | 883 |
| STATus:QUESTionable:PTRansition..... | 967 |
| STATus:QUESTionable:SYNC:CONDition? | 884 |
| STATus:QUESTionable:SYNC:ENABle..... | 885 |
| STATus:QUESTionable:SYNC:NTRansition..... | 885 |
| STATus:QUESTionable:SYNC:PTRansition..... | 885 |
| STATus:QUESTionable:SYNC[:EVENT]? | 884 |
| STATus:QUESTionable:TIME:CONDition? | 885 |
| STATus:QUESTionable:TIME:ENABle..... | 886 |
| STATus:QUESTionable:TIME:NTRansition..... | 886 |
| STATus:QUESTionable:TIME:PTRansition..... | 886 |
| STATus:QUESTionable:TIME[:EVENT]? | 886 |
| STATus:QUESTionable[:EVENT]? | 967 |
| STATus:QUEEue[:NEXT]? | 968 |
| SYSTem:APPLication:SRECoverY[:STATe]..... | 969 |
| SYSTem:CLOGging..... | 969 |
| SYSTem:COMMunicate:GPIB[:SELF]:ADDReSS..... | 970 |
| SYSTem:COMMunicate:GPIB[:SELF]:RTERminator..... | 970 |
| SYSTem:COMMunicate:PRINter:ENUMerate:FIRSt? | 970 |
| SYSTem:COMMunicate:PRINter:ENUMerate[:NEXT]? | 971 |
| SYSTem:COMMunicate:PRINter:SElect <1 2>..... | 971 |
| SYSTem:COMMunicate:RDEvice:PMETer<p>:CONFigure:AUTO[:STATe]..... | 888 |
| SYSTem:COMMunicate:RDEvice:PMETer<p>:COUNt? | 888 |
| SYSTem:COMMunicate:RDEvice:PMETer<p>:DEFine..... | 887 |
| SYSTem:COMMunicate:TCPip:CONTRol? | 971 |
| SYSTem:COMPAtible..... | 972 |
| SYSTem:DATE..... | 972 |
| SYSTem:DEvice:ID?/SYSTem:DID?..... | 972 |
| SYSTem:DISPlay:FPANel..... | 972 |
| SYSTem:DISPlay:UPDate..... | 973 |
| SYSTem:ERRor:CLEar:ALL..... | 973 |

| | |
|---------------------------------------|-----|
| SYSTem:ERRor:LIST?..... | 973 |
| SYSTem:ERRor[:NEXT]?..... | 973 |
| SYSTem:FIRMware:UPDate..... | 974 |
| SYSTem:FORMat:IDENT..... | 974 |
| SYSTem:HPCoupling..... | 974 |
| SYSTem:IDENtify:FACTory..... | 975 |
| SYSTem:IDENtify[:STRing]..... | 975 |
| SYSTem:IFGain:MODE..... | 976 |
| SYSTem:KLOCK..... | 976 |
| SYSTem:LANGuage..... | 976 |
| SYSTem:LXI:INFo?..... | 977 |
| SYSTem:LXI:LANReset..... | 977 |
| SYSTem:LXI:MDEScription..... | 977 |
| SYSTem:LXI:PASSword..... | 977 |
| SYSTem:PASSword:RESet..... | 978 |
| SYSTem:PASSword[:CENable]..... | 978 |
| SYSTem:PRESet..... | 978 |
| SYSTem:PSA:WIDeband..... | 978 |
| SYSTem:REBoot..... | 979 |
| SYSTem:REVisiOn:FACTory..... | 979 |
| SYSTem:REVisiOn[:STRing]..... | 979 |
| SYSTem:RSW..... | 980 |
| SYSTem:SHUTdown..... | 980 |
| SYSTem:SPEaker:VOLume..... | 888 |
| SYSTem:TIME..... | 980 |
| SYSTem:TIME:TSTamp?..... | 888 |
| SYSTem:VERSion?..... | 981 |
| TRACe<n>:COPY..... | 889 |
| TRACe<n>:IQ:AVERAge:COUNT..... | 895 |
| TRACe<n>:IQ:AVERAge[:STATe]..... | 895 |
| TRACe<n>:IQ:BWIDth..... | 896 |
| TRACe<n>:IQ:DATA..... | 896 |
| TRACe<n>:IQ:DATA:FORMat..... | 897 |
| TRACe<n>:IQ:DATA:MEMory?..... | 899 |
| TRACe<n>:IQ:DIQFilter..... | 900 |
| TRACe<n>:IQ:EGATe..... | 901 |
| TRACe<n>:IQ:EGATe:GAP..... | 901 |
| TRACe<n>:IQ:EGATe:LENGth..... | 901 |
| TRACe<n>:IQ:EGATe:NOFGateperiods..... | 902 |
| TRACe<n>:IQ:EGATe:TYPE..... | 902 |
| TRACe<n>:IQ:EVAL..... | 902 |
| TRACe<n>:IQ:RELEngth..... | 903 |
| TRACe<n>:IQ:SET..... | 904 |
| TRACe<n>:IQ:SRATe..... | 906 |
| TRACe<n>:IQ:TPISample?..... | 906 |
| TRACe<n>:IQ[:STATe]..... | 895 |
| TRACe<n>[:DATA]..... | 892 |
| TRACe<n>[:DATA]:MEMory?..... | 893 |
| TRACe<n>[:DATA]:X?..... | 893 |
| TRACe<n>[:DATA]?..... | 889 |

| | |
|--|-----|
| TRIGger:MODE..... | 908 |
| TRIGger<n>[:SEQuence]:BBPower:HOLDoff..... | 909 |
| TRIGger<n>[:SEQuence]:HOLDoff[:TIME]..... | 908 |
| TRIGger<n>[:SEQuence]:IFPower:HOLDoff..... | 909 |
| TRIGger<n>[:SEQuence]:IFPower:HYSTeresis..... | 909 |
| TRIGger<n>[:SEQuence]:LEVel:AM:RELative..... | 910 |
| TRIGger<n>[:SEQuence]:LEVel:AM[:ABSolute]..... | 910 |
| TRIGger<n>[:SEQuence]:LEVel:BBPower..... | 910 |
| TRIGger<n>[:SEQuence]:LEVel:FM..... | 911 |
| TRIGger<n>[:SEQuence]:LEVel:IFPower..... | 911 |
| TRIGger<n>[:SEQuence]:LEVel:PM..... | 912 |
| TRIGger<n>[:SEQuence]:LEVel:RFPower..... | 912 |
| TRIGger<n>[:SEQuence]:LEVel:SFM:LEFT..... | 916 |
| TRIGger<n>[:SEQuence]:LEVel:SFM:MONO..... | 917 |
| TRIGger<n>[:SEQuence]:LEVel:SFM:MPX..... | 916 |
| TRIGger<n>[:SEQuence]:LEVel:SFM:PILot..... | 918 |
| TRIGger<n>[:SEQuence]:LEVel:SFM:RDS..... | 918 |
| TRIGger<n>[:SEQuence]:LEVel:SFM:RIGHT..... | 916 |
| TRIGger<n>[:SEQuence]:LEVel:SFM:STEReo..... | 917 |
| TRIGger<n>[:SEQuence]:LEVel:VIDeo..... | 912 |
| TRIGger<n>[:SEQuence]:LEVel[:EXTernal]..... | 911 |
| TRIGger<n>[:SEQuence]:MASK:CONDition..... | 913 |
| TRIGger<n>[:SEQuence]:SLOPe..... | 913 |
| TRIGger<n>[:SEQuence]:SOURce..... | 913 |
| TRIGger<n>[:SEQuence]:SOURce..... | 918 |
| TRIGger<n>[:SEQuence]:TDTRigger:LEVel..... | 915 |
| TRIGger<n>[:SEQuence]:TIME:RINTerval..... | 915 |
| UNIT:ADEV..... | 921 |
| UNIT:ANGLE..... | 921 |
| UNIT:POWer..... | 922 |
| UNIT:RDEV..... | 922 |
| UNIT:THD..... | 921 |
| UNIT:THD..... | 922 |
| UNIT<n>:PMETer<p>:POWer..... | 920 |
| UNIT<n>:PMETer<p>:POWer:RATio..... | 920 |
| UNIT<n>:POWer..... | 920 |

Index

Symbols

| | |
|------------------------------|--------|
| *OPC | 529 |
| *OPC? | 529 |
| *RST | 546 |
| *WAI | 529 |
| 1xEV-DO BTS mode (K84) | 13 |
| 3G FDD BTS mode (K72) | 12, 13 |

A

| | |
|---|--------------------|
| A Weighted | |
| Softkey | 340, 362, 396, 411 |
| Abs. Dev Unit | |
| softkey | 343, 399, 400, 405 |
| ACLR | |
| absolute limit | 172 |
| adjacent channel name (remote control) | 849 |
| alternate channel name (remote control) | 850 |
| Channel Bandwidth | 168 |
| channel name (remote control) | 850 |
| channel names | 170 |
| Channel Spacing | 169 |
| limit check | 171 |
| Limit Checking | 171 |
| number of channels | 167 |
| reference | 169 |
| relative limit | 172 |
| Weighting Filter | 170 |
| ACLR User Standard | 174 |
| Delete | 175 |
| Load | 175 |
| Save | 175 |
| Acquisition time | |
| Statistics | 228 |
| ACT | |
| Statistics | 228 |
| Active probes | |
| Activating | 270, 385 |
| Configuring | 275 |
| Connecting | 274 |
| State | 276 |
| Using | 273 |
| AF Auto Scale | |
| softkey | 359 |
| AF diagram | 336 |
| K7 | 390 |
| AF Full Span | |
| softkey | 350 |
| AF Spectrum (analog demodulation) | 328 |
| AF Time Domain (analog demodulation) | 328 |
| AF trigger (K7) | 323 |
| Alignment | |
| Results | 433 |
| Touch screen | 433 |
| All AF Filter Off | |
| softkey | 341, 363, 397, 412 |
| AM | |
| softkey | 372 |
| AM demodulation | 132 |
| AM modulation | |
| depth | 251 |
| Depth | 154 |

| | |
|---|-------------------|
| AM Modulation depth | |
| Measurement | 251 |
| Results | 251 |
| Amplitude | |
| electronic attenuation | 74 |
| Menu | 67 |
| option B25 | 74 |
| Amplitude distribution | 227 |
| Amplitude menu | |
| analog demodulation | 351 |
| K7 | 402 |
| AMPT key | 67 |
| analog demodulation | 318 |
| AF trigger (K7) | 323 |
| bandwidth (K7) | 320 |
| circuit description (K7) | 318 |
| measurement results (analog demodulation) | 324 |
| measurement time (analog demodulation) | 325 |
| sample rate (analog demodulation) | 325 |
| trigger offset (analog demodulation) | 325 |
| Analog demodulation | 11 |
| Analog Demodulation menu (K7) | 334 |
| Analysis | |
| Bandwidth, definition | 303, 424 |
| Annotation | 441 |
| ASCII Trace export | 107, 333 |
| attenuation | |
| (option B25) | 71, 355, 407 |
| Attenuation | |
| (option B25) | 71, 355, 406 |
| Automatic | 71, 354, 406 |
| Manual | 70, 354, 406, 732 |
| Option B25 | 70, 354, 406 |
| Audio demodulation | |
| volume (remote control) | 888 |
| Auto adjustment | |
| triggered measurement | 778 |
| Auto ID | |
| External Mixer (B21, remote control) | 832 |
| External Mixer (B21) | 491 |
| Softkey | 503 |
| Auto ID Threshold | |
| External Mixer (B21, remote control) | 833 |
| Softkey | 504 |
| Auto level | |
| Hysteresis | 77, 358 |
| Auto Level | |
| Baseband Digital | 282 |
| Auto Peak detector | 106, 324 |
| AUTO SET key | 75 |
| Auto Set menu | 357 |
| Average detector | 106, 324 |
| Average trace mode | 95, 104, 323, 367 |
| averaging | |
| continuous sweep | 105 |
| single sweep | 105 |
| sweep count | 105 |

B

| | |
|--------------------------------------|-------------------|
| Band | |
| Conversion Loss Table (B21) | 499 |
| External Mixer (B21, remote control) | 828, 829 |
| External Mixer (B21) | 495, 496 |
| Band Power | |
| remote control | 559, 624 |
| softkey | 136, 300, 301 |
| bandwidth | |
| resolution (analog demodulation) | 359, 408 |
| Bandwidth | |
| Maximum usable | 302, 424 |
| Menu | 79 |
| Occupied | 182 |
| Resolution | 80, 115 |
| Video | 80 |
| Bandwidth menu | |
| analog demodulation | 359 |
| K7S | 408 |
| Baseband power | |
| Trigger mode | 111, 293 |
| Bias | |
| Conversion Loss Table (B21) | 499 |
| External Mixer (B21, remote control) | 826, 827 |
| external mixers (B21) | 489 |
| Bias Settings | |
| Conversion Loss Table (B21) | 502 |
| Softkey | 502 |
| Blank trace mode | 95, 105, 323, 367 |
| Bluetooth mode (K8) | 11 |
| Boolean parameters | 524 |
| BW key | 79 |

C

| | |
|---------------------------|-------------------------|
| Calibration | |
| Remote | 551 |
| Capture mode | 365 |
| Capture time | 365 |
| Case-sensitivity | |
| SCPI | 520 |
| CCIR | |
| Softkey | 340, 361, 362, 396, 410 |
| CCIT | |
| Softkey | 339, 361, 396, 410 |
| CDMA2000 BTS mode (K82) | 13 |
| CDMA2000 MS mode (K83) | 13 |
| Center frequency | 60, 347 |
| Step size | 60 |
| channel | |
| bandwidth | 168, 185 |
| number | 167 |
| spacing | 169 |
| Channel | |
| Bandwidth | 181, 287 |
| Channel Power | |
| Configuring | 161 |
| Fast ACLR | 157 |
| Measurement Repeatability | 157 |
| Measurements | 155 |
| Methods | 156 |
| Performing | 161 |
| Results | 159 |
| Characters | |
| Special | 549 |

| | |
|--------------------------------------|-------------------|
| Clear status | |
| Remote | 551 |
| Clear Write trace mode | 94, 104, 322, 366 |
| CNT (marker functions) | 126 |
| Colon | 525 |
| Color curve | 32 |
| Color Mapping | 29 |
| Color printout | 443 |
| Color scheme | 30 |
| Color settings | |
| Default | 442 |
| Color Setup dialog box | 443 |
| Comma | 525 |
| Command sequence | |
| recommendation | 546 |
| Remote | 554 |
| Commands | 510 |
| Colon | 525 |
| Comma | 525 |
| Command line structure | 525 |
| Common | 510 |
| Description | 548 |
| Double dagger | 525 |
| GBIP, addressed | 517 |
| GBIP, universal | 517 |
| Instrument control | 510 |
| Overlapping | 527 |
| Question mark | 525 |
| Quotation mark | 525 |
| SCPI confirmed | 510 |
| Sequential | 527 |
| Syntax elements | 525 |
| Tracking | 439 |
| White space | 525 |
| CommandS | |
| Programming examples | 1015 |
| Common commands | |
| Syntax | 519 |
| CONDition | 531 |
| Connector | |
| OCXO | 429 |
| Continuous sweep | 89, 364 |
| Continuous Value Update | |
| Softkey | 312 |
| Controller | 508 |
| Conversion Loss | |
| External Mixer (B21, remote control) | 831 |
| Conversion Loss tables | 498, 501 |
| Available (remote control) | 786 |
| Band (remote control) | 786 |
| Bias (remote control) | 788 |
| Configuring (B21) | 498 |
| Deleting (remote control) | 789 |
| External Mixer (B21, remote control) | 831 |
| External Mixer (B21) | 497 |
| External mixers (B21) | 489 |
| Harmonic order (remote control) | 787 |
| mixer type (remote control) | 788 |
| Selecting (remote control) | 786 |
| Correction | |
| inherent noise | 72, 175 |
| Coupled | |
| Result Summary Setup (K7S) | 393, 397 |
| coupling | |
| default settings | 85 |

- Coupling
 - Resolution bandwidth 80
 - Sweep time 82, 90
 - Video bandwidth 81
- create folder 455
- D**
- Data Acquisition
 - Softkey 282
- Date 441
- DCL 517
- DEF 523
- Default color settings 442
- default scalings of x- and y-axis 235, 241
- Default values
 - Remote 553
- definition of transducer factors 1038
- delay
 - gate signal 115
- Delta markers 119
- Demod Filter
 - Gaussian 363
 - softkey 363
- Demodulation
 - Offset 366
- demodulation bandwidth (K7) 320
- Density
 - remote control 558, 559, 623, 624
 - softkey 136, 301
- detector
 - overview 106, 324
- Detector
 - Auto Peak 97, 369
 - Autoselect 96, 368
 - Average 97, 369
 - CISPR Average 97, 369
 - K7S 393
 - Negative Peak 97, 369
 - Positive Peak 97, 369
 - Quasi Peak 97, 369
 - RMS 97, 369
 - RMS Average 98, 370
 - Sample 97, 369
- Device ID 445
- Device-specific commands 510
- Diagram title 441
- Diff.Freq. Distortion
 - remote control 678
 - softkey 417
- Diff.Freq.Distortion (On/Off)
 - softkey 418
- DigIConf
 - Softkey 272, 281, 387, 482
- Digital Baseband Info
 - Remote control 745
- Digital IQ data
 - device 270, 280, 385, 479
- Digital IQ Info
 - Remote control 733
 - Softkey 273, 286, 388, 480
- Digital Output
 - Enabling 272, 285, 387, 480
 - Softkey 272, 285, 387, 480
- Display
 - Date 441
 - maximized 711
 - Power-save mode 444
 - split 711
 - Time 441
- Display Config
 - Softkey 284
- display configuration
 - analog demodulation 327
 - K7 390
 - K7S 330
- Display configuration 336
- Display lines 260, 261
- display range
 - level 68, 69, 232, 233, 234, 239, 240, 288, 289, 290, 352, 353
- Display range
 - Frequency 60, 347
- display settings
 - Softkey Bar State (remote control) 935
 - Status Bar State (remote control) 935
- Double dagger 525
- DOWN 523
- Dynamic range
 - Intermodulation-free 248
 - Measuring 253
- E**
- Edit Limit Line dialog box 264, 267
- Electronic attenuator
 - option B25 74
 - setting 74
- Electronic input attenuation
 - FSV-B25 736
- ENABLE 531
- Enable registers
 - Remote 553
- error messages
 - device-specific 1060
- Error messages 1060
- Error queues
 - recommendations 546
- ESE (Event Status Enable register) 535
- ESR (Event Status Register) 530, 535
- EVENT 531
- Event status enable register (ESE)
 - Remote 551
- Event Status Enable register (ESE) 535
- Event status register (ESR)
 - Remote 551
- Event Status Register (ESR) 535
- EX-IQ-BOX 271, 280, 386, 471, 481
 - DigIConf 272, 281, 387, 482
- Export
 - I/Q data (remote) 742
- export format 107, 333
- Exporting
 - I/Q data (remote) 742
- External Mixer (B21) 487
 - activating (remote control) 826, 827
 - Band 495
 - band settings 495, 828
 - Band settings 495
 - Bias current 489
 - configuration 494
 - Conversion Loss 497
 - Conversion Loss Tables 489, 498, 501
 - General information 488

- Handover frequency 495
 - Harmonic Order 496
 - Harmonic Type 496
 - Measurement example 504
 - Preset Band 496
 - Range 496
 - remote control 785, 826
 - RF Overrange 496
 - RF Start 495
 - RF Stop 495
 - softkey 270, 385
 - Softkey 63, 494
 - Type 496
 - External Mixer Config
 - Softkey 494
 - external noise source 269, 384
 - external trigger 110, 292
- F**
- Fast ACLR 157
 - FFT Filter Mode
 - Auto 78, 83, 91
 - Narrow 79, 83, 91
 - softkey 78, 83, 91
 - FFT window 45
 - file
 - copying 455
 - deleting 455
 - renaming 455
 - File Manager dialog box 454
 - Filter
 - Digital I/Q (remote control) 900
 - Filter bandwidth
 - Baseband Digital 283
 - Digital I/Q (remote control) 896
 - Filter types
 - 5-Pole 85
 - Normal (3dB) 85
 - RRC 85
 - Filters
 - A Weighted 340, 362, 396, 411
 - Baseband Digital 283
 - I/Q data 283
 - Overview 86
 - Selecting 85
 - Types 85
 - Firmware
 - Version 445
 - fixed reference 131, 379, 416
 - FM
 - softkey 372
 - FM demodulation 132
 - FM Stereo mode (K7S) 11
 - folder
 - renaming 455
 - FREQ key 59
 - frequency
 - line 262
 - offset 62
 - start 62
 - stop 62
 - Frequency
 - Axis 59
 - Center 60, 347
 - Display 441
 - Lines 261
 - Frequency mask trigger 49
 - Frequency menu 60
 - analog demodulation 347
 - Full Scale Level
 - Digital I/Q Interface (remote control) 734
 - Digital IQ 270, 280, 386, 479
 - Full screen level
 - External Mixer (B21) 490
 - FXD (marker functions) 126
- G**
- gate
 - delay 115
 - length 115
 - ranges 242
 - Gate
 - External/internal 114
 - MODE <mode> 114
 - gated statistics
 - configuration 242
 - configuration example 244
 - example 244
 - gated trigger 242
 - GET 517
 - GPIOB
 - Address 517
 - Characteristics 514
 - interface messages 515
 - Remote control interface 508
 - GPIOB bus control
 - Remote 552
 - GPIOB Language 982
 - GSM/EDGE Analyzer mode (K10) 12
 - GTL 517
- H**
- Handover frequency
 - External Mixer (B21, remote control) 828
 - External Mixer (B21) 495
 - Hardware Information dialog box 444
 - Harmonic Distortion
 - Measurement 252
 - Results 255
 - Harmonic order
 - Conversion Loss Table (B21) 499
 - External Mixer (B21) 496
 - Harmonic Type
 - External Mixer (B21, remote control) 830
 - External Mixer (B21) 496
 - Harmonics
 - External Mixer (B21, remote control) 829, 830
 - Measurement 155, 255
 - HiSLIP
 - Protocol 512
 - Resource string 511
 - HOME key 10
 - HP emulation 981
 - Hysteresis
 - Lower (Auto level) 77, 358
 - Upper (Auto level) 77, 358
- I**
- I/Q Analyzer 277
 - Softkey 279

- I/Q Analyzer mode 11
 - I/Q data
 - Export (remote control) 742
 - Import (remote control) 741
 - Maximum bandwidth 302, 424
 - Sample rate 302, 424
 - trigger point in sample (TPIS) 906
 - I/Q data acquisition 1039
 - I/Q Gating
 - edge triggered 906
 - level triggered 906
 - I/Q-Vector
 - I/Q Analyzer 284
 - ID String User 982
 - Identification
 - Remote 552
 - IEC/IEEE bus
 - Command description 548
 - IECWIN 546
 - IF power
 - Trigger mode 111, 293
 - IFC 517
 - Impedance
 - Input 73, 356, 408
 - Importing
 - I/Q data (remote) 741
 - INF 523
 - Inherent noise
 - correction 72, 175
 - initial configuration 58
 - Input sample rate
 - Digital IQ 270, 280, 385, 479
 - Input sample rate (ISR)
 - Definition 303, 424
 - Input/Output menu 268, 383
 - Instrument messages 510
 - Interface functions
 - RSIB 513
 - Interface messages 510
 - Interfaces
 - GPIB 514
 - Intermod. Distortion
 - softkey 418, 680
 - Intermod.Distortion (On/Off)
 - softkey 419
 - intermodulation product 245
 - Interrupt 543
 - IP address 511
 - IQ data
 - remote control 893
 - IQ Export
 - Softkey 454
 - IQ Import
 - Softkey 454
 - IST 530
 - IST flag 534
 - Remote 552
- K**
- key
 - AMPT 67
 - AUTO SET 75
 - BW 79
 - DISPLAY 936
 - ESC 581
 - LINES 256
 - MEAS 152
 - MEAS CONFIG 256
 - MEAS CONFIG (K7) 336
 - MKR 120
 - MKR FUNC 127, 128
 - MKR-> 142
 - MODE (remote control) 739, 741
 - MODE <mode> 10
 - PEAK SEARCH 127
 - PRESET 58, 978
 - PRINT 465
 - RUN CONT 276
 - RUN SINGLE 276
 - SAVE/RCL 449
 - SETUP 426
 - SPAN 65
 - SWEEP 88
 - TRACE 92
 - TRIG 108
 - USER 467
- Key
- FREQ 59
 - HOME 10
 - MKR 119
- Keywords
- see Mnemonics 519
- L**
- LAN
 - Interface 511
 - IP address 511
 - Remote control interface 508
 - RSIB protocol 513
 - VISA 511
 - VXI protocol 512
 - Left
 - softkey 390, 413
 - level
 - axis 69, 290
 - display range 68, 69, 232, 233, 234, 239, 240, 288, 289, 290, 352, 353
 - range 68, 69, 232, 233, 234, 239, 240, 288, 289, 290, 352, 353
 - trigger 112
 - Level
 - Reference 67, 288, 351, 403
 - Softkey 282
 - Level Unit
 - Digital I/Q Interface (remote control) 735
 - Digital IQ 271, 280, 386, 479
 - limit
 - ACLR measurement 172
 - Limit
 - Evaluation range 226
 - limit check
 - ACLR measurement 171
 - limit line 262
 - scaling 265
 - shift 267
 - span setting 265
 - Limit lines
 - Copying 259
 - Deleting 260
 - Editing 259, 267
 - New 258
 - Offset 260

- Spurious Emissions 216
- Time Domain Power measurement 225
- line
 - frequency 262
 - limit 262
 - threshold 135, 145, 300, 382, 422
 - time 262
- Lines
 - display 261
 - Frequency (Frequency Line 1, 2) 261
 - Menu 257
 - Time (Time Line 1, 2) 261
- LINES key 256
- LLO 517
- LO exclude 146
- LO level
 - External Mixer (B21, remote control) 830
- LO Level
 - Softkey 502
- local menu 464
- Logo 441
- Lower Level Hysteresis
 - Softkey 77, 358
- Lower-case (commands) 549
- LTE mode (K100/K101/K104/K105) 14
- LVDS connector
 - B17 485
- M**
- Magnitude
 - I/Q Analyzer 284
- maintenance 1058
- Malfunctions
 - reacting 546
- manual operation 464
 - changing to 464
- marker
 - center frequency to 143
 - peak 143
 - reference level to 143
 - search limit 144
- Marker
 - Zoom 124, 378
- Marker Function menu 128
- Marker menu 120
 - analog demodulation 374
- Marker Number
 - softkey 135, 300, 383, 422
- Marker Peak List
 - Activating/Deactivating 134, 299, 381, 421
 - Configuring 134, 298, 381, 421
 - Number display 135, 300, 383, 422
 - Number of entries 134, 299, 382, 421
- Marker Search Area
 - Softkey 148
- Marker Search Type
 - Softkey 147
- Marker To menu 142
- Marker to trigger 47
- Marker Wizard
 - softkey 121, 376
- Markers 119
 - Field 119
 - Set to trace 121, 143, 375
 - Signal track 63
- MAX 523
- Max Hold trace mode 94, 104, 322, 366
- Max Peak Count
 - softkey 134, 299, 382, 421
- Maxhold 40
- maximum search 143
- maximum value 226
- MC-ACLR 166
- Mean power (GSM burst) 226
- MEAS CONFIG key 256
 - K7 336
- MEAS key 152
- Meas Time
 - Baseband Digital 283
- Meas To Ref
 - Result Summary Setup (K7S) 394
- measurement
 - functions 119
 - parameters 56
- measurement example
 - high-sensitivity harmonics 254
 - intermodulation 245
- Measurement menu 152
- measurement mode
 - available modes 10
 - changing 10
 - Spectrum 10
- Measurement mode
 - analog demodulation 11
- Measurement modes
 - 1xEV-DO BTS (K84) 13
 - 3G FDD BTS (K72) 12, 13
 - Bluetooth (K8) 11
 - CDMA2000 BTS (K82) 13
 - CDMA2000 MS (K83) 13
 - Displaying main menus 10
 - FM Stereo (K7S) 11
 - GSM/EDGE Analyzer (K10) 12
 - I/Q Analyzer 11
 - LTE (K100/K101/K104/K105) 14
 - Noise Figure (K30) 12
 - Phase Noise (K40) 12
 - TDS BTS 13
 - TDS UE 13
 - Vector Signal Analysis (K70) 12
 - WiMAX/WiBro (K92/92) 14
 - WLAN (K91) 14
- menu
 - Amplitude (analog demodulation) 351
 - Amplitude (K7) 402
 - Analog Demodulation (K7) 334
 - Auto Set 75
 - Auto Set (analog demodulation) 357
 - Bandwidth (analog demodulation) 359
 - Bandwidth (K7S) 408
 - Frequency (analog demodulation) 347
 - Input/Output 268, 383
 - Marker 120
 - Marker (analog demodulation) 374
 - Marker Function 128
 - Marker To 142
 - Measurement (K7) 334
 - Phase Noise 130
 - Power Sensor (K9) 305, 311
 - Print 465
 - SAVE/RCL 450
 - Span 65
 - Span (analog demodulation) 349

- Sweep 88
- Sweep (analog demodulation) 363
- Trace 93
- Trigger 109, 291
- Trigger (analog demodulation) 372
- Trigger (K7S) 412
- User 467
- Menu
 - Amplitude 67
 - Bandwidth 79
 - Frequency 60
 - Lines 257
 - Meas 152
 - Setup 426
- Messages
 - Commands 510
 - Instrument 510
 - Instrument responses 511
 - Interface 510
- MIN 523
- Min Hold trace mode 95, 104, 322, 367
- minimum search 144
- Mixer settings
 - Conversion Loss Table (B21) 499
- Mixer Type
 - External Mixer (B21) 496, 832
- MKR FUNC key 127, 128
- MKR key 119, 120
- MKR-> key 142
- Mnemonics 519
 - Optional 521
- MOD (marker functions) 126
- mode
 - see also measurement mode 10
 - trigger 109, 292
- Mode
 - Result Summary (K7S) 393
- MODE key 10
- Modulation
 - Depth 154, 251
- Modulation depth 251
- Modulation index 251
- Mono
 - softkey 401, 413
- More Traces
 - softkey 98, 370
- MPX
 - softkey 401, 413
- Multi-carrier
 - ACLR 166
- multi-carrier ACLR measurement 156
- N**
 - n dB down
 - marker function 133, 298, 380, 420
 - NAN 523
 - Negative Peak detector 106, 324
 - Next Mode X
 - Softkey 146
 - Next Mode Y
 - Softkey 147
 - NINF 523
 - NOI (marker functions) 126
 - noise
 - correction 72, 175
 - source, external 269, 384
 - Noise Figure mode (K30) 12
 - NTRansition 531
 - Numeric values
 - Special 523
- O**
 - OBW
 - Multi-carrier signal 183
 - Search limits 183
 - Occupied bandwidth 182
 - OCXO
 - Internal reference 429
 - offset
 - frequency 62
 - gate signal 115
 - reference level 72, 291, 356, 407
 - Offset
 - Limit line 260
 - Trigger 113, 295, 414
 - Online help
 - Working with 8
 - Operation complete
 - Remote 552
 - options
 - Analog Demodulation 318
 - Options
 - Additional Interfaces (B5) 304
 - FSV-B25 70, 354, 406, 736
 - Identification (remote) 552
 - Installed 445
 - Power Sensor (K9) 304
 - RF Preamplifier (B22) 70, 282, 354, 405
 - Output
 - Sample rate, definition 303, 424
 - Output buffer 530
 - Overlapping commands 527
 - Preventing 529
 - Overwrite mode 94, 104, 322, 366
- P**
 - packing 1058
 - Parallel poll register enable
 - Remote 553
 - Parameters
 - Block data 525
 - Boolean 524
 - SCPI 522
 - Special numeric values 523
 - String 525
 - Text 524
 - Units 523
 - path 451
 - Peak List On/Off
 - softkey 134, 299, 381, 421
 - Peak search
 - Area (spectrograms) 148
 - Mode 146
 - Mode (spectrograms) 146, 147
 - Type (spectrograms) 147
 - PEAK SEARCH key 127
 - PEAKSEARCH 143
 - Persistence 39
 - Persistence spectrum
 - color curve 32
 - color mapping 29

- color scheme 30
 - maxhold 40
 - trace style 41
 - Ph. Noise Auto Peak Search
 - remote control 562
 - Phase Noise mode (K40) 12
 - PHN (marker functions) 126
 - Pilo
 - softkey 402
 - Pilot
 - softkey 413
 - PM
 - softkey 373
 - polarity
 - external trigger 295, 373, 414
 - external trigger/gate 112
 - trigger edge 112, 295, 373, 414
 - Ports
 - External Mixer (B21, remote control) 832
 - User 746
 - Positive Peak detector 106, 324
 - Posttrigger 54
 - power
 - bandwidth percentage 185
 - Power
 - Mean 226
 - remote control 558, 559, 623, 624
 - Remote control 558
 - softkey 136, 301
 - power cables 1058
 - Power Classes
 - SEM 196
 - power measurement 152
 - trace 173
 - zero span 224
 - Power measurement
 - Occupied bandwidth 182
 - Power Sensor
 - assignment 312
 - configuration 312
 - Configuration 313
 - Continuous Value Update 312
 - Continuous Value Update (remote control) 844
 - Dropout 316
 - Duty Cycle 314
 - Duty Cycle (remote control, K9) 838, 839
 - External Power Trigger 315
 - External Trigger Level 316
 - Frequency 314
 - Frequency Coupling 314
 - Frequency Coupling (remote control, K9) 839
 - Frequency Manual (remote control, K9) 839
 - Holdoff 316
 - Hysteresis 316
 - Meas Time / Average 314
 - Meas Time/Average (remote control, K9) 840
 - menu (K9) 305
 - Number of Readings 315
 - Number of Readings (remote control, K9) 841
 - Ref Level Offset 315
 - Reference from measurement 315
 - Reference Value 315
 - Selecting 313
 - Slope 316
 - Trigger (remote control) 842, 843, 844
 - Trigger Level (remote control) 843
 - Trigger mode 111, 294
 - Unit / Scale 314
 - Use Ref Lev Offset (remote control, K9) 841
 - Zeroing 313
 - Power Sensor (K9)
 - menu 311
 - results 306
 - Power Sensor Assignment
 - softkey 312
 - Power Sensor Config
 - softkey 312
 - Power Sensors
 - Configuring 309
 - Connecting 309
 - Power Sensors (K9) 304
 - Power Trigger
 - Parameters 309
 - PPC 517
 - PPE 530
 - PPE register 534
 - PPU 517
 - pre-trigger 113, 295, 374, 414
 - Preamplifier (B22) 70, 282, 354, 405
 - preset instrument 57
 - PRESET key 58
 - Pretrigger 54
 - print
 - screen 465
 - PRINT key 465
 - Print menu 465
 - Printers and Faxes window 467
 - Probes
 - Activating 270, 385
 - Active 273
 - Configuration (Softkey) 270, 385
 - programming examples
 - averaging I/Q data 1049
 - channel power measurement 1028
 - I/Q data 1039
 - level measurement 1036
 - limit lines and limit test 1026
 - occupied bandwidth measurement 1031
 - power ramp measurement 1033
 - reading files 1041
 - Spectrum Emission Mask measurement 1042
 - Spurious Emissions measurement 1046
 - time domain power measurement 1032
 - transducers 1038
 - writing files 1042
 - Programming examples
 - Service request 1017
 - Protocol
 - RSIB 513
 - VXI 512
 - PSA emulation 1011
 - PTRansition 531
- ## Q
- Queries 510, 526
 - Status 544
 - Question mark 525, 526
 - Quotation mark 525
- ## R
- R&S DigiConf 471

- R&S Digital I/Q Interface (B17) 272, 273, 285, 286, 387, 388, 469, 480, 733, 744, 745
 - Applications 470
 - Description 485
 - settings (remote control) 904
 - R&S EX-IQ-BOX 485
 - R&S Support
 - softkey 272, 281, 387, 481
 - RDS
 - softkey 401, 413
 - Real/Imag (I/Q)
 - I/Q Analyzer 284
 - Realtime mode
 - color curve 32
 - color mapping 29
 - color scheme 30
 - external trigger 54
 - FFT window 45
 - free run 54
 - maxhold 40
 - persistence 39
 - posttrigger 54
 - pretrigger 54
 - realtime bandwidth 45
 - resolution bandwidth 46
 - span 45
 - spectrogram 24
 - sweep time 44
 - time domain trigger 53
 - trace style 41
 - trigger 49
 - Rebooting
 - remote control 979
 - Recall dialog box 452, 456
 - Recalling
 - Settings 456
 - Recommendations
 - remote control programming 546
 - Record Length
 - Baseband Digital 283
 - reference
 - fixed 131, 379, 416
 - level to marker level 143
 - value (channel power) 174
 - Reference
 - External 428
 - Internal 428
 - Reference Deviation
 - K7S 392
 - Reference frequency
 - OCXO (option B4) 429
 - reference level
 - channel power 176
 - offset 72, 291, 356, 407
 - to marker level 143
 - Reference level 67, 288, 351, 403
 - Reference Level
 - Baseband Digital 282
 - Digital IQ 271, 280, 386, 480
 - reference point
 - frequency 130, 131, 380, 417
 - level 130, 131, 380, 416
 - peak search 130, 131, 380, 417
 - time 130, 131, 380, 417
 - Registers 530
 - remote
 - remote control
 - changing to 464
 - Remote control
 - Basics 508
 - GPIB address 517
 - Interfaces 508
 - Programming examples 1015
 - Protocols 508
 - Starting 518
 - Stopping 519
 - Repetition interval
 - Time trigger 113, 296, 374, 415
 - reset
 - switch on or off 95, 367
 - Reset values
 - Remote 553
 - resolution bandwidth
 - analog demodulation 359, 408
 - Resolution bandwidth 46, 80, 115
 - Result Display
 - analog demodulation 327
 - K7S 330
 - Result Summary Setup
 - softkey 392
 - REV String Factory
 - Softkey 438
 - REV String User
 - Softkey 438
 - RF
 - softkey 373, 413
 - RF diagram 336
 - K7 390
 - RF Input
 - Active probes 273
 - RF Overrange
 - External Mixer (B21, remote control) 827
 - External Mixer (B21) 496
 - RF Power trigger 110, 293
 - RF Preamplifier (B22) 70, 282, 354, 405
 - RF Spectrum (analog demodulation) 328
 - RF Spectrum (K7) 331
 - RF Time Domain (analog demodulation) 328
 - RF Time Domain (K7S) 331
 - Right
 - softkey 401, 413
 - RMS
 - VBW 81, 107, 325
 - RMS detector 106, 324
 - RMS value 226
 - RSIB
 - interface functions 513
 - protocol 513
 - RUN CONT key 276
 - RUN SINGLE key 276
 - RX Settings
 - softkey 271, 281, 386, 481
- ## S
- Sample detector 106, 324
 - sample number 232, 238
 - Sample rate
 - Definition 303, 424
 - Digital I/Q Interface (remote control) 735
 - Digital IQ 270, 280, 385, 479
 - Maximum 302, 424

- Sample Rate
 - I/Q Analyzer 283
- Samples
 - Statistics 228
- Save dialog box 451, 456
- SAVE/RCL key 449
- SAVE/RCL menu 450
- Saving
 - Results 456
- scaling
 - level axis 72, 291, 356
 - x- and y-axis (signal statistic) 232, 238
- SCPI
 - Conformity information 548
 - Parameters 522
 - Syntax 519
 - Version 509
- SCPI confirmed commands 510
- SDC 517
- search
 - minimum 144
 - peak 143
 - range 144
- Search
 - Bandwidth 63
- Search limits
 - OBW 183
- Search Mode
 - Softkey 146
- Search Settings
 - softkey (B17) 296
- Search Signals
 - remote control 681
 - softkey 418, 420
- Select Limit Line dialog box 267
- Select Screen Color Set dialog box 442
- Self test 448
- Selftest
 - Remote 554
- SEM
 - Results 198
- sensitivity
 - APD measurement 235, 236, 241, 242
 - CCDF measurement 235, 236, 241, 242
- Sequential commands 527
- Service request (SRQ) 533, 543
- Service request enable register (SRE) 533
 - Remote 553
- Setting commands 510
- Settings
 - Recalling 456
 - Saving 456
- setup
 - general 433
- SETUP key 426
- Setup menu 426
- shutdown
 - remote control 980
- signal count 129, 297
- Signal ID
 - External Mixer (B21, remote control) 832
 - Softkey 502
- Signal Source
 - I/Q Analyzer 270, 279, 385, 479
 - Remote control 738
 - Softkey 270, 279, 385, 479
- Signal tracking 63
 - Search bandwidth 63
- softkey 173, 185
 - 235, 236, 241, 242
 - # of Adj Chan 167
 - # of Adj Chan (remote control) 845
 - # of Samples 232, 238
 - # of Samples (remote control) 699
 - # of TX Chan 167
 - # of TX Chan (remote control) 853
 - % Power Bandwidth 185
 - % Power Bandwidth (remote control) 854
 - = Center 62, 349
 - = Marker 62
 - 0.1 * RBW 61
 - 0.1 * RBW (remote control) 809
 - 0.1 * Span 61
 - 0.1 * Span (remote control) 809
 - 0.1*Demod BW (K7) 61
 - 0.5 * RBW 61
 - 0.5 * RBW (remote control) 809
 - 0.5 * Span 61
 - 0.5 * Span (remote control) 809
 - 0.5*Demod BW (K7) 61
 - A Weighted (remote control) 858
 - Abs Dev. Unit (K7S, remote control) 921, 922
 - ACLR Abs/Rel 173
 - ACLR Abs/Rel (remote control) 849
 - ACLR Ref Setting (remote control) 851
 - ACLR Ref Spacing (remote control) 852
 - Active On/Off (remote control) 962
 - Adjust Ref Level 176
 - Adjust Ref Level (remote control) 851
 - Adjust Ref Lvl 185
 - Adjust Settings (remote control) 700, 850
 - AF Center (analog demodulation) 349
 - AF Center (remote control, analog demodulation) 752
 - AF Coupling AC/DC (K7) 342, 399, 404
 - AF Coupling AC/DC (remote control, analog demodulation) 752
 - AF Filter (K7s) 394
 - AF Full Span (analog demodulation) 350
 - AF Full Span (remote control, analog demodulation) 753
 - AF Range (K7s) 341, 398, 403
 - AF Span Manua (remote control, analog demodulation) 753
 - AF Span Manual (analog demodulation) 350
 - AF Start (analog demodulation) 349
 - AF Start (remote control, analog demodulation) 754
 - AF Stop (analog demodulation) 349
 - AF Stop (remote control, analog demodulation) 754
 - All AF Filter OFF (remote control, analog demodulation) 803, 856
 - All Functions off 154, 155
 - All Functions off (remote control) 667
 - All Marker Off 122, 123, 377
 - AM (K7) 336
 - AM (remote control) 626
 - AM/FM/PM/RF (remote control, analog demodulation) 705
 - Ampere 69, 290
 - APD (remote control) 698, 700
 - Application Setup Recovery(remote control) 969
 - ASCII File Export 135, 194, 300, 382, 422
 - ASCII File Export (remote control) 742, 743
 - ASCII Trace Export 99, 371, 453

| | |
|---|--|
| ASCII Trace Export (remote control) | 743 |
| Auto (remote control) | 873 |
| Auto All | 76, 357 |
| Auto Max Peak | 144 |
| Auto Max Peak (remote control) | 611 |
| Auto Min Peak | 144 |
| Auto Min Peak (remote control) | 614 |
| Average Mode (remote control) | 780 |
| Band Power | 136, 300 |
| Band Power On/Off | 136, 301 |
| C/N (remote control) | 651, 654 |
| C/No (remote control) | 651, 654 |
| Calibration Frequency MW | 928 |
| Calibration Frequency RF | 927 |
| CCDF (remote control) | 698, 700 |
| Center =Mkr Freq | 143 |
| Center =Mkr Freq (remote control) | 625 |
| CF Stepsize (remote control) | 808 |
| Chan Pwr/Hz | 172 |
| Chan Pwr/Hz (remote control) | 654 |
| Channel Bandwidth | 185 |
| Channel Bandwidth (remote control) | 845, 846 |
| Channel Settings | 167 |
| Channel Spacing (remote control) | 852, 853 |
| Clear All Messages (remote control) | 973 |
| Clear/Write | 173 |
| Color (On/Off) | 466 |
| Color On/Off (remote control) | 942 |
| Colors | 466 |
| Comment | 467 |
| Cont Demod (remote control) | 625 |
| Cont Meas (remote control) | 729 |
| Continue Single Sweep (remote control) | 729 |
| Continuous Sweep (remote control) | 729 |
| Copy | 455 |
| Copy (remote control) | 949 |
| Copy to (remote control) | 581 |
| Copy Trace | 98 |
| Copy Trace (remote control) | 889 |
| Corr Data On/Off (remote control) | 925, 926 |
| Coupling (FSx/HP)(remote control) | 974 |
| Coupling Ratio | 83 |
| CP, ACP, MC-ACLR (remote control) | 651, 654 |
| CP/ACLR Config | 167 |
| CP/ACLR Standard | 166 |
| Current File List (1/2) | 456 |
| Cut | 455 |
| Date | 455 |
| dBm | 69, 290 |
| dBmV | 69, 290 |
| dBpW | 69, 290 |
| dB μ A | 69, 290 |
| dB μ V | 69, 290 |
| Decim Sep 100, 135, 195, 224, 300, 371, 383, 422, 454 | |
| Deemphasis (remote control, analog demodulation) | 805 |
| Default Coupling | 85 |
| Default Settings | 235, 241 |
| Default Settings (remote control) | 699, 701 |
| Delete | 455 |
| Delete (remote control) | 582, 950, 955, 961 |
| Delete File | 452 |
| Delete File (remote control) | 948 |
| Delete Range | 192, 222 |
| Delete Range (remote control) | 795 |
| Demod BW (analog demodulation) | 338, 350, 359 |
| Demod BW (remote control, analog demodulation) .. | 781 |
| Demod Filter | 363 |
| Demod Filter (remote control) | 760, 781 |
| Density | 136, 301 |
| Description | 977 |
| Detector Auto Select (remote control) | 875 |
| Detector Manual Select (remote control) | 874 |
| Dev per Division (K7) | 341, 398, 403 |
| Deviation Lin/Log (K7) | 343, 399, 404 |
| Deviation Lin/Log (remote control) | 717 |
| Device (1/2) | 466 |
| Device 1/2 (remote control) | 953 |
| Device Setup | 466 |
| Device Setup (remote control) .. | 941, 942, 945, 970, 971 |
| Disable all Items | 452 |
| Disable all Items (remote control) | 956 |
| Disconnect Network Drive | 456 |
| Disconnect Network Drive (remote control) | 954 |
| Display Config (K7) | 390 |
| Display Config (remote control, analog demodulation) | |
| | 705 |
| Display Config (remote control) | 721 |
| Display Line 1 (remote control) | 577, 578 |
| Display Line 2 (remote control) | 577, 578 |
| Edit (remote control) | 581, 584, 594, 595, 604, 605, 606, 960 |
| Edit ACLR Limit (remote control) | 585, 586, 587, 589, 590, 591 |
| Edit Comment | 452 |
| Edit File Name | 451 |
| Edit Name (remote control) | 962 |
| Edit Path | 454 |
| Edit Path (remote control) | 948, 949, 953 |
| Edit Power Classes | 196 |
| Edit Reference Range | 193, 195 |
| Edit Reference Range (remote control) .. | 791, 792, 802 |
| Edit Unit (remote control) | 962 |
| Edit Values (remote control) | 961 |
| El Atten Mode (Auto/Man) | 71, 355, 407 |
| Enable all Items | 452 |
| Enable all Items (remote control) | 955 |
| Exclude LO (remote control) | 610 |
| Export | 453 |
| Extension | 455 |
| External | 110, 292 |
| Fast ACLR On/Off | 174 |
| Fast ACLR On/Off (remote control) | 854 |
| File Lists (1/2) | 456 |
| File Manager | 454 |
| Filter Type | 85 |
| Filter Type (remote control) | 782, 783 |
| Firmware Update (remote control) | 974 |
| FM (K7) | 344 |
| FM (remote control) | 626 |
| Free Run | 110, 292 |
| Freq Axis (Lin/Log) (remote control) | 717 |
| Frequency Line 1 (remote control) | 579, 580 |
| Frequency Line 2 (remote control) | 579, 580 |
| Frequency Offset | 62 |
| Full Span (analog demodulation) | 350 |
| Full Span (remote control, K7) | 773 |
| Full Span (remote control) | 811 |
| Gate Delay (remote control) | 867 |
| Gate Length (remote control) | 868 |
| Gate Mode Lvl/Edge (remote control) | 871, 873 |
| Gate Ranges | 235, 241 |
| Gate Ranges (remote control) | 869, 870 |
| Gated Trigger (On/Off) | 235, 241 |
| Gated Trigger (remote control) | 867, 868 |

- GPIB Address (remote control) 970
- GPIB Language (remote control) 976
- GPIB Terminator LFEOL/EOI (remote control) 970
- Grid Abs/Rel 72, 291, 356
- Grid Abs/Rel (remote control) 719
- Hardware Info (remote control) 927
- High Pass AF Filter (analog demodulation) 338, 360, 394, 409
- High Pass AF Filter (remote control, analog demodulation) 805, 806
- Hold/Cont 95, 367
- ID String Factory (remote control) 975, 979
- ID String User (remote control) 975
- IF Gain (Norm/Puls)(remote control) 976
- IF Output IF/Video (remote control) 959
- Import 454
- Info 977
- Input 50 Ω /75 Ω (remote control) 737
- Input RF/Cal/TG (remote control) 928
- Insert after Range 192, 222
- Insert after Range (remote control) 798
- Insert before Range 192, 222
- Insert before Range (remote control) 798
- Install Printer 467
- Installed Options (remote control) 926
- Interpolation Lin/Log (remote control) 961
- LAN Reset 977
- Last Span 66
- Left Limit 134, 144, 299, 382, 421
- Left Limit (remote control) 618
- Length Auto (K7) 344, 400
- Length Auto (remote control, analog demodulation) 775, 776
- Length Manual (K7) 344, 400
- Length Manual (remote control, analog demodulation) 775, 776
- Limit Chk On/Off (remote control) 585, 588, 592
- Limit Line Select dialog box (remote control) 603, 606
- Limits On/Off (remote control) 618
- Lin 99, 100, 370
- Link AF Spectrum Marker 379
- Link AF Spectrum Marker (remote control) 610
- Link Mkr1 and Delta1 124, 378
- Link Mrk1 and Delta1 (remote control) 563
- Link Time Marker 378
- Link Time Marker (remote control) 610
- List Evaluation 193
- List Evaluation On/Off 194
- List Evaluation On/Off (remote control) 578
- Load Standard 197
- Local 464
- Log 101
- Low Pass AF Filter (remote control, analog demodulation) 806, 807, 862
- Manual 62, 349
- Manual (remote control) 808
- Map Network Drive 456
- Map Network Drive (remote control) 954, 955
- Margin 194
- Margin (remote control) 579
- Marker 1 (remote control) 557
- Marker 1 to 4 (remote control) 568, 569, 608, 618
- Marker 1-16 120, 250, 252, 375
- Marker 1, Marker 2 ... 16 120, 250, 252, 375
- Marker 2 (remote control) 557
- Marker 3 (remote control) 557
- Marker 4 (remote control) 557
- Marker List (remote control) 627
- Marker Norm/Delta 120, 250, 252, 375
- Marker Norm/Delta (remote control) 557
- Marker Stepsize 123, 377
- Marker Stepsize (remote control) 620
- Marker Table (Off/On/Aut) (remote control) 710
- Marker Table (On/Off) 123, 377
- Marker to Trace (remote control) 567
- Marker Wizard 121, 376
- Marker Zoom (remote control) 640
- Max Hold 173
- Mean (remote control) 669, 670
- Meas Start/Stop 197
- Meas Start/Stop (remote control) 731
- Meas Time Auto 77, 358, 777
- Meas Time Manual 77, 358, 777
- Meas to Ref (remote control, K9) 691
- Min 144
- Min (remote control) 565, 613
- Mkr Demod On/Off (remote control) 627
- Mkr List On/Off (remote control) 627
- Mkr Stop Time (remote control) 626
- More Markers 121, 375
- n dB down 133, 298, 380, 420
- n dB down (remote control) 633, 634, 635, 636
- Name 455
- Name (remote control) 583
- Network Drive 456
- New (remote control) 581, 584, 594, 595, 604, 605, 606
- New Folder 455
- New Folder (remote control) 952
- Next Min 144
- Next Min (remote control) 567, 614, 615
- Next Mode </abs/> 145
- Next Peak 143
- Next Peak (remote control) 564, 565, 566, 612, 613, 614, 615
- Noise Correction 72, 175
- Noise Meas On/Off 129
- Noise Meas On/Off (remote control) 636, 637
- Noise Source 269, 384
- Noise Src On/Off (remote control) 928
- OBW (remote control) 654
- Password 977
- Password (remote control) 978
- Paste 455
- Peak 143
- Peak (remote control) 564, 611, 672
- Peak Excursion 134, 148, 299, 382, 421
- Peak Excursion (remote control) 616
- Peak Search 130, 131, 380, 417
- Peak Search (remote control) ... 560, 627, 629, 630, 631
- Percent Marker 237, 698
- Percent Marker (remote control) 622
- Ph Noise On/Off (remote control) 559, 561, 562
- Ph Noise/Ref Fixed (remote control) 559, 561
- Phase Noise 130, 379
- Phase Noise (remote control, analog demodulation) 638
- Phase Noise Auto Peak Search 130
- Phase Noise On/Off 130
- Phase Unit Rad/Deg (K7) 343, 353, 399, 404, 405
- Phase Wrap On/Off (K7) 346
- Phase Wrap On/Off (remote control, analog demodulation) 708
- PM (K7) 345
- Power 99, 101, 136, 301, 371
- Power Mode 172

| | | | |
|---|-------------------------|---|-----------------------------------|
| Power Mode (remote control) | 650 | Right Limit (remote control) | 619 |
| Power Sensor | 268, 383 | RMS (remote control) | 674, 675 |
| Power Sensor Assign | 888 | Save | 451 |
| Power Sensor Assignment | 312 | Save As Standard | 197 |
| Power Sensor Config | 312 | Save As Standard (remote control) | 794 |
| Power Sensor On/Off (K9) | 311 | Save Evaluation List | 194 |
| Power Sensor On/Off (remote control, K9) | 838 | Save Evaluation List (remote control) | 742 |
| Predefined Colors | 466 | Save File | 451 |
| Predefined Colors (remote control) | 941 | Save File (remote control) | 957, 958 |
| Print Screen | 465 | Scaling | 232, 238 |
| Print Screen (remote control) | 943, 944, 953 | Screen Colors (remote control) | 940 |
| R&S Support | 272, 281, 387, 481 | ScreenShot | 453 |
| Range | 68, 288 | Search Lim Off | 145 |
| Range Lin. Unit | 69, 234, 240, 290, 353 | Search Lim Off (remote control) | 618, 703 |
| Range Lin. Unit (remote control) | 717 | Search Limits | 144 |
| Range Linear % | 69, 234, 240, 290, 353 | Search Limits (remote control) | 618 |
| Range Linear % (remote control) | 717 | Select 1 2 3 4 (remote control) | 608 |
| Range Log (remote control) | 717, 718 | Select Dataset | 453 |
| Range Log 1 dB | 69, 233, 240, 289, 353 | Select Directory (remote control) | 962 |
| Range Log 5 dB | 68, 233, 239, 289, 352 | Select File | 451 |
| Range Log 10 dB | 68, 233, 239, 289, 352 | Select Items | 452 |
| Range Log 50 dB | 68, 233, 239, 289, 352 | Select Items (remote control) | 956, 957 |
| Range Log 100 dB | 68, 232, 239, 288, 352 | Select Marker (No) | 129, 131, 136, 297, 301, 379, 416 |
| Range Log Manual | 69, 234, 240, 290, 353 | Select Object | 466 |
| RBW/VBW Manual | 84 | Select Path | 451 |
| RBW/VBW Noise [10] | 84 | Select Print Color Set | 466 |
| RBW/VBW Pulse [1] | 83 | Select Print Color Set (remote control) | 940 |
| RBW/VBW Sine [1/3] | 83 | Select Trace | 173 |
| Recall | 452 | Select Trace (K7) | 338 |
| Recall (remote control) | 793 | Select Trace (remote control) | 664, 855 |
| Recall File | 451 | Select Traces to check (remote control) | 583, 584 |
| Recall File (remote control) | 951 | Self Align (remote control) | 925 |
| Ref Fixed | 131, 379, 416 | Selftest Results (remote control) | 930 |
| Ref Level (remote control) | 701 | Service Function (remote control) | 929, 930 |
| Ref Level Adjust Man/Auto (remote control) | 960 | Set CP Reference | 174 |
| Ref Level Offset | 72, 291, 356, 407 | Set Standard (remote control) | 793 |
| Ref Level Offset (remote control) | 720 | Set to Default | 466 |
| Ref Level Position | 72, 291, 356 | Set to Default (remote control) | 940 |
| Ref Level Position (remote control) | 720 | Settings | 77, 358 |
| Ref Lvl =Mkr Lvl | 143 | Shift X Limit Line (remote control) | 595 |
| Ref Lvl =Mkr Lvl (remote control) | 638 | Shift Y Limit Line (remote control) | 605 |
| Ref Point Frequency | 130, 131, 380, 417 | Show Align Results (remote control) | 925 |
| Ref Point Frequency (remote control) | 560 | Show Peaks | 194 |
| Ref Point Level | 130, 131, 380, 416 | Show Peaks (remote control) | 579 |
| Ref Point Level (remote control) | 561 | Sig Count | 129, 297 |
| Ref Point Time (remote control) | 560 | Sig Count On/Off (remote control) | 608, 609 |
| Ref Value (remote control) | 721 | Signal Track (remote control) | 665 |
| Ref Value Position (remote control) | 720 | Single Meas (remote control) | 729 |
| Reference Fixed On/Off | 131, 380, 416 | Single Sweep (remote control) | 729 |
| Reference Int/Ext (remote control) | 963, 964 | Size | 455 |
| Reference Position (K7) | 341, 398, 403 | Soft Frontpanel (remote control) | 972 |
| Reference Position (remote control) | 720 | Sort Mode | 455 |
| Reference Value (K7) | 342, 398, 403 | Sort Mode Freq/Lvl (remote control) | 630 |
| Reference Value (remote control, analog demodulation) | 721 | Span | 136, 301 |
| Reference Value (remote control, K9) | 690 | Span Manual | 66 |
| Rename | 455 | Span Manual (analog demodulation) | 350 |
| Rename (remote control) | 952 | Span Manual (remote control, K7) | 773 |
| Res BW | 231, 238 | Span Manual (remote control) | 811 |
| Res BW (analog demodulation) | 359, 408 | Span/RBW Auto [50] | 84 |
| Res BW (remote control, K7) | 771 | Span/RBW Manual | 84 |
| Res BW (remote control) | 782 | Start | 62 |
| Res BW Auto (remote control) | 782, 783 | Start (K7) | 344, 400 |
| Res BW Manual (remote control) | 782 | Start (remote control) | 811 |
| Restore Standard Files | 197 | Start Frequency (remote control) | 811 |
| RF Power(K7) | 346 | Startup Recall | 453 |
| Right Limit | 135, 144, 299, 382, 422 | Startup Recall (On/Off) | 453 |
| | | Startup Recall On/Off(remote control) | 951 |

- Std Dev (remote control) 677
 Stepsize Standard 123, 377
 Stepsize Standard (remote control) 620
 Stepsize Sweep Points 123, 378
 Stepsize Sweep Points (remote control) 620
 Stop 62
 Stop (remote control) 811
 Stop Frequency (remote control) 811
 Sweep Count 91, 364
 Sweep List (remote control) 794, 795, 796, 797, 798,
 799, 800, 801, 818, 819, 820, 821, 822, 823, 824, 825
 Sweep Points 91, 365
 Sweep Points (remote control) 872
 Sweep Rep (On/Off)(remote control) 980
 Sweep Time 115, 173
 Sweeptime Auto (remote control) 873
 System Messages (remote control) 973
 T1-T2 ->T1 100
 T1-T3 ->T1 100
 T1-T4 ->T1 100
 T1-T5 ->T1 100
 T1-T6 ->T1 100
 THD Unit %/DB (K7) 343, 354, 399, 404, 405
 THD Unit %/DB (remote control) 921, 922
 Threshold 135, 145, 300, 382, 422
 Threshold (remote control) 702, 703
 Time Domain Power (remote control) 678
 Time Line 1 (remote control) 703
 Time Line 2 (remote control) 703
 Time+Date (remote control) 972, 980
 Trace 1 2 3 4 5 6 (remote control) 715
 Trace Math 100
 Trace Math (remote control) 688, 689
 Trace Math Mode 100
 Trace Math Mode (remote control) 690
 Trace Math Off 101
 Trace Math Position 101
 Trace Mode (remote control) ... 667, 668, 669, 670, 671,
 673, 674, 675, 676, 719
 Track BW (remote control) 664
 Track On/Off (remote control) 665
 Track Threshold (remote control) 664
 Trg/Gate Level 112
 Trg/Gate Level (remote control) 912
 Trg/Gate Polarity Pos/Neg 112
 Trg/Gate Polarity Pos/Neg (remote control) 868, 913
 Trg/Gate Source (remote control) 868, 911, 912
 Trigger Holdoff (remote control) 908
 Trigger Offset (analog demodulation) 373
 Trigger Out (Low/High)(remote control) 959
 Trigger Polarity 295, 373, 414
 Trigger Source (analog demodulation) 372
 Trigger Source (K7S) 412
 Trigger Source (remote control, K7) 918
 Unit 69, 290
 Unit (K7s) 343, 399, 404, 405
 Unit (remote control) 704, 920, 922
 Unit %/DB (K7) 418, 419
 Unit/Scale (remote control, K9) 691, 920
 Update Path (remote control) 974
 Use Zoom Limits 145
 Use Zoom Limits (remote control) 620
 User Defined Colors 466
 User Defined Colors (remote control) 940
 User Pref Setup 467
 Value (remote control) 593, 600, 604
 Versions + Options (remote control) 930
 Versions+Options (remote control) 972
 Video 110, 292
 Video BW Auto (remote control) 784
 Video BW Manual (remote control) 784
 Video Output 269, 384
 Volt 69, 290
 Watt 69, 290
 Weight ADJ (On/Off) (remote control) 848
 Weight TX (On/Off) (remote control) 848
 Weighting (remote control, analog demodulation) ... 803,
 804
 Weighting Filter (remote control) 847, 848
 X * RBW 62
 X * RBW (remote control) 809
 X * Span 61
 X * Span (remote control) 809
 x Offset (remote control) 594
 x-Axis Range 232, 238
 x-Axis Range (remote control) 701
 x-Axis Ref Level 232, 238
 x-Axis Ref Level (remote control) 701
 x*Demod BW (K7) 62
 y Offset (remote control) 605
 y-Axis Max Value 234, 240
 y-Axis Max Value (remote control) 702
 y-Axis Min Value 234, 241
 y-Unit %/Abs 235, 241
 y-Unit %/Abs (remote control) 702
 Zero (remote control, K9) 709
 Zero Phase Reference Point (K7) 346
 Zero Phase Reference Point (remote control, K7) 768
 Zero Span 66
 Zero Span (remote control) 811
 Zoom (remote control, analog demodulation) ... 774, 775
Softkey
 *IDN Format Legacy 439
 = Marker (remote control) 625
 Active (On/Off) 430
 Adjust Settings 182, 256, 287
 Adjust X-Axis 222, 224
 AF Filter (analog demodulation) 338, 360, 409
 Alignment 432
 AM 132
 AM Mod Depth 154, 251
 AM Mod Depth (remote control) 632
 Annotation (On/Off) 441
 Annotation On/Off (remote control) 932, 935
 APD 154, 231
 Application Setup Recovery 446
 ASCII File Export 223
 AUTO 78, 83, 91
 Auto Freq 76, 357
 Auto Level 77, 358
 Auto select Reference 429
 Average 95, 104, 323, 367
 Average Mode 98, 370
 Band Power (remote control) 559, 624
 BB Power 111, 293
 BB Power Retrigger Holdoff (remote control) 909
 Blank 95, 105, 323, 367
 C/N 181, 287
 C/N (remote control) 655
 C/N, C/No 153, 181, 286
 C/No 181, 287
 C/No (remote control) 655
 Calibration Frequency MW 447
 Calibration Frequency RF 447

- CCDF 154, 237
- Center 60, 347
- Center (remote control) 808
- CF Stepsize 60
- Ch Power ACLR 153, 166
- Channel Bandwidth 181, 287
- Clear All Messages 445
- Clear Write 94, 104, 322, 366
- Close Sweep List 192, 222
- Color (On/Off) 442, 444
- color mapping 29
- Colors 442
- Compatibility Mode 436
- Computer Name 434
- Configure Monitor 439
- Cont Demod 132
- Cont Meas (remote control) 730
- Continue Single Sweep 89, 364
- Continuous Sweep 89, 364
- Continuous Sweep (remote control) 730
- continuous trigger 54
- Copy to 259, 432
- Coupling (FSx/HP) 438
- CP, ACP, MC-ACLR (remote control) 655
- CP/ACLR Standard (remote control) 650
- Decim Sep (remote control) 728
- Deemphasis (analog demodulation) . 340, 362, 397, 411
- Default Colors 1 (remote control) 932
- Default Colors 2 (remote control) 932
- Delete 260, 432
- Delete (ACLR User Standard) 175
- Delete mask 53
- Delete Value 259, 431
- Density (remote control) 558, 559, 623, 624
- Description 435
- Deselect all 258
- Details On/Off 223
- DHCP (On/Off) 434
- DigiConf 272, 281, 387, 482
- Display Config 336
- Display Line 1 260
- Display Line 2 260
- Display lines 260
- Display Pwr Save 444
- Display Pwr Save (remote control) 934
- Display Setup 440
- Display Update (On/Off) 438
- Edit 259, 430
- Edit (remote control) 601, 602, 603
- Edit Comment 258
- Edit Margin 258
- Edit Name 258, 430
- Edit Unit 431
- Edit Value 259
- Edit Values 431
- EL Atten (remote control) 736
- EL Atten Mode (Auto/Man) (remote control) 736
- EI Atten On/Off 71, 355, 406
- EX-IQ-BOX 271, 280, 386, 481
- Exclude LO 146
- Export (remote control) 742
- FFT 78, 82, 90
- FFT Filter Mode 78, 83, 91
- FFT window 45
- Firmware Update 446
- FM 132
- Frequency Line 1 261
- Frequency Line 2 261
- Frequency mask 49
- Frequency Offset (remote control) 811
- full span 45
- Full Span 66
- Gate Delay 115
- Gate Length 115
- Gate Mode Lvl/Edge 114
- Gate Settings 114
- Gated Trigger 114
- General Setup 433
- GPIB 435
- GPIB Address 435
- GPIB Language 436
- GPIB Terminator LFEOI/EOI 438
- Handle missing Ext. Ref 429
- Hardware Info 444
- Harmonic Distortion 155, 255
- Harmonic RBW Auto 256
- Harmonic Sweep Time 256
- I/O Logging (On/Off) 439
- ID String Factory 435
- ID String User 436
- IF Gain (Norm/Puls) 437
- IF Power 111, 293
- IF Power Retrigger Holdoff (remote control) 909
- IF Power Retrigger Hysteresis (remote control) 909
- Import (remote control) 741
- Info (LXI) 434
- Input (AC/DC) 73, 269, 356, 384, 407
- Input (AC/DC)(remote control) 732
- Input 50 Ω /75 Ω 73, 356, 408
- Input Source 447
- Insert Value 259, 431
- Install Option 446
- Install Option by XML 446
- Interpolation Lin/Log 431
- IP Address 434
- IQ Export 454
- IQ Import 454
- LAN Reset 435
- Left Limit 227
- Limits On/Off 226
- List Evaluation 222
- List Evaluation On/Off 223
- Load (ACLR User Standard) 175
- Load mask 53
- Log 99, 371
- Logo (On/Off) 441
- Logo On/Off (remote control) 934
- Low Pass AF Filter (analog demodulation) 339, 360, 395, 409
- LXI 434
- Margin 223
- Marker 1 to 4 (remote control) 620
- Marker Demod 131
- Marker Number 135, 300, 383, 422
- Marker Number (remote control) 628
- Marker Peak List 134, 298, 381, 421
- Marker to Trace 121, 143, 375
- Marker to Trace (remote control) 617
- marker to trigger 47
- Marker Zoom 124, 378
- Max Hold 94, 104, 322, 366
- Max Peak Count 134, 299, 382, 421
- maxhold intensity 40
- maxhold reset 40

| | |
|--|-------------------------|
| May Peak Size (remote control) | 629 |
| Mean | 226 |
| Meas Start/Stop | 224 |
| Meas Time (analog demodulation) .. | 338, 360, 364, 394, 408 |
| Mech Atten Auto | 71, 354, 406 |
| Mech Atten Auto (remote control) | 732 |
| Mech Atten Manual | 70, 354, 406 |
| Mech Atten Manual (remote control) | 732 |
| Min Hold | 95, 104, 322, 367 |
| Mkr Demod On/Off | 132 |
| Mkr Stop Time | 132 |
| Mode Default | 436 |
| Mode R&S FSP | 436 |
| Mode R&S FSU | 436 |
| Network Address | 434 |
| New | 258, 431 |
| New (remote control) | 601, 602, 603 |
| New mask | 50 |
| New Spectrum (remote control) | 740 |
| No. of Harmonics | 256 |
| OBW | 153, 184 |
| OBW (remote control) | 655 |
| Option Licenses | 446 |
| Other LAN Settings | 433 |
| Password | 435, 448 |
| Peak | 226 |
| Peak List (remote control) | 629 |
| Peak List On/Off | 134, 299, 381, 421 |
| Peaks per Range | 223 |
| persistence | 39 |
| persistence granularity | 39 |
| posttrigger | 54 |
| Power (remote control) | 558, 559, 623, 624 |
| Preamp On/Off | 70, 282, 354, 405 |
| Preamp On/Off (remote control) | 737 |
| Predefined Colors | 443 |
| Predefined Colors (remote control) | 933 |
| pretrigger | 54 |
| Print Colors | 443 |
| Ref Level | 67, 288, 351, 403 |
| Ref Level (remote control) | 720 |
| Ref Level Adjust (Man/Auto) | 432 |
| Reference Int/Ext | 428 |
| res BW | 46 |
| Res BW Auto | 80 |
| Res BW Manual | 80, 115 |
| Reset Password | 448 |
| RF | 447 |
| RF Atten Auto | 71, 354, 406 |
| RF Atten Auto (remote control) | 732 |
| RF Atten Manual | 70, 354, 406 |
| RF Atten Manual (remote control) | 732 |
| RF Power | 110, 293 |
| Right Limit | 227 |
| RMS | 226 |
| Save (ACLR User Standard) | 175 |
| Save (remote control) | 744 |
| Save Evaluation List | 223 |
| Save Factor | 431 |
| Save Limit Line | 259 |
| Save mask | 53 |
| Screen Colors (remote control) | 933 |
| Screen Title | 441 |
| Screen Title (remote control) | 936 |
| Search Signals | 250, 252 |
| Select 1 2 3 4 (remote control) | 620 |
| Select Color Set | 442, 443 |
| Select Directory | 432 |
| Select Object | 442 |
| Select Trace | 63 |
| Select Traces to check | 258 |
| Self Alignment | 433 |
| Selftest | 448 |
| Selftest Results | 448 |
| Service | 447 |
| Service Function | 448 |
| Set to Default | 443 |
| Set to Default (remote control) | 932 |
| Shift Y Limit Line (remote control) | 602 |
| Show Align Results | 433 |
| Show Error Flag | 429 |
| Show Peaks | 223 |
| Signal Track | 63 |
| Single Meas (remote control) | 730 |
| Single Sweep | 89, 364 |
| Single Sweep (remote control) | 730 |
| Soft Frontpanel | 439 |
| Sort Mode Freq/Lvl | 134, 299, 381, 421 |
| span | 45 |
| Spectrum Emission Mask | 153, 188 |
| Spurious Emissions | 153, 219 |
| Squelch | 132, 344, 401 |
| Squelch (remote control) | 773, 790 |
| Squelch Level | 133, 344, 401 |
| start frequency | 45 |
| State On / Off | 343, 400 |
| Std Dev | 226 |
| stop frequency | 45 |
| stop on trigger | 54 |
| style (vec dots) | 41 |
| Subnet Mask | 434 |
| Sweep | 78, 82, 90 |
| Sweep Count (remote control) | 866 |
| Sweep List | 188, 219 |
| Sweep Repeat (On/Off) | 438 |
| Sweep Time (remote control) | 872 |
| sweep time auto | 44 |
| sweep time manual | 44 |
| Sweep Type | 78, 82, 90 |
| Sweeptime Auto | 82, 90 |
| Sweeptime Manual | 81, 89 |
| Sweeptime Manual (remote control) | 872 |
| System Info | 444 |
| System Messages | 445 |
| Theme Selection | 442 |
| Time Domain Power | 154, 226 |
| time domain trigger | 53 |
| Time Domain Zoom (K7) | 343, 400 |
| Time Line 1 | 261 |
| Time Line 2 | 261 |
| Time+Date | 439 |
| Time+Date (On/Off) | 441 |
| Time+Date Format | 441 |
| Time+Date Format (remote control) | 937 |
| Time+Date On/Off (remote control) | 936 |
| TOI | 154, 250 |
| TOI (remote control) | 639, 640 |
| Tool Bar State (On/Off) | 441 |
| Tool Bar State On/Off (remote control) | 935 |
| Touch Screen Alignment | 433 |
| Trace 1 | 94, 366 |
| Trace 2 | 94, 366 |
| Trace 3 | 94, 366 |

- Trace 4 94, 366
- Trace 5 94, 366
- Trace 6 94, 366
- Trace Mode (remote control) 716
- Track BW 63
- Track On/Off 63
- Track Threshold 63
- Transducer 429
- Trg/Gate Source 109, 292
- Trg/Gate Source (remote control) 910, 911, 913
- Trigger Holdoff 113, 296, 374, 415
- Trigger Hysteresis 113, 296, 374, 415
- Trigger Offset 113, 295, 414
- Trigger Out 269, 385
- User Defined Colors 443
- User Standard 174
- Versions+Options 445
- Video BW Auto 81
- Video BW Manual 80
- View 95, 105, 323, 367
- Weighting AF Filter 339, 361, 395, 410
- X Offset 260
- Y Offset 260
- y Offset (remote control) 601
- Softkeys
 - Autoselect 96, 368
 - Continuous Value Update 312
 - Detector Auto Peak 97, 369
 - Detector Average 97, 369
 - Detector CISPR Average 97, 369
 - Detector Manual Select 96, 368
 - Detector Negative Peak 97, 369
 - Detector Positive Peak 97, 369
 - Detector Quasi Peak 97, 369
 - Detector RMS 97, 369
 - Detector RMS Average 98, 370
 - Detector Sample 97, 369
 - Lower Level Hysteresis 77, 358
 - Marker Search Area 148
 - Marker Search Type 147
 - Next Mode X 146
 - Next Mode Y 147
 - Power Sensor 111, 294
 - Probe Config 270, 385
 - Search Mode 146
 - Upper Level Hysteresis 77, 358
- Span 45
 - softkey 136, 301
- SPAN key 65
- Span menu 65
 - analog demodulation 349
- SPD 517
- SPE 517
- Speaker
 - remote control 888
- Special characters 549
 - SCPI 522
- Spectrogram
 - clear 24
 - color curve 32
 - color mapping 29
 - color scheme 30
 - frame count 24
 - history 24
 - realtime mode 24
 - time stamp 24
 - zoom 26
- Spectrum Emission Mask
 - Measurements 186
 - Power Classes 196
 - Softkey 153, 188
- Spectrum mode 10
- SPLIT/MAXIMIZE
 - Key 711
- Spurious Emissions
 - Limit lines 216
 - Measurements 213
 - Results 215
 - Softkey 153
- Squelch
 - Remote control 773, 790
 - Softkey 132, 344, 401
- Squelch Level
 - Softkey 133, 344, 401
- SRE 530
- SRE (service request enable register) 533
- SRQ (service request) 533, 543
- start frequency 62
- statistic measurements
 - gated trigger 242
- Status
 - Queries 544
- Status bar
 - Hiding/restoring 441
- Status byte
 - Remote 551, 554
- Status registers 530
 - CONDition 531
 - ENABLE 531
 - EVENT 531
 - model 531
 - NTRansition 531
 - parts 531
 - PTRansition 531
 - STATus:OPERation 535
 - STATus:QUESTionable 536
 - STATus:QUESTionable:ACPLimit 537
 - STATus:QUESTionable:FREQuency 538
 - STATus:QUESTionable:LIMit 539
 - STATus:QUESTionable:LMARgin 539
 - STATus:QUESTionable:POWER 540
 - STATus:QUESTionable:TIME 541
- Status reporting system 530
 - Application 542
 - Common commands 550
- STB 530
- Step size
 - Center frequency 60
- Stereo
 - softkey 401, 413
- stop frequency 62
- storing 1058
- Suffixes 521
- supply voltage, external noise source 269, 384
- sweep
 - count 91, 364
 - Free Run 110, 292
 - gated 116
- Sweep
 - Continue single sweep 89, 364
 - Continuous 89, 364
 - Gated 114
 - Single 89, 364
 - Time 81, 89

SWEEP key 88
sweep list
 Fast SEM (remote control) 792
Sweep List
 Symmetrical 192
Sweep menu 88
 analog demodulation 363
Sweep time 44
 Coupling 82, 90
 Statistics 228
Syntax elements
 SCPI 525
System Messages dialog box 445

T

TDS BTS mode 13
TDS UE mode 13
Test
 Self test 448
threshold
 line 135, 145, 300, 382, 422
Threshold
 Signal tracking 63
Time 441
 softkey 112, 294, 414
Time Domain Power
 Restricting range 225
 Results 224
time line 262
Time line 261
Time per Division
 softkey 400
Time trigger
 Repetition interval 113, 296, 374, 415
timestamp
 instrument (remote control) 888
Title
 Diagram 441
TOI
 Measurement 245
 Results 249
TOI (marker functions) 126
Touch screen
 Alignment 433
TPIS
 I/Q data 906
trace
 power measurement 173
Trace
 Clear Write 94, 104, 322, 366
 Signal tracking 63
TRACE key 92
Trace menu 93
Trace mode 94, 366
 Average 95, 104, 323, 367
 Blank 95, 105, 323, 367
 Clear Write 94, 104, 322, 366
 Max Hold 94, 104, 322, 366
 Min Hold 95, 104, 322, 367
 View 95, 105, 323, 367
Trace style 41
TRACe:IQ subsystem 893
transducer 429
Transducer
 Activating 430
TRIG key 108

trigger
 external 110, 292
 level 112
 slope 112, 295, 373, 414
Trigger
 Event (remote) 554
 External gate 114
 Gated sweep 114
 Holdoff 113, 296, 374, 415
 Hysteresis 113, 296, 374, 415
 Level 294, 373, 414
 Offset 113, 295, 414
Trigger (realtime mode) 49
Trigger menu 109, 291
 analog demodulation 372
 K7S 412
trigger mode 109, 292
 External 110, 292
 Free Run 110, 292
 Video 110, 292
Trigger mode
 BB power 111, 293
 IF power 111, 293
 RF power 110, 293
Triggers
 Power Sensor 309
TRK (marker functions) 126
TX Settings
 EX-IQ-BOX 271, 281, 386, 481

U

Units 523
UP 523
Upper Level Hysteresis
 Softkey 77, 358
Upper-case (commands) 549
Usable I/Q bandwidth
 Definition 303, 424
USER key 467
 Remote 958
User ports
 Remote control 746
User sample rate
 Definition 303, 424
user-defined menu 467

V

VBW
 RMS detector 81, 107, 325
Vector Signal Analysis mode (K70) 12
Versions/Options dialog box 445
Video bandwidth 80
video triggering 110, 292
View Filter 264
View trace mode 95, 105, 323, 367
VISA 509, 511
 Libraries 510
 Resource string 510, 511
Volume
 remote control 888
VXI protocol 512

W

| | |
|---------------------------|--------------------|
| Wait | |
| Remote | 554 |
| Weighting | |
| Analog demodulation | 339, 361, 396, 410 |
| weighting filter | 170 |
| White space | 525 |
| WiMAX mode (K92/92) | 14 |
| WLAN mode (K91) | 14 |

Y

| | |
|--------------------|-----|
| Y-Axis Max | |
| I/Q Analyzer | 291 |

Z

| | |
|-----------------------------|-------------------|
| zero span | 66 |
| zeroing (K9) | 308 |
| zoom | |
| area (remote control) | 723 |
| remote control | 724 |
| Zoom | 26, 124, 378 |
| Amplitude | 95, 105, 323, 367 |