

# R&S® SMZ75/90/110/170 Frequency Multiplier 50-75 GHz, 60-90 GHz, 75-110 GHz, 110-170 GHz Manual



1417.4027.32 – 08

The manual describes the following R&S®SMZ75 /90 /110/170 Frequency Multiplier models and their options:

#### Basic Units

- Frequency Multiplier 50-75 GHz R&S®SMZ75, 1417.4004.02
- Frequency Multiplier 60-90 GHz R&S®SMZ90, 1417.4504.02
- Frequency Multiplier 75-110 GHz R&S®SMZ110, 1417.5000.02
- Frequency Multiplier 110-170 GHz R&S®SMZ170, 1417.5500.02

A frequency multiplier can be equipped with a mechanical or an electronic attenuator, except of the R&S®SMZ170. To obtain an instrument with an attenuator, order the corresponding option in addition to the basic unit.

Provided options for the corresponding base units (only factory fitted):

- Electronically controlled attenuator R&S®SMZ-B75E for R&S®SMZ75
- Electronically controlled attenuator R&S®SMZ-B90E for R&S®SMZ90
- Electronically controlled attenuator R&S®SMZ-B110E for R&S®SMZ110
- Mechanically controlled attenuator R&S®SMZ-B75M for R&S®SMZ75
- Mechanically controlled attenuator R&S®SMZ-B90M for R&S®SMZ90
- Mechanically controlled attenuator R&S®SMZ-B110M for R&S®SMZ110

You find the order numbers of the attenuator options in the data sheet, or also at the Rohde & Schwarz website: <http://www.rohde-schwarz.com/product/SMZ.html>. In addition, this manual describes the PC software R&S®SMZ Control including R&S®SMZ-K1 (1417.8400.02): Activation key code for one R&S®SMZ frequency multiplier to use with the R&S®SMZ Control.

The software contained in this product makes use of several valuable open source software packages. For information, see the "Open Source Acknowledgement" document, which is available for download from the R&S SMZ product page at <http://www.rohde-schwarz.com/product/sMZ.html> > "Downloads" > "Firmware".

Rohde & Schwarz would like to thank the open source community for their valuable contribution to embedded computing.

© 2015 Rohde & Schwarz GmbH & Co. KG

Mühlhofstr. 15, 81671 München, Germany

Phone: +49 89 41 29 - 0

Fax: +49 89 41 29 12 164

Email: [info@rohde-schwarz.com](mailto:info@rohde-schwarz.com)

Internet: [www.rohde-schwarz.com](http://www.rohde-schwarz.com)

Subject to change – Data without tolerance limits is not binding.

R&S® is a registered trademark of Rohde & Schwarz GmbH & Co. KG.

Trade names are trademarks of the owners.

Throughout this manual, R&S® is abbreviated as R&S and applies to the following products: R&S®SMZ75 /90 /110/170, R&S®SMF100A, R&S®SMB100A, R&S®SMR and R&S®SMZ Control. In addition, R&S®SMZ75/90/110/170 is abbreviated as R&S SMZ75/90/110/170 or R&S SMZ, R&S®SMF100A as R&S SMF100A or R&S SMF, and R&S®SMB100A as R&S SMB100A or R&S SMB.

# Basic Safety Instructions

## Always read through and comply with the following safety instructions!

All plants and locations of the Rohde & Schwarz group of companies make every effort to keep the safety standards of our products up to date and to offer our customers the highest possible degree of safety. Our products and the auxiliary equipment they require are designed, built and tested in accordance with the safety standards that apply in each case. Compliance with these standards is continuously monitored by our quality assurance system. The product described here has been designed, built and tested in accordance with the EC Certificate of Conformity and has left the manufacturer's plant in a condition fully complying with safety standards. To maintain this condition and to ensure safe operation, you must observe all instructions and warnings provided in this manual. If you have any questions regarding these safety instructions, the Rohde & Schwarz group of companies will be happy to answer them.

Furthermore, it is your responsibility to use the product in an appropriate manner. This product is designed for use solely in industrial and laboratory environments or, if expressly permitted, also in the field and must not be used in any way that may cause personal injury or property damage. You are responsible if the product is used for any purpose other than its designated purpose or in disregard of the manufacturer's instructions. The manufacturer shall assume no responsibility for such use of the product.

The product is used for its designated purpose if it is used in accordance with its product documentation and within its performance limits (see data sheet, documentation, the following safety instructions). Using the product requires technical skills and, in some cases, a basic knowledge of English. It is therefore essential that only skilled and specialized staff or thoroughly trained personnel with the required skills be allowed to use the product. If personal safety gear is required for using Rohde & Schwarz products, this will be indicated at the appropriate place in the product documentation. Keep the basic safety instructions and the product documentation in a safe place and pass them on to the subsequent users.

Observing the safety instructions will help prevent personal injury or damage of any kind caused by dangerous situations. Therefore, carefully read through and adhere to the following safety instructions before and when using the product. It is also absolutely essential to observe the additional safety instructions on personal safety, for example, that appear in relevant parts of the product documentation. In these safety instructions, the word "product" refers to all merchandise sold and distributed by the Rohde & Schwarz group of companies, including instruments, systems and all accessories. For product-specific information, see the data sheet and the product documentation.

## Safety labels on products

The following safety labels are used on products to warn against risks and dangers.





Symbol	Meaning	Symbol	Meaning
	Notice, general danger location Observe product documentation		ON/OFF Power
	Caution when handling heavy equipment		Standby indication
	Danger of electric shock		Direct current (DC)

## Basic Safety Instructions

Symbol	Meaning	Symbol	Meaning
	Caution ! Hot surface		Alternating current (AC)
	Protective conductor terminal To identify any terminal which is intended for connection to an external conductor for protection against electric shock in case of a fault, or the terminal of a protective earth		Direct/alternating current (DC/AC)
	Earth (Ground)		Class II Equipment to identify equipment meeting the safety requirements specified for Class II equipment (device protected by double or reinforced insulation)
	Frame or chassis Ground terminal		EU labeling for batteries and accumulators For additional information, see section "Waste disposal/Environmental protection", item 1.
	Be careful when handling electrostatic sensitive devices		EU labeling for separate collection of electrical and electronic devices For additional information, see section "Waste disposal/Environmental protection", item 2.
	Warning! Laser radiation For additional information, see section "Operation", item 7.		

### Signal words and their meaning

The following signal words are used in the product documentation in order to warn the reader about risks and dangers.

	Indicates a hazardous situation which, if not avoided, will result in death or serious injury.
	Indicates a hazardous situation which, if not avoided, could result in death or serious injury.
	Indicates a hazardous situation which, if not avoided, could result in minor or moderate injury.
	Indicates information considered important, but not hazard-related, e.g. messages relating to property damage. In the product documentation, the word ATTENTION is used synonymously.

These signal words are in accordance with the standard definition for civil applications in the European Economic Area. Definitions that deviate from the standard definition may also exist in other economic areas or military applications. It is therefore essential to make sure that the signal words described here are always used only in connection with the related product documentation and the related product. The use of signal words in connection with unrelated products or documentation can result in misinterpretation and in personal injury or material damage.

## Basic Safety Instructions

### Operating states and operating positions

*The product may be operated only under the operating conditions and in the positions specified by the manufacturer, without the product's ventilation being obstructed. If the manufacturer's specifications are not observed, this can result in electric shock, fire and/or serious personal injury or death. Applicable local or national safety regulations and rules for the prevention of accidents must be observed in all work performed.*

1. Unless otherwise specified, the following requirements apply to Rohde & Schwarz products: predefined operating position is always with the housing floor facing down, IP protection 2X, use only indoors, max. operating altitude 2000 m above sea level, max. transport altitude 4500 m above sea level. A tolerance of  $\pm 10\%$  shall apply to the nominal voltage and  $\pm 5\%$  to the nominal frequency, overvoltage category 2, pollution degree 2.
2. Do not place the product on surfaces, vehicles, cabinets or tables that for reasons of weight or stability are unsuitable for this purpose. Always follow the manufacturer's installation instructions when installing the product and fastening it to objects or structures (e.g. walls and shelves). An installation that is not carried out as described in the product documentation could result in personal injury or even death.
3. Do not place the product on heat-generating devices such as radiators or fan heaters. The ambient temperature must not exceed the maximum temperature specified in the product documentation or in the data sheet. Product overheating can cause electric shock, fire and/or serious personal injury or even death.

### Electrical safety

*If the information on electrical safety is not observed either at all or to the extent necessary, electric shock, fire and/or serious personal injury or death may occur.*

1. Prior to switching on the product, always ensure that the nominal voltage setting on the product matches the nominal voltage of the mains-supply network. If a different voltage is to be set, the power fuse of the product may have to be changed accordingly.
2. In the case of products of safety class I with movable power cord and connector, operation is permitted only on sockets with a protective conductor contact and protective conductor.
3. Intentionally breaking the protective conductor either in the feed line or in the product itself is not permitted. Doing so can result in the danger of an electric shock from the product. If extension cords or connector strips are implemented, they must be checked on a regular basis to ensure that they are safe to use.
4. If there is no power switch for disconnecting the product from the mains, or if the power switch is not suitable for this purpose, use the plug of the connecting cable to disconnect the product from the mains. In such cases, always ensure that the power plug is easily reachable and accessible at all times. For example, if the power plug is the disconnecting device, the length of the connecting cable must not exceed 3 m. Functional or electronic switches are not suitable for providing disconnection from the AC supply network. If products without power switches are integrated into racks or systems, the disconnecting device must be provided at the system level.
5. Never use the product if the power cable is damaged. Check the power cables on a regular basis to ensure that they are in proper operating condition. By taking appropriate safety measures and carefully laying the power cable, ensure that the cable cannot be damaged and that no one can be hurt by, for example, tripping over the cable or suffering an electric shock.

## Basic Safety Instructions

6. The product may be operated only from TN/TT supply networks fuse-protected with max. 16 A (higher fuse only after consulting with the Rohde & Schwarz group of companies).
7. Do not insert the plug into sockets that are dusty or dirty. Insert the plug firmly and all the way into the socket provided for this purpose. Otherwise, sparks that result in fire and/or injuries may occur.
8. Do not overload any sockets, extension cords or connector strips; doing so can cause fire or electric shocks.
9. For measurements in circuits with voltages  $V_{rms} > 30$  V, suitable measures (e.g. appropriate measuring equipment, fuse protection, current limiting, electrical separation, insulation) should be taken to avoid any hazards.
10. Ensure that the connections with information technology equipment, e.g. PCs or other industrial computers, comply with the IEC 60950-1 / EN 60950-1 or IEC 61010-1 / EN 61010-1 standards that apply in each case.
11. Unless expressly permitted, never remove the cover or any part of the housing while the product is in operation. Doing so will expose circuits and components and can lead to injuries, fire or damage to the product.
12. If a product is to be permanently installed, the connection between the protective conductor terminal on site and the product's protective conductor must be made first before any other connection is made. The product may be installed and connected only by a licensed electrician.
13. For permanently installed equipment without built-in fuses, circuit breakers or similar protective devices, the supply circuit must be fuse-protected in such a way that anyone who has access to the product, as well as the product itself, is adequately protected from injury or damage.
14. Use suitable overvoltage protection to ensure that no overvoltage (such as that caused by a bolt of lightning) can reach the product. Otherwise, the person operating the product will be exposed to the danger of an electric shock.
15. Any object that is not designed to be placed in the openings of the housing must not be used for this purpose. Doing so can cause short circuits inside the product and/or electric shocks, fire or injuries.
16. Unless specified otherwise, products are not liquid-proof (see also section "Operating states and operating positions", item 1). Therefore, the equipment must be protected against penetration by liquids. If the necessary precautions are not taken, the user may suffer electric shock or the product itself may be damaged, which can also lead to personal injury.
17. Never use the product under conditions in which condensation has formed or can form in or on the product, e.g. if the product has been moved from a cold to a warm environment. Penetration by water increases the risk of electric shock.
18. Prior to cleaning the product, disconnect it completely from the power supply (e.g. AC supply network or battery). Use a soft, non-linting cloth to clean the product. Never use chemical cleaning agents such as alcohol, acetone or diluents for cellulose lacquers.

## Operation

1. Operating the products requires special training and intense concentration. Make sure that persons who use the products are physically, mentally and emotionally fit enough to do so; otherwise, injuries or material damage may occur. It is the responsibility of the employer/operator to select suitable personnel for operating the products.

## Basic Safety Instructions

2. Before you move or transport the product, read and observe the section titled "Transport".
3. As with all industrially manufactured goods, the use of substances that induce an allergic reaction (allergens) such as nickel cannot be generally excluded. If you develop an allergic reaction (such as a skin rash, frequent sneezing, red eyes or respiratory difficulties) when using a Rohde & Schwarz product, consult a physician immediately to determine the cause and to prevent health problems or stress.
4. Before you start processing the product mechanically and/or thermally, or before you take it apart, be sure to read and pay special attention to the section titled "Waste disposal/Environmental protection", item 1.
5. Depending on the function, certain products such as RF radio equipment can produce an elevated level of electromagnetic radiation. Considering that unborn babies require increased protection, pregnant women must be protected by appropriate measures. Persons with pacemakers may also be exposed to risks from electromagnetic radiation. The employer/operator must evaluate workplaces where there is a special risk of exposure to radiation and, if necessary, take measures to avert the potential danger.
6. Should a fire occur, the product may release hazardous substances (gases, fluids, etc.) that can cause health problems. Therefore, suitable measures must be taken, e.g. protective masks and protective clothing must be worn.
7. Laser products are given warning labels that are standardized according to their laser class. Lasers can cause biological harm due to the properties of their radiation and due to their extremely concentrated electromagnetic power. If a laser product (e.g. a CD/DVD drive) is integrated into a Rohde & Schwarz product, absolutely no other settings or functions may be used as described in the product documentation. The objective is to prevent personal injury (e.g. due to laser beams).
8. EMC classes (in line with EN 55011/CISPR 11, and analogously with EN 55022/CISPR 22, EN 55032/CISPR 32)
  - Class A equipment:  
Equipment suitable for use in all environments except residential environments and environments that are directly connected to a low-voltage supply network that supplies residential buildings  
Note: Class A equipment is intended for use in an industrial environment. This equipment may cause radio disturbances in residential environments, due to possible conducted as well as radiated disturbances. In this case, the operator may be required to take appropriate measures to eliminate these disturbances.
  - Class B equipment:  
Equipment suitable for use in residential environments and environments that are directly connected to a low-voltage supply network that supplies residential buildings

### Repair and service

1. The product may be opened only by authorized, specially trained personnel. Before any work is performed on the product or before the product is opened, it must be disconnected from the AC supply network. Otherwise, personnel will be exposed to the risk of an electric shock.

## Basic Safety Instructions

- Adjustments, replacement of parts, maintenance and repair may be performed only by electrical experts authorized by Rohde & Schwarz. Only original parts may be used for replacing parts relevant to safety (e.g. power switches, power transformers, fuses). A safety test must always be performed after parts relevant to safety have been replaced (visual inspection, protective conductor test, insulation resistance measurement, leakage current measurement, functional test). This helps ensure the continued safety of the product.

### Batteries and rechargeable batteries/cells

*If the information regarding batteries and rechargeable batteries/cells is not observed either at all or to the extent necessary, product users may be exposed to the risk of explosions, fire and/or serious personal injury, and, in some cases, death. Batteries and rechargeable batteries with alkaline electrolytes (e.g. lithium cells) must be handled in accordance with the EN 62133 standard.*

- Cells must not be taken apart or crushed.
- Cells or batteries must not be exposed to heat or fire. Storage in direct sunlight must be avoided. Keep cells and batteries clean and dry. Clean soiled connectors using a dry, clean cloth.
- Cells or batteries must not be short-circuited. Cells or batteries must not be stored in a box or in a drawer where they can short-circuit each other, or where they can be short-circuited by other conductive materials. Cells and batteries must not be removed from their original packaging until they are ready to be used.
- Cells and batteries must not be exposed to any mechanical shocks that are stronger than permitted.
- If a cell develops a leak, the fluid must not be allowed to come into contact with the skin or eyes. If contact occurs, wash the affected area with plenty of water and seek medical aid.
- Improperly replacing or charging cells or batteries that contain alkaline electrolytes (e.g. lithium cells) can cause explosions. Replace cells or batteries only with the matching Rohde & Schwarz type (see parts list) in order to ensure the safety of the product.
- Cells and batteries must be recycled and kept separate from residual waste. Rechargeable batteries and normal batteries that contain lead, mercury or cadmium are hazardous waste. Observe the national regulations regarding waste disposal and recycling.

### Transport

- The product may be very heavy. Therefore, the product must be handled with care. In some cases, the user may require a suitable means of lifting or moving the product (e.g. with a lift-truck) to avoid back or other physical injuries.
- Handles on the products are designed exclusively to enable personnel to transport the product. It is therefore not permissible to use handles to fasten the product to or on transport equipment such as cranes, fork lifts, wagons, etc. The user is responsible for securely fastening the products to or on the means of transport or lifting. Observe the safety regulations of the manufacturer of the means of transport or lifting. Noncompliance can result in personal injury or material damage.
- If you use the product in a vehicle, it is the sole responsibility of the driver to drive the vehicle safely and properly. The manufacturer assumes no responsibility for accidents or collisions. Never use the product in a moving vehicle if doing so could distract the driver of the vehicle. Adequately secure the product in the vehicle to prevent injuries or other damage in the event of an accident.



## Instrucciones de seguridad elementales

### Waste disposal/Environmental protection

1. Specially marked equipment has a battery or accumulator that must not be disposed of with unsorted municipal waste, but must be collected separately. It may only be disposed of at a suitable collection point or via a Rohde & Schwarz customer service center.
2. Waste electrical and electronic equipment must not be disposed of with unsorted municipal waste, but must be collected separately.  
Rohde & Schwarz GmbH & Co. KG has developed a disposal concept and takes full responsibility for take-back obligations and disposal obligations for manufacturers within the EU. Contact your Rohde & Schwarz customer service center for environmentally responsible disposal of the product.
3. If products or their components are mechanically and/or thermally processed in a manner that goes beyond their intended use, hazardous substances (heavy-metal dust such as lead, beryllium, nickel) may be released. For this reason, the product may only be disassembled by specially trained personnel. Improper disassembly may be hazardous to your health. National waste disposal regulations must be observed.
4. If handling the product releases hazardous substances or fuels that must be disposed of in a special way, e.g. coolants or engine oils that must be replenished regularly, the safety instructions of the manufacturer of the hazardous substances or fuels and the applicable regional waste disposal regulations must be observed. Also observe the relevant safety instructions in the product documentation. The improper disposal of hazardous substances or fuels can cause health problems and lead to environmental damage.

For additional information about environmental protection, visit the Rohde & Schwarz website.

## Instrucciones de seguridad elementales

### **¡Es imprescindible leer y cumplir las siguientes instrucciones e informaciones de seguridad!**

El principio del grupo de empresas Rohde & Schwarz consiste en tener nuestros productos siempre al día con los estándares de seguridad y de ofrecer a nuestros clientes el máximo grado de seguridad. Nuestros productos y todos los equipos adicionales son siempre fabricados y examinados según las normas de seguridad vigentes. Nuestro sistema de garantía de calidad controla constantemente que sean cumplidas estas normas. El presente producto ha sido fabricado y examinado según el certificado de conformidad de la UE y ha salido de nuestra planta en estado impecable según los estándares técnicos de seguridad. Para poder preservar este estado y garantizar un funcionamiento libre de peligros, el usuario deberá atenerse a todas las indicaciones, informaciones de seguridad y notas de alerta. El grupo de empresas Rohde & Schwarz está siempre a su disposición en caso de que tengan preguntas referentes a estas informaciones de seguridad.

Además queda en la responsabilidad del usuario utilizar el producto en la forma debida. Este producto está destinado exclusivamente al uso en la industria y el laboratorio o, si ha sido expresamente autorizado, para aplicaciones de campo y de ninguna manera deberá ser utilizado de modo que alguna persona/cosa pueda sufrir daño. El uso del producto fuera de sus fines definidos o sin tener en cuenta las instrucciones del fabricante queda en la responsabilidad del usuario. El fabricante no se hace en ninguna forma responsable de consecuencias a causa del mal uso del producto.















## Instrucciones de seguridad elementales

Se parte del uso correcto del producto para los fines definidos si el producto es utilizado conforme a las indicaciones de la correspondiente documentación del producto y dentro del margen de rendimiento definido (ver hoja de datos, documentación, informaciones de seguridad que siguen). El uso del producto hace necesarios conocimientos técnicos y ciertos conocimientos del idioma inglés. Por eso se debe tener en cuenta que el producto solo pueda ser operado por personal especializado o personas instruidas en profundidad con las capacidades correspondientes. Si fuera necesaria indumentaria de seguridad para el uso de productos de Rohde & Schwarz, encontraría la información debida en la documentación del producto en el capítulo correspondiente. Guarde bien las informaciones de seguridad elementales, así como la documentación del producto, y entréguelas a usuarios posteriores.

Tener en cuenta las informaciones de seguridad sirve para evitar en lo posible lesiones o daños por peligros de toda clase. Por eso es imprescindible leer detalladamente y comprender por completo las siguientes informaciones de seguridad antes de usar el producto, y respetarlas durante el uso del producto. Deberán tenerse en cuenta todas las demás informaciones de seguridad, como p. ej. las referentes a la protección de personas, que encontrarán en el capítulo correspondiente de la documentación del producto y que también son de obligado cumplimiento. En las presentes informaciones de seguridad se recogen todos los objetos que distribuye el grupo de empresas Rohde & Schwarz bajo la denominación de "producto", entre ellos también aparatos, instalaciones así como toda clase de accesorios. Los datos específicos del producto figuran en la hoja de datos y en la documentación del producto.

### Señalización de seguridad de los productos

Las siguientes señales de seguridad se utilizan en los productos para advertir sobre riesgos y peligros.

Símbolo	Significado	Símbolo	Significado
	Aviso: punto de peligro general Observar la documentación del producto		Tensión de alimentación de PUESTA EN MARCHA / PARADA
	Atención en el manejo de dispositivos de peso elevado		Indicación de estado de espera (standby)
	Peligro de choque eléctrico		Corriente continua (DC)
	Advertencia: superficie caliente		Corriente alterna (AC)
	Conexión a conductor de protección		Corriente continua / Corriente alterna (DC/AC)
	Conexión a tierra		El aparato está protegido en su totalidad por un aislamiento doble (reforzado)
	Conexión a masa		Distintivo de la UE para baterías y acumuladores Más información en la sección "Eliminación/protección del medio ambiente", punto 1.

## Instrucciones de seguridad elementales

Símbolo	Significado	Símbolo	Significado
	Aviso: Cuidado en el manejo de dispositivos sensibles a la electrostática (ESD)		Distintivo de la UE para la eliminación por separado de dispositivos eléctricos y electrónicos  Más información en la sección "Eliminación/protección del medio ambiente", punto 2.
	Advertencia: rayo láser  Más información en la sección "Funcionamiento", punto 7.		

### Palabras de señal y su significado

En la documentación del producto se utilizan las siguientes palabras de señal con el fin de advertir contra riesgos y peligros.



Indica una situación de peligro que, si no se evita, causa lesiones graves o incluso la muerte.



Indica una situación de peligro que, si no se evita, puede causar lesiones graves o incluso la muerte.



Indica una situación de peligro que, si no se evita, puede causar lesiones leves o moderadas.



Indica información que se considera importante, pero no en relación con situaciones de peligro; p. ej., avisos sobre posibles daños materiales.

En la documentación del producto se emplea de forma sinónima el término CUIDADO.

Las palabras de señal corresponden a la definición habitual para aplicaciones civiles en el área económica europea. Pueden existir definiciones diferentes a esta definición en otras áreas económicas o en aplicaciones militares. Por eso se deberá tener en cuenta que las palabras de señal aquí descritas sean utilizadas siempre solamente en combinación con la correspondiente documentación del producto y solamente en combinación con el producto correspondiente. La utilización de las palabras de señal en combinación con productos o documentaciones que no les correspondan puede llevar a interpretaciones equivocadas y tener por consecuencia daños en personas u objetos.

### Estados operativos y posiciones de funcionamiento

*El producto solamente debe ser utilizado según lo indicado por el fabricante respecto a los estados operativos y posiciones de funcionamiento sin que se obstruya la ventilación. Si no se siguen las indicaciones del fabricante, pueden producirse choques eléctricos, incendios y/o lesiones graves con posible consecuencia de muerte. En todos los trabajos deberán ser tenidas en cuenta las normas nacionales y locales de seguridad del trabajo y de prevención de accidentes.*

## Instrucciones de seguridad elementales

1. Si no se convino de otra manera, es para los productos Rohde & Schwarz válido lo que sigue: como posición de funcionamiento se define por principio la posición con el suelo de la caja para abajo, modo de protección IP 2X, uso solamente en estancias interiores, utilización hasta 2000 m sobre el nivel del mar, transporte hasta 4500 m sobre el nivel del mar. Se aplicará una tolerancia de  $\pm 10\%$  sobre el voltaje nominal y de  $\pm 5\%$  sobre la frecuencia nominal. Categoría de sobrecarga eléctrica 2, índice de suciedad 2.
2. No sitúe el producto encima de superficies, vehículos, estantes o mesas, que por sus características de peso o de estabilidad no sean aptos para él. Siga siempre las instrucciones de instalación del fabricante cuando instale y asegure el producto en objetos o estructuras (p. ej. paredes y estantes). Si se realiza la instalación de modo distinto al indicado en la documentación del producto, se pueden causar lesiones o, en determinadas circunstancias, incluso la muerte.
3. No ponga el producto sobre aparatos que generen calor (p. ej. radiadores o calefactores). La temperatura ambiente no debe superar la temperatura máxima especificada en la documentación del producto o en la hoja de datos. En caso de sobrecalentamiento del producto, pueden producirse choques eléctricos, incendios y/o lesiones graves con posible consecuencia de muerte.

### Seguridad eléctrica

*Si no se siguen (o se siguen de modo insuficiente) las indicaciones del fabricante en cuanto a seguridad eléctrica, pueden producirse choques eléctricos, incendios y/o lesiones graves con posible consecuencia de muerte.*

1. Antes de la puesta en marcha del producto se deberá comprobar siempre que la tensión preseleccionada en el producto coincida con la de la red de alimentación eléctrica. Si es necesario modificar el ajuste de tensión, también se deberán cambiar en caso dado los fusibles correspondientes del producto.
2. Los productos de la clase de protección I con alimentación móvil y enchufe individual solamente podrán enchufarse a tomas de corriente con contacto de seguridad y con conductor de protección conectado.
3. Queda prohibida la interrupción intencionada del conductor de protección, tanto en la toma de corriente como en el mismo producto. La interrupción puede tener como consecuencia el riesgo de que el producto sea fuente de choques eléctricos. Si se utilizan cables alargadores o regletas de enchufe, deberá garantizarse la realización de un examen regular de los mismos en cuanto a su estado técnico de seguridad.
4. Si el producto no está equipado con un interruptor para desconectarlo de la red, o bien si el interruptor existente no resulta apropiado para la desconexión de la red, el enchufe del cable de conexión se deberá considerar como un dispositivo de desconexión. El dispositivo de desconexión se debe poder alcanzar fácilmente y debe estar siempre bien accesible. Si, p. ej., el enchufe de conexión a la red es el dispositivo de desconexión, la longitud del cable de conexión no debe superar 3 m). Los interruptores selectores o electrónicos no son aptos para el corte de la red eléctrica. Si se integran productos sin interruptor en bastidores o instalaciones, se deberá colocar el interruptor en el nivel de la instalación.
5. No utilice nunca el producto si está dañado el cable de conexión a red. Compruebe regularmente el correcto estado de los cables de conexión a red. Asegúrese, mediante las medidas de protección y de instalación adecuadas, de que el cable de conexión a red no pueda ser dañado o de que nadie pueda ser dañado por él, p. ej. al tropezar o por un choque eléctrico.

## Instrucciones de seguridad elementales

6. Solamente está permitido el funcionamiento en redes de alimentación TN/TT aseguradas con fusibles de 16 A como máximo (utilización de fusibles de mayor amperaje solo previa consulta con el grupo de empresas Rohde & Schwarz).
7. Nunca conecte el enchufe en tomas de corriente sucias o llenas de polvo. Introduzca el enchufe por completo y fuertemente en la toma de corriente. La no observación de estas medidas puede provocar chispas, fuego y/o lesiones.
8. No sobrecargue las tomas de corriente, los cables alargadores o las regletas de enchufe ya que esto podría causar fuego o choques eléctricos.
9. En las mediciones en circuitos de corriente con una tensión  $U_{\text{eff}} > 30 \text{ V}$  se deberán tomar las medidas apropiadas para impedir cualquier peligro (p. ej. medios de medición adecuados, seguros, limitación de tensión, corte protector, aislamiento etc.).
10. Para la conexión con dispositivos informáticos como un PC o un ordenador industrial, debe comprobarse que éstos cumplan los estándares IEC60950-1/EN60950-1 o IEC61010-1/EN 61010-1 válidos en cada caso.
11. A menos que esté permitido expresamente, no retire nunca la tapa ni componentes de la carcasa mientras el producto esté en servicio. Esto pone a descubierto los cables y componentes eléctricos y puede causar lesiones, fuego o daños en el producto.
12. Si un producto se instala en un lugar fijo, se deberá primero conectar el conductor de protección fijo con el conductor de protección del producto antes de hacer cualquier otra conexión. La instalación y la conexión deberán ser efectuadas por un electricista especializado.
13. En el caso de dispositivos fijos que no estén provistos de fusibles, interruptor automático ni otros mecanismos de seguridad similares, el circuito de alimentación debe estar protegido de modo que todas las personas que puedan acceder al producto, así como el producto mismo, estén a salvo de posibles daños.
14. Todo producto debe estar protegido contra sobretensión (debida p. ej. a una caída del rayo) mediante los correspondientes sistemas de protección. Si no, el personal que lo utilice quedará expuesto al peligro de choque eléctrico.
15. No debe introducirse en los orificios de la caja del aparato ningún objeto que no esté destinado a ello. Esto puede producir cortocircuitos en el producto y/o puede causar choques eléctricos, fuego o lesiones.
16. Salvo indicación contraria, los productos no están impermeabilizados (ver también el capítulo "Estados operativos y posiciones de funcionamiento", punto 1). Por eso es necesario tomar las medidas necesarias para evitar la entrada de líquidos. En caso contrario, existe peligro de choque eléctrico para el usuario o de daños en el producto, que también pueden redundar en peligro para las personas.
17. No utilice el producto en condiciones en las que pueda producirse o ya se hayan producido condensaciones sobre el producto o en el interior de éste, como p. ej. al desplazarlo de un lugar frío a otro caliente. La entrada de agua aumenta el riesgo de choque eléctrico.
18. Antes de la limpieza, desconecte por completo el producto de la alimentación de tensión (p. ej. red de alimentación o batería). Realice la limpieza de los aparatos con un paño suave, que no se deshilache. No utilice bajo ningún concepto productos de limpieza químicos como alcohol, acetona o diluyentes para lacas nitrocelulósicas.

## Instrucciones de seguridad elementales

### Funcionamiento

1. El uso del producto requiere instrucciones especiales y una alta concentración durante el manejo. Debe asegurarse que las personas que manejen el producto estén a la altura de los requerimientos necesarios en cuanto a aptitudes físicas, psíquicas y emocionales, ya que de otra manera no se pueden excluir lesiones o daños de objetos. El empresario u operador es responsable de seleccionar el personal usuario apto para el manejo del producto.
2. Antes de desplazar o transportar el producto, lea y tenga en cuenta el capítulo "Transporte".
3. Como con todo producto de fabricación industrial no puede quedar excluida en general la posibilidad de que se produzcan alergias provocadas por algunos materiales empleados —los llamados alérgenos (p. ej. el níquel)—. Si durante el manejo de productos Rohde & Schwarz se producen reacciones alérgicas, como p. ej. irritaciones cutáneas, estornudos continuos, enrojecimiento de la conjuntiva o dificultades respiratorias, debe avisarse inmediatamente a un médico para investigar las causas y evitar cualquier molestia o daño a la salud.
4. Antes de la manipulación mecánica y/o térmica o el desmontaje del producto, debe tenerse en cuenta imprescindiblemente el capítulo "Eliminación/protección del medio ambiente", punto 1.
5. Ciertos productos, como p. ej. las instalaciones de radiocomunicación RF, pueden a causa de su función natural, emitir una radiación electromagnética aumentada. Deben tomarse todas las medidas necesarias para la protección de las mujeres embarazadas. También las personas con marcapasos pueden correr peligro a causa de la radiación electromagnética. El empresario/operador tiene la obligación de evaluar y señalar las áreas de trabajo en las que exista un riesgo elevado de exposición a radiaciones.
6. Tenga en cuenta que en caso de incendio pueden desprenderse del producto sustancias tóxicas (gases, líquidos etc.) que pueden generar daños a la salud. Por eso, en caso de incendio deben usarse medidas adecuadas, como p. ej. máscaras antigás e indumentaria de protección.
7. Los productos con láser están provistos de indicaciones de advertencia normalizadas en función de la clase de láser del que se trate. Los rayos láser pueden provocar daños de tipo biológico a causa de las propiedades de su radiación y debido a su concentración extrema de potencia electromagnética. En caso de que un producto Rohde & Schwarz contenga un producto láser (p. ej. un lector de CD/DVD), no debe usarse ninguna otra configuración o función aparte de las descritas en la documentación del producto, a fin de evitar lesiones (p. ej. debidas a irradiación láser).
8. Clases de compatibilidad electromagnética (conforme a EN 55011 / CISPR 11; y en analogía con EN 55022 / CISPR 22, EN 55032 / CISPR 32)
  - Aparato de clase A:  
Aparato adecuado para su uso en todos los entornos excepto en los residenciales y en aquellos conectados directamente a una red de distribución de baja tensión que suministra corriente a edificios residenciales.  
Nota: Los aparatos de clase A están destinados al uso en entornos industriales. Estos aparatos pueden causar perturbaciones radioeléctricas en entornos residenciales debido a posibles perturbaciones guiadas o radiadas. En este caso, se le podrá solicitar al operador que tome las medidas adecuadas para eliminar estas perturbaciones.
  - Aparato de clase B:  
Aparato adecuado para su uso en entornos residenciales, así como en aquellos conectados directamente a una red de distribución de baja tensión que suministra corriente a edificios residenciales.

## Instrucciones de seguridad elementales

### Reparación y mantenimiento

1. El producto solamente debe ser abierto por personal especializado con autorización para ello. Antes de manipular el producto o abrirlo, es obligatorio desconectarlo de la tensión de alimentación, para evitar toda posibilidad de choque eléctrico.
2. El ajuste, el cambio de partes, el mantenimiento y la reparación deberán ser efectuadas solamente por electricistas autorizados por Rohde & Schwarz. Si se reponen partes con importancia para los aspectos de seguridad (p. ej. el enchufe, los transformadores o los fusibles), solamente podrán ser sustituidos por partes originales. Después de cada cambio de partes relevantes para la seguridad deberá realizarse un control de seguridad (control a primera vista, control del conductor de protección, medición de resistencia de aislamiento, medición de la corriente de fuga, control de funcionamiento). Con esto queda garantizada la seguridad del producto.

### Baterías y acumuladores o celdas

*Si no se siguen (o se siguen de modo insuficiente) las indicaciones en cuanto a las baterías y acumuladores o celdas, pueden producirse explosiones, incendios y/o lesiones graves con posible consecuencia de muerte. El manejo de baterías y acumuladores con electrolitos alcalinos (p. ej. celdas de litio) debe seguir el estándar EN 62133.*

1. No deben desmontarse, abrirse ni triturarse las celdas.
2. Las celdas o baterías no deben someterse a calor ni fuego. Debe evitarse el almacenamiento a la luz directa del sol. Las celdas y baterías deben mantenerse limpias y secas. Limpiar las conexiones sucias con un paño seco y limpio.
3. Las celdas o baterías no deben cortocircuitarse. Es peligroso almacenar las celdas o baterías en estuches o cajones en cuyo interior puedan cortocircuitarse por contacto recíproco o por contacto con otros materiales conductores. No deben extraerse las celdas o baterías de sus embalajes originales hasta el momento en que vayan a utilizarse.
4. Las celdas o baterías no deben someterse a impactos mecánicos fuertes indebidos.
5. En caso de falta de estanqueidad de una celda, el líquido vertido no debe entrar en contacto con la piel ni los ojos. Si se produce contacto, lavar con agua abundante la zona afectada y avisar a un médico.
6. En caso de cambio o recarga inadecuados, las celdas o baterías que contienen electrolitos alcalinos (p. ej. las celdas de litio) pueden explotar. Para garantizar la seguridad del producto, las celdas o baterías solo deben ser sustituidas por el tipo Rohde & Schwarz correspondiente (ver lista de recambios).
7. Las baterías y celdas deben reciclarse y no deben tirarse a la basura doméstica. Las baterías o acumuladores que contienen plomo, mercurio o cadmio deben tratarse como residuos especiales. Respete en esta relación las normas nacionales de eliminación y reciclaje.

### Transporte

1. El producto puede tener un peso elevado. Por eso es necesario desplazarlo o transportarlo con precaución y, si es necesario, usando un sistema de elevación adecuado (p. ej. una carretilla elevadora), a fin de evitar lesiones en la espalda u otros daños personales.

## Instrucciones de seguridad elementales

2. Las asas instaladas en los productos sirven solamente de ayuda para el transporte del producto por personas. Por eso no está permitido utilizar las asas para la sujeción en o sobre medios de transporte como p. ej. grúas, carretillas elevadoras de horquilla, carros etc. Es responsabilidad suya fijar los productos de manera segura a los medios de transporte o elevación. Para evitar daños personales o daños en el producto, siga las instrucciones de seguridad del fabricante del medio de transporte o elevación utilizado.
3. Si se utiliza el producto dentro de un vehículo, recae de manera exclusiva en el conductor la responsabilidad de conducir el vehículo de manera segura y adecuada. El fabricante no asumirá ninguna responsabilidad por accidentes o colisiones. No utilice nunca el producto dentro de un vehículo en movimiento si esto pudiera distraer al conductor. Asegure el producto dentro del vehículo debidamente para evitar, en caso de un accidente, lesiones u otra clase de daños.

### Eliminación/protección del medio ambiente

1. Los dispositivos marcados contienen una batería o un acumulador que no se debe desechar con los residuos domésticos sin clasificar, sino que debe ser recogido por separado. La eliminación se debe efectuar exclusivamente a través de un punto de recogida apropiado o del servicio de atención al cliente de Rohde & Schwarz.
2. Los dispositivos eléctricos usados no se deben desechar con los residuos domésticos sin clasificar, sino que deben ser recogidos por separado.  
Rohde & Schwarz GmbH & Co.KG ha elaborado un concepto de eliminación de residuos y asume plenamente los deberes de recogida y eliminación para los fabricantes dentro de la UE. Para desechar el producto de manera respetuosa con el medio ambiente, dirijase a su servicio de atención al cliente de Rohde & Schwarz.
3. Si se trabaja de manera mecánica y/o térmica cualquier producto o componente más allá del funcionamiento previsto, pueden liberarse sustancias peligrosas (polvos con contenido de metales pesados como p. ej. plomo, berilio o níquel). Por eso el producto solo debe ser desmontado por personal especializado con formación adecuada. Un desmontaje inadecuado puede ocasionar daños para la salud. Se deben tener en cuenta las directivas nacionales referentes a la eliminación de residuos.
4. En caso de que durante el trato del producto se formen sustancias peligrosas o combustibles que deban tratarse como residuos especiales (p. ej. refrigerantes o aceites de motor con intervalos de cambio definidos), deben tenerse en cuenta las indicaciones de seguridad del fabricante de dichas sustancias y las normas regionales de eliminación de residuos. Tenga en cuenta también en caso necesario las indicaciones de seguridad especiales contenidas en la documentación del producto. La eliminación incorrecta de sustancias peligrosas o combustibles puede causar daños a la salud o daños al medio ambiente.

Se puede encontrar más información sobre la protección del medio ambiente en la página web de Rohde & Schwarz.



# Quality management and environmental management

Certified Quality System  
**ISO 9001**

Certified Environmental System  
**ISO 14001**

## Sehr geehrter Kunde,

Sie haben sich für den Kauf eines Rohde&Schwarz Produktes entschieden. Sie erhalten damit ein nach modernsten Fertigungsmethoden hergestelltes Produkt. Es wurde nach den Regeln unserer Qualitäts- und Umweltmanagementsysteme entwickelt, gefertigt und geprüft. Rohde&Schwarz ist unter anderem nach den Managementsystemen ISO9001 und ISO 14001 zertifiziert.

## Der Umwelt verpflichtet

- Energie-effiziente, RoHS-konforme Produkte
- Kontinuierliche Weiterentwicklung nachhaltiger Umweltkonzepte
- ISO 14001-zertifiziertes Umweltmanagementsystem

## Dear customer,

You have decided to buy a Rohde&Schwarz product. This product has been manufactured using the most advanced methods. It was developed, manufactured and tested in compliance with our quality management and environmental management systems. Rohde&Schwarz has been certified, for example, according to the ISO9001 and ISO 14001 management systems.

## Environmental commitment

- Energy-efficient products
- Continuous improvement in environmental sustainability
- ISO 14001-certified environmental management system

## Cher client,

Vous avez choisi d'acheter un produit Rohde&Schwarz. Vous disposez donc d'un produit fabriqué d'après les méthodes les plus avancées. Le développement, la fabrication et les tests de ce produit ont été effectués selon nos systèmes de management de qualité et de management environnemental. La société Rohde&Schwarz a été homologuée, entre autres, conformément aux systèmes de management ISO 9001 et ISO 14001.

## Engagement écologique

- Produits à efficience énergétique
- Amélioration continue de la durabilité environnementale
- Système de management environnemental certifié selon ISO 14001



# Customer Support

## Technical support – where and when you need it

For quick, expert help with any Rohde & Schwarz equipment, contact one of our Customer Support Centers. A team of highly qualified engineers provides telephone support and will work with you to find a solution to your query on any aspect of the operation, programming or applications of Rohde & Schwarz equipment.

## Up-to-date information and upgrades

To keep your instrument up-to-date and to be informed about new application notes related to your instrument, please send an e-mail to the Customer Support Center stating your instrument and your wish. We will take care that you will get the right information.

### Europe, Africa, Middle East

Phone +49 89 4129 12345  
[customersupport@rohde-schwarz.com](mailto:customersupport@rohde-schwarz.com)

### North America

Phone 1-888-TEST-RSA (1-888-837-8772)  
[customer.support@rsa.rohde-schwarz.com](mailto:customer.support@rsa.rohde-schwarz.com)

### Latin America

Phone +1-410-910-7988  
[customersupport.la@rohde-schwarz.com](mailto:customersupport.la@rohde-schwarz.com)

### Asia/Pacific

Phone +65 65 13 04 88  
[customersupport.asia@rohde-schwarz.com](mailto:customersupport.asia@rohde-schwarz.com)

### China

Phone +86-800-810-8228 /  
+86-400-650-5896  
[customersupport.china@rohde-schwarz.com](mailto:customersupport.china@rohde-schwarz.com)



# Contents

<b>1 Preface</b> .....	<b>5</b>
1.1 Documentation Overview.....	5
1.2 Typographical Conventions.....	5
<b>2 Safety Instructions</b> .....	<b>6</b>
<b>3 Welcome to R&amp;S SMZ</b> .....	<b>7</b>
<b>4 Preparing for Use</b> .....	<b>10</b>
4.1 Unpacking and Checking the R&S SMZ.....	10
4.2 Putting into Operation.....	11
4.3 Adjusting the Feet.....	11
4.4 Instrument Tour.....	12
<b>5 Getting Started</b> .....	<b>22</b>
5.1 System Requirements.....	22
5.2 Starting Up.....	24
<b>6 Basic Operation</b> .....	<b>37</b>
6.1 Operating Principle.....	37
6.2 Operation with an R&S Microwave Signal Generator Supporting USB Control.....	38
6.3 Operation with R&S SMZ Control.....	56
6.4 Automation of Test Setups with R&S SMZ.....	69
<b>7 Remote Control Basics</b> .....	<b>73</b>
7.1 Remote Control Interfaces and Protocols.....	73
<b>8 Remote Control Commands</b> .....	<b>85</b>
8.1 SOURce:FREQuency:MULTiplier Subsystem.....	85

8.2 R&S SMZ Control Commands.....	96
<b>9 Maintenance.....</b>	<b>101</b>
9.1 Storing and Packaging.....	102
9.2 Additional Information.....	102
<b>List of Commands.....</b>	<b>103</b>
<b>Index.....</b>	<b>104</b>

# 1 Preface

## 1.1 Documentation Overview

The user documentation for the R&S SMZ consists of the "Manual" and the "Data Sheet", supplied with the instrument in printed form.

## 1.2 Typographical Conventions

The following text markers are used throughout this documentation:

Convention	Description
"Graphical user interface elements"	All names of graphical user interface elements on the screen, such as dialog boxes, menus, options, buttons, and softkeys are enclosed by quotation marks.
KEYS	Key names are written in capital letters.
File names, commands, program code	File names, commands, coding samples and screen output are distinguished by their font.
<i>Input</i>	Input to be entered by the user is displayed in italics.
<a href="#">Links</a>	Links that you can click are displayed in blue font.
"References"	References to other parts of the documentation are enclosed by quotation marks.

## 2 Safety Instructions

The R&S SMZ Frequency Multipliers have been designed and tested in accordance with the EC Certificate of Conformity and has left the manufacturer's plant in a condition fully complying with safety standards.

---

**NOTICE****Risk of instrument damage**

To maintain this condition and to provide safe operation, observe all instructions and warnings given on this page and in the following description.

---

**RF input power**

The RF input power at the connector RF IN must not exceed the maximum values quoted in the data sheet.

Mostly, a generator provides higher RF source power than the maximum input level of the multiplier. To protect the R&S SMZ from damage due to high input level, it is strongly recommend that you keep the generator's output within the permissible range.

**Protection of waveguide flanges**

Protect the waveguide flanges of the frequency multiplier and test port adapters against mechanical damage. Furthermore shield the waveguides from dust and moisture.

When the frequency multiplier is not in use leave the test port adapter mounted, and attach one of the included protective caps to the adapter.

Avoid scratching the contact surfaces of the waveguide flanges.

**Avoid heavy shocks**

Heavy shocks may damage inner parts of the frequency multiplier. Therefore use a shock-proof packing for storing or dispatching the instrument.

## 3 Welcome to R&S SMZ ...

New fields of application such as vehicle distance radar or short-range communications (for example 10 Gb/s WLAN) are creating a steadily growing market for applications in the range 50 GHz up to 170 GHz.

The Rohde & Schwarz Frequency Multipliers R&S SMZ are the tools needed to expand the range of microwave systems, implemented in a compact one-box solution.

Conventional frequency multipliers have no adjustable level and frequency response, that means you need to adjust a test setup according to the characteristics of the multiplier.

The R&S SMZ models, however, are available in three variants - either with mechanical or electronic level control, or without level control.

- Models with **electronic level control** (R&S SMZ75/90/110) automatically control the output level. In operation with an Rohde & Schwarz microwave signal generator, the required generator settings are also set automatically.
- With a frequency multiplier with **mechanical level control** (R&S SMZ75/90/110) you can manually set the attenuation by means of an adjustment screw.
- The **models without level control** (R&S SMZ75/90/110/170) provide applications with fixed level conditions, for example, due to the interpretation of the measured object or to appropriate attenuation measures.

An R&S SMZ frequency multiplier works best with R&S Microwave Signal Generators; however, you can also operate a multiplier with any appropriate generator, as for example the R&S SMR, or even from other manufacturers. However, in order to take full advantage of all the benefits of the R&S SMZ, you can work with the R&S SMZ Control software that supports all features of the R&S SMZ.

Since each frequency multiplier shows a frequency response with not perfectly linear power level, all R&S SMZ are calibrated before delivery. Stored in the frequency multiplier, the calibration data are used, for example by the R&S signal generator or the R&S SMZ Control software, to control the level automatically. The instruments are simply connected via USB to the R&S signal generator or to the computer with R&S SMZ Control.

For example, an Rohde & Schwarz microwave signal generator recognizes a connected frequency multiplier and adjusts its output level automatically to the required input level of the instrument. Working with a controllable frequency multi-

plier, the Rohde & Schwarz microwave signal generator also provides the corresponding control parameters. For models with mechanical attenuator, the generator displays the setting of the adjustment screw, and for models with electronic attenuator, the signal at the output of the frequency multiplier is set automatically. Even with an R&S SMZ without level control, the Rohde & Schwarz microwave signal generator indicates the appropriate output level value.

The R&S frequency multiplier types R&S SMZ75, R&S SMZ90 and R&S SMZ110 multiply the frequency by a factor of 6, whereas the R&S SMZ170 even multiplies by factor 12. Basically, the instruments can be operated in stand-alone mode and do not necessarily have to be controlled over the USB port. All R&S SMZ can work with microwave generators that provide the appropriate frequency ranges and output levels.

**Tip:**R&S SMZ Frequency Multiplier with mechanically controlled attenuator come with a "Adjustment Screw Settings" table that contains the screw settings listed for each frequency and level value pair.

If you operate an R&S SMZ with an Rohde & Schwarz microwave signal generator or R&S SMZ Control, the instruments provide the following additional features:

- Once the multiplier is connected via USB, the Rohde & Schwarz microwave signal generator controls the frequency and the output level by considering the multiplication factor and the frequency limits of the multiplier. In addition, it locks all the modes which are not compatible with the multiplier.
- The Rohde & Schwarz microwave signal generator or R&S SMZ Control display the technical data of the multiplier, such as model, variant, part number, serial number, firmware version, etc.
- In mechanically adjustable frequency multipliers, the Rohde & Schwarz microwave signal generator and R&S SMZ Control indicate the value that is to be set at the screw. They receive the value from the multipliers adjustment screw settings table and then provide the level settings for the current frequency.
- When working with an R&S SMZ with electronically controlled attenuator, the Rohde & Schwarz microwave signal generator or R&S SMZ Control can control the level at the output of the frequency multiplier directly. The internally stored calibration data of the multiplier are considered automatically. Equipped with an electronically controlled attenuator, you can also operate the R&S SMZ in sweep mode.
- You can remotely control any test setup consisting of an R&S SMZ and the Rohde & Schwarz microwave signal generator or R&S SMZ Control, respectively.



A measurement setup with the Rohde & Schwarz microwave signal generator and a multiplier with electronic level control is remote-controllable via SCPI.

- Furthermore, R&S SMZ Control provides the setting of the RF signal of any connected generator via remote control.
- With R&S SMZ Control or the Rohde & Schwarz microwave signal generator you can execute a firmware update for your R&S SMZ.



### Information on updates and extensions

Firmware and software updates as well as the release notes, describing the improvements and modifications are provided on the internet at the download site of Rohde & Schwarz: <http://www.rohde-schwarz.com/product/SMZ.html>

This website always offers the latest information on your R&S SMZ, about the current firmware and software, and also on changes of the software update procedure.

The new R&S SMZ170 does not yet support the mechanical or electronic level control options. Accordingly, all descriptions in this manual that relate specifically to the models equipped with one of the level control options are not relevant for the R&S SMZ170.

---

This manual gives a brief introduction to connection and use of the R&S SMZ frequency multipliers. For detailed technical information refer to the data sheet. Find details to the settings of the R&S microwave signal generators also in the corresponding manuals and help systems.

## 4 Preparing for Use

This section explains how to take an R&S SMZ frequency multiplier into operation. It includes the controls and connectors of the R&S SMZ, and provides all the information necessary for connection.

For equipment required for a basic test setup see [Chapter 5.1, "System Requirements"](#), on page 22.

### 4.1 Unpacking and Checking the R&S SMZ

To remove the instrument from its packaging and check the equipment for completeness proceed as follows:

1. Unpack the R&S SMZ and the other contents of the shipping container.
2. Check the equipment for completeness using the delivery list.
3. Remove the protective cap from the test port adapter at the front of the R&S SMZ. Inspect the instrument carefully, to make sure that it was not damaged during shipment.

In case it is damaged, immediately contact the freight forwarder, who has delivered the instrument.



#### Packaging material

It is recommended that you retain the original packaging material. If the R&S SMZ needs to be transported or shipped at a later date, you can use the material to prevent control elements and connectors from being damaged.

Equipment returned or sent in for repair must be packed in an appropriate packaging, if the original packaging is no longer available.

Also use the packaging material for storage of the instrument and the accessories.

---

## 4.2 Putting into Operation

The frequency multiplier is designed for use under laboratory conditions on a bench top. The surface of the bench top should be flat. Always use the frequency multiplier in horizontal position.

The general ambient conditions required at the operating site are as follows:

- The ambient temperature must be in the ranges specified for operation and for compliance with specifications (see data sheet).
- All ventilation openings must be unobstructed.

---

**NOTICE****Risk of instrument and DUT damage**

To avoid damage of electronic components of the DUT and the frequency multiplier, protect the operating site against electrostatic discharge (ESD).

---

## 4.3 Adjusting the Feet

You can set up the R&S SMZ with three or four feet, which are mounted on the underside. In order to achieve larger stability, we recommend that you use three feet: two in front at the sides, and one centered in the back.

In most cases, you best align an instrument as follows: Screw the front feet as much as possible into the instrument. Then use the back foot, to align the instrument horizontally, that is parallel to the bench.



Setups with three feet and four feet

## 4.4 Instrument Tour

### 4.4.1 Front View

At the front the R&S SMZ covers the interface to the DUT, that is the output of the multiplied RF frequency.

#### Test Port Adapter (Waveguide Flange)

An R&S SMZ is equipped with a mounted test port adapter for the corresponding frequency band.

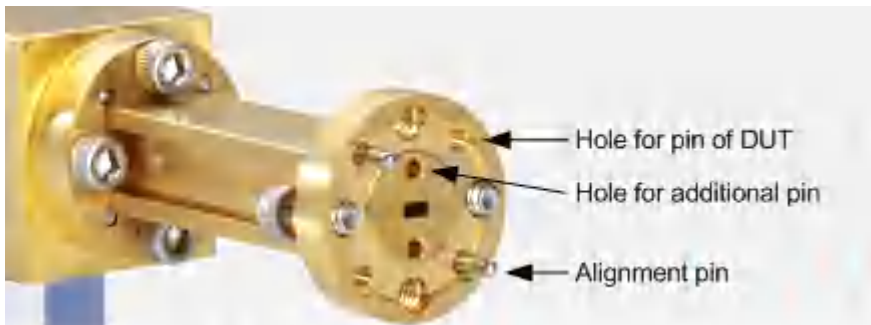

Figure 4-1: Front of an R&S SMZ at the example of the R&S SMZ110 without attenuator

At the front, all R&S SMZ are similar in design.

The precision waveguide flange of the test port adapter is equipped with two alignment pins and two holes that receive the alignment pins of the DUT. Two additional holes in the middle allow to insert additional alignment of needles that

are included. Use the extra pins, when the flange of the DUT has the appropriate holes for these pins. This increases the accuracy and stability of the connection.



**Figure 4-2: Assignment of the test port adapter**

The test port adapters are similar in design for all frequency bands. Refer to the data sheet for more details on the type of waveguide.

Connect the DUT (Device Under Test) to this test port adapter.



A DUT with thin pins reduces the alignment and stability. If possible, use two additional pins above and below the waveguide cross-section, in order to compensate the reduced alignment.

---

If you do not need the adapter, dismount it from the waveguide flange of the R&S SMZ.

### Mounting the Test Port Adapter

Mount the selected adapter to the waveguide flange of the instrument using the delivered screws and the hex ball driver. Check whether the connection is properly tightened. A tight and accurate connection is prerequisite for precise results.



For a correct assembly / disassembly we recommend that you use only the provided hex ball driver and screws.

---

## 4.4.2 Top View



R&S SMZ instruments with mechanical level control are equipped with a power adjustment screw on top.

### Output Power Adjustment Screw



The adjustment screw on top of the casing is a mechanical solution to manually modify the signal output power, corresponding to the current frequency. Based on calibration data, the scale at the screw supports adjusting the signal level. It is located on the left side of the R&S SMZ, looking from front.

Turning the screw clockwise reduces the output power, while turning the screw counter-clockwise increases the output power.

If the screw is turned out onto the top position, that is to 2 mm, you have maximum power at the output of the R&S SMZ. Conversely, at 0 mm (entirely screwed in), the R&S SMZ provides the signal with minimal output power.

Setting the adjustment screw:

- 0: maximum attenuation
- 1x 0...49...0: the adjustment screw is screwed 0.5 mm
- 2x 0...49...0: the adjustment screw is screwed 1.0 mm



If you accidentally unscrew the knob completely, simply screw it on again. If you readjust the screw, the power calibration is still valid.

If you operate your R&S SMZ with an Rohde & Schwarz microwave signal generator via USB, the signal generator displays a "SMZxxx" block, labeled according to the connected model, as described in [Chapter 6.2.1, "Indicating an R&S SMZ"](#), on page 39. The generator reads the calibration table of the multiplier, calcu-

lates the frequency multiple, and indicates this frequency and its level in the status bar, as well as the corresponding scale-setting for the screw in the "SMZxxx" block. For more information on how to configure the R&S SMZ when it is connected to an Rohde & Schwarz microwave signal generator see [Chapter 6.2.2, "Setting Frequency and Level"](#), on page 42.

If you work with a different signal generator, you will find the adjustment screw settings for the appropriate frequency and level values in the calibration table, supplied with your R&S SMZ.

### 4.4.3 Rear View

The rear panel of the frequency multiplier provides the connectors and control elements described below:

- [On/Off Switch](#)
- [Power LED](#)
- [USB Remote LED](#)
- [USB Interface](#)
- [Power Supply Connector](#)
- [RF IN Connector](#)
- [ATTENUATOR ON/OFF - Switch](#)

**Note:** The ATTENUATOR ON/OFF switch applies only to multipliers with electronic level control.



Figure 4-3: Rear view of the frequency multiplier

#### 4.4.3.1 On/Off Switch



The switch turns on the internal modules of a frequency multiplier, or disconnects the instrument from the power supply.



The power supply still leads power, even when the frequency multiplier is switched off.

#### 4.4.3.2 Power LED



This green LED (Light-Emitting Diode) above the switch indicates when the 9V voltage is applied and the frequency multiplier is switched on. The instrument is in ready state. When the instrument is switched off, the LED is also off.



### 4.4.3.3 USB Remote LED



The green USB LED indicates when the frequency multiplier is remotely controlled, that means a USB cable is connected and the communication is active.

### 4.4.3.4 USB Interface

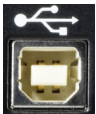

USB (Universal Serial Bus) interface of type B. This port is used to communicate with the host instrument, e.g. an Rohde & Schwarz microwave signal generator.



- It is recommended that you use the cable included in delivery. Do not use USB connecting cables exceeding 3 m in length. Refer to the data sheet for information on the part number of the associated cable.
- For information on the Rohde & Schwarz microwave signal generator supporting communication with the R&S SMZ via USB, see [Table 5-1](#) or the release notes provided on the R&S website of the respective Rohde & Schwarz microwave signal generator.

### 4.4.3.5 Power Supply Connector

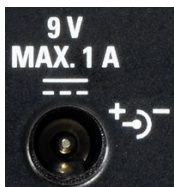

R&S SMZ75/90/110



R&S SMZ170

Connection for the DC power supply.



It is strongly advised that you use only the included power supply unit for the operation of the R&S SMZ.

Otherwise the specified data and the EMC regulations are not surely met.

#### **NOTICE**

##### **Risk of instrument damage**

The input voltage and current must not exceed the maximum values according to the labeling or the data sheet.

Switch off the instrument before removing the power supply.

The permissible input current for a frequency multiplier is  $<1$  A for the R&S SMZ75/90/110 series, and  $<2$  A for an R&S SMZ170 instrument (see data sheet). Therefore, a matching power supply unit is included, according to the R&S SMZ model. The power supplies support the AC input voltages between 100 V and 240 V and frequencies between 47 Hz and 63 Hz

##### **Power supply of the R&S SMZ75/90/110**

These instruments are delivered with an AC to DC power supply with four interchangeable AC plugs (Europe, USA, British, Australia). Select the plug suitable for your region.

The following figure shows an example for using Europe AC plug:



**Figure 4-4: Assembling the power supply adapter**

- ① = AC plug
- ② = Power adapter
- ③ = Release button for unplugging the AC plug
- Ⓐ = Connection: AC plug and power adapter
- Ⓑ = Connection: 9 V DC power output and 9V MAX 1A socket
- Ⓒ = Connection: Assembled power supply to mains supply

To assemble the power supply and connect to the mains, proceed as follows:

1. To assemble AC plug ① and power adapter ②, mount the plug as shown in the figure ( connection Ⓐ).

You will hear a "click" sound when the plug is properly locked in place.

**Tip:** Use the release button ③ to unlock AC plug and power adapter again.

2. Connect the assembled power supply to the 9V MAX 1A socket (connection Ⓑ) and to the AC power (connection Ⓒ).

### Power supply of the R&S SMZ170

The R&S SMZ170 instruments are delivered with the AC/DC power supply adapter for desktop, type *NJ FRA045 AC/DC ADAPTOR 1X 45W 9V 6A*, (R&S part number 3589.6959.00). The matching power cord is included.

#### 4.4.3.6 RF IN Connector



Connector for RF signal input. This connector is a 2.9 mm coaxial connector with an impedance of 50 Ohm.

#### NOTICE

##### Risk of instrument damage

The RF input power at the connector RF IN must not exceed the maximum values quoted in the data sheet.



To avoid electromagnetic interference (EMI), use double shielded cables at the RF connectors of the instruments.

It is recommended that you use a suitable RF cable for the connection which is characterized by low attenuation. Find information on the appropriate cable and its R&S part number in the data sheet.

- If you work with an R&S signal generator, suitable cables are provided by the generator.
- Generators of other manufacturers might not have the matching connector sockets for the multiplier, for example an N connector. In this case, an adapter is required.

#### 4.4.3.7 ATTENUATOR ON/OFF - Switch



For models with **electronic level control**, this switch determines, whether the power of the outgoing signal is adjusted or set to the maximum level. This switch is relevant in stand-alone mode, that means when you use the frequency multiplier without USB control.

- Switch the attenuator **on**, if you want to control the output power via USB.  
**Note:** If USB is disconnected, the output power is set to minimum, to protect the DUT from high input level.

- Switch the attenuator **off**, if you want to use the frequency multiplier without remote control.



Information to the switch positions:

- ON assumes that the control over USB is active. If not, the R&S SMZ outputs the signal with minimum power level, in order to protect the DUT from high input power.
  - OFF assumes that the frequency multiplier is operated without level control. In this case, the instrument provides the signal with the maximum output power, that is without attenuation.
-

## 5 Getting Started

This section explains the required steps and components for putting the R&S SMZ into operation. It describes how to connect the instruments, and what you have to observe. To establish a measurement, it is recommended that you perform the connection and steps in the order given, to protect the frequency multiplier from damage caused by high input level.

### NOTICE

#### Risk of instrument damage

Note, that the general safety instructions also contain information on operating conditions that will prevent damage to the instrument. Also the data sheet contains additional operating conditions.

Before you put the instrument into operation, make sure that the following conditions are met:

- All ventilation openings are unobstructed and the airflow perforations are unimpeded. The minimum distance from the wall is 10 cm.
- Ventilation openings are unobstructed.
- The instrument is dry and shows no sign of condensation.
- The interfaces of the instrument are correctly connected.
- The instrument is operated in the horizontal position on an even surface.
- The ambient temperature is not exceeding the range specified in the data sheet.
- Signal levels at the input and output connectors are all within the specified ranges.

Non-observance of these conditions may cause damage to the instrument or other instruments in the test setup.

### 5.1 System Requirements

To operate a multiplier, you need:

- An R&S SMZ frequency multiplier and the included test port adapter, where necessary.

- A suitable signal source, which can generate a signal within the frequency range of your R&S SMZ and a level of 7 dBm, see "[Signal Sources](#)" on page 23.
- A suitable RF cable.
- An RF adapter, if required.



A suitable USB cable is included, for operating the R&S SMZ with an Rohde & Schwarz microwave signal generator, provided the signal generator supports communication via USB. See the overview in [Table 5-1](#).

You also need this USB cable when you operate the R&S SMZ with the configuration software R&S SMZ Control, see [Chapter 5.2.2, "Starting Up with R&S SMZ Control"](#), on page 28.

Note also that USB cables are of varying and often poor quality. Therefore, it is recommended to use only this USB cable supplied.

## R&S SMZ Control Configuration Software

With R&S SMZ Control, you can configure a test setup that does not support the direct communication between the signal generator and the R&S SMZ via USB. In addition, you can remotely control your application.

For working with R&S SMZ Control, you need:

- An R&S SMZ.
- The software, available on the R&S website <http://www.rohde-schwarz.com/product/SMZ.html>.
- A license key code for each used R&S SMZ, see [Chapter 5.2.2.2, "Activating an R&S SMZ for use with R&S SMZ Control"](#), on page 31.
- A controller with windows operating system. As controller you can use the PC with R&S SMZ Control, or any PC in the network.
- A suitable signal source, as listed in [Table 5-1](#).
- A LAN cable (optionally for remote control)

## Signal Sources

The R&S SMZ works with the signal sources listed in the [Table 5-1](#). In addition, you find information if the configuration via USB or with R&S SMZ Control is possible.

**Table 5-1: Microwave Signal Sources**

Instruments	USB control? <sup>1)</sup>	Prerequisites	R&S SMZ Control?	Prerequisites
R&S SMF100A	yes	FW 2.15.270.06 or later FW 2.20.232.16 or later	not required	---
R&S SMB100A	yes	FW 2.20.382.106 or later Microwave instrument	not required	---
R&S SMR	no	---	yes	GPIB
R&S SMT	no	---	yes	GPIB
any Microwave Signal Generator	no	---	yes	GPIB or LAN

<sup>1)</sup> communication via USB supported



Basically, make sure that the frequency range of the signal generator matches to the range of the R&S SMZ.

## 5.2 Starting Up

This chapter provides a brief overview of the different ways you can operate your R&S SMZ, and the startup of the typical test setups:

- The R&S SMZ with a Rohde & Schwarz microwave signal generator, see [Chapter 5.2.1, "Starting Up with an R&S Microwave Signal Generator supporting USB Control"](#), on page 26
- The R&S SMZ controlled by the software R&S SMZ Control.
- The R&S SMZ with a microwave signal generator without USB connection, see [Chapter 5.2.3, "Starting Up with any Microwave Signal Generator"](#), on page 34

Basically each R&S SMZ must be connected to a signal generator, preferably to an Rohde & Schwarz microwave signal generator, the power supply and to the DUT.



**NOTICE****Risk of RF connector and cable damage**

Excessive tightening of the connectors can damage the cables and connectors. Too weak tightening leads to inaccurate results.

Always use an appropriate torque wrench suitable for this type of connector.

**First, some general information and helpful links to the startup:**

- RF connection  
We recommend that you switch off RF before connecting the R&S SMZ, to prevent damage of the R&S SMZ due to high input power. Additionally, make sure that the input power level is always less than 10 dBm.
- USB connection  
To establish the connection between the R&S SMZ and the controller, connect the USB cable plug B to the frequency multiplier, and the USB cable plug A to the controller.  
Refer to [Chapter 4.4.3.4, "USB Interface"](#), on page 17 or the data sheet for information on the USB interface and on the approved cable.
- Connection to the DUT  
Depending on the interface, you may need to first remove the test port adapter, see [Chapter 4.4.1, "Front View"](#), on page 12.
- Warming up  
Warm up the R&S SMZ for at least 30 minutes.
- Power supply of the R&S SMZ  
The DC supply is located at the rear panel. For information on the handling of the plug adapter see [Chapter 4.4.3.5, "Power Supply Connector"](#), on page 17.
- Switching on the R&S SMZ  
The On/Off switch is located at the rear panel (see [Chapter 4.4.3.1, "On/Off Switch"](#), on page 16). To switch the instrument to ready state, press the button. The green LED next to the switch must be lit.

## 5.2.1 Starting Up with an R&S Microwave Signal Generator supporting USB Control

Working with an Rohde & Schwarz microwave signal generator, you only need to select the appropriate R&S SMZ multiplier corresponding to the frequency range of your application and possibly with attenuator.

To find out if your signal generator supports communication with the multiplier via USB, see [Table 5-1](#).

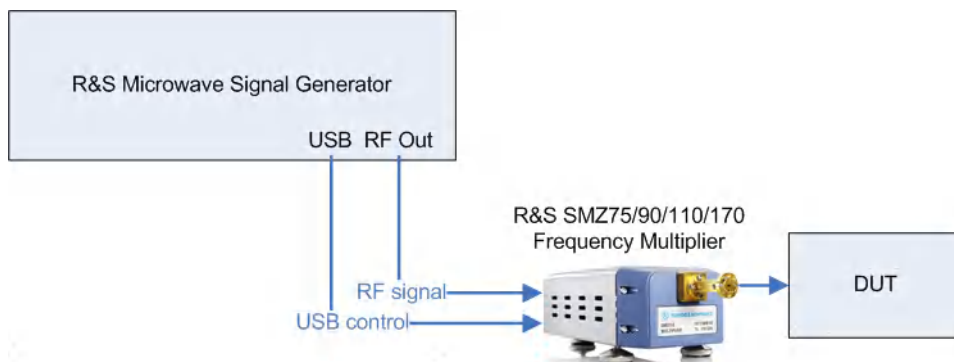

This example explains the starting up with a multiplier without attenuator. You can also find tips on how to proceed if you are using an R&S SMZ with an attenuator.

1. Switch on the Rohde & Schwarz microwave signal generator.
2. Connect the R&S frequency multiplier to the DC supply.  
For information about the power supply and the handling of the plug adapter see [Chapter 4.4.3.5, "Power Supply Connector"](#), on page 17.

3. Switch on the R&S SMZ.

**Note:** Keep the warm-up time of at least 30 minutes.

4. Establish the USB connection.

**Note:**

- With connecting USB, the Rohde & Schwarz microwave signal generator recognizes the R&S SMZ automatically, and immediately turns off the RF output signal to protect the frequency multiplier from high input level. The generator reads all parameters for identification and the calibration table of the frequency multiplier.
- At a reboot with a connected R&S SMZ, RF may remain active, since the Rohde & Schwarz microwave signal generator starts with the last used settings.

5. Connect the RF output of the signal generator to RF IN of the frequency multiplier.
6. Connect the frequency multiplier with the DUT.
7. Set the RF output signal of the generator.  
Since you are working with an Rohde & Schwarz microwave signal generator, you can directly enter the frequency required at the DUT - either with the **FREQ** key or in the [Chapter 6.2.2, "Setting Frequency and Level"](#), on page 42 dialog.

The Rohde & Schwarz microwave signal generator indicates the signal level at the specified frequency, the R&S SMZ provides at its signal output (read only) .

**Tip:** R&S SMZ with attenuator.

Equipped with an attenuator, you can also determine the level value as follows:

- **Electronically controlled:** the Rohde & Schwarz microwave signal generator automatically sets the level to the value that is specified.
- **Mechanically controlled:** the Rohde & Schwarz microwave signal generator shows the setting for the adjustment screw to obtain the specified level.

Just set the screw according to the displayed value.

8. Switch on RF output of the signal generator.

The system is running.



The Rohde & Schwarz microwave signal generator indicates the output frequency and level from the R&S SMZ in the status bar, independently of the connected frequency multiplier type. That means even the output level of a multiplier R&S SMZ without level control is shown. Additionally, if a frequency multiplier with mechanical level control is connected, the Rohde & Schwarz microwave signal generator displays the corresponding scale-setting for the adjustment screw in the "SMZxxx" block. With an electronically controlled frequency multiplier, both instruments automatically control the signal required for the DUT.

---

## 5.2.2 Starting Up with R&S SMZ Control

You can operate each R&S SMZ with the configuration software R&S SMZ Control, available on the R&S website <http://www.rohde-schwarz.com/product/SMZ.html>.

R&S SMZ Control works with all instruments of the R&S SMZ family, regardless of the used generator.



Prior to the starting up, install the configuration software R&S SMZ Control on the PC. Proceed as described in [Installing R&S SMZ Control](#).

In addition, a frequency multiplier needs to be licensed and enabled for performing settings with R&S SMZ Control. How to proceed is described in [Chapter 5.2.2.2, "Activating an R&S SMZ for use with R&S SMZ Control"](#), on page 31.

### 5.2.2.1 Installing R&S SMZ Control

R&S SMZ Control runs on Windows operating systems. It is designed specifically for the configuration of multipliers of the R&S SMZ family. Its scope corresponds to the functionality offered by the Rohde & Schwarz microwave signal generators that support communication via USB, and thus enables convenient handling even when used with other microwave generators.

This section briefly describes how to install the software R&S SMZ Control, the tool for setting the parameters of an R&S SMZ on a PC.

#### Prerequisites

It is recommended that you:

- Use the latest software.
- Close all running applications before installing.
- Disconnect all R&S SMZ and do not connect any during installation.

**Table 5-2: PC Requirements**

Component	Minimum requirement
Operating system	Windows XP (32 bit), Windows 7
Hard disk	80 MByte free space
Interfaces	USB 2.0

-  According to its specification, the driver also works with Windows 2000 or Windows Vista, as well as with USB 1.1. Thus, configurations with these systems may also work properly.

## Installing

The setup file for the installation is provided at the R&S website <http://www.rohde-schwarz.com/product/SMZ.html> and can be downloaded free charge. The internet site also provides the associated release notes containing the improvements and modifications.

1. Execute `SMZ-Control_x.xx.xx.exe` and proceed with "Next".  
The version number x.xx.xx in the filename represents the current version. Each update has a new release number.

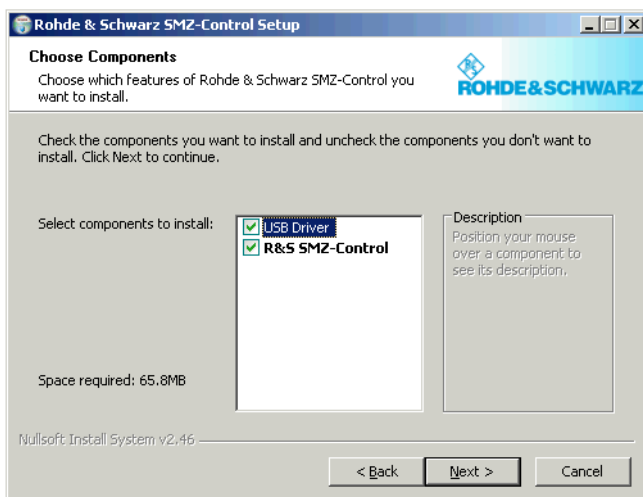

It is recommended that you install the preselected components.

2. Select the destination directory and path, and proceed with "Install".

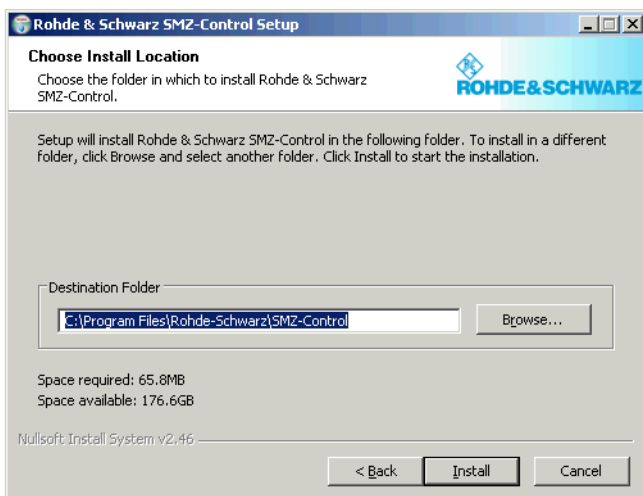

During installation the program creates various subdirectories needed by the application.

You can find R&S SMZ Control stored under

`%PROGRAMFILES%\Rohde-Schwarz\SMZ_Control\bin\`

`RS_SMZ_Control.exe`. The system variable `%PROGRAMFILES%` represents the directory of installed programs.

## Uninstalling

To uninstall the software use either the R&S SMZ Control uninstaller,

- ▶ "Start > programs > SMZ Control > Uninstall"

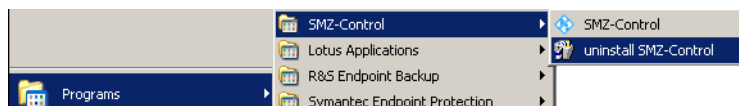

or the PC's control panel:

- ▶ "Start > Setting > Control Panel" in the windows task bar and open the "Add or Remove Programs". Select "R&S SMZ Control" and uninstall with "Remove".

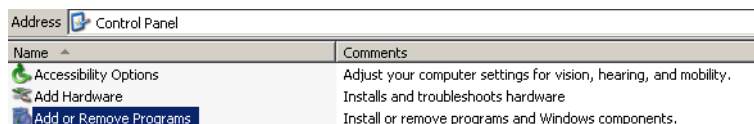



Both uninstall routines remove all currently installed R&S SMZ Control components, including directories as well as files with user-specific settings of previously connected R&S SMZ.

However, a software update does not affect user-specific settings files.

### 5.2.2.2 Activating an R&S SMZ for use with R&S SMZ Control

A R&S SMZ frequency multiplier needs to be licensed and enabled for configuration with R&S SMZ Control. Contact the R&S sales department for purchase. The license key comes as a file or on paper with an instruction for registration.

To activate the R&S SMZ proceed as follows:

1. Connect the multiplier, switch it on and start R&S SMZ Control.  
The "SMZ Control" dialog opens, indicates the basic settings and several buttons, providing access to further dialogs.

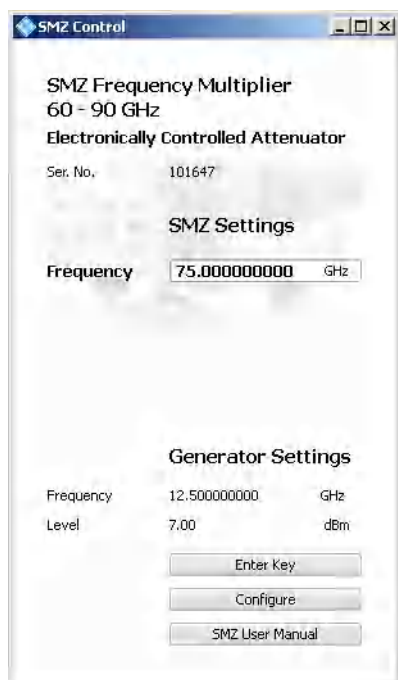

2. Select "Enter Key".  
The "Enter Key" dialog opens

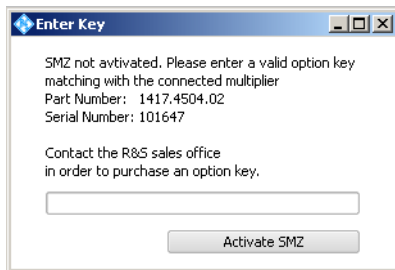

3. Enter the license key either manually or with copy and paste, and confirm with "Activate SMZ".

The R&S SMZ is enabled and ready for operation with R&S SMZ Control.

### 5.2.2.3 Test Setup

The example below shows the setup of an R&S SMZ without attenuation and any signal generator. Differences to R&S SMZs with attenuator are explicitly pointed out. For detailed description of R&S SMZ Control, refer to [Chapter 6.3, "Operation with R&S SMZ Control"](#), on page 56.



In the following section, we assume that you have already installed R&S SMZ Control and enabled your R&S SMZ.

If you have not yet activated the R&S SMZ, proceed as described in [Chapter 5.2.2.2, "Activating an R&S SMZ for use with R&S SMZ Control"](#), on page 31.

---

In addition, you can remotely configure the RF signal of the generator directly in R&S SMZ Control. Hence, the R&S SMZ Control offers you convenient configuration of both instruments. Moreover, it is possible to remotely control also R&S SMZ Control, and therefore the entire test setup, see [Chapter 6.4.1, "Automation of R&S SMZ Control"](#), on page 69.



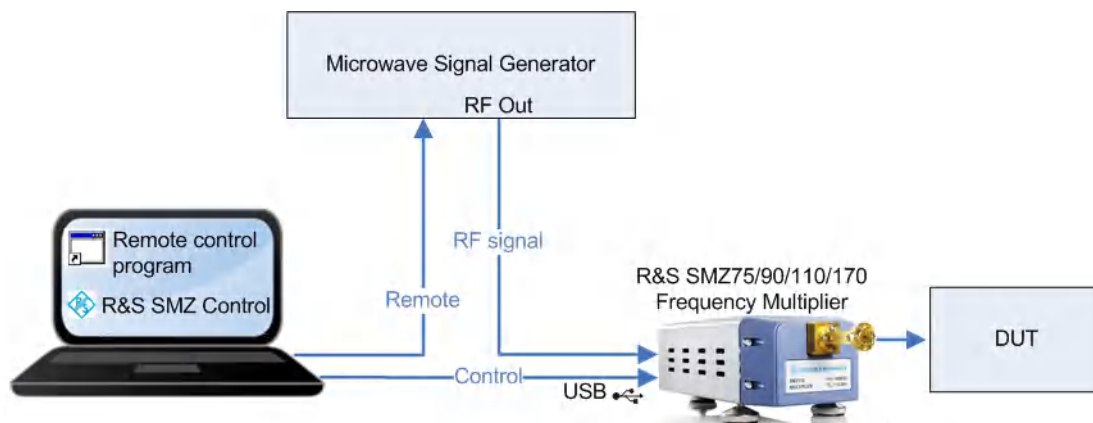

### Setting up R&S SMZ and R&S SMZ Control:

1. Start R&S SMZ Control.

**Note:** With connecting USB, the R&S SMZ Control recognizes the R&S SMZ automatically. It reads all parameters for identification and indicates serial number, frequency and level of the connected R&S SMZ. If you work with an R&S SMZ with mechanically controlled attenuator R&S SMZ Control reads out the adjustment screw settings table and indicates the screw setting corresponding to the entered frequency.

2. Connect the R&S SMZ to the DC supply.
3. Establish the USB connection from the PC to the R&S SMZ (cable plug B).
4. Switch on the R&S SMZ.

**Note:** Keep the warm-up time of at least 30 minutes.

### Setting up the signal generator:

1. Switch on the signal generator before you connect the R&S SMZ.
2. Switch off the signal generator RF output.
3. Switch off all active level correction functions in the generator, such as "User Correction", etc., and enter the "cable loss" in the "SMZ Control > Configure" dialog.

The cable loss function executes level correction at the generators output signal, to keep the 7 dBm input level, required from the R&S SMZ. Therefore, all other correction functions would interfere this functionality.

4. Determine the cable loss.

As the R&S SMZ requires quite exactly 7 dBm input level, you should know the cable loss of the connection between the generator and the multiplier.

If you don't know the cable loss refer to [Chapter 6.2.3.3, "SMZ Cable Compensation Settings"](#), on page 46 for determination.

5. Establish the RF connection from the generator to the R&S SMZ (RF IN).
6. Connect the Frequency Multiplier with the DUT.
7. Set the output frequency of the R&S SMZ.  
R&S SMZ Control automatically indicates the corresponding level value of the multiplier (read only) as well as the frequency value to be set in the generator.  
**Tip:** R&S SMZ with attenuator.  
Equipped with an attenuator, you can also determine the level value as follows:
  - **Electronically controlled:** R&S SMZ Control automatically indicates level to be set in the generator.
  - **Mechanically controlled:** R&S SMZ Control indicates the setting for the adjustment screw to achieve the specified level.  
Just set the screw according to the displayed value.
8. Setup the remote connection, if you want to remotely control the generator:
  - a) Establish the remote connection (LAN or GPIB) from the generator to the controller.
  - b) Enter the address (IP or GPIB) of the signal generator in the "SMZ Control > Configure" dialog and activate "Remote Generator".  
Once you assign the settings with "Apply", the RF output of the generator is turned off to protect the DUT.
  - c) R&S SMZ Control sets frequency and level of the RF signal in the generator and turns on signal output, and indicates "RF ON".
9. In Local mode, set the RF output signal in the generator, according to the values R&S SMZ Control displays and turn on signal output manually.

The system is running.

### 5.2.3 Starting Up with any Microwave Signal Generator

You can also use an R&S SMZ with any other microwave signal generator that provides the appropriate frequency and input level for the multiplier, see [Table 5-1](#). In this case you have to calculate the input frequency and adjust the output power manually.

The following example shows the startup of a R&S SMZ without attenuation, but also mentions how to proceed with a multiplier with attenuator.

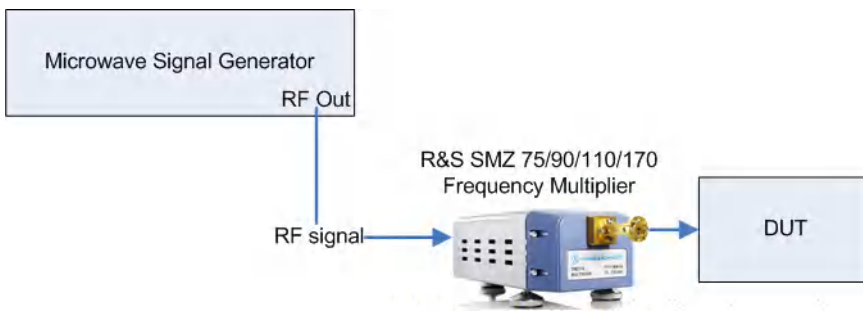

1. Switch on the signal generator before you connect the R&S SMZ.
2. Connect the frequency multiplier with the DUT.
3. Switch off the signal generator RF output and then connect it with the R&S SMZ (RF IN).

**Note:** Remember that the input power of the R&S SMZ must be less than 10 dBm, to provide damage due to overloading.

4. Connect the frequency multiplier to the DC supply (rear panel).
5. Switch on the R&S SMZ.

**Note:** Keep the warm-up time of at least 30 minutes.

6. Set the RF output signal of the generator.

**Tip:** How to get the settings:.

- Calculate the generator frequency under consideration of the multiplication factor.
- Determine the correct input level for the frequency multiplier, considering the cable loss. That means the generators output signal level must be accordingly higher than 7 dBm.
- Measure the output power of the R&S SMZ at the desired frequency, and adjust it if necessary, with appropriate external attenuators.

**Tip:** R&S SMZ with attenuator.

Additional features if you operate with an R&S SMZ equipped with attenuator:

- **Electronically controlled:** with this feature of the instrument, you have several options, as follows:
  - In a "conventional" test setup as shown above, the R&S SMZ operates like a multiplier without attenuator.
  - If you use R&S SMZ Control, you can enter your target frequency, and get the corresponding RF frequency of the generator displayed. In this case, the generator output power is 7 dBm and cable loss is not taken into account. See [Chapter 5.2.2, "Starting Up with R&S SMZ Control"](#),

on page 28 for the corresponding test setup, and [Chapter 6.3, "Operation with R&S SMZ Control"](#), on page 56 for description in detail.

- If you additionally purchase a license key for the activation of the R&S SMZ in R&S SMZ Control, you obtain the full functionality this frequency multiplier provides. You can start without additional preparation and perform your measurement.
  - **Mechanically controlled:** included in delivery, you find the "Adjustment Screw Settings" table. Select the appropriate setting and turn the level adjustment screw accordingly.
7. Switch on RF output of the signal generator.
- The system is running.

## 6 Basic Operation

This chapter describes how to configure an R&S SMZ, both, if it is operated with any microwave signal generator and the software R&S SMZ Control, and especially if it is connected to an Rohde & Schwarz microwave signal generator.

This section covers the following topics:

- [Chapter 6.1, "Operating Principle"](#), on page 37, a short overview of the R&S SMZ family and key facts
- [Chapter 6.2, "Operation with an R&S Microwave Signal Generator Supporting USB Control"](#), on page 38, appearance and configuration
- [Chapter 6.3, "Operation with R&S SMZ Control"](#), on page 56, connection and configuration
- [Chapter 6.4, "Automation of Test Setups with R&S SMZ"](#), on page 69, the possibilities of remote control

### 6.1 Operating Principle

The R&S SMZ family includes the frequency multipliers R&S SMZ75/90/110/170 covering a wide frequency range as well as optional attenuators installed in the same housing. This "one-box" solution simplifies setups and the operation compared to conventional setups.

In addition, most of the R&S microwave signal generators, as well as the software R&S SMZ Control can communicate with an R&S SMZ via USB. Using this connection, the instruments exchange for example the pre-calibrated frequency response values of the multiplier, or the cable loss of the RF connection, and are thus able to provide a very precise output signal for the DUT.

The models R&S SMZ75/90/110 multiply the input frequency by a factor of 6, and the R&S SMZ170 by 12. Accordingly, the multiplier requires the 6th, respectively the 12th part of the output frequency at its input from the generator. The input level of an R&S SMZ must always be 7 dBm.

Each R&S SMZ is pre-calibrated, with the frequency response values stored internally. Equipped with the USB interface, it enables access to the data, provided the required access rights are given. The access is enabled automatically within the connection to an Rohde & Schwarz microwave signal generator, and

Operation with an R&S Microwave Signal Generator Supporting USB Control with R&S SMZ Control, you can unlock the access with the license key code, see [Chapter 5.2.2.2, "Activating an R&S SMZ for use with R&S SMZ Control"](#), on page 31.



- The frequency multiplier is supplied by R&S in fully calibrated condition. Further calibration or initialization is not required.
- Consider connection losses, like the attenuation of the cable, as shown in ["Cable Loss \(10 GHz\)"](#) on page 47.
- If you use a microwave signal generator without control via USB or R&S SMZ Control, you must determine the frequency and level values in advance.

## 6.2 Operation with an R&S Microwave Signal Generator Supporting USB Control

This section briefly shows how a connected R&S SMZ frequency multiplier is displayed and configured when you are working with an Rohde & Schwarz microwave signal generator.

For controlling the R&S SMZ with an Rohde & Schwarz microwave signal generator via USB, the instruments must be connected, as described in [Chapter 5.2, "Starting Up"](#), on page 24.

Once an R&S SMZ is connected via USB, an Rohde & Schwarz microwave signal generator automatically recognizes the multiplier. It adjusts the frequency, level and block diagram accordingly, and also adjusts the relevant parameters of the frequency multiplier in the settings dialogs.

The following sections provide both, a general overview to the operation with the R&S generators, as well as specific information on the individual instruments, see...

- [Chapter 6.2.1, "Indicating an R&S SMZ"](#), on page 39
- [Chapter 6.2.4, "Operation with the R&S SMF100A"](#), on page 51
- [Chapter 6.2.5, "Operation with the R&S SMB100A"](#), on page 54
- [Chapter 6.2.2, "Setting Frequency and Level"](#), on page 42
- [Chapter 6.2.3, "SMZ Info/Update Settings in the R&S Signal Generator"](#), on page 43

 The Rohde & Schwarz microwave signal generator appends the serial number of the connected R&S SMZ to the list of available multipliers in the "SMZ Info/Update" dialog. Further information, indicated in this dialog is described in detail in [Chapter 6.2.3, "SMZ Info/Update Settings in the R&S Signal Generator"](#), on page 43.

## 6.2.1 Indicating an R&S SMZ

By connecting USB, an Rohde & Schwarz microwave signal generator recognizes the multiplier automatically and changes its display accordingly.

### Functional Blocks

The instrument displays appropriate information in a functional block, as shown in the figure:

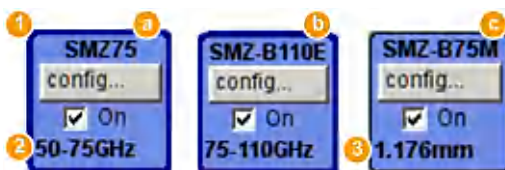

**Figure 6-1: Appearance of the functional blocks**

- 1 = R&S SMZ type
- a = R&S SMZ without attenuator
- b = R&S SMZ with electronically controlled attenuator ("E")
- c = R&S SMZ with mechanically controlled attenuator ("M")
- 2 = frequency range
- 3 = scale setting for the adjustment screw

The header of the block shows the connected multiplier type and the footer indicates its output frequency range. If a frequency multiplier with mechanically controlled attenuator is connected, the frequency range changes to the corresponding scale-setting for the adjustment screw.

### Frequency and Level in the Status Bar



The Rohde & Schwarz microwave signal generator also changes its frequency and level display to the appropriate values of the R&S SMZ signal output (status bar). Even for models without attenuator, the Rohde & Schwarz microwave signal generator indicates the output level of the R&S SMZ, in read-only mode.



### Generator settings with an active frequency multiplier



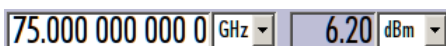

To be compatible with a connected frequency multiplier, the Rohde & Schwarz microwave signal generator automatically displays the lowest output frequency of the R&S SMZ, indicates the frequency limits in the tooltip and adjusts its own output level.

The following table is an overview of the "Frequency" and "Level" display in dependency of the R&S SMZ type:

R&S SMZ	Frequency/Level	Characteristics
R&S SMZxxx <sup>1)</sup>  no attenuator		<p>The output frequency of the multiplier, that is the input frequency at the DUT can be set in the status bar.</p> <p>The corresponding output level is calculated based on the calibration table and displayed in read-only mode.</p> <p>This level has to be considered at the input of the DUT.</p>
R&S SMZxxxM <sup>2)</sup>  mechanically controlled attenuator		<p>The RF output frequency and level of the multiplier required for the DUT can be set in the status bar.</p> <p>The scale setting for the adjusting screw is calculated based on the calibration table, and displayed in the status line of the function block.</p> <p>See <a href="#">Chapter 6.2.6, "How to Adjust the Level of an R&amp;S SMZxxxM"</a>, on page 56</p> <p>Adjust the value with the screw, and the signal at the input of the DUT has the set frequency and level values.</p>



## Operation with an R&amp;S Microwave Signal Generator Supporting USB Control

R&S SMZ	Frequency/Level	Characteristics
R&S SMZxxxE <sup>2)</sup>  electronically controlled attenuator		The RF frequency and level required for the DUT can be set in the status bar. Further settings are not required.  Both instruments, the signal generator and the multiplier provide exactly this signal at input of the DUT, see <a href="#">Chapter 6.2.4.1, "Test Setup Example"</a> , on page 53
R&S SMZxxxE <sup>2)</sup>  switched off attenuator		The output frequency of the multiplier is editable.  When the attenuator is turned off, the signal generator still enables you to set the frequency. The corresponding output level is calculated based on the calibration table of the multiplier, and displayed in read-only mode.  This level has to be considered at the input of the DUT.

1) R&S SMZ75/90/110/170

2) R&S SMZ75/90/110

The overview shown by means of "75 GHz" also applies to all frequency ranges of the R&S SMZ frequency multipliers.



### Impact of operating modes and functions that affect the RF output level

The output level of the RF signal is determined by the operation mode the instrument generates the signal, and additionally by the level correction functions, the generator provides to optimize the accuracy of the level.

However, some of these functions affect the operation with a R&S SMZ. To avoid impact, the generator automatically switches off the associated operating modes, once an R&S SMZ is connected via USB.

Interactions and special characteristics to the operating modes of an R&S signal generator when an R&S SMZ is connected:

- AM (amplitude modulation): blocked
- ASK (amplitude shift keying): blocked
- List mode: blocked
- UCOR (user correction): not implemented
- Sweep mode: It is recommended that you use an R&S SMZ with electronically controlled attenuator, when you generate an RF signal in frequency or level sweep mode. Also note the response times of the dwell time in the data sheet of the R&S SMZ.

## 6.2.2 Setting Frequency and Level

After connecting the frequency multiplier, enter frequency and, if editable, the level values of the R&S SMZ output signal. The Rohde & Schwarz microwave signal generator treats a connected R&S SMZ as integrated function block. It automatically considers the multiplication factor and the appropriate input level of the frequency multiplier and shows these values in the status bar.

To set the frequency or level perform the following:

1. On the front panel, press the FREQ or LEVEL key.

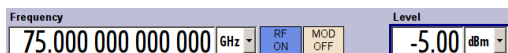

The corresponding entry field changes to edit mode.

2. Enter the corresponding value with the aid of the keypad or use the rotary knob.

### 6.2.3 SMZ Info/Update Settings in the R&S Signal Generator

The general functions of an Rohde & Schwarz microwave signal generator provide the "SMZ Info/Update" dialog. The dialog covers information on a connected R&S SMZ like multiplier type, serial number, revision state, frequency range or firmware version. You can directly update the firmware of your frequency multiplier to the latest version.

In addition, the Rohde & Schwarz microwave signal generator supports a correction function to compensate external losses of the RF connection to the R&S SMZ, in order to achieve the 7 dBm input level for the R&S SMZ very precisely.

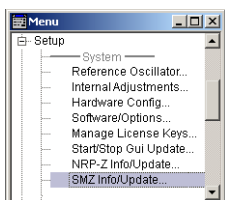

- ▶ To access the "SMZ Info/Update" dialog, perform one of the following:
  - In the "SMZ xxx" function block, select the "Config..." key.
  - On the front panel of the instrument, press the SETUP or MENU key and select "Setup > System > SMZ Info Update".

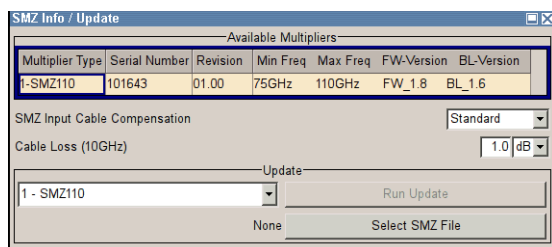

The "SMZ Info / Update" dialog lists connected frequency multipliers, including device specific information, and you can specify correction values in order to compensate the loss of the RF cable. In the update section, you can update the FW of the multiplier.

The remote commands required for configuring the frequency multiplier settings are described in [Chapter 8.1.1, "SMZ Info Update Settings"](#), on page 85

**Note to firmware versions of the R&S SMF100A**

Up to the R&S SMF firmware version 2.20.232.xx, the "Update" function is a protected procedure which can be accessed if protection level 2 is disabled (authorized personnel of R&S Service Departments only). With locked protection, the section is hidden.

Starting with the R&S SMF firmware version 2.20.530.xx, the function is no longer protected, see [Chapter 6.2.3.2, "Firmware Update"](#), on page 44.

**6.2.3.1 Available Multipliers**

Section "Available Multipliers" displays information on the connected R&S SMZ.

**Multiplier Type, Serial Number, ...**

Shows detailed information on the connected frequency multiplier, as listed in [Table 6-1](#):

**Table 6-1: Specific information on the R&S SMZ model**

Parameter	Information	SCPI command:
"Multiplier Type"	Model of the R&S SMZ.	<code>[ :SOURCE&lt;hw&gt; ] :FREQUENCY:MULTIPLIER:EXTERNAL:TYPE?</code> on page 86
"Serial Number"	Part number of the R&S SMZ.	<code>[ :SOURCE&lt;hw&gt; ] :FREQUENCY:MULTIPLIER:EXTERNAL:SNUMBER?</code> on page 86
"Revision"	Revision number of the R&S SMZ.	<code>[ :SOURCE&lt;hw&gt; ] :FREQUENCY:MULTIPLIER:EXTERNAL:REVISION?</code> on page 86
"Min Freq"/ "Max Freq"	Output frequency range.	<code>[ :SOURCE&lt;hw&gt; ] :FREQUENCY:MULTIPLIER:EXTERNAL:FMINIMUM?</code> on page 86 <code>[ :SOURCE&lt;hw&gt; ] :FREQUENCY:MULTIPLIER:EXTERNAL:FMAXIMUM?</code> on page 86
"FW-Version"	The currently installed firmware version.	<code>[ :SOURCE&lt;hw&gt; ] :FREQUENCY:MULTIPLIER:EXTERNAL:FIRMWARE:VERSION?</code> on page 86
"BL-Version"	The boot loader version.	<code>[ :SOURCE&lt;hw&gt; ] :FREQUENCY:MULTIPLIER:EXTERNAL:LOADER:VERSION?</code> on page 86

**6.2.3.2 Firmware Update**

Section "Update" provides access to the file system in order to select a file for an R&S SMZ firmware update (button "Select SMZ File"), and to perform an update.

## Operation with an R&amp;S Microwave Signal Generator Supporting USB Control

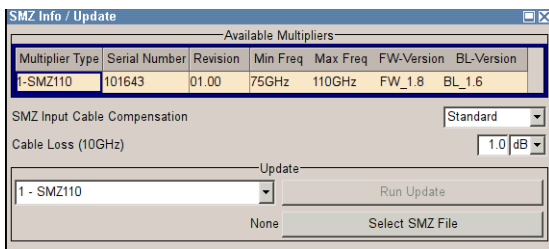

Your R&S SMZ is delivered with the latest firmware version. For updates to the latest version, see the R&S website <http://www.rohde-schwarz.com/product/SMZ.html> for download. Besides the firmware, this site always offers the latest information on your frequency multiplier, like release notes, containing improvements and modifications, as well as changes on the firmware update procedure.

## Update

Provides all functions needed to perform a firmware of the frequency multiplier:

- Selection field  
indicates the frequency multiplier to be updated.
- "Select SMZ File"  
provides access to the file system to select the update file. A selected file is indicated to the left of the button.
- "Run Update"  
starts the update.

To update the firmware, proceed as follows:

- Open the R&S website <http://www.rohde-schwarz.com> in section "Signal Generators > Analog > R&S SMZ Frequency Multiplier".
- Select "Downloads > Firmware" and the offered firmware.
- Save the firmware in the appropriate file directory.
- Connect the frequency multiplier to the Rohde & Schwarz microwave signal generator and select "Setup > System > SMZ Info Update" to open the dialog.
- Select the multiplier in the left selection field.
- Select the update file with "Select SMZ File" (\*.efmfirm) and activate "Run Update".

The update starts and a bar indicates the progress.

**Note:** If the update is interrupted for example by accidental removal of the frequency multiplier during the process, reconnect the frequency multiplier and perform a restart. The R&S SMZ starts in bootloader mode and you can re-run the firmware update.

## Operation with an R&amp;S Microwave Signal Generator Supporting USB Control

Remote command:

[ :SOURce<hw> ] :FREQuency:MULTIplier:EXTernal:FIRMWare:CATalog? on page 88

[ :SOURce<hw> ] :FREQuency:MULTIplier:EXTernal:FIRMWare:SElect on page 88

[ :SOURce<hw> ] :FREQuency:MULTIplier:EXTernal:FIRMWare:UPDate on page 89

### 6.2.3.3 SMZ Cable Compensation Settings

In this section you can configure level correction values to compensate cable losses of the RF cable between the signal generator and the frequency multiplier. Taking the cable loss into consideration, you can very precisely achieve the required level of 7 dBm at the input of your R&S SMZ. The correction values are either calculated on the basis of an interpolation curve or on values of a user-defined cable correction table.

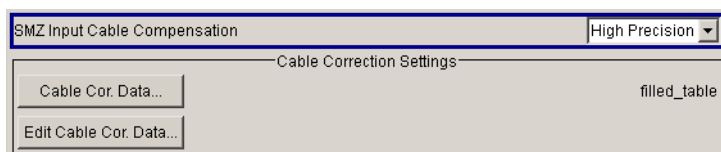

Using the cable compensation function, note the following:

- Several level corrections lead to an incorrect input level at the R&S SMZ or even to overload, since all correction values take effect. Therefore, the Rohde & Schwarz microwave signal generator automatically switches UCOR (User Correction) off, when an R&S SMZ is connected.
- The level is limited to 3 dBm in order to protect RF input of the R&S SMZ from overload.

Also note that you keep the frequency within the frequency range of the used R&S SMZ.

You can create a data table and enter the correction value pairs manually, see "[Cable Cor. Data](#)" on page 48 and "[Edit Cable Correction Data](#)" on page 49.

The data is stored in a file, with free selectable file name. The file extension \* .efmccor is predefined.

Operation with an R&S Microwave Signal Generator Supporting USB Control

Correction is performed by adding the attenuation value to the output level of the RF signal. The RF output level is the sum of both values:

$$\text{Level} + \text{CCOR} = \text{RF}_{\text{out}} \text{ dBm}$$

### SMZ Input Cable Compensation

Selects the mode for setting the correction values in order to compensate cable losses.

To achieve 7 dBm level at the input of the R&S SMZ, it is recommended that you consider the attenuation of the cable.

For this purpose, you have the following options:

- |                  |   |
|------------------|---|
| "None"           | Deactivates cable compensation.<br>This mode is provided to measure the cable loss to the R&S SMZ, without any further correction effects.  |
| "Standard"       | Uses standard mode.<br>In this mode, you can specify the value of your cable attenuation at 10 GHz. The attenuation value of your operating frequency is then automatically interpolated, according to the diagram shown in <a href="#">Cable Loss (10 GHz)</a> . |
| "High Precision" | Enables precise compensation of the cable loss with the help of correction values.<br>You can enter the values and store them in a table. The level of an intermediate frequency is automatically interpolated.   |

Remote command:

`[ :SOURce<hw> ] :FREQuency:MULTiplier:EXTernal:CORRection:MODE`

on page 93

### Cable Loss (10 GHz)

Sets the cable loss at 10 GHz.

The Rohde & Schwarz microwave signal generator uses this value to interpolate the cable loss at the target frequency, as shown in the graph below:

## Operation with an R&amp;S Microwave Signal Generator Supporting USB Control

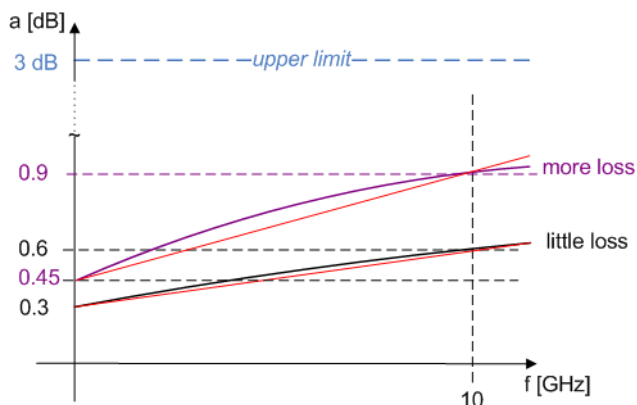

**Figure 6-2: Schematic representation of two RF cables with different cable loss**

The program interpolates the values corresponding to the red lines.

Remote command:

```
[ :SOURce<hw> ] :FREQuency:MULTIplier:EXTernal:CORRection:CLOSs
```

on page 91

### Cable Correction Settings

Section "Cable Correction Settings" provides enhanced configuration of cable correction data, available in "High Precision" mode ([SMZ Input Cable Compensation](#)).

#### Cable Cor. Data ← Cable Correction Settings

Opens a menu where you can either create a new cable compensation table or open an existing table from a file. Additionally you can access the file manager for file management functionality.

The extended correction options for cable compensation are available in "High Precision" mode ([SMZ Input Cable Compensation](#)).

Remote command:

```
[ :SOURce<hw> ] :FREQuency:MULTIplier:EXTernal:CORRection:CATalog?
```

on page 90

```
[ :SOURce<hw> ] :FREQuency:MULTIplier:EXTernal:CORRection:SElect
```

on page 96

```
[ :SOURce<hw> ] :FREQuency:MULTIplier:EXTernal:CORRection:DElete
```

on page 91

#### Edit Cable Cor. Data

Opens the editor "Edit Cable Correction Data", see [Chapter 6.2.3.4, "Cable Correction Data Editor"](#), on page 49.



Operation with an R&S Microwave Signal Generator Supporting USB Control

The extended correction options for cable compensation are available in "High Precision" mode ([SMZ Input Cable Compensation](#)), provided a file for compensation is selected.

### 6.2.3.4 Cable Correction Data Editor

In this editor you can create, save or select user-defined correction value tables for the compensation of the RF cable loss.

- ▶ To open the editor, click "Edit Cable Cor. Data..." in the "SMZ Info/Update" dialog.

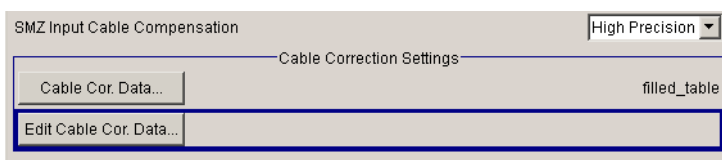

You can access the editor in "High Precision" mode ([SMZ Input Cable Compensation](#)), when a file is selected with [Cable Cor. Data](#).

### Edit Cable Correction Data

Determine your specific cable correction values. You can also save them for reuse.

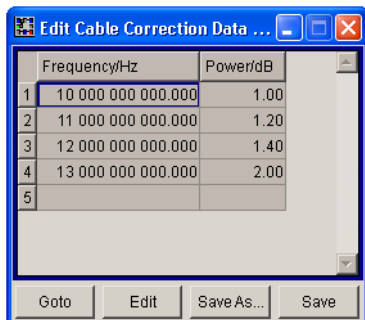

The currently selected table is displayed. Each table is saved as a separate file with extension `*.efmccor`. The file name and the directory are user-selectable. The editor comprises up to 1000 frequency / level value pairs. With the built-in keys you can navigate in the table, add or remove value pairs and store your settings.

You can enter the values pairs either manually, or fill the table automatically, by specifying start and end values and the number of entries.

The following section describes the "Fill" function. "Goto", as well as "Insert", "Delete" or "Save" are self-explanatory.

Operation with an R&S Microwave Signal Generator Supporting USB Control

**Note:** Save the table only after filling both columns, otherwise the entries are lost.

Remote command:

`[ :SOURCE<hw> ] :FREQUENCY:MULTIPLIER:EXTERNAL:CORRECTION:FREQUENCY` on page 92

`[ :SOURCE<hw> ] :FREQUENCY:MULTIPLIER:EXTERNAL:CORRECTION:FREQUENCY:POINTS?` on page 93

`[ :SOURCE<hw> ] :FREQUENCY:MULTIPLIER:EXTERNAL:CORRECTION:POWER` on page 94

`[ :SOURCE<hw> ] :FREQUENCY:MULTIPLIER:EXTERNAL:CORRECTION:POWER:POINTS?` on page 95

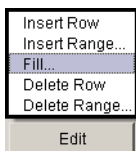

### Fill Cable Correction Data

The "Fill Cable Correction Data" dialog enables you to automatically set the cable correction level values.

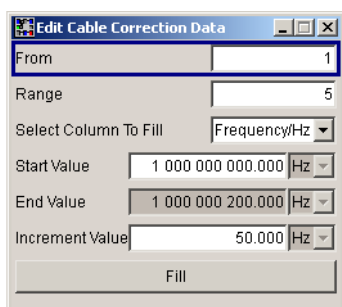

**Note:** The correction list entries are only computed when "Fill" is pressed.

#### From / Range ← Fill Cable Correction Data

Define the start index and the number of rows to be filled.

#### Select Column To Fill ← Fill Cable Correction Data

Selects either the frequency of the level column to be filled with the values defined below.

#### Start Value / End Value ← Fill Cable Correction Data

"Start" sets the start value for the selected column, and "End" indicates the last entry.

#### Increment Value ← Fill Cable Correction Data

Determines the step size for the respective entries.

Operation with an R&S Microwave Signal Generator Supporting USB Control

### Fill ← Fill Cable Correction Data

Fills the selected column in the set range with values, starting with the start value and using the set increment.

## 6.2.4 Operation with the R&S SMF100A

This section shows some specific details of operating an R&S SMZ with an "R&S SMF100A Microwave Signal Generator".



*Figure 6-3: R&S SMF100A with a connected R&S SMZ Frequency Multiplier*

### Connection

RF connection is established via the RF output connector at the front panel of the R&S SMF.

The USB interface is provided at the front panel. Alternatively, your instrument can be equipped with a USB interface at the rear (see the data sheet of the R&S SMF).



- The Rohde & Schwarz microwave signal generator supports communication with the R&S SMZ via USB from a certain firmware version, see [Table 5-1](#).
- With connecting the R&S SMZ, the R&S SMF immediately turns off the RF output signal to protect the frequency multiplier from high input level.

## Operation with an R&amp;S Microwave Signal Generator Supporting USB Control

**Display**

The R&S SMF indicates the R&S SMZ in a separate functional block in the block diagram, underneath the "Attenuator" block.

See [Chapter 6.2.1, "Indicating an R&S SMZ"](#), on page 39 for the different views.

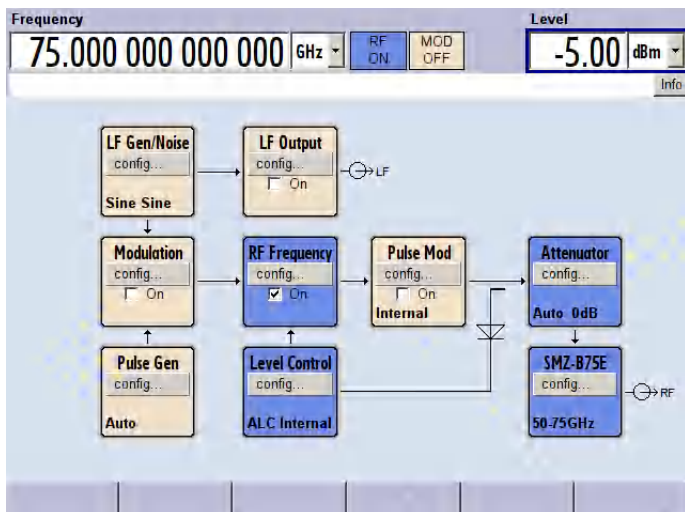

**Figure 6-4: Block diagram of the R&S SMF indicating a connected R&S SMZ with electronic level control**

**Settings**

Setting values for operation with a frequency multiplier are its frequency and, if possible, the output level. To configure these parameters, refer to [Chapter 6.2.2, "Setting Frequency and Level"](#), on page 42.

In addition, the general instrument functions of an Rohde & Schwarz microwave signal generator contain device specific information to a connected frequency multiplier, and you can directly perform an update of the multiplier firmware, see [Chapter 6.2.3, "SMZ Info/Update Settings in the R&S Signal Generator"](#), on page 43.



### Generator settings with an active frequency multiplier

To be compatible with a connected frequency multiplier, the Rohde & Schwarz microwave signal generator automatically displays the lowest output frequency of the R&S SMZ, indicates the frequency limits in the tooltip and adjusts its own output level.

In addition, the generator locks all operating modes that cannot be performed when an R&S SMZ is connected, see "[Impact of operating modes and functions that affect the RF output level](#)" on page 42.

#### 6.2.4.1 Test Setup Example

If you work with a frequency multiplier with electronically controlled attenuator, you can directly enter the signal parameters for the DUT in the Rohde & Schwarz microwave signal generator. Further settings are not required. The two instruments automatically provide the correct signal for the DUT.

In the example, a frequency multiplier, model R&S SMZ75E is working with an R&S SMF100A Microwave Signal Generator.

Let us assume, that a frequency of 60 GHz with a power level of -10 dBm is required for testing the DUT.

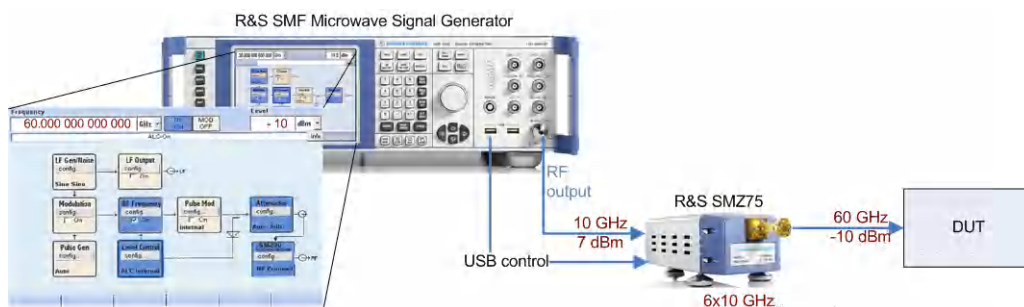

How to proceed:

1. In the status bar of the R&S SMF, enter *60 GHz* frequency.
2. Similarly, enter *-10 dBm* level value.

Involving cable losses and the calibration data of the R&S SMZ, the Rohde & Schwarz microwave signal generator provides its output signal to the R&S SMZ, which in turn outputs the required signal of *60 GHz* and *-10 dBm* for the DUT with very high level accuracy.

Operation with an R&S Microwave Signal Generator Supporting USB Control

## 6.2.5 Operation with the R&S SMB100A

This section shows some specific details of operating an R&S SMZ with an "R&S SMB100A RF and Microwave Signal Generator".



*Figure 6-5: R&S SMB100A with a connected R&S SMZ Frequency Multiplier*

### Connection

RF connection is established via the RF output connector at the front panel of the R&S SMB.

The USB interface is provided at the rear panel.



With recognizing the R&S SMZ, the Rohde & Schwarz microwave signal generator immediately turns off the RF output signal to protect the frequency multiplier from high input level.

Operation with an R&S Microwave Signal Generator Supporting USB Control

## Display

The R&S SMB indicates a frequency multiplier in the RF block. It changes the appearance according to the connected multiplier model.

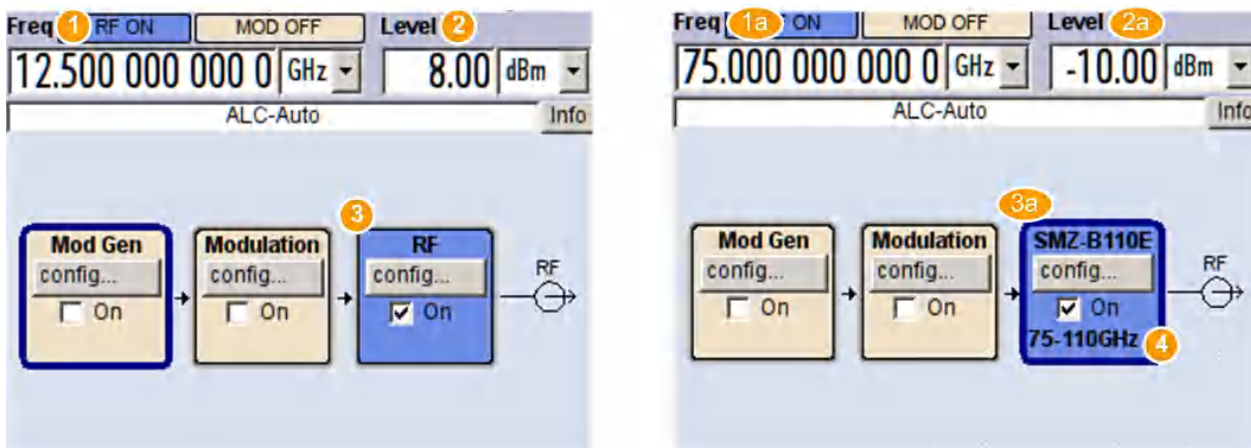

**Figure 6-6: Views of the R&S SMB100A block diagram without and with a connected R&S SMZ**

- 1 = RF frequency at the RF output of the R&S SMB
- 1a = RF frequency at the RF output of the R&S SMZ
- 2 = RF level at the RF output of the R&S SMB
- 2a = RF level at the RF output of the R&S SMZ
- 3 = RF Block
- 3a = RF Block with connected R&S SMZ
- 4 = Label of the connected R&S SMZ type

See [Chapter 6.2, "Operation with an R&S Microwave Signal Generator Supporting USB Control"](#), on page 38 for the views of the various R&S SMZ models.

## Settings

To set the parameters of the frequency multiplier, refer to [Chapter 6.2.2, "Setting Frequency and Level"](#), on page 42.



### Generator settings with an active frequency multiplier

To be compatible with a connected frequency multiplier, the Rohde & Schwarz microwave signal generator automatically displays the lowest output frequency of the R&S SMZ, indicates the frequency limits in the tooltip and adjusts its own output level.

In addition, the generator locks all operating modes that cannot be performed when an R&S SMZ is connected, see ["Impact of operating modes and functions that affect the RF output level"](#) on page 42.

## 6.2.6 How to Adjust the Level of an R&S SMZxxxM

If the connected frequency multiplier is equipped with a mechanically controlled attenuator, you can manually adjust the level using the adjustment screw.

How to proceed:

1. Enter frequency and level, required at the DUT.  
In the status line of the "SMZxxx" function block, the Rohde & Schwarz microwave signal generator shows the scale setting for the adjustment screw to achieve the required signal level at the DUT.
2. Turn the screw according to the value indicated in the block.  
You reach the following increments by turning the screw:
  - 1x 0...49...0: the adjustment screw is screwed 0.5 mm
  - 2x 0...49...0: the adjustment screw is screwed 1.0 mm

**Note:** Position 0 is equivalent with maximum attenuation, that means minimum signal level according to the set frequency.

## 6.3 Operation with R&S SMZ Control

This section describes how to configure a connected R&S SMZ frequency multiplier with the software R&S SMZ Control. First a brief overview is given, listing the functions available in locked state versus the full functionality when working with an R&S SMZ activated in the software.



### Basic functionality of R&S SMZ Control with non licensed R&S SMZ

If you have not licensed your R&S SMZ in R&S SMZ Control, you can still:

- Enter the output frequency of the R&S SMZ.  
R&S SMZ Control then provides:
  - The respective input frequency, to be set in the generator.
  - The level value (7 dBm) needed at the R&S SMZ input.
  - A message, to remind that the cable loss is to be considered.
- Perform a firmware update.
- Read out the "Adjustment Screw Settings" table if you work with an R&S SMZ with mechanically controlled attenuator.
- Enable your R&S SMZ when you have purchased a license.
- Receive information on how to purchase a license including serial and part number.

Without a license it is not possible to display the actual output level of the R&S SMZ at the respective frequency, nor to configure the value.

### Full functionality of R&S SMZ Control with licensed R&S SMZ

If you work with R&S SMZ Control and a licensed R&S SMZ, you can utilize the full functionality of the software.

Additionally to the above mentioned functions, with R&S SMZ Control you can:

- Read or determine the level value of the R&S SMZ output signal.
- Include the cable loss between the generator and the multiplier.
- Remotely control frequency and level of the signal generator.
- Remotely control the software, and thus in turn the signal generator.

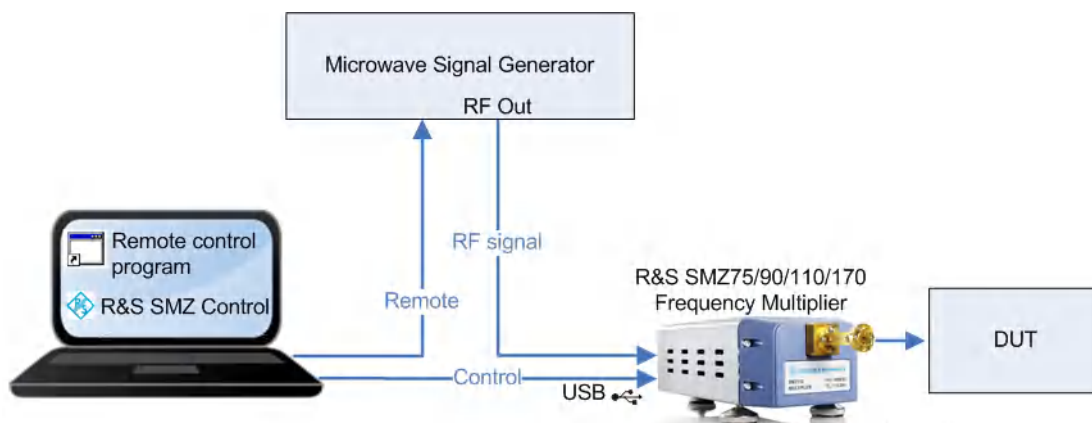

**NOTICE****Prevent the RF input of your R&S SMZ from overload**

It is recommended, that you

- Turn off the RF output signal of the generator, before connecting the R&S SMZ, to prevent damage due to excessive input power.
- Consider any output level corrections at the generators RF output, like user correction, etc.

In particular, if you specify "Cable Loss" in R&S SMZ Control, it executes RF output level correction.

Therefore it is strongly recommended, that you switch off any further level corrections. Additional level corrections lead to an incorrect input level at the R&S SMZ, or even to overload, since all correction values take effect.

In any case, the input power must not exceed 10 dBm.



Note also that the input power of the R&S SMZ must be very precisely 7 dBm, to obtain high level accuracy of the output signal.

To control the R&S SMZ with R&S SMZ Control, connect the frequency multiplier with the PC via USB, and the RF connectors between the multiplier and the generator. If you intend to remotely control the generator, additionally establish a LAN connection between the PC and generator, or a or GPIB connection, provided the PC is equipped with a GPIB bus card.

► Start R&S SMZ Control.

R&S SMZ Control automatically recognizes a connected R&S SMZ, shows its frequency range and assigns the lowest output frequency in the frequency field, see [Indicating a licensed R&S SMZ](#).

To set the parameters, refer to [Chapter 6.3.2, "Frequency and Level Settings - R&S SMZ Control"](#), on page 61.

### 6.3.1 Indicating an R&S SMZ in R&S SMZ Control

This section describes how a connected R&S SMZ frequency multiplier is indicated and configured in the R&S SMZ Control configuration software. Depending on

the model of the R&S SMZ, and whether it has been enabled, R&S SMZ Control indicates the available parameters.

### 6.3.1.1 Indicating a licensed R&S SMZ

With the R&S SMZ activated in R&S SMZ Control, the "SMZ Control" dialog indicates all relevant parameters and information according to the connected frequency multiplier model.

**Table 6-2: R&S SMZ Control appearance depending on the R&S SMZ model (licensed)**

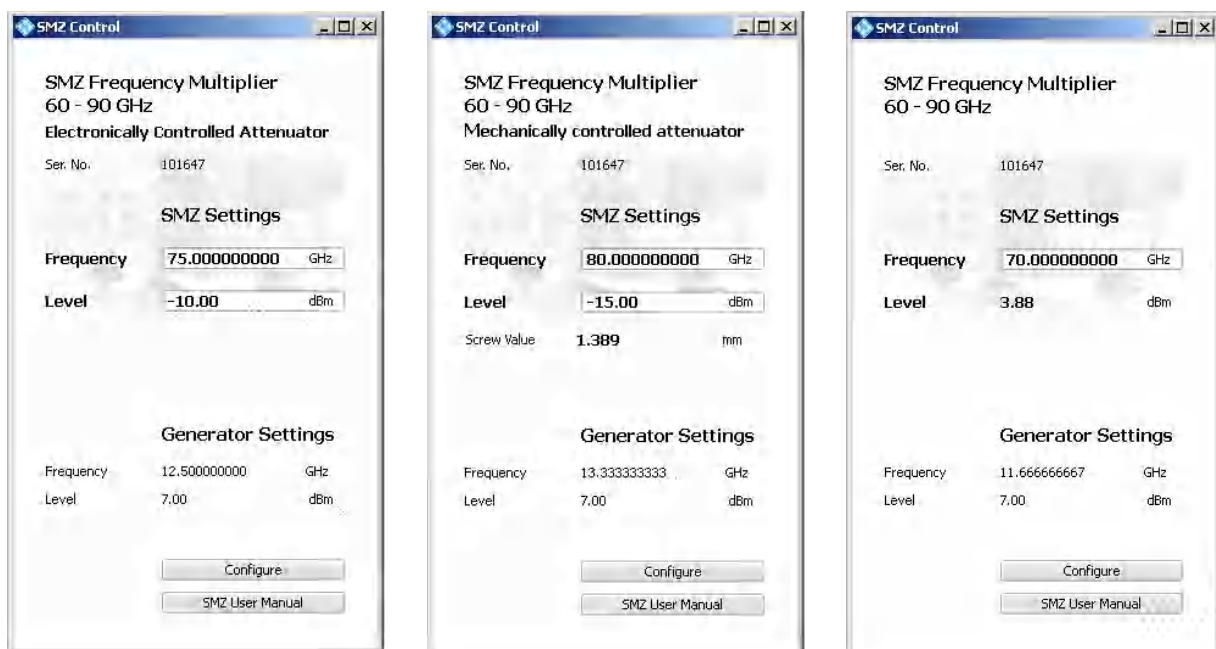

R&S SMZ90, with electronically controlled attenuator

R&S SMZ90, with mechanically controlled attenuator

R&S SMZ90, basic unit

Basically, R&S SMZ Control indicates the connected frequency multiplier, with information on type, serial number and frequency range. The dialog also contains "SMZ Settings" and "Generator settings" like the respective frequency and level values, and provides access to the "Configure" dialog with enhanced possibilities for remote control and input of cable loss correction.



Equipped with an attenuator, you can determine the level of the R&S SMZ output. R&S SMZ Control supports as follows:

- **Electronically controlled:** R&S SMZ Control controls the R&S SMZ, which automatically adjusts the output level to the specified value.
- **Mechanically controlled:** R&S SMZ Control shows the setting for the adjustment screw to obtain the specified output level. Just set the screw according to the displayed value.

If "Remote Generator" is activated, see [Remote Generator](#), R&S SMZ Control additionally indicates whether the RF signal is switched on or off.

R&S SMZ Control also indicates a great variety of different messages such as status messages, error messages, warnings and information, each next to the corresponding parameter.

### 6.3.1.2 Indicating an unlicensed R&S SMZ

The information in the R&S SMZ Control dialog varies depending on the connected frequency multiplier.

**Table 6-3: R&S SMZ Control appearance depending on the R&S SMZ model (unlicensed)**



R&S SMZ90, with electronically controlled attenuator

R&S SMZ90, with mechanically controlled attenuator

R&S SMZ90, basic unit

Basically, R&S SMZ Control indicates the connected frequency multiplier, with information on type, serial number and frequency range. The dialog also contains "SMZ Settings" and "Generator settings", that means it calculates the generator frequency according to the defined multiplier frequency, and indicates the required 7 dBm level. "Configure" provides access to "Firmware Update" and the "Adjustment Screw Settings" table, in case a multiplier with mechanically controlled attenuator is used. With "Enter Key", you can activate your multiplier when you have purchased a license key.

### 6.3.2 Frequency and Level Settings - R&S SMZ Control

In the main dialog, enter output frequency and, if possible, the level value of the R&S SMZ (required at the DUT).

R&S SMZ Control calculates the input frequency for the R&S SMZ, with the auto-detected multiplication factor, the input level needed from the multiplier, and also considers any correction values specified for the cable loss.

 The settings in this chapter assume that you have unlocked your multiplier. Without a license, some parameters are only displayed or even not available.

#### SMZ Settings

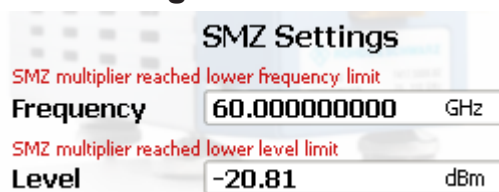

In "SMZ Settings", the output signal of the R&S SMZ is defined. With multipliers with controlled attenuator, you can determine the output level. For instruments without attenuator R&S SMZ Control indicates the level value corresponding to the frequency, which is supplied at the output.

**Note:** Behavior of the level setting after power off and on again of a R&S SMZ with electronically controlled level attenuator: Immediately after turning on, R&S SMZ Control sets the level value to the minimum value at the corresponding frequency. If you set the frequency and level values, R&S SMZ Control memorizes these values when switching off.

If you switch on again, the level value appears in *italics*, indicating that you can accept the setting, or change it to a preset value.

Select the field and press either "Enter" to accept, or "ESC" to preset the value to minimum.

### Frequency ← SMZ Settings

Sets the frequency required for the DUT.

Remote command:

`[SOURce]:FREQuency[:CW|FIXed]` on page 98

### Level ← SMZ Settings

Sets the power level required for the DUT.

Remote command:

`[SOURce]:POWer[:LEVel][:IMMediate][:AMPLitude]` on page 98

### Generator Settings

Generator settings		
Frequency	10.000000000	GHz
Level	7.00	dBm

"Generator Settings" shows the input signal of the R&S SMZ.

Just set these values in the generator to achieve the required output signal.

As the R&S SMZ requires quite exactly 7 dBm input level, you should know the cable loss of the connection between the generator and the multiplier. You can enter the value in the [Configure Dialog - SMZ Control](#) dialog.

### Enter Key

Opens the "Manage License Key" dialog to activate the R&S SMZ, provided, you have purchased a license key. See [Chapter 6.3.3, "Manage License Key"](#), on page 63 for description.

### Configure

Opens the "Configure" dialog with settings for cable loss and remote control, see [Chapter 6.3.4, "Configure Dialog - SMZ Control"](#), on page 64.

Once you remotely control R&S SMZ Control, the "Configure" button label changes to be "Local", and you can switch back manual operation.

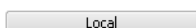

### SMZ User Manual

Opens the manual of the R&S SMZ in pdf format.



### 6.3.3 Manage License Key

In the "Enter Key" dialog, you can register your R&S SMZ with a purchased license key code. The frequency multiplier and R&S SMZ Control provide full functionality after the R&S SMZ is activated using the license key.

 You can order a license at the R&S sales department, specifying the device type, serial number and part number of your R&S SMZ. The license key is delivered as a file or on paper. It is bound to that particular R&S SMZ and can not be moved to other frequency multipliers. However, you can perform R&S SMZ Control from any PC.

For detailed information on the license registration, refer to the installation instructions provided license key and the documentation of the online tool "R&S License Manager" (<https://extranet.rohde-schwarz.com/service>).

- ▶ To access the dialog click "Enter Key" in the "SMZ Control" dialog.

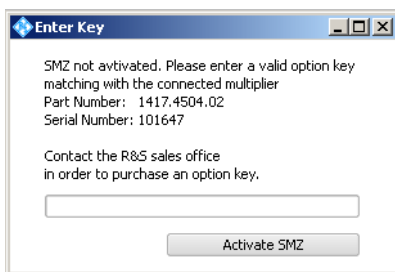

- ▶ Enter the license key either manually or with copy and paste, and confirm with "Activate SMZ".

The R&S SMZ is enabled and ready for operation with R&S SMZ Control.

 If you have accidentally entered a wrong code, a warning appears:



- ▶ Confirm with ok, check the identification data and try again.

### 6.3.4 Configure Dialog - SMZ Control

The "Configure" dialog contains the parameters for the remote control of the generator, as well as the address for remotely control the program itself. Additionally, you can define the loss of the connection between the signal generator and the multiplier (RF cable), and you can run a firmware update of the R&S SMZ.



Table 6-4: Configure dialog of R&amp;S SMZ Control

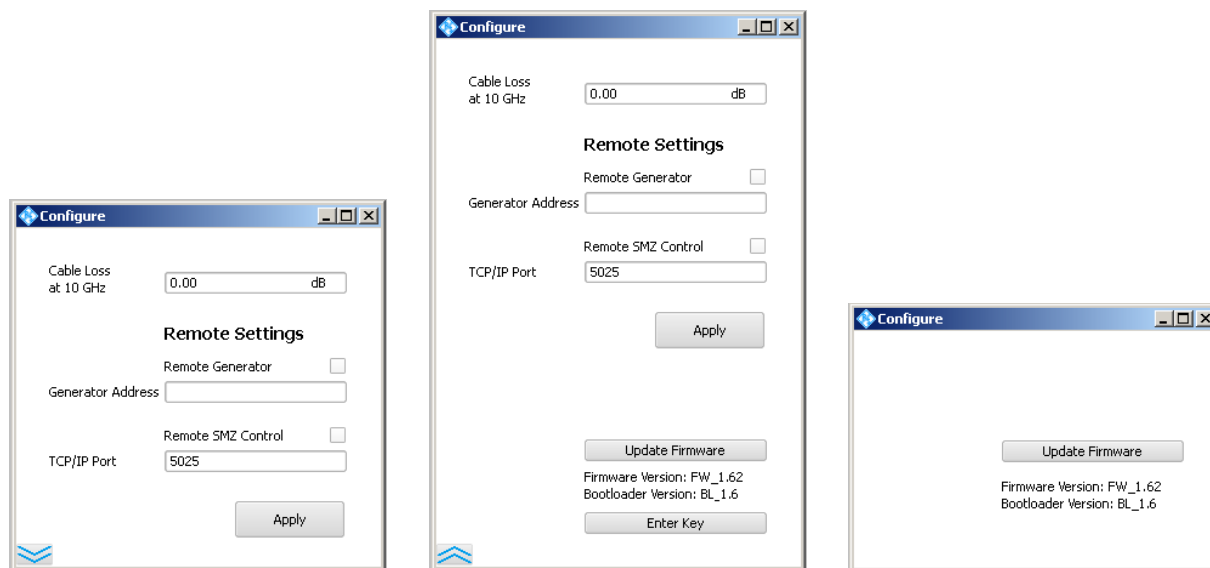

Configure dialog with licensed R&S SMZ

Configure dialog with licensed R&S SMZ, showing enhanced parameters

Configure dialog with unlicensed R&S SMZ

The  provides access to update the firmware, or read the "Adjustment Screw Settings" table of an R&S SMZ with mechanically controlled attenuator.

### Cable Loss

Sets the cable loss of the RF cable between the signal generator and the R&S SMZ.

R&S SMZ Control adds this value to the 7 dBm required at the R&S SMZ input, and therefore provides the level setting of the generator.

$$\text{Level}_{\text{SigGen}} = 7 \text{ dBm} + \text{Cable Loss}$$

**Note:** Only one level correction should be active. If you define "Cable Loss", R&S SMZ Control executes RF output level correction. Therefore it is strongly recommended, that you switch off any further level corrections. Several level corrections lead to an incorrect input level at the R&S SMZ, or even to overload, since all correction values take effect.

To determine the loss of your cable, see the data sheet, or refer to "[Cable Loss \(10 GHz\)](#)" on page 47 for additional information.

### Remote Generator

Activates remote access of R&S SMZ Control to the generator.

Usually, you can remotely control a signal generator via a LAN, GPIB, or USB interface. Refer to the operating manual of your instrument to receive detailed information on the available remote control interfaces and their use.

R&S SMZ Control remotely controls a signal generator via a GPIB or LAN (TCP/IP) interface. Find more details to the remote control interfaces in [Chapter 7.1, "Remote Control Interfaces and Protocols"](#), on page 73.

**Remote Generator requires that:**

- the signal generator is connected to the PC
- the network address is entered
- the VISA library is installed on the controller PC
- the signal generator recognizes the remote control commands for frequency, level and output state, according to the given SCPI syntax, see [Chapter 8.2.2, "Specific Commands - R&S SMZ Control"](#), on page 97.

**Note:** VISA is a standardized software interface library providing input and output functions to communicate with instruments. A VISA installation on the controller is a prerequisite for remote control over LAN when using VXI-11 protocol.

Once the checkbox is selected, R&S SMZ Control shows the status of the RF signal from the generator.

It distinguishes between local and remote operation:

- **Local**

In local mode, you can toggle between RF on and off:



The RF signal is switched on, pressing the button turns it off, and vice versa.

- **Remote**

In remote control mode, R&S SMZ Control indicates the signal state.

RF ON RF OFF

Remote command:

[:OUTPut \[:STATe\]](#) on page 99

### Generator Address

Sets the IP or GPIB address to set up the connection to the signal generator.

The program assembles the complete resource string internally.

### Remote SMZ Control

Permits remote access of a controller to R&S SMZ Control.

Select the checkbox to enable remote control.

Remote access is done via TCP/IP connection. See [Chapter 6.4.1, "Automation of R&S SMZ Control"](#), on page 69 for possible configurations, and [Chapter 7.1.1.2, "Remote Control of R&S SMZ Control"](#), on page 75 for the IP address and communication protocol.

### TCP/IP Port

Sets the port for remote control of R&S SMZ Control.

You can remotely control the software by using socket communication, also called "Raw Ethernet" communication, with the port as part of the socket address, see [Chapter 7, "Remote Control Basics"](#), on page 73 for details. R&S SMZ Control uses port number "5025" by default, but can be set.

### Apply

Assigns the specified settings.

### <more>

Shows a section with enhanced functions concerning system configuration of the R&S SMZ.

 Reduces the dialogue to its original size.

### Print Adjustment Screw Settings of SMZ

Opens the windows "Print" dialog to print the "Adjustment Screw Settings" table of the R&S SMZ.

This function applies to R&S SMZ with mechanically controlled attenuator. The procedure may take a few time.

**Tip:** The "Adjustment Screw Settings" table is also included in delivery.

R&S®SMZ90  
Multiplier with Mechanical Level Control  
Adjustment Screw Settings

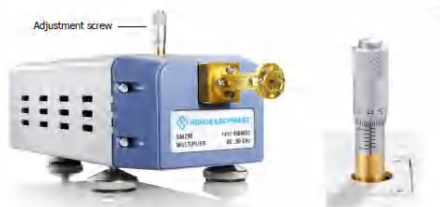

Dear Customer,  
the following table informs you about the required settings of the power adjustment screw of your multiplier in order to reach a certain level at the given frequency.

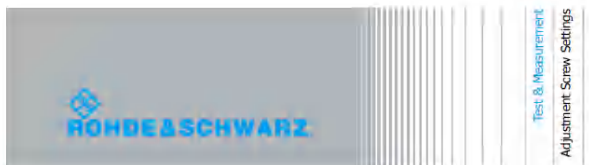

**R&S®SMZ90 Multiplier**

max. Level (dBm) at 1.4 mm	1.00	3.05	3.22	3.74	3.36	3.66	3.74	3.65	3.16
Frequency (GHz)	60.0	61.0	62.0	63.0	64.0	65.0	66.0	67.0	68.0
10.00	---	---	---	---	---	---	---	---	---
9.00	---	---	---	---	---	---	---	---	---
8.00	---	---	---	---	---	---	---	---	---
7.00	---	---	---	---	---	---	---	---	---
6.00	---	---	---	---	---	---	---	---	---
5.00	---	---	---	---	---	---	---	---	---
4.00	---	---	---	---	---	---	---	---	---
3.00	---	1.298	1.393	1.380	1.369	1.362	1.350	1.352	1.394
2.00	---	1.265	1.362	1.353	1.359	1.354	1.353	1.354	1.363
1.00	1.399	1.333	1.143	1.133	1.152	1.137	1.136	1.159	1.476
0.00	1.300	1.141	1.061	1.076	1.069	1.057	1.053	1.100	1.113
-1.00	1.142	1.006	1.036	1.028	1.043	1.055	1.040	1.059	1.068
-2.00	1.075	1.042	0.990	0.986	0.999	1.012	0.998	1.017	1.026
-3.00	1.025	0.998	0.954	0.948	0.962	0.975	0.963	0.980	0.987
-4.00	0.981	0.962	0.917	0.910	0.926	0.940	0.928	0.945	0.952
-5.00	0.944	0.925	0.884	0.877	0.891	0.905	0.894	0.911	0.919
-6.00	0.906	0.891	0.854	0.847	0.862	0.875	0.865	0.880	0.886
-7.00	0.875	0.861	0.824	0.816	0.833	0.846	0.836	0.851	0.857
-8.00	0.846	0.832	0.793	0.784	0.804	0.816	0.806	0.822	0.828
-9.00	0.816	0.802	0.758	0.748	0.769	0.784	0.772	0.791	0.799
-10.00	0.784	0.767	0.723	0.713	0.733	0.749	0.736	0.755	0.763
-11.00	0.748	0.731	0.687	0.676	0.698	0.713	0.700	0.718	0.727
-12.00	0.712	0.695	0.650	0.639	0.660	0.676	0.662	0.681	0.691
-13.00	0.676	0.658	0.614	0.603	0.624	0.640	0.624	0.644	0.655
-14.00	0.638	0.621	0.579	0.567	0.588	0.600	0.587	0.606	0.615
-15.00	0.600	0.584	0.545	0.533	0.550	0.566	0.551	0.570	0.579
-16.00	0.564	0.549	0.511	0.499	0.514	0.531	0.515	0.534	0.543
-17.00	0.528	0.514	0.479	0.470	0.482	0.496	0.482	0.499	0.507
-18.00	0.492	0.480	0.448	0.440	0.451	0.465	0.451	0.467	0.475
-19.00	0.459	0.448	0.418	0.411	0.421	0.434	0.420	0.435	0.444
-20.00	0.426	0.416	0.392	0.389	0.394	0.403	0.393	0.404	0.413
-21.00	0.395	0.390	0.372	0.371	0.375	0.382	0.373	0.382	0.388
-22.00	0.373	0.369	0.352	0.354	0.356	0.362	0.353	0.362	0.368
-23.00	0.352	0.348	0.331	0.336	0.338	0.345	0.332	0.341	0.348
-24.00	0.330	0.327	0.311	0.318	0.319	0.323	0.312	0.321	0.327
-25.00	0.309	0.306	0.289	0.290	0.290	0.294	0.282	0.290	0.297
-26.00	0.294	0.291	0.264	0.261	0.262	0.263	0.270	0.279	0.285
-27.00	0.257	0.255	0.239	0.261	0.264	0.262	0.248	0.256	0.263
-28.00	0.230	0.229	0.213	0.241	0.245	0.241	0.227	0.233	0.241
-29.00	0.203	0.203	0.188	0.222	0.227	0.220	0.205	0.211	0.218
-30.00	0.180	0.182	0.163	0.202	0.209	0.199	0.191	0.194	0.198
-31.00	0.158	0.161	0.137	0.178	0.186	0.188	0.178	0.184	0.184
-32.00	0.136	0.141	0.112	0.154	0.167	0.176	0.167	0.168	0.171
-33.00	0.113	0.120	0.090	0.130	0.138	0.145	0.154	0.155	0.159
-34.00	0.095	0.100	0.071	0.106	0.109	0.113	0.142	0.142	0.144
-35.00	0.062	0.065	0.052	0.063	0.060	0.062	0.130	0.128	0.131
-36.00	0.069	0.071	0.033	0.013	0.151	0.130	0.118	0.116	0.118
-37.00	0.057	0.057	0.013	---	0.142	0.119	0.106	0.103	0.104
-38.00	0.044	0.042	---	---	0.133	0.107	0.097	0.093	0.096
-39.00	0.031	0.028	---	---	0.125	0.095	0.090	0.085	0.094
-40.00	0.019	0.014	---	---	0.116	0.079	0.083	0.077	0.085
-41.00	0.006	---	---	---	0.107	0.064	0.076	0.062	0.080
-42.00	---	---	---	---	0.106	0.049	0.070	0.060	0.074
-43.00	---	---	---	---	0.139	0.039	0.062	0.062	0.065
-44.00	---	---	---	---	0.161	0.018	0.056	0.043	0.063
-45.00	---	---	---	---	0.151	0.003	0.050	0.035	0.057

Serial number: 101646

Date of reading: September 22, 2011

Page 1 / 4

Figure 6-7: Example of the adjustment screw settings table

Update Firmware

Opens the "Open File" dialog to select the firmware file for the update.

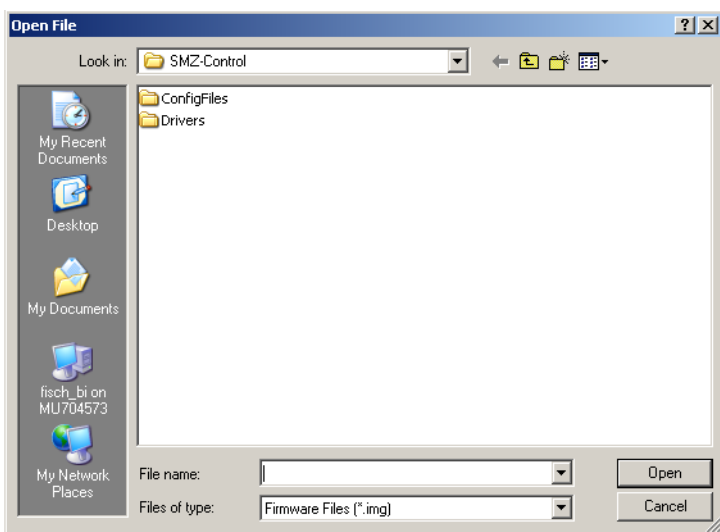

## Automation of Test Setups with R&amp;S SMZ

Just browse to the appropriate directory where you saved your downloaded firmware file and confirm with "Open". Firmware files are saved with extension `*.efmfirm`. The file name and the directory are user-selectable.

**Note:** The firmware update may take some time. It is recommended that you do not turn off the frequency multiplier during the upgrade, since it aborts the running process. Otherwise you must repeat the update.

Your R&S SMZ is delivered with the latest firmware version. For updates to the latest version, see the R&S website <http://www.rohde-schwarz.com/product/SMZ.html>. Besides the firmware, this site always offers the latest information on your frequency multiplier, like release notes, containing improvements and modifications, as well as changes on the firmware update procedure.

## 6.4 Automation of Test Setups with R&S SMZ

This section shows briefly how you can remotely control an R&S SMZ, both in operation with R&S SMZ Control, as well as with an Rohde & Schwarz microwave signal generator. Using commands following the **SCPI** (Standard Commands for Programmable Instruments) standard, you can configure the R&S SMZ remotely. Find additional information on remote control in [Chapter 7, "Remote Control Basics"](#), on page 73, and the associated commands in [Chapter 8, "Remote Control Commands"](#), on page 85.

### 6.4.1 Automation of R&S SMZ Control

In addition to the manual control of the R&S SMZ using R&S SMZ Control, you can remotely control the entire system.

It is particularly useful for repeating measurement sequences reproducible or automated testing.

You can remotely control R&S SMZ Control with a suitable software (Controller) that runs on either the same or on a separate PC. You only need a LAN connection to the PC with R&S SMZ Control.

Possible remote control configurations are:

- Controller and R&S SMZ Control installed on the same PC:

## Automation of Test Setups with R&amp;S SMZ

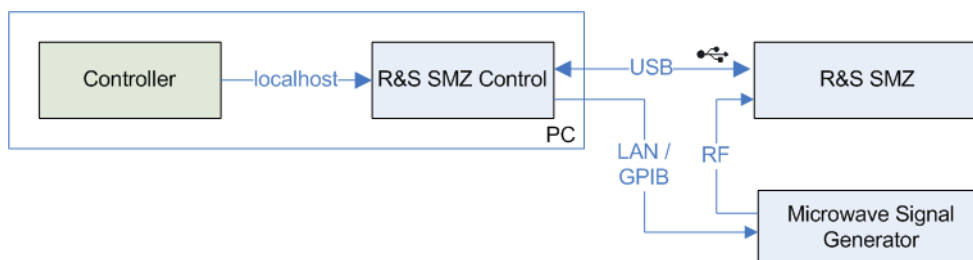

- Controller and R&S SMZ Control running on separate PCs:

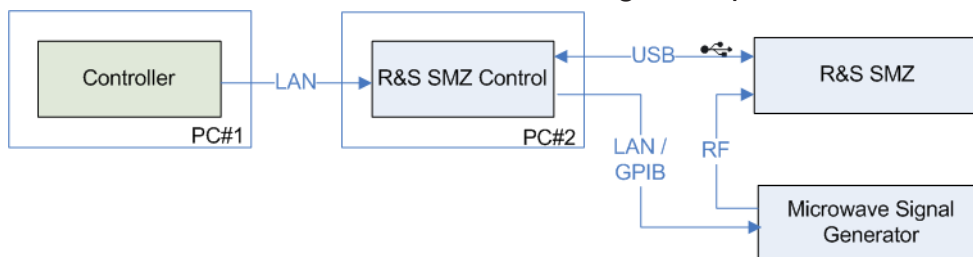

### Remarks and characteristics to the remote control test setup with separate PCs

Since R&S SMZ Control primarily covers the setting parameters of the generator, that directly relate to the frequency multiplier, further parameters are usually set by the controller. For this purpose, the controller requires direct access to the generator.

The following paragraph considers the differences between all components connected in a **LAN** network, versus the **GPIB** connection from R&S SMZ Control to the generator:

#### – LAN

Within a LAN network, you can access all instruments, that means you can remotely control R&S SMZ Control and the generator directly.

#### – GPIB

With the GPIB connection, the controller has no direct access to the signal generator. In order to still remotely control all settings, you can pass a setting via R&S SMZ Control to the generator, by means of a loop-through function, designed especially for those test setups.

Just add `TRANS :` at the beginning of the associated SCPI command.

R&S SMZ Control forwards the command directly to the generator, and vice versa, returns responses back to the controller.

**Note:** To work with the addition `TRANS :` requires that you have enabled both, the [Remote Generator](#) and [Remote SMZ Control](#).



Additional information on remote control:

- To remotely control the signal generator via R&S SMZ Control, check if your generator recognizes the commands correctly, according to the given SCPI syntax, see [Chapter 8.2.2, "Specific Commands - R&S SMZ Control"](#), on page 97.
- It is recommended that you set the settings "frequency" and "level" exclusively in R&S SMZ Control, to use its advantages and protection mechanisms, since:
  - it automatically considers the multiplication factor and specified cable losses.
  - limits the level value and thus protects the RF input of the SMZ R&S SMZ against to high input power.
  - there is no verification, if you use the `TRANS :` function (loop-through), that means in particular the **level is not limited** to the maximum input level of the SMZ!

For information on how to get started and how to establish a remote control connection between the controller and the software, see [Chapter 7.1.3, "Starting a Remote Control Session"](#), on page 77.

Find the SCPI commands available for R&S SMZ Control in [Chapter 8.2, "R&S SMZ Control Commands"](#), on page 96.

## 6.4.2 Automation of an R&S Signal Generator

Since the Rohde & Schwarz microwave signal generator supports various interfaces for remote control, refer to the *Operating Manual* of the respective Rohde & Schwarz microwave signal generator. Find in chapter "Remote Control Basics" all information to the interfaces and protocols that you can use, as well as the required configuration.

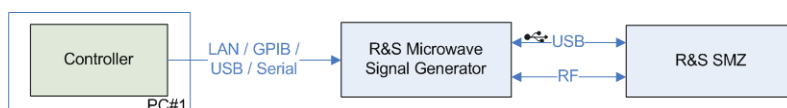

Also when remotely controlled, the Rohde & Schwarz microwave signal generator communicates with the R&S SMZ via USB and thus automatically transfers the settings.

The remote control commands, available for the R&S SMZ settings are part of this manual, see [Chapter 8.1, "SOURCE:FREQUENCY:MULTIPLIER Subsystem"](#), on page 85.



## 7 Remote Control Basics

This chapter contains the basic information you need for remote control, primarily concerning the remote control of R&S SMZ Control, as well as information on the remote control via the Rohde & Schwarz microwave signal generator. It includes a brief description of the connection and interface protocols, as well as how to start a remote control session by means of an example.



Information on SCPI syntax and structure are not part of this manual, you can find it described in the relevant documentation to SCPI.

Additionally, if you work with an Rohde & Schwarz microwave signal generator or other R&S Signal Generator, its online help and operating manual contain the basics on SCPI and remote control in detail.

### 7.1 Remote Control Interfaces and Protocols

Depending on what is remote controlled, you have several interfaces and protocols:

- **R&S SMZ Control remotely controls a signal generator**

To remotely control a signal generator, R&S SMZ Control supports

- a **LAN** (Local Area Network) interface, based on TCP/IP, using VXI-11 protocol, or
- a **GPIB** (General Purpose Interface Bus)

**Note:** Within this interface description, the term GPIB is used as a synonym for the IEC/IEEE bus interface.

- **a controller remotely controls R&S SMZ Control, and thus also the signal generator** (optionally)

R&S SMZ Control in turn is remotely controlled by a separate controller PC via a **LAN** interface, or in case the controller program runs on the same computer, the link is established via **Local Host**. Both links communicate with TCP/IP socket protocol.

Find the test setups also graphically shown in [Chapter 6.4.1, "Automation of R&S SMZ Control"](#), on page 69.



LAN and GPIB links require VISA libraries, whereas socket communication does not necessarily require a VISA installation on the remote controller side. You can also perform connection with **Win Socket** communication.

## SCPI (Standard Commands for Programmable Instruments)

SCPI commands - messages - are used for remote control. Commands that are not taken from the SCPI standard follow the SCPI syntax rules. R&S SMZ Control supports the SCPI version 1999. The SCPI standard is based on standard IEEE 488.2 and aims at the standardization of device-specific commands, error handling and the status registers. The tutorial "Automatic Measurement Control - A tutorial on SCPI and IEEE 488.2" from John M. Pieper (R&S order number 0002.3536.00) offers detailed information on concepts and definitions of SCPI.

Tables provide a fast overview of the bit assignment in the status registers. The tables are supplemented by a comprehensive description of the status registers.

### 7.1.1 LAN interface

To be integrated in a LAN, each instrument is equipped with a LAN interface, consisting of a connector, a network interface card and protocols. The PC must be connected via the LAN interface to a common network with TCP/IP protocol. They are connected using a commercial RJ-45 cable. The TCP/IP network protocol and the associated network services are preconfigured on the instruments.



#### Identifying instruments in a network

If several instruments are connected in a network, each instrument has its own IP address and associated resource string. The controller identifies these instruments by means of the resource string.

#### 7.1.1.1 Remote Control of the Signal Generator

To remotely control a signal generator in a LAN, R&S SMZ Control uses TCP/IP network protocol.

The VISA program library must be installed on the controller.

## VXI-11 Protocol

The VXI-11 standard is based on the ONC RPC (Open Network Computing Remote Procedure Call) protocol which in turn relies on TCP/IP as the network/transport layer. The TCP/IP network protocol and the associated network services are preconfigured. TCP/IP ensures connection-oriented communication, where the order of the exchanged messages is adhered to and interrupted links are identified. With this protocol, messages cannot be lost.

### IP address

The IP address or the computer name (LAN device name) is required to set up the connection. The IP address/computer name is part of the "visa resource string" used by the program to identify and control R&S SMZ Control. The visa resource string has the form:

TCPIP::host address::[LAN device name]::[INSTR], where:

- **TCPIP** designates the network protocol
- **host address** is the IP address
- **LAN device name** is the computer name of the control device (alternative to IP address)
- **INSTR** indicates that the VXI-11 protocol is used

### Example:

The instrument has the IP address *192.1.2.3*; the resulting resource string is:

```
TCPIP::192.1.2.3::INSTR
```

### 7.1.1.2 Remote Control of R&S SMZ Control

R&S SMZ Control is either remotely controlled by a separate controller PC via a LAN interface, or by a controller program running on the same computer. In this case the link is established via "Local Host". Both links communicate with TCP/IP socket protocol, that means Raw Socket (simple telnet).

### Socket communication

Alternatively, you can remotely control the software by establishing a simple network communication using sockets. The socket communication, also referred as **Raw Ethernet communication** or *Raw socket*, does not require a VISA installation on the remote controller side.

## IP address

Socket connections are established on a specially defined port. The socket address is a combination of the IP address or the host name of the instrument and the number of the port configured for remote-control. R&S SMZ Control uses port number "5025" for this purpose by default, but can be set. The port is configured for communication on a command-to-command basis and for remote control from a program.

The interface is based on TCP/IP with VISA resource string composed of:

```
TCPIP::::<port>::SOCKET
```

- **TCPIP** designates the network protocol
- **ip addr** is the IP address
- **port** is the port number
- **SOCKET** indicates that the socket protocol is used

## Local Host

In case the R&S SMZ Control and the controller are installed on the same PC, *Local Host* can be used. Hence the valid visa resource string is:

```
TCPIP::::<port>::SOCKET
```

### Example:

Host address is *127.0.0.1*; the valid resource string is:

```
TCPIP::127.0.0.1::5025::SOCKET
```

## 7.1.2 GPIB Interface (IEC/IEEE Bus Interface)

To be able to control the signal generator via the GPIB bus, the instrument and the controller must be connected by a GPIB bus cable. A GPIB bus card, the card drivers and the program libraries for the programming language used must be provided in the controller. The connection is setup with the instruments GPIB address.

### Characteristics

The following features characterize a GPIB interface:

- You can connect up to 15 instruments
- The total cable length is restricted to a maximum of 15 m

- The cable length between two instruments should not exceed 2m
- A wired "OR"-connection is used if several instruments are connected in parallel, since the slowest instrument determines the speed.



Any connected IEC bus cable must be terminated by an instrument or a controller.

### GPIB instrument address

To operate the instrument via remote control, it must be addressed using the GPIB address. For remote control, addresses from 0 to 30 are allowed.

The GPIB address/computer name is part of the *visa resource string* used by the program to identify and control the instrument. The visa resource string has the form:

`GPIB::primary address[::INSTR]`, where:

- **GPIB** designates the IEC/IEEE bus interface
- **primary address** is the GPIB address
- **[::INSTR]** indicates that the VXI-11 protocol is used (optional)

### 7.1.3 Starting a Remote Control Session



This chapter refers to the remote control of R&S SMZ Control, since you can start remote control of the signal generator directly in the "Configuration" dialog of R&S SMZ Control, see "[Remote Generator](#)" on page 65.

To start the remote control:

1. Connect the controller PC and the PC with R&S SMZ Control, if these programs are not running on the same computer.
2. Start the remote control program and configure the connection to R&S SMZ Control:
  - a) Enter the IP address and the Port number for the LAN socket connection ([LAN interface](#))

- b) Open the connection to R&S SMZ Control using "Raw socket" or "VISA" functionality.

The system is ready for operation. You can send commands to R&S SMZ Control, and receive responses respectively.

Refer to [Chapter 7.1.5, "Setting up a LAN connection with a controller software"](#), on page 78 for setting up a remote control link and starting a remote control session.

## 7.1.4 Switching to Remote Control

R&S SMZ Control always starts in the last used mode and can be operated directly. It switches to remote control state, when the remote connection is established, or when a command is received. The "LOCAL" button switches back to manual control.

## 7.1.5 Setting up a LAN connection with a controller software

The following example shows you how to set up a LAN connection, and start a remote control session with R&S SMZ Control.

We assume that you have basic knowledge of programming and operation of the controller. For more information on the interface commands see the corresponding manuals.

The LAN remote control link is established and started with the program "Measurement & Automation Explorer" by National Instruments under Windows operating system.

### Configuring the controller

In this example, the controller software and R&S SMZ Control are running on the same computer.

To enable the external controller to communicate with the software via TCP/IP protocol, set up a remote control link as follows:

1. Connect the controller and the PC with R&S SMZ Control to the network (network cable) and switch both computers on.
2. Start the 'Measurement & Automation Control' program on the controller.

3. Select "Devices and Interfaces > Create New".

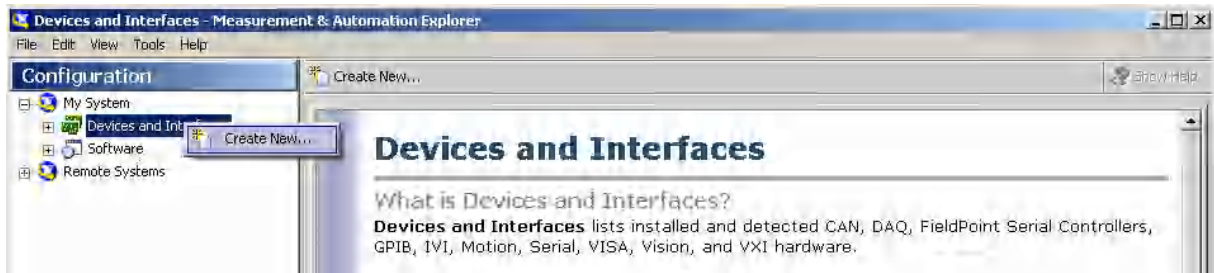

4. Select "VISA TCP/IP Resource" and confirm with "Next".

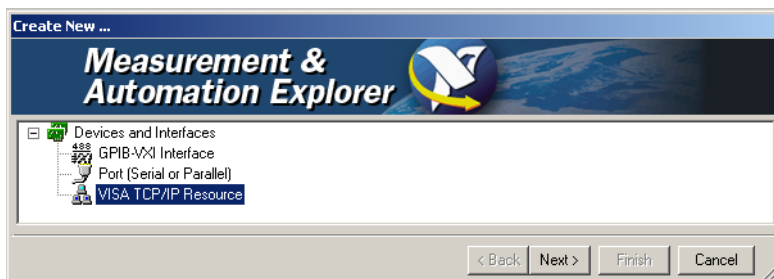

5. Choose the type of TCP/IP resource you wish to add and select "Next".



6. Enter the IP address or the host name of R&S SMZ Control and select "Next".

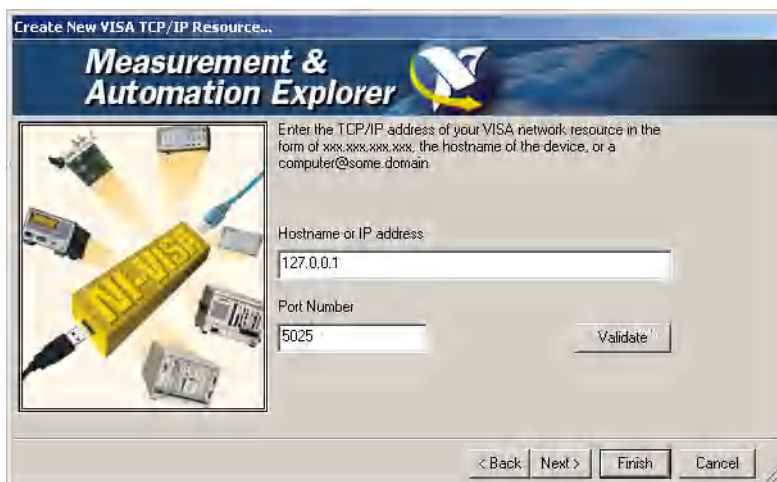

7. Enter the alias name if required.



The alias name must not be mistaken for the computer name. It is only used for instrument identification within the program and displayed in the menu as an option in case of an Ethernet link.

8. Confirm the settings with "Finish".



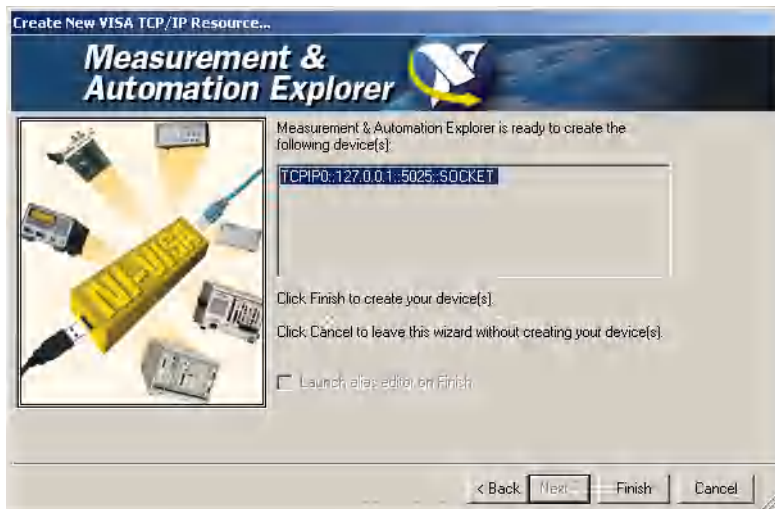

The link is configured and the settings are displayed in:

- the "General" tab, containing basic information

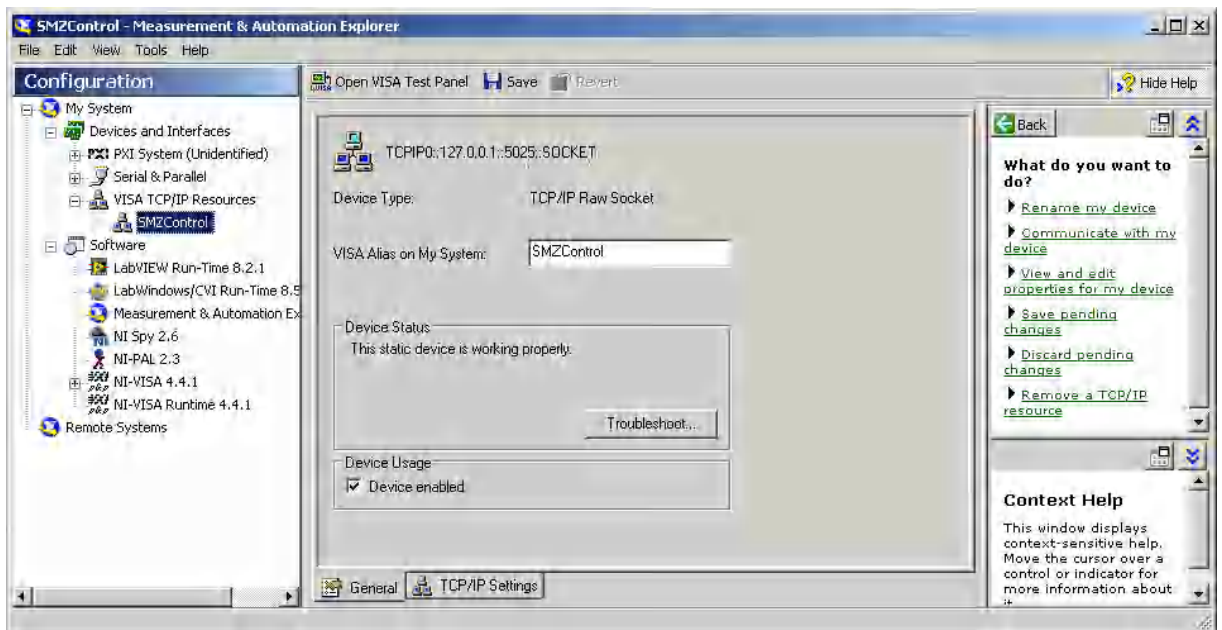

- the "TCP/IP Settings" tab with the "IP address" and "Port" number

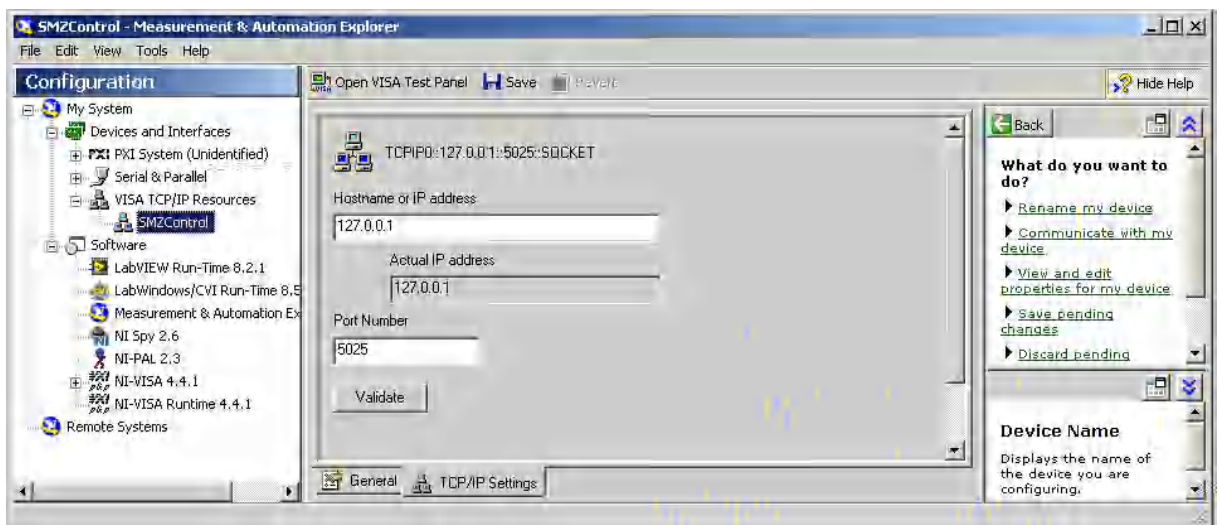

- To test the connection, select "Validate".

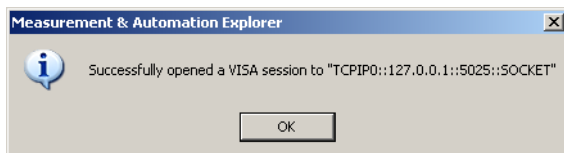

A message indicates whether the link to the instrument can be set up or not. If a connection cannot be set up, check whether the controller and the instrument are connected to the network (network cable) and switched on. Correct spelling of the IP address or the computer name can also be checked. For further error location, inform the network administrator. In large networks, specification of additional addresses may be required for link setup, for example gateway and subnet mask, which are known to the network administrator. R&S SMZ Control is now registered in the program and can be addressed via the resource string or alias name.

### Starting remote control

- Start the 'Measurement & Automation Explorer' on the controller.
- In the "Configuration" window, select "Device and Interfaces > VISA TCP/IP Resources", select the required instrument and select "Open VISA Test Panel".

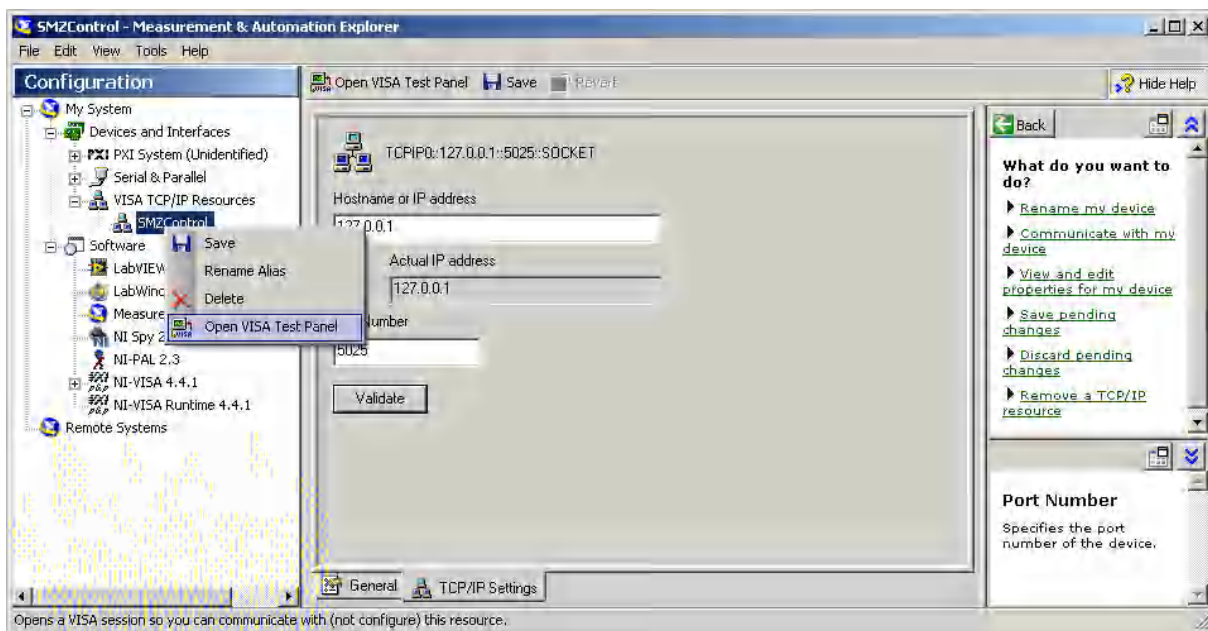

3. In the "viWrite" tab, write the command to be send to the R&S SMZ Control and select "Execute".

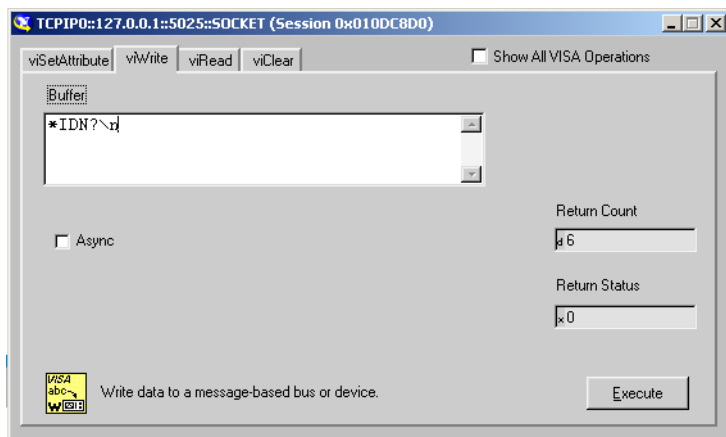

Instrument responses are displayed on the "viRead" tab.

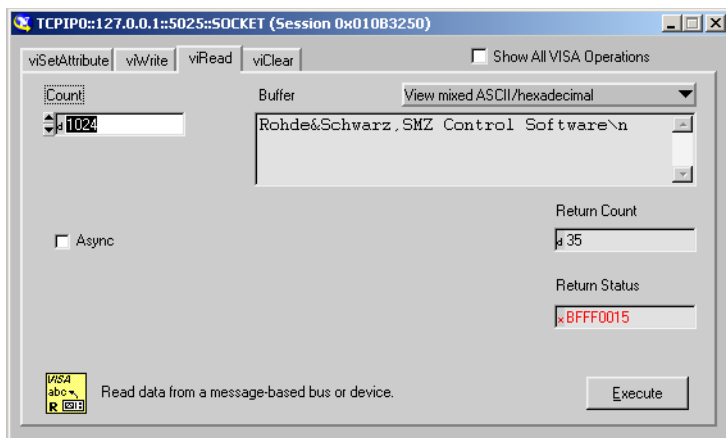



For further program operation refer to the online help of the program.

## 8 Remote Control Commands

This part of the manual contains all remote-control commands are presented in detail with their parameters and the ranges of numerical values. They are grouped according to the instrument that they address, the Rohde & Schwarz microwave signal generator and R&S SMZ Control, and then sorted alphabetically.

### 8.1 SOURce:FREQuency:MULTIplier Subsystem

You can use the following commands to remotely control the R&S SMZ with the Rohde & Schwarz microwave signal generator Microwave Signal Generator.

#### 8.1.1 SMZ Info Update Settings

With the following commands you can check all hardware and software information of the R&S SMZ and update the firmware.

[SOURce<hw>]:FREQuency:MULTIplier:EXTernal:FIRMware:VERSion?.....	86
[SOURce<hw>]:FREQuency:MULTIplier:EXTernal:FMAXimum?.....	86
[SOURce<hw>]:FREQuency:MULTIplier:EXTernal:FMINimum?.....	86
[SOURce<hw>]:FREQuency:MULTIplier:EXTernal:LOADer:VERSion?.....	86
[SOURce<hw>]:FREQuency:MULTIplier:EXTernal:REVision?.....	86
[SOURce<hw>]:FREQuency:MULTIplier:EXTernal:SNUMber?.....	86
[SOURce<hw>]:FREQuency:MULTIplier:EXTernal:TYPE?.....	86
[SOURce<hw>]:FREQuency:MULTIplier:EXTernal:IPMax?.....	86
[SOURce<hw>]:FREQuency:MULTIplier:EXTernal:IPower?.....	86
[SOURce<hw>]:FREQuency:MULTIplier:EXTernal:MULTIplier?.....	87
[SOURce<hw>]:FREQuency:MULTIplier:EXTernal:PMAXimum?.....	87
[SOURce<hw>]:FREQuency:MULTIplier:EXTernal:PMINimum?.....	87
[SOURce<hw>]:FREQuency:MULTIplier:EXTernal:STATe?.....	87
[SOURce<hw>]:FREQuency:MULTIplier:EXTernal:FIRMware:CATalog?.....	88
[SOURce<hw>]:FREQuency:MULTIplier:EXTernal:FIRMware:SElect.....	88
[SOURce<hw>]:FREQuency:MULTIplier:EXTernal:FIRMware:UPDate.....	89
[SOURce<hw>]:FREQuency:MULTIplier:EXTernal:PSDMinimum?.....	89
[SOURce<hw>]:FREQuency:MULTIplier:EXTernal:PADJust?.....	90

```
[:SOURce<hw>]:FREQuency:MULTiplier:EXTernal:FIRMware:VERSion?
[:SOURce<hw>]:FREQuency:MULTiplier:EXTernal:FMAXimum?
[:SOURce<hw>]:FREQuency:MULTiplier:EXTernal:FMINimum?
[:SOURce<hw>]:FREQuency:MULTiplier:EXTernal:LOADer:VERSion?
[:SOURce<hw>]:FREQuency:MULTiplier:EXTernal:REVision?
[:SOURce<hw>]:FREQuency:MULTiplier:EXTernal:SNUMber?
[:SOURce<hw>]:FREQuency:MULTiplier:EXTernal:TYPE?
```

Returns information on the connected frequency multiplier.

**Return values:**

<Type>	string
	<b>FW Version</b>
	The currently installed firmware version.
	<b>Max Freq</b>
	Maximum output frequency.
	<b>Min Freq</b>
	Minimum output frequency.
	<b>BL Version</b>
	The boot loader version.
	<b>Revision</b>
	Revision number of the R&S SMZ.
	<b>Serial Number</b>
	Part number of the R&S SMZ.
	<b>Multiplier Type</b>
	Model of the R&S SMZ.

**Example:**

```
FREQ:MULT:EXT:SNUM?
Response: 10647.
FREQ:MULT:EXT:TYPE?
Response: "SMZ-B110E".
```

**Usage:** Query only

**Manual operation:** See "[Multiplier Type, Serial Number, ...](#)" on page 44

```
[:SOURce<hw>]:FREQuency:MULTiplier:EXTernal:IPMax?
[:SOURce<hw>]:FREQuency:MULTiplier:EXTernal:IPOWER?
```

Returns the nominal or maximum input power of the frequency multiplier.

## SOURce:FREQuency:MULTiplier Subsystem

**Return values:**

<InputPower> float  
 Range: 7 ... 10 dBm  
 Increment: 0.01  
 \*RST: 7

**Example:**           FREQ:MULT:EXT:IPOW?  
 Response 7 dBm

**Usage:**            Query only

**[:SOURce<hw>]:FREQuency:MULTiplier:EXTernal:MULTiplier?**

Returns the multiplication factor of the connected frequency multiplier.

**Return values:**

<Multiplier> float  
 Increment: 1E-3

**Example:**           FREQ:MULT:EXT:MULT?  
 Response: 6

**Usage:**            Query only

**[:SOURce<hw>]:FREQuency:MULTiplier:EXTernal:PMAXimum?****[:SOURce<hw>]:FREQuency:MULTiplier:EXTernal:PMINimum?**

Returns the maximum or minimum output power of the frequency multiplier.

**Return values:**

<PMin> float  
 Range: Depends on the R&S SMZ model, see data-sheet.  
 Increment: 0.01

**Example:**           FREQ:MULT:EXT:PMAX?  
 Response: 7 dBm (maximum output power)

**Usage:**            Query only

**[:SOURce<hw>]:FREQuency:MULTiplier:EXTernal:STATe?**

Queries whether a frequency multiplier is connected.

**Return values:**

<State> 0 | 1 | OFF | ON

**Example:**

FREQ:MULT:EXT:STAT?

Response 1, an R&S SMZ is connected to the signal generator.

**Usage:**

Query only

**[:SOURce<hw>]:FREQuency:MULTiplier:EXTernal:FIRMware:CATalog?**

Returns a list of firmware files, separated by a comma.

Firmware files have the fixed file extension \*.efmfirm, whereas file name and the directory are user-selectable. To determine the directory use the command MMEM:CDIR.

**Note:** Your R&S SMZ is delivered with the latest firmware version. For updates to the latest version, see the R&S website <http://www.rohde-schwarz.com/product/SMZ.html>. Besides the firmware, this site always offers the latest information on your frequency multiplier, like release notes, containing improvements and modifications, as well as changes on the firmware update procedure.

**Return values:**

<Catalog> string

**Example:**

MMEM:CDIR '/smz/firmware'

selects the directory the firmware files are stored.

FREQ:MULT:EXT:FIRM:CAT?

Response: "FW\_1.50,FW\_1.60,FW\_1.62"

returns the available firmware files.

**Usage:**

Query only

**Manual operation:** See "Update" on page 45

**[:SOURce<hw>]:FREQuency:MULTiplier:EXTernal:FIRMware:SElect  
<FileName>**

Selects the firmware file.

**Parameters:**

<FileName> string



## SOURce:FREQuency:MULTiplier Subsystem

**Example:**                   FREQ:MULT:EXT:FIRM:CAT?  
 Response: "FW\_1.50,FW\_1.60,FW\_1.62"  
 returns the available firmware files.  
 FREQ:MULT:EXT:FIRM:SEL "FW\_1.62.efmfirm"  
 selects the firmware file for update.

**Manual operation:**    See ["Update"](#) on page 45

**[:SOURce<hw>]:FREQuency:MULTiplier:EXTernal:FIRMware:UPDate**

Executes the firmware update.

This process starts after a few seconds and may take some minutes.

**Note:** It is recommended that you do not turn off the frequency multiplier during the update, since it aborts the running process. Otherwise you must repeat the procedure.

**Example:**                   FREQ:MULT:EXT:FIRM:UPD  
 starts the firmware update.

**Usage:**                    Event

**Manual operation:**    See ["Update"](#) on page 45

**[:SOURce<hw>]:FREQuency:MULTiplier:EXTernal:PSDMinimum?**

Returns the minimum dwell value when the RF output signal is generated in level sweep mode.

**Return values:**

<PowerSweepDwell> float

Increment: 100E-6

**Example:**                   FREQ:MULT:EXT:PSDM?  
 Response: '0.8'

**Usage:**                    Query only

**[:SOURce<hw>]:FREQuency:MULTiplier:EXTernal:PADJust?**

Queries the setting value for the adjustment screw. The value is determined for the current frequency, on the basis of the calibration table of the frequency multiplier.

**Return values:**

<PowerAdjust> float  
 Range: 0 to 6.5  
 Increment: 0.001  
 \*RST: 3.25

**Example:**

FREQ:MULT:EXT:PADJ?  
 Queries target screw setting.  
 Response: '0847'

**Usage:** Query only

**8.1.2 Cable Compensation Settings**

These commands are relevant for the setting of correction values to compensate cable losses.

[:SOURce<hw>]:FREQuency:MULTiplier:EXTernal:CORRection:CATalog?.....	90
[:SOURce<hw>]:FREQuency:MULTiplier:EXTernal:CORRection:CLOSS.....	91
[:SOURce<hw>]:FREQuency:MULTiplier:EXTernal:CORRection:DELeTe.....	91
[:SOURce<hw>]:FREQuency:MULTiplier:EXTernal:CORRection:FREQuency.....	92
[:SOURce<hw>]:FREQuency:MULTiplier:EXTernal:CORRection:FREQuency: POINTs?.....	93
[:SOURce<hw>]:FREQuency:MULTiplier:EXTernal:CORRection:MODE.....	93
[:SOURce<hw>]:FREQuency:MULTiplier:EXTernal:CORRection:POWEr.....	94
[:SOURce<hw>]:FREQuency:MULTiplier:EXTernal:CORRection:POWEr:POINts?.....	95
[:SOURce<hw>]:FREQuency:MULTiplier:EXTernal:CORRection:SELeCt.....	96
[:SOURce<hw>]:FREQuency:MULTiplier:EXTernal:CORRection:SENSor<ch>: SONCe.....	96

**[:SOURce<hw>]:FREQuency:MULTiplier:EXTernal:CORRection:CATalog?**

Returns a list of files containing cable correction tables, separated by commas.

## SOURce:FREQuency:MULTiplier Subsystem

Table correction files have the fixed file extension `*.efmccor`, whereas file name and the directory are user-selectable. To determine the directory use the command `MMEM:CDIR`.

**Return values:**

<Catalog>

**Example:**

```
MMEM:CDIR '/var/lists/cablecor'
selects the directory for the cable correction files.
FREQ:MULT:EXT:CORR:CAT?
queries the available correction tables.
Response: "CCOR1,CCOR2,CCOR3"
returns the available correction files.
```

**Usage:** Query only

**Manual operation:** See "[Cable Cor. Data](#)" on page 48

**[:SOURce<hw>]:FREQuency:MULTiplier:EXTernal:CORRection:CLOSS**  
<CableLoss>

Sets the cable loss at 10 GHz.

The Rohde & Schwarz microwave signal generator uses this value to interpolate the cable loss at the desired frequency, as shown in "[Cable Loss \(10 GHz\)](#)" on page 47.

**Parameters:**

<CableLoss> float  
Range: 0 to 3  
Increment: 0.1  
\*RST: 1

**Example:** `FREQ:MULT:EXT:CORR:CLOS 0.6`  
sets 0.6 dB cable loss at 10 GHz.

**Manual operation:** See "[Cable Loss \(10 GHz\)](#)" on page 47

**[:SOURce<hw>]:FREQuency:MULTiplier:EXTernal:CORRection:DELeTe**  
<Filename>

Deletes the selected correction file.

**Setting parameters:****<Filename>** string**Example:**

```
MMEM:CDIR '/var/Lists/cablecor'
selects the directory for the cable correction files.
FREQ:MULT:EXT:CORR:DEL 'CCORR1'
deletes the table CCORR1.
```

**Usage:** Setting only**Manual operation:** See "[Cable Cor. Data](#)" on page 48

**[:SOURce<hw>]:FREQuency:MULTIplier:EXTernal:CORRection:FREQuency**  
**<ListFreq>**

Enters the frequency values in the selected correction table. The number of frequency entries must correspond to the number of level values.

**Parameters:****<ListFreq>** <frequency#>{, <frequency#2>, ...} | block data

You can either enter the data as a list of numbers, or as binary block data.

The list of numbers can be of any length, with the list entries separated by commas. In binary block format, 8 (4) bytes are always interpreted as a floating-point number with double accuracy.

Range: 1GHz to 22GHz

Increment: 0.001Hz

\*RST: 1GHz

**Example:**

```
FREQ:MULT:EXT:CORR:SEL "CCOR2.efmccor"
selects the file for editing.
```

```
FREQ:MULT:EXT:CORR:FREQ 1GHz, 1.2GHz,
1.4GHz, 1.6GHz, ..
```

specifies the frequency correction values in CCOR2. The number of frequency entries must correspond to the number of level values. Existing data is overwritten.

**Manual operation:** See "[Edit Cable Correction Data](#)" on page 49

**[:SOURce<hw>]:FREQuency:MULTiplier:EXTernal:CORRection:  
FREQuency:POINts?**

Queries the number (points) of frequency entries in the selected list.

**Return values:**

<Points>                    integer  
Range:                    0 to 10000  
\*RST:                    0

**Example:**

FREQ:MULT:EXT:CORR:SEL "CCOR2.efmccor"  
selects the file for cable loss compensation.  
FREQ:MULT:EXT:CORR:FREQ:POIN?  
queries the number of entries.  
Response: "327"  
the table has 327 frequency entries.

**Usage:**                    Query only

**Manual operation:**    See ["Edit Cable Correction Data"](#) on page 49

---

**[:SOURce<hw>]:FREQuency:MULTiplier:EXTernal:CORRection:MODE  
<Mode>**

Selects the mode for setting the correction values in order to compensate cable losses.

**Parameters:**

&lt;Mode&gt;

HPReCision | STANdard | NONE

**NONE**

Disables cable compensation.

Use this mode to measure the cable loss to the R&amp;S SMZ, without any further correction effects.

**STANdard**Selects standard mode, i.e. you can determine the cable attenuation at 10 GHz, with command `[ :SOURce<hw> ] : FREQuency:MULTiplier:EXTernal:CORRection: CLOSs`.**HPReCision**

Activates precise cable compensation by means of correction values from a table. You determine the values in advance and store them in a file. The correction value of an intermediate frequency is automatically interpolated.

`*RST: STANdard`**Example:**`FREQ:MULT:EXT:CORR:MODE STAN`

selects the standard mode for determining the cable loss correction at 10 GHz.

**Manual operation:** See "[SMZ Input Cable Compensation](#)" on page 47**`[ :SOURce<hw> ] : FREQuency:MULTiplier:EXTernal:CORRection:POWER <ListPow>`**

Enters the level values in the selected correction table. The number of level entries must correspond to the number of frequency values.

**Parameters:**

&lt;ListPow&gt;

&lt;power#&gt;{, &lt;power#2&gt;, ...} | block data

You can either enter the data as a list of numbers, or as binary block data.

The list of numbers can be of any length, with the list entries separated by commas. In binary block format, 8 (4) bytes are always interpreted as a floating-point number with double accuracy.

Range: 0 ... 3 dBm

Increment: 0.01

\*RST: 0 dBm

**Example:**

FREQ:MULT:EXT:CORR:SEL "CCOR2.efmccor"  
selects the file for editing.

FREQ:MULT:EXT:CORR:POW 0dBm, 0.2dBm,  
0.4dBm, 0.6dBm, ..

specifies the level correction values in CCOR2. The number of level entries must correspond to the number of frequency values. Existing data is overwritten.

**Manual operation:** See ["Edit Cable Correction Data"](#) on page 49

**[:SOURce<hw>]:FREQuency:MULTIplier:EXTernal:CORRection:POWer:POINTS?**

Queries the number (points) of level entries in the selected list.

**Return values:**

&lt;Points&gt;

integer

Range: 0 to 10000

\*RST: 0

**Example:**

FREQ:MULT:EXT:CORR:SEL "CCOR2.efmccor"  
selects the file for cable loss compensation.

FREQ:MULT:EXT:CORR:POW:POIN?

queries the number of levels.

Response: "327"

the table has 327 level entries.

**Usage:**

Query only

**Manual operation:** See ["Edit Cable Correction Data"](#) on page 49

**[[:SOURce<hw>]:FREQUency:MULTIplier:EXTernal:CORRection:SElect  
<Filename>**

Selects a file containing cable correction values. If a file does not yet exist, it is created automatically.

**Parameters:**

<Filename>                      string

**Example:**

```
FREQ:MULT:EXT:CORR:MODE HPR
selects the high precision mode to use cable correction
data for compensation.
FREQ:MULT:EXT:CORR:CAT?
queries the available correction tables.
Response: "CCOR1,CCOR2,CCOR3"
FREQ:MULT:EXT:CORR:SEL "CCOR2.efmccor"
selects the correction firmware file for cable loss compen-
sation.
```

**Manual operation:**    See "[Cable Cor. Data](#)" on page 48

**[[:SOURce<hw>]:FREQUency:MULTIplier:EXTernal:CORRection:  
SENSor<ch>:SONCe**

Fills the selected cable correction list with the level values measured by the power sensor for the given frequencies. Determine the sensor to be used with the suffix in key word `SENSe<ch>`.

**Example:**

```
FREQ:MULT:EXT:CORR:SENS:SONC
fills the cable correction table with level values acquired by
the sensor.
```

**Usage:**                      Event

## 8.2 R&S SMZ Control Commands

You can use the following commands to remotely control the R&S SMZ with R&S SMZ Control.



## 8.2.1 Common Commands - R&S SMZ Control

Common commands are described in the IEEE 488.2 (IEC 625-2) standard. These commands have the same effect and are employed in the same way on different devices. The headers of these commands consist of "\*" followed by three letters.

The following are the common commands implemented in R&S SMZ Control.

*CLS.....	97
*IDN?.....	97
*RST.....	97

---

### \*CLS

CLear Status

Clears the error queue.

---

### \*IDN?

IDeNtification query R&S SMZ.

The query returns "Rohde&Schwarz,<device type>,<serial number>, <firmware version>". The information is returned at fixed positions in a comma-separated string.

---

### \*RST

ReSet

Sets the R&S SMZ to a defined initial status.

## 8.2.2 Specific Commands - R&S SMZ Control

With the specific commands, you can set frequency and level of the signal generator, activate the RF output signal and check the error queue.



To remotely control the signal generator via R&S SMZ Control, check if your generator recognizes the commands correctly, according to the given SCPI syntax.

[SOURce]:FREQUency[:CW FIXed].....	98
[SOURce]:POWer[:LEVel][:IMMediate][:AMPLitude].....	98
:OUTPut[:STATe].....	99
:SYSTem:ERRor:ALL?.....	99
:SYSTem:ERRor[:NEXT]?.....	99
TRANS:<command>.....	100

### [SOURce]:FREQUency[:CW|FIXed]

Sets the multiplier output frequency.

#### Parameters:

<float>

#### Minimum frequency ... Maximum frequency

The value range for the frequency settings varies according to the instrument model. The values are given in the data sheet.

\*RST: Minimum frequency  
Default unit: Hz

**Example:** :FREQ 75 ghz

**Manual operation:** See "[Frequency](#)" on page 62

sets the RF output frequency of the multiplier to 75 GHz.

### [SOURce]:POWer[:LEVel][:IMMediate][:AMPLitude]

Sets the multiplier output level.

#### Parameters:

<amplitude>

#### Minimum level ... Maximum level

The value range for the level settings varies according to the instrument model. The values are given in the data sheet.

\*RST: Minimum level  
Default unit: dBm

**Example:** :POW -10 dbm

**Manual operation:** See "[Level](#)" on page 62

sets the RF output power of the frequency multiplier to -10 dBm.

### **:OUTPut[:STATe]**

Activates RF signal output of the generator.

#### **Parameters:**

<state>                    **ON|OFF | 0|1**  
                               \*RST:            OFF

**Example:**                    :OUTP ON  
                                   activates the signal output.

**Manual operation:** See "[Remote Generator](#)" on page 65

### **:SYSTem:ERRor:ALL?**

Returns the error code with description of all occurred errors, separated by commas.

When executed, the list is cleared automatically.

**Example:**                    :SYST:ERR:ALL?  
                                   Response: 0, "No error", the queue is empty, no error  
                                   has been occurred.

### **:SYSTem:ERRor[:NEXT]?**

Returns one error message from the SCPI error queue, starting with the first one (FIFO). When executed, the message is cleared.

To get all error messages, send the command for each message. If the queue is empty, the response is 0, "No error".

**Example:**                    :SYST:ERR:NEXT?  
                                   Response: '-222, "Value out of range"'.

**TRANS:<command>**

Passes any command that starts with `TRANS :` directly to the generator, and returns the responses to the controller.

**Note:** R&S SMZ Control does not perform any verification within this loop-through function. Therefore, it is strongly recommended that you set frequency, RF output state and in particular the **level** exclusively with the SMZ-Control commands in order to protect the RF input of your R&S SMZ. Use `:POW`, `:FREQ` and `:OUTP` instead, without `TRANS :`.

**Example:**                   `TRANS : *IDN?`  
                              queries the generator ID.

**Response:** Rohde&Schwarz, SMF100A,  
1167.0000k02/000000, 2.7.15.0-02.20.xxx

## 9 Maintenance

The frequency multiplier does not require any special maintenance.

Make sure that the air vents are not obstructed.

---

### NOTICE

#### Opening the instrument

Do not disassemble the R&S SMZ frequency multiplier. If you need repair, ship the instrument to the R&S servicing departments.

Use the original packaging when the R&S SMZ is to be transported or dispatched. If the original packaging is no longer available, use a sturdy cardboard box of suitable size and carefully wrap the R&S SMZ to protect it against mechanical damage.

---

---

### NOTICE

#### Risk of instrument damage

Cleaning agents contain substances that may damage the instruments, for example solvent-containing cleaning agents may damage the front panel labeling or plastic parts.

Do not use cleaning agents such as solvents (thinners, acetone, etc), acids, bases, or other substances for they may damage the labeling.

The outside of the instrument is suitably cleaned using a soft, line-free dust cloth.

---



#### Service Information

For service information contact your Rohde & Schwarz support center, provided on the R&S website: [Rohde&Schwarz Service and Support](#). Additionally, a list of useful R&S contact addresses are provided at the beginning of this manual.

---

## 9.1 Storing and Packaging

For storage, pay attention to the temperature range that is specified in the data-sheet. For a long period of time, keep the instrument protected from dust.

Retain the original packaging material, particularly the protective cap and the cardboard box. Use it for transporting or dispatching your R&S SMZ, in order to protect the controls and connectors from damage. See also [Chapter 4.1, "Unpacking and Checking the R&S SMZ"](#), on page 10.

## 9.2 Additional Information

You find technical details to the R&S SMZ frequency multipliers in the data sheet.

For a comprehensive description of the Rohde & Schwarz microwave signal generator refer to the Rohde & Schwarz microwave signal generator online help system or to the printable operating manual, which is available for download at <http://www.rohde-schwarz.com/product/SMF100A>.

# List of Commands

:OUTPut[:STATe].....	99
:SYSTem:ERRor:ALL?.....	99
:SYSTem:ERRor[:NEXT]?.....	99
[:SOURce<hw>]:FREQUency:MULTIplier:EXTernal:CORRection:CATalog?.....	90
[:SOURce<hw>]:FREQUency:MULTIplier:EXTernal:CORRection:CLOSs.....	91
[:SOURce<hw>]:FREQUency:MULTIplier:EXTernal:CORRection:DELete.....	91
[:SOURce<hw>]:FREQUency:MULTIplier:EXTernal:CORRection:FREQUency.....	92
[:SOURce<hw>]:FREQUency:MULTIplier:EXTernal:CORRection:FREQUency:POINts?.....	93
[:SOURce<hw>]:FREQUency:MULTIplier:EXTernal:CORRection:MODE.....	93
[:SOURce<hw>]:FREQUency:MULTIplier:EXTernal:CORRection:POWER.....	94
[:SOURce<hw>]:FREQUency:MULTIplier:EXTernal:CORRection:POWER:POINts?.....	95
[:SOURce<hw>]:FREQUency:MULTIplier:EXTernal:CORRection:SELEct.....	96
[:SOURce<hw>]:FREQUency:MULTIplier:EXTernal:CORRection:SENSor<ch>:SONCe.....	96
[:SOURce<hw>]:FREQUency:MULTIplier:EXTernal:FIRMware:CATalog?.....	88
[:SOURce<hw>]:FREQUency:MULTIplier:EXTernal:FIRMware:SELEct.....	88
[:SOURce<hw>]:FREQUency:MULTIplier:EXTernal:FIRMware:UPDate.....	89
[:SOURce<hw>]:FREQUency:MULTIplier:EXTernal:FIRMware:VERSion?.....	86
[:SOURce<hw>]:FREQUency:MULTIplier:EXTernal:FMAXimum?.....	86
[:SOURce<hw>]:FREQUency:MULTIplier:EXTernal:FMINimum?.....	86
[:SOURce<hw>]:FREQUency:MULTIplier:EXTernal:IPMax?.....	86
[:SOURce<hw>]:FREQUency:MULTIplier:EXTernal:IPower?.....	86
[:SOURce<hw>]:FREQUency:MULTIplier:EXTernal:LOADer:VERSion?.....	86
[:SOURce<hw>]:FREQUency:MULTIplier:EXTernal:MULTIplier?.....	87
[:SOURce<hw>]:FREQUency:MULTIplier:EXTernal:PADJust?.....	90
[:SOURce<hw>]:FREQUency:MULTIplier:EXTernal:PMAXimum?.....	87
[:SOURce<hw>]:FREQUency:MULTIplier:EXTernal:PMINimum?.....	87
[:SOURce<hw>]:FREQUency:MULTIplier:EXTernal:PSDMinimum?.....	89
[:SOURce<hw>]:FREQUency:MULTIplier:EXTernal:REVision?.....	86
[:SOURce<hw>]:FREQUency:MULTIplier:EXTernal:SNUMber?.....	86
[:SOURce<hw>]:FREQUency:MULTIplier:EXTernal:STATe?.....	87
[:SOURce<hw>]:FREQUency:MULTIplier:EXTernal:TYPE?.....	86
[SOURce]:FREQUency[:CW FIXed].....	98
[SOURce]:POWER[:LEVel][:IMMediate][:AMPLitude].....	98
*CLS.....	97
*IDN?.....	97
*RST.....	97
TRANS:<command>.....	100

# Index

- A**
- Adjustment screw ..... 14
  - ATT ON OFF switch ..... 20
- B**
- Basic operation ..... 37
- C**
- Cable correction editor
    - SMZ input cable compensation ..... 49
  - Catalog
    - Cable compensation (SMZ) ..... 48
    - Firmware file (SMZ) ..... 45
    - firmware file (SMZ) ..... 88
  - CLS
    - clear status ..... 97
  - Common commands
    - clear status ..... 97
    - identification query ..... 97
    - reset ..... 97
  - Correction
    - Cable compensation (SMZ) ..... 46
    - cable compensation file (SMZ) ..... 96
    - Cable compensation file (SMZ) ..... 48
    - Cable compensation file catalog (SMZ) ..... 48
    - cable compensation file delete (SMZ) 91
    - Cable compensation file delete (SMZ) 48
    - cable compensation fill with sensor (SMZ) ..... 96
    - cable compensation frequency (SMZ) 92
    - Cable compensation frequency (SMZ) ..... 49
    - cable compensation frequency points (SMZ) ..... 93
    - cable compensation loss (SMZ) ..... 91
    - Cable compensation loss (SMZ) ..... 47
    - cable compensation mode (SMZ) ..... 93
    - Cable compensation mode(SMZ) ..... 47
    - cable compensation power (SMZ) ..... 94
    - Cable compensation power (SMZ) ..... 49
    - cable compensation power points (SMZ) ..... 95
    - Cable compensation power points (SMZ) ..... 49
- D**
- DC power ..... 24
  - Delete
    - cable compensation file (SMZ) ..... 91
    - Cable compensation file (SMZ) ..... 48
- F**
- Factor
    - multiplication (SMZ) ..... 87
  - Feet ..... 11
  - File
    - cable compensation (SMZ) ..... 96
    - Cable compensation (SMZ) ..... 48
  - Fill with sensor
    - cable compensation (SMZ) ..... 96
  - Firmware
    - Update (SMZ) ..... 45
  - Frequency
    - cable compensation (SMZ) ..... 92
    - Cable compensation (SMZ) ..... 49
  - Frequency points
    - cable compensation (SMZ) ..... 93
  - Frequency settings ..... 42
    - SMZ control ..... 61
- I**
- IDN
    - identification query ..... 97
  - Input powers ..... 20
  - Instrument setup ..... 11
- L**
- Loss
    - cable compensation (SMZ) ..... 91
    - Cable compensation (SMZ) ..... 47
- M**
- Maintenance ..... 101
  - Maximum
    - input power (SMZ) ..... 86
    - output power (SMZ) ..... 87
  - Measurement principle ..... 37
  - Minimum
    - output power (SMZ) ..... 87



Mode		SMZ Info .....	43
cable compensation (SMZ) .....	93	BL-Version .....	44, 86
Cable compensation (SMZ) .....	47	Cable compensation file catalog .....	48
Multiplier configuration .....	43	cable compensation file delete .....	91
<b>N</b>		Cable compensation file delete .....	48
Nominal		cable compensation file select .....	96
input power (SMZ) .....	86	Cable compensation file select .....	48
<b>O</b>		cable compensation fill with sensor ....	96
On/Off switch .....	16	cable compensation frequency .....	92
Operating principle .....	37	Cable compensation frequency .....	49
<b>P</b>		cable compensation frequency points	93
Power		cable compensation loss (10 GHz) ....	91
cable compensation (SMZ) .....	94	Cable compensation loss (10 GHz) ....	47
Cable compensation (SMZ) .....	49	cable compensation mode .....	93
Power adjustment screw .....	14	Cable compensation mode .....	47
Power LED .....	16	cable compensation power .....	94
Power on .....	24	Cable compensation power .....	49
Power points		cable compensation power points ....	95
cable compensation (SMZ) .....	95	Cable compensation power points ....	49
Cable compensation (SMZ) .....	49	catalog FW files .....	88
Power settings .....	42	Catalog FW files .....	45
SMZ control .....	61	Fill with sensor .....	48
Power supply connector .....	17	Firmware update .....	44, 45
Preparing for Use .....	10	FW-Version .....	44, 86
<b>R</b>		Input cable compensation .....	46
Rear panel .....	15	MAX Freq .....	44, 86
Required Equipment .....	22	maximum input power .....	86
RF connection .....	24	maximum output power .....	87
RF connector input .....	20	Min Freq .....	44, 86
RF IN .....	20	minimum output power .....	87
RST		multiplication factor .....	87
reset .....	97	nominal input power .....	86
<b>S</b>		Revision .....	44, 86
Select		Select file .....	45
Firmware file (SMZ) .....	45	Select instrument .....	45
Select file		Serial number .....	44, 86
cable compensation (SMZ) .....	96	state .....	87
Cable compensation (SMZ) .....	48	Type .....	44, 86
Signal Sources .....	24	SMZ input cable compensation	
SMZ Firmware		Cable correction editor .....	49
catalog FW files .....	88	SMZ Update .....	43
Catalog FW files .....	45	Starting Up .....	24
Select file .....	45	State	
Update .....	45	SMZ connected .....	87
		Storing the frequency multiplier .....	102
		<b>T</b>	
		TCPIP address .....	74
		Test port .....	12
		Test port adapter .....	12

**U**

Unpacking .....	10
Update	
Firmware (SMZ) .....	45
USB cable .....	24
USB interface .....	17
USB remote LED .....	17

**V**

Visa resource string .....	74
----------------------------	----

**W**

Waveguide flange .....	12
------------------------	----