

R&S® SMA100B RF AND MICROWAVE SIGNAL GENERATOR

Performance leadership without compromise



Product Brochure
Version 08.00

ROHDE & SCHWARZ

Make ideas real



CONTENTS

Highlights

At a glance

► page 4

First-class devices thanks to first-class signals

► page 6

Very high output power without compromise

► page 8

User friendly in every detail

► page 10

Versatile features and functions

► page 11



Applications

High-end ADC and DAC component tests

► page 12

Integration into ATE test systems

► page 14

R&S® LegacyPro: refresh your technology

► page 15

Base station receiver tests

► page 16

Radar receiver testing

► page 17

Generating chirped radar signals for advanced radar system testing

► page 18

Simulating scanning radar antennas

► page 19

Uninterrupted level sweep with high dynamic range

► page 20

Local oscillator substitution with lowest SSB phase noise

► page 21

Additional information

Specifications in brief

► page 22

Ordering information

► page 24



AT A GLANCE

The R&S®SMA100B RF and microwave signal generator delivers maximum performance without compromise. It provides purest output signals while maintaining the highest output power level, far outpacing the competition. As the world's leading signal generator, it can handle the most demanding component, module and system T&M tasks in the RF semiconductor, wireless communications and aerospace and defense industries.

The R&S®SMA100B is the first choice for all applications requiring extremely clean analog signals. For LO substitution in radar applications, the R&S®SMA100B can generate microwave signals with extremely low close-in SSB phase noise, enabling radar systems to detect even very slow objects. For testing analog-to-digital converters (ADC), the R&S®SMA100B produces signals with extremely low jitter and highest spurious-free dynamic range (SFDR).

Via a second, independent output, the R&S®SMA100B can at the same time provide extremely pure clock signals for ADC testing with lowest wideband phase noise.

In automated production environments, the R&S®SMA100B generator's ultra high output power eliminates the need for additional amplifiers while keeping harmonics extremely low.

With the R&S®SMA100B, it is no longer necessary to choose between signal purity and high output power. It is the only signal generator that can supply signals with ultra high output power in combination with extremely low harmonic signal components, setting new standards for high-end analog signal generators.

The R&S®SMA100B covers all fields of application, from research and development to production, service and maintenance.

To meet the specific needs of any given application, the base unit's already excellent performance can be improved with options. Different levels to improve the SSB phase noise and diverse stages to maximize the output power can be selected.



R&S®SMA100B, 3 HU model with 7" touch display

BENEFITS

- ▶ First-class devices thanks to first-class signals
 - Purest signals
 - Lowest harmonic and nonharmonic signal components
- ▶ Very high output power without compromise
 - Exceptionally high output power levels (measured values)
 - Excellent level accuracy and repeatability for CW signals, narrow pulses and modulated signals
- ▶ User friendly in every detail
 - Flexible size: 2 HU or 3 HU housing
 - 3 HU with larger 7" display and multiple front panel connectors
 - Ergonomic operation thanks to state-of-the-art GUI with touch display
- ▶ Versatile features and functions

KEY FACTS

- ▶ Frequency range from 8 kHz to 3 GHz, 6 GHz, 12.75 GHz, 20 GHz, 31.8 GHz, 40 GHz, 50 GHz and 67 GHz (overrange up to 72 GHz)
- ▶ Excellent SSB phase noise of
 - 152 dBc (typ.) at 1 GHz and
 - 132 dBc (typ.) at 10 GHz, each at 10 kHz offset
- ▶ Virtually no wideband noise (–162 dBc (meas.) at 10 GHz and 30 MHz offset)
- ▶ Maximum output power exceeds 30 dBm across wide frequency ranges
- ▶ Exceptionally low harmonics
- ▶ State-of-the-art GUI with touch display



R&S®SMA100B, 2 HU model with 5" touch display

FIRST-CLASS DEVICES THANKS TO FIRST-CLASS SIGNALS

The signal quality of a signal generator deserves special attention. In order to quantitatively measure a DUT, the signal quality of the signal generator must be significantly better than the DUT's performance. Only then can it be ensured that just the DUT is measured. The R&S®SMA100B sets new standards in excellent signal quality.

Key facts

- ▶ Purest signals
 - Outstanding SSB phase noise (with option):
–132 dBc (typ.) at 10 GHz and 10 kHz offset
 - Lowest close-in SSB phase noise (with option):
–83 dBc (typ.) at 10 GHz and 10 Hz offset
 - Virtually no wideband noise (with option):
–162 dBc (meas.) at 10 GHz and 30 MHz offset
- ▶ Lowest harmonic and nonharmonic signal components
 - Very low harmonic signal components across the entire frequency range even at very high output powers
 - Very low nonharmonic signal components (with option): < -90 dBc (meas.) at 10 GHz

Extremely low SSB phase noise

Phase noise is a key aspect of signal quality. A distinction is made between close-in phase noise, phase noise with the typical carrier offset of 10 kHz or 20 kHz, and the behavior far from the carrier, i.e. wideband phase noise with a carrier offset of typically > 10 MHz. To achieve top values, each of these areas was carefully considered when developing the R&S®SMA100B. Low phase noise options can be added to the R&S®SMA100B to meet all requirements.

The R&S®SMAB-B1H high performance OCXO option achieves lower close-in phase noise than the base unit alone and offers higher stability versus temperature and time (aging). The phase noise close to the carrier can be further reduced with the R&S®SMAB-B710(N) option (improved close-in phase noise performance). This is necessary for example when a radar needs to detect slow-moving objects (small Doppler shift of the reflected receive signal).

The ultimate solution is the R&S®SMAB-B711(N) ultra low phase noise option, which sets new standards with its exceptionally low phase and wideband noise across the entire offset range.

Measured SSB phase noise performance

R&S®SMA100B with R&S®SMAB-B711(N) option

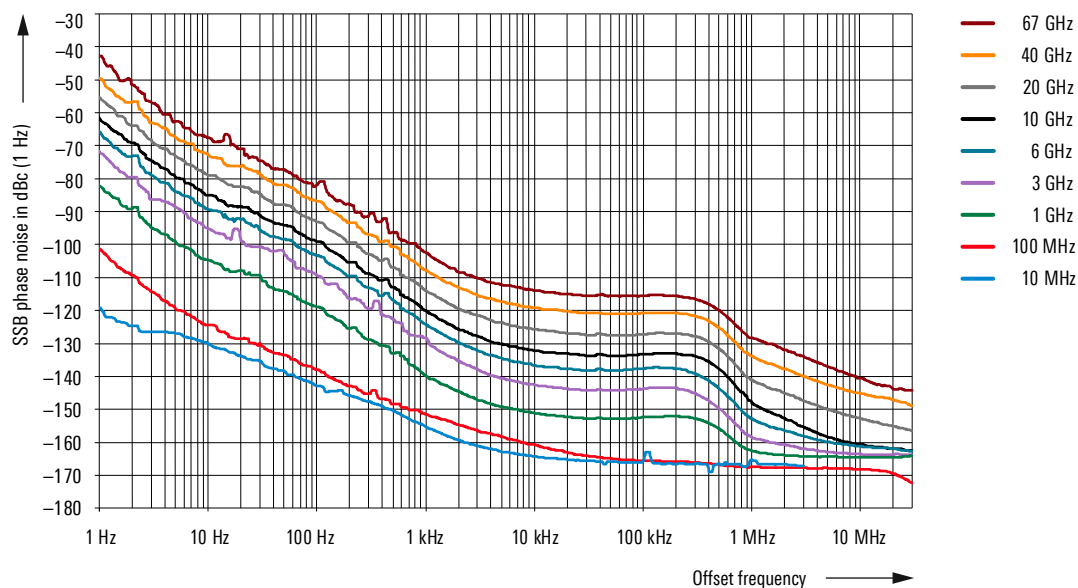

Very low harmonic and nonharmonic signal components

Very low harmonic signal components are another important performance feature of a signal generator. Often, high output power is required at the same time. The R&S®SMA100B perfectly fulfills both requirements. Even at very high output powers, harmonics are suppressed by more than 70 dBc over a wide frequency range, a major benefit when measuring an amplifier's harmonic signal components.

Nonharmonic signal components play an equally important role, e.g. when testing ADCs. When equipped with the R&S®SMAB-B711(N) option, the R&S®SMA100B features exceptionally good nonharmonic performance of < -110 dBc (meas.) at 1 GHz and < -90 dBc (meas.) at 10 GHz.

Purest 1 GHz reference output

The R&S®SMA100B also has a special 1 GHz reference output. The 1 GHz reference provides better phase-locked coupling of multiple R&S®SMA100B than the 10 MHz reference. The 1 GHz output also features phenomenal signal purity, as illustrated in the figure below.

Measured harmonic performance of 20 GHz instrument

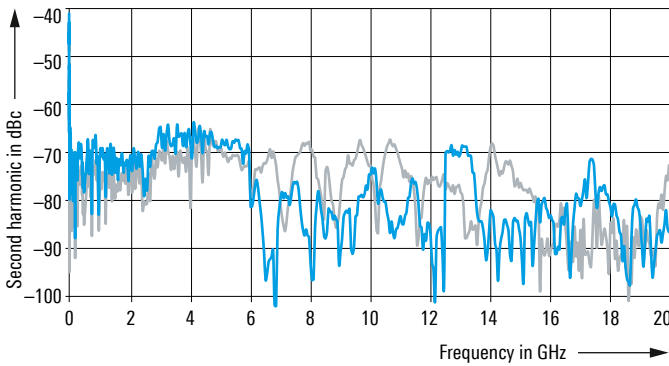

- Measured at 18 dBm, with the ultra high output power option installed (R&S®SMAB-K33 + R&S®SMAB-B34)
- Measured at 13 dBm, with the high output power option installed (R&S®SMAB-K33)

Measured harmonic performance of 67 GHz instrument

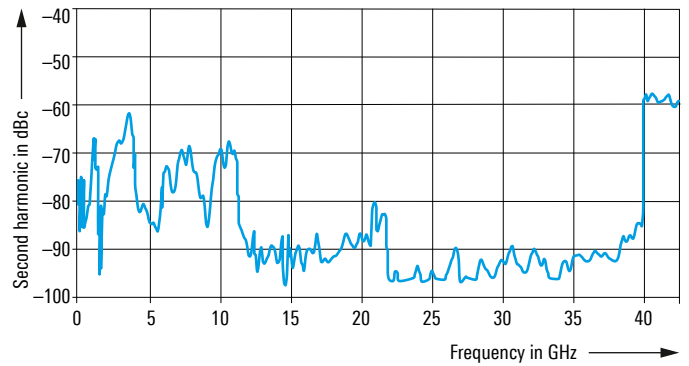

- Measured at 10 dBm with the high output power option installed (R&S®SMAB-B39)

Measured nonharmonics values

$f_{\text{offset}} \geq 10$ kHz, with R&S®SMAB-B711(N) option

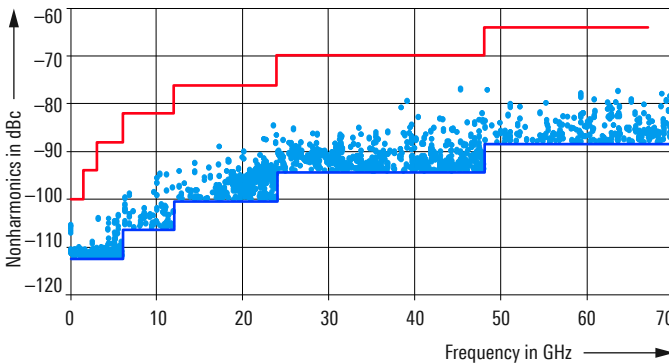

- Measured nonharmonic suppression
- Specified nonharmonic suppression
- Lower test limit

Measured SSB phase noise of reference outputs

100 MHz and 1 GHz reference outputs (R&S®SMAB-K703 option) with the R&S®SMAB-B710(N) and the R&S®SMAB-B711(N) options

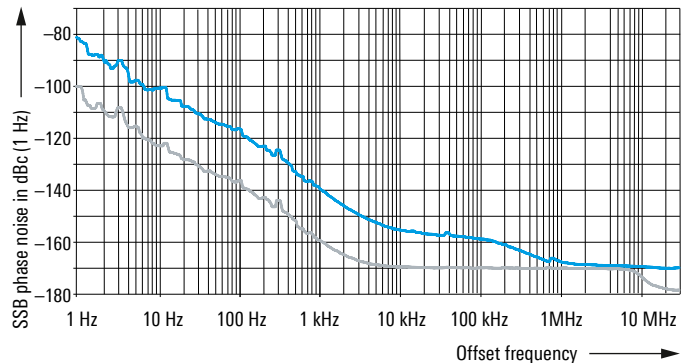

- 1 GHz, with R&S®SMAB-B710(N)/-B711(N) option
- 100 MHz, with R&S®SMAB-B710(N)/-B711(N) option

VERY HIGH OUTPUT POWER WITHOUT COMPROMISE

Very high output power without compromise is desirable but also a challenge. It requires a very large dynamic range, high absolute level accuracy, excellent level repeatability and very short level settling times. It also requires outstanding signal purity, for example very low harmonics. The R&S®SMA100B meets all of these requirements.

Key facts

- ▶ Exceptionally high output power levels (measured values)
 - Ultra high output power up to 38 dBm with the 6 GHz instrument
 - Over 30 dBm at 18 GHz and 28 dBm at 20 GHz with the 20 GHz instrument
 - Over 30 dBm between 20 GHz and 36 GHz with the 40 GHz instrument
 - Over 22 dBm between 40 GHz and 65 GHz with the 67 GHz instrument
- ▶ Excellent level accuracy and repeatability for CW signals, narrow pulses and modulated signals

Highest output power

Very high output powers are often required, particularly in the microwave frequency range. This is because the higher the frequencies, the greater the attenuation. The R&S®SMA100B offers different output power stages to compensate for these losses. As a result, no external amplifier is required downstream.

Equipped with the appropriate options, a 6 GHz instrument generates up to 38 dBm RF output power, and a 20 GHz instrument generates up to 32 dBm in the microwave frequency range. The 40 GHz instrument can deliver 29 dBm at 40 GHz and the 67 GHz instrument can provide 23 dBm at 60 GHz at the RF output. Even with high output powers, harmonics are extremely low across the entire frequency range.

High absolute level accuracy

A signal generator's absolute level accuracy is just as important as its output power. A signal source must have very good absolute level accuracy in order to quantitatively characterize the nonlinear performance of an amplifier (1 dB compression point). The R&S®SMA100B excels with outstanding absolute level accuracy for exactly these applications.

Rarely is a DUT connected directly to the signal generator. There are often cables and other components between

the generator and the DUT. This shifts the reference plane from the generator's RF output to the DUT. A Rohde&Schwarz power sensor can be connected to the signal generator via USB to enable extremely precise calibration (tenth of a dB range) at the new reference plane.

Unmatched level repeatability

Level repeatability also plays an important role. For frequently repeated test sequences with varying levels, it is essential to be able to reproduce each individual level value for each test sequence. Here again the R&S®SMA100B is best in class.

Level-controlled narrow pulses

High absolute level accuracy is required not only for CW signals, but also for modulated signals, and most particularly for pulsed signals. The challenge is to absolutely and reproducibly control even very narrow pulses with a small duty cycle. The R&S®SMA100B provides level-controlled narrow pulses from 100 ns onwards and low duty cycles with exceptional level accuracy and level repeatability.

Fast settling times

Another important characteristic to be considered for the above-mentioned test sequences is that test sequences should be quickly executed (e.g. in automated test equipment (ATE) systems). This requires short level settling times. If the level values are transmitted individually via GPIB, it typically takes 1 ms to set the new level (when the electronic step attenuator is used).

Step attenuator

The electronic step attenuator makes it possible to switch levels quickly. Up to 20 GHz, the R&S®SMA100B offers electronic attenuation as standard. As the contribution of the electronic step attenuator to the total settling time is in the range of microseconds, the R&S®SMA100B can achieve a 1 ms level settling time across the entire frequency range up to 20 GHz. For the R&S®SMA100B equipped with the 31.8 GHz, 40 GHz, 50 GHz or 67 GHz frequency option, a mechanical step attenuator is used as standard. When one of the high output power options is installed, the electronic step attenuator is also available up to 20 GHz.

Measured maximum available output power

Note: The high output power option is a prerequisite for the ultra high output power option and the ultra high output power option is a prerequisite for the super ultra high output power option.

6 GHz instrument and 20 GHz instrument

Base unit (standard output power) with the high output power option and with the ultra high output power option

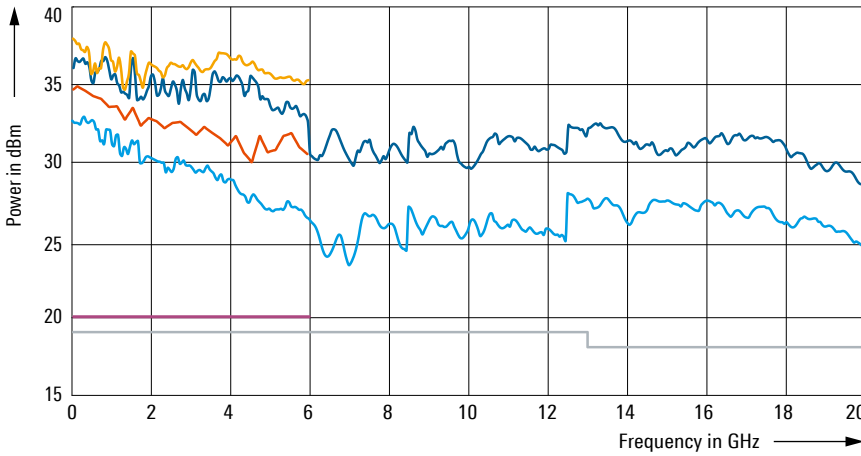

6 GHz instrument

- Ultra high output power option (R&S®SMAB-B32)
- High output power option (R&S®SMAB-K31)
- Standard output power up to 6 GHz (base unit)

20 GHz instrument

- Ultra high output power option (R&S®SMAB-B34)
- High output power option (R&S®SMAB-K33)
- Standard output power up to 20 GHz (base unit)

40 GHz instrument

Base unit (standard output power) with the high output power option, with the ultra high output power option and with the super ultra high output power option

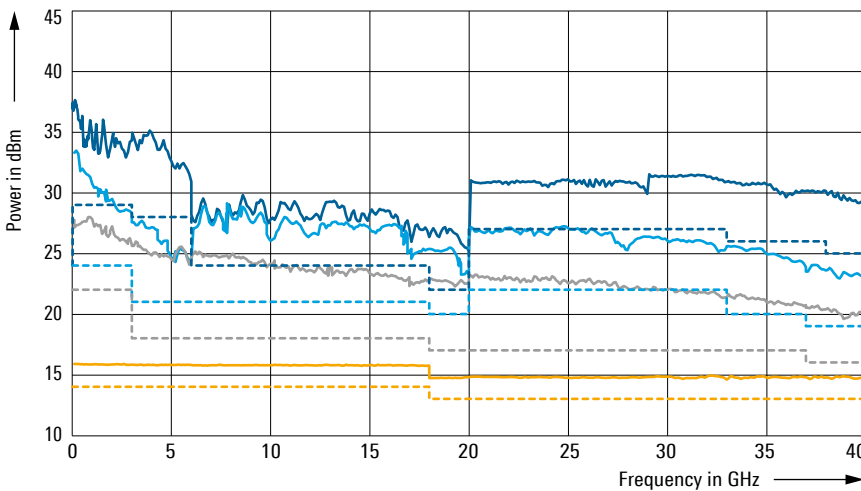

- R&S®SMAB-B140(N) + R&S®SMAB-B35 + R&S®SMAB-K36 + R&S®SMAB-B36S
- R&S®SMAB-B140(N) + R&S®SMAB-B35 + R&S®SMAB-K36
- R&S®SMAB-B140(N) + R&S®SMAB-B35
- R&S®SMAB-B140(N)
- - - R&S®SMAB-B140(N) + R&S®SMAB-B35 + R&S®SMAB-K36 + R&S®SMAB-B36S (specification)
- - - R&S®SMAB-B140(N) + R&S®SMAB-B35 + R&S®SMAB-K36 (specification)
- - - R&S®SMAB-B140(N) + R&S®SMAB-B35 (specification)
- - - R&S®SMAB-B140(N) (specification)

67 GHz instrument

Base unit (standard output power) with the high output power option and with the ultra high output power option

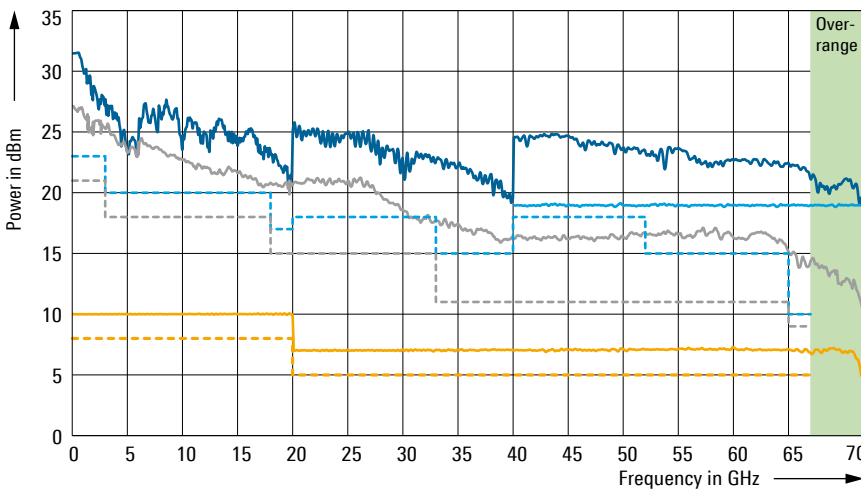

- R&S®SMAB-B167 + R&S®SMAB-B39 + R&S®SMAB-K40
- R&S®SMAB-B167N + R&S®SMAB-B39 + R&S®SMAB-K40
- R&S®SMAB-B167(N) + R&S®SMAB-B39
- R&S®SMAB-B167(N)
- - - R&S®SMAB-B167(N) + R&S®SMAB-B39 + R&S®SMAB-K40 (specification)
- - - R&S®SMAB-B167(N) + R&S®SMAB-B39 (specification)
- - - R&S®SMAB-B167(N) (specification)

USER FRIENDLY IN EVERY DETAIL

How user friendly a signal generator is can be seen in how easily it can be integrated into existing test systems or in its innovative operating features that save the user development time.

Key facts

- ▶ Flexible size: 2 HU or 3 HU housing
- ▶ 3 HU with larger 7" display and multiple front panel connectors
- ▶ Ergonomic operation thanks to state-of-the-art GUI with touch display

Ergonomic operation thanks to state-of-the-art GUI with touch display

The graphical user interface with a high-resolution touch display makes the R&S®SMA100B very ergonomic and practical to use. The main screen clearly displays all important parameters and information. There is no need to spend valuable time searching for frequently used setting parameters.

The ability to save a user menu on the R&S®SMA100B also saves time. Frequently used menu items can be added to the user menu so that users can quickly and directly access all needed settings from a single menu.

Context-sensitive online help provides comprehensive information. It describes parameters and setting menus in detail, gives the associated setting ranges and shows the relevant remote control commands. Users can also search for specific parameters in the user manual installed on the instrument.

In addition to providing the SCPI commands themselves, the R&S®SMA100B also offers an SCPI macro recorder with a code generator that is used to automatically record manual settings and create an executable MATLAB® script.

Main screen with all key parameters and relevant information

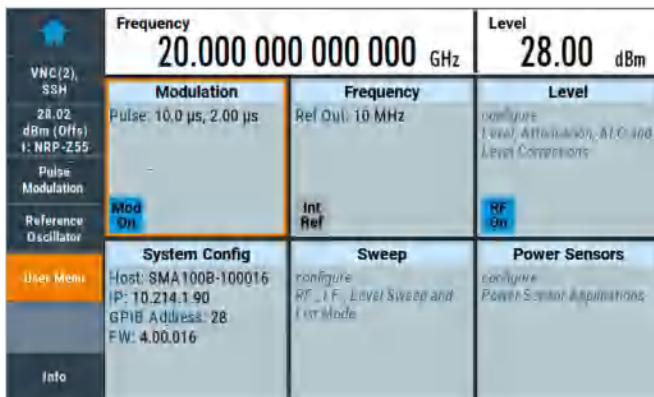

The built-in SCPI macro recorder and code generator supports fast, easy generation of SCPI program sequences

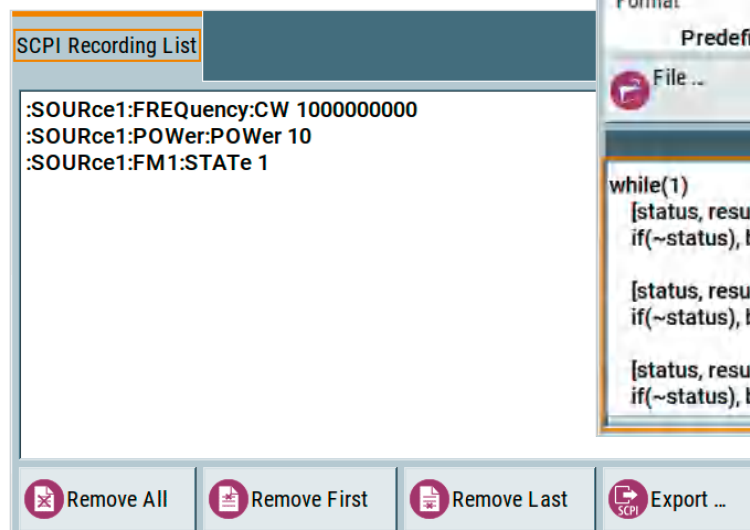

VERSATILE FEATURES AND FUNCTIONS

VOR/ILS signal generation

VHF omnidirectional radio range (VOR) navigation systems, i.e. conventional VOR (CVOR) and Doppler VOR (DVOR) systems, operate at VHF frequencies from 108 MHz to 118 MHz to provide aircraft with bearings of the ground station.

The instrument landing system (ILS) helps aircraft pilots approach the runway during landing by delivering data relative to the ideal landing course. Marker beacon (MB) receivers decode audio data and provide signaling to indicate the aircraft's distance from the end of the runway on approach using three (outer, middle and inner) marker beacons.

When equipped with the R&S®SMAB-K25 option, the R&S®SMA100B can generate avionics signals (VOR/ILS) in accordance with ICAO standards. Due to its low modulation error and very high level accuracy, the R&S®SMA100B with the R&S®SMAB-K25 is the optimal high-precision VOR/ILS signal source for testing avionics receivers.

Ramp sweep function

The analog ramp sweep mode corresponds to the analog sweep of classic sweep generators except that the sweep is fully synchronized across the entire range. With this function, the R&S®SMA100B achieves the excellent frequency accuracy of digital step sweeps throughout the sweep range, delivering sweep rates of e.g. 1000 MHz/ms at 20 GHz, which are clearly superior to those of classic instruments.

In conjunction with a scalar network analyzer or suitable spectrum analyzer, realtime tuning of microwave filters can be performed, for example.

To mark important frequency ranges such as filter bandwidths or the positions of filter poles, the R&S®SMA100B has 10 user-selectable frequency markers which can be output at a dedicated connector.

Power analysis tool

If no spectrum or network analyzer is available, scalar network analysis can be performed using the R&S®SMA100B analog signal generator with the R&S®SMAB-K28 power analysis option and with an R&S®NRP-Z8x power sensor. In this configuration, "power versus frequency", "power versus time" and "power versus power" can be measured.

A typical application is to measure the passband characteristic of a bandpass filter. The above configuration can be used to determine whether the filter has passed the test after filter tuning.

Another application is to measure the compression point of an external amplifier. By measuring power versus power, the amplifier's performance for a specific application can be determined quickly and with high accuracy.

Measurement modes with R&S®SMAB-K28 power analysis option and external R&S®NRP-Z8x power sensor

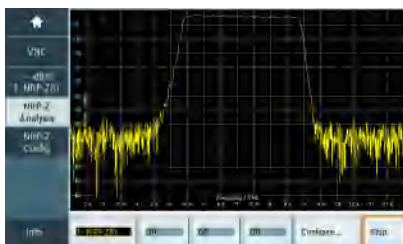

Power versus frequency

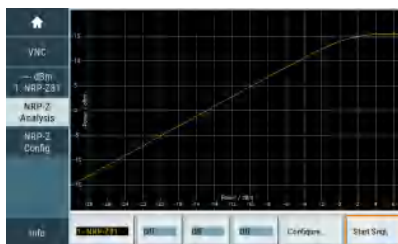

Power versus power



Power versus time

HIGH-END ADC AND DAC COMPONENT TESTS

Measure the true performance of your device

With each new ADC generation, the analog input bandwidth increases, and with it the required clock frequency. In addition, the larger effective number of bits results in a larger signal-to-noise ratio. The most advanced DACs allow the reconstruction of wideband digitized signals up into the microwave range.

This means that extremely clean, high-frequency signals that exceed the DUT performance are required to test ADCs and DACs. Its outstanding performance makes the R&S®SMA100B the benchmark solution, giving users a tool that is perfect not only for optimizing DUTs, but also for bringing them to the very edge of the technically feasible.

Typical ADC test setup

With two R&S®SMA100B as signal sources for the analog input and the clock input

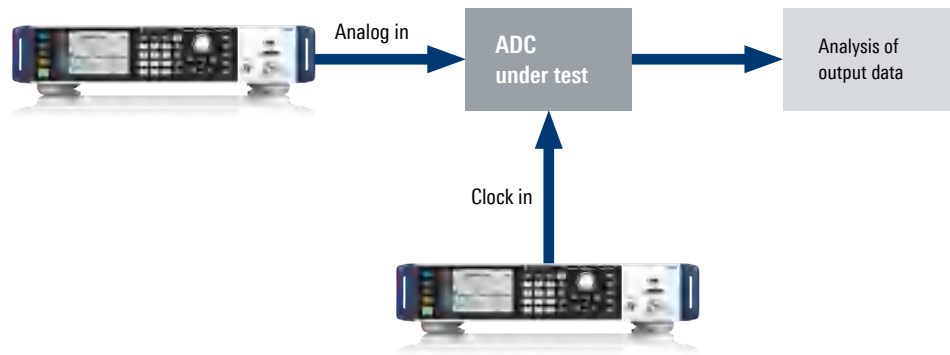

Compact ADC test setup

For clock signals up to 6 GHz with a single R&S®SMA100B with an integrated second source

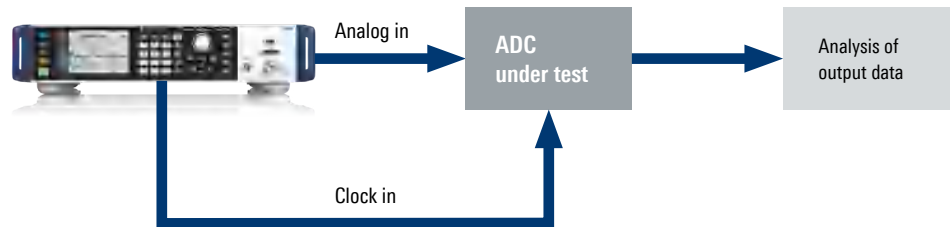

Typical DAC test setup

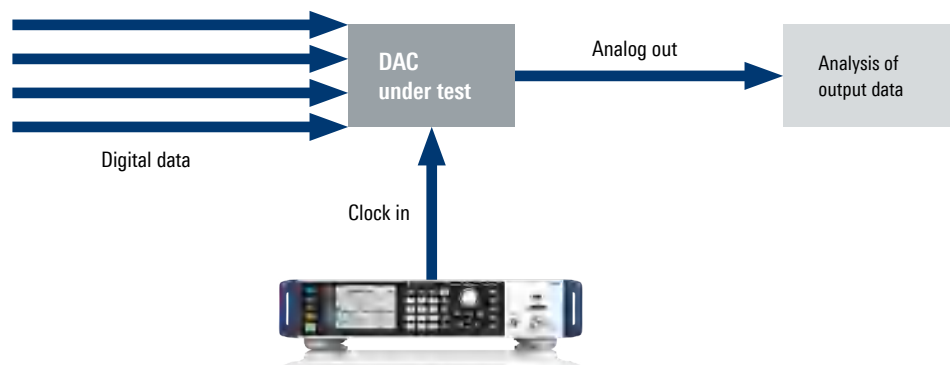

Typical ADC test setup

When testing ADCs, an analog input signal and an external clock signal are needed. At the analog input, the R&S®SMA100B supplies the ADC with extremely pure RF signals with exceptionally low SSB phase noise, the lowest harmonics and nonharmonics, and the lowest wideband noise. Since the signal source does not distort the measurement results, users can validate the spurious-free dynamic range and the signal-to-noise ratio of the most advanced ADCs.

ADCs are sampling systems, and the wideband phase noise of the clock signal reduces the signal-to-noise ratio of the ADC. The R&S®SMA100B was optimized to provide clock signals with extremely low wideband phase noise for ADC tests. This is particularly important in the case of undersampling, i.e. if the clock rate of the ADC is lower than twice the maximum RF input frequency.

Compact ADC test setup for clock signals up to 6 GHz

Specifically for this application, the R&S®SMA100B offers, in addition to the RF output, an optional clock output up to 6 GHz with exceptionally low wideband noise for extremely clean clock signals. The frequency of the clock output can be selected independently of the RF output. The signal type (square wave or sine wave), the amplitude and a DC offset can be set for this output independently of the RF output in order to provide single-ended or differential signals for the clock input at the ADC.

Typical DAC test setup

An extremely clean clock signal is also required to reconstruct the analog output signal when testing DACs. Thanks to its excellent characteristics, which include exceptionally low SSB phase noise and a large spurious-free dynamic range, the R&S®SMA100B can provide this signal so that the measurement results for these tests are not influenced by the signal source and the user can measure the DUT's true performance.

Measured SSB phase noise performance of clock synthesizer output signal

With the R&S®SMAB-B29, R&S®SMAB-B711(N) and R&S®SMAB-K722 options

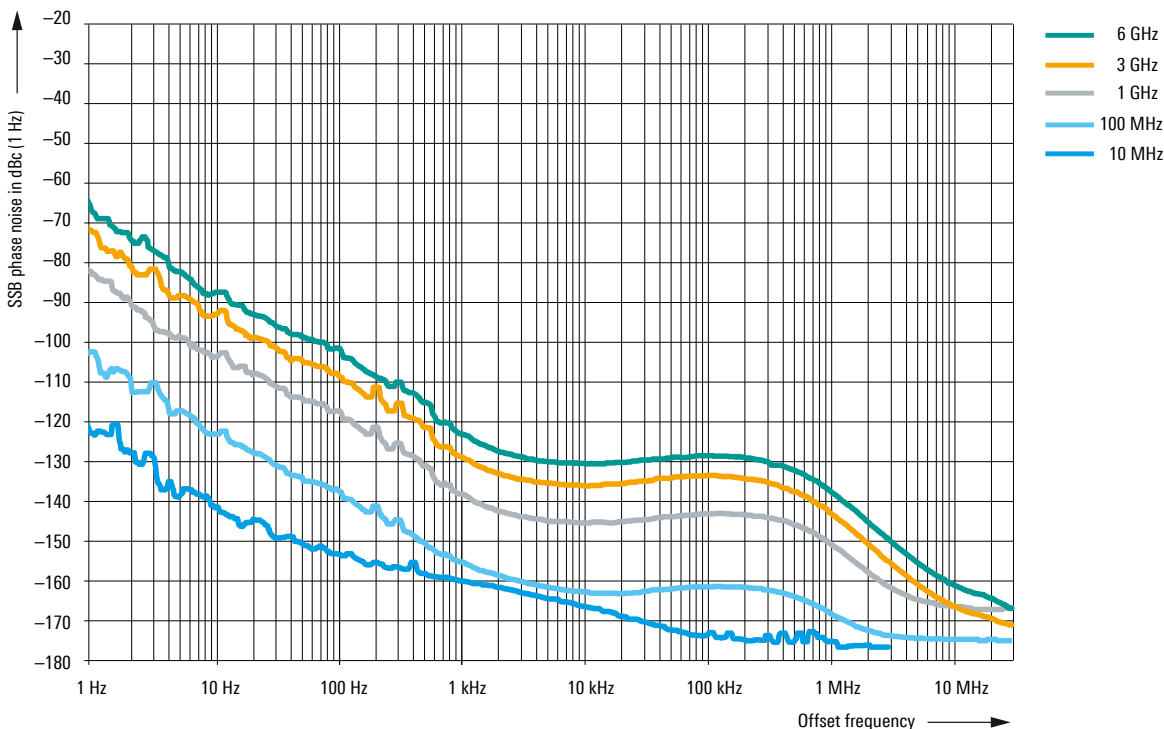

INTEGRATION INTO ATE TEST SYSTEMS

Simplify the ATE setup and improve reliability

When developing or maintaining an ATE test system, there are four competing challenges that must be juggled. Does the test equipment have enough RF performance to meet the test specifications? Is the overall test time quick enough to meet the throughput requirements? Can the overall setup be simplified to reduce size and complexity? How can the system be designed to maximize uptime?

With its leading performance, the R&S®SMA100B can produce high-quality, accurate test signals that meet the toughest test requirements. With its ability to quickly switch frequency and amplitude, the R&S®SMA100B will ensure that these high-quality signals are quickly delivered to the DUT, minimizing test time.

In the ATE world, outstanding performance helps reduce the complexity of a system. One of the major factors that contributes to the complexity of a setup as well as to costs and long-term reliability are external components such as amplifiers. To achieve the correct power level at the DUT, amplifiers are used to overcome attenuation in components such as cables and splitters, which is especially problematic in the microwave range.

With its ultra high output power option, the R&S®SMA100B has enough output power to overcome these losses, ensuring that the signal at the DUT is at the right power level. This allows external amplifiers to be eliminated from the setup. Eliminating these expensive, uncalibrated components saves money, simplifies the test station and reduces the overall measurement uncertainty.

An ATE system can be in operation 24/7, going through many different testing cycles at a number of different power levels. If the generator being used has a mechanical attenuator, each change in power level can require the relays in the attenuator to switch, a relatively time-consuming procedure. The R&S®SMA100B is the first signal generator to offer a fully electronic attenuator up to 20 GHz. This sophisticated attenuator technology ensures wear and tear free switching and very fast level settling times.

The R&S®SMA100B also offers a 3-year calibration interval, rear connectors, a choice of form factors and R&S®LegacyPro (see next page) – making it a complete solution for signal generation in an ATE environment.

Emulation of instruments with the R&S®SMA100B

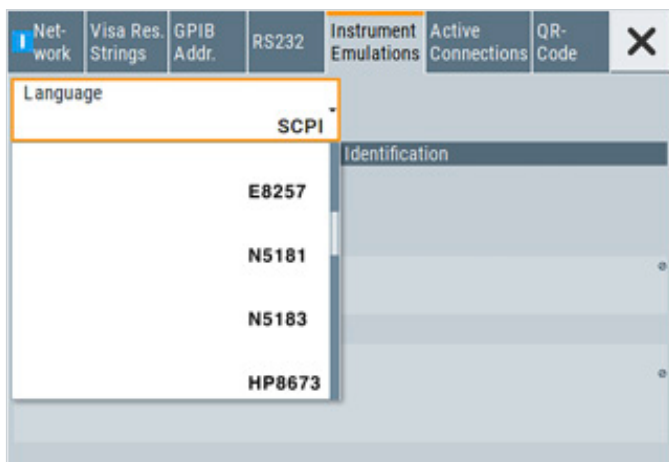

R&S® LegacyPro: REFRESH YOUR TECHNOLOGY

Trade in your legacy signal generators

For older test systems, the challenge of maintaining old test equipment is commonplace. When individual pieces of equipment become obsolete before the entire ATE system does, regular calibration and repair of the obsolete equipment becomes expensive and very time consuming. Replacing the obsolete test equipment with equivalent state-of-the-art instruments should be straightforward and require minimal hardware and software changes. In reality, it can be a challenging task. The R&S®SMA100B with R&S®LegacyPro code emulation makes this a straightforward task, reducing the workload and eliminating risks. R&S®LegacyPro enables the R&S®SMA100B to reliably emulate a wide range of legacy generators from vendors such as Keysight, Agilent, HP, Anritsu and Rohde&Schwarz. As a result, the R&S®SMA100B can be deployed in legacy systems without major software changes, effectively increasing uptime, lowering the cost of ownership and lengthening the test system's useful life.

Enjoy plug and play replacement of your legacy signal generators with R&S®LegacyPro and the R&S®SMA100B

Flexible housing size

If the signal generator to be replaced is installed in an ATE rack, it must be ensured that there is enough room to accommodate the height of the new generator. The R&S®SMA100B offers a unique solution. The R&S®SMA100B (up to 20 GHz) can be purchased with either 2 or 3 height units (HU), even when fully configured. This also applies to instruments equipped with a frequency option higher than 20 GHz, with the exception that for devices equipped with one of the high output power options, 3 height units are needed. To replace an R&S®SMF100A (3 HU) or R&S®SMA100A (2 HU), the user only needs to choose the correct number of HUs. This also holds true when replacing products from other manufacturers. An R&S®SMA100B can easily replace an MXG or PSG from Keysight. The MXG can be replaced with an instrument with exactly the same number of HUs. A PSG can be replaced with up to two R&S®SMA100B generators, doubling the number of RF outputs while maintaining the same number of HUs.

The display area of a 3 HU instrument is twice as large as the display area of a 2 HU instrument, which makes manual operation in the lab much more convenient.



Size of 2 HU instrument versus 3 HU instrument with additional front panel connectors



BASE STATION RECEIVER TESTS

Purest signal source for blocking tests

Blocking tests are used to measure a receiver's selectivity, i.e. how well a receiver can suppress interferers outside the wanted channel. For example, cellular standards define different blocking scenarios that must be applied to test a base station receiver. Both out-of-band blocking tests and in-band blocking tests are usually performed.

Interfering signals are usually stronger than the wanted signal. Signal generators that deliver the blocking (interfering) signals must therefore offer very good spectral purity. Otherwise the phase noise or wideband noise from the interferer would cover the wanted signal in the receive channel.

The R&S®SMA100B meets even the highest standards because it not only exhibits extremely low wideband noise but also provides excellent phase noise performance at all carrier offsets. The phase noise performance can be further optimized to match application-specific requirements. This can be achieved by switching the PLL bandwidth from normal to narrow or vice versa as required for a specific carrier offset range.

Measured SSB phase noise at 10 GHz

With the main PLL bandwidth set to "normal" and "narrow", and with the ultra low phase noise option (R&S®SMAB-B711(N)) installed

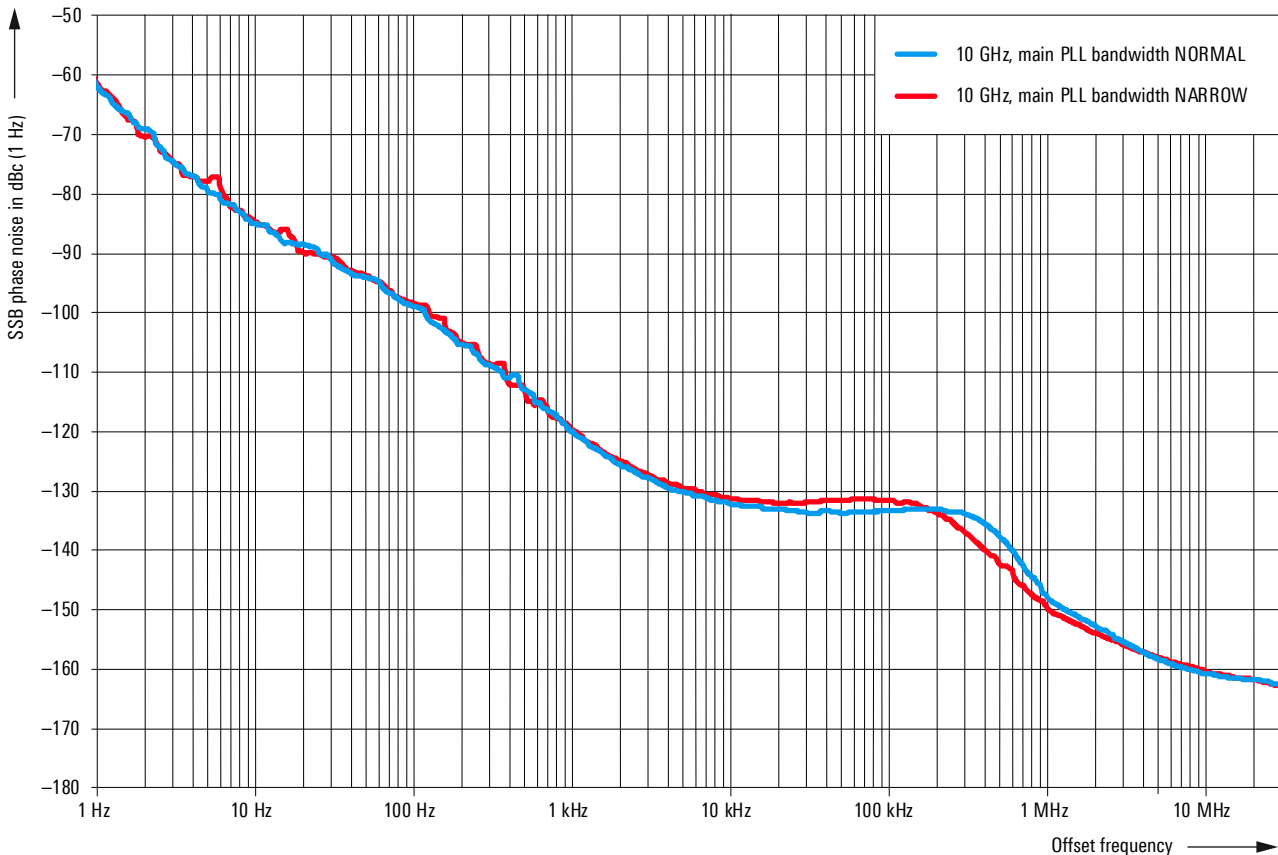

RADAR RECEIVER TESTING

Overcome the challenge of level-controlled narrow pulses

When testing the functionality and sensitivity of radar and EW receivers, the challenge is always the same. Accurate, repeatable test signals are needed to measure the true performance of a receiver, because these devices are designed to work at the limits of what is technically feasible. For radar testing, the quality of the pulsed CW signals is the key to verifying and optimizing performance. The signal generator has to produce unmodulated pulsed CW signals that are accurate in terms of both frequency and power. They must be repeatable over a large number of pulses, and the pulse width has to be small enough to meet the requirements of the specific receiver.

The R&S®SMA100B signal generator is ideal for this application since it can repeatably produce accurate narrow pulses, enabling engineers to reliably test the sensitivity and functionality of today's leading-edge receivers.

High-performance automatic level control

With its high-quality pulse modulator and digital automatic level control (ALC), the R&S®SMA100B can generate pulsed CW signals with exceptional accuracy, even when the pulse width is in the nanosecond range. This cutting-edge ALC design ensures that the pulse flatness and power level are consistent from pulse to pulse. In combination with the R&S®SMA100B microwave frequency options, engineers have a signal generator they can rely on to produce accurate, repeatable pulses with widths ranging from less than 100 ns to 100 s in the typical radar frequency bands.

Instantaneous pulse generation

External pulse generators are typically used when the signal generator is integrated into a larger test system. In that case, the key consideration for the signal generator is how quickly it can synchronize and modulate the incoming pulses. Conventional generators with analog ALCs can take some time to react to the incoming pulses. This means that there will be no RF output for the first tens of pulses.

Due to the modern, digital ALC implemented in the R&S®SMA100B, level-controlled pulse generation starts instantaneously, irrespective of whether the internal or an external pulse generator is used. When you expect a CW pulse out of the generator immediately, that's what you will get with the R&S®SMA100B.

Pulse trains for complex test cases

When used as a standalone instrument, the R&S®SMA100B offers not only an internal pulse generator with selectable pulse width, but also a pulse train option for more complex test cases. The graphical user interface makes it easy to combine a series of pulses with different widths and pulse repetition intervals (PRI). Multiple test cases can be created, stored and recalled.

Thanks to its exceptional RF performance, narrow pulse modulation and advanced pulse generation, the R&S®SMA100B not only produces high-quality narrow pulses to test sensitivity, it also delivers more advanced test cases for testing the receiver functionality. The complex pulse trains make it possible to test receiver capabilities such as the unambiguous range, coherent processing interval (CPI) and range resolution. All in all, the R&S®SMA100B is a complete solution for testing radar and EW receivers.

Pulse modulation performance	
Minimum pulse width	< 20 ns
Rise/fall time	5 ns (typ.)
On/off ratio	> 80 dB
Minimum pulse width of closed-loop level-controlled pulses with table&on mode	100 ns

Pulse train

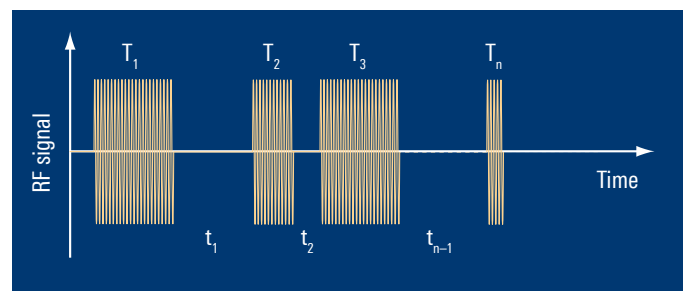

GENERATING CHIRPED RADAR SIGNALS FOR ADVANCED RADAR SYSTEM TESTING

A wide variety of radar systems, e.g. weather radars and long-range surveillance radars, benefit from pulse compression techniques. Therefore, they use modulation on pulse such as linear frequency modulation (chirps). Radars profit from using chirped pulses, since range resolution then only depends on the signal bandwidth. Also, processing gain is high while lower transmit power levels can be used. Consequently, the probability of intercept of the radar's transmit signal is considerably lower.

To properly test radar receivers that use pulse compression techniques, the signal generator needs to produce chirps that are accurate in terms of chirp rate, pulse length and power level. The R&S®SMA100B can generate chirped

pulses very easily by combining a pulse-modulated signal with a linear FM-modulated signal from the multifunction generator (R&S®SMAB-K24 option). Thanks to the huge variety of setting options, the chirp is always perfectly tailored to the individual requirements. Large bandwidths and high chirp rates are no problem for the R&S®SMA100B. Impairments such as noise, amplitude fluctuations or Doppler drifts can be conveniently added. They are generated using amplitude and frequency modulation on one or more of the additional sources provided by the multifunction generator. This is an effective approach to model effects coming from real radar hardware.

Chirped signal with a duration of 10 μ s and a bandwidth of 30 MHz generated with the multifunction generator (R&S®SMAB-K24 option) in the R&S®SMA100B

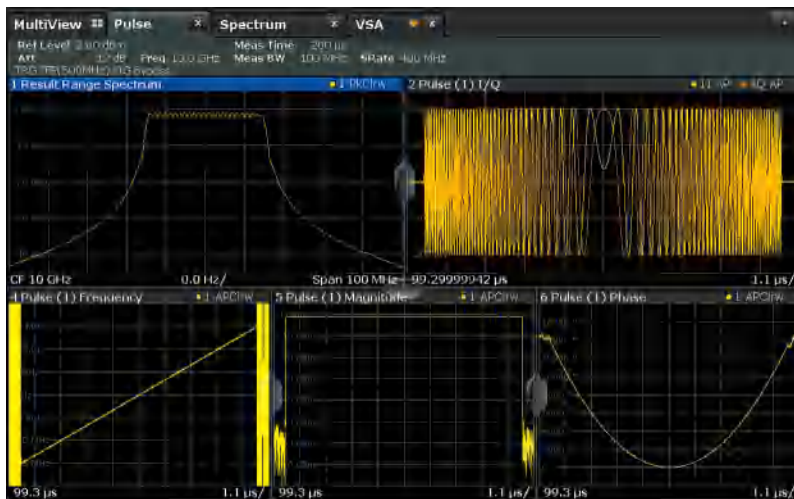

Up to five modulation sources (AM1/AM2, FM1/FM2, pulse modulation) and two LF function generators are available with the multifunction generator (R&S®SMAB-K24 option) in the R&S®SMA100B

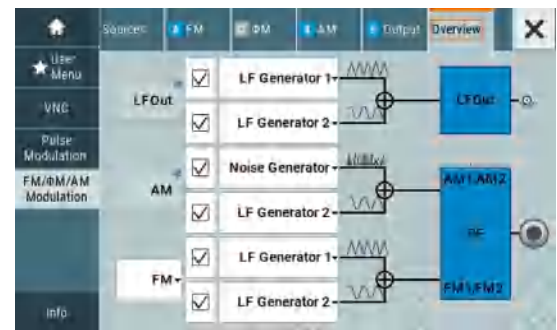

Impaired chirped pulse with added AM noise, AM drift and Doppler drift impairments (green) generated with the multifunction generator (R&S®SMAB-K24 option) in the R&S®SMA100B (left: Doppler drift; middle: AM drift/AM noise; right: Doppler drift)

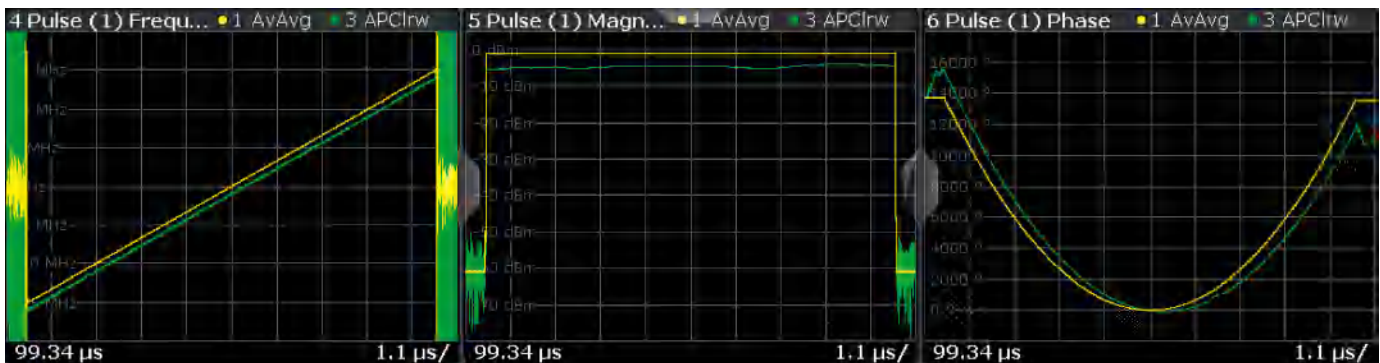

SIMULATING SCANNING RADAR ANTENNAS

Signals received by radar and EW receivers often carry simultaneous pulse and amplitude modulation. Whereas pulse modulation is performed in the transmitter, the amplitude modulation results from the antenna scan and the antenna radiation pattern.

Generation of realistic test signals is challenging, since the radiation pattern of highly directive antennas often shows a narrow main beam, significant sidelobe power and even nulls in some directions. A large dynamic range of the signal generator is therefore required to provide accurately level-controlled signals for meaningful receiver tests.

The R&S®SMA100B together with the R&S®SMAB-K721 scan AM option is the perfect choice for this application. Thanks to its highly sophisticated RF output unit, it produces amplitude-modulated signals with a modulation depth larger than 70 dB. This allows very accurate simulation of peaks and nulls in complex antenna patterns. The outstanding attenuation accuracy of the R&S®SMA100B ensures repeatable, high-quality signal generation, enabling engineers to reliably test the sensitivity and functionality of state-of-the-art radar and EW receivers.

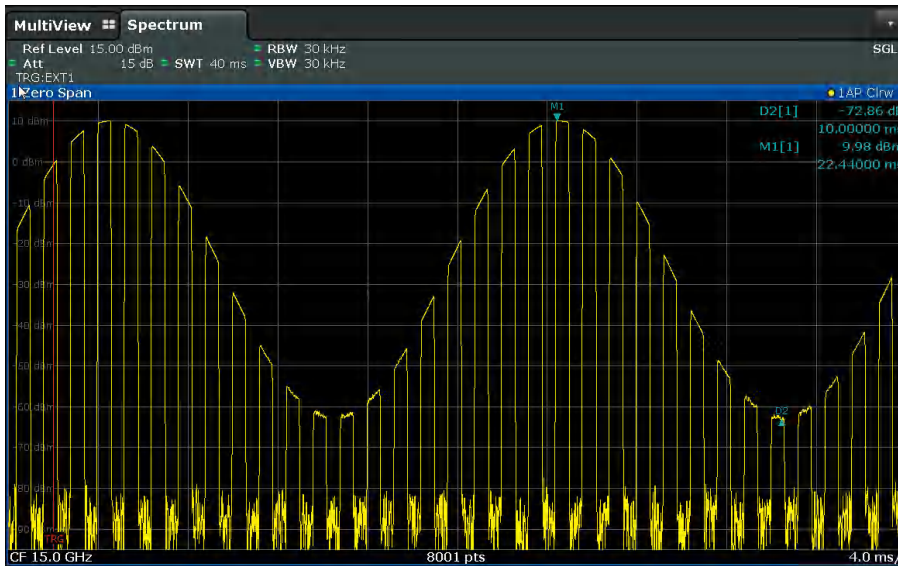

Exponential amplitude modulation with the R&S®SMA100B using the internal LF generator to deliver a sinusoidal modulation signal in order to produce a signal with 72 dB (meas.) modulation depth

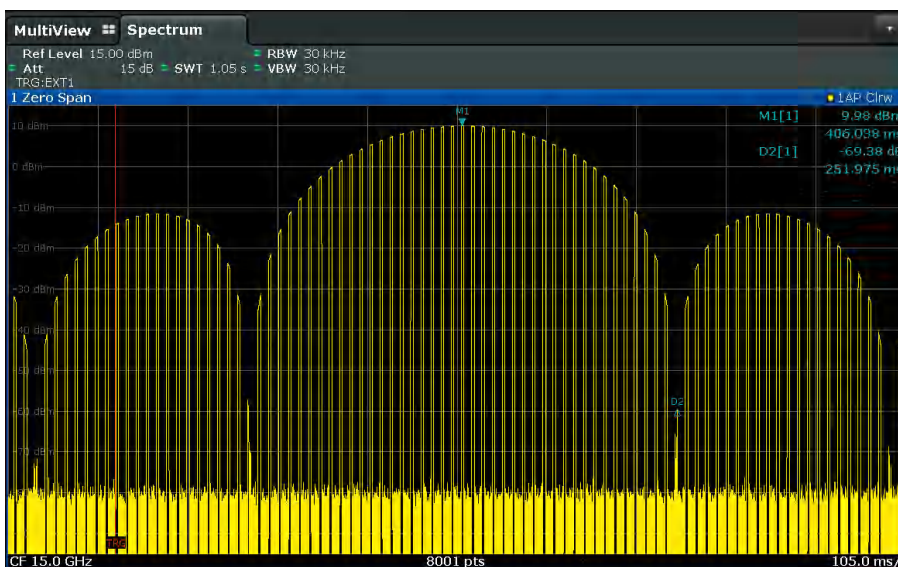

Pulse- and amplitude-modulated signal generated with the R&S®SMA100B. The $\sin(x)/x$ modulation signal is fed at the external analog modulation input and used to produce a signal with 70 dB (meas.) modulation depth

UNINTERRUPTED LEVEL SWEEP WITH HIGH DYNAMIC RANGE

When measuring the gain transfer function or the output saturation point of an amplifier with integrated automatic level control (ALC), or of a traveling wave tube amplifier (TWTAs), the signal generator must provide a wide level sweep range. This is more or less a common requirement for all signal sources. However, and this is even more important, the required level sweep for the above-mentioned measurements must be blank-free. Unwanted blanking of the RF output signal takes place, for instance, during switching of the signal generator's attenuator. Blanking can cause an unpredictable and unwanted reaction of the ALC of the amplifier under test, which must be avoided. In addition to a blank-free level sweep, high level linearity is required across a wide level sweep range in order to achieve reliable results.

The R&S®SMA100B equipped with the R&S®SMAB-K724 high dynamic uninterrupted level sweep option is the ideal choice to meet all of the above requirements. It enables measuring the gain transfer function of DUTs such as TWTAs without the user having to worry about blanks during the level sweep. Offering a blank-free dynamic level sweep range of more than 70 dB, the instrument together with the R&S®SMAB-K724 option provides ample headroom in excess of the minimum required 30 dB to 40 dB.

The R&S®SMAB-K724 option essentially provides the following:

- ▶ Blank-free (uninterrupted) level sweep with exceptionally high dynamic range
- ▶ High level linearity across the entire level sweep range

Uninterrupted level sweep with high dynamic range

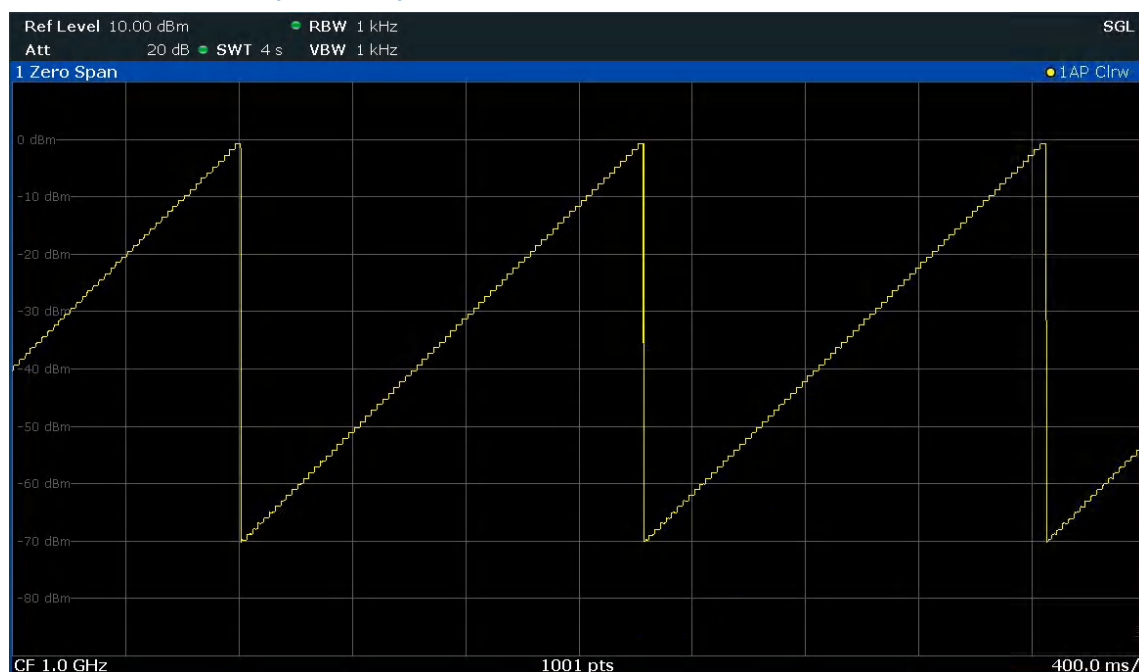

LOCAL OSCILLATOR SUBSTITUTION WITH LOWEST SSB PHASE NOISE

The spectral purity of the local oscillator is key to the performance of each radar system. Radars receive the returns from the target object together with clutter echoes from the surroundings. A radar's phase noise performance impacts its accuracy and ability to detect and resolve radar echo signals. Small objects may go undetected in the vicinity of objects with large radar cross sections that can be caused, for example, by clutter. Echoes with a small Doppler frequency shift can be hidden due to close-in phase noise. Therefore, low phase noise on the radar's local oscillator signal is the key to maximizing the probability of detecting radar echo signals. Any unwanted spurs in the local oscillator signal will immediately emerge as unwanted spectral components in the downconverted and digitized radar receive signal.

During system development, engineers must test the system components prior to system integration. These component tests often require a signal generator to act as a coherent oscillator (COHO) or stable local oscillator (STALO) replacement or to fulfill other, more general LO replacement roles.

Thanks to its outstanding signal purity with lowest harmonics and nonharmonics and its industry-leading phase noise performance, the R&S®SMA100B is the best choice as a local oscillator substitution. It offers superior signal quality, also for high and ultra high output power levels, which are often needed to drive mixers. Using the R&S®SMA100B as a local oscillator substitution enables in-depth performance verification of the radar system with the highest test accuracy. The chart below shows the SSB phase noise performance of the R&S®SMA100B equipped with the ultra low phase noise option for a 10 GHz carrier signal. The measured close-in phase noise is as low as -83 dBc (1 Hz) at 10 Hz carrier offset and -100 dBc (1 Hz) at 100 Hz carrier offset. This delivers optimal radar performance, especially for radars using long coherent integration intervals to resolve small differences in Doppler frequencies.

Measured SSB phase noise performance of R&S®SMA100B at 10 GHz

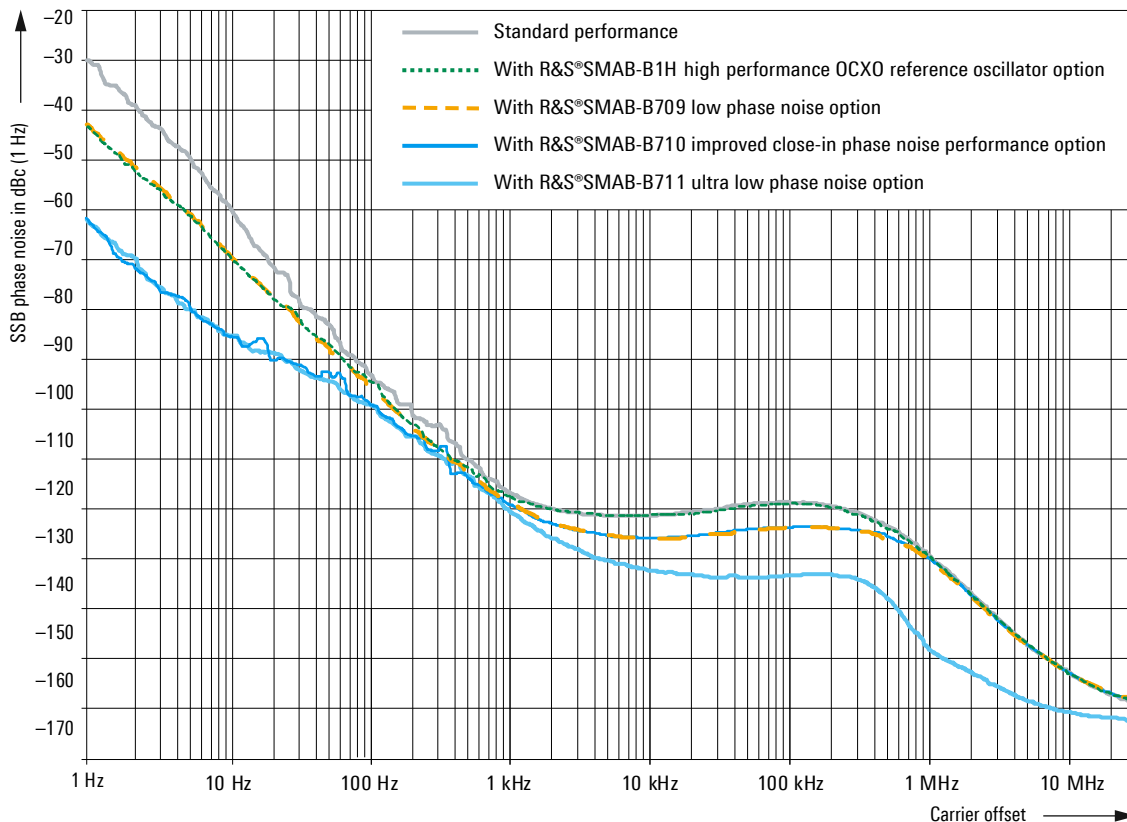

SPECIFICATIONS IN BRIEF

Specifications in brief

Frequency

Frequency range	R&S®SMAB-B103	8 kHz to 3 GHz
	R&S®SMAB-B106	8 kHz to 6 GHz
	R&S®SMAB-B112	8 kHz to 12.75 GHz
	R&S®SMAB-B120	8 kHz to 20 GHz
	R&S®SMAB-B131	8 kHz to 31.8 GHz
	R&S®SMAB-B140/-B140N	8 kHz to 40 GHz
	R&S®SMAB-B150/-B150N	8 kHz to 50 GHz
	R&S®SMAB-B167/-B167N	8 kHz to 67 GHz (overrange up to 72 GHz)

Level

Maximum specified output power (PEP)	R&S®SMAB-B103/-B106	f = 3 GHz	f = 6 GHz
	standard	+19 dBm	+19 dBm
	with R&S®SMAB-K31	+25 dBm	+25 dBm
	with R&S®SMAB-K31 and R&S®SMAB-B32	+30 dBm	+30 dBm
	R&S®SMAB-B112/-B120	f = 12.75 GHz	f = 20 GHz
	standard	+18 dBm	+17 dBm
	with R&S®SMAB-K33	+20 dBm	+20 dBm
	with R&S®SMAB-K33 and R&S®SMAB-B34	+27 dBm	+24 dBm
	R&S®SMAB-B131/-B140/-B140N	f = 31.8 GHz	f = 40 GHz
	standard	+13 dBm	+13 dBm
	with R&S®SMAB-B35	+17 dBm	+16 dBm
	with R&S®SMAB-B35 and R&S®SMAB-K36	+22 dBm	+19 dBm
	with R&S®SMAB-B35, R&S®SMAB-K36 and SMAB-B36S	+27 dBm	+25 dBm
	R&S®SMAB-B150/-B150N/-B167/-B167N	f = 50 GHz	f = 67 GHz
	standard	+5 dBm	+5 dBm
	with R&S®SMAB-B37/-B39	+11 dBm	+9 dBm
	with R&S®SMAB-B37/-B39 and R&S®SMAB-K38/-K40	+18 dBm	+10 dBm

Spectral purity

SSB phase noise	f = 1 GHz, 1 Hz measurement bandwidth	
	standard, carrier offset = 20 kHz	< -135 dBc, -140 dBc (typ.)
	with R&S®SMAB-B709, carrier offset = 10 kHz	< -140 dBc
	with R&S®SMAB-B710(N), carrier offset = 10 kHz	< -140 dBc, -145 dBc (typ.)
	with R&S®SMAB-B711(N), carrier offset = 10 kHz	< -147 dBc, -152 dBc (typ.)
	f = 10 GHz, 1 Hz measurement bandwidth	
	standard, carrier offset = 20 kHz	-115 dBc, -120 dBc (typ.)
	with R&S®SMAB-B709, carrier offset = 10 kHz	< -120 dBc
	with R&S®SMAB-B710, carrier offset = 10 kHz	-120 dBc, -125 dBc (typ.)
	with R&S®SMAB-B711, carrier offset = 10 kHz	-128 dBc, -132 dBc (typ.)



Rear view of 2 HU R&S®SMA100B

Specifications in brief

Harmonics

Instruments equipped with R&S®SMAB-B103/-B106 and R&S®SMAB/-K31/-B32 options		
	10 MHz < f ≤ 6 GHz, P = 18 dBm	< -60 dBc
Instruments equipped with R&S®SMAB-B112/-B120 and R&S®SMAB-K33/-B34 options		
	10 MHz < f ≤ 20 GHz, P = 16 dBm	< -55 dBc
Instruments equipped with R&S®SMAB-B131/-B140(N)/-B150(N)/-B167(N) and R&S®SMAB-B35/-K36/-B36S/-B37/-K38/-B39/-K40 options		
	10 MHz < f ≤ 42.5 GHz, P = 13 dBm	< -55 dBc
Nonharmonics		
	f = 1 GHz, > 10 kHz from carrier, 10 dBm	< -92 dBc
	f = 1 GHz, > 10 kHz from carrier, 10 dBm with R&S®SMAB-B711(N) option	< -100 dBc
Supported modulation modes		
	with R&S®SMAB-K720 option	AM, FM, φM
	with R&S®SMAB-K721 option	scan AM
Pulse modulation		
	with R&S®SMAB-K22 option	
Rise/fall time	f > 700 MHz	< 10 ns, 5 ns (typ.)
On/off ratio		> 80 dB
Minimum pulse width		< 20 ns

Compatible command sets

These command sets can be used to emulate another instrument. A subset of common commands is supported.

Hewlett Packard HP8340, HP8341 HP8360 HP83620, HP83622, HP83623, HP83624 HP83630, HP83640, HP83650 HP8373 HP83711, HP83712 HP83731, HP83732 HP8642, HP8643, HP8644, HP8645 HP8647, HP8648 HP8656, HP8657 HP8662, HP8663, HP8664, HP8665 HP8673	Agilent/Keysight Technologies E4421, E4422, E4428 E8257, E8663 N5161, N5181, N5183, N5171, N5173 Aeroflex (IFR/Marconi) 2023, 2024 2030, 2031, 2032 2040, 2041, 2042 Anritsu 68017, 68037	Panasonic VP-8303A Racal Dana 3102, 9087 Rohde&Schwarz R&S®SMA100A R&S®SME R&S®SMF100A R&S®SMG/SMH R&S®SMGU/SMHU R&S®SML/SMP/SMR R&S®SMT/SMY
--	--	---



Rear view of 3 HU R&S®SMA100B

ORDERING INFORMATION

Designation	Type	Order No.
RF and microwave signal generator		
Signal generator ¹⁾ including power cable and quick start guide	R&S®SMA100B	1419.8888.02
Options		
Frequency options		
8 kHz to 3 GHz	R&S®SMAB-B103	1420.8488.02
8 kHz to 6 GHz	R&S®SMAB-B106	1420.8588.02
8 kHz to 12.75 GHz	R&S®SMAB-B112	1420.8688.02
8 kHz to 20 GHz	R&S®SMAB-B120	1420.8788.02
8 kHz to 31.8 GHz	R&S®SMAB-B131	1420.8888.02
8 kHz to 40 GHz	R&S®SMAB-B140	1420.8988.02
8 kHz to 40 GHz, limited minimum pulse width	R&S®SMAB-B140N	1420.8965.02
8 kHz to 50 GHz	R&S®SMAB-B150	1420.9049.02
8 kHz to 50 GHz, limited minimum pulse width	R&S®SMAB-B150N	1420.9026.02
8 kHz to 67 GHz	R&S®SMAB-B167	1420.9149.02
8 kHz to 67 GHz, limited minimum pulse width	R&S®SMAB-B167N	1420.9126.02
Platform height options		
2 HU with 5" touch display	R&S®SMAB-B92	1420.8288.04
3 HU with 7" touch display	R&S®SMAB-B93	1420.8388.04
Phase noise performance and reference oscillator options		
High performance OCXO reference oscillator ²⁾	R&S®SMAB-B1H	1420.8188.02
Low phase noise ²⁾	R&S®SMAB-B709	1420.9849.02
Improved close-in phase noise performance for R&S®SMAB-B106/-B112/-B120/-B131/-B140/-B150/-B167 ²⁾	R&S®SMAB-B710	1420.8007.02
Improved close-in phase noise performance for R&S®SMAB-B103 ²⁾	R&S®SMAB-B710N	1420.8107.02
Ultra low phase noise for R&S®SMAB-B106/-B112/-B120/-B131/-B140/ -B150/-B167 ²⁾	R&S®SMAB-B711	1420.8020.02
Ultra low phase noise for R&S®SMAB-B103 ²⁾	R&S®SMAB-B711N	1420.8120.02
100 MHz, 1 GHz reference input and output	R&S®SMAB-K703	1420.9761.02
Flexible reference input, 1 MHz to 100 MHz	R&S®SMAB-K704	1420.9778.02
Output power options		
High output power, 3 GHz/6 GHz	R&S®SMAB-K31	1420.7100.02
Ultra high output power, 3 GHz/6 GHz ³⁾	R&S®SMAB-B32	1420.7200.02
High output power, 12.75 GHz/20 GHz	R&S®SMAB-K33	1420.7300.02
Ultra high output power, 12.75 GHz/20 GHz ⁴⁾	R&S®SMAB-B34	1420.7400.02
High output power, 31.8 GHz/40 GHz ⁵⁾	R&S®SMAB-B35	1420.7500.02
Ultra high output power, 31.8 GHz/40 GHz ⁶⁾	R&S®SMAB-K36	1420.9178.02
Super ultra high output power, 31.8 GHz/40 GHz ⁷⁾	R&S®SMAB-B36S	1420.9190.02
High output power, 50 GHz ⁵⁾	R&S®SMAB-B37	1420.7700.02
Ultra high output power, 50 GHz ⁹⁾	R&S®SMAB-K38	1420.9255.02
High output power 67 GHz ⁵⁾	R&S®SMAB-B39	1420.7900.02
Ultra high output power, 67 GHz ⁹⁾	R&S®SMAB-K40	1420.9278.02

¹⁾ The base unit must be ordered with an R&S®SMAB-B1xx frequency option and an R&S®SMAB-B92 or R&S®SMAB-B93 platform height option.

²⁾ Only one of the following six options can be installed: R&S®SMAB-B1H, R&S®SMAB-B709, R&S®SMAB-B710, R&S®SMAB-B710N, R&S®SMAB-B711, R&S®SMAB B711N.

³⁾ R&S®SMAB-B32 can only be ordered in combination with R&S®SMAB-K31.

⁴⁾ R&S®SMAB-B34 can only be ordered in combination with R&S®SMAB-K33.

⁵⁾ Requires R&S®SMAB-B93 3 HU option.

⁶⁾ R&S®SMAB-K36 can only be ordered in combination with R&S®SMAB-B35.

⁷⁾ R&S®SMAB-B36S can only be ordered in combination with R&S®SMAB-K36.

⁸⁾ R&S®SMAB-K38 can only be ordered in combination with R&S®SMAB-B37.

⁹⁾ R&S®SMAB-K40 can only be ordered in combination with R&S®SMAB-B39.

Designation	Type	Order No.
Analog modulation options		
High performance pulse modulator	R&S®SMAB-K22	1420.9710.02
Pulse generator	R&S®SMAB-K23	1420.9726.02
Multifunction generator	R&S®SMAB-K24	1420.9732.02
VOR/ILS	R&S®SMAB-K25	1420.9855.02
Pulse train ¹⁰⁾	R&S®SMAB-K27	1420.9749.02
AM/FM/φM	R&S®SMAB-K720	1420.9790.02
Scan AM ¹¹⁾	R&S®SMAB-K721	1420.9784.02
Additional performance options		
Ramp sweep	R&S®SMAB-B28	1420.6579.02
Differential clock synthesizer, 3 GHz	R&S®SMAB-B29	1420.8088.02
Clock synthesizer frequency extension to 6 GHz ¹²⁾	R&S®SMAB-K722	1420.9810.02
High dynamic uninterrupted level sweep ¹³⁾	R&S®SMAB-K724	1420.9832.02
Other options		
Power analysis	R&S®SMAB-K28	1420.9755.02
Rear panel connectors (3 GHz/6 GHz)	R&S®SMAB-B80	1420.6504.02
Rear panel connectors (12.75 GHz/20 GHz/31.8 GHz/40 GHz), PC 2.92 mm	R&S®SMAB-B81	1420.6510.02
Rear panel connectors (50 GHz/67 GHz), PC 1.85 mm	R&S®SMAB-B82	1420.6527.02
Removable mass storage	R&S®SMAB-B85	1420.6556.02
Remote control GPIB and USB	R&S®SMAB-B86	1420.6562.02
Recommended extras		
19" rack adapter for 2 HU platform	R&S®ZZA-KNP21	1177.8803.00
19" rack adapter for 3 HU platform	R&S®ZZA-KNP31	1177.8810.00
USB serial adapter for RS-232 remote control	R&S®TS-USB1	6124.2531.00
Spare SD card	R&S®SMAB-Z10	1420.6662.02
Adapters for instruments with R&S®SMAB-B112/-B120 frequency option		
Test port adapter, 2.4 mm female		1088.1627.02
Test port adapter, 2.92 mm female		1036.4790.00
Test port adapter, 2.92 mm male		1036.4802.00
Test port adapter, N female		1036.4777.00
Test port adapter, N male		1036.4783.00
Documentation		
Documentation of calibration values	R&S®DCV-2	0240.2193.18
R&S®SMA100B accredited calibration, up to 6 GHz	R&S®ACASMA100B	3598.3307.03
R&S®SMA100B accredited calibration, 12.75 GHz to 40 GHz	R&S®ACASMA100B	3598.3236.03
R&S®SMA100B accredited calibration, 50 GHz to 67 GHz	R&S®ACASMA100B	3598.3207.03

Option identification: R&S®SMAB-Bxxx = hardware option, R&S®SMAB-Kxxx = software/keycode option.

¹⁰⁾ R&S®SMAB-K27 can only be ordered in combination with R&S®SMAB-K23.

¹¹⁾ Requires R&S®SMAB-K720 AM/FM/φM option. For instruments with a serial number < 102000, please contact the Rohde&Schwarz service department.

¹²⁾ Only in combination with an R&S®SMAB-B1xx frequency option higher than 3 GHz. Requires R&S®SMAB-B29.

¹³⁾ For instruments with a serial number < 102000, please contact the Rohde&Schwarz service department.

Warranty

Base unit	3 years
All other items ¹⁾	1 year

Options

Extended warranty, one year	R&S®WE1	Contact your local Rohde & Schwarz sales office.
Extended warranty, two years	R&S®WE2	
Extended warranty with calibration coverage, one year	R&S®CW1	
Extended warranty with calibration coverage, two years	R&S®CW2	
Extended warranty with accredited calibration coverage, one year	R&S®AW1	
Extended warranty with accredited calibration coverage, two years	R&S®AW2	

¹⁾ For options that are installed, the remaining base unit warranty applies if longer than 1 year. Exception: all batteries have a 1 year warranty.

Your local Rohde & Schwarz expert will help find the best solution for you.

Contact your local Rohde & Schwarz sales office for more information.

www.sales.rohde-schwarz.com



FROM PRESALES TO SERVICE. AT YOUR DOORSTEP.

The Rohde & Schwarz network in over 70 countries ensures optimum on-site support by highly qualified experts.

User risks are reduced to a minimum at all project stages:

- ▶ Solution finding/purchase
- ▶ Technical startup/application development/integration
- ▶ Training
- ▶ Operation/calibration/repair



Service at Rohde & Schwarz You're in great hands

- ▶ Worldwide
- ▶ Local and personalized
- ▶ Customized and flexible
- ▶ Uncompromising quality
- ▶ Long-term dependability

Rohde & Schwarz

The Rohde&Schwarz technology group is among the trail-blazers when it comes to paving the way for a safer and connected world with its leading solutions in test & measurement, technology systems and networks&cybersecurity. Founded more than 85 years ago, the group is a reliable partner for industry and government customers around the globe. The independent company is headquartered in Munich, Germany and has an extensive sales and service network with locations in more than 70 countries.

www.rohde-schwarz.com

Sustainable product design

- ▶ Environmental compatibility and eco-footprint
- ▶ Energy efficiency and low emissions
- ▶ Longevity and optimized total cost of ownership

Certified Quality Management

ISO 9001

Certified Environmental Management

ISO 14001

Rohde & Schwarz training

www.training.rohde-schwarz.com

Rohde & Schwarz customer support

www.rohde-schwarz.com/support

