

R&S®SGU100A

SGMA Upconverter

User Manual



1176772602
Version 10

ROHDE & SCHWARZ
Make ideas real



This document describes the R&S®SGU100A, stock no. 1418.2005.02 and its options.

- R&S®SGU-B26 (1418.3401.02)
- R&S®SGU-B120/120V (1418.2605.02/1418.2657.02)
- R&S®SGU-B140/140V (1418.2870.02/1418.2928.02)

This manual describes firmware version FW 5.00.232.xx and later of the R&S®SGU100A.

© 2022 Rohde & Schwarz GmbH & Co. KG
Muehldorfstr. 15, 81671 Muenchen, Germany
Phone: +49 89 41 29 - 0
Email: info@rohde-schwarz.com
Internet: www.rohde-schwarz.com

Subject to change – data without tolerance limits is not binding.

R&S® is a registered trademark of Rohde & Schwarz GmbH & Co. KG.

All other trademarks are the properties of their respective owners.

1176.7726.02 | Version 10 | R&S®SGU100A

Throughout this manual, products from Rohde & Schwarz are indicated without the ® symbol , e.g. R&S®SGU is indicated as R&S SGU.

Contents

1	Safety and regulatory information.....	11
1.1	Safety instructions.....	11
1.2	Labels on R&S SGU.....	13
1.3	Warning messages in the documentation.....	13
1.4	Korea certification class B.....	14
2	Welcome.....	15
2.1	Key features.....	15
2.2	What's new.....	15
2.3	Documentation overview.....	16
2.3.1	Getting started manual.....	16
2.3.2	User manual and help.....	16
2.3.3	Service manual.....	16
2.3.4	Instrument security procedures.....	16
2.3.5	Basic safety instructions.....	17
2.3.6	Data sheets and brochures.....	17
2.3.7	Release notes and open source acknowledgment (OSA).....	17
2.3.8	Application notes, application cards, white papers, etc.....	17
2.4	Typographical conventions.....	17
2.5	Notes on screenshots.....	18
3	Preparing for use.....	19
3.1	Lifting and carrying.....	19
3.2	Unpacking and checking.....	19
3.3	Choosing the operating site.....	19
3.4	Setting up the R&S SGU.....	20
3.4.1	Placing the R&S SGU on a bench top.....	20
3.4.2	Mounting the R&S SGU in a rack.....	21
3.5	Considerations for test setup.....	22
3.6	Connecting to power.....	22
3.7	Connecting to LAN.....	23
3.8	Connecting to RF 50Ω.....	23
3.9	Connecting to non-screwable connectors.....	24

3.10	Switching on or off.....	25
3.11	Checking default settings.....	26
3.12	Working with Linux operating system.....	27
3.13	Connecting an external PC and devices.....	27
3.13.1	Installing the R&S SGMA-GUI software.....	28
3.13.2	Connecting a remote PC via LAN.....	30
3.13.3	Connecting a controller via PCI Express.....	33
3.13.4	Connecting a controller via USB.....	33
4	Instrument tour.....	35
4.1	Front panel tour.....	35
4.2	Rear panel tour.....	37
5	Trying out the Instrument.....	40
5.1	Extending R&S SGS with the R&S SGU.....	40
5.2	R&S SGU as a Standalone Upconverter.....	44
6	Instrument control.....	47
6.1	Manual operation via R&S SGMA-GUI.....	47
6.1.1	Introduction to the user interface.....	47
6.1.2	How to use the help system.....	48
7	System overview.....	50
7.1	Setups for instrument control.....	50
7.1.1	Manual operation from the R&S SGMA-GUI.....	50
7.1.2	Remote control from a controller.....	50
7.1.3	Controlling the R&S SGU with an R&S signal generator.....	51
7.2	Connecting an R&S SGS and an R&S SGU.....	51
7.2.1	Using a direct LAN connection.....	52
7.2.2	Connecting to a company network.....	53
7.2.3	Connecting via a PCIe switch.....	56
8	Understanding the R&S SGMA-GUI software.....	58
8.1	Operating menu and toolbar.....	58
8.1.1	File menu.....	59
8.1.2	Setup menu.....	60
8.1.3	Help.....	67

8.2	Info dialog and messages in the info bar.....	68
8.2.1	Info dialog.....	68
8.2.2	Understanding the messages in the info bar.....	69
8.3	Main panel.....	70
8.4	Working with R&S SGMA-GUI.....	73
8.4.1	Saving and loading settings.....	73
8.4.2	Handling instruments in the R&S SGMA-GUI.....	73
8.4.3	Finding out the default hostname of the instrument.....	76
8.4.4	Bidirectional instrument identification.....	77
8.4.5	Managing messages in the info dialog.....	80
8.5	Remote control of R&S SGMA-GUI.....	81
8.5.1	Programming examples.....	81
8.5.2	R&S SGMA-GUI commands.....	83
8.5.3	List of R&S SGMA-GUI commands.....	88
9	Upconverter settings.....	89
9.1	Frequency settings.....	89
9.2	Level and power-on settings.....	90
9.2.1	RF level.....	90
9.2.2	Attenuator.....	93
9.2.3	Power-On/EMF settings.....	94
9.2.4	ALC.....	95
9.3	I/Q modulation and signal impairment.....	96
9.3.1	I/Q impairments.....	96
9.3.2	General I/Q settings.....	98
9.3.3	Analog impairment settings.....	99
9.4	Pulse modulation.....	100
9.4.1	Pulse modulation settings.....	101
9.4.2	Pulse connector/trigger settings.....	101
9.5	External local oscillator settings.....	102
9.6	Trigger connector settings.....	103
9.7	Preset.....	104
10	General instrument settings and instrument setup.....	105
10.1	Hardware configuration.....	105

10.2	Software / options.....	107
10.3	Install SW options.....	109
10.4	Protection.....	109
10.5	Security.....	110
10.6	Network settings.....	113
10.7	Remote channels.....	116
10.8	Factory preset.....	117
10.9	Eco mode.....	118
10.10	Standby and restart.....	118
10.11	Diagnostic and tests.....	119
10.11.1	Keyboard tests.....	119
11	Performing configuration tasks.....	120
11.1	How to generate I/Q signals.....	120
11.2	How to restore the LAN connection.....	123
11.3	How to switch between operating states.....	123
11.4	How to use computer names.....	125
11.5	How to install a new firmware version on the instrument.....	125
11.6	How to activate options.....	127
11.7	How to set a PCIe direct connection.....	127
12	Network operation and remote control.....	129
12.1	Remote control interfaces and protocols.....	129
12.1.1	Remote control programs and libraries.....	130
12.1.2	LAN interface.....	133
12.1.3	USB interface.....	136
12.1.4	PCI Express interface.....	136
12.1.5	GPIB interface (IEC/IEEE bus interface).....	137
12.2	Starting a remote control session.....	138
12.2.1	How to find the VISA resource string.....	138
12.2.2	Remote control over LAN using socket communication.....	138
12.3	Advanced remote control using PCIe.....	140
12.3.1	Setting up a remote control connection via PCIe.....	140
12.3.2	Downloading the drivers.....	141
12.3.3	Configuring the controller.....	141

12.3.4	Connecting the controller and the instrument.....	144
12.3.5	Enabling fast settings.....	144
12.4	Advanced remote control using fast socket.....	145
12.4.1	Setting up a remote control connection via fast socket.....	145
12.4.2	Installing the protocol driver.....	146
12.4.3	Enabling fast settings.....	146
12.5	Status reporting system.....	147
12.5.1	Hierarchy of the status registers.....	147
12.5.2	Structure of a SCPI status register.....	149
12.5.3	Status byte (STB) and service request enable register (SRE).....	151
12.5.4	Event status register (ESR) and event status enable register (ESE).....	152
12.5.5	Questionable status register (STATus:QUESTionable).....	152
12.5.6	Operation status register (STATus:OPERation).....	153
12.5.7	Application of the status reporting system.....	153
12.5.8	Reset values of the status reporting system.....	155
12.6	LXI configuration.....	155
12.6.1	Default network settings.....	156
12.6.2	LXI browser settings.....	156
12.6.3	LAN configuration.....	157
12.6.4	How to record SCPI commands and messages via LXI.....	159
12.7	Monitoring remote control operation with R&S SGMA-GUI.....	160
13	Remote control commands.....	162
13.1	Programming Examples.....	163
13.1.1	Performing General Tasks for Instrument Setup.....	163
13.1.2	Generating an I/Q Modulated Signal.....	165
13.1.3	Advanced Task for Optimizing Performance.....	166
13.1.4	Adjusting Network and Remote Channel Settings.....	168
13.2	Common commands.....	169
13.3	General commands.....	173
13.4	Preset commands.....	174
13.5	CALibration subsystem.....	175
13.6	CONNector subsystem.....	180
13.7	DIAGnostic subsystem.....	180

13.8	Fast speed commands	181
13.9	FORMat Subsystem	181
13.10	MMEMory subsystem	183
13.10.1	File naming conventions.....	183
13.10.2	Extensions for user files.....	184
13.10.3	Examples.....	184
13.10.4	Remote control commands.....	186
13.11	OUTPut subsystem	191
13.12	SOURce subsystem	193
13.13	SOURce:IQ subsystem	194
13.14	SOURce:LOSCillator subsystem	196
13.15	SOURce:POWer subsystem	198
13.16	SOURce:PULM subsystem	202
13.17	STATus subsystem	203
13.18	SYSTem subsystem	207
13.19	TEST subsystem	217
13.20	UNIT subsystem	219
13.21	List of R&S SGU commands	219
14	Error messages and troubleshooting	223
14.1	Status information	223
14.2	Error messages	223
14.2.1	Volatile messages.....	223
14.2.2	Permanent messages.....	224
14.3	SCPI-Error messages	224
14.4	Device-Specific error messages	224
14.5	Contacting customer support	226
15	Transporting	227
16	Maintenance, storage and disposal	228
16.1	Cleaning	228
16.2	Storage	228
16.3	Disposal	228

Annex..... 229

A Telnet program examples.....229

Index.....235

1 Safety and regulatory information

The product documentation helps you use the product safely and efficiently. Follow the instructions provided here and in the following chapters.

Intended use

The product is intended for the development, production and verification of electronic components and devices in industrial, administrative, and laboratory environments. Use the product only for its designated purpose. Observe the operating conditions and performance limits stated in the data sheet.

Where do I find safety information?

Safety information is part of the product documentation. It warns you of potential dangers and gives instructions on how to prevent personal injury or damage caused by dangerous situations. Safety information is provided as follows:

- In [Chapter 1.1, "Safety instructions"](#), on page 11. The same information is provided in many languages as printed "Safety Instructions". The printed "Safety Instructions" are delivered with the product.
- Throughout the documentation, safety instructions are provided when you need to take care during setup or operation.

1.1 Safety instructions

Products from the Rohde & Schwarz group of companies are manufactured according to the highest technical standards. To use the products safely, follow the instructions provided here and in the product documentation. Keep the product documentation nearby and offer it to other users.

Use the product only for its intended use and within its performance limits. Intended use and limits are described in the product documentation such as the data sheet, manuals and the printed "Safety Instructions". If you are unsure about the appropriate use, contact Rohde & Schwarz customer service.

Using the product requires specialists or specially trained personnel. These users also need sound knowledge of at least one of the languages in which the user interfaces and the product documentation are available.

Never open the casing of the product. Only service personnel authorized by Rohde & Schwarz are allowed to repair the product. If any part of the product is damaged or broken, stop using the product. Contact Rohde & Schwarz customer service at <http://www.customersupport.rohde-schwarz.com>.

Lifting and carrying the product

The maximum weight of the product is provided in the data sheet. To move the product safely, you can use lifting or transporting equipment such as lift trucks and forklifts. Follow the instructions provided by the equipment manufacturer.

Choosing the operating site

Only use the product indoors. The product casing is not waterproof. Water that enters can electrically connect the casing with live parts, which can lead to electric shock, serious personal injury or death if you touch the casing. If Rohde & Schwarz provides accessories designed for your product, e.g. a carrying bag, you can use the product outdoors.

Unless otherwise specified, you can operate the product up to an altitude of 2000 m above sea level. The product is suitable for pollution degree 2 environments where nonconductive contamination can occur. For more information on environmental conditions such as ambient temperature and humidity, see the data sheet.

Setting up the product

Always place the product on a stable, flat and level surface with the bottom of the product facing down. If the product is designed for different positions, secure the product so that it cannot fall over.

If the product has foldable feet, always fold the feet completely in or out to ensure stability. The feet can collapse if they are not folded out completely or if the product is moved without lifting it. The foldable feet are designed to carry the weight of the product, but not an extra load.

If stacking is possible, keep in mind that a stack of products can fall over and cause injury.

If you mount products in a rack, ensure that the rack has sufficient load capacity and stability. Observe the specifications of the rack manufacturer. Always install the products from the bottom shelf to the top shelf so that the rack stands securely. Secure the product so that it cannot fall off the rack.

Connecting to power

The product is an overvoltage category II product. Connect the product to a fixed installation used to supply energy-consuming equipment such as household appliances and similar loads. Keep in mind that electrically powered products have risks, such as electric shock, fire, personal injury or even death.

Take the following measures for your safety:

- Before switching on the product, ensure that the voltage and frequency indicated on the product match the available power source. If the power adapter does not adjust automatically, set the correct value and check the rating of the fuse.
- Only use the power cable delivered with the product. It complies with country-specific safety requirements. Only insert the plug into an outlet with protective conductor terminal.
- Only use intact cables and route them carefully so that they cannot be damaged. Check the power cables regularly to ensure that they are undamaged. Also ensure that nobody can trip over loose cables.
- If the product needs an external power supply, use the power supply that is delivered with the product or that is recommended in the product documentation or a power supply that conforms to the country-specific regulations.





- Only connect the product to a power source with a fuse protection of maximum 20 A.
- Ensure that you can disconnect the product from the power source at any time. Pull the power plug to disconnect the product. The power plug must be easily accessible. If the product is integrated into a system that does not meet these requirements, provide an easily accessible circuit breaker at the system level.

Cleaning the product

Use a dry, lint-free cloth to clean the product. When cleaning, keep in mind that the casing is not waterproof. Do not use liquid cleaning agents.

Meaning of safety labels

Safety labels on the product warn against potential hazards.

	<p>Potential hazard</p> <p>Read the product documentation to avoid personal injury or product damage.</p>
	<p>Electrical hazard</p> <p>Indicates live parts. Risk of electric shock, fire, personal injury or even death.</p>
	<p>Hot surface</p> <p>Do not touch. Risk of skin burns. Risk of fire.</p>
	<p>Protective conductor terminal</p> <p>Connect this terminal to a grounded external conductor or to protective ground. This connection protects you against electric shock if an electric problem occurs.</p>

1.2 Labels on R&S SGU

Labels on the casing inform about:

- Personal safety, see "[Connecting to power](#)" on page 12.
- Product and environment safety, see [Table 1-1](#).
- Identification of the product, see the serial number on the [rear panel](#).

Table 1-1: Labels regarding R&S SGU and environment safety

	<p>Labeling in line with EN 50419 for disposal of electrical and electronic equipment after the product has come to the end of its service life. For more information, see Chapter 16, "Maintenance, storage and disposal", on page 228.</p>
---	--

1.3 Warning messages in the documentation

A warning message points out a risk or danger that you need to be aware of. The signal word indicates the severity of the safety hazard and how likely it will occur if you do not follow the safety precautions.

WARNING

Potentially hazardous situation. Could result in death or serious injury if not avoided.

CAUTION

Potentially hazardous situation. Could result in minor or moderate injury if not avoided.

NOTICE

Potential risks of damage. Could result in damage to the supported product or to other property.

1.4 Korea certification class B



이 기기는 가정용(B급) 전자파 적합기기로서 주로 가정에서 사용하는 것을 목적으로 하며, 모든 지역에서 사용할 수 있습니다.

2 Welcome

The R&S SGU is an upconverter in the frequency range of 10 MHz to 40 GHz.

Optimized for use in automated test equipment (ATE), the instrument offers fast settling times in an exceptionally small form factor and low power consumption. The R&S SGU has LO connectors for coupling multiple generators to a common LO source and can be equipped with a mechanical step attenuator.

2.1 Key features

The key features of the R&S SGU include the following:

- Compact size and low power consumption
- Remote connection via PCI Express, minimizing the setup time
Alternatively, LAN or USB connections available
- Coherent LO input and output connectors, also usable as MIMO input/output and phase coherent I/Q demodulation
- Linux operating system
- Graphical user interface R&S SGMA-GUI to set up and control one or more R&S SGU instruments simultaneously from one remote computer, available for Windows and Linux systems

2.2 What's new

This manual describes firmware version FW 5.00.232.xx and later of the R&S®SGU100A.

Compared to the previous version, it provides the new features listed below:

- Upgrading to R&S SGU firmware versions 5.00.vvv.vv and later, see ["Upgrading to firmware versions 5.00.vvv.vv and later"](#) on page 29.
- Extended "Configure Instruments" settings including scanning the subnet, setting the IP address and the prefix length, see [Chapter 8.1.2.1, "Configure instruments"](#), on page 60.
- Password management including user password and security password settings, see [Chapter 10.5, "Security"](#), on page 110.
- Editorial changes, major changes are as follows:
 - Safety and regulatory information updated, see [Chapter 1, "Safety and regulatory information"](#), on page 11.
 - Getting started updated, see [Chapter 3, "Preparing for use"](#), on page 19, [Chapter 4, "Instrument tour"](#), on page 35, [Chapter 5, "Trying out the Instrument"](#), on page 40 and [Chapter 6, "Instrument control"](#), on page 47.
 - Transporting added, see [Chapter 15, "Transporting"](#), on page 227.

- Maintenance, storage and disposal added, see [Chapter 16, "Maintenance, storage and disposal"](#), on page 228.

2.3 Documentation overview

This section provides an overview of the R&S SGU user documentation. Unless specified otherwise, you find the documents on the R&S SGU product page at:

www.rohde-schwarz.com/manual/sgu100a

2.3.1 Getting started manual

Introduces the R&S SGU and describes how to set up and start working with the product. Includes basic operations, typical measurement examples, and general information, e.g. safety instructions, etc. A printed version is delivered with the instrument.

2.3.2 User manual and help

Contains the description of all instrument modes and functions. It also provides an introduction to remote control, a complete description of the remote control commands with programming examples, and information on maintenance, instrument interfaces and error messages. Includes the contents of the getting started manual.

The contents of the user manuals are available as help in the R&S SGU. The help offers quick, context-sensitive access to the complete information.

All user manuals are also available for download or for immediate display on the Internet.

2.3.3 Service manual

Describes the performance test for checking the rated specifications, module replacement and repair, firmware update, troubleshooting and fault elimination, and contains mechanical drawings and spare part lists.

The service manual is available for registered users on the global Rohde & Schwarz information system (GLORIS, <https://gloris.rohde-schwarz.com>).

2.3.4 Instrument security procedures

Deals with security issues when working with the R&S SGU in secure areas. It is available for download on the Internet.

2.3.5 Basic safety instructions

Contains safety instructions, operating conditions and further important information. The printed document is delivered with the instrument.

2.3.6 Data sheets and brochures

The data sheet contains the technical specifications of the R&S SGU. It also lists the options and their order numbers and optional accessories.

The brochure provides an overview of the instrument and deals with the specific characteristics.

See www.rohde-schwarz.com/brochure-datasheet/sgu100a

2.3.7 Release notes and open source acknowledgment (OSA)

The release notes list new features, improvements and known issues of the current firmware version, and describe the firmware installation.

The open source acknowledgment document provides verbatim license texts of the used open source software.

See www.rohde-schwarz.com/firmware/sgu100a

2.3.8 Application notes, application cards, white papers, etc.

These documents deal with special applications or background information on particular topics.

See www.rohde-schwarz.com/application/sgu100a.

2.4 Typographical conventions

The following text markers are used throughout this documentation:

Convention	Description
"Graphical user interface elements"	All names of graphical user interface elements on the screen, such as dialog boxes, menus, options, buttons, and softkeys are enclosed by quotation marks.
[Keys]	Key and knob names are enclosed by square brackets.
Filenames, commands, program code	Filenames, commands, coding samples and screen output are distinguished by their font.
<i>Input</i>	Input to be entered by the user is displayed in italics.

Convention	Description
Links	Links that you can click are displayed in blue font.
"References"	References to other parts of the documentation are enclosed by quotation marks.

2.5 Notes on screenshots

When describing the functions of the product, we use sample screenshots. These screenshots are meant to illustrate as many as possible of the provided functions and possible interdependencies between parameters. The shown values may not represent realistic usage scenarios.

The screenshots usually show a fully equipped product, that is: with all options installed. Thus, some functions shown in the screenshots may not be available in your particular product configuration.

3 Preparing for use

Here, you can find basic information about setting up the product for the first time.

3.1 Lifting and carrying

See also "[Lifting and carrying the product](#)" on page 11.

- ▶ Use the carrying handles at the side for lifting and carrying the R&S SGU. The handles at the front are only for pushing and pulling the instrument when mounting in a rack, see [Chapter 3.4.2, "Mounting the R&S SGU in a rack"](#), on page 21.

3.2 Unpacking and checking

1. Unpack the R&S SGU carefully.
2. Retain the original packing material. Use it to protect the control elements and connectors when transporting or shipping the R&S SGU later.
See also [Chapter 15, "Transporting"](#), on page 227.
3. Using the delivery notes, check the equipment for completeness.
4. Check the equipment for damage.

If the delivery is incomplete or equipment is damaged, contact Rohde & Schwarz.

3.3 Choosing the operating site

Specific operating conditions ensure proper operation and avoid damage to the product and connected devices. For information on environmental conditions such as ambient temperature and humidity, see the data sheet.

See also "[Choosing the operating site](#)" on page 12.

Electromagnetic compatibility classes

The electromagnetic compatibility (EMC) class indicates where you can operate the product. The EMC class of the product is given in the data sheet.

- Class B equipment is suitable for use in:
 - Residential environments
 - Environments that are directly connected to a low-voltage supply network that supplies residential buildings

- Class A equipment is intended for use in industrial environments. It can cause radio disturbances in residential environments due to possible conducted and radiated disturbances. It is therefore not suitable for class B environments. If class A equipment causes radio disturbances, take appropriate measures to eliminate them.

3.4 Setting up the R&S SGU

See also:

- ["Setting up the product"](#) on page 12
- ["Intended use"](#) on page 11

3.4.1 Placing the R&S SGU on a bench top

To place the product on a bench top

1. Place the product on a stable, flat and level surface. Ensure that the surface can support the weight of the product. For information on the weight, see the data sheet.
2. **WARNING!** A stack of products can fall over and cause injury. Never stack more than three products on top of each other. Instead, mount them in a rack.

Stack as follows:

- If the products have foldable feet, fold them in completely.
- It is best if all products have the same dimensions (width and length). If the products have different dimensions, stack according to size and place the smallest product on top.
- Do not exceed the permissible total load placed on the product at the bottom of the stack:
 - 50 kg when stacking products of identical dimensions (left figure).
 - 25 kg when stacking smaller products on top (middle figure).

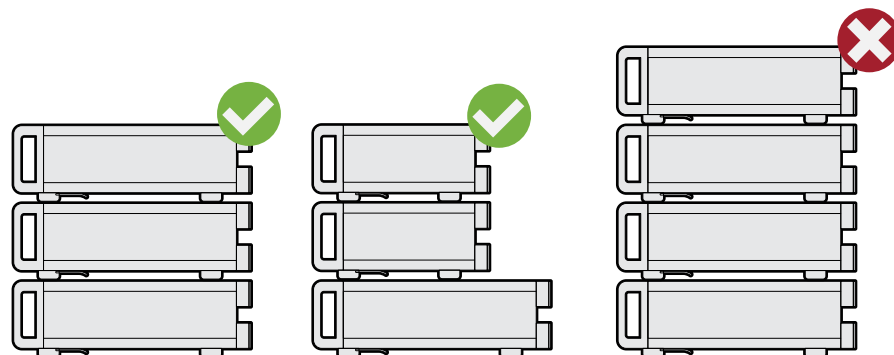

Left = Stacked correctly, same dimensions
Middle = Stacked correctly, different dimensions
Right = Stacked incorrectly, too many products

3. **NOTICE!** Overheating can damage the product.

Prevent overheating as follows:

- Keep a minimum distance of 10 cm between the fan openings of the product and any object in the vicinity.
- Do not place the product next to heat-generating equipment such as radiators or other products.

3.4.2 Mounting the R&S SGU in a rack

To prepare the rack

1. Observe the requirements and instructions in "[Setting up the product](#)" on page 12.
2. **NOTICE!** Insufficient airflow can cause overheating and damage the product. Design and implement an efficient ventilation concept for the rack.

To mount the R&S SGU in a rack

1. Use an adapter kit that fits the dimensions of the R&S SGU to prepare the instrument for rack mounting.
 - a) Order the rack adapter kit designed for the R&S SGU. For the order number, see data sheet.
 - b) Mount the adapter kit. Follow the assembly instructions provided with the adapter kit.
2. Push the R&S SGU onto the shelf until the rack brackets fit closely to the rack.
3. Tighten all screws at the rack brackets with a tightening torque of 1.2 Nm to secure the R&S SGU in the rack.

To unmount the R&S SGU from a rack

1. Loosen the screws at the rack brackets.
2. Remove the R&S SGU from the rack.
3. If placing the R&S SGU on a bench top again, unmount the adapter kit from the R&S SGU. Follow the instructions provided with the adapter kit.

3.5 Considerations for test setup

Cable selection and electromagnetic interference (EMI)

Electromagnetic interference (EMI) can affect the measurement results.

To suppress electromagnetic radiation during operation:

- Use high-quality shielded cables, especially for the following connector types:
 - SMA/SMB
Double-shielded SMA/SMB cables.
How to: [Chapter 3.8, "Connecting to RF 50Ω"](#), on page 23
 - USB
Double-shielded USB cables.
How to: [Chapter 3.13.4, "Connecting a controller via USB"](#), on page 33.
 - LAN
At least CAT6 STP cables.
How to: [Chapter 3.7, "Connecting to LAN"](#), on page 23
- Always terminate open cable ends.
- Ensure that connected external devices comply with EMC regulations.

Signal input and output levels

Information on signal levels is provided in the data sheet. Keep the signal levels within the specified ranges to avoid damage to the R&S SGU and connected devices.

Preventing electrostatic discharge (ESD)

Electrostatic discharge is most likely to occur when you connect or disconnect a DUT.

- ▶ **NOTICE!** Electrostatic discharge can damage the electronic components of the product and the device under test (DUT).
Ground yourself to prevent electrostatic discharge damage:
 - a) Use a wrist strap and cord to connect yourself to ground.
 - b) Use a conductive floor mat and heel strap combination.

3.6 Connecting to power

For safety information, see ["Connecting to power"](#) on page 12.

1. Plug the AC power cable into the AC power connector on the rear panel of the instrument. Only use the AC power cable delivered with the R&S SGU.
2. Plug the AC power cable into a power outlet with ground contact.
The required ratings are listed next to the AC power connector and in the data sheet.

There is no need to set the voltage manually or change fuses.

3.7 Connecting to LAN

Network environment

Before connecting the product to a local area network (LAN), consider the following:

- Install the latest firmware to reduce security risks.
- For internet or remote access, use secured connections if applicable.
- Ensure that the network settings comply with the security policies of your company. Contact your local system administrator or IT department before connecting your product to your company LAN.
- When connected to the LAN, the product may potentially be accessed from the internet, which may be a security risk. For example, attackers might misuse or damage the product.

To connect to LAN

The connector is on the [rear panel](#).

- ▶ Connect the LAN socket via an RJ-45 cable to the LAN.

By default, the R&S SGU is configured to use DHCP (dynamic host configuration protocol) and no static IP address is configured.

3.8 Connecting to RF 50Ω

The connector is on the [rear panel](#).

To prepare for connecting to RF 50Ω

1. **NOTICE!** Damaged or not clean connections can lead to RF insertion loss and mismatch, and even premature wear of the connectors.
Before connecting to the port, inspect the RF connector visually to check that it is clean, undamaged and mechanically compatible.
See the application note [1MA99](#) for information on how to handle and maintain the RF port, to minimize measurement deviations and ensure its longevity.
2. **NOTICE!** Risk of instrument damage. Excessive reverse power or DC voltage at the RF 50Ω connector can damage the instrument.
Make sure that the values do not exceed the reverse power and DC limits as given in the data sheet.
3. If switched-on, deactivate the RF output of the R&S SGU, before connecting an RF cable to the RF 50Ω connector.

On the front panel, press the [RF ON] key.

To connect to screwable connectors

Additional to the RF 50Ω connector, the following procedure holds for all screwable connectors of the R&S SGU. Screwable connectors include connector types as listed in [Table 3-1](#).

1. Use a high-quality cable that matches the connector type.
See "[Cable selection and electromagnetic interference \(EMI\)](#)" on page 22.
2. **NOTICE!** Risk of instrument damage and connector damage. Excessive tightening can damage the cables and the connectors. However, if you do not tighten the connectors enough, the measurement results can be inaccurate.
To connect the cable with the connector, proceed as follows:
 - a) Carefully align the connector of the cable and the connector along a common axis.
 - b) Mate the connectors along the common axis until the male pin of the inner connector engages with the female socket of the outer connector.
 - c) Turn the nut of the outer connector until the connectors are firmly coupled.
 - d) Torque the nut to the specified limit using a calibrated torque wrench. Hold the opposite connector part stationary with a spanner.
For torque limits of the most relevant connector types, see [Table 3-1](#). For more information, see chapter "Handling" of the application note [1MA99](#).
3. Torque the nut to the specified limit using a calibrated torque wrench. Hold the opposite connector part stationary with a spanner.

Table 3-1: Connector types and torque limits

Type	Torque limit		Nut opening	
	lb-Inch	Nm	Inch	mm
SMA, SMB	5	0.56	5/16	8
K, 2.92 mm	8	0.9	5/16	8

To prevent RF output switch-off

- ▶ **NOTICE!** If you set a too high output level without a load connected to the instrument, the reverse power can exceed a limit forcing the R&S SGU to switch off the RF output.
Connect a load with sufficient return loss.

3.9 Connecting to non-screwable connectors

Non-screwable connectors of the R&S SGU are BNC type connectors on the [rear panel](#).

- ▶ To connect the RF cable with the RF 50Ω connector, proceed as follows:
 - a) Carefully align the connector of the cable and the RF 50Ω connector along a common axis.
 - b) Mate the connectors along the common axis until the male pin of the connector of the cable engages with the female socket of the RF 50Ω connector.

3.10 Switching on or off

The following table provides an overview of power states, LEDs and power switch positions.

Table 3-2: Overview of power states

State	LED	Position of power switch
Off	● gray	[0]
Standby	● orange	[1]
Ready	● green	[1]

To switch on the R&S SGU

The R&S SGU is off but connected to power. See [Chapter 3.6, "Connecting to power"](#), on page 22.

1. Set the switch on the power supply to position [1].
The switch is on the [rear panel](#).
The LED of the [POWER ON/STANDBY] key is orange.
2. Press the [POWER ON/STANDBY] key.
Key and LED are on the [front panel](#).
The LED changes to green. The R&S SGU boots.

When starting for the first time, the R&S SGU starts with the default settings. When restarting the instrument, the settings depend on the instrument configuration before shut-down.

See [Chapter 8.1.1, "File menu"](#), on page 59.

To perform functional checks

When the instrument is switched on, it automatically monitors main functions. You can query erroneous functions.

See [Chapter 14, "Error messages and troubleshooting"](#), on page 223.

To switch between standby and ready state

- ▶ Press the [POWER ON/STANDBY] key briefly to switch the instrument from the standby to ready state or vice versa.

In ready state, the button is green. The instrument is ready for operation. All modules are power-supplied and the R&S SGU initiates its startup procedure.

In standby state, the button is orange. The standby power mode keeps the power switch circuits and the remote control system active.

To start up and boot

The instrument boots the operating system and starts the instrument firmware. During the booting process, the green [POWER ON/STANDBY] key blinks. If the previous session was terminated regularly, the instrument uses the last setup with the relevant instrument settings.

Once the startup procedure has been terminated, the instrument is ready for operation.



In the R&S SGMA-GUI, select "Instrument > Preset" function to return the instrument to its defined reset/preset state, if the current setup is no longer relevant.

To customize the start settings, use the "SGMA-GUI > File > Save As/Open" function.

To shut down the product

The product is in the ready state.

- ▶ Press the [POWER ON/STANDBY] key.

The operating system shuts down. The LED changes to orange.

In standby state, the power switch circuits are active. To deactivate them, disconnect the instrument from the power supply.

To disconnect from power

The R&S SGU is in the standby state.

1. **NOTICE!** Risk of data loss. If you disconnect the product from power when it is in the ready state, you can lose settings and data. Shut it down first.

Set the toggle switch on the power supply to position [0].

The LED of the [POWER ON/STANDBY] key is switched off.

2. Disconnect the R&S SGU from the power source.

3.11 Checking default settings

When the instrument is switched on, it is not the preset state that is active, but rather the instrument state that was set before the instrument was switched off. It is recommended that you use the "SGMA-GUI > Instrument > Preset" function to return the

instrument to its defined preset state every time a new configuration is required or the current setup is no longer relevant.

The R&S SGU offers a two-stage preset concept:

- Preset the instrument to a predefined state.
The "SGMA-GUI > Instrument Name > Preset" function calls up a defined instrument setup. All parameters and switching states are preset. The default instrument settings provide a reproducible initial basis for all other settings. However, functions that concern the integration of the instrument into a measurement setup are not changed.
- Preset the instrument to its factory settings.
The instrument can also be forced to load its default factory settings. To access the corresponding dialog box, select the "SGMA-GUI > Instrument Name > Setup > Factory Preset" function.
For more information and an overview of the settings affected by the factory preset function, see [Chapter 10.8, "Factory preset"](#), on page 117.



User-defined instrument states can be stored and called up using the functions "SGMA-GUI > File > Save As/Open".

3.12 Working with Linux operating system

The instrument uses an embedded Linux operating system, optimally adapted to the instrument.



Accessing the operating system

No access to the operating system is required for normal operation. All necessary system settings can be made in the "Setup" dialog.

3.13 Connecting an external PC and devices

For control and operation, the R&S SGU requires a connection to an external device. The external device, e.g. an external PC, controls the R&S SGU via remote control or manual operation via the R&S SGMA-GUI software installed on the external PC.

Both the remote control and the manual operation of the instrument require an external controller. For the prerequisites and the instructions on how to configure an external controller for remote control, refer to the user manual. A brief introduction to the remote control capabilities is provided in [Chapter 12, "Network operation and remote control"](#), on page 129.

This section gives an introduction on how to configure the external PC for manual operation. See [Chapter 3.13.1, "Installing the R&S SGMA-GUI software"](#), on page 28.

In addition to connecting an external controller, you can connect other external devices, e.g. a memory stick. The following interfaces are on the **rear panel** of the R&S SGU:

- "LAN": [Chapter 3.13.2, "Connecting a remote PC via LAN"](#), on page 30
- "PCIe": [Chapter 3.13.3, "Connecting a controller via PCI Express"](#), on page 33
- "USB In": [Chapter 3.13.4, "Connecting a controller via USB"](#), on page 33

3.13.1 Installing the R&S SGMA-GUI software

The R&S SGMA-GUI software is a graphical user interface program for one or more instruments. It runs on a remote PC.

The R&S SGMA-GUI software is provided as separate installation package for the different operating systems. The latest version of the software together with the release notes is available for download at:

<http://www.rohde-schwarz.com/product/SGU100A.html> > "Downloads" > "Software"

This page always offers the latest information on your R&S SGMA-GUI.

The R&S SGMA-GUI installation package for Windows 64-bit operating system consists of the file `SGMA-GUI_<version_number>.exe`. The version number within the file name (`<version_number>=v.vv.vvv.vv`) varies with each update.

To install the R&S SGMA-GUI, check that your PC and drivers fulfill the following hardware and software requirements.

Table 3-3: Hardware and software requirements

Requirement	Remark
Operating system: Windows 10, 1607 "Anniversary Edition" and later	Install R&S SGMA-GUI on one of the supported operating systems. Also, make sure that Microsoft offers support for the version of the operating system. Note: Any other Windows version or other operating systems are not supported. During installation, the operation system is checked. The installation is terminated if this requirement is not fulfilled.
System type: <ul style="list-style-type: none"> • 64-bit operating system • x64-based or x86-based processor 	You can only run the latest software on a 64-bit operating system.
R&S VISA	VISA drivers can be obtained on the Rohde & Schwarz website: http://www.rohde-schwarz.com/rsvisa
CPU	At least Pentium or compatible, as from 1 GHz (recommended).
VGA color display resolution	At least 800*600 pixels

Installing a new software version

1. Download the R&S SGMA-GUI software.
2. In Windows Explorer, navigate to the download folder of the installation file `SGMA-GUI_v.vv.vvv.vv.exe` (`<version_number>=v.vv.vvv.vv`).

3. Open the installation file using administrator rights.
4. Follow the instructions in the installation wizard.

After the installation of the R&S SGMA-GUI software, two icons will be shown in your Windows menu: one is the standard version and one for which the remote command of the software through SCPIs is disabled. The SCPI disabled version allows you to install and use the R&S SGMA-GUI on other instruments, without interfering with the remote control of the host instrument.

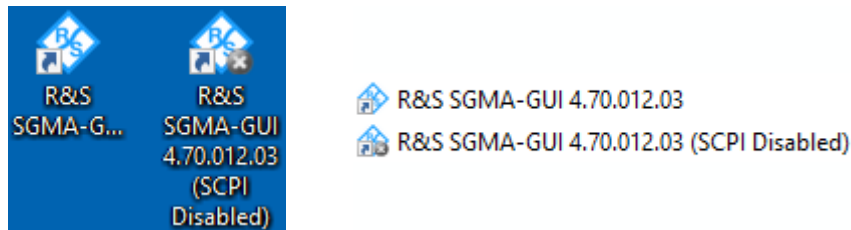

Start the version that is required for your application.

Upgrading to firmware versions 5.00.vvv.vv and later

For upgrading the R&S SGU to firmware versions 5.00.vvv.vv and later, proceed as follows:

1. Download the *.rsu file for R&S SGU firmware version 4.30.046.300.
2. Install this firmware version before installing a firmware version 5.00.vvv.vv and later.
Follow the step-by-step description in the release notes document, see [Chapter 2.3.7, "Release notes and open source acknowledgment \(OSA\)"](#), on page 17.
3. Download and install a firmware version 5.00.vvv.vv and later.
Follow the step-by-step description in the release notes document, see [Chapter 2.3.7, "Release notes and open source acknowledgment \(OSA\)"](#), on page 17.

Uninstalling an old software version

You can uninstall a previous version of the software before the installing a new software version, but this step is not mandatory.

1. To uninstall this version, go to "Start > Settings > Control Panel > Add/Remove Programs".
2. Select the entry `SGMA-GUI_v.vv.vvv.vv`.
The script file identifies and removes all currently installed R&S SGMA-GUI software items.

3.13.2 Connecting a remote PC via LAN

The R&S SGU is equipped with a network interface and can be connected to an Ethernet LAN (local area network). The interface can be used, for example:

- To connect an external computer for manual control of the instrument by the R&S SGMA-GUI software.
- To operate the device by a remote control program.
See [Chapter 12, "Network operation and remote control"](#), on page 129.

This section describes how to configure the LAN interface. It covers the following topics:

- [Connecting to the network](#)..... 30
- [Assigning the IP address](#)..... 31
- [Adding instruments to R&S SGMA-GUI](#).....32

3.13.2.1 Connecting to the network

There are two methods to establish a LAN connection to the instrument:

- A non-dedicated network (Ethernet) connection from the instrument to an existing network.
- A dedicated network connection (Point-to-point connection) between the instrument and a single computer.

In both cases, an IP address has to be assigned to the instrument and the computer, see [Chapter 3.13.2.2, "Assigning the IP address"](#), on page 31.

Setting up a non-dedicated network (LAN) connection

- ▶ See [Chapter 3.7, "Connecting to LAN"](#), on page 23.

Setting up a dedicated network connection

If your network does not support DHCP, set a dedicated network connection between a stand-alone PC and a R&S SGU.

Prerequisite: The external PC and the R&S SGU are turned on and running.

1. Start the R&S SGMA-GUI.
2. **NOTICE!** Risk of network failure.
Consult your network administrator before performing the following tasks:
 - Connecting the instrument to the network
 - Configuring the network
 - Changing IP addresses
 Errors can affect the entire network.
Connect the computer and the R&S SGU with a LAN network cable.
3. Wait for about one minute for the automatic assignment of IP addresses to complete.
4. R&S SGMA-GUI main panel, select "Setup > Instruments".

5. In the "Configure Instruments" dialog, click "Scan".
The new instrument appears with a Zeroconf IP address 169.254.xx.yy.
6. To assign a static IP address to the instrument, see ["Assigning a static IP address to the R&S SGU"](#) on page 31.
7. To assign a static IP address to the PC, see ["Assigning a static IP address to your Windows-PC network card"](#) on page 32.
8. To edit the instrument settings, see [Chapter 8.4.2.6, "How to edit instruments"](#), on page 76.

3.13.2.2 Assigning the IP address

Depending on the network capacities, the TCP/IP address information for the instrument can be obtained in different ways.

- If the network supports dynamic TCP/IP configuration using the Dynamic Host Configuration Protocol (DHCP), all address information can be assigned automatically.
- If the network does not support DHCP, the instrument tries to obtain the IP address via Zeroconf (APIPA) protocol. If this attempt does not succeed or if the instrument is set to use, alternate TCP/IP configuration, the addresses must be set manually, see ["Setting up a dedicated network connection"](#) on page 30.



The R&S SGU uses the Zeroconf IP addresses 169.254.xxx.yyy, where xxx takes values between 1...254 and yyy the values in the value range 1...255; the subnet mask is always 255.255.0.0. The IP address of the host must be within the same address area for Zeroconf.

Assigning a static IP address to the R&S SGU

Prerequisites: A connection is established between the R&S SGU and the controller with installed SGMA-GUI.

For how to set up a LAN connection, see [Chapter 3.13.2.1, "Connecting to the network"](#), on page 30.

For how to set up a USB connection, see ["Setting up a USB connection from a PC to the R&S SGU"](#) on page 33.

1. Open "SGMA-GUI > Instrument > Setup > Network Settings" dialog.
2. Set the "Address Mode" to "Static".
3. Enter the "IP Address", for example *192.168.0.1*.
4. Enter the "Subnet mask", for example *255.255.255.0*.
5. Enter the "Default Gateway", for example *192.168.0.1*.

Assigning a static IP address to your Windows-PC network card

1. Obtain the IP address and subnet mask for the R&S SGU and the IP address for the local default gateway from your network administrator. If necessary, also obtain the name of your DNS domain and the IP addresses of the DNS and WINS servers on your network. If you use more than one LAN connector, you need separate address information for each connector.
2. Press the "Windows" key to access the operating system.
3. Open the "Control Panel" by selecting "Start > Settings > Control Panel".
4. Select "Network and Sharing Center".
5. In the left panel, click "Change adapter settings".
6. Select the network adapter that you want to change. Click "Change settings of this connection".
7. On the "Networking" tab, click "Internet Protocol Version 4 (TCP/IPv4)". Select "Properties".
8. Select "Use the following IP address".
9. Enter the address information as obtained from the network administrator.
10. If necessary, you can also select "Use the following DNS server addresses" and enter your own DNS addresses.

For more information, refer to your Windows system help.

3.13.2.3 Adding instruments to R&S SGMA-GUI



For information on how to install the R&S SGMA-GUI software, refer to [Chapter 3.13.1, "Installing the R&S SGMA-GUI software"](#), on page 28.

1. For each new instrument perform the following steps:
 - a) Connect the instrument to the network.
 - b) Press the [POWER ON/STANDBY] key to switch on the instrument.
 - c) Wait until the [POWER ON/STANDBY] LED is green and not blinking.
 - d) Press the [ID] key on the front panel of the instrument.
2. Start the SGMA-GUI on a computer connected to the same network.
3. Open the "Instruments" dialog.
4. Select "Scan".

Note: This step is performed automatically on the first start and can also be omitted for instruments with a direct LAN connection to the computer.

All instruments are added automatically to the main panel of the SIGMA-GUI.

3.13.3 Connecting a controller via PCI Express

Using the "PCIe" interface for remote control of the R&S SGU requires extended knowledge. See [Chapter 12.3, "Advanced remote control using PCIe"](#), on page 140.

3.13.4 Connecting a controller via USB

The USB interface on the rear panel of the R&S SGU allows you to connect either a USB device or use the R&S SGU as a device and connect it to a controller.

Connecting a controller (host PC or compatible signal generator)

If you connect a controller (host PC or compatible signal generator) to the R&S SGU, the R&S SGU acts as a USB device.

To connect the controller to the USB interface of the R&S SGU, always connect the **USB type Micro-B** connector to the R&S SGU. Refer to the documentation of the controller to find out which USB connector type you can connect to the controller.

The [Figure 3-1](#) illustrates schematically the required connector type to emphasize on the different connector shape.

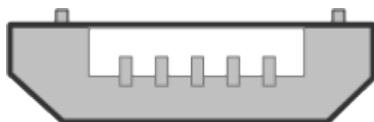

Figure 3-1: USB type Micro-B connectors

An external PC with installed R&S SGMA-GUI is required for manual operation of the R&S SGU.

Setting up a USB connection from a PC to the R&S SGU

If your network does not support DHCP, you can set a USB connection between a PC and a R&S SGU.

Prerequisite: the computer and the R&S SGU are turned on and running.

1. Start the R&S SGMA-GUI.
2. Connect the computer and the R&S SGU with a USB cable.

In the "Setup > Instruments > Configure Instruments" table, the new instrument appears automatically.
If it does not appear, open the "Setup > Instruments > Configure Instruments" dialog and select "Scan".
3. If your network does not support DHCP, you can now set a static IP address to your computer.
 - a) To assign a static IP address to the instrument, see ["Assigning a static IP address to the R&S SGU"](#) on page 31.

- b) To assign a static IP address to the PC, see ["Assigning a static IP address to your Windows-PC network card"](#) on page 32.
- c) To edit the instrument settings, see [Chapter 8.4.2.6, "How to edit instruments"](#), on page 76.

Connecting a USB device

If you connect a USB device (memory stick, CD-ROM, an instrument) to the R&S SGU, the R&S SGU acts as a host.

To connect a USB device to the interface of the R&S SGU, always connect the **USB type Micro-A** connector to the R&S SGU. Refer to the documentation of the USB device to find out which USB connector type you can connect to the USB device.

The [Figure 3-2](#) illustrates schematically the required connector type to emphasize on the different connector shape.

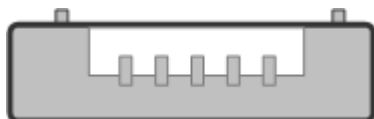

Figure 3-2: USB type Micro-A connectors

If you connect an R&S SGS to an R&S SGU via a USB cable, perform the steps as described in [Chapter 7.2, "Connecting an R&S SGS and an R&S SGU"](#), on page 51.



Using a USB adapter

You can use a USB adapter to customize the connectors of a USB cable to the requirements of the instrument.

For example, use a Type-A / Micro-A adapter to customize a standard USB cable. The customized cable connects type A and type Micro-B connectors for the connection of an R&S SGS (acting as a host) to an R&S SGU (acting as a USB device).

Also, you can use a Type-A / Micro-B adapter to establish a connection to the instrument. To check, whether the adapter you have is suitable or not you can connect a USB stick with an LED through the adapter to the instrument. If the LED of the USB stick lights up after a connection to the instrument then you can use this adapter for further applications with the instrument.

4 Instrument tour

This chapter explains the control elements and the connectors of the R&S SGU. The views of the front panel and the rear panel help you to get familiar with the instrument and to perform first steps. For specifications of the interfaces, see the data sheet.

The meanings of the labels on the R&S SGU are described in [Chapter 1.2, "Labels on R&S SGU"](#), on page 13.

4.1 Front panel tour

This section provides an overview of control elements on the front panel of the R&S SGU. The front panel contains LEDs to inform you about the status of the instrument, in particular for remote control of the R&S SGU.

The connectors of the R&S SGU are on the [rear panel](#).



Figure 4-1: R&S SGU front panel controls

- 1 = [POWER ON/STANDBY]
- 2 = [RF ON]
- 3 = [LO IN]
- 4 = [ERROR / WARNING]
- 5 = [LAN]
- 6 = [ID]

[POWER ON/STANDBY]

The [POWER ON/STANDBY] key switches the instrument from the standby to the ready state or vice versa.

The LED above the [POWER ON/STANDBY] key indicates the instrument state, see [Table 3-2](#).

How to:

- [Chapter 3.10, "Switching on or off"](#), on page 25
- ["To switch between standby and ready state"](#) on page 26

[RF ON]

The [RF ON] key switches the RF signal on or off. If activated, the key is green.

Table 4-1: Overview of RF signal states

[RF ON] state	LED	Remark
On	● green	RF signal output at the RF 50Ω connector.
Off	● gray	No RF signal output.

How to: [Chapter 3.8, "Connecting to RF 50Ω"](#), on page 23

[LO IN]

The [LO IN] LED indicates the compatibility of the level of the local oscillator (LO) input signal with the correct operation of the R&S SGU.

Table 4-2: Overview of local oscillator input signal states

[LO IN] state	LED	Remark
Correct LO input	● green	The level of the LO input signal is in the range of correct operation.
Error	● red	The level of the LO input signal is too high or too low.
Off	● gray	The R&S SGU is in a bypass mode.

[ERROR / WARNING]

The [ERROR / WARNING] LED indicates the status of the R&S SGU.

Table 4-3: Overview of [ERROR / WARNING] key states

[ERROR / WARNING] state	LED	Remark
Error	● red	Error occurred, e.g. temperature exceeded or power failure.
Running process	✳ blinking orange	Indicates a running process (e.g calibration, self-test).
No error	● gray	No errors or warnings occurred.

See also [Chapter 14, "Error messages and troubleshooting"](#), on page 223.

[LAN]

The [LAN] key indicates the LAN connection state.

Pressing the [LAN] key resets the network settings, e.g., "IP Address Mode" is reset to "DHCP".

Table 4-4: Overview of LAN connection states

[LAN] state	LED	Remark
Connected	● green	Connected to the network.
Running process	✳ blinking orange	Resets the network settings, applies the default settings.
Error	● red	Network error occurred.
Off	● gray	The internal reference signal is used.

How to:

- [Chapter 3.7, "Connecting to LAN"](#), on page 23
- [Chapter 3.13.2, "Connecting a remote PC via LAN"](#), on page 30

[ID]

The [ID] key allows you to identify your R&S SGU, e.g. in complex test setups with more instruments.

The following applies if the R&S SGU is connected to a remote controller with R&S SGMA-GUI installed:

- Press the [ID] key identify your R&S SGU on the remote controller. In the dialog "SGMA-GUI > Setup > Instruments > Configure Instruments > Edit Instrument", the R&S SGU is active.
- Set "Edit Instrument > Device Identify > On" to identify your R&S SGU from the remote controller. The LED of the [ID] key is orange and blinking.

Table 4-5: Overview of [ID] key states

[ID] state	LED	Remark
Identification	🔦 blinking orange	Identification of the R&S SGU.
Off/Inactive	● gray	No identification.

4.2 Rear panel tour

This section provides an overview of the connectors on the rear panel of the instrument. For technical data of the connectors, refer to the data sheet.

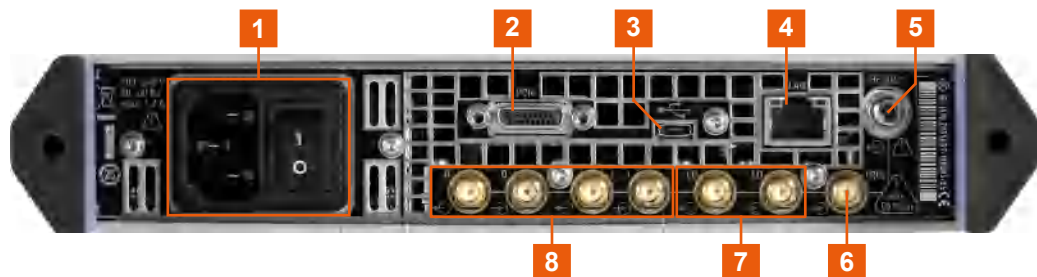

Figure 4-2: R&S SGU rear panel controls and connectors

- 1 = AC power supply connector and power switch
- 2 = PCIe
- 3 = USB In
- 4 = LAN
- 5 = RF 50Ω
- 6 = TRIG
- 7 = LO IN, LO OUT
- 8 = I/Q

AC power supply connector and power switch

Mains power switch for performing the following tasks:

- Connecting the internal power supply to the power source
- Disconnecting the internal power supply from the power source

How to: [Chapter 3.6, "Connecting to power"](#), on page 22

LAN

RJ-45 connector to connect the R&S SGU to a LAN for remote control.

How to:

- [Chapter 3.7, "Connecting to LAN"](#), on page 23
- [Chapter 3.13.2, "Connecting a remote PC via LAN"](#), on page 30

If the instrument acts as an extension to a signal generator, to an R&S SGS for instance, the LAN interface can also be used for remote control of the R&S SGU.

See also [Chapter 7.1.3, "Controlling the R&S SGU with an R&S signal generator"](#), on page 51.

PCIe

PCIe (Peripheral Component Interconnect Express) single lane interface for remote control with optimized speed.

How to: [Chapter 12.3.4, "Connecting the controller and the instrument"](#), on page 144.

USB In

USB (universal serial bus) type Micro-B connector for remote control via various external devices.

How to: [Chapter 3.13.4, "Connecting a controller via USB"](#), on page 33

RF 50Ω

K-type female connector for output of the RF signal.

How to: [Chapter 3.8, "Connecting to RF 50Ω"](#), on page 23

LO IN, LO OUT

SMA type connectors for local oscillator input and output signals and alternatively also in MIMO setups.

Local oscillator input and output:

- "LO IN": Input for external LO signals
- "LO OUT": Output of internal LO signals.

How to: ["To connect to screwable connectors"](#) on page 24

TRIG

SMA female multipurpose connector for input and output signals, e.g., for the following signals: "Trigger", "Marker 1/2", "Clock In/Out", "Sync In/Out".

Also, use the "TRIG" connector for input of an external pulse modulator signal.

How to: ["To connect to screwable connectors"](#) on page 24

I/Q

Requires R&S SGU-B120V/-B140V.

SMA female type connectors for input and output of I/Q signals.

"I/Q In" connectors are for input of external analog I/Q signals. The signals are fed directly into the I/Q modulator.

"I/Q Out" connectors are for direct output of analog I/Q signals.

How to: ["To connect to screwable connectors"](#) on page 24

5 Trying out the Instrument

If an R&S SGU is connected to a signal generator, the instrument acts as an extension to the signal generator extending its frequency range.

This section provides an example on how to configure the instrument to convert a continuous wave (CW) signal.

5.1 Extending R&S SGS with the R&S SGU

If you connect the R&S SGU to a compatible Rohde & Schwarz signal generator, you need a controller. This controller talks to the signal generator and configures the R&S SGU.

In the following example, the instrument the R&S SGMA-GUI software controls an R&S SGS and an R&S SGU. The R&S SGU is equipped with the frequency option R&S SGU-B120.

Configuring the R&S SGU

This step-by-step instruction describes how to configure the R&S SGU to upconvert a CW signal. As a prerequisite for this example the R&S SGMA-GUI software has to be installed on a remote PC.

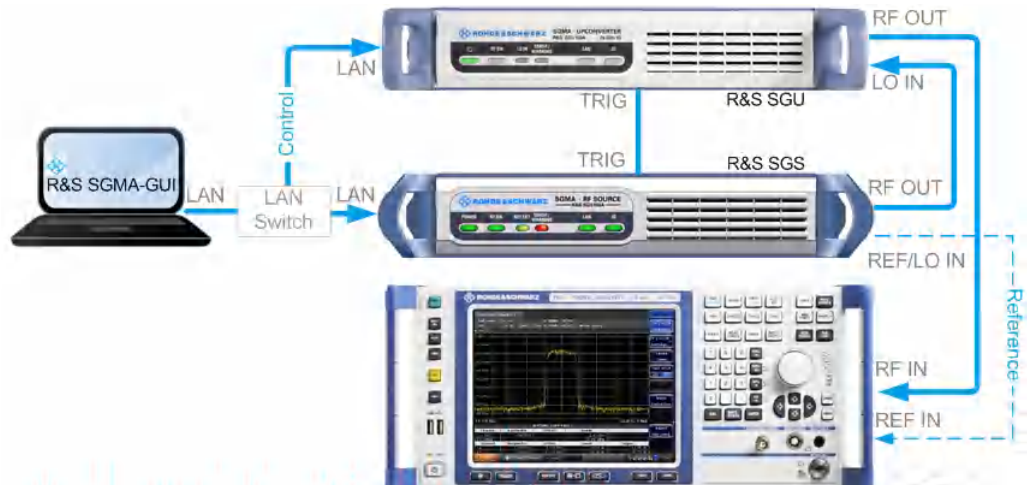

Figure 5-1: Example of a test setup for upconverting a CW signal generated by the R&S SGS



For higher setting/ measuring speeds, use a PCIe switch and PCIe connections.

1. Connect the test equipment as shown on [Figure 5-1](#):
 - a) Connect the R&S SGS, R&S SGU and the controller to a LAN switch.
 - b) Connect the "RF 50Ω" of the R&S SGS to the "LO IN" of the R&S SGU.

- c) Connect the "TRIG" connectors of the R&S SGS and the R&S SGU.
 - d) Connect the "RF 50Ω" of the R&S SGU to the RF input connector of the signal analyzer.
2. Switch on the R&S SGS and the R&S SGU.
Wait until the [POWER ON/STANDBY] keys are **green** and not blinking.
 3. If connected in a company network, press the [ID] keys on the front panels of the R&S SGS and the R&S SGU.
 4. On the connected remote PC, start the R&S SGMA-GUI software application.

The main panel of the application and the configure instruments dialog open. Both instruments are added automatically to the instruments list and to the main panel of the R&S SGMA-GUI software.

The main panel provides a quick access to the main settings of the configured and activated instruments. The display shows one row per instrument with the instrument-specific settings. The rows comprise the instrument, the connection state, the used frequency and power level and the state of the RF output and the modulator.

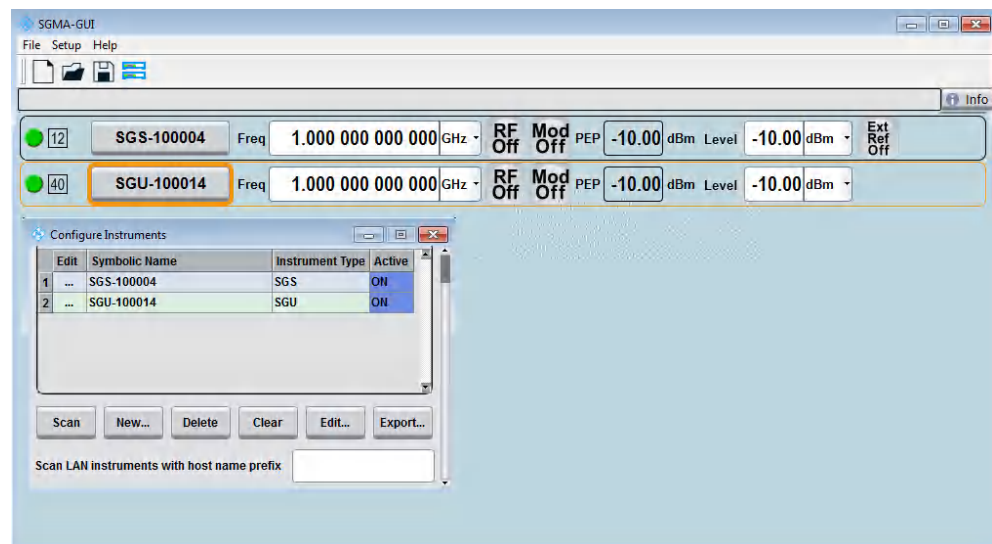

In the R&S SGMA-GUI main panel, the green indicator indicates a connection between the instrument and the remote PC. It also indicates that the software recognizes the instrument.

5. To restore the default configuration of this instrument, select "Instrument Name > Preset".
6. Select "SGMA-GUI main panel > R&S SGS > Extension".
The "Extension" dialog opens.

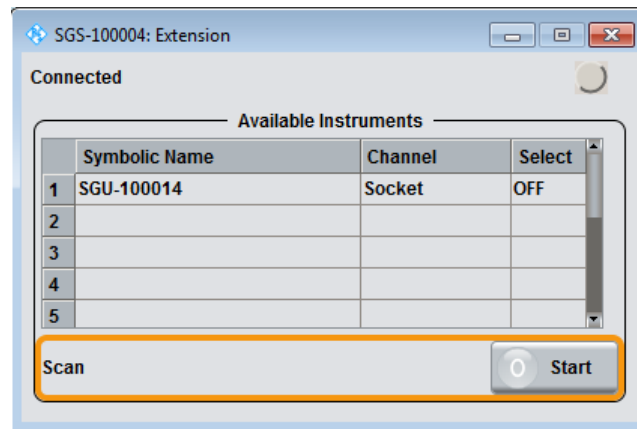

Tip: Instrument does not appear in the extension dialog. If the R&S SGU is not automatically shown in this dialog, press "Scan > Start" to find the instrument.

7. Select the R&S SGU from the list.
8. Set "Available Instruments > Select > On" to enable it as an extension.

A green status indicator "Connected" indicates the successfully established remote connection between the R&S SGS and the R&S SGU. The R&S SGMA-GUI indicates the extended frequency range of the R&S SGS and the activated extension mode.

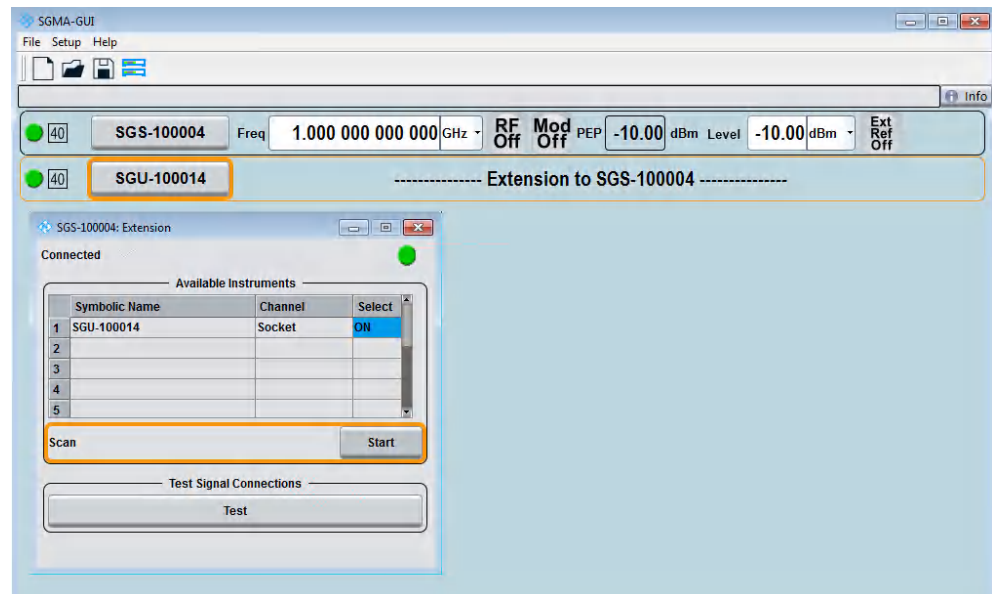

9. Select "Test Signal Connections > Test" to trigger a check of all required signal connections.

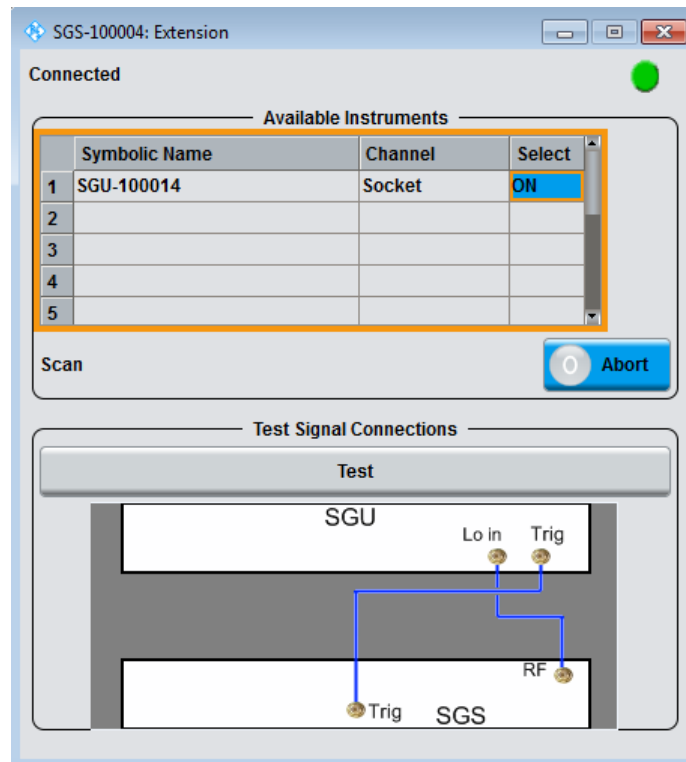

The diagram displays the connection state of the tested connections.

10. Select "SGMA-GUI > R&S SGS > Freq = 40 GHz", "Lev = -30 dBm".
11. Select "SGMA-GUI > R&S SGS > RF > State > On" to enable the output of the CW signal.

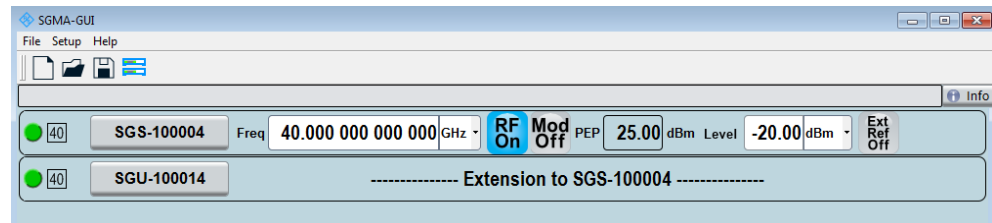

The extension adopts these values and states automatically. Also, it generates a CW signal with RF = 40 GHz and Level = -20 dBm.

The signal is output at the "RF 50Ω" connector on the rear panel of the R&S SGU.



Identifying a specific instrument

If several instruments are active in the R&S SGMA-GUI, use one of the device identification functions to identify a specific device:

- Select "SGMA-GUI > Instrument Name > Setup > Remote > Remote Channels > Device Identify". On the front panel, the LED of the [LAN] key is green and blinks.
- Press the [ID] key on the instrument's front panel. The "Edit Instrument" dialog of the respective instrument opens.

5.2 R&S SGU as a Standalone Upconverter

This section provides an example on how to configure the instrument to convert a continuous wave (CW) signal. The signal in this example is provided by an incompatible signal generator (local oscillator).

In the following example, the instrument is manually operated via the R&S SGMA-GUI software. The R&S SGU in this example is a base unit equipped with the frequency option R&S SGU-B120.

Configuring the R&S SGU to convert a CW signal

As a prerequisite for this example, the R&S SGMA-GUI software has to be installed on a remote PC and the local oscillator has to be prepared for use.

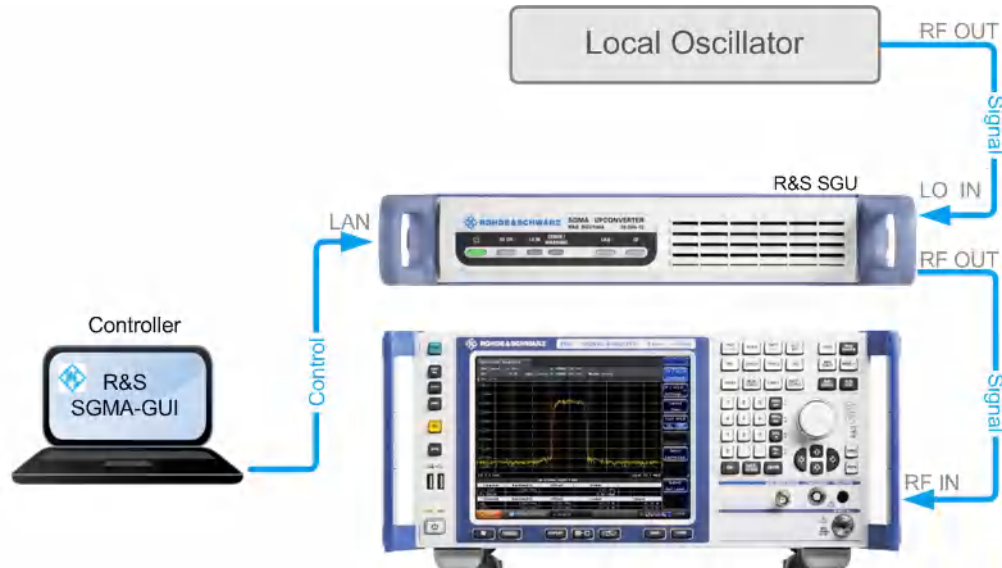

Figure 5-2: Example of a setup of the R&S SGU as an upconverter

1. Connect the test equipment as shown in [Figure 5-2](#). Additional connections may be needed to fulfill the requirements of the connected local oscillator. To find out what connections are needed refer to its user manual.
2. Switch on the R&S SGU.

The [POWER ON/STANDBY] key has to be **green** and not blinking.

3. Press the [ID] key on the front panel the R&S SGU (only required if the components are connected via a company network).
4. On the connected remote PC, start the R&S SGMA-GUI software application.

The main panel of the application and the configure instruments dialog open. The R&S SGU is added automatically to the instruments list and to the main panel of the R&S SGMA-GUI software.

The main panel provides a quick access to the main settings of the configured and activated instruments. The display shows one row per instrument with the instrument specific settings. The rows comprise the instrument, the connection state, the used frequency and power level and the state of the RF output and the modulator.

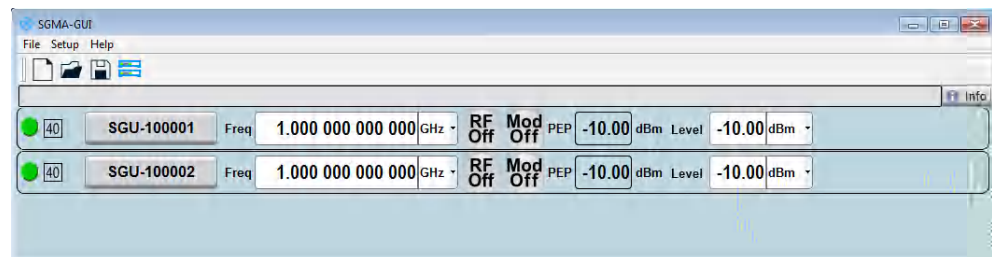

5. In the R&S SGMA-GUI main panel, the green indicator in front of the instrument's name confirms that there is a connection between the instrument and the remote PC and that the instrument is recognized by the software.
6. In the R&S SGMA-GUI main panel, select the row corresponding to the instrument to be configured and select "Instrument Name > Preset" to restore the predefined instrument's settings.

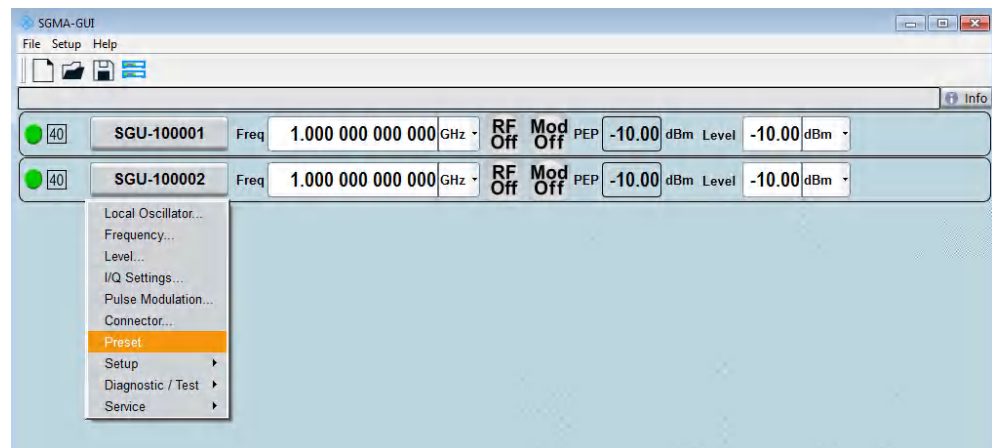

7. Select "SGMA-GUI > R&S SGU > Freq = 15 GHz", "Lev = -10 dBm", "RF > On".

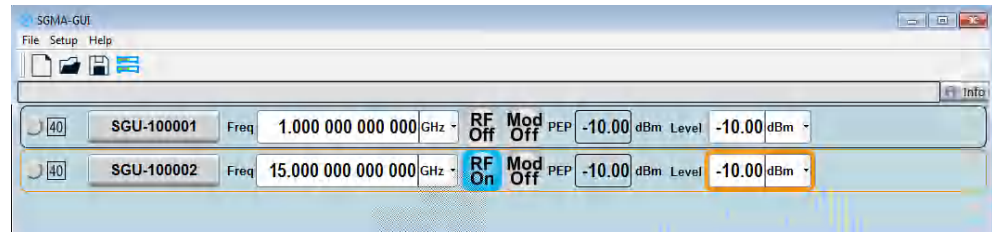

8. Select "SGMA-GUI > Instrument Name > Ext. Local Oscillator". Read the required frequency and level values for the LO.

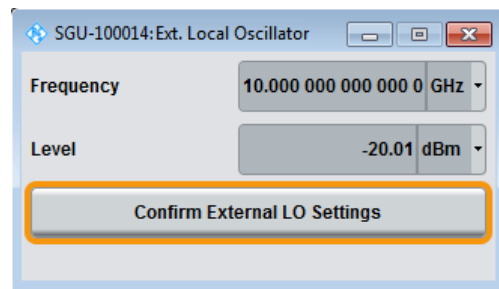

9. Change the settings of the LO to the required values.
10. Select "SGMA-GUI > Instrument Name > Ext. Local Oscillator > Confirm External LO Settings" to apply the changes.

The 15 GHz signal is output at the "REF OUT" connector at the rear panel of the R&S SGU.



Identifying a specific instrument

If several instruments are active in the R&S SGMA-GUI, use one of the device identification functions to identify a specific device:

- Select "SGMA-GUI > Instrument Name > Setup > Remote > Remote Channels > Device Identify". The green [LAN] LED on the front panel of the instrument blinks.
- Press the [ID] key on the instrument's front panel. The "Edit Instrument" dialog of the respective instrument opens.

6 Instrument control

As a rule, the R&S SGU is operated exclusively via programmatic remote control from a connected PC. For service and diagnostic tasks, and for manual configuration, a graphical user interface (R&S SGMA-GUI) is provided which runs on the remote PC.

Also, some basic functionality is provided via the keys on the front panel of the instrument (see [Chapter 4.1, "Front panel tour"](#), on page 35).

6.1 Manual operation via R&S SGMA-GUI

The R&S SGMA-GUI software application can be installed on a PC with Windows or Linux operating system. This program allows you to control several devices of the SGMA product family at the same time and to monitor the device status during remote control. R&S SGMA-GUI requires one of the external interfaces described in [Chapter 3.13, "Connecting an external PC and devices"](#), on page 27.

6.1.1 Introduction to the user interface

After the start of R&S SGMA-GUI, the main dialog of the application is displayed.

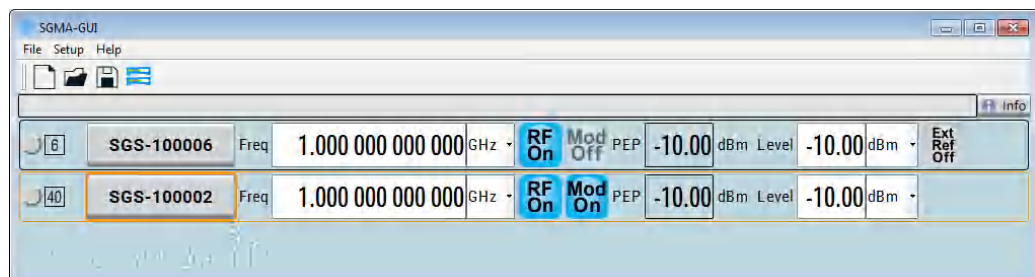

The main dialog with an overview of the configured instruments is the operating and control interface for the whole program. From here, all program functions are accessible.

The menus and dialogs are built using elements like selection lists, check boxes, and entry fields. A blue frame indicates that the selected item is active. Entries can be made in the highlighted element.

The main dialog comprises two main areas:

- On the top of the main panel, there are bars: the menu bar, the tool bar and the info bar with the corresponding "Info" button.
The menu bar provides access to the functions related to the software application itself, like saving current configurations, retrieving information about the installed software version or configuring the connected instruments.
The messages displayed in the info line indicate information, warnings, and errors. They are displayed in different colors depending on their importance and display duration. Use the "Info" button to open a dialog with information on the messages in greater detail.

- The central part of the R&S SGMA-GUI main dialog is the main panel that shows the list of all active instruments.
The main panel is the core element for the manual operation and provides quick access to the main settings of the configured instruments. The display shows one row per active instrument. Each row comprises the instrument's name and state, the used frequency and level, the state of the RF output and the modulator and the kind of used frequency reference.
The buttons with the instrument's symbolic name on it provides access to menus and dialogs for further instrument configuration. Refer to the user manual for a detailed description of all parameters and functions provided for configuration.



A detailed description of the R&S SGMA-GUI, in-depth information on how to work with the application and on how to operate the R&S SGU is provided in the user manual.

6.1.2 How to use the help system

The R&S SGMA-GUI is equipped with a context-sensitive help function. A help page is available for each parameter and can be called anytime during instrument operation.

Calling context-sensitive and general help

- To display the general help dialog box, select the "SGMA-GUI > Help > Contents" or use the F1 key.

The help dialog is displayed. A topic containing information about the current menu or the currently opened dialog box and its function is displayed.

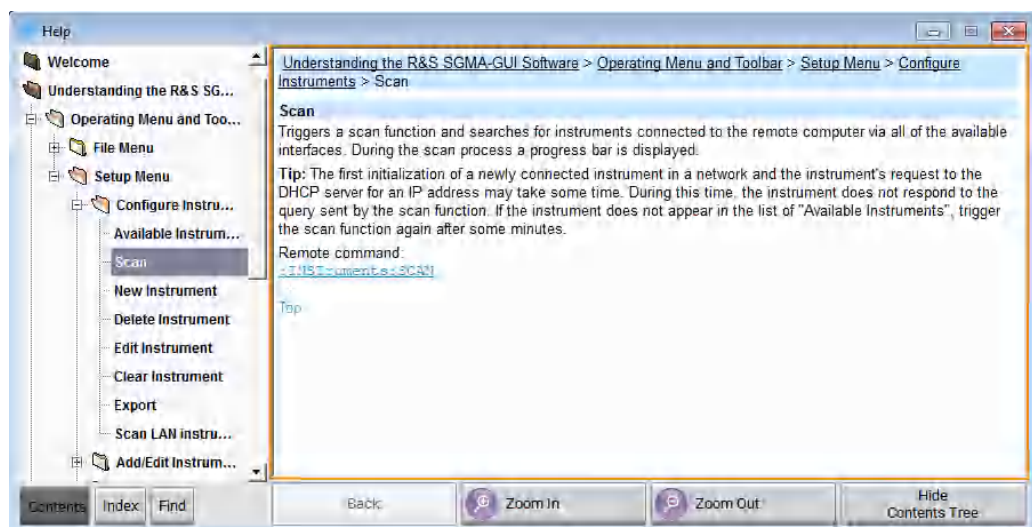

Contents of the help dialog box

The help dialog box contains two main areas:

- "Contents" - contains a table of help contents
- "Topic" - contains a specific help topic

The help system also provides an "Index", "Find" and "Zoom" functions that are accessed with the corresponding buttons.

Navigating in the table of contents and in the help topics

1. To move through the displayed contents entries, use the mouse or the [Up/Down] keys. Entries that contain further entries are marked with a plus sign.
2. To display a help topic, double click on the topic name or press the [ENTER] key.
3. To jump to the linked topic, press the link text.
4. Use the "Previous" or "Next" links to jump to the corresponding topic.
5. Use the "Scroll Right" or "Scroll Left" buttons to shift the indicated area of the navigation window to the left or right.

Using the index

1. Select "SGMA-GUI > Help > Index" or use the "Go to Index" button in the "Help" display.
2. Enter the first characters of the topic that you are interested in. The entries starting with these characters are displayed.
3. Press the [ENTER] key to display the help topic.
The corresponding help topic is displayed.

7 System overview

The R&S SGU is an instrument intended either for the modulation of IQ signals or as an upconverter in the frequency range of 10 MHz to 40 GHz.

Optimized for use in automated test equipment (ATE), the instrument offers fast settling times in an exceptionally small formfactor and low power consumption. The R&S SGU can be equipped optionally with a mechanical step attenuator.

7.1 Setups for instrument control

The R&S SGU is an instrument designed for the automated test equipment (ATE) needs. To maintain the small size, the instrument is not equipped with a display and hence additional equipment is required to control the instrument.

This section provides an overview of the possible configuration setups for controlling the R&S SGU.

7.1.1 Manual operation from the R&S SGMA-GUI

The following example represents a basic configuration of the R&S SGU, operated manually by the configuration software R&S SGMA-GUI. The configuration software is installed on a remote PC and controls several instruments. The instruments are connected to the remote PC over different remote control interfaces. Any combination of the used interfaces is possible.

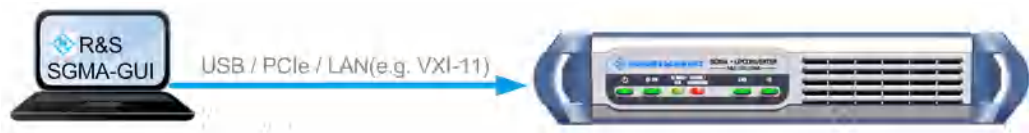

Figure 7-1: Configuration example: manual control from R&S SGMA-GUI



For information about the manual control, refer to:

- [Chapter 8, "Understanding the R&S SGMA-GUI software"](#), on page 58
- [Chapter 9, "Upconverter settings"](#), on page 89
- [Chapter 10, "General instrument settings and instrument setup"](#), on page 105

7.1.2 Remote control from a controller

The remote control provides access to the instrument's settings from a remote computer (external controller) by remote commands. To automate often repeating settings and sequences, these settings are grouped in the remote control programs, i.e. application programs.

An instrument can be connected to the controller via any of the supported interfaces LAN, USB or PCIe.



Figure 7-2: Configuration example: remote control from a controller



For information about remote control, refer to [Chapter 12, "Network operation and remote control"](#), on page 129.

7.1.3 Controlling the R&S SGU with an R&S signal generator

If an R&S SGU is connected to a compatible R&S Signal Generator (e.g. R&S SGS), it extends its frequency range. In this setup, a controller does not need to access the R&S SGU directly. Instead, the compatible R&S Signal Generator acts as a controller to the R&S SGU. The generator performs all required settings automatically depending on the required output signal parameters.

The [Figure 7-3](#) shows a configuration example of the R&S SGU, directly controlled by an R&S SGS. For a detailed description of the connecting possibilities, refer to [Chapter 7.2, "Connecting an R&S SGS and an R&S SGU"](#), on page 51.

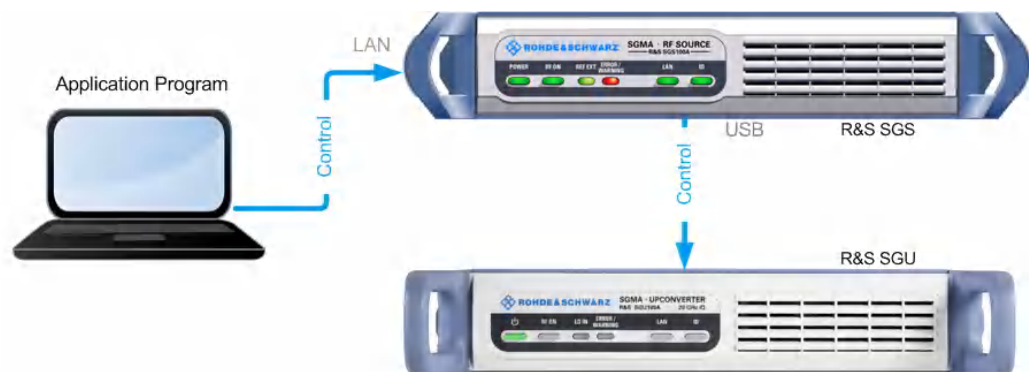

Figure 7-3: R&S SGU as an extension to an R&S SGS

7.2 Connecting an R&S SGS and an R&S SGU

If an R&S SGU is connected to an R&S SGS, the R&S SGU acts as an extension to the R&S SGS extending its frequency range. In this setup, a controller does not need to access the R&S SGU directly. Instead, the R&S SGS acts as a controller to the R&S SGU. The generator performs all required settings automatically depending on the required output signal parameters.

This chapter gives an overview of how to connect the instruments. It covers the following topics.

- [Using a direct LAN connection](#).....52
- [Connecting to a company network](#).....53
- [Connecting via a PCIe switch](#)..... 56

7.2.1 Using a direct LAN connection

The R&S SGS and the R&S SGU can be connected through a direct connection as shown in [Figure 7-4](#).

Direct connection of an R&S SGS and an R&S SGU

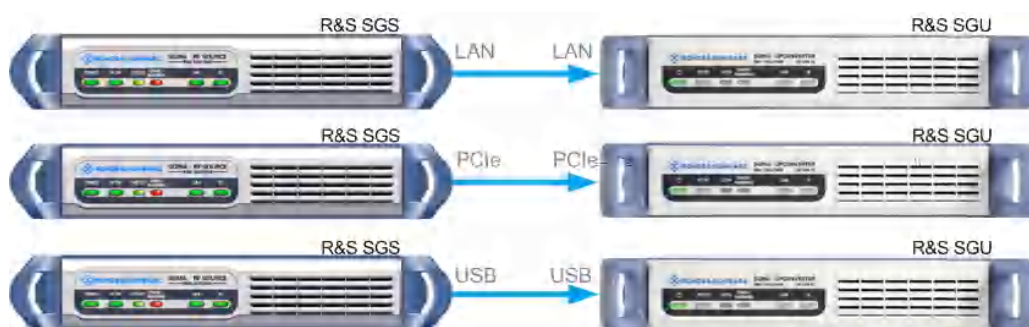

Figure 7-4: Direct connection of an R&S SGS and an R&S SGU

1. Connect the R&S SGS and the R&S SGU directly using one of the following options:
 - a) USB cable. Use a type Micro-A connector for R&S SGS and a type Micro-B connector for R&S SGU. See also [Chapter 3.13.4, "Connecting a controller via USB"](#), on page 33.
 - b) LAN cable.
 - c) PCIe cable. Refer to [Chapter 12.3.4, "Connecting the controller and the instrument"](#), on page 144 for cable requirements and setup information.
2. Switch on the R&S SGS and the R&S SGU.
The R&S SGS automatically identifies the connected R&S SGU as its extension and starts the extension mode.



For a direct PCIe connection, an automatic identification of the R&S SGU as an extension is only available for an R&S SGS with a "Controller > Revision" 5 or higher. For a description on how to set the PCIe identification manually, see [Chapter 11.7, "How to set a PCIe direct connection"](#), on page 127.

You can check the "Controller > Revision" of your instrument in the "SGMA-GUI > Instrument Name > Hardware Config" dialog.



If instrument is not automatically added as an extension

You can do that manually in the "SGMA-GUI > R&S SGS Name > Extension" dialog.

If the R&S SGU is not listed in the list of "Available Instruments", you can press "Scan > Start" to find the instrument.

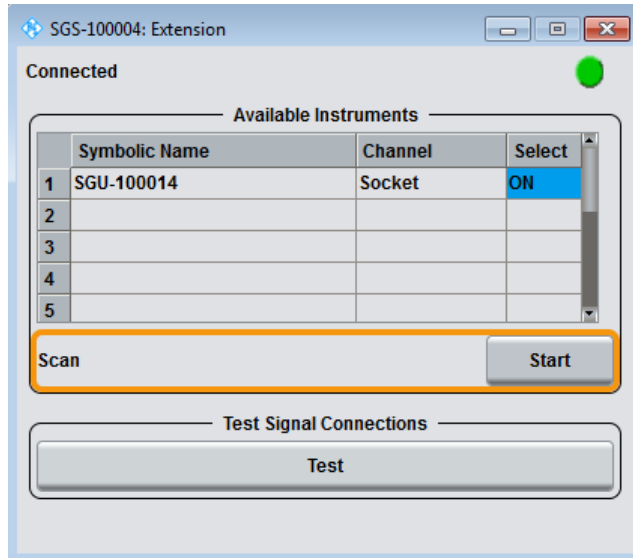

7.2.2 Connecting to a company network

This step-by-step instruction describes how to connect an R&S SGS and an R&S SGU in a company network. As a prerequisite for this example the R&S SGMA-GUI software has to be installed on a remote PC.

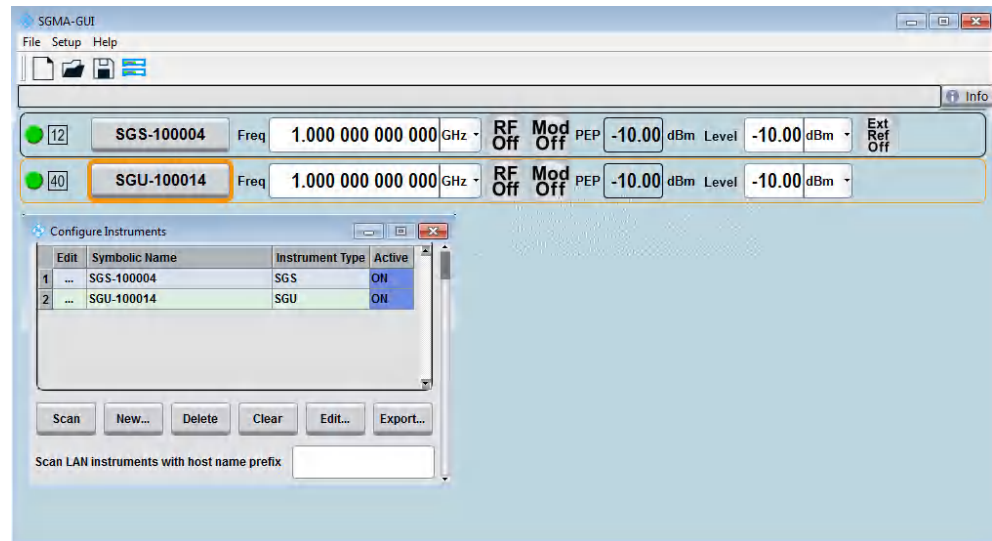

Figure 7-5: Connection of an R&S SGS and an R&S SGU in a company network

1. Connect the test equipment as shown in [Figure 7-5](#):
 - a) Connect the R&S SGS, the R&S SGU and the controller to the company network.
 - b) Connect the "RF 50Ω" of the R&S SGS to the "LO IN" of the R&S SGU.

Connecting an R&S SGS and an R&S SGU

2. Switch on the R&S SGS and the R&S SGU.
Wait until the [POWER ON/STANDBY] keys are **green** and not blinking.
3. Press the [ID] keys on the front panels of the R&S SGS and the R&S SGU.
4. On the connected remote PC, start the R&S SGMA-GUI software application.
The main panel of the application and the configure instruments dialog open. Both instruments are added automatically to the instruments list and to the main panel of the R&S SGMA-GUI software.



Note: If you connect the instruments to the company network for the first time, this process can take several minutes.

5. In the R&S SGMA-GUI main panel, the green indicator in front of the instrument's name confirms that there is a connection between the instrument and the remote PC. Also, it confirms that the software recognizes the instrument.
6. Select "SGMA-GUI main panel > R&S SGS > Extension".

The "Extension" dialog opens.

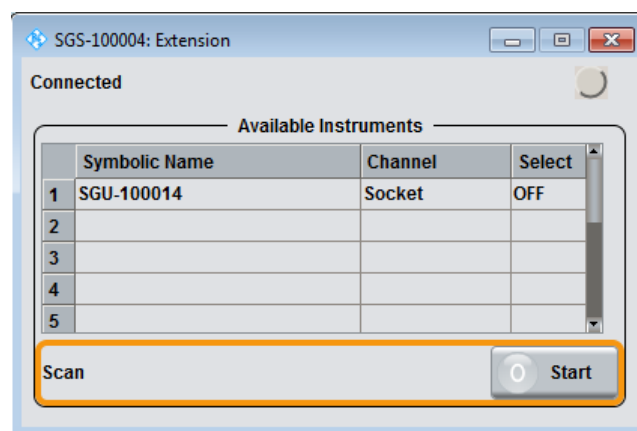

Tip: Instrument does not appear in the extension dialog. If the R&S SGU is not automatically shown in this dialog press "Scan > Start" to find the instrument.

7. Select the R&S SGU from the list.
8. Set "Available Instruments > Select > On" to enable it as an extension.

A green status indicator "Connected" indicates the successfully established remote connection between the R&S SGS and the R&S SGU. The R&S SGMA-GUI indicates the extended frequency range of the R&S SGS and the activated extension mode.

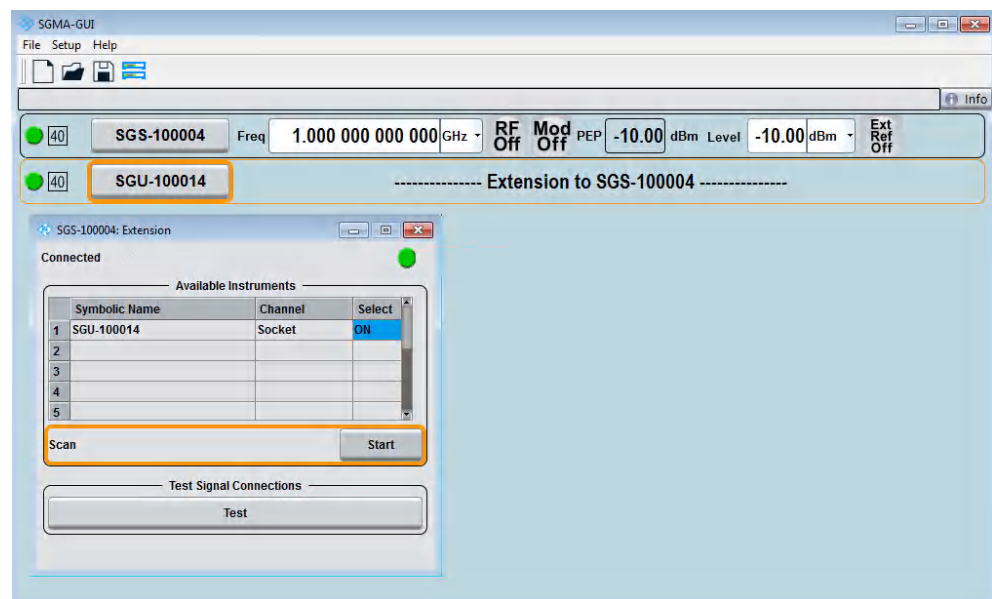

9. Select "Test Signal Connections > Test" to trigger a check of all required signal connections.

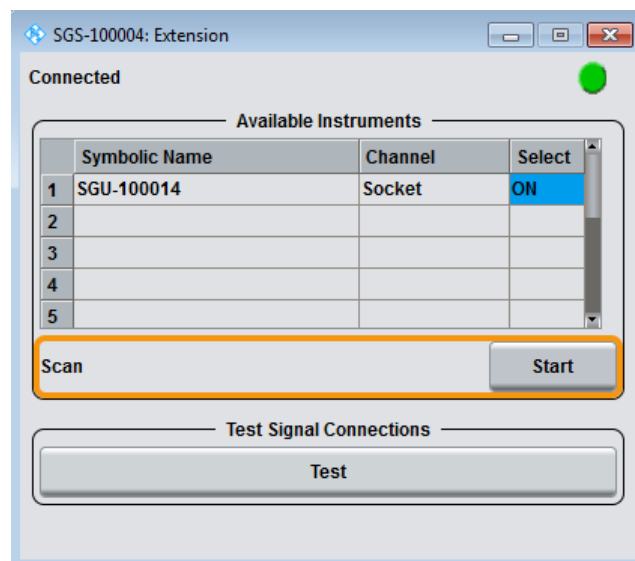

The diagram displays the connection state of the tested signal connections. If the test connections are correct (shown by an uninterrupted blue line), you can start using the R&S SGS and the R&S SGU in extension mode.

Tip: If your connection is marked as faulty, check whether the cables are connected properly. Check also if the connection cables are functioning properly.

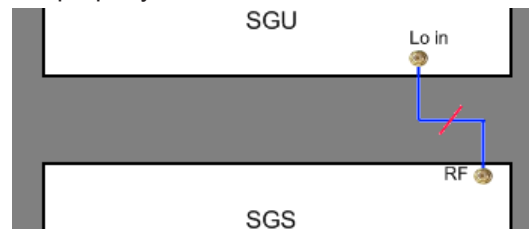

Figure 7-6: A faulty connection between an R&S SGU and an R&S SGS

7.2.3 Connecting via a PCIe switch

The R&S SGS and the R&S SGU can be connected through a PCIe switch as shown in Figure 7-7. This setup is recommended for achieving the highest setting/ measuring speeds.

PCIe switch connection of an R&S SGS and an R&S SGU



Figure 7-7: Connection of an R&S SGS and an R&S SGU through a PCIe switch

1. Connect the PCIe switch to a switched off computer with a single lane PCIe cable.
2. Connect the R&S SGS and the R&S SGU to the PCIe switch.
3. Switch on the R&S SGS and the R&S SGU.
Wait until the [POWER ON/STANDBY] keys are **green** and not blinking.
4. Switch on the computer.
5. On the computer start one of the following:
 - a) The R&S SGMA-GUI
 - b) An application program for remote control of the instruments
6. Manually (or remotely) activate the R&S SGU as an extension to the R&S SGS.



The logical connection between an R&S SGS and an R&S SGU is established by the driver layer of a program (e.g. the R&S SGMA-GUI) or the library PCIeController.dll (Linux: libpciecontroller.so) of a remote control program on the PC. Make sure that such a program runs on the PC so that an R&S SGS is able to communicate with an R&S SGU.

8 Understanding the R&S SGMA-GUI software

This section gives a detailed description of the R&S SGMA-GUI user interface and information on how to work with it. The main panel with the overview of the configured instruments is the operating and control interface for the whole program. From here, all program functions are accessible. This panel is displayed after the start of R&S SGMA-GUI. The software always loads the previously used settings, so you can continue your work in the next session.

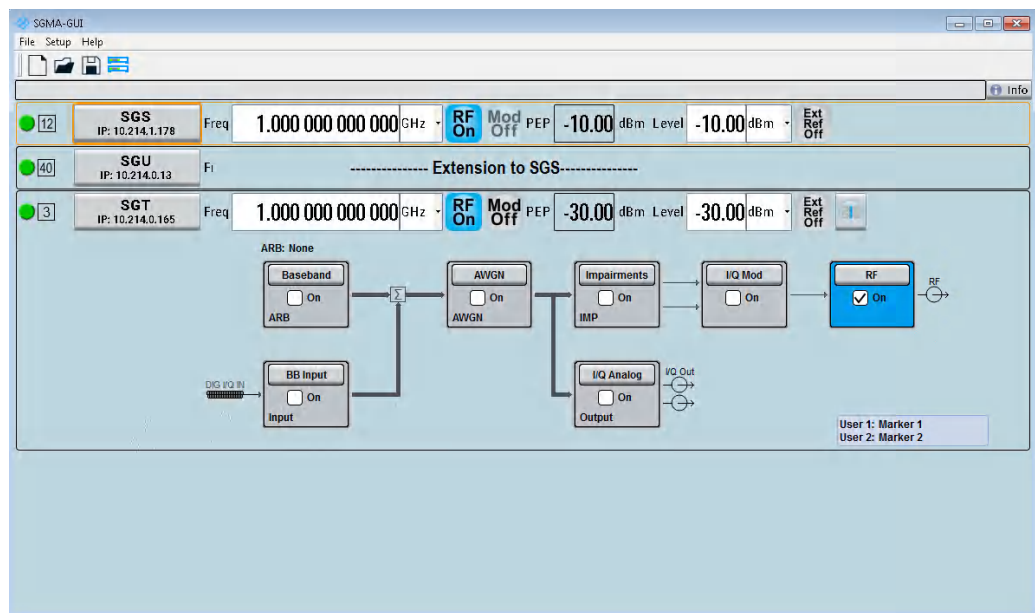



- [Operating menu and toolbar](#)..... 58
- [Info dialog and messages in the info bar](#)..... 68
- [Main panel](#).....70
- [Working with R&S SGMA-GUI](#)..... 73
- [Remote control of R&S SGMA-GUI](#)..... 81

8.1 Operating menu and toolbar

On the top of the main panel, there is the menu bar, the toolbar and the info bar with the corresponding "Info" key. Some of the functions are accessible via the toolbar with its icons below the menu selection line.

The dialogs are built using elements, e.g., selection lists, checkboxes, and entry fields. A blue frame indicates that the selected item is active. In a highlighted element, entries can be made.

Table 8-1: Content of the operating menu

File	Setup	Help
 New	Instruments	About
 Open	Software	Contents
Save	Reset SGMA-GUI	Index
 Save as	Remote	
Exit		
Shut down instruments and exit		

8.1.1 File menu

The R&S SGMA-GUI employs the standard Save/Recall file management function and allows you to save and reload settings in/to a file with a user-defined name and location (see also [Chapter 8.4.1, "Saving and loading settings"](#), on page 73).

In the following, the "File" menu of the R&S SGMA-GUI is described in detail. It incorporates standard functions.

New

Resets R&S SGMA-GUI and all connected instruments to their preset settings.

Open

Opens the standard file open browser for loading a saved R&S SGMA-GUI file (*.savrc1). The file contains the user-specific settings of a session, such as instruments configured in the software. The complete settings of a session can be saved and loaded.

Only files of this type are selectable.

Note: Instrument-specific settings, e.g. frequency and level settings, are saved locally on the particular instrument itself. These instruments settings are saved automatically in a predefined directory and loaded by default when starting the instrument again. The files with instrument settings are not accessible.

Save

Standard quick save of the settings of the current session if a filename previously has been applied. If not, the "Save As" dialog is opened.

Save as

Opens the standard file save browser for saving the settings of the current session. R&S SGMA-GUI files have the file extension .savrc1 so the name typed in is equipped with this extension. The complete settings of a session are saved.

Exit

Quits the R&S SGMA-GUI. The current settings of the instrument's session are saved and loaded by default when starting the software again.

Note: The instruments configured in the R&S SGMA-GUI are not shut down.

Shut down instruments and exit

Quits the R&S SGMA-GUI and switches the connected instruments to the standby state (see also [Chapter 11.3, "How to switch between operating states"](#), on page 123).

8.1.2 Setup menu

Access:

- ▶ Select "SGMA-GUI > Setup"

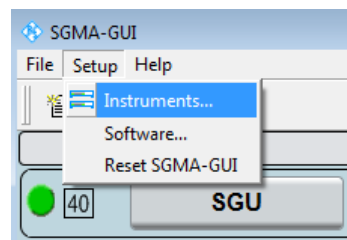

The setup menu provides access to dialogs for setting the general settings of the software, like dialogs for managing the connected instruments or dialogs providing information about the installed options.

Settings

- [Configure instruments](#).....60
- [Add/Edit instruments](#).....64
- [Software](#).....66
- [Reset SGMA-GUI](#).....67
- [Remote](#).....67

8.1.2.1 Configure instruments

This dialog is the central point for managing the instrument that is configured and operated via the R&S SGMA-GUI. New instruments can be created and appended to the list of available instruments. Connection settings can be edited, instruments can be removed from the list or they can be deactivated, but kept in the list for further use.

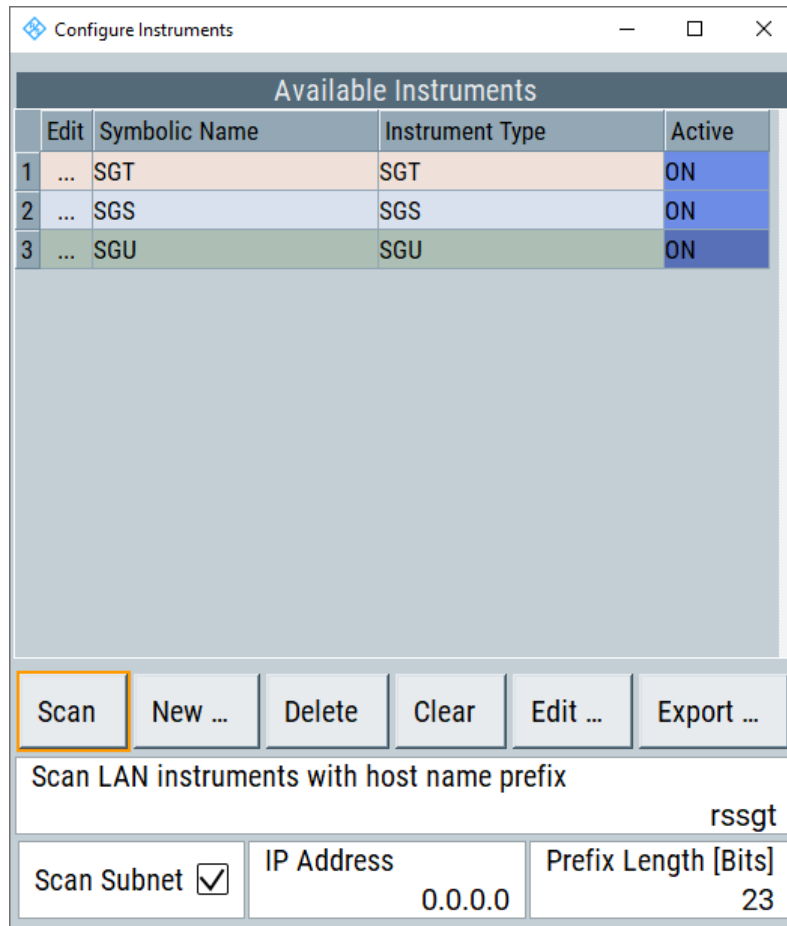

Refer to [Chapter 8.4.2, "Handling instruments in the R&S SGMA-GUI"](#), on page 73 for information on how to configure and manage instruments in R&S SGMA-GUI.

[Available Instruments](#).....61

[Scan](#).....62

[New](#).....62

[Delete](#).....62

[Clear](#).....62

[Edit](#).....62

[Export](#).....62

[Scan LAN instruments with host name prefix](#).....63

[Scan Subnet](#).....63

[IP Address](#).....63

[Prefix Length](#).....63

Available Instruments

This section comprises a list of configured instruments. Each instrument is represented by a "Symbolic Name" which is also displayed in the main panel and an "Instrument Type". It is also displayed whether the instrument is activated in the R&S SGMA-GUI and hence displayed in the main panel or not.

Remote command:

`:INSTRUMENTS:COUNT?` on page 84

`:INSTRUMENTS:NAME` on page 85

`:INSTRUMENTS:TYPE` on page 88

`:INSTRUMENTS:ACTIVE[:STATE]` on page 83

Scan

Triggers a scan function and searches for instruments connected to the remote computer via all the available interfaces. During the scan process, a progress bar is displayed.

Tip: The first initialization of a newly connected instrument in a network and the instrument's request to the DHCP server for an IP address may take some time. During this time, the instrument does not respond to the query sent by the scan function. If the instrument does not appear in the list of "Available Instruments", trigger the scan function again after some minutes.

Remote command:

`:INSTRUMENTS:SCAN` on page 86

New

Calls the [Add/Edit instruments](#) dialog.

Delete

Removes the selected instrument from the list of [Available Instruments](#).

Clear

Removes all instruments from the list of [Available Instruments](#).

Edit

Calls the [Add/Edit instruments](#) dialog.

Export

Opens the standard file save browser for saving the list of the available instruments in a mapping file. The mapping files have the file extension `.map` so the filename typed in is automatically equipped with this extension.

A mapping file provides a cross-reference between the instruments' symbolic names and their respective remote control parameters. The information in the mapping file is grouped in rows, where one row corresponds to one configured instrument. The rows have the following structure:

```
<InstrumentType> <SymbolicName> <IP_Address/Hostname>  
<RemoteChannel> <SerialNumber>
```

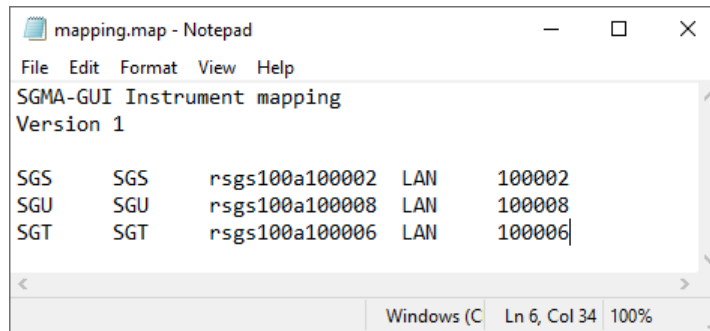

Figure 8-1: Mapping file example

Tip: In a remote control application program, address the instruments by their symbolic names and retrieve the remain required settings from the mapping file. This workflow is especially useful for frequent exchange of instruments.

Remote command:

`:INSTRUMENTS:MAPPING:FILE` on page 85

Scan LAN instruments with host name prefix

Sets the prefix the searched host names begin with. Use this function to limit the amount of the searched instruments and to speed up the scan process.

For example, set this field to "RsSGS, RsSGU, RsSGT", if you want to search for all available instruments.

If your instrument is not listed in the "Available Instruments" dialog, leave the field empty and execute another scan.

Remote command:

`:INSTRUMENTS:SCAN:HNPREFIX` on page 86

Scan Subnet

Activates scanning of the subnet.

If you click "Scan" the scanning procedure includes instruments detected in the subnet.

Remote command:

`:INSTRUMENTS:SCAN:SNET[:STATE]` on page 87

IP Address

Sets the IP address with the subnet.

Remote command:

`:INSTRUMENTS:SCAN:SNET:IPADDRESS` on page 86

Prefix Length

Sets the prefix length in bits.

Remote command:

`:INSTRUMENTS:SCAN:SNET:PLENGTH` on page 87

8.1.2.2 Add/Edit instruments

The dialog provides access to the main instrument's settings, such as "Symbolic Name", "Instrument Type" and connection settings.



Refer to [Chapter 8.4.2, "Handling instruments in the R&S SGMA-GUI"](#), on page 73 for information on how to configure and manage instruments in R&S SGMA-GUI.

Instrument Nr.

Automatically assigned number that indicates the instrument's index in the list of "Available Instruments".

Symbolic Name

Selects the alias name of the instrument.

Remote command:

`:INSTRUMENTs:NAME` on page 85

Instrument Type

Selects the instrument's family.

Remote command:

`:INSTRUMENTs:TYPE` on page 88

Active

Activates/deactivates the display of the instrument's settings in the main panel.

Note: Only instruments in an active state can be controlled from the R&S SGMA-GUI.

Remote command:

[:INSTRUMENTS:ACTIVE\[:STATe\]](#) on page 83

Exclusive Access

Checks whether the instrument is locked by another user and if not locks the instrument.

When an instrument is locked, it is reserved for manual and remote operation. Locking means, that you can operate the instrument **exclusively** from the remote PC on which the R&S SGMA-GUI is running or from which the SCPI command is sent.

For interfaces using VISA, i.e. for LAN and USB, enabling the "Exclusive Access" triggers the standard `viLock` request. For remote control over PCIe or Socket, the lock request is performed on a higher application level.

Tip: We recommend that you lock the instrument before further configuration. Locked instruments are not found by the scan function. Unlock the instrument to allow operation from another remote PC.

Note: The two functions "Exclusive Access" and monitoring are mutually exclusive. Disable "Exclusive Access" if the instrument is monitored by an external PC.

Remote command:

[:INSTRUMENTS:EACCESS\[:STATe\]](#) on page 84

[:LOCK?](#) on page 173

[:UNLOCK](#) on page 174

Device Identity

Triggers the device identification function. The [LAN] LED on the front panel of the selected instrument blinks.

See also [Chapter 8.4.4, "Bidirectional instrument identification"](#), on page 77.

Hardware Channel

Selects the hardware interface used by the remote channel.

Remote command:

[:INSTRUMENTS:REMOte:CHANnel](#) on page 85

Instrument Name / IP Address

Enters the IP address or the host name of the connected instrument.

See also [Chapter 8.4.3, "Finding out the default hostname of the instrument"](#), on page 76.

Remote command:

[:INSTRUMENTS:REMOte:NAME](#) on page 86

GPIB Address

Enters the GPIB address of the connected instrument.

See also [Chapter 12.1.5, "GPIB interface \(IEC/IEEE bus interface\)"](#), on page 137.

Remote command:

[:INSTRUMENTS:GPIB:ADDRESS](#) on page 85

Board Number

Identifies the GPIB bus card of the controller to that the adapter is connected.

See also [Chapter 12.1.5, "GPIB interface \(IEC/IEEE bus interface\)"](#), on page 137.

Remote command:

:INSTRuments:GPIB:BOARD on page 85

Serial Number

Enters the serial number as instrument's identification while using the USB or PCIe interfaces for remote control.

Remote command:

:INSTRuments:SERial on page 87

Ok

Confirms the settings and closes the dialog.

Apply

Confirms the settings.

Cancel

Discards settings and closes the dialog.

8.1.2.3 Software**Querying information about the installed options and software version**

- ▶ Select "Setup > Software".

The "Versions / Options" info dialog opens, showing program information.

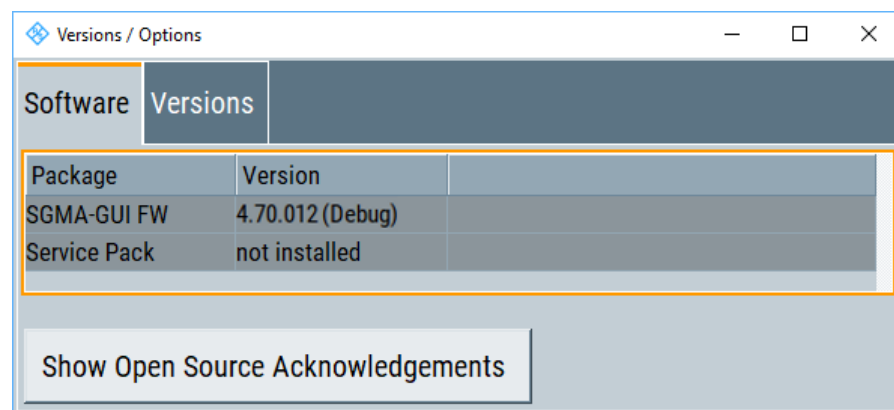
**Software**

Displays information on:

- "Package" Installed software packages.
- "Version" Release of the software package.

Show Open Source Acknowledgments

Accesses the list of the used open source software packages and the corresponding verbatim license texts.

Versions

Shows the installed software platform and its version.

8.1.2.4 Reset SGMA-GUI

Resets R&S SGMA-GUI to its factory preset settings.



The connected instruments are not affected by this preset.

To preset one specific instrument to its factory preset settings, select "SGMA-GUI > Instrument Name > Setup > Factory Preset". Refer to [Chapter 10.8, "Factory preset"](#), on page 117 for an overview of the settings affected by this function.

8.1.2.5 Remote

Access: "SGMA-GUI > Setup > Remote".

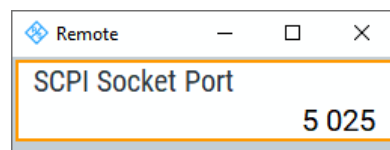
**SCPI Port**

Sets the port number of the LAN interface for remote control with TCP/IP socket protocol.

Set different port numbers to control different software from the same application, e.g. R&S SGMA-GUI and R&S WinIQSIM2.

Remote command:

`:SYSTEM:COMMunicate:SOCKET:PORT` on page 214

8.1.3 Help

The R&S SGMA-GUI is equipped with a context-sensitive help function. A help page can be called anytime during software operation.

The context-sensitive page which is opened with the [F1] key is part of a comprehensive help system.

It is possible to move from this context-sensitive page to any page of the help system. An overview of the contents of the online help can be reached via the menu "SGMA-GUI > Help > Contents".

A search for keywords within the help function is available via menu item "SGMA-GUI > Help > Index".

8.2 Info dialog and messages in the info bar

A few operating states and the current messages are displayed in the info line. For information on messages in greater detail and their management, an "Info" dialog can be opened.

8.2.1 Info dialog

The "Info" dialog provides a list of currently active permanent messages and a detailed description of each message. The messages are color-coded according to their level.

Accessing the info dialog

- ▶ In the "R&S SGMA-GUI main panel", select the "Info" key.

The "Info" dialog opens.

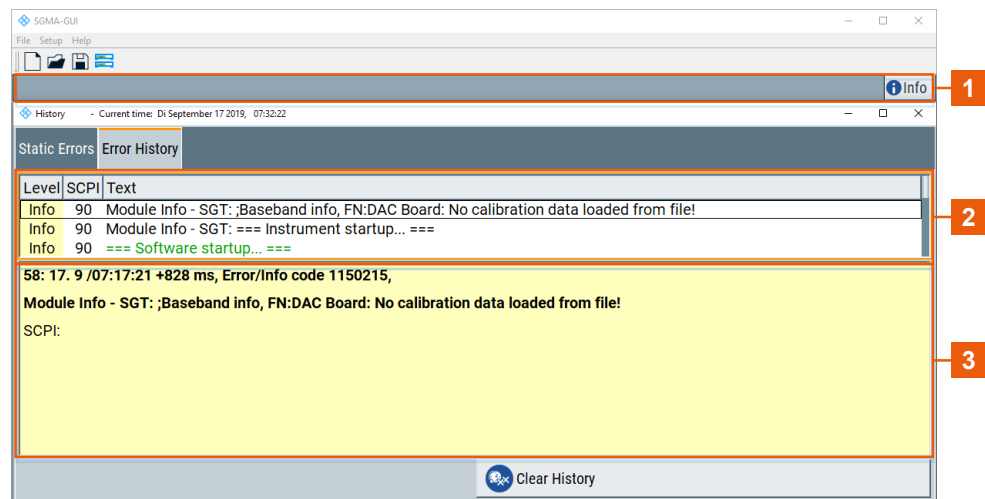

- 1 = Info line
- 2 = List of current messages with short description
- 3 = Detailed description of a selected message

The upper part of the "Info" dialog lists the currently active permanent messages. See the following table for explanation of the displayed information.

Parameter	Description
"LEV"	<p>Message level. Messages referring to a logical component of R&S SGMA-GUI, e.g., Unicode, are marked in red color, info messages are marked in black color.</p> <p>The following level messages can occur:</p> <ul style="list-style-type: none"> • Err: Error message • Info: Information message • Sys: System message • Crit: Critical message <p>For detailed information on the message types, see Chapter 8.2.2, "Understanding the messages in the info bar", on page 69.</p>
"SCPI"	Indicates the SCPI error code.
Text	A list of all currently permanent messages in the order of their occurrence, i.e., the most recent message is displayed first.

The keys in the lower part of the "Info" dialog provide quick access to some functions for managing these messages. For a detailed description on how to clear error messages or display a history of all messages, refer to [Chapter 8.4.5, "Managing messages in the info dialog"](#), on page 80.

Function	Description
"Delete"	Clears the highlighted message. This key is available only if the history of the messages is displayed.
"Delete All"	Clears all messages. This key is available only if the history of the messages is displayed.
"Del. volatile"	Clears all brief messages. This key is available only if the history of the messages is displayed.
"Show History/Static"	Calls the list of all messages that have occurred since instrument switch-on. The most recent messages are displayed at the top of the list. When the key is pressed again, the list of current messages is displayed.



Refer to [Chapter 8.4.5, "Managing messages in the info dialog"](#), on page 80 for information on how to manage messages.

8.2.2 Understanding the messages in the info bar

Messages indicate information, warnings, and errors. They are displayed in the info line in different colors depending on their importance and display duration. The following messages are displayed:

- Error
 - There are two options:
 - Critical errors are errors that prevent the instrument from working, e.g. an HW failure. Critical errors are displayed in red color.
 - System errors are errors that concern the operating system, e.g., wrong file path. System errors are displayed in black color.
- Information

The information, e.g., file not found, is displayed in black color.

- **Warning**
A warning indicates a less significant error and is displayed in black color.
- **Brief message**
Brief messages report automatic settings in the program, e.g. switching on illegal entries that are not accepted by the program, e.g., range violations. They are displayed in the info line on a yellow background. They are displayed on top of status information or permanent messages.
Brief messages usually do not demand user actions and disappear automatically after a short period of time. They are saved in the history, however.
- **Permanent messages**
Permanent messages are displayed if an error occurs that impairs further program operation. The error signaled by a permanent message must be eliminated before correct software operation can be ensured.
The message is displayed until the error is eliminated. It covers the status display in the info line. After error elimination, the message automatically disappears and is also recorded in the history.

8.3 Main panel

The main panel of the R&S SGMA-GUI provides quick access to the main settings of the configured instruments. The display shows one row per instrument and comprises the instrument name and state. It also shows the used frequency and power level, the states of the RF output and modulator and the used reference source.

Click one of the keys with an instrument name on it to access the menu tree with further settings for the corresponding instrument. For a detailed description of the provided settings, see:

- [Chapter 10, "General instrument settings and instrument setup"](#), on page 105 for general settings
- [Chapter 9, "Upconverter settings"](#), on page 89 for R&S SGU settings.

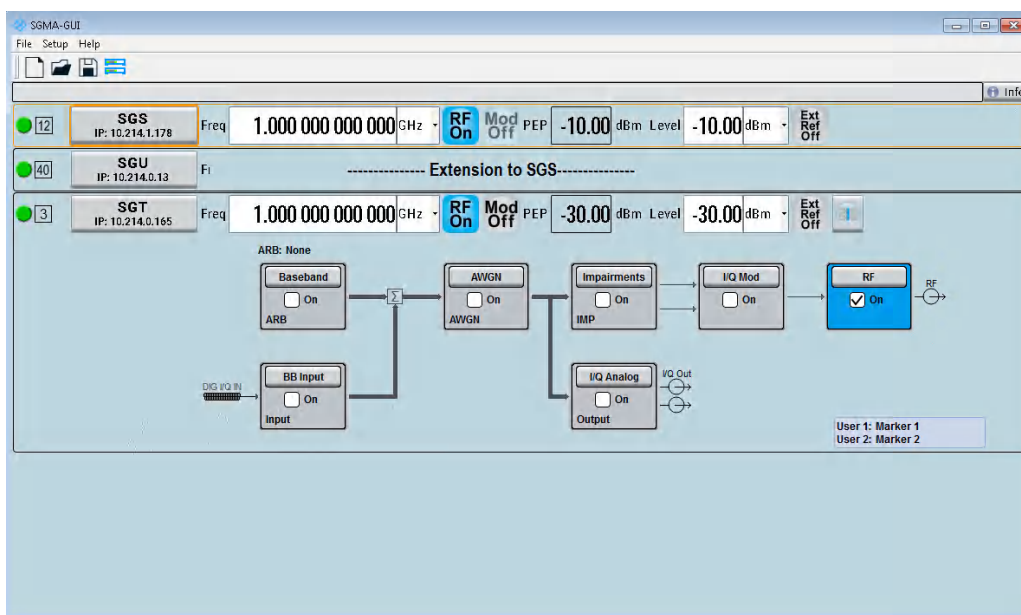

Settings

Instrument/Connection State.....	71
Maximum Frequency.....	72
Pulse Modulation.....	72
Instrument Name/ IP Address.....	72
Frequency.....	72
RF On/Off.....	72
Mod State.....	72
PEP.....	72
Level/Level Offset.....	72

Instrument/Connection State

The three colors of the state indicator in front of the instrument's name distinguish between the following states:

- Gray: the instrument is configured and activated in the R&S SGMA-GUI but there is no connection to the instrument.
- Green: the instrument is active, the connection is working and the instrument can be manually and remotely operated.
- Red: the instrument is in one of the following states:
 - Standby state
To operate the instrument manually, it has to be switched to ready state (see ["To return the instrument from standby to ready state"](#) on page 124).
 - Instrument locked
The red state indication together with the message "Instrument Locked" in the "Info" line indicates that the instrument is locked for [Exclusive Access](#) from another SGMA-GUI or controller.
 - The instrument is performing a time consuming operation, e.g. a selftest.

Maximum Frequency

The numbers in the rectangular box  on the left of the instrument's name indicate the maximum frequency of the instrument.

Pulse Modulation

A  sign on the left of the instrument's name indicates that the pulse modulation is switched on.

Instrument Name/ IP Address

Displays the alias name of the instrument and the IP address, as set by the parameters in "SGMA-GUI > Setup > Instruments > Add/Edit Instruments" dialog.

Click the key to access a menu tree for configuring the available instrument's settings, e.g. "Level" settings.

Frequency

Sets the RF frequency at the RF output connector of the selected instrument.

Remote command:

`[:SOURce] :FREQuency [:CW | FIXed]` on page 193

**RF
On****RF On/Off**

Activates and deactivates the RF output signal.

The current state of the RF output (activated and deactivated) is indicated in the main panel with the different block color (blue or gray) and the status "On/Off".

Remote command:

`:OUTPut [:STATe]` on page 192

**Mod
On****Mod State**

Switches the I/Q modulation on and off.

Remote command:

`[:SOURce] :IQ:STATe` on page 194

PEP

Displays the Peak Envelope Power (PEP) of the RF signal of the selected instrument. The value is calculated as follows:

"PEP" = Level + **Crest Factor**

Remote command:

`[:SOURce] :POWer :PEP?` on page 201

Level/Level Offset

Sets the RF level at the RF output connector of the selected instrument.

If you set a level offset, it will be indicated in the R&S SGMA-GUI main panel by a change in the name of this parameter from "Level" to "Level Offset".

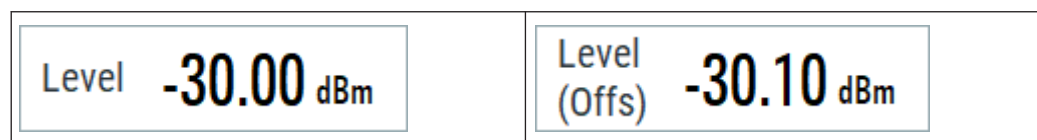

Note: The SCPI command `[:SOURce] :POWer [:LEVel] [:IMMediate] [:AMPLitude]` sets the level of the "Level" display, that means the level containing offset while `[:SOURce] :POWer :POWer` sets the level at the RF output connector.

Remote command:

`[:SOURce] :POWer [:LEVel] [:IMMediate] [:AMPLitude]` on page 200

`[:SOURce] :POWer :POWer` on page 202

8.4 Working with R&S SGMA-GUI

This section explains how to work with the R&S SGMA-GUI software and perform configuration tasks for manual operation of the instruments.

8.4.1 Saving and loading settings

To proceed work with a particular configuration of the instruments in the R&S SGMA-GUI, it is useful to save the used settings and load them again later.

How to save and load settings

1. Select "SGMA-GUI main panel > File > Save As".
2. Navigate to the desired directory.
3. Enter the filename.
The software adds the file extension `*.savrc1` automatically.
4. Select "Save".
The current settings of the software are saved to the selected file.
5. To load settings from a file, select "SGMA-GUI main panel > File > Open"
6. Navigate to the storage directory of the saved file.
7. Select this file.
Loads the saved settings to the R&S SGMA-GUI and the main panel displays the saved configuration of the instrument.

8.4.2 Handling instruments in the R&S SGMA-GUI

This section provides information on how to configure and manage instruments in the R&S SGMA-GUI.

For reference information about all provided settings in the user interface, refer to the corresponding sections:

- [Chapter 8.1.2.1, "Configure instruments"](#), on page 60 and [Chapter 8.1.2.2, "Add/Edit instruments"](#), on page 64
- [Chapter 8.1.2.3, "Software"](#), on page 66

[Chapter 8.1.2.4, "Reset SGMA-GUI"](#), on page 67

8.4.2.1 How to add new instruments automatically

1. For each new instrument perform the following steps:
 - a) Connect the instrument to the network.
 - b) Switch on the instrument.
 - c) Press the [ID] key on the front panel of the instrument.
2. Start the SGMA-GUI on a computer connected to the same network.

All instruments are added automatically to the main panel of the SGMA-GUI.

8.4.2.2 How to add new instruments manually

1. In the R&S SGMA-GUI main panel, select "Setup > Instruments".

The [Configure Instruments](#) dialog opens.
2. Select the "New" key.

The [Add Instrument](#) dialog opens to register a new instrument.
3. In the "Symbolic Name" field, enter an alias name of your choice, e.g. SGU-100021.
4. In the "Instrument Type" field, select the device family to connect to.
5. To select the hardware interface, select "Remote Control > Hardware Channel".
6. For LAN or Socket interfaces, select "Remote Control > Instrument Name / IP Address".
7. Enter the IP address or the hostname of the connected instrument, e.g. rssgu100a100021.

See also [Chapter 8.4.3, "Finding out the default hostname of the instrument"](#), on page 76.
8. For USB or PCIe interfaces, select "Remote Control > Serial Number".
9. Enter the serial number of the connected instrument, e.g., 100021.
10. Set "Active > On" to activate the instrument. Only active instruments are displayed in the R&S SGMA-GUI main panel.
11. To apply the settings, you have two options:
 - Click "OK".

The dialog also closes.
 - Click "Apply".
 - The dialog remains opened.

12. Click the "Cancel" key to discard settings and to close the dialog.

8.4.2.3 How to scan for new instruments

1. In the R&S SGMA-GUI main panel, select "Setup > Instruments".
The [Configure Instruments](#) dialog opens.
2. Click the "Scan" key to trigger the instrument to scan all remote channel interfaces for connected instruments.

Tip: To limit the amount of the searched instruments and to speed up the scan process, select "Configure Instruments > Scan LAN instruments with hostname prefix" and enter the prefix the searched hostnames begin with. The scan function searches only for instruments whose hostnames begin with the selected prefix.

The "Available Instruments" list all instruments that are connected to one of the available interfaces, switched on and not locked by a control instrument. The R&S SGMA-GUI obtains all information for connecting to the instrument, so further configuration is not necessary.

8.4.2.4 How to activate instruments for control

1. In the R&S SGMA-GUI main panel, select "Setup > Instruments".
The "Available Instruments" in the [Configure Instruments](#) dialog lists all instruments configured in the software.
2. Select the new or deactivated instrument.
3. To activate the instrument, select "Active > On".

Tip: Only active instruments are displayed in the R&S SGMA-GUI main panel.

8.4.2.5 How to reserve the instrument for control

1. Open the "SGMA-GUI > Setup > Instruments > Configure Instruments" dialog.
2. Select the instrument in the list of "Available Instruments".
3. Select "Edit".
4. In the "Edit Instrument" dialog, enable "Exclusive Access".
5. Alternatively, send the SCPI command `:INSTRUMENTS:EACCESS[:STATE]` from the external PC that has an R&S SGMA-GUI software installation.

The instrument is reserved for control from this external PC and cannot be accessed from any other controller. A scan function started from another controller finds the instrument but the instrument is indicated as locked.



The two functions "Exclusive Access" and monitoring are mutually exclusive. The "Exclusive Access" must be disabled to remote control or monitor the instrument from another external PC (see [Chapter 12.7, "Monitoring remote control operation with R&S SGMA-GUI"](#), on page 160).

8.4.2.6 How to edit instruments

1. In the R&S SGMA-GUI main panel, select "Setup > Instruments".
The [Configure Instruments](#) dialog opens and lists the "Available Instruments".
2. Select the instrument, that you want to edit.
3. Click the "Edit" key.
The [Edit Instrument](#) dialog opens.
4. Change the settings.
5. Confirm with "Ok".
The edited settings are applied.

8.4.2.7 How to delete an instrument

1. In the R&S SGMA-GUI main panel, select "Setup > Instruments".
The [Configure Instruments](#) dialog opens.
2. Select the instrument, that you want to delete.
3. Click the "Delete" key.
The selected instrument is deleted from the list of "Available Instruments".

8.4.2.8 How to delete all instruments

1. In the R&S SGMA-GUI main panel, select "Setup > Instruments".
The [Configure Instruments](#) dialog opens.
2. Click the "Clear" key.
All instruments are deleted from the list of "Available Instruments".

8.4.3 Finding out the default hostname of the instrument

The default hostname of the instrument is a non-case-sensitive string built as follows:

- `hostname = <instrument name><serial number>`
- `<serial number>` is the individual serial number of the instrument.

- `<instrument name>` is the complete name of the instrument, written without spaces.

How to query the hostname of the instrument

1. Find the individual serial number on rear of the instrument, e.g. 100021.
2. Build the default hostname.

For the R&S SGU with serial number 100021, the default hostname is
`rssgu100a100021`.



For instructions on how to change the default hostname, refer to [Chapter 11.4, "How to use computer names"](#), on page 125.

8.4.4 Bidirectional instrument identification

In practice, instruments are integrated into a large network or placed in racks together with several other instruments of the same kind. It can be difficult to find out, which of the instruments configured in the R&S SGMA-GUI corresponds to which physical instrument. Also, localizing all instruments operated by the current controller.

The R&S SGMA-GUI and the instrument provide the "Device Identification" function for this purpose.

How to find an instrument in the R&S SGMA-GUI

- ▶ If you activate several instruments in the R&S SGMA-GUI, press the [ID] key on the instrument's front panel to trigger device identification.

The "Edit Instrument" dialog of this instrument opens.

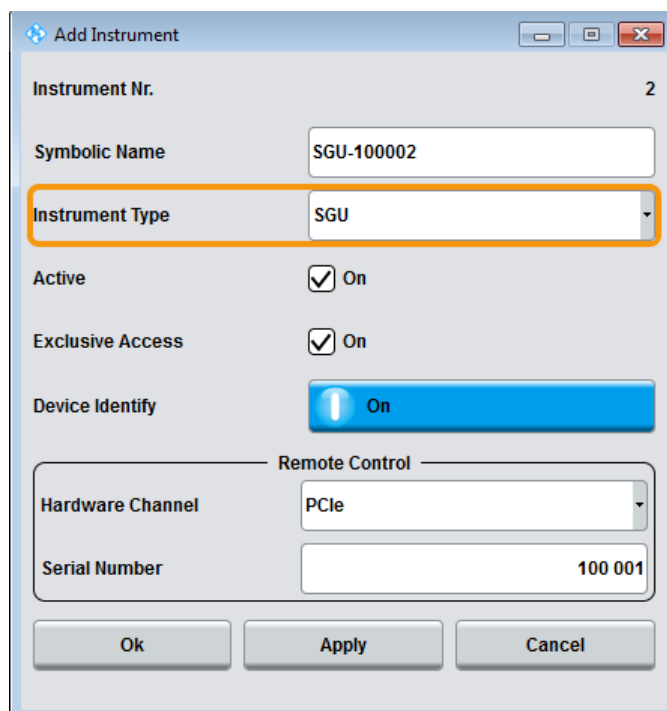

The screenshot shows a dialog box titled "Add Instrument" with the following fields and controls:

- Instrument Nr.: 2
- Symbolic Name: Text box containing "SGU-100002"
- Instrument Type: Dropdown menu showing "SGU" (highlighted with an orange border)
- Active: On
- Exclusive Access: On
- Device Identify: Blue button with "On" and a light indicator
- Remote Control section:
 - Hardware Channel: Dropdown menu showing "PCIe"
 - Serial Number: Text box containing "100 001"
- Buttons: "Ok", "Apply", and "Cancel"

Field "Edit Instrument > Symbolic Name" displays the name of the instrument as shown in the R&S SGMA-GUI main panel.



Dialog "Edit Instrument" does not appear

If this dialog does not open, perform the following:

- Check whether the instrument is correctly connected to the external PC on which you work with the R&S SGMA-GUI.
- Check if the instrument is configured in the R&S SGMA-GUI and perform, if necessary, the steps described in [Chapter 8.4.2, "Handling instruments in the R&S SGMA-GUI"](#), on page 73.
- Select "SGMA-GUI > Setup > Instruments", check the state of the instrument in the "Configure Instruments > Available Instruments" table and activate it, if disabled.

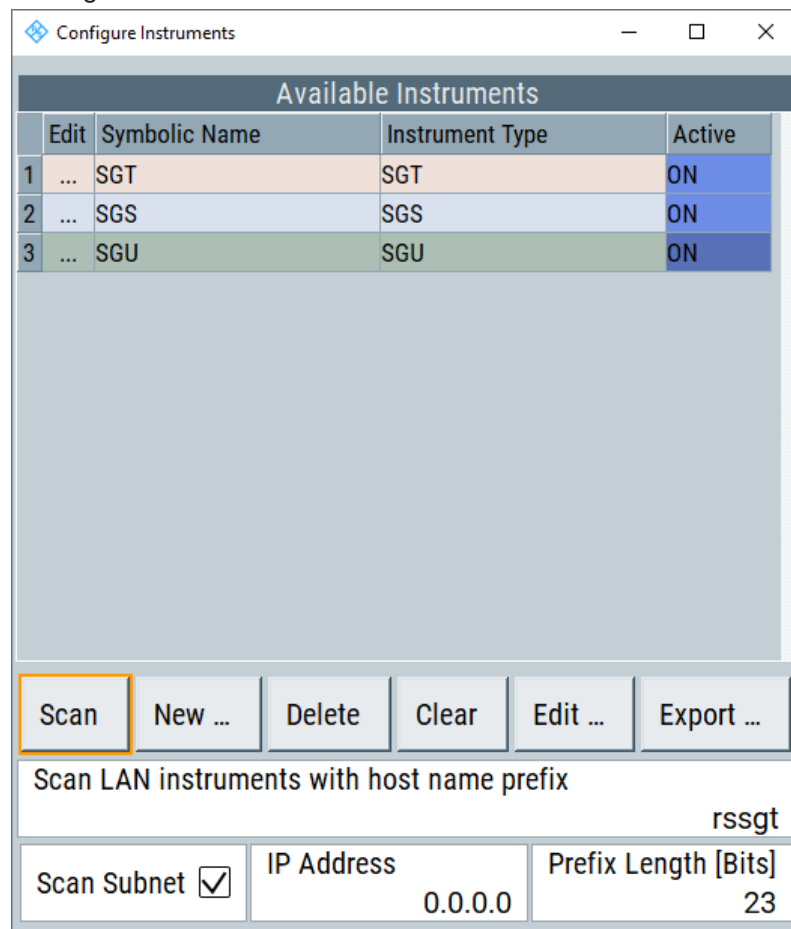

How to identify an instrument in an instrument set

1. To identify the instrument in an instrument set, use one of the device identification functions:
 - Select "SGMA-GUI > Setup > Instruments > Available Instruments > Instrument > Edit > Edit Instrument".
 - Select "SGMA-GUI > Instrument Name > Setup > Remote > Remote Channels".
 - Select "SGMA-GUI > Instrument Name > Setup > LXI Status".

2. Select "Device Identify" to trigger identification.
The green [LAN] LED on the front panel of the instrument blinks.

8.4.5 Managing messages in the info dialog

How to get additional information on the message

- ▶ In the "Info" dialog, click a message to select it.

In the lower section of the dialog, additional information on the highlighted message is displayed.

How to display all messages

- ▶ In the "Info" dialog, click the "History" key.

A history of all messages that have occurred since the R&S SGMA-GUI software was started is listed in the upper dialog pane. The most recent message is displayed first.

How to delete an error message

1. In the "Info" dialog, select the highlighted message and
2. Click the "Delete" key.

Tip: This key is available only when the history of the messages is displayed.

The highlighted message is cleared.

How to delete all error messages

- ▶ In the "Info" dialog, click the "Delete All" key.

Tip: This key is available only when the history of the messages is displayed.

All messages are cleared.

How to delete all brief messages

- ▶ In the "Info" dialog, click the "Del. volatile" key.

Tip: This key is available only when the history of the messages is displayed.

All brief messages are cleared.

How to call the history

1. In the "Info" dialog, click the "History" key.

A list of all messages that have occurred since the instrument switch-on is displayed. The most recent messages are displayed at the top of the list.

2. Click the "History" key once more.
The history lists current instrument messages.

8.5 Remote control of R&S SGMA-GUI

This section focuses on remote control of the R&S SGMA-GUI software. Also, all remote-control commands are presented in detail with their parameters and the ranges of numerical values.

Prerequisites for remote control of R&S SGMA-GUI

Remote control of R&S SGMA-GUI requires the following:

- A remote PC is connected to the SGMA instrument.
- The remote PC and the SGMA instrument are switched on.
- A connection between remote PC and the SGMA instrument is established
- The security setting "System Config > Setup > Security > SCPI over LAN" is enabled.

For more information, see [Chapter 3.13, "Connecting an external PC and devices"](#), on page 27.

For general information on remote control of Rohde & Schwarz products via SCPI, refer to www.rohde-schwarz.com/rc-via-scpi.

8.5.1 Programming examples

The corresponding sections of the same title provide simple programming examples for the R&S SGU. The purpose of the examples is to present **all** commands for a given task. In real applications, one would rather reduce the examples to an appropriate subset of commands.

The programming examples have been tested with a software tool which provides an environment for the development and execution of remote tests. To keep the examples as simple as possible, only the "clean" SCPI syntax elements are reported. Non-executable command lines (for example comments) start with two characters `//`.

At the beginning of the most remote control programs, an instrument preset/reset is recommended to set the R&S SGU to a definite state. The commands `*RST` and `SYSTem:PRESet` are equivalent for this purpose. `*CLS` also resets the status registers and clears the output buffer.

The programming examples address the following tasks:

- [Example "Searching for SGMA instruments"](#) on page 82
- [Example "Scanning a subnet for SGMA instruments"](#) on page 82
- [Example "Evaluating scan results"](#) on page 82

- [Example "Configuring SGMA instruments"](#) on page 83

Example: Searching for SGMA instruments

```
// Search for SGMA instruments using the scan function. It detects instruments
// that are connected to the remote computer via all of the available interfaces.
INSTRuments:SCAN 1
*OPC?

// Query the number of available instruments.
INSTRuments:COUNT?
// Response: 3
// Query instrument types.
INSTRuments:TYPE?
// Response: SGU,SGS,SGT
// Query the symbolic names.
INSTRuments:NAME?
// Response: SGU-100002,SGS-100006,SGT-100008
// Query the serial numbers.
INSTRuments:SERial?
// Response: 100002,100006,100008
// Query the remote channel used.
INSTRuments:REMOte:CHANnel?
// Response: LAN,USB,PCIE
// Query the hostname/IP address.
INSTRuments:REMOte:NAME?
// Response: rsgu100a100002, rsgs100a100006, rsgt100a100008

// You can also define a hostname prefix to filter detected SGMA instruments.
:INSTRuments:SCAN:HNPRefix "rsg"
// The scan returns only instruments with hostname beginning with "rsg".
:INSTRuments:SCAN 1
```

Example: Scanning a subnet for SGMA instruments

```
// Set the IP address of an instrument of the subnet.
INSTRuments:SCAN:SNET:IPADdress 10.111.1.11
// Set the prefix length of the subnet.
INSTRuments:SCAN:SNET:PLENght 20
// Higher prefix lengths accelerate the scan but lower the ability to detect all
// instruments within the subnet.
INSTRuments:SCAN 1
```

Example: Evaluating scan results

```
// Check the instrument state and activate instruments, if required.
INSTRuments:ACTive:STATe?
// Response: 0,1,1
INSTRuments:ACTive:STATe ON,OFF,OFF
// Activates the first instrument in the list, i.e. the instrument SGS-100006.

// Export the configuration into a mapping file.
INSTRuments:MAPPING:FILE "d:\mapping_files\mapping.map"
```

```
// Enable exclusive access for the selected instrument.
INSTRuments:EACcEss:STATe?
// Response: 0,0,0
INSTRuments:EACcEss:STATe ON,OFF,OFF
// Locks the first instrument.
```

Example: Configuring SGMA instruments

```
// Clear the device list and add new instruments manually.
INSTRuments:CLear
INSTRuments:NAME "MYSGT100A","MYSGS100A","MYSGU100A"
// Define the instrument types.
INSTRuments:TYPE "SGT","SGS"
// Specify the remote interface and name or address for the instruments in the
// device list.
INSTRuments:REMOte:CHANnel LAN,USB,GPIB
INSTRuments:REMOte:NAME "10.124.1.247","RSSGS100A1000025",
INSTRuments:USB:SERial 0,0,100025
INSTRuments:GPIB:ADDRes 0,0,28
INSTRuments:GPIB:BOARd 0,0,0
```

8.5.2 R&S SGMA-GUI commands

This section comprises the SCPI commands provided for remote control of the R&S SGMA-GUI software.

:INSTRuments:ACTive[:STATe].....	83
:INSTRuments:CLear.....	84
:INSTRuments:COUNt?.....	84
:INSTRuments:EACcEss[:STATe].....	84
:INSTRuments:GPIB:ADDRes.....	85
:INSTRuments:GPIB:BOARd.....	85
:INSTRuments:MAPPing:FILE.....	85
:INSTRuments:NAME.....	85
:INSTRuments:REMOte:CHANnel.....	85
:INSTRuments:REMOte:NAME.....	86
:INSTRuments:SCAN.....	86
:INSTRuments:SCAN:HNPRefix.....	86
:INSTRuments:SCAN:SNET:IPADdress.....	86
:INSTRuments:SCAN:SNET:PLENght.....	87
:INSTRuments:SCAN:SNET[:STATe].....	87
:INSTRuments:SERial.....	87
:INSTRuments:TYPE.....	88

:INSTRuments:ACTive[:STATe] <State>

Enables/disables the instrument for the R&S SGMA-GUI. The main panel of this software displays only activated instruments.

Parameters:

<State> List of BOOL-values
 <StateInstr#1>,<StateInstr#2>,...
 0, 1, ON, OFF

Example: See [Example "Evaluating scan results"](#) on page 82.

Manual operation: See ["Available Instruments"](#) on page 61
 See ["Active"](#) on page 64

:INSTruments:CLEar

Clears all instruments in the device list.

Parameters:

<Count> float
 Range: 0 to 12

Example: See [Example "Configuring SGMA instruments"](#) on page 83.

Usage: Event

:INSTruments:COUNT?

Queries the number of the currently available instruments.

Return values:

<Count> float
 Range: 0 to 12

Example: See [Example "Searching for SGMA instruments"](#) on page 82.

Usage: Query only

Manual operation: See ["Available Instruments"](#) on page 61

:INSTruments:EACCess[:STATe] <State>

"Locks" the instruments, meaning the instrument is reserved and can be operated exclusively from the remote PC that sent this SCPI command.

Tip: It is recommended to lock the instrument prior to further configuration.

Parameters:

<State> List of BOOL-values
 <LockInstr#1>,<LockInstr#2>,...
 0,1,OFF,ON

Example: See [Example "Evaluating scan results"](#) on page 82.

Manual operation: See ["Exclusive Access"](#) on page 65

:INSTruments:GPIB:ADDRes <Serial>

Sets the GPIB address of the connected instrument.

Parameters:

<Serial> List of Numbers

Example: See [Example "Configuring SGMA instruments"](#) on page 83.

Manual operation: See ["GPIB Address"](#) on page 65

:INSTruments:GPIB:BOARd <Board>

Identifies the GPIB bus card the controller uses.

Parameters:

<Board> List of Numbers

Example: See [Example "Configuring SGMA instruments"](#) on page 83.

Manual operation: See ["Board Number"](#) on page 66

:INSTruments:MAPPing:FILE <File>

Saves the list of the available instruments in a mapping file. Mapping files are stored with the predefined file extension `.map`; the file extension may be omitted.

The file is saved in the default directory. Use the command `MMEM:CDIRectory` to change the default directory or specify the complete path.

Parameters:

<File> string

Example: See [Example "Evaluating scan results"](#) on page 82.

Manual operation: See ["Export"](#) on page 62

:INSTruments:NAME <Name>

Selects the alias name of the instruments, i.e. sets the "Symbolic Name".

Parameters:

<Name> <SymbolicNameInstr#1>,<SymbolicNameInstr#2>,...

Example: See [Example "Searching for SGMA instruments"](#) on page 82.

Manual operation: See ["Available Instruments"](#) on page 61
See ["Symbolic Name"](#) on page 64

:INSTruments:REMOte:CHANnel <Channel>

Sets the hardware interface used by the remote channel.

Parameters:

<Channel> List of CHAR-Data
 <Channellnstr#1>,<Channellnstr#2>,...
 The available interfaces are: LAN, USB, SOCKET, PCIe, GPIB, HiSLIP

Example: See [Example "Searching for SGMA instruments"](#) on page 82.

Manual operation: See ["Hardware Channel"](#) on page 65

:INSTruments:REMOte:NAME <Name>

Enters the IP Address or the host name of the connected instrument.

Parameters:

<Name> <Hostname/IP-Addresslnsr#1>,<Hostname/IP-Addresslnsr#2>,...

Example: See [Example "Searching for SGMA instruments"](#) on page 82.

Manual operation: See ["Instrument Name / IP Address"](#) on page 65

:INSTruments:SCAN <State>

Triggers a scan function and searches for instruments connected to the remote computer via all of the available interfaces.

Parameters:

<State> number
 1 = triggers the scan function, 0 = aborts the running scan process
 The query command returns 1 as long as scan is running; 0 indicates completed scan process.

Example: See [Example "Searching for SGMA instruments"](#) on page 82.

Manual operation: See ["Scan"](#) on page 62

:INSTruments:SCAN:HNPRefix <Prefix>

Sets the prefix the searched host names begin with.

Parameters:

<Prefix> string

Example: See [Example "Searching for SGMA instruments"](#) on page 82.

Manual operation: See ["Scan LAN instruments with host name prefix"](#) on page 63

:INSTruments:SCAN:SNET:IPADdress <Address>

Sets the IP address of an instrument within a subnet.

Use the IP address to optimize scanning for instruments within a subnet.

Parameters:

<Address> string

Example: See [Example "Scanning a subnet for SGMA instruments"](#) on page 82.

Manual operation: See ["IP Address"](#) on page 63

:INSTruments:SCAN:SNET:PLENgtH <Number>

Sets the prefix length of the subnet mask.

Use the prefix length to optimize scanning for instruments within a subnet. A higher value accelerates the scanning procedure but lowers the ability to detect all instruments within the subnet.

Parameters:

<Number> integer
 Range: 18 to 30
 *RST: 18
 Default unit: bit

Example: See [Example "Scanning a subnet for SGMA instruments"](#) on page 82.

Manual operation: See ["Prefix Length"](#) on page 63

:INSTruments:SCAN:SNET[:STATe] <State>

Activates scanning of a subnet with given IP address and prefix length of the subnet.

Parameters:

<State> 1 | ON | 0 | OFF
 *RST: n.a. (no preset. default: OFF)

Example: See [Example "Scanning a subnet for SGMA instruments"](#) on page 82.

Manual operation: See ["Scan Subnet"](#) on page 63

:INSTruments:SERIal <Serial>

Enters the serial number as instrument's identification while using the USB interface for remote control.

Parameters:

<Serial> <SerialNumberInstr#1>, <SerialNumberInstr#2>,...

Example: See [Example "Configuring SGMA instruments"](#) on page 83.

Manual operation: See ["Serial Number"](#) on page 66

:INSTruments:TYPE <Type>

Sets the instrument type.

Parameters:

<Type> List of CHAR-Data
 <TypeInstr#1>,<TypeInstr#2>,...

Example: See [Example "Configuring SGMA instruments"](#) on page 83.

Manual operation: See ["Available Instruments"](#) on page 61
 See ["Instrument Type"](#) on page 64

8.5.3 List of R&S SGMA-GUI commands

:INSTruments:ACTive[:STATe].....	83
:INSTruments:CLEar.....	84
:INSTruments:COUNT?.....	84
:INSTruments:EACCess[:STATe].....	84
:INSTruments:GPIB:ADDRes.....	85
:INSTruments:GPIB:BOARd.....	85
:INSTruments:MAPPing:FILE.....	85
:INSTruments:NAME.....	85
:INSTruments:REMote:CHANnel.....	85
:INSTruments:REMote:NAME.....	86
:INSTruments:SCAN.....	86
:INSTruments:SCAN:HNPRefix.....	86
:INSTruments:SCAN:SNET:IPADdress.....	86
:INSTruments:SCAN:SNET:PLENgtH.....	87
:INSTruments:SCAN:SNET[:STATe].....	87
:INSTruments:SERial.....	87
:INSTruments:TYPE.....	88

9 Upconverter settings

This section summarizes the settings necessary to configure the instrument for signal generation. The description in this section follows the menu tree structure of the graphical user interface. Each of the discussed topics follows a common structure, providing basic background information and reference to the user interface.

For step-by-step instructions for fulfilling typical tasks, refer to [Chapter 11, "Performing configuration tasks"](#), on page 120.

• Frequency settings	89
• Level and power-on settings	90
• I/Q modulation and signal impairment	96
• Pulse modulation	100
• External local oscillator settings	102
• Trigger connector settings	103
• Preset	104

9.1 Frequency settings

Depending on the installed options, the instrument provides an adjustable output frequency in the frequency range of 10 MHz to 40 GHz.

Access:

- ▶ Select "SGMA-GUI > Instrument Name > Frequency".

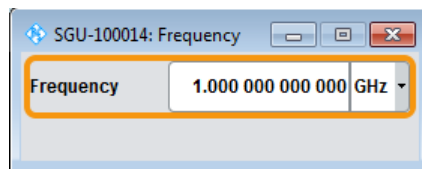

Configuring the RF frequency

- To change the RF frequency of the selected instrument, perform one of the following:
 - Select "SGMA-GUI main panel > Freq".
 - Select "SGMA-GUI > Instrument Name > Frequency/Phase > Frequency".
- Confirm the changes of the RF frequency in the [External local oscillator settings](#) dialog.

Frequency

Sets the RF frequency at the RF output connector of the selected instrument.

Remote command:

[:SOURce] :FREQuency [:CW|FIXed] on page 193

9.2 Level and power-on settings

This section explains the level settings of the R&S SGU. The instrument can be equipped optionally with an active electronic step attenuator (R&S SGU-B26).

Configuring RF level

- To change the RF level of the selected instrument, perform one of the following:
 - Select "SGMA-GUI main panel > Level".
 - Select "SGMA-GUI > Instrument Name > Level > RF Level > Level".
- Confirm the changes of the RF level in the [External local oscillator settings](#) menu.

9.2.1 RF level

Access:

- ▶ Select "SGMA-GUI > Instrument Name > Level > RF Level".

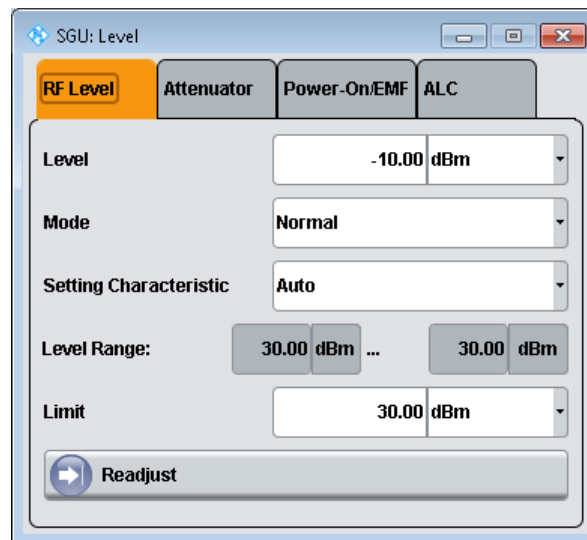

This dialog comprises settings like the RF level and level limit.

Level/Level Offset

Sets the RF level at the RF output connector of the selected instrument.

If you set a level offset, it will be indicated in the R&S SGMA-GUI main panel by a change in the name of this parameter from "Level" to "Level Offset".

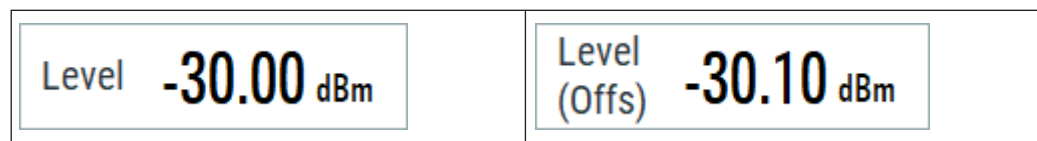

Note: The SCPI command `[:SOURce] :POWer [:LEVel] [:IMMediate] [:AMPLitude]` sets the level of the "Level" display, that means the level containing offset while `[:SOURce] :POWer :POWer` sets the level at the RF output connector.

Remote command:

`[:SOURce] :POWer [:LEVel] [:IMMediate] [:AMPLitude]` on page 200
`[:SOURce] :POWer :POWer` on page 202

Offset

Sets a level offset.

This value represents the level shift of a downstream instrument, as, for example, an attenuator or an amplifier, and is indicated in the status bar of the display. It does not change the level at the RF output.

Remote command:

`[:SOURce] :POWer [:LEVel] [:IMMediate] :OFFSet` on page 201

Mode

Allows you to optimize the RF output signal for applications, where improved harmonic distortion or improved wideband noise is required.

- | | |
|------------------|---|
| "Normal" | In normal mode, the generator provides an RF output signal with high signal to noise ratio and low distortion, according to the data sheet. |
| "Low Noise" | This setting forces the generator to optimize the signal to noise ratio. |
| "Low Distortion" | In this mode, the generator reduces distortions of the RF signal to a minimum. |

Remote command:

`[:SOURce] :POWer :LMODE` on page 200

Setting Characteristic

Selects the characteristic for the level setting. For some general applications, the instrument operation can be optimized by choosing one of the predefined level setting characteristics.

- | | |
|-------------------------------|---|
| "Auto" | The instrument provides the highest dynamic range and the fastest setting times according to the data sheet.
The RF signal is shortly blanked when you switch on the step attenuator. |
| "Uninterrupted Level setting" | Suppresses level blanking at frequency and level changes.
This mode reduces the dynamic range of the instrument. The step attenuator is fixed. |
| "Strictly Monotone" | Provides level setting without discontinuities. All electronic switches in the RF path are clamped. The operation mode is useful for applications using level searching algorithms.
This mode further reduces the dynamic range of the instrument. |

"Constant-VSWR"

Suppresses output impedance variations at the "RF 50Ω" connector due to switching off the step attenuator. The step attenuator is fixed. This mode reduces the dynamic range of the instrument.

Remote command:

[\[:SOURce\]:POWer:SCHaracteristic](#) on page 200

Level Range

Displays the level range within which the level setting is expected to work properly. The range limits depend on several parameters like "Mode", "Setting Characteristic", the I/Q signal's crest factor and other parameters.

Remote command:

[\[:SOURce\]:POWer:RANGe:LOWer?](#) on page 202

[\[:SOURce\]:POWer:RANGe:UPPer?](#) on page 202

Limit

Sets the level limit.

The value specifies the upper limit of the level at the "RF 50Ω" connector. A message appears if an attempt is made to set a level above this limit and the level at the RF output is confined to the upper limit. However, the level indication is not influenced.

The value is not affected by an instrument preset function. This parameter is influenced only by the [Factory preset](#) and its factory value is equal to the upper limit.

Remote command:

[\[:SOURce\]:POWer:LIMit\[:AMPLitude\]](#) on page 201

Readjust

Recalculates the instrument internal settings optimized for the current level. Not required for automatic modes.

Remote command:

[\[:SOURce\]:POWer:ALC:SONCe](#) on page 199

9.2.2 Attenuator

Access:

- ▶ Select "SGMA-GUI > Instrument Name > Level > Attenuator".

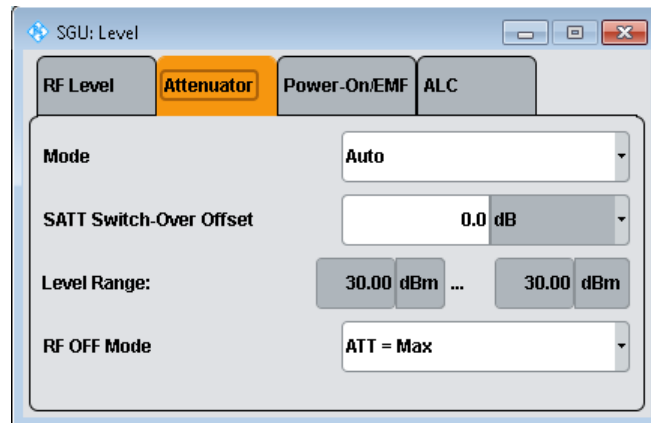

This dialog comprises the settings for the power-on behavior of the instrument.

Mode

Sets the attenuator mode at the RF output.

- | | |
|---------|--|
| "Auto" | Standard mode.
The electronically switching attenuator switches with a ~ 6 dB step width at optimized switching points. The entire level range is available. The level setting is performed by continuous electronic level control combined with switching the step attenuator. |
| "Fixed" | The level settings are made without switching the attenuator. When this operating mode is switched on, the attenuator is fixed in the current position to provide level settings without interruption. The resulting variation range is defined and displayed under Level Range .

Note: The function is effective when automatic level control is activated ("ALC State = On"). If the normal variation range is overranged or underranged, level errors increase considerably and the warning "Level under/overrange" appears in the info line. The spectral purity of the output signal decreases with high attenuation. |

Remote command:

[:OUTPut:AMODE](#) on page 191

Level Range

Requires "Attenuator > Mode = Fixed".

Displays the level range in which the level is set without interruption.

Remote command:

[:OUTPut:AFIXed:RANGe:LOWer?](#) on page 192

[:OUTPut:AFIXed:RANGe:UPPer?](#) on page 193

SATT Switch-Over Offset

Sets the switch-over offset value of the attenuator.

Remote command:

`[:SOURce] :POWer:ATTenuation:SOVer [:OFFSet]` on page 199

RF-Off-Mode

Determines the attenuator's state after the instrument is switched off.

In default setting, the electronic step attenuator switches to highest attenuation when RF is off. By setting the RF-Off mode, the electronic step attenuator can be fixed to keep the output impedance constant during RF off.

Remote command:

`[:SOURce] :POWer:ATTenuation:RFOff:MODE` on page 199

9.2.3 Power-On/EMF settings

Access:

- ▶ Select "SGMA-GUI > Instrument Name > Level > Power-On/EMF".

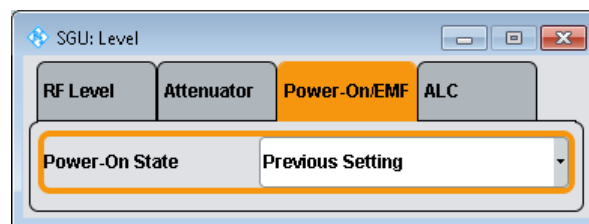

This dialog comprises the settings for the power-on behavior of the instrument.

Power-On State

Selects the state which the RF output takes after the instrument is switched on.

"RF Off" The output is deactivated when the instrument is switched on.

"Previous Setting"

When the instrument is switched on, the output takes the same state as it had when the instrument was switched off.

Remote command:

`:OUTPut [:STATe] :PON` on page 192

9.2.4 ALC

Access:

- ▶ Select "SGMA-GUI > Instrument Name > Level > ALC".

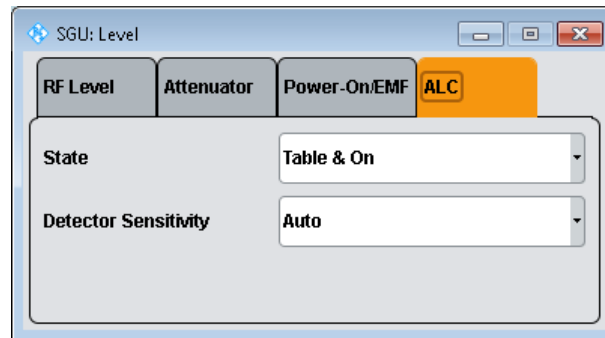

Automatic level control can be used with almost all applications, especially I/Q modulation. Deactivate it only for certain settings in the baseband and when you activate I/Q impairments ("Impairments > On").

By default, the instrument operates in "Table & On" mode to provide the highest level accuracy and fastest setting time. Level control can be switched to "Off (Table)" or "On" for particular applications. The "Off (Table)" state (level control Off) is recommended if in CW mode the signal/intermodulation ratio is to be improved for multi-transmitter measurements.

State

Sets the internal level control.

- | | |
|---------------|--|
| "Table & On" | Default mode.
First sets the level to the target value using the internal level table.
Then activates the level control circuit to achieve maximum level accuracy. |
| "On" | Internal level control is permanently activated.
If "On" and "Attenuator Mode Fixed" is selected, the level is recalibrated for every level and frequency setting. |
| "Off (Table)" | Internal level control is performed according to the ALC table. |

Remote command:

`[:SOURce] :POWer :ALC [:STATe]` on page 198

Detector Sensitivity

Allows you to fix the internal level detector. We recommend that you use the Auto mode (default).

- | | |
|--------|--|
| "Auto" | Automatic detector selection. Recommended mode of operation. |
| "Low" | Low sensitivity detector selected.
This setting is intended for signals with high internal electronic levels. |
| "Med" | Medium sensitivity detector selected.
This setting corresponds to normal mode. It is intended for signals with medium internal electronic levels. |

"High"	High sensitivity detector selected. Selects the detector path with high sensitivity, intended for signals with low internal electronic levels.
"Fix"	Fixes the last set sensitivity setting.

9.3 I/Q modulation and signal impairment

The R&S SGU offers I/Q modulation with external analog I/Q signals. I/Q modulation with an external analog I/Q signal is possible for the instrument equipped with frequency options R&S SGU-B120V/-B140V.

The external signal is input via the "I/Q In" connectors and transferred to the I/Q modulator.

Before the signal is fed into the I/Q modulator, the signal can be impaired. Impairment at this point along the signal flow is offered to allow error correction of the supplied signal or set dedicated impairments.

9.3.1 I/Q impairments

Signal impairments are well-defined arithmetic modifications of the data. Every data sample is modified in the same way. The purpose of adding impairments to the data stream is to simulate frequent sources of distortions in a real signal-processing chain to generate a test signal with dirty transmitter conditions.

9.3.1.1 Gain and gain imbalance

An I/Q gain is a multiplication of all I/Q amplitudes by a common factor. The effect is equivalent to two identical I and Q gain factors. The effect of an increased gain factor in the I/Q constellation diagram is shown below.

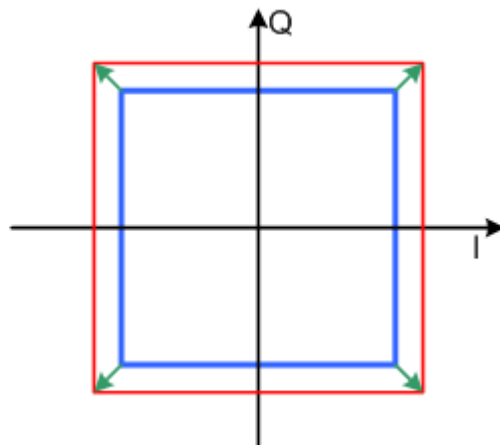

Figure 9-1: Effect of an increased amplitude in the I/Q constellation diagram

An I gain multiplies the I amplitudes by a factor, leaving the Q amplitudes unchanged. A Q gain has the opposite effect. Different I and Q gain factors result in an I/Q imbalance. The imbalance is usually due to different gains of the amplifiers in the I and Q channels of the I/Q modulator. The effect of a positive and negative gain imbalance is shown below.

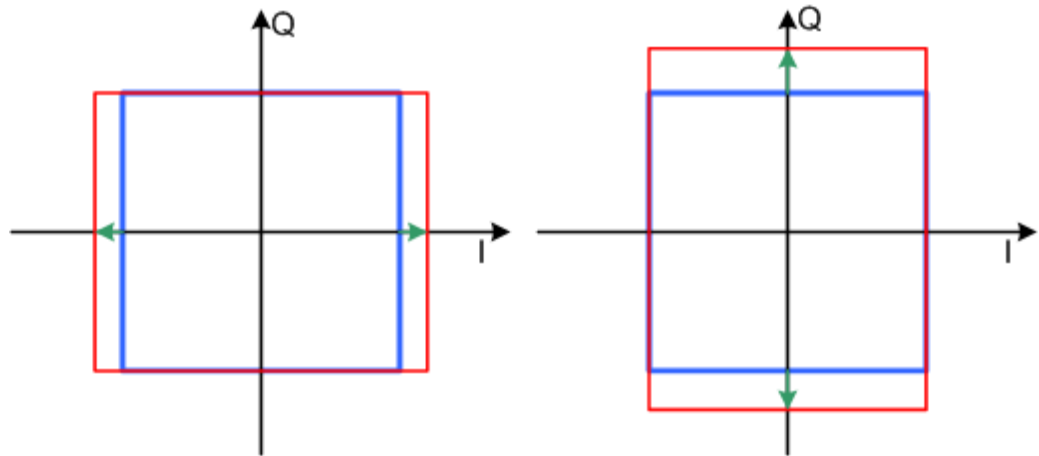

Figure 9-2: Negative gain imbalance (left) and positive (right) gain imbalance in the I/Q constellation diagram

9.3.1.2 I and Q offset

An I offset adds a constant value to all I amplitudes, leaving the Q amplitudes unchanged. A Q offset has the opposite effect. A combination of I and Q values results in an I/Q offset, which is usually due to carrier feedthrough in the I/Q modulator. Possible reasons are interfering signals at the RF carrier frequency, e.g. an unsuppressed RF carrier subchannel. The effect of a positive I and Q offset in the I/Q constellation diagram is shown below.

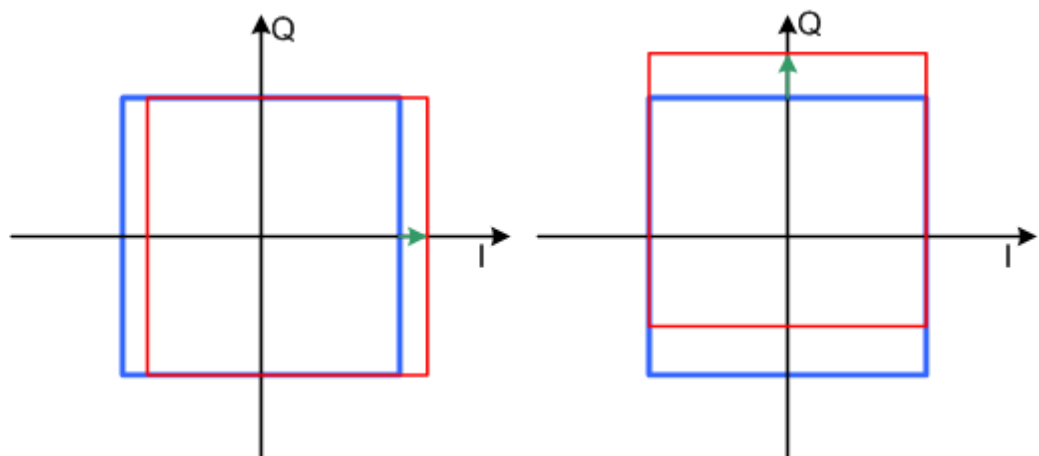

Figure 9-3: I offset (left) and Q offset (right) in the I/Q constellation diagram

9.3.1.3 Quadrature offset

Changes the phase angle between the I and Q vectors from the ideal 90 degrees, while the amplitudes are maintained. A positive quadrature offset results in a phase angle greater than 90 degrees. The effect of a positive quadrature offset in the I/Q constellation diagram is shown below.

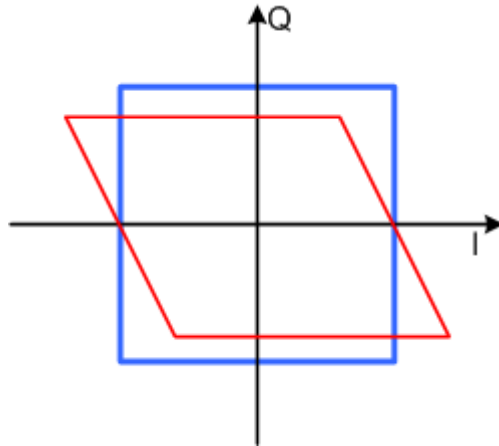
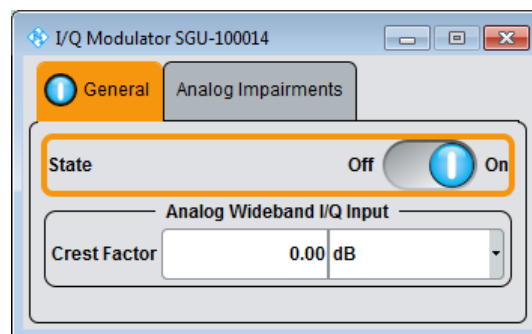

Figure 9-4: Positive quadrature offset in the I/Q constellation diagram

9.3.2 General I/Q settings

Access:

- ▶ Select "SGMA-GUI > Instrument Name > I/Q Settings > General".



Comprises the settings for setting the state and the analog wideband I/Q input.



Mod State

Switches the I/Q modulation on and off.

Remote command:

`[:SOURce] : IQ : STATE` on page 194

Crest Factor

Sets the crest factor of the I/Q modulation signal.

The crest factor gives the difference in level between the peak envelope power (PEP) and average power value (RMS) in dB. This value is necessary for the generation of the correct output power at the RF output, i.e. the instrument uses the PEP value to compensate the average power.

The maximum input voltage at the I/Q input is equated to the peak power and is used as the "reference" for setting the level of the output signal. The signal does not usually supply the peak power at a constant level. It supplies lower average power. The crest factor specifies how many decibel (dB) the software has to add internally to reach correct output power.

Remote command:

[\[:SOURce\]:IQ:CREStfactor](#) on page 196

9.3.3 Analog impairment settings

Access:

- ▶ Select "SGMA-GUI > Instrument Name > I/Q Settings > Analog Impairments".

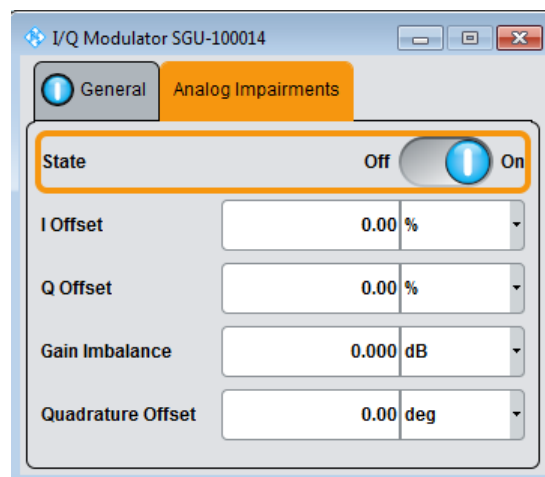

Comprises the settings like I/Q offset and quadrature offset.

State

Activates/deactivates I/Q impairments.

If activated, the settings for offset, gain imbalance and quadrature offset become effective.

Note: We recommend that you switch automatic level control to the "Off (Table)" mode. Otherwise level errors can occur.

Remote command:

[\[:SOURce\]:IQ:IMPairment:STATe](#) on page 196

Offset

Sets the carrier offset (in percent) of the amplitudes (scaled to the peak envelope power (PEP) for the I and/or Q signal component. An ideal I/Q modulator suppresses the carrier offset completely (offset = 0 percent).

For more information, see [Chapter 9.3.1.2, "I and Q offset"](#), on page 97.

Remote command:

[\[:SOURce\]:IQ:IMPairment:LEAKage:I](#) on page 195

[\[:SOURce\]:IQ:IMPairment:LEAKage:Q](#) on page 195

Gain Imbalance

Sets the imbalance of the I and Q vector (see [Chapter 9.3.1.1, "Gain and gain imbalance"](#), on page 96).

The entry is made in dB (default) or %, where 1 dB offset is roughly 12 % according to the following:

$$\text{Imbalance [dB]} = 20 \log (| \text{GainQ} | / | \text{GainI} |)$$

Positive values mean that the Q vector is amplified more than the I vector by the corresponding percentage. Negative values have the opposite effect.

Remote command:

[\[:SOURce\]:IQ:IMPairment:IQRatio](#) on page 195

Quadrature Offset

Sets the quadrature offset (see [Chapter 9.3.1.3, "Quadrature offset"](#), on page 98).

Remote command:

[\[:SOURce\]:IQ:IMPairment:QUADrature\[:ANGLE\]](#) on page 195

9.4 Pulse modulation

The R&S SGU offers pulse modulation using external pulse signals. To receive external pulse signals, connect the signal source to the "TRIG" connector on the rear panel of the R&S SGU.

9.4.1 Pulse modulation settings

Access:

- ▶ Select "SGMA-GUI > Instrument Name > Pulse Modulation".

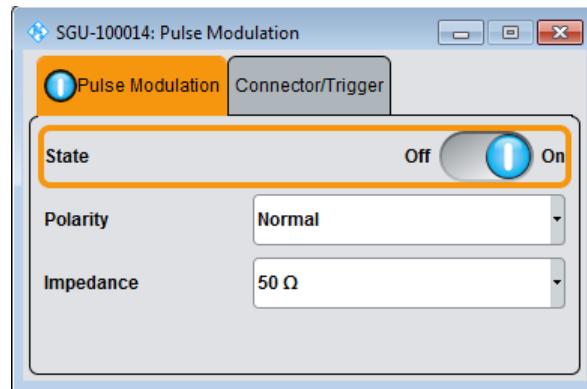

The "Pulse Modulation" dialog contains all parameters required to configure pulse modulation and pulse signal generation.

State

Sets the state of the pulse modulator.

Remote command:

[\[:SOURce<hw>\]:PULM:STATe](#) on page 202

Polarity

Sets the polarity of the pulse modulator signal.

"Normal" The RF signal is suppressed during the pulse pause.

"Inverse" The RF signal is suppressed during the pulse.

Remote command:

[\[:SOURce<hw>\]:PULM:POLarity](#) on page 203

9.4.2 Pulse connector/trigger settings

Access:

- ▶ Select "SGMA-GUI > Instrument Name > Pulse Modulation > Connector/Trigger".

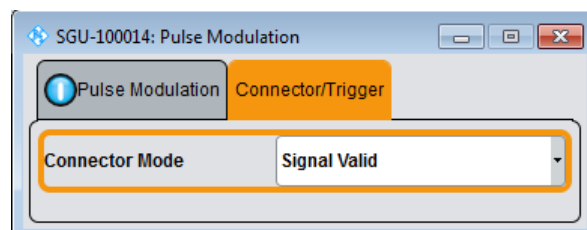

Comprises the settings necessary to configure the signal at the multi-purpose "TRIG" connector in the external trigger mode.

Trigger Connector Mode

Determines the signal at the input/output of the multi purpose [TRIG] connector.

"Signal Valid"

Output of high signal to mark valid frequency and level settings.

"Not Signal Valid "

Output of high signal to mark the transition state when frequency and level change.

"Pulse Mod Ext Source"

Input for an externally provided pulse modulation signal

Used when an external pulse modulator source is provided at the connector.

Remote command:

:CONNector:TRIGger:OMODE on page 180

9.5 External local oscillator settings

You can also connect the R&S SGU to an incompatible signal generator (local oscillator). The controller has to change the frequency and the level of this local oscillator (LO) to output the signal as configured from the R&S SGU. The "Local Oscillator" dialog provides related settings.

Access:

- ▶ Select "SGMA-GUI > Instrument Name >Ext. Local Oscillator".

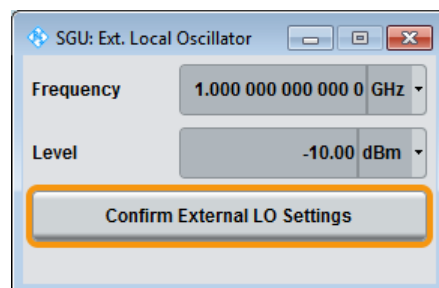

When changing any parameters which affect the output signal of the combined system of an incompatible LO and an R&S SGU, follow these steps:

Setting the signal of the R&S SGU

1. Set the parameters of the R&S SGU like frequency and level in the R&S SGMA-GUI as needed.
2. Open the "SGMA-GUI > Instrument Name >Ext. Local Oscillator" dialog.
3. Read the settings for "Frequency" and " Level".

4. Apply the required changes to the LO.
5. Press the "Confirm External LO Settings" button to confirm that you have made the settings on the LO.

The desired signal is output by the R&S SGU.

Frequency

Shows the desired frequency for the LO input signal.

Remote command:

`[:SOURce] :LOSCillator :FREQuency?` on page 197

Level

Shows the desired level for the LO input signal.

Remote command:

`[:SOURce] :LOSCillator :POWer?` on page 198

Confirm External LO Settings

Outputs the signal.

Remote command:

`[:SOURce] :SETTings :APPLY [:IMMediate]` on page 193

9.6 Trigger connector settings

Access:

- ▶ Select "SGMA-GUI > Instrument Name > Connector".

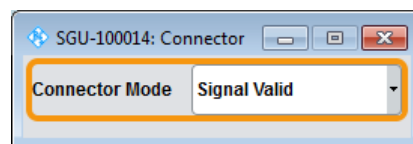

This dialog comprises the settings for configuring the connector.

Trigger Connector Mode

Determines the signal at the input/output of the multi purpose [TRIG] connector.

"Signal Valid"

Output of high signal to mark valid frequency and level settings.

"Not Signal Valid "

Output of high signal to mark the transition state when frequency and level change.

"Pulse Mod Ext Source"

Input for an externally provided pulse modulation signal
Used when an external pulse modulator source is provided at the connector.

Remote command:

`:CONNector:TRIGger:OMODE` on page 180

9.7 Preset

Calls up a defined instrument setup. Presets all parameters and switching states including inactive operating modes. The default instrument settings provide a reproducible initial basis for all other settings. However, functions that concern the integration of the instrument into a measurement setup are not changed.

Overview of the most important preset states

The following list gives an overview of the presets for the most important generator settings. The other presets can be found in the information accompanying the remote commands.

- "RF frequency" = 1 GHz
- "RF output" switched off
- "Modulator State" = Off

Settings that are **not affected** by the "SGMA-GUI > Instrument Name > Preset" function:

- Power on settings ("Level" dialog)
- Network settings ("Setup" dialog)
- Password and settings protected by passwords ("Setup" dialog)



To preset the R&S SGMA-GUI itself and all configured instruments to their predefined state, use the "SGMA-GUI > File > New" function.

SCPI command:

`:SYSTem:PRESet` on page 174

10 General instrument settings and instrument setup

This section describes the settings which do not directly affect signal generation.

Access:

1. Select "SGMA-GUI > Instrument Name > Setup".
2. Select the required dialog.

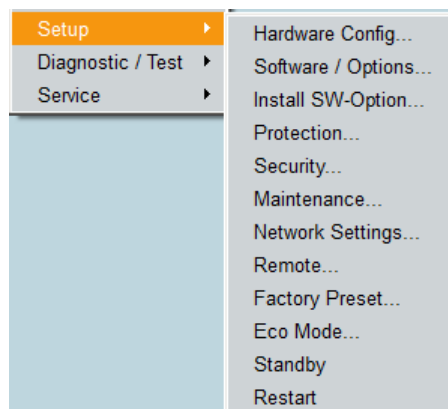

Settings

• Hardware configuration	105
• Software / options	107
• Install SW options	109
• Protection	109
• Security	110
• Network settings	113
• Remote channels	116
• Factory preset	117
• Eco mode	118
• Standby and restart	118
• Diagnostic and tests	119

10.1 Hardware configuration

Querying information about the installed assemblies

- ▶ Select "SGMA-GUI > Instrument Name > Setup > Hardware Config".

In the "Hardware Config" dialog, the installed assemblies together with their variants and revision states can be displayed for servicing purposes.

SGU-100014: Hardware Config

Counter

Common Assembly

Assembly	Part Number	Serial Number	Revision
SGU	1418.2005k02	100014	
Controller	1416.1201.02	101184	04.01
PCI FPGA			01.17.01

RF Assembly

Assembly	Part Number	Serial Number	Revision
IqUpcon FPGA			01.02.17
IqUpcon20	1418.2705.02	101376	06.02
IqUpcon40	1315.2003.02	101072	03.05
IqUpcon40 BRD	1418.3201.02	101072	06.05
IqUpcon40 uW	1315.2026.02	100032	05.00

The dialog is a table that lists the installed assemblies. It is divided into the sections:

- "Common Assembly"
- "RF Assembly"

Settings

[Assembly](#).....106

Assembly

The tables list the installed assemblies.

"Assembly" Name of the assembly

"Part Number" Part number of the assembly

"Serial Number"
Serial number of the assembly

"Revision" Revision state of assembly

Remote command:

`:SYSTEM:HARDWARE:ASSEMBLY<dir>:SNUMBER?` on page 215

10.2 Software / options

Querying information about the installed options and software version

- ▶ Select "SGMA-GUI > Instrument Name > Setup > Software/Options".

The "Software/Options" dialog shows the firmware version of the instrument software and all installed hardware and software options.

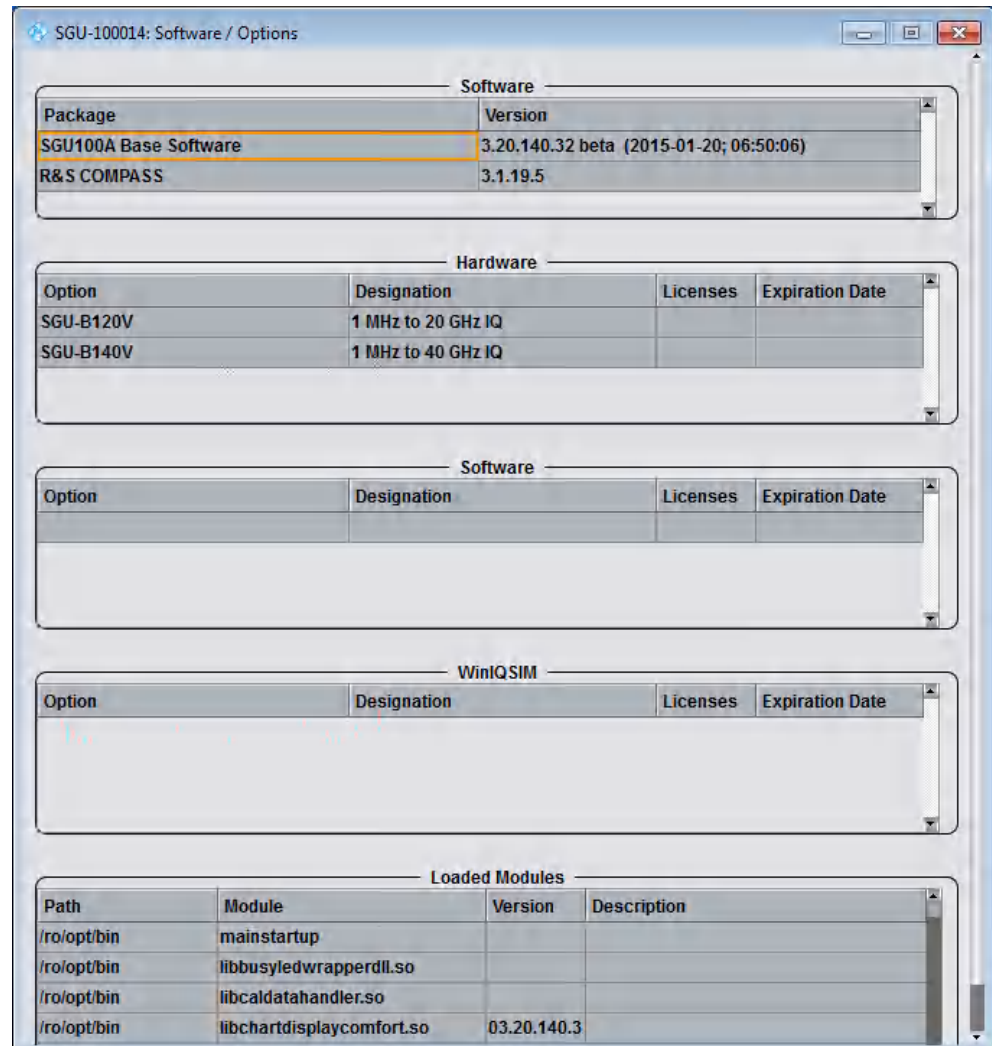

The dialog is divided into the following sections:

- "Firmware"
- "Hardware"
- "Software"
- "Loaded Modules"



Software options purchased at a later stage can be activated with a keycode. The activation code is supplied with the software option. An instruction on how to install options is described in the service manual. You can install most hardware options at an authorized Rohde & Schwarz service center.

Settings

Software.....	108
Hardware / Software/WinIQSIM.....	108
Loaded Modules.....	108
Show Open Source Acknowledgments.....	108
LucasFonts RSCorpid EULA.....	108

Software

Shows the software/firmware version and the version of the software platform.

Note: Your instrument is delivered with the latest firmware version available. Firmware updates and the release notes are provided on the Internet at the download site of the instrument's home page. This home page always offers the latest information on your instrument, e.g. also on changes of the firmware update procedure.

Hardware / Software/WinIQSIM

The tables in the sections "Hardware" and "Software" list the installed hardware and software options.

"Option" Short name of the option

"Designation" Name of the option

"Licenses" Number of licenses

"Expiration Date"

For regular options, "Permanent" is indicated in this column. Some options are available as trial versions. This column shows their expiration date. After this date, the option is no longer available on the instrument.

Loaded Modules

Section "Loaded Modules" is provided for service purposes. It lists all loaded software modules with their versions and offers a short description of each module.

Show Open Source Acknowledgments

Accesses the list of the used open-source software packages and the corresponding verbatim license texts.

For R&S SGMA-GUI, the list shows the open-source acknowledgement for software with Windows® operating system.

For R&S SGU/SGS/SGT, the list shows the open-source acknowledgement for software with Linux® operating system.

LucasFonts RSCorpid EULA

Accesses copyright information on LucasFonts font type RSCorpid EULA.

10.3 Install SW options

Newly purchased software options are enabled in the "Install SW-Option" dialog. They are ready to operate after they are enabled by a key code supplied with the option.

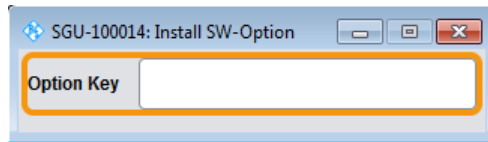

Only if the instrument is equipped with an older firmware version, a firmware update before enabling the software option can be required. The information on the valid firmware versions for the purchased software option is provided together with the option.

See:

- [Chapter 11.5, "How to install a new firmware version on the instrument"](#), on page 125 for information on how to perform firmware update
- [Chapter 11.6, "How to activate options"](#), on page 127 for instruction on how to install new options

The firmware update is also described in the service manual.

10.4 Protection

The "Protection" dialog provides access to the unlocking of protected service functions (authorized personnel of R&S service departments only).

Unlocking protected service functions

1. Select "SGMA-GUI main panel > Instrument Name > Setup > Protection".
The "Protection" dialog provides access to the unlocking of protected service functions (authorized personnel of R&S service departments only).
2. To deactivate the protection, enter the correct password. After booting the instrument, protection levels 1 to 4 are active.
Enter "Protection Level 1 > Password > 123456".
Protection Level 1 is activated.



Settings

[Protection Level / Password](#)..... 110

Protection Level / Password

"Protection Level 1" can be activated to expand the functionality of the internal adjustment. The password is 123456.

The other protection levels 2 to 4 provide access to protected service functions. Only the authorized personnel of R&S service departments can access these functions.

10.5 Security

The R&S SGU employs a security concept based on user and security password. The security password is required for changing several critical settings, like performing firmware updates. Access to the passwords and mass storage security settings is provided in the "Security" dialog.

Access:

- ▶ Select "SGMA-GUI > Instrument Name > Setup > Security".

The dialog is divided into the password sections and the security settings section. In the password section, the passwords for securing a controlled access to the instrument are defined and changed.

A change of passwords for the operating system and security password requires the entry of the old and new password and the conformation of the new password. All settings are only accepted after the "Change Password" button is pressed.

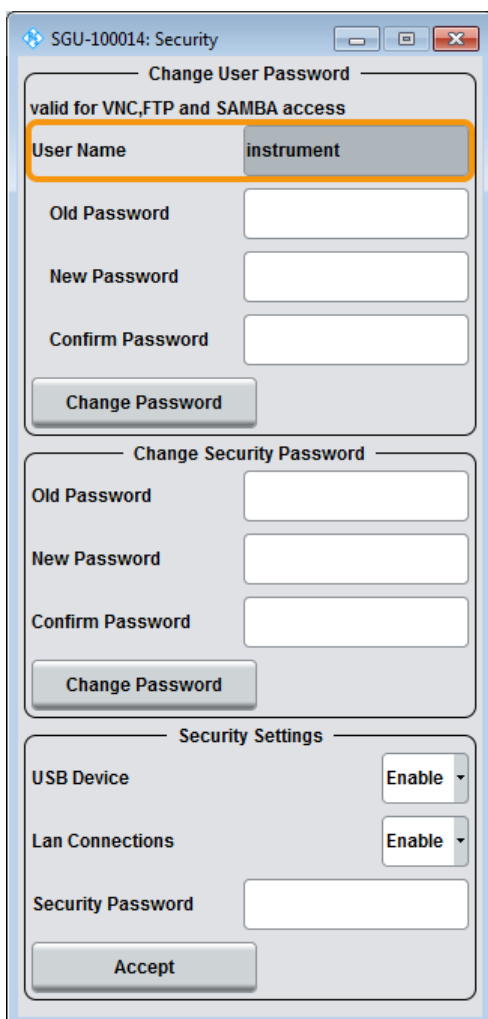

 The settings of this dialog are not accessible over remote control (e.g. SCPI commands).

Settings

- User Password..... 112
 - L User Name..... 112
 - L Old Password..... 112
 - L New Password..... 112
 - L Confirm Password..... 112
 - L Change Password..... 112
- Security Password..... 112
 - L Old Password..... 112
 - L New Password..... 112
 - L Confirm Password..... 112
 - L Change Password..... 113
- Security Settings..... 113
 - L USB Storage..... 113

L LAN Interface.....	113
L Security Password.....	113
L Accept.....	113

User Password

The user name and password are required for remote access to the instrument via VNC, FTP or SAMBA.

Note: It is highly recommended to change the default user password before connecting the instrument to the network.

Note: Note that you cannot reset the password to factory state.

If you encounter problems with the password, contact the Rohde & Schwarz customer support, see [Chapter 14.5, "Contacting customer support"](#), on page 226.

User Name ← User Password

Indicates the user name used for access to the Linux operating system and valid for VNC, FTP and SAMBA access.

Old Password ← User Password

Enter the currently used user password. The default password is "instrument".

New Password ← User Password

Enter the new user password.

Confirm Password ← User Password

Enter the new password for conformation.

The new password is only valid after the "Change Password" button is pressed.

Change Password ← User Password

Changes the password accordingly.

Security Password

The security password is, for example, required when changing the status of the USB and LAN interface or other security settings.

Note: It is highly recommended to change the default security password before connecting the instrument to the network.

Note: Note that you cannot reset the password to factory state.

If you encounter problems with the password, contact the Rohde & Schwarz customer support, see [Chapter 14.5, "Contacting customer support"](#), on page 226.

Old Password ← Security Password

Enter the currently used security password. The default password is '123456'.

New Password ← Security Password

Enter the new security password. The security password can only contain decimal characters.

Confirm Password ← Security Password

Enter the new password for conformation.

The new password is only valid after the "Change Password" button is pressed.

Change Password ← Security Password

Changes the password accordingly.

Security Settings

Comprises the settings for enabling and disabling the USB and LAN interfaces. The setting requires the entry of the security password and is only accepted after the "Accept" button is pressed.

USB Storage ← Security Settings

Enables/disables the access to external USB storage media.

The instrument does not recognize any device connected to the USB interface when the interface is disabled.

To apply the change: enter the security password and confirm with "Accept". Otherwise the change has no effect.

Note: Remove all USB memory devices before disabling the USB storage. If any USB memory device remains connected, disabling is blocked, and the instrument returns a warning message.

LAN Interface ← Security Settings

Enables/disables the LAN interface.

Note: It is not possible to access the instrument via LAN while the LAN connection is disabled.

An enabled LAN connection is a prerequisite for the remote control of the instrument via VNC, FTP or SAMBA.

To disable the LAN interface enter the security password and confirm with "Accept". Otherwise the change has no effect.

Security Password ← Security Settings

Enters the password that is required to enable or to disable the settings protected by a security password. The default is '123456'.

Note: It is highly recommended to change the default security password before connecting the instrument to the network. To change the security password, select "SGMA-GUI > Instrument Name > Setup > Security > Change Security Password".

The settings are only accepted after the "Accept" button is pressed.

Accept ← Security Settings

Accept a new entry or selection and change the settings accordingly.

10.6 Network settings

The instrument is equipped with a network interface and can be connected to an Ethernet LAN (local area network). The "Network Settings" dialog provides access to the network settings.

Access:

- ▶ Select "SGMA-GUI > Instrument Name > Setup > Network Settings".

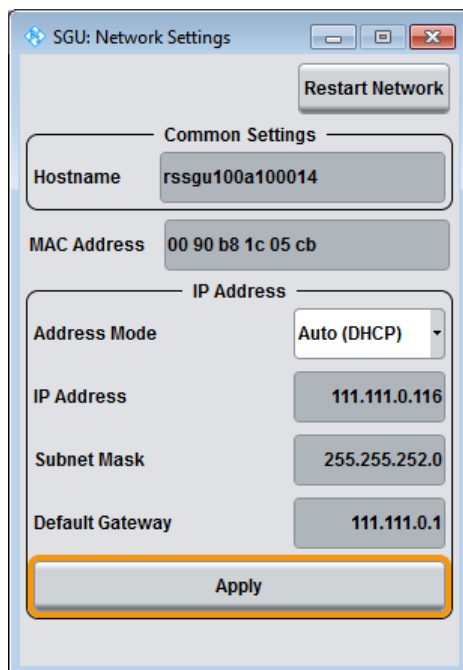

The dialog provides access to the network settings, like settings about the general network environment and specific identification of the computer in the network. The dialog also displays an indication whether the instrument is connected to the network or not.

Settings

Restart Network	114
Hostname	114
MAC Address	115
Address Mode	115
IP Address	115
Subnet Mask	115
Default Gateway	116
Apply	116

Restart Network

Shuts down the network connection of the instrument and then re-establishes the connection.

This function can be used to resolve network problems.

Note: Only the connection of the instrument to the network restarts, the network itself is not affected.

Hostname

Displays the individual computer name of the instrument.

A predefined name is indicated and can be used for network connections, see [Chapter 8.4.3, "Finding out the default hostname of the instrument"](#), on page 76.

It is recommended that a connection of the instrument to the network is coordinated with the network administrator. Connection errors can affect the entire network.

Remote command:

`:SYSTem:COMMunicate:NETWork[:COMMON]:HOSTname` on page 212

MAC Address

Indicates the MAC address of the network adapter.

Address Mode

Selects if the IP address is assigned automatically or manually.

It is recommended that a connection of the instrument to the network is coordinated with the network administrator. Connection errors can affect the entire network.

Note: Lost LAN connection to an instrument.

If the connection to an instrument configured to use static IP addresses is lost, press the [LAN LED] on the instrument front panel.

Pressing triggers a reset of the assignment mode ("Address Mode > Auto (DHCP)").

"Auto (DHCP)" The IP address is assigned automatically.

The network used must support automatic assignment of IP address via DHCP or APIPA (Zeroconf) to use this function.

"Static" The IP address is assigned manually.

Remote command:

`:SYSTem:COMMunicate:NETWork:IPAddress:MODE` on page 211

IP Address

Displays the IP address. To enter the IP address manually, select "Address Mode > Static".

If there is manual input of the IP address, it is recommended that a connection of the instrument to the network is coordinated with the network administrator. Connection errors can affect the entire network.

Remote command:

`:SYSTem:COMMunicate:NETWork:IPAddress` on page 211

Subnet Mask

Displays the subnet mask. To enter the subnet mask manually, select "Address Mode > Static".

This number is used together with the IP address to identify the network segment the instrument is in.

It is recommended that a connection of the instrument to the network is coordinated with the network administrator. Connection errors can affect the entire network.

Remote command:

`:SYSTem:COMMunicate:NETWork[:IPAddress]:SUBNet:MASK` on page 213

Default Gateway

Displays the IP address of the default gateway. To enter the default gateway manually, select "Address Mode > Static".

This address identifies the router on the same network as the instrument that is used to forward traffic to destinations beyond the local network.

It is recommended that a connection of the instrument to the network is coordinated with the network administrator. Connection errors can affect the entire network.

Remote command:

`:SYSTem:COMMunicate:NETWork[:IPADdress]:GATeway` on page 212

Apply

Applies the network settings to the instrument.

10.7 Remote channels

Access:

- ▶ Select "SGMA-GUI > Instrument Name > Setup > Remote".

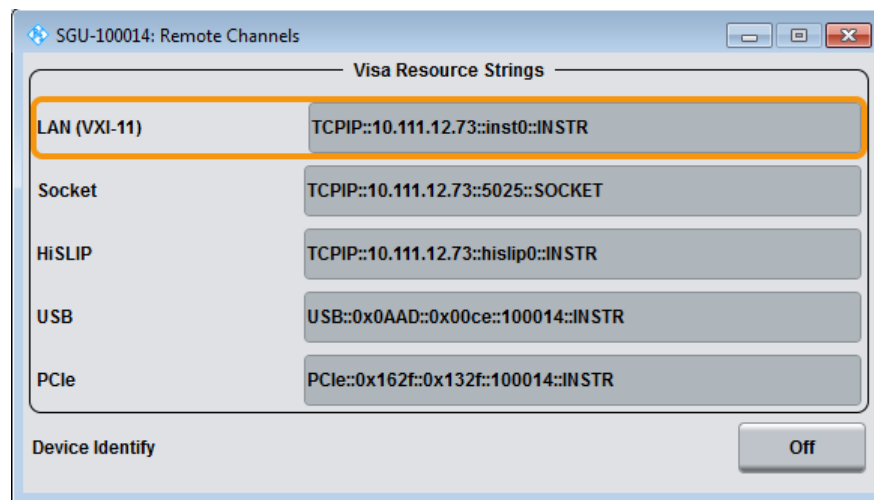

The "Remote" dialog provides access to the settings for remote control.

Settings

Visa Resource Strings	116
Device Identity	117

Visa Resource Strings

Indicates the VISA resource strings used for remote control of the instrument. A separate string is provided for remote control via the different interfaces.

Note: For background information and description of the syntax of the VISA resource strings, refer to the description of the corresponding interface in [Chapter 12.1, "Remote control interfaces and protocols"](#), on page 129.

Remote command:

:SYSTem:COMMunicate:HISLip:RESource? on page 213

:SYSTem:COMMunicate:NETWork:RESource? on page 213

:SYSTem:COMMunicate:SOCKet:RESource? on page 214

:SYSTem:COMMunicate:USB:RESource? on page 215

:SYSTem:COMMunicate:PCIexpress:RESource? on page 213

Device Identity

Triggers the device identification function. The [LAN] LED on the front panel of the selected instrument blinks.

See also [Chapter 8.4.4, "Bidirectional instrument identification"](#), on page 77.

10.8 Factory preset

The "Factory Preset" dialog provides a function to reset the instrument's settings to their factory states.

Access:

1. Select "SGMA-GUI > Instrument Name > Setup > Factory Preset".

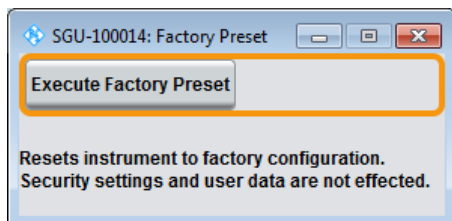

2. Select "Execute Factory Preset".

The instrument's settings are reset to their factory states. Security settings and user data are not affected.

Settings

[Execute Factory Preset](#)..... 117

Execute Factory Preset

Reset the instrument's settings to their factory state.

Note: Because "Factory Preset" resets the "Remote Channel Settings" and "Network Settings" to the default values, executing factory preset via remote control can terminate the connection to the instrument, if these settings had been configured to values different to the default ones.

The factory preset function resets nearly all instrument settings. In addition to the regular preset, a "Factory Preset" resets also the following values:

- Power on settings ("Level" dialog)
- Network settings including hostname ("Setup > Network Setting" dialog)
- Remote Channel settings ("Setup > Remote Channel" dialog)
- Eco mode state ("Setup > Eco Mode" dialog)

To maintain security, password settings and all settings protected by these passwords like disabled USB and LAN connections are not changed.

Not affected by the "Factory Preset" are also user data, lists or instrument settings files, created, for example, with the "File Save As" function.

Remote command:

:SYSTem:FPReset on page 175

10.9 Eco mode

This energy-saving mode is available only for instruments equipped with option R&S SGU-B140/B140V.

Access:

- ▶ Select "SGMA-GUI > Instrument Name > Setup > Eco Mode".

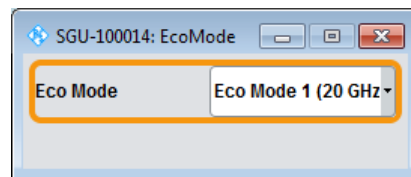

With enabled "Eco Mode 1", the doubler stage in a 40 GHz instrument is permanently switched off to reduce power consumption and the maximum frequency is limited to 20 GHz. An enabled "Eco Mode" is indicated by a green coloring of the frequency range in the R&S SGMA-GUI.

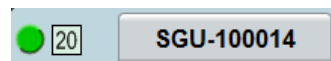

The state of this parameter is not affected by an instrument "Preset". This parameter is influenced only by the [Factory preset](#).

SCPI command:

10.10 Standby and restart

See [Chapter 11.3, "How to switch between operating states"](#), on page 123.

10.11 Diagnostic and tests

This section describes the settings provided for diagnostic and test purposes.

Access:

- ▶ Select "SGMA-GUI > Instrument Name > Setup > Diagnostic / Test".

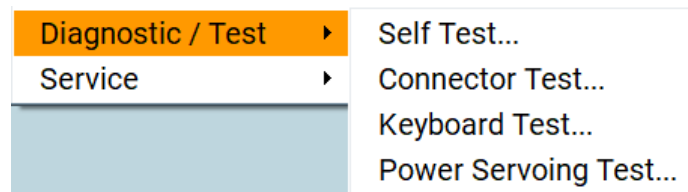

The selection provides the following settings.

Settings

- [Keyboard tests](#)..... 119

10.11.1 Keyboard tests

Access:

- ▶ Select "SGMA-GUI > Instrument Name > Diagnostic Tests > Keyboard Test".

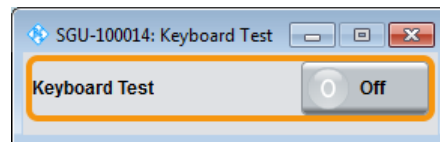

Use this function to check the proper operation of all front panel elements.

If "Keyboard Test" is enabled, all front panel LEDs except the [POWER ON] are orange.

The exact test procedure is described in the service manual.

SCPI command:

`:TEST:KEYBoard[:STATe]` on page 218

11 Performing configuration tasks

This section provides a general explanation on how to operate the instrument manually via the R&S SGMA-GUI software.

We assume, that the R&S SGU is connected to a remote PC. The R&S SGMA-GUI software is installed on this remote PC and the instrument has to be added to the list of "Available Instruments".



For information on how to fulfill these requirements, refer to:

- [Chapter 3.13.2.1, "Connecting to the network"](#), on page 30
- [Chapter 3.13.1, "Installing the R&S SGMA-GUI software"](#), on page 28
- [Chapter 3.13.2.3, "Adding instruments to R&S SGMA-GUI"](#), on page 32

11.1 How to generate I/Q signals



Options R&S SGS-B112V and R&S SGU-B120V/-B140V are required for the I/Q modulation.

To generate an I/Q modulated signal with higher frequency

In this example, the R&S SGU acts as an extension to the R&S SGU extending its frequency range to 40 GHz.

The [Figure 11-1](#) shows an example of the test setup.

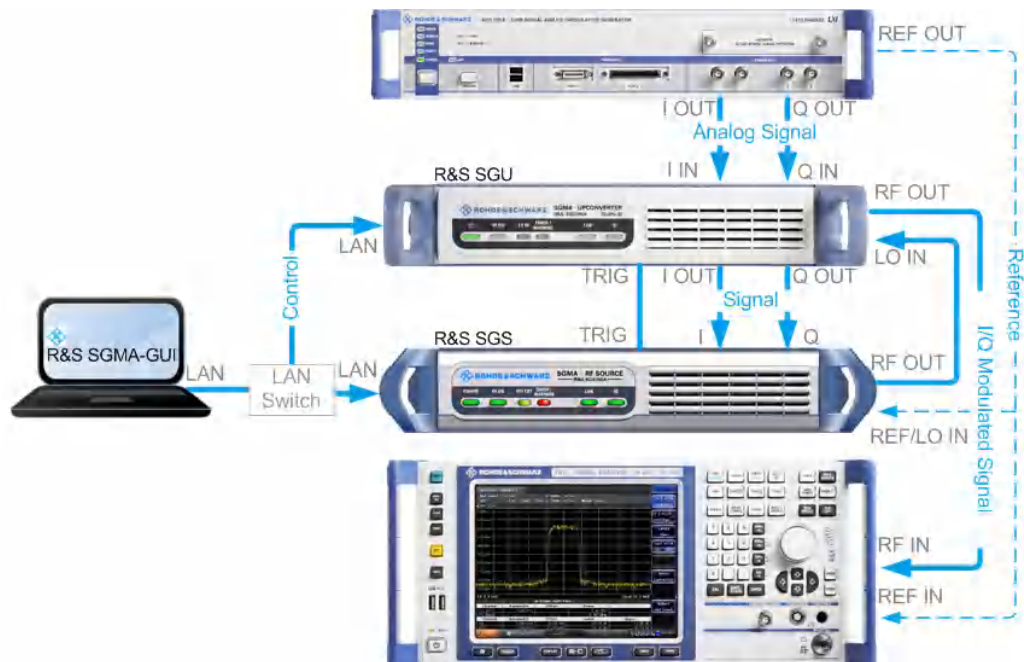

Figure 11-1: Example of the test setup



For higher setting/ measuring speeds, use a PCIe switch and PCIe connections.

If a common reference frequency is required, use the internal reference signal of the signal generator and provide it to the R&S SGU and the connected signal analyzer, e.g. the R&S FSW.

1. Connect the test equipment as shown on [Figure 11-1](#):
 - a) Connect the R&S SGS, the R&S SGU and the controller to a LAN switch.
 - b) Connect the "I/Q OUT" of the base band signal source to the "I/Q IN" of the R&S SGU.
 - c) Connect the "I/Q OUT" of the R&S SGS to the I and Q connectors of the R&S SGU.
 - d) Connect the "RF 50Ω" of the R&S SGS to the "LO IN" of the R&S SGU.
 - e) Connect the "TRIG" connectors of the R&S SGS and the R&S SGU.
 - f) Connect the "RF 50Ω" of the R&S SGU to the RF input connector of the signal analyzer.
2. Select "SGMA-GUI main panel > R&S SGS > Extension".

Tip: Steps 3 to 5 can be omitted if the R&S SGS and a single R&S SGU are connected using PCIe or USB or by a direct LAN connection. In this case, the R&S SGS automatically activates the R&S SGU.
3. Press the ID key on the front panel of the R&S SGU (only required if you connect the components via a company network).
4. In the "Extension" dialog, trigger "Scan".

The scan function finds out the connected R&S SGU.

5. To enable the R&S SGU as an extension, proceed as follows:
 - a) Select the R&S SGU from the list
 - b) Set "Available Instruments > Select > On".

A green status indicator "Connected" indicates the successfully established remote connection to the extension.

6. Select "Test Signal Connections > Test" to trigger a check of all required signal connections.

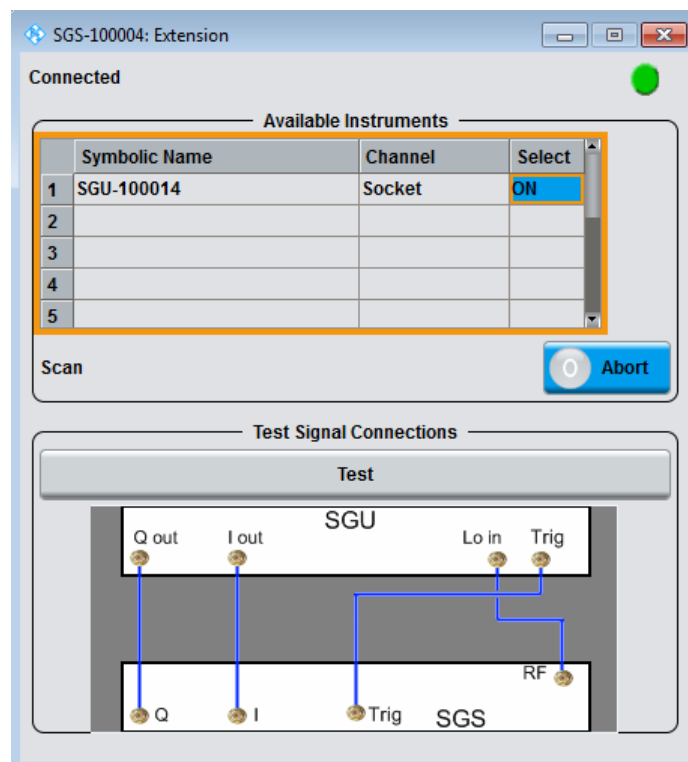

The diagram displays the connection state of the tested connections.

7. Configure RF output signal settings:
 - a) Select "SGMA-GUI > R&S SGS > Freq = 20 GHz".
 - b) Select "Lev = -30 dBm".
 - c) Activate the RF output: Select "RF > State > On".

The extension adopts these values and states automatically. Generated is an I/Q signal with "RF = 20 GHz" and "Level = -30 dBm".

11.2 How to restore the LAN connection

If you lose the LAN connection of the instrument, for example, after assigning a static IP address, proceed as follows:

- ▶ On the front panel of the instrument, press the [LAN] LED for more than 3 seconds. Pressing trigger a reset of the LAN settings. In particular, the "Address Mode" on page 115 switches to "DHCP".

If your network supports automatic assignment of IP address, the new IP address is assigned to the instrument automatically.

11.3 How to switch between operating states

The [Figure 11-2](#) gives an overview of the operating states of the instruments and how to trigger the switch-over between them.

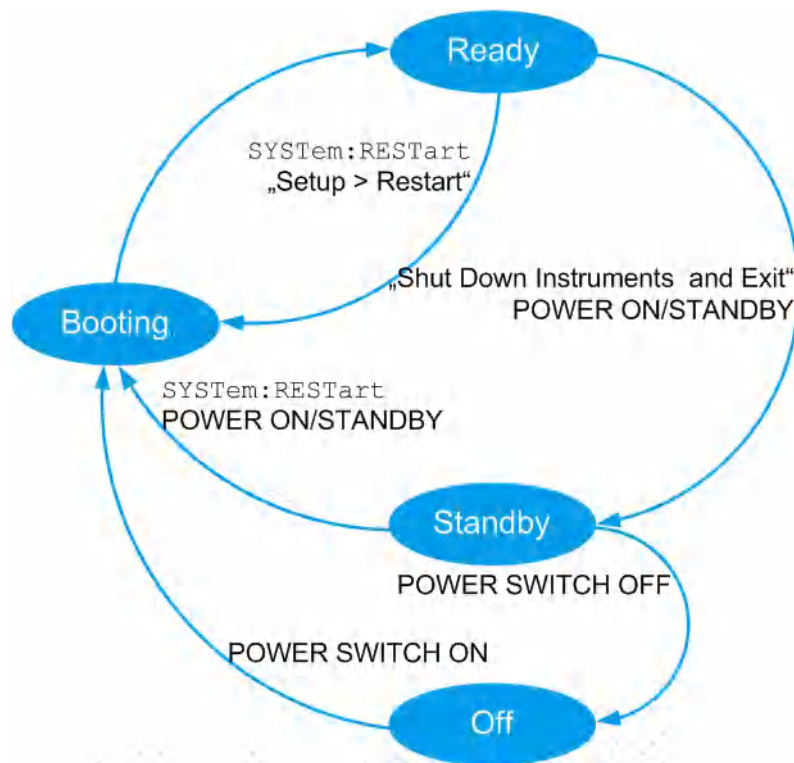

Figure 11-2: Operating states

:REStart, :STANdbY

= SCPI commands

"Setup" > "Standby", "Setup" > "Restart", "Shut Down Instruments and Exit"

[POWER ON/STANDBY], power switch [I/O]

= R&S SGMA-GUI controls
= Hardkey controls on the front/rear panel of the instrument

The [Table 11-1](#) provides a short description of the operating states and their indication.

Table 11-1: Indication of the operating states

Operating state	Description	Indication
Off	The instrument is shut down.	All LEDs on the front panel of the instrument are off.
Booting	The instrument boots the operating system and starts the instrument firmware. If the previous session was terminated regularly, the instrument uses the last setup with the relevant instrument settings.	The green [POWER ON/STANDBY] key blinks.
Standby	The standby power mode keeps the power switch circuits and the remote control system active. In this state, it is safe to switch off the AC power and disconnect the instrument from the power supply.	In the R&S SGMA-GUI, the status indicator in front of the instrument name is red. The orange [POWER ON/STANDBY] key is on.
Ready (normal operation)	The instrument is ready for operation. All modules are power-supplied.	In the R&S SGMA-GUI, the status indicator in front of the instrument name is green. The green [POWER ON/STANDBY] key is on.

To switch the instrument to standby state

- Use one of the following:
 - a) On the remote PC, select "SGMA-GUI > Instrument Name > Setup > Standby".
 - b) Press the [POWER ON/STANDBY] key on the front panel of the instrument.
 - c) Send the SCPI command:

```
:SYSTem:REBoot
```

The current instrument settings are automatically saved. The instrument switches to a power-saving mode.

In the R&S SGMA-GUI, the standby state is indicated by the red state symbol in front of the corresponding instrument's name, on the front panel, by the orange [POWER ON/STANDBY] button.

You can still remotely control the instrument.

To return the instrument from standby to ready state

- Use one of the following:
 - a) On the remote PC, select "SGMA-GUI > Instrument Name > Setup > Restart".
 - b) Press the orange [POWER ON/STANDBY] key on the front panel of the instrument.
 - c) Send the SCPI command:

```
:SYSTem:REStArt
```

The instrument loads the last setup with all instrument settings, switches to ready state and is ready for normal operation.

In the R&S SGMA-GUI, the ready state is indicated by the green state symbol in front of the instrument's name.

On the front panel, the ready state is indicated by the green [POWER ON/STANDBY] button.

To switch all connected instruments to standby state and close the R&S SGMA-GUI

- ▶ In the R&S SGMA-GUI main panel, select "File > Shut down instruments and exit".

The R&S SGMA-GUI quits and switches the connected instruments to standby state.



For description on how to terminate work and shut down the instrument regularly, see [Chapter 3.10, "Switching on or off"](#), on page 25.

11.4 How to use computer names

If there is a name server in the network, alternatively to the IP address each PC or instrument connected in a LAN can be accessed via an unambiguous computer name. Each instrument is delivered with an assigned computer name, but this name can be changed.



For instruction on how to find out the default computer name, refer to [Chapter 8.4.3, "Finding out the default hostname of the instrument"](#), on page 76.

To query and change a computer name



To avoid violations and to use easy identification provided by the computer name, we recommend that you to keep the default hostname unchanged.

1. Open "SGMA-GUI > Instrument Name > Setup > Network Settings" dialog.

The computer name is displayed under "Hostname".

2. Select "SGMA-GUI > Instrument Name > Setup > Protection"
3. Enable the "Protection Level 1".

The parameter "Hostname" in the "Network Settings" dialog is now enabled for configuration.

4. Change the "Hostname".
5. Press the [POWER ON/STANDBY] key to restart the instrument.

Note: The "Factory Preset" function restores the factory value of the parameter "Hostname".

11.5 How to install a new firmware version on the instrument

You can update the firmware of the R&S SGU.

Firmware installation via R&S SGMA-GUI



Install or update the firmware of the R&S SGU before installing or updating the software R&S SGMA-GUI.

1. Select "SGMA-GUI main panel > Instrument Name > Setup > Maintenance > Operation > Install firmware package".
2. Press "Select Package" and navigate to the directory of the new firmware.
3. If several instruments require a firmware update, enable "Update All" to accelerate the update procedure.

All instruments that are in active state and are connected to this controller are updated simultaneously.

4. Enter the "Security Password".
5. Confirm the update with "Accept".

The software transfers the firmware file and automatically starts the update procedure. During the update, the message "Updating Firmware" is displayed in the "Info" line. The update process is indicated by an LED running light.

Note: The update procedure requires a restart of the instrument. The restart is performed automatically. The instrument is not accessible during that time.

6. Wait until the message "Updating Firmware" disappears. After the message disappears, the update is complete.

The [POWER ON/STANDBY] LED is green.

7. If necessary, install the new R&S SGMA-GUI.

For detailed description, refer to [Chapter 3.13.1, "Installing the R&S SGMA-GUI software"](#), on page 28

8. If you connect the instrument and the controller/PC over the PCIe interface and the external PC does not support hot-plugging, restart the external PC.

Firmware update through a session control protocol (SCP)



Install or update the firmware of the R&S SGU before installing or updating the software R&S SGMA-GUI.

1. Connect the R&S SGU and a Windows PC to the same network.
2. On the PC, open a windows explorer window.
3. To connect to the R&S SGU, enter the name of the instrument or its IP address in the windows taskbar.
4. Enter the user name and password to connect to the R&S SGU. The default user name is *instrument* and the password is *instrument*.

A folder opens, containing the `share` and the `update` folder.

5. Open the `update` folder.
6. Copy the new firmware update file into the folder.
The update starts automatically.



Unsuccessful or erroneous firmware update

An erroneous or unsuccessful installation of firmware update package is indicated by a combination of one orange and red LEDs on the front panel.

Refer to the service manual for a description of the displayed error code or contact the customer support center, see [Chapter 14.5, "Contacting customer support"](#), on page 226.

11.6 How to activate options



A firmware update before the activation of the SW option can be required.

Refer to the description of the SW option for the required firmware version.

See also [Chapter 11.5, "How to install a new firmware version on the instrument"](#), on page 125 for instruction on how to update the firmware version.

1. Select "SGMA-GUI main panel > Instrument Name > Setup > Install SW-Options".
2. Select "Option Key".
3. Enter the key code delivered with the new option.

The new option is now enabled and ready for operation.

11.7 How to set a PCIe direct connection

To build a direct PCIe connection between an R&S SGU and an R&S SGS, which has a "Controller > Revision" < 5, first you have to set the correct PCIe interface mode manually. If your R&S SGS has a "Controller > Revision" 5 or higher, these settings are done automatically.



You can check the "Controller > Revision" of your instrument in the "SGMA-GUI > Instrument Name > Hardware Config" dialog.

To set a PCIe direct connection between an R&S SGS and an R&S SGU manually

1. Connect the R&S SGS and the R&S SGU directly using a PCIe cable. Refer to [Chapter 12.3.4, "Connecting the controller and the instrument"](#), on page 144 for cable requirements and setup information.
2. Switch on the R&S SGS and the R&S SGU.

3. Select "SGMA-GUI main panel > Instrument Name > Setup > Maintenance".
4. Select "Operation > PCIe Interface Mode".
5. Select "PCIe Interface Mode > Root Complex".
6. Restart your instrument for the changes to take place.

The PCIe connection between the R&S SGS and the R&S SGU is established and the instruments can be used.

12 Network operation and remote control

As an alternative to operating the R&S SGU interactively via the R&S SGMA-GUI, you can operate the R&S SGU also from a remote location.



Information on network operation and remote control

The following descriptions provide information required for operating the R&S SGU remotely. The information applies to all applications and operating modes supported by the instrument. Definitions specified in the SCPI standard are not provided.

For basic knowledge on remote control operation and additional information, see the following documents, available on the Rohde & Schwarz website:

- [Remote control via SCPI](#)
- [1GP72: Connectivity of Rohde&Schwarz Signal Generators](#)
- [1MA208: Fast Remote Instrument Control with HiSLIP](#)

• Remote control interfaces and protocols	129
• Starting a remote control session	138
• Advanced remote control using PCIe	140
• Advanced remote control using fast socket	145
• Status reporting system	147
• LXI configuration	155
• Monitoring remote control operation with R&S SGMA-GUI	160

12.1 Remote control interfaces and protocols

The instrument supports several interfaces for remote control. The following table gives an overview.

Table 12-1: Remote control interfaces and protocols

Interface	Protocols, VISA ¹⁾ address string and Library	Remarks
Local Area Network (LAN)	<ul style="list-style-type: none"> • HiSLIP High-Speed LAN Instrument Protocol (IVI-6.1) TCPIP::host address::hislip0[::INSTR] • VXI-11 TCPIP::host address::inst0[::INSTR] Library: VISA • socket communication (Raw Ethernet, simple Telnet) TCPIP::host address[::LAN device name]::<port>::SOCKET Library: VISA or socket controller 	<p>A LAN connector is located on the rear panel of the instrument.</p> <p>The interface is based on TCP/IP and supports various protocols.</p> <p>For details, see Chapter 12.1.2, "LAN interface", on page 133</p>
USB	<p>USBTMC</p> <p>USB::<vendor ID>::<product ID>::<serial number>[::INSTR]</p> <p>Library: VISA</p>	<p>A USB connector is located on the rear panel of the instrument.</p> <p>For details, see Chapter 12.1.3, "USB interface", on page 136</p>

Interface	Protocols, VISA ^{*)} address string and Library	Remarks
PCIe	Proprietary PCIe:: <vendor id="">::<product ID>:: <serial number>[::INSTR] Library: PCIe controller </vendor>	A PCIe connector is located on the rear panel of the instrument. For details, see Chapter 12.1.4, "PCI Express interface" , on page 136
GPIB (IEC/IEEE Bus Interface)	– • GPIB:: <address>[::INSTR] (no secondary address) VISA </address>	The instrument is not equipped with GPIB bus interfaces. Use a GPIB-to-LAN or GPIB-to-USB adapter instead. For details, see Chapter 12.1.5, "GPIB interface (IEC/IEEE bus interface)" , on page 137

^{*)} VISA is a standardized software interface library that provides input and output functions to communicate with instruments. A VISA installation on the controller is a prerequisite for remote control over LAN (when using VXI-11 or HiSLIP protocol) or USB. However, no VISA installation is necessary for remote control while using socket communication. For more information about VISA, refer to the user documentation.



Rohde & Schwarz provides the standardized I/O software library R&S VISA for communication via TCP/IP (LAN: HiSLIP, VXI-11 and raw socket) or USB (USBTMC) interfaces.

R&S VISA is available for download at the Rohde & Schwarz website <http://www.rohde-schwarz.com/rsvisa>.

SCPI (Standard Commands for Programmable Instruments)

SCPI commands are used for remote control. Commands that are not taken from the SCPI standard follow the SCPI syntax rules. The instrument supports the SCPI version 1999. The SCPI standard is based on standard IEEE 488.2 and aims at the standardization of device-specific commands, error handling and the status registers. The tutorial "Automatic Measurement Control - A tutorial on SCPI and IEEE 488.2" from John M. Pieper (R&S order number 0002.3536.00) offers detailed information on concepts and definitions of SCPI.

12.1.1 Remote control programs and libraries

The [Figure 12-1](#) provides a schematic illustration of the remote control capabilities of the instrument.

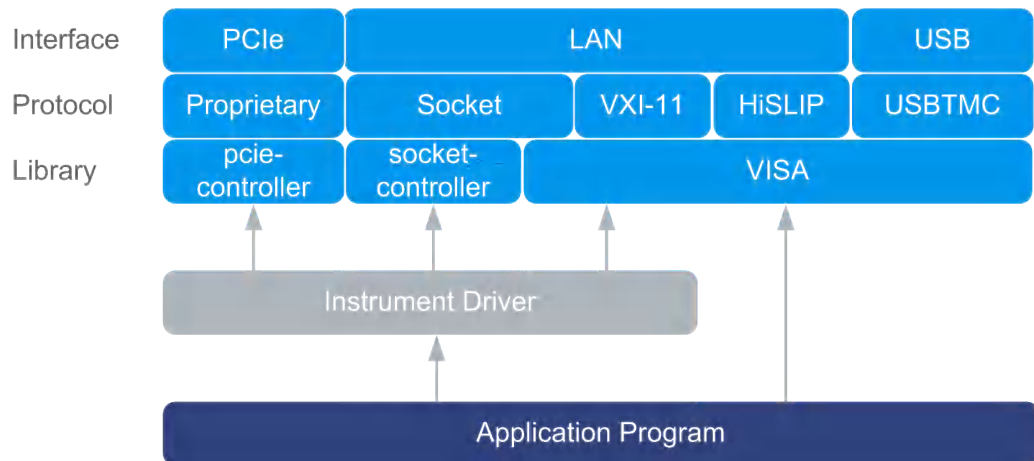

Figure 12-1: Remote control interfaces, protocols and libraries

The following examples give an overview of the dependencies between the available libraries, the possible interfaces and protocols, and whether an instrument driver is provided. The involved parts are **highlighted**.

- Remote control program using VISA

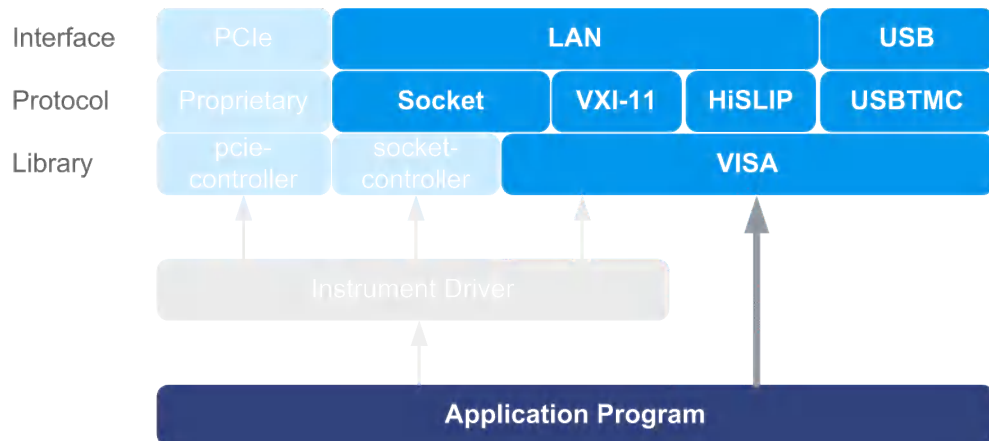

Figure 12-2: Remote control program using VISA

Protocol	Remote control program
Socket	<code>viOpen (... , "TCPIP:rssgu100a100010::5025::SOCKET", ...)</code> <code>viPrintf (... , "SOUR:FREQ 2GHz\n")</code>
VXI-11	<code>viOpen (... , "TCPIP:rssgu100a100010::inst0::INSTR", ...)</code> <code>viPrintf (... , "SOUR:FREQ 2GHz\n")</code>
HiSLIP	<code>viOpen (... , "TCPIP:rssgu100a100010::hislip0::INSTR", ...)</code> <code>viPrintf (... , "SOUR:FREQ 2GHz\n")</code>
USBTMC	<code>viOpen (... , "USB::0x0aad::0x00ce::1000010::INSTR", ...)</code> <code>viPrintf (... , "SOUR:FREQ 2GHz\n")</code>

- Remote control program using instrument driver (VISA available)

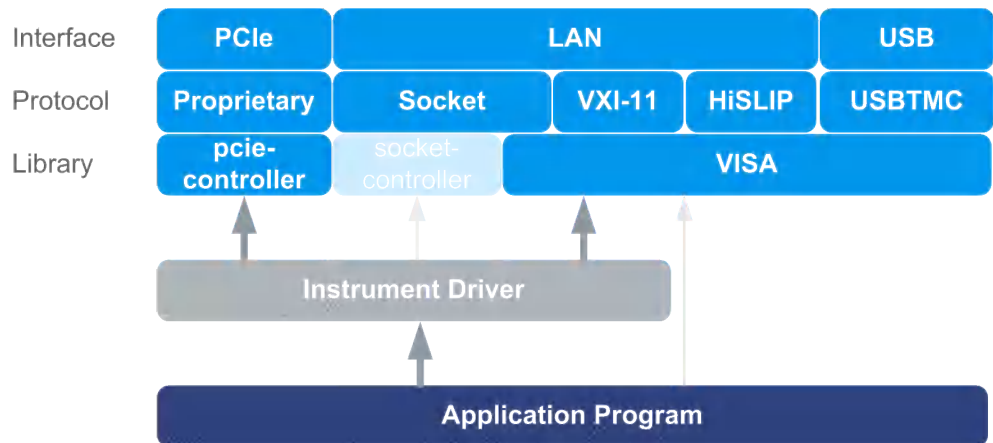

Figure 12-3: Remote control program using instrument driver (VISA available)

Protocol	Remote control program
Socket	<code>rssgu_init ("TCPIP:rssgu100a100010::5025::SOCKET", ...)</code> <code>rssgu_SetFrequency (... , 2e9)</code>
VXI-11	<code>rssgu_init ("TCPIP:rssgu100a100010::inst0::INSTR", ...)</code> <code>rssgu_SetFrequency (... , 2e9)</code>
HiSLIP	<code>rssgu_init ("TCPIP:rssgu100a100010::hislip0::INSTR", ...)</code> <code>rssgu_SetFrequency (... , 2e9)</code>
USBTMC	<code>rssgu_init ("USB::0x0aad::0x00ce::1000010::INSTR", ...)</code> <code>rssgu_SetFrequency (... , 2e9)</code>
PCIe	<code>rssgu_init ("PCIe::0x162f::0x132e::1000010::INSTR", ...)</code> <code>rssgu_SetFrequency (... , 2e9)</code>

- Remote control program using instrument driver (VISA not available)

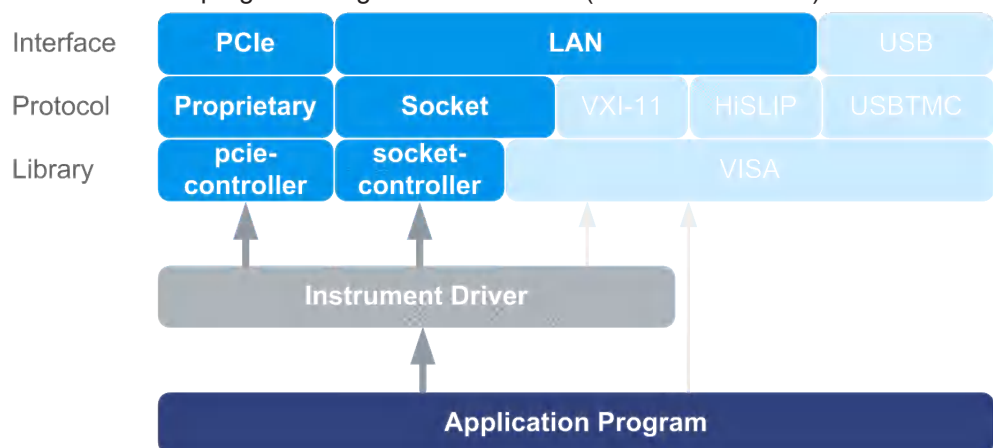

Figure 12-4: Remote control program using instrument driver (VISA not available)

Protocol	Remote control program
Socket	<pre>rssgu_init ("TCPIP:rssgu100a100010::5025::SOCKET", ...) rssgu_SetFrequency (... , 2e9)</pre>
PCIe	<pre>rssgu_init ("PCIe::0x162f::0x132e::1000010::INSTR", ...) rssgu_SetFrequency (... , 2e9)</pre>

12.1.2 LAN interface

To be integrated in a LAN, the instrument is equipped with a LAN interface, consisting of a connector, a network interface card and protocols.

For remote control via a network, the PC and the instrument must be connected via the LAN interface to a common network with TCP/IP network protocol. They are connected using an RJ45 cable (shielded or unshielded twisted-pair category 5). The TCP/IP network protocol and the associated network services are preconfigured on the instrument. Software for instrument control and (for specified protocols only) the VISA program library must be installed on the controller.



Identifying instruments in a network

If several instruments are connected to the network, each instrument has its own IP address and associated resource string. The controller identifies these instruments by the resource string.

12.1.2.1 VISA resource strings

The VISA resource string is required to establish a communication session between the controller and the instrument in a LAN. The resource string is a unique identifier, composed of the specific IP address of the instrument and some network and VISA-specific keywords.

```
TCPIP::host address[::LAN device name][::INSTR]
```

- **TCPIP** designates the network protocol used
- **Host address** is the IP address or host name of the device
See also [Chapter 8.4.3, "Finding out the default hostname of the instrument"](#), on page 76.
- **[::LAN device name]** defines the protocol and the instance number of a subinstrument:
- **[::INSTR]** indicates the instrument resource class (optional)

The **IP address** (host address/computer name) is used by the programs to identify and control the instrument. It is automatically assigned by the DHCP server the first time that the device is registered on the network. Alternatively, you can also assign its **LAN device name**.

You can find the IP address in the "SGMA-GUI > Instrument Name > Setup > Remote" dialog, and also adjust it manually, if necessary.

See below the characteristics of the VISA resource strings for the corresponding interface protocols. The highlighted characters are crucial.

HiSLIP

```
TCPIP::host address::hislip0[::INSTR]
```

- **hislip0** HiSLIP device name, designates that the interface protocol HiSLIP is used (mandatory).

hislip0 is composed of [::HiSLIP device name[,HiSLIP port]] and must be assigned.

For details of the HiSLIP protocol, refer to [Chapter 12.1.2.2, "HiSLIP protocol"](#), on page 134.

VXI-11

```
TCPIP::host address[::inst0][::INSTR]
```

- [::**inst0**] LAN device name, indicates that the VXI-11 protocol is used (optional).

inst0 currently selects the VXI-11 protocol by default and can be omitted.

For details of the VXI-11 protocol, refer to [Chapter 12.1.2.3, "VXI-11 protocol"](#), on page 135.

Socket communication

```
TCPIP::host address::port::SOCKET
```

- **Port** determines the used port number
- **SOCKET** indicates the raw network socket resource class

Socket communication requires the specification of the port (commonly referred to as port number) and of "SOCKET" to complete the VISA resource string with the associated protocol used.

The registered port for socket communication is port 5025.

See also [Chapter 12.1.2.4, "Socket communication"](#), on page 135.

Example:

- Instrument has the IP address *10.113.11.91*; the valid resource string using VXI-11 protocol is:
TCPIP::10.113.11.91::INSTR
- The DNS host name is *rssgu100a100021*; the valid resource string is:
TCPIP::rssgu100a100021::hislip0 (HiSLIP)
TCPIP::rssgu100a100021::inst0 (VXI-11)
- A raw socket connection can be established using:
TCPIP::10.113.11.91::5025::SOCKET

12.1.2.2 HiSLIP protocol

The High Speed LAN Instrument Protocol (HiSLIP) is the successor protocol for VXI-11 for TCP-based instruments specified by the IVI foundation. The protocol uses two TCP

sockets for a single connection - one for fast data transfer, the other for non-sequential control commands (e.g. `Device Clear` or `SRQ`).

HiSLIP has the following characteristics:

- High performance as with raw socket network connections
- Compatible IEEE 488.2 support for Message Exchange Protocol, Device Clear, Serial Poll, Remote/Local, Trigger, and Service Request
- Uses a single IANA registered port (4880), which simplifies the configuration of firewalls
- Supports simultaneous access of multiple users by providing versatile locking mechanisms
- Usable for IPv6 or IPv4 networks



Using VXI-11, each operation is blocked until a VXI-11 instrument handshake returns. However, using HiSLIP, data is sent to the instrument using the "fire and forget" method with immediate return. Thus, a successful return of a VISA operation such as `viWrite()` guarantees only that the command is delivered to the instrument's TCP/IP buffers. There is no confirmation, that the instrument has started or finished the requested command.

For more information see also the application note:

[1MA208: Fast Remote Instrument Control with HiSLIP](#)

12.1.2.3 VXI-11 protocol

The VXI-11 standard is based on the ONC RPC (Open Network Computing Remote Procedure Call) protocol which in turn relies on TCP/IP as the network/transport layer. The TCP/IP network protocol and the associated network services are preconfigured. TCP/IP ensures connection-oriented communication, where the order of the exchanged messages is adhered to and interrupted links are identified. With this protocol, messages cannot be lost.

12.1.2.4 Socket communication

An alternative way for remote control of the software is to establish a simple network communication using sockets. The socket communication, also referred to as "Raw Ethernet communication", does not require a VISA installation on the remote controller side.

The simplest way to establish socket communication is to use the built-in telnet program. The telnet program is part of every operating system and supports communication with the software on a command-by-command basis.

Socket connections are established on a specially defined port. The socket address is a combination of the IP address or the host name of the instrument and the number of the port configured for remote-control. All instruments use port number 5025 for this

purpose. The port is configured for communication on a command-to-command basis and for remote control from a program running on a connected PC.

12.1.3 USB interface

For remote control via USB connection, the PC and the instrument must be connected via the USB interface. A USB connection requires the VISA library to be installed. VISA detects and configures the R&S instrument automatically when the USB connection is established. You do not have to install a separate driver.

USB resource string

The syntax of the used USB resource string is:

`USB::<vendor ID>::<product ID>::<serial number>[::INSTR]`, where:

- **USB** denotes the used interface
- **<vendor ID>** is the manufacturer ID for Rohde&Schwarz
- **<product ID>** is the product identification of the R&S instrument
- **<serial number>** is the individual serial number on the rear of the instrument
- **[::INSTR]** indicates the instrument resource class (optional)

You can retrieve the USB resource string from the "SGMA-GUI > Instrument Name > Setup > Remote" dialog.

Example:

```
USB::0x0AAD::0x00ce::100021::INSTR
```

0x0AAD is the vendor ID for Rohde & Schwarz.

0x00ce is the product ID for the R&S SGU.

100021 is the serial number of the particular instrument.

12.1.4 PCI Express interface

A PCI Express (PCIe) connector is provided on the rear panel of the instrument.

Refer to [Chapter 12.3, "Advanced remote control using PCIe"](#), on page 140 for a description of how to set up a remote control connection via PCIe and the permitted cables.

Via PCI Express some commands can be sent to the instrument with optimized speed (memory-mapped remote control), e.g. frequency or level settings. Speed optimization allows minimum setup time.

PCIe resource string

The syntax of the used PCIe resource string is:

`PCIe::<vendor ID>::<product ID>::<serial number>[::INSTR]`, where:

- **PCIe** denotes the used interface
- **<vendor ID>** is the manufacturer ID for Rohde & Schwarz

- **<product ID>** is the product identification of the R&S instrument
- **<serial number>** is the individual serial number on the rear of the instrument
- **[::INSTR]** indicates the instrument resource class (optional)

You can retrieve the PCIe resource string from the "SGMA-GUI > Instrument Name > Setup > Remote" dialog.

Example:

```
PCIe::0x162f::0x132e::100021::INSTR
```

0x162f is the vendor ID for Rohde & Schwarz.

0x132e is the product ID for the R&S SGU.

100021 is the serial number of the particular instrument.

12.1.5 GPIB interface (IEC/IEEE bus interface)

The R&S SGU is not equipped with an IEC/IEEE bus interface.

To be able to control the instrument via the GPIB bus:

1. Connect a GPIB-to-LAN or a GPIB-to-USB adapter to the instrument.
2. Use a GPIB bus cable to connect the instrument and the controller.
3. Provide the GPIB bus card, the card drivers and the program libraries for the programming language in the controller.
4. In the "SGMA-GUI > Setup > Instruments > instrument name > Remote Control", set the "GPIB Address".
See "[GPIB Address](#)" on page 65.
5. If the controller has several GPIB bus cards, define the used "Board Number".

GPIB address

The controller must address the instrument with the GPIB bus channel. GPIB provides channel addresses from 0 to 30.

The GPIB resource string is `GPIB::<address>[::INSTR]`, where:

- **GPIB** denotes the used interface.
- **<address>** indicates the used channel.
- **[::INSTR]** indicates the instrument resource class (optional).

Note: If the VISA implementation supports the GPIB interface, you can optionally define the VISA instrument control resource (INSTR). It is used to define the basic operations and attributes for a device, such as reading, writing, or triggering.



Any connected IEC bus cable must be terminated by an instrument or controller.

12.2 Starting a remote control session

To start a remote control session, connect the instrument and the controller with a suitable cable and switch on both of them.

A remote control program must open a connection to the instrument, before it can send commands to and receive device responses from the instrument.



Instrument address

To operate the instrument via remote control, it must be addressed using the defined interface address.

See [Chapter 12.1.2, "LAN interface"](#), on page 133, [Chapter 12.1.3, "USB interface"](#), on page 136 or [Chapter 12.1.4, "PCI Express interface"](#), on page 136 for details.



The VISA resource strings are indicated in the "SGMA-GUI main panel > Instrument name > Setup > Remote Channels" dialog.

12.2.1 How to find the VISA resource string

To find the VISA resource strings of your instrument:

- ▶ Select "SGMA-GUI main panel > Instrument name > Setup > Remote Channels".

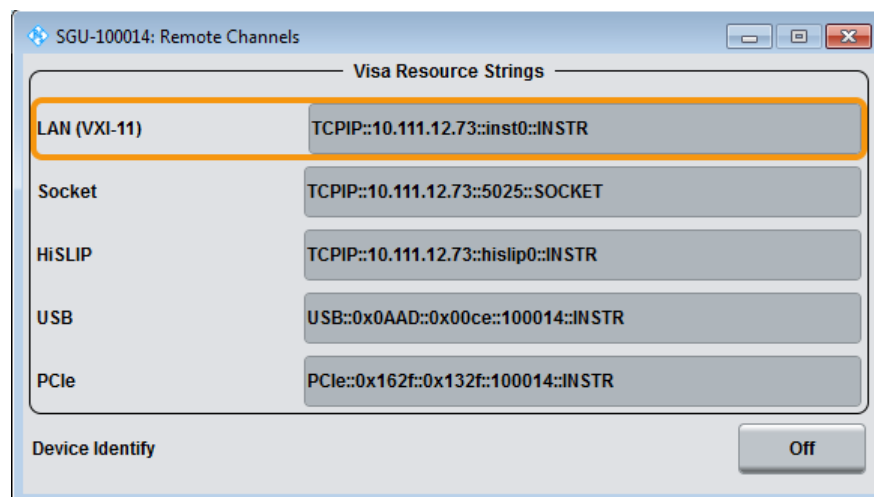

The "Remote Channel Settings" dialog shows all specified resource strings of the supported remote control interfaces.

12.2.2 Remote control over LAN using socket communication

This section provides an example of how to establish a remote control connection over telnet protocol and a simple sockets-based program example that can be further developed (see also [Chapter A, "Telnet program examples"](#), on page 229).

Basic knowledge of programming and operation of the controller are assumed. A description of the interface commands can be obtained from the relevant manuals.



Refer to the getting started manual for an example of how to set up remote control connection over LAN using VXI-11 protocol.

To set up a Telnet connection

To control the software, only a telnet program is required. The telnet program is part of every operating system.

1. To establish a Telnet connection with the R&S SGU, start the telnet program.
2. Enter the socket address.

The socket address is a combination of the IP address or the host name of the R&S SGU and the number of the port configured for remote-control via telnet.

Tip: The R&S SGU uses the port number 5025 for remote connection via Telnet.

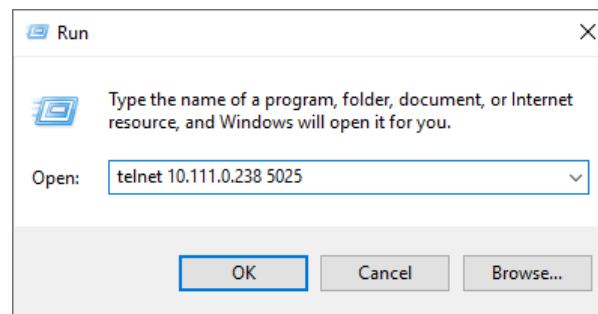

The connection to the instrument is set up and remote-control commands can be sent.

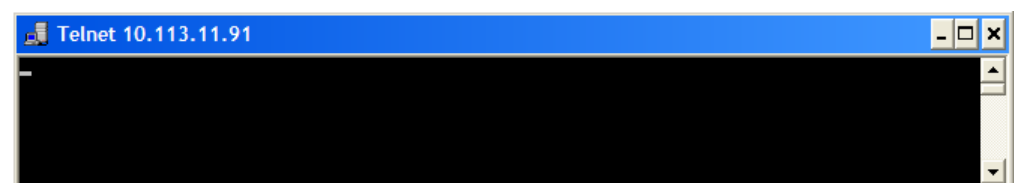

3. Even if the cursor is not visible on the screen, enter blind a remote-control command.
4. Confirm with "Enter".

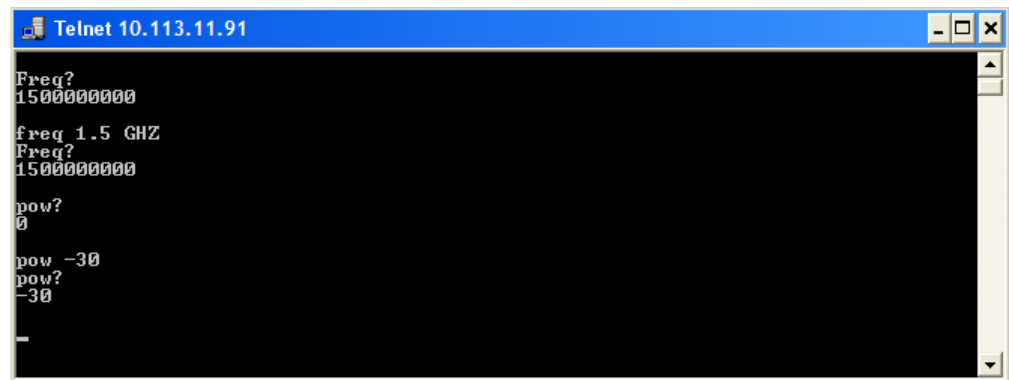

```
Telnet 10.113.11.91
Freq?
1500000000
freq 1.5 GHz
Freq?
1500000000
pow?
0
pow -30
pow?
-30
```

12.3 Advanced remote control using PCIe

The PCIe bus is a high-speed serial bus, composed of point-to-point serial links. A pair of serial links, one transmitting and one receiving link, make up a lane.

Fast settings

The PCIe interface can be utilized not only to transfer text messages, e.g., SCPI commands but also to carry register based remote control messages. The latter mode is called fast settings mode. The specially for this purpose provided instrument's driver is mandatory for the instrument control with fast settings. This instrument driver contains special functions for fast setup.



To use the advantage of the fast settings, the following prerequisites must be fulfilled:

- Using the PCIe interface is mandatory (see also [Chapter 12.3.1, "Setting up a remote control connection via PCIe"](#), on page 140)
- The fast settings must be enabled with the function `rssgu_useFastSettings` (see also [Chapter 12.3.5, "Enabling fast settings"](#), on page 144).

The instrument driver automatically uses the fast settings method whenever possible - currently only for the parameters frequency, level, RF state, modulator state - and sends SCPI messages in all other cases.

Remote control programs written for PCIe will, without modifications, also run if one of the other control channels, LAN or USB is used.

12.3.1 Setting up a remote control connection via PCIe

To set up a remote control connection via PCIe, perform the following steps:

1. Download the drivers: See [12.3.2](#).
2. Configure the controller: See [12.3.3](#)

3. Connect the controller and the instrument: See [12.3.4](#)
4. Enable fast settings: See [12.3.5](#).

12.3.2 Downloading the drivers

All required driver files are available for download on the product page at:

<http://www.rohde-schwarz.com/product/SGU100A.html> > "Downloads" > "Drivers"

Provided are the following files:

- LabWindows/CVI, Linux/OSX driver `rssgu (InstrumentDriver)`
C source code files which provide a functional application programming interface (API) to R&S SGU instruments. Required if you want to control an instrument via PCIe.
- Low-Level SGU drivers
Archive file that contains the following:
 - `KernelDriver`
C source code files from which you can build a Linux kernel mode driver for the R&S SGU PCIe remote control interface.
 - `SguDriverDemo`
C source code module for a demo program using the instrument driver API.
 - `SharedLibraries-Dlls`
Shared libraries (*.dll files) for remote control channels Socket and PCIe. To be used with the instrument driver.
- `VXIplug&play x64/x86 driver rssgu`

Download the required archive and extract the files on a remote PC.

12.3.3 Configuring the controller

This section lists the steps necessary to configure a controller with Linux or Windows operating system.

12.3.3.1 Building and installing the hardware driver

The hardware driver defines the way to communicate with the instrument via PCIe interface.



For Windows operating systems, the hardware driver is installed automatically together with the installation of the R&S SGMA-GUI software.

See also section "Installation of R&S SGMA-GUI Software" in the getting started manual.

For Linux operating system, the source code of the driver is included in the `Low-Level SGU drivers` file.

To build and install this driver, root authority is required.

1. Copy folder `KernelDriver` to your `hdd`
2. Go to directory `host`.
3. On the command line, enter `make`.
The driver `sgshost.ko` is automatically built.
4. Enter `make install`.
Device nodes `sguX` are created under the folder `/dev` (X from 0 to 31).
The module `sguhost` is loaded.
5. Enter `lsmod` to verify the module.

12.3.3.2 Making shared libraries accessible

Two library files per operating system are included in `SharedLibraries-Dlls` file:

- For Linux operating system
`libsocketcontroller.so` and `libpciecontroller.so`
- For Windows operating system
`SocketController.dll` and `PCIeController.dll`

These libraries act as the dynamic link libraries for programs using the socket or PCIe interface.

Linux operating system

- ▶ To make the libraries accessible, perform one of the following:
 - a) Append the environment variable `LD_LIBRARY_PATH` with the path of these two files, e.g., by changing the `/etc/environment` file.
 - b) Move these two files to `/usr/lib` or `/lib` directory.

Windows operating system

- ▶ To make the libraries accessible, perform one of the following:
 - a) Copy these two files to the folder of your executable.
 - b) Copy these two files to the `WINDOWS\system32` folder.

12.3.3.3 Building a program

The help file `rssgu_vxi.chm` shows all functions of the instrument which you can use in your own remote control program.

An example file is provided (`SguDriverDemo.c`), too.

Building the example program (Linux)

1. Copy folders `InstrumentDriver` and `SguDriverDemo` to your hard disk.

2. Go to folder `Build`
3. On the command line, enter `cmake ..`
4. Enter `make`

Folder `Build` contains the executable `SguDriverDemo`.

Building the example program (Windows)

1. Copy folders `InstrumentDriver` and `SguDriverDemo` to your hard disk.
2. Open `SguDriverDemo.vcproj` with Visual Studio.
3. Build the program.

Running the example program

- ▶ On the command line, enter `./SguDriverDemo RESOURCESTRING [cmd]`.

Where

- `RESOURCESTRING` is the (VISA) resource string of your instrument, e.g.
`TCPIP::ipaddress::5025::SOCKET` or `PCIE::0x162f::0x132e::serialno::INSTR`.
 Where `ipaddress` is the IP address or hostname of your instrument and `serialno` is its serial number.
- `cmd` is an optional command (see table).

The following table list the available commands.

Command	Description
<code>?</code>	Usage
<code>q</code>	Quit
<code>f value</code>	Set frequency
<code>f?</code>	Query frequency
<code>l value</code>	Set level
<code>l?</code>	Query level
<code>r value</code>	Set RF state (value = 0 1 ON OFF)
<code>r?</code>	Query RF state

If you enter an additional optional command, `SguDriverDemo` executes it and enters a loop waiting for further commands.

Example:

```
TCPIP::10.111.11.44::5025::SOCKET ?
```

Lists the available commands.

12.3.4 Connecting the controller and the instrument

The "PCIe" connector is located on the [rear panel](#).



Permitted PCIe cables

PCIe extension cables must fulfill the following requirements:

- **Single lane connectors**
- **Maximum cable length of 5 m.**

For example: OSS-PCIe-CBL-x1 cable from One Stop Systems or 74576-000x cable from Molex.

Connecting an external PC that does not support hot-plugging

1. Switch off the external PC and the instrument.
See also [Chapter 3.10, "Switching on or off"](#), on page 25.
2. **NOTICE!** Risk of device failure. The R&S SGU is equipped with a single lane PCIe interface that supports hot plugging.
Do not connect an external PC to the PCIe connector of the instrument during operation if this external PC does not support hot-plugging!
Connect the instrument and the controller with a permitted PCIe cable as specified in ["Permitted PCIe cables"](#) on page 144.
3. Switch on the instrument.
4. Wait until the instrument has completed the booting (the "POWER" LED on the instrument's front panel is constantly on).
5. Switch on the external PC.

Connecting an R&S SGS and an R&S SGU

If you use the R&S SGU as an upconverter to the R&S SGS, the R&S SGS acts as a controller to the R&S SGU. For a description of how to connect the instruments refer to [Chapter 7.2, "Connecting an R&S SGS and an R&S SGU"](#), on page 51.

12.3.5 Enabling fast settings

- ▶ To enable the special PCI express feature fast settings, enable the function `rssgu_UseFastSettings` (`ViSession instrumentHandle`, `ViBoolean fastEnabled`, `ViBoolean asynchronousEnabled`) included in the instrument driver.

Settings for some parameters like level and frequency accelerate.

To disable the fast settings, call the function `rssgu_UseFastSettings` with argument `fastEnabled=false`.

12.4 Advanced remote control using fast socket

Fast settings

The socket interface can be utilized not only to transfer text messages, e.g., SCPI commands but also to carry register based remote control messages. The latter mode is called fast settings mode. The fast socket communication is based on the Ethernet protocol which does not support routing. Therefore a controller PC can only control devices within its own network segment using the fast socket method.



To use the advantage of the fast settings, the following prerequisites must be fulfilled:

- On Windows operating systems, the fast socket driver must be installed.
- The application program must be run with root/administrator rights.
- The fast settings must be enabled with the function `rssgu_useFastSettings` (see also [Chapter 12.3.5, "Enabling fast settings"](#), on page 144).

The instrument driver automatically uses the fast settings method whenever possible, currently for the parameters frequency, level, RF state, I/Q modulator state, crest factor, host frequency, host level, apply settings. In all other cases, SCPI messages are sent.

12.4.1 Setting up a remote control connection via fast socket

Download the required archive and extract the files on a remote PC, as described in [Chapter 12.3.2, "Downloading the drivers"](#), on page 141.

Windows operating systems

To set up a remote control connection via fast socket for Windows operating systems, perform the following steps:

1. Connect the controller and the instrument: See [Chapter 3.13.2, "Connecting a remote PC via LAN"](#), on page 30.
2. Install the protocol driver to the controller: See [Chapter 12.4.2, "Installing the protocol driver"](#), on page 146.
3. On the controller, start the driver by using one of the following:
 - a) Start the Windows console user interface as an administrator.
Execute the command `net start SGMANDISPROT`.
 - b) Use a program for opening the driver.
See, for example, the example file `SguDriverDemo.c`.
4. Start the application with administrator rights.
5. Enable fast settings: See [Chapter 12.4.3, "Enabling fast settings"](#), on page 146.

Linux operating systems

To set up a remote control connection via fast socket for Linux operating systems, perform the following steps:

1. Connect the controller and the instrument: See [Chapter 3.13.2, "Connecting a remote PC via LAN"](#), on page 30.
2. Start the application as root.
3. Enable fast settings: See [Chapter 12.4.3, "Enabling fast settings"](#), on page 146.

12.4.2 Installing the protocol driver

The protocol driver defines the way to communicate with the instrument via the LAN fast socket interface.

For Linux operating system, no special driver is needed.

For Windows operating systems, the `SGMANDISPROT` driver is required. The protocol driver is installed automatically together with the installation of the R&S SGMA-GUI software. It is also provided in the `Low-Level SGU drivers` file.

To install the driver manually on a Windows operating system:

1. Open "Control Panel > Network and Sharing Center".
2. Select the network adapter on which you want to install the driver.
The "Local Area Connection Status" dialog opens.
3. Click "Properties" to open the "Local Area Connection Properties" dialog.
4. Click "Install" to open the "Select Network Feature Type" dialog.
5. Select "Protocol".
6. Select "Add".
7. In the "Select Network Protocol" dialog, select "Have Disk".
8. To select the driver, navigate to its storage directory.
9. Click "OK" to install the driver.

12.4.3 Enabling fast settings

- ▶ To enable the fast settings for the fast socket, call function `rssgu_UseFastSettings` (`ViSession instrumentHandle`, `ViBoolean fastEnabled`, `ViBoolean asynchronousEnabled`) included in the instrument driver.

Settings for some parameters like level and frequency accelerate.

To disable the fast settings, call the function `rssgu_UseFastSettings` with argument `fastEnabled=false`.

12.5 Status reporting system

The status reporting system stores all information on the current operating state of the instrument, and on errors which have occurred. This information is stored in the status registers and in the error queue.

You can query both with the commands of the [STATus subsystem](#).

12.5.1 Hierarchy of the status registers

The [Figure 12-5](#) shows the hierarchical structure of information in the status registers (ascending from left to right).

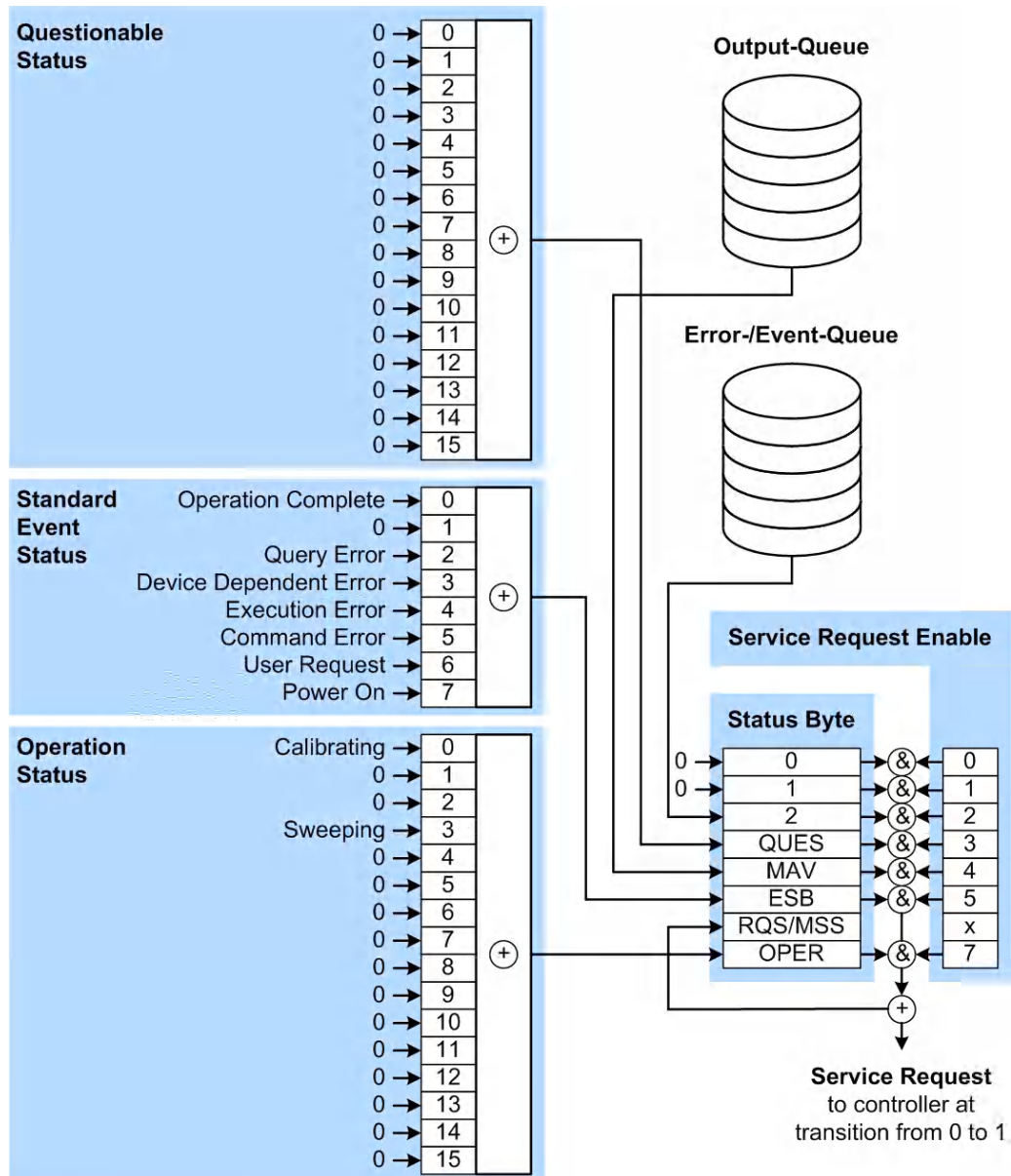

Figure 12-5: Graphical overview of the status registers hierarchy

- OPER = Operation Status Summary Bit
- RQS/MSS = Service Request Generation
- ESB = Standard Event Status Summary Bit
- MAV = Message Available in Output Queue
- QUES = Questionable Status Summary Bit
- 2 = Error- /Event-Queue
- 1, 0 = not used

Note: This legend explains the abbreviations to the Status Byte Register.

The R&S SGU uses the following status registers:

- **Status Byte (STB)** and **Service Request Enable (SRE)**, see [Chapter 12.5.3, "Status byte \(STB\) and service request enable register \(SRE\)"](#), on page 151.

- **Standard Event Status**, i.e. the Event status Register (ESR) and the Event Status Enable (ESE), see [Chapter 12.5.4, "Event status register \(ESR\) and event status enable register \(ESE\)"](#), on page 152.
- **Questionable Status and Operation Status**, the (SCPI status registers, see [Chapter 12.5.2, "Structure of a SCPI status register"](#), on page 149, [Chapter 12.5.5, "Questionable status register \(STATUS:QUESTionable\)"](#), on page 152 and [Chapter 12.5.6, "Operation status register \(STATUS:OPERation\)"](#), on page 153.
- **Output-Queue**
The output queue contains the messages the instrument returns to the controller. It is not part of the status reporting system but determines the value of the MAV bit in the STB and thus is represented in the overview.
- **Error- /Event-Queue**
The error-/event-queue contains all errors and events that have occurred in the past. When reading the queue, the instrument starts with the first occurred error/ event.

All status registers have the same internal structure.



SRE, ESE

The service request enable register SRE can be used as ENABLE part of the STB if the STB is structured according to SCPI. By analogy, the ESE can be used as the ENABLE part of the ESR.

12.5.2 Structure of a SCPI status register

Each SCPI status register consists of five parts. Each part has a width of 16 bits and has different functions. The individual bits are independent of each other, i.e. each hardware status is assigned a bit number, which is valid for all five parts. Bit 15 (the most significant bit) is set to zero for all parts. Thus, the contents of the register parts can be processed by the controller as positive integers.

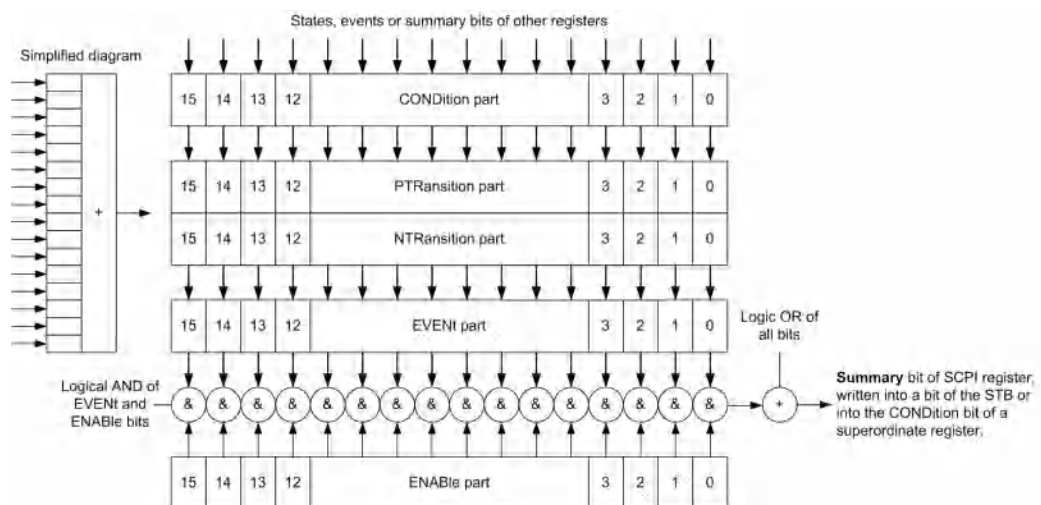

Figure 12-6: The status-register model

Description of the five status register parts

The five parts of a SCPI status register have different properties and functions:

- **CONDition**

The `CONDition` part is written directly by the hardware or it mirrors the sum bit of the next lower register. Its contents reflect the current instrument status. This register part can only be read, but not written into or cleared. Its contents are not affected by reading.

- **PTRansition / NTRansition**

The two transition register parts define which state transition of the `CONDition` part (none, 0 to 1, 1 to 0 or both) is stored in the `EVENT` part.

The **Positive-TRansition** part acts as a transition filter. When a bit of the `CONDition` part is changed from 0 to 1, the associated `PTR` bit decides whether the `EVENT` bit is set to 1.

- `PTR` bit =1: the `EVENT` bit is set.
- `PTR` bit =0: the `EVENT` bit is not set.

This part can be written into and read as required. Its contents are not affected by reading.

The **Negative-TRansition** part also acts as a transition filter. When a bit of the `CONDition` part is changed from 1 to 0, the associated `NTR` bit decides whether the `EVENT` bit is set to 1.

- `NTR` bit =1: the `EVENT` bit is set.
- `NTR` bit =0: the `EVENT` bit is not set.

This part can be written into and read as required. Its contents are not affected by reading.

- **EVENT**

The `EVENT` part indicates whether an event has occurred since the last reading, it is the "memory" of the condition part. It only indicates events passed on by the transition filters. It is permanently updated by the instrument. This part can only be read by the user. Reading the register clears it. This part is often equated with the entire register.

- **ENABLE**

The `ENABLE` part determines whether the associated `EVENT` bit contributes to the sum bit (see below). Each bit of the `EVENT` part is "ANDed" with the associated `ENABLE` bit (symbol '&'). The results of all logical operations of this part are passed on to the sum bit via an "OR" function (symbol '+').

`ENABLE` bit = 0: the associated `EVENT` bit does not contribute to the sum bit

`ENABLE` bit = 1: if the associated `EVENT` bit is "1", the sum bit is set to "1" as well.

This part can be written into and read by the user as required. Its contents are not affected by reading.

Sum bit

The sum bit is obtained from the `EVENT` and `ENABLE` part for each register. The result is then entered into a bit of the `CONDition` part of the higher-order register.

The instrument automatically generates the sum bit for each register. Thus an event can lead to a service request throughout all levels of the hierarchy.

12.5.3 Status byte (STB) and service request enable register (SRE)

The `STATUS_BYTE` (STB) is already defined in IEEE 488.2. It provides a rough overview of the instrument status by collecting the pieces of information of the lower registers. A special feature is that bit 6 acts as the sum bit of the remaining bits of the status byte.

The STB is read using the command `*STB?` or a serial poll.

The `STATUS_BYTE` (STB) is linked to the `SERVICE_REQUEST_ENABLE` (SRE) register. Each bit of the STB is assigned a bit in the SRE. Bit 6 of the SRE is ignored. If a bit is set in the SRE and the associated bit in the STB changes from 0 to 1, a service request (SRQ) is generated. The SRE can be set using the command `*SRE` and read using the command `*SRE?`.

Table 12-2: Meaning of the bits used in the status byte

Bit No.	Meaning
0...1	Not used
2	Error Queue not empty The bit is set when an entry is made in the error queue. If this bit is enabled by the SRE, each entry of the error queue generates a service request. Thus an error can be recognized and specified in greater detail by polling the error queue. The poll provides an informative error message. This procedure is to be recommended since it considerably reduces the problems involved with remote control.
3	QUESTIONable status register summary bit The bit is set if an <code>EVENT</code> bit is set in the <code>QUESTIONable</code> status register and the associated <code>ENABLE</code> bit is set to 1. A set bit indicates a questionable instrument status, which can be specified in greater detail by querying the <code>STATUS:QUESTIONable</code> status register.
4	MAV bit (message available) The bit is set if a message is available in the output queue which can be read. This bit can be used to enable data to be automatically read from the instrument to the controller.
5	ESB bit Sum bit of the event status register. It is set if one of the bits in the event status register is set and enabled in the event status enable register. Setting of this bit indicates a serious error which can be specified in greater detail by polling the event status register.
6	MSS bit (main status summary bit) The bit is set if the instrument triggers a service request. This is the case if one of the other bits of this registers is set together with its mask bit in the service request enable register SRE.
7	<code>STATUS:OPERation</code> status register summary bit The bit is set if an <code>EVENT</code> bit is set in the <code>OPERation</code> status register and the associated <code>ENABLE</code> bit is set to 1. A set bit indicates that the instrument is just performing an action. The type of action can be determined by querying the <code>STATUS:OPERation</code> status register.

12.5.4 Event status register (ESR) and event status enable register (ESE)

The ESR is defined in IEEE 488.2. It can be compared with the `EVENT` part of a SCPI register. The event status register can be read out using command `*ESR?`.

The ESE corresponds to the `ENABLE` part of a SCPI register. If a bit is set in the ESE and the associated bit in the ESR changes from 0 to 1, the ESB bit in the STB is set. The ESE register can be set using the command `*ESE` and read using the command `*ESE?`.

Table 12-3: Meaning of the bits used in the event status register

Bit No.	Meaning
0	Operation Complete This bit is set on receipt of the command <code>*OPC</code> exactly when all previous commands have been executed.
1	Not used
2	Query Error This bit is set if either the controller wants to read data from the instrument without having sent a query, or if it does not fetch requested data and sends new instructions to the instrument instead. The cause is often a query which is faulty and hence cannot be executed.
3	Device-dependent Error This bit is set if a device-dependent error occurs. An error message with a number between -300 and -399 or a positive error number, which denotes the error in greater detail, is entered into the error queue.
4	Execution Error This bit is set if a received command is syntactically correct but cannot be performed for other reasons. An error message with a number between -200 and -300, which denotes the error in greater detail, is entered into the error queue.
5	Command Error This bit is set if a command is received, which is undefined or syntactically incorrect. An error message with a number between -100 and -200, which denotes the error in greater detail, is entered into the error queue.
6	User Request This bit is set when the instrument is switched over to manual control.
7	Power On (supply voltage on) This bit is set on switching on the instrument.

12.5.5 Questionable status register (STATus:QUESTIONable)

This register contains information on questionable instrument states. Such states may occur when the instrument is not operated in compliance with its specifications.

To read the register, use the query commands `STAT:QUEST:COND?` or `STAT:QUEST[:EVEN]?`.

Table 12-4: Meaning of the bits used in the questionable status register

Bit No.	Meaning
0–15	Not used

12.5.6 Operation status register (STATus:OPERation)

This condition part contains information on the actions currently being performed by the instrument, while the event part contains information on the actions performed by the instrument since the last readout of the register.

To read the register, use the query commands `STAT:OPER:COND?` or `STAT:OPER[:EVEN]?`.

Table 12-5: Meaning of the bits used in the operation status register

Bit No.	Meaning
0	Calibrating The bit is set during the calibration phase.
1–2	Not used
3	
4–15	Not used

12.5.7 Application of the status reporting system

The purpose of the status reporting system is to monitor the status of one or several devices in a measuring system. To do this and react appropriately, the controller must receive and evaluate the information of all devices. The following standard methods are used:

- **Service request** (SRQ) initiated by the instrument
- **Serial poll** of all devices in the bus system, initiated by the controller to find out who sent an SRQ and why
- Query of a **specific instrument status** by commands
- Query of the **error queue**

12.5.7.1 Service request

Under certain circumstances, the instrument can send a service request (SRQ) to the controller. Usually this service request initiates an interrupt at the controller, to which the control program can react appropriately. An SRQ is always initiated if one or several of bits 2, 4 or 5 of the status byte are set and enabled in the SRE. Each of these bits combines the information of the error queue or the output buffer. To use the possibilities of the service request effectively, all bits should be set to "1" in the enable registers SRE and ESE.

Example:

Use command `*OPC` to generate an SRQ .

`*ESE 1` - set bit 0 of ESE (Operation Complete)

`*SRE 32` - set bit 5 of SRE (ESB).

After its settings have been completed, the instrument generates an SRQ.

The SRQ is the only possibility for the instrument to become active on its own. Each controller program should set the instrument such that a service request is initiated in the case of malfunction. The program should react appropriately to the service request.

12.5.7.2 Serial poll

In a serial poll, just as with command `*STB`, the status byte of an instrument is queried. However, the query is realized via interface messages and is thus clearly faster.

The serial poll method is defined in IEEE 488.1 and used to be the only standard possibility for different instruments to poll the status byte. The method also works for instruments which do not adhere to SCPI or IEEE 488.2.

The serial poll is mainly used to obtain a fast overview of the state of several instruments connected to the controller.

12.5.7.3 Query of an instrument status

Each part of any status register can be read using queries. There are two types of commands:

- The common commands `*ESR?`, `*IDN?`, `*IST?`, `*STB?` query the higher-level registers.
- The commands of the `STATus` system query the SCPI registers (`STATus:QUEStionable...`)

The returned value is always a decimal number that represents the bit pattern of the queried register. This number is evaluated by the controller program.

Queries are usually used after an SRQ in order to obtain more detailed information on the cause of the SRQ.

12.5.7.4 Error queue

Each error state in the instrument leads to an entry in the error queue. The entries of the error queue are detailed plain text error messages that can be looked up in the Error Log or queried via remote control using `SYSTem:ERRor[:NEXT]?`. Each call of `SYSTem:ERRor[:NEXT]?` provides one entry from the error queue. If no error messages are stored there any more, the instrument responds with 0, "No error".

The error queue should be queried after every SRQ in the controller program as the entries describe the cause of an error more precisely than the status registers. Especially in the test phase of a controller program the error queue should be queried regu-

larly since faulty commands from the controller to the instrument are recorded there as well.

12.5.8 Reset values of the status reporting system

The following table contains the different commands and events causing the status reporting system to be reset. None of the commands, except of *RST and SYSTem:PRESet affect the functional instrument settings. In particular, DCL does not change the instrument settings.

Table 12-6: Resetting the status reporting system

Event	Switching on supply voltage Power-On-Status-Clear		DCL, SDC (Device Clear, Selected Device Clear)	*RST or SYSTem: PRESet	STATus: PRESet	*CLS
	0	1				
Clear STB, ESR	-	Yes	-	-	-	Yes
Clear SRE, ESE	-	Yes	-	-	-	-
Clear PPE	-	Yes	-	-	-	-
Clear error queue	Yes	Yes	-	-	-	Yes
Clear output buffer	Yes	Yes	Yes	1)	1)	1)
Clear command processing and input buffer	Yes	Yes	Yes	-	-	-

1) The first command in a command line that immediately follows a <PROGRAM MESSAGE TERMINATOR> clears the output buffer.

12.6 LXI configuration

"LAN eXtensions for Instrumentation" (LXI) is an instrumentation platform for measuring instruments and test systems that is based on standard Ethernet technology. LXI is intended to be the LAN-based successor to GPIB, combining the advantages of Ethernet with the simplicity and familiarity of GPIB.

On the R&S SGU, the LXI functionality is already installed and enabled. Thus, the instrument can be accessed via any web browser (like the Microsoft Internet Explorer) to perform the following tasks:

- Modifying network configurations
- Remote control of the instrument
- Performing SCPI remote diagnostics

12.6.1 Default network settings

According to the LXI standard, an LCI must set the following parameters to a default state.

Parameter	Value
TCP/IP mode	DHCP + Auto IP Address
Dynamic DNS	Enabled
ICMP ping	Enabled
Password for LAN configuration	LxiWebIfc

The LAN reset also resets the following parameters for the R&S SGU:

Parameter	Value
Hostname	<Instrument-specific host name>
Description	Signal generator
Negotiation	Auto detect
VXI-11 discovery	Enabled

The LAN settings are configured using the instrument's [LXI browser settings](#).

12.6.2 LXI browser settings

You can access LXI browser settings via a web browser.

Access:

- ▶ **Note:** Do not add the missing zeros in the IP address, while opening the instrument home page.

The instrument home page (welcome page) opens.

The navigation pane of the browser interface contains the following elements:

- "LXI"
 - "Home" opens the instrument home page.
The home page displays the device information required by the LXI standard, including the VISA resource string in read-only format.
 - "Device Indicator" activates or deactivates the LXI status indication.
When activated, the LXI LEDs flash in the browser dialog. A green LXI status symbol indicates that a LAN connection has been established; a red symbol indicates that no LAN cable is connected.
 - "Lan Configuration" allows you to configure LAN parameters and to initiate a ping, see [Chapter 12.6.3, "LAN configuration"](#), on page 157.
 - "Status" displays information about the LXI status of the instrument.
 - "Utilities" provides access to the LXI event log functionality required by the LXI standard.

- "Diagnostics"
 - "SCPI Remote Trace" records messages exchanged via the remote control interface, see [Chapter 12.6.3.4, "SCPI remote trace"](#), on page 158.
- "Help"
 - "Glossary" explains terms related to the LXI standard.
 - www.rohde-schwarz.com opens the Rohde & Schwarz home page.

12.6.3 LAN configuration

The "LAN Configuration" web page displays all mandatory LAN parameters and allows their modification.

It comprises the following navigation entries.

- [IP configuration](#)..... 157
- [Advanced Config](#)..... 157
- [Ping client](#)..... 158
- [SCPI remote trace](#)..... 158

12.6.3.1 IP configuration

The "IP configuration" web page displays all mandatory LAN parameters and allows their modification.

The "IP Address Mode" selects a configuration mode for the IP address of the instrument. With static configuration, the entered IP address, subnet mask, and default gateway are used. With dynamic configuration via DHCP or dynamic link local addressing (automatic IP), the instrument IP address is assigned automatically.



Password protection

Changing the LAN configuration is password protected and requires the security password. The default password is "instrument".

12.6.3.2 Advanced Config

The "Advanced Config" web page provides LAN settings that are not declared mandatory by the LXI standard.

The following advanced parameters are available:

- "mDNS and DNS-SD": The additional protocols "multicast DNS" and "DNS service discovery" are used for device communication in zero configuration networks, working without DNS and DHCP.
- "ICMP Ping": Must be enabled to use the ping utility.
If you disable this setting, the instrument does not answer ping requests. The setting does not affect the LXI ping client. You can ping other hosts from the instrument, even if the setting is disabled.
- "VXI-11 Discovery": Must be enabled to detect the instrument in the LAN.

If you disable this setting, the instrument cannot be detected by the VXI-11 discovery protocol mechanism. The setting does not affect other detection mechanisms. Setting up a VXI-11 connection via the IP address or the host name is independent of this setting.



Password protection

Changing the LAN configuration is password protected and requires the security password. The default password is "instrument".

12.6.3.3 Ping client

The "Ping Client" page provides the ping utility to verify the connection between the LXI-compliant instrument and another device.

The ping is initiated from the instrument. Using the `ICMP` echo request and echo reply packets, the function checks whether the communication with a device via LAN is working. Ping is useful for the diagnosis of IP network or router failures.

To initiate a ping at the instrument:

1. On the "Ping Client" page, enter the IP address of the host in the "Destination Address" field (for example 10.111.0.125).
2. Select "Submit".

12.6.3.4 SCPI remote trace

The remote trace functionality allows you to trace input and output strings at the remote control interface of the R&S SGU, see [Chapter 12.6.4, "How to record SCPI commands and messages via LXI"](#), on page 159.

A recorded trace (message log) can be evaluated directly in the dialog. Use the highlighting and navigation functions provided by the lower toolbar to locate error messages and messages containing arbitrary search strings. You can also export the message log to a `*.CSV` file and evaluate the file using a suitable program.

To trace and display messages, switch on "logging" and "live mode" in the toolbar.

Toolbars

The toolbar at the top of the dialog provides basic settings and functions.

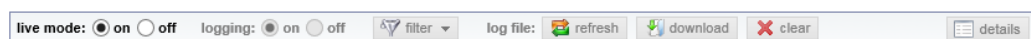

- "Live mode" / "logging": If logging is switched on, messages are traced. They are stored in an internal database and can be displayed upon request, using the refresh button (live mode off) or they can be displayed automatically (live mode on).
- "Filter": applies a filter to columns and/or rows when working (live mode off)
- "Refresh": reads the message log from the internal database and displays it

- "Download": stores the SCPI trace log to a *.csv file
- "Clear": deletes all message log entries in the database and at the screen
- "Details": displays details of the selected message, for example a SCPI command in hex format (also possible by double-clicking a message)

Columns

The following columns are available if no column filter is applied:

- "Rec": record number of the message within the message log
- "MT": indicates the type of the message. Possible values and related message contents are:
 - > = incoming command
 - < = outgoing response to a query
 - E = error message, highlighted by red color
 - T = execution time, i.e. time required by the instrument to process the command internally
- I: number of the subinstrument
- "message": indicates the type of the message. Possible values and related message contents are:
 - > = incoming command
 - < = outgoing response to a query
 - E = error message, denoted in red
 - T = execution time, i.e. time required by the instrument to process the command internally

12.6.4 How to record SCPI commands and messages via LXI

The remote trace functionality allows you to trace commands and messages exchanged via a remote control interface of the R&S SGU.

To activate the SCPI remote trace:

1. Start a web browser that supports html5 (W3C compliant).
2. Enter the IP address of the R&S SGU in the browser's address bar.
The R&S SGU's welcome page is displayed.
3. In the navigation pane, select "Diagnostics > SCPI Remote Trace".
4. In the toolbar bar of the "SCPI Remote Trace" page, select "live mode > on" and "logging > on".
"live mode > on" displays all commands and responses, and "logging > on" also traces messages.

If you now control the R&S SGU with SCPI commands, using an appropriate tool, the LXI function records the information sent and received.

The function records all sent commands, received responses and messages, and stores them in an internal database. If "live mode" is disabled, you can display the recent traces upon request, using the "refresh" button. You can also store the log in a file.

12.7 Monitoring remote control operation with R&S SGMA-GUI

The R&S SGMA-GUI can be used to monitor the behavior of one or more instruments while they are remote controlled.

A typical configuration consists of one monitor, controllers and instruments. The monitor is the remote PC on which the R&S SGMA-GUI is installed and the controller is the remote PC on which the application program runs.

Simultaneous control of an instrument from a controller and a monitor can lead to collisions whenever both the controller and the monitor utilize the same remote channel. These collisions are indicated by an error message in the "Info" line, e.g. "Query interrupted" or "Resource locked". Simultaneous monitoring and control over the same remote channel is only possible, if the used protocols support `viLock()`/`viUnlock()` and the remote program use these functions.

The [Table 12-7](#) shows whether a collision-free communication over a particular combination of remote channels is possible or not and if there are any restrictions.

Table 12-7: Cross reference between used remote channels and collision-free communication

Monitor/ Controller	LAN (VXI-11)	LAN (HiSLIP)	USB	LAN (Socket)	PCIe
LAN (VXI-11)	OK*	OK	OK	OK	OK
LAN (HiSLIP)	OK	OK	OK	OK	OK
USB	OK	OK	<code>viLock/viUnlock</code>	OK	OK
LAN (Socket)	OK	OK	OK	X	OK
PCIe	OK	OK	OK	OK	X

Where:

- **OK:** communication possible, no collisions
*) the R&S SGMA-GUI always uses the LAN device name **instr1**, see also [Chapter 12.1.2.3, "VXI-11 protocol"](#), on page 135.
- **X:** communication is not possible without collisions
- `viLock/viUnlock`: communication is only possible, if the remote control commands are enclosed in a `viLock () - viUnlock ()` pair.



The R&S SGMA-GUI uses the `viLock()`/`viUnlock()` functions.

Monitoring remote control operation with R&S SGMA-GUI

The figure below shows an example of configuration where the monitor and the controller are two different computers, connected to the same instrument over two different hardware interfaces.

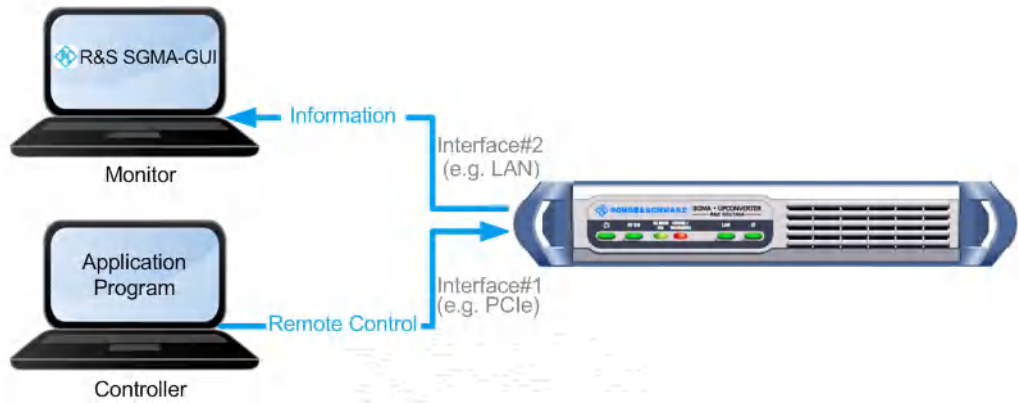

Figure 12-7: Example of a setup for remote control monitoring

Connecting and configuring the monitoring PCs



In the "Setup > Security > Security Settings" dialog, check the state of the LAN and USB interfaces and enable them if necessary.

1. Connect the monitoring PC to the instrument.

Note: Choose the hardware interface considering the limitations described in [Table 12-7](#).

2. Configure the instrument in the R&S SGMA-GUI: See [Chapter 8.4.2, "Handling instruments in the R&S SGMA-GUI"](#), on page 73.

3. In the "SGMA-GUI > Setup > Instruments > Edit Instruments" dialog, disable "Exclusive Access".

Note: The two functions "Exclusive Access" and monitoring are mutually exclusive.

4. Send remote control commands from the controller to the instrument.
5. Open the corresponding dialogs in the R&S SGMA-GUI. Observe the status of the parameters.

13 Remote control commands

In the following, all remote-control commands are presented in detail with their parameters and the ranges of the numerical values.

For an introduction to remote control and the status registers, refer to the following sections:

- ["Information on network operation and remote control"](#) on page 129
- [Chapter 12.5, "Status reporting system"](#), on page 147

Conventions used in SCPI Command Descriptions

The following conventions are used in the remote command descriptions:

- **Command usage**
If not specified otherwise, commands can be used both for setting and for querying parameters.
If a command can be used for setting or querying only, or if it initiates an event, the usage is stated explicitly.
- **Parameter usage**
If not specified otherwise, a parameter can be used to set a value and it is the result of a query.
Parameters required only for setting are indicated as **Setting parameters**.
Parameters required only to refine a query are indicated as **Query parameters**.
Parameters that are only returned as the result of a query are indicated as **Return values**.
- **Conformity**
Commands that are taken from the SCPI standard are indicated as **SCPI confirmed**. All commands used by the R&S SGU follow the SCPI syntax rules.
- **Asynchronous commands**
A command which does not automatically finish executing before the next command starts executing (overlapping command) is indicated as an **Asynchronous command**.
- **Reset values (*RST)**
Default parameter values that are used directly after resetting the instrument (*RST command) are indicated as ***RST** values, if available.
- **Factory preset values**
Default parameter values that are reset only by factory preset.
- **Default unit**
The default unit is used for numeric values if no other unit is provided with the parameter.
- **Manual operation**
If the result of a remote command can also be achieved in manual operation, a link to the description is inserted.
- [Programming Examples](#)..... 163
- [Common commands](#)..... 169
- [General commands](#)..... 173
- [Preset commands](#)..... 174

• CALibration subsystem.....	175
• CONNector subsystem.....	180
• DIAGnostic subsystem.....	180
• Fast speed commands.....	181
• FORMat Subsystem.....	181
• MMEMory subsystem.....	183
• OUTPut subsystem.....	191
• SOURce subsystem.....	193
• SOURce:IQ subsystem.....	194
• SOURce:LOSCillator subsystem.....	196
• SOURce:POWer subsystem.....	198
• SOURce:PULM subsystem.....	202
• STATus subsystem.....	203
• SYSTem subsystem.....	207
• TEST subsystem.....	217
• UNIT subsystem.....	219
• List of R&S SGU commands.....	219

13.1 Programming Examples

This chapter provides simple programming examples for the R&S SGU. The purpose of the examples is to present **all** commands for a given task. In real applications, one would rather reduce the examples to an appropriate subset of commands.

The programming examples have been tested with a software tool which provides an environment for the development and execution of remote tests. To keep the examples as simple as possible, only the "clean" SCPI syntax elements are reported. Non-executable command lines (e.g. comments) start with two // characters.

At the beginning of most remote control programs, an instrument (p)reset is recommended to set the R&S SGU to a defined state. The commands `*RST` and `SYSTem:PRESet` are equivalent for this purpose. `*CLS` also resets the status registers and clears the output buffer.

It is also recommended to lock the instrument for remote control from the selected controller prior to further configuration. Use the `LOCK` command for this purpose.

13.1.1 Performing General Tasks for Instrument Setup

In the following example we assume that a remote PC is connected to the instrument, the remote PC and the instrument are switched on and a connection between them is established.

```
// *****
// Reset the instrument first
// *****

*RST; *CLS
// SYSTem:PRESet
```

```

// :REStArT
// SYSTem:FPReset

// *****
// Lock the instrument to the controller
// *****

LOCK? 12345
// Lock the instrument to avoid interference by other controllers
// Use an arbitrary number
// Response: 1
// Request granted, i.e. the instrument is locked
// Abort program if request is refused

// *****
// Launch diagnostic
// *****

DIAGnostic:POINt:CATalog?
// Response: : D_TEMP_UP20,D_TEMP_CPU
DIAGnostic:MEASure:POINt? 'D_TEMP_UP20'

// *****
// Query the entries in the error queue
// *****

SYSTem:SERRor?
// Query static errors
// SYSTem:ERRor:CODE:NEXt?
// SYSTem:ERRor:COUNt?
// SYSTem:ERRor:NEXt?
// STATus:QUEue:NEXt?
// SYSTem:ERRor:CODE:ALL?
SYSTem:ERRor:ALL?
// Query error queue

// *****
// Query system information
// *****

SYSTem:VERSion?
SYSTem:OSYStem?

// *****
// Activate eco mode
// *****

SYSTem:EMODe EM1

// *****

```

```
// Unlock the instrument
// *****

UNL 12345
```

13.1.2 Generating an I/Q Modulated Signal

In the following example we assume that a remote PC is connected to the instrument, the remote PC and the instrument are switched on and a connection between them is established. An external analog signal is provided at the I and Q connectors of the instrument.

```
// *****
// Reset the instrument first
// *****

*RST; *CLS

// *****
// Lock the instrument to the controller
// *****

LOCK? 12345
// Lock the instrument to avoid interference by other controllers
// Use an arbitrary number
// Response: 1
// Request granted, i.e. the instrument is locked
// Abort program if request is refused

// *****
// Set RF frequency and level
// *****

SOURCE:FREQUENCY:CW 2 GHz
SOURCE:POWER:-10dBm
SOURCE:POWER:PEP?

// *****
// Define and enable impairments
// Enable modulation
// *****

SOURCE:IQ:STATE ON
SOURCE:IQ:IMPAIRMENT:STATE ON

SOURCE:IQ:IMPAIRMENT:LEAKAGE:I -1
SOURCE:IQ:IMPAIRMENT:LEAKAGE:Q 1
SOURCE:IQ:IMPAIRMENT:IQRATIO: 1
SOURCE:IQ:IMPAIRMENT:QUADRATURE:ANGLE 2
```

```

SOURCE:IQ:CREStfactor 0.05

// *****
// Enable output of the generated signal at the RF connector
// *****

OUTPut:STATe ON
OUTPut:STATe:PON UNCH

// *****
// Query LO frequency and power values and set LO
// *****

LOSCillator:FREQuency?
LOSCillator:POWer?

// Set frequency and power on the local oscillator as required

// *****
// Switch on the signal
// *****

SETTings:APPLy

// *****
// Unlock the instrument
// *****

UNL 12345

```

13.1.3 Advanced Task for Optimizing Performance

In the following example we assume that a remote PC is connected to the instrument, the remote PC and the instrument are switched on and a connection between them is established.

```

// *****
// Reset the instrument first
// *****

*RST; *CLS
// SYSTem:PRESet
// :REStart
// SYSTem:FPRreset

// *****
// Lock the instrument to the controller
// *****

```

```

LOCK? 12345
// Lock the instrument to avoid interference by other controllers
// Use an arbitrary number
// Response: 1
// Request granted, i.e. the instrument is locked
// Abort program if request is refused

// *****
// Query the level that can be set without adjustments of the attenuator
// *****

OUTPut:AFIXed:RANGe:LOWer?
OUTPut:AFIXed:RANGe:UPPer?

// *****
// Optimizing the quality characteristics of the RF signal
// *****

SOURce:POWer:LMODe LNOise
// optimize the signal to low noise ratio
SOURce:POWer:SCHaracteristic AUTO
// ensure highest dynamic range
SOURce:POWer:LEVel:IMMediate:AMPLitude -30dBm
SOURce:POWer:LIMit:AMPLitude 30dBm

OUTPut:STATe:PON UNCHanged

// *****
// Query local oscillator frequency and power values and set LO
// *****

LOSCillator:FREQuency?
LOSCillator:POWer?

// Set frequency and power on the local oscillator as required

// *****
// Switch on the signal
// *****

SETTings:APPLy

// *****
// Unlock the instrument
// *****

UNL 12345

```

13.1.4 Adjusting Network and Remote Channel Settings

In the following example we assume that a remote PC is connected to the instrument, the remote PC and the instrument are switched on and a connection between them is established.

```
// *****
// Reset the instrument first
// *****

*RST; *CLS

// *****
// Lock the instrument to the controller
// *****

LOCK? 12345
// Lock the instrument to avoid interference by other controllers
// Use an arbitrary number
// Response: 1
// Request granted, i.e. the instrument is locked
// Abort program if request is refused

// *****
// Query the VISA resource strings
// *****

SYSTEM:COMMunicate:NETWork:RESource?
// Response: TCPIP::10.113.10.187::INSTR
SYSTEM:COMMunicate:SOCKet:RESource?
// Response: TCPIP:10.113.10.187::5025::SOCKET
SYSTEM:COMMunicate:USB:RESource?
// Response: USB::0x0AAD::0x00ce::100021::INSTR
SYSTEM:COMMunicate:PCiexpress:RESource?
// Response: PCIE::0x162f::0x132f::100002::INSTR

// *****
// Query network settings
// *****

SYSTEM:COMMunicate:NETWork:COMMon:HOSTname?
// Response: rssgu100a100002
SYSTEM:COMMunicate:NETWork:IPAddress:MODE?
// Response: AUTO
SYSTEM:COMMunicate:NETWork:IPAddress?
// Response: 10.113.10.187
SYSTEM:COMMunicate:NETWork:IPAddress:SUBNet:MASK?
// Response: 255.255.0.0
SYSTEM:COMMunicate:NETWork:IPAddress:GATeway?
// Response: 10.113.0.1
```



```
// *****
// Unlock the instrument
// *****

UNL 12345
```

13.2 Common commands

Common commands are described in the IEEE 488.2 (IEC 625-2) standard. These commands have the same effect and are employed in the same way on different devices. The headers of these commands consist of "*" followed by three letters. Many common commands are related to the Status Reporting System.

Available common commands:

*CLS.....	169
*ESE.....	169
*ESR?.....	170
*IDN?.....	170
*IST?.....	170
*OPC.....	170
*OPT?.....	171
*PRE.....	171
*PSC.....	171
*RCL.....	171
*RST.....	172
*SAV.....	172
*SRE.....	172
*STB?.....	172
*TRG.....	172
*WAI.....	173

*CLS

Clear status

Sets the status byte (STB), the standard event register (ESR) and the `EVENT` part of the `QUESTIONABLE` and the `OPERATION` registers to zero. The command does not alter the mask and transition parts of the registers. It clears the output buffer.

Usage: Setting only

*ESE <Value>

Event status enable

Sets the event status enable register to the specified value. The query returns the contents of the event status enable register in decimal form.

Parameters:

<Value> Range: 0 to 255

***ESR?**

Event status read

Returns the contents of the event status register in decimal form and then sets the register to zero.

Return values:

<Contents> Range: 0 to 255

Usage: Query only

***IDN?**

Identification

Returns the instrument identification.

Return values:

<ID> "Rohde&Schwarz,<device type>,<part number>/<serial number>,<firmware version>"

Example: Rohde&Schwarz,SGU100A,
1412.0000K02/000000,3.1.17.1-03.01.158

Usage: Query only

***IST?**

Individual status query

Returns the contents of the IST flag in decimal form. The IST flag is the status bit which is sent during a parallel poll.

Return values:

<ISTflag> 0 | 1

Usage: Query only

***OPC**

Operation complete

Sets bit 0 in the event status register when all preceding commands have been executed. This bit can be used to initiate a service request. The query writes a "1" into the output buffer when all preceding commands have been executed, which is useful for command synchronization.

***OPT?**

Option identification query

Queries the options included in the instrument. For a list of all available options and their description, refer to the data sheet.

Return values:

<Options> The query returns a list of options. The options are returned at fixed positions in a comma-separated string. A zero is returned for options that are not installed.

Usage: Query only

***PRE <Value>**

Parallel poll register enable

Sets parallel poll enable register to the indicated value. The query returns the contents of the parallel poll enable register in decimal form.

Parameters:

<Value> Range: 0 to 255

***PSC <Action>**

Power on status clear

Determines whether the contents of the `ENABLE` registers are preserved or reset when the instrument is switched on. Thus a service request can be triggered when the instrument is switched on, if the status registers ESE and SRE are suitably configured. The query reads out the contents of the "power-on-status-clear" flag.

Parameters:

<Action> 0 | 1
0
 The contents of the status registers are preserved.
1
 Resets the status registers.

***RCL <Number>**

Recall

Loads the instrument settings from an intermediate memory identified by the specified number. The instrument settings can be stored to this memory using the command `*SAV` with the associated number.

It also activates the instrument settings which are stored in a file and loaded using the `MMEMory:LOAD <number>, <file_name.extension>` command.

***RST**

Reset

Sets the instrument to a defined default status. The default settings are indicated in the description of commands.

The command is equivalent to `SYSTEM:PRESet`.

Usage: Setting only

***SAV <Number>**

Save

Stores the current instrument settings under the specified number in an intermediate memory. The settings can be recalled using the command `*RCL` with the associated number.

To transfer the stored instrument settings in a file, use the command `:MMEMory:STORe:STATe`.

***SRE <Contents>**

Service request enable

Sets the service request enable register to the indicated value. This command determines under which conditions a service request is triggered.

Parameters:

<Contents> Contents of the service request enable register in decimal form.
Bit 6 (MSS mask bit) is always 0.
Range: 0 to 255

***STB?**

Status byte query

Reads the contents of the status byte in decimal form.

Usage: Query only

***TRG**

Trigger

Triggers all actions waiting for a trigger event. In particular, `*TRG` generates a manual trigger signal. This common command complements the commands of the `TRIGger` subsystem.

Usage: Event

***WAI**

Wait to continue

Prevents servicing of the subsequent commands until all preceding commands have been executed and all signals have settled (see also command synchronization and *OPC).

Usage: Event

13.3 General commands

:REMOte:OPMode.....	173
:LOCK?.....	173
:UNLock.....	174

:REMOte:OPMode <OpMode>

Sets the remote operation mode of the instrument.

Parameters:

<OpMode> STDalone | EXTension

STDalone

The instrument acts standalone.

EXTension

The instrument is controlled by another Rohde&Schwarz instrument. This parameter is used by the SGMA-GUI to disable settings when the instrument is in extension mode.

*RST: STDalone

:LOCK? <Lock Request Id>

Sends a lock request ID which uniquely identifies the controller of the instrument.

Parameters:

<Lock Request Id> Number

0

test query to check whether the instrument is locked

Controller ID

request lock from the controller with the specified Controller ID

Return values:

<Value> Number

0

request refused; the instrument is already locked to another <Lock Request Id>, i.e. to another controller

1

request granted

Example: :LOCK? 12345
 Response: 1
 :UNL 12345

Usage: Query only

Manual operation: See "[Exclusive Access](#)" on page 65

:UNLock <Unlock Id>

Unlocks an instrument locked to a controller with Controller ID = <Unlock Id>.

Setting parameters:

<Unlock Id>	Number
-------------	--------

Unlock ID which uniquely identifies the controller of the instrument. The value must match the Controller ID <Lock Request Id> set with the command `:LOCK?`.

Usage: Setting only

Manual operation: See "[Exclusive Access](#)" on page 65

13.4 Preset commands

The following preset actions are available:

- Activation of the default state of all internal instrument functions (`*RST` on page 172). Functions that concern the integration of the instrument into a measurement setup are not changed, e.g. TCP/IP address or remote operating mode.
- Activation of the original state of delivery (factory reset, `:SYSTem:FPReset` on page 175). Only functions that are protected by a password remain unchanged and the passwords themselves.

:SOURce<hw>:PRESet

:SYSTem:PRESet

Triggers an instrument reset. It has the same effect as:

- The `*RST` command
- The "SGMA-GUI > Instrument Name > Preset" function.
 However, the command does not close open GUI dialogs like the function does.

For an overview of the settings affected by the preset function, see [Chapter 9.7, "Preset"](#), on page 104.

Example: SYST:PRES
 All instrument settings (also the settings that are not currently active) are reset to their default values.

Usage: Setting only

:SYSTem:FPRreset

The command triggers an instrument reset to the original state of delivery. Only functions that are protected by a password remain unchanged.

The factory preset function resets nearly all instrument settings. In addition to the regular preset a "Factory Preset" resets also the following values:

- Power on settings ("Level" dialog)
- Network settings including hostname ("Setup > Network Setting" dialog)
- Remote Channel settings ("Setup > Remote Channel" dialog)

For an overview of the settings affected by the factory preset function, see [Chapter 10.8, "Factory preset"](#), on page 117.

Example: `SYST:FPR`
all instrument settings (also those that are not currently active) are reset to the factory values.

Usage: Event

Manual operation: See ["Execute Factory Preset"](#) on page 117

13.5 CALibration subsystem

The CALibration system contains the commands needed for calibrating the R&S SGU.

R&S SGU cannot be calibrated on its own. Therefore a connection with a signal generator (local oscillator (LO)) is needed. If you use a compatible R&S signal generator, then the calibration process will be completed automatically after starting the calibration process. Otherwise you have to follow the steps described in ["Calibration process of the R&S SGU"](#) on page 176. We assume that a remote PC is connected to the instruments, the remote PC and the instruments are switched on and a connection between them is established.

The selftest of an R&S SGU also requires a similar instrumental setup. You can perform the selftest and read its results using the commands `:TEST:ALL:START` and `:TEST:ALL:RESult?`.

Calibration process of the R&S SGU

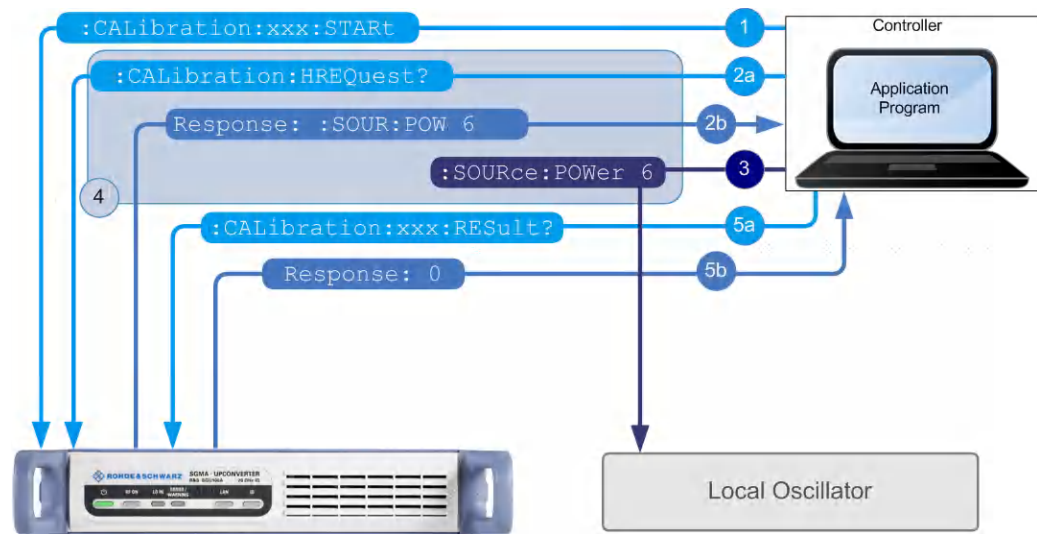

Figure 13-1: Calibration process of the R&S SGU. No physical connections between the instruments are shown in this graphic.

To complete the calibration process, complete the following steps:

1. Start an adjustment request with the SCPI command `:CALibration:xxx:START`, where `xxx` stands for `IQModulator`, `IQModulator:LOCAl` or `LEVel`.
2. `:CALibration:HREQuest?`
 - a) Query R&S SGU for the required LO settings with the SCPI command `:CALibration:HREQuest?`.
 - b) Interpret the response of the query. A SCPI command returns the response. For example, a response `:SOUR:POW 6` asks for a power of 6 dBm. For a list of all possible responses see `:CALibration:HREQuest?` on page 177.
3. Set the LO according to the required settings.
4. Repeat steps 2 and 3 until the value of step 2b is `:CALibration:HREQ:STOP`.
5. `:CALibration:xxx:RESult?`

`xxx` stands for `IQModulator`, `IQModulator:LOCAl` or `LEVel`

 - a) Query the result of the adjustment request with the SCPI command `:CALibration:xxx:RESult?`.
 - b) The query returns either 0 or 1 signifying pass or fail.

The instrument is calibrated and can be further used.

Table 13-1 shows the described process. If you use a compatible R&S signal generator the whole process is completed automatically.

Table 13-1: Programming example of a calibration process

Local Oscillator/ Controller	R&S SGU Response	Interpretation
1):CALibration:LEVel:START	-	R&S SGU starts the Level Adjustment.
2):CALibration:HREQuest?	:PROG:CREate Level Adjustment	To do: create a progress bar with a caption "Level Adjustment".
3):CALibration:HREQuest?	:OUTP:STATe 1	To do: activate the RF output of the LO.
4):CALibration:HREQuest?	:PROG:UPDate 5	The progress of the level adjustment is 5 %.
5):CALibration:HREQuest?	:SOUR:FREQ 15e9; :SOUR:POW -10.0	To do: set the frequency of the LO to 15GHZ and its level to -10dBm
6):CALibration:HREQuest?	:SOUR:POW 5	To do: set the level of the LO to 5dBm.
7):CALibration:HREQuest?	:PROG:UPDate 20	The progress of the level adjustment is 20 %.
8):CALibration:HREQuest?	:SOUR:POW 20	To do: set the level of the LO to 5dBm.
9):CALibration:HREQuest?	:PROG:UPDate 100	The progress of the level adjustment is 100 %.
10):CALibration:HREQuest?	:PROG:REMOve	To do: delete the progress bar.
11):CALibration:HREQuest?	:OUTP:STATe 0	To do: deactivate the RF output of the LO.
12):CALibration:HREQuest?	:CAL:HREQ:STOP	End of the calibration process.

:CALibration:HREQuest?.....	177
:CALibration:IQModulator:START.....	178
:CALibration:IQModulator:RESult?.....	178
:CALibration:IQModulator:TEMPerature?.....	178
:CALibration:IQModulator:LOCal:START.....	179
:CALibration:IQModulator:LOCal:RESult?.....	179
:CALibration:LEVel:START.....	179
:CALibration:LEVel:RESult?.....	179
:CALibration:LEVel:TEMPerature?.....	179

:CALibration:HREQuest?

Queries the settings required from the instrument during a calibration or a selftest.

See "[Calibration process of the R&S SGU](#)" on page 176 for a step by step description of the calibration process.

Return values:

<Command> string

All of the commands described below return the values in the parameter's default unit.

:VERsion <Number>

Shows the command set version with which the instrument is compliant

:OUTP:STATe <Number>

Shows the state required of the local oscillator

:SOUR:FREQ <Number>

Shows the frequency required of the local oscillator

:SOUR:POW<Number>

Shows the power required of the external local oscillator

:PROG:CREate <Text>

Asks the controller to create a progress bar

:PROG:REName <Text>

Asks the controller to rename the progress bar

:PROG:REMove

Asks the controller to delete the most recently created progress bar

:PROG:UPDate <Number>

Shows the current progress value in percent

:NOP/:NO DATA

Intermediate message. No action is required

:CAL:HREQ:STOP

End of the calibration procedure

Example: See [Table 13-1](#).**Usage:** Query only**:CALibration:IQModulator:STARt**Starts an internal I/Q adjustment. Query the result of the adjustment with the SCPI command `:CALibration:IQModulator:RESult?`.See "[Calibration process of the R&S SGU](#)" on page 176 for a step by step description of the calibration process.**Usage:** Event**:CALibration:IQModulator:RESult?**Queries the result of the internal I/Q adjustment. Start the adjustment with the SCPI command `:CALibration:IQModulator:STARt`.**Return values:**

<Result> 0 | 1 | RUNning | STOPped

Usage: Query only**:CALibration:IQModulator:TEMPerature?**

Queries the delta temperature since the last adjustment of the IQ modulator.

Return values:

<Temperature> string

Usage: Query only

:CALibration:IQModulator:LOCAl:START

Starts an adjustment for the I/Q modulator of the current frequency. The I/Q modulator is adjusted with respect to carrier leakage, I/Q imbalance and quadrature. Query the result of the adjustment with the SCPI command `:CALibration:IQModulator:LOCAl:RESult?`.

See "[Calibration process of the R&S SGU](#)" on page 176 for a step by step description of the calibration process.

Usage: Event

:CALibration:IQModulator:LOCAl:RESult?

Queries the result of the I/Q modulation adjustment for the current frequency. Start the adjustment with the SCPI command `:CALibration:IQModulator:LOCAl:START` on page 179.

Return values:

<Result> 0 | 1 | RUNning | STOPped

Usage: Query only

:CALibration:LEVel:START

Starts an internal level adjustment. Query the result of the adjustment with the SCPI command `:CALibration:LEVel:RESult?`.

See "[Calibration process of the R&S SGU](#)" on page 176 for a step by step description of the calibration process.

Usage: Event

:CALibration:LEVel:RESult?

Queries the result of the internal level adjustment. Start the adjustment with the SCPI command `:CALibration:LEVel:START`.

Return values:

<Result> 0 | 1 | RUNning | STOPped

Usage: Query only

:CALibration:LEVel:TEMPerature?

Queries the delta temperature since the last level adjustment.

Return values:

<Temperature> string

Usage: Query only

13.6 CONNector subsystem

[:CONNector:TRIGger:OMODE](#).....180

:CONNector:TRIGger:OMODE <Mode>

Sets the operating mode of the trigger connector.

Parameters:

<Mode> SVALid | SNValid | PEMSource

SVALid|SNValid

signal valid /not valid

PEMSource

external pulse modulator source

Manual operation: See "[Trigger Connector Mode](#)" on page 102

13.7 DIAGnostic subsystem

[:DIAGnostic:POINt:CATalog?](#).....180

[:DIAGnostic\[:MEASure\]:POINt?](#).....180

:DIAGnostic:POINt:CATalog?

Queries the test points available in the instrument.

For description of the test points, see the service manual.

Example: See [Chapter 13.1.1, "Performing General Tasks for Instrument Setup"](#), on page 163.

Usage: Query only

:DIAGnostic[:MEASure]:POINt? <Name>

Triggers a voltage or a temperature measurement at the specified test point and returns the measured value.

Use the command [:DIAGnostic:POINt:CATalog?](#) to retrieve a list of the available test points.

For description of the test points, see the service manual.

Query parameters:

<Name> string

Return values:

<Value> number
 Default unit: V or °C

Example: See [Chapter 13.1.1, "Performing General Tasks for Instrument Setup"](#), on page 163.

Usage: Query only

13.8 Fast speed commands

This section describes special commands that allow a fast frequency and level setting.

:FFASt	181
:PFASt	181

:FFASt <Freq>

Special command to set the RF output frequency with minimum latency. No unit (e.g. Hz) allowed.

Bypasses the status system so command *OPC? cannot be appended.

Parameters:

<Freq> float

Example: FFASt 12750000000

:PFASt <Pow>

Special command to set the RF output level with minimum latency at the RF output connector. This value does not consider a specified offset. No unit (e.g. dBm) allowed.

Bypasses the status system so command *OPC? cannot be appended.

Parameters:

<Pow> float

Example: :PFASt -20

13.9 FORMat Subsystem

The FORMat subsystem contains the commands which determine the format of the data that the R&S SGU returns to the controller. This affects all query commands which return a list of numerical data or block data. Reference is made to this in the descriptions of the commands.

:FORMat:BORDER	182
:FORMat[:DATA]	182
:FORMat:SREGister	182

:FORMat:BORe <Border>

Determines the sequence of bytes within a binary block. This only affects blocks which use the IEEE754 format internally.

Parameters:

<Border> NORMal | SWAPped

NORMal

The instrument expects (with setting commands) and sends (with queries) the least significant byte of each IEEE754 floating-point number first and the most significant byte last.

SWAPped

The instrument expects (with setting commands) and sends (with queries) the most significant byte of each IEEE754 floating-point number first and the least significant byte last.

*RST: NORMal

Example:

FORM:BORe SWAP

The data is transferred with the most significant bit first.

:FORMat[:DATA] <Data>

Determines the data format which the R&S SGU uses to return data. When data is transferred from the control computer to the instrument, the instrument detects the data format automatically. In this case, the value set here is irrelevant.

Parameters:

<Data> ASCii | PACKed

ASCii

Numerical data is transferred as plain text separated by commas.

PACKed

Numerical data is transferred as binary block data. The format within the binary data depends on the command. The various binary data formats are explained in the description of the parameter types.

*RST: ASCii

Example:

FORM DATA ASC

The data is transferred as ASCII data.

:FORMat:SREGister <Format>

Determines the numerical format which is returned when the status registers are queried.

Parameters:

<Format> ASCii | BINary | HEXadecimal | OCTal

ASCii

The register content is returned as a decimal number.

BINary

The register content is returned as a binary number. #B is placed in front of the number.

HEXadecimal

The register content is returned as a hexadecimal number. #H is placed in front of the number.

OCTal

The register content is returned as an octal number. #Q is placed in front of the number.

*RST: ASCii

Example:

FORM:SREG HEX

The register content is returned as a hexadecimal number.

13.10 MMEMory subsystem

The MMEMory subsystem (**Mass Memory**) contains the commands for managing files and directories as well as for loading and storing complete instrument settings in files.

The files are stored on the internal flash memory of the instrument or on external USB memory devices.

The default directory is determined using the command `MMEMory:CDIR`.



Use the command `:SYSTem:MMEMory:PATH:USER?` to query the path of the directory for user-defined data.



The `/opt` directory is a protected and therefore not accessible system directory. The files on this directory contain data that must not be changed. Therefore, this directory should not be accessed, since reconstruction of the system partition will lead to data loss.

13.10.1 File naming conventions

To enable files in different file systems to be used, the following file naming conventions should be observed.

The file name can be of any length and is case-sensitive, meaning it is distinguished between uppercase and lowercase letters.

The file and the optional file extension are separated by a dot. All letters and numbers are permitted (numbers are, however, not permitted at the beginning of the file name). If possible, special characters should not be used. The use of the slashes "\" and "/" should be avoided since they are used in file paths. A number of names are reserved for the operating system, e.g. `CLOCK$, CON, AUX, COM1 . . . COM4, LPT1 . . . LPT3, NUL` and `PRN`.

In the R&S SGU all files in which lists and settings are stored are given a characteristic extension. The extension is separated from the actual file name by a dot (see [Chapter 13.10.2, "Extensions for user files"](#), on page 184 for an overview of the file types).

The two characters "*" and "?" function as "wildcards", meaning they are used for selecting several files. The "?" character represents exactly one character, while the "*" character represents all characters up to the end of the file name. "*.*" therefore stands for all files in a directory.

When used in conjunction with the commands, the parameter <file_name> is specified as a string parameter with quotation marks. It can contain either the complete path including the drive, only the path and the file name, or only the file name. The file name must include the file extension. The same applies for the parameters <directory_name> and <path>.

Depending on how much information is provided, either the values specified in the parameter or the values specified with the command `MMEM:CDIR` (default directory) are used for the path and the drive settings in the commands.

Before the instrument settings can be stored in a file, they have to be stored in an intermediate memory using common command `*SAV <number>`. The specified number is subsequently used in the `:MMEMory:STORe:STATe` on page 191 command. Also, subsequently to loading a file with instrument settings with command `:MMEMory:LOAD:STATe` on page 189, these settings have to be activated with the common command `*RCL <number>`.

13.10.2 Extensions for user files

The following table lists all available file extensions for user files.

Table 13-2: Automatically assigned file extensions in the instrument

Function	Contents	File suffix
R&S SGMA-GUI Save As/Open	Software settings	*.savrcl

13.10.3 Examples

In these examples, the current instrument setting is stored in the file `test.savrcltxt` in the directory `/var/user/..`

Storing and Loading Current Settings

1. Store the current setting in an intermediate memory with the number 4. This setting can be called using command `*RCL` and the associated number of the memory, for example `*RCL 4`.
`*SAV 4`
2. To store the settings in a file in a specific directory, specify the complete path.
`MMEM:STOR:STAT 4, "/var/user/test.savrcltxt"`

- To store the settings in a file in the default drive, set the default drive and specify only the file name.

```
MMEM:CDIR '/var/user/'*SAV 4
MMEM:STOR:STAT 4,"test.savrcltxt"
```

- Load the file `test.savrcltxt` in the user directory.

```
MMEM:LOAD:STAT 4,'/var/user/test.savrcltxt'
```

- Activate the instrument setting of the file `test.savrcltxt`.

```
*RCL 4
```

Working with Files and Directories

- Read out all files in the specified directory.

```
MMEM:CAT? '/usb/user'
```

```
Response: 127145265,175325184,"test,DIR,0","temp,DIR,0",
"readme.txt,ASC,1324","state.savrcltxt,STAT,5327",
"waveform.wv,BIN,2342"
```

the directory `/usb/user` contains the subdirectories `test` and `temp` as well as the files `readme.txt`, `state.savrcltxt` and `waveform.wv` which have different file types.

Tip: To query only the subdirectories of the current or specified directory, perform:

```
MMEM:DCAT? '/usb/user'
```

```
Response: 'test', 'temp'
```

To query only the number of subdirectories in the current or specified directory, perform:

```
MMEM:DCAT:LENG? '/usb/user'
```

```
Response: 2
```

- To query the number of files in the current or specified directory, perform:

```
MMEM:CAT:LENG? '/usb/user'
```

```
Response: 3
```

- Create a new subdirectory for mass memory storage in the specified directory.

```
MMEM:MDIR '/usb/new'
```

- Copy the file `state` to a new file.

```
MMEM:COPY '/var/user/state.savrcltxt','/usb/new'
```

- Rename the file `state`.

```
MMEM:MOVE 'state.savrcltxt','state_new.savrcltxt'
```

- Remove the `test` directory.

```
MMEM:RDIR 'usbtest'
```

13.10.4 Remote control commands

:MMEMory:CATalog?	186
:MMEMory:CATalog:LENGth?	186
:MMEMory:CDIRectory	187
:MMEMory:COPI	187
:MMEMory:DATA	188
:MMEMory:DCATalog?	188
:MMEMory:DCATalog:LENGth?	189
:MMEMory:DELe	189
:MEMory:HFRee?	189
:MMEMory:LOAD:STATe	189
:MMEMory:MDIRectory	190
:MMEMory:MOVE	190
:MMEMory:MSIS	190
:MMEMory:RDIRectory	191
:MMEMory:STORe:STATe	191

:MMEMory:CATalog? <path>

Returns the content of a particular directory.

Query parameters:

<path>	string
--------	--------

String parameter to specify the directory.
If you leave out the path, the command returns the contents of the directory selected with [:MMEMory:CDIRectory](#).
The path may be relative or absolute.

Return values:

<UsedDiskSpace>	Byte size of all files in the directory.
<FreeDiskSpace>	Remaining disk space in bytes.
<FileInfo>	<NameFileN>,<SuffixFileN>,<SizeFileN> List of files, separated by commas
	<NameFileN> Name of the file.
	<SuffixFileN> Type of the file. Possible suffixes are: ASCii, BINary, DIRectory
	<SizeFileN> Size of the file in bytes.

Example: See "[Working with Files and Directories](#)" on page 185.

Usage: Query only

:MMEMory:CATalog:LENGth? <Path>

Returns the number of files in the current or in the specified directory.

Query parameters:

<Path> string
String parameter to specify the directory. If the directory is omitted, the command queries the content of the current directory, queried with `:MMEMory:CDIRectory` command.

Return values:

<FileCount> integer
Number of files.

Example: See "[Working with Files and Directories](#)" on page 185.

Usage: Query only

:MMEMory:CDIRectory <Directory>

Changes the default directory for mass memory storage. The directory is used for all subsequent `MMEM` commands if no path is specified with them.

Parameters:

<Directory> <directory_name>
String containing the path to another directory. The path can be relative or absolute.
To change to a higher directory, use two dots '..'.

Example: See "[Working with Files and Directories](#)" on page 185.

Usage: SCPI confirmed

:MMEMory:COPY <SourceFile>[,<DestinationFile>]

Copies an existing file to a new file. Instead of just a file, this command can also be used to copy a complete directory together with all its files.

Setting parameters:

<SourceFile> string
String containing the path and file name of the source file

<DestinationFile> string
String containing the path and name of the target file. The path can be relative or absolute.
If <DestinationFile> is not specified, the <SourceFile> is copied to the current directory, queried with the `:MMEMory:CDIRectory` command.

Note: Existing files with the same name in the destination directory are overwritten without an error message.

Example: See "[Working with Files and Directories](#)" on page 185.

Usage: Setting only
SCPI confirmed

:MMEMory:DATA <Filename>, <BinaryBlock>
:MMEMory:DATA? <Filename>

The setting command writes the block data <BinaryBlock> to the file identified by <Filename>.

Tip: Use this command to read/transfer stored instrument settings or waveforms directly from/to the instrument.

Parameters:

<BinaryBlock> #<number><length_entry><data>
 #: Hash sign; always comes first in the binary block
 <number>: the first digit indicates how many digits the subsequent length entry has
 <length_entry>: indicates the number of subsequent bytes
 <data>: binary block data for the specified length.
 For files with a size with more than nine digits (gigabytes), the instrument allows the syntax # (<Length>), where <Length> is the file size in decimal format.

Parameters for setting and query:

<Filename> string
 String parameter to specify the name of the file.

Example: MMEMory:DATA '/var/user/test.txt', #15hallo
 Writes the block data to the file test.txt.
 The digit 1 indicates a length entry of one digit; the digit 5 indicate a length of the binary data (hallo) in bytes.
 MMEMory:DATA? '/var/user/test.txt'
 Sends the data of the file test.txt from the instrument to the controller in the form of a binary block.
 Response: #15hallo

Usage: SCPI confirmed

:MMEMory:DCATalog? <path>

Returns the subdirectories of a particular directory.

Query parameters:

<path> String parameter to specify the directory. If the directory is omitted, the command queries the content of the current directory, queried with [:MMEMory:CDIRectory](#) command.

Return values:

<Catalog> <file_entry>
 Names of the subdirectories separated by colons. The first two strings are related to the parent directory.

Example: See "[Working with Files and Directories](#)" on page 185.

Usage: Query only

:MMEMory:DCATalog:LENGth? [<Path>]

Returns the number of subdirectories in the current or specified directory.

Query parameters:

<Path> String parameter to specify the directory. If the directory is omitted, the command queries the contents of the current directory, to be queried with `:MMEMory:CDIRectory` command.

Return values:

<DirectoryCount> integer
Number of parent and subdirectories.

Example: See "[Working with Files and Directories](#)" on page 185.

Usage: Query only

:MMEMory:DELeTe <Filename>

Removes a file from the specified directory.

Setting parameters:

<Filename> string
String parameter to specify the name and directory of the file to be removed.

Example: See "[Working with Files and Directories](#)" on page 185.

Usage: Event
SCPI confirmed

:MEMory:HFRee?

Returns the used and available memory in Kb.

Return values:

<TotalPhysMemKb> integer
Total physical memory.

<ApplicMemKb> integer
Application memory.

<HeapUsedKb> integer
Used heap memory.

<HeapAvailableKb> integer
Available heap memory.

Usage: Query only

:MMEMory:LOAD:STATe <SavRclStateNumb>, <file_name>

Loads the specified file stored under the specified name in an internal memory.

After the file has been loaded, the instrument setting must be activated using an `*RCL` command.

Setting parameters:

<SavRclStateNumb> Determines to the specific <number> to be used with the `*RCL` command, e.g. `*RCL 4`.

<file_name> String parameter to specify the file name with extension `*.savrcltxt`.

Example: See "[Storing and Loading Current Settings](#)" on page 184.

Usage: Setting only

:MMEMory:MDIRectory <Directory>

Creates a subdirectory for mass memory storage in the specified directory. If no directory is specified, a subdirectory is created in the default directory. This command can also be used to create a directory tree.

Setting parameters:

<Directory> string
String parameter to specify the new directory.

Example: See "[Working with Files and Directories](#)" on page 185.

Usage: Event

:MMEMory:MOVE <SourceFile>, <DestinationFile>

Moves an existing file to a new location or, if no path is specified, renames an existing file.

Setting parameters:

<SourceFile> string
String parameter to specify the name of the file to be moved.

<DestinationFile> string
String parameters to specify the name of the new file.

Example: See "[Working with Files and Directories](#)" on page 185.

Usage: Event
SCPI confirmed

:MMEMory:MSIS <Msis>

Defines the drive or network resource (in the case of networks) for instruments with windows operating system, using `msis` (MSIS = Mass Storage Identification String).

Note: Instruments with Linux operating system ignore this command, since Linux does not use drive letter assignment.

Usage: SCPI confirmed

:MMEMory:RDIRECTory <Directory>

Removes an existing directory from the mass memory storage system. If no directory is specified, the subdirectory with the specified name is deleted in the default directory.

Setting parameters:

<Directory> string
String parameter to specify the directory to be deleted.

Example: See "[Working with Files and Directories](#)" on page 185.

Usage: Event

:MMEMory:STORE:STATE <savrcl_state_nr>, <file_name>

Stores the current instrument setting in the specified file.

The instrument setting must first be stored in an internal memory with the same number using the common command *SAV.

Setting parameters:

<savrcl_state_nr> Corresponds to the specific <number> defined with the *SAV command, e.g. *SAV 4.

<file_name> String parameter to specify the file name with extension *.savrcltxt.

Example: See "[Storing and Loading Current Settings](#)" on page 184.

Usage: Event

13.11 OUTPut subsystem

:OUTPut:AMODE	191
:OUTPut[:STATE]	192
:OUTPut[:STATE]:PON	192
:OUTPut:AFIXed:RANGe:LOWer?	192
:OUTPut:AFIXed:RANGe:UPPer?	193
:OUTPut<hw>:PROTection:CLEar	193

:OUTPut:AMODE <AMode>

Sets the mode of the attenuator (**A**ttenuator **MODe**) at the RF output.

Parameters:

<AMode> AUTO | FIXed

AUTO

The attenuator is switched automatically. The level settings are made in the full range.

FIXed

The level settings are made without switching the attenuator. When this operating mode is switched on, the attenuator is fixed to its current position and the resulting variation range is defined.

*RST: AUTO

Manual operation: See ["Mode"](#) on page 93

:OUTPut[:STATe] <State>

Activates/deactivates the RF output.

Parameters:

<State> 1 | ON | 0 | OFF

Example: See [Chapter 13.1.2, "Generating an I/Q Modulated Signal"](#), on page 165.

Manual operation: See ["RF On/Off"](#) on page 72

:OUTPut[:STATe]:PON <Mode>

Selects the state which the RF output takes when the instrument is switched on.

Parameters:

<Mode> OFF | UNCHanged

OFF

When the instrument is switched on, the output is deactivated .

UNCHanged

When the instrument is switched on, the output remains in the same state as it was before the instrument was switched off.

*RST: UNCHanged

Example: See [Chapter 13.1.2, "Generating an I/Q Modulated Signal"](#), on page 165 .

Manual operation: See ["Power-On State"](#) on page 94

:OUTPut:AFIXed:RANGe:LOWer?

Queries the minimum level which can be set without the attenuator being adjusted.

Return values:

<Lower> float
Default unit: dBm

Example: See [Chapter 13.1.3, "Advanced Task for Optimizing Performance"](#), on page 166.

Usage: Query only

Manual operation: See ["Level Range"](#) on page 93

:OUTPut:AFIXed:RANGe:UPPer?

Queries the maximum level which can be set without the attenuator being adjusted.

Return values:

<Upper> float
Default unit: dBm

Example: See [Chapter 13.1.3, "Advanced Task for Optimizing Performance"](#), on page 166 .

Usage: Query only

Manual operation: See "[Level Range](#)" on page 93

:OUTPut<hw>:PROTection:CLEAr

Resets the protective circuit after it has been tripped. The state of the output is again determined by `OUTPut:STATe`.

Example: `OUTP:PROT:CLE`
resets the protective circuit for RF output.

Usage: Event

13.12 SOURce subsystem

[:SOURce]:SETTings:APPLY[:IMMediate]	193
[:SOURce]:FREQuency[:CW FIXed]	193
[:SOURce]:TRAits<ch>	194
[:SOURce]:TRAits:COUNT?	194

[:SOURce]:SETTings:APPLY[:IMMediate]

Applies the signal settings and outputs the signal.

See [Chapter 13.14, "SOURce:LOSCillator subsystem"](#), on page 196 for a description of the setting process.

Usage: Event

Manual operation: See "[Confirm External LO Settings](#)" on page 103

[:SOURce]:FREQuency[:CW|FIXed] <Cw>

Sets the RF frequency at the RF output connector of the instrument.

Parameters:

<Cw> float
 Range: 1E+6 to 40E+9
 Increment: 1E-3
 *RST: 1E+9

Example: See [Chapter 13.1.2, "Generating an I/Q Modulated Signal"](#), on page 165.

Manual operation: See ["Frequency"](#) on page 72

[[:SOURce]:TRAits<ch>

Queries for a list of values for the corresponding trait. The following values are available for the channel number:

- 1: queries the upper edge frequencies for the frequency bands
- 2: queries the upconverter frequency multiplication factors for each band
- 3: queries if the bypass mode is active for each band
- 4: queries the pulsmodulation performed in LO for each band
- 5: queries the AM signal allowed for each band
- 6: queries the PM / PhiM signal allowed for each band

[[:SOURce]:TRAits:COUNT?

Queries the number of trait lists.

Return values:

<Count> float

Usage: Query only

13.13 SOURce:IQ subsystem

The IQ Impairment remote commands are available only for R&S SGU-B120V/-B140V.

[:SOURce]:IQ:STATe	194
[:SOURce]:IQ:IMPAirment:IQRatio	195
[:SOURce]:IQ:IMPAirment:LEAKage:I	195
[:SOURce]:IQ:IMPAirment:LEAKage:Q	195
[:SOURce]:IQ:IMPAirment:QUADrature[:ANGLE]	195
[:SOURce]:IQ:IMPAirment:STATe	196
[:SOURce]:IQ:CREStfactor	196

[[:SOURce]:IQ:STATe <State>

Switches the I/Q modulation on and off.

Parameters:

<State> 1 | ON | 0 | OFF
 *RST: 0

Example: See [Chapter 13.1.2, "Generating an I/Q Modulated Signal"](#), on page 165.

Manual operation: See ["Mod State"](#) on page 72

[[:SOURce]:IQ:IMPairment:IQRatio <IqRatio>

Sets the ratio of I modulation to Q modulation (gain "imbalance"). The input may be either in dB or %. An input in percent is rounded to the closest valid value in dB. A query returns the value in dB.

Parameters:

<IqRatio> float
 Range: -1 to 1
 Increment: 1E-3
 *RST: 0

Example: See [Chapter 13.1.2, "Generating an I/Q Modulated Signal"](#), on page 165.

Manual operation: See ["Gain Imbalance"](#) on page 100

[[:SOURce]:IQ:IMPairment:LEAKage:I <I>**[[:SOURce]:IQ:IMPairment:LEAKage:Q <Q>**

Sets the carrier leakage amplitude for the I-signal/ Q-signal component.

Parameters:

<Q> float
 Range: -5 to 5
 Increment: 0.01
 *RST: 0
 Default unit: PCT

Example: See [Chapter 13.1.2, "Generating an I/Q Modulated Signal"](#), on page 165.

Manual operation: See ["Offset"](#) on page 100

[[:SOURce]:IQ:IMPairment:QUADrature[:ANGLE] <Angle>

Sets the quadrature offset for the digital I/Q signal.

Parameters:

<Angle> float
 Range: -8 to 8
 Increment: 0.01
 *RST: 0
 Default unit: DEG

Example: See [Chapter 13.1.2, "Generating an I/Q Modulated Signal"](#), on page 165.

Manual operation: See ["Quadrature Offset"](#) on page 100

[:SOURce]:IQ:IMPairment:STATe <State>

Activates/deactivates the impairment or correction values LEAKage, QUADrature and IQRatio for the baseband signal prior to input to the I/Q modulator.

Parameters:

<State> 1 | ON | 0 | OFF
 *RST: 0

Example: See [Chapter 13.1.2, "Generating an I/Q Modulated Signal"](#), on page 165.

Manual operation: See ["State"](#) on page 99

[:SOURce]:IQ:CREStfactor <Crest>

Sets the crest factor of the I/Q modulation signal.

Parameters:

<Crest> float
 Range: 0 to 35
 Increment: 0.01
 *RST: 0
 Default unit: dB

Example: See [Chapter 13.1.2, "Generating an I/Q Modulated Signal"](#), on page 165

Manual operation: See ["Crest Factor"](#) on page 98

13.14 SOURce:LOSCillator subsystem

R&S SGU as an extension to a compatible R&S signal generator

If a R&S SGU is connected to a compatible R&S signal generator the R&S SGU acts as an extension to the signal generator extending its frequency range. In this setup a controller does not need to access the R&S SGU directly. Instead, the signal generator

acts as a controller to the R&S SGU and depending on the required output signal parameters performs all required settings automatically.

For example, if the signal generator is set to an output frequency of 15 GHz it passes this value on to the R&S SGU. During reception of the new frequency, the R&S SGU blanks its output and computes the necessary settings for the local oscillator (signal generator). Next, the signal generator queries R&S SGU for the required frequency and level values of the local oscillator, which answers with, for example, 7.5 GHz and -10 dBm. The signal generator applies these settings to its own oscillator hardware. Also, it confirms that the required signal is now present at its output connector by sending the apply command to the R&S SGU. The R&S SGU unblanks its own output thus finishing the cycle.

R&S SGU as an upconverter for any signal generator

If the R&S SGU is connected to an incompatible signal generator, the controller has to perform the above steps instead of the signal generator. We assume that a remote PC (controller) is connected to both the R&S SGU and the signal generator (local oscillator). When changing any parameters which affect the output signal of the combined system of local oscillator and R&S SGU the controller has to follow these steps:

Setting the signal of the R&S SGU

1. Set the parameters of the R&S SGU like frequency and level as needed.
2. Query the local oscillator frequency and the local oscillator level from R&S SGU with the SCPI commands `[:SOURce] :LOSCillator:FREQuency?` and `[:SOURce] :LOSCillator:POWer?`.
3. Interpret the result.
4. Apply the required changes to the LO.
5. Send the SCPI command `[:SOURce] :SETTings:APPLY [:IMMediate]` to R&S SGU to output the signal.

See [Chapter 13.1.3, "Advanced Task for Optimizing Performance"](#), on page 166 for an example.

<code>[:SOURce] :LOSCillator:FREQuency?</code>	197
<code>[:SOURce] :LOSCillator:POWer?</code>	198

`[:SOURce] :LOSCillator:FREQuency?`

Queries the frequency of the local oscillator input signal.

See [Chapter 13.14, "SOURce:LOSCillator subsystem"](#), on page 196 for a description of the setting process.

Return values:

<Frequency> float
 Range: 1E+6 to 20E+9
 Increment: 1E-3
 *RST: 1E+9

Usage: Query only

Manual operation: See "[Frequency](#)" on page 103

[:SOURce]:LOSCillator:POWer?

Queries the level of the local oscillator input signal.

See [Chapter 13.14, "SOURce:LOSCillator subsystem"](#), on page 196 for a description of the setting process.

Return values:

<Amplitude> float
 Range: -120 to 25
 Increment: 0.01
 *RST: -10

Usage: Query only

Manual operation: See "[Level](#)" on page 103

13.15 SOURce:POWer subsystem

[:SOURce]:POWer:ALC[:STATe]	198
[:SOURce]:POWer:ALC:DSEnsitivity	199
[:SOURce]:POWer:ALC:SONCe	199
[:SOURce]:POWer:ATTenuation:RFOFF:MODE	199
[:SOURce]:POWer:ATTenuation:SOVer[:OFFSet]	199
[:SOURce]:POWer:LMODe	200
[:SOURce]:POWer:SCHaracteristic	200
[:SOURce]:POWer[:LEVel][:IMMediate][:AMPLitude]	200
[:SOURce]:POWer[:LEVel][:IMMediate]:OFFSet	201
[:SOURce]:POWer:LIMit[:AMPLitude]	201
[:SOURce]:POWer:PEP?	201
[:SOURce]:POWer:POWer	202
[:SOURce]:POWer:RANGe:LOWer?	202
[:SOURce]:POWer:RANGe:UPPer?	202

[:SOURce]:POWer:ALC[:STATe] <State>

Activates/deactivates the automatic level control.

Parameters:

<State> 1 | OFFTable | ONTable | ON
 *RST: ONTable

Manual operation: See "[State](#)" on page 95

[:SOURce]:POWer:ALC:DSENSitivity <Sensitivity>

Sets the sensitivity of the power detector.

Parameters:

<Sensitivity> OFF | LOW | MED | HIGH
 *RST: OFF

[:SOURce]:POWer:ALC:SONCe

Briefly activates automatic level control for correction purposes.

Usage: Event

Manual operation: See "[Readjust](#)" on page 92

[:SOURce]:POWer:ATTenuation:RFOff:MODE <Mode>

Selects the state which the attenuator assumes when the instrument is switched on.

Parameters:

<Mode> MAX | FIXed

MAX

Sets attenuation to maximum when the RF signal is switched off. This setting is recommended for applications that require a high level of noise suppression.

FIXed

Retains the current setting and keeps the output impedance constant during RF off.

*RST: MAX

Manual operation: See "[RF-Off-Mode](#)" on page 94

[:SOURce]:POWer:ATTenuation:SOVer[:OFFSet] <Offset>

Sets the switch-over offset value of the attenuator.

Parameters:

<Offset> float
 *RST: 0

Manual operation: See "[SATT Switch-Over Offset](#)" on page 94

[:SOURce]:POWer:LMODe <LevMode>

Selects the level mode.

Parameters:

<LevMode> NORMAl | LNOise | LDISortion

NORMAl
automatic selection of the best settings

LNOISe
settings for lowest noise

LDISortion
settings for lowest distortions

*RST: n.a. (factory preset: NORMAl)

Example: see [Chapter 13.1.3, "Advanced Task for Optimizing Performance"](#), on page 166

Manual operation: See "[Mode](#)" on page 91

[:SOURce]:POWer:SCHARacteristic <Characteristic>

Selects the characteristic for the level setting.

Parameters:

<Characteristic> AUTO | UNINterrupted | CVSWr | USER | MONotone

UNINterrupted: Uninterrupted Level setting, CVSWr: Constant-VSWR, MONotone: Strictly Monotone

*RST: AUTO

Example: see [Chapter 13.1.3, "Advanced Task for Optimizing Performance"](#), on page 166

Manual operation: See "[Setting Characteristic](#)" on page 91

[:SOURce]:POWer[:LEVel][:IMMediate][:AMPLitude] <Amplitude>

Sets the RF level at the RF output connector of the instrument.

Parameters:

<Amplitude> float

Range: -120 to 25

Increment: 0.01

*RST: -10

Example: See [Chapter 13.1.3, "Advanced Task for Optimizing Performance"](#), on page 166.

Manual operation: See "[Level/Level Offset](#)" on page 72

[[:SOURce]:POWer[:LEVel][:IMMediate]:OFFSet <Offset>

Specifies the constant level offset of a downstream attenuator/amplifier. If a level offset is entered, the level entered with [[:SOURce]:POWer:POWer no longer corresponds to the RF output level.

The following correlation applies:

:POWer = RF output level + POWer:OFFSet.

Entering a level offset does not change the RF output level, but rather the query value of :POWer.

Only dB is permitted as the unit here. The linear units (V, W, etc.) are not permitted.

Parameters:

<Offset>	float
	Range: -100 to 100
	Increment: 0.1
	*RST: 0

Manual operation: See "[Offset](#)" on page 91

[[:SOURce]:POWer:LIMit[:AMPLitude] <Amplitude>

Sets the upper limit of the RF signal power.

The value is not affected by an instrument preset and *RST function. This parameter is influenced only by the factory preset (SYST:FPR) and its factory value is equal to the upper limit.

Parameters:

<Amplitude>	float
	Range: -300 to 30
	Increment: 0.01
	*RST: 30
	Default unit: dBm

Manual operation: See "[Limit](#)" on page 92

[[:SOURce]:POWer:PEP?

Queries the RF signal's peak envelope power at the DUT.

Return values:

<PEP>	float
	Range: -120 to 25
	Increment: 0.01
	*RST: -10

Example: see [Chapter 13.1.3, "Advanced Task for Optimizing Performance"](#), on page 166

Usage: Query only

Manual operation: See "PEP" on page 72

[:SOURce]:POWer:POWer <Power>

Sets the level at the RF output connector.

This value does not consider a specified offset. The command `[:SOURce]:POWer[:LEVel][:IMMediate]:OFFSet` sets the level of the "Level" display, that means the level containing offset.

Parameters:

<Power> float
 Range: -120 to 25
 Increment: 0.01
 *RST: -10

Example: POW:POW 15
 sets the RF level at output to 15 dBm.

Manual operation: See "Level/Level Offset" on page 72

[:SOURce]:POWer:RANGe:LOWer?

[:SOURce]:POWer:RANGe:UPPer?

Queries the minimum/maximum level range in the current level mode

Return values:

<Upper> float
 Range: -300 to 30
 Increment: 0.01
 *RST: 30

Usage: Query only

Manual operation: See "Level Range" on page 92

13.16 SOURce:PULM subsystem

`[:SOURce<hw>]:PULM:STATe`.....202

`[:SOURce<hw>]:PULM:POLarity`.....203

[:SOURce<hw>]:PULM:STATe <State>

Activates the pulse modulation.

Parameters:

<State> 0 | 1 | OFF | ON
 *RST: 0

Example: PULM:STAT ON
 activates pulse modulation.

Manual operation: See "State" on page 101

[:SOURce<hw>]:PULM:POLarity <Polarity>

Sets the polarity of the pulse modulator signal. This command is effective only for an external modulation signal.

Parameters:

<Polarity> NORMal | INVerted

NORMal

The RF signal is suppressed during the pulse pause.

INVerted

The RF signal is suppressed during the pulse.

*RST: NORMal

Example:

PULM:POL INV
selects inverted polarity.

Manual operation: See "Polarity" on page 101

13.17 STATus subsystem

This system contains the commands for the status reporting system. See also [Chapter 12.5, "Status reporting system"](#), on page 147 for detailed information.

*RST on page 172 has no effect on the status registers.

Value ranges

- Queries return the current value of the respective register, which permits a check of the device status.
Return values: A decimal value in the range 0 to 32767 ($=2^{15}-1$)
- The configuration commands set the respective register thus determining which status changes of the R&S SGU cause the status registers to be changed.
Setting values: A decimal value in the range 0 to 32767 ($=2^{15}-1$)

:STATus:OPERation:CONDition?	204
:STATus:OPERation:ENABle	204
:STATus:OPERation[:EVENT]	204
:STATus:OPERation:NTRansition	204
:STATus:OPERation:PTRansition	205
:STATus:PRESet	205
:STATus:QUEStionable:CONDition	205
:STATus:QUEStionable:ENABle	205
:STATus:QUEStionable[:EVENT]	206
:STATus:QUEStionable:NTRansition	206
:STATus:QUEStionable:PTRansition	206
:STATus:QUEue[:NEXT]?	206

:STATus:OPERation:CONDition?

Queries the content of the CONDition part of the STATus:OPERation register.

This part contains information on the action currently being performed in the instrument. The content is not deleted after being read out because it indicates the current hardware status.

Return values:

<Condition> string

Example: :STATus:OPERation:CONDition?

Usage: Query only

:STATus:OPERation:ENABle <Enable>

Sets the bits of the ENABle part of the STATus:OPERation register. This setting determines which events of the Status-Event part are forwarded to the sum bit in the status byte. These events can be used for a service request.

Parameters:

<Enable> string

Example: :STAT:OPER:ENAB 32767
all events are forwarded to the sum bit of the status byte.

:STATus:OPERation[:EVENT] <Event>

Queries the content of the EVENT part of the STATus:OPERation register. This part contains information on the actions performed in the instrument since the last readout. The content of the EVENT part is deleted after being read out.

Parameters:

<Event> string

Example: :STAT:OPER:EVENT?
queries the STATus:OPERation:EVENT register.

:STATus:OPERation:NTRansition <Ntransition>

Sets the bits of the NTRansition part of the STATus:OPERation register. If a bit is set, a transition from 1 to 0 in the condition part causes an entry to be made in the EVENT part of the register. The disappearance of an event in the hardware is thus registered, for example the end of an adjustment.

Parameters:

<Ntransition> string

Example: :STAT:OPER:NTR 0
a transition from 1 to 0 in the condition part of the Status:Operation register does not cause an entry to be made in the EVENT part.

:STATus:OPERation:PTRansition <Ptransition>

Sets the bits of the PTRansition part of the STATus:OPERation register. If a bit is set, a transition from 0 to 1 in the condition part causes an entry to be made in the EVENT part of the register. A new event in the hardware is thus registered, for example the start of an adjustment.

Parameters:

<Ptransition> string

Example:

:STAT:OPER:PTR 32767

all transitions from 0 to 1 in the condition part of the Status:Operation register cause an entry to be made in the EVENT part.

:STATus:PRESet <Preset>

Resets the status registers. All PTRansition parts are set to FFFFh (32767), i.e. all transitions from 0 to 1 are detected. All NTRansition parts are set to 0, i.e. a transition from 1 to 0 in a CONDition bit is not detected. The ENABle parts of STATus:OPERation and STATus:QUEStionable are set to 0, i.e. all events in these registers are not passed on.

Parameters:

<Preset> string

Example:

STAT:PRES

resets the status registers.

:STATus:QUEStionable:CONDition <Condition>

Queries the content of the CONDition part of the STATus:QUEStionable register. This part contains information on the action currently being performed in the instrument. The content is not deleted after being read out since it indicates the current hardware status.

Parameters:

<Condition> string

Example:

:STATus:QUEStionable:CONDition?

queries the Status:Questionable:Condition register.

:STATus:QUEStionable:ENABle <Enable>

Sets the bits of the ENABle part of the STATus:QUEStionable register. The enable part determines which events of the STATus:EVENT part are enabled for the summary bit in the status byte. These events can be used for a service request.

If a bit in the ENABle part is 1, and the corresponding EVENT bit is true, a positive transition occurs in the summary bit. This transition is reported to the next higher level.

Parameters:

<Enable> string

Example: `STAT:QUES:ENAB 1`
 Problems when performing an adjustment cause an entry to be made in the sum bit.

:STATus:QUESTionable[:EVENT] <Event>

Queries the content of the EVENT part of the STATus:QUESTionable register. This part contains information on the actions performed in the instrument since the last readout. The content of the EVENT part is deleted after being read out.

Parameters:

<Event> string

Example: `STAT:QUES:EVENT?`
 queries the Status:Questionable:Event register.

:STATus:QUESTionable:NTRansition <Ntransition>

Sets the bits of the NTRansition part of the STATus:QUESTionable register. If a bit is set, a transition from 1 to 0 in the condition part causes an entry to be made in the EVENT part of the register.

Parameters:

<Ntransition> string

Example: `STAT:QUES:NTR 0`
 a transition from 1 to 0 in the condition part of the STATus:QUESTionable register does not cause an entry to be made in the EVENT part

:STATus:QUESTionable:PTRansition <PTransition>

Sets the bits of the PTRansition part of the STATus:QUESTionable register. If a bit is set, a transition from 1 to 0 in the condition part causes an entry to be made in the EVENT part of the register.

Parameters:

<PTransition> string

Example: `STAT:QUES:PTR 32767`
 all transitions from 0 to 1 in the condition part of the STATus:QUESTionable register cause an entry to be made in the EVENT part

:STATus:QUEue[:NEXT]?

Queries the oldest entry in the error queue and then deletes it. Positive error numbers denote device-specific errors, and negative error numbers denote error messages defined by SCPI. If the error queue is empty, 0 ("No error") is returned.

The command is identical to `:SYSTem:ERRor[:NEXT]?` on page 210.

Return values:**<Next>** string**Example:**

:STATus:QUEue?

queries the oldest entry in the error queue.

Response: 0, 'no error'

no errors have occurred since the error queue was last read out

Usage:

Query only

13.18 SYSTem subsystem

The SYSTem subsystem contains a series of commands for general functions which do not directly affect signal generation.

:SYSTem:EMODE.....	208
:SYSTem:ERRor:ALL?.....	208
:SYSTem:ERRor:CODE:ALL?.....	208
:SYSTem:ERRor:CODE[:NEXT]?.....	209
:SYSTem:ERRor:COUNT?.....	209
:SYSTem:ERRor[:NEXT]?.....	210
:SYSTem:SERRor?.....	210
:SYSTem:STANdby:STATe?.....	210
:SYSTem:VERSion?.....	211
:SYSTem:COMMunicate:NETWork:IPADdress.....	211
:SYSTem:COMMunicate:NETWork:IPADdress:MODE.....	211
:SYSTem:COMMunicate:NETWork:MACAddress.....	211
:SYSTem:COMMunicate:NETWork:RESart.....	212
:SYSTem:COMMunicate:NETWork:STATus?.....	212
:SYSTem:COMMunicate:NETWork[:COMMon]:HOSTname.....	212
:SYSTem:COMMunicate:NETWork[:IPADdress]:GATeway.....	212
:SYSTem:COMMunicate:NETWork[:IPADdress]:SUBNet:MASK.....	213
:SYSTem:COMMunicate:NETWork:RESource?.....	213
:SYSTem:COMMunicate:HISLip:RESource?.....	213
:SYSTem:COMMunicate:PClexpress:RESource?.....	213
:SYSTem:COMMunicate:SOCKet:PORT.....	214
:SYSTem:COMMunicate:SOCKet:RESource?.....	214
:SYSTem:COMMunicate:SERial:RESource?.....	214
:SYSTem:COMMunicate:SERial:BAUD.....	214
:SYSTem:COMMunicate:SERial:PARity.....	215
:SYSTem:COMMunicate:SERial:SBITs.....	215
:SYSTem:COMMunicate:USB:RESource?.....	215
:SYSTem:HARDware:ASSEMBly<dir>:SNUMber?.....	215
:SYSTem:MMEMemory:PATH:USER?.....	216
:SYSTem:NINformation?.....	216
:SYSTem:OSYSstem?.....	216
:SYSTem:REBoot.....	216
:SYSTem:RESart.....	216

:SYSTem:SHUTdown.....	217
:SYSTem:PROTect<ch>[:STATe].....	217
:SYSTem:STARtup:COMPLete?.....	217

:SYSTem:EMODe <Mode>

Enables and selects the eco mode.

Parameters:

<Mode> OFF | EM1
 *RST: OFF

Example: See [Chapter 13.1.1, "Performing General Tasks for Instrument Setup"](#), on page 163.

:SYSTem:ERRor:ALL?

Queries the error/event queue for all unread items and removes them from the queue.

Return values:

<All> string
 Error/event_number,"Error/event_description>[:Device-depend-ent info]"
 A comma separated list of error number and a short description of the error in FIFO order.
 If the queue is empty, the response is 0, "No error"
 Positive error numbers are instrument-dependent. Negative error numbers are reserved by the SCPI standard.
 Volatile errors are reported once, at the time they appear. Identical errors are reported repeatedly only if the original error has already been retrieved from (and hence not any more present in) the error queue.

Example: SYST:ERR:ALL?
 Queries all entries in the error queue.
 Response: 0, 'no error'
 No errors have occurred since the error queue was last read out.

Usage: Query only

:SYSTem:ERRor:CODE:ALL?

Queries the error numbers of all entries in the error queue and then deletes them.

Return values:

<All> string
 Returns the error numbers. To retrieve the entire error text, send the command :SYSTem:ERRor:ALL?.
 0
 "No error", i.e. the error queue is empty

Positive value

Positive error numbers denote device-specific errors

Negative value

Negative error numbers denote error messages defined by SCPI.

Example:

```
SYST:ERR:CODE:ALL
```

Queries all entries in the error queue.

```
Response: 0
```

No errors have occurred since the error queue was last read out.

Usage:

Query only

:SYSTem:ERRor:CODE[:NEXT]?

Queries the error number of the oldest entry in the error queue and then deletes it.

Return values:

<Next>

string

Returns the error number. To retrieve the entire error text, send the command `:SYSTem:ERRor:ALL?`.

0

"No error", i.e. the error queue is empty

Positive value

Positive error numbers denote device-specific errors

Negative value

Negative error numbers denote error messages defined by SCPI.

Example:

```
SYST:ERR:CODE
```

Queries the oldest entry in the error queue.

```
Response: 0
```

No errors have occurred since the error queue was last read out.

Usage:

Query only

:SYSTem:ERRor:COUNT?

Queries the number of entries in the error queue.

Return values:

<Count>

integer

0

The error queue is empty.

Example:

```
SYST:ERR:COUN
```

Queries the number of entries in the error queue.

```
Response: 1
```

One error has occurred since the error queue was last read out.

Usage:

Query only

:SYSTem:ERRor[:NEXT]?

Queries the error/event queue for the oldest item and removes it from the queue.

Return values:

<Next> string
 Error/event_number,"Error/event_description>[;Device-dependent info]"
 Error number and a short description of the error.
 If the queue is empty, the response is 0, "No error"
 Positive error numbers are instrument-dependent. Negative error numbers are reserved by the SCPI standard.
 Volatile errors are reported once, at the time they appear. Identical errors are reported repeatedly only if the original error has already been retrieved from (and hence not any more present in) the error queue.

Example:

SYST:ERR?
 Queries the oldest entry in the error queue.
 Response: 0, 'no error'
 No errors have occurred since the error queue was last read out.

Usage:

Query only

:SYSTem:SERRor?

Returns a list of all errors existing at the time when the query is started. This list corresponds to the display on the info page under manual control.

Return values:

<Serror> string

Example:

SYST:SERR
 queries all errors existing in the error queue.

Example:

Response: -221, 'Settings conflict', 153,
 'Input voltage out of range'
 The two returned errors have occurred since the error queue was last queried.

Usage:

Query only

:SYSTem:STANdby:STATe?

Queries the standby state of the R&S SGU.

Suffix:

<dir> 1..2

Return values:

<State> 1 | ON | 0 | OFF

0|OFF

The R&S SGU is in ready state, standby is not active.

1|ON

The R&S SGU is in standby state, the ready state is not active.

*RST: 0

Usage: Query only

:SYSTem:VERSion?

Queries the SCPI version the instrument's command set complies with.

Return values:

<Version> string

Example:

SYST:VERS

queries the SCPI version.

Response: "1996"

The instrument complies with the SCPI version from 1996.

Usage: Query only

:SYSTem:COMMunicate:NETWork:IPAddress <IpAddress>

Sets the IP address.

Parameters:

<IpAddress> string

Range: 0.0.0.0. to ff.ff.ff.ff

Example:

SYSTem:COMMunicate:NETWork:IPAddress "7.8.9.10"
sets the IP address of the instrument.

Manual operation: See "[IP Address](#)" on page 115

:SYSTem:COMMunicate:NETWork:IPAddress:MODE <Mode>

Selects manual or automatic setting of the IP address.

Parameters:

<Mode> AUTO | STATic

*RST: n.a. (factory preset: AUTO)

Example:

SYSTem:COMMunicate:NETWork:IPAddress:MODE AUTO
The IP address is assigned automatically (DHCP)

Manual operation: See "[Address Mode](#)" on page 115

:SYSTem:COMMunicate:NETWork:MACAddress <MacAddress>

Queries the MAC address of the network adapter.

Parameters:

<MacAddress> string

Example: `SYST:COMM:NETW:MAC`
queries the MAC address.

:SYSTem:COMMunicate:NETWork:REStart

Restarts the network connection to the instrument, terminates the connection and sets it up again.

Example: `SYSTem:COMMunicate:NETWork:REStart`

Usage: Event

:SYSTem:COMMunicate:NETWork:STATus?

Queries the network configuration state.

Return values:

<State> 0 | 1 | OFF | ON

Usage: Query only

:SYSTem:COMMunicate:NETWork[:COMMON]:HOSTname <Hostname>

Sets the individual host name of the R&S SGU.

Note: it is recommended that you do not change the host name in order to avoid problems with the network connection. However, if you change the host name be sure to use an unique name.

The host name is a protected parameter, To change it, first disable protection level 1 with command `:SYSTem:PROTECT<ch>[:STATe]` on page 217.

Parameters:

<Hostname> string

Example: `SYSTem:PROTECT1:STATe OFF,123456`
`SYSTem:COMMunicate:NETWork:HOSTname 'SIGGEN'`
sets the individual computer name of the R&S SGU.

Manual operation: See "[Hostname](#)" on page 114

:SYSTem:COMMunicate:NETWork[:IPAddress]:GATeway <Gateway>

Sets the IP address of the default gateway.

Parameters:

<Gateway> string
Range: 0.0.0.0 to ff.ff.ff.ff

Example: `SYSTem:COMMunicate:NETWork:IPAddress:GATeway`
`'1.2.3.4'`
sets the IP address of the default gateway.

Manual operation: See "[Default Gateway](#)" on page 116

:SYSTem:COMMunicate:NETWork[:IPAddress]:SUBNet:MASK <Mask>

Sets the subnet mask.

Parameters:

<Mask> string

Example: SYSTem:COMMunicate:NETWork:IPAddress:SUBNet:
MASK '255.255.0.0'
determines the subnet mask.

Manual operation: See "[Subnet Mask](#)" on page 115

:SYSTem:COMMunicate:NETWork:RESource?

Queries the VISA resource string, used for remote control of the instrument with VXI-11 protocol.

Return values:

<Resource> string

Example: SYSTem:COMMunicate:NETWork:RESource?
Response: "TCPIP::192.1.2.3::INSTR"

Usage: Query only

Manual operation: See "[Visa Resource Strings](#)" on page 116

:SYSTem:COMMunicate:HISLip:RESource?

Queries the VISA resource string, used for remote control of the instrument with HiSLIP protocol.

Return values:

<Resource> string

Example: SYSTem:COMMunicate:HISLip:RESource?
Response: "TCPIP::192.1.2.3::hislip0::INSTR"

Usage: Query only

Manual operation: See "[Visa Resource Strings](#)" on page 116

:SYSTem:COMMunicate:PClexpress:RESource?

Queries the visa resource string for remote control via the PCIe interface.

Return values:

<Resource> string

Usage: Query only

Manual operation: See "[Visa Resource Strings](#)" on page 116

:SYSTem:COMMunicate:SOCKet:PORT <ScpiEthPort>

Sets the port number for remote control via socket communication.

Parameters:

<ScpiEthPort>	integer
Range:	1000 to 65535
*RST:	n.a. (factory preset: 5025)

Example:

```
SYSTem:COMMunicate:SOCKet:PORT 5030
// specifies the socket port number.
```

Manual operation: See "[SCPI Port](#)" on page 67

:SYSTem:COMMunicate:SOCKet:RESource?

Queries the VISA resource string for remote control via LAN interface, using TCP/IP socket protocol.

Return values:

<Resource>	string
------------	--------

Example:

```
SYSTem:COMMunicate:SOCKet:RESource?
Response: "TCPIP::10.113.1.150::5025::SOCKET"
```

Usage: Query only

Manual operation: See "[Visa Resource Strings](#)" on page 116

:SYSTem:COMMunicate:SERial:RESource?

Queries the VISA resource string for the serial remote control interface. This string is used for remote control of the instrument.

Return values:

<Resource>	string
------------	--------

Example:

```
SYSTem:COMMunicate:SERial:RESource?
queries the VISA resource string.
Response: "ASRL1::INSTR"
```

Usage: Query only

:SYSTem:COMMunicate:SERial:BAUD <Baud>

Sets the baudrate for the serial remote control interface.

Parameters:

<Baud>	2400 4800 9600 19200 38400 57600 115200
*RST:	n.a. (factory preset: 115200)

Example:

```
SYSTem:COMMunicate:SERial:BAUD 115200
Sets 115200 baudrate.
```

:SYSTem:COMMunicate:SERial:PARity <Parity>

Sets the parity for the serial remote control interface.

Parameters:

<Parity> NONE | ODD | EVEN
*RST: n.a. (factory preset: NONE)

Example: SYST:COMM:SER:PAR NONE
Selects parity NONE.

:SYSTem:COMMunicate:SERial:SBITs <SBits>

Sets the number of stop bits for the serial remote control interface.

Parameters:

<SBits> 1 | 2
*RST: n.a. (factory preset: 1)

Example: SYST:COMM:SER:SBIT 2
Selects 2 stop bits.

:SYSTem:COMMunicate:USB:RESource?

Queries the VISA resource string for remote control via the USB interface.

Return values:

<Resource> string

Example: SYSTem:COMMunicate:USB:RESource?
queries the VISA resource string for remote control via the USB interface.
Response: "USB::72::000000::INSTR"

Usage: Query only

Manual operation: See "[Visa Resource Strings](#)" on page 116

:SYSTem:HARDware:ASSEMBly<dir>:SNUMBER?

Queries the list of hardware module serial numbers.

Suffix:

<dir> 1 | 2
Defines the section: 1 = common assembly, 2 = RF assembly.

Return values:

<SNumber> string

Example: SYSTem:HARDware:ASSEMBly1:SNUMBER?

Usage: Query only

Manual operation: See "[Assembly](#)" on page 106

:SYSTem:MMEMory:PATH:USER?

Queries the user directory, that means the directory the instrument stores user files on.

Return values:

<PathUser> string

Example:

SYSTem:MMEMory:PATH:USER?

Response: "/var/user/"

Usage:

Query only

:SYSTem:NINFormation?

Queries the oldest information message ("Error History > Level > Info") in the error/event queue.

Return values:

<NextInfo> string

Example:

:SYSTem:NINFormation?

Queries the oldest entry in the info message queue.

Response: 90,"Info;=== Instrument startup...
==="

Information message containing error number 90, that states, that the instrument startup is complete.

Usage:

Query only

:SYSTem:OSYSstem?

Queries the operating system of the instrument.

Return values:

<OperSystem> string

Example:

SYSTem:OSYSstem?

Response: "Linux"

Usage:

Query only

:SYSTem:REBoot

Restarts the firmware and the operating system.

Usage:

Event

:SYSTem:REStart

Restarts the firmware. The operating system remains active.

Usage:

Event

:SYSTem:SHUTdown

Shuts down the instrument.

Usage: Event

:SYSTem:PROTect<ch>[:STATe] <State>[, <Key>]

Activates and deactivates the specified protection level.

Suffix:

<ch> Indicates the protection level.

Parameters:

<State> select
*RST: n.a. (factory preset: 1)

Setting parameters:

<Key> integer

The respective functions are disabled when the protection level is activated. No password is required for activation of a level. A password must be entered to deactivate the protection level. The password for the first level is 123456.

Example:

```
// to activate protection level
SYSTem:PROTect1:STATe 1
// internal adjustments or hostname cannot be changed
// to unlock protection level 1
SYSTem:PROTect1:STATe 0,123456
// internal adjustments are accessible
```

:SYSTem:STARtup:COMPLetE?

Queries if the startup of the instrument is completed.

Return values:

<Complete> 0 | 1 | OFF | ON
*RST: 0

Example:

```
SYST:STAR:COMP?
// 1
// the startup of the instrument is completed
```

Usage: Query only

13.19 TEST subsystem

The TEST system contains the commands for performing the routines. R&S SGU cannot perform the selftest on its own. Therefore a connection with a signal generator is needed. If you use a compatible R&S signal generator, then the calibration process will

be completed automatically after starting the calibration process. Otherwise you have to follow the steps described in "[Calibration process of the R&S SGU](#)" on page 176. In the given example, replace the `:CALibration:xxx:START` SCPI command with `:TEST:ALL:START` and `:CALibration:xxx:RESult` with `:TEST:ALL:RESult`. We assume that a remote PC is connected to the instruments, the remote PC and the instruments are switched on and a connection between them is established.

The self tests returns a "0" if the test is performed successfully, otherwise a value other than "0" is returned. None of the commands of this system has a `*RST` value.

NOTICE

Improper use can destroy the assembly

The respective hardware assembly responds directly to the `:TEST:DIRect` command; any safety mechanisms are bypassed. The command is intended for servicing purposes and should be used only by the Rohde & Schwarz service personnel.

<code>:TEST:ALL:START</code>	218
<code>:TEST:ALL:RESult?</code>	218
<code>:TEST:KEYBoard[:STATe]</code>	218

`:TEST:ALL:START`

Starts a selftest. Use the command `:TEST:ALL:RESult?` to query the result.

Use `:CALibration:HREQuest?` to query for settings required by the instrument.

Usage: Event

`:TEST:ALL:RESult?`

Queries the result of the performed selftest. Start the selftest with `:TEST:ALL:START`.

Return values:

<Result> 0 | 1 | RUNning | STOPped
*RST: STOPped

Example: See [Chapter 13.1.1, "Performing General Tasks for Instrument Setup"](#), on page 163.

Usage: Query only

`:TEST:KEYBoard[:STATe] <State>`

Enables/disables the keyboard and the LED test state.

Parameters:

<State> 1 | ON | 0 | OFF
*RST: OFF

13.20 UNIT subsystem

The `UNIT` subsystem contains the commands specifying which units are valid if no unit is indicated in a command. These settings are valid for the entire instrument.

`:UNIT:ANGLE` <Angle>

Sets the default angle unit for remote control. Does not influence the manual control parameter units and the display.

Parameters:

<Angle> DEGREE | RADIAN
*RST: RADIAN

Example:

`UNIT:ANGL DEG`
sets DEG as a default unit for all commands which determine angle values.

`:UNIT:POWER` <Power>

Defines the default unit for power parameters. This setting affects the GUI, as well as all remote control commands that determine power values.

Parameters:

<Power> V | DBUV | DBM
*RST: DBM

Example:

`UNIT:POW V`
sets V as a default unit for all commands which determine power values.

13.21 List of R&S SGU commands

<code>:CALibration:HREQuest?</code>	177
<code>:CALibration:IQModulator:LOCAl:RESult?</code>	179
<code>:CALibration:IQModulator:LOCAl:STARt</code>	179
<code>:CALibration:IQModulator:RESult?</code>	178
<code>:CALibration:IQModulator:STARt</code>	178
<code>:CALibration:IQModulator:TEMPerature?</code>	178
<code>:CALibration:LEVel:RESult?</code>	179
<code>:CALibration:LEVel:STARt</code>	179
<code>:CALibration:LEVel:TEMPerature?</code>	179
<code>:CONNector:TRIGger:OMODE</code>	180
<code>:DIAGnostic:POINt:CATalog?</code>	180
<code>:DIAGnostic[MEASure]:POINt?</code>	180
<code>:FFASt</code>	181
<code>:FORMat:BORDER</code>	182
<code>:FORMat:SREGister</code>	182
<code>:FORMat[.DATA]</code>	182

:LOCK?	173
:MEMory:HFRee?	189
:MMEMory:CATalog:LENGth?	186
:MMEMory:CATalog?	186
:MMEMory:CDIRectory	187
:MMEMory:COPI	187
:MMEMory:DATA	188
:MMEMory:DCATalog:LENGth?	189
:MMEMory:DCATalog?	188
:MMEMory:DELete	189
:MMEMory:LOAD:STATe	189
:MMEMory:MDIRectory	190
:MMEMory:MOVE	190
:MMEMory:MSIS	190
:MMEMory:RDIRectory	191
:MMEMory:STORe:STATe	191
:OUTPut:AFIXed:RANGe:LOWer?	192
:OUTPut:AFIXed:RANGe:UPPer?	193
:OUTPut:AMODE	191
:OUTPut[:STATe]	192
:OUTPut[:STATe]:PON	192
:OUTPut<hw>:PROTection:CLEar	193
:PFASt	181
:REMote:OPMode	173
:SOURce<hw>:PRESet	174
:STATus:OPERation:CONDition?	204
:STATus:OPERation:ENABLE	204
:STATus:OPERation:NTRansition	204
:STATus:OPERation:PTRansition	205
:STATus:OPERation[:EVENT]	204
:STATus:PRESet	205
:STATus:QUEStionable:CONDition	205
:STATus:QUEStionable:ENABLE	205
:STATus:QUEStionable:NTRansition	206
:STATus:QUEStionable:PTRansition	206
:STATus:QUEStionable[:EVENT]	206
:STATus:QUEue[:NEXT]?	206
:SYSTem:COMMunicate:HISLip:RESource?	213
:SYSTem:COMMunicate:NETWork:IPAdDress	211
:SYSTem:COMMunicate:NETWork:IPAdDress:MODE	211
:SYSTem:COMMunicate:NETWork:MACAdDress	211
:SYSTem:COMMunicate:NETWork:RESource?	213
:SYSTem:COMMunicate:NETWork:REStart	212
:SYSTem:COMMunicate:NETWork:STATus?	212
:SYSTem:COMMunicate:NETWork[:COMMOn]:HOSTname	212
:SYSTem:COMMunicate:NETWork[:IPAdDress]:GATeway	212
:SYSTem:COMMunicate:NETWork[:IPAdDress]:SUBNet:MASK	213
:SYSTem:COMMunicate:PClexpress:RESource?	213
:SYSTem:COMMunicate:SERial:BAUD	214
:SYSTem:COMMunicate:SERial:PARity	215

:SYSTem:COMMunicate:SERial:RESource?	214
:SYSTem:COMMunicate:SERial:SBITs	215
:SYSTem:COMMunicate:SOCKet:PORT	214
:SYSTem:COMMunicate:SOCKet:RESource?	214
:SYSTem:COMMunicate:USB:RESource?	215
:SYSTem:EMODe	208
:SYSTem:ERRor:ALL?	208
:SYSTem:ERRor:CODE:ALL?	208
:SYSTem:ERRor:CODE[:NEXT]?	209
:SYSTem:ERRor:COUNT?	209
:SYSTem:ERRor[:NEXT]?	210
:SYSTem:FPReset	175
:SYSTem:HARDware:ASSEMBly<dir>:SNUMBER?	215
:SYSTem:MMEMory:PATH:USER?	216
:SYSTem:NINformation?	216
:SYSTem:OSYSstem?	216
:SYSTem:PRESet	174
:SYSTem:PROTect<ch>[:STATe]	217
:SYSTem:REBoot	216
:SYSTem:REStart	216
:SYSTem:SERRor?	210
:SYSTem:SHUTdown	217
:SYSTem:STANdbY:STATe?	210
:SYSTem:STARtup:COMPLete?	217
:SYSTem:VERSIon?	211
:TEST:ALL:RESult?	218
:TEST:ALL:STARt	218
:TEST:KEYBoard[:STATe]	218
:UNIT:ANGLe	219
:UNIT:POWer	219
:UNLock	174
[:SOURce]:FREQUency[:CW FIXed]	193
[:SOURce]:IQ:CREStfactor	196
[:SOURce]:IQ:IMPairment:IQRatio	195
[:SOURce]:IQ:IMPairment:LEAKage:I	195
[:SOURce]:IQ:IMPairment:LEAKage:Q	195
[:SOURce]:IQ:IMPairment:QUADrature[:ANGLe]	195
[:SOURce]:IQ:IMPairment:STATe	196
[:SOURce]:IQ:STATe	194
[:SOURce]:LOSCillator:FREQUency?	197
[:SOURce]:LOSCillator:POWer?	198
[:SOURce]:POWer:ALC:DSENSitivity	199
[:SOURce]:POWer:ALC:SONCe	199
[:SOURce]:POWer:ALC[:STATe]	198
[:SOURce]:POWer:ATTenuation:RFOFF:MODE	199
[:SOURce]:POWer:ATTenuation:SOVer[:OFFSet]	199
[:SOURce]:POWer:LIMit[:AMPLitude]	201
[:SOURce]:POWer:LMODe	200
[:SOURce]:POWer:PEP?	201
[:SOURce]:POWer:POWer	202

[:SOURce]:POWer:RANGe:LOWer?.....	202
[:SOURce]:POWer:RANGe:UPPer?.....	202
[:SOURce]:POWer:SCHaracteristic.....	200
[:SOURce]:POWer[LEVel][:IMMediate]:OFFSet.....	201
[:SOURce]:POWer[LEVel][:IMMediate][:AMPLitude].....	200
[:SOURce]:SETTings:APPLY[:IMMediate].....	193
[:SOURce]:TRAIts:COUNT?.....	194
[:SOURce]:TRAIts<ch>.....	194
[:SOURce<hw>]:PULM:POLarity.....	203
[:SOURce<hw>]:PULM:STATe.....	202
*CLS.....	169
*ESE.....	169
*ESR?.....	170
*IDN?.....	170
*IST?.....	170
*OPC.....	170
*OPT?.....	171
*PRE.....	171
*PSC.....	171
*RCL.....	171
*RST.....	172
*SAV.....	172
*SRE.....	172
*STB?.....	172
*TRG.....	172
*WAI.....	173

14 Error messages and troubleshooting

This chapter describes the error messages of the R&S SGU. The error messages are output in the "Info" line on the screen and entered in the error/event queue of the status reporting system.

A great variety of different messages such as status messages, error messages, warnings or information are displayed in the header field of the screen. Some error messages require that the error must be eliminated before correct instrument operation can be ensured. The "Info" window with a list of current messages and a detailed description of each message can be opened with the "Info" button (see also [Chapter 8.2.1, "Info dialog"](#), on page 68).

14.1 Status information

The status messages are displayed in the Info line of the R&S SGMA-GUI main panel. The status information gives the user an overview of the main operating states and settings of the instrument. The states are indicated for information only and do not necessitate any action by the user.

Status Information displayed in the Info line

AttFixed

Attenuator fixed mode is active.

The uninterrupted level settings are made in a fixed range without attenuator switching. The variation range is set automatically when this mode is activated. The range is displayed with the parameter "SGMA-GUI > Instrument Name > Level > Attenuator Fixed Range".

14.2 Error messages

Messages indicate errors in the instrument. They are displayed in the info line in different colors depending on their importance and display duration. Errors (e.g. no calibration data) are displayed in red, information (e.g. file not found) and warnings in black. Warnings indicate less significant errors (e.g. the instrument operates outside specified data).

See also [Chapter 8.2.1, "Info dialog"](#), on page 68 and [Chapter 8.2.2, "Understanding the messages in the info bar"](#), on page 69.

14.2.1 Volatile messages

Volatile messages report automatic settings in the instrument (e.g. switching off of incompatible types of modulation) or on illegal entries that are not accepted by the

instrument (e.g. range violations). They are displayed in the info line on a yellow background. They are displayed on top of status information or permanent messages.

Volatile messages do not normally demand user actions and disappear automatically after a brief period of time. They are stored in the history, however.

SCPI command: `:SYSTem:ERRor:ALL?` and `:SYSTem:ERRor[:NEXT]?`.

14.2.2 Permanent messages

Permanent messages are displayed if an error occurs that impairs further instrument operation, e.g. a hardware fault. The error signaled by a permanent message must be eliminated before correct instrument operation can be ensured.

The message is displayed until the error is eliminated. It covers the status display in the info line. After error elimination, the message automatically disappears and is also recorded in the history.

SCPI command: `:SYSTem:SERRor?`

14.3 SCPI-Error messages

The SCPI error messages are the same in all SCPI instruments. Detailed information and an overview of all error messages as defined in SCPI standard can be found in the corresponding documentation.

The errors are assigned negative numbers. The error text being entered into the error/event queue or being displayed is printed in bold face on the left together with the error code. Below the error text, there is an explanation as to the respective error.

14.4 Device-Specific error messages

The following table contains all error messages specific for the instrument in alphabetical order, and an explanation of the error situation. The positive error codes mark the errors specific of the instrument.

The device-specific error messages set bit 3 in the ESR register.



The index provides a list of the error messages sorted according to their error codes.

Device-Specific error messages

Error Code	Error	Description	Remedy
180	Adjustment failed	Adjustment could not be executed	The adjustment data have to be generated first by an internal or external adjustment or to be loaded into the device.
182	Adjustment data missing	Adjustment data are missing.	The adjustment data have to be generated first by an internal or external adjustment or to be loaded into the instrument.
183	Adjustment data invalid	Adjustment data are invalid and must be restored.	The adjustment data have to be generated again by an internal or external adjustment or to be loaded into the instrument.
200	Cannot access hardware	The data transmission to a module was unsuccessful.	The module is not installed, not properly installed or missing.
201	Hardware revision out of date	A later version of certain parts of the instrument is necessary to execute the function selected.	The driver does not support the installed version of a module.
202	Cannot access the EEPROM	An error occurs when writing or reading a EEPROM.	The EEPROM can be defective and requires replacement.
203	Invalid EEPROM data		
204	Driver initialization failed	Initialization of a driver fails when booting the instrument firmware.	The driver is not compatible with the hardware or software configuration of the instrument.
241	No current list	There is no list selected.	To execute the required operation, a list has to be selected in the related dialog. If no list is available, a new list must be created.
242	Unknown list type specified	The list type selected is not valid for the required operation. For instance, the file extension for mapping files is *.map. It is not possible to enter another file extension when selecting a list.	Check the selected list type.
460	Cannot open file	The selected file cannot be opened.	Check the path and file name.
461	Cannot write file	The file cannot be written.	Check if the file is read-only.
462	Cannot read file	The file cannot be read.	Check if the file contents are compatible with the file type.
463	Filename missing	The required operation cannot be executed because the file name is not specified.	A file name has to be entered when creating a list.
464	Invalid filename extension	The file extension is not valid for the required operation.	Check the file extension. For instance, the file extension for the mapping files is *.map. It is not possible to enter another file extension when storing a list.

Error Code	Error	Description	Remedy
465	File contains invalid data	The selected file contains data that is not valid for the file type.	Check the file extension. The file extension determines the data that is valid for this file type. If the file extension is changed, the lists are no longer recognized and the data are therefore invalid.
468	Cannot find directory	Required folder cannot be found.	Check drive and path.
469	No files found	Folder is empty	

14.5 Contacting customer support

Technical support – where and when you need it

For quick, expert help with any Rohde & Schwarz product, contact our customer support center. A team of highly qualified engineers provides support and works with you to find a solution to your query on any aspect of the operation, programming or applications of Rohde & Schwarz products.

Contact information

Contact our customer support center at www.rohde-schwarz.com/support, or follow this QR code:



Figure 14-1: QR code to the Rohde & Schwarz support page

15 Transporting

Lifting and carrying

See:

- ["Lifting and carrying the product"](#) on page 11
- [Chapter 3.1, "Lifting and carrying"](#), on page 19.

Packing

Use the original packaging material. It consists of antistatic wrap for electrostatic protection and packing material designed for the product.

If you do not have the original packaging, use similar materials that provide the same level of protection.

Securing

When moving the R&S SGU in a vehicle or using transporting equipment, make sure that the R&S SGU is properly secured. Only use items intended for securing objects.

Transport altitude

Unless otherwise specified in the data sheet, the maximum transport altitude without pressure compensation is 4500 m above sea level.

16 Maintenance, storage and disposal

The product does not require regular maintenance. It only requires occasional cleaning. It is however advisable to check the nominal data from time to time.

16.1 Cleaning

How to clean the product is described in "[Cleaning the product](#)" on page 13.

Do not use any liquids for cleaning. Cleaning agents, solvents, acids and bases can damage the front panel labeling, plastic parts and display.

16.2 Storage

Protect the product against dust. Ensure that the environmental conditions, e.g. temperature range and climatic load, meet the values specified in the data sheet.

16.3 Disposal

Rohde & Schwarz is committed to making careful, ecologically sound use of natural resources and minimizing the environmental footprint of our products. Help us by disposing of waste in a way that causes minimum environmental impact.

Disposing electrical and electronic equipment

A product that is labeled as follows cannot be disposed of in normal household waste after it has come to the end of its service life. Even disposal via the municipal collection points for waste electrical and electronic equipment is not permitted.



Figure 16-1: Labeling in line with EU directive WEEE

Rohde & Schwarz has developed a disposal concept for the eco-friendly disposal or recycling of waste material. As a manufacturer, Rohde & Schwarz completely fulfills its obligation to take back and dispose of electrical and electronic waste. Contact your local service representative to dispose of the product.

Annex

A Telnet program examples

The following program example shows a simple `TcpClient` class that is intended to explain on how to get started with programming of sockets.

The example sets up a socket communication to R&S SGU and opens a simple user interface, very similar to the telnet, which allows input of commands. To enable real automation, further development of the program is required.

TcpClient.h

```
#include <string>
//defines structs for socket handling
#include <netinet/in.h>
using namespace std;
typedef struct sockaddr_in SockAddrStruct;
typedef struct hostent      HostInfoStruct;
class TcpClient
{
public:
    TcpClient();
    ~TcpClient();
    void connectToServer( string &hostname, int port );
    void disconnect( );
    void transmit( string &txString );
    void receive( string &rxString );
    string getCurrentHostName( ) const;
    int    getCurrentPort( ) const;
private:
    string      currentHostName;
    int         currentPort;
    int         currentSocketDescr;
    SockAddrStruct  serverAddress;
    HostInfoStruct * currentHostInfo;
    bool        clientIsConnected;
    int         receiveBufferSize;
};
```

TcpClient.cpp

```
#include <string>
//defines structs for socket handling
#include <netinet/in.h>
using namespace std;
typedef struct sockaddr_in SockAddrStruct;
typedef struct hostent      HostInfoStruct;
class TcpClient
```

```

{
    public:
        TcpClient();
        ~TcpClient();
        void connectToServer( string &hostname, int port );
        void disconnect( );
        void transmit( string &txString );
        void receive( string &rxString );
        string getCurrentHostName( ) const;
        int    getCurrentPort( ) const;
    private:
        string      currentHostName;
        int         currentPort;
        int         currentSocketDescr;
        SockAddrStruct  serverAddress;
        HostInfoStruct * currentHostInfo;
        bool        clientIsConnected;
        int         receiveBufferSize;
};

#include <netdb.h>
#include <netinet/in.h>
#include <unistd.h>
#include "TcpClient.h"
TcpClient::TcpClient()
: currentHostName( "" )
, currentPort( 0 )
, currentSocketDescr( 0 )
, serverAddress ( )
, currentHostInfo( NULL )
, clientIsConnected( false )
, receiveBufferSize( 1024 )
{
}
TcpClient::~TcpClient()
{
    currentHostInfo = NULL;
}

void TcpClient::connectToServer( string &hostname, int port )
{
    currentHostInfo = gethostbyname( hostname.c_str( ) );
    if( currentHostInfo == NULL )
    {
        currentHostName = "";
        currentPort     = 0;
        currentHostInfo = NULL;
        clientIsConnected = false;
        printf("error connecting host\n" );
    }
}

```

```

currentHostName = hostname;
currentPort      = port;
currentSocketDescr = socket(AF_INET, SOCK_STREAM, 0);
if( currentSocketDescr == 0 )
{
    currentHostName = "";
    currentPort      = 0;
    currentHostInfo = NULL;
    clientIsConnected = false;
    printf("can't create socket\n" );
}
serverAddress.sin_family = currentHostInfo->h_addrtype;
serverAddress.sin_port   = htons( currentPort );
memcpy( (char *) &serverAddress.sin_addr.s_addr,
currentHostInfo->h_addr_list[0], currentHostInfo->h_length );
if( connect( currentSocketDescr, ( struct sockaddr *) &serverAddress,
sizeof( serverAddress ) ) < 0 )
{
    throw string("can't connect server\n" );
}
clientIsConnected = true;
}
void TcpClient::disconnect( )
{
    if( clientIsConnected )
    {
        close( currentSocketDescr );
    }
    currentSocketDescr = 0;
    currentHostName    = "";
    currentPort        = 0;
    currentHostInfo    = NULL;
    clientIsConnected = false;
}
void TcpClient::transmit( string &txString )
{
    if( !clientIsConnected )
    {
        throw string("connection must be established before any data can be sent\n");
    }
    char * transmitBuffer = new char[txString.length() +1];
    memcpy( transmitBuffer, txString.c_str(), txString.length() );
    transmitBuffer[txString.length()] = '\n'; //newline is needed!
    if( send( currentSocketDescr, transmitBuffer, txString.length() + 1, 0 ) < 0 )
    {
        throw string("can't transmit data\n");
    }
    delete [] transmitBuffer;
}
void TcpClient::receive( string &rxString )

```

```

{
    if( !clientIsConnected )
    {
        throw string("connection must be established before any data can be received\n");
    }
    char * receiveBuffer = new char[receiveBufferSize];
    memset( receiveBuffer, 0, receiveBufferSize );
    bool receiving = true;
    while( receiving )
    {
        int receivedByteCount = recv( currentSocketDescr,
            receiveBuffer, receiveBufferSize, 0 );
        if( receivedByteCount < 0 )
        {
            throw string("error while receiving data\n");
        }
        rxString += string( receiveBuffer );
        receiving = ( receivedByteCount == receiveBufferSize );
    }
    delete [] receiveBuffer;
}
string TcpClient::getCurrentHostName( ) const
{
    return currentHostName;
}
int TcpClient::getCurrentPort( ) const
{
    return currentPort;
}

```

TelnetClient.cpp

```

#include <iostream>
#include "TcpClient.h"
void printUsage()
{
    cout<<"usage: EthernetRawCommand <server-ip> [scpi-command]"<<endl;
}
int main( int argc, char *argv[] )
{
    int errorCode          = 0; //no error
    bool useSingleCommand = false;
    string singleCommand  = "";
    string hostname       = "";
    int    port           = 5025;
    string input          = "";
    TcpClient client;
    switch( argc )
    {
        case 3:

```



```

        useSingleCommand = true;
        singleCommand    = argv[2];
    case 2:
        hostname         = argv[1];
        break;
    default:
        printUsage();
        return(-1);
    }
    try
    {
        client.connectToServer( hostname, port );
        bool terminate = false;
        while( !terminate )
        {
            char buffer[1024];
            if( useSingleCommand )
            {
                input = singleCommand; //send string
            }
            else
            {
                cin.getline( buffer, 1024 );
                input = buffer;
                if( input == "end" )
                {
                    terminate = true;
                }
            }
            if( !terminate)
            {
                client.transmit( input ); //send string
                int qPos = input.find( "?", 0 );
                //receive string only when needed
                if( qPos > 0 )
                {
                    string rcStr = "";
                    client.receive( rcStr );
                    cout << rcStr << endl;
                }
            }
            if( useSingleCommand )
            {
                terminate = true;
            }
        }
    }catch( const string errorString )
    {
        cout<<errorString<<endl;
    }
}

```

```
client.disconnect( );  
return errorCode;  
}
```

Index

Symbols

/var directory	183
180 - Adjustment failed	225
182 - Adjustment data missing	225
183 - Adjustment data invalid	225
200 - Cannot access hardware	225
201 - Hardware revision out of date	225
202 - Cannot access the EEPROM	225
203 - Invalid EEPROM data	225
204 - Driver initialization failed	225
241 - No current list	225
242 - Unknown list type specified	225
460 - Cannot open file	225
461 - Cannot write file	225
462 - Cannot read file	225
463 - Filename missing	225
464 - Invalid filename extension	225
465 - File contains invalid data	226
468 - Cannot find directory	226
469 - No files found	226

A

AC power supply	
Connector	37
Accept	
Security settings	113
Advanced configuration	
LXI	157
Application cards	17
Application notes	17
Apply network settings	116
AttFixed	223

B

Bench top, placing	20
Brochures	17

C

Carrying the instrument	19
Change password	112, 113
Checking the instrument	19
Cleaning	228
Clear status	
Remote	169
Command sequence	
Remote	173
Computer name	114
Changing	125
CONDition	150
Configure instruments	
Available instruments	61
Clear instrument list	62
Delete instrument	62
Edit instrument	62
Export instrument mapping	62
Hostname prefix	63
IP address	63
New instrument	62
Prefix length	63

Scan	62
Scan subnet	63
Confirm external LO settings	103
Confirm password	112
Connecting	
LAN	23
Power	22
RF	23, 24
Connector	
AC power supply	37
I	38
LAN	38
LO IN	38
LO OUT	38
PCIe	38
Q	38
RF 50Ω	38
TRIG	38
USB In	38
Connector mode	102, 103
Connectors	37
Crest factor	72, 98
Customer support	226

D

Data sheets	17
Default instrument settings	26
Default values	
Remote	172
Delete instrument settings	189
Detector sensitivity	
ALC	95
Device identify	65, 117
DHCP	31
Displaying	
All messages	80
Disposal	228
Documentation overview	16

E

Eco mode	
Activating	118
Enable	
LAN connection	113
LAN interface	113
ENABle	150
Enable registers	
Remote	171
Error	
Key	36
Error message	
Query interrupted	160
Resource locked	160
Error messages	223
Adjustment data invalid (183)	225
Adjustment data missing (182)	225
Adjustment failed (180)	225
Cannot access hardware (200)	225
Cannot access the EEPROM (202)	225
Cannot open file (460)	225
Cannot read file (462)	225

Cannot write file (461)	225
Driver initialization failed (204)	225
Driver invalid EEPROM data (203)	225
File cannot find directory (468)	226
File contains invalid data (465)	226
Filename missing (463)	225
Hardware revision out of date (201)	225
Invalid filename extension (464)	225
No current list (241)	225
No files found (469)	226
SCPI	224
Unknown list type specified (242)	225
Error messages - display list	210
Error queue	151
Error queue query	208, 209, 210
ESE (event status enable register)	152
ESR	148
ESR (event status register)	152
EVENT	150
Event status enable register (ESE)	152
Remote	169
Event status register (ESR)	152
Remote	170
Expiration date of option	108
Extension mode	
Higher frequency	120
External controller	27
External devices	27
F	
Factory preset	117
Factory recovery	
See service manual	127
Fast settings	140, 145
File	
Exit	59
Menu	59
New	59
Open	59
Save	59
Save as	59
File list	186
Firmware update	
Several instruments	125
Firmware version	108
Floating licenses	108
Frequency	72, 89
Limit to 6GHz	118
Frequency range extension	120
Functional checks	25
G	
Gain	
impairment	96
Gain imbalance	96
Gateway	116
Getting started	16
GPIB	129
Characteristics	137
H	
Hardware	
Requirements	28
Hardware options	107
Help	16
HiSLIP	129
Protocol	134
Resource string	133
History	80
Hostname	114
Changing	125
Default	77
I	
I offset	97
I/Q	
Connectors	38
I/Q impairments	96
I/Q modulation	72, 98
Crest factor	98
ID	
Key	37
Identification	
Remote	170
Imbalance	100
Impairment	96
Input	
Pulse polarity	101
Input connector	38
Input/Output connector	38
Install FW	125
Install SW-Option	109
Installed assembly	106
Installing	
PC, CPU, VGA	28
R&S SGMA-GUI	28
Requirements	28
Software	28
Uninstalling the old version	28
Update	28
Instrument	
Carrying	19
Checking	19
Lifting	19
Operating site	19, 20
Unpacking	19
Instrument control	47
Instrument help	16
Instrument name	72
Instrument security procedures	16
Instrument settings	
Recall	171, 189
Save	172, 191
Interfaces	
GPIB	137
USB	136
Interrupt	153
IP address	72, 115, 133
Changing	31
IP address mode	115
IP configuration	
LXI	157
IST	148
IST flag	
Remote	170

K

Key	
ID	37
LAN	36
POWER ON/STANDBY	35
RF ON	35

L

LAN	
Configuration	30
Connecting	23
Connector	38
Environment	23
Interface	133
IP address	133
Key	36
Reset	156
VXI protocol	135
LAN configuration	
LXI	157
LAN connection	
Enable	113
Reset address mode	115
LAN interface	
Enable	113
LED	
ERROR / WARNING	36
LO IN	36
Level	
RF output	72, 90
Level limit	92
Level offset	72, 90
Level range	
RF output	92
License for software option	108
Lifting the instrument	19
Linux	27
LO IN	
Connector	38
Key	36
LO OUT	
Connector	38
Load instrument settings	171, 189
Loaded modules	108
Local oscillator	
Connector	36
Frequency	103
Level	103
Lost LAN connection to an instrument	115
LucasFonts	
RSCorpid EULA	108
LXI	
Advanced configuration	157
configuration	155
IP configuration	157
LAN configuration	157
Ping	158
Remote trace (SCPI)	158
Reset (LCI)	156

M

Maintenance	228
-------------------	-----

Message	68
Additional information	80
All messages	80
Brief	80
Deleting	80
Deleting all	80
Deleting brief	80
Displaying	80
Error	80
Message level	68
Mode	
RF level	91
TRIG connector	102, 103
Mode IP address	115
Monitoring	
Collisions	160
Same remote channel	160
Mounting, in a rack	21

N

Network	
Environment	23
Network settings	113
New instrument	
Scan	75
Search	75
New password	112
NTRansition	150
Number of licenses	108

O

Offset	91, 100
Old password	112
Online help	
Working with	48
Open source acknowledgment	17
Open-source acknowledgments	67, 108
Operating site	
Choosing	19
Setting up the instrument	20
Operating system	27
Operation complete	
Remote	170
Option	
Hardware	107
R&S SGU-B120V/-B140V	38
Software	107
Option key	109
Options	
Identification (remote)	171
OSA	17
Output connector	38
Output queue	148

P

Parallel poll register enable	
Remote	171
PCIe	
Connecting	33
Connector	38
PEP	72
Ping	
LXI	158
Placing, on a bench top	20

- Polarity
 - Pulse modulation 101
- Power
 - Connecting the instrument 22
- POWER ON/STANDBY
 - Key 35
- PPE 148
- Preset instrument settings 26, 104
- Protection 109
- Protocol
 - VXI 135
- PTRransition 150

- Q**
- Q offset 97
- Quadrature offset 98, 100
- Queries
 - Status 154
- Questionable status register 152, 153

- R**
- Rack, mounting 21
- Readjust 92
- Ready state 26
- Recall instrument settings 171, 189
- Recall intermediate 171
- Reducing power consumption 118
- Registers 148
- Release notes 17
- Remote control
 - Connect 129
 - Programming examples 81, 163
- Remote trace
 - LXI 158
- Rename
 - File 190
- Reset instrument settings 26
- Reset values
 - Remote 172
- Resource string
 - VISA 133
- Resource strings 116
- Restart 123
- Restart network 114
- RF 50Ω
 - Connector 38
- RF frequency 89
- RF level 90
 - Mode 91
- RF ON
 - Key 35
- RF output level 72, 90

- S**
- Safety instructions 11, 17
- Save instrument settings 172, 191
- Save intermediate 172
- SCPI
 - Error messages 224
 - Version 130
- SCPI remote trace
 - LXI 158
- Searching a new instrument 75

- Security
 - USB device (setup) 113
 - USB storage (setup) 113
- Security password 113
- Security settings
 - Accept 113
 - Change password 112, 113
 - Confirm password 112
 - New password 112
 - Old password 112
 - Security password 113
 - User name 112
- Service manual 16
- Service request (SRQ) 151, 153
- Service request enable register (SRE) 151
 - Remote 172
- Setup
 - Configure instruments 60
 - USB device (security) 113
 - USB storage (security) 113
- Socket 129
- Software
 - Requirements 28
 - VISA driver 28
- Software options 107
- SRE 148
- SRE (service request enable register) 151
- SRQ (service request) 151, 153
- Standby 26, 123
- State
 - ALC 95
 - I/Q modulation 72, 98
 - Impairments 99
 - Pulse modulation 101
- Static IP address
 - Lost connection 115
- Status
 - Queries 154
- Status byte
 - Remote 169, 172
- Status byte (STB) 151
- Status messages
 - AttFixed 223
- Status registers 148
 - CONDition 150
 - ENABle 150
 - EVENT 150
 - Model 149
 - NTRansition 150
 - Parts 149
 - PTRansition 150
- Status reporting system 147
 - Application 153
 - Common commands 169
- STB 148
- Storage 228
- Subnet mask 115
- Switching
 - On or off 25
- System directory 183

- T**
- Telnet 129
- TRIG connector
 - Signal 102, 103

Trigger	
Connector	38
Event (remote)	172
Trigger connector mode	102, 103

U

Unpacking the instrument	19
Update package	
Error	127
Updating R&S SGMA-GUI	28
Upgrading software	
Version 5.00.vvv.vv and later	29
USB	
Connecting	33
Interfaces	136
Storage (security)	113
USB In	
Connector	38
USB install	
See service manual	127
USB recovery	
See service manual	127
User manual	16
User name	112

V

VISA	129
HiSLIP string	116
LAN string	116
PCIe string	116
Resource string	133
Serial string	116
USB string	116
VXI protocol	135
VXI-11	129

W

Wait	
Remote	173
Warnings	223
White papers	17

Z

Zeroconf (APIA) protocol	31
--------------------------------	----