

R&S®LCX Series LCR Meter User Manual



1179226002
Version 05

ROHDE & SCHWARZ
Make ideas real



This manual describes the instruments of the R&S®LCX Series, including options and measurement accessories:

- R&S®LCX100 LCR Meter(3629.8856.02)
- R&S®LCX200 LCR Meter (3629.8856.03)
- R&S®NG-B105 Option IEE 488 (GPIB) interface (5601.6000.02)
- R&S®LCX-K106 Option advanced analysis (3630.1922.03)
- R&S®LCX-K107 Option digital I/O ports and binning (3660.7741.03)
- R&S®LCX-K108 Option extended bias (3692.9791.03)
- R&S®LCX-K201 Option frequency upgrade 1 MHz (3630.1880.03)
- R&S®LCX-K210 Option frequency upgrade 10 MHz (3630.1900.03)
- R&S®LCX-Z1 Accessory test fixture for axial/radial lead type components (3639.2296.02)
- R&S®LCX-Z2 Accessory Kelvin clip lead (3638.6446.02)
- R&S®LCX-Z3 Accessory test fixture for SMD components (3639.2509.02)
- R&S®LCX-Z4 Accessory test tweezers for SMD components (3639.2515.02)
- R&S®LCX-Z5 Accessory transformer test cables (3639.2521.02)
- R&S®LCX-Z11 Accessory BNC-to-BNC extension (1m) (3639.2538.02)

© 2023 Rohde & Schwarz GmbH & Co. KG
Muehldorfstr. 15, 81671 Muenchen, Germany
Phone: +49 89 41 29 - 0
Email: info@rohde-schwarz.com
Internet: www.rohde-schwarz.com

Subject to change – data without tolerance limits is not binding.

R&S® is a registered trademark of Rohde & Schwarz GmbH & Co. KG.

All other trademarks are the properties of their respective owners.

1179.2260.02 | Version 05 | R&S®LCX Series

Throughout this manual, products from Rohde & Schwarz are indicated without the ® symbol, and the instruments of the R&S®LCX series are abbreviated as R&S LCX. For example, R&S®LCX200 is indicated as R&S LCX.

Contents

1	Safety and regulatory information.....	9
1.1	Safety instructions.....	9
1.2	Labels on the R&S LCX.....	11
1.3	Warning messages in the documentation.....	12
1.4	Korea certification class A.....	12
2	Welcome.....	13
2.1	Key features.....	13
3	Documentation overview.....	14
3.1	Getting started manual.....	14
3.2	User manual.....	14
3.3	Tutorials.....	14
3.4	Service manual.....	14
3.5	Instrument security procedures.....	14
3.6	Printed safety instructions.....	15
3.7	Data sheets and brochures.....	15
3.8	Release notes and open-source acknowledgment (OSA).....	15
3.9	Application notes, application cards, white papers, etc.....	15
3.10	Remote control driver.....	15
4	Getting started.....	16
4.1	Preparing for use.....	16
4.1.1	Lifting and carrying.....	16
4.1.2	Unpacking and checking.....	16
4.1.3	Choosing the operating site.....	16
4.1.4	Setting up the R&S LCX.....	17
4.1.5	Considerations for test setup.....	18
4.1.6	Connecting to power.....	19
4.1.7	Connecting to LAN.....	21
4.1.8	Connecting USB devices.....	22
4.1.9	Connecting a test fixture.....	23
4.1.10	Switching on or off.....	25

4.2 Instrument tour.....	25
4.2.1 Front panel tour.....	26
4.2.2 Rear panel tour.....	29
4.3 Trying out the instrument.....	32
4.4 Instrument control.....	35
4.4.1 Ways to operate the instrument.....	35
4.4.2 Means of manual interaction.....	35
4.4.3 Remote control.....	46
5 Measurement basics.....	47
5.1 Impedance measurement parameters in general.....	47
5.2 Impedance measurement parameters of the R&S LCX.....	48
5.3 Considerations on measurement accuracy.....	50
6 Measurement setups.....	52
6.1 About test fixtures.....	52
6.1.1 Test fixture for axial/radial lead type components.....	52
6.1.2 Kelvin clip lead.....	53
6.1.3 Test fixture for SMD components.....	54
6.1.4 Test tweezers for SMD components.....	55
6.1.5 Test fixture with cables for transformer components.....	56
6.1.6 BNC-to-BNC extension.....	57
6.2 Configuring the test signal.....	58
6.3 Configuring BIAS.....	60
6.3.1 Internal bias voltage.....	60
6.3.2 External voltage bias.....	61
6.3.3 Current bias.....	62
7 Performing measurements.....	64
8 Instrument functions.....	69
8.1 Measurement mode.....	69
8.1.1 Measurement mode settings.....	69
8.1.2 Working with the measurement modes.....	70
8.2 Display mode.....	71
8.2.1 Display mode settings.....	71

8.2.2	Configuring the main view.....	72
8.3	Measurement functions.....	73
8.4	Test signal functions.....	73
8.4.1	Test signal settings.....	73
8.5	Measurement control functions.....	75
8.6	Measurement parameters.....	75
8.6.1	Measurement parameter settings.....	77
8.6.2	Open/short/load correction settings.....	80
8.6.3	Performing open/short/load correction.....	83
8.7	Configuration preset.....	86
8.7.1	Configuration preset settings.....	87
8.7.2	Using the configuration preset function.....	88
8.8	Specific instrument functions.....	89
8.8.1	Live chart viewer.....	89
8.8.2	Logging chart viewer.....	93
8.8.3	Logging.....	97
8.8.4	Dynamic impedance measurement.....	102
8.8.5	Binning.....	106
9	General instrument settings.....	115
9.1	File and data management.....	116
9.1.1	File manager settings.....	117
9.1.2	Using the file manager.....	118
9.1.3	Data and file types.....	120
9.2	Interfaces.....	120
9.2.1	Interface settings.....	121
9.2.2	Configuring interfaces.....	122
9.3	User button.....	122
9.3.1	User button settings.....	122
9.3.2	Using the user button function.....	123
9.4	Screenshot.....	123
9.4.1	Screenshot settings.....	124
9.4.2	Using the screenshot function.....	124
9.5	CSV settings.....	126

9.5.1	Settings for CSV data.....	126
9.5.2	Configuring CSV data.....	127
9.6	Date & time.....	127
9.7	Appearance.....	128
9.8	Sound.....	129
9.9	Licenses.....	130
9.9.1	Licenses settings.....	130
9.9.2	Managing licenses.....	131
9.10	Device information.....	133
9.10.1	Device information settings.....	133
9.10.2	Using the dump file function.....	134
9.11	Update device.....	135
9.11.1	Update device settings.....	135
9.11.2	Updating the instrument software.....	136
9.12	Save/recall.....	137
9.12.1	Save/recall settings.....	137
9.12.2	Using the save/recall function.....	138
9.13	Customizing general instrument settings.....	140
10	Network operation and remote control.....	144
10.1	Overview of remote access modes.....	145
10.2	Remote control interfaces and protocols.....	146
10.2.1	LAN interface.....	147
10.2.2	USB interface.....	149
10.2.3	GPIB interface (IEC/IEEE bus interface).....	150
10.2.4	Status reporting system.....	151
10.3	Remote access settings.....	154
10.3.1	Network settings.....	154
10.3.2	LAN settings.....	156
10.3.3	VNC settings.....	158
10.3.4	FTP settings.....	159
10.3.5	USB settings.....	161
10.3.6	GPIB settings.....	162
10.4	Connecting the R&S LCX for remote access.....	162

10.5	Adjusting interface addresses.....	164
10.6	Operating the R&S LCX remotely.....	168
10.6.1	Controlling the R&S LCX over LAN.....	169
10.6.2	Accessing the file system of the R&S LCX using FTP.....	172
11	Remote control commands.....	176
11.1	Conventions used in SCPI command description.....	176
11.2	Programming examples.....	177
11.3	Common commands.....	177
11.4	Test signal commands.....	180
11.5	BIAS subsystem.....	183
11.6	CORRection subsystem.....	185
11.7	DATA subsystem.....	190
11.8	DIMeasure subsystem.....	191
11.9	DISPLay subsystem.....	195
11.10	FUNcTion subsystem.....	197
11.11	HANDler subsystem.....	201
11.12	HCOPy subsystem.....	203
11.13	LOG subsystem.....	205
11.14	Measurement commands.....	209
11.15	STATus subsystem.....	213
11.15.1	Status operation register.....	213
11.15.2	Status questionable register.....	215
11.16	SYSTem subsystem.....	216
12	Troubleshooting.....	227
12.1	Displaying status information.....	227
12.2	Problems during firmware update.....	227
12.3	Cannot establish a LAN connection.....	228
12.4	Contacting customer support.....	228
13	Transporting.....	229
14	Maintenance, storage and disposal.....	230
14.1	Cleaning.....	230
14.2	Changing fuses.....	230

14.3 Storage.....230

14.4 Disposal..... 230

Glossary: List of the often used terms and abbreviations.....232

List of commands..... 235

Index.....238

1 Safety and regulatory information

The product documentation helps you use the product safely and efficiently. Follow the instructions provided here and in the following chapters.

Intended use

The product is intended for the development, production and verification of electronic components and devices in industrial, administrative, and laboratory environments. Use the product only for its designated purpose. Observe the operating conditions and performance limits stated in the data sheet.

Where do I find safety information?

Safety information is part of the product documentation. It warns you of potential dangers and gives instructions on how to prevent personal injury or damage caused by dangerous situations. Safety information is provided as follows:

- In [Chapter 1.1, "Safety instructions"](#), on page 9. The same information is provided in many languages as printed "Safety Instructions". The printed "Safety Instructions" are delivered with the product.
- Throughout the documentation, safety instructions are provided when you need to take care during setup or operation.

1.1 Safety instructions

Products from the Rohde & Schwarz group of companies are manufactured according to the highest technical standards. To use the products safely, follow the instructions provided here and in the product documentation. Keep the product documentation nearby and offer it to other users.

Use the product only for its intended use and within its performance limits. Intended use and limits are described in the product documentation such as the data sheet, manuals and the printed "Safety Instructions". If you are unsure about the appropriate use, contact Rohde & Schwarz customer service.

Using the product requires specialists or specially trained personnel. These users also need sound knowledge of at least one of the languages in which the user interfaces and the product documentation are available.

Reconfigure or adjust the product only as described in the product documentation or the data sheet. Any other modifications can affect safety and are not permitted.

Never open the casing of the product. Only service personnel authorized by Rohde & Schwarz are allowed to repair the product. If any part of the product is damaged or broken, stop using the product. Contact Rohde & Schwarz customer service at <https://www.rohde-schwarz.com/support>.

Lifting and carrying the product

The maximum weight of the product is provided in the data sheet. You can lift or carry the product by yourself, if you can manage the weight on your own. Alternatively, you can use lifting or transporting equipment. Follow the instructions provided by the equipment manufacturer.

Choosing the operating site

Only use the product indoors. The product casing is not waterproof. Water that enters can electrically connect the casing with live parts, which can lead to electric shock, serious personal injury or death if you touch the casing. If Rohde & Schwarz provides accessories designed for your product, e.g. a carrying bag, you can use the product outdoors.

Unless otherwise specified, you can operate the product up to an altitude of 2000 m above sea level. The product is suitable for pollution degree 2 environments where nonconductive contamination can occur. For more information on environmental conditions such as ambient temperature and humidity, see the data sheet.

Setting up the product

Always place the product on a stable, flat and level surface with the bottom of the product facing down. If the product is designed for different positions, secure the product so that it cannot fall over.

If the product has foldable feet, always fold the feet completely in or out to ensure stability. The feet can collapse if they are not folded out completely or if the product is moved without lifting it. The foldable feet are designed to carry the weight of the product, but not an extra load.

If stacking is possible, keep in mind that a stack of products can fall over and cause injury.

If you mount products in a rack, ensure that the rack has sufficient load capacity and stability. Observe the specifications of the rack manufacturer. Always install the products from the bottom shelf to the top shelf so that the rack stands securely. Secure the product so that it cannot fall off the rack.

Connecting to power

The product is an overvoltage category II product. Connect the product to a fixed installation used to supply energy-consuming equipment such as household appliances and similar loads. Keep in mind that electrically powered products have risks, such as electric shock, fire, personal injury or even death. Replace parts that are relevant to safety only by original parts, e.g. power cables or fuses.

Take the following measures for your safety:

- Before switching on the product, ensure that the voltage and frequency indicated on the product match the available power source. If the power adapter does not adjust automatically, set the correct value and check the rating of the fuse.
- If a product has an exchangeable fuse, its type and characteristics are indicated next to the fuse holder. Before changing the fuse, switch off the product and dis-

connect it from the power source. How to change the fuse is described in the product documentation.





- Only use the power cable delivered with the product. It complies with country-specific safety requirements. Only insert the plug into an outlet with protective conductor terminal.
- Only use intact cables and route them carefully so that they cannot be damaged. Check the power cables regularly to ensure that they are undamaged. Also ensure that nobody can trip over loose cables.
- If you connect the product to an external power supply, use the one delivered with the product or recommended in the product documentation. The external power supply must conform to the country-specific regulations.
- Only connect the product to a power source with a fuse protection of maximum 20 A.
- Ensure that you can disconnect the product from the power source at any time. Pull the power plug to disconnect the product. The power plug must be easily accessible. If the product is integrated into a system that does not meet these requirements, provide an easily accessible circuit breaker at the system level.

Cleaning the product

Use a dry, lint-free cloth to clean the product. When cleaning, keep in mind that the casing is not waterproof. Do not use liquid cleaning agents.

Meaning of safety labels

Safety labels on the product warn against potential hazards.





	<p>Potential hazard</p> <p>Read the product documentation to avoid personal injury or product damage.</p>
	<p>Electrical hazard</p> <p>Indicates live parts. Risk of electric shock, fire, personal injury or even death.</p>
	<p>Hot surface</p> <p>Do not touch. Risk of skin burns. Risk of fire.</p>
	<p>Protective conductor terminal</p> <p>Connect this terminal to a grounded external conductor or to protective ground. This connection protects you against electric shock if an electric problem occurs.</p>

1.2 Labels on the R&S LCX

Labels on the casing inform about:

- Personal safety, see "[Meaning of safety labels](#)" on page 11.
- Product and environment safety, see [Table 1-1](#).

Table 1-1: Labels regarding R&S LCX and environment safety

	Labeling in line with EN 50419 for disposal of electrical and electronic equipment after the product has come to the end of its service life. For more information, see " Disposing of electrical and electronic equipment " on page 231.
	Grounding connection
	Chassis grounding connection
	Noiseless ground. The input signal at these connectors must be free from external voltages. The measurement results are otherwise incorrect.

1.3 Warning messages in the documentation

A warning message points out a risk or danger that you need to be aware of. The signal word indicates the severity of the safety hazard and how likely it will occur if you do not follow the safety precautions.

WARNING

Potentially hazardous situation. Could result in death or serious injury if not avoided.

CAUTION

Potentially hazardous situation. Could result in minor or moderate injury if not avoided.

NOTICE

Potential risks of damage. Could result in damage to the supported product or to other property.

1.4 Korea certification class A



이 기기는 업무용(A급) 전자파 적합기기로서 판매자 또는 사용자는 이 점을 주의하시기 바라며, 가정외의 지역에서 사용하는 것을 목적으로 합니다.

2 Welcome

2.1 Key features

The R&S LCX LCR Meter sets standards in analyzing passive components. It provides the full range of measurements to characterize resistors, capacitors and inductors, and displays results as absolute, relative or average values.

Outstanding key features are:

- Frequency range: 4 kHz to 300 kHz (R&S LCX100), and up to 10 MHz (R&S LCX200)
- Measurement functions: L, C, R, |Z|, X, |Y|, G, B, D, Q, Φ , Δ , M, N
- Basic accuracy: 0.05 %
- Continuous, manual or external control via interface, binning interface or trigger
- Digital I/O ports and binning function for automatic sorting of components (option R&S LCX-K107)
- LAN, USB interface for remote control, optionally IEEE-488 (GPIB) bus interface (option R&S NG-B105)

For details on the specification, see the data sheet.

3 Documentation overview

This section provides an overview of the R&S LCX user documentation. Unless specified otherwise, you find the documents at:

www.rohde-schwarz.com/manual/lcx

3.1 Getting started manual

Introduces the R&S LCX and describes how to set up and start working with the product. Includes basic operations, typical measurement examples, and general information, e.g. safety instructions, etc. A printed version is delivered with the instrument.

3.2 User manual

The user manual contains the description of all instrument modes and functions. It also provides an introduction to remote control, a complete description of the remote control commands with programming examples, and information on maintenance, instrument interfaces and error messages. Includes the contents of the getting started manual.

The user manual is also available for download or for immediate display on the Internet.

3.3 Tutorials

Tutorials offer guided examples and demonstrations on operating the R&S LCX. They are provided on the product page of the internet.

3.4 Service manual

Describes the performance test for checking compliance with rated specifications, firmware update and maintenance.

The service manual is available for registered users on the global Rohde & Schwarz information system (GLORIS): <https://gloris.rohde-schwarz.com>

3.5 Instrument security procedures

Deals with security issues when working with the R&S LCX in secure areas. It is available for download on the internet.

3.6 Printed safety instructions

Provides safety information in many languages. The printed document is delivered with the product.

3.7 Data sheets and brochures

The data sheet contains the technical specifications of the R&S LCX. It also lists the firmware applications and their order numbers, and optional accessories.

The brochure provides an overview of the instrument and deals with the specific characteristics.

See www.rohde-schwarz.com/brochure-datasheet/lcx

3.8 Release notes and open-source acknowledgment (OSA)

The release notes list new features, improvements and known issues of the current firmware version, and describe the firmware installation.

The software makes use of several valuable open source software packages. An open-source acknowledgment document provides verbatim license texts of the used open source software.

See www.rohde-schwarz.com/firmware/lcx

3.9 Application notes, application cards, white papers, etc.

These documents deal with special applications or background information on particular topics.

See www.rohde-schwarz.com/application/lcx

3.10 Remote control driver

The instrument drivers enable remote control via the corresponding interfaces. The drivers and installation instructions are available for download on the product page at www.rohde-schwarz.com/driver/lcx.

4 Getting started

This chapter contains the same information as the getting started manual.

4.1 Preparing for use

Here, you can find basic information about setting up the product for the first time.

4.1.1 Lifting and carrying

See "[Lifting and carrying the product](#)" on page 10.

4.1.2 Unpacking and checking

1. Unpack the R&S LCX carefully.
2. Retain the original packing material. Use it when transporting or shipping the R&S LCX later.
3. Using the delivery notes, check the equipment for completeness.
4. Check the equipment for damage.

If the delivery is incomplete or equipment is damaged, contact Rohde & Schwarz.

See also: [Chapter 13, "Transporting"](#), on page 229.

4.1.3 Choosing the operating site

Specific operating conditions ensure proper operation and avoid damage to the product and connected devices. For information on environmental conditions such as ambient temperature and humidity, see the data sheet.

See also "[Choosing the operating site](#)" on page 10.

Electromagnetic compatibility classes

The electromagnetic compatibility (EMC) class indicates where you can operate the product. The EMC class of the product is given in the data sheet.

- Class B equipment is suitable for use in:
 - Residential environments
 - Environments that are directly connected to a low-voltage supply network that supplies residential buildings

- Class A equipment is intended for use in industrial environments. It can cause radio disturbances in residential environments due to possible conducted and radiated disturbances. It is therefore not suitable for class B environments. If class A equipment causes radio disturbances, take appropriate measures to eliminate them.

4.1.4 Setting up the R&S LCX

See also:

- ["Setting up the product"](#) on page 10
- ["Intended use"](#) on page 9

4.1.4.1 Placing the R&S LCX on a bench top

To place the product on a bench top

1. Place the product on a stable, flat and level surface. Ensure that the surface can support the weight of the product. For information on the weight, see the data sheet.
2. **CAUTION!** Foldable feet can collapse. See ["Setting up the product"](#) on page 10. Always fold the feet completely in or out. With folded-out feet, do not place anything on top or underneath the product.
3. **WARNING!** A stack of products can fall over and cause injury. Never stack more than three products on top of each other. Instead, mount them in a rack.

Stack as follows:

- If the products have foldable feet, fold them in completely.
- All products must have the same dimensions (width and length).
- Do not exceed a total load of 50 kg placed on the product at the bottom of the stack.

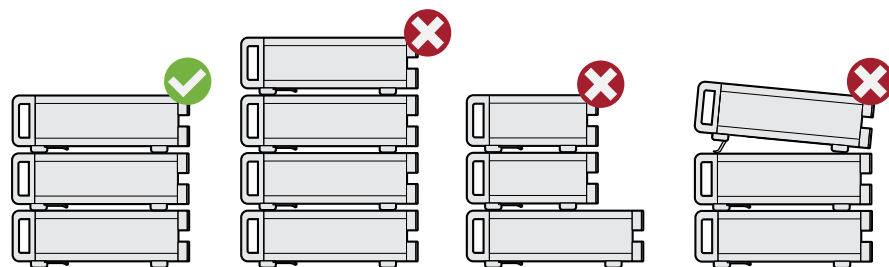

- Left = Stacked correctly
 Middle left = Stacked incorrectly, too many products
 Middle right = Stacked incorrectly, different dimensions
 Right = Stacked incorrectly, folded-out feet

4. **NOTICE!** Overheating can damage the product.
Prevent overheating as follows:

- Keep a minimum distance of 10 cm between the fan openings of the product and any object in the vicinity to provide sufficient airflow and ventilation.
- Do not place the product next to heat-generating equipment such as radiators or other products.

4.1.4.2 Mounting the R&S LCX in a rack

To prepare the rack

1. Observe the requirements and instructions in "[Setting up the product](#)" on page 10.
2. **NOTICE!** Insufficient airflow can cause overheating and damage the product. Design and implement an efficient ventilation concept for the rack.

Mounting the R&S LCX in a rack

To mount the R&S LCX in a rack:

1. Use an adapter kit that fits the dimensions of the R&S LCX to prepare the R&S LCX for rack mounting.
 - a) Order the rack adapter kit designed for the R&S LCX. For the order number, see the data sheet.
 - b) Mount the adapter kit. Follow the assembly instructions provided with the adapter kit.
2. Lift the R&S LCX to shelf height.
3. Push the R&S LCX onto the shelf until the rack brackets fit closely to the rack.
4. Tighten all screws at the rack brackets with a tightening torque of 1.2 Nm to secure the R&S LCX at the rack.

Unmounting the R&S LCX from a rack

To unmount the R&S LCX from a rack:

1. Loosen the screws at the rack brackets.
2. Bring the lifting equipment to shelf height.
3. Remove the R&S LCX from the rack.
4. If placing the R&S LCX on a bench top again, unmount the adapter kit from the R&S LCX. Follow the instructions provided with the adapter kit.

4.1.5 Considerations for test setup

Cable selection and electromagnetic interference (EMI)

Electromagnetic interference (EMI) can affect the measurement results.

To suppress electromagnetic radiation during operation:

- Use high-quality shielded cables, especially for the following connector types:
 - Connectors for external devices
Double-shielded data cables. The length of data cables must not exceed 3 m.
 - Connectors for signal transmission
Shielded coaxial cables. The length of signal cables must not exceed 1 m.
We recommend that you use the R&S LCX-Z11 BNC-to-BNC extension (1 m) from Rohde & Schwarz.
 - BNC
Double-shielded BNC cables.
 - USB
Double-shielded USB cables. The length of passive USB cables must not exceed 1 m.
 - LAN
At least CAT6+ cables
 - IEEE-488 (GPIB)
Double-shielded cables. We recommend that you use the double-shielded cable "R&S HZ72" from Rohde & Schwarz.
- Always terminate open cable ends.
- Ensure that connected external devices comply with EMC regulations.

Signal input and output levels

Information on signal levels is provided in the data sheet. Keep the signal levels within the specified ranges to avoid damage to the product and connected devices.

4.1.6 Connecting to power

For safety information, see "[Connecting to power](#)" on page 10.



When using the R&S LCX the first time, you can skip [Replacing the external bias fuse](#) and [Replacing the line fuse](#).

If there are any problems during power-on or malfunction of the bias, check the condition of the mains fuse. Also check the fuse for the external bias input as described in these instructions. They explain how to check and change the protective fuses, if necessary.

Replacing the external bias fuse

The bias voltage input of the R&S LCX is protected by a fuse of type IEC 60127-2/5-F0.5L/250V (order no. 0009.5463.00). The externally accessible fuse is at the [rear panel](#).

To check and exchange the external bias fuse:

1. **NOTICE!** Risk of instrument damage. Malfunction of the fuse that protects the bias voltage input from overload can damage the circuitry of the instrument.

Do not use either fuse type other than specified, nor a defective fuse, and never short-circuit the fuse.

Make sure that you have disconnected the R&S LCX from the mains.

2. Check the condition of the external bias fuse.
3. If necessary, install the fuse type required for the external bias voltage.
 - a) Unscrew the fuse holder with a suitable screwdriver.
 - b) Pull out the fuse holder.
 - c) Replace the fuse by a fuse of the specified type.
 - d) Insert the fuse holder into the external bias inlet.

When inserting the fuse holder, press it slightly and tighten it.

Replacing the line fuse

The product is protected by one fuse of type IEC 60127-2/5-T2.0H/250V (order no. 0020.7546.00). The externally accessible fuse is part of the IEC socket of the power supply at the [rear panel](#).

To exchange the line fuse:

1. Check the available supply voltage.

The mains voltage must be within the voltage range as denoted on the instrument. The label is at the [rear panel](#), on the left of the "AC power" connector and power switch.

The power supply module covers a wide power supply range and normally does not require adjustment.
2. If the power supply exceeds the permissible range, contact Rohde & Schwarz customer service.
3. **WARNING!** The fuse is part of the main power supply. Handling the fuse while the power is on can lead to electric shock.

If necessary, exchange the fuse required for the supply voltage.
4. Before changing the fuse:
 - a) Set the switch on the power supply to position [0].
 - b) Disconnect the R&S LCX from the power source.
5. Replace the line fuse.
 - a) Unplug the power cable.
 - b) Press the plastic lock on the bottom of the fuse holder inwards using a screwdriver (with a blade width of approximately 2 mm).

A narrow guide on the bottom of the fuse holder denotes the insertion point. When unlocking the mechanism, compression springs automatically push the fuse holder outwards.
 - c) Pull out the fuse holder.
 - d) Check the condition of the fuse.

- e) Replace the fuse by a fuse of the specified type.
A label next to the fuse holder also indicates the fuse type and its characteristics.
- f) **Note:** The protruding contact springs must not be deformed. Align the fuse holder with the guide bar facing the socket.
Carefully slide the fuse holder against the spring pressure into the slot until the plastic lock latches.

Connecting to power

To connect the instrument to the mains:

1. Check the available supply voltage.
The mains voltage must be within the voltage range as denoted on the instrument. The label is at the [rear panel](#), on the left of the "AC power" connector and power switch.
The power supply module covers a wide power supply range and normally does not require adjustment.
2. If the power supply exceeds the permissible range, contact Rohde & Schwarz customer service.
3. If necessary, ground the instrument using the grounding connection \perp .
A ground connector socket is at the [front panel](#) to connect a ground cable with a banana plug.
As an alternative, a ground terminal at the [rear panel](#) enables you to connect a ground cable firmly with a screw:
 - a) At the [rear panel](#), unscrew the screw of the ground terminal using a cross-recess screw driver.
 - b) Attach a ground cable with a ring terminal and pass the screw through it.
 - c) Fasten the screw.
 - d) Connect the cable to ground.
4. Plug the AC power cable into the "AC power" connector.
The power supply switch connector is at the [rear panel](#). Only use the power cable delivered with the R&S LCX.
5. Plug the AC power cable into a power outlet with ground contact.
The required ratings are listed next to the AC connector and in the data sheet.

4.1.7 Connecting to LAN

Establishing the LAN connection

The R&S LCX provides Ethernet (LAN) connectivity. Provided the corresponding rights are assigned, you can use these interfaces for remote control and data transfer from a controller PC. The controller PC must also be connected in the network.

The "LAN" connector is at the [rear panel](#).

To connect the R&S LCX to the LAN:

1. Connect the "LAN" socket using an RJ-45 cable to the LAN.
By default, the R&S LCX configuration uses **DHCP** that assigns the IP address automatically.
2. **NOTICE!** If the R&S LCX cannot obtain an IP address automatically, or cannot establish the connection, the icon in the status bar turns red.
Possible reasons are that the LAN does not support DHCP or requires a specific TCP/IP configuration, or that the connection is missing.
To troubleshoot the problem, proceed as follows:
 - a) Check if you have connected both, the R&S LCX and the controller PC to the LAN.
 - b) Consult your network administrator to request support and an IP address, if necessary.
 - c) If necessary, assign the IP address manually as described in "[Assigning the LAN interface addresses manually](#)" on page 164.

If switched on and connected, the R&S LCX indicates the address information and LAN parameters in the "Ethernet Settings dialog".

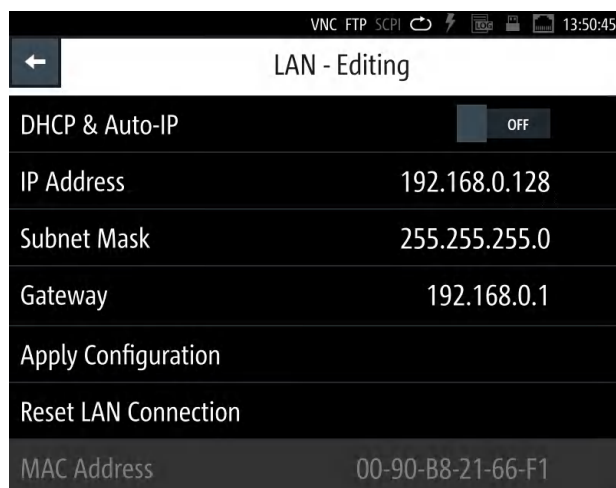

Figure 4-1: LAN settings dialog

4.1.8 Connecting USB devices

The "USB A" connector is at the **front panel**. You can connect or disconnect all USB devices from the R&S LCX during operation. But do not remove an external USB memory stick while the instrument is saving data, since it leads to loss of data.

To connect USB storage devices

USB storage devices, such as memory sticks, allow easy data transfer from or to the R&S LCX. You can also use them for firmware updates.

- ▶ Connect the USB storage device to the "USB A" connector.
If you use the front panel connectors, connect the USB storage device directly, without connecting cable. Connecting cables can cause electromagnetic radiation and impair the measurement result.

To connect USB devices with external power supply

It is also possible, to use an USB device with external power supply.

1. **NOTICE!** Connected devices with external power supply can feed back current into the 5 V power supply of the USB interface and thus damage the R&S LCX.
Make sure that there is no connection between the positive pole of the power supply and the +5 V power pin of the USB interface (VBUS).
2. Connect the USB storage device to the "USB A" connector at the front panel.

4.1.9 Connecting a test fixture

The R&S LCX enables you to measure passive components like capacitors, coils, resistors, transformers. To measure such components requires the use of suitable measurement adapters, in this context considered as test fixtures.

For information on the test fixtures available for the R&S LCX, see [Measurement Set-ups > About Test Fixtures](#).

The test fixtures are connected firmly to the four BNC connectors H POT (high potential), H CUR (high current), L POT (low potential) and L CUR (low current) at the [front panel](#).



The following instructions describe the mechanical connection of the adapter only. Before starting a measurement, consider the prerequisites and steps to be performed before as described in [Chapter 4.3, "Trying out the instrument"](#), on page 32.

Connecting a test fixture to the instrument

To connect a 4-terminal test fixture to the R&S LCX:

1. **NOTICE!** Check all terminals to make sure that they are not damaged.
NOTICE! Before connecting, discharge all components. Externally supplied voltage can damage the BNC connectors of the R&S LCX.
Turn the levers at the "BNC" connectors of the test fixture to the left to release the lock (1).

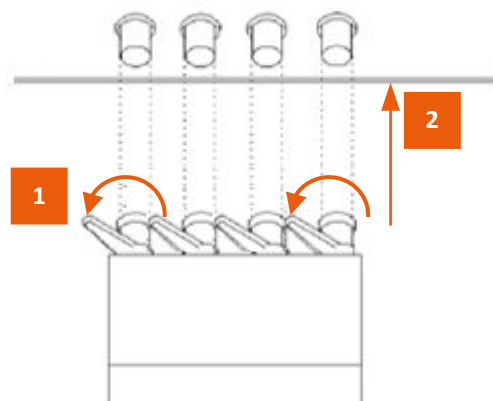

Figure 4-2: Connecting a test fixture

2. Carefully plug the test fixture to the four "BNC" measurement connectors of the R&S LCX (2).
3. Turn all levers to the right to tighten the connection (3).



Figure 4-3: Fastening the test fixture

The mechanical test setup is ready for operation.

Connecting a test fixture with the BNC-to-BNC extension

If you are using the BNC-to-BNC extension (option R&S LCX-Z11), you can connect all devices as described in [Connecting a test fixture to the instrument](#). We recommend that you keep the order as follows:

1. Connect the BNC-to-BNC to the R&S LCX.
Proceed as described in [step 1](#).
2. Connect the test fixture to the extension.

4.1.10 Switching on or off

Switching on the product

The product is off but connected to power.

1. Set the switch on the power supply to position [I].
The power supply switch connector is on the [rear panel](#).
The R&S LCX starts, and the front panel keys light up briefly.
2. Press the power key for a second.
The power is on the front panel.
The instrument checks the system, boots the operating system, and then starts the R&S LCX firmware.
The power lights green.
When starting for the first time, the R&S LCX starts with the default settings. When restarting the instrument, the settings depend on the instrument configuration before shut-down.

Shutting down the product

- ▶ Press the power key.
All current settings are saved and the operating system shuts down.
The power changes to gray (off).

To disconnect from power

The product is in the standby state.

1. **NOTICE!** Risk of data loss. If you disconnect the product from power when it is in the ready state, you can lose settings and data. Shut it down first.
Set the switch on the power supply to position [0].
2. Disconnect the product from the power source.

4.2 Instrument tour

The following topics help you to get familiar with the instrument and perform the first steps:

- [Front panel tour](#)
- [Rear panel tour](#)

The sections explain the controls and connections at the front and back of the R&S LCX. For specifications of the interfaces, see the data sheet.

The meanings of the labels on the R&S LCX are described in [Chapter 1.2, "Labels on the R&S LCX"](#), on page 11.

4.2.1 Front panel tour



Figure 4-4: R&S LCX front panel

- 1 = Basic display keys, see ["Basic display keys"](#) on page 27
- 2 = Touchscreen display, see [Chapter 4.2.1.1, "Touchscreen display"](#), on page 26
- 3 = Navigation controls, see ["Navigation controls"](#) on page 27
- 4 = Function keys, see ["Function keys"](#) on page 28
- 5 = Setting keys, see ["Settings keys"](#) on page 28
- 6 = Measurement control keys, see ["Measurement control keys"](#) on page 28
- 7 = BNC measurement connectors, see ["L CUR, L POT, H CUR, H POT"](#) on page 29
- 8 = Measurement mode keys, see ["Measurement mode keys"](#) on page 28
- 9 = Ground connector, see ["Ground socket"](#) on page 29
- 10 = POWER key, see ["POWER On/Standby key"](#) on page 29
- 11 = USB host connector

4.2.1.1 Touchscreen display

The color TFT touchscreen at the front panel is the graphical user interface. It shows the measurement readings, status information and settings, and provides access to settings dialogs.



Figure 4-5: Touchscreen display

For details on the screen display, see [Chapter 4.4.2.1, "Understanding the display information"](#), on page 36.

The touch-sensitive panel provides an alternative means of user interaction for quick and easy handling of the instrument, see [Chapter 4.4.2, "Means of manual interaction"](#), on page 35.

4.2.1.2 Keys

This section introduces the functionality of the hardkeys at the front panel. These controls lead you to menus and dialogs displayed on the screen. For information on how to operate the instrument, see [Chapter 4.4.2, "Means of manual interaction"](#), on page 35.

Basic display keys

The utility keys arrange different windows on the display.

Table 4-1: Display keys

Display key	Assigned functions
[home]	Returns to the initial feature screen.
[settings]	Displays a menu list for accessing general instrument functions.
[★ (User)]	Executes a previously assigned user action. Press and hold accesses the favorites menu for assigning a user action.

Navigation controls

The navigation controls include a rotary knob and navigation keys. They allow you to navigate within the display or within dialogs, see [Chapter 4.4.2, "Means of manual interaction"](#), on page 35.

Table 4-2: Navigation controls

Key	Assigned functions
[Rotary knob]	Selects, activates or confirms settings.
[◀] / [▶]	Moves the cursor in entry fields.
[Back]	Returns to a previous level in menus, or closes a view.

Measurement mode keys

The measurement controls enable you to select the measurement mode and view of the representation of the measurement readings.

Table 4-3: Measurement mode controls

Key	Assigned functions
[Meas. Mode]	Selects either continuous or manually triggered measurement mode.
[Display Mode]	Selects the display of measurement readings.

Function keys

The keys in the function panel select the parameters for the measurement.

Table 4-4: Measurement function controls

Key	Assigned functions
[L]	Selects the function for measuring inductance.
[C]	Selects the function for capacity measurement.
[R]	Selects the measurement for a resistor.
[Transformer]	Selects the transformer measurement.

Settings keys

The keys in the settings panel enable you to select measurement ranges and additional parameters for executing the measurement.

Table 4-5: Measurement function controls

Key	Assigned functions
[Freq.]	Sets the signal frequency.
[Range]	Selects the impedance range.
[Level]	Sets the level.
[Comp.]	Opens the "Open/Short/Load Correction" dialog for quick access.
[Bias Level]	Sets the bias voltage and current.
[Bias Enable]	Activates internal or external bias.

Measurement control keys

These keys provide control during the measuring procedure.

Table 4-6: Navigation controls

Key	Assigned functions
[Auto]	Activates the automatic selection of the measurement function.
[Hold]	Freezes the measurement range, on the screen indicated with prefix "Hold:" at the range value.
[Trig.]	Triggers a measurement manually.

POWER On/Standby key

The [On/Standby] key switches the instrument from the standby to the ready state or vice versa.

The [On/Standby] lights green when the instrument is switched on, see [Chapter 4.1.10, "Switching on or off"](#), on page 25.

4.2.1.3 Connectors

The measurement input connectors and the USB connector are on the [front panel](#).

L CUR, L POT, H CUR, H POT

Four BNC sockets:

- "L CUR" (low current): signal output for series measurements (signal generator).
- "L POT" (low potential): signal input for parallel measurement (voltage measurements).
- "H CUR" (high current): signal input for series measurements (current measurements).
- "H POT" (high potential): signal input and output for parallel measurements (measurement bridge).

Ground socket

Protective socket (4 mm banana socket) to ground the R&S LCX, e.g. with a grounded external conductor.

The front panel ground socket is directly connected to the mains safety ground by the line cord.

See [Table 1-1](#).

USB A

Female USB (universal serial bus) connector of type A (host USB). You can connect a USB memory stick, e.g., to record and export measurement data, to capture screenshots, or to update the firmware.

How to: [Chapter 4.1, "Preparing for use"](#), on page 16

4.2.2 Rear panel tour

This section provides an overview of the connectors at the rear panel of the instrument. For technical data of the connectors, see the data sheet.



Figure 4-6: R&S LCX rear panel

- 1 = IEEE-488 interface, see "[IEC 625/IEEE 488](#)" on page 30
- 2 = Kensington lock, see "[Kensington lock](#)" on page 30
- 3 = AC power connector and power switch, see "[AC power supply](#)" on page 30
- 4 = Ground terminal, see "[Ground terminal](#)" on page 31
- 5 = D-sub connector, see "[Digital I/O](#)" on page 31
- 6 = Bias connectors and fuse holder, see "[External Voltage Bias](#)" on page 31, "[BIAS Fuse](#)" on page 31
- 7 = Trigger input connector, see "[Trigger Input](#)" on page 31
- 8 = USB host connector, see "[USB A](#)" on page 29
- 9 = USB device connector, see "[USB B](#)" on page 31
- 10 = Ethernet (LAN) interface connector, see "[LAN](#)" on page 31

IEC 625/IEEE 488

Option: R&S NG-B105

General purpose interface bus (GPIB) interface to connect a computer for remote control of the R&S LCX.

See "[Establishing the GPIB remote control connection](#)" on page 163.

Kensington lock

Flat key security slot to prevent the instrument from removal.

The locking system consists of a small, metal-reinforced hole with a metal anchor and a rubberized metal cable that is secured with a key lock. The loop at the end of the cable allows you to tie the unit to a fixed object.

AC power supply

Mains power supply with power switch, fuse holder and IEC socket.

- Mains power switch:
Switch for connecting and disconnecting the internal power supply from the power source, see [Chapter 4.1.10, "Switching on or off"](#), on page 25.
- Fuse holder
Socket for the fuse securing the line voltage. Depending on the power supply system, the corresponding fuse must be plugged before connecting to power. See "[Connecting to power](#)" on page 21.
- IEC socket

Power supply connector for connecting the R&S LCX to the mains., see [Chapter 4.1.6, "Connecting to power"](#), on page 19.

Ground terminal

Protective ground terminal to secure the R&S LCX, e.g. with a grounded external conductor, see [Table 1-1](#).

Digital I/O

15-pole D-Sub socket to connect the binning interface.

External Voltage Bias

4 mm safety sockets for external bias voltage.

Note: External BIAS requires constant voltage.

Before applying the voltage, make sure that you have set the constant voltage mode in the supplying instrument. Refer to the user manual of the power supply.

The External Voltage Bias socket is not directly connected to ground.

Indirectly, there is a connection to ground with low impedance over the "H CUR" output buffer.

When the bias voltage is turned on, the potential to ground deviates only by a maximum of ± 18 V. Without external bias, make sure that the voltage at the two sockets does not exceed the safety extra low voltage or the specified 40 V DC.

BIAS Fuse

Socket for the fuse securing the external bias voltage.

Trigger Input

BNC socket for external trigger signal.

The outer conductor of the trigger input is directly connected to the mains safety ground by the line cord.

USB A

Female USB (universal serial bus) connector of type A (host USB). You can connect a USB memory stick, e.g., to record and export measurement data, to capture screenshots, or to update the firmware.

How to: [Chapter 4.1, "Preparing for use"](#), on page 16

USB B

Female USB (universal serial bus) type B connector. This interface provides remote control of the instrument from a controller PC.

See ["Establishing a USB remote control connection"](#) on page 163.

LAN

RJ-45 socket to connect the R&S LCX to a LAN for remote control, remote operation, and data transfer.

How to: [Chapter 4.1.7, "Connecting to LAN"](#), on page 21

4.3 Trying out the instrument

As a brief introduction, the following example describes the basic steps to be taken when setting up a measurement. The instructions guide you through the measurement of a resistor.

Further test setups and measurement methods are described in the user manual, see [Chapter 6, "Measurement setups"](#), on page 52.

The test setup uses the R&S LCX-Z3 SMD test fixture connected to the R&S LCX for measuring leadless components.



If necessary, you can connect the R&S LCX-Z11 BNC-to-BNC extension between the R&S LCX and the test fixture, e.g., to make it easier to pick and place the DUTs.

Basic measurement steps

The R&S LCX LCR meter measures the impedance and phase angle with an AC signal, and derives the required characteristics.

As the equivalent circuit of each DUT contains capacitive, real and conductive parts, the characteristics of passive components vary dependent on frequency, level, temperature and additional bias. Even the test equipment can impact the measurement results. Therefore, we recommend that you use the test fixture that fits best for your application, and align the instrument on all frequencies. Keep the order as given to minimize parasitic parts and thus to optimize the measurement accuracy.

1. Select the test fixture that fits best for your application.
2. After power-on set the R&S LCX to an initial state, see ["Setting the initial state"](#) on page 32.
3. Connect the test fixture, see [Chapter 4.1.9, "Connecting a test fixture"](#), on page 23.
4. Configure the test signal, see ["Setting up the test signal"](#) on page 33.
5. Align the instrument on all frequencies, see ["Aligning the instrument on all frequencies"](#) on page 34.
6. Start a resistor measurement ["Measuring a resistor"](#) on page 34.

Setting the initial state

1. **NOTICE!** Check all terminals to make sure that they are not damaged.
Power on the R&S LCX, as described in [Chapter 4.1.6, "Connecting to power"](#), on page 19.
2. Switch on the R&S LCX, see [Chapter 4.1.10, "Switching on or off"](#), on page 25.
3. **NOTICE!** Risk of measurement inaccuracy. Measurements can be inaccurate, if performed when the instrument is not warmed-up. Wait until the instrument has reached its operating temperature before you start the measurement procedure. The warm-up time is up to 30 minutes.

To start from an initial state, set the instrument to default:

- a) Press the [settings] key at the front panel.
On the front panel, press the [settings] button.
- b) In the "Device" tab, select "Save/Recall Device Settings".
- c) Select "Default Settings".
The instrument prompts you to confirm the operation.
- d) Confirm with "Ok".
The R&S LCX resets all parameters except for system settings.
- e) Select  to return to the settings menu.

Connecting the test fixture

The figure shows schematically the elements to be connected.

- ▶ To connect the test fixture, proceed as described in [Chapter 4.1.9, "Connecting a test fixture"](#), on page 23.

Setting up the test signal

To configure the test signal:

1. To set the frequency:
 - a) On the screen, select "Frequency".
 - b) Enter, e.g. 10 kHz using the keypad on the screen.
 - c) Confirm with .
2. To select the level parameter:

Before setting the test signal level, you can select either the signal voltage, or the signal current for the level setting:

 - a) Press the [settings] at the front panel.
 - b) Select the "Measurement" tab.
 - c) Select "Test Signal Level".
 - d) Select, e.g. "Voltage".
 - e) Confirm with "Set".
 - f) Press the [home] key to return to the measurement window.

The R&S LCX provides the selected parameter for the level setting on the screen.
3. To set the test signal level:
 - a) On the screen, select "Level".
 - b) Enter, e.g. 1.3 VRMS.
 - c) Confirm with .
4. If you know the expected range, set the range as follows.
Otherwise skip this step and proceed with [step 5](#):
 - a) Select "Range".
 - b) In the "Select Measurement Range" dialog, select the expected impedance, e.g. 10 kΩ.
 - c) Confirm with "Set".

5. On the front panel, press the [Auto] key to activate automatic detection of the measurement function according to the component type of the DUT.

Aligning the instrument on all frequencies

To compensate impacts and measurement errors, you can align the instrument on all frequencies before starting the measurement.

This example describes, how to execute a short and an open correction with the connected SMD test fixture (R&S LCX-Z3).



During the correction procedure, the R&S LCX sweeps through defined frequency steps that are determined by the selected source impedance and the correction mode. For information on the frequency steps, see [Table 8-1](#).

1. Press the [Comp.] key at the front panel.
The "Open/Short/Load Correction" dialog opens.
2. Execute a short correction:
 - a) Short-circuit the contact devices, i.e. the clamps or pins, according to the used test fixture.
 - b) In the "Open/Short/Load Correction" dialog, select "Short correction".
 - c) Set "Enabled" > "ON".
 - d) Select "Start Short Correction (Full)".The short correction takes about 2 minutes.
3. Execute an open correction:
 - a) Open the contact devices.
Depending on the test fixture, take care that you set the required position. For example, Kelvin clamps require the same position as expected for the measurement, or the spacing between SMD pins must correspond to the size of the measurement sample.
 - b) In the "Open/Short/Load Correction" dialog, select "Open correction".
 - c) Set "Enabled" > "ON".
 - d) Select "Start Open Correction (Full)".The open correction also lasts for about 2 minutes.

Note: For information on corrections with other test fixtures, see [Chapter 6.1, "About test fixtures"](#), on page 52.

Measuring a resistor

1. To select the resistor measurement (DUT component type), press the [R] key.
2. To select the parameters for measurement results display:
 - a) Select the softkey in the upper left corner, to open the selection editor.
 - b) Select the parameters "R-X" (resistance, reactance).
 - c) Repeat the steps to select the second parameters, e.g. select "Z- Θ " (impedance, phase angle).

3. Insert the sample resistor in the test fixture as follows:
 - a) To open the contact pins, relax and hold the lever to the left.
 - b) Carefully position the sample between the contacts in the center.
 - c) Release the lever to fix the sample.

The measurement starts and you can see the readings on the screen.

4.4 Instrument control

This chapter provides an overview on how to work with the R&S LCX. It introduces the possibilities for operating the instrument and describes the basic functionality of the control elements. If a measurement configuration requires specific operating steps, the corresponding settings description in the user manual points it out separately.

- [Ways to operate the instrument](#)..... 35
- [Means of manual interaction](#)..... 35
- [Remote control](#)..... 46

4.4.1 Ways to operate the instrument

You can operate an R&S LCX in two ways:

- Manual operation
Use the touchscreen and the front panel controls to configure general and measurement settings.
See [Chapter 4.4.2, "Means of manual interaction"](#), on page 35 for basic information on manual operation of the instrument.
- Remote control
Create programs to automatize repeating settings, tests and measurements. A controller PC with remote access to the instrument runs the programs.
See [Chapter 4.4.3, "Remote control"](#), on page 46 for an overview of the interfaces provided for remote control.

4.4.2 Means of manual interaction

For manual interaction of the R&S LCX, use the touchscreen and front panel controls, see [front panel](#). The display shows the current settings, menus and dialogs, when you perform your settings.

For the manual interaction with the R&S LCX, you have several methods that you can use as an alternative to perform a task:

- Touchscreen
Touchscreen operation is the most direct way to interact with the instrument. Almost all control elements and actions on the screen are based on the standard operating system concept. You can tap any user interface element to set parameters in dialogs, enter data, or scroll within a dialog.

Using various finger gestures you can select any user interface element, set parameters in dialogs, enter data using online keypads, or scroll within a dialog.

– **Tapping**



Touch quickly: selects a parameter or provokes an action.

– **Swiping**



Touch and swipe: Scrolls through the contents of a display element larger than the screen, e.g. a menu list.

– **Dragging**



Touch and drag: Shifts the contents from one position to another on the display. By dragging your finger over a diagram, you can pan the displayed area of the diagram to show results that were previously out of view.

- **System, measurement and function keys**
The front panel hardkeys provide nearly all functions and controls to operate the instrument in the classic way, without touchscreen. You can access the main functions and parameters, measurement and display modes and configure general instrument settings. When selected, i.e. a function is active, the corresponding function key lights up white.
- **Navigation controls**
The navigation controls include a [rotary knob] and right [▶], left [◀] keys. The rotary knob allows you to navigate on the home screen or in dialogs, and to set parameters. The [◀] [▶] move the cursor in entry fields.

This manual describes the manual interaction with the instrument using the touchscreen. It mentions the alternative methods using the keys on the instrument or the on-screen keypads if it deviates from the standard operating procedures.



Throughout the manual, the term "select" refers to any of the described methods, i.e. using a finger on the touchscreen or a key on the instrument or on a keyboard.

For basic instructions on how to control the R&S LCX, see [Chapter 4.4.2.2, "Accessing the functionality"](#), on page 43.

4.4.2.1 Understanding the display information

The initial display screen shows the measurement result window, status information and general settings at the top. The main area displays the measurement results, depending on the selected measurement and display mode.

For detailed information, see [Chapter 8.2, "Display mode"](#), on page 71.

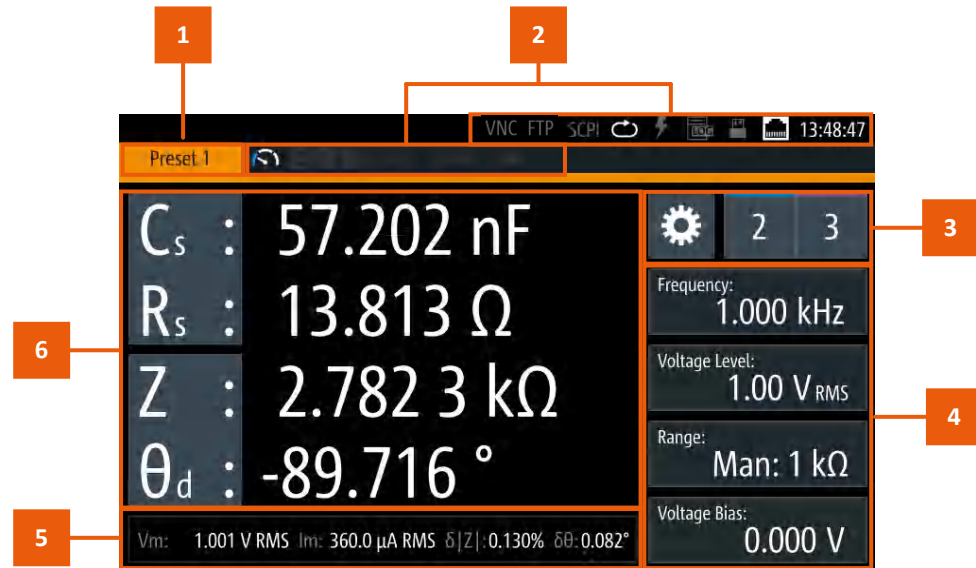

Figure 4-7: Example of screen display

- 1 = Configuration preset indicator, see ["Configuration preset indicator"](#) on page 37
- 2 = Status bars, see ["Status bar"](#) on page 37
- 3 = Settings softkey and configuration preset softkeys, see ["Settings softkey"](#) on page 40, ["Configuration preset softkeys"](#) on page 40
- 4 = Signal parameters, see ["Signal parameters"](#) on page 40
- 5 = Test signal monitor, see ["Test signal monitor"](#) on page 40
- 6 = Measurement parameters and results, see ["Measurement parameters and results"](#) on page 41

The following sections explain the information areas as labeled.

Configuration preset indicator

The R&S LCX enables you to set up to three different measurement configurations and assign them as favorites with the ["Configuration preset softkeys"](#) on page 40. The indicator displays the currently active preset configuration.

Preset 1 (Preset 1/2/3) displays the currently active preset configuration.

Status bar

You can see two status bar lines. The status bar in the upper line on the right, referred to as instrument status bar, indicates icons which represent the states of connections, remote control communication and operating modes. The status bar to the right of "Preset", is referred to as measurement status bar. Its icons indicate measurement modes and states.









Instrument status bar

The instrument status bar refers to the general instrument configuration and operating modes, see [Table 4-7](#) for information on the icons.

The color of the symbols indicates the status of, e.g. a function, connection or a process:

- **white** - enabled, or running
- **gray** - disabled
- **red** - faulty
- **yellow** - denotes a specific status

Table 4-7: Instrument status bar

Indicator	Description
 Touchscreen	Indicates that the touchscreen is locked. See Chapter 9.3, "User button" , on page 122
 Virtual Network Computing	White indicates that the VNC service is enabled for remote access over LAN. See "Remote operation (VNC)" on page 145.
 File Transfer Protocol	White indicates that the remote access to the file system over LAN is enabled. See "Remote file access (FTP)" on page 146.
 (Remote control with SCPI commands)	Indicates the status when working with remote control commands: <ul style="list-style-type: none"> • single white flash: SCPI command received successfully • red: A remote control error has occurred, entered in the SCPI error queue • gray: no SCPI communication
 Measurement mode	White indicates that the R&S LCX measures in continuous measurement mode. See Chapter 8.1, "Measurement mode" , on page 69
 Trigger event	Flashes once on a trigger event.
 Logging	Indicates the logging state: <ul style="list-style-type: none"> • white: Data logging is running. • red: A logging error has occurred. • gray: Logging is disabled See Chapter 8.8.3, "Logging" , on page 97
 USB host interface	White indicates that a connected USB memory device is in use. See Chapter 4.1.8, "Connecting USB devices" , on page 22.
USB device interface	The USB remote control connection is established. See "Establishing a USB remote control connection" on page 163.
 LAN interface	The R&S LCX is connected to LAN. See Chapter 4.1.7, "Connecting to LAN" , on page 21.

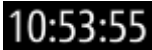
Indicator	Description
GPIB/IEE-488	The IEE-488 bus interface (GPIB) connection is established. See Chapter 10.4, "Connecting the R&S LCX for remote access" , on page 162.
 Time	Indicates the time set on the instrument. See Chapter 9.6, "Date & time" , on page 127.

Measurement status bar









The measurement status bar provides information on certain measurement modes, functions and states. When activated, indicators displayed in white color represent the corresponding functions.



For information on the measurement modes and functions, see ["About measurement parameters"](#) on page 75.



Table 4-8: Measurement status bar

Indicator	Description
Measurement mode	
 Measurement speed	Indicates the set measurement speed: <ul style="list-style-type: none"> •  fast •  medium •  slow In triggered mode, the icon is grayed out. See "Measurement Speed" on page 78
 "O", "S", "L"	Indicates if open, short, and load corrections are enabled. <ul style="list-style-type: none"> • white: full correction enabled • blue: spot correction enabled • gray: correction disabled See Chapter 8.6.2, "Open/short/load correction settings" , on page 80
 "LowZ"	Low impedance measurement mode is set. See "Source Impedance" on page 79
 "BIAS"	Indicates an activated BIAS: <ul style="list-style-type: none"> • "VBIAS": voltage bias, provided for capacitance measurements • "IBIAS": current bias, provided for inductance measurements • "eVBIAS": external voltage bias, for capacitance measurements If disabled, the icons are grayed out. See Chapter 8.4.1, "Test signal settings" , on page 73
 "Cable Length"	White indicates that the cable length is set. The R&S LCX displays the set value (currently only 1 m applicable). See "Cable Length" on page 78

Settings softkey

The  (settings) softkey opens the measurement dialog for setting additional basic measurement parameters.

Configuration preset softkeys

The  (preset configuration) softkeys recall previously assigned measurement configurations, defined for dedicated measurements. You can assign up to three predefined configuration presets.

How to: see [Chapter 8.7.2, "Using the configuration preset function"](#), on page 88

Signal parameters

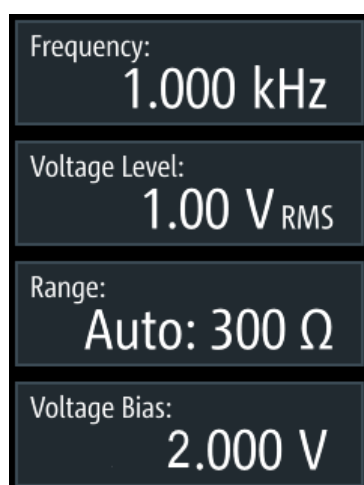

Figure 4-8: Measurement signal parameters

Each softkey opens an on-screen keypad for setting the signal parameters directly. Alternatively, you can use the corresponding settings keys at the [front panel](#).

Test signal monitor

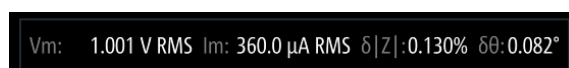

Figure 4-9: Test signal monitor

The test signal monitor displays voltage and current results and the measurement accuracy.

Measurement parameters and results

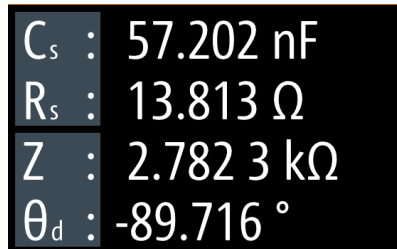

Figure 4-10: Measurement results window

The initial screen shows the basic parameters capacitance " C_s " and serial resistance " R_s ", the impedance " Z " and phase angle " θ_d ". On the right, the R&S LCX displays the measurement readings.

You can select parameters different from default by tapping the parameter softkeys.

How to: see "[Measuring a resistor](#)" on page 34

The parameter softkeys open an on-screen selection list for selecting parameters other than displayed.

Additional display characteristics

The following section provides a short insight on the indication of the screen in general, and significant elements that you see under specific operating modes, in dialogs or settings.

- **Appearance of active elements**
 - *Active* elements like On/Off switches, state buttons have a **blue** background.
 - *Selected* elements are framed or highlighted **orange**.
 - *Inactive* elements are **gray**.
- **Menus and dialogs**

Both, menus and dialogs appear similar, and contain selection lists. Throughout this manual, a list of functions which lead you to the settings of this function is referred to as menu. The term dialog refers to the views that cover the parameters of a certain function. Some dialogs are divided into tabs with logically grouped parameters.

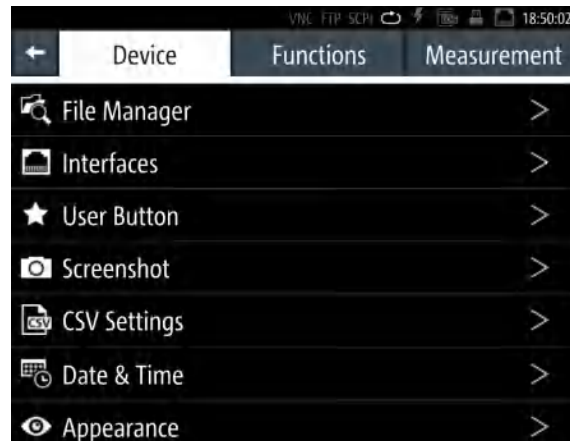

Figure 4-11: Example of a menu

- **Selection editors**

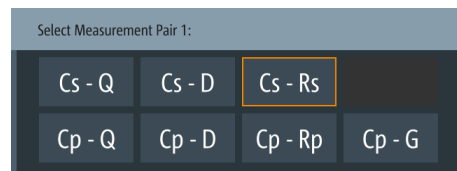

Figure 4-12: Example of selection editor for measurement parameter pairs

When opened, a generic label in the header of the editor window shows the parameter for selection. Each editor lists the available values and buttons to confirm the selection.

- **On-screen keypads**

As additional means of interacting with the instrument, either a numerical or alpha-numerical on-screen keypad appears when you activate an entry field (see [Chapter 4.4.2.3, "Entering data"](#), on page 44).



Figure 4-13: Numeric on-screen keypad

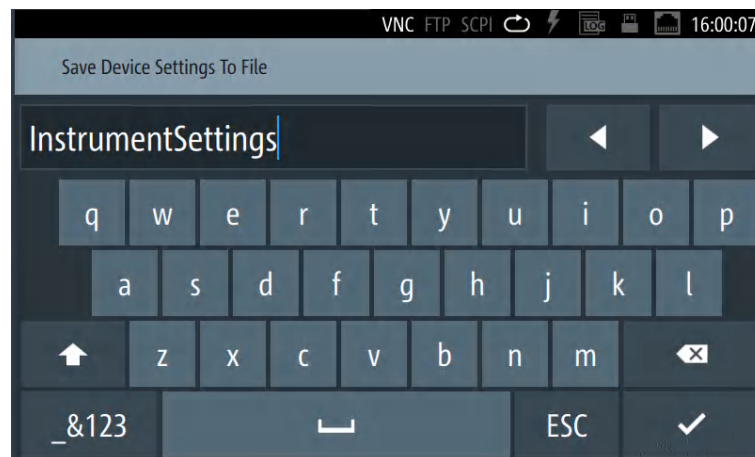

Figure 4-14: Alphanumeric on-screen keyboard

- **Info dialogs**

An "Info dialog" appears when an event generates a message. The generically assigned header shows the affected topic. The message describes the event, and short instructions lead you through the next steps.

- **Scroll bar**

Appears when the list of selection parameters exceeds the size of the screen. Touch and swipe on the screen to scroll up and down.

- **Progress indicator**

Indicates a currently running process. If a process takes some time, a progress bar shows the current state.

4.4.2.2 Accessing the functionality

All functionalities are provided in dialogs, menus, editors or keypads, as known from computer programs. You can control the instrument intuitively with the touchscreen. This section provides an overview of the accessing methods.

Apart from the main menus "Measurement" and "Device", we use the term "dialog" to refer to all editable windows.

You can access the instrument's functions and settings by using one of the following controls:

- System and function keys at the front panel of the instrument
- Interactive softkeys on the touchscreen, underlined in gray

To open the main menus

To open the two main menus:

1. Press the [settings] at the front panel.
2. Select (tap) the corresponding tab on the screen.

The selection leads you either to a settings parameter directly, or to a dedicated dialog.

To open a dialog

To open one of the dialogs, or editors, you have several options:

1. Press the corresponding hardkey at the front panel, e.g. the [Freq.] key.
2. Select (tap) a softkey on the screen, e.g. "Frequency:"

To close a dialog

1. To return to the home screen, press the [home] key.
2. To return to a previous dialog, the R&S LCX provides several softkeys:
 - Softkeys that prompt you to confirm your selection, as e.g. "Select" or "Ok"
 - the  (back) softkey in the left upper corner of a dialog
 - Softkeys that prompt you to confirm your selection, as e.g. "Select" or "Ok" automatically close a dialog.
 - the [Back] key or the [rotary knob] at the front panel

To select a parameter

If many parameters are available, they are often provided in a list:

1. If necessary, scroll through the list.

Tip: You do not need the focus exactly on the bar, touch and swipe the list.
2. As an alternative, you can use the [rotary knob]:
 - a) Turn the knob to select the parameter.
 - b) Press the knob to confirm your selection.

4.4.2.3 Entering data

Some parameters have their own key at the front panel.

For data input in dialogs, the instrument provides on-screen keypads for entering numeric and alphanumeric values. Thus, you can always set the parameters using the touchscreen, or the navigation controls at the front panel.

To correct an entry

1. To delete an entry, set the cursor to the right of the entry you want to delete. To select the position:
 - a) Select (tap) it in the entry field directly.
 - b) Use the cursor softkeys of the on-screen keypad.
 - c) Use the [◀], or [▶] keys at the front panel.
2. On the on-screen keypad, select "Clear".

Deletes the entry to the left of the cursor.
3. Enter your correction.

To complete the entry

To confirm the entry:

- ▶ On the on-screen keyboard, select  (confirm).

To abort the entry

- ▶ On the on-screen keypad, select "ESC".

The dialog closes without changing the settings.

Pressing the [rotary knob] also cancels the action and returns to the previous screen.

Entering numeric parameters

To enter values with the on-screen keypad

For numeric settings, the instrument displays the numeric keypad. The units specified correspond to the units of the parameter.

1. Enter the numeric value.
2. Select the unit button to complete the entry.
The unit is added to the entry.
3. If the parameter does not require a unit, confirm the entered value with .

To enter values by using the front panel controls

You can also control the R&S LCX with the front panel controls, e.g. if you have locked the touchscreen.

See [Chapter 9.3.2, "Using the user button function"](#), on page 123.

1. Select the corresponding settings hardkey at the front panel, e.g. select [Freq.].
The on-screen keypad opens.
2. Press the [rotary knob].
The R&S LCX changes to edit mode, and returns to the home screen.
3. Turn the [rotary knob] to select the corresponding entry field (framed **orange**).
4. To enter a value, e.g. the frequency, use the controls as follows:
 - a) Pressing the [rotary knob] enables the entry field for editing.
 - b) Turning the knob decreases or increases the currently selected digit (highlighted in **blue**).
 - c) Pressing the button again switches to the next digit.
Alternatively, you can use the [◀] or [▶] keys.
5. To enter a selection editor, e.g. to change a measurement parameter indicated in the result window:
 - a) Turn the [rotary knob] to select the parameter (softkey on the screen).

- b) Press the [rotary knob].
The selection editor opens.
 - c) Turn the knob to scroll within the list.
 - d) Press the [rotary knob] again to confirm your selection.
6. To access the main menus and subdialogs, use the functionality of the [rotary knob] and the [◀] or [▶] keys the same way.

Entering alphanumeric parameters

If a field requires alphanumeric input, you can use the on-screen keyboard to enter letters and (special) characters.

Access and control are similar as described above.

4.4.3 Remote control

In addition to operating the R&S LCX directly on the instrument, it is also possible to operate and control it from a remote PC.

Remote control interfaces

The R&S LCX provides several interfaces for remote control:

- Ethernet (LAN) interface
- USB standard interface
- IEE-488 bus interface (GPIB) (option: R&S NG-B105)

For detailed information on how to configure the remote control interfaces, see [Chapter 10, "Network operation and remote control"](#), on page 144.

See [Chapter 4.1.7, "Connecting to LAN"](#), on page 21 for an example on how to set up LAN connection for remote control.

5 Measurement basics

The following graph shows the capacitive and inductive parts of passive components during impedance measurement in dependency on the frequency and the phase shift.

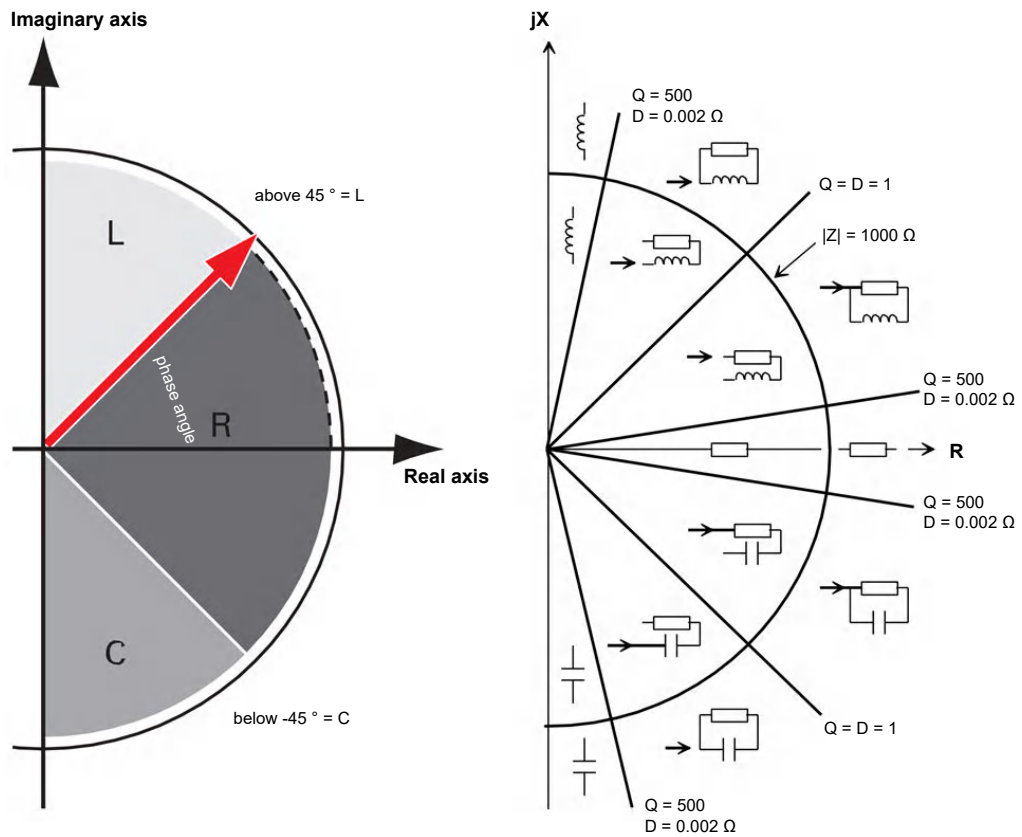

Figure 5-1: Phase angle and integral sections

L = inductance
 R = resistance
 C = capacitance
 |Z| = impedance
 D = dissipation factor
 Q = quality factor

5.1 Impedance measurement parameters in general

The following table outlines the basic parameters and their definitions:

Table 5-1: Basic parameters and definitions

Parameter (designation and [unit])	Definition
Z (Ω)	Impedance
 Z (Ω)	Magnitude of Z

Impedance measurement parameters of the R&S LCX

R (Ω)	Resistance
X_s (Ω)	Reactance
Y (S)	Admittance
$ Y $ (S)	Magnitude of Y
G_p (S)	Equivalent parallel conductance measured with parallel-equivalent circuit model
B_p (S)	Susceptance Imaginary part of Y
Q	Quality factor (inverse of D)
D or $\tan\delta$	Dissipation factor
Θ_r (rad, °)	Phase angle of impedance/admittance (radian)
Θ_d (°)	Phase angle of impedance/admittance (degree)
φ (rad, °)	Phase angle of Y
C_s (F)	Capacitance value measured with series-equivalent circuit model
C_p (F)	Capacitance value measured with parallel-equivalent circuit model
L_s (H)	Inductance value measured with series-equivalent circuit model
L_p (H)	Inductance value measured with parallel-equivalent circuit model
R_s or ESR (Ω)	Equivalent series resistance measured with series-equivalent circuit model
R_p (Ω)	Equivalent parallel resistance measured with parallel-equivalent circuit model
R_{DC} (Ω)	Direct-current resistance
V_{DC} (V)	Direct-current voltage
I_{DC} (A)	Direct-current electricity
q_d (°)	Phase angle of impedance/admittance (degree)
q_r (rad)	Phase angle of impedance/admittance (radian)

5.2 Impedance measurement parameters of the R&S LCX

In addition to the characterization of the resistance, inductance and capacity of passive components, the R&S LCX determines parameters like the quality factor (Q), the dissipation factor (D), the phase angle (Θ), and the complex values of the impedance (Z) and the admittance (Y).

The following tables show the parameter pairs that you can select for display.

Impedance measurement parameters of the R&S LCX

Table 5-2: Resistance measurement parameters

Parameter	Designation and unit
Rs-X	series resistance (Ω) - reactance (Ω)
Rp-B	parallel resistance (Ω) - susceptance (Ω)
Rdc	DC current resistance (Ω) - reactance (Ω)
G-B ^{*)}	conductance (S) - susceptance (Ω)
Z- Θ ^{*)}	impedance (Ω) - phase angle (rad)
Z- Θ ^{d*)}	impedance (Ω) - phase angle ($^{\circ}$)
Y- Θ ^{*)}	admittance (S) - phase angle (rad)
Y- Θ ^{d*)}	admittance (S) - phase angle ($^{\circ}$)
*) selectable as second measurement parameter pair	

Table 5-3: Capacitor measurement parameters

Parameter	Designation and unit
Cs-Q	serial capacitance (F) - quality factor
Cs-D	serial capacitance (F) - dissipation factor
Cs-Rs	serial capacitance (F) - serial resistance (Ω)
Cp-Q	parallel capacitance (F) - quality factor
Cp-D	parallel capacitance (F) - dissipation factor
Cp-Rp	parallel capacitance (F) - serial resistance (Ω)
Cp-G	parallel capacitance (F) - conductance (S)
G-B ^{*)}	conductance (S) - susceptance (Ω)
Z- Θ ^{*)}	impedance (Ω) - phase angle (rad)
Z- Θ ^{d*)}	impedance (Ω) - phase angle ($^{\circ}$)
Y- Θ ^{*)}	admittance (S) - phase angle (rad)
Y- Θ ^{d*)}	admittance (S) - phase angle ($^{\circ}$)
*) selectable as second measurement parameter pair	

Table 5-4: Inductor measurement parameters

Parameter	Designation and unit
Ls-Q	serial inductance (H) - quality factor
Ls-D	serial inductance (H) - dissipation factor
Ls-Rs	serial inductance (H) - serial resistance (Ω)
Lp-Q	parallel inductance (H) - quality factor
Lp-D	parallel inductance (H) - dissipation factor

Parameter	Designation and unit
Lp-Rp	parallel inductance (H) - resistance (Ω)
Lp-G	parallel inductance (H) - conductance
Rs-X ^{*)}	series resistance (Ω) - reactance (Ω)
G-B ^{*)}	conductance (S) - susceptance (Ω)
Z- Θ ^{*)}	impedance (Ω) - phase angle (rad)
Z- Θ ^{d*)}	impedance (Ω) - phase angle ($^{\circ}$)
Y- Θ ^{*)}	admittance (S) - phase angle (rad)
Y- Θ ^{d*)}	admittance (S) - phase angle ($^{\circ}$)
*) selectable as second measurement parameter pair	

Table 5-5: Transformer measurement parameters

Parameter	Designation and unit
M- Θ d	mutual inductance (H) - phase angle ($^{\circ}$)
N- Θ d	transformer ratio / turns ratio - phase angle ($^{\circ}$) (phase difference between primary and secondary winding)
Rs-X ^{*)}	series resistance (Ω) - reactance (Ω)
G-B ^{*)}	conductance (S) - susceptance (Ω)
Z- Θ ^{*)}	impedance (Ω) - phase angle (rad)
Z- Θ ^{d*)}	impedance (Ω) - phase angle ($^{\circ}$)
Y- Θ ^{*)}	admittance (S) - phase angle (rad)
Y- Θ ^{d*)}	admittance (S) - phase angle ($^{\circ}$)
*) selectable as second measurement parameter pair	

5.3 Considerations on measurement accuracy

To know the measurement accuracy of a, e.g. capacitance measurement, the accuracy and characteristics of the instrument are essential.

An R&S LCX LCR meter measures the impedance (Z) and phase (Θ), and derives the results of the also provided measurement parameters. The accuracy of a determined parameter therefore refers to the accuracy of these measured parameters.

During a measurement, the R&S LCX displays the accuracy of (Z) and (Θ) at the current working point in the [Test signal monitor](#) on the screen.

If you need to know the accuracy outside a running measurement or for a secondary measurement parameter, you can calculate the accuracy individually.

How to:

- see the application note "LCX accuracy calculations" on the product page www.rohde-schwarz.com/application/lcx.
The application note guides you how to proceed in general, and how to determine the value for specific sample components.
- see the data sheet "Specifications" on the product page www.rohde-schwarz.com/brochure-datasheet/lcx). The data sheet provides the formulas and the instrument-specific calculation factors.

6 Measurement setups

Measuring components requires the use of suitable measurement adapters, referred to as test fixtures.

6.1 About test fixtures

Test fixtures provide precise measurements of electronic components, such as passive components, either with lead wires or SMD modules. They are designed to hold or directly connect the measurement samples.



Frequency range

Some of the test fixtures are limited in frequency range. For details on the specifications, see the data sheet, section "Specifications" > "Options".

- [Test fixture for axial/radial lead type components](#)..... 52
- [Kelvin clip lead](#)..... 53
- [Test fixture for SMD components](#)..... 54
- [Test tweezers for SMD components](#)..... 55
- [Test fixture with cables for transformer components](#)..... 56
- [BNC-to-BNC extension](#)..... 57

6.1.1 Test fixture for axial/radial lead type components

This test fixture R&S LCX-Z1 is a 4-terminal THT (through hole) test fixture for measurements of both, axial or radial wired components.



Figure 6-1: R&S LCX-Z1 test fixture for axial/radial lead type components

The R&S LCX-Z1 test adapter has two contact slots, each to plug in one lead of the component. To perform short correction, connect the short circuit plate supplied with the test fixture. For open correction, leave the slots unconnected.

The clamping jaws adapt to the wire diameter automatically.

6.1.2 Kelvin clip lead

The Kelvin clip lead R&S LCX-Z2 test fixture is designed for measuring components with particular size, shape or terminals.



Figure 6-2: R&S LCX-Z2 Kelvin clip lead

The test fixture is equipped with two insulated Kelvin clips that hold the wires or terminals of the component. To perform short correction, connect the clips together. For open correction, leave the clips unconnected.

NOTICE

The cable positioning for R&S LCX-Z2 has impact to measurement results, especially with higher frequencies.

6.1.3 Test fixture for SMD components

The R&S LCX-Z3 test fixture is designed for measuring SMD, i.e. leadless components. It is suitable for rectangular or cylindrical shaped chips with parallel electrodes, and components similar in shape and type.



Figure 6-3: R&S LCX-Z3 SMD test fixture

The test fixture provides a section to position and center the component and clamp it between two connection pins.

To perform short correction, close the contacts of the connection pins. For open correction, use the lever to open the pins until the spacing between them corresponds approximately to the length of the measurement sample. Hold this position during the correction.

6.1.4 Test tweezers for SMD components

The test tweezers R&S LCX-Z4 test fixture is designed for measuring SMD components, even when they are mounted on printed circuit boards. It provides simple and fast contacting and is thus suitable, for example, for pre-selection during incoming inspection or of small batches.



Figure 6-4: R&S LCX-Z4 SMD test tweezers

The test fixture is equipped with tweezers, and miniature SMD tweezers.

To perform short correction, hold the contacts of the tweezers closed. For open correction, leave the contacts open.

6.1.5 Test fixture with cables for transformer components

The transformer R&S LCX-Z5 test fixture is designed for measuring transformers or transmitters in combination with transformers.



Figure 6-5: R&S LCX-Z5 transformer test fixture and test cables

The test fixture comes with four test leads equipped with alligator clips, to contact the primary and secondary circuits of the measurement sample. The BNC connectors on the right and left outside are intended to contact the circuit with the higher number of windings. The two BNC connectors in the middle correspondingly for the circuit with lower number of windings.

As an alternative, it is possible, to install a user-specific test setup at the BNC connectors directly.

6.1.6 BNC-to-BNC extension

The R&S LCX-Z11 BNC-to-BNC extension (1m) enables you to place the test setup in the distance of 1 m from the site of the R&S LCX.



Figure 6-6: R&S LCX-Z11 BNC-to-BNC extension

The extension also provides four BNC measurement ports for connecting a test fixture or establish user-specific connection.



When you use the R&S LCX-Z11 BNC-to-BNC extension, you must set the cable length to 1 m in the measurement settings for cable length compensation, see [Chapter 8.6.1, "Measurement parameter settings"](#), on page 77.

How to: see ["Connecting a test fixture with the BNC-to-BNC extension"](#) on page 24

6.2 Configuring the test signal

The accuracy of the measured impedance depends mainly on the test frequency and level. Therefore, each measurement requires that you specify the test signal to obtain results under defined conditions.

In addition to the frequency and level settings, e.g. to measure at a certain working point, you can define a measurement range. E.g., if you want to analyze the behavior of a component over a certain range. For measurements of coils or capacitors you can superimpose a current, or voltage bias, respectively.

We assume that you have set up the R&S LCX as described in [Chapter 4.1.4, "Setting up the R&S LCX"](#), on page 17. For basic information on setting up a measurement, including the test signal, see the example in ["Basic measurement steps"](#) on page 32. For details on the setting parameters, see [Chapter 8, "Instrument functions"](#), on page 69.

The following sections provide additional information to be considered for the specific measurements.

Depending on a bias required for your measurement, see [Chapter 6.3, "Configuring BIAS"](#), on page 60 on how to proceed.

Considerations for test signal configuration

- **Dependency of the selected impedance range and the low impedance measurement setting**

The impedance range depends on various settings, e.g., the range selection and the setting of the "LowZ" state.

The following overview explains the corresponding setting (in quotes) for the impedance in the expected range:

LowZ Mode > ON

- $\leq 10 \Omega$
"3 Ω ": measures values from 0 Ω to $\approx 3 \Omega$
- $> 10 \Omega$
"10 Ω ": measures all values but with limited accuracy
"30 Ω ": measures values from 30 Ω up to infinity

LowZ Mode > OFF

- $\leq 100 \Omega$
"3 Ω ": measures values from 0 Ω to $\approx 3 \Omega$
- $> 100 \Omega$
"100 Ω ": measures all values but with limited accuracy
"300 Ω ": measures values from 300 Ω up to infinity

To achieve best measurement results for the expected sample component, select the range as close to these limits as possible.

Examples for LowZ Mode > OFF, based on the range settings 3 Ω , 10 Ω , 30 Ω , 100 Ω , 300 Ω , 1 k Ω , 3 k Ω , ...:

- 1.2 Ω DUT > select 3 Ω range
- 3.1 Ω DUT > select 10 Ω range
- 150 Ω DUT > select 100 Ω range
- 310 Ω DUT > select 300 Ω range

Auto range

The auto range function selects the range that fits best automatically.

Currently we recommend that you execute measurements with automatic range selection only in "SLOW" measurement speed mode. This limitation will be fixed in future releases.

- **Dependency of the mains frequency and the test signal frequency for high impedances**

Measuring high impedances with a signal frequency of ≈ 100 Hz or 120 Hz lead to inaccurate readings as the mains frequency with usually 50 Hz / 60 Hz interferes the test signal frequency.

For an example on how to configure the test signal parameters, see ["Setting up the test signal"](#) on page 33.

6.3 Configuring BIAS

Referred to as biasing defines the method of superimposing a voltage or current on an existing voltage/current to shift the operating point of an electronic component to a specific value.

With the bias function of the R&S LCX, you can predefine a working DC bias that corresponds to an expected supply voltage, or (current) in a circuit. The function enables you, to measure the component sample under operating conditions, as expected for the intended use.

Example: DC dependency of inductors

To measure the current flowing through an inductor under real conditions, e.g., in power supplies, the current of approximately < 0.1 mA supplied by the R&S LCX is not sufficient. To achieve higher current, the most common method is to superimpose the AC with a DC current.

How to: "[Setting a current bias](#)" on page 62

Example: DC dependency of capacitors

Some capacitor types, e.g. electrolytic or tantalum capacitors, require a positive voltage bias to achieve accurate measurements of the component sample. To add the bias, you can use either the internal bias source, or supply the bias externally, e.g. using a power supply.

How to: "[Setting an external voltage bias](#)" on page 61

6.3.1 Internal bias voltage

Setting an internal voltage bias

To bias a capacitive component sample:

1. To select the capacitance measurement (DUT component type), press the [C] key.
2. Configure the test signal.
3. To select the parameters for measurement results display:
 - a) Select the measurement pair softkey in the upper left corner, to open the selection editor.
 - b) Select the parameters "Cp-D" (parallel capacitance, dissipation factor).
 - c) Confirm you selection.
 - d) Repeat the steps to select the second parameters, e.g. select "Cp-Rp" (parallel capacitance, parallel resistance).
4. To set the voltage bias value:
 - a) Press the [Bias Level] key.
 - b) Enter, e.g. 5 V using the keypad on the screen.
5. Confirm with .

6. Set up the measurement of the capacitance as described, e.g. in "[Measuring a capacitor](#)" on page 64.
7. To activate the voltage bias, press the [Bias Enable] key.
The lighting [Bias Enable] key indicates that bias is active.

Deactivating current bias

To turn off current bias:

1. Press the [Bias Enable] key.
The unlit [Bias Enable] key indicates that current bias is deactivated.
2. Remove the component sample.

6.3.2 External voltage bias

Option: R&S LCX-K108



The read-back voltage indicated on the "GUI" relies on the external power supply that must be activated. If the power supply output is deactivated or the connection is open, both, the test signal voltage monitor and the external bias voltage monitor can be inaccurate.

Setting an external voltage bias



For safety reasons, the instrument limits the test signal level to 2 V when using external voltage bias.

To bias a capacitive component sample with a DC voltage supplied by a power supply instrument:

1. **NOTICE!** Check all cables to make sure that they are not damaged.
Connect the safety sockets of the power supply with the cables of the same color to the corresponding External Voltage Bias at the [rear panel](#).
Note: The voltage at the + bias input must be positive regarding the - bias input. Do not apply a negative voltage at the bias input.
The output of the power supply must be floating against ground.
2. **NOTICE!** Risk instrument damage.
Too high external voltage bias can damage the circuitry of the instrument.
Do not apply a voltage higher than the specified 40 V DC to the external voltage bias inputs.
3. **NOTICE!** External BIAS requires constant voltage. Before applying the voltage, make sure that you have set the constant voltage mode in the supplying instrument. Refer to the user manual of the power supply.
Set the output voltage of the supplying instrument to constant voltage mode.

4. On the R&S LCX, select the capacitance measurement with the [C] key.
5. Configure the test signal.
6. To select the parameters for measurement results display:
 - a) Select the measurement pair softkey in the upper left corner, to open the selection editor.
 - b) Select the parameters "Cp-Rp" (parallel capacitance, parallel resistance).
 - c) Confirm you selection.
 - d) Repeat the steps to select the second parameters, e.g. select "Cp-D" (parallel capacitance, dissipation factor).
7. To select the external voltage bias:
 - a) Press the [settings] key.
 - b) Select the "Measurement" tab.
 - c) Set the "Voltage Bias" to "Ext."
8. Press the [home] key to return to the measurement window.
9. Set up the measurement of the capacitance as described, e.g. in ["Measuring a capacitor"](#) on page 64.
10. To activate the voltage bias, press the [Bias Enable] key.

The lighting [Bias Enable] key indicates that bias is active.

6.3.3 Current bias

Option: R&S LCX-K108

When measuring inductances, it is often necessary to superimpose a current bias on the test signal. You can set an internal current bias from 0 mA to 200 mA (DC), with a resolution of 1 mA. An external current bias is not supported.

Discharging a current bias before power off

1. **NOTICE!** Risk of instrument damage caused by overvoltage. When you power off the instrument with the mains power switch, make sure that the bias current is fully discharged.

When activated, deactivate the bias by pressing [Bias Enable] key.

A progress bar indicates that the discharging process is running.

2. Wait until the process has finished.

Setting a current bias

To bias an inductive component sample:

1. To select the inductance measurement (DUT component type), press the [L] key.
2. Configure the test signal.
3. To select the parameters for measurement results display:

- a) Select the measurement pair softkey in the upper left corner, to open the selection editor.
 - b) Select the parameters "Lp-Rp" (parallel inductance, parallel resistance).
 - c) Confirm your selection.
 - d) Repeat the steps to select the second parameters, e.g. select "Lp-Q" (parallel inductance, quality factor).
4. To set the current bias value:
 - a) Press the [Bias Level] key.
 - b) Enter a current value using the keypad on the screen.
 5. Confirm with .
 6. Set up the measurement of the inductance as described, e.g. in ["Measuring an inductor"](#) on page 65.
 7. To activate the current bias, press the [Bias Enable] key.
The lighting [Bias Enable] key indicates that bias is active.

Deactivating current bias

To turn off current bias:

1. Press the [Bias Enable] key.
The unlit [Bias Enable] key indicates that current bias is deactivated.
The R&S LCX starts the discharging process, as described in ["Discharging a current bias before power off"](#) on page 62.
2. Wait for the inductor or coil to discharge before disconnecting.
3. Remove the component sample.

7 Performing measurements

Using the R&S LCX and the corresponding test fixture, you can measure various component types. The following description explains how to proceed for measuring the typical components and what to consider.

Prerequisite of each measurement is the correction of the measurement setup to compensate stray capacities, residual inductances and residual resistances of test fixtures, leads and terminals. Therefore, the first steps are the open and short circuit correction, to minimize the measurement errors.



We assume that you have set up your measurement and aligned the instrument as described, e.g. in ["Basic measurement steps"](#) on page 32, including the example for measuring a resistor.

If there are specific steps to consider for measurements of certain components, we explicitly point them out in the corresponding descriptions.

Measuring a capacitor

This example refers to a measurement of a capacitor of 1000 μF , by using the Kelvin clip lead (R&S LCX-Z2), see [Chapter 6.1.2, "Kelvin clip lead"](#), on page 53. To measure this component sample, a DC voltage bias is necessary.

1. To select the capacitance measurement (DUT component type), press the [C] key.
2. Set the measurement frequency of the test signal, e.g., 1 kHz.
3. To select the parameters for measurement results display:
 - a) Select the measurement pair softkey in the upper left corner, to open the selection editor.
 - b) Select the parameters "Cp-D" (parallel capacitance, dissipation factor).
 - c) Repeat the steps to select the second parameters, e.g. select "Cp-Rp" (parallel capacitance, parallel resistance).

Note: In automatic mode, the LCX selects the "C-D" parameter automatically.

4. Set the bias voltage according to the measurement requirements, see [Chapter 6.3, "Configuring BIAS"](#), on page 60.
5. Connect the sample capacitor to the terminals of the test fixture:
 - a) Connect the black terminal to the negative (-) terminal of the capacitor.
 - b) Accordingly, connect the positive (+) terminal.

The measurement starts and you can see the readings on the screen.

As the preselected frequency of 1 kHz does not match to the intended working point of the capacitor, the measurement result shows approximately only "Cp \approx 900 μF ".

6. To achieve the expected result, set the frequency to 50 Hz.

The expected value is approximately 1000 μF \pm tolerance. The dissipation factor "D" is low, even close to 0, and the phase angle is $\approx -87^\circ$.

Decreasing the frequency reduces the loss angle, and thus the real components come closer to the ideal value.

Measuring an inductor

This example refers to a measurement of an inductor of 280 μH on a printed circuit board, by using the miniature SMD tweezers (R&S LCX-Z4), see [Chapter 6.1.4, "Test tweezers for SMD components"](#), on page 55.

1. To select the inductance measurement (DUT component type), press the [L] key.
2. Set the measurement frequency of the test signal, e.g., 500 kHz.
3. To select the parameters for measurement results display:
 - a) Select the measurement pair softkey in the upper left corner, to open the selection editor.
 - b) Select the parameters "Ls-Q" (series inductance, quality factor).
 - c) Repeat the steps to select the second parameters, e.g. select "Z- Θ " (impedance, phase angle).
4. Carefully contact the miniature tweezers of the test fixture to the sample inductor on the circuit board.
5. Hold the tweezers closed during measurement.

The measurement starts and you can see the readings on the screen.

The expected result is approximately "Ls \approx 280 μH " \pm tolerance. The phase angle "Z- Θ " \approx +70°.

Measuring the primary or secondary inductance of a transformer

This example refers to a measurement of a transformer with the test fixture (R&S LCX-Z5), see [Chapter 6.1.5, "Test fixture with cables for transformer components"](#), on page 56.

A transformer measurement often leads to varying measurement results due to iron core losses and to the unknown state of the premagnetized core. The sample component depends on both, the frequency and the measurement voltage. Varying the frequency causes changes in magnetization and iron core losses, which impact the phase angle, and an increasing measurement voltage leads to higher impedance.

This measurement on the transformer, also considered as "open" measurement, corresponds to the measurement of a single coil.

To measure the primary or secondary inductance:

1. For inductance measurements, press the [L] key.
2. Set the measurement frequency, e.g. the mains frequency for a mains transformer.
3. Select the parameters for measurement results display as described under ["Measuring an inductor"](#) on page 65.
4. To measure the parameters of a transformer coil:

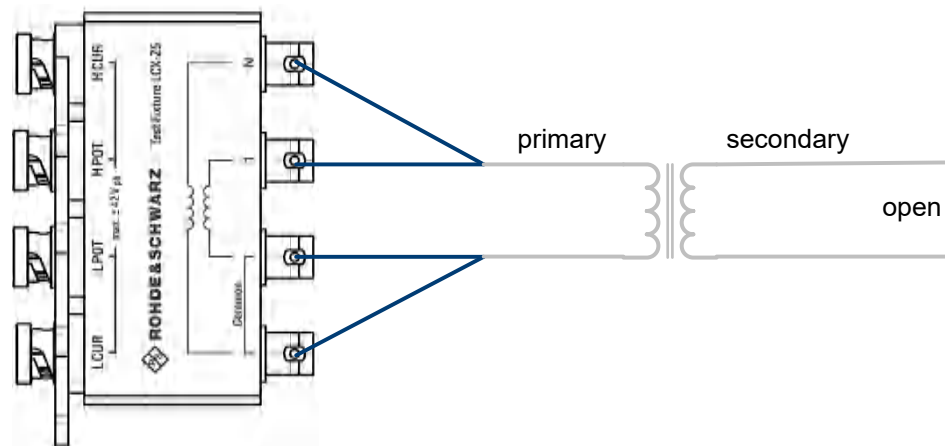

Figure 7-1: Primary inductance measurement

- a) Connect the "Common" test leads of the corresponding circuit to one terminal of the transformer winding to be measured.
- b) Connect both, the "1" and the "N" test leads to the other terminal of the winding to be measured.
- c) Leave the second winding of the transformer open.

To measure the secondary inductance of the transformer, connect the secondary winding to the R&S LCX-Z5 and leave the primary winding open.

Measuring the transformer ratio and the mutual inductance of a transformer

This example refers to a measurement of a transformer with the test fixture (R&S LCX-Z5).

To measure the mutual inductance, both windings are connected to the test fixture.

1. To select the transformer measurement, press the [Transformer] key.
2. Set the measurement frequency, e.g. the mains frequency for a mains transformer.
3. To select the parameters for measurement results display:
 - a) Select the measurement pair softkey in the upper left corner, to open the selection editor.
 - b) Select the parameters "N- Θ d" (transformer ratio, phase angle).
 - c) Repeat the steps to select the second parameters, e.g. select "M- Θ d" (inductance, phase angle).
4. To measure the parameters of a transformer circuit:
 - a) Connect both, the "1" and the "Common" test leads of the test fixture to the primary winding of the transformer.
 - b) Connect both, the "N" and the "Common" test leads to the secondary circuit of the transformer. Observe the polarity of the windings, if known. Both "Common" test leads are equivalent.

The measurement starts and you can see the readings on the screen.

The transformer ratio "N-Θd" is the ratio between measured primary voltage and measured secondary voltage.

The mutual inductance "M-Θd" is calculated from measured primary current "I_p" and the measured secondary voltage "V_s" as follows (Z is a virtual complex impedance value):

$$Z = \frac{V_s}{I_p}$$

$$M = \frac{\text{Im}\{Z\}}{\omega}$$

Z = virtual impedance
 V_s = measured voltage in secondary circuit
 I_p = measured current in primary circuit
 M = mutual inductance
 Im{Z} = imaginary part of impedance
 ω = angular frequency

If Θd is between 90° and 270°, the transformer inverts the signal. In this case, the "M" result can display "RANGE" instead of a value. Invert the connection of one of the windings to obtain a non-inverting setup and a valid measurement result for "M".

Measuring the leakage inductance of a transformer

This example refers to a measurement of a transformer with the test fixture (R&S LCX-Z5). You can also use only the included standard cables for inductance measurements without the test adapter.

The connections and measurement settings are the same as for primary inductance measurement, except that the secondary winding is shorted.

1. To select the inductance measurement (DUT component type), press the [L] key.
2. Set the measurement frequency, e.g. the mains frequency for a mains transformer.
3. Select the parameters for measurement results display as described under "[Measuring an inductor](#)" on page 65.
4. Short-circuit the secondary winding of the transformer.

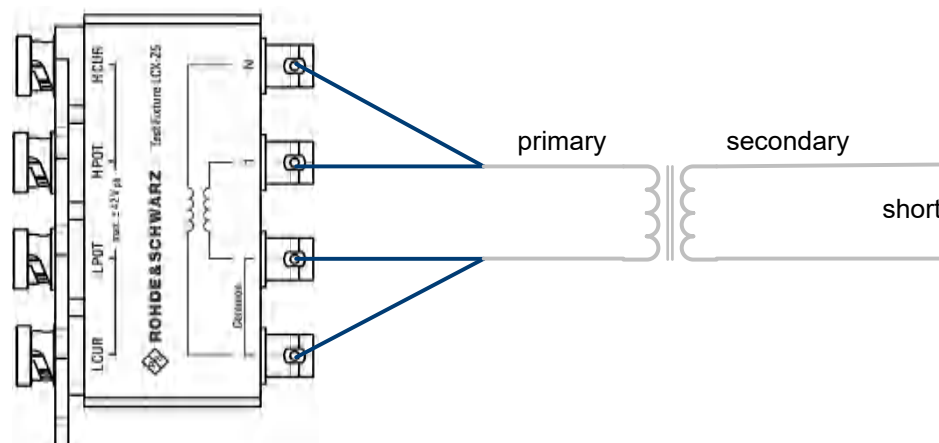

Figure 7-2: Leakage inductance measurement

The inductance value of the primary winding measured with secondary winding shorted corresponds to the primary leakage inductance.

To measure the secondary leakage inductance, connect the secondary winding instead of the primary to the R&S LCX-Z5 and short circuit the primary winding.

8 Instrument functions

8.1 Measurement mode

The R&S LCX LCR meter starts and executes a measurement according to the used measurement mode:

- **Continuous**
The instrument starts the measurement and executes it continuously.
Using this mode enables you to collect a series of measured values, e.g. to determine value deviations of the component sample, or to determine tolerance ranges.
- **Triggered**
The instrument starts a measurement cycle controlled by a trigger event.
You can initiate a trigger event on the instrument directly or with a remote control command, or you can use an externally applied trigger signal.
Using the manual trigger mode, you can e.g., measure a sample component at a series of defined working points, by switching to the working points between the measurements.

Combined with the logging function, you can record the readings and export them for subsequent evaluation, see [Chapter 8.8.3, "Logging"](#), on page 97.

8.1.1 Measurement mode settings

Access:

1. Press the [Meas. Mode] key at the front panel.
If the key lights up, the R&S LCX switches to manual trigger mode and displays the recently measured results.
2. Pressing the [Meas. Mode] key again switches back to continuous measurement.
The R&S LCX displays the readings continuously and turns off the key.

How to: see [Chapter 8.1.2, "Working with the measurement modes"](#), on page 70

Measurement mode

Executes the measurement either continuously or initiated by specified trigger events

Continuously Starts the measurement and continues after a completed measurement cycle automatically.

Remote command:

`MEASure:MODE CONTInuous`

Manually triggered

Press the [Trig.] key at the front panel.

After one measurement cycle, the measurement stops and waits for the next manual trigger event.

Remotely triggered

Select the measurement mode and send the trigger command.

Remote command:

`MEASure:MODE TRIGgered`

*TRG on page 180

After one measurement cycle, the measurement stops and waits for the next trigger command.

Externally triggered

You have two options to apply an external trigger signal:

- Trigger Input at the rear panel
Assign an external trigger signal to the [Trigger Input](#) at the [rear panel](#).
The falling edge of the digital signal triggers the measurement at the TTL level of +5 V.
- Trigger signal input of the binning interface (option: R&S LCX-K107)
The binning interface provides the digital trigger signal at pin 9, see [Binning > Assignment of the binning interface](#).
The rising edge of the signal triggers the measurement.

After one measurement cycle, the measurement stops and waits for the next trigger signal. Signals received at the trigger input during a measurement cycle take no effect until the current cycle is completed. For details on the signal level and specification of the interfaces, see section "Digital trigger and control interfaces" in the data sheet.

8.1.2 Working with the measurement modes

Using the continuous measurement mode

To measure a component sample in the default continuous measurement mode:

1. If the [Meas. Mode] key at the front panel lights up, press it to switch to continuous mode.
The R&S LCX measures continuously with updates according to selected measurement speed, see ["Measurement Speed"](#) on page 78.
2. Press the [Hold] key to keep the range setting constant.
The [Hold] key lights up. You can use the function, e.g. to measure a batch of the same components.
3. To reactivate automatic range selection, press the [Hold] key again.
The key no longer lights up.

Using the manual trigger mode

This example describes the steps to be taken, for measuring a component sample at a series of working points, triggered manually:

1. Press the [Meas. Mode] key at the front panel.
The key lights up. The R&S LCX stops a continuous measurement and waits for a trigger event.
2. Press the [Trig.] key at the front panel, to start the measurement (Remote command: *TRG on page 180).
The R&S LCX executes one measurement cycle. When completed, it is waiting for the next trigger signal.
3. Optionally, configure the next working point.
4. Repeat step [step 2](#) to [step 3](#) until you have executed the measurement at all working points.

8.2 Display mode

The R&S LCX indicates the measurement results numerically and graphically.

Based on the measured values, the instrument calculates and derives the non-measurable parameters for display.

8.2.1 Display mode settings

Access:

1. To select the measurement result display, press the [home] key at the front panel.
The numeric display shows the readings of four-measurement pairs by default.

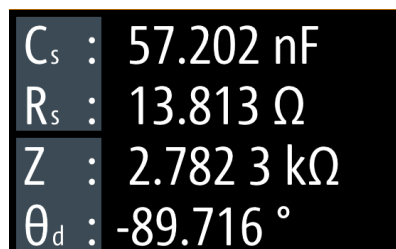

Figure 8-1: Four measurement pairs display

2. Press the [Display Mode] key.
3. Pressing the key repeatedly, toggles between this view, the view with one measurement pair and the graphical view.

Note: You can also access the graphical display in the "Functions" tab, see [Chapter 8.8, "Specific instrument functions"](#), on page 89.

The results display shows the measurement results of the currently selected parameters. The softkeys enable you to select the parameters for display according to your measurement.

The required remote commands are described in: [Chapter 11.10, "FUNCTION subsystem"](#), on page 197

How to: see [Chapter 8.2.2, "Configuring the main view"](#), on page 72.

<measurement pair>	72
<measurement accuracy>	72

<measurement pair>

Selects the measurement parameters.

Depending on the type of component sample, the R&S LCX adjusts the list of parameters automatically.

Remote command:

`FUNCTION:IMPedance[:TYPE]` on page 200

<measurement accuracy>



The test signal monitor indicates accuracy of the recent measurement.

Remote command:

`MEASure:ACCuracy?` on page 212

8.2.2 Configuring the main view

Selecting the parameters for display

To select the measurement parameters in the numeric view:

1. At the front panel, press the [home] key.
2. Select the parameter pair softkey in the upper left corner of the screen, to open the selection editor.
3. Select the corresponding measurement pair.
4. Confirm the selection.
5. Select the second measurement pair accordingly.

8.3 Measurement functions

The hardkeys provided in the function panel at the front select the measurement component type.

[Functions \[hardkeys\]](#)..... 73

Functions [hardkeys]

Selects the type of component sample to be measured.

Remote command:

[FUNction:MEASurement:TYPE](#) on page 201

8.4 Test signal functions

In this context referred to as test signal parameters, these parameters consider all settings the test signal is composed of. As the core parameters of a measurement, the R&S LCX provides the access to these settings directly on the screen, and the settings and function keys.

8.4.1 Test signal settings

With the "Settings" functions, you can define the main characteristics of the test signal.

Access:

1. For accessing the core parameters frequency, level, impedance range and bias, you have the following options:
 - Select the softkey of the corresponding parameter on the screen, e.g. "Frequency:".
 - Press the hardkey of the corresponding parameter at the front panel, e.g., [Freq.].

On-screen keypads open providing the corresponding entry fields for setting the value and the unit of the selected parameter.

2. Enter the value and unit accordingly.
3. Confirm with .

The required remote commands are described in:

- [Chapter 11.4, "Test signal commands"](#), on page 180
- [Chapter 11.10, "FUNCTION subsystem"](#), on page 197
- [Chapter 11.5, "BIAS subsystem"](#), on page 183

[Frequency: / \[Freq.\]](#)..... 74
[Level: / \[Level\]](#)..... 74
[Range: / \[Range\]](#)..... 74
[Current Bias: / \[Bias Level\]](#)..... 74

Voltage Bias: / [Bias Level].....	74
[Comp.].....	74
[Bias Enable].....	74

Frequency: / [Freq.]

Sets the test signal frequency.

Remote command:

`FREQuency[:CW]` on page 182

Level: / [Level]

Sets level of the AC test signal.

To select the parameter for the level setting, see ["Test Signal Type"](#) on page 78.

See ["About measurement parameters"](#) on page 75.

"Voltage Level" Sets the signal voltage.

"Current Level" Sets the signal current.

Remote command:

`VOLTage[:LEVel]` on page 182

`CURRent[:LEVel]` on page 182

Range: / [Range]

Selects the measurement range.

Remote command:

`FUNction:IMPedance:RANGe:AUTO` on page 199

`FUNction:IMPedance:RANGe[:VALue]` on page 199

Current Bias: / [Bias Level]

Sets the internal the current preload.

Remote command:

`BIAS:CURRent[:LEVel]` on page 183

Voltage Bias: / [Bias Level]

Sets the value of the internal voltage preload.

Remote command:

`BIAS:VOLTage[:LEVel]` on page 184

[Comp.]

Accesses the "Open/Short/Load Correction" dialog, see [Chapter 8.6.1, "Measurement parameter settings"](#), on page 77.

[Bias Enable]

Activates the internal voltage or current bias.

Remote command:

`BIAS:STATe` on page 184

8.5 Measurement control functions

With the measurement control hardkeys at the front panel, you can control a running measurement.

Access:

- ▶ Press the corresponding key ([Auto], [Hold] or [Trig.]) at the front panel.
Repeated pressing a key turns the function on and off (toggle).

The required remote commands are described in [Chapter 11.10, "FUNCTION subsystem"](#), on page 197.

[Auto]	75
[Hold]	75
[Trig.]	75

[Auto]

Selects the impedance range automatically, according to the connected sample component.

Note: If you have fixed the impedance range with [\[Hold\] > ON](#), automatic selection is blocked.

Remote command:

[FUNCTION:IMPedance:RANGe:AUTO](#) on page 199

[Hold]

Freezes the currently set range.

When activated, the R&S LCX displays the prefix "Hold:" at the range value.

Remote command:

[FUNCTION:IMPedance:RANGe:HOLD](#) on page 199

[Trig.]

Triggers one measurement cycle manually.

Remote command:

[*TRG](#) on page 180

8.6 Measurement parameters

The settings described in this section refer to parameters that you can configure for your specific measurement in addition to the test signal, measurement mode, or measurement functions.

About measurement parameters

Aspects on the measurement parameters:

- Measurement speed

The measurement speed defines the number of measurements in one second when triggered continuously.

Impact of measurement speed and accuracy:

The measurement accuracy decreases with increasing speed, i.e. the higher the number of measurements per second you perform, the lower the measurement accuracy you can expect.

At low test signal frequencies, the R&S LCX reduces the measurement speed automatically.

See "[Measurement Speed](#)" on page 78.

- Cable length
Any cable covers inductive and capacitive parts, which depend in particular on the cable length. As these characteristics are considered as parasitics, they distort a measurement result. The cable length correction compensates these parasitic transmission characteristics.
As a rule, make sure to keep the connection between the R&S LCX and the component under test as short as possible, even more, the length must not exceed 1 m.
When using test fixtures with cables, the cable length correction function reduces the impact of cable losses to a minimum, and thus compensates the parasitic transmission characteristics. See "[Cable Length](#)" on page 78 for the corresponding setting.
- Test signal type
The R&S LCX provides either the signal voltage or the signal current for setting the test signal level, see "[Test Signal Type](#)" on page 78. If the signal current is defined, the set value corresponds to the maximum current that flows when short-circuited.
- External voltage bias
See "[Voltage Bias](#)" on page 79.
- Source impedance
By default, the R&S LCX measures with an output impedance of 100 Ω over the entire measurement range ("High Z"). For certain applications, e.g., the measurement of low-impedance components, you can set the output impedance to 10 Ω ("Low Z").
See "[Source Impedance](#)" on page 79.
- Open/Short/Load correction
The numerous types of passive components with a wide variety of shapes require suitable test fixtures, which in turn are equipped with or without test leads, clips or probes, etc. As a result, measurement errors due to the test setup and used equipment can occur. In particular, residual impedance, admittance, stray capacities or environmental factors can impact the measurement.
Using the open/short/load correction technique, the R&S LCX compensates such impacts.
The open/short correction, e.g. offsets residuals of test fixtures. For complex errors, you can use the load correction function, which refers to a reference component, e.g., a reference resistor. We recommend that you execute Open/Short and Load correction when the measurement setup covers cable lengths other than standard cables, user-specific test fixtures or additional passive circuits or components, etc.
- Auto function

The R&S LCX determines the component type of the DUT automatically, based on the measured impedance and phase angle. The auto function allows you to set the threshold values for the phase angle and the serial or parallel separation point.

The measurement principle distinguishes between pure and mixed measurement pairs, i.e. measurement pairs with only real values (Rs-X,...), and measurement pairs with additional imaginary components (LS-R).

Figure 5-1 under [Measurement basics](#) illustrates the relations.

See "Auto Function" on page 79.

8.6.1 Measurement parameter settings

The "Measurement" parameters define additional settings that relate, e.g., to the measurement conditions.

Access:

1. Press the [settings] key at the front panel.
2. Select the "Measurement" tab.

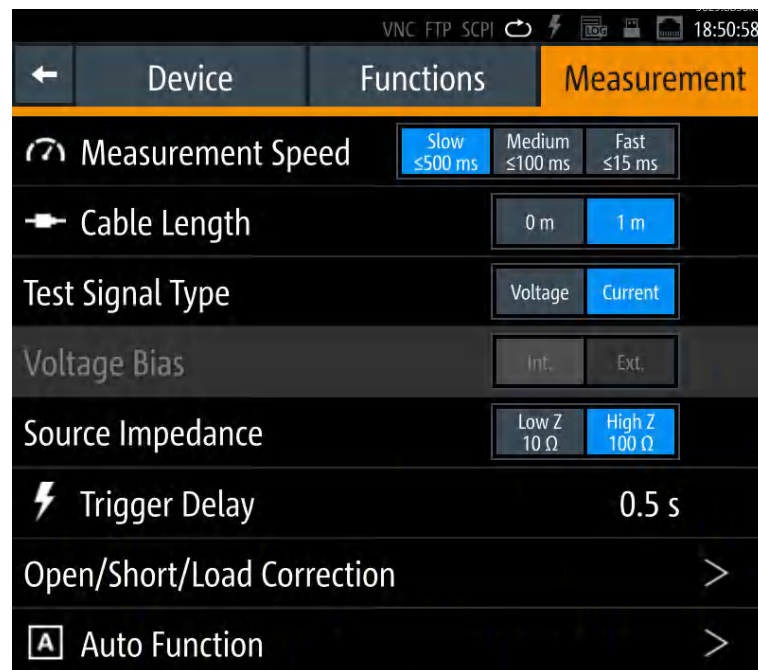

Figure 8-2: Measurement settings dialog

The dialog enables you to configure, measurement conditions, e.g. cable length from the connected test fixture, external bias of impedance measurement range.

The required remote commands are described in:

- [Chapter 11.5, "BIAS subsystem"](#), on page 183
- [Chapter 11.6, "CORRection subsystem"](#), on page 185
- [Chapter 11.10, "FUNction subsystem"](#), on page 197

How to: see [Chapter 8.6, "Measurement parameters"](#), on page 75

Measurement Speed.....	78
Cable Length.....	78
Test Signal Type.....	78
Voltage Bias.....	79
Source Impedance.....	79
Trigger Delay.....	79
Open/Short/Load Correction.....	79
Auto Function.....	79
└ Purity Angle.....	79
└ Serial/Parallel Separation Point.....	80

Measurement Speed

Selects the speed of the measurement repetitions per second.

Using this speed parameter requires that you have set continuous triggering, see [Chapter 8.1.1, "Measurement mode settings"](#), on page 69.

"Fast: ≤15 ms"

Number of measurements: ≈ 15 / s.

"Medium: ≤100 ms"

Number of measurements: ≈ 10 / s.

"Slow: ≤500 ms"

Number of measurements: ≈1.5 / s.

Remote command:

[APERTure](#) on page 181

Cable Length

Selects the length of the leads to the connected test fixture, i.e. to the DUT.

"1 m"

Considers the cable losses of the leads from the test fixture to the R&S LCX.

Required for the BNC-to-BNC extension (option R&S LCX-Z11), and for test adapters with leads to the DUT. E.g., if you use other adapters than the test adapters provided by Rohde & Schwarz.

"0 m"

Does not consider cable losses.

Use this setting for test adapters that are directly connected to the R&S LCX, i.e. the test fixtures R&S LCX-Z1/-Z2/-Z3/-Z4/-Z5.

Remote command:

[CORRection:LENGth](#) on page 187

Test Signal Type

Selects the parameter for the setting the level of the test signal level.

The setting parameter for the test signal level on the measurement window varies according to the selection, see ["Level: / \[Level\]"](#) on page 74.

"Voltage"

Enables you to set the signal level in volt.

"Current"

Enables you to specify the signal current.

Remote command:

[CORRection:LENGth](#) on page 187

Voltage Bias

Activates the use of an external voltage bias, if supplied.

Note: Make sure that the external DC voltage source supplies a constant voltage bias to avoid distortion of the measurement results due to interference.

To set the value, see [Chapter 6.3.2, "External voltage bias"](#), on page 61.

Remote command:

[BIAS:STATe](#) on page 184

Source Impedance

Selects the output impedance for the measurement.

"Low Z 10 Ω " Measures with 10 Ω output impedance.

"High Z 100 Ω " Measures with 100 Ω output impedance.
(default)

Remote command:

[FUNction:IMPedance:SOURce](#) on page 200

Trigger Delay

Sets the delay between the trigger event and the actual start of the measurement.

You can increase or decrease the delay in steps of 100 ms increment.

Remote command:

[MEASure:TRIGger:DELay](#) on page 213

Open/Short/Load Correction

Accesses the dialog for activating the correction functions, see [Chapter 8.6.2, "Open/short/load correction settings"](#), on page 80.

Auto Function

Opens the dialog for configuring the auto function parameters.

During the measurement, the auto function refers to the purity angle that is set in the instrument, and the measured value. Concerning the separation point, the function determines the equivalent circuit based on the estimated absolute value of Z.

See also:

- [About measurement parameters > Auto function](#)
- [Measurement basics > Figure 5-1](#)

Purity Angle ← Auto Function

Sets the switching point of the phase angle.

Based on the set purity angle referred to as A, and the measured angle M, the auto function assumes the following components:

Angle	Component
$-A \leq M \leq A$	pure resistance
$90^\circ - A \leq M \leq 90^\circ$	pure inductance
$A - 90^\circ \leq M \leq -90^\circ$	pure capacitance
$A < M < 90^\circ$	resistance and inductance
$-A < M < -90^\circ$	resistance and capacitance

Serial/Parallel Separation Point ← Auto Function

Sets the threshold for the function to switch from serial to parallel impedance measurement, according to the equivalent circuit.

Based on the set separation point S , and the measured impedance Z , the auto function assumes the following equivalent circuits:

Impedance	Equivalent circuit
$0 \leq Z \leq S$	serial measurement
$S < Z < \text{range}$	parallel measurement

8.6.2 Open/short/load correction settings

The correction dialog enables you to activate and execute the correction techniques provided by the instrument.

Depending on the connected test fixture and the type of component sample to be measured, refer to the description on how to execute the corresponding corrections, see [Chapter 6.1, "About test fixtures"](#), on page 52.

Access:

1. Press the [settings] key at the front panel.
2. Select the "Measurement" tab.
3. Select "Open/Short/Load Correction".

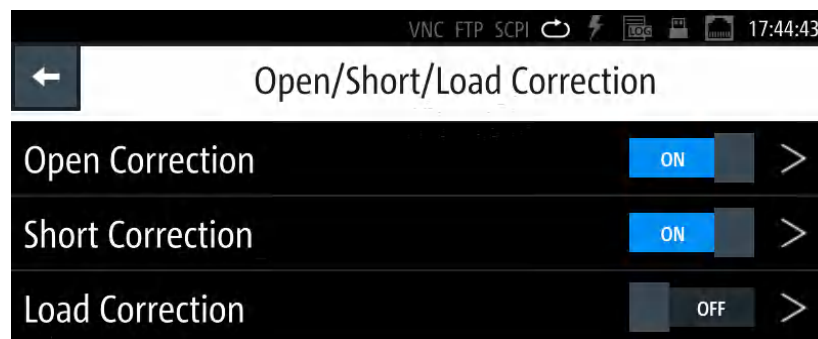

Figure 8-3: Open/Short/Load correction dialog

In this menu, you can activate the corresponding corrections directly, and access the subdialogs to configure and execute the corrections.

The required remote commands are described in: [Chapter 11.6, "CORRection sub-system"](#), on page 185

How to: see [Chapter 8.6.3, "Performing open/short/load correction"](#), on page 83.



If you need to perform the open and short correction frequently, you can assign these functions to the [★ (User)] key and execute them with just one keystroke, see [Chapter 9.3, "User button"](#), on page 122.

Settings

Open/Short/Load Correction Enabled	81
Start Short/Open Correction (Spot)	81
Start Short/Open Correction (Full)	82
Start Load Correction (Spot)	82
Reference Load R	82
Reference Load X	82

Open/Short/Load Correction Enabled

Enables the corresponding correction function.

To start a correction process, select the corresponding [Start Short/Open Correction \(Full\)](#) or [Start Short/Open Correction \(Spot\)](#) entry of the respective correction.

Remote command:

`CORRection:SHORT:STATe` on page 188

`CORRection:OPEN:STATe` on page 188

`CORRection:LOAD:STATe` on page 187

Start Short/Open Correction (Spot)

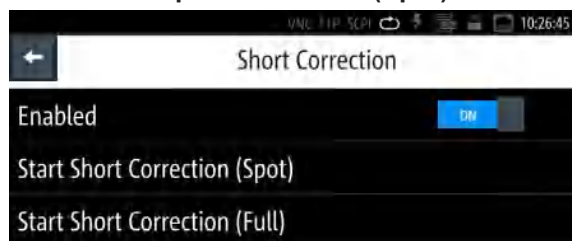

Figure 8-4: Start correction at one working point by the example of the short correction dialog

Executes the correction at a defined working point.

The function requires that you have activated the state, see ["Open/Short/Load Correction Enabled"](#) on page 81, and set the test fixture to open, or short accordingly.

How to: see ["Aligning the instrument on a dedicated working point"](#) on page 84

Remote command:

`CORRection:SPOT<Spot>:OPEN[:EXECute]` on page 189

`CORRection:SPOT<Spot>:SHORT[:EXECute]` on page 190

Start Short/Open Correction (Full)

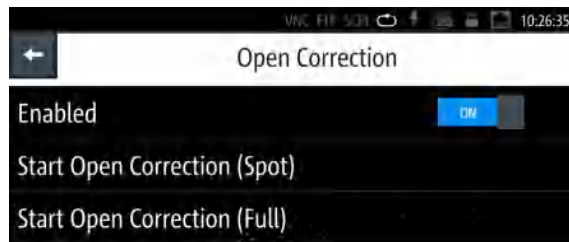

Figure 8-5: Start correction on all frequencies by the example of the open correction dialog

Executes the corresponding correction over the entire measurement range.

The function requires that you have activated the state, see "[Open/Short/Load Correction Enabled](#)" on page 81, and set the test fixture to open, or short accordingly.

How to: see "[Aligning the instrument on all frequencies](#)" on page 83

Remote command:

`CORrection:OPEN[:EXECute]` on page 188

`CORrection:SHORT[:EXECute]` on page 188

Start Load Correction (Spot)

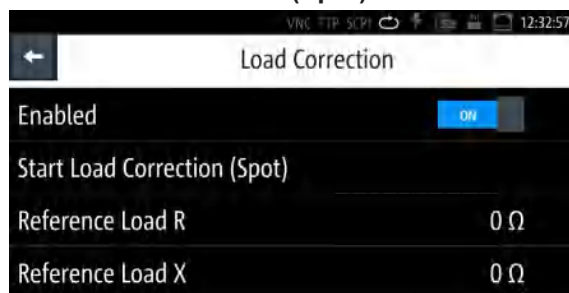

Figure 8-6: Start load correction at one working point with specified reference value

Executes the load correction at a defined working point.

The function requires that you have activated the state, see "[Open/Short/Load Correction Enabled](#)" on page 81 and specified the real resistance and the complex reactance of the reference component. The R&S LCX, prompts you to connect the specified load.

How to: see "[Aligning the instrument using load correction](#)" on page 85.

Remote command:

`CORrection:SPOT<Spot>:LOAD[:EXECute]` on page 189

Reference Load R

Sets the resistance value as reference for the load correction.

Remote command:

`CORrection:SPOT<Spot>:LOAD:STANDARD` on page 189

Reference Load X

Sets the impedance value as reference for the load correction.

Remote command:

`CORRection:SPOT<Spot>:LOAD:STANdard` on page 189

8.6.3 Performing open/short/load correction

The following procedures provide a brief overview of the steps required to perform the corrections. They point out special features, such as load correction.

Previous steps

We assume that you have prepared the measurement as follows:

1. You have set up and turned on the R&S LCX, see [Chapter 4.1, "Preparing for use"](#), on page 16.
2. You have set the R&S LCX to an initial state, see ["Setting the initial state"](#) on page 32.
3. You have connected the test fixture, see [Chapter 4.1.9, "Connecting a test fixture"](#), on page 23.

Tip: For information on how to handle the connection pins of the individual test fixtures during correction, see [Chapter 6.1, "About test fixtures"](#), on page 52.

Aligning the instrument on all frequencies

To execute full correction:

1. Set up the test signal, see ["Setting up the test signal"](#) on page 33.
2. If you are using the BNC-to-BNC extension (option R&S LCX-Z11), consider the cable length:
 - a) Press the [settings] key at the front panel.
 - b) Select the "Measurement" tab.
 - c) Set "Cable Length" to "1 m".
3. Set the "Source Impedance" as required for your measurement, set e.g. "High Z 100".
4. Select "Open/Short/Load Correction".
5. To execute the open and short correction, proceed as described in ["Aligning the instrument on all frequencies"](#) on page 34.

During full correction, i.e. alignment on all frequencies, the R&S LCX executes the correction on the following frequencies, according to the set source impedance and correction mode:

Table 8-1: Frequency sequences for open and short correction





Fre- quency	Open correction		Short correction		
	High Z 100 Ω	High Voltage > 2V	Low Z 10 Ω	High Z 100 Ω	High Voltage > 2V
DC	--	--	x	x	x
4 Hz	x	x	x	x	x
8 Hz	x	x	x	x	x
16 Hz	x	x	x	x	x
100 Hz	x	x	x	x	x
1 kHz	x	x	x	x	x
10 kHz	x	x	x	x	x
30 kHz	x	x	x	x	x
50 kHz	x	x	x	x	x
100 kHz	x	x	x	x	x
150 kHz	x	x	x	x	x
200 kHz	x	x	x	x	x
300 kHz	x	x	x	x	x
500 kHz	x	x	x	x	x
1 MHz	x	x	x	x	x
2 MHz	x			x	
3 MHz	x			x	
4 MHz	x			x	
5 MHz	x			x	
6 MHz	x			x	
7 MHz	x			x	
8 MHz	x			x	
9 MHz	x			x	
10 MHz	x			x	

The corresponding icon in the measurement status bar turns white, indicating that compensation is active, see "[Measurement status bar](#)" on page 39.

Aligning the instrument on a dedicated working point

To perform a spot correction:

1. To set the working point:
 - a) Press the [Freq.] key at the front.
 - b) Enter the test signal frequency, e.g. 10 kHz using the keypad on the screen.

- c) Confirm your setting .
 - d) Press the [Level] key.
 - e) Enter the level, e.g. 1.3 VRMS.
 - f) Confirm the setting .
 - g) Press the [Range] key.
 - h) Select the expected impedance, e.g. 3 kΩ.
2. Press the [Comp.] key at the front panel.
The "Open/Short/Load Correction" dialog opens.
3. Perform an open spot correction, in this example described for the axial/radial lead type test fixture (R&S LCX-Z1):
- a) Select "Open Correction".
 - b) Turn  "Enabled".
 - c) Select "Start Open Correction (Spot)".
The R&S LCX displays a message that prompts you to open the terminals.
 - d) If you have inserted any component, remove it from the slots of the test fixture.
Note: If you are using another test fixture, take care that you set the required position. For example, Kelvin clamps require the same position as expected for the measurement, or the spacing between SMD pins must correspond to the size of the measurement sample.
 - e) Confirm the message with "Yes".
The R&S LCX displays a progress message until the correction is completed.
The open spot correction takes only a few seconds.
- The short correction takes about 2 minutes.
4. Perform a short spot correction:
- a) Select "Short Correction".
 - b) Turn  "Enabled".
 - c) Select "Start Short Correction (Spot)".
The R&S LCX displays a message that prompts you to short-circuit the terminals.
 - d) Short-circuit the contacts, i.e. insert the supplied short circuit plate into the slots of the test fixture.
 - e) Confirm the message with "Yes".
The R&S LCX displays a progress message until the correction is completed.
The short spot correction takes only a few seconds.

The corresponding icon in measurement status bar turns blue and shows a dot in the icon. Blue color denotes that spot compensation is active, see "[Measurement status bar](#)" on page 39. The dot indicates that the spot correction applies to the current working point only. If you set another frequency, the compensation is invalid and the icon turns gray.

Aligning the instrument using load correction

For executing load correction, the R&S LCX requires a reference value of any component to derive the results of the following measurements.

The component can be a resistor or a capacitor with known impedance. I.e. a component that is similar in value and shape to the samples you want to measure, or one of the series of samples used as default (standard) value.

Prerequisite is also, that you execute the open and short correction before.

1. Execute the short and open spot corrections, as described in "[Aligning the instrument on a dedicated working point](#)" on page 84.
2. Select "Load Correction".
3. Set the resistance, and, the reactance values of the reference component, e.g.:
 - a) Set "Reference Load R" = $10\text{ k}\Omega$
 - b) Set "Reference Load X" = $0\ \Omega$
4. Perform a load spot correction:
 - a) Select "Load Correction".
 - b) Turn  "Enabled".
 - c) Connect the reference component.
 - d) Select "Start Load Correction (Spot)".

8.7 Configuration preset

The configuration preset function enables you to assign up to three measurement configurations as favorites to the preset keys. By selecting a favorite, the R&S LCX changes all predefined parameter settings at once, and thus provides to switch quickly between different measurement settings and conditions.

About configuration preset

Aspects on the functionality:

- Included parameters
 - The configuration preset comprises almost all parameters relevant for a measurement:
 - Test signal: frequency and level
 - Measurement function: L/C/R/Transformer
 - Measurement speed
 - Cable length
 - DC voltage and low current states
 - Open/Short/Load correction states
 - The configuration preset excludes measurement range, value and bias settings.
- Indication and selection of a configuration presets
 - One of the three presets is always active, while the other two are inactive, as shown on the screen:
 - Indication

The **Preset 1** (configuration preset) indicator displays the currently active configuration preset.

The different colors of each preset emphasize the display.

– Selection

The **2 3** (preset configuration) softkeys on the screen enable you to activate a preset directly.

The R&S LCX provides always the two selectable, i.e. the currently inactive preset softkeys. When you switch to another configuration preset, it adjusts the labels of the keys and the indicator according to the selection.

When switching to another preset or changing setting parameters, consider that it can last up to 10 seconds to be sure that all settings are saved.

- Persistency of configuration presets

The R&S LCX saves a configuration in the selected, i.e. active configuration preset. It saves the settings on the internal filesystem, which is not accessible. After power off, the instrument reboots with the recently active configuration preset.

- Saving options

The settings of the active configuration preset are also included in the "Save/Recall" function and saved in the *.rds file. When you recall a settings file, the R&S LCX restores the configuration preset from the file to the same memory slot ("Preset 1, 2 or 3") it was created on. It is not possible to assign it to another slot.

8.7.1 Configuration preset settings

Access:

- ▶ Press the [home] key at the front panel.

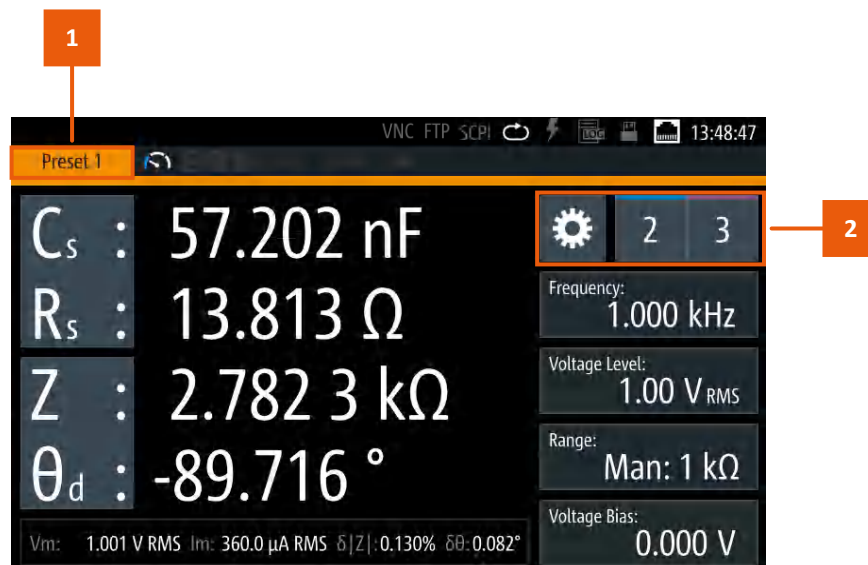





Figure 8-7: Configuration preset indication

- 1 = Configuration preset indicator
 2 = Settings softkey and configuration preset softkeys

The configuration preset softkeys enable you to assign up to three different measurement configurations for quick access.

How to: see [Chapter 8.7.2, "Using the configuration preset function"](#), on page 88

 Preset 1, Preset 2, Preset 3	88
 1 ,  2 ,  3	88
 (measurement settings)	88

Preset 1, Preset 2, Preset 3

Indicates the active configuration preset.

1, **2**, **3**

Selects one out of three configuration preset memory slots.

(measurement settings)

Accesses a dialog for configuring the parameters that are relevant for the measurement.





See [Chapter 8.6, "Measurement parameters"](#), on page 75.

8.7.2 Using the configuration preset function

You can assign up to three configurations relevant for a measurement as favorites, to skip quickly between different settings, or to repeat tests with the same settings.

Creating user defined configuration presets

To create and save a configuration preset:

1. Select the configuration preset memory slot, e.g. .
2. Select  to open the parameter settings dialog.
3. Set the corresponding parameters.
4. Press the home to return to the measurement window.
5. To preset additional configurations, select another configuration preset slot, e.g.  or .
6. Repeat [step 2](#) to [step 5](#)) until you have assigned all preset configurations.

Switching the configuration during a measurement

We assume, that you have setup measurement and a DUT applied.

To execute a measurement with changing configuration:

1. Select the measurement function required for the measurement.
2. Set the test signal parameters.

3. Select the measurement parameters for results display.
4. Assign the configuration presets as described in "[Creating user defined configuration presets](#)" on page 88.
5. Start the measurement, e.g. using configuration preset **3**.
6. Select, e.g. **1** to continue the measurement with different settings.

While the measurement is running, you can switch between the preset configurations arbitrarily.

8.8 Specific instrument functions

Specific instrument functions describes the features the instrument provides apart from the basic measurement functions. Some specific functions require that the corresponding options are installed.

Access:

1. Press the [settings] key at the front panel.
2. Select the "Functions" tab.



Figure 8-8: Functions menu

3. Select the corresponding function in the list.
 - [Live chart viewer](#)..... 89
 - [Logging chart viewer](#)..... 93
 - [Logging](#)..... 97
 - [Dynamic impedance measurement](#)..... 102
 - [Binning](#)..... 106

8.8.1 Live chart viewer

The live chart view enables you to evaluate and validate the current measurement graphically.

Access:

You have two options, to open the live chart view:

1. Open from the functions tab:
 - a) Press the [settings] key at the front panel.
 - b) In the "Functions" tab, select "Live Chart".
2. Open with the display mode key:
 - a) At the front panel, press the [Display Mode] key repeatedly until the graphical display appears.

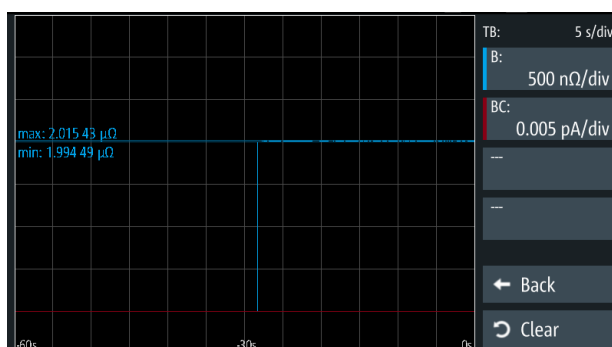

Figure 8-9: Live chart view

The graphical results display shows the traces of the measurement results for the selected parameters. The softkeys enable you to select the parameters for display according to your measurement.

How to: see [Chapter 8.8.1.2, "Displaying the readings in the live chart"](#), on page 92

8.8.1.1 Live chart settings

In the live chart view, you can select the parameters for display and configure the traces.

Access:

1. Press the [settings] key at the front panel.

2. In the "Functions" tab, select "Live Chart".

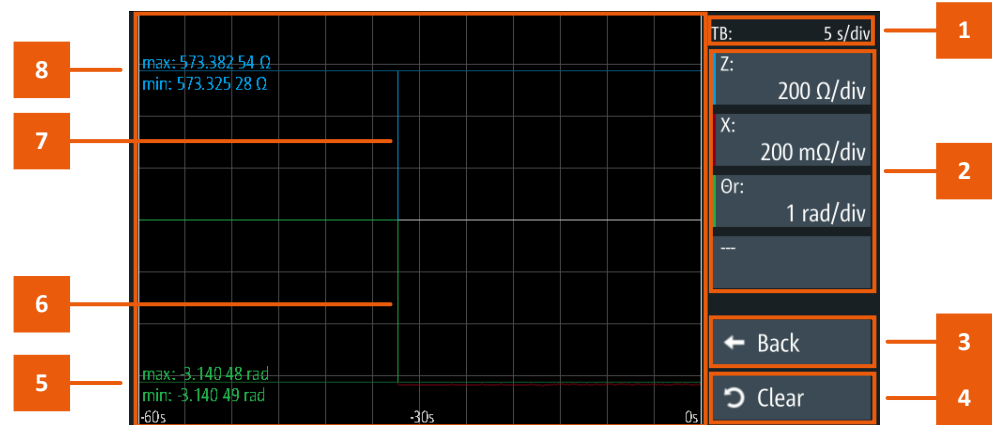

Figure 8-10: Live chart controls

- 1 = Time base
- 2 = Parameter pair softkeys
- 3 = Return softkey
- 4 = Reset softkey
- 5 = Min/Max readings of Θ_r
- 6 = Phase angle Θ_r measurement trace
- 7 = Impedance Z measurement trace
- 8 = Min/Max readings of Z

The chart window shows the traces of the measured parameters, which you can select and configure with the softkeys on the right.

How to: see [Chapter 8.8.1.2, "Displaying the readings in the live chart"](#), on page 92

TB.....	91
<measurement parameter>.....	91
Back.....	91
Clear.....	91

TB

Indicates the time scaling of the x-axis in the chart.

<measurement parameter>

Indicates the selected measurement parameter with the specified unit per division.

Back

Returns to the "Functions" tab.

Clear

Resets the chart and restarts graphical display of the measurement.

8.8.1.2 Displaying the readings in the live chart

Displaying the results graphically

To display the measurement progress and the readings in the graphic view:

1. Press the [settings] key at the front panel.
2. In the "Functions" tab, select "Live Chart".

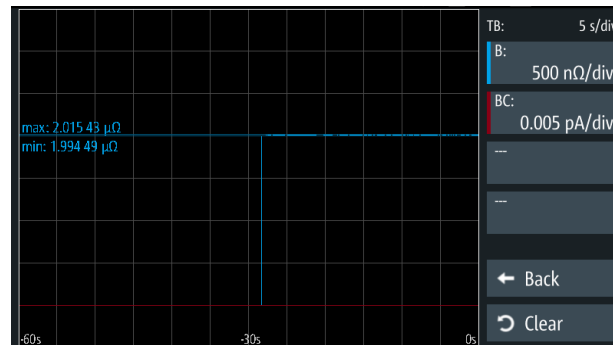

Figure 8-11: Graphic view

3. To configure a parameter for display:
 - a) Select a parameter softkey on the right of the screen. The "Configure Chart Trace <n>" dialog opens.

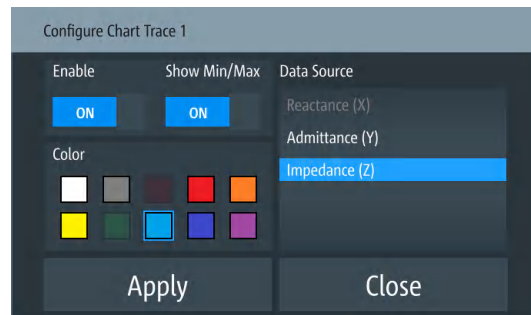

Figure 8-12: Configure live chart dialog

- b) In the "Data Source" list, select the parameter, e.g. "Impedance (Z)".
 - c) Select a color for the parameter trace.
 - d) To show the minimum and maximum readings of the selected parameter, turn "Show Min/Max".
 - e) To show the trace, turn "Enable".
 - f) Confirm with "Apply".
4. Repeat [step 3](#) to assign additional traces, e.g. to display the readings of the reactance and phase angle.

5. Select "Clear" to restart the trace display.

The graph shows the traces of the measured values for the selected parameters. If enabled, the chart assigns the measured minimum and maximum readings to the trace of the parameter and displays the values numerically.

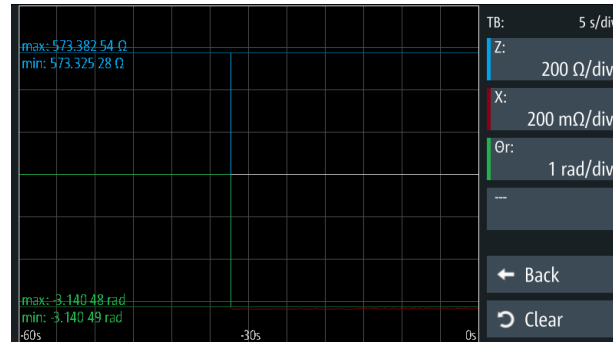

Figure 8-13: Graphical display of a resistance measurement

8.8.2 Logging chart viewer

The logging chart viewer function enables you to display recorded measurement data graphically and to evaluate and validate the results. You can view a previously recorded measurement loaded from a file.

Access:

1. Press the [settings] key at the front panel.
2. In the "Functions" tab, select "Open Log Chart".



Figure 8-14: Log chart view

The graphical results display shows the traces of the measurement results for the selected parameters. The softkeys enable you to select the parameters for display according to your measurement.



Gaps in a trace indicate invalid measurement results.

8.8.2.1 Log chart settings

Access:

1. Press the [settings] key at the front panel.
2. In the "Functions" tab, select "Open Log Chart".

The file selection dialog opens to load a previously recorded a data logging file.

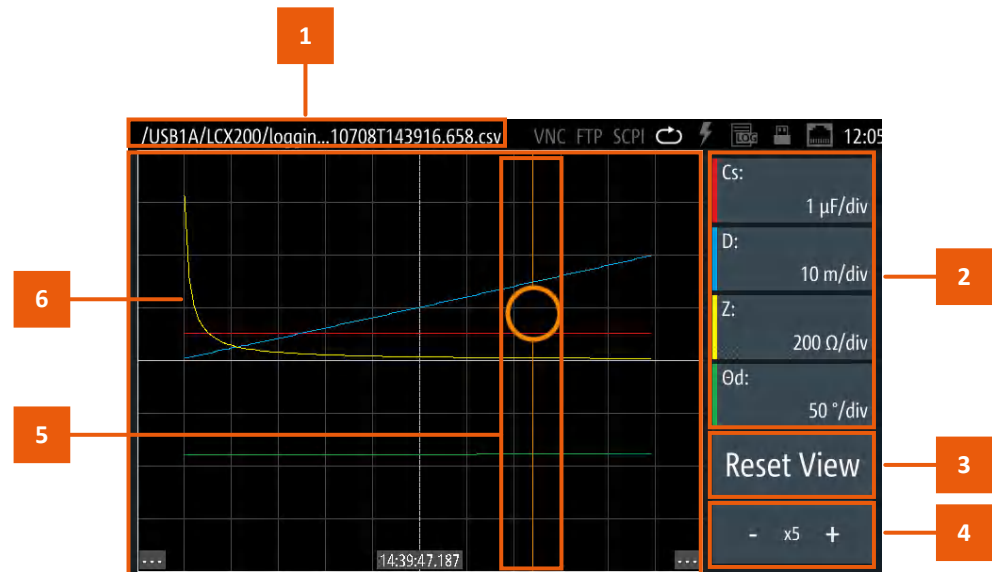

Figure 8-15: Log chart controls

- 1 = File name of the logging file
- 2 = Parameter pair softkeys
- 3 = Reset softkey
- 4 = Resolution softkey
- 5 = Capture indicator when touching and dragging within the graph
- 6 = Traces of the measured parameters

The main window shows the traces of the measured parameters, which you can select and configure with the softkeys on the right. You can set the resolution and shift the displayed traces within the graph with touch and drag.

How to: see [Chapter 8.8.2.2, "Displaying recordings in the log chart"](#), on page 95

<logging file name>.....	94
<measurement parameter>.....	95
Reset View.....	95
- x1 +.....	95
<touch capture indicator>.....	95
<traces>.....	95

<logging file name>

Indicates the file name of the loaded logging file.

Initially, the R&S LCX creates a file name composed of an identifier for a logging file <log>, a time stamp and a generic number. File format and extension are .csv.

Remote command:

[LOG:FNAME](#) on page 207

<measurement parameter>

Indicates the measurement parameter taken from the log file.

Reset View

Resets the graphical display to the initial resolution.

- x1 +

Sets the resolution of the graphical display.

You can increase or decrease the resolution by the predefined multiplication factors "x1", "x2", "x5", "x10", "x25" or "x50".

"+" Increases the resolution stepwise by the given factors.

"-" Decreases the resolution accordingly.

<touch capture indicator>

Indicates the focus with vertical line when touching and dragging on the screen.

<traces>

Shows the results of the measured parameters as interpolated traces.

8.8.2.2 Displaying recordings in the log chart

Customizing the log chart view

To shift the graph, or to adjust the trace colors or the resolution, you have the following options:

1. If the chart is out of sight or has slipped to an edge:

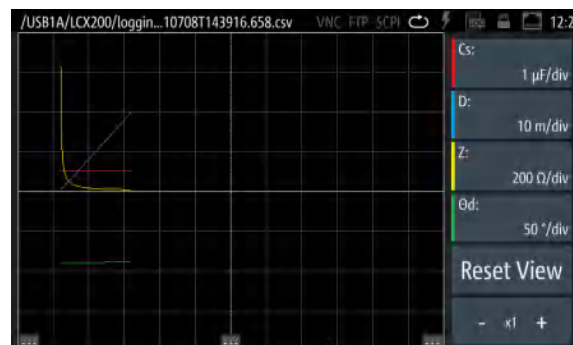

Figure 8-16: Log chart view

Touch and drag over the diagram to shift the displayed area to the right or to the left.

A touch capture indicator shows the position visually as long as you touch the screen.

2. If the traces cover only a small area of the chart, increase the resolution by selecting the "+" of the "- x1 +" softkey.

Vice versa, decrease the resolution with the "-" of the softkey.

Tip: If you change the resolution, the graphic can slip to an edge or move out of sight again. Shift it back with touch and drag.

3. To configure a parameter for display:
 - a) Select a parameter softkey on the right of the display.
The "Configure Chart Trace <n>" dialog opens.

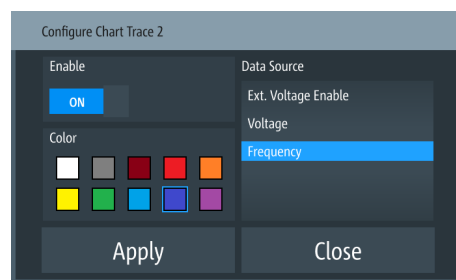

Figure 8-17: Configure chart trace dialog

- b) In the "Data Source" list, select the measurement parameter, e.g. "Frequency".
 - c) Select a color for the parameter trace.
 - d) To show the trace, turn "Enable".
 - e) Confirm with "Apply".
4. Repeat [step 3](#) to assign additional traces.

The R&S LCX displays the customized chart accordingly.

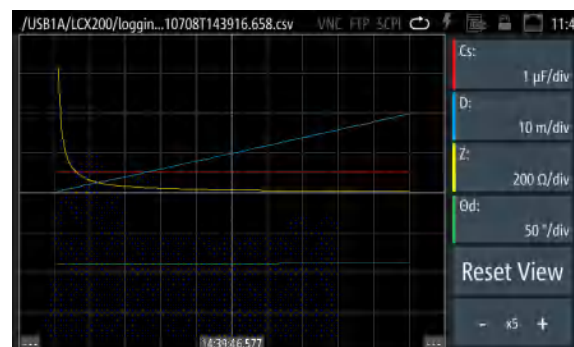

Figure 8-18: Customized log chart

5. To return to the initial view, select "Reset View".

Displaying the logging results in the chart viewer

To configure the logging chart view:

1. Press the [settings] key at the front panel.

2. In the "Functions" tab, select "Logging".
3. Select "Open Log Chart".
The R&S LCX opens a file selection dialog and prompts you to select a data logging file.
 - a) Select a file to display.
 - b) Confirm your selection with "Select".

The R&S LCX uploads the data and displays all information on the screen.

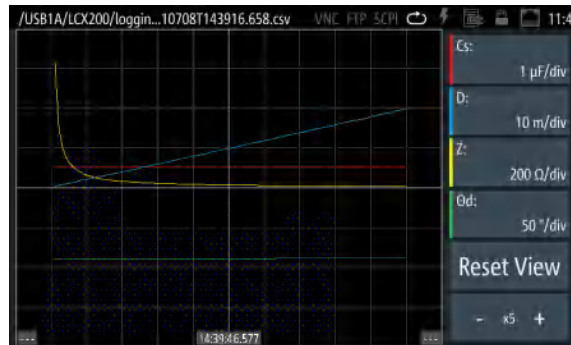

Figure 8-19: Log chart result

The labels of the parameter softkeys indicate the measured parameter with the respective unit per grid in the diagram. The colored bar of each softkey corresponds to the trace color.

8.8.3 Logging

The logging function enables you to record the measurement data. You can save the readings on the internal memory of the R&S LCX, or on an externally connected memory device, e.g. a USB flash drive. The function saves the data in a `.csv` file with generically generated file name.

Aspects on the logging function:

- The R&S LCX does not support external USB hard drives (or USB extensions). We recommend that you use USB flash drives with FAT/FAT32 formatting. The instrument recognizes the USB device automatically.
- The duration for capturing logging data in the range from 0 s to $3.49 \cdot 10^5$ s at a maximum.
- When running, the instrument indicates a white "LOG" label in the status bar. When disabled, the label color is gray.

8.8.3.1 Logging settings

In the "Logging" menu, you can configure the main parameter settings for data logging.

With a USB stick connected, you can save the file on either, the USB stick or the internal memory, with "USB1A" as default setting. Without USB connected, the R&S LCX saves the file internally in the file path `/int/logging`.

Access:

1. Press the [settings] key at the front panel.
2. In the "Functions" tab, select "Logging".

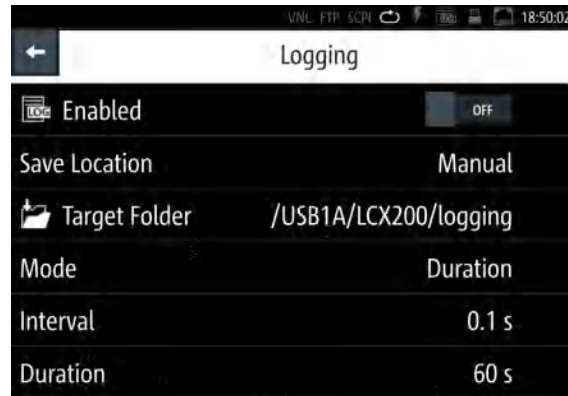

Figure 8-20: Network settings dialog

The settings dialog contains the basic parameters for setting the logging mode, and provides access to file management parameters.

The required remote commands are described in [Chapter 11.13, "LOG subsystem"](#), on page 205.

How to: see [Chapter 8.8.3.2, "Using the logging function"](#), on page 100.

Enabled	98
Save Location	98
Target Folder	99
Mode	99
Interval	100
Count	100
Duration	100
Start Time	100
↳ Set Date & Time	100

Enabled

Activates data acquisition and saving the readings.

Remote command:

`LOG[:STATe]` on page 209

Save Location

Accesses a dialog where you can select how to determine the location for the file.

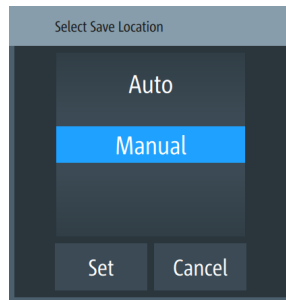

"Auto" Selects the target folder automatically.

"Manual" Enables you to select and define the target folder on the USB stick.

Target Folder

With a USB stick connected, accesses a dialog to select the memory partition where you want to save the file.

The R&S LCX sets the path and file folder according to the function used to create and save the data.

Without USB stick, the R&S LCX saves the file on the internal memory automatically.

"USB1A" Sets the destination folder on the USB stick.

"int" Sets the destination folder on the internal memory.

Mode

Selects a logging mode.

When enabled, each mode records data at specified intervals, set with ["Interval"](#) on page 100.

The R&S LCX starts recording depending on the selected mode, and if you enable data logging, see ["Enabled"](#) on page 98.

"Unlimited" Records data continuously.
Data logging starts immediately with [Enabled > ON](#), and continues until you stop the logging function.
The amount of recorded data is limited by the size of the memory the data is saved on.

"Count" Records a defined number of measurement readings.
To determine the number, see ["Count"](#) on page 100.
Data logging starts immediately with [Enabled > ON](#). It stops when the number of readings is reached.

"Duration" Records measurement readings within a defined time period.
To set the time period, see ["Duration"](#) on page 100.
Data logging starts immediately with [Enabled > ON](#). It stops after the duration time has elapsed.

"Span" Records measurement readings from a certain start time for a defined time span.
To set the parameter, see ["Duration"](#) on page 100
Data recording starts at the start time and with [Enabled > ON](#). It stops automatically after the duration time has elapsed.

Remote command:

[LOG:MODE](#) on page 208

Interval

Sets the time period for data logging.

The measurement interval specifies the time between the recorded measurement values.

Note: You can set the instrument to log each measurement performed by setting the interval value to 0 s, regardless of the selected measurement mode.

Remote command:

[LOG:INTerval](#) on page 208

Count

Sets the number of measurement readings for data logging [Mode > Count](#).

Remote command:

[LOG:COUNT](#) on page 207

Duration

Sets the time period for data logging [Mode > Duration](#) or [Mode > Span](#).

The maximum logging duration is 96 hours.

Remote command:

[LOG:DURation](#) on page 207

Start Time

Sets the time for starting data logging in [Mode > Span](#).

At first, you can set the date. When confirmed, the dialog for setting the time opens automatically.

How to: see "[Configuring logging settings](#)" on page 101.

Remote command:

[LOG:STIME](#) on page 209

Set Date & Time ← Start Time

Accesses the "Set Date & Time" function to configure a date and time stamp for the recorded data in logging [Mode > Span](#).

How to: see "[Configuring logging settings](#)" on page 101.

Remote command:

[LOG:STIME](#) on page 209

8.8.3.2 Using the logging function

The logging function enables you, to record the measurement readings. The R&S LCX stores the data with a generically created file name either on the USB stick or in the instrument internal memory directory.

Selecting the memory location

To determine the destination for saving the logging data file:

1. Press the [settings] key at the front panel.
2. In the "Functions" tab, select "Logging".
3. To determine the memory location, e.g., manually:
 - a) Select "Save Location".
The R&S LCX opens a selection editor.
 - b) In the selection editor, select "Manual".
 - c) Confirm your selection.
4. If you have connected an external USB memory device:
 - a) Select "Target Folder".
The R&S LCX opens a selection editor.
 - b) Select "USB1A".
 - c) Confirm with "Select".

Note: With no USB connected, the instrument displays a message and automatically sets the internal partition, when confirmed.

The R&S LCX saves the logging file in the predefined logging folder on the selected memory location.

Configuring logging settings

The example shows the settings for logging mode "Span", with the parameters "Interval", "Duration" and "Start Time" defined.

To configure the settings and activate logging:

1. Press the [settings] key at the front panel.
2. In the "Functions" tab, select "Logging".
3. Select "Mode" > "Span".
A selection editor opens.
4. Select "Span".
5. Confirm you selection.
6. To set the time parameters for the selected mode:
 - a) Select "Interval"
 - b) In the on-screen keypad, enter time and unit, e.g. "0.1 s".
 - c) Confirm with .
 - d) Proceed the same way to set the duration and the start time.

Note: For the start time, the R&S LCX opens a selection editor, providing date settings, and steps to a second editor for setting the start time at the selected date.

The R&S LCX starts logging at the defined date and time, and stops after the duration time has elapsed. It generates the file name and saves the logging data in the specified memory location, see "[Selecting the memory location](#)" on page 101.

To configure the other logging modes, proceed the same way.

8.8.4 Dynamic impedance measurement

Option: R&S LCX-K106

The dynamic impedance measurement feature enables you to record a set of measurement data acquired over a range of values for the selected measurement signal parameter.

When activated, the R&S LCX starts sweeping through the range of measurement signal parameter values and records the acquired measurement data in a log file. When the sweep process is completed, the instrument displays the recorded measurement data graphically.



Interactions and characteristics

The R&S LCX calculates the dynamic impedance measurement parameters according to the test signal settings. I.e. changing the frequency, range or voltage of the test signal impacts the sweep parameter values, ranges and limits.

8.8.4.1 Dynamic impedance measurement settings

In the "Dynamic Impedance Measurement" menu, you can configure the parameter settings for this function. You can select the measurement parameter for the sweep, i.e. the parameter that changes its value throughout the process based on the range of values configured.



This function requires that the option R&S LCX-K106 is installed. Otherwise, the function is not available indicated by the grayed out item in the "Functions" tab.

Access:

1. Press the [settings] key at the front panel.

- In the "Functions" tab, select "Dynamic Impedance Measurement".

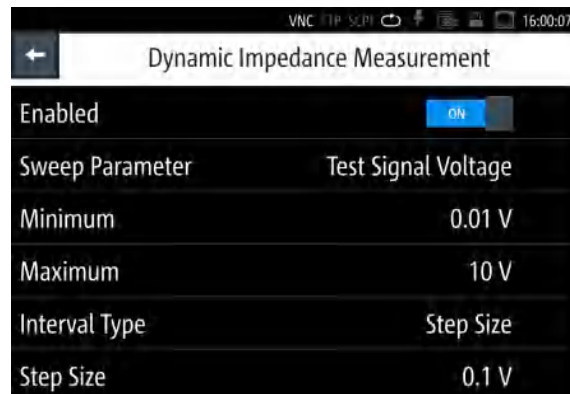

Figure 8-21: Dynamic impedance measurement menu

The softkey menu contains the basic parameters for setting the parameters and activating the measurement mode.

The required remote commands are described in [Chapter 11.8, "DIMeasure subsystem"](#), on page 191.

How to: see [Chapter 8.8.4.2, "Using the dynamic impedance measurement function"](#), on page 105

Enabled	103
Sweep Parameter	103
Minimum	104
Maximum	104
Interval Type	104
Step Size	104
Number of Points	104
Abort	105

Enabled

Starts the dynamic impedance measurement process.

The R&S LCX displays a progress dialog until the measurement is complete, see ["Measuring in dynamic impedance measurement mode"](#) on page 105.

Remote command:

[DIMeasure:EXECute](#) on page 193

Sweep Parameter

Opens a selection editor to determine the measurement signal parameter that changes during the entire measurement process.

The R&S LCX varies this parameter within the range between [Minimum](#) and [Maximum](#) in constant steps continuously. You can define the step width with the [Interval type](#) and the corresponding settings parameter, either [Step Size](#) or ["Number of Points"](#) on page 104.

"Test Signal Voltage"

Varies the test signal voltage level during the measurement process.

"Frequency" Varies the frequency of the test signal.

"Voltage Bias" Varies the voltage bias value.

"Current Bias" Varies the voltage bias value.

Remote command:

[DIMeasure:SWEEP:PARAMeter](#) on page 195

Minimum

Sets the first value of the range used for the selected sweep parameter.

Remote command:

[DIMeasure:SWEEP:MINimum](#) on page 195

Maximum

Sets the last value of the range used for the selected sweep parameter.

Remote command:

[DIMeasure:SWEEP:MAXimum](#) on page 194

Interval Type

Opens a selection editor to select the mode how the instrument calculates the width or time between the recorded sweep parameters within the measurement range ([Min/Max](#)).

"Step Size" Uses the interval between one sweep parameter value to the next, set with [Step Size](#).

"Number of Points" Uses the number of values within the range of minimum and maximum sweep parameter settings, set with [Number of Points](#).

Remote command:

[DIMeasure:INTERval:TYPE](#) on page 194

Step Size

Sets the interval between each sweep step within the measurement range ([Min/Max](#)).

Depending on the selected sweep parameter, the R&S LCX provides the corresponding value and unit.

"xx V" For [Sweep Parameter > Test Signal Voltage or Voltage Bias](#), sets the step width in V.

"xx Hz" For [Sweep Parameter > Frequency](#), sets the time interval in Hz.

"xx A" For [Sweep Parameter > Current Bias](#), sets the step width in A.

Remote command:

[DIMeasure:INTERval:STEPsize](#) on page 194

Number of Points

Sets the number of measurement points within the measurement range ([Min/Max](#)).

Remote command:

[DIMeasure:INTERval:POINTs](#) on page 193

Abort

Cancels a dynamic impedance measurement process while it is running.

Remote command:

[DIMeasure:ABORt](#) on page 193

8.8.4.2 Using the dynamic impedance measurement function

The dynamic impedance measurement function records the measurement readings automatically. The R&S LCX stores the data in a log file with a generically created file-name, either on the USB stick or in the instrument internal memory directory.

Selecting the memory location

To determine the destination for saving the data file:

- ▶ Follow the steps described in ["Selecting the memory location"](#) on page 101.

Measuring in dynamic impedance measurement mode

1. Press the [settings] key at the front panel.
2. In the "Functions" tab, select "Dynamic Impedance Measurement".
3. Configure the required settings.
4. Depending on the selected interval type, configure the value for the step size or the number of points to set the values of the sweep parameter within the range.
5. To start the dynamic impedance measurement process, turn  "Enabled".

A dialog box appears that shows the progress of the dynamic impedance measurement.

Note: Do not press any buttons on the instrument while the process is running.

Tip: As a dynamic impedance process can take a long time, you can abort the measurement with ["Abort"](#) on page 105.

When completed, the R&S LCX displays a graphical view of the acquired measurement data. It saves the generated log file with the file name indicated on the upper left side of the screen.

Canceling a dynamic impedance measurement

Once you have started the process, you can cancel the measurement in the progress dialog displayed.

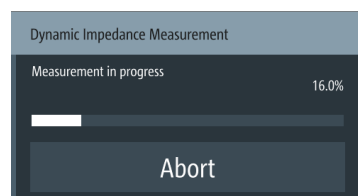

1. Select "Abort".

The R&S LCX displays a message informing you on the recorded log file and its storage location.

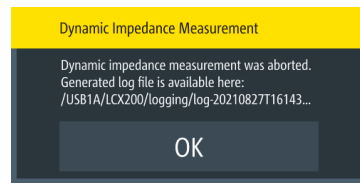

2. Confirm with "OK".
3. To evaluate the report in the log file:
 - a) If necessary, connect a USB memory device at the front panel "USB" connector.
 - b) Use the file manager to copy the log file to the memory device, see [Chapter 9.1.1, "File manager settings"](#), on page 117.
 - c) Upload the file on a PC.

For evaluation, you can use any application that supports *.CSV file format.

8.8.5 Binning

Option: R&S LCX-K107

The binning function enables you to sort a set of electrical components according to the measured characteristics. The R&S LCX measures a connected component and categorizes it based on a predefined bin configuration. You can see the corresponding result on the screen, and also get the category assigned at one of the digital outputs of the interface I/O port.

8.8.5.1 About binning

To perform binning, the R&S LCX requires the bin configuration you must define and upload in advance. In addition, you must configure the test signal (i.e. level and frequency) and bias, compensation and measurement range settings before. Changing these settings is not possible during a binning session.

To specify the bin configuration, you can define up to 8 categories according to 2 measurement characteristics in a *.CSV file, e.g. using a suitable application. Optionally, you can configure the last bin to denote the end of each measurement, independently of the result. Another control signal denotes if a component exceeds the specified limits. You can assign these results to a bin also.

To upload the file, use a USB stick. When the binning function is enabled, the R&S LCX measures the connected component initiated by a trigger signal. It indicates the result, i.e. the corresponding bin on the screen, and also assigns a signal at one of the 8 digital bin outputs.

Contents of the *.CSV file:

- Up to 2 measurement parameters

- The measured value range of each of the two parameters for the individual bin.
- The value ranges of the measurement parameters defined for the corresponding categories (up to 8 bins).
- How the limits are specified:
 - Minimum and maximum values
 - Nominal value and percentage deviation
 - Nominal and deviation value
- Additional signals you want to have assigned at the output, i.e. end of measurement, out of bin, both).

With the binning function enabled, the R&S LCX switches to measurement mode "triggered" automatically. The measurement starts with the first trigger signal. You can either trigger the measurement manually, using the [Trig.] key at the front or by sending the remote command *TRG. It is also possible, to apply an external trigger signal to the "Trigger Input" connector at the rear of the instrument.



During the binning measurements, it is still allowed to switch to continuous mode. But to achieve effective sorting of the components, we recommend that you execute the measurement in the trigger mode.

How to: see [Chapter 8.8.5.5, "Configuring and using the binning function"](#), on page 111.

For details on the trigger modes, see the data sheet, section "Digital trigger and control interfaces".

8.8.5.2 Assignment of the binning interface

The digital I/O port of the binning interface is a 15-pole D-Sub female socket, including eight data lines. The remaining pins provide digital input and output of control signals.

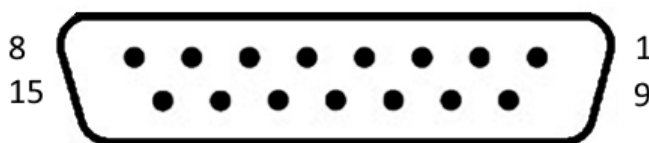

Figure 8-22: Digital I/O connector, front view

For details on the interface specification, see section "Digital trigger and control interfaces" in the data sheet.

Table 8-2: Pin assignment

Pin	Signal	Direction	Pin	Signal	Direction
1 - 8	Digital output signals 1 to 8. The digital outputs are active low.	OUT	11 - 13	GND	OUT
9	Trigger signal input. The rising edge of an externally applied signal initiates the trigger.	IN	14	+ 3.3 V	OUT
10	Digital input	IN	15	+ 12 V	OUT

8.8.5.3 Binning settings

In the "Binning" menu, you can upload the binning file, and start the measurement.

Access:

1. Press the [settings] key at the front panel.
2. In the "Functions" tab, select "Binning".

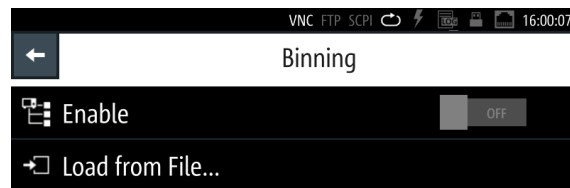

Figure 8-23: Binning menu

In the initial softkey menu, you can load the binning file and activate the measurement.

During the process, the main screen indicates the parameters related to the measurement, and access to the bin configuration.

The required remote commands are described in [Chapter 11.11, "HANDler subsystem"](#), on page 201.

Enabled	108
Load From File	108

Enabled

Enables the sorting function.

The measurement starts with a trigger signal.

Remote command:

[HANDler \[:STATe\]](#) on page 203

Load From File

Accesses the file manager function to upload the binning configuration file.

Remote command:

[HANDler:CONFig:PATH](#) on page 203

8.8.5.4 Binning measurement settings

When you have enabled the binning measurement, the R&S LCX shows the binning specific measurement results window on the screen.

Access:

1. Press the [settings] key at the front panel.
2. In the "Functions" tab, select "Binning".
3. Load the corresponding binning file as described in ["Configuring a binning file"](#) on page 111 and ["Loading the binning file"](#) on page 112.
4. In the binning menu, activate binning.

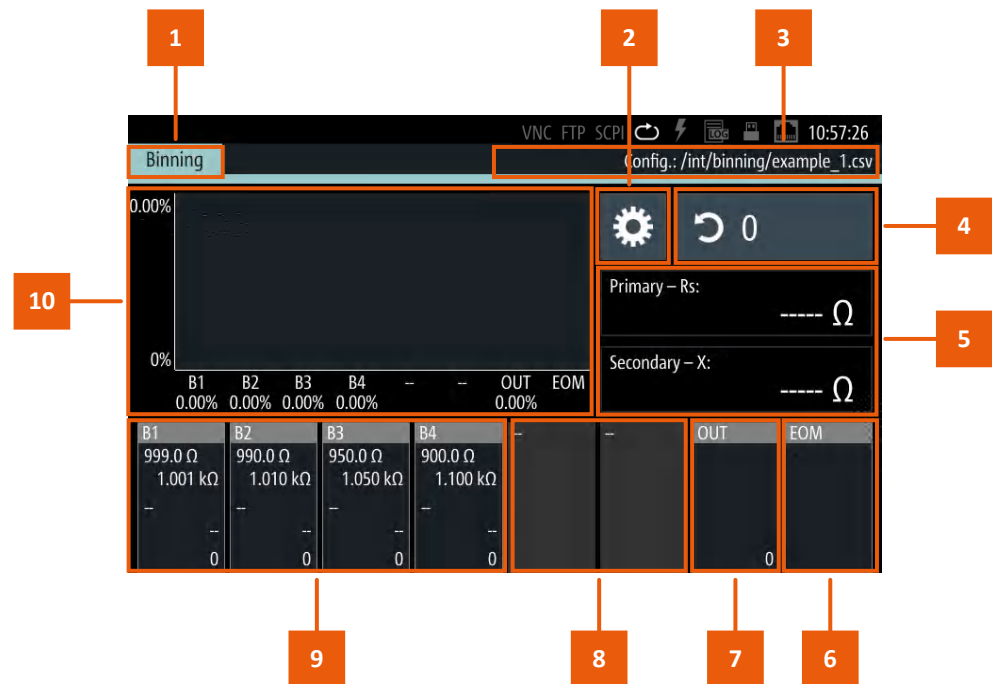

Figure 8-24: Binning measurement results window

- 1 = Measurement function indicator
- 2 = Settings softkey
- 3 = CSV file
- 4 = Counter
- 5 = Sorting characteristics
- 6 = End of measurement bin
- 7 = Out bin
- 8 = Unconfigured bin
- 9 = User-specified bins
- 10 = Histogram

The specific binning display shows the configuration parameters of the measurement and the bins for sorting the measured components. A bar graph displays the distribution of the measurement results graphically.

You can access the settings or reset the counter on the screen directly.

Binning.....	110
Settings softkey.....	110
<filename>.....	110
Counter.....	110
Primary - <param>.....	110
Secondary - <param>.....	110
Bins.....	110
L EOM.....	111
L OUT.....	111
L --.....	111
L B1 to B6 (B8).....	111
Histogram.....	111

Binning

Indicates the measurement mode that you are working in.

Settings softkey

The  (settings) softkey returns to the binning menu, see [Chapter 8.8.5.3, "Binning settings"](#), on page 108.

<filename>

Indicates the binning *CSV the measurement is based on.

Counter

Indicates the number of measurements executed.

The R&S LCX increases the number with each trigger signal received and derives the statistics from the results and the number of measurements.

You can reset the counter at any time directly on the touchscreen.

Remote command:

[HANDler:BIN:STATistic?](#) on page 202

[HANDler:BIN:STATistic:COUNT?](#) on page 202

[HANDler:BIN:STATistic:RESet](#) on page 203

Primary - <param>

Indicates the latest measurement value for the first sorting characteristic.

Secondary - <param>

Indicates the latest measurement value for the second sorting characteristic.

Bins

Indicates the configured bins, including the range of each category, and the number of measured values that fit into one of the categories. After each measurement, the R&S LCX highlights the corresponding bin and also assigns a signal at the corresponding pin of the digital output.

EOM ← Bins

Highlighted in red indicates the end of each individual measurement.

OUT ← Bins

Highlighted in red indicates that the measured values of the component do not fit in any of the configured categories.

-- ← Bins

Unconfigured bin and thus not used for the measurement.

B1 to B6 (B8) ← Bins

Highlights when the measured values of the component fit in one of the configured categories.

Note: If you have configured the additional signals "Out of Bin" or "End of Measurement", you can only define the remaining number of categories.

Histogram

Displays the percentage distribution over the bins.

8.8.5.5 Configuring and using the binning function

Configuring a binning file

To specify the file for the binning measurement, proceed as follows:

1. On a PC, open an application that can store data in *.csv format, e.g. a spreadsheet application.
2. Specify the required parameters and values in the given order:
 - a) *#Signal*: configures the control signals you can optionally assign for output at the digital interface.
Possible values are:
 - *EOM*: end of measurement
 - *OOB*: out of bin
 - *BOTH*: assigns both, the *EOM* and the *OOB* signalIf you enable both signals, the R&S LCX assigns the *OOB* signal to pin 7, and *EOM* on pin 8. If you have only one signal enabled, it is assigned to pin 8.
 - b) *#Measurement*: sets the measurement parameter pair, e.g. *Rs-X*

- c) *#PrimaryFormat, #SecondaryFormat*: determine the format the bin limits are defined.

Possible values are:

- *ABS*: specifies the limits as minimum and maximum values, i.e. 990 Ω to 1010 Ω.
 - *NOMABS*: specifies the limits as nominal value +/- deviation as absolute value, i.e. 1000 Ω +/- 10 Ω.
 - *NOMPCT*: specifies the nominal value as absolute value, and the deviation as percentage, i.e. 1000 Ω +/- 1 %.
- d) *Pri0, Pri1, Sec0, Sec1*: column headings of the following upper and lower limits for the primary and secondary formats. In the following lines, you then specify the upper and lower limits for each bin.

For an example, see [Binning configuration data for a resistor measurement](#).

3. Save the file as a *.csv file type on the USB memory device.

Note: Consider that the filename must start with `binning_*`, otherwise the R&S LCX does not display the file in the directory.

Example: Binning configuration data for a resistor measurement

The example defines a binning measurement that returns the measurement results for the resistance and impedance parameter pair (*Rs-X*), specified for 4 measurement categories. The R&S LCX returns the nominal value as absolute value, and the deviation in percent (*NOMPCT*).

```
#Signal,BOTH
#Measurement,Rs-X
#PrimaryFormat,NOMPCT
#SecondaryFormat,ABS

Pri0,Pri1
1e3,0.1
1e3,1
1e3,5
1e3,10
```

Loading the binning file

To upload the binning, proceed as follows:

1. Connect the USB stick to the USB B connector at the front panel of the instrument.
2. To access the binning settings dialog, select [settings] > "Functions" > "Binning".
3. Select "Load from File".
4. Select the partition "USB1A".

If a binning folder exists on the memory stick, the R&S LCX leads you to this directory automatically.

5. Select the corresponding *.csv binning file.

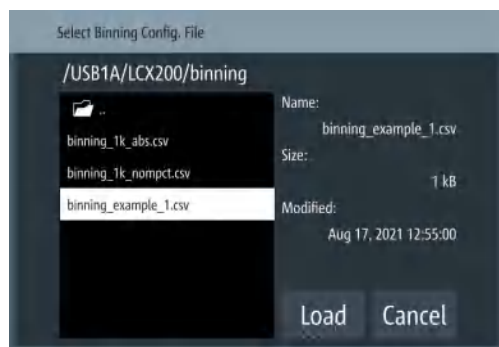

The R&S LCX indicates the file properties of the selected file on the right.

6. Confirm your selection with "Load".

Returned to the "Binning" dialog, the instrument indicates the selected file and memory location.

Executing a binning measurement



A binning measurement requires that you configure the test signal and all settings necessary for your measurement before. You cannot change a parameter while the measurement is running.

In addition, you need a trigger event that you can initiate manually with the [Trig.] key at the front, or by a trigger signal assigned to the [Trigger Input] connector at the back.

This example assumes that you have set up the measurement and aligned the instrument, see e.g., "[Basic measurement steps](#)" on page 32 and [Chapter 7, "Performing measurements"](#), on page 64.

To start the measurement:

1. Create the binning file, see "[Configuring a binning file](#)" on page 111.
2. Load the binning file according to "[Loading the binning file](#)" on page 112.
3. To activate the binning function, turn "Enable".
4. Press the [home] key.

The R&S LCX switches to measurement mode "triggered" automatically. The [Meas. Mode] key lights up.

5. Connect a sample component to the terminals of test fixture.
6. Start the first measurement with a trigger signal, e.g., press the [Trig.] key.
7. Wait until the measurement is complete.

When completed, and you have enabled the end of measurement control signal, the R&S LCX highlights the *EOM* bin.

8. Remove the sample component.

9. Repeat [step 5](#) to [step 8](#) until you have measured all components.



According to the reading, the R&S LCX sorts a component into the corresponding bin and highlights it. In addition, it indicates the summed number of components sorted into it, and displays the distribution graphically in the histogram.

9 General instrument settings

The general instrument settings include basic instrument functions, regardless of the selected operating mode and measurement. Some of these settings like screen display and peripherals are initially configured at the setup of the instrument, according to personal preferences and requirements. However, you can individually adjust the settings at any time, for example, for specific applications.

Access:

1. Press the [settings] key at the front panel.
2. Select the "Device" tab.



Figure 9-1: Device menu

3. Select the corresponding setting in the list.

The required remote commands are described in [Chapter 11.16, "SYSTEM subsystem"](#), on page 216.

• File and data management	116
• Interfaces	120
• User button	122
• Screenshot	123
• CSV settings	126
• Date & time	127
• Appearance	128
• Sound	129

• Licenses.....	130
• Device information.....	133
• Update device.....	135
• Save/recall.....	137
• Customizing general instrument settings.....	140

9.1 File and data management

The R&S LCX uses files to save all instrument data, e.g., instrument configuration and settings, measurement data or created screenshots of the current settings displayed on the screen. Known from common file explorers, the "File Manager" function enables you to transfer, copy and delete files from or to the internal and external memory directories, see [Chapter 9.1.1, "File manager settings"](#), on page 117.

In general, it is distinguished between the file groups system data and user data. Due to security reasons, system data files and the system directory are not accessible. The scope of this section is only files with user data. It provides an overview of the R&S LCX file system and covers the following topics:

- ["Types of data files"](#) on page 116
- ["File memory location"](#) on page 116
- ["File names"](#) on page 117
- ["File extensions"](#) on page 117
- ["File handling"](#) on page 117
- ["File contents"](#) on page 117

Types of data files

Data files include device settings, measurement configurations and records, screenshots, hardware and firmware configurations, and various system information.

Depending on the content, user data is roughly categorized in the following data types:

- *Settings*: instrument settings of a measurement configuration saved for later reuse, see [Chapter 9.12, "Save/recall"](#), on page 137.
- *Measurement readings*: recorded measurement results saved for evaluation, see [Chapter 8.8.3, "Logging"](#), on page 97 or [Chapter 8.8.5, "Binning"](#), on page 106.
- *Instrument configuration*: firmware, with open source acknowledgement (OSA), and support files containing information on the installed hard- and software versions for service purposes, see e.g., [Chapter 9.11, "Update device"](#), on page 135 and [Chapter 9.10, "Device information"](#), on page 133.

File memory location

The R&S LCX saves user files on the internal memory or if connected, on a memory stick.

You save files in the directory `/int/...` on the internal memory, or the `/USB1A/...` directory on the memory stick. Depending on the data file, the instrument automatically creates the corresponding subdirectory in the selected memory location.

File names

The R&S LCX assigns generic file names to internally created files, composed of an identification of the function, if applicable, and a time stamp. For user-specific files, you can assign a dedicated file name. You can compose a file name of any length, with all characters allowed, i.e. letters, numbers and, with some exceptions, also special characters. The instrument blocks unauthorized characters in the on-screen keyboard automatically.

File extensions

The R&S LCX distinguishes the file extensions according to the specific file content. The file extensions are predefined, see [Chapter 9.1.3, "Data and file types"](#), on page 120.

File handling

To access files and the file system of the R&S LCX or to use the general file management functions such as copying and moving data, see [Chapter 9.1.1, "File manager settings"](#), on page 117.

To transfer files from and to the instrument or to exchange files, use one of the following alternatives:

- Connect a memory stick to one of the USB A interfaces. The instrument recognizes automatically a connected memory stick and assigns the /USB1A/. . . drive to it.
- Connect the R&S LCX to a LAN, see [Chapter 10, "Network operation and remote control"](#), on page 144.

An instrument connected to a LAN supports the standard file transfer method (ftp protocol) from a remote client. Using the remote file transfer, you can access operational files, settings, documents, log files and the contents on the USB memory, see ["Remote file access \(FTP\)"](#) on page 146.

File contents

To keep the file size small and to speed up processing times, the R&S LCX does not save the entire instrument settings, but rather the settings that differ from the preset state.

9.1.1 File manager settings

With the "File Manager" functions, you can exchange files between the internal and an external memory, provided you have connected a USB memory device.

Access:

1. Press the [settings] key at the front panel.
2. In the "Device" tab, select "File Manager".



Figure 9-2: File manager dialog

The "File Manager" dialog shows a navigator of the memory directories, and you can copy or delete files, as known from common file explorers. The functions provided are self-explanatory in conjunction with the softkeys labeled accordingly. How to: see [Chapter 9.1.2, "Using the file manager"](#), on page 118.

Copy

Copies selected files to a destination directory.



Copy from internal memory to USB.



Copy from USB to internal memory.

Delete

Removes selected files from the directory.



Deletes the selected file.

Remote command:

[DATA:LIST?](#) on page 191

[DATA:DELeTe](#) on page 191

9.1.2 Using the file manager

We assume, that the functions provided in the file manager dialog are known. Hence this section only shows specific functions that are not recognizable at first glance.

Retrieving file information

To view information on the selected file:

1. Select [settings] > "Device" > "File Manager".
2. Select the directory.
3. Tap and hold the file of interest.

The R&S LCX shows the metadata of the selected file.

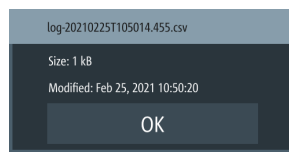

Figure 9-3: File information

Retrieving device documentation

You can retrieve the R&S LCX Open Source Acknowledgment documentation from the instrument documentation folder `/int/documentation`.

To view information on the selected file:

1. Select [settings] > "Device" > "File Manager".
2. Select the directory.
3. Tap and hold the file of interest.

The R&S LCX shows the metadata of the selected file.

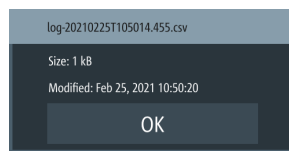

Figure 9-4: File information

Retrieving device documentation

You can retrieve the R&S LCX [OSA](#) documentation directly from the instrument.

To view the [OSA](#) document:

1. Connect a USB memory stick to the USB B connector at the front panel of the instrument.
2. To access the file manager, select [settings] > "Device" > "File Manager".
3. In the file manager dialog, select the `/int/documentation` documentation folder.

The R&S LCX displays the available files in the documentation folder.

4. Select the file you want to copy.
5. Copy the selected file with  to the USB memory stick.

Note: If a file with similar file name exists already, the R&S LCX displays a file system error and aborts the copy process.

Delete the existing file, then you can copy the file from the R&S LCX to the USB stick.

Now you can view the document on a PC.

9.1.3 Data and file types

The R&S LCX distinguishes the files according to their extensions; each type of file is assigned a specific file content and also a specific file extension. The extension is pre-defined, e.g. you can save and load files with logging data only as *.csv files.

Table 9-1: Overview of data and file types

Data type	File extension	Description
Binning	*.csv	See Chapter 8.8.5, "Binning" , on page 106
Documentation	*.pdf	Getting Started manual, and OSA (Open Source Acknowledgement).
Logging	*.csv	See Chapter 8.8.3, "Logging" , on page 97
Screenshot	*.png	See Chapter 9.4, "Screenshot" , on page 123
Settings	*.savrcl	See Chapter 9.12, "Save/recall" , on page 137
Service	*.rsd	
Device information	*.rsd	See Chapter 9.10, "Device information" , on page 133
Firmware	*.rsu	See Chapter 9.11, "Update device" , on page 135
Licenses	*.xml	See Chapter 9.9, "Licenses" , on page 130

9.2 Interfaces

The R&S LCX provides a LAN, a USB and, optionally a GPIB (IEC/IEEE) bus interface for controlling the instrument remotely.

In the "Interfaces" menu, you can access the settings dialogs for configuring the general network environment and specific identification parameters of the instrument.



The following description introduces the access to the interface settings. For detailed information on connection, protocols and additional configurations, see [Chapter 10, "Network operation and remote control"](#), on page 144. This section also covers the setting parameter descriptions and step-by-step instructions for setting up remote control for each interface.

9.2.1 Interface settings

Access:

1. Press the [settings] key at the front panel.
2. In the "Device" tab, select "Interfaces".
3. Select the corresponding menu item.



Figure 9-5: Interfaces menu

In the "Interfaces" menu, you can access the settings dialogs for configuring the general network environment and specific identification parameters of the instrument.



As the settings for the dedicated interfaces relate closely to the remote control environment, see the description in [Chapter 10.3, "Remote access settings"](#), on page 154.

Network

Leads you to the "Network" connection dialog to configure the ethernet connection.

USB Class

Opens a selection dialog to set the communication protocol for the USB interface, see [Chapter 10.3.5, "USB settings"](#), on page 161.

About: see [Chapter 10.2.2, "USB interface"](#), on page 149.

How to: see [Chapter 10.5, "Adjusting interface addresses"](#), on page 164

GPIB Address

Option: R&S NG-B105 GPIB (IEC 625/IEE 488) bus interface

Opens an on-screen keypad for setting the channel address of the address GPIB bus interface, see [Chapter 10.3.6, "GPIB settings"](#), on page 162.

About: see [Chapter 10.2.3, "GPIB interface \(IEC/IEEE bus interface\)"](#), on page 150

How to: see [Chapter 10.5, "Adjusting interface addresses"](#), on page 164.

9.2.2 Configuring interfaces

As the information on how to establish and configure a remote control connection relates closely to the remote control environment, see:

- [Chapter 10.4, "Connecting the R&S LCX for remote access"](#), on page 162
- [Chapter 10.5, "Adjusting interface addresses"](#), on page 164

9.3 User button

The user button enables you to assign a certain function to the [★ (User)] key for quick access.

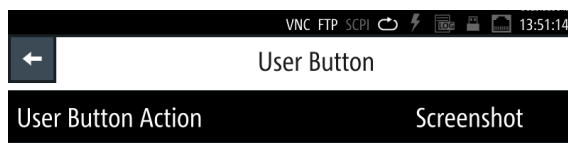

9.3.1 User button settings

Access:

1. Press the [settings] key at the front panel.
2. In the "Device" tab, select "User Button".

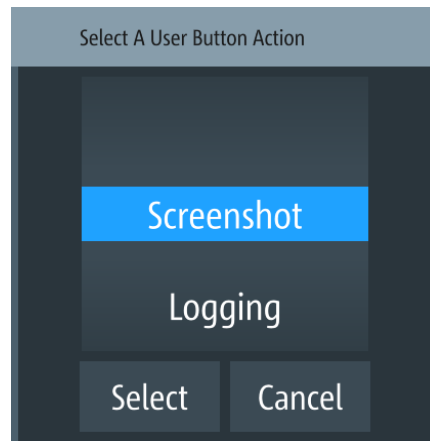

Figure 9-6: User button

The menu lists the functions, you can assign to the [★ (User)] key:

- "Screenshot", captures an image of the screen, see [Chapter 9.4, "Screenshot"](#), on page 123.
- "Logging", see [Chapter 8.8.3, "Logging"](#), on page 97.
- "Touch Lock" locks and unlocks the touchscreen operation (toggle function).

- How to: see ["Assigning the touch lock function to the "User Button" on page 123](#)
- "Open Correction", starts calibration on all frequencies for open test fixtures contacts.
How to: see [Chapter 6.2, "Configuring the test signal"](#), on page 58
 - "Short Correction", starts calibration on all frequencies for short-circuit test fixtures contacts.
How to: see [Chapter 6.2, "Configuring the test signal"](#), on page 58
 - "Open/Short Correction", starts calibration on all frequencies for open/short-circuit test fixtures contacts.
How to: see [Chapter 6.2, "Configuring the test signal"](#), on page 58

9.3.2 Using the user button function

Depending on the assigned function, pressing the [★ (User)] key executes the action.

The following instructions show how to assign a function, given by the example of the touchscreen lock. It is also explained how to undo the assignment.

Assigning the touch lock function to the "User Button"

To assign the function to the "User Button":

1. To access the user button settings, select [settings] > "Device" > "User Button".
2. Select "User Button Action".
3. Select "Touch Lock".
4. Confirm with "Select".
5. To activate the touchscreen lock, press the [★ (User)].

A status message informs you that the touch input is disabled.

6. To close the message, press the [Back] key.

Now you can control the instrument only with the front panel keys and navigation controls.

Activating the locked touch input

To unlock the touchscreen:

- ▶ Press the [★ (User)].

The R&S LCX enables the touchscreen input.

9.4 Screenshot

With the screenshot function, you can capture the image of the current screen. The R&S LCX assigns a unique, generic filename and saves the file in *.png format.

How to: see [Chapter 9.4.2, "Using the screenshot function"](#), on page 124.

9.4.1 Screenshot settings

With a USB stick connected, you can save the file on either the USB stick or the internal memory, with "USB1A" as default setting. Without USB connected, the R&S LCX saves the file internally in the file path `/int/screenshot`.

Access:

1. Press the [settings] key at the front panel.
2. In the "Device" tab, select "Screenshot".

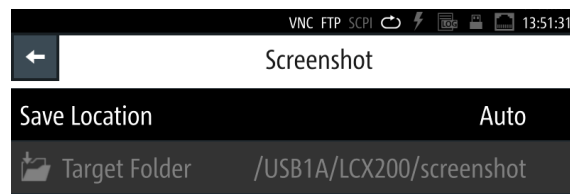

Figure 9-7: Screenshot

The "Screenshot" menu provides access to dialogs and editors for managing and saving instrument settings.

[Save Location](#)..... 124

Save Location

Accesses a dialog where you can select how to determine the location for the file.

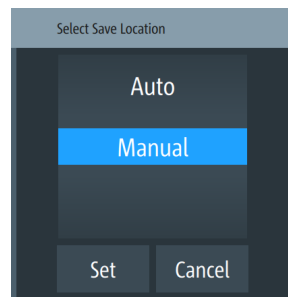

"Auto" Selects the target folder automatically.

"Manual" Enables you to select and define the target folder on the USB stick.

9.4.2 Using the screenshot function

A screenshot is done with the [**★** (User)] key, provided the function is assigned to the key.

The following instructions show how to configure function for use, and how to save a captured image, e.g., in a user-defined target folder.



Without a USB memory stick connected, the R&S LCX saves the file internally under /int/screenshot.

See [Chapter 9.1, "File and data management"](#), on page 116 for information on how to access the memory and manage file export.

Assigning the function to the "User Button"

To assign the screenshot function to the "User Button":

1. Press the [settings] key at the front panel.
2. In the "Device" tab, select "User Button".
3. Select "User Button Action".
4. Select "Screenshot".
5. Return to the "Device" settings tab with .

The ★ (User) now captures the screen when pressed.

Setting the screenshot file location manually

To determine a user-defined target folder for the screenshot files, the USB memory stick must be connected:

1. Connect the USB memory stick to the USB interface at the front panel of the R&S LCX.
2. Press the [settings] key at the front panel.
3. In the "Device" tab, select "Screenshot".
4. Set "Save Location" > "Manual".
5. Select "Target Folder".
6. In the selection editor, select the memory location, e.g. "USB1A".
7. "Close" the window.

The R&S LCX saves hardcopy file in the predefined screenshots folder on the selected memory location.

Dragging screenshots

To capture the current screen, e.g., a measurement result:

1. Press the ★ (User) at the front panel.

The R&S LCX drags a screenshot, generates a file name and saves the file in the target folder, as defined.

When completed, it shows the "Screenshot" dialog with information on file path and file name.

2. Confirm with "OK".

The R&S LCX returns to the measurement.

For further use of the screenshots, you can open the files in any application that supports *.png file format.

For information on how to access the memory and manage file export, see [Chapter 9.1, "File and data management"](#), on page 116.

9.5 CSV settings

The R&S LCX enables you to record measurement readings and save the data in a file for subsequent evaluation and validation. Recorded data consists of character strings that list general metadata, as, e.g., date, device name, etc., the parameter names and the acquired measurement values.

The standard *.csv file format the R&S LCX saves the data, allows you to use a spreadsheet application for numerical or graphical analysis and evaluation.

A *.csv file saves tabular data (numbers and text) in plain text. Each line of the file is a data record and each record consists of one or more fields, separated by a field delimiter. In the "CSV Settings" dialog, you can set the special characters to set the delimiters.

9.5.1 Settings for CSV data

Access:

1. Press the [settings] key at the front panel.
2. In the "Device" tab, select "CSV Settings".

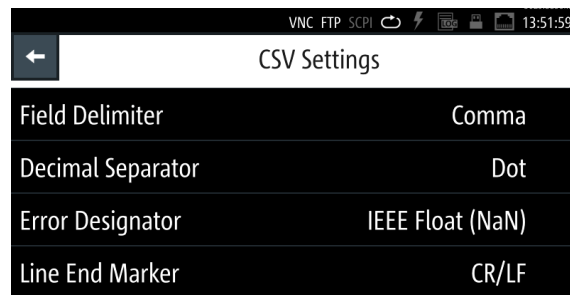

Figure 9-8: CSV settings menu

The dialog provides the parameters for setting the data separators in the *.csv file. The error designator enables you to fill up empty cells.

Field Delimiter	127
Decimal Separator	127
Error Designator	127
Line End Marker	127

Field Delimiter

Selects the line separator between individual parameters or values.

- "Semicolon" Separates the data entries by a semicolon.
"Comma" Uses a comma.

Decimal Separator

Selects the decimal separator for values.

- "Dot" Sets a decimal point.
"Comma" Uses a comma.

Error Designator

Selects whether an empty cell is filled with 0.

- "IEE Float" Fills empty cells with 0.
"Empty" Leaves empty cells.

Line End Marker

Selects the character representing a line break.

- "CR/LF" Inserts a line break with both, either a CR or an LF.
"LF" Inserts a line break with an LF.

9.5.2 Configuring CSV data

For subsequent acquisition of logged data with a PC application, you can determine the separators and designators of the measurement values accordingly.

Configuring csv data

To configure the format of data within the file:

1. Press the [settings] key at the front panel.
2. Select
3. To access the csv settings, select [settings] > "Device" > "CSV Settings".
4. Set the field and line separators, e.g:
 - a) Select "Field delimiter" > "Semicolon".
A selection dialog opens where you can set the delimiter.
 - b) Confirm the selection with "Set".
5. Repeat the configuration for each data separator and the error indicator.

9.6 Date & time

Using the "Date & Time" function, you can set a date and time.



The time is regarded as UTC. There is no timezone selectable.

The R&S LCX records the time during operation and creates a time stamp on printed outputs or in saved datasets.

Access:

1. Press the [settings] key at the front panel.
2. In the "Device" tab, select "Date & Time".

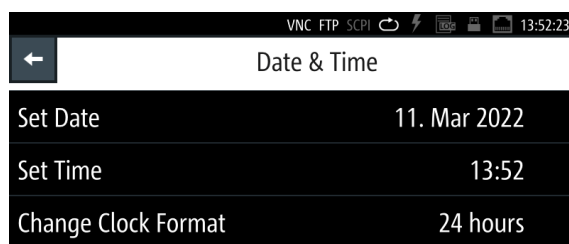

Figure 9-9: Date and time settings menu

The "Date & Time" menu provides access to dialogs and editors for setting the corresponding parameters. Initially, the R&S LCX indicates the date and time setting of the operating system. You can update or modify this setting individually.

The required remote commands are described in [Chapter 11.16, "SYSTEM subsystem"](#), on page 216.

How to: see ["Setting date and time"](#) on page 140.

Set Date

Sets the date in the format [yyyy.mm.dd].

Remote command:

[SYSTEM:DATE](#) on page 224

Set Time

Sets the time in the format [hh.mm.ss].

Remote command:

[SYSTEM:TIME](#) on page 226

Change Clock Format

Sets the hour display of a day.

You can switch between "24 hours" and "48 hours" display.

9.7 Appearance

The R&S LCX enables you to customize the appearance of the screen and the front panel keys.

Access:

1. Press the [settings] key at the front panel.
2. In the "Device" tab, select "Appearance".

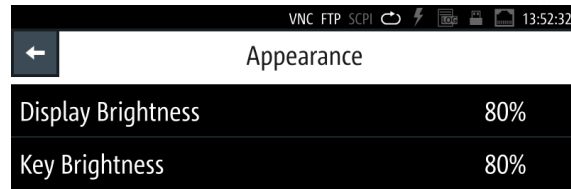

Figure 9-10: Appearance settings menu

The appearance menu provides access to on-screen editors for adjusting the brightness of the screen and front panel keys.

The required remote commands are described in [Chapter 11.9, "DISPLay subsystem"](#), on page 195 and [Chapter 11.16, "SYSTEM subsystem"](#), on page 216.

How to: see ["Customizing the appearance"](#) on page 142.

Display Brightness	129
Key Brightness	129

Display Brightness

Sets the brightness of the display in percent.

Remote command:

[DISPLay:BRIGhtness](#) on page 196

Key Brightness

Sets the intensity of the key illumination in percent.

Remote command:

[SYSTEM:KEY:BRIGhtness](#) on page 225

9.8 Sound

The R&S LCX provides the option for issuing an acoustic signal if there is an error.

Access:

1. Press the [settings] key at the front panel.
2. In the "Device" tab, select "Sound".

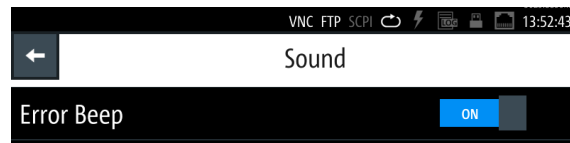

Figure 9-11: Sound settings menu

In the "Sound Settings" dialog, you can set an alert.

The required remote commands are described in [Chapter 11.16, "SYSTEM subsystem"](#), on page 216.

How to: see ["Customizing the sound settings"](#) on page 143.

[Error Beep](#)..... 130

Error Beep

Generates an acoustic signal when an error occurs.

"On" Beeps on error.

"Off" No beep.

Remote command:

[SYSTEM:BEEPper:WARNing:STATe](#) on page 221

[SYSTEM:BEEPper:WARNing\[:IMMediate\]](#) on page 221

[SYSTEM:BEEPper\[:COMplete\]:STATe](#) on page 221

[SYSTEM:BEEPper\[:COMplete\]\[:IMMediate\]](#) on page 221

9.9 Licenses

The R&S LCX provides options that you can purchase and activate. An option is ready to operate after it is enabled with a [License key](#) supplied with the option. The license key is delivered as a file or on paper.

9.9.1 Licenses settings

The "Licenses" manager function enables you to activate an option with a license key you can install either from an *.xml file, or enter manually.

Access:

1. Press the [settings] key at the front panel.
2. In the "Device" tab, select "Licenses".



Figure 9-12: Licenses dialog

The licenses dialog provides all information on installed licenses and their current activity state:

- "Active" displays options that are currently activate in the instrument.
- "Inactive" displays options that are installed but currently not active.
- "Deactivation" displays options whose licenses have expired or which have been removed.

With the softkeys on the left, you can register a new option, and activate or deactivate registered options.

How to: see [Chapter 9.9.2, "Managing licenses"](#), on page 131.

Add / Remove

Opens an on-screen keypad to enter the license key manually.



Enables you to register a new option.



Enables you to remove a registered option.

Load File

Opens a file manager window to load a license key file, e.g. from a connected USB memory device.

9.9.2 Managing licenses

An option is ready for use after it is enabled with an activation code, referred to as license key. To activate an option and to unlock the features that are bound to the option, you need to reboot the R&S LCX.

The following examples guide you through the steps of registering or deactivating licenses.

Loading the license key from a file

To install an XML file, proceed as follows:

1. On a PC, copy the *.xml file containing the license key to a USB memory stick.
2. Connect the USB stick to the USB B connector at the front panel of the instrument.
3. To access the license manager dialog, select settings > "Device" > "Licenses".

4. Select "Load File" to load the license file from the USB stick.
The R&S LCX applies the license key. It displays a message "Devicekey is installed".
Note: For the license to take effect, the R&S LCX must reboot.
5. Switch the instrument off and on again using the On/Standby key.
The instrument restarts and activates the option and its features. It lists the option in the "Active" window.

Inserting the license key manually

To enter the license key manually:

1. Get the sheet with the license key.
2. To access the license manager dialog, select [settings] > "Device" > "Licenses".
3. Select "Add" to open the "Enter License Key" keypad.



Figure 9-13: License key on-screen keypad

4. Enter the key (30-digits) of the option in the entry box.
5. Review your input carefully.
6. Confirm with .
The R&S LCX applies the license key. It displays a message "Devicekey is installed".
Note: For the license to take effect, the R&S LCX must reboot.
7. Switch the instrument off and on again using the On/Standby key.
The instrument restarts and activates the option and its features. It lists the option in the "Active" window.

Removing a license key

To remove a registered option, you must also enter the license key. You can load the license key either from the *.xml file or enter it manually.

1. To upload the key from the *.xml file, proceed as described in ["Loading the license key from a file"](#) on page 131.

2. To remove the option manually, select "Remove" in the license dialog.
The R&S LCX displays the "Enter Deactivation Key" on-screen keypad.
3. To enter the license key, proceed the same way as described in ["Inserting the license key manually"](#) on page 132.
The instrument uninstalls the license and displays the message "Devicekey is removed". It deactivates the option displays it in the "Deactivation" window.
4. For the deactivation to take effect, restart the R&S LCX.
The instrument restarts and lists the deactivated in the "Deactivation" window.

9.10 Device information

To get an overview on the configuration of your instrument, you can retrieve information on the instrument model, its hardware components and interfaces using the device information function.

9.10.1 Device information settings

Access:

1. Press the [settings] key at the front panel.
2. In the "Device" tab, select "Device Information".



The "Device Information" window shows the characteristics of the instrument assemblies. It also indicates the remaining available internal memory.

The required remote commands are described in [Chapter 11.16, "SYSTEM subsystem"](#), on page 216.

Device Information	133
Create Dump File	134

Device Information

Displays the main instrument information.

"Model"	Designation of the instrument.
"ID"	Part number of the instrument.
"Serial No.:"	Serial number of the instrument.
"Version"	Currently installed firmware version. How to: see Chapter 9.11, "Update device" , on page 135
"FPGA"	Version of the installed FPGA.
"Hardware IDs"	Unique serial number of the front and mainboard of the instrument.
"Temperature in °C"	Note: If the temperature exceeds the specification, the R&S LCX displays a warning message. Temperature of the CPU, connector board, H CUR and L CUR output connectors, low current supply and Rfb (feedback resistor), indicated in degrees.
"Misc"	Fan speed, IP address and memory capacity of the instrument.
Remote command:	
	SYSTem:HW:VERSion? on page 225

Create Dump File

Saves the device information in a file.

9.10.2 Using the dump file function

The dump file function allows you to save the device information in the file format *.rsd. It saves data in a structured format. You can, export this file and forward it to the service department, e.g. for analyzing or troubleshooting. Proceed as described in the following example.

Creating a dump file

To create and export a device information file:

1. Press the [settings] key at the front panel.
2. In the "Device" tab, select "Device Information".
3. Select "Create Dump File".

The R&S LCX generates a directory in the internal memory and saves the file under `/int/service/service.rsd`.

4. To export the file:
 - a) Connect a USB memory device at the front panel USB B connector.
 - b) Press the [settings] key.
 - c) Select "File Manager".
 - d) In the internal memory, select `/int/service/`.
 - e) Select `/int/service/service.rsd`.
 - f) Copy the file with the copy left softkey to the USB directory.

- Now you can send the file to your local service department.

9.11 Update device

The update functionality enables you to update the firmware of the instrument. Using the USB interface at the front panel, you can provide the installation file for the update.

Required equipment

- Software:
Software update file RS_LCRxxx_Software_<version>.zip
We recommend that you use the latest software version, available on the product page at www.rohde-schwarz.com/firmware/lcr.
- Hardware:
USB memory stick with enough free space to save the update file.
The memory stick does not need to be bootable and previous data on the stick is not affected. Several update files can reside on the stick in parallel. During update procedure, the stick is not modified by the instrument.

How to: see [Chapter 9.11.2, "Updating the instrument software"](#), on page 136

9.11.1 Update device settings

With the update functionality, you can install a new version of the instrument software. To provide the update, use a USB memory stick for file transfer.

Access:

- Press the [settings] key at the front panel.
- In the "Device" tab, select "Update Device".

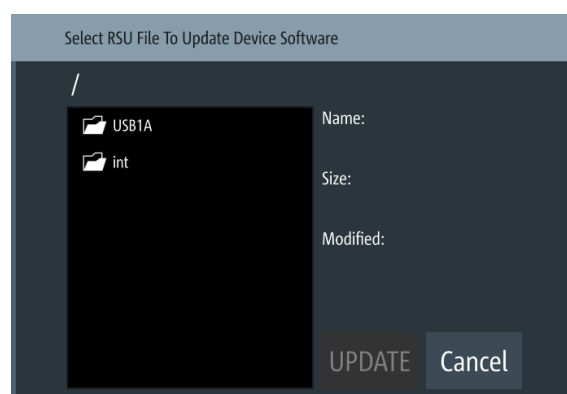

The update device dialog provides access to the memory to upload the instrument software file. The file manager dialog enables you to select the file directory and provides information on the currently installed software version.

[UPDATE](#)..... 136

UPDATE

Starts the software update.

9.11.2 Updating the instrument software

The following instructions show how to proceed for updating the instrument software version on the instrument.

Updating the instrument software

We recommend that you use the latest software version available on the product page at www.rohde-schwarz.com/firmware/lcx.

To install a new software version:

1. Download the latest version of the R&S LCX software from the Rohde & Schwarz website.
2. Unpack the compressed software *.zip file if it does not unpack during download automatically.
3. Save the file in the root directory of the USB memory stick.
4. Connect the USB memory stick to the USB interface at the front panel of the R&S LCX.
5. Press the [settings] key at the front panel.
6. In the "Device" tab, select "Update Device".
7. Select the "USB1A" memory.

The R&S LCX scans the USB memory device for software file types. It indicates the versions of the currently installed and the latest available firmware, including date and build information.

8. Select the software version you want to install.
9. Select "Update".

The software update starts.

Note: Interrupting the power supply during the firmware update only causes the update to fail. After the update, the R&S LCX automatically reboots and confirms with "Success" or "Failed".

However, we recommend that you do not power off the instrument until the update is completed.

When completed, the R&S LCX confirms that it is ready for operation.

9.12 Save/recall

The "Save/Recall" function enables you to save a certain configuration in a file and reload it for later reuse.

On power-on, the R&S LCX starts up in the configuration you used before switching off. It saves the configuration, including autosaved settings in the internal memory automatically.

With a USB stick connected, you can save a file on either the internal memory or the USB stick, with "Internal" as default setting. Without USB connected, the R&S LCX saves the file internally in the file path `/int/settings`.

9.12.1 Save/recall settings

With the "Save/Recall Device Settings" functions, you can save the complete instrument settings in files, and reload the settings for reuse.

Access:

1. Press the [settings] key at the front panel.
2. In the "Device" tab, select "Save/Recall Device Settings".



Figure 9-14: Save/Recall menu

The "Save/Recall" menu provides access to dialogs and editors for managing and saving instrument settings.

The required remote commands are described in [Chapter 11.3, "Common commands"](#), on page 177.

How to: see [Chapter 9.12.2, "Using the save/recall function"](#), on page 138

Settings

Save Settings to file.....	137
Recall Settings from file.....	138
Default Settings.....	138
Factory Reset.....	138

Save Settings to file...

Saves the current instrument settings under the defined filename.

The R&S LCX opens a file manager window and enables you to replace an existing file or create a file user-definable file name.

Remote command:

*SAV on page 179

Recall Settings from file...

Reloads a previously saved instrument configuration.

Remote command:

DATA:LIST? on page 191

*RCL on page 179

Default Settings

Resets all user-specific parameters and data to default. The reset function does not affect general instrument settings.

Remote command:

*RST on page 179

Factory Reset

Resets the instrument to the initial factory settings.

9.12.2 Using the save/recall function

You can save the current instrument settings to a file, and load these settings in one step again, e.g. to repeat tests with the same settings.

Saving instrument settings

To save the current instrument settings in a file:

1. Press the [settings] key at the front panel.
2. In the "Device" tab, select "Save/Recall Device Settings".
3. Select "Save Settings to File...".
If you have connected an external USB memory device, the R&S LCX opens a selection editor.
 - a) Select the memory location, you want to save the settings file.
 - b) Confirm your selection.

The R&S LCX opens a file selection dialog where you can choose an existing file, or create a file.

Note: With no USB connected, the instrument leads you to the internal settings directory directly.

4. To select an existing file:
 - a) In the file directory window, select the file.
 - b) Confirm with "Save".
5. To create a settings file:

- a) Select the file name entry field.
- b) In the on-screen keyboard, enter the file name.
- c) When completed, confirm your entry .

The R&S LCX saves the current instrument settings.

Recalling instrument settings

To load a settings configuration from a file, proceed the same way:

1. Select [settings] > "Device" > "Save/Recall Device Settings".
2. Select "Recall Settings to File...".

The R&S LCX leads you to the memory location to select the file.

3. Confirm you selection with "Load".

The R&S LCX applies the loaded settings.

Recalling default instrument settings

You can reset all instrument settings to factory default values, without affecting your specific system settings.

To reset the instrument to factory default settings:

1. Select [settings] > "Device" > "Save/Recall Device Settings".
2. Select "Default Settings".

The R&S LCX displays a message that prompts you to confirm.

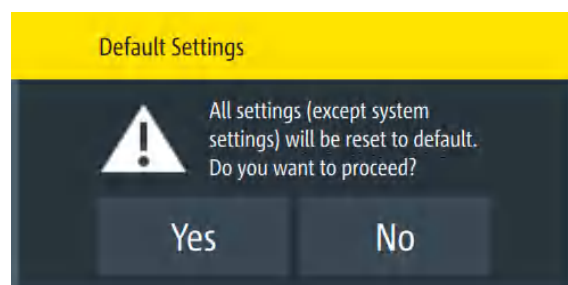

If confirmed, the R&S LCX resets current instrument settings to factory default.

3. When completed, a confirming message pops up.
4. Confirm to complete the process.

Resetting the instrument to the initial factory settings

You can reset all instrument settings, including the system settings to the factory default values. In addition, the factory reset can delete all files saved in the internal memory.

To execute a factory reset, proceed the same way:

1. Select [settings] > "Device" > "Save/Recall Device Settings".
2. Select "Factory Reset".

The R&S LCX displays a message that prompts you to confirm.

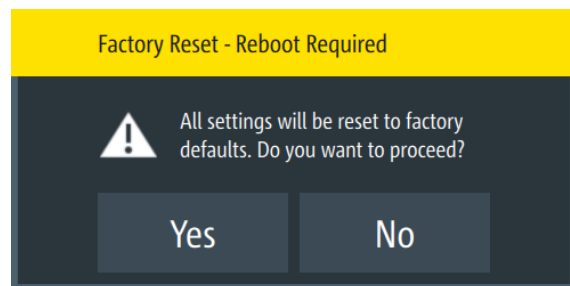

3. If confirmed, a second message provides to delete all internally saved files.

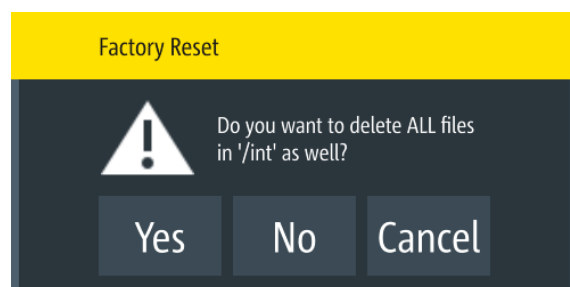

4. Confirm the prompt accordingly.
The R&S LCX resets all instrument settings to factory default and shuts down.
5. Press the [power] to restart the instrument.

9.13 Customizing general instrument settings

The R&S LCX enables you to set the instrument internal clock and calendar, or to customize the brightness of the screen display and the front panel keys. In addition, you can activate an acoustic sound for specific occurrences.

Setting date and time

To set the instrument internal calendar and clock:

1. Press the [settings] key at the front panel.
2. In the "Device" tab, select "Date & Time".
3. To set the date:

- a) Select the "Set Date" softkey.
An on-screen editor with calendar entries opens.

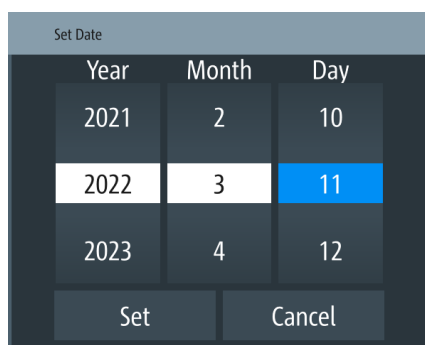

Figure 9-15: Date editor

- b) Select year, month and date.
 - c) Confirm your entry with "Set".
4. To set the time:
 - a) Select the "Set Time" softkey.
An on-screen editor with clock entries opens.

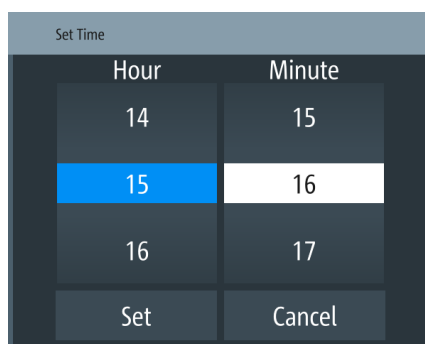

Figure 9-16: Time editor

- b) Select "Hour" and "Minute".
 - c) Confirm your entry.
5. To change the clock format:

- a) Select "Change Clock Format"

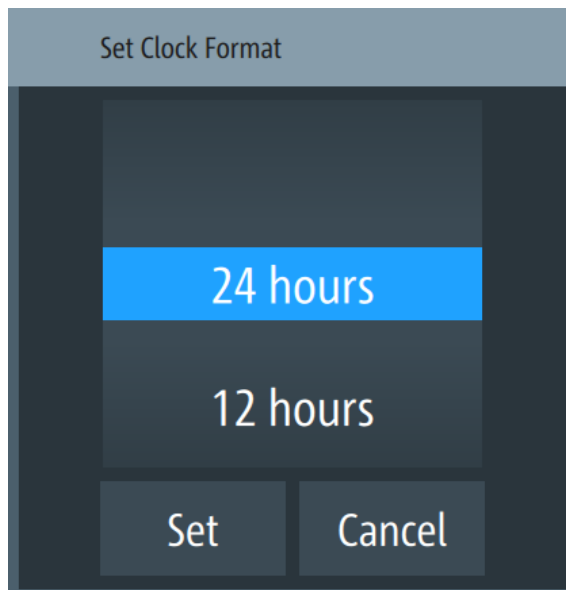

Figure 9-17: Clock format editor

- b) Set the format and confirm.

Customizing the appearance

To adjust the brightness of the display and front panel keys:

1. Press the [settings] key at the front panel.
2. In the "Device" tab, select "Appearance".
3. To change the brightness:
 - a) Select the corresponding softkey.

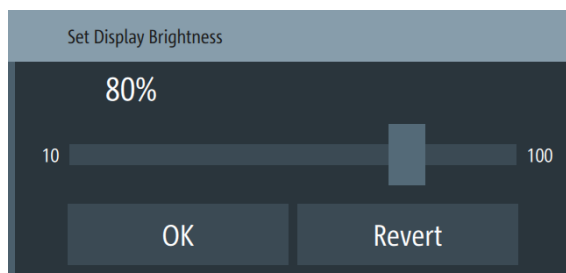



Figure 9-18: Brightness editor

- b) Shift the scrollbar to the right, or to the left, e.g. to set "50%".
 - c) Confirm with "OK".
4. Close the appearance dialog with "OK".

Customizing the sound settings

To activate a beep on error:

1. Press the [settings] key at the front panel.
2. In the "Device" tab, select "Sound".
3. Activate the beeper with .

The R&S LCX generates a beep on error and warnings, see [Chapter 9.8, "Sound"](#), on page 129.

10 Network operation and remote control

As an alternative to the interactive operation directly at the instrument, you can operate the R&S LCX also from a remote control location, for example a controller PC.

The various interfaces provide flexible access to the instrument, such as *remote control*, *remote operation* or *remote file access*. These remote access modes are fundamentally different, although they are often considered interchangeable, as described in [Overview of remote access modes](#).

Figure 10-1 shows the possibilities of the physical connection (interfaces) for remote access.



The following descriptions provide information required for operating the R&S LCX remotely. The information applies to all applications and operating modes supported by the instrument. Definitions specified in the SCPI standard are not provided.

For basic knowledge on remote control operation and additional information, see the following documents available from the Rohde & Schwarz website:

- [Remote control via SCPI](#)
- [1MA171: How to use Rohde & Schwarz Instruments in MATLAB](#)
- [1SL374: How to communicate with R&S devices using VISA](#)

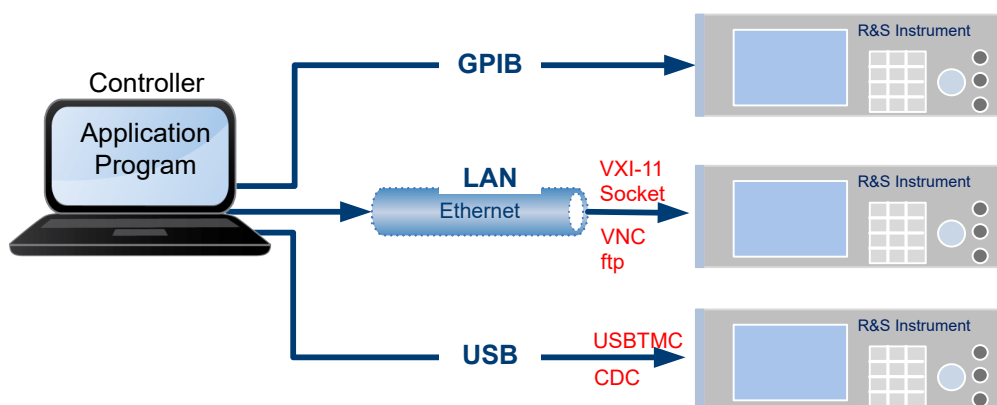

Figure 10-1: Supported remote connections

- [Overview of remote access modes](#)..... 145
- [Remote control interfaces and protocols](#)..... 146
- [Remote access settings](#)..... 154
- [Connecting the R&S LCX for remote access](#)..... 162
- [Adjusting interface addresses](#)..... 164
- [Operating the R&S LCX remotely](#)..... 168

10.1 Overview of remote access modes

This section outlines the possible access modes and their major characteristics.

Remote control (SCPI)

- A remote PC controls the instrument, usually using VISA (Virtual Instrument Software Architecture) interfaces.
- Remote control disables the manual operation of the instrument; you can set different lock states.
- The GUI is not visible on the controller PC.
- Remote control commands (SCPI) perform the settings, either individually or in sequences (SCPI programs).
- Using SCPI programs is faster than the manual operation, since they automate repeating applications.

Remote operation (VNC)

- A remote device accesses the instrument using the common platform technology VNC (Virtual Network Computing).
- The protocol allows simultaneous operation from several remote devices and the instrument nevertheless remains locally operable.
- The GUI is visible.
- To perform the settings, you can operate the instrument as with the manual control.
- During remote operation over VNC, the direct control of the instrument is not disabled.
You can control the instrument from the front panel and over the remote computer alternately.
- Clients supporting remote operation depend on the used remote device, see [Table 10-1](#).
- How to: see [Chapter 10.6.1.2, "Accessing the R&S LCX over VNC"](#), on page 170.

Table 10-1: Supported VNC operation modes

Remote device	VNC client	Requirements	Characteristics
Desktop (Windows, Linux, Mac™OS)	<ul style="list-style-type: none"> • Dedicated client software 	<i>Client Software</i> must be installed.	Fast, supports several options like full screen mode or auto-login.
	<ul style="list-style-type: none"> • Any web browser 	<i>Java Runtime</i> must be installed and activated in the browser settings.	Fast and convenient - only the instrument address required. Java runtime is sometimes considered as security concern.
	<ul style="list-style-type: none"> • Web browser with HTML5 	<i>Web sockets</i> must be supported.	Slower than the other modes. No additional installation or activation required. No security concern.

Remote file access (FTP)

- A remote client device accesses the instrument's file system over an Ethernet connection, using FTP (file transfer protocol).
- The protocol enables you to get direct access to the file directory of the R&S LCX to transfer files from or to the instrument.
- The access requires a dedicated FTP client on the host device. Usually, each operating system provides a basic built-in FTP client, but the functionality can vary and be limited to upload and download operation. The accessible file types depend on the contents of the instrument's file manager, see [Chapter 9.1, "File and data management"](#), on page 116.
- For authentication, you require the instrument's user name and password.

How to: see [Chapter 10.6.2, "Accessing the file system of the R&S LCX using FTP"](#), on page 172.

10.2 Remote control interfaces and protocols

The R&S LCX supports various interfaces for remote control. You need the connection between both devices and an application software on the controller PC that supports communication over the used interface. [Table 10-2](#) gives an overview on the connectivity:

Table 10-2: Remote control interfaces and protocols

Interface	Protocols, VISA [®] address string and library	Remarks
Local area network (LAN)	<ul style="list-style-type: none"> • Address string TCPIP::host address[:: LAN device name][::INSTR] VISA • VXI-11 TCPIP::host address[::inst0][::INSTR] VISA • Socket communication (Raw Ethernet, simple Telnet) TCPIP::host address[:: LAN device name][::<port>::SOCKET VISA or socket controller 	<p>The LAN connector is at the rear panel of the instrument.</p> <p>The interface is based on TCP/IP, see Chapter 10.2.1, "LAN interface", on page 147 for details on the address information.</p>
USB	<ul style="list-style-type: none"> • USBTMC USB::<vendor ID>::<product ID>:: <serial number>[::INSTR] VISA • CDC (communications device class, corresponds to VCP (virtual COM port)) 	<p>The USB B connector is at the rear panel of the instrument.</p> <p>For a description of the interface, see Chapter 10.2.2, "USB interface", on page 149</p>

Interface	Protocols, VISA ^{*)} address string and library	Remarks
GPIB (IEC/IEEE Bus Interface) (option R&S NG-B105)	<ul style="list-style-type: none"> – GPIB::<address>[::INSTR] (no secondary address) VISA (optional) 	<p>The optional GPIB bus interface according to standard IEC 625.1/IEEE 488.1 is at the rear panel of the instrument.</p> <p>For a description of the interface, see Chapter 10.2.3, "GPIB interface (IEC/IEEE bus interface)", on page 150.</p>
<p>^{*)} VISA (Virtual Instrument Software Architecture) is a standardized software interface library providing input and output functions to communicate with instruments. A VISA installation on the controller is a prerequisite for remote control over LAN and USB interface. For remote control over socket communication VISA installation is optional. When using socket communication or the GPIB interface, VISA installation is optional. For basic information, see Remote control via SCPI.</p>		



Rohde & Schwarz provides the standardized I/O software library R&S VISA for download at the Rohde & Schwarz website <http://www.rohde-schwarz.com/rsvisa>.

How to: see [Chapter 10.4, "Connecting the R&S LCX for remote access"](#), on page 162 and [Chapter 10.5, "Adjusting interface addresses"](#), on page 164

- [LAN interface](#)..... 147
- [USB interface](#)..... 149
- [GPIB interface \(IEC/IEEE bus interface\)](#)..... 150
- [Status reporting system](#)..... 151

10.2.1 LAN interface

To be integrated in a LAN, the instrument is equipped with a LAN interface, consisting of a connector, a network interface card and protocols.

The network card can be operated with the following interfaces:

- 10 Mbit/s Ethernet IEEE 802.3
- 100 Mbit/s Ethernet IEEE 802.3u

For remote control, the PC and the instrument must be connected over the LAN interfaces to a common network with TCP/IP network protocol. The instruments are connected with a commercial RJ45 cable (shielded or unshielded twisted-pair category 5). The TCP/IP network protocol and the associated network services are preconfigured on the instrument. Software for instrument control and (for specified protocols only) the VISA program library must be installed on the controller.



Identifying instruments in a network

If several instruments are connected to the network, each instrument has its own IP address and associated resource string. The controller identifies these instruments by the resource string.

10.2.1.1 VISA resource strings

The VISA resource string is required to establish a communication session between the controller and the instrument in the LAN. The resource string is a unique identifier,

composed of the specific IP address of the instrument and some network and VISA-specific keywords.

TCPIP::<host address>[:<LAN device name>][:INSTR]

TCPIP = designates the network protocol
 host address = designates the IP address or hostname of the instrument
 [[:LAN device name]] = defines the protocol and the instance number of a subinstrument
 [[:INSTR]] = indicates the instrument resource class (optional)

The **IP address** (host address/computer name) is used by the programs to identify and control the instrument. It is automatically assigned by the DHCP server the first time the device is registered in the network. Optionally, you can also assign its **LAN device name**.

The R&S LCX indicates the IP address in the [Chapter 10.3.2, "LAN settings"](#), on page 156 dialog. You can also adjust the IP address manually, see ["Assigning the LAN interface addresses manually"](#) on page 164.

The following section lists the characteristics of the VISA resource strings for the corresponding interface protocols. The emphasized characters determine the protocol.



For description of the protocols refer to [Remote control via SCPI](#).

VXI-11

TCPIP::<host address>[:inst0][:INSTR]

[[:inst0]] = LAN device name, indicates that the VXI-11 protocol is used (optional)

[[:inst0]] selects the VXI-11 protocol by default and can be omitted.

Example:

TCPIP::192.1.2.3::INSTR

Socket communication

TCPIP::<host address>::<port>::SOCKET

port = determines the used port number
 SOCKET = indicates the raw network socket resource class

Socket communication requires the specification of the port (commonly referred to as port number) and of "SOCKET" to complete the resource string.

Basically, instruments from Rohde & Schwarz use port number 5025 for socket communication.

Example:

TCPIP::192.1.2.3::5025::SOCKET

To assign a user-specific port number, see [Chapter 10.5, "Adjusting interface addresses"](#), on page 164.

FTP communication

`ftp://<host address>[:<port>]`

port = determines the used port number

By default, instruments from Rohde & Schwarz use port number 21 for FTP communication.

Example:

```
ftp://192.1.2.3/
```

To assign a user-specific port number, see ["Assigning the FTP port address manually"](#) on page 166.

VNC communication

`vnc://<host address>[:<port>]`

port = determines the used port number

By default, instruments from Rohde & Schwarz use port number 5900 for VNC communication.

Example:

```
vnc://192.1.2.3
```

To assign a user-specific port number, see ["Assigning the VNC port manually"](#) on page 165.

10.2.2 USB interface

For remote control using USB, the PC and the instrument must be connected over the USB B interface.

The USB B connector is at the [rear panel](#) of the instrument.

Software for instrument control and the VISA program library must be installed on the controller. VISA detects and configures the Rohde & Schwarz instrument automatically when the USB connection is established. You do not have to install a separate driver.

You can communicate with the instrument over the USB TMC class or the CDC class protocols:

- **USBTMC**
(USB Test & Measurement Class Specification) is a protocol that is built on top of USB for communication with USB devices, like GPIB. It defines class code information of the instrument, that identifies its functionality to load the respective device

driver. Using VISA library, it supports service request trigger, and other specific operations, similar to GPIB.

For control, you can use the SCPI terminal function of the R&S HMExplorer software. This software also provides logging of measurement values, or graphical display.

- **CDC**

(Communications Device Class, also known as **VCP** Virtual COM Port) is a protocol used for emulating serial ports over USB. Using the CDC protocol, you have to install the USB VCP driver corresponding to the Windows operating system of the controller PC, available for download on the Rohde & Schwarz product site at www.rohde-schwarz.com/driver/lcx/.

To select the USB interface, see "[Selecting the USB communication class protocol](#)" on page 167-

USB resource string

The resource string represents an addressing scheme that is used to establish a communication session with the instrument. It is based on the instrument address and some instrument- and vendor-specific information.

The USB resource string syntax is as follows:

USB::<vendor ID>::<product ID>::<serial number>[:INSTR]

USB	= denotes the used interface
<vendor ID>	= is the manufacturer ID for Rohde & Schwarz
<product ID>	= is the product identification of the instrument
<serial number>	= is the individual serial number at the rear of the instrument
[:INSTR]	= indicates the instrument resource class (optional)

To select the USB communication protocol, see "[Selecting the USB communication class protocol](#)" on page 167.

Example:

USB::0x0AAD::0x01DD::100001

0x0AAD is the vendor ID for Rohde & Schwarz.

0x01DD is the product ID for the R&S LCX

100001 is the serial number of the particular instrument.

10.2.3 GPIB interface (IEC/IEEE bus interface)

Option: R&S NG-B105 GPIB (IEC 625/IEE 488) bus interface

The GPIB interface is at the [rear panel](#).

To control the R&S LCX over the GPIB bus, the instrument and the controller must be connected with a GPIB bus cable. A GPIB bus card, the card drivers and the program libraries for the programming language used must be provided in the controller.



See [Remote control via SCPI](#) for additional information on the characteristics, control commands and messages of the GPIB interface.

GPIB address

The controller addresses the instrument with the GPIB bus channel, see [Chapter 9.2.1, "Interface settings"](#), on page 121. GPIB provides channel addresses from 0 to 30. The GPIB address is preset to 20 (factory-set), but you can adjust it according to your network environment, see ["Assigning the GPIB address manually"](#) on page 168. An instrument preset does not affect the GPIB address.

The GPIB resource string syntax is as follows:

`GPIB::<<channel>[:INSTR]`

GPIB = denotes the used interface
 <channel address> = the used channel
 [:INSTR] = indicates the instrument resource class (optional)



If the VISA implementation supports the GPIB interface, you can optionally define the VISA Instrument Control Resource (INSTR). It is used to define the basic operations and attributes for a device, such as reading, writing, or triggering.

Example:

`GPIB : : 28`

28 is the selected GPIB bus channel

10.2.4 Status reporting system

The status reporting system saves all information on the current operating state of the instrument and errors which have occurred. This information is saved in the status registers and in the error queue. You can query the status of the registers remotely, i.e. over the USB, GPIB or LAN interfaces with the commands of the [Chapter 11.15, "STATus subsystem"](#), on page 213.

10.2.4.1 Overview of the R&S LCX status registers

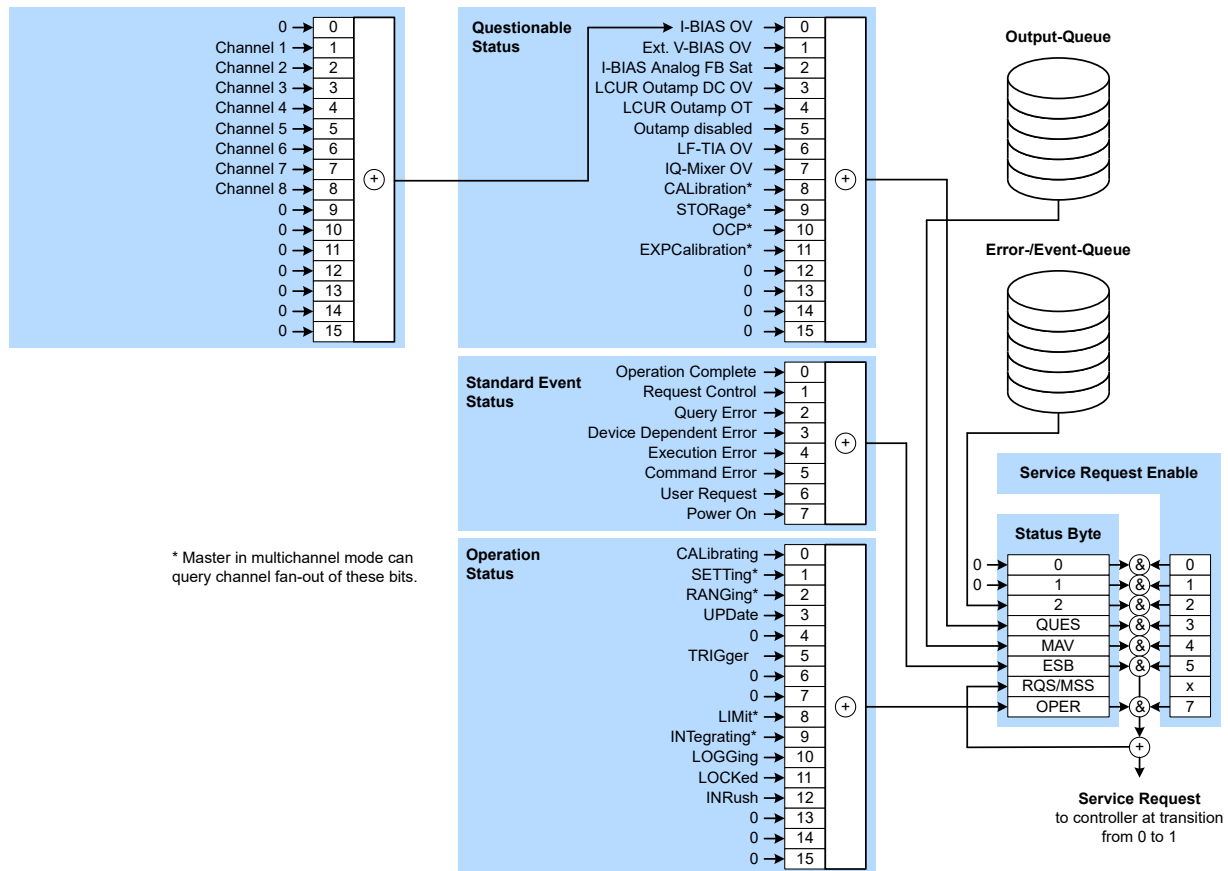

Figure 10-2: Graphical overview of the status registers hierarchy



The following sections describe the instrument-specific bit assignments of the operation status and the questionable status registers.

For more information, see:

- [Remote control via SCPI](#): provides general information on the status reporting system of Rohde & Schwarz instruments. This document also provides information on the standard event status register and the error queue.
- [Chapter 11.15, "STATus subsystem"](#), on page 213: describes the corresponding remote control commands of the status register
- SCPI standard documentation for comprehensive information on the standard

10.2.4.2 Instrument-specific status operation register

The condition part contains information on currently executed actions. The event part covers information on the actions performed since the last readout of the register.

To read the register, use the query commands `STATus:OPERation:CONDition?` on page 214 or `STATus:OPERation[:EVENT]?` on page 214. The remote commands for the operation status register are described in [Chapter 11.15.1, "Status operation register"](#), on page 213.

Table 10-3: Assignment of the bits used in the operation status register

Bit No.	Meaning
0	CALibrating The bit is set during the calibration phase (for service department only).
1	SETting
2	RANging
3	UPDate
4	0
5	TRIGger This bit is set while the instrument is waiting for the trigger.
6	0
7	0
8	LIMit
9	INTegrating
10	LOGging This bit is set as long as "Logging" is enabled
11	LOCKed Instrument locked (RWLock)
12	INRush
13	0
14	0
15	This bit is always 0

10.2.4.3 Instrument-specific status questionable register

This status register contains information on questionable instrument states. Questionable states occur when the instrument is not operated in compliance with its specifications.

To read the register, use the commands `STATus:QUESTionable:CONDition?` on page 215 and `STATus:QUESTionable[:EVENT]?` on page 216. The remote commands for the status questionable register are described in [Chapter 11.15.2, "Status questionable register"](#), on page 215.

Table 10-4: Assignment of the bits used in the questionable status register

Bit No.	Meaning
0	I-BIAS OV
1	Ext. V-BIAS OV
2	I-BIAS Analog FB Sat
3	LCUR outamp DC OV
4	LCUR outamp OT
5	Outamp disabled
6	LF-TIA OV
7	IQ-Mixer OV
8	CALibrating
9	Resistance overrange
10	OCP
11	EXPCalibration
12 to 14	Not used
15	This bit is always 0

See the schematic representation [Figure 10-2](#).

10.3 Remote access settings

This section outlines the settings required for accessing and configuring the provided remote control interfaces. It includes the interface settings, access addresses, and the access using controller devices.

10.3.1 Network settings

The Ethernet (LAN) connectivity enables you, to access the R&S LCX remotely. Provided the corresponding rights are assigned, you can use these interfaces for remote control and data transfer from a controller PC.

This section introduces the settings for remote control connections of the interfaces provided by the R&S LCX.

Access:

1. Press the [settings] key at the front panel.
2. In the device settings menu, select "Interfaces".
3. Select "Network".

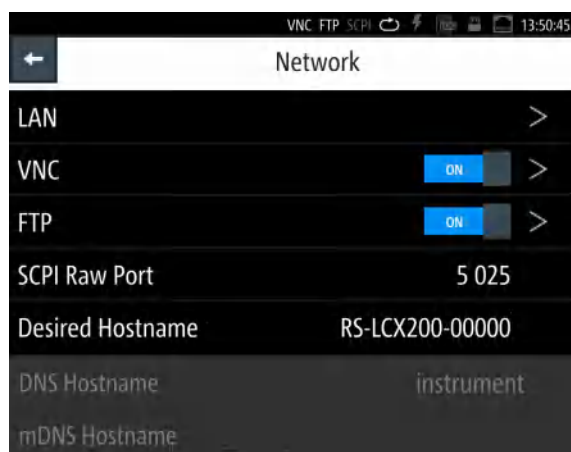

Figure 10-3: Network settings dialog

In the "Network" dialog, you can access the LAN and VNC interface addresses, assign the port for raw socket communication and a hostname for the instrument.

The remote commands required to configure the network remotely are described in [Chapter 11.16, "SYSTEM subsystem"](#), on page 216.

LAN.....	155
VNC.....	155
FTP.....	155
SCPI Raw Port.....	155
Desired Hostname.....	156
DNS Hostname.....	156
DNS Hostname.....	156

LAN

Opens the "LAN" dialog for setting the interface parameters, see [Chapter 10.3.2, "LAN settings"](#), on page 156.

VNC

Accesses the VNC dialog for configuring the VNC port address, see [Chapter 10.3.3, "VNC settings"](#), on page 158.

FTP

Accesses the FTP dialog for configuring the FTP port address, see [Chapter 10.3.4, "FTP settings"](#), on page 159.

SCPI Raw Port

Sets the port number for remote control over LAN, using TCP/IP socket protocol.

The socket address is a combination of the IP address or the host name of the instrument and the number of the port configured for remote-control.

To assign the socket port manually, set [DHCP & Auto-IP > Off](#)

How to: see ["Assigning the LAN interface addresses manually"](#) on page 164.

Remote command:
["SCPI Raw Port"](#) on page 155

Desired Hostname

Displays the hostname.

Each instrument is delivered with an assigned hostname, a logical name you can use instead of the IP address.

With the default network settings, the IP address is allocated by the DHCP server. This address can change each time the instrument is reconnected. Unlike the IP address, the hostname name does not change.

Note: We recommend that you do not change the hostname to avoid problems with the network connection. If you change the hostname, be sure to use a unique name.

How to: see ["Assigning the SCPI raw port and hostname manually"](#) on page 167.

Remote command:
`SYSTem:COMMunicate:LAN:HOSTname` on page 223

DNS Hostname

Displays the [DNS](#) hostname.

The DNS host name is a unique designation for an instrument, composed of the host-specific name and the domain name, separated by a "." (dot).

DNS Hostname

Displays the [mDNS](#) hostname.

10.3.2 LAN settings

Access:

1. Press the [settings] key at the front panel.
2. In the device settings menu, select "Interfaces".
3. Select "Network".
4. Select "LAN" .



Figure 10-4: LAN settings dialog

In this dialog, you can configure the settings of the general network environment and specific identification parameters of the instrument in the network. The R&S LCX displays the VISA resource strings and additional parameters for information on the LAN interface, and the status of the connection.

By default, the R&S LCX is configured to use dynamic TCP/IP configuration and to obtain the whole address information automatically. If the network does not support DHCP, you can assign the IP address manually.

The remote commands required to configure the network remotely are described in [Chapter 11.16, "SYSTEM subsystem"](#), on page 216.

How to: ["Assigning the LAN interface addresses manually"](#) on page 164.

Settings

DCHP & Auto-IP

Sets the mode for assigning the IP address.

"OFF" Assigns the IP address automatically, provided the network supports [DHCP](#).

"ON" Enables you to assign the IP address manually.

Remote command:

[SYSTEM:COMMunicate:LAN:DHCP](#) on page 222

IP Address

Displays the IP address of the instrument in the network. By default, the R&S LCX is configured to use dynamic TCP/IP configuration and to obtain the whole address information automatically.

To assign the socket port manually, set [DHCP & Auto-IP > Off](#)

How to: see ["Assigning the LAN interface addresses manually"](#) on page 164 for the steps to be taken for assign the address manually.

Remote command:

[SYSTem:COMMunicate:LAN:ADDRESS](#) on page 222

Subnet Mask

Displays the bit group of the subnet in the host identifier.

To assign the subnet mask manually, set [DHCP & Auto-IP > Off](#).

How to: see ["Assigning the LAN interface addresses manually"](#) on page 164.

Remote command:

[SYSTem:COMMunicate:LAN:SMASk](#) on page 223

Gateway

Displays the gateway address.

This address identifies the router on the same network as the instrument that is used to forward traffic to destinations beyond the local network.

To assign the subnet mask manually, set [DHCP & Auto-IP > Off](#).

How to: see ["Assigning the LAN interface addresses manually"](#) on page 164.

Remote command:

[SYSTem:COMMunicate:LAN:DGATeway](#) on page 222

Apply Configuration

Applies the modified settings.

Reset LAN Connection

Terminates the network connection of the instrument and sets it up again.

You can use this function to fix network problems.

Note: This function restarts only the connection of the instrument to the network. It does not impact the network itself.

How to: see ["Assigning the LAN interface addresses manually"](#) on page 164.

Remote command:

[SYSTem:COMMunicate:LAN:RESet](#) on page 223

MAC Address

Indicates the [MAC](#) address, a unique identifier of the network adapter in the R&S LCX.

Remote command:

[SYSTem:COMMunicate:LAN:MAC?](#) on page 223

10.3.3 VNC settings

Using a VNC client tool on a computer, you can control the R&S LCX remotely. Establish a connection between the computer and R&S LCX in the network, see ["Establishing the LAN connection"](#) on page 21.

Access:

1. Press the [settings] key at the front panel.

2. In the device settings menu, select "Interfaces".
3. Select "Network".
4. Select "VNC".



Figure 10-5: VNC settings dialog

The "VNC" dialog enables you to assign a port address for accessing the R&S LCX over VNC and activate the access.

The remote commands required to configure the network remotely are described in [Chapter 11.16, "SYSTem subsystem"](#), on page 216.

How to: ["Assigning the LAN interface addresses manually"](#) on page 164.

Enabled

Activates remote access over the VNC port.

Remote command:

`SYSTem:COMMunicate:NETWork:VNC[:STATe]` on page 224

VNC Port

Sets the port number for remote control using a VNC client tool.

How to: see ["Assigning the VNC port manually"](#) on page 165.

Remote command:

`SYSTem:COMMunicate:NETWork:VNC:PORT` on page 223

10.3.4 FTP settings

The file transfer protocol (FTP) provides remote access to the file system of an instrument over LAN.

FTP supports the following operations:

- Upload files from the remote PC (host) to the instrument.
- Download files from the instrument to the host.
- Browse the file system on the instrument remotely.

Establish a connection between the computer and R&S LCX in the network, see ["Establishing the LAN connection"](#) on page 21.

Using an FTP client application on a computer, you can access the internal memory or a connected USB memory stick of the R&S LCX. The connection enables you to transfer files with operating data, saved device settings, measurement data files or documents from or to the device.



The file access (access-transparency) depends on the used FTP client. Therefore, it can be necessary that you have to download a file before you can access or modify it.

Access:

1. Press the [settings] key at the front panel.
2. In the device settings menu, select "Interfaces".
3. Select "Network".
4. Select "FTP".

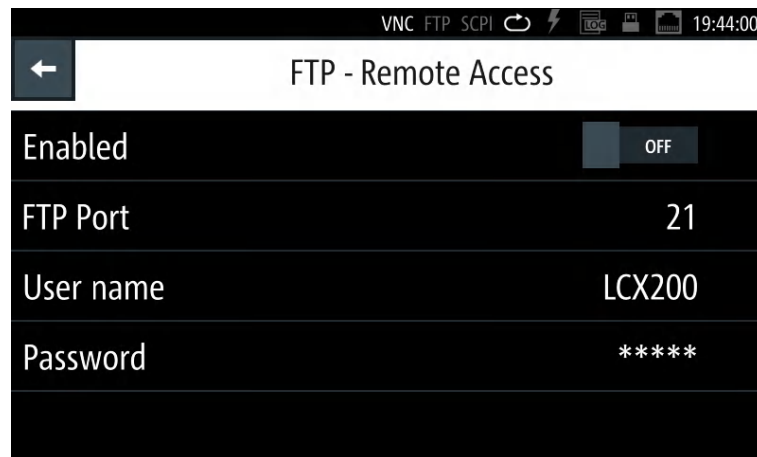

Figure 10-6: FTP settings dialog

For accessing the R&S LCX over FTP, you must assign a port address, a user name and password to activate the connection.

How to: see ["Assigning the VNC port manually"](#) on page 165.

Settings

Enabled	160
FTP Port	160
User name	161
Password	161

Enabled

Activates remote access over the FTP port.

FTP Port

Sets the port number for remote access, using an FTP client application.

The R&S LCX uses port 21 by default, but you can use any port address in the range of 100 to 65635.

How to: see ["Assigning the FTP port address manually"](#) on page 166.

User name

Sets a user name for the FTP connection.

The user name consists of the instrument name by default, e.g. LCX200. To assign a user-specific name, you can set any sequence with at least 1 letter and 1 digit.

How to: see ["Assigning the FTP port address manually"](#) on page 166.

Password

Sets a password for the FTP connection.

The password is a string of characters to verify the identity for authentication. By default, the password for FTP access corresponds to the serial number of your instrument.

Note: We recommend that you assign a dedicated user-specific password. You can set any character sequence with at least 1 letter and 1 digit.

How to: see ["Assigning the FTP port address manually"](#) on page 166.

10.3.5 USB settings

For remote control over USB, you can address the R&S LCX over the USB TMC class, or the virtual COM port CDC (VCP).

Access:

1. Press the [settings] key at the front panel.
2. In the device settings menu, select "Interfaces".
3. Select "USB Class".

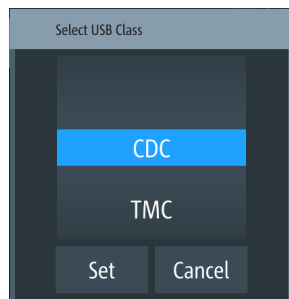

Figure 10-7: USB class selection editor

The R&S LCX activates the connection and indicates the selected USB interface port on top of the display.

USB Class

Selects the communication class protocol.

The R&S LCX supports CDC and TMC communication, see [Chapter 10.2.2, "USB interface"](#), on page 149.

Note: If you change the "USB Class", you must reboot the instrument to load the corresponding USB driver, see ["Selecting the USB communication class protocol"](#) on page 167.

Remote command:

`INTerfaces:USB:CLASs` on page 220

10.3.6 GPIB settings

Option: R&S NG-B105 GPIB (IEC 625/IEE 488) bus interface

For remote control over [GPIB](#), you can address the R&S LCX over a channel address.

Access:

1. Press the [settings] key at the front panel.
2. In the device settings menu, select "Interfaces".
3. Select "GPIB Address".

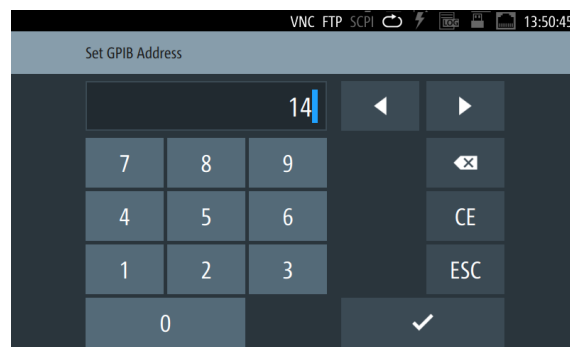

Figure 10-8: GPIB address on-screen keypad

The controller must address the instrument with the GPIB bus address.

GPIB Address

Set the GPIB channel address of the connected instrument.

About: see [Chapter 10.2.3, "GPIB interface \(IEC/IEEE bus interface\)"](#), on page 150

How to: see ["Assigning the GPIB address manually"](#) on page 168

10.4 Connecting the R&S LCX for remote access

This section briefly explains how to set up the remote control connections for the interfaces provided by the R&S LCX.



Establishing the LAN connection

The R&S LCX provides Ethernet (LAN) connectivity. Provided the corresponding rights are assigned, you can use these interfaces for remote control and data transfer from a controller PC. The controller PC must also be connected in the network.

The "LAN" connector is at the [rear panel](#).

To connect the R&S LCX to the LAN:

1. Connect the "LAN" socket using an RJ-45 cable to the LAN.

By default, the R&S LCX configuration uses [DHCP](#) that assigns the IP address automatically.

2. **NOTICE!** If the R&S LCX cannot obtain an IP address automatically, or cannot establish the connection, the icon in the status bar turns red. Possible reasons are that the LAN does not support DHCP or requires a specific TCP/IP configuration, or that the connection is missing.

To troubleshoot the problem, proceed as follows:

- a) Check if you have connected both, the R&S LCX and the controller PC to the LAN.
- b) Consult your network administrator to request support and an IP address, if necessary.
- c) If necessary, assign the IP address manually as described in "[Assigning the LAN interface addresses manually](#)" on page 164.



Establishing a USB remote control connection

You can use the USB B interface for remote control and data transfer from a controller PC. Remote control over USB requires the VISA library, or the corresponding TMC or CDC protocol drivers. The controller PC and the instrument must be connected at the USB B interface.

The USB B connector is at the [rear panel](#).

To connect the R&S LCX to the controller PC:

- ▶ Connect the USB B connector using a double-shielded USB cable to the controller PC.

VISA detects and configures the instrument automatically when the USB connection is established. You do not have to enter an address string or install a separate driver.

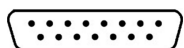

Establishing the GPIB remote control connection

Option: R&S NG-B105 GPIB (IEC 625/IEE 488) bus interface

You can use the GPIB bus interface for controlling the instrument remotely.

The USB B connector is at the [rear panel](#).

To connect the R&S LCX to the controller PC:

1. Connect the IEC 625/IEEE 488 connector of the R&S LCX to the controller PC with a double-shielded GPIB bus interface cable.
2. Configure the settings for remote control as described in ["Assigning the GPIB address manually"](#) on page 168.

The controller must address the instrument with the GPIB bus address, see [Chapter 10.2.3, "GPIB interface \(IEC/IEEE bus interface\)"](#), on page 150.

10.5 Adjusting interface addresses



Depending on the network capabilities, the TCP/IP address information for the instrument can be obtained in different ways.

- If the network supports DHCP (dynamic host configuration protocol), the address information is assigned automatically. This mode enables you to establish a physical connection to the LAN without any additional instrument configuration.
- If the network does not support DHCP, or if the instrument is set to use alternate TCP/IP configuration, you must set the addresses manually, see ["Assigning the LAN interface addresses manually"](#) on page 164.
- SCPI Raw Port
As an alternative, you can establish a raw TCP/IP connection using sockets for sending raw SCPI commands to the instrument. To configure the connection, assign the port, and, if necessary, the host name of the instrument, see ["Assigning the SCPI raw port and hostname manually"](#) on page 167

Assigning the LAN interface addresses manually

If the network provides DHCP, this protocol assigns the IP address automatically (default setting). But you can also assign the address manually, if necessary. It is assumed that you have connected controller PC and the instrument, see ["Establishing the LAN connection"](#) on page 21.

To assign the IP addresses for the LAN interface manually:

1. **NOTICE!** Risk of network failure. Connecting to the network can cause network failure. Errors can affect the entire network.

Consult your network administrator before performing the following tasks:

- Connecting the instrument to the network
- Configuring the network
- Changing IP addresses

2. Access: see [154](#)
3. Turn "DHCP & Auto-IP".

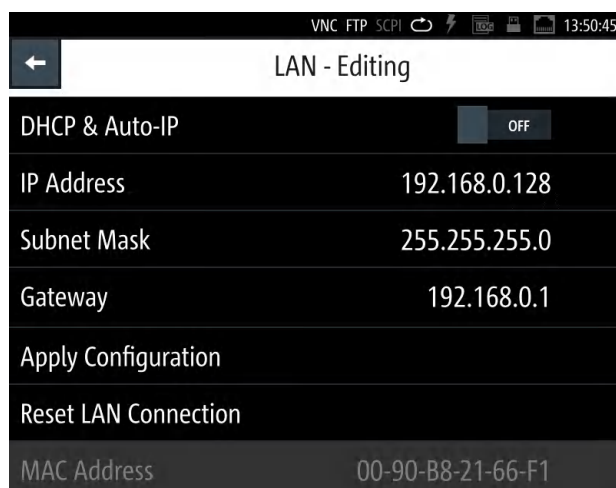



Figure 10-9: LAN settings

The R&S LCX enables edit mode.

4. Select the "IP Address".
The IP address consists of four blocks separated by dots. Every block contains 3 numbers at a maximum.
5. Enter the address, e.g. *123.123.1.123*.
6. Confirm with .
7. Set the "Subnet Mask" and "Gateway" in the same way.
8. Select "Apply Configuration".
The R&S LCX applies the modified settings.
9. To undo the changes, select "Reset LAN Connection".
Note: The MAC address is assigned statically and cannot be modified.
10. Return with .

When the connection is established successfully, the R&S LCX displays the white network icon in the instrument status bar.

Assigning the VNC port manually

Using a VNC client, you can access the R&S LCX remotely over the VNC interface. The controller addresses the instrument with the port address. The R&S LCX has the factory-set address 5900, but you can adjust it manually according to your network environment. It is assumed, that you have established the connection, see "[Establishing the LAN connection](#)" on page 21.

To set the VNC port manually:

1. To access the setting, press the [settings] key at the front panel.
2. In the device settings menu, select "Interfaces" > "Network" > "VNC".

Note: You can modify the settings only, when VNC state is deactivated.

3. Turn VNC.
4. Select "VNC Port".
An on-screen keypad opens.
5. Enter the port number.
6. Confirm with .

The R&S LCX changes the VNC port address accordingly.

Note: The VNC address settings are retained by an instrument preset, and also when you recall previously saved instrument settings, see [Chapter 9.12, "Save/recall"](#), on page 137.

However, a factory reset presets the VNC address to the default value, see ["Resetting the instrument to the initial factory settings"](#) on page 139.

Assigning the FTP port address manually

Using an FTP application, the remote controller addresses the R&S LCX instrument with the port address. The R&S LCX has the factory-set address 21, but you can adjust it manually according to your network environment. It is assumed, that you have established the connection, see ["Establishing the LAN connection"](#) on page 21.

To set the FTP access settings manually:

1. Press the [settings] key at the front panel.
2. In the device settings menu, select "Interfaces" > "Network" > "FTP".
Note: You can modify the settings only, when FTP is deactivated.
3. Turn "FTP".
4. Select "Port".
An on-screen keypad opens.
5. Enter the port number.
6. If necessary, assign an individual user name:
Initially, the assigned user name is the <instrument name>, e.g., "LCR200".
 - a) Select "User name".
 - b) Enter the user name, e.g., *MyLCR Meter1*. You can specify any sequence with at least 1 letter and 1 digit.
 - c) Confirm with .
7. **NOTICE!** The password is required when you use the FTP function the first time, and after changing the port and user name.

To change or confirm the password:

Initially, the assigned password is the <serial number> of the instrument, see the label at the [rear panel](#).

- a) Select "Password".
- b) Enter the password.
You can specify any sequence with at least one letter and one digit.

c) Confirm with .

The R&S LCX changes the FTP port address accordingly.

Note: The FTP address settings are retained by an instrument preset, and also when you recall previously saved instrument settings, see [Chapter 9.12, "Save/recall"](#), on page 137.

However, a factory reset presets the FTP address to the default value, see ["Resetting the instrument to the initial factory settings"](#) on page 139.

Assigning the SCPI raw port and hostname manually

To assign the socket port and the instrument name manually:

1. Access: see [154](#)
2. Select "SCPI Raw Port".
The R&S LCX opens an on-screen keypad to enter the port number.
3. Enter the port number, e.g., *5025*.
4. Confirm with .
5. Proceed the same way to enter the hostname, e.g. *LCX200-01*.

Assigning the IP address manually on the controller PC

- ▶ Obtain the necessary information from your network administrator. If you use more than one LAN connector, you need separate address information for each connector.

For information on how to configure the LAN settings, refer to the documentation of the operating system the PC uses.



Selecting the USB communication class protocol

A USB connection requires the VISA library to be installed. VISA detects and configures the R&S instrument automatically when the USB connection is established. You do not have to enter an address string or install a separate driver. It is assumed that you have connected controller PC and the instrument, see ["Establishing a USB remote control connection"](#) on page 163

To install the driver and select the USB class:

1. Press the [settings] key at the front panel.
2. In the device settings menu, select "Interfaces" > "USB Class".
A selection dialog opens.
3. Select the communication protocol for the USB interface, e.g. "CDC".
4. Confirm your selection.

If you have changed the USB class, the R&S LCX displays a message that prompts you to reboot.

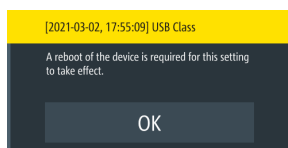

The instrument must reboot to load the corresponding protocol driver.

5. To proceed, you have the following options:
 - a) Confirm with "OK".
The R&S LCX reboots and activates the connection. It indicates the selected USB interface port in the device status bar on top of the screen.
 - b) If you want to undo your selection, tap any point of the screen outside the message.
The message disappears and you can correct your selection.

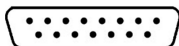

Assigning the GPIB address manually

Option: R&S NG-B105 GPIB (IEC 625/IEE 488) bus interface

The controller addresses the instrument within the GPIB bus channel, providing addresses from 0 to 30. The R&S LCX has the factory-set address 20, but you can adjust it manually according to your network environment. It is assumed, that you have established the connection, see "[Establishing the GPIB remote control connection](#)" on page 163.

To select and enter the GPIB manually:

1. To access the setting, the [settings] key at the front panel.
 2. In the device settings menu, select "Interfaces" > "GPIB Address".
An on-screen keypad opens.
 3. Enter the channel number.
 4. Confirm with .
- The R&S LCX changes the GPIB address accordingly.

Note: The address is maintained after a reset of the instrument settings.

10.6 Operating the R&S LCX remotely

When you switch on the instrument, it is always in manual operation state (local state). You can operate it using the controls on the front panel. To operate the instrument from a remote location, see the following possibilities, how to set up remote control connections over the available interfaces.

Prerequisites to proceed with the following instructions are:

- You have set up the connection between the R&S LCX and the controller, see [Chapter 10.4, "Connecting the R&S LCX for remote access"](#), on page 162.
- The instrument and the controller are turned on and ready for operation.

- You have established the correct interface address, see [Chapter 10.2, "Remote control interfaces and protocols"](#), on page 146.

10.6.1 Controlling the R&S LCX over LAN

10.6.1.1 Using SCPI commands

Activating the LAN interface

The LAN interface is enabled automatically, when the connection is established and the IP addresses are valid. To check the settings:

1. Press the [settings] key at the front panel.
2. In the device settings menu, select "Interfaces".
3. Select "Network".
4. Select "LAN".
5. If turned off, enable "DHCP & Auto IP" .

The "LAN settings" dialog shows the current address configuration of the interface.

Starting a remote control session

To start remote control:

1. Send a command from the controller.
2. VXI-11 protocol (LAN or USB interface): Use >R interface message.

The instrument switches to remote control and executes the command.

On the screen, a status symbol indicates that remote control is active. The display remains on and you can still operate it manually using the front panel controls.

Returning to manual operation

The instrument switches back to manual operation once you close the remote connection. You can also return to manual operation manually or with a remote command:

To return to manual control:

- ▶ VXI-11 protocol (LAN or USB interface): Use >L interface message.



The instrument switches to manual control.

10.6.1.2 Accessing the R&S LCX over VNC

Enabling the VNC service for remote access

For remote access over VNC, you must connect the controller PC and the R&S LCX in a LAN, see ["Establishing the LAN connection"](#) on page 21.

To enable the service on the R&S LCX:

1. Press the [settings] key at the front panel.
2. In the device settings menu, select "Interfaces".
3. Select "Network".
4. Select "VNC".
5. If necessary, configure the VNC port address, see ["Assigning the VNC port manually"](#) on page 165.
6. Return  to the "Network" settings menu.
7. Turn  "VNC".
8. Select "LAN".
9. Turn  "DHCP & Auto IP".

The R&S LCX indicates the IP address, you can use for accessing the instrument over a web application.

10. For accessing the instrument remotely, you have several options, see e.g.:
 - [Setting up a VNC remote access connection with a web browser](#)
 - [Setting up a VNC connection with a dedicated desktop client](#)

Setting up a VNC remote access connection with a web browser

Prerequisite: the controller PC and the R&S LCX are connected in a LAN, see ["Establishing the LAN connection"](#) on page 21.

To enable the VNC connection, follow the instructions as given under [Enabling the VNC service for remote access](#):

1. Open any web browser on the controller PC.
2. Enter the IP address of the R&S LCX in the URL address bar.
3. Confirm with enter.

The web page of your LCR meter appears.

4. Select the "VNC Device Control".

The web-based VNC client window opens and displays the front panel view of your instrument.

In the status line at the bottom, you can see the port address.

Tip: If you want to configure a different port, enter the port and confirm with "Connect".

5. To zoom the instrument view, select "Open in fullscreen".

The R&S LCX is ready for remote operation.

You can use all functions similar to manual operation. The operation works on the touch-sensitive screen, and also when you select the keys of the front panel.

6. To operate the R&S LCX:
 - a) Select a parameter on the screen.
 - b) Enter the value using the on-screen keyboard.
 - c) Select a front panel key, to activate the corresponding function.
 - d) Select the [rotary knob].
 - e) Drag the knob to the right or left to select a parameter, or to increase or decrease a value, etc.

Setting up a VNC connection with a dedicated desktop client

Prerequisite: the controller PC and the R&S LCX are connected in a LAN, see "[Establishing the LAN connection](#)" on page 21.



The controller PC requires a dedicated VNC client application. The operating systems Linux/Unix provide a build-in VNC client, but for Windows operating systems, you must have installed a VNC client software on the controller PC.

Various free-of charge applications are available for download on the Internet.

This example refers to an application on a Windows client.

To enable the VNC connection, follow the instructions given under [Enabling the VNC service for remote access](#):

1. To launch the VNC client application on the controller PC:
 - a) On the Internet, download a VNC client application, e.g. the Real VNC, see <https://www.realvnc.com>.
 - b) Start the VNC client installation.
 - c) Select VNC viewer component and follow the installation instructions.
 - d) When completed, confirm the installation.
2. Start the VNC client.
3. Enter the IP address of the R&S LCX in the address line.

The address string follows the syntax:

`<ip address or hostname>[:port]`, e.g., `//192.168.0.128:5678`

Note: If you use a port number different from the default port 5900, you must add this number to the IP address.

Note that when you reconnect, the changed port number is not retained, but reset to default.

To save a connection with a different port, just bookmark this page with the port number contained in the address string.

4. Confirm with enter.
An icon of the LCR meter appears on the VNC viewer window.
5. Select the icon to open the remote desktop of the instrument.
The R&S LCX is ready for remote operation.
You can use all functions similar to manual operation. The operation works on the touch-sensitive screen, and also when you select the keys of the front panel.
6. To operate the R&S LCX:
 - a) Select a parameter on the screen
 - b) Enter the value using the on-screen keyboard.
 - c) Select a front panel key, to activate the corresponding function.
 - d) Select the [rotary knob].
 - e) Drag the knob to the right or left to select a parameter, or to increase or decrease a value, etc.

Stopping the remote desktop operation

You can terminate remote access operation anytime without affecting ongoing processes and measurements.



1. Close the VNC client application.
Note: If the connection is interrupted accidentally, e.g. by a reboot of the instrument, the VNC client does not re-establish the connection automatically.
2. To reconnect, proceed as described above.

10.6.2 Accessing the file system of the R&S LCX using FTP

Enabling the FTP service for remote access

For remote access over FTP, you must connect the controller PC and the R&S LCX in a LAN, see "[Establishing the LAN connection](#)" on page 21.

To enable the service on the R&S LCX:

1. Press the [settings] key at the front panel.
2. In the device settings menu, select "Interfaces".
3. Select "Network".
4. Select "FTP".
5. If necessary, configure the FTP port address, see "[Assigning the FTP port address manually](#)" on page 166.
6. Return  to the "Network" settings menu.
7. Turn  "FTP".
8. Select "LAN".

9. Turn  "DHCP & Auto IP".

The R&S LCX indicates the IP address, you can use for accessing the instruments file system over FTP protocol, see [Accessing the file system remotely over a file explorer](#).

Accessing the file system remotely over a file explorer

Prerequisite: the controller PC and the R&S LCX are connected in a LAN, see ["Establishing the LAN connection"](#) on page 21.



For FTP access, you need a URI address string you must enter the user name and password of the instrument. For security reasons, we recommend that you assign a dedicated user-specific password in the "FTP Remote-Access" dialog before connecting to the instrument. See [Chapter 10.3.4, "FTP settings"](#), on page 159.

This example refers to an application on a Windows client.

To enable the FTP file transfer connection, follow the instructions as given under [Enabling the FTP service for remote access](#).

1. Open a file explorer on the controller PC, e.g. the Windows Explorer, or the Internet Explorer.
2. To connect to the FTP server, enter the FTP address string of the R&S LCX in the address bar.

The address string follows the syntax:

```
ftp://<ip address or hostname>[:port], e.g.  
ftp://192.168.0.128:5678
```

A "Log On As" dialog opens that prompts you to enter the user name and password of the instrument.

Note: If you use a port number different from the default port 21, you must add this number to the address string, e.g. `ftp://192.168.0.128:5678`.

Tip: As an alternative, you can add the login credentials directly in the address string:

```
ftp://<user name>:<password>@<ip address or hostname>[:port],  
e.g. ftp://LCR200:<password>@192.168.0.128:5678
```

3. Confirm with enter.

The file system of your LCR meter appears.

You can browse the content of the internal and externally connected USB memory device, and upload and download files as known from file manager functions.

Mounting the FTP connection for quick access

For quick access to the instrument without logging in, you can assign the FTP remote network address connection to the file explorer:

This example refers to the file manager application on a Windows client.

To mount the FTP network address string to the file explorer:

1. Open the file explorer on the controller PC.
2. Connect to the R&S LCX file system as described in [Accessing the file system remotely over a file explorer](#).
3. Select the computer name directory of your controller PC, e.g. "This PC".
4. In the ribbon bar of the "Computer" tab, select "Add a network location".

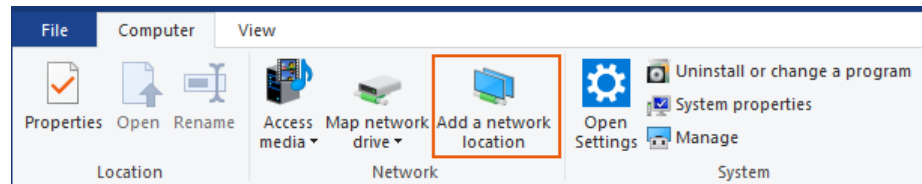

The "Add Network Location" wizard opens.

5. Follow the steps of the wizard:
 - a) Select "Choose a custom network location".
 - b) In step "Specify the location of your web site", enter the FTP address string, e.g. `ftp://LCR200:<password>@192.168.0.128:5678`.
 - c) Assign a user name for the directory, e.g. `_LCR200_FTP`, if necessary.
 - d) For immediate access, enable the "Open this network location" checkbox.
 - e) Confirm with "Finish".

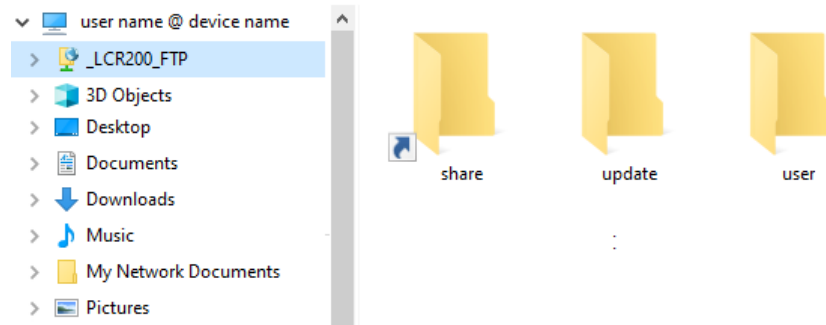

The available file directories of the instrument appear under the mounted directory in the navigation tree. You can browse in the instruments file system and upload or download files.

Note: The address string in the example contains the login credentials and thus directly accesses the instrument's file system when reconnecting.

To protect the instrument from unauthorized access, you can also set up only the FTP network address, and thus explicitly require the login for each connection.

Stopping the remote FTP file access

To terminate FTP file access:

1. **NOTICE!** Risk of data loss. Terminating FTP file access during file transfer can impact a file and lead to data loss. Also, when the connection to the controller PC is interrupted accidentally.

Wait until an ongoing transfer process has finished.

2. Close the FTP client application.
3. To reconnect, proceed as described above.

11 Remote control commands

In the following, all remote-control commands are presented in detail with their parameters and the ranges of numerical values.

For an introduction to remote control and the status registers, see:

- [Chapter 10, "Network operation and remote control"](#), on page 144
- [Chapter 10.2.4, "Status reporting system"](#), on page 151

See also the list of commands in alphabetical order at the end of this user manual.

11.1 Conventions used in SCPI command description

Note the following conventions used in the remote command descriptions:

- **Command usage**
If not specified otherwise, commands can be used both for setting and for querying parameters.
If a command can be used for setting or querying only, or if it initiates an event, the usage is stated explicitly.
- **Parameter usage**
If not specified otherwise, a parameter can be used to set a value and it is the result of a query.
Parameters required only for setting are indicated as **Setting parameters**.
Parameters required only to refine a query are indicated as **Query parameters**.
Parameters that are only returned as the result of a query are indicated as **Return values**.
- **Conformity**
Commands that are taken from the SCPI standard are indicated as **SCPI confirmed**. All commands used by the R&S LCX follow the SCPI syntax rules.
- **Asynchronous commands**
A command which does not automatically finish executing before the next command starts executing (overlapping command) is indicated as an **Asynchronous command**.
- **Reset values (*RST)**
Default parameter values that are used directly after resetting the instrument (*RST command) are indicated as ***RST** values, if available.
- **Factory preset values**
Default parameter values that are reset only by factory preset.
- **Default unit**
The default unit is used for numeric values if no other unit is provided with the parameter.
- **Manual operation**
If the result of a remote command can also be achieved in manual operation, a link to the description is inserted.

11.2 Programming examples

The corresponding sections of the same title provide simple programming examples for the R&S LCX. The purpose of the examples is to present **all** commands for a given task. In real applications, one would rather reduce the examples to an appropriate subset of commands.

The programming examples have been tested with a software tool which provides an environment for the development and execution of remote tests. To keep the examples as simple as possible, only the "clean" SCPI syntax elements are reported. Non-executable command lines (for example comments) start with two // characters.

At the beginning of the most remote control programs, we recommend that you (p)reset the instrument to set the R&S LCX to a definite state. The commands `*RST` and `SYSTem:PRESet` are equivalent for this purpose. `*CLS` also resets the status registers and clears the output buffer.

In all the examples we assume that:

- A remote PC is connected to the instrument
- The remote PC and the instrument are switched on
- A connection between them is established

11.3 Common commands

Common commands are described in the IEEE 488.2 (IEC 625-2) standard. These commands have the same effect and are employed in the same way on different devices. The headers of these commands consist of "*" followed by three letters. Many common commands are related to the Status Reporting System.



We recommend that you reset the R&S LCX with `*RST` on page 179 to set the instrument to a defined status before starting any remote control sequence.

The R&S LCX does not support parallel processing of remote commands. If the query `*OPC?` (see `*OPC` on page 178) returns a „1“, the device is able to process new commands.

Available common commands:

<code>*CLS</code>	178
<code>*ESE</code>	178
<code>*ESR?</code>	178
<code>*IDN?</code>	178
<code>*OPC</code>	178
<code>*RCL</code>	179
<code>*RST</code>	179
<code>*SAV</code>	179
<code>*SRE</code>	179

*STB?.....	180
*TRG.....	180
*WAI.....	180

***CLS**

Clear status

Sets the status byte (STB), the standard event register (ESR) and the `EVENT` part of the `QUESTIONABLE` and the `OPERATION` registers to zero. The command does not alter the mask and transition parts of the registers. It clears the output buffer.

Usage: Setting only

***ESE <Value>**

Event status enable

Sets the event status enable register to the specified value. The query returns the contents of the event status enable register in decimal form.

Parameters:

<Value> Range: 0 to 255

***ESR?**

Event status read

Returns the contents of the event status register in decimal form and then sets the register to zero.

Return values:

<Contents> Range: 0 to 255

Usage: Query only

***IDN?**

Returns the instrument identification.

Return values:

<ID> Rohde&Schwarz,<device type>,<order number>/<serial number>,<firmware version> <hardware version>

Example: Rohde&Schwarz,LCX200,3629.8856k03/900020,02.018**Usage:** Query only

***OPC**

Operation complete

Sets bit 0 in the event status register when all preceding commands have been executed. This bit can be used to initiate a service request. The query writes a "1" into the output buffer when all preceding commands have been executed, which is useful for command synchronization.

***RCL** <Number>

Recall

Loads the instrument settings from an intermediate memory identified by the specified number. The instrument settings can be saved to this memory using the command [*SAV](#) with the associated number.

Manual operation: See ["Recall Settings from file..."](#) on page 138

***RST**

Reset

Sets the instrument to a defined default status. The default settings are indicated in the description of commands.

Usage: Setting only

Manual operation: See ["Default Settings"](#) on page 138

***SAV** <Number>

Save

Stores the current instrument settings under the specified number in an intermediate memory. The settings can be recalled using the command [*RCL](#) with the associated number.

Manual operation: See ["Save Settings to file..."](#) on page 137

***SRE** <Contents>

Service requests enable

Sets the service request enable register to the indicated value. This command determines under which conditions a service request is triggered.

The query [*SRE?](#) returns a decimal value of the service request enable register which corresponds to the binary-weighted sum of all bits.

Parameters:

<Contents> Contents of the service request enable register in decimal form.
Bit 6 (MSS mask bit) is always 0.
Range: 0 to 255

***STB?**

Status byte query

Reads the contents of the status byte in decimal form.

Usage: Query only

***TRG**

Trigger

Triggers all actions waiting for a trigger event. In particular, *TRG generates a manual trigger signal. This common command complements the commands of the TRIGger subsystem.

Usage: Event

Manual operation: See "[Measurement mode](#)" on page 69
See "[\[Trig.\]](#)" on page 75

***WAI**

Wait to continue

Prevents servicing of the subsequent commands until all preceding commands have been executed and all signals have settled (see also command synchronization and [*OPC](#)).

Usage: Event

11.4 Test signal commands

The following section describes the commands for setting the test signal and general measurement parameters.



The value range of a specified parameter, e.g. frequency, current and voltage varies depending on the settings of other measurement parameters. For the specified characteristics, see the data sheet, section "Specifications" > "Effective measurement ranges".

Example: Setting key parameters

The example represents the main remote control commands for the test signal, and measurement environment.

```
*****
// Set frequency and voltage level of the test signal
FREQuency[:CW] 1000 // 1 KHz
VOLTagE[:LEVel] 1 // 1.00 Vrms

// Set the current level of the test signal (instead of voltage)
CURRent[:LEVel] 0.1 //100 mA

*****
// Set the measurement time interval
APERTure SHORT,8

*****
// Query current settings, min, max and default values
FREQuency[:CW]?
// Response: 1000
FREQuency[:CW]? MAX
// Response: 10E+6
FREQuency[:CW]? MIN
// Response: 4

VOLTagE[:LEVel]?
// Response: 1.00
VOLTagE[:LEVel]? MAX
// Response: 10
VOLTagE[:LEVel]? MIN
// Response: 0.01
VOLTagE[:LEVel]? DEF
// Response: 1.00

APERTure?
// Response: "SHORT",8
```

APERTure.....	181
CURRent[:LEVel].....	182
FREQuency[:CW].....	182
VOLTagE[:LEVel].....	182

APERTure [<Measurement Time Mode>]

Sets the measurement time mode and the acquisition time interval.

Parameters:

<Measurement Time Mode> SHORT | MEDium | LONG | DEFault

Mode> Selects the basic measurement speed for one measurement.

MIN | MINimum

Queries the lower limit of the signal level.

MAX | MAXimum

Queries the upper limit of the signal level.

DEF | DEFault

Queries the signal level the instrument sets by default.

Range: 0.01 V to 10 V (depends on measurement settings)

*RST: 1 V

Default unit: V

Example: See [Example "Setting key parameters"](#) on page 181.

Manual operation: See ["Level: / \[Level\]"](#) on page 74

11.5 BIAS subsystem

The BIAS subsystem contains the commands for bias configuration.

Example: Bias settings

The example represents the remote control commands for applying either an external or an internal DC bias level.

```
// Assign an internally generated voltage level and enable bias.
BIAS:VOLTage[:LEVel] 1
BIAS:CURREnt[:LEVel] 0.1
BIAS:STATe 1
// Query an externally applied voltage level and enable bias.
BIAS:EXTernal:MEASure:VOLTage?
// Response: 0.2
BIAS:EXTernal[:VOLTage][:STATe]ON
// Response: 1
```

BIAS:CURREnt[:LEVel]	183
BIAS:EXTernal:MEASure:VOLTage?	184
BIAS:EXTernal[:VOLTage][:STATe]	184
BIAS:STATe	184
BIAS:VOLTage[:LEVel]	184

BIAS:CURREnt[:LEVel] <Bias Current Level>

BIAS:CURREnt[:LEVel]? <Bias Current Level>

Sets the internal bias current value.

To activate the bias, use command [BIAS:STATe](#) on page 184.

Parameters for setting and query:

BiasCurrent Range: 0 A to 0.2 A
 *RST: 0 A
 Default unit: A

Example: See [Example "Bias settings"](#) on page 183.

Manual operation: See ["Current Bias: / \[Bias Level\]"](#) on page 74

BIAS:EXTeRnal:MEASure:VOLTage?

Queries the value of the externally applied voltage.

Parameters for setting and query:

<voltage> Default unit: V

Example: See [Example "Bias settings"](#) on page 183.

Usage: Query only

BIAS:EXTeRnal[:VOLTage][:STATe] <External Voltage Bias State>

BIAS:EXTeRnal[:VOLTage][:STATe]? <External Voltage Bias State>

Activates the externally supplied bias voltage.

Parameters for setting and query:

<External Voltage 1 | 0 | ON | OFF

Bias State> *RST: 0|OFF

Example: See [Example "Bias settings"](#) on page 183.

BIAS:STATe <Bias State>

BIAS:STATe? <Bias State>

Activates the internal DC bias.

To set the corresponding bias voltage or current value, use commands [BIAS:CURRent\[:LEVel\]](#) on page 183, or [BIAS:VOLTage\[:LEVel\]](#) on page 184.

Parameters for setting and query:

<Bias State> 1 | 0 | ON | OFF

*RST: 0|OFF

Example: See [Example "Bias settings"](#) on page 183.

Manual operation: See ["\[Bias Enable\]"](#) on page 74

See ["Voltage Bias"](#) on page 79

BIAS:VOLTage[:LEVel] <Bias Voltage Level>

BIAS:VOLTage[:LEVel]? <Bias Voltage Level>

Sets the internal DC bias voltage value.

To activate the bias, use command [BIAS:STATe](#) on page 184.

Parameters for setting and query:

<Bias Voltage Level> Range: 0 to max, depends on signal frequency (Freq > 2 MHz: max 2).

*RST: 0 V

Default unit: V

Example: see [Example "Bias settings"](#) on page 183.

Manual operation: See "[Voltage Bias: / \[Bias Level\]](#)" on page 74

11.6 CORRection subsystem

The CORRection subsystem contains the commands for controlling the Open/Short and Load correction operations.

Example: Setting correction parameters

The example represents the remote control commands to configure the correction settings.

```
// Configure the corrections settings:
// set the cable length between the DUT and the instrument
CORrection:LENGth 1 // the test leads are of 1m length

// *****
// Perform open correction on all frequencies
CORrection:OPEN:STATe 1
CORrection:OPEN[:EXECute]

// *****
// Perform open correction on the current working point
CORrection:SPOT<Spot>:OPEN[:EXECute]

// *****
// Perform short correction on all frequencies
CORrection:SHORT:STATe 1
CORrection:SHORT[:EXECute]

// Perform short correction on the current working point
CORrection:SPOT<Spot>:SHORT[:EXECute]

// *****
// Perform load correction on all frequencies
CORrection:LOAD:STATe 1

// Configure the expected value of the load
CORrection:SPOT<Spot>:LOAD:STANdard 15,20

// Perform load correction at the current working point
CORrection:SPOT<Spot>:LOAD[:EXECute]

// *****
// Query the current status of correction
CORrection:OPEN:STATe?
// Response: 1 // 1:active, 0: inactive
CORrection:SHORT:STATe?
CORrection:LOAD:STATe?

// *****
// Query the activated mode of a correction
CORrection:OPEN:MODE?
// Response: "FULL"
CORrection:SHORT:MODE?
// Response: "SPOT"
```

```
CORRection:LOAD:MODE?
// Response: "OFF"
```

CORRection:LENGth.....	187
CORRection:LOAD:MODE?.....	187
CORRection:LOAD:STATe.....	187
CORRection:OPEN:MODE?.....	188
CORRection:OPEN:STATe.....	188
CORRection:OPEN[:EXECute].....	188
CORRection:SHORT:MODE?.....	188
CORRection:SHORT:STATe.....	188
CORRection:SHORT[:EXECute].....	188
CORRection:SPOT<Spot>:LOAD:STANdard.....	189
CORRection:SPOT<Spot>:LOAD[:EXECute].....	189
CORRection:SPOT<Spot>:OPEN[:EXECute].....	189
CORRection:SPOT<Spot>:SHORT[:EXECute].....	190

CORRection:LENGth <Cable Length>

Sets the length of the leads to the connected test fixture i.e. the DUT.

Parameters:

<Cable Length> Range: 0 m to 1 m
 *RST: 0 m
 Default unit: m

Example: See [Example"Setting correction parameters"](#) on page 186.

Manual operation: See ["Cable Length"](#) on page 78
 See ["Test Signal Type"](#) on page 78

CORRection:LOAD:MODE?

Queries the current state and mode of load correction, if enabled.

Example: See [Example"Setting correction parameters"](#) on page 186.

Usage: Query only

CORRection:LOAD:STATe <Load Correction State>

Activates the load correction function.

Parameters:

<Load Correction 1 | 0 | ON | OFF
 State> *RST: 0|OFF

Example: See [Example"Setting correction parameters"](#) on page 186.

Manual operation: See ["Open/Short/Load Correction Enabled"](#) on page 81

CORRection:OPEN:MODE?

Queries the current state and mode of open correction, if enabled.

Example: See [Example "Setting correction parameters"](#) on page 186.

Usage: Query only

CORRection:OPEN:STATe <Open Correction State>

Activates the open correction function.

Parameters:

<Open Correction State> 1 | 0 | ON | OFF
*RST: 0|OFF

Example: See [Example "Setting correction parameters"](#) on page 186.

Manual operation: See ["Open/Short/Load Correction Enabled"](#) on page 81

CORRection:OPEN[:EXECute]

Executes an open correction on all frequencies.

Example: See [Example "Setting correction parameters"](#) on page 186.

Usage: Event
Asynchronous command

Manual operation: See ["Start Short/Open Correction \(Full\)"](#) on page 82

CORRection:SHORT:MODE?

Queries the current state and mode of short correction, if enabled.

Example: See [Example "Setting correction parameters"](#) on page 186.

Usage: Query only

CORRection:SHORT:STATe <Short Correction State>

Activates the short correction function.

Parameters:

<Short Correction State> 1 | 0 | ON | OFF
*RST: 0|OFF

Example: See [Example "Setting correction parameters"](#) on page 186.

Manual operation: See ["Open/Short/Load Correction Enabled"](#) on page 81

CORRection:SHORT[:EXECute]

Executes a short correction on all frequencies.

Example: See [Example"Setting correction parameters"](#) on page 186.

Usage: Event
Asynchronous command

Manual operation: See ["Start Short/Open Correction \(Full\)"](#) on page 82

CORRection:SPOT<Spot>:LOAD:STANdard <Reference value for primary>,
<Reference value for secondary>

Defines a working point for load correction.

Assign the working point number and the primary and secondary reference values.

Suffix:
<Spot> 1..n

Parameters:
<Reference value for primary> Sets the primary standard value as reference, e.g. the value of a calibration resistor.
Default unit: Ohm

<Reference value for secondary> Sets the secondary standard value.
Default unit: Ohm

Example: See [Example"Setting correction parameters"](#) on page 186.

Manual operation: See ["Reference Load R"](#) on page 82
See ["Reference Load X"](#) on page 82

CORRection:SPOT<Spot>:LOAD[:EXECute]

Executes a load correction at a dedicated working point.

Suffix:
<Spot> 1..n

Example: See [Example"Setting correction parameters"](#) on page 186.

Usage: Event
Asynchronous command

Manual operation: See ["Start Load Correction \(Spot\)"](#) on page 82

CORRection:SPOT<Spot>:OPEN[:EXECute]

Executes an open correction at a dedicated working point.

Suffix:
<Spot> 1..n

Example: See [Example"Setting correction parameters"](#) on page 186.

Usage: Event
Asynchronous command

Manual operation: See ["Start Short/Open Correction \(Spot\)"](#) on page 81

CORRection:SPOT<Spot>:SHORT[:EXECute]

Executes a short correction at a dedicated working point.

Suffix:

<Spot> 1..n

Example: See [Example"Setting correction parameters"](#) on page 186.

Usage:

Event
Asynchronous command

Manual operation: See ["Start Short/Open Correction \(Spot\)"](#) on page 81

11.7 DATA subsystem

The DATA subsystem contains the commands for managing files and data.

Example: Managing files

The example represents the remote control commands to manage files in directories.

```
*****
// Request information on files
// and their contents:
// list of files in a directory,number of measurement
// points in a file, the saved readings.
// Remove a file
DATA:LIST?
DATA:POINTs?
DATA:DATA? "/USB1A/LCX100/logging/log-20210221T123456.789.csv"

*****
// Remove a file
DATA:DELeTe "/USB1A/LCX100/logging/log-20210221T123456.789.csv"
```

DATA:DATA?	190
DATA:DELeTe	191
DATA:LIST?	191
DATA:POINTs?	191

DATA:DATA? <File Path>

Queries the contents of a file, e.g. the data of a logging file.

Query parameters:

<File Path>

Example: See [Chapter 11.7, "DATA subsystem"](#), on page 190.

Usage: Query only

DATA:DELeTe <File Path>

Removes a file from the specified directory.

Setting parameters:

<File Path>

Example: See [Chapter 11.7, "DATA subsystem"](#), on page 190.

Usage: Setting only

Manual operation: See ["Delete"](#) on page 118

DATA:LIST?

Queries all files in a specified directory.

Example: See [Chapter 11.7, "DATA subsystem"](#), on page 190.

Usage: Query only

Manual operation: See ["Delete"](#) on page 118
See ["Recall Settings from file..."](#) on page 138

DATA:POINts? <File Path>

Queries the number of measurement readings saved in a file.

Query parameters:

<File Path>

Example: See [Chapter 11.7, "DATA subsystem"](#), on page 190.

Usage: Query only

11.8 DIMeasure subsystem

Option: R&S LCX-K106

The DIMeasure subsystem contains the commands for configuring and executing dynamic impedance measurements.



The dynamic impedance measurement parameter limits can vary depending on the frequency, voltage and range setting of the test signal.

Example: Using the DIMeasure function

The example represents the remote control commands for setting up a dynamic impedance measurement.

```
*****
// Select the sweep parameter to be varied.
// Configure the corresponding sweep parameters.

// Select the sweep parameter to be varied,
DIMeasure:SWEEp:PARAmeter VOLTage
// DIMeasure:SWEEp:PARAmeter FREQuency
// DIMeasure:SWEEp:PARAmeter VBias
// DIMeasure:SWEEp:PARAmeter IBias

// Set the sweep range, the interval type and size
DIMeasure:SWEEp:MINimum 0.01 // V
DIMeasure:SWEEp:MAXimum 10 // V

// Define the step size within the sweep range
DIMeasure:INTerval:TYPE STEPsize
DIMeasure:INTerval:STEPsize 0.1 // V

*****
// Define a number of measurement points within
// the sweep range
// DIMeasure:INTerval:TYPE STEPsize
// DIMeasure:INTerval:POINTs

*****
// Start the dynamic impedance measurement
DIMeasure:EXECute

// Execute sweep with settings & block until sweep completed or aborted
DIMeasure:EXECute;*OPC?

*****
// Query the dynamic impedance measurment settings
DIMeasure:SWEEp:PARAmeter?
// Response: "VOLTage"
DIMeasure:SWEEp:MINimum?
// Response: 0.01 // 10 mV
DIMeasure:SWEEp:MAXimum?
// Response: 10 // 10 V
DIMeasure:INTerval:TYPE?
// Response: "STEPsize"
DIMeasure:INTerval:STEPsize?
// Response: 0.1 // 100 mV

DIMeasure:EXECute?
// Response: 1 // running
```



```
*****
// Cancel a running dynamic impedance measurement
DIMeasure:ABORt
```

DIMeasure:ABORt	193
DIMeasure:EXECute	193
DIMeasure:INTerval:POINTs	193
DIMeasure:INTerval:STEPsize	194
DIMeasure:INTerval:TYPE	194
DIMeasure:SWEep:MAXimum	194
DIMeasure:SWEep:MINimum	195
DIMeasure:SWEep:PARAmeter	195

DIMeasure:ABORt

Stops a running dynamic impedance measurement.

Example: See [Example"Using the DIMeasure function"](#) on page 192.

Usage: Event

Options: Option: R&S LCX-K106

Manual operation: See ["Abort"](#) on page 105

DIMeasure:EXECute

Starts the dynamic impedance measurement with the selected parameters.

Example: See [Example"Using the DIMeasure function"](#) on page 192.

Options: Option: R&S LCX-K106

Manual operation: See ["Enabled"](#) on page 103

DIMeasure:INTerval:POINTs <Interval points>

Sets the number of measurement points within the measurement range for interval type `DIMeasure:INTerval:TYPE > Number of Points`.

Parameters:

<Interval points> numeric
 Range: 1 to 65536 points

Example: See [Example"Using the DIMeasure function"](#) on page 192.

Options: Option: R&S LCX-K106

Manual operation: See ["Number of Points"](#) on page 104

DIMeasure:INTerval:STEPsize <Interval stepsize>

Sets the step size within the measurement range for interval type `DIMeasure:INTerval:TYPE > Step Size`.

Parameters:

<Interval stepsize> numeric

Example: See [Example"Using the DIMeasure function"](#) on page 192.

Options: Option: R&S LCX-K106

Manual operation: See ["Step Size"](#) on page 104

DIMeasure:INTerval:TYPE <Interval parameter>**DIMeasure:INTerval:TYPE?** <Interval parameter>

Selects the mode to determine the measurement steps within the sweep range (`DIMeasure:SWEep:MINimum` to `DIMeasure:SWEep:MAXimum`).

Parameters for setting and query:

<Interval parameter> STEPsize | POINTs

STEPsize

Measures in defined step sizes within the sweep range, set with `DIMeasure:INTerval:STEPsize`.

POINTs

Measures in increments calculated by the number of sweep points (`DIMeasure:INTerval:POINTs` on page 193) within the sweep range.

Example: See [Example"Using the DIMeasure function"](#) on page 192.

Options: Option: R&S LCX-K106

Manual operation: See ["Interval Type"](#) on page 104

DIMeasure:SWEep:MAXimum <Sweep stop value>

Sets the stop value for the selected sweep parameter.

The value must be at least > `DIMeasure:SWEep:MINimum`. The maximum value depends on the instrument model and installed options.

Parameters:

<Sweep stop value> numeric

Example: See [Example"Using the DIMeasure function"](#) on page 192.

Options: Option: R&S LCX-K106

Manual operation: See ["Maximum"](#) on page 104

DIMeasure:SWEEp:MINimum <Sweep start value>

Sets the start value for the selected sweep parameter.

The value depends on the instrument model and installed options. The maximum value must be at least < [DIMeasure:SWEEp:MAXimum](#).

Parameters:

<Sweep start value> numeric

Example: See [Example"Using the DIMeasure function"](#) on page 192.

Options: Option: R&S LCX-K106

Manual operation: See ["Minimum"](#) on page 104

DIMeasure:SWEEp:PARAmeter <Sweep parameter>

DIMeasure:SWEEp:PARAmeter? <Sweep parameter>

Selects the measurement parameter that varies in defined steps within the sweep range ([DIMeasure:SWEEp:MINimum](#).

Parameters for setting and query:

<Sweep parameter> VOLTage | FREQuency | VBias | IBias

VOLTage

Sweeps the test signal voltage.

FREQuency

Sweeps the test signal frequency.

VBias

Sweeps the voltage bias.

IBias

Sweeps the current bias.

Example: See [Example"Using the DIMeasure function"](#) on page 192.

Options: Option: R&S LCX-K106

Manual operation: See ["Sweep Parameter"](#) on page 103

11.9 DISPLay subsystem

The DISPLay subsystem contains the commands for customizing the display appearance, and enables you to close messages.

Example: Configuring the display brightness and user defined text messages

The example represents the remote control commands for setting the brightness of the screen and front panel keys. For description of the key brightness command, see [SYSTem:KEY:BRIGhtness](#) on page 225.

```
// Set display and key brightness.
DISPLay:BRIGhtness 0.5
SYSTem:KEY:BRIGhtness 0.5

// Query the settings
DISPLay:BRIGhtness?
// Response: 0.5
SYSTem:KEY:BRIGhtness?
// Response: 0.5

// Display or close a message box
DISPLay:TEXT "User defined message."
DISPLay[:WINDow]:TEXT:CLEar
```

DISPLay:BRIGhtness	196
DISPLay[:WINDow]:TEXT:CLEar	196
DISPLay[:WINDow]:TEXT[:DATA]	197

DISPLay:BRIGhtness <Display Brightness>

Sets the brightness of the display.

Parameters:

<Display Brightness> Range: 0.1 to 1
 Increment: 0.1
 *RST: 0.8

Example: see [Example"Configuring the display brightness and user defined text messages"](#) on page 196.

Manual operation: See "[Display Brightness](#)" on page 129

DISPLay[:WINDow]:TEXT:CLEar

Closes a user defined text message on the display.

To create an own message, use command [DISPLay\[:WINDow\]:TEXT\[:DATA\]](#) on page 197.

Example: see [Example"Configuring the display brightness and user defined text messages"](#) on page 196.

Usage: Event

DISPlay[:WINDow]:TEXT[:DATA] <Message>

Enables you to post a text message on the display.

To close user defined message, use command `DISPlay[:WINDow]:TEXT:CLEAr` on page 196.

Setting parameters:

<Message> Text message for display.

Example: See [Example"Configuring the display brightness and user defined text messages"](#) on page 196.

Usage: Setting only

11.10 FUNction subsystem

The FUNction subsystem enables you to configure the measurement type and ranges.

Example: Selecting the measurement function and setting the impedance range

The example represents the remote control commands for the measurement functions.

```
// *****
// Select the measurement function by setting
// the type of component sample.
// Select the parameters to be measured,
// e.g., parallel inductance, dissipation
FUNCTION:MEASurement:TYPE L //impedance
FUNCTION:IMPedance[:TYPE] LPD

// *****
// Activate automatic range selection
FUNCTION:IMPedance:RANGe:AUTO 1

// *****
// Set the impedance and DC resistance ranges manually
FUNCTION:IMPedance:RANGe:AUTO 0
FUNCTION:IMPedance:RANGe[:VALue] 10E6 // 10KOhm

// *****
// Query the measurement type and ranges
FUNCTION:IMPedance:RANGe:AUTO?
// Response: 0
FUNCTION:IMPedance:RANGe[:VALue]?
// Response: 10E6

// *****
// Lock the selected measurement range
FUNCTION:IMPedance:RANGe:HOLD ON
FUNCTION:IMPedance:RANGe:HOLD?
// Response: 1

// *****
// Set source impedance to LowZ mode,
// i.e. set the output impedance 10 Ohm
FUNCTION:IMPedance:SOURce LOW

// *****
// Query the output impedance setting
FUNCTION:IMPedance:SOURce?
// Response: 'LOW'

// *****
// Set the transformer turn ratio range
FUNCTION:TRANSformer:RANGe[:TYPE] N500
```

FUNCTION:IMPedance:RANGe:AUTO.....	199
FUNCTION:IMPedance:RANGe:HOLD.....	199
FUNCTION:IMPedance:RANGe[:VALue].....	199
FUNCTION:IMPedance:SOURce.....	200
FUNCTION:IMPedance[:TYPE].....	200
FUNCTION:MEASurement:TYPE.....	201
FUNCTION:TRANSformer:RANGe[:TYPE].....	201

FUNCTION:IMPedance:RANGe:AUTO <Auto Range>

Activates automatic impedance range selection.

To set the impedance range manually, use command `FUNCTION:IMPedance:RANGe[:VALue]` on page 199.

Parameters:

<Auto Range> 1 | 0 | ON | OFF
 *RST: 0|OFF

Example: See [Example"Selecting the measurement function and setting the impedance range"](#) on page 198.

Manual operation: See "[Range: / \[Range\]](#)" on page 74
 See "[\[Auto\]](#)" on page 75

FUNCTION:IMPedance:RANGe:HOLD <Locks selected range>

Freezes the set impedance measurement range.

Parameters:

<Locks selected
range> 1 | 0 | ON | OFF
 *RST: 0 | OFF

Example: See [Example"Selecting the measurement function and setting the impedance range"](#) on page 198.

Manual operation: See "[\[Hold\]](#)" on page 75

FUNCTION:IMPedance:RANGe[:VALue] <Range>

Sets the impedance range value.

For setting the parameter manually, disable auto selection with `FUNCTION:IMPedance:RANGe:AUTO 0`.

Parameters:

<Range> Range: 0.3 R to 30E+6 R
 *RST: 1E+3 R

Example: See [Example"Selecting the measurement function and setting the impedance range"](#) on page 198.

Manual operation: See "[Range: / \[Range\]](#)" on page 74

FUNction:IMPedance:SOURce <Impedance>

FUNction:IMPedance:SOURce? <Impedance>

Selects the output impedance for the measurement.

Parameters for setting and query:

<Impedance> LOW | R10 | HIGH | R100

LOW | R10

Sets 10 Ω output impedance.

HIGH | R100

Sets 100 Ω output impedance.

*RST: HIGH

Example: See [Example"Selecting the measurement function and setting the impedance range"](#) on page 198.

Manual operation: See "[Source Impedance](#)" on page 79

FUNction:IMPedance[:TYPE] <Impedance Type>

FUNction:IMPedance[:TYPE]? <Impedance Type>

Selects the impedance parameter for the measurement corresponding to the measurement type, see [FUNction:MEASurement:TYPE](#) on page 201.

Parameters for setting and query:

<Impedance Type> CPD | CPQ | CPG | CPRP | CSD | CSQ | CSRS | LPD | LPQ | LPG | LPRP | LSD | LSQ | LSRS | RX | RPB | RDC | MTD | NTD | ZTD | ZTR | GB | YTD | YTR

CPD | CPQ | CPG | CPRP | CSD | CSQ | CSRS

Capacitive measurement type: Cp (parallel capacitance), Cs (serial capacitance), D (dissipation factor), Q (quality factor), G (conductance), Rp (parallel resistance), Rs (serial resistance)

LPD | LPQ | LPG | LPRP | LPRDc | LSD | LSQ | LSRS | LSRDc

Inductive measurement type: Lp (parallel inductance), Ls (serial inductance), D (dissipation factor), Q (quality factor), G (conductance), Rp (parallel resistance), Rs (serial resistance), RDC (direct current resistance)

RX | RPB | RDC | MTD | NTD | ZTD | ZTR | GB | YTD | YTR

Resistance measurement type: R (resistance), X impedance, Rp (parallel resistance), RDC (direct current resistance), B (susceptance), M (mutual inductance), N (transformer ratio), Z (impedance), G (conductance), Y (admittance), TD (phase angle degree), TR (phase angle rad)

Example: See [Example"Selecting the measurement function and setting the impedance range"](#) on page 198.

Manual operation: See "<[measurement pair](#)>" on page 72

FUNCTION:MEASurement:TYPE <Measurement Type>
FUNCTION:MEASurement:TYPE? <Measurement Type>

Selects the measurement function.

Parameters for setting and query:

<Measurement Type> L | C | R | T

L

Impedance measurement.

C

Capacitance measurement.

R

Resistance measurement.

T

Transformer measurement.

Example: See [Example"Selecting the measurement function and setting the impedance range"](#) on page 198.

Usage: Asynchronous command

Manual operation: See ["Functions \[hardkeys\]"](#) on page 73

FUNCTION:TRANSformer:RANGe[:TYPE] <Turn Ratio>
FUNCTION:TRANSformer:RANGe[:TYPE]? <Turn Ratio>

Selects the impedance range for transformer measurement.

Parameters for setting and query:

<Turn Ratio> N50 | N500

Example: See [Example"Selecting the measurement function and setting the impedance range"](#) on page 198.

11.11 HANDler subsystem

The HANDler subsystem contains the commands for configuring the binning function.

Example: Using the binning function

The example represents the remote control commands for setting the storage location of the binning file, and setting the parameters for the binning measurement.

```
*****
// Upload a user-defined binning file
// Select storage location, file name and
// file extension
// Upload the binning file
// Activate the binning function
HANDler:CONFig:PATH "USB1A/LCX200/binning/binning_1k_nompct.csv"
HANDler[:STATe] 1

*****
// Query the statistic results of the binning measurement
// Query the counts of all bins
HANDler:BIN:STATistic?
// Returns a set of 8 integer values
// Response: 6,125,2,122,0,0,0,2

// Query the number of measured samples since reset
HANDler:BIN:STATistic:COUnT?
// Response: 257 // sum of all counts

*****
// Reset the statistic of the binning measurement
HANDler:BIN:STATistic:RESet
```

HANDler:BIN:STATistic?	202
HANDler:BIN:STATistic:COUnT?	202
HANDler:BIN:STATistic:RESet	203
HANDler:CONFig:PATH	203
HANDler[:STATe]	203

HANDler:BIN:STATistic?

Queries the number of samples counted in the bins.

The query returns 8 integer values.

Example: See [Example"Using the binning function"](#) on page 202.

Usage: Query only

Options: R&S LCX-K107

Manual operation: See ["Counter"](#) on page 110

HANDler:BIN:STATistic:COUnT?

Queries the total number of samples measured since reset

The query returns the sum of all counts.

Example: See [Example"Using the binning function"](#) on page 202.

Usage: Query only

Options: R&S LCX-K107

Manual operation: See ["Counter"](#) on page 110

HANDler:BIN:STATistic:RESet

Resets the evaluated binning measurement statistics.

Example: See [Example"Using the binning function"](#) on page 202.

Usage: Event

Options: R&S LCX-K107

Manual operation: See ["Counter"](#) on page 110

HANDler:CONFIg:PATH <File Path>

HANDler:CONFIg:PATH? <File Path>

Uploads the binning configuration file.

Parameters for setting and query:

<File Path>

Example: See [Example"Using the binning function"](#) on page 202.

Options: R&S LCX-K107

Manual operation: See ["Load From File"](#) on page 108

HANDler[:STATe] <Handler State>

Activates the binning measurement.

Parameters:

<Handler State>

Example: See [Example"Using the binning function"](#) on page 202.

Options: R&S LCX-K107

Manual operation: See ["Enabled"](#) on page 108

11.12 HCOPY subsystem

The `HCOPY` subsystem contains the commands for requesting information and configuring the format of hardcopies.

Example: Using the HCOpy function

The example represents the remote control commands for prints of the screen.

```
*****
// Query the screenshot parameters
:HCOpy FORMat?
// Response: PNG
:HCOpy:SIZE:X?
// Response: 800
:HCOpy:SIZE:Y?
// Response: 540
:HCOpy:DATA?
// Response: screenshot in raw data format
```

HCOpy:DATA?	204
HCOpy:FORMat?	204
HCOpy:SIZE:X?	204
HCOpy:SIZE:Y?	205

HCOpy:DATA?

Queries the current display content (screenshot) in binary (raw data) format.

Example: see [Chapter 11.12, "HCOpy subsystem"](#), on page 203.

Usage: Query only

HCOpy:FORMat? <format>**HCOpy:FORMat?? <format>**

Queries the file format used for saving a screenshot.

Parameters for setting and query:

```
<format>      PNG
               PNG
               Portable Network Graphic
               *RST:      PNG
```

Example: see [Chapter 11.12, "HCOpy subsystem"](#), on page 203.

Usage: Query only

HCOpy:SIZE:X?

Queries the width (horizontal dimension) of the screenshot.

Example: see [Chapter 11.12, "HCOpy subsystem"](#), on page 203.

Usage: Query only

HCOPY:SIZE:Y?

Queries the height (vertical dimension) of the screenshot.

Example: see [Chapter 11.12, "HCOPY subsystem"](#), on page 203.

Usage: Query only

11.13 LOG subsystem

The LOG subsystem contains the commands for setting the parameters of the measurement logging function.

Example: Logging data settings

The example represents the remote control commands for configuring the logging mode.

```
*****
// Configure the logging function.
// Deactivate logging mode to set the parameters:
*****
:LOG:STATe OFF

*****
// Configure the parameters:
// select 10 min time interval, SPAN mode, start time and duration.
:LOG:INTerval 300
:LOG:MODE SPAN
:LOG:STIME 2020,5,1,13,30,00
:LOG:DURation 150

// :LOG:MODE COUNT
// :LOG:COUNT 100

*****
// Query the data logging settings
:LOG:MODE?
// Response: SPAN
:LOG:FNAME?
// Response: 'log-20210225T105014.455.csv', EXT

:LOG:INTerval?
/// Response 300
:LOG:STIME?
// Response: 2020,5,1,13,30,00 // 2020-05-01, 13:30 pm
:LOG:DURation?
// Response: 150 // 2 h 30 min,0 s
:LOG:COUNT?
// Response: 100

:LOG:COUNT? MIN
// Response: 1
:LOG:COUNT? MAX
// Response: 1000000

*****
// Start and stop logging data
:LOG[:STATe] ON
:LOG[:STATe]?
// Response: 1 // logging data is activated

*****
// Restart logging of a new measurement
```

:LOG:INTerval 0

LOG:COUNT.....	207
LOG:DURation.....	207
LOG:FNAME.....	207
LOG:INTerval.....	208
LOG:MODE.....	208
LOG:STIMe.....	209
LOG[:STATe].....	209

LOG:COUNT <Sample Count>[, <Return min or max>]

LOG:COUNT? [<Return min or max>]

Sets the number of measurement readings in count mode. To set the mode, use the command [LOG:MODE](#) on page 208 to be captured.

Setting parameters:

<Sample Count> Range: 1 to 10E+6
 *RST: 10

Parameters for setting and query:

<Return min or max> MIN | MINimum | MAX | MAXimum

Example: See [Example"Logging data settings"](#) on page 206.

Manual operation: See ["Count"](#) on page 100

LOG:DURation <Logging Duration>[, <Return min or max>]

LOG:DURation? [<Return min or max>]

Defines the duration of logging for the measurement in span and duration mode. To set the mode, use the command [LOG:MODE](#) on page 208.

Setting parameters:

<Logging Duration> Numeric value in seconds.
 Range: 0 to 349199
 *RST: 60

Parameters for setting and query:

<Return min or max> MIN | MINimum | MAX | MAXimum

Example: See [Example"Logging data settings"](#) on page 206.

Manual operation: See ["Duration"](#) on page 100

LOG:FNAME <Logging File Name>

Sets the file name and path for the storing the data recorded during data logging.

The query returns the file name and path. You can query the information also when data logging is running.

Setting parameters:

<Logging File Name> String with the directory and filename.

Example: See [Example"Logging data settings"](#) on page 206.

Manual operation: See "[logging file name](#)" on page 94

LOG:INTERVAL <Sample Interval>[, <Return min or max>]

LOG:INTERVAL? [<Return min or max>]

Selects the logging measurement interval. The measurement interval describes the time between the recorded measurements.

Setting parameters:

<Sample Interval> Numeric value in seconds.

0

Logs a new measurement.

Range: 0 s to 600 s

*RST: 0.1 s

Default unit: s

Parameters for setting and query:

<Return min or max> MIN | MINimum | MAX | MAXimum

Example: See [Example"Logging data settings"](#) on page 206.

Manual operation: See "[Interval](#)" on page 100

LOG:MODE <Logging Mode>

LOG:MODE? <Logging Mode>

Selects the data logging mode.

Parameters for setting and query:

<Logging Mode> UNLlimited | COUNT | DURation | SPAN

UNLlimited

No specified limit of measurement readings.

COUNT

Determines the number of measurement readings.

DURation

Sets a time interval between the measurement readings.

SPAN

Defines start time and time span for the measurement readings.

*RST: UNL

Example: See [Example"Logging data settings"](#) on page 206.

Manual operation: See "[Mode](#)" on page 99

LOG:STIME <Year>, <Month>, <Day>, <Hour>, <Minute>, <Second>

Sets the logging start time.

Setting parameters:

<Year>	integer
	Four-digit number, including the century and millennium information.
<Month>	Range: 1 to 12
<Day>	Range: 1 to 365
<Hour>	Range: 0 to 23 Default unit: h
<Minute>	Range: 0 to 59 Default unit: min
<Second>	Range: 0 to 59 Default unit: s

Example: See [Example "Logging data settings"](#) on page 206.

Manual operation: See ["Start Time"](#) on page 100
See ["Set Date & Time"](#) on page 100

LOG[:STATE] <Logging State>

Activates the data logging function.

Parameters:

<Logging State>	ON OFF 1 0
*RST:	OFF 0

Example: See [Example "Logging data settings"](#) on page 206.

Manual operation: See ["Enabled"](#) on page 98

11.14 Measurement commands

This section describes the remote control commands to set the measurement mode, query the main parameters and accuracy, and to get the results of a measurement.

It comprises commands of the following subsystems:

- MEASure commands for setting the measurement parameters
- INITiate command for starting a new measurement
- READ commands for requesting measurement results
- FETCh commands for validating the measurement results

Example: Using the MEASure commands

The example represents the remote control commands to set the measurement mode, to query the voltage or current values, and the measurement accuracy.

```
*****
// Query current and voltage values of the next working point
MEASure:VOLTage?
// Response: 2 // 2 V
MEASure:CURRent?
// Response: 0.1 // 100 mA

// Select the measurement mode and set a trigger delay
MEASure:MODE TRIGgered
MEASure:TRIGger:DELay 2
// Start the measurement manually
*TRG

*****
// Query the measurement accuracy
MEASure:ACCuracy?
// Response: 2.123, 1.123 // percent, degree
```

Example: Using the INITiate command

The example represents the remote control commands for triggering a measurement.

```
*****
// Start the measurement manually
*TRG
// Start a new measurement immediately
INITiate[:IMMediate]
```

Example: Acquiring measurement readings

The example represents the remote control commands of the measurement results.

```
*****
// Request information on the measurement result
// query recently measured impedance values
READ:IMPedance?
// Response: returns Z and Theta d values
// query the recently measured values of measurement pair 2
READ?
// Response: returns the measurement values of he selected parameter pair
// Request information on the measurement result
// query recently measured values of the impedance

// Request most recent valid readings
// Query the valid impedance measurement values
FETCh:IMPedance?
// Response: returns Z and Theata d

// Query the valid values of measurement pair 2
FETCh?
// Response: returns the valid values of the selected parameter pair
```

FETCh?	211
FETCh:IMPedance?	211
INITiate[:IMMediate]	212
MEASure:ACCuracy?	212
MEASure:CURRent?	212
MEASure:MODE	212
MEASure:TRIGger:DELay	213
MEASure:VOLTage?	213
READ?	213
READ:IMPedance?	213

FETCh?

Queries the most recent valid values for measurement pair 2.

If no valid measurement values are available, the response reports error code -230.

Example: See [Example"Acquiring measurement readings"](#) on page 211.

Usage: Query only

FETCh:IMPedance?

Queries the most recent valid values of the measured impedance.

If no valid measurement values are available, the response reports error code -230.

Example: See [Example"Acquiring measurement readings"](#) on page 211.

Usage: Query only

INITiate[:IMMediate]

Starts a new measurement.

In manual trigger mode, the command triggers a single measurement cycle. When completed, the R&S LCX waits for the next trigger event.

Example: See [Example"Using the INITiate command"](#) on page 210.

Usage: Event

MEASure:ACCuracy?

Queries the accuracy of the last measurement.

The R&S LCX returns the accuracy of the impedance ($\delta|Z|$) in percent, and the phase angle ($\delta\theta$) in degrees.

Usage: Query only

Manual operation: See "[<measurement accuracy>](#)" on page 72

MEASure:CURRent?

Queries the current value following next in the measurement.

Example: See [Example"Using the MEASure commands"](#) on page 210.

Usage: Query only

MEASure:MODE <Measurement Mode>

MEASure:MODE? <Measurement Mode>

Selects whether the R&S LCX starts and continues a measurement, or starts on initiated trigger events.

Parameters for setting and query:

<Measurement Mode> CONTInuous | TRIGgered

Mode>

CONTInuous

Restarts the measurement automatically after a measurement cycle has been completed.

TRIGgered

Starts a measurement cycle initiated by a trigger signal.

To delay the measurement start to a certain extent, use command `MEASure:TRIGger:DElay`.

Example: See [Example"Using the MEASure commands"](#) on page 210.

Manual operation: See "[Measurement mode](#)" on page 69

MEASure:TRIGger:DELay <Trigger Delay>

Sets a delay time that elapses after a trigger event before the measurement starts.

Parameters:

<Trigger Delay> Range: 0 s to 60 s
 Increment: 100 ms
 *RST: 0 s
 Default unit: s

Example: See [Example"Using the MEASure commands"](#) on page 210.

Manual operation: See ["Trigger Delay"](#) on page 79

MEASure:VOLTage?

Queries the voltage value following next in the measurement.

Example: See [Example"Using the MEASure commands"](#) on page 210.

Usage: Query only

READ?

Queries the measurement results for measurement pair 2.

Example: See [Example"Acquiring measurement readings"](#) on page 211.

Usage: Query only

READ:IMPedance?

Queries the impedance measurement results.

Example: See [Example"Acquiring measurement readings"](#) on page 211.

Usage: Query only

11.15 STATus subsystem

This system contains the commands for the status reporting system, see [Chapter 10.2.4, "Status reporting system"](#), on page 151. *RST has no effect on the status registers.

11.15.1 Status operation register

This system contains the commands for controlling the STATus:OPERation register of the status reporting system.

Return values:

<OPERation> Range: 1 to 65535

Usage: Query only

11.15.2 Status questionable register

This system contains the commands for controlling the `STATus:QUEStionable` register of the status reporting system, see [Chapter 10.2.4.3, "Instrument-specific status questionable register"](#), on page 153.

Queries return the current value of the corresponding register, which permits a check of the device status.

Return values: Decimal values in the range 0 to 32767 ($=2^{15}-1$)

<code>STATus:QUEStionable:CONDition?</code>	215
<code>STATus:QUEStionable:ENABle</code>	215
<code>STATus:QUEStionable:ENABle?</code>	215
<code>STATus:QUEStionable:NTRansition</code>	216
<code>STATus:QUEStionable:PTRansition</code>	216
<code>STATus:QUEStionable[:EVENT]?</code>	216

STATus:QUEStionable:CONDition?

Returns the contents of the `CONDition` part of the status register to check for questionable instrument or measurement states. Reading the `CONDition` registers does not delete the contents.

Return values:

<Condition> Condition bits in decimal representation

Range: 1 to 65535

Usage: Query only

STATus:QUEStionable:ENABle <Enable_value>

Sets the enable mask that allows true conditions in the `EVENT` part to be reported in the summary bit. If a bit in the enable part is set to 1 and its associated event bit transitions to true, a positive transition occurs in the summary bit and is reported to the next higher level.

Parameters:

<Enable_value> Bit mask in decimal representation

Range: 1 to 65535

STATus:QUEStionable:ENABle?

Queries the enable register and returns a decimal value which corresponds to the binary-weighted sum.

Usage: Query only

STATus:QUESTionable:NTRansition <Value>

Sets or queries the negative transition filter. If a bit is set, a 1 to 0 transition in the corresponding bit of the condition register causes a 1 to be written in the corresponding bit of the event register.

Parameters:

<Value> Bit mask in decimal representation
Range: 1 to 65535

STATus:QUESTionable:PTRansition <Value>

Sets or queries the positive transition filter. If a bit is set, a 0 to 1 transition in the corresponding bit of the condition register causes a 1 to be written in the corresponding bit of the event register.

Parameters:

<Value> Bit mask in decimal representation
Range: 1 to 65535

STATus:QUESTionable[:EVENT]?

Queries the contents of the EVENT part of the status register to check whether an event has occurred since the last reading. Reading an EVENT register deletes its contents.

Return values:

<QUESTionable> Event bits in decimal representation
Range: 1 to 65535

Usage: Query only

11.16 SYSTem subsystem

The SYSTem subsystem contains the commands for general functions which do not directly affect instrument operation.

Example: General instrument settings

The example represents the remote control commands for general settings.

```

*****
// Request information on the instrument configuration,
// up time and restart the instrument.
SYSTEM:HW:VERSion?
// Response: 0x3
SYSTEM:UPTime?
// Response: "0.08:11:00"
SYSTEM:REStart

*****
// Save instrument default settings in a file
SYSTEM:SETting:DEFault:SAVE "/USB1A/LCX100/Settings/LMeasurementSettings.rds"

*****
// Switch between manual and remote control
SYSTEM:RWLock // disables manual control
SYSTEM:REMOte // switches to remote state
SYSTEM:LOCal // enables manual control

*****
// Set the instrument internal calendar and clock
SYSTEM:DATE 2021,02,21
SYSTEM:DATE?
// Response: 2021,2,21
SYSTEM:TIME 10,08,41
SYSTEM:TIME?
// Response: 10,8,41

*****
// Adjust the key brightness, e.g. to 70%
SYSTEM:KEY:BRIGhtness 0.7

*****
// Set the sound functionality of the beeper.
// Enable a beep on error or warning
SYSTEM:BEEPer:WARning:STATe 1
SYSTEM:BEEPer:WARning[:IMMediate] 1
SYSTEM:BEEPer:WARning:STATe?
Response: 1

// Enable a beep on operation completed
SYSTEM:BEEPer[:COMplete]:STATe 1
SYSTEM:BEEPer[:COMplete][:IMMediate] 1
SYSTEM:BEEPer[:COMplete]:STATe?
// Response: 1

```

```
SYSTEM:BEEPper[:COMplete][:IMMediate?  
// Response: 1  
  
// Disable the acoustic signal  
SYSTEM:BEEPper:WARning:STATe 0  
SYSTEM:BEEPper[:COMplete]:STATe 0
```

Example: Network communication settings

The example represents the remote control commands for configuring and activating the interfaces for remote control.

```
*****
// Configure the network-related settings
// assign the address information manually
SYSTem:COMMunicate:LAN:DHCP 0
SYSTem:COMMunicate:LAN:ADDRes "10.113.0.104"
SYSTem:COMMunicate:LAN:SMASk "255.255.252.0"
SYSTem:COMMunicate:LAN:DGATeway "10.113.0.1"
SYSTem:COMMunicate:LAN:APPLy
// Reset the network configuration and restart
SYSTem:COMMunicate:LAN:RESet

*****
// Query the MAC address
SYSTem:COMMunicate:LAN:MAC?
// Response: "00-90-B8-21-66-F1"

*****
// Set a user-deined hostname for the instrument
SYSTem:COMMunicate:LAN:HOSTname "RS-LCX2000-123456"

*****
// Request information on the LAN settings
SYSTem:COMMunicate:LAN:DHCP?
// Response: 0
SYSTem:COMMunicate:LAN:ADDRes?
// Response: "10.113.0.104"
SYSTem:COMMunicate:LAN:SMASk?
// Response: "255.255.252.0"
SYSTem:COMMunicate:LAN:DGATeway?
// Response: "10.113.0.1"
SYSTem:COMMunicate:LAN:HOSTname?
// Response: "RS-LCX2000-123456"

// Query the MAC address
SYSTem:COMMunicate:LAN:MAC?
// Response: "00-90-B8-21-66-F1"

*****
// Set the VNC port address and activate VNC access over LAN
SYSTem:COMMunicate:NETWork:VNC:PORT 5900
SYSTem:COMMunicate:NETWork:VNC:STATe 1

// Request information on the VNC port address:
SYSTem:COMMunicate:NETWork:VNC:PORT?
// Response: 5900
```

```
*****
// Set the USB interface protocol:
INTerfaces:USB:CLASs "TMC"
```

INTerfaces:USB:CLASs.....	220
SYSTem:BEEPer:WARning:STATe.....	221
SYSTem:BEEPer:WARning[:IMMediate].....	221
SYSTem:BEEPer[:COMPLete]:STATe.....	221
SYSTem:BEEPer[:COMPLete][:IMMediate].....	221
SYSTem:COMMunicate:LAN:ADDResS.....	222
SYSTem:COMMunicate:LAN:APPLy.....	222
SYSTem:COMMunicate:LAN:DGATeway.....	222
SYSTem:COMMunicate:LAN:DHCP.....	222
SYSTem:COMMunicate:LAN:DISC ard.....	222
SYSTem:COMMunicate:LAN:EDITed?.....	222
SYSTem:COMMunicate:LAN:HOSTname.....	223
SYSTem:COMMunicate:LAN:MAC?.....	223
SYSTem:COMMunicate:LAN:RESet.....	223
SYSTem:COMMunicate:LAN:SMASk.....	223
SYSTem:COMMunicate:NETWork:VNC:PORT.....	223
SYSTem:COMMunicate:NETWork:VNC[:STATe].....	224
SYSTem:COMMunicate:NETWork:VNC:PORT.....	224
SYSTem:COMMunicate:NETWork:VNC[:STATe].....	224
SYSTem:DATE.....	224
SYSTem:HW:VERsion?.....	225
SYSTem:KEY:BRIGHtneSS.....	225
SYSTem:LOCal.....	225
SYSTem:REMote.....	225
SYSTem:RESart.....	225
SYSTem:RWLock.....	226
SYSTem:SETTing:DEFault:SAVE.....	226
SYSTem:TIME.....	226
SYSTem:UPTime?.....	226

INTerfaces:USB:CLASs <USB class>

Selects the USB communication class.

Parameters:

<USB class> CDC | TMC

CDC

Uses the virtual communication port protocol, that enables you to emulate serial ports over USB.

TMC

Uses the protocol for communication with USB devices.

Example: See [Example "Network communication settings"](#) on page 219.

Manual operation: See ["USB Class"](#) on page 161

SYSTem:BEEPer:WARNing:STATe <En-/Disable warning beep>

Activates the R&S LCX to create an acoustic signal on errors and warnings.

The query returns the current state.

Parameters:

<En-/Disable warning beep> 1 | 0 | ON | OFF
*RST: 1|ON

Example: See [Example"General instrument settings"](#) on page 217.

Manual operation: See ["Error Beep"](#) on page 130

SYSTem:BEEPer:WARNing[:IMMEDIATE]

Activates that the R&S LCX issues a beep on error or warning immediately.

Parameters:

<state> 1 | 0 | ON | OFF
*RST: ON | 1

Example: See [Example"General instrument settings"](#) on page 217.

Usage: Event

Manual operation: See ["Error Beep"](#) on page 130

SYSTem:BEEPer[:COMPLete]:STATe <En-/Disable operation complete beep>

Activates the R&S LCX to create an acoustic signal on a completed operation.

The query returns the current state.

Parameters:

<En-/Disable operation complete beep> 1 | 0 | ON | OFF
*RST: ON | 1

Example: See [Example"General instrument settings"](#) on page 217.

Manual operation: See ["Error Beep"](#) on page 130

SYSTem:BEEPer[:COMPLete][:IMMEDIATE]

Activates that the R&S LCX issues a beep after operation complete immediately.

The query returns the current state.

Parameters:

<boolean> 1 | 0 | ON | OFF
*RST: ON | 1

Example: See [Example"General instrument settings"](#) on page 217.

Usage: Event

Manual operation: See ["Error Beep"](#) on page 130

SYSTem:COMMunicate:LAN:ADDRESS <Ip address>

Sets the IP address.

Parameters:

<Ip address> Range: 0.0.0.0. to ff.ff.ff.ff

Example: See [Example"Network communication settings"](#) on page 219.

Manual operation: See ["IP Address"](#) on page 157

SYSTem:COMMunicate:LAN:APPLY

Assigns and confirms the settings.

Example: See [Example"Network communication settings"](#) on page 219.

Usage: Event

SYSTem:COMMunicate:LAN:DGATeway <Gateway>

Sets the IP address of the default gateway.

Parameters:

<Gateway> Range: 0.0.0.0. to ff.ff.ff.ff

Example: See [Example"Network communication settings"](#) on page 219.

Manual operation: See ["Gateway"](#) on page 158

SYSTem:COMMunicate:LAN:DHCP <En-/Disable DHCP>

Parameters:

<En-/Disable DHCP> ON | OFF | 1 | 0

*RST: OFF | 0

Example: See [Example"Network communication settings"](#) on page 219.

Manual operation: See ["DCHP & Auto-IP"](#) on page 157

SYSTem:COMMunicate:LAN:DISCard

Removes the LAN configuration.

Usage: Event

SYSTem:COMMunicate:LAN:EDITed?

Usage: Query only

SYSTem:COMMunicate:LAN:HOSTname <Device hostname>

Sets an individual hostname for the R&S LCX.

Parameters:

<Device hostname>

Example: See [Example"Network communication settings"](#) on page 219.

Manual operation: See ["Desired Hostname"](#) on page 156

SYSTem:COMMunicate:LAN:MAC?

Queries the MAC address of the network.

Example: See [Example"Network communication settings"](#) on page 219.

Usage: Query only

Manual operation: See ["MAC Address"](#) on page 158

SYSTem:COMMunicate:LAN:RESet

Terminates the network configuration and restarts the network.

Example: See [Example"Network communication settings"](#) on page 219.

Usage: Event

Manual operation: See ["Reset LAN Conection"](#) on page 158

SYSTem:COMMunicate:LAN:SMASK <Subnet mask>

Sets the subnet mask.

Parameters:

<Subnet mask>

Example: See [Example"Network communication settings"](#) on page 219.

Manual operation: See ["Subnet Mask"](#) on page 158

SYSTem:COMMunicate:NETWork:VNC:PORT <Port>

Sets the VNC port address.

Parameters:

<Port> Range: 100 to 65535
 *RST: n.a. (factory preset: 5900)

Example: See [Example"Network communication settings"](#) on page 219.

Manual operation: See ["VNC Port"](#) on page 159

SYSTem:COMMunicate:NETWork:VNC[:STATe] <En-/Disable VNC>

Activates the VNC interface for remote access.

Parameters:

<En-/Disable VNC> ON | OFF | 1 | 0
*RST: n.a. (factory preset: 0)

Example: See [Example"Network communication settings"](#) on page 219.

Manual operation: See ["Enabled"](#) on page 159

SYSTem:COMMunicate:NETWork:VNC:PORT <Port>

Sets the VNC port address.

Parameters:

<Port> Range: 100 to 65535
*RST: n.a. (factory preset: 5900)

Example: See [Example"Network communication settings"](#) on page 219.

Manual operation: See ["VNC Port"](#) on page 159

SYSTem:COMMunicate:NETWork:VNC[:STATe] <En-/Disable VNC>

Activates the VNC interface for remote access.

Parameters:

<En-/Disable VNC> ON | OFF | 1 | 0
*RST: n.a. (factory preset: 0)

Example: See [Example"Network communication settings"](#) on page 219.

Manual operation: See ["Enabled"](#) on page 159

SYSTem:DATE <Year>, <Month>, <Day>

Sets or queries the date for the instrument-internal calendar.

Parameters:

<Year> Sets the year.
Range: 2010 to 2037

<Month> Sets the month.
Range: 1 to 12

<Day> Sets the day.
Range: 1 to 31

Example: See [Example"General instrument settings"](#) on page 217.

Manual operation: See ["Set Date"](#) on page 128

SYSTem:HW:VERSion?

Queries the hardware version of the instrument.

Example: See [Example "General instrument settings"](#) on page 217.

Usage: Query only

Manual operation: See ["Device Information"](#) on page 133

SYSTem:KEY:BRIGHtness <Front key brightness>

Sets the brightness of the front panel keys.

Parameters:

<Front key brightness>	Range:	0.1 to 1
	Increment:	0.1
	*RST:	0.8
	Default unit:	%

Example: See [Example "General instrument settings"](#) on page 217.

Manual operation: See ["Key Brightness"](#) on page 129

SYSTem:LOCal

Enables manual operation, i.e. unlocks front panel control.

To lock manual control, use command [SYSTem:RWLock](#) on page 226.

Example: See [Example "General instrument settings"](#) on page 217.

Usage: Event

SYSTem:REMote

Activates remote control.

The R&S LCX switches to remote state, and locks all front panel controls.

You can control the R&S LCX remotely. Sending a command sets the instrument to remote state, indicated by the white SCPI icon in the status bar.

To return to manual control, use command [SYSTem:LOCa1](#) on page 225.

Example: See [Example "General instrument settings"](#) on page 217.

Usage: Event

SYSTem:REStart

Restarts the instrument without restarting the operating system.

Example: See [Example "General instrument settings"](#) on page 217.

Usage: Event

SYSTem:RWLock

Locks all front panel controls, i.e. manual operation.

To unlock the front panel control, use command [SYSTem:LOCa1](#) on page 225.

Example: See [Example"General instrument settings"](#) on page 217.

Usage: Event

SYSTem:SETTING:DEFault:SAVE [<File path>]

Saves the current instrument settings in a file with defined filename.

To recall an instrument configuration, use command [*RCL](#).

Setting parameters:

<File path>

Example: See [Example"General instrument settings"](#) on page 217.

Usage: Setting only

SYSTem:TIME <Hour>, <Minute>, <Second>

Sets or queries the time for the instrument-internal clock.

The R&S LCX indicates the time in the status bar.

Parameters:

<Hour> Range: 0 to 23

<Minute> Range: 0 to 59

<Second> Range: 0 to 59

Example: See [Example"General instrument settings"](#) on page 217.

Manual operation: See ["Set Time"](#) on page 128

SYSTem:UPTime?

Queries the up time of the operating system.

Example: See [Example"General instrument settings"](#) on page 217.

Usage: Query only

12 Troubleshooting

- [Displaying status information](#)..... 227
- [Problems during firmware update](#)..... 227
- [Cannot establish a LAN connection](#)..... 228
- [Contacting customer support](#)..... 228

12.1 Displaying status information

The R&S LCX displays status information in different ways:

- **Status bars**
Using icons, the status bars indicate general instrument configuration and operating modes, and measurement modes and states, see "[Status bar](#)" on page 37.
- **Messages**
Messages that appear on the screen inform you on current settings and states. The R&S LCX distinguishes between status messages, information messages, and also warning and error messages.
Some information and messages are entered in the error/event queue of the status reporting system, see [Chapter 10.2.4, "Status reporting system"](#), on page 151.

12.2 Problems during firmware update

The firmware update is described in [Chapter 9.11, "Update device"](#), on page 135. Solutions for potential problems that can occur during firmware update are described in the following sections.

Firmware update was interrupted

If for example, a power cut happened during the firmware update, problems can occur.

1. Perform the firmware update again. Sometimes, a further update fixes the problems.
2. If you nevertheless cannot access the R&S LCX, contact the local service representative, see [Chapter 12.4, "Contacting customer support"](#), on page 228.

Firmware update was aborted

If there is not enough free memory space, the firmware update aborts. The instrument displays an error message.

1. Execute the sanitization procedure, as described in the instrument security procedures. You find this document on the product page at: www.rohde-schwarz.com/manual/lcx.
2. Start the firmware update again.

12.3 Cannot establish a LAN connection

If you have problems to establish a LAN connection as described in [Chapter 4.1.7, "Connecting to LAN"](#), on page 21:

1. Check if the TCP/IP address information is valid.
2. Assign the IP address manually, e.g. if the network does not support DHCP configuration, see [Chapter 10.5, "Adjusting interface addresses"](#), on page 164.

12.4 Contacting customer support

Technical support – where and when you need it

For quick, expert help with any Rohde & Schwarz product, contact our customer support center. A team of highly qualified engineers provides support and works with you to find a solution to your query on any aspect of the operation, programming or applications of Rohde & Schwarz products.

Contact information

Contact our customer support center at www.rohde-schwarz.com/support, or follow this QR code:



Figure 12-1: QR code to the Rohde & Schwarz support page

13 Transporting

Lifting and carrying

See:

- ["Lifting and carrying the product"](#) on page 10
- [Chapter 4.1.1, "Lifting and carrying"](#), on page 16.

Packing

Use the original packaging material. It consists of antistatic wrap for electrostatic protection and packing material designed for the product.

If you do not have the original packaging, use similar materials that provide the same level of protection. You can also contact your local Rohde & Schwarz service center for advice.

Securing

When moving the product in a vehicle or using transporting equipment, make sure that the product is properly secured. Only use items intended for securing objects.

Transport altitude

Unless otherwise specified in the data sheet, the maximum transport altitude without pressure compensation is 4500 m above sea level.

14 Maintenance, storage and disposal

The product does not require regular maintenance. It only requires occasional cleaning. It is however advisable to check the nominal data from time to time.

14.1 Cleaning

How to clean the product is described in "[Cleaning the product](#)" on page 11.

Do not use any liquids for cleaning. Cleaning agents, solvents, acids and bases can damage the front panel labeling, plastic parts and display.

14.2 Changing fuses

The R&S LCX is protected by two fuses, you can check and replace, if there are any problems:

- F1: Line fuse
If the R&S LCX does not start, it is possible that a blown line fuse is the cause. In this case, check the line fuse and replace it, see [Replacing the line fuse](#).
- F2: Bias fuse
Protects the bias voltage input from overload to avoid damage of the circuitry. Regularly check the condition of the fuse and replace it in case it is blown or damaged, see "[Replacing the external bias fuse](#)" on page 19.

If you have still problems, contact Rohde & Schwarz customer service at www.rohde-schwarz.com/support.

14.3 Storage

Protect the product against dust. Ensure that the environmental conditions, e.g. temperature range and climatic load, meet the values specified in the data sheet.

14.4 Disposal

Rohde & Schwarz is committed to making careful, ecologically sound use of natural resources and minimizing the environmental footprint of our products. Help us by disposing of waste in a way that causes minimum environmental impact.

Disposing of electrical and electronic equipment

A product that is labeled as follows cannot be disposed of in normal household waste after it has come to the end of its life. Even disposal via the municipal collection points for waste electrical and electronic equipment is not permitted.



Figure 14-1: Labeling in line with EU directive WEEE

Rohde & Schwarz has developed a disposal concept for the eco-friendly disposal or recycling of waste material. As a manufacturer, Rohde & Schwarz completely fulfills its obligation to take back and dispose of electrical and electronic waste. Contact your local service representative to dispose of the product.

Glossary: List of the often used terms and abbreviations

A

Activation key: [License key](#)

C

CDC: Communications device class: protocol used for emulating serial ports over USB.

Computer name: An unambiguous indication of the instrument a LAN that uses a [DNS](#) server.

The default computer name follows the syntax `<instrument>-<serial number>`, e.g. `LCX100-123456`.

Synonym: [Hostname](#)

See [Serial number](#).

D

Device key: [License key](#)

DHCP: Dynamic host configuration protocol

DNS: Domain name system: a service that translates domains names into IP addresses.

E

e.g.: For example

G

Glossary: List of the often used terms and abbreviations

GPIB: General purpose interface bus: digital interface system, used to control an instrument remotely or transfer data between two or more instruments.

GUI: Graphical user interface

H

Hostname: [Computer name](#)

I

IEC 625/IEEE 488: [GPIB](#)

L

License key: Unique ID (30-digit number) coming with an option for activating.

Line voltage: AC voltage of the network.
Synonyms: Mains voltage

LXI: LAN extensions for instrumentation: device platform for measuring instruments and test equipment that is based on standard Ethernet technology.

M

MAC: Media access control address: unique identifier of the network adapter in an instrument.

mDNS: Multicast **mDNS**: protocol that translates hostnames to IP addresses in small networks which do not include a local server name.

O

OSA: Open source acknowledgment documentation embedded in the instrument firmware.

P

PC: Personal computer

product page: A designation of the R&S LCX product page <http://www.rohde-schwarz.com/product/LCX.html>

R

Remote control: The operation of the R&S LCX by remote control commands or programs to perform automated tests.
The instrument is connected to a system controller via LAN/VXI-11, GPIB or USB using **VISA**. The instrument is controlled directly or supported by instrument drivers.

Remote device: External device controls the R&S LCX in remote operation mode, see Remote operation.
Synonyms: External controller, client device

S

SCPI: Standard commands for programmable instruments.

Serial number: Unique instrument identification, provided on the rear panel of the instrument and required to build the **Computer name**.
The serial number are the last 6 digits in the string `<stock no.>-<serial number>`, e.g. LCX100-123456

T

TCP/IP: Transmission control protocol / Internet protocol for communication of devices in a network (Internet or private network).

Test fixture: In testing electronic components, an electronic device that enables you to fix and hold a component (DUT) in place for testing with electronic signals.

THT test fixture: Through hole test fixture for leaded components.

U

URI: Uniform resource identifier: address string for unique identification of a device used by web technologies.

URL: Uniform resource locator: address string for unique identification of a device connected to a network.

USB: Universal bus interface

USBTMC: USB test & measurement class specification: a protocol that is built on top of USB for communication with USB devices.

V

VCP: Virtual COM port
Synonym: [CDC](#)

VISA: Virtual instrument software architecture for communication over various interfaces, e.g. Ethernet, LAN or USB.

VISA library: Standardized I/O software interface library for communication of devices over TCP/IP protocols.

List of commands

*CLS.....	178
*ESE.....	178
*ESR?.....	178
*IDN?.....	178
*OPC.....	178
*RCL.....	179
*RST.....	179
*SAV.....	179
*SRE.....	179
*STB?.....	180
*TRG.....	180
*WAI.....	180
APERture.....	181
BIAS:CURRent[:LEVel].....	183
BIAS:EXtErnal:MEASure:VOLtagE?.....	184
BIAS:EXtErnal[:VOLtagE][:STATe].....	184
BIAS:STATe.....	184
BIAS:VOLtagE[:LEVel].....	184
CORRection:LENGth.....	187
CORRection:LOAD:MODE?.....	187
CORRection:LOAD:STATe.....	187
CORRection:OPEN:MODE?.....	188
CORRection:OPEN:STATe.....	188
CORRection:OPEN[:EXECute].....	188
CORRection:SHORT:MODE?.....	188
CORRection:SHORT:STATe.....	188
CORRection:SHORT[:EXECute].....	188
CORRection:SPOT<Spot>:LOAD:STANdard.....	189
CORRection:SPOT<Spot>:LOAD[:EXECute].....	189
CORRection:SPOT<Spot>:OPEN[:EXECute].....	189
CORRection:SPOT<Spot>:SHORT[:EXECute].....	190
CURRent[:LEVel].....	182
DATA:DATA?.....	190
DATA:DELete.....	191
DATA:LIST?.....	191
DATA:POINts?.....	191
DIMeasure:ABORt.....	193
DIMeasure:EXECute.....	193
DIMeasure:INtErval:POINts.....	193
DIMeasure:INtErval:STEPsize.....	194
DIMeasure:INtErval:TYPE.....	194
DIMeasure:SWEep:MAXimum.....	194
DIMeasure:SWEep:MINimum.....	195
DIMeasure:SWEep:PARAmeter.....	195
DISPlay:BRIGhtness.....	196
DISPlay[:WINDow]:TEXT:CLear.....	196
DISPlay[:WINDow]:TEXT[:DATA].....	197

FETCh:IMPedance?	211
FETCh?	211
FREQuency[:CW]	182
FUNCTion:IMPedance:RANGe:AUTO	199
FUNCTion:IMPedance:RANGe:HOLD	199
FUNCTion:IMPedance:RANGe[:VALue]	199
FUNCTion:IMPedance:SOURce	200
FUNCTion:IMPedance[:TYPE]	200
FUNCTion:MEASurement:TYPE	201
FUNCTion:TRANSformer:RANGe[:TYPE]	201
HANDler:BIN:STATistic:COUNT?	202
HANDler:BIN:STATistic:RESet	203
HANDler:BIN:STATistic?	202
HANDler:CONFig:PATH	203
HANDler[:STATe]	203
HCOPY:DATA?	204
HCOPY:FORMat?	204
HCOPY:SIZE:X?	204
HCOPY:SIZE:Y?	205
INITiate[:IMMediate]	212
INTerfaces:USB:CLASs	220
LOG:COUNT	207
LOG:DURation	207
LOG:FNAME	207
LOG:INTerval	208
LOG:MODE	208
LOG:STIME	209
LOG[:STATe]	209
MEASure:ACCuracy?	212
MEASure:CURREnt?	212
MEASure:MODE	212
MEASure:TRIGger:DELay	213
MEASure:VOLtage?	213
READ:IMPedance?	213
READ?	213
STATus:OPERation:CONDition?	214
STATus:OPERation:ENABLE	214
STATus:OPERation:NTRansition	214
STATus:OPERation:PTRansition	214
STATus:OPERation[:EVENT]?	214
STATus:QUEStionable:CONDition?	215
STATus:QUEStionable:ENABLE	215
STATus:QUEStionable:ENABLE?	215
STATus:QUEStionable:NTRansition	216
STATus:QUEStionable:PTRansition	216
STATus:QUEStionable[:EVENT]?	216
SYSTem:BEEPer:WARning:STATe	221
SYSTem:BEEPer:WARning[:IMMediate]	221
SYSTem:BEEPer[:COMPLETE]:STATe	221
SYSTem:BEEPer[:COMPLETE][:IMMediate]	221

SYSTem:COMMunicate:LAN:ADDRess.....	222
SYSTem:COMMunicate:LAN:APPLY.....	222
SYSTem:COMMunicate:LAN:DGATeway.....	222
SYSTem:COMMunicate:LAN:DHCP.....	222
SYSTem:COMMunicate:LAN:DISCard.....	222
SYSTem:COMMunicate:LAN:EDITed?.....	222
SYSTem:COMMunicate:LAN:HOSTname.....	223
SYSTem:COMMunicate:LAN:MAC?.....	223
SYSTem:COMMunicate:LAN:RESet.....	223
SYSTem:COMMunicate:LAN:SMASK.....	223
SYSTem:COMMunicate:NETWork:VNC:PORT.....	223
SYSTem:COMMunicate:NETWork:VNC:PORT.....	224
SYSTem:COMMunicate:NETWork:VNC[:STATe].....	224
SYSTem:COMMunicate:NETWork:VNC[:STATe].....	224
SYSTem:DATE.....	224
SYSTem:HW:VERSion?.....	225
SYSTem:KEY:BRIGHtness.....	225
SYSTem:LOCal.....	225
SYSTem:REMote.....	225
SYSTem:REStart.....	225
SYSTem:RWLock.....	226
SYSTem:SETTing:DEFault:SAVE.....	226
SYSTem:TIME.....	226
SYSTem:UPTime?.....	226
VOLTage[:LEVel].....	182

Index

A

Abort	
Dynamic impedance measurement	105
About	
Auto function	75
Binning	106
Cable length	75
External bias	75
Measurement speed	75
Open/Short/Load correction	75
Source impedance	75
Test fixture	52
Test signal type	75
Access	
Binning settings	108, 109
Configuration preset	87
CSV settings	126
Data and time settings	128, 129
Device information	133
Display mode settings	71
Dynamic impedance measurement settings	102
File manager settings	117
FTP settings	159, 160
GPIB settings	161, 162
Instrument	43
Interfaces	121
LAN settings	154, 156
Licenses settings	130
Live chart settings	90
Live chart viewer	90
Logging chart settings	94
Logging chart viewer	93
Logging settings	98
Measurement control functions	75
Measurement mode settings	69
Measurement parameters	77
Open/Short/Load correction parameters	80
Save/Recall settings	137
Screenshot	124
Sound settings	129
Specific instrument functions	89
Test signal settings	73
Update device	135
User button	122
VNC settings	158
Activating the locked touch input	123
Active elements	41
Address	
GPIB settings	162
Alphanumeric parameters	46
APERTure	
Commands	180
Appearance	
Setup	128
Application cards	15
Application notes	15
Apply configuration	
Time	158
Assign screenshot to user button	125
Assign touch lock to user button	123
Auto	
Measurement control functions	75

Auto function	
Measurement functions	79
Purity angle	79
Serial/Parallel separation point	79
Axial lead type	
Test fixture	52
B	
Back	
Live chart	91
Basic steps	
Trying out	32
Beeper	129
Bench top, placing the R&S LCX	17
Bias	
Configure	60
connector	31
External voltage	61
Fuse holder	31
Internal current	62
Internal voltage	60
BIAS	
Commands	183
Bias current	
How to: configure internal current bias	62
How to: deactivate internal current bias	63
Bias enable	
Measurement functions	74
Binning	
About	106
Bins	111
Commands	201
connector	31
Counter	110
Enable	108
End of measurement bin	111
File	110
Histogram	111
How to: Configure binning file	111
Indicator	110
Load from file	108
Out bin	111
Pin assignment of interface	107
Primary parameter characteristic	110
Secondary parameter characteristic	110
Settings	108
Settings softkey	110
Specific functions	106
Binning measurement	
Settings	109
Bins	
Binning	111
BNC	
Connectors	29
BNC-to-BNC extension	
Test fixture	57
Brightness	
Display	128, 129
Keys	128, 129
Setup	129
Brochures	15

- C**
- Cable length
 - Measurement functions 78
 - Cancel dynamic impedance measurement 105
 - Capacitor
 - How to: measure 64
 - Carrying the instrument 16
 - CDC
 - USB settings 161
 - Characteristic
 - Primary parameter 110
 - Secondary parameter 110
 - Chart
 - Live 89
 - Logging 93
 - Chart viewer
 - Logging 93
 - Checking the instrument 16
 - Cleaning 230
 - Clear
 - Live chart 91
 - Clear status
 - Remote 178
 - Clock format
 - How to change 140
 - Setup 128
 - Close FTP file access
 - Remote access 174
 - Command sequence
 - Remote 180
 - Commands
 - Remote control 176
 - Configuration preset
 - Access 87
 - How to configure 88
 - How to use 88
 - How to: Save or recall configuration settings 88
 - Indicator 37, 40
 - Measurement functions 86
 - Settings 87
 - Softkeys 40
 - Configure
 - Bias 60
 - Test signal 58
 - Configuring dynamic impedance measurement settings 105
 - Configuring logging chart settings 95, 96
 - Configuring logging settings 101
 - Connect to power
 - How to: 21
 - Connecting
 - LAN 21
 - Memory stick 22
 - Power 19
 - Test fixture 23
 - USB devices 22
 - Connecting measurement equipment 23
 - Connector
 - AC power supply 30
 - Bias external 31
 - Bias fuse 31
 - Binning interface 31
 - BNC 29
 - Digital I/O interface 31
 - GPIB 30
 - H CUR 29
 - H POT 29
 - IEC/IEEE 30
 - L CUR 29
 - L POT 29
 - LAN 31
 - Trigger external 31
 - USB A 29, 31
 - USB B 31
 - Connectors
 - Front panel 29
 - Considerations
 - EMI 18
 - Test setup 18
 - Test signal 59
 - Conventions
 - Remote control 176
 - Copy
 - File manager 118
 - CORRection
 - Commands 185
 - Count
 - Logging 100
 - Counter
 - Binning 110
 - Create dump file
 - Device information 134
 - Creating a configuration preset 88
 - CSV
 - General functions 126
 - Settings 126
 - CSV settings
 - Decimal separator 127
 - Error value 127
 - Field delimiter 127
 - Line end marker 127
 - Line separator 127
 - Current bias
 - Measurement functions 74
 - Customer support 228
- D**
- DATA
 - Commands 190
 - Data entry 44
 - Data format
 - How to: Configure csv data 127
 - Data sheets 15
 - Date
 - General functions 127
 - How to change 140
 - Setup 128
 - Decimal separator
 - CSV settings 127
 - Default
 - Settings 138
 - Default values
 - Remote 179
 - Delete
 - File manager 118
 - Device information
 - Create dump file 134
 - Display 133
 - General functions 133
 - How to: Create dump file 134
 - Settings 133
 - Device update
 - Update 136

- DHCP 164
 - DHCP & Auto-IP
 - LAN settings 157
 - Digital I/O interface
 - connector 31
 - DIMeasure
 - Commands 191
 - Display
 - Active elements 41
 - Brightness 129
 - Context-sensitive menu 41
 - Front panel 26
 - Info line 41
 - Key brightness 129
 - Measurement accuracy 72
 - Measurement pair settings 72
 - Mode 71
 - On-screen keypad 41
 - Settings 71, 72
 - Tab labels 41
 - DISPlay
 - Commands 195
 - Display brightness
 - General functions 128
 - Display information 36
 - Display mode
 - Access 71
 - Live chart 89
 - Disposal 230
 - DNS hostname
 - Network settings 156
 - Documentation overview 14
 - Dragging screenshots 125
 - Driver for remote control 15
 - Duration
 - Logging 100
 - Dynamic impedance measurement
 - Abort 105
 - Enable 103
 - How to: Cancel measurement settings 105
 - How to: Configure measurement settings 105
 - How to: Configure the measurement 105
 - How to: Select memory location 105
 - Interval type 104
 - Maximum 104
 - Minimum 104
 - Number of points 104
 - Settings 102
 - Specific functions 102
 - Step size 104
 - Sweep parameter 103
- E**
- EMI
 - Considerations 18
 - Enable
 - Binning 108
 - Dynamic impedance measurement 103
 - Logging 98
 - End of measurement bin
 - Binning 111
 - Error beep
 - How to change 143
 - Setup 130
 - Error value
 - CSV settings 127
 - Event status enable register (ESE)
 - Remote 178
 - Event status register (ESR)
 - Remote 178
 - External voltage bias 61
- F**
- Factory reset
 - Settings 138
 - Field delimiter
 - CSV settings 127
 - File
 - Binning 110
 - File manager
 - Access 117
 - Copy file 118
 - Delete file 118
 - General functions 116
 - How to: Retrieve device documentation 119
 - How to: Retrieve file information 118
 - Settings 117
 - File name
 - Logging chart 94
 - File transfer protocol
 - See FTP 159
 - Frequency
 - Measurement functions 74
 - FREquency
 - Commands 180
 - Front panel
 - Connectors 29
 - Display 26
 - Overview 26
 - Status bar 37
 - Front panel keys
 - Usage 36
 - FTP
 - How to: Change access settings 166
 - How to: Configure FTP settings manually 166
 - How to: Enable FTP for file transfer 172
 - Network settings 155
 - State 160
 - FTP password
 - Network settings 161
 - FTP port
 - Network settings 160
 - FTP settings
 - Access 159, 160
 - FTP user name
 - Network settings 161
 - FUNction
 - Commands 197
 - Function keys
 - Front panel tour 28
 - Functions
 - Instrument functions 69
 - Measurement functions 73
 - Fuse holder
 - AC power supply 30
 - Bias 31
 - Fuses
 - How to replace the bias fuse 19
 - How to replace the line fuse 20

G

Gateway	
LAN settings	158
General function	
Save location	98, 124
Target folder	99
General functions	115
Appearance	128
Apply configuration	158
Clock format	128
Copy file	118
CSV	126
Date	128
Date and time	127
Default settings	138
Delete file	118
Device information	133
Display brightness	128, 129
Error beep	130
Factory reset	138
File manager	116
Interface settings	121
Interfaces	120
Key brightness	128, 129
Licenses	130
Network	121
Recall	138
Save	137
Save/Recall	137
Screenshot	123
Sound	129
Time	128
Update device	135
USB class	121
User button	122
General instrument settings	115
General settings	
How to: Customizing	140
Getting started	14
GPIOB	
Characteristics	150
How to: Assign address manually	168
How to: Connect for remote access	163
Settings	162
GPIOB address	
How to: Change address	168
Remote access	162
GPIOB settings	
Access	161, 162
Address	162
Ground socket	29
Ground terminal	31

H

HANDler	
Commands	201
HCOPY	
Commands	203
High impedance measurement	
Measurement functions	79
High Z mode	
Measurement functions	79
Histogram	
Binning	111

Hold	
Measurement control functions	75
Hostname	
Network settings	156
How to:	
Access remotely using a file explorer	173
Access remotely using a web browser	170
Access settings	43
Activating the locked touch input	123
Adding external voltage bias	61
Adding internal voltage bias	60
Adjust interface address for remote access	164
Align the instrument on all frequencies	34, 83
Align the instrument on one working point	84
Assign GPIB address manually	168
Assign IP address manually	164, 167
Assign screenshot to user button	125
Assign touch lock to user button	123
Assign VNC port address manually	165
Basic measurement steps	32
Binning	111
Cancel dynamic impedance measurement	105
Configuration preset	88
Configure an interface (see configure remote access)	
.....	122
Configure csv data	127
Configure dynamic impedance measurement settings	
.....	105
Configure FTP settings manually	166
Configure logging chart settings	95, 96
Configure logging settings	101
Configure measurement parameters	83
Configure the test signal	33
Configuring Live chart	92, 95
Connect a test fixture	23, 33
Connect GPIB for remote control	163
Connect to LAN	21, 163
Connect to power	21
Connect USB for remote control	163
Connect USB storage device	23
Create dump file	134
Creating a configuration preset	88
Customize general instrument settings	140
Deactivating current bias	63
Decimal separator	127
Disconnect the instrument from power	25
Dragging screenshots	125
Dump file	134
Dynamic impedance measurement	105
Enable FTP	172
Enable LAN	169
Enable VNC service	170
Enter data	44
Enter license key manually	132
Error designator	127
Factory reset	139
Field delimiter	127
Full correction	83
Graphical display	92, 95
Licenses	131
Line end marker	127
Load binning configuration file	111, 112, 113
Load license key from file	131
Logging	100
Measure a capacitor	64
Measure a resistor	34
Measure an inductor	65

- Measure continuously 70
 - Measure the inductance of a transformer 65
 - Measure the leakage inductance of a transformer 67
 - Measure the mutual inductance of a transformer 66
 - Mount the FTP address to the file explorer 173
 - Mount the instrument in a rack 18
 - Recall default instrument settings 139
 - Recall instrument settings 139
 - Remove license key manually 132
 - Replace the bias fuse 19
 - Replace the line fuse 20
 - Retrieve device documentation 119
 - Retrieve file information 118
 - Save instrument settings 138
 - Save/Recall 118, 138
 - Screenshot 124, 136
 - Select clock format 140
 - Select memory location 101
 - Select parameters for numerical display 72
 - Select USB class 167
 - Set an initial state 32
 - Set date 140
 - Set error beep 143
 - Set screenshot file location 125
 - Set up remote access over VNC client on Windows 171
 - Setting current bias 62
 - Shut down 25
 - Software update 136
 - Spot correction 84
 - Start remote control 169
 - Stop FTP file access 174
 - Stop remote access 172
 - Stop remote control 169
 - Switch configuration presets during measurement 88
 - Switch on 25
 - Time 140
 - Unmount the instrument from a rack 18
 - User button 123
 - Using the continuous measurement mode 70
 - Work with measurement modes 70
- I**
- Identification
 - Remote 178
 - IEC426/IEEE488
 - see GPIB 162
 - Inductance
 - How to: measure a transformer 65
 - Inductance measurement 28
 - Inductor
 - How to: measure 65
 - Inserting license key manually 132
 - Instrument
 - Carrying 16
 - Checking 16
 - Lifting 16
 - Operating site 16, 17
 - Tour 25
 - Unpacking 16
 - Instrument control 35
 - Manual operation 35
 - Remote control 35
 - Ways of operation 35
 - Instrument Control
 - Status bar 37
 - Instrument functions 69
 - Specific 89
 - Instrument security procedures 14
 - Instrument settings
 - Recall 179
 - Save 179
 - Instrument status bar 37
 - Interface
 - Binning pin assignment 107
 - GPIB 150
 - LAN 147
 - USB 149
 - Interface address
 - How to adjust manually 164
 - Interface settings
 - General functions 121
 - Network 121
 - USB class 121
 - Interfaces
 - Access 121
 - General functions 120
 - How to: configure (see configure remote access) 122
 - Internal current bias 62
 - Internal voltage bias 60
 - Interval
 - Logging 100
 - Interval type
 - Dynamic impedance measurement 104
 - IP address 147
 - Changing 164
 - How to: Assign address manually 164, 167
 - LAN settings 157
- K**
- Kelvin clip lead
 - Test fixture 53
 - Kensington lock 30
 - Key 28
 - 28
 - ◀ 28
 - ★ (User) 27
 - Auto 29
 - Back 28
 - Bias enable 28
 - Bias Level 28
 - C (capacity) 28
 - Comp. (level compensation) 28
 - Freq (frequency) 28
 - Hold 29
 - home 27
 - L (inductance) 28
 - Level 28
 - On/Standby 29
 - R (resistance) 28
 - Range (frequency range) 28
 - Rotary knob 28
 - settings 27
 - Transformer 28
 - Trigger 29
 - Key brightness
 - General functions 128
 - Setup 129
 - Key features 13
 - Keyboard
 - On-screen 44
 - Keypad
 - On-screen 44

L	
Lan	
Interface	147
LAN	
Characteristics	147
Connecting	21
How to: Assign IP address manually	164, 167
How to: Connect for remote access	21, 163
How to: Enable LAN for remote access	169
IP address	147
Network settings	155
Settings	156
LAN connection	
Problems	228
LAN settings	
Access	154, 156
DHCP & Auto-IP mode	157
Gateway	158
IP address	157
MAC address	158
Reset connection	158
Subnet mask	158
Leakage inductance	
How to: measure	67
Licenses	
Access	130
General functions	130
How to: Manage licenses	131
Settings	130
Lifting the instrument	16
Line end marker	
CSV settings	127
Line separator	
CSV settings	127
Live chart	
Back	91
Chart viewer settings	90
Clear	91
How to configure graphical display	92, 95
Measurement parameter	91
Specific functions	89
Time base scaling	91
Load binning configuration file	111, 112, 113
Load correction start	
Measurement functions	82
Reference load R	82
Reference load X	82
Load from file	
Binning	108
Load instrument settings	179
Load license key from file	131
LOG	
Commands	205
Log chart	
Specific functions	93
LOG subsystem	
Remote control commands	205
Logging	
Chart	93
Chart viewer	93
Chart viewer settings	94
Count	100
Duration	100
Enable	98
How to: Configure logging settings	101
How to: Record measurement data	100
How to: Select memory location	101
Interval	100
Mode	99
Set date & time	100
Settings	97
Specific functions	97
Start time	100
Logging chart	
File name	94
How to: Configure graphical display	95, 96
Measurement parameter	95
Reset	95
Touch capture indicator	95
Traces	95
Low impedance measurement	
Measurement functions	79
Low Z mode	
Measurement functions	79
M	
MAC address	
LAN settings	158
Maintenance	230
Manual interaction	35
Manual operation	35
Maximum	
Dynamic impedance measurement	104
mDNS hostname	
Network settings	156
MEASure	
Commands	209
Measurement	
How to examples	64
Mode	69
Setups	52
Measurement accuracy	
Calculations	50
Display	72
Introduction	50
Measurement basics	
General measurement parameters	47
LCX measurement parameters	48
Measurement accuracy	50
Measurement control functions	
Auto	75
Hold	75
Trig.	75
Measurement control keys	
Front panel tour	28
Measurement examples	64
Measurement function keys	
Front panel tour	28
Measurement functions	73
Auto function	79
Bias enable	74
Cable length	78
Configuration preset	86
Current bias	74
Frequency	74
High Z mode	79
Load correction reference R	82
Load correction reference X	82
Load correction start	82
Low Z mode	79
Measurement parameters	75
Open correction start	82

Open/Short/Load correction settings	80
Open/Short/Load correction start	81
Open/Short/Load correction state	81
Preset indicator	88
Preset softkeys	88
Purity angle	79
Range	74
Serial/Parallel separation point	80
Setting measurement parameters	77
Setting softkey	88
Signal level	74
Source impedance	79
Speed	78
Test signal type	78
Trigger delay	79
Voltage bias	74, 79
Measurement mode	
How to: work with measurement modes	70
Setting measurement mode parameters	69
Settings	69
Measurement mode keys	
Front panel tour	28
Measurement parameter	
Live chart	91
Logging chart	95
Measurement parameters	
Access	77
Accuracy calculation	50
Basic definition	47
How to: configure measurement settings	83
LCX terms	48
Measurement settings keys	
Front panel tour	28
Measurement status bar	39
Minimum	
Dynamic impedance measurement	104
Mode	
Display	71
Logging	99
Measurement	69
Mounting, in a rack	18
Mutual inductance	
How to: measure	66
N	
Navigation controls	
Front panel tour	27
Network	
Interface settings	121
Settings	154
Network settings	
DNS hostname	156
FTP	155
FTP enable	160
FTP password	161
FTP port	160
FTP user name	161
Hostname	156
LAN	155
mDNS hostname	156
SCPI raw port	155
SNS hostname	156
VNC	155
VNC enable	159
VNC port	159
Number of points	
Dynamic impedance measurement	104
Numeric data entry	44
Numeric parameters	45
Numerical display	
How to select parameters	72
O	
On-screen keyboard	46
On-screen keypad	41
Open correction start	
Measurement functions	82
Open source acknowledgement	119
Open source acknowledgment (OSA)	15
Open/Short/Load correction	
Access	80
Open/Short/Load correction settings	
Measurement functions	80
Open/Short/Load correction start	
Measurement functions	81
Open/Short/Load correction state	
Measurement functions	81
Operating site	
Choosing	16
Setting up the instrument	17
Operation	
Manually	35
Remotely	46
Operation complete	
Remote	178
Operation status register	152
OSA	119
Out bin	
Binning	111
Overview	
Front panel	26
Rear panel	29
P	
Parameters	
Entering	45, 46
Measurement functions	75
Password	
FTP	161
Power	
Connecting the instrument	19
Power on	
Key	29
Power states	25
Power supply	
Connector	30
Fuse holder	30
Switch	30
Power switch	
AC power supply	30
Preparing for use	16
Preset	
Configuration indicator	37, 40
Indicator	88
Softkey	88
Product introduction	13
Programming examples	
Remote control	177
Purity angle	
Measurement functions	79

Q

Questionable status register 153

R

R&S LCX-Z1

Axial/radial lead type test fixture 52
Kelvin clip lead test fixture 53

R&S LCX-Z3

SMD test fixture 54
Test tweezers for SMD 55

R&S LCX-Z5

Transformer test fixture 56

R&S LCX-Z11

BNC-to-BNC extension test fixture 57

Rack, mounting 18

Radial lead type

Test fixture 52

Range

Measurement functions 74

Raw port 155

Rear panel

Overview 29

Recall

General functions 137

Settings 138

Recall instrument settings 179

Recall intermediate 179

Recalling default instrument settings 139

Recalling instrument settings 139

Release notes 15

Remote access 144

Close FTP file access 174

DHCP & Auto-IP mode setting 157

DNS hostname 156

FTP 155

FTP password 161

FTP port 160

FTP state 160

FTP user name 161

Gateway setting 158

GPIB address 162

Hostname 156

How to: Stop FTP file access 174

How to: Stop remote access 172

IP address 157

LAN 155

MAC address 158

mDNS hostname 156

Network Mac address 158

Reset LAN connection 158

Return to manual operation 172

SCPI raw port 155

Settings 154

Subnet mask setting 158

USB class 161

VNC 155

VNC port 159

VNC state 159

Remote control 35, 46

Access modes 145

Commands 176

Conventions 176

Driver 15

GPIB interface 150

How to: Start remote control 169

How to: Stop remote control 169

Interfaces 46

Interfaces and protocols 146

LAN interface 147

Programming examples 177

Return to manual operation 169

SCPI 144

Start 168

Stop 168

USB interface 149

Remote control commands

LOG subsystem 205

Remote operation

VNC 144

Removing a license key manually 132

Replace the bias fuse

How to: 19

Replace the line fuse

How to: 20

Reset

Logging chart 95

Reset LAN connection

LAN settings 158

Reset values

Remote 179

Resetting to factory settings 139

Resource string

VISA 147

Retrieve device documentation 119

Retrieve file information 118

Return to manual operation

Remote access 172

Remote control 169

S

Safety information 9

Safety instructions 9, 15

Save

General functions 137

Settings 137

Save instrument settings 179

Save intermediate 179

Save location

General function 98, 124

Save/Recall

Access 137

How to: Factory reset 139

How to: Recall instrument default settings 139

How to: Recall instrument settings 139

How to: Save instrument settings 138

How to: Save or recall instrument settings 118, 138

Settings 137

Saving instrument settings 138

SCPI

APERTure 180

BIAS 183

Binning 201

Command description 176

CORRection 185

DATA 190

DIMEasure 191

DISPLay 195

FREQuency 180

FUNCTion 197

HANDler 201

HCOPY 203

- LOG 205
 - MEASure 209
 - STATUS 213
 - Status operation register 213
 - Status questionable register 215
 - SYSTEM 216
 - VOLTage 180
 - SCPI raw port
 - Network settings 155
 - Screenshot
 - General functions 123
 - How to: Capture a screen image 124, 136
 - Settings 124
 - Security procedures 14
 - Selecting memory location 101
 - Serial/Parallel separation point
 - Measurement functions 80
 - Service manual 14
 - Service request enable register (SRE)
 - Remote 179
 - Set date & time
 - Logging 100
 - Set screenshot file location 125
 - Setting
 - Softkey 88
 - Settings
 - Binning 108
 - Binning measurement 109
 - Configuration preset 87
 - CSV 126
 - Device information 133
 - Display 71, 72
 - Dynamic impedance measurement 102
 - File manager 117
 - GPIB 162
 - LAN 156
 - Licenses 130
 - Live chart viewer 90
 - Logging 97
 - Logging chart viewer 94
 - Measurement mode 69
 - Measurement pair display 72
 - Measurement parameters 77
 - Network 154
 - Remote access 154
 - Save/Recall 137
 - Screenshot 124
 - Softkey 110
 - Update software 135
 - USB 161
 - User button 122
 - Settings keys
 - Front panel tour 28
 - Setup
 - Appearance 128
 - Brightness 129
 - Clock format 128
 - Date 128
 - Error beep 130
 - Key brightness 129
 - Measurement 52
 - Sound 129
 - Time 128
 - Signal level
 - Measurement functions 74
 - SMD
 - Test fixture 54
 - SMD test tweezers
 - Test fixture 55
 - Socket
 - see SCPI raw port 155
 - Sound
 - Setup 129
 - Source impedance
 - Measurement functions 79
 - Specific functions
 - Binning 106
 - Dynamic impedance measurement 102
 - Live chart 89
 - Log chart 93
 - Logging 97
 - Specific instrument functions 89
 - Speed
 - Measurement functions 78
 - Standby
 - Key 29
 - Start time
 - Logging 100
 - STATUS
 - Commands 213
 - Status bar
 - Front panel 37
 - Instrument 37
 - Measurement 39
 - Status bar information
 - Measurement status bar 39
 - Status byte
 - Remote 178, 180
 - Status operation register
 - Commands 213
 - Status questionable register
 - Commands 215
 - Status reporting system 151
 - Common commands 177
 - Hierarchy of status registers 152
 - Step size
 - Dynamic impedance measurement 104
 - Storage 230
 - Subnet mask
 - LAN settings 158
 - Sweep parameter
 - Dynamic impedance measurement 103
 - Switch configuration presets during measurement 88
 - Switching on or off 25
 - SYSTEM
 - Commands 216
- ## T
- Target folder
 - General function 99
 - Test fixture
 - About 52
 - Axial/radial lead type (R&S LCX-Z1) 52
 - BNC-to-BNC (R&S LCX-Z11) 57
 - Connecting 23
 - Kelvin clip lead (R&S LCX-Z2) 53
 - SMD (R&S LCX-Z3) 54
 - SMD test tweezers (R&S LCX-Z4) 55
 - Transformer (R&S LCX-Z5) 56
 - Test setup
 - Considerations 18

Test signal	
Configure	58
Considerations	59
Frequency	74
Test signal settings	
Access	73
Test signal type	
Measurement functions	78
Text entry	44
Time	
General functions	127
How to change internal clock	140
Setup	128
Time base scaling	
Live chart	91
TMC	
USB settings	161
Touch capture indicator	
Logging chart	95
Touchscreen	
Front panel	26
Usage	35
Traces	
Logging chart	95
Transformer	
Test fixture	56
Transporting	229
Trig.	
Measurement control functions	75
Trigger	
Connector	31
Event (remote)	180
Trigger delay	
Measurement functions	79
Troubleshooting	
LAN connection problems	228
Trying out	
Basic steps	32
Tutorials	14
U	
Unpacking the instrument	16
Update	
Device update	136
How to: update software	136
Update device	
General functions	135
Settings	135
USB	
Characteristics	149
How to: Connect for remote access	163
How to: Select class	167
Settings	161
USB A	
Connector	29, 31
USB B	
Connector	31
USB class	
How to: Select interface protocol	167
Interface settings	121
Remote access	161
USB settings	
TMC / CDC	161
User button	
General functions	122
How to: Capture a screen image	123
Settings	122
Touch lock	123
User manual	14
User name	
FTP	161
Using the dump file function	134
Using the front panel keys	36
Using the touchscreen	35
Utility keys	
Front panel tour	27
V	
VISA	147
Resource string	147
VNC	
How to: Access the instrument over a file explorer ...	173
How to: Access the instrument with a web browser .	170
How to: Assign port address manually	165
How to: Enable VNC for remote access	170
How to: Set up VNC client on Windows	171
Network settings	155
State	159
VNC port	
How to: Change address	165
Network settings	159
VNC settings	
Access	158
VOLTage	
Commands	180
Voltage bias	
external/internal	79
How to: configure external voltage bias	61
How to: configure internal bias	60
Measurement functions	74, 79
W	
Wait	
Remote	180
Ways of operation	35
White papers	15