

R&S®ELEKTRA

EMC Test Software

User Manual



1178678502
Version 16



This user manual describes the **R&S®ELEKTRA EMC Test Software** for electromagnetic compatibility (EMC) tests, software version **V5.01** and later. Licenses for the following software modules are available:

- R&S®ELEKTRA EMI test software ("**ELEMI-E**"), order no. 5601.0030.02
- R&S®ELEKTRA EMI extension to advanced test software ("**ELEMI-A**"), order no. 5601.0053.02
- R&S®ELEKTRA EMI extension to systems test software ("**ELEMI-S**"), order no. 5601.0076.02
- R&S®ELEKTRA EMI extension to **RSE** measurement ("**ELEMI-RSE**"), order no. 5601.0253.02
- R&S®ELEKTRA EMI extension to RSE 5G FCC meas. ("**ELEMI-5GFC**"), order no. 5601.0682.02
- R&S®ELEKTRA EMI extension to RSE out-of-band meas. ("**ELEMI-OOB**"), order no. 5601.0724.02
- R&S®ELEKTRA EMI extension to multi-band measurement ("**ELEMI-MBM**"), order no. 5601.0676.02
- R&S®ELEKTRA EMI extension to 3D results evaluation ("**ELEMI-3D**"), order no. 5601.0260.02
- R&S®ELEKTRA EMS test software conducted ("**ELEMS-C**"), order no. 5601.0099.02
- R&S®ELEKTRA EMS test software radiated ("**ELEMS-R**"), order no. 5601.0118.02
- R&S®ELEKTRA EMS extension to system test software ("**ELEMS-S**"), order no. 5601.0130.02
- R&S®ELEKTRA EMS extension to automotive/military ("**ELEMS-AMEX**"), order no. 5601.0353.02
- R&S®ELEKTRA oscilloscope drivers extension ("**ELEMS-SCP**"), order no. 5601.0630.02
- R&S®ELEKTRA EMS MIL-STD CS103/104/105 extension ("**ELEMS-C345**"), order no. 5601.0576.02
- R&S®ELEKTRA waveform management for AIM 7351731 ("**ELEMS-AIM**"), order no. 5601.0582.02
- R&S®ELEKTRA audio breakthrough measurement extension ("**ELEMS-ABT**"), order no. 5601.0730.02
- R&S®ELEKTRA rotating-tuner reverberation measurements ("**ELEMS-RVC**"), order no. 5601.2410.02
- R&S®ELEKTRA generic device drivers extension ("**ELEMC-DRV**"), order no. 5601.0230.02
- R&S®ELEKTRA EMI extension to 5G signaling ("**ELEMC-5GS**"), order no. 5601.0276.02
- R&S®ELEKTRA extension to RSE cellular signaling ("**ELEMC-CELS**"), order no. 5601.0699.02
- R&S®ELEKTRA extension to WLAN/BT signaling ("**ELEMC-WRLS**"), order no. 5601.0701.02
- R&S®ELEKTRA extension to report customization ("**ELEMC-REP**"), order no. 5601.0460.02
- R&S®ELEKTRA enhanced database for up to 20 clients ("**ELEMC-EDB**"), order no. 5601.0530.02
- R&S®ELEKTRA extension to data exchange interface ("**ELEMC-DEX**"), order no. 5601.0547.02
- R&S®ELEKTRA remote control interface extension ("**ELEMC-REM**"), order no. 5601.0553.02
- R&S®ELEKTRA extension to EUT test list automation ("**ELEMC-TLA**"), order no. 5601.0560.02
- R&S®ELEKTRA extension for EUT test bench control ("**ELEMC-ATB**"), order no. 5601.2340.02
- R&S®ELEKTRA extension to offline processing ("**ELEMC-OFF9**"), order no. 5601.0599.02

© 2023 Rohde & Schwarz

Muehldorfstr. 15, 81671 Muenchen, Germany

Phone: +49 89 41 29 - 0

Email: info@rohde-schwarz.com

Internet: www.rohde-schwarz.com

Subject to change – data without tolerance limits is not binding.

R&S® is a registered trademark of Rohde & Schwarz GmbH & Co. KG.

The Bluetooth® word mark and logos are registered trademarks owned by Bluetooth SIG, Inc. and any use of such marks by Rohde & Schwarz is under license.

All other trademarks are the properties of their respective owners.

1178.6785.02 | Version 16 | R&S®ELEKTRA

Throughout this manual, products from Rohde & Schwarz are indicated without the ® symbol, e.g. R&S®ELEKTRA is indicated as R&S ELEKTRA.

Contents

1	Welcome	13
1.1	Key features.....	13
1.2	EMC standards.....	14
1.3	Documentation overview.....	17
1.3.1	User manuals and help.....	18
1.3.2	Specifications and brochures.....	18
1.3.3	Release notes and open-source acknowledgment (OSA).....	18
1.3.4	Application notes, white papers, etc.....	19
1.3.5	Video tutorials.....	19
2	Software installation	20
2.1	System requirements.....	20
2.2	Software installation procedure.....	21
2.3	License dongle.....	24
2.3.1	Using the smart card reader.....	26
2.4	Configuration Wizard for creating basic data.....	28
2.4.1	Recovering data.....	31
2.5	Language selection.....	31
2.6	Migration Tool - XML data converter.....	32
2.7	Network firewall settings.....	35
2.8	Modify, repair or remove installation.....	36
3	Getting started	40
3.1	User login.....	42
3.2	Graphical user interface.....	43
3.3	Common action buttons.....	45
3.4	Touch operation.....	50
3.5	Measurement settings.....	51
3.6	Performing a test.....	53
3.7	Test results.....	54
3.8	Verdict.....	57
3.8.1	Editing the verdict.....	59
3.8.2	Unexpected verdict.....	59

3.9	Reporting.....	60
4	Configuration.....	62
4.1	Home menu.....	62
4.2	Dashboard.....	65
4.3	EUTs.....	66
4.3.1	EUT description.....	67
4.4	Tests.....	88
4.4.1	Configuring tests.....	88
4.4.1.1	Configuring calibration measurements.....	90
4.4.1.2	Configuring EMI tests.....	92
4.4.1.3	Configuring EMS tests.....	94
4.4.2	Configuring test charts.....	98
4.4.2.1	Chart.....	99
4.4.2.2	Trace.....	104
4.4.2.3	Marker.....	105
4.4.3	Configuring test tables.....	108
4.5	Test Templates.....	117
4.5.1	Test Templates for calibration measurements.....	119
4.5.1.1	EUT Type.....	120
4.5.1.2	Configuration tabs.....	132
4.5.1.3	Select Device.....	133
4.5.1.4	Device Settings and Properties.....	133
4.5.1.5	Test Information.....	135
4.5.2	Test Templates for EMI tests.....	136
4.5.2.1	General Settings.....	142
4.5.2.2	Measurement Flow.....	161
4.5.2.3	Flow Details.....	201
4.5.2.4	Test Information.....	229
4.5.2.5	Actions.....	230
4.5.3	Test Templates for EMS tests.....	243
4.5.3.1	General Settings.....	246
4.5.3.2	Measurement Flow.....	257
4.5.3.3	Flow Details.....	258

4.5.3.4	System Monitoring.....	294
4.5.3.5	Additional Sensor Channels.....	303
4.5.3.6	Test Information.....	304
4.5.3.7	Actions.....	305
4.5.3.8	Excluded Frequency Bands.....	307
4.5.4	EUT Monitoring templates.....	307
4.6	Report Templates.....	324
4.6.1	Configuring report templates.....	325
4.7	Hardware Setups.....	331
4.7.1	Hardware setups for calibration measurements.....	334
4.7.2	Hardware setups for EMI tests.....	334
4.7.2.1	EMI - Transducer / Probe (conducted).....	337
4.7.2.2	EMI - LISN (conducted).....	338
4.7.2.3	EMI - Slidebar (conducted).....	340
4.7.2.4	EMI - Electric Field Strength (radiated).....	341
4.7.2.5	EMI - Electric Field Strength - GTEM (radiated).....	342
4.7.2.6	EMI - Magnetic Field Strength - Triple Loop Antenna (radiated).....	343
4.7.2.7	EMI - Magnetic Field Strength - Loop Antenna + Turntable (radiated).....	344
4.7.2.8	EMI - Radiated Spurious Emission.....	345
4.7.3	Hardware setups for EMS tests.....	347
4.7.3.1	EMS - Bulk Current Injection (conducted).....	350
4.7.3.2	EMS - CDN / EM Clamp (conducted).....	352
4.7.3.3	EMS - Antenna Port (conducted).....	354
4.7.3.4	EMS - Anechoic Chamber (radiated).....	355
4.7.3.5	EMS - TEM Waveguides (radiated).....	357
4.7.3.6	EMS - Reverberation Chamber (radiated).....	359
4.8	Device List.....	362
4.8.1	Action buttons in the Device List.....	366
4.8.2	Device properties.....	377
4.8.3	Common device properties.....	379
4.8.3.1	General properties.....	379
4.8.3.2	Connection properties.....	382
4.8.3.3	Configuration properties.....	386

4.8.4	Amplifier.....	389
4.8.4.1	RF Parameters.....	391
4.8.4.2	Power Correction.....	392
4.8.4.3	Band Selection.....	394
4.8.4.4	Notifications.....	394
4.8.4.5	Functional Check.....	395
4.8.5	Antenna.....	395
4.8.5.1	Type.....	396
4.8.5.2	Measurement Correction.....	397
4.8.5.3	Tower Control.....	398
4.8.5.4	Antenna Selection.....	399
4.8.6	Antenna Tower.....	400
4.8.6.1	Details.....	401
4.8.6.2	Functional Check.....	402
4.8.7	Audio Analyzer.....	402
4.8.7.1	Functional Check.....	403
4.8.8	Field Probe.....	409
4.8.8.1	Parameters.....	410
4.8.8.2	Measurement Correction.....	410
4.8.8.3	Functional Check.....	412
4.8.9	Generator.....	413
4.8.9.1	Details.....	414
4.8.9.2	File Management.....	414
4.8.9.3	Functional Check.....	414
4.8.10	Generic Inserter.....	415
4.8.10.1	Data Configuration.....	415
4.8.10.2	Functional Check.....	416
4.8.11	Interlock Monitoring.....	417
4.8.11.1	Module Configuration.....	417
4.8.11.2	Functional Check.....	418
4.8.12	IO Device.....	418
4.8.12.1	Functional Check.....	419
4.8.13	LISN.....	420

4.8.13.1	Details.....	423
4.8.13.2	Measurement Correction.....	425
4.8.13.3	Functional Check.....	426
4.8.14	Monitoring.....	426
4.8.14.1	Device Programming.....	428
4.8.14.2	Measurement Result Queries.....	429
4.8.14.3	Functional Check.....	429
4.8.15	Network Analyzer.....	431
4.8.16	Oscilloscope.....	431
4.8.16.1	Functional Check.....	432
4.8.17	Positioner.....	435
4.8.17.1	Details.....	436
4.8.17.2	Position.....	437
4.8.17.3	Extended Connection.....	438
4.8.17.4	Functional Check.....	438
4.8.18	Power Meter.....	440
4.8.18.1	Details.....	441
4.8.18.2	Functional Check.....	441
4.8.19	Radio Communication Tester.....	443
4.8.19.1	Extended Connection.....	444
4.8.19.2	Functional Check.....	444
4.8.20	Receiver.....	468
4.8.20.1	Details.....	469
4.8.20.2	Functional Check.....	470
4.8.21	Remote Action.....	471
4.8.21.1	Functional Check.....	471
4.8.22	Signal Path.....	471
4.8.22.1	Measurement Correction.....	472
4.8.23	Sidebar.....	473
4.8.23.1	Details.....	473
4.8.23.2	Functional Check.....	474
4.8.24	Switch Unit.....	475
4.8.24.1	Details.....	477

4.8.24.2	Functional Check.....	478
4.8.25	System Control.....	479
4.8.25.1	Switching.....	479
4.8.25.2	Generic Inserter.....	480
4.8.25.3	Functional Check.....	480
4.8.26	TEM Waveguide.....	480
4.8.26.1	Details.....	481
4.8.26.2	Type.....	481
4.8.26.3	Measurement Correction.....	482
4.8.26.4	Functional Check.....	484
4.8.27	Transducer.....	485
4.8.27.1	Transducer Type.....	486
4.8.27.2	Measurement Correction.....	487
4.8.28	Triple Loop.....	488
4.8.28.1	Details.....	489
4.8.28.2	Measurement Correction.....	490
4.8.28.3	Functional Check.....	491
4.8.29	Turntable.....	491
4.8.29.1	Details.....	492
4.8.29.2	Functional Check.....	494
4.9	Tables.....	494
4.9.1	Limit Lines.....	497
4.9.2	Attenuation.....	500
4.9.3	Amplifier Gain.....	501
4.9.4	Frequency List.....	502
4.9.5	Transducer Correction.....	502
4.9.6	Linearity.....	504
4.9.7	Normalization.....	505
4.9.8	Reference Calibration.....	505
4.10	Tools.....	507
4.10.1	Export.....	507
4.10.2	Import.....	508
4.10.3	Configuration Wizard.....	510

4.10.4	Unit Converter.....	511
4.10.5	Table Merge.....	511
4.10.5.1	Table conversion formula.....	514
4.11	Archive.....	515
4.11.1	EUT.....	515
4.11.2	Test.....	517
4.12	Administration.....	517
4.12.1	Data Management.....	518
4.12.1.1	Backup.....	518
4.12.1.2	Database.....	522
4.12.1.3	Server Admin.....	525
4.12.1.4	Test Site.....	527
4.12.2	Device Files.....	528
4.12.3	Test Automation.....	531
4.12.4	License Management.....	532
4.12.5	User Admin.....	538
4.12.5.1	Users.....	539
4.12.5.2	Roles & Permissions.....	540
4.12.5.3	Groups.....	541
4.12.6	Settings.....	543
4.12.6.1	General.....	543
4.12.6.2	EUT.....	545
4.12.6.3	Test.....	546
4.12.6.4	Graphics.....	547
4.12.6.5	Report.....	550
4.12.6.6	Log.....	555
4.12.6.7	External Mixer.....	556
5	Measurement basics.....	560
5.1	Fundamental principles.....	560
5.2	Test matrix.....	560
5.3	Detectors.....	562
5.4	Attenuation in signal paths.....	564
5.4.1	EMI measurement correction.....	565

5.4.2	EMS power correction.....	566
6	Special software features.....	569
6.1	Handling changed items.....	569
6.2	Dashboard search.....	569
6.3	Searches.....	570
6.4	Arranging elements in tests.....	573
6.4.1	Charts and tables.....	573
6.4.2	Dialogs.....	574
6.4.3	Cross icons.....	575
6.5	Keyboard shortcuts.....	576
6.6	Creating customized reports.....	577
6.7	Data exchange.....	585
6.8	Remote control.....	591
7	Running tests.....	592
7.1	Calibration measurements.....	593
7.2	EMI tests.....	594
7.2.1	Automated measurement for EMI tests.....	596
7.2.2	Interactive measurement for EMI tests.....	596
7.3	EMS tests.....	597
7.3.1	Automated measurement for EMS tests.....	599
7.3.2	Interactive measurement for EMS tests.....	599
7.4	Using the test control elements.....	600
7.4.1	Test control top menu.....	600
7.4.2	Test control toolbar.....	602
7.4.3	Test Components.....	606
7.4.3.1	Attachments.....	610
7.4.4	Measurement Flow Control.....	611
7.4.5	Accessories.....	612
7.4.5.1	Antenna.....	612
7.4.5.2	LISN.....	613
7.4.5.3	Positioner.....	613
7.4.5.4	Slidebar.....	614
7.4.5.5	TEM Waveguide.....	615

7.4.5.6	Triple Loop.....	616
7.4.5.7	Turntable.....	616
7.4.6	EUT Failure Mode Analysis.....	617
7.4.7	Frequency Control.....	619
7.4.8	Parameter.....	622
7.4.9	Measurements.....	623
7.4.10	Evaluation Control.....	624
7.4.11	Calibration Control.....	625
7.4.12	EMS Test Generator.....	626
7.4.13	Uniformity Evaluation.....	626
7.4.14	Test Validation.....	627
7.5	Test result tables.....	628
7.5.1	Merged overview results.....	630
7.5.2	Editing critical points.....	631
7.5.3	Margin.....	631
7.6	Test result graphics.....	632
7.7	EMI test result evaluation.....	633
7.7.1	Evaluation - 3D Evaluation.....	634
7.7.2	Evaluation - Subrange Maxima.....	638
7.7.3	Evaluation - Subrange Minima.....	638
7.7.4	Evaluation - Peak Search.....	639
7.7.5	Evaluation - Acceptance Analysis.....	640
7.7.6	Evaluation - Maxima Limitation.....	641
7.7.7	Evaluation - Limit and Margin.....	642
7.7.8	Evaluation - Merge Results.....	642
7.7.9	Evaluation - Max-Hold.....	643
8	Calibration measurements.....	645
8.1	Signal path calibration.....	646
8.1.1	Attenuation relative.....	647
8.1.2	Attenuation absolute.....	648
8.1.3	Signal path.....	650
8.2	Transducer calibration.....	652
8.3	Reference calibration of a CDN.....	652

8.4	Reference calibration with constant field strength.....	654
8.5	Field uniformity measurement with constant power.....	655
8.6	Field uniformity evaluation.....	657
9	Measurement examples.....	663
10	How to use the software.....	668
10.1	Notes for EMI tests.....	668
10.1.1	Find and analyze EMC emissions.....	668
10.2	Notes for EMS tests.....	669
10.2.1	Using detectors and modulation in EMS tests.....	669
10.3	Determination of a monitoring clamp transducer table.....	670
11	Getting help.....	675
11.1	Embedded help.....	675
11.2	Log information.....	677
11.3	VISA trace tool.....	678
11.4	Troubleshooting information.....	679
11.5	Product information.....	681
11.6	R&S ELEKTRA on the internet.....	683
11.7	Support.....	683
11.7.1	Contacting customer support.....	683
11.8	Training.....	684
	Glossary: Frequently Used Terms and Abbreviations.....	685
	Index.....	697

1 Welcome

R&S ELEKTRA is the Rohde & Schwarz system software for **electromagnetic compatibility (EMC)** measurements, comprising **electromagnetic interference tests (EMI, or "emission")** and **electromagnetic susceptibility tests (EMS, or "immunity")**.

This chapter introduces key features of the EMI Test Software, refers to the applicable test standards and provides an overview of the available documentation.

- [Key features](#)..... 13
- [EMC standards](#)..... 14
- [Documentation overview](#)..... 17

1.1 Key features

R&S ELEKTRA is optimized for 64-bit Microsoft Windows operating systems, especially Windows 10 or later versions.

It is designed to act as a virtual instrument with different access levels, for example for unskilled operators or for system administrators.

The software combines the convenience of an intuitive graphical user interface with maximum flexibility. It includes touchscreen and remote operation, both for controlling test instrumentation and for running EMC tests.

R&S ELEKTRA provides high measurement speeds by using multi-threading technology. Enhanced data transfer with next generation EMI receivers enables handling the extended data volume of those receivers.

This performance allows test preparation, measurement and reporting in parallel. A new device driver concept supports more interfaces, including possibilities to interact with third-party hardware and software.

Among others, R&S ELEKTRA provides the following key features:

- Graphical user interface (GUI) with optional [Touch operation](#)
- Template-based test preparation, measurement and report generation
- EUT-related storage of test results
- Simple selection of test templates, tables and devices, supported by an advanced search functionality
- Remote access to devices via VISA interface using LAN, GPIB or USB
- Dynamic application extensions and device drivers
- Automated device search dialog
- Compatible with international harmonized EMC standards, guidelines & directives
- Enhanced usability for beginners and customer-specific solutions

R&S ELEKTRA is available in modular options for EMI and EMS, each in an "essential", "advanced" or "systems" version, respectively. This manual describes all supported types of measurement. If you have not installed the applicable option, skip that description.



Screenshots

Sample screenshots in this documentation are used to illustrate as much as possible of the functions provided by R&S ELEKTRA and of potential interdependencies between parameters. Note that:

- Values in these screenshots do **not** necessarily represent realistic test situations.
- The values must not at all be considered as recommended by Rohde & Schwarz.
- The screenshots usually show a fully equipped software platform with all options installed. The availability of these functions depends on your particular equipment and configuration.

1.2 EMC standards

R&S ELEKTRA enables measuring electromagnetic compatibility in compliance with all relevant EMC standards worldwide. For the currently supported standards, refer to the specifications.

It is not within the scope of this manual to reproduce those standards. Instead, obtain original information on the various standards, directives, rules, regulations, proceedings and associated publications, for example at the following websites:

- [CISPR / IEC / ISO](#) (international)
- [EN / CENELEC / ETSI](#) (Europe), [FCC / CFR](#) (USA), [CCC](#) (China), ...
- [MIL-STD / EDSTAR / VG](#) (search title "EMV") / [DEF STAN / GAM](#) (military)
- [RTCA](#) (aviation / airborne), [BSI](#) (wind turbines), [DIN](#) (special interest), ...

Among the standards listed above, CISPR (or the equivalent EN standards in Europe, see [Table 1-1](#)) are especially relevant for commercial applications. The US standard MIL-STD-461 is pivotal for military and aerospace applications (see [Table 1-2](#)).

Table 1-1: Overview of CISPR / EN standards for test applications

Publication	Description
CISPR 10	CISPR organization, rules and procedures
CISPR 11, EN 55011	Industrial, scientific and medical (ISM) equipment containing a radio-frequency generator: <i>Emission</i>
CISPR 12, EN 55012	Vehicles, motor boats and internal combustion engines: <i>Emission</i> - protection of off -board receivers
CISPR 13, EN 55013	Sound / television broadcast receivers and associated equipment: <i>Emission</i> (see CISPR 32)
CISPR 14-1, EN 55014-1	Household appliances, portable electrical tools and similar apparatus, part 1: <i>Emission</i>
CISPR 14-2, EN 55014-2	Household appliances, portable electrical tools and similar apparatus, part 2: <i>Immunity</i>
CISPR 15, EN 55015	Electrical lighting and similar equipment, for example fluorescent lamps: <i>Emission</i>

Publication	Description
CISPR 16-1, EN 55016-1	<i>Specification</i> for EMI/EMS measurement apparatus and methods, part 1: <i>Apparatus</i>
CISPR 16-2, EN 55016-2	<i>Specification</i> for EMI/EMS measurement apparatus and methods, part 2: <i>Methods</i>
CISPR 16-3, EN 55016-3	<i>Specification</i> for EMI/EMS measurement apparatus and methods, part 3: <i>Reports</i>
CISPR 16-4, EN 55016-4	<i>Specification</i> for EMI/EMS measurement apparatus and methods, part 4: <i>Uncertainties</i>
CISPR 17, EN 55017	Measurement methods for the characteristics of suppression components, for example passive radio interference filters
CISPR 18, EN 55018	Overhead power lines and high-voltage equipment: <i>Emission</i>
CISPR 20, EN 55020	Sound / television broadcast receivers and associated equipment: <i>Immunity</i>
CISPR 22, EN 55022	Information technology equipment (ITE): <i>Emission</i> (see CISPR 32)
CISPR 24, EN 55024	Information technology equipment (ITE): <i>Immunity</i>
CISPR 25, EN 55025	Vehicles, motor boats and internal combustion engines: <i>Emission</i> - protection of on -board receivers
CISPR 28	Industrial, scientific and medical (ISM) equipment containing a radio-frequency generator: <i>Emission within ITU bands</i>
CISPR 29	Electronic control gear for fluorescent lamps and discharge lamps
CISPR 32, EN 55032	Multimedia equipment: <i>Emission</i> (replaced CISPR 13, CISPR 22 and EN 55103-1 on 5 March 2017, transition period ended 5 May 2018)
CISPR 35, EN 55035	Multimedia equipment: <i>Immunity</i> (published in August 2016, replacing CISPR 20 and CISPR 24, transition period until 2021)
CISPR 36, EN 55036	Electric and hybrid electric road vehicles: <i>Emission</i> - protection of off -board receivers below 30 MHz

Detailed [guidance](#) for users of the [CISPR standards](#) can be found on the internet.

R&S ELEKTRA supports you in complying with international standards for EMC testing and measurement techniques, for example EN/IEC 61000-4-3 (radiated susceptibility) and EN/IEC 61000-4-6 (conducted susceptibility), as described in the R&S ELEKTRA [EMC product brochure](#).

In contrast with civilian applications, testing to MIL-STD-461 is more expensive due to wider frequency ranges, higher EMS power levels, lower limits and the required higher sensitivity. It is typically also used for aerospace applications.

Table 1-2: Overview of MIL-STD-461

Test type	Requirement	Description
Conducted emission	CE101	Power leads, 30 Hz to 10 kHz
	CE102	Power leads, 10 kHz to 10 MHz
	CE106	Antenna terminal, 10 kHz to 40 GHz
Conducted susceptibility	CS101	Power leads, 30 Hz to 150 kHz
	CS103	Antenna port, intermodulation, 15 kHz to 10 GHz
	CS104	Antenna port, rejection of undesired signals, 30 Hz to 20 GHz
	CS105	Antenna port, cross-modulation, 30 Hz to 20 GHz
	CS106	Transients, power leads
	CS109	Structure current, 60 Hz to 100 kHz
	CS114	Bulk cable injection, 10 kHz to 200 MHz
	CS115	Bulk cable injection, impulse excitation
	CS116	Damped sinusoidal transients, cables and power leads, 10 kHz to 100 MHz
Radiated emission	RE101	Magnetic field, 30 Hz to 100 kHz
	RE102	Electric field, 10 kHz to 18 GHz
	RE103	Antenna spurious and harmonic outputs, 10 kHz to 40 GHz
Radiated susceptibility	RS101	Magnetic field, 30 Hz to 100 kHz
	RS103	Electric field, 2 MHz to 40 GHz
	RS105	Transient electromagnetic field

The requirements (CE101 through RS105) specified in Table 1-2 are assigned to the various areas of application as shown in Table 1-3. R&S ELEKTRA supports many requirement sections with [application-specific sample data](#), for example default [test templates](#).

Table 1-3: Application areas of MIL-STD-461 requirements

Equipment installed in, on, or launched from the following platforms	Requirement applicability																	
	CE			CS									RE			RS		
	101	102	106	101	103	104	105	106	109	114	115	116	101	102	103	101	103	105
Surface ships	A	A	L	A	S	S	S	A	L	A	S	A	A	A	L	A	A	L
Submarines	A	A	L	A	S	S	S	A	L	A	S	L	A	A	L	L	A	L
Aircraft, Army & flight line	A	A	L	A	S	S	S			A	A	A	A	A	L	A	A	L
Aircraft, Navy	L	A	L	A	S	S	S			A	A	A	L	A	L	L	A	L
Aircraft, Air Force		A	L	A	S	S	S			A	A	A		A	L		A	
Space systems & launch vehicles		A	L	A	S	S	S			A	A	A		A	L		A	

Equipment installed in, on, or launched from the following platforms	Requirement applicability																	
	CE			CS									RE			RS		
	101	102	106	101	103	104	105	106	109	114	115	116	101	102	103	101	103	105
Ground, Army		A	L	A	S	S	S			A	A	A		A	L	L	A	
Ground, Navy		A	L	A	S	S	S			A	A	A		A	L	A	A	L
Ground, Air Force		A	L	A	S	S	S			A	A	A		A	L		A	

A = Applicable, **L** = Limited as specified in the individual sections of this standard, **S** = Procuring activity must be specified in procurement documentation

Table 1-4: History of MIL-STD-461 revisions

Publication	Year issued	Description
MIL-STD-461C	1986	Specific description of measurements and limits, as well as measurement equipment and methods. Note that using the most recent revision of MIL-STD-461 is not necessarily mandatory. The applicable revision is typically agreed upon in a commercial contract between producer and procuring authority.
MIL-STD-461D	1993	
MIL-STD-461E	1999	
MIL-STD-461F	2007	
MIL-STD-461G	2015	

The former MIL-STD-462D (measurement equipment and methods, issued 1993) was canceled in 1999. From then on, MIL-STD-461 is referenced, as specified above.

Besides MIL-STD-461, other US military standards exist that can be relevant for special applications, such as MIL-STD-449D, -464, -469A, -1310G, -1512, -1541A, -1542B, -1605, -1795A and -1857.

1.3 Documentation overview

This section provides an overview of the R&S ELEKTRA user documentation. Unless specified otherwise, you find the documents at:

www.rohde-schwarz.com/product/elektra

This website provides the following:

- Rohde & Schwarz contacts for information, quotes and demos
- Key facts, features and options of the software
- An overview of available software options
- [Specifications and brochures](#)
- The software's [user manuals](#)
- The current [Software](#) version, the [Release Notes and OSA](#)
- [Documents & Articles](#) like application sheets, tips and tricks
- [Video tutorials](#) and training videos
- Related products

1.3.1 User manuals and help

The user documentation is available as manuals (online format `HTML` or download format `PDF`) and as context-sensitive help in `CHM` format, embedded in the software. These documents provide explanations, step-by-step procedures, figures and examples to support you during your first experience with the software, from installation and configuration to the various EMC measurements.

Several versions of the user documentation are available:

- A *basic version* for software features with the "ELEMI-E" license, alone
 - User manual, available at www.rohde-schwarz.com/manual/elektra-emc
 - Embedded help, available in the software via the [F1] key
- A *main version* for software features with all available [licenses](#), except the "ELEMI-T" license
 - User manual, available at www.rohde-schwarz.com/manual/elektra-emc
 - Embedded help, available in the software via the [F1] key

The R&S ELEKTRA installer also saves the manuals in `PDF` format on your computer in the following directory:

```
C:\Program Files\Rohde-Schwarz\ELEKTRA\x.xx\Documentation
```

1.3.2 Specifications and brochures

The specifications document, also called data sheet, contains the technical specifications of the software. The brochure provides an overview of the software and deals with its specific characteristics.

See www.rohde-schwarz.com/brochure-datasheet/elektra-emc

1.3.3 Release notes and open-source acknowledgment (OSA)

The release notes list new features, improvements and known issues of the current software version, and describe the software installation.

The open-source acknowledgment document provides verbatim license texts of the used open source software.

See www.rohde-schwarz.com/software/elektra-emc

The R&S ELEKTRA installer saves the release notes, the open source acknowledgment and some application notes also in the following directory on your computer:

```
C:\Program Files\Rohde-Schwarz\ELEKTRA\x.xx\Documentation
```

1.3.4 Application notes, white papers, etc.

These documents deal with special applications or background information on particular topics. The documents & articles with application sheets, tips and tricks for the software are available at:

www.rohde-schwarz.com/appnote (search for *elektra*)

www.rohde-schwarz.com/search/applications_63466.html?term=elektra

1.3.5 Video tutorials

Video tutorials and a series of training videos offer guided examples and demonstrations on using the software.

www.rohde-schwarz.com/product/elektra > R&S ELEKTRA Training Video Series

2 Software installation

This chapter contains information on how to install R&S ELEKTRA, downloaded from www.rohde-schwarz.com/software/elektra. The installation of several different versions of R&S ELEKTRA on one local computer is possible.

The software can optionally be configured for multiple **users** within a computer network. For example, dedicated permissions for different test operators facilitate the organizational separation of EMI and EMS measurements.

Existing data sets of other software packages are not affected by R&S ELEKTRA. If any version of R&S EMC32, R&S AMS32, R&S WMS32 or R&S ES-SCAN has previously been installed, it is not required to uninstall them before installing R&S ELEKTRA.

When the [System requirements](#) are provided, R&S ELEKTRA can be installed: Follow the procedure described in [Chapter 2.2, "Software installation procedure"](#), on page 21. A wizard in the setup file ELEKTRASetup_Vx.xx.exe guides the installation.

• System requirements	20
• Software installation procedure	21
• License dongle	24
• Configuration Wizard for creating basic data	28
• Language selection	31
• Migration Tool - XML data converter	32
• Network firewall settings	35
• Modify, repair or remove installation	36

2.1 System requirements

Before installing R&S ELEKTRA, make sure that the computer meets the following minimum system requirements:

- Microsoft-Windows-based PC with Intel Core i5 processor
or
Laptop / [tablet PC](#) with Intel Core i7 processor
- Clock rate: at least 2 GHz (recommended)
- Memory: >8 GByte RAM recommended
- Storage: 250 GByte hard drive, solid-state disk (SSD) recommended
Free storage: >50 GByte free drive space recommended
- Operating system (64 bit): Windows 10
- Administrator access rights (only for software installation)
- Super VGA monitor, display resolution at least 1280 x 720 pixels, 65536 colors
- USB 2.0 interface
- 100 Mbit LAN interface

If your computer does not meet these requirements, the performance of the software can be impaired.



R&S VISA for control of local area networks (LAN) is included in the installation, but you can use any VISA version already available on your computer (optionally supporting GPIB, too).



If you install the software on a tablet computer and you need more USB ports than it provides, you can connect an external USB hub that offers more USB ports.

For connecting your tablet computer to the Ethernet, consider using a wireless LAN connection (Wi-Fi).

2.2 Software installation procedure

To install the software on a local computer or in a network

1. Terminate other active programs (recommended).
If any **other instances of R&S ELEKTRA** are active, be sure to **terminate** them.
2. In your browser, navigate to www.rohde-schwarz.com/product/elektra > [Software](#).
3. Download the R&S ELEKTRA setup file.
4. Navigate to your download directory.
5. Right-click ELEKTRASetup_Vx.xx.exe
6. Select "Run as administrator".

Tip: Depending on your user-rights configuration, consider executing this whole procedure after signing into your Windows account with administrator rights, to avoid conflicts of access rights during installation. If unsure how to proceed, or if conflicts of access rights occur during installation, ask your system administrator for support.

7. Wait for the R&S ELEKTRA installation wizard to launch.
8. The wizard automatically checks the installation prerequisites:
 - Microsoft .NET Framework
 - Visual C++ 2010 SP1 Redistributable x64
 - Visual C++ 2012 Redistributable x64
 - Visual C++ 2019 Redistributable x64
 - Firebird Server 3.0 (64-bit)
 - R&S License Server
 - R&S Smart Card Minidriver
 - R&S VISA
 - VISA Shared Components

If any of these programs in the required versions are missing on the computer, the wizard installs them in a background process.

Depending on the installation environment, the wizard can bring up additional messages. In this case, proceed as indicated.

9. The installation wizard brings up the following dialog:

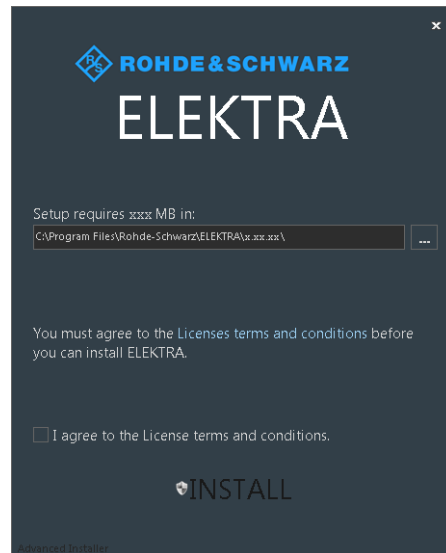

To continue the installation, the software expects you to agree to the license terms and conditions.

If you know the content and agree with it, activate the checkbox, click "INSTALL" and proceed with [step 12](#).

10. Otherwise click the link for "Licenses terms and conditions" to read them.

The following "End User License Agreement" (EULA) comes up:



If you wish to print the license text, click the printer icon on top of the text.

11. To continue the installation, select "Accept and Install".
12. Wait while the wizard executes the installation of R&S ELEKTRA:

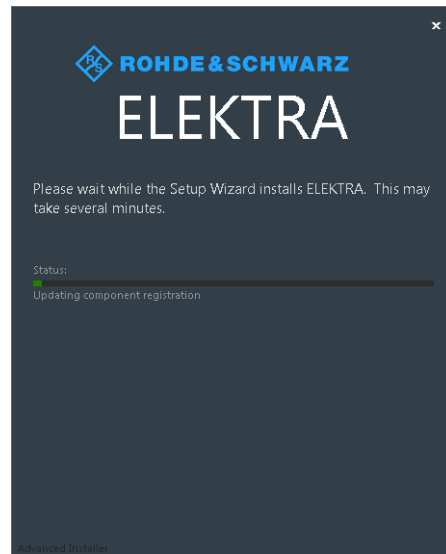

13. If the wizard finds one or more **previous** installations of R&S ELEKTRA, it prompts you with the following dialog:

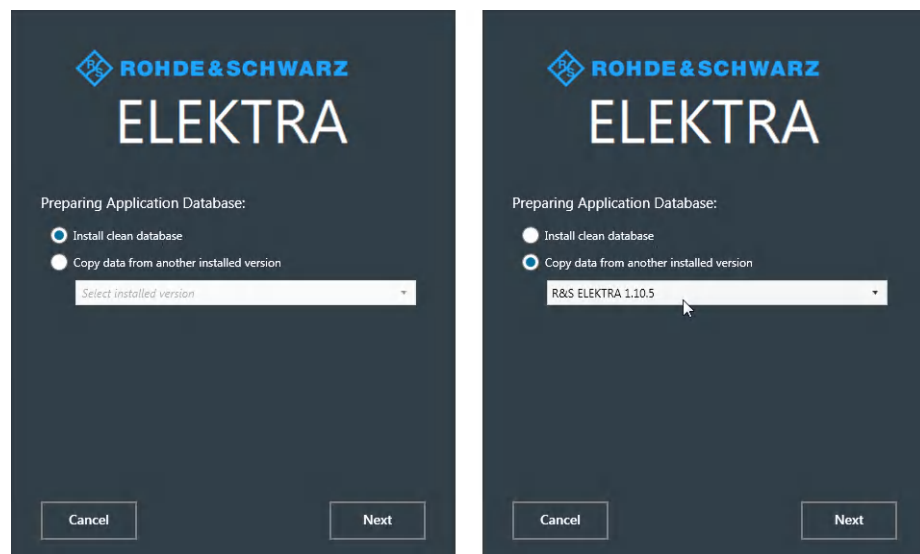
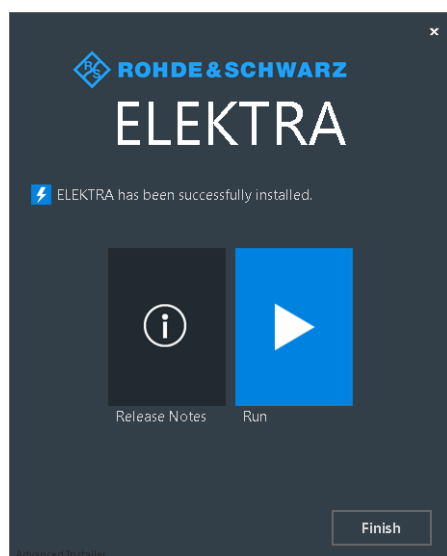

Figure 2-1: Dialog for installing a clean database (left) or copying data from an existing database

Select your preference as in the figure above.

The wizard either installs a clean new database or copies existing data into the database of your new installation.

14. Click "Next" to proceed without or with copying data from a previous database, according to your selection.
15. In the final setup dialog, select how to complete the installation:



Select one of the following actions:

- Open the "Release Notes" document.
- "Run" the software.
- "Finish" the installation.



Once the [Software installation](#) is completed, double-click the new desktop icon to start R&S ELEKTRA:

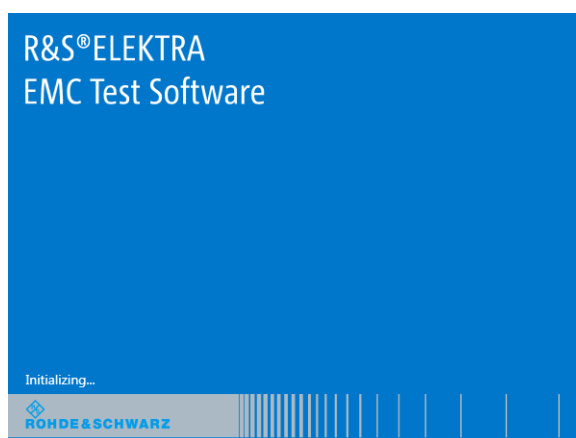

Related subject: [License dongle](#) and [User login](#).

2.3 License dongle



R&S ELEKTRA is protected by encryption. You can start the software with licenses installed only, if the **[R&S EMPCPC] license dongle** is connected to the computer. This dongle is a mini smart-card reader within a USB flash drive that contains a license smart card. It unlocks the licenses that have been activated for your R&S ELEKTRA serial number.



If your computer has a smart card reader slot, you can directly insert the license smart card into this slot, without using the dongle, as described in [Chapter 2.3.1, "Using the smart card reader"](#), on page 26.

To start R&S ELEKTRA with your set of licenses, connect the license dongle to a USB port of your computer.

If you start R&S ELEKTRA without the license dongle connected, the software can only run in demo mode. The following dialog comes up:

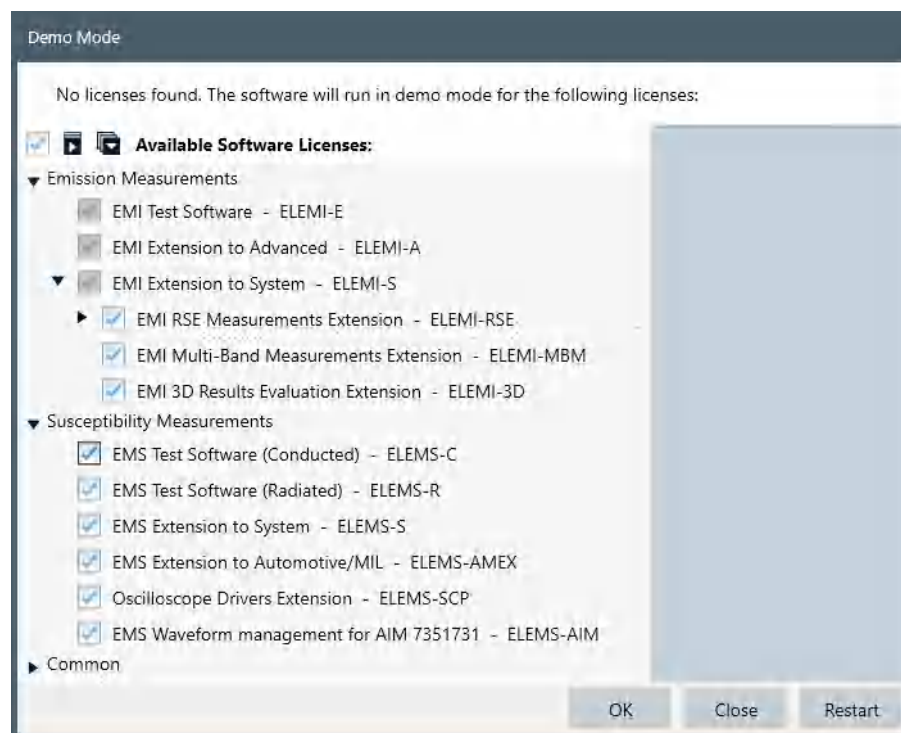

Figure 2-2: Demo mode message, if there is a missing license dongle

The "Details" section on the right side of the dialog provides information on the highlighted license.

In this dialog, you can select how to proceed:

- **Select** the demo mode [licenses](#) that you want to use
- **"OK"**: Run R&S ELEKTRA without licenses, hence, in demo mode. No physical measurements can be made, but you can execute tests with simulated data.
- **"Close"**: Shut down the software.

- **"Restart"**: Using this button is the easiest procedure, if you have not yet connected the license dongle, but the dialog just reminded you of doing it now. Insert the license dongle to a USB port of your computer, then click "Restart". The software shuts down and automatically restarts. With the license dongle connected, the "Demo Mode" dialog does not come up. Instead, the software starts with the licenses available on the dongle, see [License Management](#).

2.3.1 Using the smart card reader

The R&S ELEKTRA software requires a smart card containing the software license to be connected to the PC when you are using the software. The R&S EMPC license dongle that contains the software license consists of a smart card and a USB dongle. The smart card can be used in the supplied USB dongle or in a smart card reader. The R&S EMPC license dongle is available as a separate product and *must be ordered in addition to the software*.

You can connect the smart card in two ways.

- Connect the smart card in SIM format.
To connect the smart card in SIM format, use the USB smart card reader (dongle) provided with the smart card.
- Connect the smart card in its full format.
To connect the smart card in full format, an interface compatible to the card format is required.

The following devices are able to read the smart card in full format.

- Smart card reader integrated in a keyboard, notebook, or in a desktop PC (e.g. OMNIKEY)
- Smart card reader connected to the computer via serial bus or USB (e.g. OMNIKEY)
- USB reader connected to a LAN-to-USB converter to distribute the license via the network (e.g. DIGI AnywhereUSB/2)



Licensing support

If you have any difficulties with the licensing system, support is only assured when you are using the R&S EMPC license dongle.

Using the R&S EMPC USB smart card reader (dongle)

1. The R&S EMPC license dongle consists of a smart card in full format and a USB smart card reader (dongle).

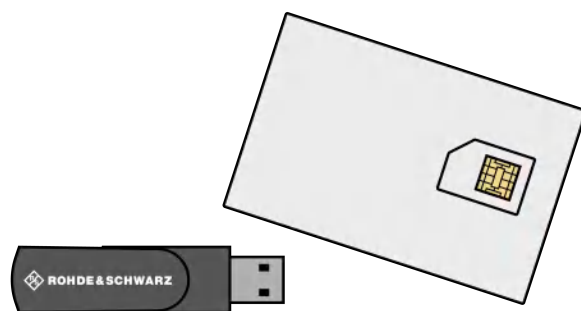

2. Break out the smart card in SIM format.

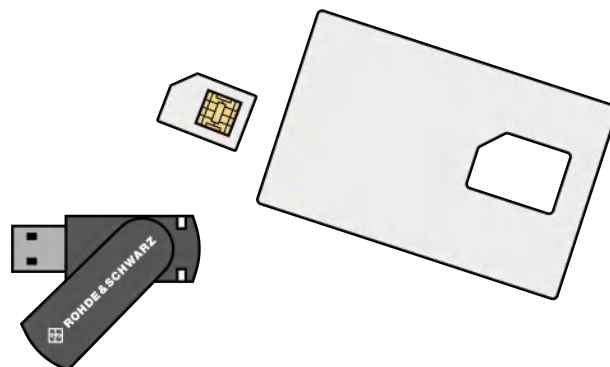

3. Twist out the upper part of the smart card reader.
4. Insert the smart card with the chip facing upwards and the angled corner facing the USB dongle, whose "Rohde & Schwarz" label is also facing upwards.

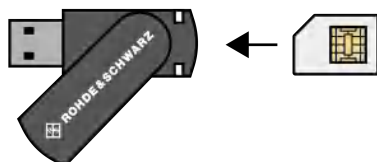

Insert the smart card as far as possible.



5. Twist the smart card reader back into its original state.



The smart card reader is ready for use on any USB interface.



Drivers

When you connect the reader to the computer, MS Windows automatically installs the necessary drivers. If not, you can install the drivers manually from the Internet site of the manufacturer at <http://support.identiv.com/ustrust-token-standard/>.

Problems during login due to smart card reader

When the smart card reader is connected, the operating system may falsely identify the smart card as a medium to perform a login procedure on the PC. In this case, the windows lock screen is displayed instead of a login window.

You can solve this issue by editing the "DisableCAD" ("Disable Ctrl-Alt-Del") registry key in the system registry. This key is located at
HKEY_LOCAL_MACHINE\SOFTWARE\Microsoft\Windows\CurrentVersion\
policies\system.



Administration rights

Security policies of your network environment might prevent you from editing the system registry or installing drivers. Contact your IT administration in that case.

To change the registry key

1. From the Windows "Start Menu", select the "Run" item.
(Windows 10: "Start > All applications > Windows System > Run")
2. Enter `regedit` in the dialog box to open the system registry.
3. Look for
HKEY_LOCAL_MACHINE\SOFTWARE\Microsoft\Windows\CurrentVersion\
policies\system.
4. Set the value of `DisableCad` to `0`.

2.4 Configuration Wizard for creating basic data



In the original delivery state of R&S ELEKTRA, the newly installed database is empty. To prepare some basic data for tests, you can run a special wizard tool at any time: The "Configuration Wizard" is designed to generate only dedicated content for your use cases, to avoid overstuffing the database with unnecessary data. Such a customer-specific software setup facilitates the process of getting started with the required EMC tests.



The content and data generated from the configuration wizard shows examples for typical cases and can differ from the actual requirement. Before executing the test, we recommend that you update the parameters accordingly to the requirement.



Avoid overstuffing the database

We recommend not to create more data than necessary. Here is one reason for limiting the number of entries that you let the wizard create: With more data subsets, **deleting** device entries from the **Device List** becomes very complex due to interdependencies between related entries. For example, test templates that have references to specific devices prevent deleting these device entries.

Instead, you can always come back to the wizard and let it create additional entries that you may require later.

Depending on your test scenarios, instruct the wizard to load sets of suitable data into the database. This data includes the appropriate limit lines, device drivers, specific test templates for the applicable standards, and the like.

The "Configuration Wizard" is available as follows:

- From any dialog, by going to "Home" > "Tools" > "Configuration Wizard".

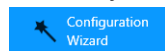

- In the **Welcome screen with configuration wizard for creating sample test data**, which is **optionally shown** on startup of the software:

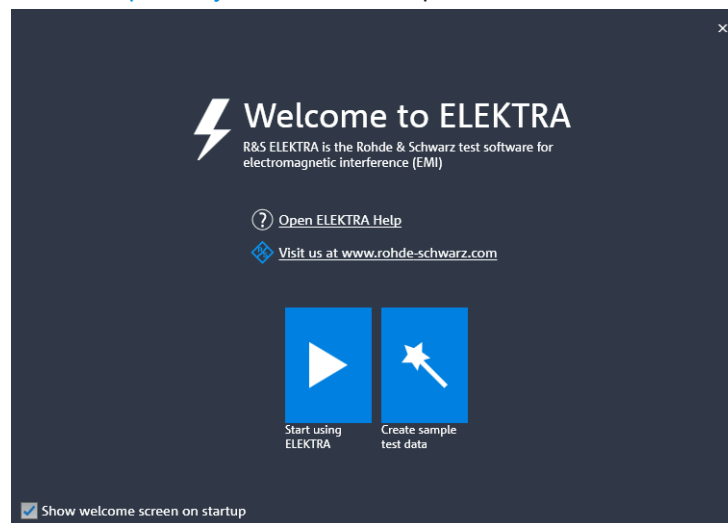
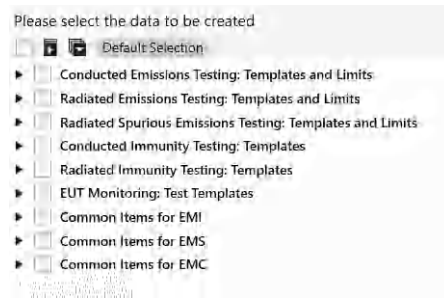

Figure 2-3: Welcome screen with configuration wizard for creating sample test data

From the welcome screen, you can skip the wizard and run R&S ELEKTRA without creating basic data, by selecting "Start using ELEKTRA". Otherwise, select "Create sample test data".

To execute the "Configuration Wizard", proceed as follows:

1. Start with the following dialog:



2. Select "All" or "Default Selection" or (recommended) exactly those data that you want the wizard to create:

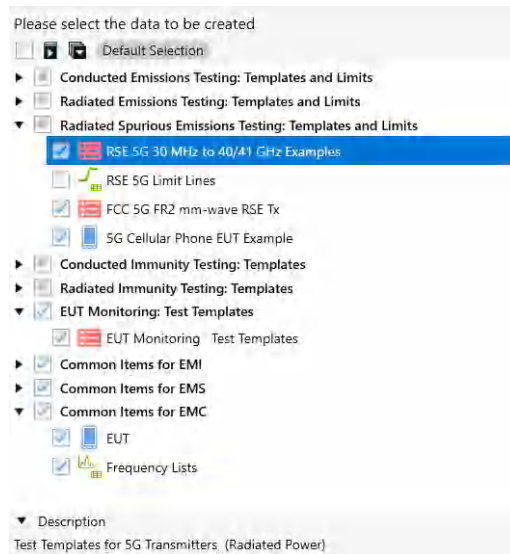

3. Click "Finish & Execute" to complete the procedure.

The wizard creates sample data:

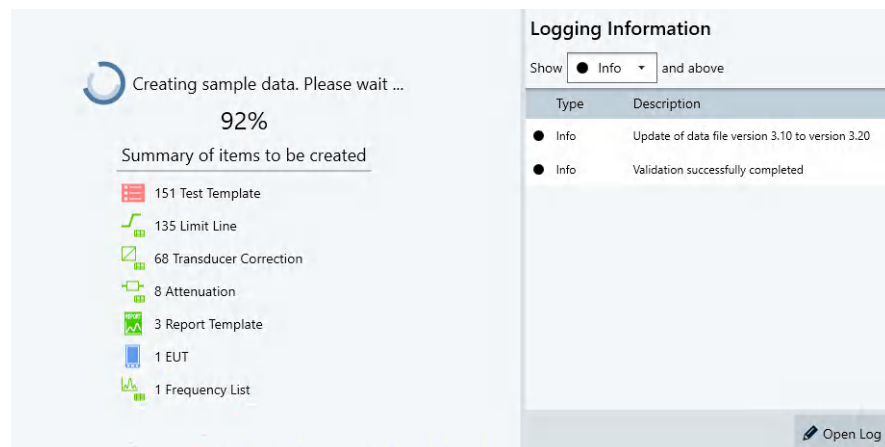

4. During the data creation, you can select which logging information is shown.
 - "Process" shows all logging information
 - "Info" shows the next higher level, only

- "Warning" shows warnings and errors, only
- "Error" shows errors, only

While the dialog is still shown, you can open the log in a viewer by clicking the "Open Log" button on the lower right. Later, you can still find it as an "Import_(...).log" file in a time-stamped subdirectory of the folder "c:\ProgramData\Rohde-Schwarz\ELEKTRA\x.xxx\Logs\...".

5. Wait for the wizard to complete the sample data creation.

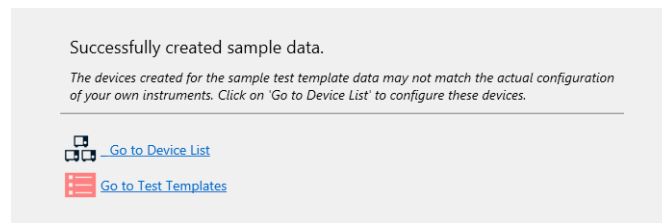

When this process is completed, R&S ELEKTRA shows the following dialog:



6. Optionally click "Log" to see information about the creation procedure.
7. Click "Go to ..." or "Done" or "Close" to leave this dialog.

2.4.1 Recovering data

If R&S ELEKTRA crashes or is shut down unexpectedly during a running test, the software automatically tries to recover data that was not saved. The restarted R&S ELEKTRA brings up a dialog that asks you how to proceed with recovered items:

-  "Keep" = recover the data (hence, save it to the database)
-  "View" = open a dialog to view, edit and save the data
-  "Discard" = delete the data (hence, the data is not recovered)



The recovery feature's auto save function is executed approximately every 5 minutes. Even if data recovery is possible, any data that was created within the last few minutes (up to 5 minutes) before the shut-down can still be lost.

2.5 Language selection

To adjust the language setting, especially when running R&S ELEKTRA for the first time, click the globe symbol and select your language:

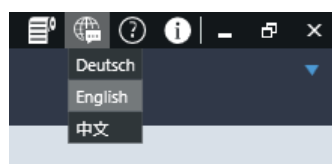

Figure 2-4: Language options are German / English / Chinese

Upon selecting a language that is different from the current setting, a dialog opens to let you decide:

- "No": The dialog closes and the software remains active with the previous language setting.
- "Yes": R&S ELEKTRA immediately shuts down and restarts to activate the new language setting.



The help content (accessible via [F1] or ) is only available in English, independent of the selected language.

2.6 Migration Tool - XML data converter

Access:

```
C:\Program Files\Rohde-Schwarz\ELEKTRA\x.xx.xx\  
ELEKTRAMigrationTool.exe
```

Or use the MS Windows "Start" button > All programs > R&S ELEKTRA > x.xx.xx > ELEKTRA x.xx.xx Migration Tool

The "ELEKTRA Migration Tool" converts data from R&S ES-SCAN or R&S EMC32 to XML data for R&S ELEKTRA.

The following subsection describes using the migration tool with R&S ELEKTRA below version 4.40. For R&S ELEKTRA **version 4.40 and above**, refer to the application note "1SL396", available at www.rohde-schwarz.com/appnote/1SL396.



To convert data from a previous version of R&S ELEKTRA to a current version, use the "Export" and "Import" functions in R&S ELEKTRA.



Previous EMC Test Software products like R&S ES-SCAN or R&S EMC32 are based on a file system that allows editing data manually. In contrast, R&S ELEKTRA is based on a database that does not permit direct user access to any data or file content. To view or modify data, always use the functions provided by the user interface of R&S ELEKTRA. For more information, see [Test container](#).

To convert data from R&S EMC32 or R&S ES-SCAN to an XML format that can be interpreted by R&S ELEKTRA, run the program `ELEKTRAMigrationTool.exe`. A two-step dialog comes up: first select the source application and then the data files and folders.

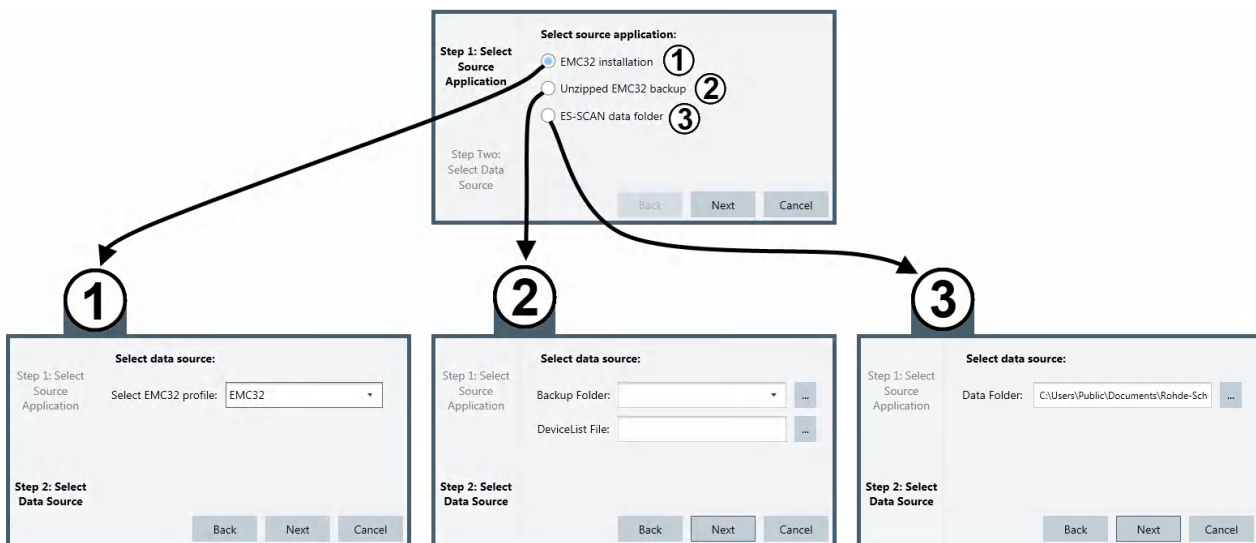

Figure 2-5: Source selection dialog (Step One & Step Two) of the XML data converter

- 1 = Source application is "EMC32 installation"
- 2 = Source application is "Unzipped EMC32 backup"
- 3 = Source application is "ES-Scan data folder"

In "Step One" of the source selection (upper dialog window in [Figure 2-5](#)), specify the type of source application.

In "Step Two" of the source selection (lower dialog windows in [Figure 2-5](#)), select the folders or data files.



Make sure that the `C:\ProgramData` folder, which contains the data files, is not hidden. To do so, verify the folder properties in Windows Explorer: If the folder has the attribute "hidden", uncheck this attribute.

- Case (1) in [Figure 2-5](#): If the source application is an "EMC32 installation", select "EMC32" and click "Next".
- Case (2) in [Figure 2-5](#): If the source application is an "Unzipped EMC32 backup", first extract the folders from the ZIP file that was created during the R&S EMC32 backup. Then select the backup folder (for example `C:\ProgramData\EMC32\Data\Backup\Unzipped`) and the device list file (for example `C:\ProgramData\EMC32\Configuration\EMC32.DeviceList`). Click "Next".
- Case (3) in [Figure 2-5](#): If the source application is an "ES-SCAN data folder", select a folder that contains data generated by R&S ES-SCAN. Then click "Next".

With your source data selection, R&S ELEKTRA prepares the appropriate settings in the following dialog window:

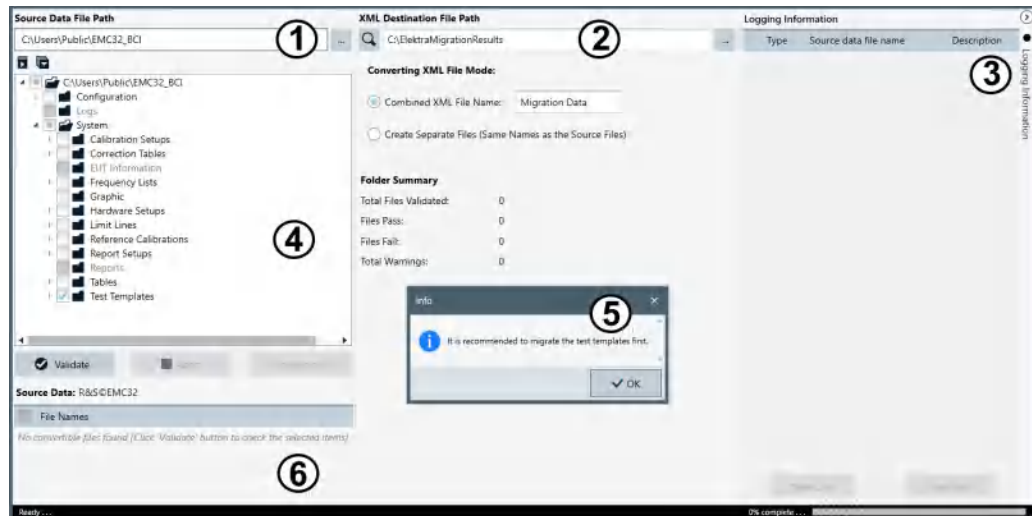

Figure 2-6: Start window of the XML converter

- 1 = Selection of "Source Data File Path"
- 2 = Selection of the "XML Destination File Path"
- 3 = Logging information (can be hidden)
- 4 = Selection of the folders with the "Source Data" files
- 5 = Recommendation pop-up message on using the migration tool
- 6 = Selection of "Source Data" files, files are available only after the "Validate" button is clicked

The following subsection describes using R&S ELEKTRA migration tool.

R&S ELEKTRA displays an information message dialog box and the following dialog window. You can start using the tool after acknowledging the information message (5).

You can select the "Source Data File Path" (1) in detail. For example, let the tool only migrate files from specific subdirectories.

By default, when converting EMC32 data, the tool selects the "Test Templates" folder automatically. When migrating a template, the migration tool also converts all relevant referenced data in the test templates, such as hardware setups, device list and correction table. Hence, we recommend that you migrate the test templates first.

When you click "Validate", the tool triggers a plausibility check for the selected items or dependent files and generates validation statuses for each data file in the selected folders. There are three validation statuses:

- Green checkmark - no errors found
The data files can be converted.
- Yellow exclamation mark - warnings found.
The data files can be converted, but requires attention, additional manual interaction or data input.
- Red exclamation mark - errors found
The data files cannot be converted.

You can also validate multiple folders.

The selections described above determine the list of "Source Data" files that are available for migration:

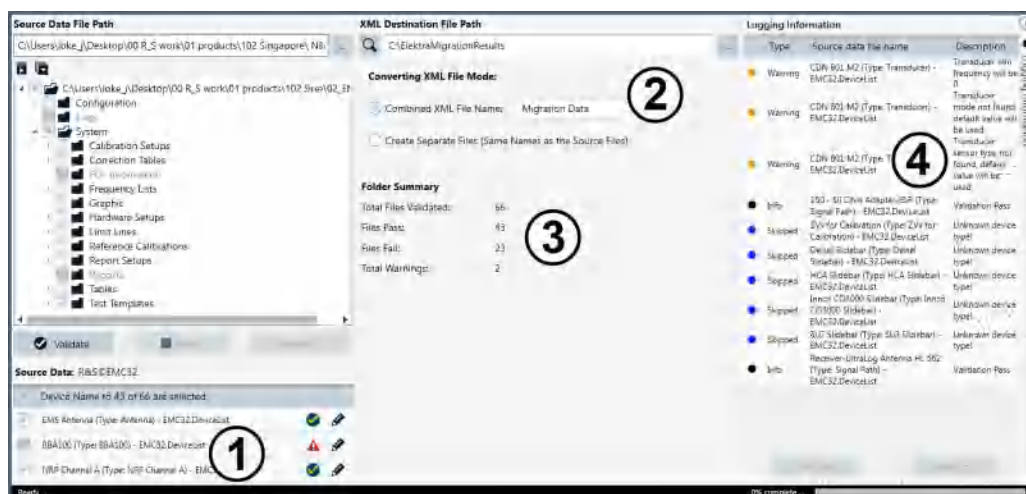

Figure 2-7: Source data selected for conversion to XML data (EMC32)

- 1 = Selection of "Source Data" files
- 2 = Selection of the "Converting XML File Mode"
- 3 = "Folder Summary"
- 4 = List of "Logging Information"

In the list of "Source Data" files (1), you can select the available files individually. In this dialog section, if you check the checkbox on top of the list, the tool selects all files that have passed validation (see sections (3) and (4) in [Figure 2-7](#)).

In section (2), specify a destination path for saving the result of the data migration. Also specify in this dialog, if you want the migration tool to create one combined XML file containing all the converted data or separate XML files.

Section (3) provides a summary of the folder's content. R&S ELEKTRA validates the available files and lists their "Logging Information" (4). It shows either "Validation Pass" or briefly describes any issues.

When the data selection, validation and destination are completed, click "Convert >>>".

The migration tool executes the XML data conversion and shows a "Conversion Report".

As a result, XML files that contain the converted data are now available for import, as described in [Chapter 4.10.2, "Import"](#), on page 508.

2.7 Network firewall settings

At some point in time, typically while configuring devices or during a first measurement, the Windows firewall system brings up the following security alert:



Tick all checkboxes to make sure that R&S ELEKTRA can communicate with devices in any kind of network. Then click "Allow access".

2.8 Modify, repair or remove installation

If R&S ELEKTRA is already installed, rerunning `ElektraSetup_Vx.xx.exe` for the same software version does not overwrite the installation, but calls up a wizard to modify, repair or remove it:

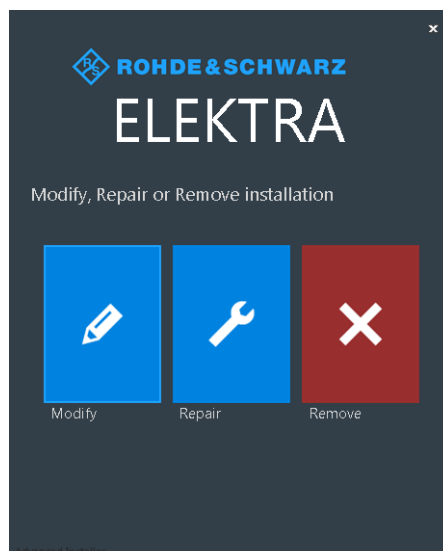

- **"Modify"** brings up a dialog for custom selection of desired components to be installed:



To execute the installation of custom selected components, click "Modify". In the next step, if the wizard finds one or more previous installations of R&S ELEKTRA, it prompts you with a dialog for handling the database of this installation:

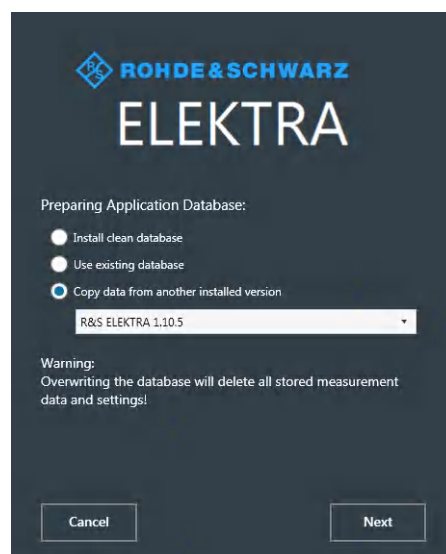

- "Install clean database" resets your database to the clean state of the first installation of this version. If you have generated data in the meanwhile, the wizard creates a [Backup](#) and then overwrites the existing database with its default ("clean") state.
- "Use existing database" leaves your current database unchanged.
- "Copy data from another installed version" lets you select the database of an older installation for overwriting your current database. If you have generated data in the meanwhile, the wizard creates a [Backup](#) and then overwrites the existing database with the selected older database.

NOTICE**Loss of settings and measurements**

If you have already generated any data in the current database (settings and measurements), you lose this data when you select "Install clean database" or "Copy data from another installed version". If you do not wish that R&S ELEKTRA overwrites any data, select "Use existing database".

- **"Repair"** brings up a dialog for running an installation repair routine:

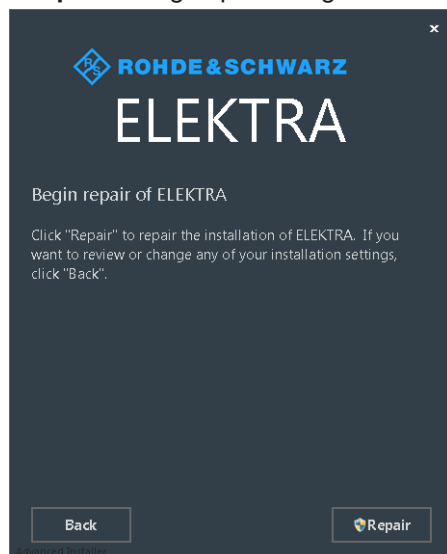

To execute the repair procedure, click "Repair". This selection leaves your current database unchanged.

- **"Remove"** brings up a dialog for removing R&S ELEKTRA from the computer:

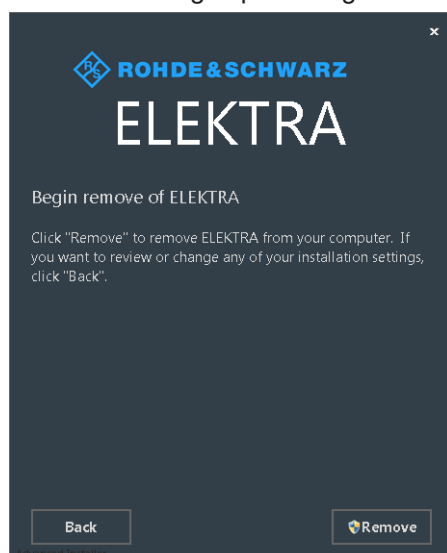

To execute the removal procedure, click "Remove".



Removing / uninstalling the software does not delete the database.

However, migrating to a different (higher) version of R&S ELEKTRA can require to copy the database of the previous (lower) version of R&S ELEKTRA, as described in [step 13](#) of the installation procedure.

Alternatively, you can [Export](#) old data and [Import](#) it into the new version of R&S ELEKTRA.

3 Getting started

This chapter guides through the basic steps of operating the software. Starting with an overview of the software structure and the user interface, it describes the test preparation, test execution, results evaluation and reporting.

Software structure overview

To understand the interaction of the main components for EMC tests in R&S ELEKTRA and their [Configuration](#), it is important to know the specific hierarchy that they follow:

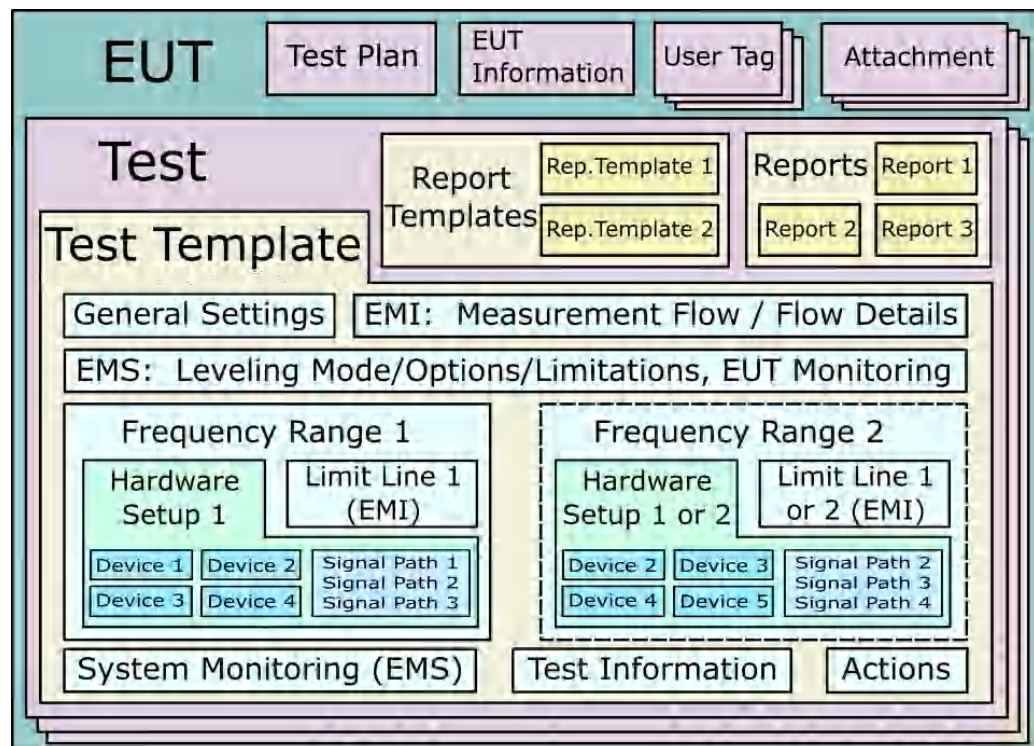

Figure 3-1: Hierarchy of main components within R&S ELEKTRA

What does this figure tell about components in the various hierarchical levels?

For example, the EUT is on the highest level of hierarchy. It can contain every other component (test plans, tests, templates, hardware setups, reports, etc.), but it cannot be contained in any of those components. The following list gives a complete overview:

- On the top level is the **EUT**, which "contains" a **test** (or several tests), a test plan, EUT information, **user tags** and attachments.
- A **test** is generated and stored in the database as a unique set of data, which is also called the **Test container**. It contains:
 - Exactly one copy of a **test template**
 - Optionally an **EUT monitoring template** (in EMS tests, only)
 - Optionally one or several **report templates** for generating an arbitrary number of **reports**, which are exclusively contained in the test

- The **test template** can be split into several **frequency ranges**, each containing:
 - A **hardware setup**
 - A **limit line** (in EMI tests, only)

Additionally, a test template can contain an **EUT monitoring template** (in EMS tests, only)

- A **hardware setup** contains *references* for the following components (jointly called devices) in the **Device List**:
 - All required **instruments** (generators, amplifiers, receivers, power meters)
 - The involved **signal paths**
 - Any **transducers** (antennas, field probes, TEM waveguides, LISNs, triple loops and other probes or transmitters)
 - Any **switch units, positioners, turntables** and **antenna towers**
 - Any **monitoring equipment** for interlocks and for the EUT



Where do the *components integrated in a Test container* come from?

Integrated components are either **newly created**, or **copies**, or **references**.

In detail:

- Those components, which are **newly created** for a test, or which are **copies** of original components in a list of items, include:
 - The **test template**
 - EUT monitoring templates
 - Report templates
 - Reports (which are, however, never copied, but always newly created out of report templates)
- Those components, which are **references**, include:
 - The one or more **Hardware Setups** within the test template
 - Limit lines within the test template

...and references that link to *items in the Device List*:

 - The instruments (test receiver or spectrum analyzer, signal generator, amplifier, power meters, etc.)
 - The signal paths
 - The transducers
 - Any switch units, positioners, turntables, antenna towers, interlocks and monitoring equipment

From [Figure 3-1](#), you can see how these components are integrated into each other on different hierarchical levels. From the note above, you can see where the components come from. To summarize this structure:

- The copy of a test template is integrated into a test, which is stored as a **Test container**.
- References for hardware setups, limit lines (or power / sensor limitations) and optionally EUT monitoring templates are integrated into the test template.

- References for the devices and signal paths are integrated into these hardware setups.
- Reports are created from report templates to compile test results. Reports are exclusively stored in the test container.
- Each saved test is integrated into the description of the EUT, for which it was executed. The EUT description can also contain optional EUT information, user tags and attachments.

For illustrative examples (EMI, EMS), see [Chapter 9, "Measurement examples"](#), on page 663.

The **configuration** of all components is described in detail in [Chapter 4, "Configuration"](#), on page 62.

The following sections explain how to get started with:

• User login	42
• Graphical user interface	43
• Common action buttons	45
• Touch operation	50
• Measurement settings	51
• Performing a test	53
• Test results	54
• Verdict	57
• Reporting	60

3.1 User login

When you start R&S ELEKTRA with your [License dongle](#) connected, and if more than the default "Admin" user (R&S ELEKTRA administrator) is defined, the following "User Login" dialog comes up:

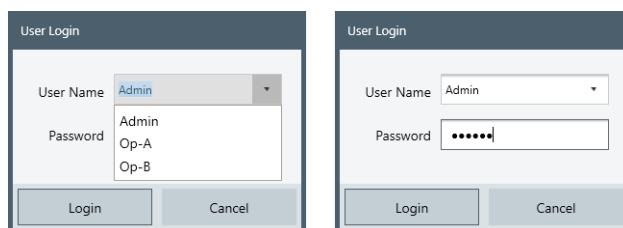

Figure 3-2: User login dialog

Left = Enter your user name or select it from a drop-down list

Right = Enter your password

- If you are the default administrator, your "User Name" is `Admin` and your "Password" is either empty or you have set it already during a previous session.
- The drop-down list (left in [Figure 3-2](#)) contains only names of users that have already logged in during a previous session. If your user name is missing in the list, typically during your 1st login, you must type it in.

- If you enter a wrong user name, the dialog displays a message: "The user name and/or password is incorrect."
- If you are no administrator but any other user of R&S ELEKTRA, get your "User Name" from an administrator. Your "Password" is either empty or you have set it already during a previous session. If you have lost your password, an administrator can reset it.

For changing your password, see ["User Information"](#) on page 64.

Each user is identified by an individual "User Name", which is assigned to a combination of roles and groups:

- The role assignment "Operator", "Expert" or "Admin" establishes specific permissions.
- The assignment to one or more groups establishes specific data access rights.

See [Figure 4-191](#) and [Chapter 4.12.5.2, "Roles & Permissions"](#), on page 540.

For example, as a member of an operator group, typically you have restrictions on modifying or deleting some basic content, such as test templates or device entries. Ask your administrator for the roles and permissions that apply to you.

3.2 Graphical user interface

R&S ELEKTRA features a graphical user interface (GUI) in a versatile design. The main dialog is the "Dashboard", which is always available via "Home" > "Dashboard" from any other dialog. The "Dashboard" dialog provides direct access to all software components.

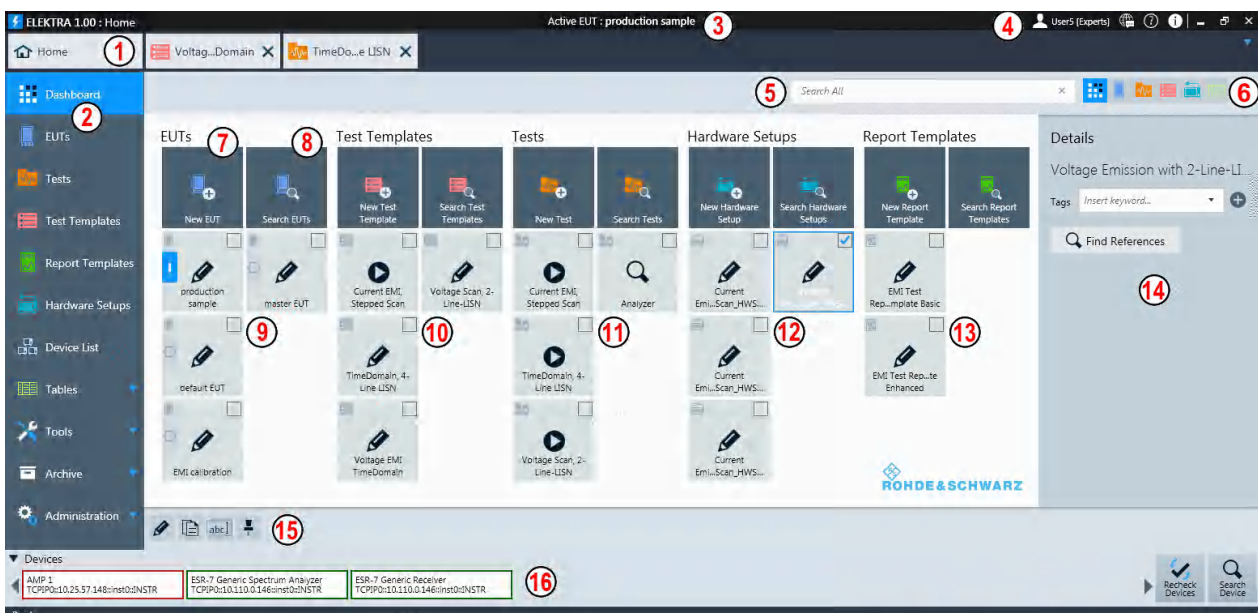

Figure 3-3: The Dashboard dialog

- 1 = Tab bar area with the "Home" button, which brings up the home menu (2) with the most recently selected dialog (here: the "Dashboard"). Next to the home button, two more tabs are available in the tab bar area in this example: a test template and a test
- 2 = [Home menu](#) with the "Dashboard" dialog currently selected (highlighted in blue). Buttons for other dialogs are below: "EUTs", "Tests", "Test Templates" etc.
- 3 = Title bar with name of the active EUT, see (9)
- 4 = Global function buttons in the title bar, see [Home menu](#)
- 5 = [Dashboard search](#) field, here with default filter for searching everywhere
- 6 = Filter buttons for the [Dashboard search](#)
- 7 = Create button (here for a new [EUT](#)). To the right: equivalent buttons for creating other items
- 8 = Search button (here for "EUTs"). To the right: equivalent buttons for searching other items
- 9 = [Pinned "EUTs"](#), with the [activated](#) EUT labeled as active
- 10 = Pinned "Test Templates", with the first one being "Pinned as New Test Direct" (for "Create test from template"), see [Creating and running tests](#)
- 11 = Pinned "Tests", with the last one being a [search result list](#) for tests with the keyword "Analyzer"
- 12 = Pinned "Hardware Setups", with the last one being selected (checkbox and blue frame)
- 13 = Pinned "Report Templates"
- 14 = Item details, shows details of the selected "Hardware Setup" (12)
- 15 = Actions bar, contains [action buttons](#) for all actions that can be executed for the selected one or more items, here a "Hardware Setup" (12)
- 16 = Device status bar, shows connectivity status of devices in the [Device List](#) and allows checking or searching for connections

The "Dashboard" dialog shown in the figure above summarizes your pinned (favorite) items in the following categories:

- "EUTs"
- "Test Templates"
- "Tests"
- "Hardware Setups"
- "Report Templates"



Instead of executing an action in the **individual** dialog of any of these items, most actions can also be executed in the "Home" > "**Dashboard**" dialog: Check an item's checkbox and click the required [action button](#).

As a prerequisite, the item must be [pinned](#) to the "Dashboard".

A pinned item can have one of the following functions:

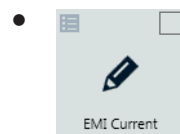

It can act as a link for **opening this item**.

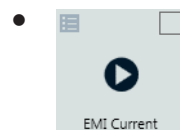

It can act as a link for **creating a test** from a test template.

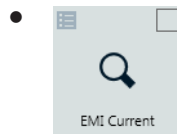

It can act as a link for **opening a pinned search**.

In the home menu (labeled (2) in [Figure 3-3](#)), below the "Dashboard" button, you have access to the following software components:

- [EUTs](#)
- [Tests](#)
- [Test Templates](#)
- [Hardware Setups](#)
- [Report Templates](#)
- [Device List](#)
- [Tables](#)
- [Tools](#)
- [Archive](#)
- [Administration](#)

For details on how to work with these components, see the chapters listed above and [Chapter 4, "Configuration"](#), on page 62 and [Chapter 6, "Special software features"](#), on page 569.

3.3 Common action buttons

This chapter describes the usage of several common action buttons that are available in many dialog windows of R&S ELEKTRA. The buttons are located in the actions bar of the [Graphical user interface](#). Some action buttons are also located directly in each row of the list of items.

The available set of buttons depends on the exact selection and type of items. An example is shown in [Figure 3-4](#):

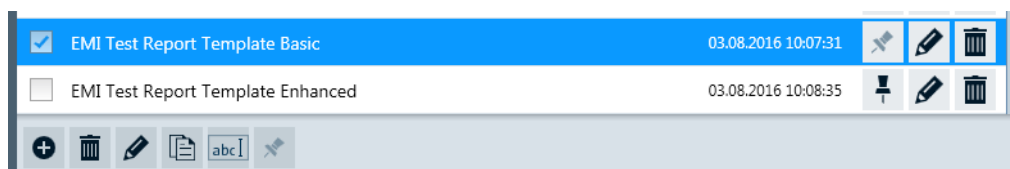

Figure 3-4: Example of some action buttons that are available for a selected report template

For details on how to handle the other, dialog-specific action buttons, see [Chapter 4, "Configuration"](#) and its subchapters:

- [Chapter 4.3, "EUTs"](#)
- [Chapter 4.4, "Tests"](#)

- [Chapter 4.5.2, "Test Templates for EMI tests"](#), especially section [Handling test template items](#)
- [Chapter 4.6, "Report Templates"](#)
- [Chapter 4.7, "Hardware Setups"](#)
- [Chapter 4.8.1, "Action buttons in the Device List"](#) (different from the action buttons described below)

Refer also to the following [Special software features](#):

- [Handling changed items](#)
- [Dashboard search](#)
- [Searches](#)
- [Arranging elements in tests](#)
- [Keyboard shortcuts](#)
- [Creating customized reports](#)



Save (in component configuration dialogs, tables and tests)

Saves the configuration that you defined, for example in a new [test template](#), or saves a completed [test](#). If you have changed any settings, you can leave but not close the dialog. To close a changed configuration dialog or an executed test, you must decide if you want to save or discard the changes or measurement results.

R&S ELEKTRA supports the shortcut key "[Ctrl + s]" for the "Save" command.



Save (in Administration settings dialogs)

Saves the changes that you made, for example at [Administration](#) > "Graphic Settings". If you leave this dialog without saving, the changes in your settings have no effect and are lost upon shutting down R&S ELEKTRA.

The shortcut key "[Ctrl + s]" is not supported.



Save As

Saves a configured component with a name that you can specify. Only available, if the component has been saved before.

R&S ELEKTRA supports the shortcut key "[F12]" for the "Save As" command in component configuration dialogs, tables and tests.



Discard all Changes

Resets your changes in a settings dialog to the previously saved values.



Reset to Default

Overwrites any changes that you made in a settings dialog with preset default values.



Select ...

To select any existing item (typically a row in a table), either directly click this item, or click the item's checkbox.

- Clicking checkboxes allows both multiple selections and unselecting items.
- To [Rename](#) an item, click the item name.



Depending on the selection and type of items, additional action buttons are displayed.

Note: For a disambiguation of the term "select", see [Select / Create New / Edit](#).



Pin to Dashboard (Edit)

Adds ("pins") the selected one or more items to the "Dashboard". Multiple selected items can be pinned simultaneously. Once pinned, the icon changes to .

For the special  version of this button, called "Pin to Dashboard (Create Test)", as opposed to , see [Handling test template items](#).

Note: Instead of pinning individual items to the "Dashboard" dialog, they can also be included there by a pinned [Search](#).

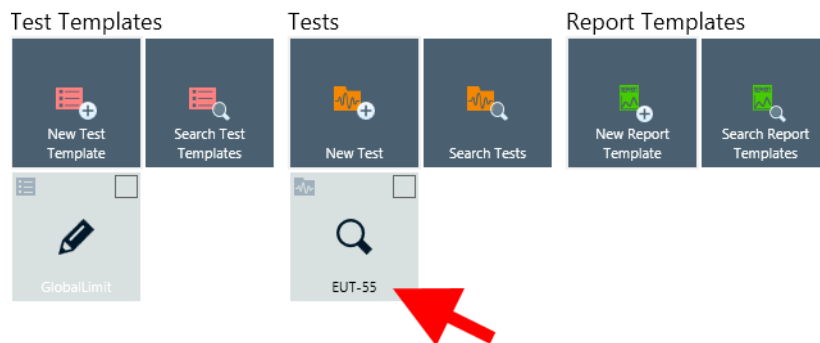





Figure 3-5: A search labeled "EUT-55" is pinned to the Dashboard

Clicking such a pinned search brings up a list of search results, see [Figure 6-2](#).



Unpin from Dashboard (Edit)

Removes ("unpins") the selected one or more items from the "Dashboard". Multiple selected items can be unpinned simultaneously. Once unpinned, the icon changes to .

For the special  version of this button, called "Unpin from Dashboard (run test)", as opposed to , see [Handling test template items](#).



Open

Click "Open" to view, configure, edit or evaluate the selected item or items. Multiple selected items can be opened simultaneously.



Delete

Click "Delete" to delete the selected item or items. Deletion is protected by the following alert: "Are you sure you want to delete the selected item(s)?"

Confirm with "OK" or "Cancel" the deletion process. Multiple selected items can be deleted simultaneously.



Create: ...

Generates a new item of a type that depends on the current dialog context. In some cases, the type of item must be selected from a list, before the dialog for specifying the new item opens. If any content in such a dialog is entered or changed, this state is marked in the dialog's tab by an asterisk (*), which disappears upon saving.

A new item must be saved to keep the entries, or it can be closed without saving to discard the entries. Closing an item without saving is protected by the following alert: "Would you like to save your changes?"

Options are "Save", "Don't Save" or "Cancel" to return to the dialog without saving.



Copy

Generates an identical copy of the selected item or items. The new copy of an item is listed with the addition "- Copy" in its name, or "- Copy (1)" etc., if previous copies exist. Multiple selected items can be copied simultaneously.



Rename

Edit the name of any single selected item. Alternatively, the name can be clicked directly to edit it:

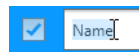

Activate

Activates the selected **EUT**. Only available, if the checkbox of one **non-activated EUT** is checked.



Archive

Only available for **EUTs** and **Tests**. Archives the selected EUT or test as described in [Chapter 4.11, "Archive"](#), on page 515.



Import ...

Only available for **Tables**. Imports a table from an external file into the R&S ELEKTRA database as described in ["Importing tables"](#) on page 496.



Select / Create New / Edit

In many cases, the button brings up a dialog for **selecting** an item. Depending on the context, you can **create** an item of the same type, **add** a device, **edit** or **rename** one of the listed items. To quit from this dialog, click "Cancel".

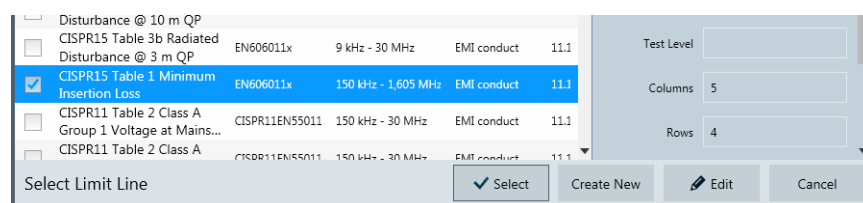

Figure 3-6: Example of selecting a limit line - with additional options Create New or Edit

Note: The term "to select" has an ambiguous meaning, illustrated in [Figure 3-6](#):

1.) The item highlighted in blue is "selected" (or marked) by clicking the checkbox or the row.



2.) To use this item in a given context, it can be "selected" (or adopted) by the "Select" button:

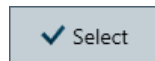

Most of the [Common action buttons](#) require to select an item in the first meaning of "marking" it, to decide what to do next with this item.

However, in the remainder of this manual, "selecting" an item typically has the second meaning of "adopting" it for further usage. For example, select a limit line to integrate it into a test template.

Details

To see information details of an item in any components dialog (for example "Home" > "Tests"), select the checkbox at the left end of the item's row. This selection brings up a "Details" list in the right part of the components dialog.

To see information details of a pinned item in the "Dashboard" dialog, select the checkbox in the top-right corner of the component's icon. This selection brings up a "Details" list in the right part of the "Dashboard" dialog.

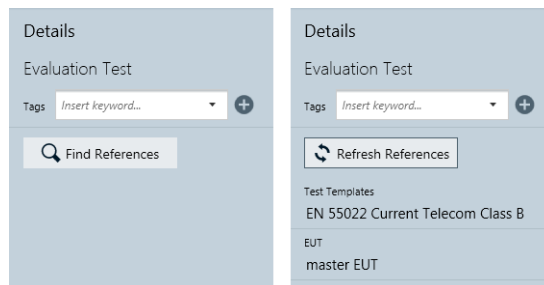

Figure 3-7: Example of a details list (here of a test), left: before searching for references, right: after

The information in the list depends on the type of the selected item and its content.

If you select more than one item, the software displays only information that is common to all selected items.

Tags ← Details

Displays user-defined "Tags" of the selected component or components. Tagging especially facilitates finding groups of components that you have labeled with the same specific tag or tags.

To add a tag to an item, select the item to display the "Details" dialog, enter the tag text and hit [Return] or click the "+" sign next to the input field.

A [search](#) cannot be tagged.

Tags are shown for selected items in the "Dashboard" and in the lists of items (for example "Tests"). Note that tags are not visible in opened items, except while using the "Save" dialog. This dialog shows tags and also allows defining new tags.

To delete a tag, click the "X" sign next to it.

Note: If R&S ELEKTRA [recovers](#) an item, for example a test or a test template, after an unexpected program shut-down, the tag "Recovered Data" is automatically added to this component.

Find References ← Details

"Find References" searches for references from the selected component to other components, which either use this component or are used by it. For example, a test can have references to a test template.

Once you have executed a search for references, the "Find References" button changes to "[Refresh References](#)", which allows repeating the search.

[Pinned "Search" items](#) do not have any references.

Note: A test is always based on a **copy** of the test template that was used to create the test. Upon test creation, this copy is integrated into the [Test container](#). Therefore, the original test template is not directly referenced in the test.

This relationship becomes obvious, for example, if you modify the original test template: the copy of this test template inside the test container remains unmodified.

Nevertheless, just **for operator orientation**, the displayed reference indicates that the test was created using this test template.

Refresh References ← Details

Repeats the [search for references](#) and displays the updated results. Refreshing can be useful, for example, after modifying a referenced item.



Collapse Content

The arrow pointing down indicates that some expanded content below the arrow can be collapsed.

Click to collapse (hence minimize) the content, for example a settings dialog or a list.



Expand Content

The arrow pointing to the right indicates that some collapsed content can be expanded.

Click to expand (hence unfold) the content, for example a settings dialog or a list.

Note: In a new test template, some dialogs cannot be expanded before selecting a hardware setup. The following dialogs are locked:

- In a new [EMI test template](#):
 - "General Settings"
 - "Measurement Flow"
 - "Actions"
- In a new [EMS test template](#):
 - "General Settings"
 - "System Monitoring"
 - "Actions"
 - "Excluded Frequency Bands"

You must select a hardware setup before you can make entries in these dialogs.

3.4 Touch operation





R&S ELEKTRA can be installed on a tablet computer (MS Windows) with a touch-sensitive display. In this case, finger-touch operation intuitively replaces conventional mouse operation of the software.

Example:

You can **zoom** a test chart in conventional mouse operation by drawing a rectangle around the area that you wish to see enlarged. On the contrary, in touch operation, you would enlarge this area by stretching the chart by a two-fingers gesture.

The following touch actions replace mouse actions:

Table 3-1: Correlation of mouse and touch actions

Mouse operation	Touch operation	Gesture icon
Click	Tap	
Double-click	Double-tap	
Click and hold	Touch and hold	
Right-click	Touch, hold for 1 second and release	
Drag-&-drop (= click and hold, then drag and release)	Touch and hold, then drag and release	
Zoom by drawing a rectangle	Two-finger zoom ("pinch to zoom")	
Mouse wheel to scroll up or down	Swiping a window area down or up	
Dragging scrollbars to scroll up or down, left or right	Swiping a window area down or up, right or left	

This manual describes all user operations as if executed with a mouse. If instead you use a tablet computer with touch operation, proceed according to the correlations given in [Table 3-1](#). Exceptions apply in those cases that are considerably different from the general correlations. In these cases, both types of operation are described.

On the tablet computer, if you select a field for keyboard input, R&S ELEKTRA automatically brings up an on-screen keyboard. If it overlaps with an input field or covers a relevant display area, undock the on-screen keyboard. Once it floats, you can move it out of the way.

3.5 Measurement settings

R&S ELEKTRA controls your test devices during EMC measurements. Some devices require dedicated measurement settings, depending on the test scenario.



Measurement settings vs. device properties

R&S ELEKTRA stores **measurement settings** in each test template, which makes these settings available in each test based on this test template. However, measurement settings can differ among your test templates, which allows adapting the settings individually (per test template) to your various testing requirements.

On the contrary, **device properties** are stored directly in the [Device List](#), which assures that these properties are globally available only once for each device. However, test templates also provide a view of the device properties. Be aware of the following: If you modify any device properties anywhere (in the device list or in a test template), these properties are changed for all instances that use this device.



Note that settings in the "Functional Check" dialogs in the device list are **no globally effective measurement settings** and do not take effect in any test templates or tests. Use these settings only for functional checks of the device.

However, for simplicity, the devices' measurement settings are described in the "Functional Check" dialogs, because you can find this place easily. It is always available in the user interface, independent of your configuration scenario.

Dialogs for specifying measurement settings

To specify measurement settings for your tests, use the following dialogs:

- **"CAL"**: in a calibration template, select (highlight) an active device, for example the generator, network analyzer, power meter, test receiver or spectrum analyzer. Then go to the [Device Settings and Properties](#) > "Settings" dialog.
- **"EMI"**: in an EMI test template, proceed as follows:
 - Select (highlight) a step in the [Measurement Flow](#), for example the "Overview Measurement" or the "Final Measurement".
 - Then go to the "Measurement Settings" dialog in the "Flow Details", see [Figure 4-53](#).
 - In a frequency range, select (highlight) an active device, for example the test receiver or spectrum analyzer.
 - Go to the [Settings \(Overview\)](#), [Settings \(Zoom\)](#) or [Settings \(Final\)](#) dialog.
- **"EMS"**: in an EMS test template, proceed as follows:
 - Select (highlight) the "Overview Measurement" in the [Measurement Flow](#).
 - Then go to the [Measurement Settings](#) dialog in the "Flow Details".
 - In a frequency range, open the [Device Settings](#) dialog.
 - Select (highlight) an active device, for example the generator, power amplifier or field probe.
 - Go to the [Device Properties](#) > "Settings" dialog.
- **"EUT Monitoring"**: in an EUT monitoring template, open the [Device Settings](#) dialog and select (highlight) the monitoring device. Then go to the [Device Properties](#) > "Settings" dialog.

3.6 Performing a test

Generally, performing EMC tests with R&S ELEKTRA involves the following steps:

1. Determining, **which EUTs** to test.
2. Creating **descriptions** for these **EUTs** in R&S ELEKTRA.
3. Determining, **which types of test** to perform, as suggested in the EUT-related **Test matrix**.
This decision leads to the applicable **EMC standards** (for example CISPR, IEC/EN, or MIL-STD-461).
4. Determining the test concept based on those standards.
5. Planning the hardware setups both for initial **calibration measurements** and for the **tests** of EUTs.
This planning leads to a list of required devices and signal paths. A wizard for **pre-configuring** entries in the software's database support you in this task.
6. Establishing a useful **data nomenclature** with speaking names for saving, e.g., limit lines **and other tables**, various templates, devices and the like.
7. Physically **setting up the hardware** for the respective measurement, and **connecting the devices** to the PC. The software requires this setup to perform the following steps:
8. Entering the measurement **devices** in R&S ELEKTRA by creating or editing entries in the **device list**. A **search function** for network devices supports you in this task. If a firewall message comes up, see **Network firewall settings**.
9. Specifying and configuring **calibration test templates** for **calibration measurements** in R&S ELEKTRA.
 - a) Calibrating **signal paths** by generating attenuation tables.
 - b) Calibrating **transducers** by generating transducer correction tables.
 - c) In case of radiated EMS tests: Generating a **uniform field** of immunity test radiation.
10. Describing and configuring the **hardware setups** for **EMC tests** in R&S ELEKTRA.
11. Creating or editing **limit lines** in R&S ELEKTRA according to the relevant standards.
12. Configuring EMI or EMS test settings in R&S ELEKTRA **test templates**.
13. Optionally creating **EUT monitoring templates** for EMS tests.
14. **Creating tests** as described in **Chapter 4.4.1, "Configuring tests"**, on page 88
15. **Running tests** as described in **Chapter 7, "Running tests"**, on page 592.

Once a test is completed, **save** it and proceed with the following steps:

- **Evaluating** the results as described in [Chapter 3.7, "Test results"](#), on page 54. R&S ELEKTRA supports you in the [EMI test result evaluation](#).
- Generating **test reports** as described in [Chapter 3.9, "Reporting"](#), on page 60.



These steps can become clearer in [Chapter 9, "Measurement examples"](#), on page 663. Or refer to a "Step by Step Guide" for R&S ELEKTRA, available on the internet at www.rohde-schwarz.com/applications (search term *elektra step*).



For compliant EMC tests, all details of the measurement procedure must be taken from the applicable [EMC standards](#). R&S ELEKTRA supports you in this task. However, it is outside of the scope of this software to ensure that all regulations from the relevant standards are properly applied. Therefore, the compliance of testing remains in your responsibility.

3.7 Test results

Once a test has been run and saved, the whole [Test container](#) with all measurement results is stored in the database. To see the test results, make sure to have the test opened.

Access: "Home" > "Tests" > "Open" > "... test"



A test can also be opened from the [EUT](#), for which it has been executed. This option facilitates direct access from an EUT to its related tests and reports.

EMI

The following first example shows an EMI test. For an EMS test example, [see below](#).

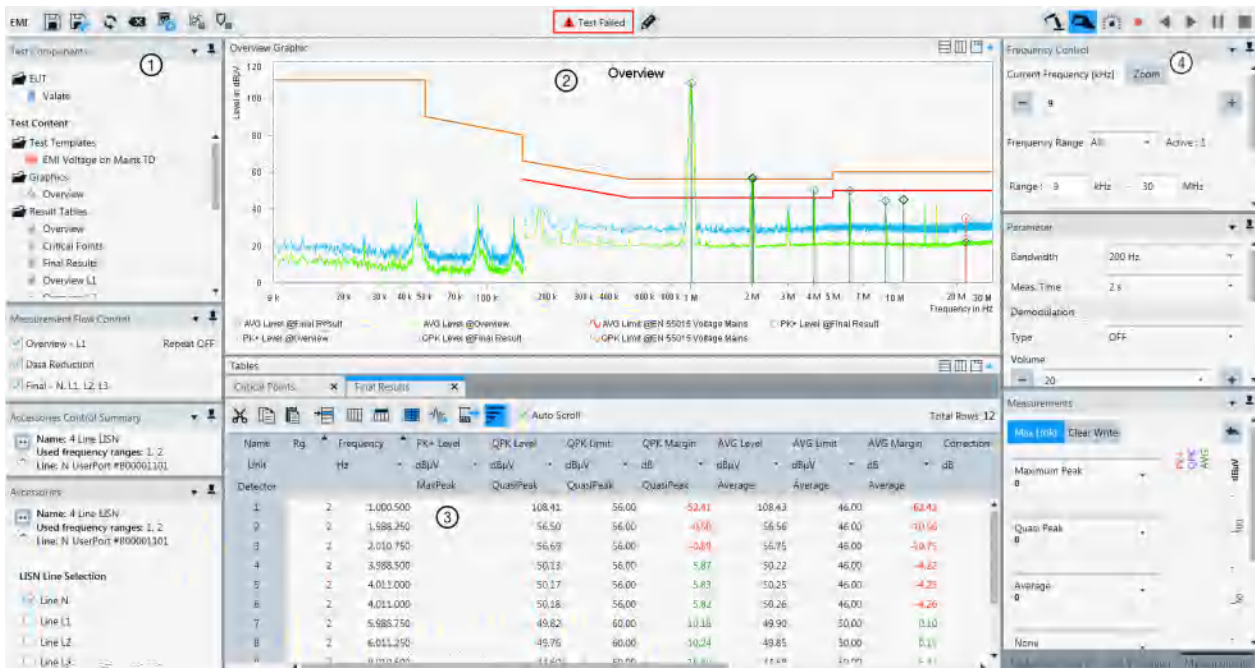

Figure 3-8: Example of a test window

- 1 = Side panels on left-hand side (see list below and [Using the test control elements](#))
- 2 = Test charts. For details on how to work with these graphics, see [Configuring test charts](#) and [Test result graphics](#)
- 3 = Test result tables. For details on how to work with these tables, see [Configuring test tables](#), and [Test result tables](#)
- 4 = Side panels on right-hand side (see list below and [Using the test control elements](#)). On the top right, find the [Test control toolbar](#)

You can use the following side panels on the left-hand and right-hand side:

- [Test Components](#)
- [Measurement Flow Control](#)
- [Accessories Control Summary](#) and [Accessories](#)
- [Frequency Control](#)
- [Parameter](#)
- [Measurements](#)
- [Evaluation Control](#)
- [Test Validation](#)



Overview of LISN results

If the transducer used in the measurement is a [LISN](#), the "Overview Graphic" and the "Overview Table" show merged maximum levels measured on any of the selected lines.

For example, consider a test template that [defines measurements](#) on lines N and L1: The overview results can comprise levels measured on line N in some parts of the frequency range and measured on line L1 in other parts of the frequency range. The "Line" column in the test table indicates, from which line the level result in each row was taken.

To see the results of an individual line, open its "Result Table" from the [Test Components](#) dialog and click the [Show Graphic Display](#) button (.



Overview of antenna results

If the transducer used in the measurement is an [Antenna](#), the "Overview Graphic" and the "Overview Table" show merged maximum levels measured at different [accessory settings](#) (if selected):

- Antenna polarization (horizontal or vertical)
- Antenna height on its [tower](#)
- EUT azimuth angle on the [turntable](#)

For example, consider a test template that [defines measurements](#) at various polarizations, antenna heights and azimuth angles: The overview results can comprise levels measured at any combination of accessory states at any frequency point. The "Polarization", "Azimuth" and "Antenna Height" columns in the test table indicate, at which accessory states the level result in each row was measured.

To see all results at each state, open the "Spectrum Overview Trace" from the [Test Components](#) dialog and click the [Show Graphic Display](#) button (.

The chart in the "Overview Graphic" and the values in the "Final Results" table represent a view of the test results. However, a complete EUT testing task typically also requires *evaluating* the measurement results. An example is finding broadband signals or specific frequencies, at which the minimum [Margin](#) between measured level and a limit line is violated. Evaluation is intended to provide crucial information (see [Verdict](#)) to decide whether an EUT conforms with a given EMC standard.

Such [evaluation](#) tasks are supported in R&S ELEKTRA by the following functions, which lead to enhanced or additional charts and tables:

- [Evaluation - Subrange Maxima](#) (see page 638)
- [Evaluation - Subrange Minima](#) (see page 638)
- [Evaluation - Peak Search](#) (see page 639)
- [Evaluation - Acceptance Analysis](#) (see page 640)
- [Evaluation - Maxima Limitation](#) (see page 641)
- [Evaluation - Limit and Margin](#) (see page 642)
- [Evaluation - Merge Results](#) (see page 642)

After having performed the required evaluation tasks, proceed with [Reporting](#).

EMS

The following example shows an EMS test. For an EMI test example, [see above](#).

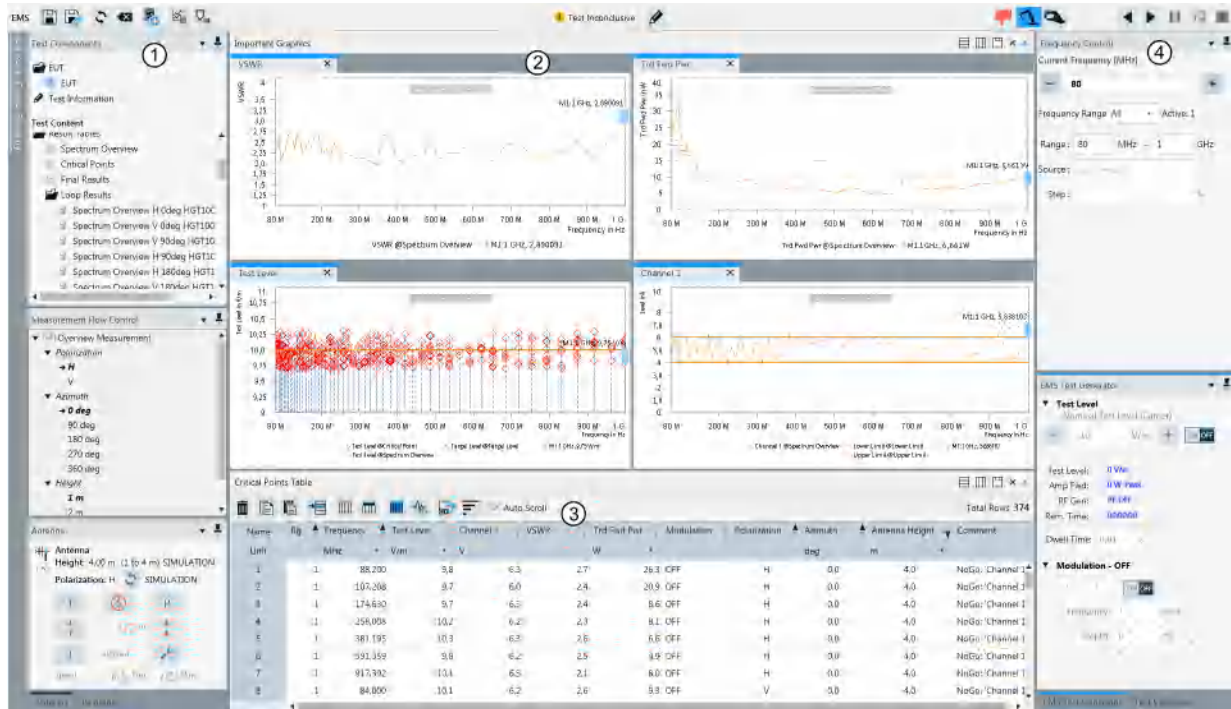

Figure 3-9: Example of a test window

- 1 = Side panels on left-hand side (see list below and [Using the test control elements](#))
- 2 = Test charts. For details on how to work with these graphics, see [Configuring test charts](#) and [Test result graphics](#)
- 3 = Test result tables. For details on how to work with these tables, see [Configuring test tables](#), and [Test result tables](#)
- 4 = Side panels on right-hand side (see list below and [Using the test control elements](#)). On the top right, find the [Test control toolbar](#)

You can use the following side panels on the left-hand and right-hand side:

- [Test Components](#)
- [Measurement Flow Control](#)
- Accessories Control Summary and [Accessories](#)
- [Frequency Control](#)
- [EMS Test Generator](#)
- [Uniformity Evaluation](#)
- [Test Validation](#)

3.8 Verdict

The "Verdict" is a label for EMC test results, which is either assigned automatically or [edited](#) manually. It can state that a test is "Failed", "Inconclusive" or "Passed":

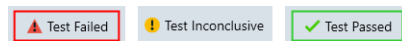

Figure 3-10: Test verdict: Failed, Inconclusive or Passed

EMI

The following rules apply for automatic verdict assignment in **EMI** tests:

- **Start condition:** A [newly created](#) or [cleared](#) test (but not a [refreshed](#) test) is set to the verdict "Inconclusive".
- **Evaluation:** R&S ELEKTRA calculates the verdict for a test, when the [automatic](#) measurement sequence is successfully completed, including the "Final Measurement".
- **Algorithm:** The verdict depends on *all margin values* in the "Final Result" table. At each frequency point, the [Margin](#) is defined as the limit line's value minus the measured level value. Hence, if the level remains below the limit, the margin is positive.

The three verdict states are derived as follows:

- Initially, or if there is a test interruption, the verdict is set to or stays **"Inconclusive"**
- If no limit line is set, the verdict stays **"Inconclusive"**
- If at least one frequency has a margin value < 0 , the verdict is **"Failed"**
- Else (hence, no margin value < 0), if at least one frequency has a margin value ≥ 0 , the verdict is **"Passed"**
- Else, if no margin values exist (for example, if the measured values are not covered by a limit line), the verdict is **"Passed"**
- **Revaluation:** If a verdict was calculated for a completed test and you manually change one or several limit lines or measurement values in the "Final Results" table, R&S ELEKTRA immediately recalculates the verdict.
- **Interruption:** If you or R&S ELEKTRA pause or suspend a test or you resume or continue it, after it was stopped by an exception, the verdict is set to **"Inconclusive"**. Note that in this situation, the software does not recalculate the verdict after operator intervention, such as changing limit lines or measurement values.
- **Limitation:** the [interactive measurements](#) and the [test result evaluation](#) have no influence on the verdict.

EMS

R&S ELEKTRA evaluates the EMS test verdict only, if the "Data Evaluation" checkbox in the [Measurement Flow](#) dialog of the [EMS test template](#) is enabled. See "[Data Evaluation](#)" on page 272.

The following rules apply for automatic verdict assignment in **EMS** tests:

- If the test is stopped, before it stops automatically after measuring at the last frequency of the last loop, R&S ELEKTRA performs no evaluation and the EMS test verdict is **"Inconclusive"**
- Else, if the software does not detect any entry in the "Critical Frequencies" table after completion of the test, the EMS test verdict is **"Passed"**

- Else, if the "Critical Frequencies" table has one or more entries after completion of the test, the EMS test verdict is **"Failed"**

3.8.1 Editing the verdict

Independent of the automatic verdict assignment, R&S ELEKTRA allows you to select the verdict manually. This feature is in accordance with your option to edit measured values, see [Chapter 7.5, "Test result tables"](#), on page 628. As an operator, you are responsible for the test results.

To select the verdict manually, click the "Edit" button (✎) next to the verdict in an opened test. The following dialog comes up:

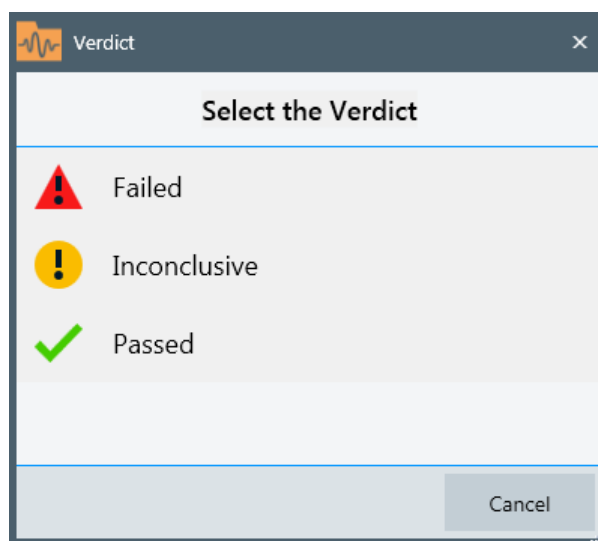

Figure 3-11: Verdict types

Click the verdict type that you wish to select. Your selection is immediately assigned to the test. To keep this change, save the test.

3.8.2 Unexpected verdict

If the verdict of an EMI test differs from what you expected from the displayed test results, the reason can be a mismatching detector setting in the limit line table.

If the [test template](#) skips the [final measurement](#), use the correct detectors in the [Overview Measurement](#). R&S ELEKTRA supports you in using the correct detector: When you disable the final measurement in the test template, the software automatically sets the final measurement detector in the overview measurement and alerts you of this setting.

3.9 Reporting

To generate a report for a completed test or to open an existing test report, first open the test.

Access: "Home" > "Tests" > "Open" "... test"

Report generation procedure



1. Click "Add Report" to create a report based on a default report template.

If you use the "Add Report" button **without** a preselected report template in the "Report Templates" folder of the "Test Components" menu, a non-preconfigured ("empty") report opens.

Also, R&S ELEKTRA adds a non-preconfigured report template to the "Report Templates" folder.

For **better** report preconfiguration, proceed as follows:

2. In the "Test Components" dialog, if the "Report Templates" folder is not yet open, click its icon to open it.
 3. Right-click the "Report Templates" folder.
A context menu opens.
 4. Select one of the following options:
 - "New Report Template" is equivalent to "Add Report" without a preselected report template.
Selecting this option immediately creates a non-preconfigured report template and a report based on it.
 - "Add global Report Template" allows selecting from a list of standard report templates.
Selecting a template adds it to the "Report Templates" folder and immediately creates a report based on this template.
 - "Add/Replace external template - Main" (*) allows selecting an **external** main report template without immediately creating a report.
 - "Add/Replace external template - Subreport" (*) allows selecting an **external** sub-report template without immediately creating a report.
- (*) external templates are available only, if you have installed and enabled the [license](#) "ELEM-REP".
5. If you have selected an option that immediately creates a report, you can modify it as described in [Chapter 4.6, "Report Templates"](#), on page 324.
 6. If you want to use external report templates, proceed as described in [Chapter 6.6, "Creating customized reports"](#), on page 577.

To update the report contents, for example, if report template components or test contents have changed since creating the report, click "Refresh" (↻) in the *top menu of the report*. Do **not** confuse this button with the taller "Refresh" button (🔄) in the *top menu of the test*.

To save a report in the R&S ELEKTRA database together with the test, select "Attach" (the paper-clip icon ). This action opens the "Reports" folder in the "Test Components" menu, where the attached report can now be seen. If the "Reports" folder is not open, click its icon to see attached reports.

Optionally, click the "Export" button  or  to save a report as a PDF or DOCX file in a selectable folder outside of the R&S ELEKTRA database.

To open a report in a separate window of a PDF file viewer program, or in Microsoft Word for DOCX, if installed, double-click the attached report in the "Test Components" menu.



Customized reports

If you have installed the [license](#) "ELEM-REP" for report customization, R&S ELEKTRA provides enhanced features for using your own external reports. See [External](#) (global settings), [Test Plan](#) and [Creating customized reports](#).

4 Configuration

R&S ELEKTRA supports the creation of user-specific test cases for custom application scenarios.

This chapter describes the configuration of the following software components:

- The [Home menu](#) - see page 62
- The [Dashboard dialog](#) - see page 65
- [EUTs](#) - see page 66
- [Tests](#) - see page 88
- [Test Templates](#) - see page 117
- [Report Templates](#) - see page 324
- [Hardware Setups](#) - see page 331
- The [Device List](#) - see page 362
(with generators, amplifiers, measuring instruments, all kinds of transducing devices, signal paths, switch units, positioning equipment and the like)
- Various [Tables](#) - see page 494

This chapter also describes the use and configuration of the following:

- [Tools](#) - see page 507
- The [Archive](#) - see page 515
- [Administrative settings](#) - see page 517

Related subjects:

- The [configuration wizard](#) is a tool for the application-specific generation of sample data and templates for tests.
- Measurement devices connected to the computer that runs R&S ELEKTRA can be automatically searched, checked and integrated into the [Device List](#).
- For an **overview** of the "Dashboard" dialog, see [Chapter 3.2, "Graphical user interface"](#), on page 43.
- For the most basic **action buttons**, see [Chapter 3.3, "Common action buttons"](#), on page 45.

4.1 Home menu

This chapter describes the configurable items in the "Home" view of the [Graphical user interface](#). You can configure settings in the dialogs of the home menu (or navigation menu, left) and in the title bar (top right).

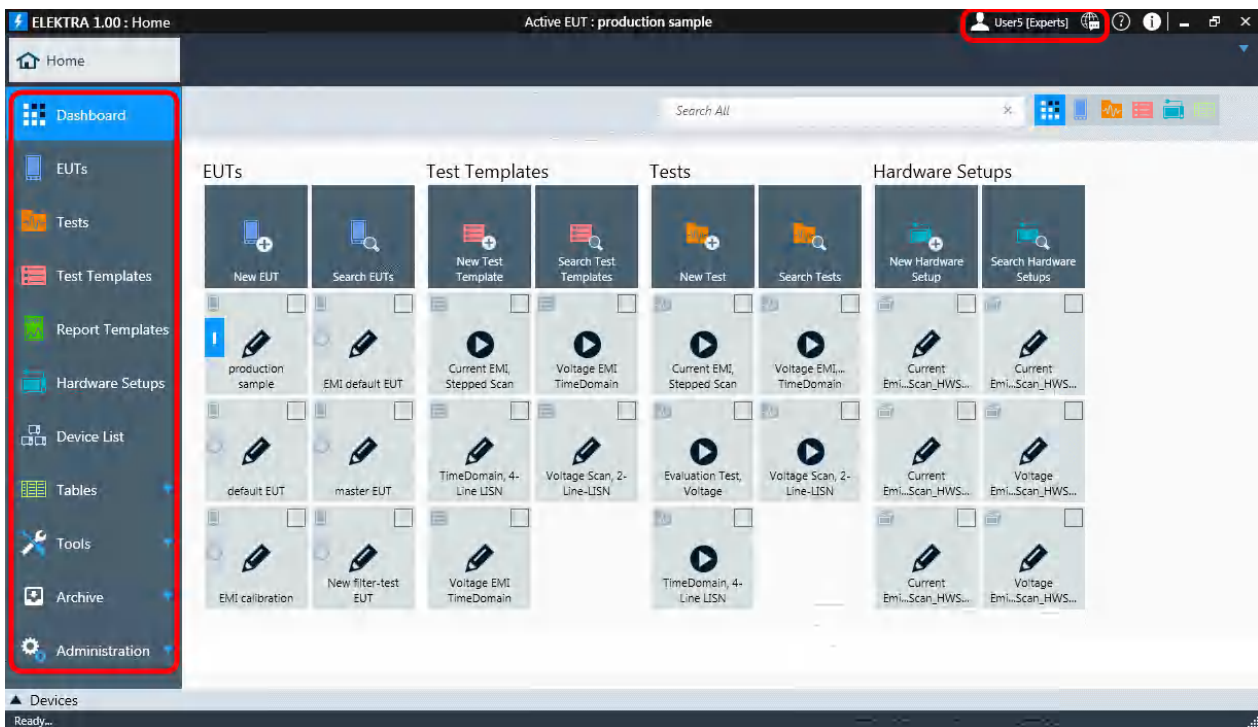



Figure 4-1: Configurable items in the home menu and in the title bar

Red frame at left hand = Configurable items in the home menu

Red frame on top right = Configurable settings in the title bar

- For a description of the configurable settings in the **title bar** (top), see below:
 - [Language selection](#)
 - [User Information](#)
- If you get a "Disabled Licenses" Disabled Licenses notification, see [Disabled Licenses](#).
- For the  button see [Embedded help](#).
- For the  button see [Product information](#).
- For a description of the configurable items in the **home menu** (left), refer to the appropriate chapter, which you can select from the overview in [Chapter 4, "Configuration"](#), on page 62.
- For a description of the dashboard search, see [Chapter 6.2, "Dashboard search"](#), on page 569.



Dashboard search



Language selection

The language selection button  in the title bar selects one of the available language options. For description of the language settings, see [Chapter 2.5, "Language selection"](#), on page 31.

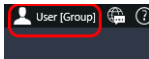

User Information

The user icon is available in the title bar only, if more users than the default "Admin" user are defined. To open the "User Information" dialog, click the icon.

The dialog displays the "Login" (= user name, see [User login](#)) together with your "Name", "Role" and all "Groups" assigned to you. You cannot edit this information here. Instead, only an administrator can edit it in the "User Admin" dialog, which is exclusively available to users with administration rights.

The "User Information" dialog also allows **changing your password**.

To do so, click the "Change Password" button to expand the dialog as in [Figure 4-2](#). Enter your current password in the field "Old Password". If an administrator has previously reset your old password, leave this field blank.

Then enter your new password in the field "New Password" and repeat it in the field "Confirm Password". No special rules and requirements apply to the length and complexity of your password or to the characters that you use. Complete the change of password by clicking "OK".

 A screenshot of the "User Information" dialog box. It contains several input fields: "Login" (Login-C), "Name" (Charlie), "Role" (Expert), and "Groups" (A1, B2, C3). Below these is a section titled "Change Password" with three sub-fields: "Old Password", "New Password", and "Confirm Password". At the bottom are "OK" and "Cancel" buttons.

Figure 4-2: User information dialog with some example data

If you have forgotten your password, ask an administrator to reset it.

See [Chapter 4.12.5, "User Admin"](#), on page 538.

Disabled Licenses!

Disabled Licenses

If you see a "Disabled Licenses!" notification in the title bar of R&S ELEKTRA, check the [Administration > License Management](#) dialog:

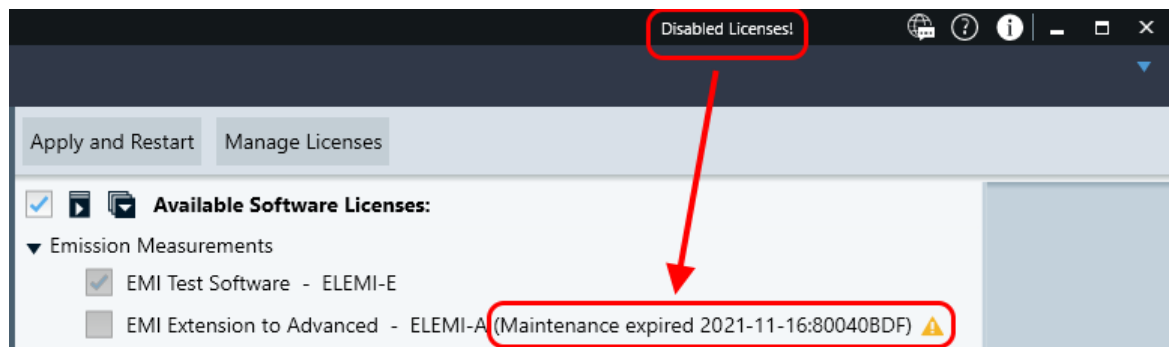

Figure 4-3: Example of expired maintenance period for ELEMI-A license

You cannot use software features related to a disabled license. Contact Rohde & Schwarz for an update of your licenses. See also ["Manage Licenses"](#) on page 534.

4.2 Dashboard



Dashboard

Access: "Home" > "Dashboard"

The user-configurable "Dashboard" dialog (see [Graphical user interface](#)) displays the icons of [pinned](#) items. Use these icons for one-click access to your favorite items. The configuration of this dialog is described in the section ["Handling pinned items"](#) on page 65.

To pin an item, select "Pin to Dashboard" . The pin icon changes to .

Access, for example: "Home" > "Test Templates"

This function is available in many dialogs (such as "Tests" or "Test Templates"), but *not* in the "Home" > "Dashboard" dialog. For an example, see [Figure 4-4](#).

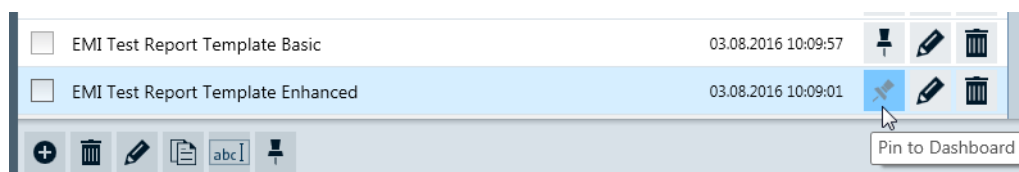
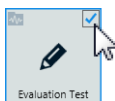

Figure 4-4: Pinning a component (here: a report template) to the "Dashboard" dialog

Once a component is pinned, it can be opened directly from the "Dashboard" dialog by clicking the item there.

Handling pinned items



To see [Details](#) of a pinned item and get access to the [Common action buttons](#) available for this item, check the checkbox in its top right corner.

Checking more than one item reduces the displayed details and action buttons to those details and buttons, which are commonly valid for the checked items.



You can limit the categories of pinned items to be displayed in the "Dashboard" dialog, see "[Dashboard: Show ...](#)" on page 544.

4.3 EUTs

Available only, if you have activated at least one [license](#) above "ELEMI-E", which requires that a [dongle](#) with this license is connected.

An EUT (equipment under test) can be any device. In EMC context, typically it either *emits* RF power or functionally depends upon *receiving* RF signals (with a limited level of disturbing interference), or both. Examples are mobile phones, computers, tablets, multimedia players, printers, navigation devices, mass storage media, routers, displays, television sets, set-top boxes, radio transmitters or receivers, military transceivers, medical equipment, digital cameras, camcorders, automobiles, automotive subsystems, motor controllers, electric power tools, household appliances, lighting devices or installations, etc.

Each physical EUT (hardware on the test site) is represented by an [EUT item or EUT description](#) in R&S ELEKTRA. Creating an EUT description is a prerequisite for [testing](#) the EUT.

When tests are completed, their [test containers](#) are associated to the EUT description's [Test Plan](#), as shown in [Figure 4-7](#). Your [test reports](#) are also available in those test containers within the EUT description.

For an overview of these components and their relation in the software structure, refer also to [Figure 3-1](#).

Handling EUT items



Access: "Home" > "EUTs"

Depending on the selection of one or several EUT descriptions, different action buttons are available in the actions bar. Most of them are common action buttons, described in [Chapter 3.3 on page 45](#). The dialog-specific action buttons for EUTs are:



"Delete" removes the selected one or more EUT descriptions from the database.

Deletion is protected with a confirmation warning:

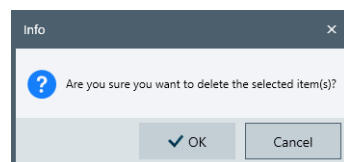

Figure 4-5: Example of a confirmation warning without subitems (tests) referenced by an EUT

If an EUT is associated with tests, deleting the EUT also deletes these tests. Therefore, R&S ELEKTRA brings up the following dialog with details:

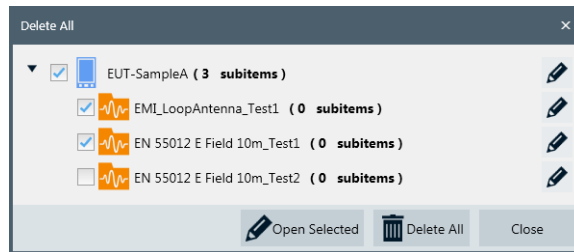



Figure 4-6: Example of a confirmation warning with tests referenced by an EUT



"Copy EUT with Test(s)" is a more comprehensive variation of the simple [Copy](#) . It creates a copy of the selected one or more EUT descriptions, where each created EUT copy includes copies of all tests associated with its original EUT. At the same time, these copies of tests appear in the [Tests](#) menu. The copies of EUTs and tests have the addition "- Copy" at the end of their names.



"Activate" defines that this EUT is used for each test, until a different EUT is activated. This button is exclusively available for EUT descriptions. Only *one* EUT can be active at a time. Its name is displayed in the title bar of the R&S ELEKTRA window (see label (3) in [Figure 3-3](#)). Also in the [Dashboard](#) dialog, the icon of the activated EUT is marked as active.



"Archive" moves the selected one or more EUT descriptions and all associated tests to the archive of R&S ELEKTRA, as described in [Chapter 4.11, "Archive"](#), on page 515.



Reassigning a test

You can reassign a test to a different EUT. Reassigning a test is especially helpful, if by mistake the wrong EUT description was activated while executing the test.

To reassign a test, open it and right-click the EUT headline in the [Test Components](#) dialog.

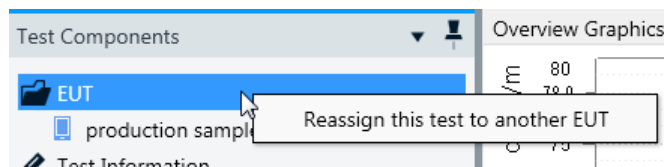

Click "Reassign this test to another EUT" and select the EUT that you want to reassign the test to.

4.3.1 EUT description

Access: "Home" > "EUTs" > "Create EUT" (or "Open")

When you edit any content in an EUT description dialog, this changed (or "dirty") state is marked by an asterisk (*) in the dialog's flag. The asterisk disappears upon saving the EUT description.

Closing an EUT description without saving, discards the changes. This loss of settings is protected by the following alert: "Would you like to save your changes?"

Select "Save" or "Don't Save", alternatively click "Cancel" to return to the EUT description without saving.

The content of EUT descriptions is structured in the following way:

Save and Group.....	68
Name.....	69
Active.....	69
Use external templates for reporting.....	69
Test Plan.....	69
L Search tests by keyword.....	71
L Filter tests by criteria.....	71
L Test Steps.....	71
L Test-Specific Action Buttons.....	72
L Test Step Details.....	73
L Reuse overview results.....	74
L GMW Reporting.....	75
L Folder Information.....	77
L Actions.....	77
L Test-Plan Action Buttons.....	77
L NR / LTE.....	80
Test Automation.....	81
L Pre-Condition.....	83
L Show executing test in a window on selected monitor.....	83
L Test Step Details.....	83
L Automation Log.....	83
L Test-Automation Action Buttons.....	83
General Information.....	84
L Additional Information.....	85
L Attachments.....	86
L Dimensions.....	86
L Audio Breakthrough.....	86
Reports.....	87
External Report templates.....	87

Save and Group



- 💾 "Save (Ctrl + S)"

Saves the EUT description under its existing name. The saved data includes the test plan and data of existing tests.

If the EUT description was not saved before, the dialog offers to enter a new name, otherwise this saving option overwrites the previously saved data.

Note that R&S ELEKTRA remembers the collapsed or expanded states of folders in the [Test Plan](#), when you save the EUT description.
- 💾✎ "Save As... (with planned test steps only - F12)"

Saves the EUT description under a new name **with planned test steps only**. This saving option does not include the data of tests that are listed in the [Test Plan](#).

Use this option for applying the test plan to a different EUT.
- 💾⚡ "Save As... (including copies of all referenced tests)"

Saves the EUT description under a new name, including copies of all referenced tests.

Saves the EUT description under a new name **including copies of all referenced tests**. This saving option ensures to include data of tests that are listed in the [Test Plan](#).

Use this option for creating and saving a full copy of a tested EUT. For example, if you want to [archive](#) the EUT's original data, the saved copy of the EUT is still available for further testing.



-  "Export"
Exports the content of the root folders, which are selected (checkbox ticked) in the [Test Plan](#) dialog, to an XML file, archived in a ZIP file. For exporting the content, you can select whether to include tests into the exported file.
- **"Group"**: Selects a [user group](#)
Available only, if you have created at least one group of [Users](#).

Name

Defines the name of the EUT. R&S ELEKTRA automatically suggests a default name, for example `New EUT`. If a default name already exists, the suggested name gets an additional counter, for example `New EUT (1)`.



Active

The activity status selector is equivalent to the  /  buttons at "Home" > "EUTs". If you check the status selector, it interactively deactivates any other EUT that was previously activated. For a description, see [Handling EUT items](#).

Use external templates for reporting

Available only, if the [license](#) "ELEMC-REP" installed and enabled.

Enables customizing your reports by using external report templates in `.dotx` format, see [External Report templates](#).

Test Plan

Test Plan

Access: "Home" > "EUTs" > "Create EUT" (or "Open") > "Test Plan"

Available only, if the [license](#) for "EMI Extension to System - ELEMI-S" or "EMS Extension to System - ELEMS-S" is activated.

This dialog organizes tests for individual EUTs. You can decide to [search tests](#) or [select types](#), create and use a list of [Test Steps](#) and define the [Test Step Details](#).

In the list of test steps, you can plan tests, run tests and organize report handling.

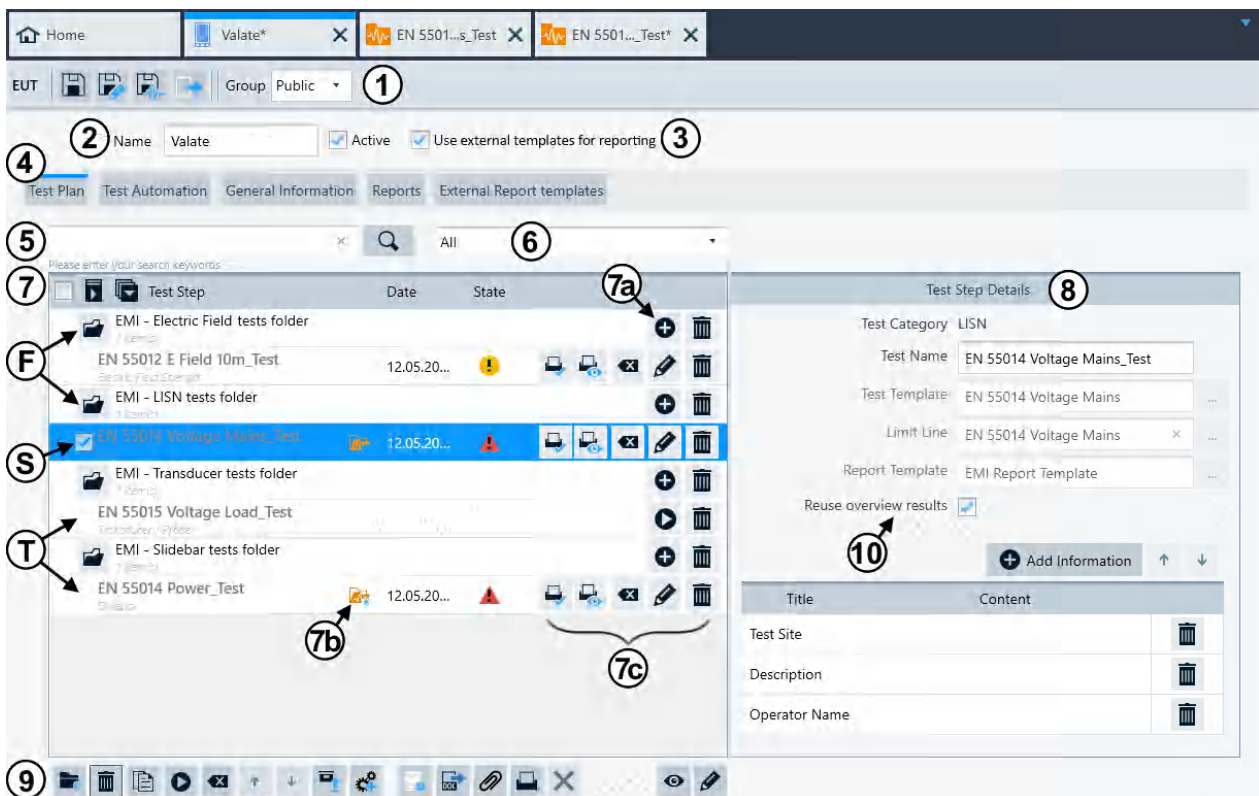



Figure 4-7: Example of an EUT description dialog with focus on the Test Plan

- 1 = Save and Group
- 2 = Name
- 3 = Active and Use external templates for reporting
- 4 = Test Plan (described below), Test Automation, General Information, Reports and External Report templates
- 5 = Search tests by keyword
- 6 = Filter tests by criteria
- 7 = List of test folders that contain Test Steps, available only if previously added via the action button "Add a Root or Sub Folder"
- 7a = Button to "Add a Test Step"
- 7b = Test is open in separate tab (and can be saved or not saved, see Columns in the list of test steps)
- 7c = Test-Specific Action Buttons
- F = Folders (here: root folders)
- S = Selected test step
- T = Test steps
- 8 = Test Step Details, available only if one test step is selected ("S"). If instead a folder ("F") is selected, this part of the dialog allows editing folder information.
- 9 = Test-Plan Action Buttons
- 10 = Reuse overview results

NOTICE! Removing test steps. If you remove (or delete ) one or more "Test Steps" from the "Test Plan" list, this action does not only remove the tests from the EUT description, but **fully deletes the tests from the database**. If you delete a test step that contains subtest steps (Figure 4-8), this action also deletes all subtest steps. Deleting items is protected by the following alert: "Are you sure you want to remove the test step(s)?"

Options are "Yes" to delete them or "No" to return to the dialog (without saving).

Note that removing test steps does not delete the correlated test templates.

Search tests by keyword ← Test Plan

Searches for arbitrary text in the names of [Test Steps](#) assigned to this EUT description. When you enter a search string, R&S ELEKTRA narrows the list of test steps down to those tests that match your search.

If you have previously used the [Filter tests by criteria](#) to filter the test steps, entering a search string resets the filter. Hence, R&S ELEKTRA automatically sets the filter criterion "All" when you enter a search string.

Filter tests by criteria ← Test Plan

Filters the [Test Steps](#) to be displayed according to the following criteria:

- "All"
- "All planned tests"
- "All executed tests"
- "All inconclusive tests"
- "All passed tests"
- "All failed tests"
- "All document relevant tests"

Hence, executed tests that are not excluded (🚫) from the summary report. All tests labeled with 🚫 are eligible for being included in the summary report, see [Test-Specific Action Buttons](#).
- "All tests of category CAL"
- "All tests of category Transducer / Probe, EMI"
- "All tests of category LISN, EMI"
- "All tests of category Slidebar, EMI"
- "All tests of category Electric Field Strength, EMI"
- "All tests of category Electric Field Strength (GTEM), EMI"
- "All tests of category Magnetic Field Strength (Triple Loop Antenna), EMI"
- "All tests of category Magnetic Field Strength (Loop Antenna + Turntable), EMI"
- "All tests of category Radiated Spurious Emission, EMI"
- "All tests of category Bulk Current Injection, EMS"
- "All tests of category CDN / EM-Clamp, EMS"
- "All tests of category Antenna Port, EMS"
- "All tests of category Anechoic Chamber, EMS"
- "All tests of category Reverberation Chamber, EMS"
- "All tests of category TEM Waveguides, EMS"



If you have previously used the [Search tests by keyword](#) to narrow the list of test steps down, selecting a filter criterion resets the search. Hence, R&S ELEKTRA removes the search string when you select a filter criterion, but it keeps the string as a selectable alternative.

Test Steps ← Test Plan

The list of test steps is the core of a [Test Plan](#). It serves for the following tasks:

- Planning the tests for this EUT
- Defining the [Test Step Details](#)
- Running tests
- Listing both the planned and the executed tests
- Generating and managing summary reports, optionally as [customized reports](#)

Note: Executing and saving a test for an EUT, but independently of this EUT's test plan, always adds the test to the EUT's test plan in an automatically created folder labeled "Unplanned". You can shift the independently executed (unplanned) test to a different folder in the test plan.

To create test steps in the list, first make sure that folders are available. Use the "Add a Root or Sub Folder" button  to create folders, see [Test-Plan Action Buttons](#). Then use the "Add a Test Step" button  to create a test step in the selected folder, see [Test-Specific Action Buttons](#).











Use  to collapse all entries in the list or  to expand all. Note that R&S ELEKTRA remembers the collapsed or expanded states of folders in the [Test Plan](#), when you save the EUT description. To change a column width, drag the (invisible) separations between the columns to the left or right with your mouse pointer.

Table 4-1: Columns in the list of test steps

Column	Description
1st column: "Test ID"	When you save an executed test, R&S ELEKTRA automatically generates an ID for this individual test. Each test ID is unique within the test plan, starting with ID 1. If you have enabled "Show Test Id" in Administration > Settings > General , the ID is visible in the 1st column of the test plan and in the test's search view (Figure 6-2). The ID is available also via the Data exchange interface. If you delete or reset a test, its ID is not reused.
2nd column: "Test Step"	Names of the folders, subfolders and test steps. Also in this column, but only in rows of folders (left of the folder's name): <ul style="list-style-type: none"> : This folder is open, click to close it : This folder is closed, click to open it Also in this column, but only in rows of executed tests (right of the test's name), and only, if this test is open in a separate tab: <ul style="list-style-type: none">  "Test is open" (and unchanged)  "Test is open and dirty" (hence, not saved after making changes)
3rd column: "Date"	Date- and time-stamp of a test, available only for test steps that are already executed, not for planned tests. If the column is too narrow for showing all information, drag it wider or hover the mouse pointer over the entry to see the full date and time. The timestamp format can be <code>mm.dd.yyyy hh:mm:ss</code> or <code>dd.mm.yyyy hh:mm:ss</code> , for example, depending on the country settings of your computer.
4th column: "Verdict"	Verdict of already executed tests: <ul style="list-style-type: none">  "Test Passed"  "Test Inconclusive"  "Test Failed"
5th column: "Done"	Lists the test activities that you have already completed. See Test-Plan Action Buttons

Test-Specific Action Buttons ← Test Steps ← Test Plan







The following buttons are available for folders:

-  "Add a Test Step", use this button to add a new test step in the selected folder
-  "Remove this Folder"

If you remove a folder that contains one or more executed test steps, and if you save the EUT, this action also deletes the test results, as described in [Removing test steps](#).

For "Remove this Test Step", see below.

The availability of the following buttons for test steps depends on whether a test is planned or already executed:

-  "Include this item in the Report", available only for executed tests
If deactivated , the software excludes this test from the report
-  "Preview of the Report", available only for executed tests
-  "Reset this Test Step", available only for executed tests, equivalent with [Clear Results](#) in the [Test control top menu](#)
-  "Edit this Test Step", available only for executed tests
-  "Run this Test Steps", available only for planned tests. R&S ELEKTRA requires that you save the EUT description before you can run a test step.
-  "Remove this Test Step", available both for planned and executed test steps. If you remove an executed test step (possibly with deleting the folder that it is in), note that this action also deletes the test results, as described in [Removing test steps](#).

Test Step Details ← Test Plan

Available only, if you select (highlight) exactly one [test step](#).

This part of the test plan specifies the following details of the selected test step:

- "Test Category" (not editable), depends on your selection when you added  this test step (see [Test-Plan Action Buttons](#))
- "Test Name", first automatically entered as a default ("New Test"), then overwritten according to the folder's name and name of the test template that you select. You can edit the test name, but first select the "Test Template" in the next line, before you edit the name.
- **"Test Template" (for EMI) or "EMS Test Template"**, to be selected **first**
- [Limit Line](#) (for selecting a table, available only for EMI tests)
- [Test Method](#) (available only for EMS tests)
Options are: "Amplifier Test", "EUT Qualification" or "Reference Calibration", with the following additional parameters:
 - "Leveling Mode" (available only for "EUT Qualification" or "Reference Calibration")
Options are: "Sensor", "Substitution Method" or "Transducer Power"
 - "Reference Calibration" (for selecting a table, available only for "EUT Qualification" with "Substitution Method")
 - "Test Level" (available only for EMS tests)
 - "Sensor Limit" (available only for EMS tests with activated [Sensor Level Limitation](#) > "By Value")
- "Cut Out Comm Bands" (for selecting "Downlink" only or "Downlink & Uplink", available only for an "EMI - Radiated Spurious Emission" test template with [Radio Communication Tester](#)). Available only, if at least in one of the "NR" and "LTE" tabs (see [Figure 4-15](#)), the "Duplex Mode" is set to "FDD".
- [EUT Monitoring Template](#) (optional, only for EMS tests)
- [Report Template](#) (optional)
- Additional information for the individual test step, for example "Description", "Test Standard", "Test Site", "Operator Name"

We recommend that you select a test template first, because this selection generates a default test name according to the template's name. Also, the test template can include a limit line (EMI), test method parameters (EMS), an EUT monitoring template (EMS) and a report template. If so, R&S ELEKTRA overwrites these fields upon selecting a test template, even if you have edited them before.

Selecting a test template in this dialog is a prerequisite for running a test step from out of the "Test Plan".

Reuse overview results ← Test Plan

Available only for EMI test templates.

Allows you to run the overview measurement only once and to execute data reduction and final measurement repeatedly for its results, but with different limit lines.

Enabling "Reuse overview results" has the following effects in the dialog:

- It disables [GMW Reporting](#), which is available in some *radiated* EMI test templates.



- It enables a button for adding subtest steps of the same test-template type under the test step:

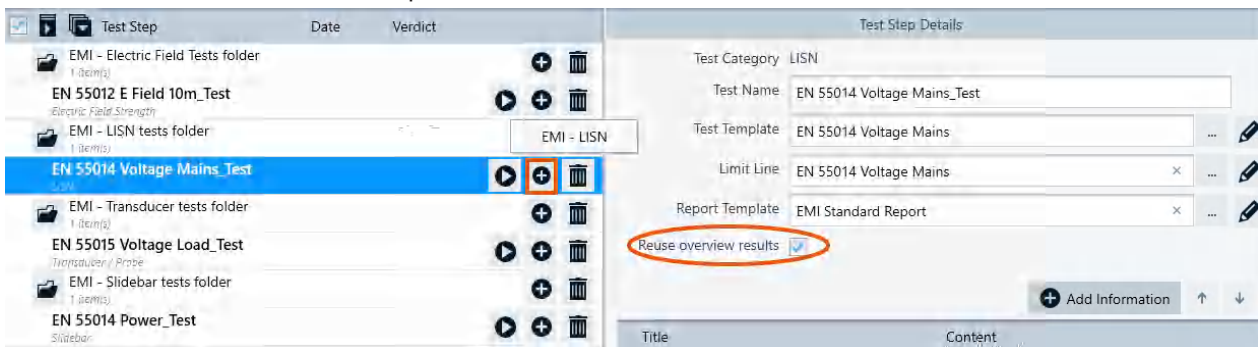

Figure 4-8: Example of adding a subtest step under a test step

Note: How to add a subtest step. Click the button. Above this button, a small dialog field appears for selecting a template type, for example "EMI - LISN". This template type is the same as in the original test step. Click the small dialog to select this template type for the subtest step. R&S ELEKTRA creates a subtest step and adds it below the test step.

Discern **two cases** for how to apply different limit lines to the test results:

- If the test template of the original test step uses only **one** frequency range or only **one common** limit line for all ranges, proceed as follows:
 - For a given test step, add as many subtest steps as you want to perform.
 - In the "Test Step Details" of each subtest step, select the same ("primary") template as in the original test step.
 - Change the limit line for each subtest step directly in the "Test Step Details":

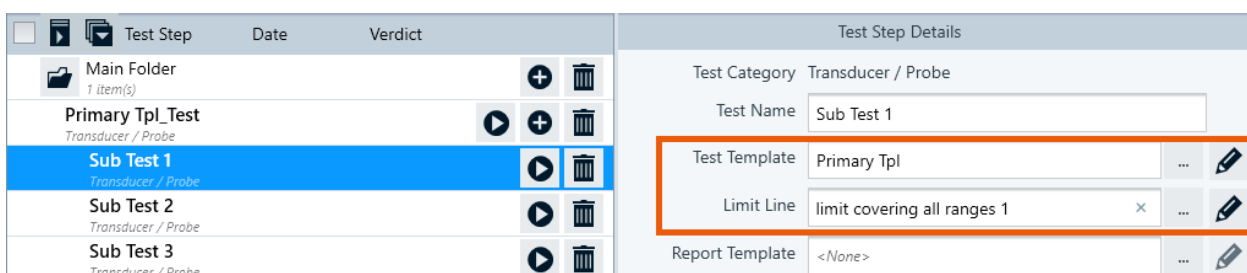

Figure 4-9: A test step and 3 subtest steps with only one limit line, each

- If the template of the original test step uses **multiple** frequency ranges with different **individual** limit lines, proceed as follows:
 - For each subtest step that you want to perform, create a copy (a "subtemplate") of the original ("primary") test template.
 - Give speaking names to the subtemplates (copies), for example "Sub Tpl 1", "Sub Tpl 2".
 - Edit each subtemplate, but modify only the limit lines in the frequency ranges. Hence, for example in "Sub Tpl 1", select those limit lines, for which you want to perform data reduction in subtest step 1.
 - For a given test step, add as many subtest steps as you want to perform.
 - In the "Test Step Details" of each subtest step, select only the correct subtemplate. It contains already the required limit lines, therefore the "Limit Line" selection is disabled in the "Test Step Details" of subtest steps:

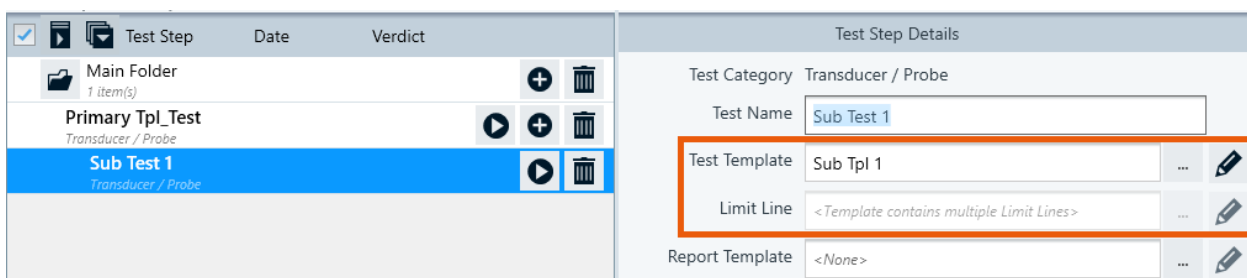

Figure 4-10: A test step and 1 subtest step with multiple limit lines, each

GMW Reporting ← Test Plan

Available only for *radiated* (also magnetic) EMI test templates, except for test templates with setups for **GTEM** and **RSE** measurements.

Allows you to prepare a set of related tests grouped under one main test, with the EUT in different modes of operation. Out of all tests, R&S ELEKTRA generates a maximum-peak spectrum under worst-case conditions. The software further evaluates this spectrum to find the maximum peak inside defined frequency bands. Finally, it generates a report according to the General Motors standard GMW3097, with the band table required by this standard.

"GMW Reporting" is intended for testing EUTs that are automotive components. Typically, these tests require a shielded chamber, which allows using only one **Rx** test antenna at a time. Hence, for the different required antennas, configure tests with non-overlapping frequency ranges. In each test, run measurements at different EUT modes and at both polarizations of the current antenna.

Enabling "GMW Reporting" has the following effects in the dialog:

- It disables [Reuse overview results](#).





- It enables the radio buttons "Spark" and "Non-Spark", which toggle between test scenarios with or without ignition of a vehicle's combustion engine. See also ["GMW Report Settings"](#) on page 553.
- It enables a  button for adding subtest steps of the same test-template type under the test step:



Figure 4-11: Example of adding a subtest step under a test step

Note: How to add a subtest step. Click the  button. Above this button, a small dialog field appears for selecting a template type, for example "EMI - Electric Field Strength". This template type is the same as in the original test step. Click the small dialog to select this template type for the subtest step. R&S ELEKTRA creates a subtest step and adds it below the test step.

In the "Test Step Details" of each subtest step, select the test template for which you want to perform a test.

With "GMW Reporting" enabled, R&S ELEKTRA automatically takes the following actions in a test:

- It applies the [Data Reduction](#) to each frequency range individually, hence disabling the test template's "Over all Frequency Ranges" option
- Even if [Save Results for 3D Chart Evaluation](#) is not enabled, it saves loop results for the following:
 - The different antennas (per frequency range)
 - The H and V antenna polarizations
 - The different EUT modes
- In the [Test container](#), it adds a folder labeled "GMW Evaluation", which collects and displays the results from all subtests
- It creates an editable local copy of the [GMW Report Settings](#) in the test
- It creates a series of graphics according to the GMW standard:
 - Separate test result charts for the executed loops
 - Summary charts
 - Worst-case charts
 - So-called "important graphics"
 - Charts per frequency range, if [Graphics per Range](#) is enabled
- It prevents deleting test result charts from the test container
- It creates test reports according to the GMW standard, selectable for "Spark" or "Non-Spark" scenarios

- At the node of the primary test, it provides all information required for creating the GMW report

Folder Information ← Test Plan

After adding a root folder or a subfolder (Figure 4-13), when you select (highlight) a folder, you can add folder information.

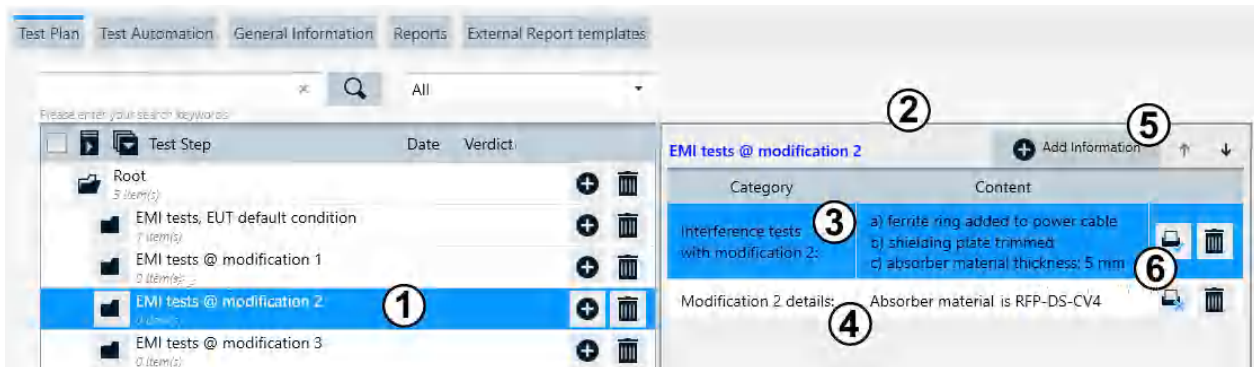

Figure 4-12: Example of detail information on a subfolder

- 1 = Selected (highlighted) subfolder
- 2 = Folder information dialog for the selected subfolder
- 3 = First line of text, to be included in reports (see 6)
- 4 = Second line of text, to be excluded from reports (see 6)
- 5 = Button for adding more lines of text
- 6 = Button for including a line of text in reports, or for excluding it

Actions ← Test Plan

Executes user-defined actions upon starting, resuming or stopping a test, as described in Chapter 4.5.2.5, "Actions", on page 230.

Test-Plan Action Buttons ← Test Plan

The action buttons that are available at the lower edge of the "Test Plan" dialog depend on several parameters:

- Is a test step selected (highlighted)?
- Is a test step selected (checkbox ticked)?
- Is a folder selected (highlighted)?
- Is a folder selected (checkbox ticked)?
- Is [Use external templates for reporting](#) enabled?

Action buttons that are available are shown bold and can be applied to one or more selected items.

Action buttons that are not available are either missing or shown grayed out.

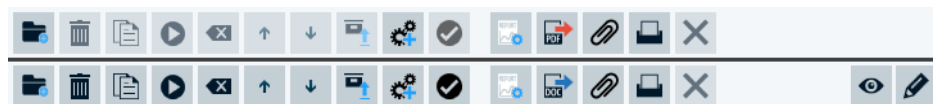

Figure 4-13: Two examples of available sets of action buttons in the Test Plan dialog

Top row = With no test step selected (checked)

Lower row = With an executed test step selected, with "ELEMCR-REP" installed and "Use external templates for reporting" enabled

- **"Add a Root or Sub Folder"**

Lets you choose to add a root folder or a subfolder at the selected position in the list of test steps, see [Figure 4-7](#).

If there are multiple tests in a folder or subfolder, you can expand or collapse them to view or hide the details. R&S ELEKTRA saves the expand or collapse state of the folders and recalls the state when you open the test plan on the next occasion.

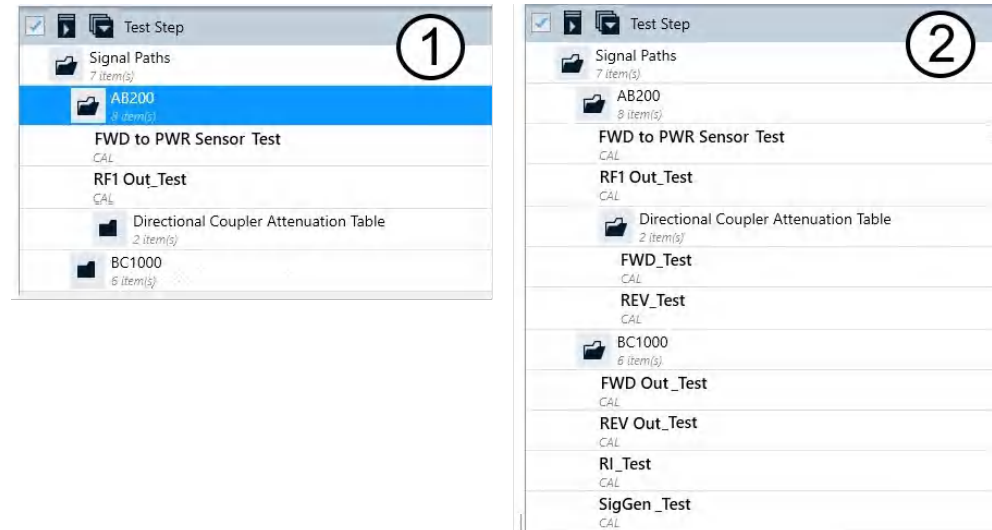

Figure 4-14: An example of a test plan with expanded or collapsed folders

1 = Folders collapsed

2 = Folders expanded



When you select (highlight) a folder, the right part of the test-plan dialog allows editing folder information. See ["Folder Information"](#) on page 77.

- **"Add a Test Step"**

Use this button to set up your test plan. For each addition of a test step, select one of the following test categories:





- "CAL"
- "EMI - Transducer / Probe"
- "EMI - LISN"
- "EMI - Slidebar"
- "EMI - Electric Field Strength"
- "EMI - Electric Field Strength (GTEM)"
- "EMI - Magnetic Field Strength (Triple Loop Antenna)"
- "EMI - Magnetic Field Strength (Loop Antenna + Turntable)"
- "EMI - Radiated Spurious Emission"
- "EMS - Bulk Current Injection"
- "EMS - CDN / EM-Clamp"
- "EMS - Antenna Port"
- "EMS - Anechoic Chamber"
- "EMS - TEM Waveguides"

The software adds a "New Test" entry into the test plan. The [Test Step Details](#) list is displayed, but empty (except for the test category and the default name "New Test"). We recommend that you proceed with [editing the test step](#) by selecting a test template.





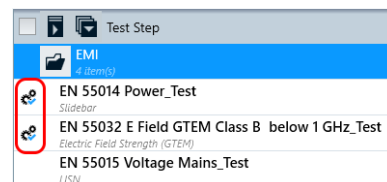

-  "Remove the selected Test Steps"
If you want to remove an executed test step, note that this action also deletes the test results, as described in [Removing test steps](#).
-  "Copy the selected Test Steps"
Creates a copy, but only as a planned test step. Hence, if you select to make a copy of a test step that contains an executed test, the copy is created without this test.
-  "Run the selected Test Steps"
The following prerequisites apply, before you can run a test step:
 - You must have saved the EUT description.
 - The above condition requires, that you have selected a test template for each test step.

If you run a **planned** test step, R&S ELEKTRA opens the test dialog in a separate tab. Proceed as described in [Chapter 7, "Running tests"](#), on page 592.

If you run a test step that has already been **executed** before, the test is opened. If desired, you can click [Start or Resume](#) to rerun the test.





-  "Reset the selected Test Steps" (available only for executed tests)
Deletes executed tests out of the selected test steps. Hence, these steps are reset to the state of planned test steps.
-  "Move Up / Down the selected Test Category" (not available for test steps, only for their categories)
-  "Archive tests associated with selected Test Steps"
Moves the selected tests to the [Archive > Test](#) section, but leaves the test step in the list for further usage (planned tests).
-  "Add selected Test Steps to Automation"
Available only, if the [license](#) "ELEMC-TLA" for test-list automation is enabled. Copies the selected test steps to the [Test Automation](#) section and jumps to this section. In the "Test Plan" dialog, the copied steps are labeled by a test step automation icon:



-  "Set selected tests as Done"
Labels the selected one or more tests as done. Not available for open tests. You cannot modify a test that has the "Done" state, and you cannot remove the "Done" state. If you want to edit such a test, consider making a copy of it, see ["Copy"](#) on page 48. Or open it and save it under a new name, see ["Save As"](#) on page 46.
-  "Show Report Settings"
Opens the [Report](#) dialog.
-  /  "Create a Report" in pdf or docx format (available only, if the test plan contains executed tests)
 -  (pdf icon), available if [Use external templates for reporting](#) is disabled: reports use standard [Internal](#) report templates
 -  (dotx icon), available if [Use external templates for reporting](#) is enabled: reports use customized [External](#) report templates

Creates a joint and summarized report for all executed tests in the test plan, if for these tests in the [Test-Specific Action Buttons](#), the button "Include this item in the Report"  is enabled.

The report summarizes the test names, test template names, dates, operators and verdicts of all executed and included tests. The summary is presented in a table on the first page of the report. The following pages show the individual reports of each test.

-  "Generate the Report as an Attachment"
Creates a summarized report as described above and saves it in the [Reports](#) tab.
-  "Send the Report to the Printer"
Creates a summarized report as described above and sends it to your computer's standard print output.
-  "Cancel the Report generation", available only during report generation
-  "View last generated/attached report", opens the report file in an appropriate program
-  "Open Report Log" (see [Custom reporting procedure](#) in [Chapter 6.6, "Creating customized reports"](#), on page 577)

NR / LTE ← Test Plan

Available only, if the following conditions are all met:

- The selected test step was created for the test category "EMI - Radiated Spurious Emissions"
- The test template selected for this test step contains a [hardware setup](#) that contains a [Radio Communication Tester](#)

The "NR" and "LTE" dialogs in the "Test Plan" facilitate configuring the parameters of a radio communication tester for different modifications of the setup or the EUT. To do so, you can copy a configured test step (see [Test-Plan Action Buttons](#)) and modify the "NR" and "LTE" configuration immediately in this new step's dialog.

For a description of the settings, see "NR" on page 458 and "LTE" on page 463.

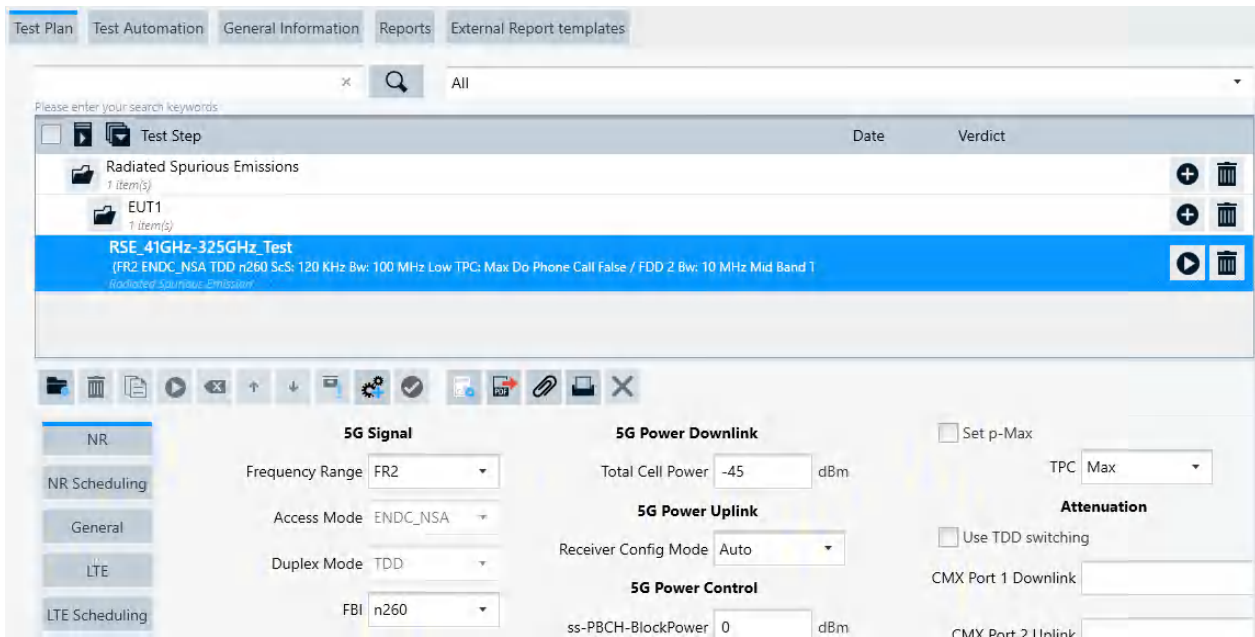



Figure 4-15: Example of radio communication tester settings in the Test Plan dialog

Test Automation

Available only, if the [license](#) "ELEMC-TLA" for test-list automation is enabled.

Note: To see any content in the "Test Step" list of the "Test Automation" dialog, add test steps from the [Test Plan](#). To do so, go to the "Test Plan" dialog, select test steps and click the  icon ("Add selected Test Steps to Automation").

When content is available in the list, you can search for tests using a search field and a filter field. These fields provide the same features as described for the "Test Plan" dialog at [Search tests by keyword](#) and [Filter tests by criteria](#).

For general settings related to test-list automation, see [Chapter 4.12.3, "Test Automation"](#), on page 531.

Automation

The purpose of the test automation feature is executing tests without user interaction, including, for example, the confirmation of dialog boxes. [Figure 4-16](#) shows an example with a notification that comes up during automated test execution. R&S ELEKTRA automatically selects "Continue":

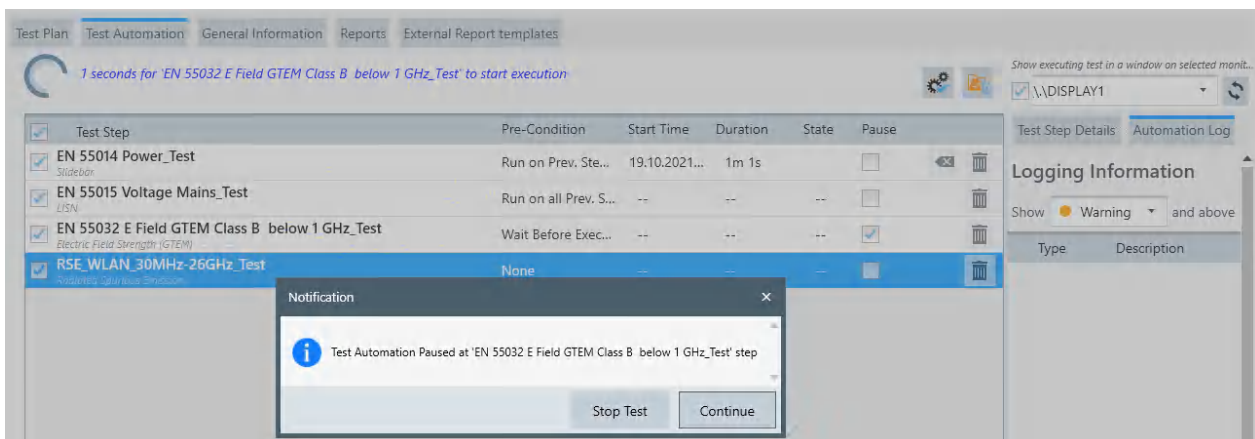

Figure 4-16: Test automation runs a series of tests, taking over most user interaction

Some tests, however, can require user interaction, indicated, for example, by a text message (blue in Figure 4-17): "Please resume in Test View". This situation requires actual user interaction in the test view.

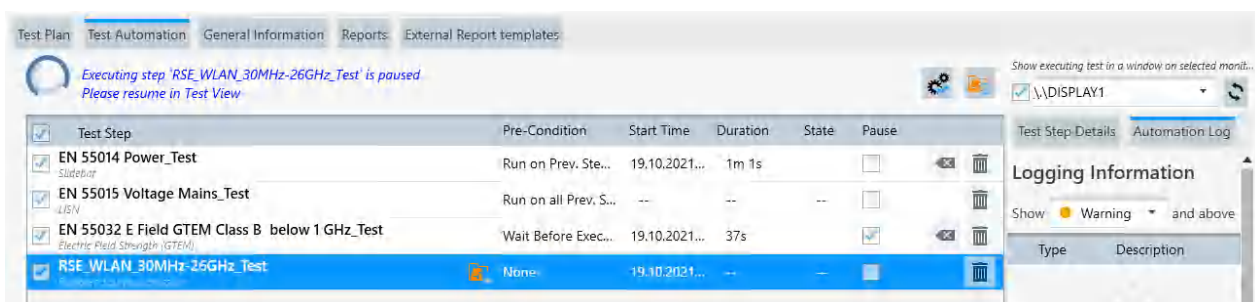

Figure 4-17: Some tests require user interaction

Figure 4-17 shows also the following parameters:

- "Pre-Condition", see "Pre-Condition" on page 83
- "Start Time", "Duration" and "State" show execution information for each test step, automatically reported by R&S ELEKTRA.
- "Pause" selects bringing up a notification, before a test step is executed automatically. With "Pause" enabled, a test step requires user interaction to be executed.
- "Click to scroll to running step in Automation View"
Available only, while automated tests are being executed.
R&S ELEKTRA brings the currently executed test step into the focus and highlights it. If your list of test steps is longer than the window, R&S ELEKTRA scrolls to the currently executed test step.
- "Show running Test tab"
Available only, while automated tests are being executed.
R&S ELEKTRA brings the test tab of the currently executed test step into the focus and displays this test tab.
- "Show executing test in a window on selected monitor", see "Show executing test in a window on selected monitor" on page 83
- "Test Step Details", see "Test Step Details" on page 83
- "Automation Log", see "Automation Log" on page 83

For action buttons at the lower edge of the "Test Automation" dialog window, see "[Test-Automation Action Buttons](#)" on page 83.

Pre-Condition ← Test Automation

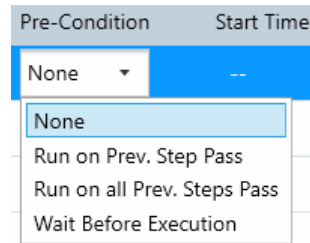

Figure 4-18: Select a pre-condition

- "None": R&S ELEKTRA executes this test step without precondition.
- "Run on Prev. Step Pass": R&S ELEKTRA executes this test step only, if the previously executed test step has the verdict "Passed".
- "Run on all Prev. Steps Pass": R&S ELEKTRA executes this test step only, if all previously executed test steps have the verdict "Passed".
- "Wait Before Execution": R&S ELEKTRA executes this test step, but delays execution for the delay time specified by the parameter "Duration for Precondition "Wait Before Execution"" in the "Admin" > [Test Automation](#) dialog.

Show executing test in a window on selected monitor ← Test Automation

If disabled, test execution runs in the same R&S ELEKTRA window.

If enabled, you can select a primary or secondary display, or an external monitor connected to your computer. R&S ELEKTRA displays the automatically executed tests in a separate window in the selected monitor.

The "Refresh" button  reloads available monitors.

Test Step Details ← Test Automation

Shows the test step details of the selected (highlighted) test step, as described in "Test Plan" > [Test Step Details](#).

Automation Log ← Test Automation

Shows logging information of "Test Automation" activities, starting from the time of opening the [EUT description](#) (the EUT item currently opened).

You can select the level of information to be shown:

- "Process" shows all available logging information
- "Info" shows all information relevant for user interaction, including warnings and errors
- "Warning" shows all unexpected events, including errors
- "Error" shows nothing but error events

Test-Automation Action Buttons ← Test Automation

The action buttons that are available at the lower edge of the "Test Automation" dialog window depend on two parameters:

- Is a test step selected (highlighted)?
- Is a test step selected (checkbox ticked)?

Action buttons that are available are shown bold and can be applied to one or more selected items.

Action buttons that are not available are shown grayed out.



Figure 4-19: Action buttons at the lower edge of the Test Automation dialog

- **▶** "Start Automation"

The following prerequisites apply, before you can start automation of a test step:

 - You must have saved the EUT. No unsaved change in the EUT is allowed.
 - The above condition requires, that you have selected a test template for each test step.

Starts automated execution of all test steps in the order as listed in the "Test Automation" dialog.
See also [Chapter 7, "Running tests"](#), on page 592.
- **■** "Stop Automation"

Stops any currently running automated execution of test steps. Available only while automated tests are running.
- **↶** "Reset the process state of selected Test Steps in Automation"

Resets the selected tests to the state before being executed.
Note that this action refers to those test steps that are selected by a **ticked checkbox**, but not by highlighting.
- **■** "Remove selected Test Steps from Automation"

Removes the selected tests (checkbox ticked) from the list in the "Test Automation" dialog.
Note that this action refers to those test steps that are selected by a **ticked checkbox**, but not by highlighting.
- **↑ ↓** "Move Up / Down the selected Test Step in Automation"

Note that this action refers to the test step that is selected by **highlighting**, but not by a ticked checkbox.
- **📄** "Show Test Step in Test Plan view"

Jumps to the [Test Plan](#) dialog and highlights the test step previously **highlighted** in the "Test Automation" dialog.

General Information

General Information

Access: "Home" > "EUTs" > "Create EUT" (or "Open") > "General Information"

The "General Information" dialog offers the following content:

- "User Tags": selects from a predefined list of tags or defines new user tags
- "Serial Number": specifies the EUT's serial number for identification and traceability
- "Error Criteria": describes the test criteria that define this EUT as faulty
- Subdialog [Additional Information](#)
- Subdialog [Attachments](#)

The screenshot shows the 'EUT' configuration dialog for 'Valate*'. The 'Group' is set to 'Public'. The 'Name' is 'Valate'. There are checkboxes for 'Active' and 'Use external templates for reporting'. The 'General Information' tab is selected, showing 'User Tags' (Version B4), 'Serial Number' (0123456789), and 'Error Criteria' (No GPS signal found). Below are tabs for 'Additional Information', 'Attachments', 'Dimensions', and 'Audio Breakthrough'. A table below these tabs lists categories: 'Description', 'Manufacturer', and 'Software Version', each with a 'Content' column and printer/trash icons.

Figure 4-20: Example of an EUT description dialog with focus on General Information

- 1 = [Save and Group](#)
- 2 = [Name](#)
- 3 = [Active](#)
- 4 = "General Information" (see also [Test Plan](#), [Reports](#) and [External Report templates](#))
- 5 = [Additional Information](#)
- 5a = Some information categories in the list of additional information
- 6 = [Attachments](#)
- 7 = [Dimensions](#)
- 8 = [Audio Breakthrough](#)

Additional Information ← General Information

These fields can be edited. Examples for useful categories are:

- "Description": arbitrary text for your remarks
- "Manufacturer": name of the EUT manufacturer
- "Software Version": identifier for the software or firmware version
- "Hardware Version": identifier for the hardware version
- "Barcode": information content of the EUT's barcode or data matrix code

You can add new categories by clicking the "Add Information" button. Alternatively, you can edit the global specification at "Home" > [Administration](#) > [Settings](#) > [External Mixer](#).

To shift a selected category up or down, click the arrows.

Per default, R&S ELEKTRA includes each category of additional information into your test reports. The printer icon with checkmark represents this default setting. To exclude a category from reports, click the icon. It changes to a printer icon without checkmark , indicating that this category is not set to be included into reports.

Note: Content history. For each category, R&S ELEKTRA memorizes previously stored text in the "Content" column. After saving the EUT and deleting any text from the "Con-

tent" column, the software helps you in restoring that text by selecting it from a context dialog.

To delete a category of additional information, click the delete button  in this category's line.

Attachments ← General Information



You can attach arbitrary files to the EUT description by clicking "Add Attachment", for example:

- A picture of the EUT
- A picture of the setup, in which it is tested
- An operating manual in digital format
- Copies of certificates
- Developers' documents

Note: To attach report files from external sources, we recommend using the [Reports](#) tab.

To attach files to individual tests, use the [Attachments](#) dialog in the [Test container](#).

To shift a selected attachment up or down, click the  arrows.

Per default, R&S ELEKTRA includes each attachment into your test reports, if it is a printable file. For printable files, a printer icon with checkmark  represents this default setting. To exclude an attachment from reports, click the icon. It changes to a printer icon without checkmark , indicating that this attachment is not set to be included into reports.

The list shows icons of the attachment type (for example, PDF), the filename and the date of creation. You can enter an arbitrary comment for each attachment.

To open an attached file in an appropriate program, click "View this Attachment" (the  eye button).

To delete an attachment, click the delete button  in this attachment's line.

Dimensions ← General Information



Allows entering the geometrical dimensions of the EUT.

If you have installed the [license](#) "ELEMI-5GFC" for [RSE](#) 5G FCC measurements, R&S ELEKTRA uses these dimension entries for calculating the grid positions in [TRP](#) measurements.

In a newly created EUT description, the dimensions table contains 3 lines for the EUT's "Depth", "Width" and "Height".

To delete a line, click the delete button  in this line. If at least one line was deleted from the table, you can add the missing lines by clicking "Add Dimensions".

To shift a selected line up or down, click the  arrows.

Per default, R&S ELEKTRA includes each dimension into your test reports, if entries are available. The printer icon with checkmark  represents this default setting. To exclude an entry from reports, click the icon. It changes to a printer icon without checkmark , indicating that this entry is not set to be included into reports.

Audio Breakthrough ← General Information

Allows saving audio breakthrough calibration values.

In a newly created EUT description, the audio breakthrough table contains a table with the following calibration values:

- "Mobile Network Standard" signal type - selects the mobile signal type
 - "NR"
 - "GSM"
 - "WCDMA"
 - "LTE"
- "Band" of the signal on the network standard - selects the relevant signal band depending on the mobile network standard
- "Uplink Reference Value" of the signal - specifies the value in dB μ V
- "Mobile Downlink Reference Value" - specifies the value in dB μ V
- "Hands-free Speaker Audio Level" - specifies the value in dB μ V
- "Date" - the date when a line with audio breakthrough reference values is added

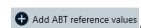

To add a line with audio breakthrough reference values, click the add button

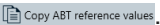

To copy a line with existing audio breakthrough reference values, select the line then click 

To delete a line, click the delete button  in this line. If at least one line was deleted from the table, you can add the missing lines by clicking "Add Dimensions".

To shift a selected line up or down, click the  arrows.

Per default, R&S ELEKTRA includes each dimension into your test reports, if entries are available. The printer icon with checkmark  represents this default setting. To exclude an entry from reports, click the icon. It changes to a printer icon without checkmark , indicating that this entry is not set to be included into reports.

Reports

Reports

To attach any report file from an external source to this EUT description, click "Add a Report".

Also, you can use the [test step action button](#) "Generate the Report as an Attachment" (in the [Test Plan](#) dialog) to attach a summary report to this list.

The list shows icons of the attached report's file type (for example, pdf), the filename and the date of creation. You can enter an arbitrary comment for each attached report.

To open an attached report file in an appropriate program, click "View this Report" (the  eye button).

To delete an attached report, click the delete button  in this report's line.

External Report templates

External Report templates

Available only, if you have installed the [license](#) "ELEMC-REP" for report customization, which requires that a [dongle](#) with this license is connected.

This dialog allows selecting and viewing the customized XML-based text templates (in dotx format) to be used as main and individual report templates for this EUT, as described in [Administration](#) > [Report](#) > [External](#).

For a guideline of how to create customized report templates, refer to [Chapter 6.6](#), "[Creating customized reports](#)", on page 577.

4.4 Tests

Tests are used to measure the electromagnetic compatibility of EUTs. Each test is based on a single [Test Template](#), which must be configured before running the test.

The [software structure](#) shows that an EUT description can contain tests, and a test contains one test template.

By creating a test and selecting a test template for it, all settings of this test template are copied into a newly generated [Test container](#). If the original test template is modified later on, its changes do not influence any previously created tests.



See [Chapter 7, "Running tests"](#), on page 592 for information on how to run tests and how to work with the [test control elements](#) in an opened test.

Handling test items



Access: "Home" > "Tests"

Depending on the selection of one or several tests, different action buttons are available in the actions bar. Most of them are common action buttons, described in [Chapter 3.3 on page 45](#). The dialog-specific action buttons for tests are:



"Delete" removes the selected one or more tests from the database. But if a test is associated with an EUT, deleting the test also removes it from the test plan of this EUT.

Deletion is protected with a confirmation warning.



"Archive" moves the selected one or more tests to the archive of R&S ELEKTRA, as described in [Chapter 4.11, "Archive"](#), on page 515. But if a test is associated with an EUT, archiving the test (but not the EUT) also removes the test from the test plan of this EUT.



"Set selected tests as Done" labels the selected one or more tests as completed. Not available for open tests. You cannot modify a completed test, and you cannot remove the "Done" state. If you want to edit a completed test, consider making a copy of it, see ["Copy"](#) on page 48. Or open it and save it under a new name, see ["Save As"](#) on page 46. To search for tests in "Done" state, use the search filter, see [Figure 6-3](#).

For information on how to proceed from **"Create: Test"**, see [Chapter 4.4.1, "Configuring tests"](#), on page 88.

Use the "Open" button to view or configure selected tests (see [Configuring test charts](#) and [Configuring test tables](#)) or to evaluate the [Test results](#).

The following chapters describe how to configure tests, test charts and test tables.

- [Configuring tests](#)..... 88
- [Configuring test charts](#)..... 98
- [Configuring test tables](#)..... 108

4.4.1 Configuring tests

Access: "Home" > "Tests"

- Click "Create: Test" to generate a new test. In the dialog that comes up, select the test type:

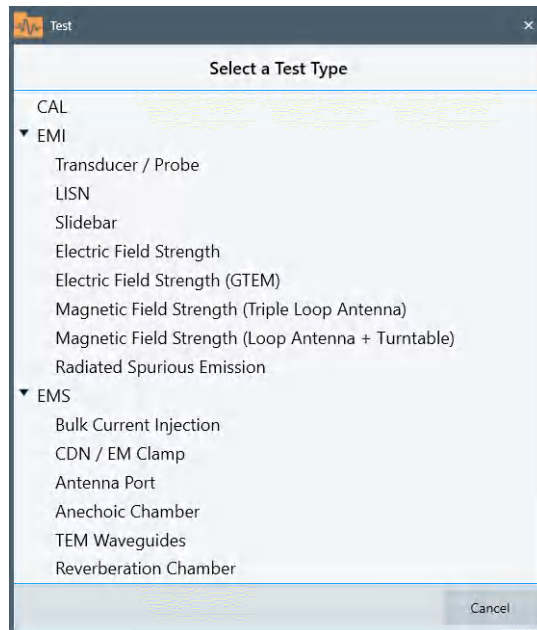

Figure 4-21: Click a line to select a test type (also called test category)

Selecting any of these test types opens a dialog to create and configure this type of test. The following chapters explain, how this configuration is done:

- **"CAL"** - see [Configuring calibration measurements](#)
- **"EMI - ..."** - see [Configuring EMI tests](#)
Available EMI test types are:
 - "Transducer / Probe"
 - "LISN"
 - "Slidebar"
 - "Electric Field Strength"
 - "Electric Field Strength (GTEM)"
 - "Magnetic Field Strength (Triple Loop Antenna)"
 - "Magnetic Field Strength (Loop Antenna + Turntable)"
 - "Radiated Spurious Emission"
- **"EMS - ..."** - see [Configuring EMS tests](#)
Available EMS test types are:
 - "Bulk Current Injection"
 - "CDN / EM-Clamp"
 - "Antenna Port"
 - "Anechoic Chamber"
 - "TEM Waveguides"
 - "Reverberation Chamber"

4.4.1.1 Configuring calibration measurements

Access: "Home" > "Tests" > "Create: Test" > "CAL"

The screenshot shows a 'New Test' dialog box. At the top, there are tabs for 'Home' and 'New Test'. The 'Test Category' is set to 'CAL'. Below this, there are four dropdown menus: 'EUT' (set to '<None>'), 'Test Name' (set to 'New_Test_Test'), 'Test Template' (set to '<None>'), and 'Report Template' (set to '<None>'). Each dropdown has a three-dot menu icon to its right. Below the dropdowns is a button labeled '+ Add Information' with up and down arrow icons. Underneath is a table with two columns: 'Title' and 'Content'. The table has four rows: 'Description', 'Test Standard', 'Test Site', and 'Operator Name'. Each row has a trash icon in the 'Content' column. At the bottom of the dialog are two buttons: 'New Test' and 'Cancel'.

Figure 4-22: New Test configuration dialog, here: for calibration measurements

The top line in this dialog specifies the "Test Category" that you have selected, see "Test Type" in [Figure 4-21](#). Here, the "Test Category" is "CAL".



Start with selecting the "Test Template".

Below the top line, the dialog offers the following selections:

EUT

Selects the equipment under test (EUT) from a list of preconfigured EUT descriptions. If any EUT is already **activated**, R&S ELEKTRA automatically enters it in this field as a default. If you select a different EUT and create the test by clicking the "New Test" button, the test uses this EUT instead of the globally activated default EUT. However, your selection does not change the activation state of the globally activated EUT.

For the configuration of EUT descriptions, see [Chapter 4.3, "EUTs"](#), on page 66.

Selecting an EUT is a prerequisite for creating a calibration measurement.

Test Name

The software suggests a default test name. When you select a test template (see below), R&S ELEKTRA automatically sets the "Test Name" to the name of the test template, extended by "_Test". You can edit this name.

If you first enter a name and then select the test template, R&S ELEKTRA overwrites your name by the name that it generates automatically.

Specifying a test name is a prerequisite for creating a calibration measurement.

Test Template

Selects a test template from a list of preconfigured items.

The test template configuration for "CAL" measurements is described in [Chapter 4.5.1, "Test Templates for calibration measurements"](#), on page 119.

Selecting a test template is a prerequisite for creating a calibration measurement.

Report Template

Selects a report template from a list of preconfigured items.

The report template configuration is described in [Chapter 4.6, "Report Templates"](#), on page 324.

Selecting a report template is optional for creating a test. If the test template selected above is specified with a default report template, this report template is automatically entered here.

Test Information

Allows specifying test information, especially such information that is valid for every calibration measurement based on this template.

Click "Add Information"  to create more lines of information. Edit the "Title" and "Content" of each line as required.

To move a line up or down, first double-click it to highlight the whole line. You can also click once inside the line, but this click must be anywhere outside of the editable fields, hence the dark blue area in the following figure:

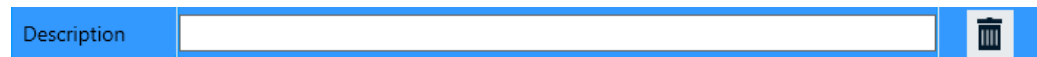

Once the line is highlighted, click the now enabled up or down arrows to move the line.

To remove a line that you do not need, click the "Delete Information" button .

You can add individual, test-specific information per measurement in the [Test Components](#) dialog.

Actions

Specify [actions](#) that are executed when a particular event occurs during a measurement.

New Test



Click "New Test" to run a [calibration measurement](#) or "Cancel" to quit the test configuration immediately.

4.4.1.2 Configuring EMI tests

Access: "Home" > "Tests" > "Create: Test" > "EMI - ..."

The screenshot shows a 'New Test' configuration dialog. At the top, there are tabs for 'Home' and 'New Test'. The main area is titled 'Test Category Transducer / Probe'. Below this, there are several input fields: 'EUT' with a dropdown menu showing '<None>', 'Test Name' with the text 'New_Test_Test', 'Test Template' with a dropdown menu showing '<None>', 'Limit Line' with a dropdown menu showing '<None>', and 'Report Template' with a dropdown menu showing '<None>'. Each dropdown menu has a small icon to its right. Below these fields is a table with two columns: 'Title' and 'Content'. The table has four rows: 'Description', 'Test Standard', 'Test Site', and 'Operator Name'. Each row has a trash icon to its right. At the bottom of the dialog, there is an 'Add Information' button with a plus sign and arrows, and two buttons: 'New Test' and 'Cancel'.

Figure 4-23: New Test configuration dialog for EMI tests

The top line in this dialog specifies the "Test Category" that you have selected, see "Test Type" in [Figure 4-21](#). Here, the "Test Category" is "EMI - Transducer / Probe").



Start with selecting the "Test Template".

Below the top line, the dialog offers the following selections:

EUT

Selects the equipment under test (EUT) from a list of preconfigured EUT descriptions. If any EUT is already **activated**, R&S ELEKTRA automatically enters it in this field as a default. If you select a different EUT and create the test by clicking the "New Test" button, the test uses this EUT instead of the globally activated default EUT. However, your selection does not change the activation state of the globally activated EUT.

For the configuration of EUT descriptions, see [Chapter 4.3, "EUTs"](#), on page 66.

Selecting an EUT is a prerequisite for creating a test.

Test Name

The software suggests a default test name. When you select a test template (see below), R&S ELEKTRA automatically sets the "Test Name" to the name of the test template, extended by "_Test". You can edit this name.

If you first enter a name and then select the test template, R&S ELEKTRA overwrites your name by the name that it generates automatically.

Specifying a test name is a prerequisite for creating a test.

Test Template

Selects a test template from a list of preconfigured items. R&S ELEKTRA automatically limits the choice to those items that qualify as EMI test templates for your type of test, for example "EMI - Transducer / Probe".

The configuration of test templates for EMI tests is described in [Chapter 4.5.2, "Test Templates for EMI tests"](#), on page 136.

Selecting a test template is a prerequisite for creating a test.

Limit Line

The limit line is *automatically* entered in this field by R&S ELEKTRA, when the test template is selected (which is obligatory), but *only*, if the test template contains exactly one limit line. Afterwards, you can optionally select a different limit line from the list of preconfigured items. But if you do so and then select a test template *after* that, your limit line selection is overwritten by the setting in the test template.

If *no limit line is suggested* by the software upon selecting a test template, this lack of a suggestion can have two different reasons:

- The test template contains no limit line, which is indicated by a placeholder "<none>" in the empty "Limit Line" field
- The test template contains more than one limit line (for various frequency ranges), which is indicated by a placeholder "<Multiple Selection>" in the empty "Limit Line" field

In either case, you can decide:

- Leave this field blank. In this case, R&S ELEKTRA does not overwrite anything.
- Select any limit line. In this case, if different limit lines have been specified in the test template, R&S ELEKTRA *overwrites all of them* with the limit line that you have selected.

Therefore, unless you are sure, we recommend leaving a blank limit line field blank in this instance, to avoid overwriting different limit lines in the test template's frequency ranges.

Instead of selecting a limit line in this field, we recommend to first create the test and then open the test template inside the test. This way, you can better decide, if one or more limit lines need to be selected.

The configuration of limit lines is described in [Chapter 4.9.1, "Limit Lines"](#), on page 497.

Selecting a limit line is optional for creating a test.

Report Template

Selects a report template from a list of preconfigured items.

The configuration of report templates is described in [Chapter 4.6, "Report Templates"](#), on page 324.

Selecting a report template is optional for creating a test. If the test template selected above is specified with a default report template, this report template is automatically entered here.

Test Information

Allows specifying test information, especially such information that is valid for every test based on this template.

Click "Add Information"  to create more lines of information. Edit the "Title" and "Content" of each line as required.

To move a line up or down, first double-click it to highlight the whole line. You can also click once inside the line, but this click must be anywhere outside of the editable fields, hence the dark blue area in the following figure:

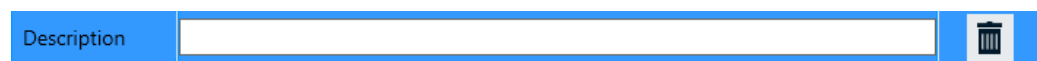

Once the line is highlighted, click the enabled up or down arrows to move the line.

To remove a line that you do not need, click the "Delete Information" button .

You can add individual, test-specific information per measurement in the [Test Components](#) dialog.

New Test



Click "New Test" to run an [EMI test](#) or "Cancel" to quit the test configuration immediately.

4.4.1.3 Configuring EMS tests

Access: "Home" > "Tests" > "Create Test" > "EMS"

Test Category Bulk Current Injection

EUT <None> ...

Test Name New Test_Test

EMS Test Template <None> ...

Test Method

Report Template <None> ...

+ Add Information ↑ ↓

Title	Content
Description	
Test Standard	
Test Site	
Operator Name	

New Test Cancel

Figure 4-24: New Test configuration dialog for EMS tests

The top line in this dialog specifies the "Test Category" that you have selected, see "Test Type" in [Figure 4-21](#). Here, the "Test Category" is "EMS - Bulk Current Injection".



Start with selecting the "EMS Test Template".

Test Category Bulk Current Injection

EUT EUT 1 ...

Test Name EN 61000-4-6 BCI EUT Test 10V_Test

EMS Test Template EN 61000-4-6 BCI EUT Test 10V ...

Test Method EUT Qualification

Leveling Mode Substitution Method

Reference Calibration CC 100mA Example × ...

Test Level 10 V

Sensor Limit 66 mA

EUT Monitoring Template EUT Monitoring with AdvISE × ...

Report Template EMS Standard Report × ...

Title

Figure 4-25: Example of extended dialog after selecting an EMS test template

Below the "Test Category" line, the dialog can offer the following selections, depending on the content of the fields "EMS Test Template", "Test Method" and "Leveling Mode":

EUT

Selects the equipment under test (EUT) from a list of preconfigured EUT descriptions. If any EUT is already [activated](#), R&S ELEKTRA automatically enters it in this field as a default. If you select a different EUT and create the test by clicking the  "New Test" button, the test uses this EUT instead of the globally activated default EUT. However, your selection does not change the activation state of the globally activated EUT.

For the configuration of EUT descriptions, see [Chapter 4.3, "EUTs"](#), on page 66.

Selecting an EUT is a prerequisite for creating a test.

Test Name

The software suggests a default test name. When you select an EMS test template (see below), R&S ELEKTRA automatically sets the "Test Name" to the name of the test template, extended by "_Test". You can edit this name.

If you first enter a name and then select the test template, R&S ELEKTRA overwrites your name by the name that it generates automatically.

Specifying a test name is a prerequisite for creating a test.

EMS Test Template

Selects an EMS test template from a list of preconfigured items. R&S ELEKTRA automatically limits the choice to those items that qualify as EMS test templates for your type of test, for example "EMS - Bulk Current Injection".

The configuration of test templates for EMS tests is described in [Chapter 4.5.3, "Test Templates for EMS tests"](#), on page 243.

Selecting a test template is a prerequisite for the availability of all the following fields (except "Report Template") and for creating a test.

Test Method

R&S ELEKTRA automatically selects the test method, based on the settings in the selected test template (which is obligatory). See ["Test Method"](#) on page 252.

Test Standard

Available only, if the test category is "Antenna Port". R&S ELEKTRA automatically defines the test standard, based on the settings in the selected test template. See ["Specific Data"](#) on page 268.

Leveling Mode

Available only, if the test method is "EUT Qualification" or "Reference Calibration". R&S ELEKTRA automatically selects the leveling mode, based on the settings in the selected test template (which is obligatory). See ["Leveling Mode"](#) on page 259.

Frequency f0

Available only, if the test category is "Antenna Port". R&S ELEKTRA automatically defines the frequency at the EUT port, based on the settings in the selected test template. See "[Specific Data](#)" on page 268.

Reference Calibration

Available only, if the leveling mode is "Substitution Method". R&S ELEKTRA automatically selects the reference calibration table, based on the settings in the selected test template (which is obligatory). Alternatively, you can select a different reference calibration table or create a new one. See "[Reference Calibration Table](#)" on page 263.

Test Level

Available only after selecting a test template. R&S ELEKTRA automatically enters the test level setting from the test template. Afterwards, here you can change the test level only, if the test template uses the same level unit across all frequency ranges. See "[Test Level](#)" on page 277.

For "Antenna Port" test category, see "[Specific Data](#)" on page 268.

Exclude Range f(Low)

Available only with test category "Antenna Port". R&S ELEKTRA automatically enters the lowest excluded frequency, based on the settings in the selected test template. See "[Specific Data](#)" on page 268.

Exclude Range f(High)

Available only with test category "Antenna Port". R&S ELEKTRA automatically enters the highest excluded frequency, based on the setting in the selected test template. See "[Specific Data](#)" on page 268.

EUT Sensitivity

Available only with test category "Antenna Port". R&S ELEKTRA automatically enters the EUT sensitivity level, based on the setting in the selected test template. See "[Specific Data](#)" on page 268.

EUT Monitoring Template

Available only with the test methods "EUT Qualification" or "EUT Susceptibility". R&S ELEKTRA automatically enters the EUT monitoring template specified in the test template (if specified there).

You can select a (possibly different) EUT monitoring template. If you change the test template *after* selecting an EUT monitoring template, the test template overwrites your EUT monitoring template selection.

The configuration of EUT monitoring templates is described in [Chapter 4.5.4, "EUT Monitoring templates"](#), on page 307.

Selecting an EUT monitoring template is optional for creating a test.

Report Template

Selects a report template from a list of preconfigured items. R&S ELEKTRA automatically enters the report template specified in the test template (if specified there).

You can select a (possibly different) report template. If you change the test template *after* selecting a report template, the test template overwrites your report template selection.

The configuration of report templates is described in [Chapter 4.6, "Report Templates"](#), on page 324.

Selecting a report template is optional for creating a test.

Test Information

Allows specifying test information, recommended especially for information that is valid for every test based on this template.

Click "Add Information"  to create more lines of information. Edit the "Title" and "Content" of each line as required.

To move a line up or down, first double-click it to highlight the whole line. You can also click once inside the line, but this click must be anywhere outside of the editable fields, hence the blue area in the following figure:



Once the line is highlighted, click the enabled up or down arrows to move the line.

To remove a line that you do not need, click the "Delete Information" button .

You can add individual, test-specific information per measurement in the [Test Components](#) dialog.

New Test



Click "New Test" to run an [EMS test](#) or "Cancel" to quit the test configuration immediately.

4.4.2 Configuring test charts

Access: "Home" > "Tests" > "Open" "... test"

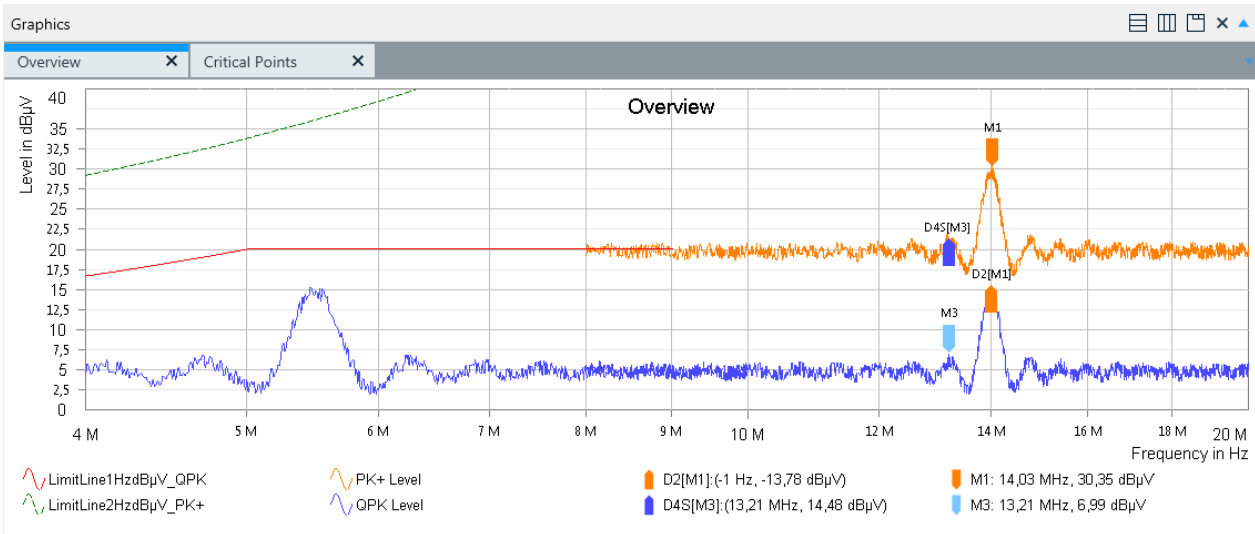

Figure 4-26: Example of an EMI test chart

- PK+ Level = Trace of "Max Peak" detector measurements
- QPK Level = Trace of "Quasi Peak" detector measurements (here: two frequency ranges, overlapping at 8 MHz to 10 MHz)
- M1 = Marker 1 (in color of its own trace), see [Marker](#)
- D2[M1] = Delta marker 2 (referenced to M1, in color of reference trace), see [Set Reference](#)
- M3 = Unreferenced marker 3 (light blue = selected)
- D4S[M3] = Synchronized delta marker 4 (referenced to M3, in color of reference trace)

In an existing EMI test (which has previously been executed and saved, as described in [EMI tests](#)), you can configure the test results presentation as described in the following chapters.

The presentation of the results of an existing EMS test (which has previously been executed and saved, as described in [EMS tests](#)), is configured accordingly.

- [Chart](#)..... 99
- [Trace](#)..... 104
- [Marker](#)..... 105

4.4.2.1 Chart



Access: "Home" > "Tests" > "Open" "... test" > "Chart Menu" button

In the charts configuration, you can determine how one or more charts are displayed and how the axes are scaled. You can determine the graphic properties and make the content of charts available outside of R&S ELEKTRA.

- [Hide / show charts](#)..... 100
- [Close / Close all](#)..... 100
- [Arrange charts](#)..... 100
- [Chart](#)..... 100
 - L [Connect Charts](#)..... 100
 - L [Set Logarithmic x-Axis in all Graphics](#)..... 101
 - L [Set Linear x-Axis in all Graphics](#)..... 101
 - L [Axis X](#)..... 101

L X Axis Logarithmic.....	101
L Change scale.....	101
L Manual frequency scaling.....	101
L Do Autoscale.....	101
L Autoscale to measurement result.....	102
L Axis Y.....	102
L Y Axis Logarithmic.....	102
L Change scale.....	102
L Manual level scaling.....	102
L Do Autoscale.....	103
Copy To Clipboard.....	103
Save Image to File.....	103
Store Zoom Settings.....	103
Graphics Properties.....	103
Print.....	104
Zoom.....	104

Hide / show charts



The top "Graphics" bar toggles between hiding and showing all charts. If both graphics and tables are visible (half screen, each), hiding the graphics shows the tables in full size. Hiding the tables, too, leaves the two top bars visible, only. Opening the graphics while the tables are hidden shows the charts in full size.

Close / Close all

Closes the selected chart or all charts that are shown. To reopen closed charts, double-click their names in the [Test Components](#) side panel.



Arrange charts

To arrange charts horizontally, vertically or cascade them behind each other, use the buttons   . Available only, if more than one chart is open.

Chart

Right-clicking the chart and selecting "Chart" (or clicking the "Chart Menu" button ) provides access to the chart configuration functions described below. If more than one chart is open, clicking the "Chart Menu" button also requires selecting the chart for which you want to access the chart configuration functions.

Connect Charts ← **Chart**

Right-clicking a chart and selecting "Chart" > "Connect Charts" allows moving markers jointly in different charts. The connect function is only available, if at least two charts are present and at least one marker is set in one of the charts. Setting or moving a marker in another chart moves the "active" marker (the one that was selected last) in each of the connected charts to the same frequency.

Synchronized markers within the same chart remain synchronized, even when connected to a marker in a different chart. A marker in a connected chart is no longer displayed, if it moves out of the frequency range of "its" trace, while following a marker in a different chart. When it is moved back into that frequency range, it is displayed again.

Note that markers cannot be *referenced* to markers in other charts. Instead, display the trace in question within the same chart by ["Add Trace"](#) on page 104.

The joint movement of connected markers can best be seen in charts that are displayed next to each other by "[Arrange charts](#)" on page 100.

To terminate the connect function, click "Chart" > "Connect Charts" again. Deleting all markers in one chart also terminates the connect function.

Set Logarithmic x-Axis in all Graphics ← Chart

Right-clicking the chart and selecting "Chart" allows enabling "Set Logarithmic x-Axis in all Graphics".

Set Linear x-Axis in all Graphics ← Chart

Right-clicking the chart and selecting "Chart" allows enabling "Set Linear x-Axis in all Graphics".

Axis X ← Chart

Right-clicking the chart and selecting "Chart" > "Axis X" provides access to the X-axis configuration functions described below.

X Axis Logarithmic ← Axis X ← Chart

Toggles between logarithmic and linear X-axis. Alternatively, right-clicking the X-axis allows enabling or disabling the logarithmic scale.

Note: Logarithmic scale is not available, if zero or negative values are shown on the axis.

Change scale ← Axis X ← Chart

Opens a dialog to set the frequency range limits for the X-axis. Alternatively, right-clicking the X-axis and selecting "Change scale" opens the same dialog.

Manual frequency scaling ← Change scale ← Axis X ← Chart

Clicking, holding and horizontally drawing the mouse pointer in the left, center or right third of the X-axis allows a manual frequency scale adjustment:

- In the **left** third, the lower (left) end of the frequency scale is manipulated.
- In the **center** third, the whole frequency scale is shifted up or down.
- In the **right** third, the upper (right) end of the frequency scale is manipulated.

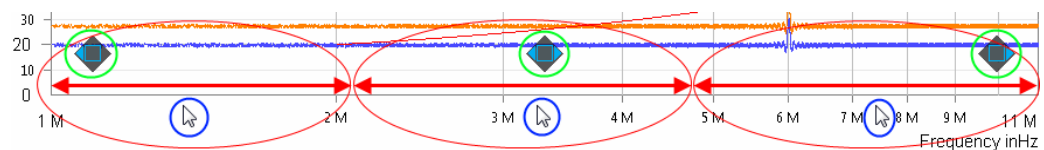

- | | |
|-------------------------|---|
| Green circles | = Direction indicators for manual scale adjustment of the frequency axis (only one indicator visible at a time) |
| Red arrows in red ovals | = Left 1/3, center 1/3 and right 1/3 of the frequency axis |
| Blue circles | = Mouse pointer positions in the left, center and right third of the axis |

Do Autoscale ← Axis X ← Chart

Automatically adjusts the scale of the X-axis to the frequency range used for measurements. Alternatively, right-click the X-axis and select "Do Autoscale" or hit the [Shift] + [x] keys to do the same.

Autoscale to measurement result ← Axis X ← Chart

Truncates frequencies outside the measured range: R&S ELEKTRA adjusts the boundaries on the X-axis to the values displayed in the chart. Alternatively, right-clicking the X-axis and selecting "Autoscale to measurement result" allows doing the same.

Axis Y ← Chart

Right-clicking the chart and selecting "Chart" > "Axis Y" provides access to the Y-axis configuration functions described below.

Y Axis Logarithmic ← Axis Y ← Chart

Toggles between logarithmic and linear Y-axis. Alternatively, right-clicking the Y-axis allows enabling or disabling the logarithmic scale.

Note: Logarithmic scale is not available, if zero or negative values are shown on the axis.

Logarithmic Y-axis is not available for dB levels, because dB levels are logarithmic already.

Change scale ← Axis Y ← Chart

Opens a dialog to set the level range limits for the Y-axis. Alternatively, right-clicking the Y-axis and selecting "Change scale" opens the same dialog.

Manual level scaling ← Change scale ← Axis Y ← Chart

Clicking, holding and vertically drawing the mouse pointer in the upper, middle or lower third of the Y-axis allows a manual level scale adjustment:

- In the **upper** third, the upper end of the level scale is manipulated.
- In the **middle** third, the whole level scale is shifted up or down.
- In the **lower** third, the lower end of the level scale is manipulated.

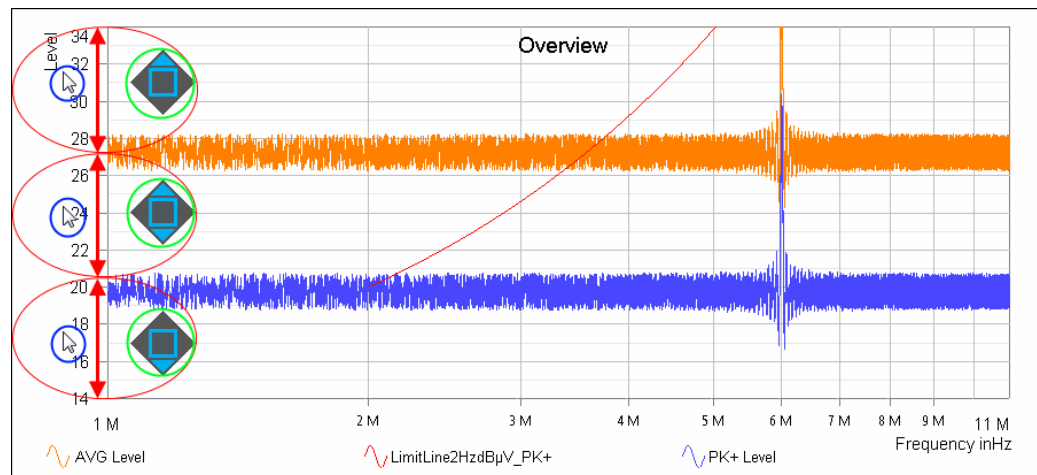

- | | |
|-------------------------|---|
| Green circles | = Direction indicators for manual scale adjustment of the level axis (only one indicator visible at a time) |
| Red arrows in red ovals | = Upper 1/3, middle 1/3 and lower 1/3 of the level axis |
| Blue circles | = Mouse pointer positions in the upper, middle and lower third of the axis |

Do Autoscale ← Axis Y ← Chart

Automatically adjusts the scale of the Y-axis to a range that is a bit wider than the measured levels. Alternatively, right-click the Y-axis and select "Do Autoscale" or hit the [Shift] + [y] keys to do the same.

Copy To Clipboard

Right-clicking the chart and selecting "Copy To Clipboard" captures a screenshot bitmap of the active chart and copy it to the clipboard. Outside of R&S ELEKTRA, this bitmap chart can then be entered into any application that allows pasting graphics.

Save Image to File

Right-clicking the chart and selecting "Save to Image File" saves a screenshot bitmap of the active chart outside of R&S ELEKTRA in portable network graphics (PNG) format.

Store Zoom Settings

Saves the current view, when you have [zoomed](#) into a chart. The saved view with its individual zoom settings is available in the "Test Content" > "Graphics" section of the [Test Components](#) dialog, where you can rename it by a right-click. Double-clicking a saved view opens this chart with the stored zoom settings. Double-clicking a different saved view of the same graphic changes the view of the displayed chart accordingly. Double-clicking the basic node of the same graphic returns the displayed chart to its full view.

The same feature is available for [Evaluation - 3D Evaluation](#) charts, where "Store Zoom Settings" saves more viewing parameters: both the angular tilt and rotation of the view ("elevation and azimuth of camera") and the zoom factor ("distance of camera"). A view's entry in the "Test Content" > "Graphics" section starts with "Camera" and labels the viewing parameters as "El" (elevation), "Az" (azimuth) and "Dist." (distance).

You can integrate the saved views directly into your [test reports](#), see [Chapter 4.6.1, "Configuring report templates"](#), on page 325.

Graphics Properties

Right-clicking the chart and selecting "Graphics Properties" opens the "Chart Options" dialog to define the settings for [Graphics](#), [Marker](#), [Grid](#) and [Traces](#).

While these settings are local for the currently opened graphic chart, the same settings can also be defined globally as a default for all new graphics, as described in [Chapter 4.12.6.4, "Graphics"](#), on page 547. However, the global settings do not influence tests that have already been created.

Note:

- The parameter "Show Pixel Mode" in the tab "Marker" > "Pixel Mode" specifies how markers are moved along traces (especially noticeable, if only a few frequency points are visible). If "Show Pixel Mode" is enabled, markers move from pixel to pixel between frequency (measurement) points. If disabled, markers can only jump from one frequency point to the next (see [Graphics > Marker > "Pixel Mode"](#)).
- The parameter "Peak Excursion" in the tab "Marker" > "Search" determines, whether local maxima qualify as peaks. For a definition of "Peak Excursion", refer to [Graphics > Marker > "Search"](#).

Print

Opens a dialog for printing the chart.

Zoom

Right-clicking the chart and selecting "Zoom" allows viewing enlarged sections of a chart ("zoom into a chart"). Zooming is done by drawing a rectangle with the left mouse button, to specify the area to be zoomed. In this way, multiple zooming into the same chart is possible. The first zoom can also be done by just drawing a rectangle, as long as the mouse pointer's origin does not collide with any object in the chart. A small copy of the whole chart, superimposed in the upper right corner, provides an overview of the zoomed area (dark rectangle) in relation to the whole chart area.

Using a tablet computer with [touch-sensitive display](#), test charts can be zoomed by stretching or shrinking them with two fingers ("pinch to zoom"): Zooming is done by touching and holding two opposite corners of the rectangular area that you want to zoom, then drawing your fingers apart or bringing them closer together.

Once zoomed, clicking and holding the chart's visible fraction allows dragging it to a different area of the full chart at the same zoom factor. Alternatively, the dark rectangle mentioned above can be dragged by clicking and holding it. However, avoid clicking the chart in a place that is occupied by a trace, line or marker, as this click would call up other functions.

The zoomed view is disabled by double-clicking the chart or by right-clicking the chart and selecting "Undo Zoom".

4.4.2.2 Trace

In the trace configuration, you can add or delete traces, move a trace to the front and set its properties.

Right-clicking the chart and selecting "Trace" provides access to the trace functions described below.

Add Trace.....	104
L Constant Trace.....	105
L Result Trace from another Test.....	105
L Global Limit Line.....	105
L Global Attenuation / Transducer Corr.....	105
Delete Trace.....	105
Move Trace To Front.....	105
Trace Properties.....	105
L Traces.....	105
L Line.....	105
L Symbol.....	105
L Line To Bottom.....	105

Add Trace

Right-clicking the chart and selecting "Trace" > "Add Trace" allows selecting the kind of trace to be added as described below.

Constant Trace ← Add Trace

Adds a horizontal line in the chart with a user-defined trace name and a constant level (Y) value.

Result Trace from another Test ← Add Trace

Adds a trace from a column selected in a result table of another test.

Global Limit Line ← Add Trace

Adds a trace from a column in "Tables" > "Limit Lines".

Global Attenuation / Transducer Corr. ← Add Trace

Adds a trace from "Tables" > "Attenuation" or from "Tables" > "Transducer Correction".

Delete Trace

Right-clicking the chart and selecting "Trace" > "Delete Trace" allows selecting a trace and deleting it.

Move Trace To Front

Right-clicking the chart and selecting "Trace" > "Move Trace To Front" allows selecting a trace and moving it to the front.

Trace Properties

Right-clicking the chart and selecting "Trace" > "Trace Properties" opens a dialog that defines the following trace settings. Alternatively, this dialog can be accessed by right-clicking a *trace* and selecting "Trace Properties".

Traces ← Trace Properties

Selects the trace, limit line or symbol trace to be configured.

Line ← Trace Properties

Specifies "Color", "Thickness" and "Style" of the selected trace.

Symbol ← Trace Properties

Specifies "Color", "Size" and "Shape" of symbols on the selected trace.

Line To Bottom ← Trace Properties

Specifies "Color", "Thickness" and "Style" of lines that connect symbols on the selected trace to the lower edge of the chart.

4.4.2.3 Marker

Access: "Home" > "Tests" > "Open" "... test" > "Marker Menu" button 

In the marker configuration, you can add or delete markers, reference markers to each other or move them to specific positions. The [Pixel Mode](#) determines the step size for moving markers. To specify default marker properties such as flag colors and "Peak Excursion", use the "Home" > [Administration](#) > [Settings](#) > [Graphics](#) > [Marker](#) dialog.

All markers have a name label and, by default, a flag with the same color as "their" trace or as the trace of the referenced [Delta](#) marker.

To select a marker, click it directly or click its legend entry. The selected marker (or selected last, if multiple markers are present) is identified by a light blue flag, if color is enabled in the [Graphics Properties](#). This blue "highlighting" color temporarily overrides the original flag color.

Moving markers manually

Click and hold a marker to drag it to any position on the same trace. Alternatively, you can use the left and right arrows on the keyboard or the mouse wheel to move the selected marker. (In [Pixel Mode](#), these steps can be too small to see them without zooming.)

Moving markers automatically

Right-click a marker to select one of the following marker positioning functions:

- "Marker" > [To Peak](#)
- "Marker" > [To Next Peak](#)
- "Marker" > [To Min](#)
- "Marker" > [To Next Min](#)
- "Marker" > [To Position](#)
- "Marker" > [To Trace](#)

Alternatively, right-click the *chart* to select one of these functions for positioning the selected (highlighted) marker.



Be aware of the following:

- Synchronized markers always move jointly.
- Selected markers in other charts also move, if [Connect Charts](#) is activated.
- The moving behavior of markers is influenced by the [Pixel Mode](#) setting.

Right-clicking the chart and selecting "Marker" (or clicking the "Marker Menu" button ) provides access to the marker functions described below. If more than one chart is open, clicking the "Marker Menu" button also requires selecting the chart for which you want to access the marker configuration functions.

Add To Trace	106
Set Reference	107
Pixel Mode	107
To Peak	108
L To Next Peak	108
To Min	108
L To Next Min	108
To Position	108
To Trace	108
Delete Marker	108

Add To Trace

Allows selecting the trace, to which a new marker is to be set, and adds the marker to this trace.

- If the marker that you set is the first one in this chart, it is immediately set to the peak of the selected trace.
- If one or more other markers are already present in the chart, R&S ELEKTRA opens a context dialog that offers three selections:
 - "Trace" - allows changing the trace that you have selected for the marker
 - "Reference Mode" - specifies if and how the marker is referenced to another marker, see [Set Reference](#)
 - "Reference Marker" - specifies to which other marker the new marker is referenced (not available for "Reference Mode" = "None")

If the [Reference Mode](#) is set to "None", R&S ELEKTRA places the new marker at the trace's peak.

Alternatively, directly double-clicking a *trace* and confirming the defaults in the "Add New Marker" dialog allows placing a new marker on the trace. Unless you have selected to [synchronize](#) the marker, it is placed at or near the mouse click position.

Note: If you double-click a trace to add a new marker, but the chart is [zoomed](#), your double-click first disables the zoom. To add the new marker, double-click the trace again.

Set Reference

Opens a dialog for specifying a "Reference Mode" for any two markers.

Alternatively, directly right-clicking a *marker* and selecting "Set Reference" opens the same dialog, with this marker preselected.

To set a reference, first select a "Marker" (or keep the preselected marker), then select one of the following options for the "Reference Mode":

- **"Delta"** shows the level difference value of the two referenced markers in the legend
- **"Synchronized"** locks the two markers to the same frequency (only available for markers on different traces)
- **"SynchronizedDelta"** locks two markers on different traces to the same frequency *and* calculates their delta
- **"None"** leaves the selected marker unreferenced with any other marker (= default)

Finally, select the "Reference Marker" from a list of markers that are available for referencing (not available for "Reference Mode" = "None").

Pixel Mode

Opens a dialog for activating or deactivating the "Pixel Mode" function.

- If enabled, a marker can move from pixel to pixel on the display between the frequency (measurement) points.
- If disabled, the marker can only jump from one frequency point to the next. The effect of this setting becomes especially noticeable, if only a few frequency points are visible, for example when zooming deeply into a trace.

Alternatively, the setting can be accessed by right-clicking a *marker* and selecting "Pixel Mode", or by right-clicking the chart and selecting [Graphics Properties](#) > "Marker" > "Pixel Mode" > "Show Pixel Mode".

The global setting for "Show Pixel Mode" can be altered at "Home" > [Administration](#) > [Settings](#) > [Graphics](#) > [Marker](#) > "Pixel Mode". However, **this setting does not influence any test** that has already been created.

To Peak

[Automatically moves](#) a marker to the peak value of a trace.

To Next Peak ← To Peak

[Automatically moves](#) a marker to the next peak value of a trace, if it has previously been set to the overall peak ("To Peak"). Moving a marker to the next peak can be repeated until the limit is reached that is specified by the parameter "Peak Excursion". This parameter is defined by clicking the chart and selecting "Graphics Properties" > "Marker". Defaults are defined at "Home" > [Administration](#) > [Settings](#) > [Graphics](#) > [Marker](#).

Note: Specifying the "Peak Excursion" in the [Graphics Properties](#) menu does not influence a test that has already been created.

To Min

[Automatically moves](#) a marker to the minimum value of a trace.

To Next Min ← To Min

[Automatically moves](#) a marker to the next minimum value of a trace, if it has previously been set to the overall minimum ("To Min").

Moving a marker to the next minimum can be repeated until the limit is reached that is specified by the parameter "Peak Excursion". This parameter is defined by clicking the chart and selecting "Graphics Properties" > "Marker". Defaults are defined at "Home" > [Administration](#) > [Settings](#) > [Graphics](#) > [Marker](#).

Note: Specifying the "Peak Excursion" in the [Graphics Properties](#) menu does not influence a test that has already been created.

To Position

[Automatically moves](#) a marker to a user-defined frequency. If this marker is synchronized with another marker, both are moved jointly to the new frequency position.

To Trace

[Automatically transfers](#) a marker to another trace or limit line. Note that a marker cannot be transferred to a trace or limit line where the same frequency position is already occupied by a synchronized marker. R&S ELEKTRA only offers the appropriate choice of targets.

Delete Marker

Allows selecting one specific marker or "All Markers" to be deleted.

Alternatively, right-clicking a marker and selecting "Delete Marker" offers the same choice.

4.4.3 Configuring test tables

Access: "Home" > "Tests" > "Open" "... test"

EMI test tables

Name	Rg	Frequency MHz	QPK Level dBµA	QPK Limit dBµA	QPK Margin dB	CAV Level dBµA	CAV: AVG Limit dBµA	CAV Margin dB	Correction dB	Meas. BW kHz	Meas. Time ms	Time of Meas.	Source	Comment
9	1	3.728	20.10	30.00	9.90				-8.84	9.000	2.000.000	10:48:24	Critical Points	
10	1	3.730				10.21	20.00	9.79	-8.84	9.000	2.000.000	10:48:24	Critical Points	
11	1	11.227	29.84	30.00	0.16				-8.73	9.000	2.000.000	10:48:24	Critical Points	
12	1	11.263				20.00	20.00	0.00	-8.73	9.000	2.000.000	10:48:24	Critical Points	
13	1	18.780	39.55	30.00	-9.55				-8.88	9.000	2.000.000	10:48:24	Critical Points	
14	1	18.809				29.70	20.00	-9.70	-8.88	9.000	2.000.000	10:48:24	Critical Points	
15	1	26.306	49.78	30.00	-19.78				-8.90	9.000	2.000.000	10:48:24	Critical Points	

Figure 4-27: Example of a final results table in an EMI test

EMI test tables contain the following columns:

- "Rg" - the frequency range number
- "Frequency" - the frequency points
- The "Level", "Limit" and "Margin" values for each [detector](#) selected in the [test template](#) (with $\text{Margin} = \text{Limit} - \text{Level}$)
- "Correction" - the accumulated amount of "Attenuation" and "Measurement Correction" specified for the [signal path](#) and [LISN](#) or [transducer](#) used in this measurement
- "Line" - only available in tests that use a [LISN](#): label of the LISN line, for example "N" or "L1". See also [Chapter 7.6, "Test result graphics"](#), on page 632.
- [Meas BW](#) - only available in "Final Results" tables
- [Meas. Time](#) - per point, only available in "Final Results" tables
- "Time of Meas." - only available in "Final Results" tables: R&S ELEKTRA automatically enters the date and time of the measurement. To toggle between a display of time only, or date and time, use the [Show / Hide Column Headers](#) button  to activate the "Accuracy" header. This header lets you select either "Date/Time" or just "Time".
- "Source" - only available in "Final Results" and "Critical Points" tables:
 - In the "Critical Points" table: The frequencies in the critical points table and in the final measurement can originate, for example, from steps in the [Data Reduction](#) or from [interactive measurements](#).
 - In the "Final Results" table: The measured values originate from the "Critical Points" or from "Interactive" measurements (individually [recorded](#)).
- "Comment" - content (which you can edit) depends on the kind of table:
 - In the "Overview" table: You can enter arbitrary comments in any cell of the "Comment" column.
 - In the "Critical Points" table: R&S ELEKTRA automatically enters the names of detectors, with which a critical level value was detected in the overview measurement at this frequency point.
 - In the "Final Results" table: During an [Interactive measurement for EMI tests](#), your comments from the [Measurements](#) dialog are automatically entered in the new rows that are generated in this table.

In a "Substitution Measurement", the EMI test table can have additional columns (one per V or H polarization, each):

- "TX Antenna Factor"

- "TX Cable Att"
- "TX SigPath Att"
- "RF Gen Level"
- "Pe"
- "Antenna Gain"
- "Margin Pe"

For more information, refer to ["Substitution Measurement"](#) on page 200.

If your test uses [Loop Parameters](#), the EMI test table can have the following additional columns:

- "Polarization"
- "Azimuth"
- "Elevation"
- "Antenna Height"
- "LISN Line"
- "Distance" (if there is a "Slidebar")
- "Final Results X/Y/Z" (axis of DUT orientation if there is a "GTEM")

If your [Final Measurement](#) uses the "CISPR APD" detector for [APD](#) measurements, the EMI test table can have the following additional columns:

- "Delta Level"
- "Delta Probability"

If your test template's "Actions" include [Capture Screenshot](#), the "Screenshot" column shows an icon that represents a human eye. The icon features a clickable link to the screenshot. When you hover the mouse pointer over the eye icon, R&S ELEKTRA shows the name of the screenshot, which is stored in the [Test container](#) > "Attachments".

EMS test tables

Name	Rg	Frequency	Test_Level	Channel 1	Gen_Out	Trd Fwd Pwr	Modulation	Comment
Unit		MHz	V/m	V	dBm	W		
1	1	1,000	9,7	7,1	-10,1	26,8	AM, 1 kHz, 80 %	NoGo: 'Channel 1'
2	1	1,010	9,8	5,6	-10,1	26,8	AM, 1 kHz, 80 %	
3	1	1,020	10,0	7,5	-9,8	28,1	AM, 1 kHz, 80 %	NoGo: 'Channel 1'
4	1	1,030	9,9	4,8	-9,9	27,9	AM, 1 kHz, 80 %	
5	1	1,041	10,0	6,3	-9,9	28,0	AM, 1 kHz, 80 %	
6	1	1,051	9,8	5,1	-10,0	27,1	AM, 1 kHz, 80 %	

Figure 4-28: Example of an overview table in a radiated EMS test

EMS test tables can contain the following columns:

- "Rg" - the frequency range number
- "Frequency" - the frequency points
- "Test_Level" - the emitted [immunity level](#) as specified in the [test template](#)

- "Channel n" - output of the EUT monitoring system, as specified for one or more channels in the [EUT monitoring template](#)
- "VSWR" ([System Monitoring](#)) - voltage standing wave ratio, based on the reverse sensor's measurement of reflected power, to evaluate the reflection coefficient in the system. A high VSWR value can be an indication that the RF connection between the amplifier and the transducer is defective.
- "Amp Fwd Pwr" ([System Monitoring](#)) - [Amplifier](#) forward power, measured by the forward sensor
- "Amp Rev Pwr" ([System Monitoring](#)) - amplifier reverse power, measured by the reverse sensor
- "Amp Saturation" ([System Monitoring](#)) - see "[Amplifier Saturation](#)" on page 298
- "Amp Input" ([System Monitoring](#)) - amplifier input level, required to reach the target immunity level
- "Gen Out" ([System Monitoring](#)) - [Generator](#) output level, required to reach the target immunity level
- "Trd Fwd Pwr" ([System Monitoring](#)) - transducer forward power, required to reach the target immunity level
- "Sensor Level" ([System Monitoring](#)) - level (V/m) measured by the test level (TL) sensor, typically a [Power Meter](#) (conducted) or [Field Probe](#) (radiated)
- "Sensor Level CHn_XYZ" - level (V/m) measured by [Additional Sensor Channels](#), if specified in the test template in a radiated setup
- "Modulation" - state (on or off) of the [Modulation](#) of the test level (immunity signal level)
- "Polarization" - antenna polarization "H" (horizontal) or "V" (vertical), if this [Loop Parameter](#) is specified
- "Azimuth" - angle of the turntable, if this [Loop Parameter](#) is specified
- "Antenna Height" - height of the antenna on the antenna tower, if this [Loop Parameter](#) is specified
- "User Defined" - test steps, if this [Loop Parameter](#) is specified
- "Comment" - automatically generated entries for EUT failure criteria detected by R&S ELEKTRA

CAL test tables

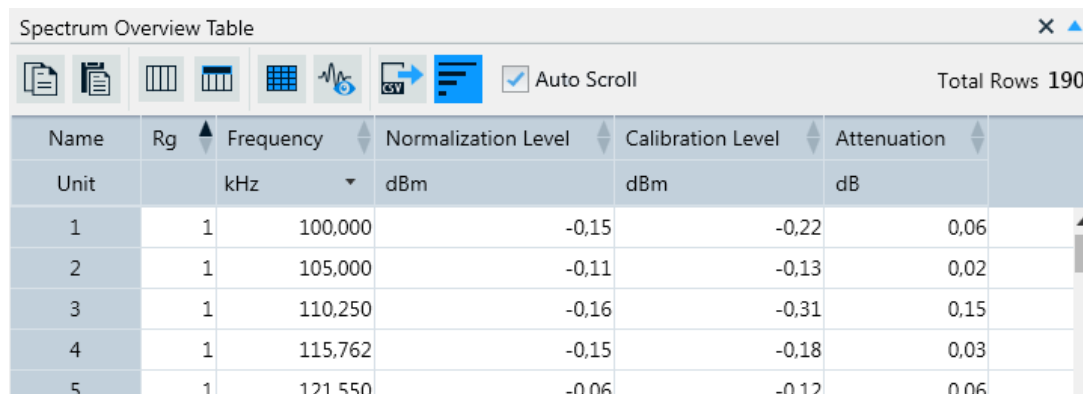

Name	Rg	Frequency	Normalization Level	Calibration Level	Attenuation	
Unit		kHz	dBm	dBm	dB	
1	1	100,000	-0,15	-0,22	0,06	
2	1	105,000	-0,11	-0,13	0,02	
3	1	110,250	-0,16	-0,31	0,15	
4	1	115,762	-0,15	-0,18	0,03	
5	1	121,550	-0,06	-0,12	0,06	

Figure 4-29: Example of a table in a calibration measurement

Calibration tables contain the following columns:

- "Rg" - the frequency range number
- "Frequency" - the frequency points
- "Normalization Level" - typically the level measured in a "shortcut" without the device to be measured, for example a signal path (a cable)
- "Calibration Level" - typically the level measured with the device present in addition to the "shortcut path" in the normalization measurement
- "Attenuation" - the difference between normalization and calibration level



To sort the table rows by any of the columns, click the column's name header. Click the name header again for reverse order.

For the default and optional headers of test tables, see [Table Headers](#).

For information on how to work with tables, see [Test result tables](#).

You can configure tables by the following functions:

Hide / show tables	113
Close / Close all	113
Arrange tables	113
Select cells	113
Delete rows	114
Copy	114
Paste	114
Add new row	114
Show / Hide Columns	114
Show / Hide Column Headers	115
Apply Process State	115
Select Table	115
Show Graphic Display	115
Export to CSV file format	115
Set default sorting	116
Auto Scroll	116

Sort table.....	116
Table Headers.....	116
L Name.....	116
L Unit.....	116
L Accuracy.....	116
L Detector.....	116
L Base Unit.....	116

Hide / show tables

The top "Graphics" bar toggles between hide and show all tables. If both graphics and tables are visible (half screen, each), hiding the tables shows the graphics in full size. Hiding the graphics, too, leaves the two top bars visible, only. Opening the tables while the graphics are hidden shows the tables in full size.

Close / Close all

Closes the selected table or all tables that are shown. To reopen closed tables, double-click their names in the [Test Components](#) side panel.



Arrange tables

To arrange multiple tables horizontally, vertically or cascade them behind each other, use the buttons   .

Select cells

A single cell is selected by clicking it directly. Selected cells are marked by bold content.

Multiple individual cells (not necessarily adjacent) are selected by pressing [Ctrl] while clicking the cells to be selected. You can also unselect previously selected cells by this combination of pressing [Ctrl] and clicking the cells. In tablet operation, selecting multiple cells requires to bring up the on-screen keyboard, tap [Ctrl] and then tap the cells to be selected.

A single row of cells is selected by clicking the row header. Selecting all cells in a row is equivalent with selecting the whole row. Selected rows are highlighted by a blue background color together with bold cell content.

Multiple adjacent rows of cells are selected by clicking the first row header, then pressing [Shift] and clicking the last row header. In tablet operation, bring up the on-screen keyboard, tap the first row header, then tap [Shift] and tap the last row header.

A rectangular range of cells is selected by clicking a cell in one corner of the rectangle, then pressing [Shift] and clicking the cell in the opposite corner of the rectangle. This procedure is also used to select one single or multiple columns. Note that the scrollbars can be used between clicking the two corner cells. In tablet operation, selecting multiple rows requires the following steps: Bring up the on-screen keyboard, tap a cell in one corner of the rectangle, tap [Shift] and tap the cell in the opposite corner of the rectangle. If you want to use the scrollbars between tapping the two corner cells, proceed as follows: First tap one corner cell, then scroll to the opposite corner cell, tap [Shift] and tap the opposite corner cell. If a relevant part of the table is hidden by the on-screen keyboard, undock it. Once the on-screen keyboard floats, it can be moved out of the way.

An alternative for selecting a rectangular range of cells is clicking a cell and using the [Shift] + [Arrow] keys to define the selection. The [Ctrl] key can be used in combination with the [Arrow] keys to jump to the first or last row or column.

You can select also [the whole table](#).



Delete rows

Deleting is only available in tables that are not controlled by a test template, for example the "Critical Points" table. Thus, it is not permitted in the "Overview" and "Final Result" table.

To delete values of selected cells from a table, right-click any selected cells and select "Delete rows", or click the "Delete rows" button .



Copy

To copy values from selected cells into the clipboard, right-click the cells and select "Copy", or click the "Copy" button , or press [Ctrl] + [C]. The copied values can be inserted in a new position by [Paste](#).



Paste

To paste [cut](#) or [copied](#) values from the clipboard into a table, right-click the new (first) cell position and select "Paste", or click the "Paste" button , or press [Ctrl] + [V].



Add new row

Adding rows is only available in tables that are not controlled by a test template, for example the "Critical Points" table. It is not permitted in the "Overview" and "Final Result" table.

To insert a new row, right-click a row header or a cell and select "Insert new row before". The new row is then inserted above the row that has been clicked.

To add a new row at the end of the table, click the button  and select "Add new row".

To delete selected rows, click the button  while the rows are highlighted and select "Delete rows".



Show / Hide Columns

To show or hide [columns](#) of a table selectively, right-click any column header and select "Show / hide columns". In the list of available columns, tick the columns to be shown and untick the columns to be hidden. Alternatively, click the "Show / hide columns" button  and activate or deactivate the individual columns in the list accordingly. You cannot hide the columns "Rg" (frequency range number) and "Frequency" (frequency points).

If you enable the checkbox "Use Report Relevant Column" for this table in the report template, the hidden columns are not shown in the report, either. Instead of the column selection in the report template, the report shows and hides the columns as selected in the "Show / Hide Columns" dialog. You can show a column in the GUI but hide it in the report by deactivating it using . See [Chapter 4.6.1, "Configuring report templates"](#), on page 325. Saving the test also saves the selection of columns.



Show / Hide Column Headers

To show or hide individual column headers described below, right-click any column header and activate or deactivate either of them. Alternatively, click the "Show / Hide Column Headers" button .

- **Detector** shows the selected **Detector types** in level, limit and margin columns, but does not allow modifying the selection.
- **Accuracy** adjusts the decimal fraction of the values in the selected column.
- **Base Unit** shows the selected base units, but does not allow modifying them.



Apply Process State

Available only in the "Critical Points" table.

Brings up a dialog to set frequency points in the critical points table to one of the following process states:

- "Data Reduction"
- "Maximiation"
- "Zoom Measurement"
- "Adjustment"
- "Final Measurement"

The steps to be carried out, until all measurements are completed for the selected points, depend on the process state that you select. Typically, each frequency point is measured individually, therefore the process states per point can differ during the test run, and the states can change at different times.

While processing one or more frequency points, R&S ELEKTRA executes only the missing steps to achieve the "Final Measurement" state. For example, if you want to redo the final measurement for a frequency point, which is in the "Final Measurement" state, you can set the state of that point to "Data Reduction". When you restart the measurement, R&S ELEKTRA repeats all steps required to reach the "Final Measurement" state.

In the "Apply Process State" dialog that opens when you click the  button, you can toggle between "All Critical Points" and "Selected Critical Points". The latter is available only, if you have selected one or more rows of the table before opening the dialog. See "[Select cells](#)" on page 113.

For your selection of critical points, you can specify, which "Current Process States" to change to which "Target Process State". To let the changes take effect, click "Apply".



Select Table

Selects all cells of a table. Alternatively, click any header of the first column or press [Ctrl] + [A] or right-click any cell in the table and select "Select Table".



Show Graphic Display

Generates a graphic representation of selected table contents. Alternatively, right-click any cell and select "Graphic Display". A dialog opens up to select the columns to be displayed. The dialog allows also selecting either the generation of a new chart or the integration of the selected column's data into an existing chart.



Export to CSV file format

Exports a table's contents to a file in `.csv` format (comma-separated values). A dialog opens up to specify the target folder and filename.

For importing such files, see ["Importing tables"](#) on page 496. For exporting table contents to an Excel file, use [copy and paste](#).



Set default sorting

Re-establishes a table's original order. Typically, a table is sorted per default by increasing frequency values.

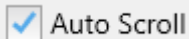

Auto Scroll

Auto Scroll

Facilitates reading the "Final Results" or "Critical Points" table during a measurement: Enabling the checkbox keeps the row that shows the currently measured frequency point within the display area.

Sort table

To sort the table's rows by the values in the "Rg" (frequency range number) or "Frequency" column, click this "Name" header. Click this header again for reverse order.

Table Headers

The [Name](#) and [Unit](#) headers are always visible, the optional [Detector](#) header is enabled per default. You can also enable [Accuracy](#) and [Base Unit](#).

Name ← Table Headers

Shows the name of the column, as in [Figure 4-27](#). You can change the order of rows by clicking the "Rg" or "Frequency" header. In detector columns, the name consists of an abbreviation for the [Detector](#) name and the type of trace, which can be "Level", "Limit" or [Margin](#).

Unit ← Table Headers

To select one of the optional units for an individual column, click its "Unit" header. The software automatically converts the displayed values.

Example:

If the unit is "kHz" and the displayed value is "2,000", changing the unit to "MHz" changes the displayed value to "2".

If the unit is "dBV" and the displayed value is "-137", changing the unit to "dBμV" changes the displayed value to "-17".

Accuracy ← Table Headers

Specifies the number of decimal places of the values displayed in the selected column. You can set this parameter from 0 to 8 decimal places.

"Accuracy" is only available, if it is enabled at [Show / Hide Column Headers](#).

Detector ← Table Headers

Displays the full name of the [measurement detector](#), which is abbreviated in the "Name" header. The detector cannot be changed in this column, which is only available, if it is enabled at [Show / Hide Column Headers](#).

Base Unit ← Table Headers

Displays the base unit of the column. The base unit cannot be edited in this column, which is only available, if it is enabled at [Show / Hide Column Headers](#).

4.5 Test Templates

Test templates are used to **configure EMC Tests**. The [software structure](#) shows that a test contains one test template, which contains [Hardware Setups](#) along with [Limit Lines](#) (or optional power limitation or sensor limitation tables in EMS tests) and user-definable configuration settings.



Types of test templates

- 1) A test template that you create and save with your settings can be considered as a **"global" test template**.
- 2) When you create a test based on a test template, a **copy** of this test template is **integrated** into the [Test container](#).

The differences between these two types of test templates are:

- **Global** test template
 - Is available at "Home" > "Test Templates"
 - Allows creating tests
 - Allows modifying device properties from within the test template dialog
 - Changing settings in a global test template has no influence on existing tests
- **Copy** of a test template in a test container
 - Is available only within the test, into which it is integrated
 - Exclusively controls the test, into which it is integrated and cannot be used for creating other tests
 - Does not allow modifying device properties from within the test template dialog
 - Changing settings in this copy in an executed test requires clearing the test to keep its results consistent with the test settings, see ["Clear Results"](#) on page 601

Handling test template items



Access: "Home" > "Test Templates"

Depending on the selection of one or several test templates, different action buttons are available in the actions bar. Most of them are common action buttons, described in [Chapter 3.3, "Common action buttons"](#), on page 45. (For information on how to proceed with **"Create: Template"**, see ["Configuring test templates"](#) on page 118.) The dialog-specific action buttons for test templates are:



"Pin to Dashboard (Create Test)" adds the selected test templates to the "Dashboard" with the function of directly creating a test (see "Create test from template" .



"Unpin from Dashboard (Create Test)" removes the selected test templates from the "Dashboard" with the function of directly creating a test (described above).



"Create test from template" applies the selected test template for directly creating a test. Only if you have not yet [activated](#) an EUT, the "New Test" dialog opens, see [Configuring tests](#). With an activated EUT, you can continue with [step 3](#) of the procedure [Creating and running tests](#).

Note that this action button is available in the actions bar only, if one single test template is selected in the "Test Templates" dialog.

Clicking the  button and then clicking the pop-up "Open test configuration" applies the selected test template for configuring a test.

The "New Test" dialog opens, which lets you configure the test settings, instead of creating the test with preconfigured settings. See [Configuring tests](#) and the following subsections:

- [Configuring calibration measurements](#)
- [Configuring EMI tests](#)
- [Configuring EMS tests](#)

 "New Test" creates a test based on the selected test template. Hence, using "New Test" in the "Test Templates" dialog is an abbreviation of the procedure described in [Chapter 4.4.1, "Configuring tests"](#), on page 88: Now, you do not have to first select a test type. Instead, the test type of the selected test template is used. Therefore, the new test configuration dialog (for example [Figure 4-23](#)) is preconfigured. Note that the "New Test" action button is available only in the "Test Templates" dialog, if one single test template is selected.

Configuring test templates

Access: "Home" > "Test Templates"

 Click "Create: Template" to generate a new test template. In the dialog that comes up, select the test template type:

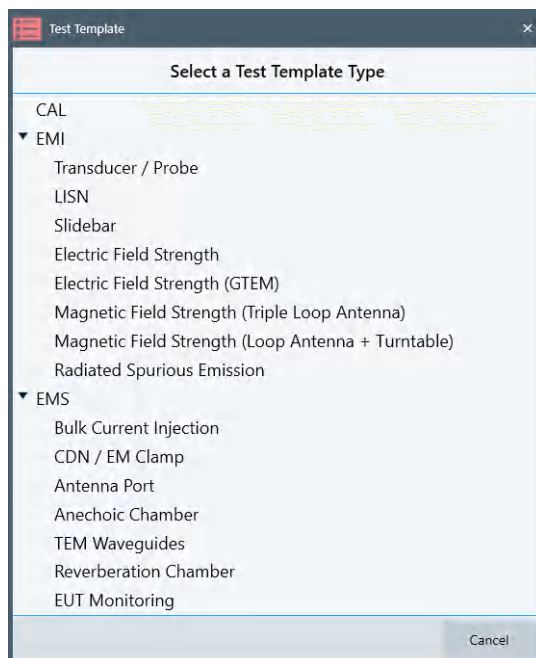

Figure 4-30: Dialog for selecting a test template type

- "CAL" = [Test Templates for calibration measurements](#)
- "EMI - ..." = [Test Templates for EMI tests](#)
- "EMS - ..." = [Test Templates for EMS tests](#)
- "EUT Monitoring" = [EUT Monitoring templates](#)

Depending on your [licenses](#), the available test template types can differ. [Figure 4-30](#) shows the full choice with all licenses enabled.

Selecting any of these test template types opens a dialog to create and configure this type of test template.

4.5.1 Test Templates for calibration measurements

This chapter explains how to create and configure test templates for various **conducted** calibration measurements.



- For controlling a calibration measurement, see [Chapter 7.4.11, "Calibration Control"](#), on page 625.
- For information on how to execute calibration measurements, see [Chapter 8, "Calibration measurements"](#), on page 645.

Access: "Home" > "Test Templates" > "Create: Template" > "CAL"

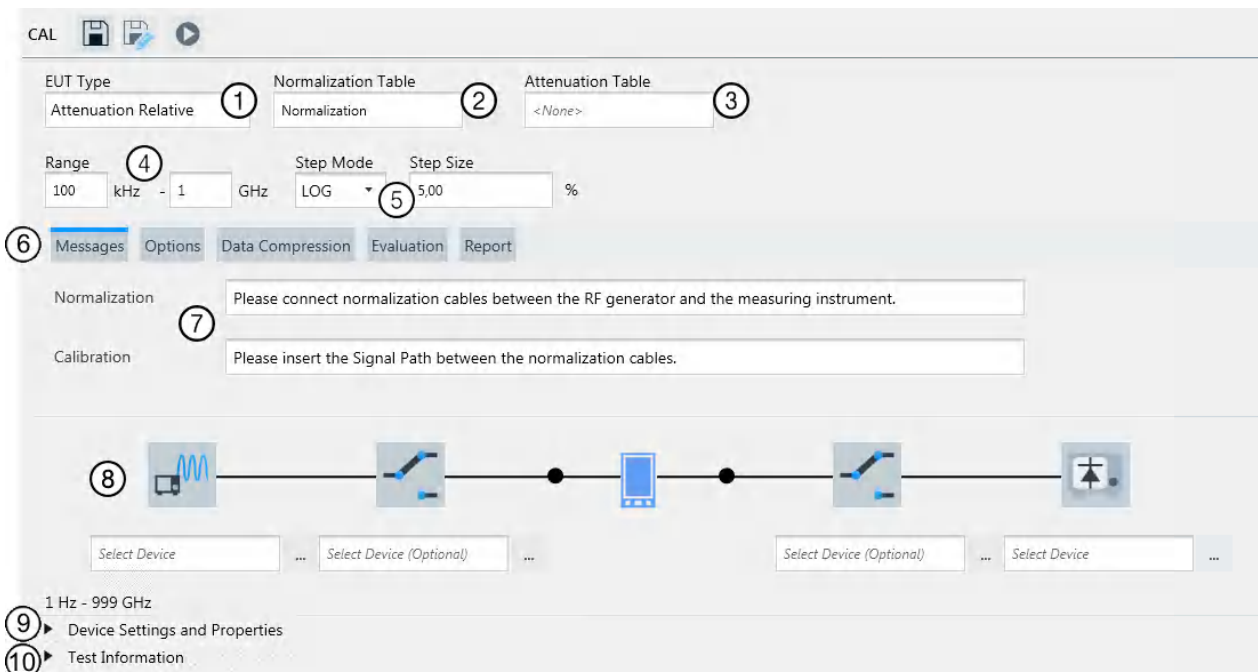

Figure 4-31: A typical default test template for conducted calibration measurements

- 1 = [EUT Type](#) selects from the calibration modes that are described in the following chapters
- 2 = Selects a [normalization](#) table
- 3 = Selects an [attenuation](#) table
- 4 = Specifies the lower and upper limit of the frequency range

- 5 = Selects the frequency step mode, and specifies the step size
- 6 = [Configuration tabs](#) allow specifying "Messages", "Options", "Data Compression", "Evaluation" and "Report" settings
- 7 = Specifies parameters for each tab (6), here: text messages to be displayed before normalization and calibration measurements
- 8 = [Select Device](#) fields along a diagram of the hardware setup, which varies with the calibration mode (see 1, "EUT Type")
- 9 = Expand/collapse button for the [Device Settings and Properties](#)
- 10 = Expand/collapse button for the [Test Information](#)

The **cable**, **signal path** or **transducer** to be calibrated can be considered as an EUT. In this sense, the "EUT Type" defines, which of the following calibration modes is used. (If the transducer is a CDN or EM coupling clamp, see also [Chapter 8.3, "Reference calibration of a CDN"](#), on page 652.)

- [EUT Type](#)..... 120
- [Configuration tabs](#)..... 132
- [Select Device](#)..... 133
- [Device Settings and Properties](#)..... 133
- [Test Information](#)..... 135

4.5.1.1 EUT Type

Selects one of the following calibration modes, which influences the whole dialog:

- [Attenuation Relative](#)..... 120
- [Attenuation Absolute](#)..... 122
- [Audio Breakthrough](#)..... 123
- [Signal Path](#)..... 125
- [Transducer](#)..... 128

Attenuation Relative

"Attenuation Relative" is the default calibration mode in a newly created test template for calibration.

It specifies the settings to perform both the "Normalization" and "Calibration" measurements, or just one of them, as described in [Chapter 8.1, "Signal path calibration"](#), on page 646.

Access: "Home" > "Test Templates" > "Create: Template" > "CAL" > "EUT Type" > "Attenuation Relative"

To configure a test template for calibration mode "Attenuation Relative"

1. Decide about the "Normalization Table":
 - Either accept the "Normalization Table" preselected by R&S ELEKTRA
 - or click  to select a different "Normalization Table", to create a new one, or to edit any selected table.

In any of these cases, when the measurement is performed, the normalization table is saved at "Home" > "Tables" > "Normalization".

Note: Later on, once this test template is applied for a calibration measurement in "Attenuation Relative" mode, R&S ELEKTRA prompts you to decide:

- Use this normalization table as the reference.
 - Perform a new normalization measurement to overwrite the table with the new values.
2. Click "Attenuation Table" >  to select one of the following options:
 - "Select" an existing attenuation table.
 - "Create New" to create a new (**empty**) table. Then "Select" or "Edit" that table.
 - "Edit" to open the selected existing attenuation table for editing it.

In any of these cases, the attenuation table is saved at "Home" > "Tables" > "Attenuation".

Later on, once this test template is applied for a calibration measurement in "Attenuation Relative" mode, R&S ELEKTRA overwrites the attenuation table with new values.

3. Optionally, "Start with Calibration" skips the reference measurement and starts with path calibration measurement instead.
4. "Range": Specify the start / stop frequencies of the calibration measurement. Note that before starting the measurement, R&S ELEKTRA checks the consistency of this frequency range with the frequency ranges defined for the devices involved.
5. "Step Mode": Specify the type of frequency steps across the range: "LIN" = linear, "LIST" = frequency values from a list, or "LOG" = logarithmic.
6. "Step Size": Specify the relative step size: an absolute frequency step size for "LIN", the name of the frequency value list for "LIST", or a percentage value (%) for "LOG".
7. Specify [Messages](#).
8. Specify [Options](#).
9. Specify [Data Compression](#).
10. Specify [Evaluation](#).
11. "Report": Optionally specify a [Report](#) template.
12. **"Select Device"**: In the hardware setup diagram, select a signal generator, a power meter and optionally one or two switch units. See also [Chapter 4.5.1.3, "Select Device"](#), on page 133.

R&S ELEKTRA displays the name of the selected device below the device icon.

13. Click a device icon in the hardware setup diagram to display and edit the "Device Settings and Properties".
 - a) The "Properties" are as specified in the device list, see [Chapter 4.8.2, "Device properties"](#), on page 377. If you modify any device properties here, except in the "Functional Check", these properties are changed in all other instances, too: in the device list, in each hardware setup that uses this device, in each test template that uses this hardware setup, etc.

- b) The "Settings" must be individually defined in the test template to configure the measurement appropriately:
- Generator: Set the power level for the calibration measurement
 - Optional one or more switch units: Select one of the signal paths that are specified in the device list
 - Power meter: Select the **Measurement Speed** "Auto", "Fast", "Medium" or "Slow"
 - Network analyzer (replacing both the signal generator and the power meter): specify the settings as described in **"Special case: Network Analyzer"** on page 134
14. "Save" the calibration test template.
15. Either close the test template or click "Create test from template" (🔍) to start a calibration measurement immediately, as described in **Chapter 8.1, "Signal path calibration"**, on page 646.

Attenuation Absolute

The calibration mode "Attenuation Absolute" is the most simple case to measure the attenuation characteristics of just an RF cable. However, you can also use it for a signal path that consists of, for example, a combination of cables and a switch unit.

This test template works similar to the calibration mode **Attenuation Relative**, except that the normalization is omitted. The software uses the difference between the given generator output level and the measured level to compute the attenuation of the path between generator and measuring instrument.

Access: "Home" > "Test Templates" > "Create: Template" > "CAL" > "EUT Type" > "Attenuation Absolute"

To configure a test template for calibration mode "Attenuation Absolute"

1. Click "Attenuation Table" >  to select one of the following options:
 - Select an existing attenuation table.
 - "Create New" to create a new (**empty**) table. Then "Select" or "Edit" that table.
 - "Edit" to open the selected existing attenuation table for editing it.

In any of these cases, the attenuation table is saved at "Home" > "Tables" > "Attenuation".

Later on, once this test template is applied for a calibration measurement in "Attenuation Absolute" mode, R&S ELEKTRA overwrites the attenuation table with new values.

2. "Range": Specify the start / stop frequencies of the calibration measurement. Note that before starting the measurement, R&S ELEKTRA checks the consistency of this frequency range with the frequency ranges defined for the devices involved.
3. "Step Mode": Specify the type of frequency steps across the range: "LIN" = linear, "LIST" = frequency values from a list, or "LOG" = logarithmic.

4. "Step Size": Specify the relative step size: an absolute frequency step size for "LIN", the name of the frequency value list for "LIST", or a percentage value (%) for "LOG".
5. Specify [Messages](#).
6. Specify [Options](#).
7. Specify [Data Compression](#).
8. Specify [Evaluation](#).
9. "Report": Optionally specify a [Report](#) template.
10. **"Select Device"**: In the hardware setup diagram, select a signal generator, a power meter and optionally one or two switch units. See also [Chapter 4.5.1.3, "Select Device"](#), on page 133.
R&S ELEKTRA displays the name of the selected device below the device icon.
11. Click a device icon in the hardware setup diagram to display and edit the "Device Settings and Properties".
 - a) The "Properties" are as specified in the device list, see [Chapter 4.8.2, "Device properties"](#), on page 377. If you modify any device properties here, except in the "Functional Check", these properties are changed in all other instances, too: in the device list, in each hardware setup that uses this device, in each test template that uses this hardware setup, etc.
 - b) The "Settings" must be individually defined in the test template to configure the measurement appropriately:
 - Generator: Set the power level for the calibration measurement
 - Optional one or more switch units: Select one of the signal paths that are specified in the device list
 - Power meter: Select the [Measurement Speed](#) "Auto", "Fast", "Medium" or "Slow"
 - Network analyzer (replacing both the signal generator and the power meter): specify the settings as described in ["Special case: Network Analyzer"](#) on page 134
12. "Save" the calibration test template.
13. Either close the test template or click "Create test from template" (🔍) to start a calibration measurement immediately, as described in [Chapter 8.1, "Signal path calibration"](#), on page 646.

Audio Breakthrough

Use the calibration mode "Audio Breakthrough" to obtain the EMS performance characteristics of a mobile phone's analogue circuit, based on the ETSI EN 301 489 standard.

The analogue circuit of a mobile phone, which is divided into the microphone section (voice pickup, uplink signal) and loudspeaker section (earphone signal generation, downlink signal), is most susceptible to EMS immunity field. To test the EUT's suscepti-

bility, the standard defines an immunity field level of 1 kHz at 80% AM modulation. Hence, audio frequency (AF) levels measured at 1 kHz can best characterize the EMS performance of the mobile's analog circuit. The audio test levels to be measured are the noise levels in relation to a suitable reference level, which is determined by the audio breakthrough calibration.



For the ABT measurement, see [Chapter 4.5.4, "EUT Monitoring templates"](#), on page 307.

The calibration template configures the hardware setup and parameters of the audio breakthrough calibration.

Access: "Home" > "Test Template" > "Create: Template" > "CAL" > "EUT Type" > "Audio Breakthrough"

To configure a test template for calibration mode "Audio Breakthrough" (ABT)

1. "Audio Breakthrough"

Selects the channels for audio frequency (AF) generation and for four calibration steps, which are described in brief in the following list:

- "AF Generator Port"
The selected channel provides the audio-frequency signal at that generator's AF port.
- "Artificial Mouth Calibration"
This calibration step determines the voltage level to be applied to the AF generator output to obtain a 0 dBPa sound pressure from the artificial mouth. We recommend to repeat this step regularly, especially if you modify or replace any audio components. If the result of this test is already available, you can skip this calibration step.
- "Uplink Reference Measurement"
This calibration step measures the audio level at the microphone section of the mobile phone's analog circuit (uplink signal), used as an offset for ABT measurement.
This measurement depends on the transmission characteristics of the mobile phone. Hence, we recommend to perform this step at least once for every new mobile phone to be tested.
- "Downlink Reference Measurement"
This calibration step measures the audio level at the loudspeaker section of the mobile phone's analog circuit (downlink signal), used as an offset for ABT measurement.
The measurement depends on the audio component involved in the step. We recommend to repeat this step regularly, even though it is only necessary, if you modify or replace any audio components.
- "Hands-Free Set Calibration"
This calibration step determines the amplification of the hands-free set, where the term "hands-free" represents the usage of the mobile's stronger loudspeaker instead of its smaller "earspeaker". The result is added to the downlink

reference value if the EUT to be tested is not a mobile phone itself but together with the hands-free set.

The measurement depends on the transmission characteristics of the mobile phone and the hands-free set. We recommend that you perform this step at least once for every new mobile phone and hands-free set to be tested.

2. "Select Device"

In the hardware setup diagram, select a radio communicator tester, an audio analyzer, and optionally a switch unit. See also [Chapter 4.5.1.3, "Select Device"](#), on page 133.

R&S ELEKTRA displays the name of the selected device below the device icon.

3. "ABT Switch Path"

Optionally selects one or more paths in a switch unit.

Paths are available only, if you have selected the optional switch unit in [step 2](#).

These paths allow to automatically configure the hardware setup in terms of the connections needed for each of the four calibration steps described above. Without specifying paths, you must manually configure the hardware setup for each calibration step.

4. "Device Settings and Properties"

To edit any device settings or properties, click a device icon in the hardware setup diagram.

a) The **"Properties"** are as specified in the device list, see [Chapter 4.8.2, "Device properties"](#), on page 377. If you modify any device properties here, except in the "Functional Check", these properties are changed in all other instances, too: in the device list, in each hardware setup that uses this device, in each test template that uses this hardware setup, etc.

b) The **"Settings"** tab is available only for the radio communicator tester. Define it's settings individually in this template to configure the calibration measurement appropriately. See also [Radio Communication Tester](#).

5. Optionally edit any content in the "Test Information" section.

6. "Save" the calibration test template.

7. Either close the test template or click "Create test from template" (🔍) to start a calibration measurement immediately.

Signal Path

The calibration mode "Signal Path" is typically used for the recalibration of a signal path that does already contain an "outdated" attenuation table.

This test template works similar to the calibration mode [Attenuation Relative](#), except that the attenuation table is selected indirectly. The procedure uses the attenuation table of the signal path; hence, this signal path must contain an attenuation table (not just a constant attenuation value). In the configuration dialog, the signal path is specified below the hardware setup diagram. There, it is located between the signal generator and the power meter, or optionally between switch units, too.

A measurement based on this test template overwrites the values in the existing "Attenuation Table" with the difference between the measured attenuation values and the values in the "Normalization Table".

Access: "Home" > "Test Templates" > "Create: Template" > "CAL" > "EUT Type" > "Signal Path"

To configure a test template for calibration mode "Signal Path"

1. Decide about the "Normalization Table":
 - Either accept the "Normalization Table" preselected by R&S ELEKTRA
 - or click  to select a different "Normalization Table", to create a new one, or to edit any selected table.

In any of these cases, the normalization table is saved at "Home" > "Tables" > "Normalization".

Note: Later on, once this test template is applied for a calibration measurement in "Signal Path" mode, R&S ELEKTRA prompts you to decide:

- Use this normalization table as the reference.
 - Perform a new normalization measurement to overwrite the table with the new values.
2. **Skip** the deactivated "Attenuation Table" selection field. When you specify the signal path (see [step 13](#)), R&S ELEKTRA automatically enters the attenuation table. After selecting a signal path, and only if this path contains more than one attenuation table, you can still select, which of these tables is used. (All attenuation tables can be found at "Home" > "Tables" > "Attenuation".)
 3. Optionally, "Start with Calibration" skips the reference measurement and starts with path calibration measurement instead.
 4. "Range": Specify the start / stop frequencies of the calibration measurement. Note that before starting the measurement, R&S ELEKTRA checks the consistency of this frequency range with the frequency ranges defined for the devices involved.
 5. "Step Mode": Specify the type of frequency steps across the range: "LIN" = linear, "LIST" = frequency values from a list, or "LOG" = logarithmic.
 6. "Step Size": Specify the relative step size: an absolute frequency step size for "LIN", the name of the frequency value list for "LIST", or a percentage value (%) for "LOG".
 7. Specify [Messages](#).
 8. Specify [Options](#).
 9. Specify [Data Compression](#).
 10. Specify [Evaluation](#).
 11. "Report": Optionally specify a [Report](#) template.

12. **"Select Device"**: In the hardware setup diagram, select a signal generator, a power meter and optionally one or two switch units. See also [Chapter 4.5.1.3, "Select Device"](#), on page 133.

Alternatively, click  in the fields below the hardware setup diagram to select the device.

R&S ELEKTRA displays the name of the selected device below the device icon.



13. **"Select Signal Path"**: In the center of the hardware setup diagram, click the signal path icon to select a signal path. (Alternatively, click the button  next to the signal path name field below the icon.) Make sure that the selected path *references an attenuation table* (not just a constant attenuation value).

- If you select a qualifying signal path that references **one** attenuation table, R&S ELEKTRA automatically enters this table into the "Attenuation Table" field.
- If you select a qualifying signal path that references **more than one** attenuation table, R&S ELEKTRA automatically enters one of these tables (the one listed first) into the "Attenuation Table" field. To decide which table the software uses in the calibration, you can alter this preselection, as mentioned in [step 2](#).
- If you select a non-qualifying signal path that references **no** attenuation table, R&S ELEKTRA brings up an "Attenuation tables are missing" message: "Please select a signal path referencing any attenuation table!"
In this case, select a different, qualifying signal path. If there is no such signal path entry in the device list, create it or add an attenuation table to an existing (non-referenced) signal path entry.

Without a selection accepted by R&S ELEKTRA, you cannot save the calibration test template.

14. Click a device icon in the hardware setup diagram to display and edit the "Device Settings and Properties".
- a) The "Properties" are as specified in the device list, see [Chapter 4.8.2, "Device properties"](#), on page 377. If you modify any device properties here, except in the "Functional Check", these properties are changed in all other instances, too: in the device list, in each hardware setup that uses this device, in each test template that uses this hardware setup, etc.
 - b) The "Settings" must be individually defined in the test template to configure the measurement appropriately:
 - Generator: Set the power level for the calibration measurement
 - Optional one or more switch units: Select one of the signal paths that are specified in the device list
 - Power meter: Select the [Measurement Speed](#) "Auto", "Fast", "Medium" or "Slow"
 - Network analyzer (replacing both the signal generator and the power meter): specify the settings as described in ["Special case: Network Analyzer"](#) on page 134

15. "Save" the calibration test template.

16. Either close the test template or click "Create test from template" (🔍) to start a calibration measurement immediately, as described in [Chapter 8.1, "Signal path calibration"](#), on page 646.

Transducer

The calibration mode "Transducer" is used for conductive measurements of transducer characteristics, hence of devices that convert conducted signals (especially current clamps, no antennas). It works similar to the calibration mode [Attenuation Relative](#), with one exception: The "Attenuation Table" is now a "Transducer Table".

Select or specify a "Transducer Table" as described in [step 2](#).

Depending on the selected "Transducer Table", R&S ELEKTRA displays for your information the "Measurement Unit" and the "Result Unit":

- The "Measurement Unit" (or source unit) is the unit in which the measured values are picked up at the transducer output. Typically, this unit would be "dB μ V" or "dBm", since power meters actually measure in volts, which is related to power values (dBm) by the sensor head's internal resistance.
- The "Result Unit" (or destination unit) represents the physical unit, which is present at the transducer's input. It is converted by the transducer to the measured volts or watts at its output. For example, the output of a current clamp is typically given in "dB μ A" for the amperes that are physically present.

With the "Transducer Table" specifying the type of transducer and hence the required unit conversion, the software is able to convert the "Measurement Unit" (for example, "dB μ V") to the "Result Unit" (for example, "dB μ A"). This conversion can require the addition of a constant dB value, as described in [step 8](#).

Access: "Home" > "Test Templates" > "Create: Template" > "CAL" > "EUT Type" > "Transducer"

To configure a test template for calibration mode "Transducer"

1. Decide about the "Normalization Table":
 - Either accept the "Normalization Table" preselected by R&S ELEKTRA
 - or click  to select a different "Normalization Table", to create a new one, or to edit any selected table.

In any of these cases, the normalization table is saved at "Home" > "Tables" > "Normalization".

Note: Later on, once this test template is applied for a calibration measurement in "Attenuation Relative" mode, R&S ELEKTRA prompts you to decide:

- Use this normalization table as the reference.
 - Perform a new normalization measurement to overwrite the table with the new values.
2. Click "Transducer Table" >  to select one of the following options:
 - Select an existing transducer table.
 - "Create New" to create a new (**empty**) table. Then "Select" or "Edit" that table.
 - "Edit" to open the selected existing transducer table for editing it.

In any of these cases, the transducer table is saved at "Home" > "Tables" > "Transducer Correction".

Later on, once this test template is applied for a calibration measurement in "Transducer" mode, R&S ELEKTRA overwrites the transducer table with new values.

Also, R&S ELEKTRA displays the "Measurement Unit" (source unit of the transducer) and the "Result Unit" (destination unit of the transducer). For example, the "Measurement Unit" is "dBm" for the power injected into a current clamp, while the "Result Unit" is "dB μ A" for the current measured at the clamp's output.

Note: The transducer's conversion of source into destination units can require to enter a constant dB value in the field "Options" > "Add a constant value" (for details, see [step 8](#)).

3. Optionally, "Start with Calibration" skips the reference measurement and starts with path calibration measurement instead.
4. "Range": Specify the start / stop frequencies of the calibration measurement. Note that before starting the measurement, R&S ELEKTRA checks the consistency of this frequency range with the frequency ranges defined for the devices involved.
5. "Step Mode": Specify the type of frequency steps across the range: "LIN" = linear, "LIST" = frequency values from a list, or "LOG" = logarithmic.
6. "Step Size": Specify the relative step size: an absolute frequency step size for "LIN", the name of the frequency value list for "LIST", or a percentage value (%) for "LOG".
7. Specify [Messages](#).
8. "Options", specify the following parameters:

- **"Formula for Result Calculation"**

Modifies the calibration results by a formula specified here.

- Typically, use this procedure to eliminate the attenuation (or gain) of a second transducer, required for measuring the attenuation of the first transducer (which you want to calibrate). To explain, consider the following example: Your setup requires combining a transmit antenna with a receive antenna for being able to insert the antennas between the two ends of your normalization cables. But to calibrate only one antenna, you must get rid of the other antenna's contribution to the measurement.

For this purpose, use the "Add Table" button to select one or more tables in the field below the formula. For example, select the attenuation table of the antenna that you use as a transmit antenna, while calibrating a receive antenna. R&S ELEKTRA assigns a placeholder name for each selected table, starting with "T1". Use these placeholder names as variables in the formula. All tables must contain values in dB, and the software interprets constant values that you use in the formula as dB values, too. In the most simple case, your entry can be "-T1", where T1 is the correction of the unwanted antenna. R&S ELEKTRA saves the transducer calibration table, it replaces the measured calibration values with the results from the formula.

Note that "NORM - CAL" is the first part of the calculation, which is always there. "NORM" represents the values in the normalization table, which contains the results of the normalization measurement. "CAL" represents the values in the calibration table, which contains the results of the calibration measurement. Typically, extend this first part by adding "-T1", such that it reads "NORM - CAL - T1", for subtracting both the calibration table and your additional table T1 from the normalization table.

If you select "Calibration Radiated" in [step 12](#), and if you enable and enter a "FSPL Distance" >0, R&S ELEKTRA also adds the free-space path loss (FSPL) to the formula. In this case, it reads "NORM - CAL - T1 + FSPL" for example, where "NORM - CAL" is displayed on the left side of the green box, and "+ FSPL" is displayed on the right side of the green box.

- If your calibration setup uses "Signal Paths", which you can select in [step 13](#), add the attenuation tables of these signal paths to the list. Enter the placeholder names of these tables to the formula with a negative sign, to subtract signal path attenuations.
 - Instead of using tables in the calculation, you can specify only a constant value (in dB) that R&S ELEKTRA adds to the transducer table for one of two purposes: You can "virtually" add an attenuator that is not present during the calibration measurement. Or the constant dB value can be required for the unit conversion in a transducer calibration measurement. In this case, the size of this constant value depends on the transducer type and on the system's impedance. For example, in a 50 ohms system, add a constant value of 73 dB for the conversion of power in dBm to current in dB μ A. For the conversion of power in dB μ V to current in dB μ A, subtract a constant value of 33.97 dB (add -33.97 dB). The application sheet [Determination of a monitoring clamp transducer table](#) explains these calculations.
 - "Measurement Start Delay" (in seconds): Specify the time to wait before the software starts the measurement.
 - "Measurement Settling Time" (in ms): Specify the time to wait after each frequency before the software starts the next measurement.
9. Specify [Data Compression](#).
 10. Specify [Evaluation](#).
 11. "Report": Optionally specify a [Report](#) template.
 12. Select one of the following calibration modes:

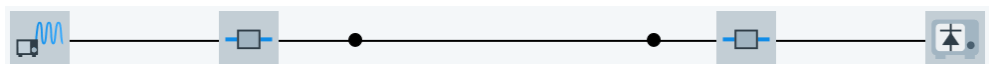



- **"Normalization"**: Uses only the normalization cables between the test instruments. R&S ELEKTRA performs a normalization measurement and lets you save the normalization table.
- **"Calibration Conducted"**: Uses the conducted transducer to be calibrated between the normalization cables and the test instruments. R&S ELEKTRA performs a calibration measurement and lets you save the transducer calibration table.



- **"Calibration Radiated"**: Uses the antenna to be calibrated and a second antenna the normalization cables and the test instruments. R&S ELEKTRA performs a calibration measurement and applies the [Formula for Result Calculation](#).

Optionally, you can enable the software to account for the free-space path loss (FSPL) by entering the "FSPL Distance" in meters. The software converts the distance into an attenuation and adds it to the [Formula for Result Calculation](#), which the software applies before you save the antenna's transducer calibration table.



13. **"Select Device"**: In the hardware setup diagram, select a signal generator, a power meter and optionally one or two signal paths. See also [Chapter 4.5.1.3, "Select Device"](#), on page 133.
Alternatively, click  in the fields below the hardware setup diagram to select the device.
R&S ELEKTRA displays the name of the selected device below the device icon.
14. Click a device icon in the hardware setup diagram to display and edit the "Device Settings and Properties".
 - a) The "Properties" are as specified in the device list, see [Chapter 4.8.2, "Device properties"](#), on page 377. If you modify any device properties here, except in the "Functional Check", these properties are changed in all other instances, too: in the device list, in each hardware setup that uses this device, in each test template that uses this hardware setup, etc.
 - b) The "Settings" must be individually defined in the test template to configure the measurement appropriately:
 - Generator: Set the power level for the calibration measurement
 - Optional one or more switch units: Select one of the signal paths that are specified in the device list
 - Power meter: Select the [Measurement Speed](#) "Auto", "Fast", "Medium" or "Slow"
 - Network analyzer (replacing both the signal generator and the power meter): specify the settings as described in ["Special case: Network Analyzer"](#) on page 134
15. "Save" the calibration test template.
16. Either close the test template or click "Create test from template" () to start a calibration measurement immediately, as described in [Chapter 8.1, "Signal path calibration"](#), on page 646.

4.5.1.2 Configuration tabs

This chapter describes the configuration tabs for non-ABT calibration measurements. For ABT measurements, see ["Audio Breakthrough"](#) on page 123.

Messages

Specifies the text messages that prompt you for actions during the calibration measurement procedure.

- "Normalization": Not available, if [EUT Type](#) is [Attenuation Absolute](#). During a normalization measurement, R&S ELEKTRA prompts you to connect the RF signal generator to the power sensor by one or several normalization cables. The default prompt is: "Please connect normalization cables between RF generator and measuring instrument."
- During a "Calibration" measurement, R&S ELEKTRA prompts you to insert the signal path between the normalization cables. The default prompt is: "Please insert the Signal Path between the normalization cables."

Optionally, overwrite the default prompts with your own text messages. Make sure that the messages reflect the actual measurement conditions, because these messages are intended to facilitate correct cabling.

Options

Specifies the following parameters:

- "Add Constant Value": Specifies a constant value (in dB) that the software adds to the attenuation table. Use this feature for "virtually" adding an attenuator that is not present during the calibration measurement. For another application, see ["Transducer"](#) on page 128.
- "Formula for Result Calculation": Available only for transducer calibration, hence if [EUT Type](#) is [Transducer](#). Instead of "Add Constant Value", the dialog allows specifying a formula that the software uses to modify the calibration results. Proceed as described in [step 8](#) of the procedure ["To configure a test template for calibration mode "Transducer" on page 128.](#)
- "Measurement Start Delay": Specifies the time to wait before the software starts the measurement.
- "Measurement Settling Time": Specifies the time to wait after each frequency before the software starts the next measurement.

Data Compression

Reduces the number of measurement frequency points to the most relevant results, according to the following parameters:

- "Compress if row count is greater than": Specifies the lowest number of frequency points (measurement result rows), from which on the software performs a data compression. The available range is 0 to 10,000 rows. If you enter 0, or if the number of rows is greater than 10,000, the software always performs a data compression.
- "Minimum level difference" specifies the lowest level difference (delta dBm) from one measurement result to the next relevant result in the range from 0.05 dB to

10 dB. For all results with a level difference lower than your specified value, the software automatically performs a data compression: it removes those values from the result table.

Evaluation

Allows comparing the calibration results with expected values:

- If "Compare with existing table" is disabled, you can select a "Lower Limit Line" and an "Upper Limit Line". Without selected limit lines, R&S ELEKTRA performs no evaluation.
- If "Compare with existing table" is enabled, specify a "Compare Tolerance". The comparison relates to the "Attenuation Table" selected above. If [EUT Type is Transducer](#), the comparison relates to the "Transducer Table" selected above.

If the calibration results violate the specified limits or the tolerance, the software brings up a warning.

Report

Optionally specifies a [Report](#) template.

4.5.1.3 Select Device

The dialog provides two options for selecting devices in the hardware setup (8 in [Figure 4-31](#)):

- Click  in the fields below the hardware setup diagram.
- If a device is not yet selected, also you can click the device icon.

The dialog that opens allows to select only a suitable device. Depending on the application, a suitable device can be, for example, a signal generator, network analyzer, radio communicator tester, audio analyzer, test receiver, power meter, signal path or switch unit.

Instead of a signal generator and a power meter, you can select a network analyzer, which replaces both the transmitting and the receiving device. A test receiver that features a tracking generator can replace both devices, too. To use this feature, switch on the tracking generator in the receiver's [Device Settings and Properties > Settings > "Measurement Settings"](#), as described in [Settings \(Overview\) > Tracking Generator](#).

4.5.1.4 Device Settings and Properties

Settings

Settings

Shows the settings of the device that you select (highlight) in the hardware setup diagram (labeled 8 in [Figure 4-31](#)).



Figure 4-32: For example, select (highlight) the icon of one of the optional switch units

The following settings are available for the devices:

- Generator settings: "Level Cable Calibration" > "Level"
Specifies the power level of the non-modulated generator signal, for example *10 dBm*.
- Switch-unit settings: "Path Selection Cable Calibration"
Defines the auxiliary paths to be set by the optional switch units before the normalization or calibration measurement is started.
- Test-level sensor settings: "Measurement Parameters" > "Measurement Speed"
Specifies the speed of the measurement device (power meter) via its integration and averaging settings, as described in ["Measurement Speed"](#) on page 442.
- Receiver and analyzer settings: "Measurement Settings", as described in [Settings \(Overview\)](#)

However, the "Meas. BW" setting is different from EMI test templates:

- When you select a predefined "Meas. BW" value, the receiver uses this fixed bandwidth across the whole frequency range.
- When you select "Auto", R&S ELEKTRA makes the receiver automatically adjust the "Meas. BW" during the measurement, while keeping it at or below half the current measurement frequency.

- Network analyzer settings: "Measurement Settings", as described in [Special case: Network Analyzer](#)

Properties

Properties

Shows the properties of the device that you select (highlight) in the hardware setup diagram.

Note the difference: "Properties" define the global characteristics of a device as specified in the [Device List](#) (see [Device properties](#)). On the contrary, the "Settings" define the individual behavior of a device during a calibration measurement that is controlled by this template.

The "Properties" are shown as specified in the [Device List](#).



Risk of unintended changing of device properties

Be careful with modifying any device properties from within a CAL template dialog. These properties are also changed in the device list and in each other "global" test template that uses the device. (Existing tests are influenced by modified device properties, too, when you rerun these tests.)

If you open a CAL template that is integrated into a test (as "copy" of a "global" CAL template), you can read but not modify device properties in this dialog.

Special case: Network Analyzer

A [Network Analyzer](#) (VNA) can replace both the signal generator and the power meter in your calibration hardware setup. This chapter describes the VNA settings.

- "Generator Port"
Selects the analyzer's port that provides the generated signal. The range of available ports (1 to 2, or 1 to 4) depends on the analyzer [type](#).

- "Analyzer Port"
Selects the port that the analyzer uses for measuring the received signal. The range of available ports (1 to 2, or 1 to 4) depends on the analyzer [type](#).
- "Measurement Quantity"
Defines the physical quantity to be measured. Select from the following:
 - "S21"
Use scattering parameters for measuring device gain, return loss, voltage standing wave ratio (VSWR), reflection coefficient and amplifier stability.
 - "b2/a1"
Use this setting for measuring incident and transmitted power.
 - "b2"
Use this setting for measuring transmitted power, only.
- "Meas. BW"
Defines the analyzer's measurement bandwidth. Select a value out of a drop-down list of bandwidths from 1 Hz to 1 MHz.
- "RF Power"
Sets the power level of the generator (integrated in the network analyzer).
- "Sweep Points"
Sets the number of sweep points, depending on the start and stop frequencies, step width and step mode.
- "Sweep Time"
Sets the total time for a sweep, or lets the software set this time automatically, if you click "Auto".

4.5.1.5 Test Information

▼ Test Information

This dialog allows editing test information that is relevant for all (or most) of the tests that you run from this test template. By entering this information in the test template instead of in the test, you avoid having to enter the same information repeatedly for the same type of tests.

To edit your predefined titles and contents for an individual test, open the [test information dialog](#) within this test.

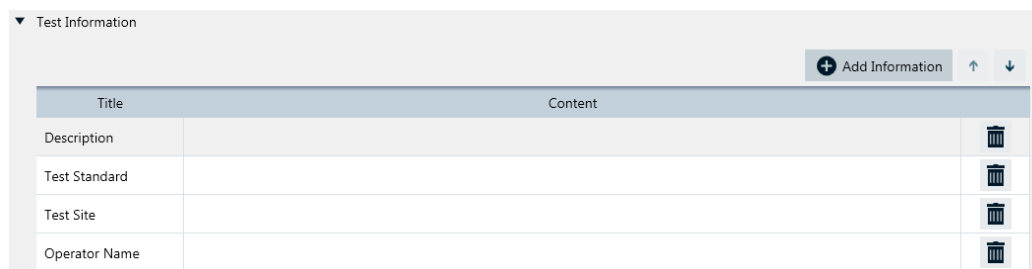

Figure 4-33: Test information dialog

+ Add Information

- "Add Information"
Adds a new row in the test information table, below the default lines "Description", "Test Standard", "Test Site" and "Operator Name".



- **"Shift Row Up / Down"**

The buttons swap the position of the selected row with the one above or below it.

- **"Title"**

Enter a title for each row of test information.

Click the titles headline to sort the rows alphabetically by their titles.

- **"Content"**

Enter arbitrary content in each row of test information. You can also leave the content of a row blank and enter only the title, for entering the content later (within the tests).

Click the contents headline to sort the rows alphabetically by their contents.



Content history

For each category, R&S ELEKTRA memorizes previously stored text in the "Content" column. After saving the test template and deleting any text from the "Content" column, the software helps you in restoring that text by selecting it from a context dialog.



- **"Delete Row"**

Deletes the selected row without additional warning and without the possibility to restore the deleted title and content.

4.5.2 Test Templates for EMI tests

This chapter explains how to configure test templates for various EMI tests. This configuration is done by selecting a [hardware setup](#) (that must be configured in advance) and specifying the [General Settings](#), the [Measurement Flow](#) and the [Flow Details](#), which contain the settings for one or more [frequency ranges](#). The configuration is completed by [Test Information](#) and optional [Actions](#).



For information on how to set up the hardware for these tests, see [Chapter 4.7.2, "Hardware setups for EMI tests"](#), on page 334.

For information on how to execute these tests, see [Chapter 7, "Running tests"](#), on page 592.

Access: "Home" > "Test Templates" > "Create: Template" > "EMI"

As shown in [Figure 4-30](#), the available EMI test template types are:

- EMI - Transducer / Probe
- EMI - LISN
- EMI - Slidebar
- EMI - Electric Field Strength
- EMI - Electric Field Strength (GTEM)
- EMI - Magnetic Field Strength (Triple Loop Antenna)
- EMI - Magnetic Field Strength (Loop Antenna + Turntable)
- EMI - Radiated Spurious Emission (available only, if the ["ELEMI-RSE"](#) license is enabled)

When you create an EMI test template, R&S ELEKTRA starts with a test template dialog as in [Figure 4-34](#). Initially, it looks the same for all types of EMI test templates. The difference with the individual EMI test template types is: each type allows using (opening or creating) only its specific type of [hardware setup](#).



In a new EMI test template, the "General Settings", the "Measurement Flow" settings and the "Actions" are available only, when you have selected a [hardware setup](#).

A default EMI test template is partly preconfigured by R&S ELEKTRA as in [Figure 4-34](#).

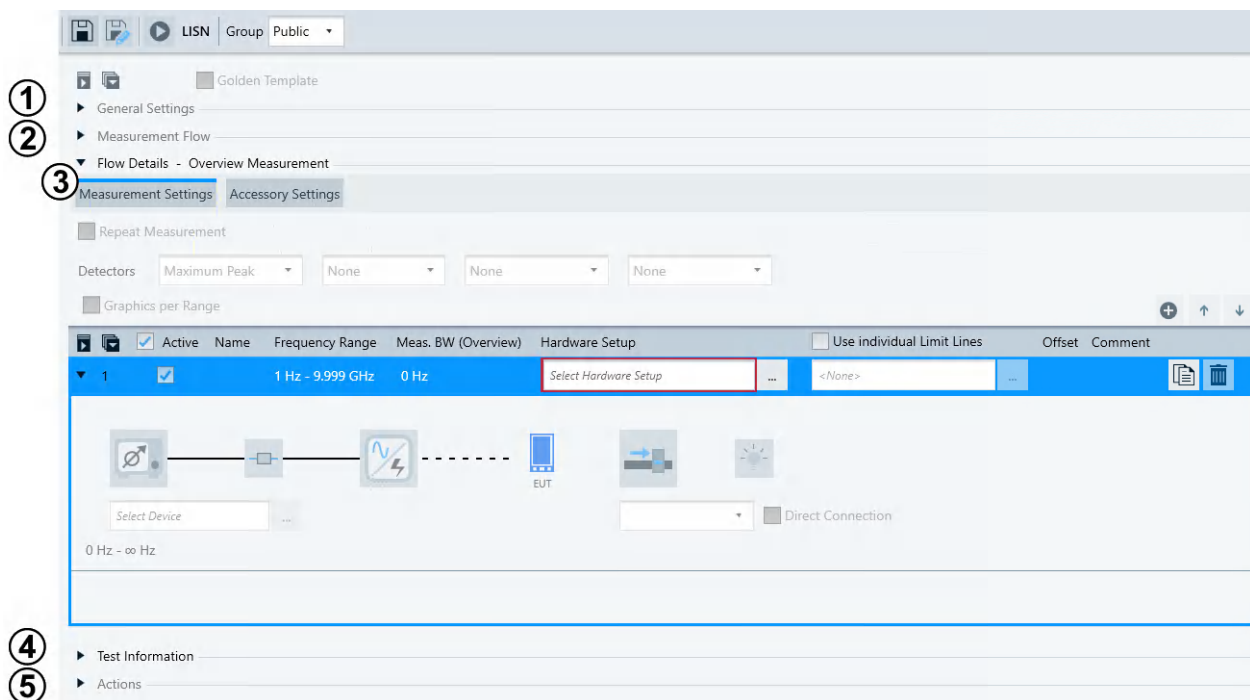

Figure 4-34: Default test template for EMI tests

- 1 = [General Settings](#), available once a hardware setup is specified globally relevant for the test execution
- 2 = [Measurement Flow](#), available once a hardware setup is specified settings for overview measurement, data reduction and final measurement
- 3 = [Flow Details](#) (here: one frequency range, only). As soon as a hardware setup is specified, more measurement settings become available
- 4 = [Test Information](#) (can be edited also in a [test components dialog](#))
- 5 = [Actions](#), available once a hardware setup is specified with settings relevant for user interaction during tests

The following chapters describe these EMI test template types jointly, although the test templates feature some differences depending on their type. The relevant differences are mentioned in the descriptions, while the different EMS hardware setups are handled in individual chapters:

- [EMI hardware setup for transducer / probe](#)
- [EMI hardware setup for LISN](#)
- [EMI hardware setup for sidebar](#)

- [EMI hardware setup for electric field strength](#)
- [EMI hardware setup for electric field strength \(GTEM\)](#)
- [EMI hardware setup for magnetic field strength \(triple loop antenna\)](#)
- [EMI hardware setup for magnetic field strength \(loop antenna + turntable\)](#)
- [EMI hardware setup for radiated spurious emission \(RSE\)](#)

**Select "Hardware Setup" first**

Selecting a [Hardware Setup](#) is a prerequisite for getting access to all other settings in the test template dialog.

For a configuration example, see [Figure 4-35](#).

General Settings

- Audio Demodulation Type: OFF
- Volume: 30 %
- Preselector Filter: Split at 2 MHz
- Notch Filter at 2.4 GHz:
- Notch Filter at 5.8 GHz:
- Level Range (Graphics): 0 - 80 dBµV/m
- LOG X-Axis:
- Separate measurement flow for each antenna:
- Separate traces for the H/V polarizations: OFF
- Do Parallel Measurements:

Measurement Flow

Overview Measurement → Spectrum Overview → Data Reduction → Critical Points → Maximization → Zoom Measurement → Adjustment → Final Measurement → Final Results

Flow Details - Overview Measurement

- Repeat Measurement: By Software
- Repetition Mode: Count Time Interval (10 s)
- Detectors: Maximum Peak, Minimum Peak, Average, RMS
- Save Results for 3D Chart Evaluation:
- Graphics per Range:
- Add Spectrogram Graphic:

Hardware Setup

EMI Test Receiver (ESV44 Receiver) → ANT - Rec (Signal Path) → Broadband Antenna → EUT → Turntable (Mature FCU Turntable) → TX Log-Per Antenna (RVC Antenna) → Gen - Ant (Signal Path) → RF Generator (SMB100A) → Positioner (Mature EAP) → System Control (Standard Control)

Settings (Overview) (30 MHz - 6 GHz)

- Operating Mode: Test Receiver Spectrum Analyzer
- Scan Mode: Time Domain
- Detectors: PK+ PK- AVG RMS
- Filter Type: 6 dB
- Meas. BW: 120 kHz (CISPR BW)
- Step Size: 30 kHz (Auto)
- Points: 5668
- Meas. Time: 500 ms
- Input Selection: 1 DC
- RF Attenuation: Auto
- Min. Attenuation: 0 dB
- Preamplifier: 0 dB
- Screen Maximum: 80 dBµV

Figure 4-35: Example of a fully configured EMI test template with radiative transducer

In Figure 4-35, the EMI test template example is configured with the following settings:

General Settings

- [Golden Template](#) is enabled.
- [Setup](#) provides the following settings:
 - [Audio Demodulation Type](#) = "OFF" (which leaves the [Volume](#) setting idle)
 - [Preselector Filter](#) is set, but [notch filters](#) are not enabled.
 - [Level Range \(Graphics\)](#) from 0 dB μ V/m to 80 dB μ V/m
 - [LOG X-Axis](#) is enabled.
 - [Separate measurements](#) / [separate traces](#) / [parallel measurements](#) are not enabled.
- [Graphics Settings](#) allows selecting additional limit lines to be displayed.
- [Report](#) allows selecting default report templates (standard or custom).
- [System Check](#) enables running a system check and specifies its parameters.
- [Tilt Mast Parameters](#) specifies geometrical details for automatic calculation of the parameters of a motorized tilt mast.

[Measurement Flow](#) allows selecting the test phase to be configured:

- The [Overview Measurement](#) test phase is highlighted, therefore its settings are available in the [Flow Details](#) section.
- The [Data Reduction](#) test phase is not highlighted, its settings are summarized in brief below the icon.
- The [Frequency List](#) option is disabled.
- The [Maximization](#), [Zoom](#) and [Adjustment](#) test phases are enabled but not highlighted, the settings are summarized in brief below the icons.
- The [Final Measurement](#) phase is enabled but not highlighted, its settings are summarized in brief below the icon, for example the [detectors](#) "Quasi Peak", "Minimum Peak", "CISPR Average" and "RMS Average".
- The [Combined Final Analysis using TD](#) is not enabled.
- The options [Flow Schema](#) and [Full TRP](#) are not shown in this figure.

[Flow Details](#), here for the "Overview Measurement" test phase highlighted above:

- The [Measurement settings](#) dialog is selected.
The available dialogs can differ for every test phase in the "Measurement Flow", for example containing [Measurement Settings](#), [Data Reduction Settings](#), [Accessory Settings](#), [Zoom Settings](#), [Adjustment Settings](#) or [Trigger](#).
- The [Repeat Measurement](#) option is enabled.
- Four [Detectors](#) for the overview measurement, here "Maximum Peak", "Minimum Peak", "Average" and "RMS"
- A first [Frequency Range](#), here *30 MHz to 200 MHz*.
See section [Various frequency range statements in the dialog](#) for more details.
- The "Meas. BW (Overview)", here *120 kHz*, is displayed next to the frequency boundaries. You can specify it in the [settings for the overview measurement](#).
- A [Hardware Setup](#) with the name
"EMI Electric Field Strength - Broadband (commercial)" has been selected from the list of hardware setups. (R&S ELEKTRA narrows the list down to hardware setups for EMI tests, only.) The hardware setup selection automatically

brings up the hardware setup diagram (Figure 4-70), which is **locked** with its specified devices. Here: the **EMI Test Receiver**, the **Signal Path Ant - Rec**, the **Transducer Broadband Antenna** and a **Turntable**.

- A **Limit Line** with the name "FCC Part 15 E Field 3m CB Rec" is selected from the list of limit lines.
- The checkbox for **individual limit lines** is activated, enabling different limit lines for different frequency ranges.
- No **Offset** for the limit line is specified.
- Some arbitrary **Comment** text is entered, here "*Customer xyz*".
- For the highlighted receiver device icon, the **settings for the overview measurement** are configured, including, for example, the **Operating Mode** = "Test Receiver", the **Scan Mode** = "Time Domain", the **Meas. BW** = 120 kHz, the **Step Size** = 30 kHz, "Auto" ranging for the **RF Attenuation** and the **Preamplifier** = 0 dB. For the same selected (highlighted) receiver icon, the dialog also provides access to the **Settings (Zoom)** and **Settings (Final)**. Note that there is a central "Select Device" field and a **...** button available for selecting the highlighted device. Changing a selected device requires **unlocking** the hardware setup.
- A **System Control** device is included in the setup.
- The hardware setup is in **normal testing** mode.
- The **Properties** of the hardware setup's devices as specified in the **Device List** are not shown in this figure.
- An additional second frequency range, here 200 MHz to 400 MHz (not expanded in this figure), with a different limit line
- The **Test Information** dialog is not shown in this figure.
- The **Actions** settings dialog is not shown in this figure (see Figure 4-82).

Per default, test templates are optimized for fast and efficient measurement procedures but must also consider the performance of your test equipment. Therefore, the software configures several settings in the background automatically. For example, if the receiver configured in the hardware setup does not support "Time Domain Scan", R&S ELEKTRA sets the **Scan Mode** to "Stepped Scan".



Test templates without auto-test editor

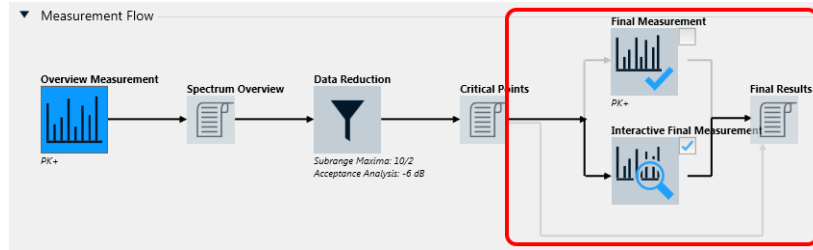

Figure 4-36: Modified EMI test template, if "ELEMI-S" license is not activated

Without a [license](#) for "EMI Extension to System - ELEMI-S", EMI test templates do not provide the auto-test feature. Instead, data acquisition at the critical points requires your interaction during the test, as described in "[Interactive Final Measurement](#)" on page 201.



Minimize frequency ranges

For best access to all frequency ranges within a limited display area, each of the frequency ranges can be minimized like the first frequency range in this example:

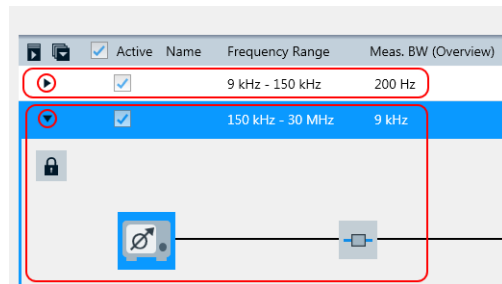

Or use the scrollbar, to shift the frequency range that you want to edit into the display area.

The following chapters explain how to configure an EMI test template.

- [General Settings](#)..... 142
- [Measurement Flow](#)..... 161
- [Flow Details](#)..... 201
- [Test Information](#)..... 229
- [Actions](#)..... 230

4.5.2.1 General Settings

▼ General Settings

This dialog provides access to several settings that are relevant independent of the type of measurement.

In a new test template, the "General Settings" are available only, when you have selected a [Hardware Setup](#) in the [Flow Details](#).

Golden Template.....	143
Setup.....	145
L Audio Demodulation Type.....	145
L Volume.....	145
L Preselector Filter.....	145
L Notch Filter at 2.4 GHz.....	146
L Notch Filter at 5.8 GHz.....	146
L Output 1.....	146
L Output 2.....	148
L Preselection Mode.....	148
L Level Range (Graphics).....	149
L LOG X-Axis.....	149
L Site Correction Factors (C2) for the GTEM Correlation.....	149
L Create new factors.....	149
L Separate measurement flow for each antenna.....	150
L Separate traces for the H/V polarizations.....	151
L Do Parallel Measurements.....	151
Graphics Settings.....	154
L Use dynamic Limit Line.....	155
Report.....	157
L Default Report Template.....	157
L External Report template - Main.....	157
L External Report template - Sub.....	157
System Check.....	158
Tilt Mast Parameters.....	160

Golden Template

Not available in [Test Templates for calibration measurements](#) and [EUT Monitoring templates](#).

Enabling this feature allows importing the same ("golden") test template and its referenced subitems into a different installation of R&S ELEKTRA. For example, when you [Export](#) a golden template and [Import](#) it at other [test sites](#) (which can be different test chambers), you can import it including contained limit lines and frequency lists. This import treats the golden template as the reference and updates the local data from the golden template's data. Hence, importing a golden template by default overwrites existing subitems, like limit lines, and consequently helps to reduce efforts in test template maintenance.

Labeling golden templates

- In the list of [Test Templates](#), R&S ELEKTRA highlights the name of each "Golden Template" with a yellow dot:

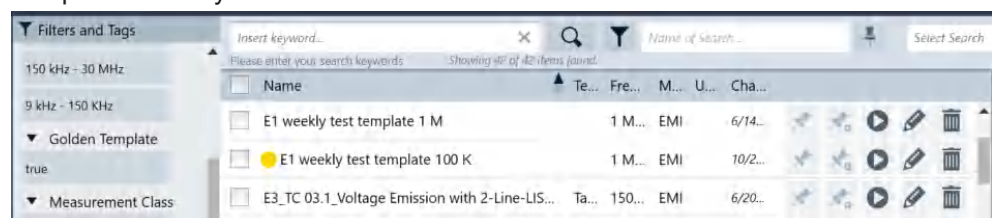

Figure 4-37: Yellow dot highlights a Golden Template

Rules for import of test templates

- By default, the [Import](#) of a normal test template does not overwrite an existing test template with the same name, because local data in the importing client is the reference.
- When you import a "Golden Template", by default it overwrites an existing test template with the same name, because the imported "Golden Template" is the reference, and not the local data. This rule applies also to data that the test template refers to, like limit lines. However, you can still select that the import creates an additional test template with a modified name, or skip the import.

Use cases for distributing test templates without or with central Database:

- *Without* a central database, you can distribute a "Golden Template" via [Export](#) and [Import](#).

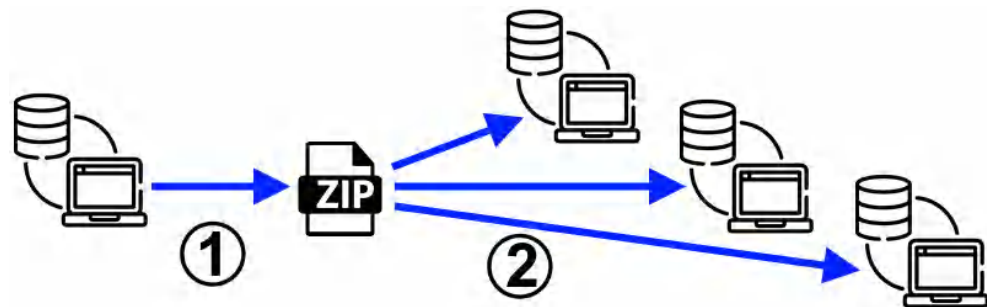

Figure 4-38: Distribution of test templates to independent instances of R&S ELEKTRA

- 1 = [Export](#) from original source
- ZIP = The compressed export file
- 2 = [Import](#) to arbitrary clients

- *With* a central database, all test templates, including each "Golden Template", are immediately available to all remotely connected instances.

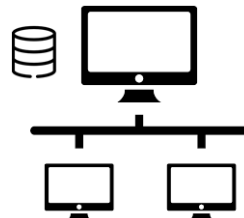

Figure 4-39: In a setup with central database, all instances use the same test templates

- Top = Central database
- Below = Connected remote clients

Test sites sharing a "Golden Template"

- The "Test Site" parameter, which you can set independently in each hardware setup, can differentiate similar hardware setups despite identical names:

<input type="checkbox"/> Name	Test Site	Frequency Range	Meas
<input type="checkbox"/> BCI EN 61000-4-6	A	150 kHz - 80 MHz	EMS
<input type="checkbox"/> BCI EN 61000-4-6	B	150 kHz - 80 MHz	EMS
<input type="checkbox"/> BCI EN 61000-4-6	C	150 kHz - 80 MHz	EMS

Figure 4-40: Hardware setups can have the same name at a different Test Site

Using identical hardware setup names but different test sites allows referencing different hardware setups in the same "Golden Template", when you use this template at different test sites. When R&S ELEKTRA loads a test template, it automatically loads the hardware setup with the name that the test template specifies, having a matching test site name. Hence, use a "Golden Template" for referencing hardware setups that have the same name but are specified for different test sites, and therefore have different entries in the "Test Site" column.

During the [Import](#) of a "Golden Template", the software updates also the limit lines and frequency lists in the importing client. If a limit line or frequency list with the same name exists, the imported data overwrites it. Hence, the software updates the complete measurement context information without requiring user interaction.

Setup

Specifies some basic settings for the test template.

Audio Demodulation Type ← Setup

Available only, if the receiver supports audio demodulation (option R&S FSV-B3) and if "FSV-B3" is enabled at "Home" > "Device List" > "Receiver" > [General](#) > "Options".

Audio demodulation can improve the identification of signals in the [Interactive measurement for EMI tests](#) mode. For example, if an FM broadcasting radio signal acts as interferer, FM demodulation can make the original audio signal audible.

Available audio demodulation types are:

- "OFF" Disables audio signal demodulation.
- "AM" Enables audio demodulation of amplitude modulated RF signals.
- "FM" Enables audio demodulation of frequency modulated RF signals.

Volume ← Audio Demodulation Type ← Setup

Sets the audio volume level, if [Audio Demodulation Type](#) is available. Use this feature for a receiver that is suited for controlling the audio demodulation volume (option "B3").

Preselector Filter ← Setup

Available only, if the [Receiver](#) type is an "ESW" model, and if [Input Selection](#) uses a conventional AC or DC port (no frequency bands, no external mixers).

Controls the preselector filter bank of the receiver.

Selects one of the following filter options:

- "No Split" uses a **one-stage** bandpass filter:

- 150 kHz to 30 MHz
- "Split at 2 MHz" uses a **two-stage** bandpass filter:
 - 150 kHz to 2 MHz
 - 2 MHz to 30 MHz
- "Split at 8 MHz" uses a **two-stage** bandpass filter:
 - 150 kHz to 8 MHz
 - 8 MHz to 30 MHz
- "Split at 2 & 8 MHz" uses a **three-stage** bandpass filter:
 - 150 kHz to 2 MHz
 - 2 MHz to 8 MHz
 - 8 MHz to 30 MHz

The available filter settings depend on the preselector board installed in the receiver.

Notch Filter at 2.4 GHz ← Setup

Available only, if the [Receiver](#) type is an "ESW" model, and if [Input Selection](#) uses a conventional AC or DC port (no frequency bands, no external mixers).

Enables or disables the 2.4 GHz notch filter in the receiver.

Notch Filter at 5.8 GHz ← Setup

Available only, if the [Receiver](#) type is an "ESW" model, and if [Input Selection](#) uses a conventional AC or DC port (no frequency bands, no external mixers).

Enables or disables the 5.8 GHz notch filter in the receiver.

Output 1 ← Setup

Available only, if the [Receiver](#) type is "FSWT26", which has 2 [IF/VIDEO/DEMODO] ports [OUTPUT1] and [OUTPUT2] on its rear panel.

"Off" Turns off the output.

- "IF Output"
- The intermediate frequency (IF) is the signal of the downconverted received frequency (resolution bandwidth, RBW) after the IF filter. Downconversion is done by the local-oscillator and mixer hardware.
Select one of the following "Output Voltage" ranges for IF output:
 - ± 0.5 V
 - ± 1.0 V
 - ± 1.5 V

"I & Q" Automatically sets [Output 2](#) to "I & Q", too. "I & Q" is available only for both outputs or none.

Select one of the following "Output Voltage" ranges for in-phase and quadrature components (I & Q):

- ± 0.5 V
- ± 1.0 V
- ± 1.5 V

"Video"

The video signal is the "IF Output" with an additional video bandwidth filter in the signal path.

Specify the following settings for video output:

- Select the "Mode" as either linear or logarithmic.
 - For "LIN" mode, also select the coupling (see below)
 - For "LOG" mode, R&S ELEKTRA automatically selects "DC" coupling
- Select the "Coupling" (for "LIN" mode) as either alternating or direct current:
 - For "AC" coupling, also select the output gain and AC cutoff (see below)
 - For "DC" coupling, no gain and no AC cutoff settings are available

When you change the coupling, note that the "Output Voltage" ranges also change (see below).

- Select the "Output Gain" (for "AC" coupling, only) as automatic, linear or logarithmic.
 - For "AUTO" output gain, no manual gain setting is available
 - For "LIN" output gain, enter a factor in the range of 0.1 to 100000
 - For "LOG" output gain, enter a gain in the range of -2 dB to 100 dB
- Specify the "AC Cutoff" (for "AC" coupling, only) in the range of 1 Hz to 900 Hz
- Enabling "Lowpass" allows specifying a limit frequency for the lowpass filter
- Select the "Output Voltage"
 - For "AC" coupling (see below), select one of the following ranges:
 - ± 0.5 V
 - ± 1.0 V
 - ± 1.5 V
 - For "DC" coupling (see below), select one of the following ranges:
 - 0 V to 0.5 V
 - 0 V to 1.0 V
 - 0 V to 3.0 V
- The "Phones" option allows sending the signal also as an audio output to the headphone jack on the receiver's front panel.
 - "Off" disables the audio output
 - "Overview" enables the audio output during the overview measurement
 - "Final" enables the audio output during the final measurement
 - "Both" enables the audio output during the overview and final measurements

- | | |
|------|---|
| "FM" | <ul style="list-style-type: none"> • Select one of the following "Output Voltage" ranges for frequency modulation (FM): <ul style="list-style-type: none"> – ± 0.5 V – ± 1.0 V – ± 1.5 V • Select the "Coupling" (for "LIN" mode) as either alternating current "AC" or direct current "DC". |
| "PM" | <ul style="list-style-type: none"> • Select one of the following "Output Voltage" ranges for phase modulation (PM): <ul style="list-style-type: none"> – ± 0.5 V – ± 1.0 V – ± 1.5 V |
| "AM" | <ul style="list-style-type: none"> • Select one of the following "Output Voltage" ranges for amplitude modulation (AM): <ul style="list-style-type: none"> – ± 0.5 V – ± 1.0 V – ± 1.5 V • Select the "Coupling" (for "LIN" mode) as either alternating current "AC" or direct current "DC". |

Output 2 ← Setup

Available only, if the [Receiver](#) type is "FSWT26".

For a description of these settings, see [Output 1](#).

Preselection Mode ← Setup

Available only, if the [Receiver](#) type is "FSWT26" with integrated preselector ([option R&S FSWT-B223](#)).

- | | |
|-----------------|--|
| "Off" | Disables preselection in the R&S FSWT. |
| "Narrow" | <p>Enables the "Auto Narrow" filter preselection function of the R&S FSWT. It automatically applies the most suitable narrowband preselection filters in a measurement, depending on the bandwidth you have selected.</p> <ul style="list-style-type: none"> • For measurement frequencies up to 30 MHz, the R&S FSWT uses combinations of lowpass and highpass filters. • For measurement frequencies above 30 MHz, the R&S FSWT uses bandpass filters. |
| "Wide" | <p>Enables the "Auto Wide" filter preselection function of the R&S FSWT. It automatically applies the following wideband filters consecutively:</p> <ul style="list-style-type: none"> • Lowpass 40 MHz • Bandpass 30 MHz to 2.25 GHz • Bandpass 2 GHz to 8 GHz • Bandpass 8 GHz to 26.5 GHz |
| "Band Pass" | Enables selecting a specific filter band for preselection in the Flow Details > Settings (Overview) > Band Pass . |
| "High/Low Pass" | Enables selecting a filter band for preselection in the Flow Details > Settings (Overview) > High/Low Pass . |

Level Range (Graphics) ← Setup

Specifies the lower and upper level range limits to be displayed on the y-axis of the test chart.

The software automatically assigns the unit of the level values depending on the [Transducing Device](#).

You can edit the unit by entering it together with the level value, for example:

- "ma" for mA
- "w" for W
- "dbm" for dBm
- "mv" for mV
- "dbµv" for dBµV

LOG X-Axis ← Setup

Enables or disables logarithmic scaling of the test chart's x-axis.

Site Correction Factors (C2) for the GTEM Correlation ← Setup

Available only in a test template of the [type](#) "EMI - Electric Field Strength (GTEM)".

Specifies two [attenuation tables](#) with dB values for the correlation between measurements in an open area test site (OATS) and in the GTEM waveguide.

R&S ELEKTRA uses these tables for a correlation algorithm. It converts the results of a measurement in a GTEM cell into equivalent results that would be measured in a true OATS with an antenna in horizontal or vertical polarization.

You can either select existing attenuation tables or let the software compute correction factors to create tables automatically.

"Horizontal" Name of the attenuation table that represents horizontal antenna polarization in the OATS. Use the  button to select a table.

"Vertical" Name of the attenuation table that represents vertical antenna polarization in the OATS. Use the  button to select a table.

Create new factors ← Site Correction Factors (C2) for the GTEM Correlation ← Setup

Uses a set of input parameters to let R&S ELEKTRA calculate attenuation tables for GTEM correlation. The software automatically creates these tables for the frequency range 10 MHz to 30 GHz.

Figure 4-41: OATS (open area test site) factor calculation

Use the following "Input" parameters:

- "d" = horizontal distance between EUT and antenna
- "e" = vertical height of the EUT above the ground
- "hmin" = minimum vertical height of the antenna above the ground
- "hmax" = maximum vertical height of the antenna above the ground
- "step" = step size of the vertical height variation of the antenna
- "Anechoic Mode" = either "Semi" anechoic or "Fully" anechoic

Note: Do not consider the default values suggested in the dialog as recommended by Rohde & Schwarz.

For the "Output", specify names for the attenuation tables for horizontal and vertical polarization, respectively.

Click "Calculate" to let R&S ELEKTRA automatically create and save these tables.

If you try to save a GTEM test template, which requires defining the C2 factors, but you have not yet done so, the following message comes up: "Select Horizontal and Vertical Correction Factors (C2)". In this case, open the [General Settings > Setup](#) dialog to select or create the "Site Correction Factors (C2) for the GTEM Correlation".

Note: For the GTEM conversion factor C1, see ["GTEM Correction"](#) on page 483.

Separate measurement flow for each antenna ← Setup

Available only, if the following conditions are all met:

- The [test template type](#) is "EMI - Electric Field Strength" or "EMI - Radiated Spurious Emission"

- The test template has at least two frequency ranges that use at least two different [antennas](#) as the [Transducing Device](#)
- [Do Parallel Measurements](#) is disabled

The option for separate measurement flows is useful, for example, if the test requires different antennas for different frequency ranges. Manually exchanging antennas several times can be time-consuming. Therefore, a solution is to run the full measurement flow for each antenna, before mounting another one.

If you enable this option, R&S ELEKTRA first runs the corresponding test segment with one antenna. When this segment is completed, the software proceeds with the next antenna. Several consecutive measurement flows per antenna can be faster than switching between the antennas several times.

Separate traces for the H/V polarizations ← Setup

Available only, if the following conditions are all met:

- The [test template type](#) is "EMI - Electric Field Strength"
- The test template uses an [Antenna](#) as the [Transducing Device](#)

The following settings take effect in each test based on this test template:

- "OFF": R&S ELEKTRA creates only the standard "Spectrum Overview" table and chart with the maximized combination of the results measured with the horizontal (H) and vertical (V) antenna polarization. Hence, the software reports only the higher-level value (H or V) at each frequency point.
- "Separate Graphs": R&S ELEKTRA also creates two separate "Spectrum Overview H" and "Spectrum Overview V" result tables and charts, one for each polarization (H and V)
- "Single Graph": as above, but the results of the H and V measurements are combined in one common "Spectrum Overview H/V" chart with separate, color-coded H and V traces. The H and V tables remain separate.

Do Parallel Measurements ← Setup

Available only, if the hardware setups in this test template allow using more than one measurement instrument at the same time.

For example, you can reduce total test time by using two receivers for measuring an EUT's radiation with a horizontally polarized (H) and a vertically polarized (V) antenna simultaneously. Likewise, multiple receivers (and accessories) can measure in different frequency ranges simultaneously.

If enabled, R&S ELEKTRA evaluates, which kind of parallel measurements are possible, based on the hardware setup and the device list. The software automatically selects the most advantageous arrangement.

Example: Parallel measurements with 4 receivers

In this example, all frequency ranges are configured with different hardware setups, each with a different receiver and with different accessories settings:

The screenshot shows the 'Flow Details - Overview Measurement' window. It has three tabs: 'Measurement Settings', 'Accessory Settings', and 'Trigger'. Under 'Measurement Settings', there is a 'Repeat Measurement' checkbox (unchecked), a 'Detectors' section with four dropdown menus (Maximum Peak, Average, None, None), and a 'Save Results for 3D Chart Evaluation' checkbox (unchecked). Below this is a table with the following columns: Active, Name, Frequency Range, Meas. BW (Overview), and Hardware Setup.

	Active	Name	Frequency Range	Meas. BW (Overview)	Hardware Setup
①	<input checked="" type="checkbox"/>		30 MHz - 200 MHz	120 kHz	RE_30M-200MHz
②	<input checked="" type="checkbox"/>		200 MHz - 1 GHz	120 kHz	RE_200M-1GHz
③	<input checked="" type="checkbox"/>		1 GHz - 18 GHz	1 MHz	RE_1G-18GHz
④	<input checked="" type="checkbox"/>		18 GHz - 40 GHz	1 MHz	RE_18G-40GHz

Figure 4-42: Frequency range list with 1 frequency range per receiver

- 1 = Band 1, using test receiver A
- 2 = Band 2, using test receiver B
- 3 = Band 3, using test receiver C
- 4 = Band 4, using test receiver D

Example: Parallel measurements with 4 receivers and more frequency ranges

In this example, more frequency ranges are configured, to address different measurement bandwidths, different antennas or different accessories settings for the same hardware setup:

Active	Name	Frequency Range	Meas. BW (Overview)	Hardware Setup
<input checked="" type="checkbox"/>		30 MHz - 500 MHz	100 kHz	RSE_30M-1GHz
<input checked="" type="checkbox"/>		500 MHz - 1 GHz	200 kHz	RSE_30M-1GHz
<input checked="" type="checkbox"/>		1 GHz - 1.5 GHz	1 MHz	RSE_1G-1.5GHz
<input checked="" type="checkbox"/>		1.5 GHz - 3 GHz	3 MHz	RSE_1.5G-3GHz
<input checked="" type="checkbox"/>		3 GHz - 10 GHz	3 MHz	RSE_1G-18GHz
<input checked="" type="checkbox"/>		10 GHz - 18 GHz	3 MHz	RSE_1G-18GHz
<input checked="" type="checkbox"/>		18 GHz - 26,5 GHz	3 MHz	RSE_18G-40GHz
<input checked="" type="checkbox"/>		26.5 GHz - 40 GHz	3 MHz	RSE_18G-40GHz
<input checked="" type="checkbox"/>		40 GHz - 40,01 GHz	3 MHz	RSE_5G (FR2)

Figure 4-43: Frequency range list with several frequency ranges per receiver

- 1 = Band 1, using test receiver A and 4 different measurement bandwidths (hence 4 frequency ranges)
- 2 = Band 2, using test receiver B and different accessories settings (hence 2 frequency ranges)
- 3 = Band 3, using test receiver C and different antennas (hence 2 frequency ranges)
- 4 = Band 4, using test receiver D above 40 GHz

Also, if "Do Parallel Measurements" is enabled, R&S ELEKTRA disables the options [Separate measurement flow for each antenna](#) and [Separate traces for the H/V polarizations](#).

During the test, R&S ELEKTRA represents the parallel threads of measurements by colored "Range" indications and colored arrows in the [Measurement Flow Control](#) dialog.

Example: Parallel measurements in the "Flow Control" dialog

In the "Flow Control" dialog, the "Range" (labeled 1 and 2 in [Figure 4-44](#)) represents the bands in the test template and the status of measurement.

The number of arrows (labeled 3 and 4) equals the number of simultaneous measurement threads. Each arrow indicates progress of its thread in the accessory's position, in the same way as the position is highlighted by color in a test run without parallel measurements.

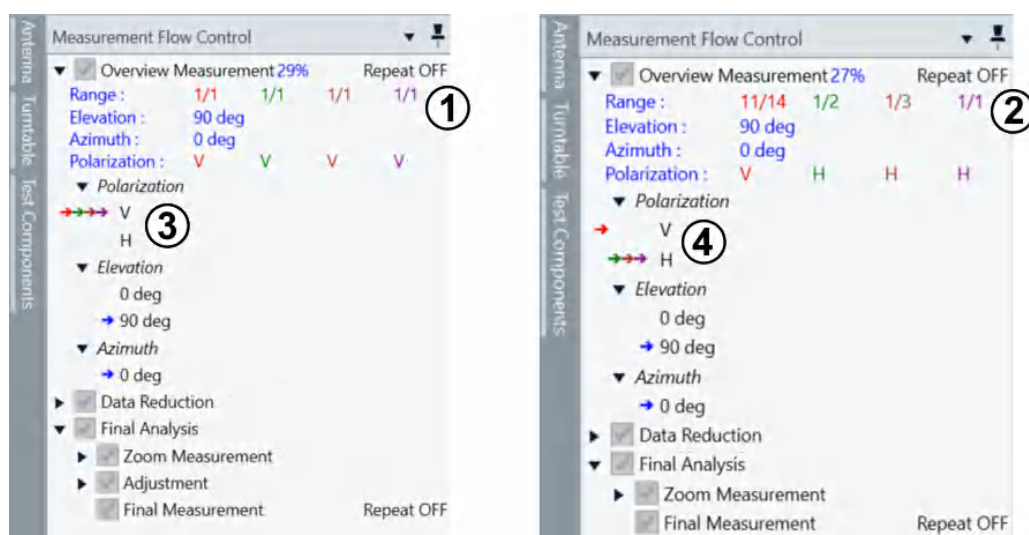

Figure 4-44: Examples of dialogs with 4 bands and no subbands (left) and with subbands (right)

- 1 = 4 bands (4 colors) that have no subbands, therefore each is represented by indicator "1/1" (1st out of 1)
- 2 = The first 3 bands have subbands, for example, the band represented by red color has 14 subbands and shows its current status by indicator "11/14" (11th out of 14)
- 3 = Colored arrows show that all measurement threads use an antenna positioned in vertical polarization
- 4 = Colored arrows show that 1 measurement thread uses an antenna positioned in vertical polarization and 3 measurement threads use an antenna positioned in horizontal polarization

You can find details on the execution of your specific parallel test in the log file "TestFlow.txt", available in the [Test Components](#) dialog.

Graphics Settings

Selects an arbitrary number of [Limit Lines](#) to be shown additionally in the test charts that are based on this test template. The limit lines in this table are not used for any test evaluation, but for display only.

The **"Add a limit line table"** button  allows selecting limit line tables to be added to the list of limit lines.

Optionally, enter an "Offset" to shift the limit line up ("+", positive dB values) or down ("-", negative dB values).

The "Delete the Table" button  removes a selected limit line table from the list.

"Auto-connect adjacent frequency range sections in a trace" is relevant only, if the test template has more than one frequency range. Use the checkbox to decide, how R&S ELEKTRA draws the trace segments between adjacent frequency ranges.

The auto-connection rules for traces are as follows:

- If a frequency range has a frequency point at its stop, and the next frequency range has a frequency point at its start:
 - If these frequency points are the same, but have different test levels:
 - With enabled checkbox, the software connects these points with a vertical trace segment
 - With disabled checkbox, the software leaves a gap in the trace between these points
 - If these frequency points differ, but have the same test level:
 - The software always connects these points with a horizontal trace segment
 - If these frequency points differ and have different test levels, the software always leaves a gap in the trace between these points
- If a frequency range has no frequency points at its start and stop, the software always connects the trace between this frequency range and its neighbors
- If a frequency range contains one frequency point, only, the software always connects the trace between this frequency range and the next frequency range

Use dynamic Limit Line ← Graphics Settings

The checkbox enables using dynamic limit lines, which R&S ELEKTRA calculates based on your settings. Two types of dynamically calculated limit lines are available: "MIL RE103/CE106" and "Band Cut Out".

"MIL RE103/CE106"

Select "MIL RE103/CE106" for radiated or conducted emission measurements according to MIL Std. 461, which allows using dynamic limit lines with the following parameters:

- "Automatic detection of fundamental frequency"
 - If enabled, R&S ELEKTRA automatically detects the fundamental frequency in the overview measurement result.
 - If disabled, specify the fundamental frequency here.
- "Suppression of 2nd and 3rd harmonic"

Specifies the limit offset at the 2nd and 3rd harmonic below the level at the fundamental frequency.

For example, this suppression is 20 dB in [Figure 4-45](#). Hence, at the frequencies of the 2nd and 3rd harmonic, 400 MHz and 600 MHz, the limit is 20 dB below the peak level of the fundamental at 200 MHz.
- "Suppression of other harmonics and spurious"

Specifies the base limit line offset below the level at the fundamental frequency.

For example, this suppression is 40 dB in [Figure 4-45](#). Hence, at all other the frequencies, the limit is 40 dB below the peak level of the fundamental at 200 MHz.
- "Blanking fundamental and 2nd/3rd harmonic"

Specifies the width of the non-suppressed area ("chimney width") around the fundamental frequency and around the 2nd and 3rd harmonic frequencies.

For example, blanking is 5 % in [Figure 4-45](#).
- "Distance between transmit/receive antenna"

Only in radiated test templates of the type "EMI - Electric Field Strength", R&S ELEKTRA requires this parameter for calculating the dynamic limit line.

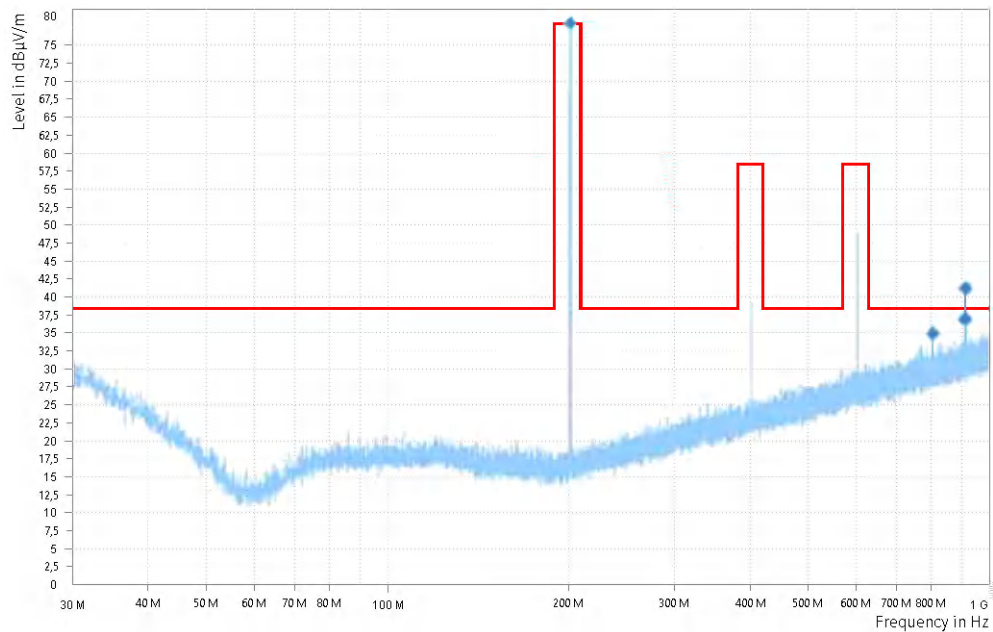

Figure 4-45: Example of a dynamic limit line for MIL RE103/CE106

"Band Cut Out"

Select "Band Cut Out" for radiated or conducted emission measurements according to FCC specification § 15.205, which allows cutting out the DUT communication band (the carrier frequency) by the following parameters:

- "Band Start Frequency"
Specifies the start frequency of your EUT's communication band, and hence the start frequency of the gap in the limit line, for example *495 MHz* in [Figure 4-46](#).
- "Band End Frequency"
Specifies the end frequency of your EUT's communication band, and hence the end frequency of the gap in the limit line, for example *505 MHz* in [Figure 4-46](#).
- "Use relative Limit Line"
Specifies the limit line's offset below the level inside the band cutout, hence below the maximum signal at the carrier frequency.
For example, this offset is *20 dB* in [Figure 4-45](#). Hence, at all other frequencies outside the gap, the limit is 20 dB below the peak level of the fundamental at 500 MHz.

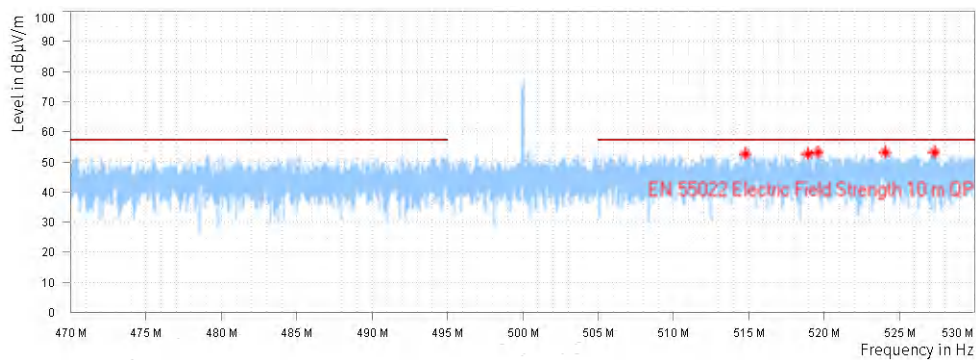

Figure 4-46: Example of a dynamic limit line for Band Cut Out, where the line has a gap around the carrier

Report

Optionally allows preselecting standard (internal) or customized (external) report templates.

Default Report Template ← Report

Optionally selects an existing (predefined) internal [standard report template](#) to be used as a default for each test based on this test template.

Note that selecting default internal report templates at [Administration > Report > Reporting Templates > Internal](#) is relevant also for tests that are saved without containing a report template: If such a test is included into automated report generation in a [Test Plan](#), R&S ELEKTRA uses the internal "Standard Report Template" selected here as a default for this test category.

External Report template - Main ← Report

Available only, if you have installed the [license](#) "ELEM-REP" for report customization.

The button optionally selects an existing customized XML-based text template (for example, an MS Word file) from your local computer or network. It is used as a default main report template for each test based on this test template.

When you have selected a file, the button allows viewing it. The button opens its source location, hence the directory that contains this file.



The button compares, if this report template differs from the external report template file in its original source location. If this check reveals that the external file was updated, a "Report Status" message comes up and suggests, that you update the file by clicking "OK". If you do not want to update it, click "Cancel".

Note that selecting default external main report templates at [Administration > Report > Reporting Templates > External](#) is relevant also for tests that are saved without containing a report template: If such a test is included into automated report generation in a [Test Plan](#), R&S ELEKTRA uses the external "Main" report template selected here as a default for this test category.

External Report template - Sub... ← Report

Available only, if you have installed the [license](#) "ELEM-REP" for report customization.

The  button optionally selects an existing customized XML-based text template (for example, an MS Word file) from your local computer or network. It is used as a default subreport template for each test based on this test template.

When you have selected a file, the  button allows viewing it. The  button opens its source location, hence the directory that contains this file.

The  button compares, if this report template differs from the external report template file in its original source location. If this check reveals that the external file was updated, a "Report Status" message comes up and suggests, that you update the file by clicking "OK". If you do not want to update it, click "Cancel".

Note that selecting default external subreport templates at [Administration](#) > [Report](#) > [Reporting Templates](#) > [External](#) is relevant also for tests that are saved without containing a report template: If such a test is included into automated report generation in a [Test Plan](#), R&S ELEKTRA uses the external "Sub..." report template selected here as a default for this test category.

System Check

Available only, if [System Check](#) is enabled in any hardware setup that is referenced by your test template.

Note: Radiated system checks are inconclusive. For conducted tests and for tests with direct connection ([Figure 4-134](#)), the system check runs like a normal test and generates a [Verdict](#). For **radiated** tests with antennas, this procedure is not suitable because of significant uncertainties, for example from near-field coupling. Therefore, checking a radiated system leads to the verdict "Inconclusive".

If any referenced hardware setup in your test template is properly defined for a system check, the checkbox "Run System Check" is available. It instructs R&S ELEKTRA to perform a system check in the test created from this test template, and to do so it enables editing the following settings:

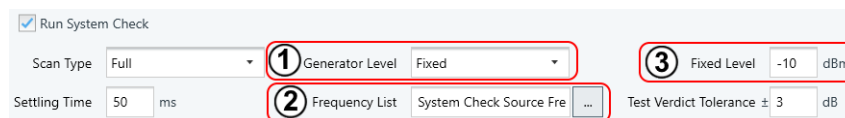

Figure 4-47: Settings 2 and 3 depend on the generator level selection (1)

- "Scan Type" selects a checking option:
 - "Full" runs a full system check across each frequency range, in each frequency range that references a hardware setup which is prepared for system check, and for each frequency from the "Frequency List" or "Normalization" table (see below) that lies within those frequency ranges.
 - "Partial" runs a partial system check at the frequencies as above, but based on the settings in the "Zoom Settings" dialog ([Figure 4-58](#)) in the [Flow Details](#) section of your test template. Therefore, selecting "Partial" also enables this "Zoom Settings" dialog, unless enabled before.
 - "Intelligent" runs a full system check (like "Full"), but only once, and it requires a stepped scan. When the transferred scan data blocks indicate that the current frequency has been passed, R&S ELEKTRA turns RF power off at the generator. It shifts the generator to the next frequency from the "Frequency List" or "Normalization" table, sets the associated output level and turns on RF power.

This approach does not work with a time domain scan, because this fast scanning technique can lead to skipped frequencies. Also, the intelligent scan does not work with an analyzer sweep, for which the analyzer transfers only complete result traces.

- "Settling Time" is a delay between frequency set-up on the RF generator and the actual measurement. Permissible delays range from 0 ms to 10.000 ms, with a default of 50 ms.
- **(1)**
"Generator Level" selects, how R&S ELEKTRA determines the required RF generator source level:
 - "Fixed" allows selecting a frequency list (see 2 in [Figure 4-47](#)) together with specifying a fixed generator level (3).
 - "LimitLine" allows selecting a frequency list (2) together with specifying a fixed offset (3) from the selected limit line (see below). When you select a limit line, R&S ELEKTRA performs measurements only for ranges that the limit line covers. The level calculation considers only the first detector limit defined in the selected limit line.
 - "Normalization" allows selecting a normalization table (2) that contains frequencies and predefined levels at these frequencies.
- **(2)**
Either "Frequency List" or "Normalization":
 - "Frequency List" is available, if "Generator Level" = "Fixed" or "LimitLine". It selects a frequency list for the following cases:
For "Generator Level" = "Fixed", R&S ELEKTRA just the frequencies from the list together with a fixed level.
For "Generator Level" = "LimitLine", R&S ELEKTRA uses the frequencies from the list together with the levels from the specified [Limit Line](#) assigned to the 1st detector. Make sure to specify limit lines for each frequency range in the [Flow Details](#) section of your test template.
Especially for test setups with a LISN, consider the following:
With the "Generator Level" set to "Limit Line", the calculation assumes a constant probe impedance of typically 50 Ω. But if a device like a LISN is involved, with typical frequencies around 10 kHz, then towards low frequencies the impedance can decrease to just 10 Ω. As a result, the impedance mismatch decreases the actual signal power, leading to smaller level results at the receiver. To compensate this mismatch, use an attenuation correction table that covers the transmitting signal path. R&S ELEKTRA includes this correction into the calculation of the required level of the signal generator.
 - "Normalization" table is available only, if "Generator Level" = "Normalization". R&S ELEKTRA uses the frequencies and predefined levels at these frequencies from the selected normalization table.
- **(3)**
Either "Fixed Level" or "Limit Offset":
 - "Fixed Level" is available only, if "Generator Level" = "Fixed". It specifies a fixed generator level in the range from -130 dBm to +40 dBm. The default level is -10 dBm.
 - "Limit Offset" is available only, if "Generator Level" = "LimitLine". It specifies a fixed offset from the level of the selected [Limit Line](#). Permissible offsets are in the range from -100 dB to +100 dB. The default offset of -6 dB is equivalent with a level 6R&S ELEKTRAdB below the limit line.

- "Test Verdict Tolerance" specifies a tolerance in the range from 0 dB to 10 dB (default 3 dB). If the level margin calculated in the system check violates the specified limit not more than this tolerance (in positive or negative direction) while considering a possible "Limit Offset", the **Verdict** for the system check is still "Passed". Any impedance mismatch at the transmitter creates an additional decrease of the received signal level. You can compensate for this decreased signal level by specifying an additional attenuation table for the transmitter's signal path.

Tilt Mast Parameters

Available only, if the following conditions are all met:

- The **license** for "ELEMI-S" is enabled
- Your test template is of the type "EMI - Electric Field Strength" or "EMI - Radiated Spurious Emission"
- The antenna's **Tower Control** uses an automatic **Antenna Tower**

Typical automated test systems use a motorized tilt mast as in [Figure 4-48](#), for example in the optional substitution measurement step (see [Flow Schema](#)) in RSE tests. If your test system uses such an automated tilt mast, calculating the tilt angle at the controller and the free-space attenuation between EUT and antenna requires the following input information:

- *Measurement distance* from the EUT to the antenna reference point in [Figure 4-48](#). Must be entered by the system operator, see "Measurement distance".
- *EUT height*. Must be entered by the system operator, see "EUT Height".
- *Antenna height*. Depends on many parameters. While the mast and antenna geometry are known to the mast manufacturer and hence available in the mast control system, the following parameters can differ:
 - *Mast height*. Is available in the mast control system
 - *Tilt angle*. Is available in the mast control system
 - *Reference point* for defining the antenna height. There are two options for specifying this *reference point*:
 - It is in the **mast** - see **1** in [Figure 4-48](#)
 - It is in the **antenna** - see **2** in [Figure 4-48](#)

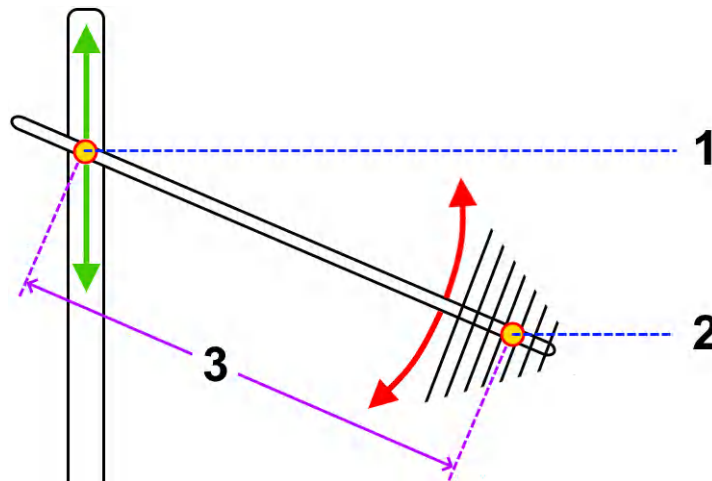

Figure 4-48: Reference points in an automated tilt-mast setup

Green arrows = Mast height movement

Red arrows = Tilting movement of the antenna

1 = Mast reference point

2 = Antenna reference point

3 = Reference length = distance between reference points

Settings to be done by you as a system operator in the "Tilt Mast Parameters" dialog:

- "Tilt Mode"
 - "Off": disables automatic tilting of the antenna
 - "Mast-Height": the mast control system moves the mast reference point (1) to the set antenna height
 - "Antenna Reference Height": the mast control system moves the antenna reference point (2) to the set antenna height. The mast height, which is required for this movement, is calculated from the antenna's reference length (3), the measurement distance to the EUT, and the EUT height.
- "Measurement distance": enter distance from the antenna reference point to the EUT
- "EUT Height": enter the EUT's height above ground
- "Adapt antenna factor for additional free space attenuation": enable or disable R&S ELEKTRA to adjust automatically the antenna factor with the free-space attenuation that it calculates from the settings above and from the current antenna height.

4.5.2.2 Measurement Flow

▼ Measurement Flow

This dialog provides access to various settings for the overview measurement, for the data reduction, for the zoom measurement and for the final measurement. In some special cases, there are also settings for a maximization phase and for an adjustment phase. All these settings are valid across all frequency ranges specified in the test template.

In a new test template, the "Measurement Flow" settings are available only, when you have selected a [Hardware Setup](#) in the [Flow Details](#).

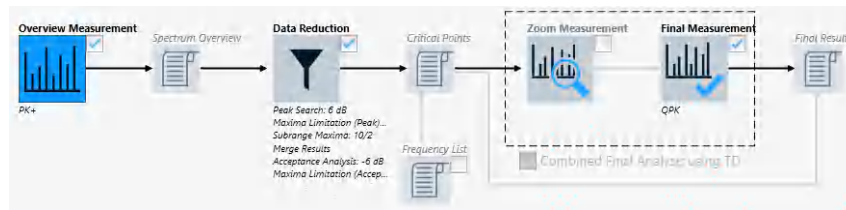

Figure 4-49: Phases in the measurement flow

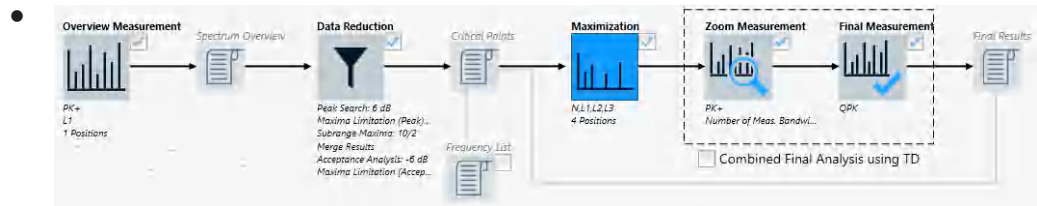

Figure 4-50: Special case: the Maximization phase is for LISNs, slidebars and electric or magnetic field strength tests

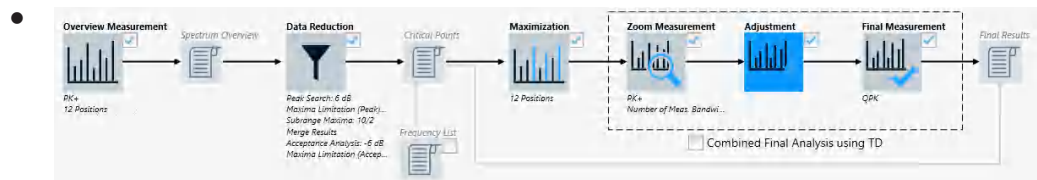

Figure 4-51: Special case: the Adjustment phase is for slidebars and electric field strength tests

To access the [Flow Details](#) settings of any individual phase in the measurement flow, click the icon of this phase. If the icon has a checkbox, you must enable it before you can select the icon.

- [Overview Measurement](#)
- [Data Reduction](#)
- [Maximization](#)
Using an optional "Frequency List" is also described in the section on [Maximization](#)
- [Zoom Measurement](#)
- [Adjustment](#)
- [Final Measurement](#)
- [Flow Schema](#) and [Full TRP](#), available only for radiated spurious emission (RSE) tests

Overview Measurement	163
L Repeat Measurement	170
L Detectors	171
L Trace Mode	171
L Averaging Mode	171
L Save Results for 3D Chart Evaluation	171
L Test Flow acc. to CISPR 32 C.4.1.6.4	172
L Graphics per Range	173
L Add Spectrogram Graphic	173
Data Reduction	173

Frequency List.....	177
Maximization.....	178
Zoom Measurement.....	182
Adjustment.....	184
Final Measurement.....	187
Combined Final Analysis using TD.....	196
Combined Final Analysis using Sweep.....	197
Flow Schema.....	198
Full TRP.....	199
Substitution Measurement.....	200
Interactive Final Measurement.....	201



Overview Measurement

The intention of the overview measurement is finding signals and frequencies that deserve being examined in more detail. This measurement is a scan or sweep, according to the [Operating Mode](#), the [Scan Mode](#) and the [Settings \(Overview\)](#). The overview measurement is executed across the full [spectral range](#) defined in the test template.

The overview measurement can be more coarse than the [Final Measurement](#), and if there is a LISN, it typically ignores some of the LISN lines. However, it must be fine enough to find all interference signals. Therefore, in the [Settings \(Overview\)](#), select a good balance of [Meas. BW](#) and [Step Size](#).

Note: Test templates without auto-test editor.

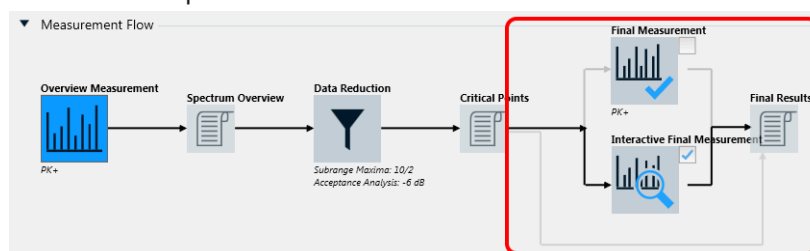

Figure 4-52: Modified EMI test template, if "ELEMI-S" license is not activated

Without a [license](#) for "EMI Extension to System - ELEMI-S", EMI test templates do not provide the auto-test feature. Instead, data acquisition at the critical points requires your interaction during the test, as described in ["Interactive Final Measurement"](#) on page 201.

Click the "Overview Measurement" icon to access the "Flow Details - Overview Measurement" settings:

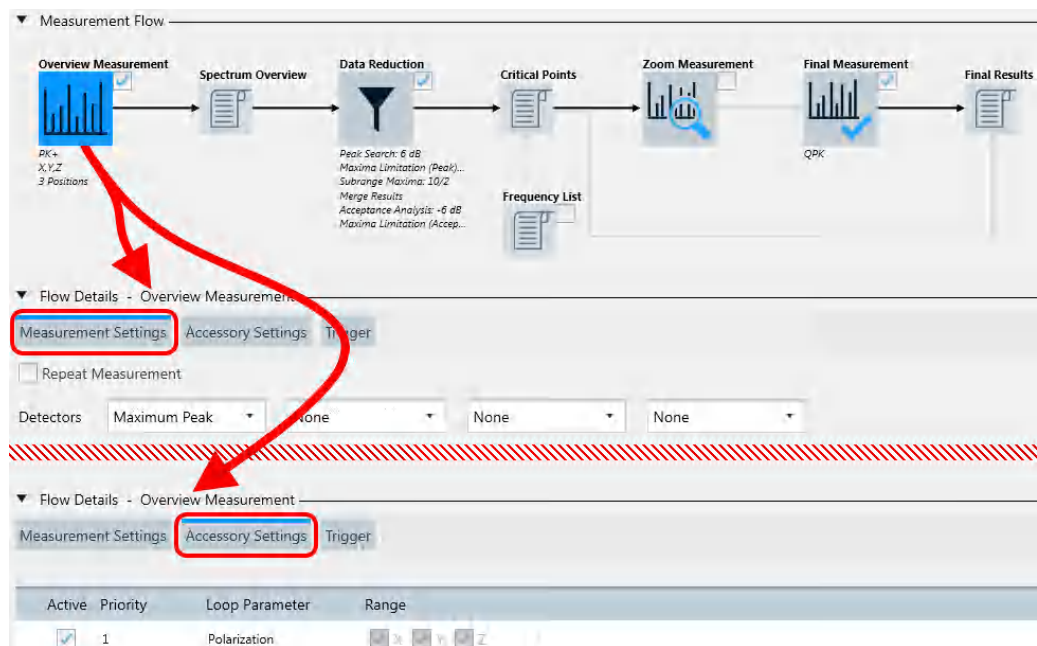

Figure 4-53: The Overview Measurement icon gives access to dialogs under Flow Details - Overview Measurement

The "Flow Details - Overview Measurement" section (Figure 4-53) offers a comprehensive "Measurement Settings" dialog and two brief "Accessory Settings" and Trigger dialogs.

- The **"Measurement Settings"** dialog comprises the following settings:
 - Repeat Measurement
 - Detectors
 - Trace Mode and Averaging Mode
 - Save Results for 3D Chart Evaluation
 - Test Flow acc. to CISPR 32 C.4.1.6.4
 - Graphics per Range
 - Add Spectrogram Graphic
 - Below these settings, find the frequency range list with the comprehensive **Settings (Overview)**, which are described in Chapter 4.5.2.3, "Flow Details", on page 201.
- The **"Accessory Settings"** dialog can comprise various "Loop Parameters".

The screenshot shows the 'Accessory Settings' dialog with a table of Loop Parameters. The table has columns for Active, Priority, Loop Parameter, Mode, Range, Step Size, Parameters, and Graphics per Position.

Active	Priority	Loop Parameter	Mode	Range	Step Size	Parameters	Graphics per Position
<input checked="" type="checkbox"/>	1	Azimuth	Stepped	0 deg - 360 deg	30 deg	Positioning Speed : 7	<input type="checkbox"/>
<input checked="" type="checkbox"/>	2	Height	Stepped	1 m - 4 m	50 cm	Positioning Speed : 7	<input type="checkbox"/>
<input checked="" type="checkbox"/>	3	Polarization	Stepped	<input checked="" type="checkbox"/> H <input checked="" type="checkbox"/> V		H → V	<input checked="" type="checkbox"/>
<input type="checkbox"/>	4	User Defined	Stepped				<input type="checkbox"/>

Figure 4-54: Example of Loop Parameters in the Accessory Settings dialog

EMI tests always run through all frequencies defined in the [frequency range list](#). But depending on the accessories in the test setup, some tests must repeat this run with varying accessory settings. By enabling "Graphics per Position" for an "Active" loop parameter, you can enable R&S ELEKTRA to create separate charts for the test results of each position of this parameter, similar to [Graphics per Range](#).



For example, in a radiated EMI test setup with an antenna tower, you typically repeat the frequency run for each defined height position of the tower. Such a repetition is called a **loop** of positions. Several instances of accessory settings can define multiple loops, for example to measure at all frequencies, multiple antenna height positions, antenna polarizations and azimuth angles. This combination can lead to many repetitions.

The availability of "Loop Parameter" types depends on the [Transducing Device](#):

– **"User Defined"**

"User Defined" actions are always available, but disabled per default. If the transducing device is a simple transducer or probe (as in a test template "EMI - Transducer / Probe"), the "User Defined" actions are the only loop parameters available in the "Accessory Settings" dialog.

R&S ELEKTRA executes "User Defined" actions (or "steps") in addition to the predefined accessory loop parameters when the test runs. You can use these steps, for example for remotely switching the EUT to a specific state. A typical application is for stepwise changing the level of an external supply voltage and measuring its influence on the EUT in the next loop of the test sequence.

To specify "User Defined" loop parameters, activate the checkbox and click the "Expand" button  or double-click the parameters' row. Click the "Add" button  in the "Actions of the Test" column to add a step, for example "Step 1". This name of the step is shown in the loop state column when you execute the test. Right-click a step to add a user-defined action to a step, or rename, delete or move this step. Also you can drag an action from the column "Available Actions" to a step. Proceed as described in [Chapter 4.5.2.5, "Actions"](#), on page 230.

Additional loop parameters can be as follows:

– **"LISN Line"**



If the transducing device is a [LISN](#) in a test template "EMI - LISN" (hence, not a "Single Line LISN"), the "Accessory Settings" offers a line selection. Select the LISN lines that you want to include into the measurement. The following settings apply:

- In a hardware setup with a 2-line LISN, you can select or deselect "N" and "L1".
- In a hardware setup with a 4-line LISN, you can select or deselect "N", "L1", "L2" and "L3".
- In a hardware setup with a multi-line LISN, you can select or deselect all single-line LISNs defined in the [Details](#) tab > ["LISN Lines"](#) on page 424 table. If specified, R&S ELEKTRA preselects the "Default" line.

Select at least one line for the overview measurement. During the test, the software automatically measures the selected lines one by one and stores the results both in combined and in separate result tables.

– **"Distance"**



If the transducing device is a [Slidebar](#) in a test template "EMI - Slidebar", R&S ELEKTRA suggests a table with 12 predefined slidebar positions. To see



this table, click the "Expand" button  or double-click the parameters' row. Default positions are from 0 cm up to 500 cm, with a maximum of 530 cm. You can activate or disable this table, add  or delete  positions and rearrange the positions in the table. If you use an automated slidebar, select a relative "Positioning Speed" between "1" (minimum) and "8" (maximum).

– **"Height" / "Polarization" / "Azimuth" / "Elevation"**

If the transducing device is an **Antenna** in a test template "EMI - Electric Field Strength", R&S ELEKTRA offers an "Accessory Settings" dialog for adjusting the antenna height, polarization and azimuth. In a test template "EMI - Radiated Spurious Emission", the DUT's elevation is an additional "Loop Parameter".

The availability of these parameters depends on the availability of an **Antenna Tower** and one or two **Turntable** devices in the hardware setup. The settings of these parameters define rules that R&S ELEKTRA applies during the test. For example, the software can control automated antenna positioners or prompt you for positioning the antenna manually.

- "Height" of the antenna on its antenna tower, if available, "Stepped" or "Continuous" in the range from 1 m to 4 m. For this range, you can specify a "Step Size" between 0 mm and 4 m and select a relative "Positioning Speed" between "1" (minimum) and "8" (maximum). If you select "Continuous" height positioning, R&S ELEKTRA automatically sets "Height" to "Priority" 1 and sets "Azimuth" positioning (and "Elevation", if available) to "Stepped" at lower priority. For "Continuous" height positioning, "Step Size" is disabled, but you can specify a relative "Measuring Speed" between "1" (minimum) and "8" (maximum).
- "Polarization" allows selecting horizontal ("H") and/or vertical ("V") polarization of the antenna on its antenna tower, if available. If you activate both "H" and "V", clicking the button in the "Parameters" column toggles between "H -> V" (horizontal first) and "V -> H" (vertical first).
- "Azimuth" or angular position of the turntable, if available, "Stepped" or "Continuous" in a "Range" between -360° and $+720^{\circ}$. You can specify the "Step Size" between 0° and $+720^{\circ}$ and select a relative "Positioning Speed" between "1" (minimum) and "8" (maximum). If you select "Continuous" azimuth positioning, R&S ELEKTRA automatically sets "Azimuth" to "Priority" 1 and sets "Height" positioning (and "Elevation", if available) to "Stepped" at lower priority. For "Continuous" azimuth positioning, "Step Size" is disabled, but you can specify a relative "Measuring Speed" between "1" (minimum) and "8" (maximum).
- "Elevation" or angular position of the horizontal turn device, if available, "Stepped" or "Continuous" in a "Range" between -100° and $+500^{\circ}$. You can specify the "Step Size" between 0° and $+500^{\circ}$ and select a relative "Positioning Speed" between "1" (minimum) and "8" (maximum). If you select "Continuous" elevation positioning, R&S ELEKTRA automatically sets "Elevation" to "Priority" 1 and sets "Height" and "Azimuth" positioning to "Stepped" at lower priority. For "Continuous" elevation positioning, "Step Size" is disabled, but you can specify a relative "Measuring Speed" between "1" (minimum) and "8" (maximum). Alternatively, you can select to "Use a table for the combined Height/Polarization setup". If this checkbox is enabled, you can define arbitrary height and polarization steps for the antenna. To do so, click the "Expand" button  or double-click the parameters' row. Click the "Add" button  to add a step and

edit its "Height" and "Polarization" entry. Also, you can change the order by moving steps up and down , or delete steps .

– **"Polarization"**

If the transducing device is a **TEM Waveguide** in a test template "EMI - Electric Field Strength (GTEM)", R&S ELEKTRA enables measuring on all 3 orthogonal EUT axes (X, Y, Z), as shown at the lower edge of [Figure 4-53](#).

You can activate or deactivate this polarization loop, but you cannot change the preselected setting for the x-axis, y-axis and z-axis. Thus, if activated, you must run three overview measurements with the EUT in three different orthogonal orientations. During the test, the software prompts you to switch (hence, rotate) the EUT axis to the three orthogonal orientations X, Y or Z, respectively. The three measurements are stored in separate result tables.

Note that TEM waveguides such as GTEM cells are not suited for [interactive measurements](#).

– **"Axis"**

If the transducing device is a **triple-loop antenna** in a test template "EMI - Magnetic Field Strength (Triple Loop Antenna)", R&S ELEKTRA enables measuring the EUT along all 3 orthogonal antenna axes (X, Y, Z).

You can activate or deactivate this polarization loop and change the preselected setting for the x-axis, y-axis and z-axis. During the test, the software prompts you to switch the triple-loop antenna to the X, Y or Z axis, respectively. The three measurements are stored in separate result tables.

– **"Azimuth" / "Axis"**

If the transducing device is a probe (transducer) of the type **magnetic single-loop antenna** used together with a **turntable** in a test template "EMI - Magnetic Field Strength (Loop Antenna + Turntable)", R&S ELEKTRA provides an "Accessory Settings" dialog for adjusting the EUT azimuth and antenna axis.

- "Azimuth" or angular position of the turntable can be "Stepped" or "Continuous" in a "Range" between -360° and $+720^{\circ}$. You can specify the "Step Size" between 0° and $+720^{\circ}$ and select a relative "Positioning Speed" between "1" (minimum) and "8" (maximum). If you select "Continuous" azimuth positioning, R&S ELEKTRA automatically sets "Azimuth" to "Priority" 1. For "Continuous" azimuth positioning, "Step Size" is disabled, but you can specify a relative "Measuring Speed" between "1" (minimum) and "8" (maximum).

- "Axis" is available only "Stepped" and with a fixed "Range" setting of all 3 orthogonal antenna axes (X, Y, Z). You can activate or deactivate this polarization loop and change the preselected setting for the x-axis, y-axis and z-axis. During the test, the software prompts you to switch the loop antenna to the X, Y or Z axis, respectively. The three measurements are stored in separate result tables.

– **"TestCycle"**

Available only, if you select a **Positioner** of the type **"AVL Test Bench"** in the following [EMI test template](#) types: "Electric Field Strength", "Transducer / Probe", "LISN", "Magnetic Field Strength (Triple Loop Antenna)", or "Magnetic Field Strength (Loop Antenna + Turntable)".

R&S ELEKTRA supports up to five accessory loops for "AVL Test Bench". Use "Continuous" mode for the test cycle, and keep it in the top position as "Priority" = 1 in the "Loop Parameter" list. Hence, you must not shift "TestCycle" away from the top priority. To ensure this condition, R&S ELEKTRA prevents setting any other loop parameter to "Continuous" mode. If you try to do so, this

change of mode is blocked with the following warning: "Test Cycle cannot be shifted from the top priority".

The "TestCycle" is a given procedure of parameter modifications in the "AVL Test Bench", described in [Chapter 4.8.17, "Positioner"](#), on page 435. Its driver enables communication between R&S ELEKTRA and the automotive test-bench control software PUMA / CONCERTO by 3rd-party manufacturer AVL. During EMI overview measurements with automotive components or systems, for example with an electric vehicle's engine being the EUT, that control software serves for varying several parameters in combination. These parameters represent various states and hence monitoring parameters of the EUT, like different voltages, engine speeds, torques, or power modes. These parameters are under control of the 3rd-party software. In the "Overview Measurement" step, R&S ELEKTRA treats the complete test cycle as a single item in the loop. On the contrary, in the [Adjustment](#) step, R&S ELEKTRA varies the parameters individually.

To query the currently activated test-bench parameters, click "Update parameters". For more information, see [Chapter 4.8.17.4, "Functional Check"](#), on page 438 and refer to the "R&S ELEMC-ATB" application note for the automotive test bench option, which you can receive from Rohde & Schwarz on request.

- **"Trigger"** functions can control your receiver or spectrum analyzer during EMI measurements. Using these functions, R&S ELEKTRA can start or stop data acquisition based on trigger events.

Measurement Settings	Accessory Settings	Trigger
Trigger Source	External	Gate Mode: Edge
Trigger Level	1.4 V	Gate Delay: 4 ms
Trigger Offset	0 s	Gate Length: 1 ms
Timeout	5 s	Continuous Gate: <input checked="" type="checkbox"/>
Trigger Polarity	Positive	Gate Period Length: 5 ms
Drop-Out Time	0 s	Gate Period Count: 100
Hold Off	0 s	

Figure 4-55: Example of settings in the Trigger dialog

The "Trigger" dialog is available only, if each frequency range uses one of the following receiver or spectrum analyzer [device types](#):

- R&S ESCI
- R&S ESPI
- R&S ESR
- R&S ESRP
- R&S ESU
- R&S ESW
- R&S FSV
- R&S FSVA
- R&S FSW
- R&S FSWT

Note the following relations in a test template of the type "EMI - Radiated Spurious Emission", if you select **Flow Schema = RSE with Burst Detection**:

- In the **Overview Measurement** dialog, the "Trigger" dialog is not available
- In the **Final Measurement** dialog, the "Trigger" dialog is reduced to the **"Time-out"** field, only, instead of the parameters as in **Figure 4-55**

Note the following relations in a test template of the type "EMI - Radiated Spurious Emission", if you select **Flow Schema = RSE with optional Substitution Measurement**:

- In the **Overview Measurement**, **Maximization** and **Substitution Measurement** dialogs, the "Trigger" dialog is available only with "Trigger Source" = "Free Run", hence no external trigger
- Only in the **Final Measurement** dialog, the "Trigger" dialog offers the additional "Trigger Source" = "Video", together with the parameters as in **Figure 4-55**.
In an RSE test, if **Flow Schema = "RSE with optional Substitution Method"**, the measurement typically uses a continuous wave signal without external triggering. In this scenario, you can use "Video" for triggering by the envelope of the IF signal.

The "Trigger" dialog provides the following parameters:

- "Trigger Source"
"Free Run" selects non-triggered operation.
"External" - or in the "Final Measurement" also "Video" - give access to the following settings:
 - "Trigger Level" specifies the voltage threshold for detecting a trigger event.
 - "Trigger Offset", available only in the "Final Measurement", and only if "Gate Mode" is "Off", defines the time offset between the trigger event and the start of the sweep.
 - "Timeout", used only in **RSE** measurements with **burst detection** and only in the "Final Measurement". It defines the maximum time to wait for a trigger event to occur.
 - "Trigger Polarity" selects a "Positive" voltage change (rising edge) or "Negative" voltage change (falling edge) for the trigger event.
 - "Drop-Out Time" is available only in the "Final Measurement", and only if the **Operating Mode** is "Spectrum Analyzer", while also "Gate Mode" is "Off" or "Edge" with positive "Trigger Polarity". Availability depends also on the device, for example it is available with the R&S FSW, but not with the R&S FSV.
It defines the time that the input signal must stay below the "Trigger Level" before triggering again. Hence, if the input signal has a brief instability (drop out) and crosses the threshold during the "Drop-Out Time", it is ignored and not considered as a trigger event.
 - "Hold Off" is available only in the "Final Measurement", and only if the **Operating Mode** is "Spectrum Analyzer". Availability depends also on the device, for example it is available with the R&S FSW, but not with the R&S FSV.
It specifies a time lapse, during which no subsequent trigger event can occur. If the next trigger signal is detected before the "Hold Off" time has passed, this signal is ignored.
 - **"Gate Mode"** is available only, if the **Operating Mode** is "Spectrum Analyzer", or if the mode is "Test Receiver" with **Scan Mode = "Stepped Scan"**.
Setting "Gate Mode" to "Level" or "Edge" enables trigger gating, which defines conditions for letting an input signal act as a trigger.

A gated sweep is a spectral measurement that captures data only, while a signal from the trigger source, which is also the gate source, "opens" a channel for data acquisition. Typically, gated sweeps are used for measuring only during selected relevant test situations. For example, the gate signal can be a 5V TTL signal that is generated externally in the EUT's environment. The gate signal must be fed into a control port of the receiver or spectrum analyzer.

The following "Gate Mode" options are available:

- "Level": The gate opens and the measurement starts when the trigger source signal exceeds the "Trigger Level". The gate closes and the measurement stops when the trigger source signal drops below the "Trigger Level". You can specify a "Gate Delay", hence a time to wait after the opening of the gate, before the measurement starts.
- "Edge": In addition to the "Level" functions, "Edge" limits the measurement's duration: It terminates the measurement after the specified "Gate Length" or upon the closing of the gate, whichever event happens first.
- "Continuous Gate": available only, if in all frequency ranges, the hardware setup's [Receiver](#) is an R&S FSW spectrum analyzer or an R&S ESW receiver with firmware 3.0 or later. Enables specifying a "Gate Period Length" and a "Gate Period Count". The gate period length defines how long the gate is open when it is triggered. The gate period count determines, how many bursts are included into the current acquisition.

Repeat Measurement ← Overview Measurement

Specifies that the overview measurement is cyclically repeated in a test, until you manually terminate the repetition. This mode is useful for observing changes in the measurement results, if you modify any test conditions during test execution.

The following settings are available (see [Figure 4-35](#)):

- "By Software" or "By Device":
 - "By Software" is enabled by default, hence R&S ELEKTRA controls the repetitions.
 - "By Device" is available only, if the [Operating Mode](#) is "Spectrum Analyzer" (not "Test Receiver"), and if the selected spectrum analyzer supports repetitions. Selecting "By Device" enables specifying the [Trace Mode](#) and the [Averaging Mode](#).
- "Repetition Mode"
 - "Count" specifies the number of repetitions between 1 and 100,000, how often the measurement is repeated.
 - "Time Interval" is available only, if measurements are repeated "By Software". The time interval specifies a duration between 1 s and 100,000 s, how long the measurement is repeated.

Note: During repeated measurements, R&S ELEKTRA compares the currently measured level values with the previously measured level values and keeps the maximum. Lower values in the still varying level measurements are thus ignored. Over time, this algorithm leads to a trace that approaches the maximum of the measured level values at each frequency point, with a continuously reduced variation along the trace.

To terminate the continuously repeating overview measurement while the test is running, click "End Repetition" in the test's [Measurement Flow Control](#) side panel.

If you disable "Repeat Measurement", the overview measurement is executed in a single scan or sweep, only.

See also the "Repeat Measurement" setting in the [Final Measurement](#).

Detectors ← Overview Measurement

Selects the detector types for up to four detectors used in the [overview measurement](#) of a test.

Select at least the 1st detector.

Your selection of detectors for the overview measurement also influences the selection of detectors for the other phases of the measurement flow (if available):

- [Maximization](#): same detectors, editable (overwriting "Overview" detectors)
- [Zoom Measurement](#): same detectors, non-editable (copied from "Overview")
- [Adjustment](#): same detectors, editable (overwriting "Overview" detectors)
- [Final Measurement](#): per default corresponding detectors according to [Table 4-2](#), editable, not overwriting "Overview" detectors

Refer also to the restrictions that apply for selecting detectors in the settings for each frequency range. See "[Detectors](#)" on page 215.

Note: Typically, we recommend using a single fast detector in the 1st detector position, for example "MaxPeak". More and other detectors are permitted and can be a good choice, too, depending on the test situation. For a list of all available detector types, see [Chapter 5.3, "Detectors"](#), on page 562.

Trace Mode ← Overview Measurement

Available only, if [Repeat Measurement](#) = "By Device" is enabled.

Selects one of the following update modes for subsequent traces in each enabled detector:

- "Clear Write" overwrites the previous trace with the levels measured last at each point. See "[Clear Write](#)" on page 624.
- "Max Hold" uses the highest level measured at each point. See "[Max Hold](#)" on page 624.
- "Min Hold" uses the lowest level measured at each point.
- "Average" determines the average level over all measurements at each point.

Averaging Mode ← Overview Measurement

Available only, if [Repeat Measurement](#) = "By Device" is enabled.

Defines the mode with which the trace is averaged over all measurements:

- "Logarithmic" (called "Video" in some instruments) activates logarithmic averaging. Hence, typical measurement levels are labeled "dB μ V" or "dBm".
- "Linear" converts the level values into linear units before averaging
- "Power" converts the level values into watt units before averaging

After averaging, the software converts the data back to the original unit.

The selected "Averaging Mode" applies to each detector, for which "[Trace Mode](#)" on page 171 is set to "Average".

Save Results for 3D Chart Evaluation ← Overview Measurement

This option is available only, if the following conditions are all met:

- The [license](#) for "EMI Extension for 3D Results Evaluation - ELEMI-3D" is activated
- The [test template type](#) is one of the following:
 - "EMI - Electric Field Strength"
 - "EMI - Radiated Spurious Emission"

Enable this saving option, if you want R&S ELEKTRA to create [3D charts](#) of the test results. See [Chapter 7.7.1, "Evaluation - 3D Evaluation"](#), on page 634.

- In "Electric Field Strength" tests, typically the 3D charts are in cylinder coordinates: The azimuth is the turntable's angular position, and the vertical axis is the antenna's height position on the antenna tower.
- In "Radiated Spurious Emission" tests, typically the 3D charts are in spherical coordinates: The azimuth is the turntable's angular position, and the elevation is the turn device's angular position.

Therefore, the 3D charts option is useful for test templates that include two accessory devices: turntable + antenna tower, or turntable + turn device. Ideally, we recommend using motorized versions of these accessory devices.

Note that this option (and the checkbox) is available also for the [Maximization](#), if the conditions listed above are met.

For scaling the 3D charts, R&S ELEKTRA uses the [Level Range \(Graphics\)](#) defined in the [General Settings](#) of the test template.

Test Flow acc. to CISPR 32 C.4.1.6.4 ← Overview Measurement

Available only, if the [test template type](#) is "EMI - Transducer / Probe" and if the "Result Unit" is "dB μ V". You can see the "Result Unit" in the dialog for selecting the [hardware setup](#) and then in the "General Settings" > [Level Range \(Graphics\)](#) of your test template.

This feature allows configuring a test flow according to standard CISPR 32 C.4.1.6.4, which requires combining a test that uses a current clamp with a test that uses a capacitive voltage probe (CVP).

The measurement is performed on the same EUT in two steps:

- The first measurement ("RF current"), which serves as a reference, is done with a current clamp. Its "Result Unit" is "dB μ A". Prepare a separate test template for this measurement and run the test before the second measurement.
- The second measurement ("RF voltage"), which uses the test template with "Test Flow acc. to CISPR 32 C.4.1.6.4", is done with a CVP. Its "Result Unit" is "dB μ V". During the evaluation of the "RF voltage" test, an algorithm reduces the results (voltage levels) by margin values that depend on the margins of the first measurement ("RF current" test).

Both results must be below their corresponding current and voltage limit lines at all frequencies.

After a successful (passed) "RF current" test, when you start the second measurement ("RF voltage" test), the following message comes up:

"A test flow acc. to CISPR 32 C.4.1.6.4 requires to select a 'Passed' EMI Current test, which is used for corrections of voltage levels. Select a test?"

- If you select "Cancel", the software informs you: "No test reference is selected. Therefore, the test cannot be performed." and the test execution is aborted.
- If you select "OK", a dialog opens for selecting the reference test. The dialog shows all tests assigned to the active EUT, filtered for the "Result Unit" dB μ A. Select the test that has resulted from the first measurement. If it has the [verdict](#) "Test Failed", a message informs you that the test cannot be performed with this reference test.

If the reference "RF current" test is valid, R&S ELEKTRA runs the "RF voltage" test and proceeds as follows, according to CISPR 32 C.4.1.6.4, for each frequency point:

- If the margin value of the "RF current" test is between 0 dB and 6 dB, this value is subtracted from the level measured in the "RF voltage" test.
- If the margin value of the "RF current" test is >6 dB, then 6 dB is subtracted from the level measured in the "RF voltage" test.

Each corrected frequency point is marked in the "Comment" column of the results table with a note: "xx.xx dB level reduction (CISPR 32 C.4.1.6.4)".

Graphics per Range ← Overview Measurement

Available only, if the [test template](#) is of the type "EMI - Electric Field Strength" or "EMI - Radiated Spurious Emission".

Enabling this graphics option has the following consequences:

- R&S ELEKTRA creates separate charts for the test results of each frequency range
- The [Name](#) field becomes available for specifying name labels for each frequency range
- R&S ELEKTRA disables the option "Over all Frequency Ranges" in the [Data Reduction](#)

Add Spectrogram Graphic ← Overview Measurement

Enables R&S ELEKTRA to generate a spectrogram table and a "waterfall" spectrogram graphic for the 1st selected [detector](#) of the overview measurement. Upon test completion, the software stores the table and graphic in the [Test container](#), with a name as "PK+@Spectrogram", for example, where "PK+" represents the [detector type](#) used for this result. See also [Chapter 7.6, "Test result graphics"](#), on page 632.



Data Reduction

Specifies various parameters for algorithms that reduce the number of measurement results from the overview measurement.

If the [license](#) for "ELEMI-S" is enabled, "Data Reduction" is optional. Also, you can interrupt the test after the automatic data reduction for an interactive selection of critical frequencies. To enable this feature, check "Pause Measurement Flow for Interactive Data Reduction", see [Figure 4-56](#). You can use this pause during a test also to manipulate the measured levels. This manipulation influences the critical results considered for further evaluation. Note that you are allowed to manipulate the measured results, but you are responsible for this manipulation.

During the test, if you have selected to let the measurement pause, R&S ELEKTRA brings up a message that alerts you of the test being paused. It also informs you that you must press the "Resume" button to continue with the measurement. Click "OK" to confirm this message. After that, you can manipulate the results of the paused test, see ["Editing results"](#) on page 629. When you are finished and want to let the measurement continue, press the "Resume" button .

To identify the most critical results, the software can perform a "Peak Search" and/or a "Subrange Maxima" evaluation. You can decide to perform one of these evaluations, a combination of both or none of them. The combination helps finding both narrowband and broadband interferers. Then you can determine, if you want to subject the outcome to an "Acceptance Analysis" and another "Maxima Limitation". To select an option, activate the checkbox next to it. In parallel, you can identify critical results by a user-defined evaluation. The software combines the results of the two parallel data reduction paths.

If the [license](#) for "ELEMI-S" is enabled, the "Data Reduction" provides more features, described below. If you want the data reduction to take effect for the total of all frequency ranges, rather than limiting the number per frequency range, enable the "Over all Frequency Ranges" checkbox.

The following diagram shows the interrelation of the data reduction options:

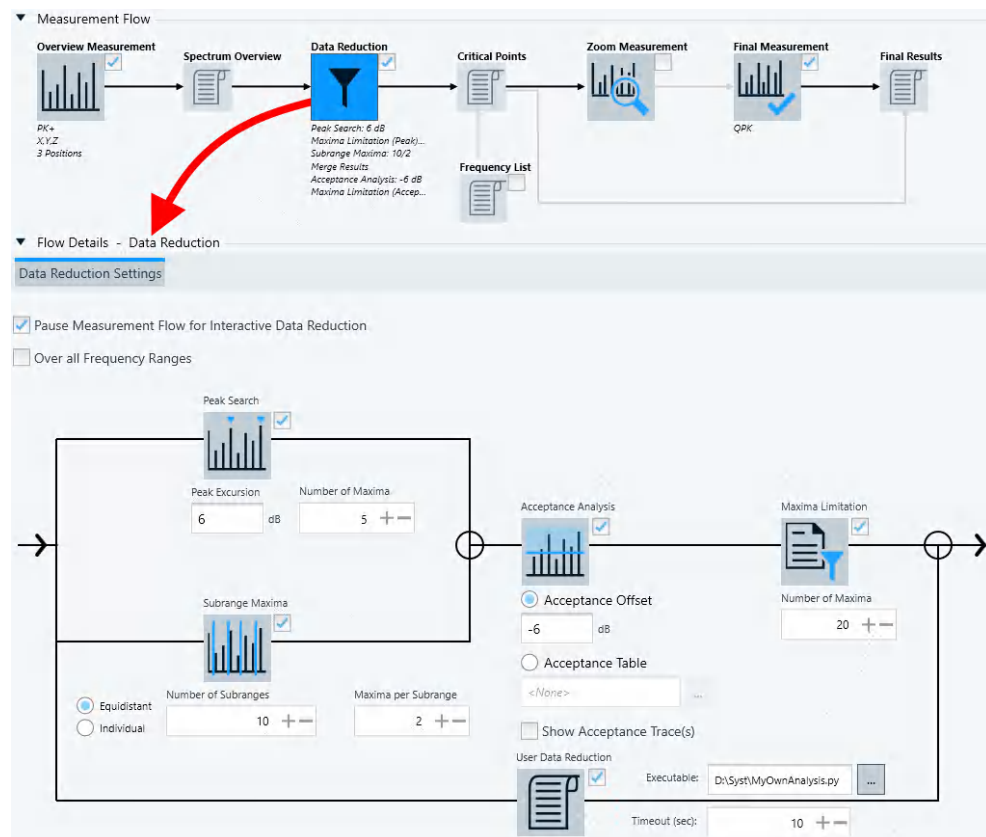

Figure 4-56: Options in the data reduction procedure

As a result of the data reduction procedure, R&S ELEKTRA stores the reduced number of critical data points (frequencies and measured levels) in the "Critical Points" table.

The data reduction algorithm is based on the "Overview" results table, which contains all maximized results of the partial measurement, for example, "Overview L1" (if there is a LISN with corresponding settings). If the test template uses a LISN, the software stores the results together with the information, which individual LISN line delivered which individual critical result.

"Peak Search"	<p>Activates a peak search evaluation. This data reduction mode finds the highest narrowband signals in the measured frequency range. The setting specifies the "Peak Excursion" (default: 6 dB), which determines, whether local maxima qualify as peaks. For a definition of "Peak Excursion", refer to "Marker" on page 548.</p> <p>The "Number of Maxima" limits the frequency points (default = 10) to be collected among those frequencies that have the most critical level values in the peak search. R&S ELEKTRA considers those level values as the most critical that come closest to the relevant limit line, or even violate it.</p>
"Subrange Maxima"	<p>Activates a subrange maxima evaluation. This data reduction mode finds critical broadband signals in the measured frequency range. You can specify the "Number of Subranges" and the "Maxima per Subrange". If you change the default "Equidistant" setting of subranges to "Individual", you can select your own Frequency List instead of entering several equidistant subranges.</p>
"Acceptance Analysis"	<p>You can let R&S ELEKTRA apply the limit line in a stricter form by specifying an "Acceptance Offset" (default = -6 dB). The specified offset shifts the limit lines of each frequency range: adding a negative dB value lowers the limit line. Frequency points with level values that fall below the shifted limit line are then discarded.</p> <p>Alternatively, you can select an "Acceptance Table", which also is a Limit Line table type. R&S ELEKTRA then sets the threshold by using the values in the acceptance table. Hence, the Limit Line (with or without offset) is replaced by the "Acceptance Table", which specifies the relevant threshold values.</p> <p>If you enable "Show Acceptance Trace(s)", the test chart displays an additional dotted trace. This trace is equivalent either to the limit lines shifted by the specified acceptance offset, or it shows the thresholds in the acceptance table relative to the limit line. If you have specified an Offset for the original limit line, the acceptance trace relates to this offset limit line, additionally shifted by the specified acceptance offset or thresholds.</p>
"Maxima Limitation"	<p>Available only, if the license for "EMI Extension to System - ELEMI-S" is activated.</p> <p>At the end of the internal data reduction procedure, you can once again limit the number of frequency points. R&S ELEKTRA collects this maximum number (default = 20) of most critical level values from the previous data reduction steps.</p>

"User Data Reduction"

Available only, if the [license](#) for "EMI Extension to System - ELEMI-S" is activated.

In addition to the data reduction steps handled by R&S ELEKTRA, you can introduce frequency points from an external evaluation by separate software. R&S ELEKTRA adds these frequency points to the points from its own data reduction steps, if enabled.

To use this feature, enable the "User Data Reduction" checkbox and select an executable file of one of the following file types:

- *.exe - executable program
- *.py - Python script
- *.pl - Perl scripts
- *.bat - batch file
- *.cmd - operating system commands batch

During test execution, "User Data Reduction" proceeds as follows:

1) R&S ELEKTRA writes the content of the current overview table into a file and saves it as `DR_Input.xml` in the same directory, from which you have selected your executable file.

2) R&S ELEKTRA launches the executable file (without parameters), which can read the content of `DR_Input.xml` and process this content as its input data.

3) R&S ELEKTRA waits for the time specified in the field "Timeout (sec)".

4) Within this timeframe, the executable file must create an output file `DR_Output.xml` in the same directory and with the same structure as the input file. However, it must contain only the rows (frequencies) of the identified critical points and with those level values, which led to identifying and selecting this frequency as a critical point. Other rows with non-critical frequencies must be removed. Also, in the critical rows, the remaining fields with non-critical level values of other detectors must be empty.

5) After the executable file has terminated, R&S ELEKTRA reads the file `DR_Output.xml` and adds its content to the "Critical Points" table.

If the executable file does not terminate within the "Timeout (sec)" period, or if R&S ELEKTRA cannot process the `DR_Output.xml` file after termination, R&S ELEKTRA notifies you by an appropriate message.

Note: Your R&S ELEKTRA installation contains two operational examples for "User Data Reduction" in Python script:

- `AcceptanceLine Evaluation.py`
- `UN R10 Evaluation.py`

Find these executable example files in the directory

`c:\ProgramData\Rohde-Schwarz\ELEKTRA\x.xx.x\DataReductionExamples\`, where `x.xx.x` is the version number of your installation.

The source code of these files contains also a brief application description.



Frequency List

Available only, if the following conditions are all met:

- The [license](#) for "ELEMI-S" is enabled
- The [Maximization](#), if available, is enabled
- The [Final Measurement](#) is enabled

Adds a list of arbitrary frequencies to the critical points that result from the [Overview Measurement](#) and from the optional [Data Reduction](#).

To configure the frequency selection for "Maximization", enable the checkboxes for "Data Reduction" and "Frequency List" as follows:

- **"Use the Data Reduction frequencies only"**

This configuration is the default: for further evaluation, R&S ELEKTRA uses the frequencies only that result from the overview measurement and subsequent (optional) data reduction.

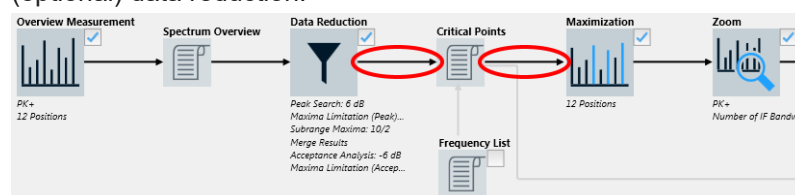

- **"Use the Data Reduction frequencies plus a Frequency List"**

Instead of using the data reduction frequencies only, R&S ELEKTRA adds a [list of frequencies](#) to the frequencies that result from the overview measurement and subsequent (optional) data reduction.

When you enable the "Frequency List" checkbox or click the list icon, a dialog opens for selecting the frequency list.

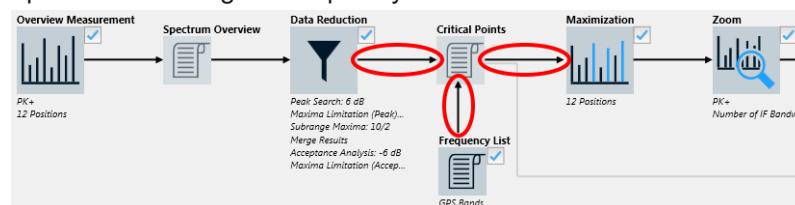

- **"Use a Frequency List only"**

Instead of the configurations above that use frequencies from the overview measurement and subsequent (optional) data reduction, R&S ELEKTRA can use a [list of frequencies](#), only.

When you enable the "Frequency List" checkbox or click the list icon, a dialog opens for selecting the frequency list.

When you run a test based on this test template, the test does not start with an overview measurement. Instead, depending on your selection, it starts with a [Maximization](#), a [Zoom Measurement](#) or [Final Measurement](#) based on the frequencies that are defined in the selected "Frequency List".

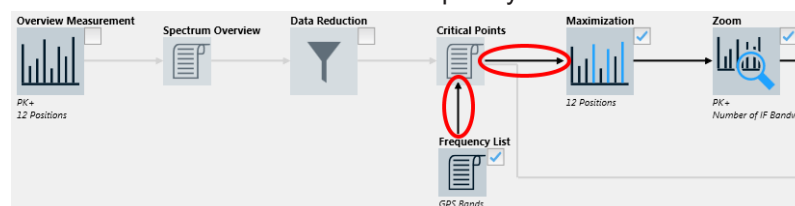



Maximization

Available only, if the following conditions are all met:

- The [license](#) for "ELEMI-S" is enabled
- The [Final Measurement](#) is enabled
- Your EMI test template uses one of the following [transducing devices](#):
 - [LISN](#)
 - [Slidebar](#)
 - [Antenna](#)
 - [Triple Loop antenna](#)
 - [Loop Antenna \(Transducer - Probe\)](#) in combination with a [Turntable](#)

Hence, the test template is of the type "EMI - LISN", "EMI - Slidebar", "EMI - Electric Field Strength", "EMI - Magnetic Field Strength (Triple-Loop Antenna)", "EMI - Magnetic Field Strength (Loop Antenna + Turntable)" or "Radiated Spurious Emission".

"Maximization" allows measuring the influence of accessory devices that determine different antenna or EUT positions or other hardware parameters. For example, different antenna polarizations or elevations typically result in different test levels.

Out of these positions or parameter conditions, "Maximization" finds the ones with the highest level, when measuring across the frequency range. Thus, the "Maximization" identifies the setup configuration that results in the highest measured level at each critical frequency. The result of maximization is a recording of these level values stored together with the accessory's positions or conditions.

To achieve the goals of "Maximization", R&S ELEKTRA runs single measurements at each critical frequency point, but with different device configurations.

Click the previously enabled "Maximization" icon (or enable the checkbox next to it) to access the "Flow Details - Maximization" settings:

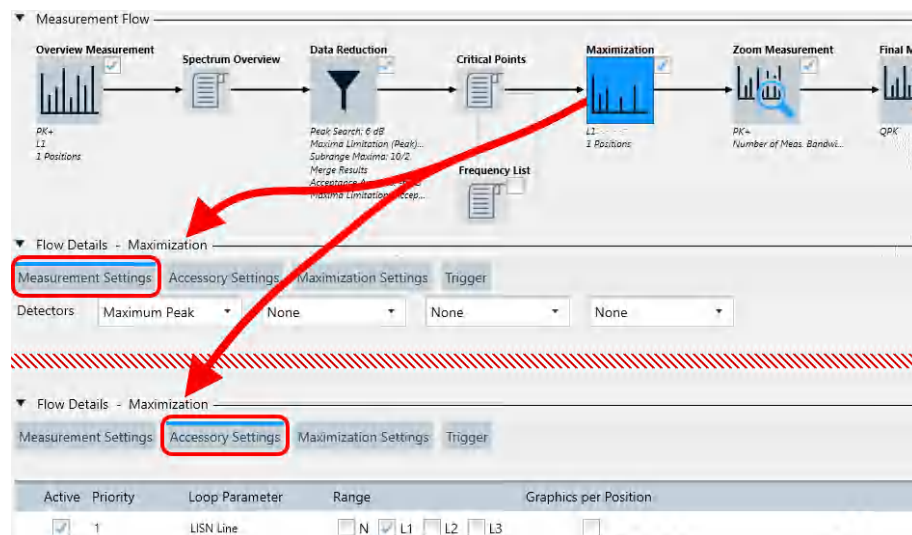



Figure 4-57: The Maximization icon opens Flow Details - Maximization

The "Flow Details - Maximization" section offers the "Measurement Settings", "Accessories Settings", "Maximization Settings" and "Trigger" dialogs, as shown in [Figure 4-57](#).

- The **"Measurement Settings"** dialog is the same as for the [Overview Measurement](#), except for the absence of [Repeat Measurement](#). The dialog comprises the following:
 - [Detectors](#) with a default selection as defined for the [Overview Measurement](#). You can change the default selection, but this change is copied to the detectors' selection in the settings for the overview and [adjustment](#) measurement (if available). Also the detectors' selection in the [final](#) measurement settings is changed to corresponding detectors, according to [Table 4-2](#).
 - If conditions are fulfilled for the availability of the checkbox "Save Results for 3D Chart Evaluation", refer to [Overview Measurement > Save Results for 3D Chart Evaluation](#) for a description.
 - Below these options, find the [frequency range list](#) with the comprehensive [Settings \(Overview\)](#), which are described in [Chapter 4.5.2.3, "Flow Details"](#), on page 201.
- The **"Accessory Settings"** dialog is the same as for the [Overview Measurement](#). The dialog comprises the following "Loop Parameters", depending on the [Transducing Device](#):
 - **"User Defined"**

"User Defined" actions are always available for each type of transducing device, but disabled per default. If the transducing device is a simple transducer or probe (as in a test template "EMI - Transducer / Probe"), the "User Defined" actions are the only loop parameters available in the "Accessory Settings" dialog.

R&S ELEKTRA executes "User Defined" actions (or "steps") in addition to the predefined accessory loop parameters when the test runs. You can use these steps, for example for remotely switching the EUT to a specific state. A typical application is for stepwise changing the level of an external supply voltage and measuring its influence on the EUT in the next loop of the test sequence.

To specify "User Defined" loop parameters, activate the checkbox and click the "Expand" button  or double-click the parameters' row. Click the "Add" button  in the "Actions of the Test" column to add a step, for example "Step 1". This name of the step is shown in the loop state column when you execute the test. Right-click a step to add a user-defined action to a step, or rename, delete or move this step. Also you can drag an action from the column "Available Actions" to a step. Proceed as described in [Chapter 4.5.2.5, "Actions"](#), on page 230.

Additional loop parameters can be as follows:
 - **"Line"**

If the transducing device is a [LISN](#) in a test template "EMI - LISN" (hence, not a "Single Line LISN"), the "Accessory Settings" offers a line selection, as shown at the lower edge of [Figure 4-57](#). Select the LISN lines that you want to include into the maximization. The following settings apply:



 - In a hardware setup with a 2-line LISN, you can select or deselect "N" and "L1".
 - In a hardware setup with a 4-line LISN, you can select or deselect "N", "L1", "L2" and "L3".

Select at least one line for the maximization. During the test, the software automatically measures the selected lines one by one and stores the results both in combined and in separate result tables.

Note that your line selection in the "Maximization" phase is binding also for the following phases of the test, especially for the [Final Measurement](#):

- If you have selected no maximization, the final measurement uses the lines, which correspond with the critical frequencies detected in the overview measurement.
- If you have selected maximization, the software uses the lines specified in your maximization settings for measuring at the critical frequencies detected in the overview measurement. Then, the final measurement also uses the lines of the maximization results.

– **"Distance"**

If the transducing device is a [Sliderbar](#) in a test template "EMI - Sliderbar", R&S ELEKTRA suggests a table with 12 predefined sliderbar positions. To see this table, click the "Expand" button  or double-click the parameters' row. Default positions are from 0 cm up to 500 cm, with a maximum of 530 cm. You can activate or disable this table, add  or delete  positions and rearrange the positions in the table. If you use an automated sliderbar, select a relative "Positioning Speed" between "1" (minimum) and "8" (maximum).



– **"Height" / "Polarization" / "Azimuth" / "Elevation"**

If the transducing device is an [Antenna](#) in a test template "EMI - Electric Field Strength", R&S ELEKTRA offers an "Accessory Settings" dialog for adjusting the antenna height, polarization and azimuth. In a test template "EMI - Radiated Spurious Emission", the DUT's elevation is an additional "Loop Parameter".

The availability of these parameters depends on the availability of an [Antenna Tower](#) and a [Turntable](#) in the hardware setup. The settings of these parameters define rules that R&S ELEKTRA applies during the test. For example, the software can control automated antenna positioners or prompt you for positioning the antenna manually.

- "Height" of the antenna on its antenna tower, if available, "Stepped" only in the range from 1 m to 4 m. For this range, you can specify a "Step Size" between 0 mm and 4 m and select a relative "Positioning Speed" between "1" (minimum) and "8" (maximum).
- "Polarization" allows selecting horizontal ("H") and/or vertical ("V") antenna polarization of the antenna on its antenna tower, if available. If you activate both "H" and "V", clicking the button in the "Parameters" column toggles between "H -> V" (horizontal first) and "V -> H" (vertical first).
- "Azimuth" or angular position of the turntable, if available, can be "Stepped" or "Continuous" in a "Range" between -200° and +400°. In "Stepped" mode, you can specify the "Step Size" between 0° and +400° and select a relative "Positioning Speed" between "0" (minimum) and "8" (maximum). In "Continuous" mode, you cannot specify the "Step Size", but you can select a relative "Positioning Speed" between "0" (minimum) and "8" (maximum) and a relative "Measuring Speed" between "0" (minimum) and "8" (maximum).
- "Elevation" or angular position of the horizontal turn device, if available, "Stepped" only in a "Range" between -100° and +500°. You can specify the "Step Size" between 0° and +500° and select a relative "Positioning Speed" between "1" (minimum) and "8" (maximum).

Alternatively, you can select to "Use a table for the combined Height/Polarization setup". If this checkbox is enabled, you can define arbitrary height and polarization steps for the antenna. To do so, click the "Expand" button  or

double-click the parameters' row. Click the "Add" button  to add a step and edit its "Height" and "Polarization" entry. Also, you can change the order by moving steps up and down , or delete steps .

- **"Polarization"**
If the transducing device is a **TEM Waveguide** in a test template "EMI - Electric Field Strength (GTEM)", R&S ELEKTRA enables measuring on all 3 orthogonal EUT axes (X, Y, Z).
You can activate or deactivate this polarization loop, but you cannot change the preselected setting for the x-axis, y-axis and z-axis. Thus, if activated, you must run three overview measurements with the EUT in three different orthogonal orientations. During the test, the software prompts you to switch (hence, rotate) the EUT axis to the three orthogonal orientations X, Y or Z, respectively. The three measurements are stored in separate result tables.
Note that TEM waveguides such as GTEM cells are not suited for [interactive measurements](#).
- **"Axis"**
If the transducing device is a **triple-loop antenna** in a test template "EMI - Magnetic Field Strength (Triple Loop Antenna)", R&S ELEKTRA enables measuring the EUT along all 3 orthogonal antenna axes (X, Y, Z).
You can activate or deactivate this polarization loop and change the preselected setting for the x-axis, y-axis and z-axis. During the test, the software prompts you to switch the triple-loop antenna to the X, Y or Z axis, respectively. The three measurements are stored in separate result tables.
- **"Azimuth" / "Axis"**
If the transducing device is a probe (transducer) of the type **magnetic single-loop antenna** used together with a **turntable** in a test template "EMI - Magnetic Field Strength (Loop Antenna + Turntable)", R&S ELEKTRA provides an "Accessory Settings" dialog for adjusting the EUT azimuth and antenna axis.
 - "Azimuth" or angular position of the turntable can be "Stepped" in a "Range" between -360° and $+720^\circ$. You can specify the "Step Size" between 0° and $+720^\circ$ and select a relative "Positioning Speed" between "1" (minimum) and "8" (maximum).
 - "Axis" is available with "Range" settings for the 3 orthogonal antenna axes (X, Y, Z). During the test, the software prompts you to switch the loop antenna to the X, Y or Z axis, respectively. The three measurements are stored in separate result tables.
- The **"Maximization Settings"** dialog allows selecting one of the following:
 - "Maximization with Overview Settings" uses the measurement settings of the [Overview Measurement](#)
 - "Maximization with Zoom Settings" uses the measurement settings of the [Zoom Measurement](#).
For example, if the overview settings are intended for a sweep across a wide frequency range in **Operating Mode** = "Spectrum Analyzer", overview settings can lead to unnecessarily long measurement times for the maximization. Hence, if the sweep time of the overview measurement is not appropriate, use zoom settings and specify more suitable settings for the maximization measurement, such as a shorter sweep time. A shorter sweep time can accelerate the maximization.
- The **"Trigger"** dialog is the same as described for the "Overview Measurement", see [Figure 4-55](#).

Which frequency points to use?

For the "Maximization" procedure, R&S ELEKTRA uses per default the frequencies that result from the [Overview Measurement](#) and from the optional [Data Reduction](#). Alternatively, you can select to add frequencies from a [Frequency List](#) or use such a list of frequencies, only.



Zoom Measurement

Available only, if the following conditions are all met:

- The [license](#) for "ELEMI-S" is enabled
- The [Final Measurement](#) is enabled

The "Zoom Measurement" uses partial measurements to increase the accuracy of the critical frequencies that remain after the [Overview Measurement](#) and [Data Reduction](#) (and optional [Maximization](#)).

Hence, the "Zoom Measurement" searches for the exact frequencies, possibly with higher frequency resolution, at which the maxima occur. This step is especially important with drifting interferences, because overview measurement and final measurement can be separated by a significant time span.

Note: Zoom measurement versus interactive measurement. A zoom measurement is an automated search within a limited frequency range, trying to find the exact frequency, at which the selected detector measures its highest level. This mode serves for fine-tuning the detection of the disturber frequencies during the automated test run. An [interactive measurement](#) is a manual mode, in which you can run individual measurements with arbitrarily changed test parameters according to your own preferences.

- If the overview measurement uses the [Operating Mode](#) "Spectrum Analyzer" (sweep), typically the frequency resolution is not sufficient. Therefore, we recommend activating the frequency zoom.
- If the overview measurement uses the [Operating Mode](#) "Test Receiver" (scan), the frequency zoom is optional. It can be useful, for example, if you expect a drifting interference.

Click the previously enabled "Zoom Measurement" icon (or enable the checkbox next to it) to access the "Flow Details - Zoom" settings:

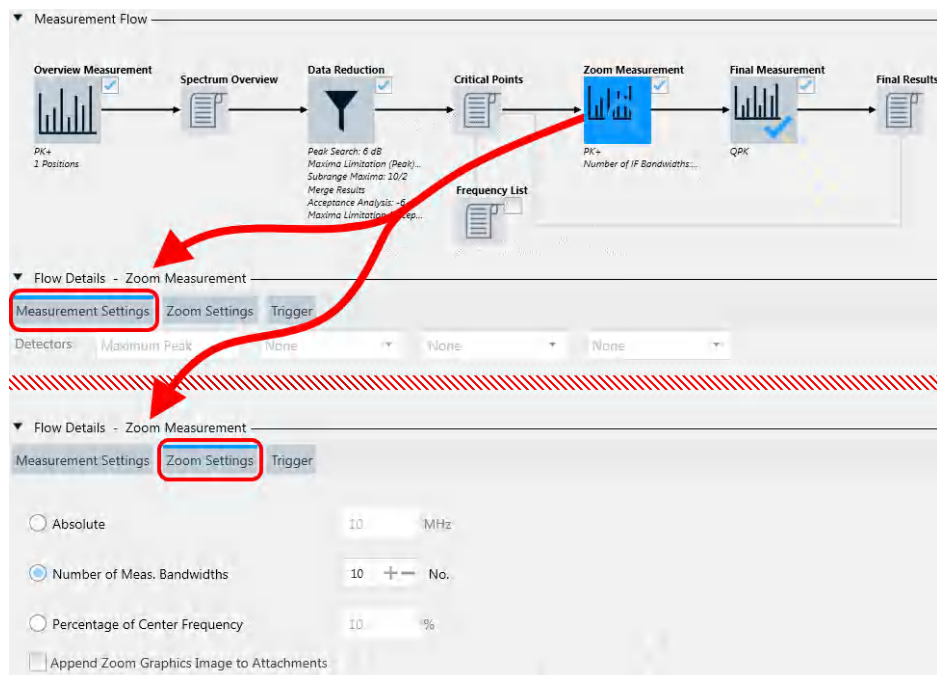

Figure 4-58: The Zoom Measurement icon opens Flow Details - Zoom Measurement

The "Flow Details - Zoom Measurement" section offers a comprehensive "Measurement Settings" dialog and a brief "Zoom Settings" dialog, as shown in [Figure 4-58](#).

- The **"Measurement Settings"** dialog comprises the following:
 - **Detectors** as defined for the [Overview Measurement](#). You cannot modify this selection for the zoom measurement.
 - Below these options, find the [frequency range list](#) with the comprehensive [Settings \(Zoom\)](#), which are described in [Chapter 4.5.2.3, "Flow Details"](#), on page 201.
- The **"Zoom Settings"** dialog defines the span of the frequency range, in which R&S ELEKTRA runs the zoom measurements. Without a [license](#) for "ELEMI-S", these settings are available, if the following conditions are all met:
 - The license for "ELEMI-A" is enabled
 - The ["Interactive Final Measurement"](#) on page 201 is activated

Alternatively, the "Zoom Settings" dialog is available, if the following conditions are all met:

- The test template is for conducted measurements, not radiated, see ["Radiated system checks are inconclusive"](#) on page 158
- [System Check](#) is selected
- [System Check](#) is enabled
- The "Scan Type" in the [System Check](#) dialog is "Partial"

The "Zoom Settings" are independent of the transducing device and comprise the following details:

- "Absolute"
 - Specifies the width of the zoom measurement's frequency range around each critical frequency as an absolute value.
- "Number of Meas. Bandwidths"

- Specifies the width of the zoom measurement range around each critical frequency as multiples of the defined [measurement bandwidth](#).
- "Percentage of Center Frequency"
 - Specifies the width of the zoom measurement range around each critical frequency as a fraction of that critical frequency.
- "Append Zoom Graphics Image to Attachments"
 - Enables keeping a screenshot of the zoom measurement's chart as a test attachment (found in the [test container](#)).
- The **"Trigger"** dialog is the same as described for the "Overview Measurement", see [Figure 4-55](#).

Note: LISN lines. If you use a [LISN](#) in the test template "EMI - LISN", there is no setting "Measure on these LISN Lines" available for the zoom measurement. Instead, the zoom measurement uses the same lines that are defined in the "Accessory Settings" dialog of the [Overview Measurement](#). If the [Maximization](#) phase is enabled, the zoom measurement uses the LISN lines defined in the "Accessory Settings" of the "Maximization".

Note: GTEM axes. If you use a [TEM Waveguide](#) in the test template "EMI - Electric Field Strength (GTEM)", there is no "Polarization" setting available for the zoom measurement. Instead, the zoom measurement uses the axis that was measured last. Typically, this axis can be the Z axis. This simplification assumes that disturbers also appear in a partial measurement, allowing to zoom in on the exact frequencies of peak disturbances.

However, determining GTEM field strength levels uses a correlation of partial measurements along all three axes. Therefore, R&S ELEKTRA uses the voltage levels of the zoom measurement only for determining the exact frequency points, but not for determining the field strength levels at these points. Hence, the software transfers only these frequency points into the "Critical Points" table, but does not transfer the level values, as in a typical zoom measurement.

Which frequency points to use?

For the "Zoom Measurement", R&S ELEKTRA uses per default the frequencies that result from the [Overview Measurement](#) and from the optional [Data Reduction](#) and [Maximization](#), if available. Alternatively, you can select to add frequencies from a [Frequency List](#) or use such a list of frequencies, only.



Adjustment

Available only, if the following conditions are all met:

- The [license](#) for "ELEMI-S" is enabled
- The [Final Measurement](#) is enabled
- Your EMI test template uses one of the following [transducing devices](#):
 - [Slidebar](#)
 - [Antenna](#)
 - [Loop Antenna \(Transducer - Probe\)](#) in combination with a [Turntable](#)
 - A [Positioner](#) of the type "AVL Test Bench"

Hence, the test template is of the type "EMI - Slidebar", "EMI - Electric Field Strength", "EMI - Magnetic Field Strength (Loop Antenna + Turntable)" or "Radiated Spurious Emission".

The "Adjustment" measures the maximum level at the exact critical frequency (typically the "Zoom" frequency), depending on the accessory conditions. For example, during the "Adjustment", the antenna elevation on a mast or the EUT position on a turntable can be continuously moved to find the highest measurement value. Hence, like the [Maximization](#), the "Adjustment" helps finding maximum levels at the most critical accessory settings, but *after* the "Zoom" measurement.

To achieve the goals of "Adjustment", R&S ELEKTRA runs single measurements at each critical frequency point with different accessory device configurations.

Click the previously enabled "Adjustment" icon (or enable the checkbox next to it) to access the "Flow Details - Adjustment" settings:

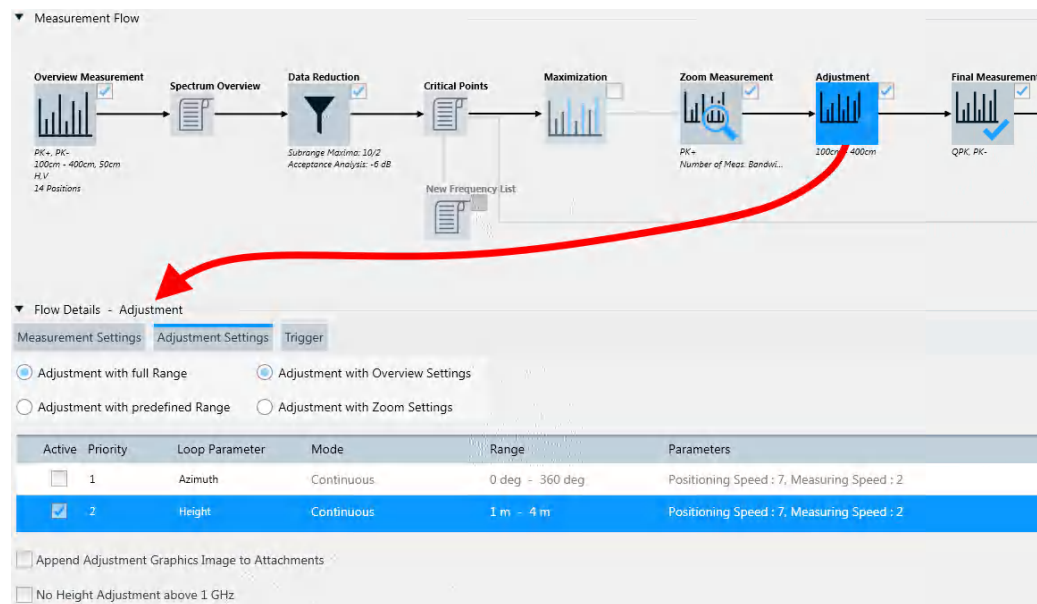

Figure 4-59: The Adjustment icon opens Flow Details - Adjustment

The "Flow Details - Adjustment" section offers a comprehensive "Measurement Settings" dialog, an "Adjustment Settings" dialog and a "Trigger" dialog, as shown in [Figure 4-59](#).

- The **"Measurement Settings"** dialog has the same detectors selection as the [Overview Measurement](#), but it has no [Repeat Measurement](#) checkbox for example. The dialog comprises the following:
 - [Detectors](#) with a default selection as defined for the [Overview Measurement](#). You can change the default selection, but this change is copied to the detectors' selection in the settings for the overview and [maximization](#) measurement (if available). Also the detectors' selection in the [final](#) measurement settings is changed to corresponding detectors, according to [Table 4-2](#).
 - "Repeat Flow" defines the number of repetitions of the adjustment measurement step. The additional option "Stop Repeat" terminates the repetitions, if the difference between the last measurement and the one before it is less than a given threshold in dB that you can define.
 - Below these options, find the [frequency range list](#) with the comprehensive [Settings \(Overview\)](#), which are described in [Chapter 4.5.2.3, "Flow Details"](#), on page 201.

- The **"Adjustment Settings"** dialog defines the range of, for example, sidebar positions or antenna heights, across which R&S ELEKTRA runs the adjustment measurements. Also, it selects the type of settings that the software applies. These settings comprise the following details:
 - "Adjustment with full Range" / "Adjustment with predefined Range"
Specifies, if R&S ELEKTRA runs the adjustment across the full range of an accessory parameter or across a range that you can define.
If you select "Adjustment with full Range", this range can be, for example, 360° rotation of a turntable, antenna heights from 1 m to 4 m or the full length of sidebar positions.
If you select "Adjustment with predefined Range", you can specify the range here, depending on the type of accessory. R&S ELEKTRA unlocks the "Range" parameters in the following section of the dialog.
 - The buttons "Adjustment with Overview Settings" and "Adjustment with Zoom Settings" toggle between specific types of receiver settings. This selection allows a more flexible configuration, typically resulting in a faster adjustment. For example, if you apply overview settings, intended for a sweep across a full range in **Operating Mode** = "Spectrum Analyzer", it can lead to unnecessarily long measurement times for the adjustment. Changing to more suitable zoom settings, using a shorter measurement time according to the smaller adjustment range, can accelerate the measurement. If you consider using also the zoom measurement, the settings are shared, hence R&S ELEKTRA applies the same settings to the zoom measurement and to the adjustment measurement.
 - "Loop Parameters"
Activates or deactivates the "Loop Parameters" ("Distance", "Height", "Azimuth" and/or "Elevation") and specifies their "Priority" (if more than 1 parameter is available), the **"Range"**, the "Step Size", the "Positioning Speed" (1 to 8) and the "Measurement Speed" (1 to 8). For a good spatial resolution, we recommend using a slow "Measurement Speed" (values 1 or 2).
The "Mode" is locked at "Continuous", therefore, make sure to use a hardware setup with automatically controlled accessory devices (antenna tower, turntable or sidebar). If your accessories are manual, R&S ELEKTRA cannot run the test in continuous mode, which is required for "Adjustment". Manual accessories in combination with an activated "Adjustment" step prevent saving the test template with the following error message: "Validation Conflict: saving is not possible! Manual (...) cannot be configured for continuous movement/adjustment".
If the hardware setup uses an "AVL Test Bench" **Positioner**, its 3rd-party control software determines the **ATB** loop parameters in the "Test Cycle", see **Overview Measurement**. The list of loop parameters in the "Adjustment Settings" dialog displays these parameters. Other than in the "Overview Measurement" step, R&S ELEKTRA can adjust each activated **ATB** loop parameter individually, and none of these parameters are limited to being in the 1st priority. You can unlock the **"Range"** by selecting "Adjustment with predefined Range", if the transducing device is an antenna or a loop antenna with turntable. Specify the range for adjusting the accessory's position around the position during the original measurement. For the sidebar, selecting "Adjustment with predefined Range" sets the range to " $\lambda/2$ " (lambda half) and keeps it locked. R&S ELEKTRA determines the value of $\lambda/2$ from the measurement frequency and adjusts the sidebar position within this range.

- "Append Adjustment Graphics Image to Attachments"
Enables keeping a screenshot of the adjustment measurement's chart as a test attachment (found in the [test container](#)).
- "No Height Adjustment above 1 GHz"
Available only, if the [Transducing Device](#) is an antenna in a test template of the type "EMI - Electric Field Strength".
Activating the checkbox excludes antenna height variations at high frequencies from the "Adjustment" procedure.
- The "**Trigger**" dialog is the same as described for the "Overview Measurement", see [Figure 4-55](#).

Which frequency points to use?

For the "Adjustment" procedure, R&S ELEKTRA uses per default the frequencies that result from the [Overview Measurement](#) and from the optional [Data Reduction](#), [Maximization](#), if available, and "[Zoom Measurement](#)" on page 182. Alternatively, you can select to add frequencies from a [Frequency List](#) or use such a list of frequencies, only.



Final Measurement

Specifies the settings for the final measurements, which are performed as single measurements and must comply with EMC standard requirements regarding detectors, measurement bandwidth, accessory settings and measurement time.

Without the "ELEMI-S" [license](#), R&S ELEKTRA does not feature [Maximization](#), [Zoom Measurement](#) and [Adjustment](#). Instead, the software proceeds from [Data Reduction](#) immediately to the "Final Measurement".

Note: Skip "Final Measurement"?

Under certain conditions, you can use the results of the "Overview Measurement" as final results, instead of actually running the "Final Measurement". The conditions include making sure, that the "Overview Measurement" was performed at the correct critical frequencies and with the correct accessory settings. In this case, R&S ELEKTRA can copy the frequencies from the critical points table and the corresponding overview measurement results to the final results table.

To let the software do so, disable the "Final Measurements" checkbox as in [Figure 4-61](#).

Click the previously enabled "Final Measurement" icon (or enable the checkbox next to it) to access the "Flow Details - Final Measurement" settings:

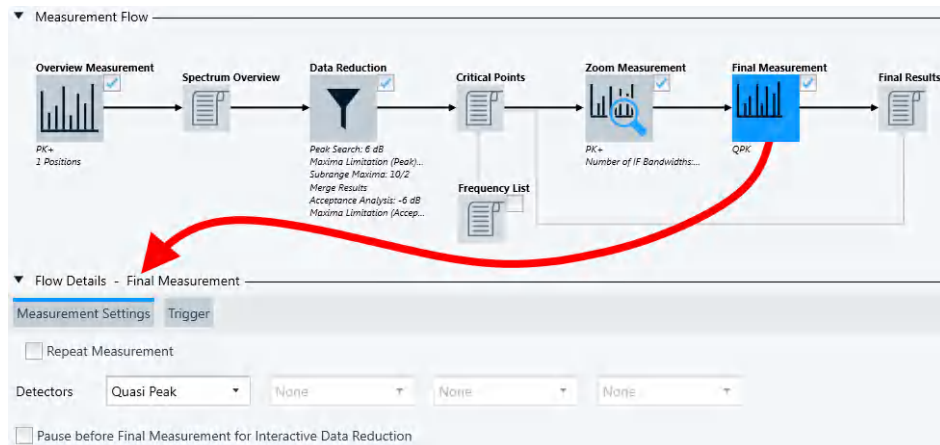

Figure 4-60: The Final Measurement icon opens Flow Details - Final Measurement

Note: LISN lines. If the [license](#) "ELEMI-S" is activated and you use a LISN in the test template "EMI - LISN", there is no setting "Measure Critical Points on these LISN Lines" available for the final measurement. Instead, the final measurement uses the same lines that are defined in the "Accessory Settings" dialog of the [Overview Measurement](#). If the [Maximization](#) phase is enabled, the final measurement uses the LISN lines defined in the "Accessory Settings" of the "Maximization".

Here is an overview of all **"Measurement Settings"** for the "Final Measurement":

"Repeat Measurement" Specifies that the final measurement is cyclically repeated in a test, until you manually terminate the repetition. This mode is useful for observing changes in the measurement results, if you modify any test conditions during test execution.

The following settings are available:

- "By Software" or "By Device":
 - "By Software" is enabled by default, hence R&S ELEKTRA controls the repetitions.
 - "By Device" is available only, if the [Operating Mode](#) is "Spectrum Analyzer" (not "Test Receiver"), and if the selected spectrum analyzer supports repetitions. Selecting "By Device" enables specifying the "Trace Mode" and the "Averaging Mode". For a description of these modes, refer to the "Overview Measurement", see ["Trace Mode"](#) on page 171 and ["Averaging Mode"](#) on page 171.
- "Repetition Mode"
 - "Count" specifies the number of repetitions between 1 and 100,000, how often the measurement is repeated.
 - "Time Interval" is available only, if measurements are repeated "By Software". The time interval specifies a duration between 1 s and 100,000 s, how long the measurement is repeated.

Note: During repeated measurements, R&S ELEKTRA compares the currently measured level values with the previously measured level values and keeps the maximum. Lower values in the still varying level measurements are thus ignored. Over time, this algorithm leads to a trace that approaches the maximum of the measured level values at each frequency point, with a continuously reduced variation along the trace.

To terminate the continuously repeating final measurement while the test is running, click "End Repetition" in the test's [Measurement Flow Control](#) side panel.

If you disable "Repeat Measurement", the final measurement is executed in a single scan or sweep, only.

See also the [Repeat Measurement](#) setting in the [Overview Measurement](#).

"Detectors"

Selects the detector types for up to four detectors used in the [final measurement](#) of a test.

The following rules apply for the selection of final measurement detectors:

- Select at least the 1st detector.
- For the optional 2nd, 3rd and 4th detector, you can select any detector type, even if it is already selected for other detector positions. Hence, there is no mutual exclusiveness, in contrast with the [Detectors](#) for the [overview measurement](#).
- You can select only as many detectors as for the overview measurement.
- If you select the "CISPR APD" detector, which is available only in the final measurement, you can select other detectors, too, but in the [Settings \(Final\)](#), you can enable either the "CISPR APD" detector or other detectors, but not both.
- R&S ELEKTRA observes a **one-to-one relation** of detector positions. Hence, the overview measurement made with the overview detector set in the 1st position is finalized with the final detector that is also set in the 1st position. If any position is set to "None" in the overview measurement settings, it remains deactivated in the final measurement.
- The automatic preselection of the default final measurement detectors depends on your selection of the [overview measurement detectors](#) and on the mapping in [Table 4-2](#).
- The default preselection is not binding, you can select an arbitrary detector on any position that is specified for an overview detector.
- Changing final detectors does not change (overwrite) any detector selection in the overview measurement settings.
- The selection of the final measurement detectors is independent of the [Transducing Device](#).

Table 4-2: Mapping of overview and final detectors

Selected detector in overview measurement	Suggested default detector in final measurement
AC Video (ACV)	AC Video (ACV)
AC Video Sine (ACS)	AC Video Sine (ACS)
Average (AVG)	CISPR Average (CAV)
CISPR Average (CAV)	CISPR Average (CAV)
Maximum Peak (PK+)	Quasi Peak (QPK)
Minimum Peak (PK-)	Minimum Peak (PK-)
Quasi Peak (QPK)	Quasi Peak (QPK)
RMS	RMS Average (RMSAV)
RMS Average (RMSAV)	RMS Average (RMSAV)

For a list of all available detector types, see [Chapter 5.3, "Detectors"](#), on page 562.

"Trace Mode"	Same function as described for the "Overview Measurement", see "Trace Mode" on page 171.
"Averaging Mode"	Same function as described for the "Overview Measurement", see "Averaging Mode" on page 171.
"Pause before Final Measurement for Interactive Data Reduction"	Interrupts the test before the final measurement for an interactive data reduction. You can use this pause during a test to manipulate the measured levels. This manipulation influences the critical results considered for further evaluation. Note that you are allowed to manipulate the measured results, but you are responsible for this manipulation.

"Use Critical Points as Final Results" Per default, the checkbox next to the "Final Measurement" icon is enabled, as in [Figure 4-60](#), and R&S ELEKTRA performs final mea-

measurements at the frequencies of the previously identified critical points.

However, you can apply a "skip" mode and use the critical points results as final results. To apply this mode, disable the checkbox as in [Figure 4-61](#).

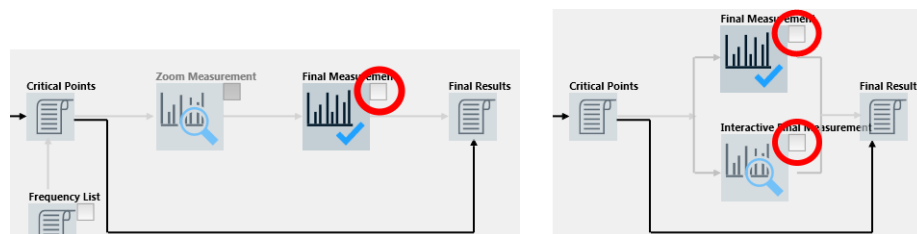

Figure 4-61: Skipping the final measurements uses the critical points as final result

- The left-hand screenshot in [Figure 4-61](#) shows the case with activated "ELEMI-S" license.
- The right-hand screenshot is without "ELEMI-S" license. Disable both checkboxes to skip the final measurement. (For the interactive final measurement, see [here](#).)

This deselection lets R&S ELEKTRA skip the final measurements. And, if available, it also skips the [Maximization](#), [Zoom Measurement](#) and [Adjustment](#).

Instead, the software copies the previously identified critical frequencies and their levels from the overview measurement into the final results table.

- If you use a TEM waveguide, the software copies the field-strength overview values (dB μ V/m) calculated from the measured overview X / Y / Z levels (dB μ V) in the result tables. Doing so, it uses the same H/V polarizations that were found to have critical points.
- If you use a LISN or a triple-loop antenna, the software copies the overview levels from the same LISN lines or antenna loops that were found to have critical points.

Note: Double-check final detectors. When you disable the "Final Measurement", the software also overwrites the final measurement "Detectors" with the detectors selected for the overview measurement. For example, it replaces the "Quasi Peak" detector by the "Maximum Peak" detector. The updated final detectors remain selected when you enable the "Final Measurement" again. You can edit the overwritten selection.

However, if you miss this potential change of detectors for the "Final Measurement", disabling and enabling the "Final Measurement" can cause an **unintended misconfiguration** of your test template.

Also note that without a final measurement, you must configure the overview measurement according to the standard requirements, such that the measured values qualify as final results.

Disabling the "Final Measurement" also disables additional measurement settings (repeat / pause measurement), if available.

Note: Consider TD scan. We recommend using the time domain (TD) option for the final measurement, if the overview measurement data is sufficient for a standard-compliant characterization of the RF emission. This option is typically reasonable, if you operate the receiver in [Scan Mode](#) "Time Domain Scan" with a compliant detector, for example [QuasiPeak](#). Even with this slow detector, a "Time Domain Scan" is often faster than a "Stepped Scan" with a fast noncompliant detector, for example "MaxPeak". This speed effect is especially relevant within the relatively small frequency ranges of conducted measurements. Because the detector is standard-compliant, you can skip the final measurement and use the levels at the critical points of the overview measurement as the final results.

Also, using the fast TD scan with a "slow" compliant detector helps to avoid missing sporadic interferers or strongly drifting interferers.

However, in some special cases of a TD scan, it can be an advantage to run the overview measurement with a fast noncompliant detector, for example "MaxPeak". An example is a broad frequency range that requires measurements in many frequency segments. In this case, using the "MaxPeak" detector for the overview measurement and the compliant "QuasiPeak" detector for the final measurement on critical points, only, can be faster. For this procedure, enable the checkbox for the final measurements.

"Perform Final Measurement on Critical Points"

Available only if the following criteria are all met:

- The [license](#) "ELEMI-S" is deactivated
- The EMI test template uses a [LISN](#) (not a different transducer) as the [Transducing Device](#)

If selected, the software runs the final measurement on the critical points. At each critical point, it measures at the same LISN line that was found to have a critical level at this frequency in the overview measurement.

"Measure Critical Points on these LISN Lines"

Available only, if the following criteria are all met:

- The [license](#) "ELEMI-S" is deactivated
- The EMI test template uses a [LISN](#) (not a different transducer) as the [Transducing Device](#)

If selected, this setting specifies the LISN lines, across which the measurements are to be repeated at the previously identified critical frequencies: "N" and "L1" for a 2-line LISN, or "N", "L1", "L2" or "L3" for a 4-line LISN.

Select at least one LISN line for the final measurement. The selection is independent from the selection in the [Overview Measurement](#).

The **"Trigger"** dialog is the same as described for the "Overview Measurement", but providing also the "Video Trigger", see [Figure 4-55](#).

As an exception, if you select [Flow Schema = RSE with Burst Detection](#) for the "Final Measurement", the "Trigger" dialog is reduced to the "Timeout" setting, only. In the background, R&S ELEKTRA automatically sets the "Trigger Offset" as $-0.5 * \text{Measurement time}$.

The **"Burst Detection"** dialog is available only, if the following conditions are all met:

- The [license](#) "ELEMI-OOB" for EMI RSE out-of-band measurements is activated. We recommend to activate also one or more of the licenses "ELEMI-5GFC", "ELEMIC-5GS" and "ELEMIC-WRLS", depending on the requirements of your hardware setup.
- The test template is of the type "EMI - Radiated Spurious Emission".
- In the [Measurement Flow](#) dialog, the [Flow Schema](#) is set to "RSE with Burst Detection".
- The [Final Measurement](#) is enabled and selected (icon highlighted).

Flow Schema	RSE with Burst Detection
▼ Flow Details - Final Measurement	
Measurement Settings	Trigger
Min. Burst Length	200 ms
Min. Gap between Bursts	10 ms
Truncated Bursts	Keep Truncated Bursts
Initial Trigger Threshold	50 %

Figure 4-62: Burst Detection dialog

Use this dialog for the following settings:

- "Min. Burst Length" [ms]
Defines the minimum duration of a burst. If a detected event is shorter in time, R&S ELEKTRA ignores it and does not interpret it as a burst. Default minimum length is 20% of the measurement time.
- "Min. Gap between Bursts" [ms]
Defines the minimum time gap between two bursts. If the gap is shorter, R&S ELEKTRA ignores the gap and interprets the detected event as a single burst. Default minimum gap is 1% of the measurement time.
- "Truncated Bursts"
At the beginning and at the end of a measurement interval, burst events can be truncated. You can select to "Keep truncated Bursts" in the evaluation, or to "Ignore truncated Bursts".
- "Initial Trigger Threshold" [%]
Specifies the *initial* threshold value for starting the triggered measurement. For example, if you set the "Initial Trigger Threshold" to 50% (= default), the threshold level for a trigger event is exactly in the middle between the minimum peak level and the maximum peak level.
For the following triggered burst-evaluation measurements, R&S ELEKTRA modifies the threshold values as described below.

Note: Burst evaluation procedure. R&S ELEKTRA controls a burst evaluation measurement as follows: Initially, it runs a zero-span measurement without triggering, to find the minimum and maximum peak levels of the input signal. Then it repeats the zero-span measurement with enabled trigger, using the specified "Initial Trigger Threshold". It stores the results internally, increases the threshold by a given increment and repeats the triggered zero-span measurement. It keeps repeating and storing measurements with increasing thresholds, until no trigger event occurs, because the threshold level is too high. Finally, R&S ELEKTRA searches all these internally stored measurements for the burst that has the highest power. The measurement that con-

tains this burst is saved as the evaluation procedure's result in an output table, which can be represented graphically like in [Figure 4-63](#), for example:

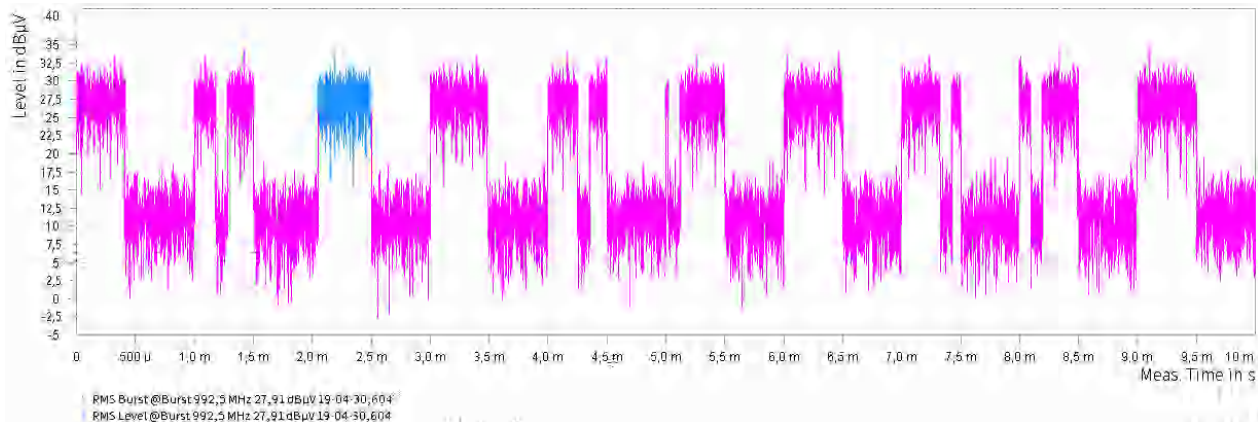

Figure 4-63: Result graphics of a burst-evaluation measurement

Pink = Measured signal with bursts around 27 dBµV and noise around 12 dBµV

Blue = Burst that was detected to have the highest power

Combined Final Analysis using TD

Note that this function for accelerated testing is different from [Combined Final Analysis using Sweep](#).

Available only, if the following conditions are all met:

- The [license](#) for "EMI Extension to System - ELEMI-S" is activated
- Both the [Zoom Measurement](#) and the [Final Measurement](#) are enabled, as indicated by the red circles in [Figure 4-64](#)
- The receiver is in [Operating Mode](#) = "Test Receiver"
- Both in the [Settings \(Overview\)](#) and in the [Settings \(Zoom\)](#), the [Scan Mode](#) must be "Time Domain" (or "TD Dynamic" or "TD Fast", if available)

This combined procedure scans the frequency ranges in [time domain \(TD\) mode](#), using the frequency span of the "Zoom Measurement". The "Zoom Measurement" and the "Adjustment" (if enabled) use the same detectors as the "Final Measurement", defined in the "Measurement Settings".

Hence, this feature uses a single measurement step for zooming in to the exact frequency of an interferer and for finally measuring its exact level at this frequency. This combination reduces overall testing time.

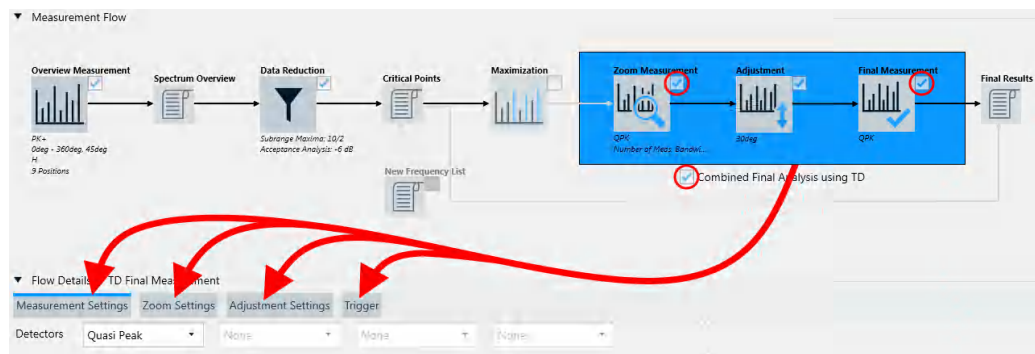

Figure 4-64: The icon for **Combined Final Analysis using TD** gives access to various settings in the **Flow Details**

- "Measurement Settings" = See ["Overview Measurement"](#) on page 163
- "Zoom Settings" = See ["Zoom Measurement"](#) on page 182
- "Adjustment Settings" = See ["Adjustment"](#) on page 184
- "Trigger" = See [Figure 4-55](#)

Combined Final Analysis using Sweep

Note that this special sweep function for "band-edge measurements" is different from [Combined Final Analysis using TD](#).

Available only, if the following conditions are all met:

- The [license](#) for "EMI Extension to System - ELEMI-S" is activated
- The test template is of the type "EMI - Radiated Spurious Emission"
- Both the [Zoom Measurement](#) and the [Final Measurement](#) are enabled, as indicated by the red circles in [Figure 4-65](#)
- The receiver is in [Operating Mode](#) = **"Spectrum Analyzer"**

This sweep analysis for [RSE](#) tests helps finding the maximum level across all "Adjustment" positions, according to your settings. Typically, these positions are azimuth and antenna height. During the sweep, R&S ELEKTRA moves the accessories in a continuous mode, while measuring as fast as possible.

To identify the most relevant spurious emissions, the software records the level of each frequency point at the accessory position, which exhibits maximum radiation. The "Max-Hold" algorithm merges these results into a common zoom table.

Then, as a special feature, the software runs these results through a 2nd "Data Reduction" procedure across all frequency ranges (after the 1st data reduction applied to the results of the "Overview" measurement). The output of this 2nd reduction is the final results table, hence without an additional final measurement.

Ideally, you can combine this sweep analysis with the "Band Cut Out" mode of the function [Use dynamic Limit Line](#). This combination facilitates searching for the "worst" spurious emissions in the band-edge regions close to the frequency band of your EUT.

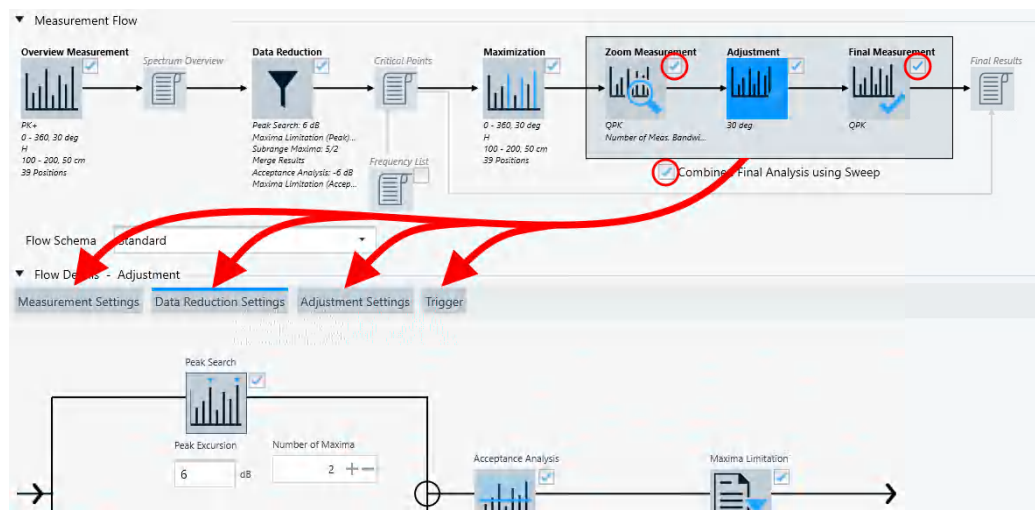

Figure 4-65: The icon for Combined Final Analysis using Sweep gives access to various settings in the Flow Details

"Measurement Settings" = See ["Overview Measurement"](#) on page 163

"Data Reduction Settings" = A 2nd set of data reduction settings, with the same features as described in ["Data Reduction"](#) on page 173

"Adjustment Settings" = See ["Adjustment"](#) on page 184

"Trigger" = See [Figure 4-55](#)

Flow Schema

Available only, if following conditions are all met:

- The test template is of the type "EMI - Radiated Spurious Emission".
- The [license](#) for "EMI RSE 5G FCC Measurements Extension - ELEMI-5GFC" is activated.

Selects one of the following EMI measurement procedures for [RSE](#):

- **"Standard"**

Enables performing conventional RSE measurements, for example as described in our application note on RSE measurements, which is available on request via the Rohde & Schwarz [support center](#).

- **"TRP mm-Wave"**

Enables performing RSE measurements on 5G mm-wave devices according to [FCC](#) recommendations, and enables [Full TRP](#).

This selection requires, that the antenna's [Tower Control](#) uses an automatic [Antenna Tower](#).

With a TRP selection, R&S ELEKTRA adapts the measurement procedure to the [FCC](#) recommendations for mm-wave 5G devices.

The adapted [TRP](#) measurement flow includes the following:

- A [TRP](#) measurement in the final measurement step, consisting of 3 spherical cuts as in [Figure 4-66](#)
- An optional [Full TRP](#) measurement (if enabled) over the whole EUT sphere

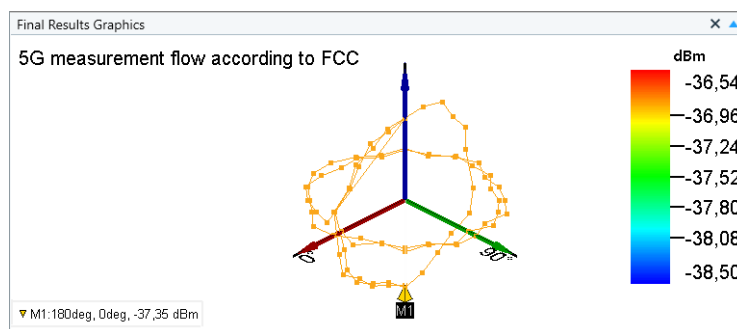

Figure 4-66: Example of test result graphics during a 5G measurement flow according to FCC

For more information, refer to our white paper on advanced EMC test solutions, available at www.rohde-schwarz.com/product/elektra > Documents & Articles.

- **"TRP mm-Wave using Antenna Positioner"**
Same as "TRP mm-Wave", but this selection requires, that the antenna's **Tower Control** uses an automatic **Positioner** of the **Type "Maturo EAP"**. This positioner allows combined control of antenna height, horizontal position and polarization.
- **"RSE with optional Substitution Method"**
This selection enables the **Substitution Measurement** icon, which allows performing an optional substitution measurement. According to ANSI C63.26-2015 (chapters 5.2.7 and 5.5), you must perform this measurement, if you do not use pre-calibrated antennas for radiated power measurements.
- **"RSE with Burst Detection"**
Enables a procedure that detects bursts during the final measurement. To do so, R&S ELEKTRA enhances the conventional zero-span level measurement with a specific evaluation of the bursts in the signal. See **"Burst evaluation procedure"** on page 195.

Selecting "RSE with Burst Detection" also influences the "Flow Details":

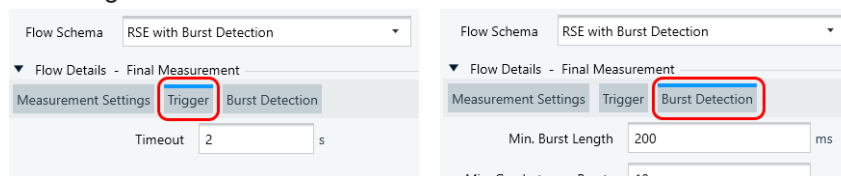

Figure 4-67: Selecting RSE with Burst Detection influences the Flow Details

Left = It reduces the "Final Measurement" > **Trigger** dialog to "Timeout", only, while removing this dialog from the other steps in the "Measurement Flow"

Right = It enables the "Final Measurement" > **Burst Detection** dialog

This selection requires, that the antenna's **Tower Control** uses an automatic **Antenna Tower**, and that the **Final Measurement** is enabled.

For more details, see **Burst Detection**.

Full TRP

The "Full TRP" icon is available only, if **Flow Schema** is set to "TRP mm-Wave" or "TRP mm-Wave using Antenna Positioner":

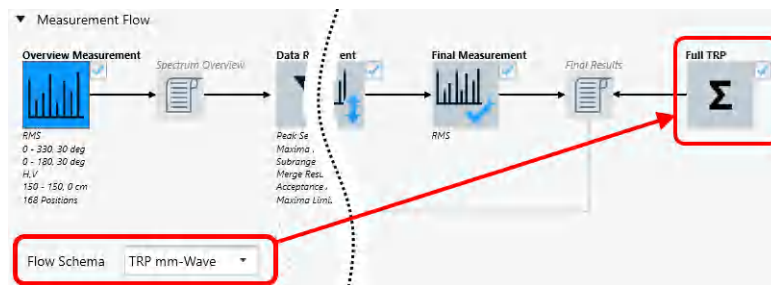

When you activate the icon's checkbox, R&S ELEKTRA allows running a full TRP measurement on selected frequencies after executing a millimeterwave measurement flow according to FCC. To do so, first run the test. When it is finished, change the "Process State" for the selected frequency in the "Final Results" table and restart the measurement.

Substitution Measurement

The "Substitution Measurement" icon is available only, if [Flow Schema](#) is set to "RSE with optional Substitution Method":

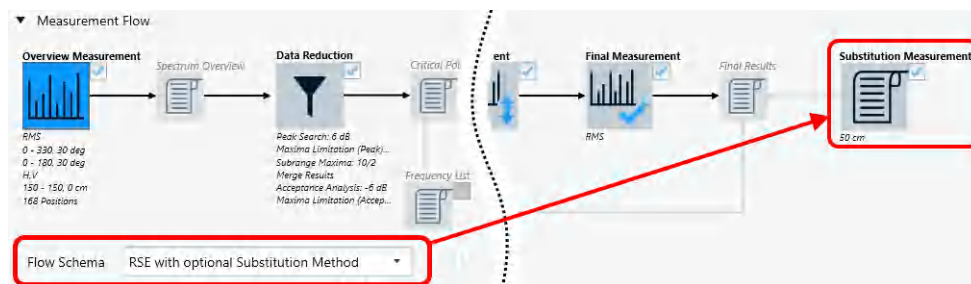

When you activate the icon's checkbox, R&S ELEKTRA performs a substitution measurement, as described step by step in the standard ANSI C63.26-2015 (chapters 5.2.7 and 5.5). This standard includes the following requirements:

- It requires a system check, hence all frequency ranges in your test template must use an [RSE hardware setup](#) with activated "System Check" option.
- It requires using a tilt mast, hence the antenna's [Tower Control](#) must use an automatic [Antenna Tower](#), and you must set the [Tilt Mast Parameters](#).
- It requires performing an adjustment measurement, hence, activating "Substitution Measurement" also activates the [Adjustment Settings](#) dialog, even if the [Adjustment](#) measurement is disabled.

In this measurement, the EUT is replaced by a substitution antenna and an RF signal generator. During the test run, R&S ELEKTRA adds a "Substitution Table" to the "Result Tables". And it adds the following special columns to the "Final Results" table (one per V or H polarization, each):

- "TX Antenna Factor": Interpolated antenna transducer table value
- "TX Cable Att": Interpolated antenna cable attenuation value
- "TX SigPath Att": Interpolated signal path attenuation value
- "RF Gen Level": RF generator value, determined while adjusting the RF generator level to within +/-0.5 dB from the measured final level
- "Pe": Equivalent emission power
- "Antenna gain": Antenna gain for TX antenna calculated from "TX Antenna Factor"

- "Margin Pe": Float margin of equivalent emission power to limit

For measurement details, refer also to our application note for [RSE](#) (linked in the glossary).



Interactive Final Measurement

This alternative measurement flow configuration is available only, if the following [license](#) conditions are all met:

- The license for "EMI Extension to Advanced - ELEMI-A" is activated
- The license for "EMI Extension to System - ELEMI-S" is **not** activated

The [Measurement Flow](#) in the EMI test template then looks like in this dialog:

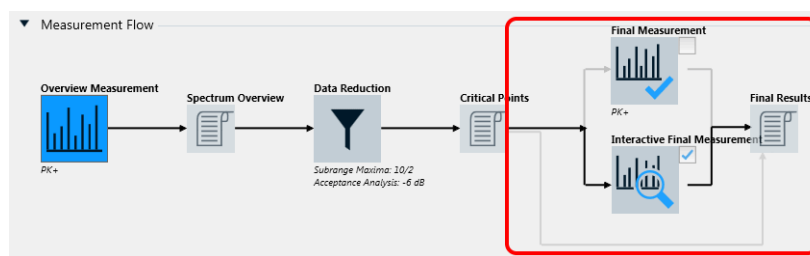

Figure 4-68: Modified EMI test template with Interactive Final Measurement

Without the "ELEMI-S" license, you can select from 3 options for reaching the final test results:

- You can still select the automated [Final Measurement](#) (see there), which bypasses the "Interactive Final Measurement"
 - You can select the "Interactive Final Measurement", which bypasses the automated "Final Measurement"
 - You can disable both checkboxes as in [Figure 4-61](#), to let R&S ELEKTRA skip the final measurements and directly copy the critical points into the final results table
- If you select the "Interactive Final Measurement" and create a test, R&S ELEKTRA starts with executing the [Automated measurement for EMI tests](#). If it finds critical points, the test switches to [Interactive measurement for EMI tests](#) mode. Now you can control the accessories manually to maximize the level at each critical point, while the measurement is running.

Which frequency points to use?

For the "Final Measurement", R&S ELEKTRA uses per default the frequencies that result from the [Overview Measurement](#) and from the [Data Reduction, Maximization](#), if available, ["Zoom Measurement"](#) on page 182 and [Adjustment](#). Alternatively, you can select to add frequencies from a [Frequency List](#) or use such a list of frequencies, only.

"Settings (Final)"

Below these options, find the [frequency range list](#) with the comprehensive [Settings \(Final\)](#), which are described in [Chapter 4.5.2.3, "Flow Details"](#), on page 201.

4.5.2.3 Flow Details

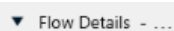

This dialog provides settings for the different phases of the measurement flow and for all frequency ranges.



All settings that are located **above** the list of frequency ranges are described in [Chapter 4.5.2.2, "Measurement Flow"](#), on page 161, because the availability of these settings greatly changes with the selected (highlighted) measurement phase.

- For "Measurement Settings", "Accessory Settings" and "Trigger", see [Figure 4-53](#)

The following sections describe these functions:

Add Frequency Range.....	203
Shift Frequency Range Up / Down.....	203
Active.....	203
Name.....	204
Frequency Range.....	204
Meas. BW (Overview).....	205
Hardware Setup.....	205
Limit Line.....	206
L Use individual Limit Lines.....	207
Offset.....	207
Comment.....	208
Copy.....	208
Delete Frequency Range.....	208
Unlock / Lock this Hardware Setup for editing.....	208
Hardware Setup.....	209
L Receiver.....	211
L Signal Path.....	211
L Sidebar.....	211
L Antenna.....	211
L Transducing Device.....	211
L Triple Loop.....	212
L Turntable.....	212
L Radio Communication Tester.....	212
Settings (Overview).....	212
L Operating Mode.....	213
L Scan Mode.....	213
L Sweep Type.....	214
L Detectors.....	215
L Filter Type.....	215
L Meas. BW.....	216
L CISPR BW.....	216
L Step Size.....	217
L Points.....	218
L Measurement time.....	218
L Meas. Time.....	219
L Total Time.....	219
L Video BW.....	220
L Input Selection.....	220
L Auto ID Threshold.....	222
L Band Pass.....	222
L High/Low Pass.....	222
L RF Attenuation.....	222

L Min Attenuation.....	223
L Preamplifier.....	224
L Signal Carrier Width.....	224
L External Gain Path.....	224
L IF Gain.....	224
L Screen Maximum / Reference Level.....	225
L Tracking Generator.....	225
L Generator Level.....	225
Settings (Zoom).....	225
Settings (Final).....	227
Settings.....	228
Setup.....	228
Properties.....	229



Add Frequency Range

Creates an additional frequency range in the same test template and with the following default settings:

- The lower limit of the new frequency range is automatically set equal to the upper limit of the highest existing frequency range in this test template.
- The upper limit of the new frequency range is automatically set 10 MHz above its lower limit, if permitted by the selected devices.
- The following settings and selections are copied, if available, from the frequency range that was previously selected (highlighted in blue).
 - The selected [Hardware Setup](#) with all its devices and the state of its [lock](#)
 - The limit line
 - All measurement settings in the dialogs [Settings \(Overview\)](#), [Settings \(Zoom\)](#) and [Settings \(Final\)](#)

Note: Frequency ranges in EMI versus EMS test templates. Note the following differences in comparison with [Test Templates for EMS tests](#):

- In EMI, the upper end of a new frequency range is set per default 10 MHz above its lower limit. On the contrary, in EMS the upper end is set 1 GHz above the lower end of a new frequency range.
- In EMI, gaps and overlapping frequency ranges are explicitly permitted. For example, an overlap allows measuring the same frequency range again with a different hardware setup. On the contrary, EMS test templates permit gaps, but no overlapping frequency ranges.



Shift Frequency Range Up / Down

Available only, if at least one other frequency range is displayed above / below the selected frequency range. The buttons swap the position of the selected frequency range with the one above / below it.

Frequency ranges are typically arranged in an order of increasing frequency, but different arrangements are permitted, too.



Active

Activates or deactivates measurements in selected frequency ranges.

The global checkbox next to the "Active" headline activates or deactivates the measurements in all frequency ranges.

Name

You can specify arbitrary names for the frequency ranges. These names appear instead of the range number in the "EMI Test Template" component of your test reports. If you activate [Graphics per Range](#), the names appear also in the headers of the range charts.

Frequency Range

Specifies the lower and upper limits of the frequency range. To edit the frequency values, click them.

You can also edit the units. Permissible units are *Hz*, *kHz*, *MHz* and *GHz*. For *kHz*, *MHz* and *GHz*, it is sufficient to enter *k*, *M* and *G*. For example, enter *10M* for *10 MHz*.

If you exchange any [Transducing Device](#) in the test template's hardware setup, the frequency values of new frequency ranges can change according to the device properties. If the device is incompatible with the existing frequency ranges, you must change them, too, before you can save the test template.

Note: Various frequency range statements in the dialog.

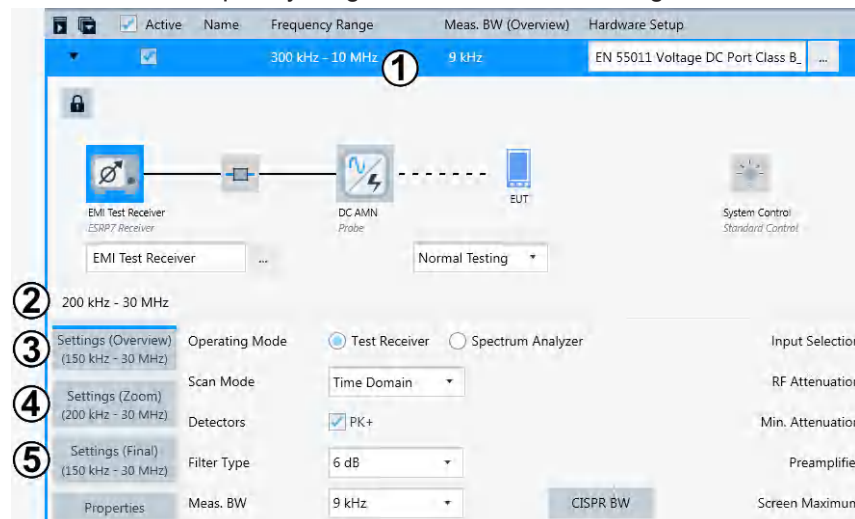

Figure 4-69: Example of frequency ranges shown in the settings dialog

- 1 = Specified lower and upper limit of the frequency range (here: 300 kHz to 10 MHz).
Mouse-over text: "Set Start and Stop Frequency"
- 2 = Frequency range, in which the combined receiver, signal path and transducer (here: an artificial mains network) can be used. This frequency range can be limited, for example, by the transducing device's correction table.
Note that (2) is the largest common range of (3), (4) and (5).
Mouse-over text: "The Frequency Range of the Hardware Setup"
- 3 = Usable frequency range of the receiver with the current [overview measurement settings](#). This frequency range can be reduced by various properties and settings of your receiver, for example, the [selected input](#). R&S ELEKTRA computes this reduction in a complex algorithm.
- 4 = Usable frequency range of the receiver with the current [zoom measurement settings](#).

- 5 = Usable frequency range of the receiver with the current [final measurement settings](#).

The frequency range (1) is an interactive setting, while the other frequency range statements are for your information, only.

The measurement settings and their frequency range statements are only shown, if the receiver icon is selected (highlighted).

Meas. BW (Overview)

Displays the measurement bandwidth as specified in the [Settings \(Overview\)](#).

...

Hardware Setup

Selects a [hardware setup](#) that defines the physical arrangement for the test and the interconnection of measurement instruments with their properties.

When you configure a new test template, start working with it by selecting a hardware setup for the first frequency range. All other subdialogs (except for "Test Information") are disabled, until the hardware setup is selected.

Your choice of hardware setups is limited by the type of test template that you have selected, see [Figure 4-30](#). According to the type of test template, hence, type of your transducing device, R&S ELEKTRA lets you select only a compatible hardware setup (if available) out of the following types:

- "EMI - Transducer / Probe"
- "EMI - LISN"
- "EMI - Slidebar"
- "EMI - Electric Field Strength" (with antenna)
- "EMI - Electric Field Strength (GTEM)" (with TEM waveguide)
- "EMI - Magnetic Field Strength (Triple Loop Antenna)"
- "EMI - Magnetic Field Strength (Loop Antenna + Turntable)"

If you have selected, for example, a test template of the type "EMI - Transducer / Probe", you can only select a hardware setup for transducers (probe or transmitter). R&S ELEKTRA automatically limits the list of selectable items to the applicable hardware setups.

Select one hardware setup for each frequency range. When you add a frequency range, the software preselects per default the hardware setup of the previous frequency range. See ["Add Frequency Range"](#) on page 203.

You can change preselected hardware setups. Hence, for different frequency ranges, you can select different hardware setups, each, but still for the same type of transducing device.

Clicking [...](#), R&S ELEKTRA offers you only the correct choice of hardware setups that are compatible with your type of test template and its existing devices. Alternatively, in the selection dialog, you can choose to create a new hardware setup, see [Chapter 4.7.2, "Hardware setups for EMI tests"](#), on page 334.

According to the hardware setup selection, the software executes the following settings:

- With the first selected hardware setup (in the first frequency range), R&S ELEKTRA unlocks these parts of the test template:
 - The [General Settings](#) dialog
 - The [Measurement Flow](#) dialog

- The selection of a [Limit Line](#) for the same frequency range
- The [measurement settings](#)
- The [device properties](#)
- The [Actions](#) dialog
- (The [Test Information](#) dialog was already unlocked before.)
- The test template allows [adding](#) frequency ranges.
- The unit for the [level range](#) is defined in the hardware setup for the first frequency range. The definition is valid and binding for all frequency ranges to be created later. Consequently, in additional frequency ranges, R&S ELEKTRA only permits the selection of hardware setups with the same measurement unit.
- The [hardware setup diagram](#) is displayed along with its devices, which are [locked](#) per default.
- The names of the devices are displayed below the device icons.
- The measurement settings defined in the test template and the properties of the devices defined in the hardware setup are available to be displayed for the selected (highlighted) device.
- R&S ELEKTRA compares the level unit of your selected (chosen) limit line with the level units of the devices in the [hardware setup](#) of the same frequency range. Before you choose a limit line, you can see its level unit in the "Details" section of the selection dialog. The unit is displayed for the selected (highlighted) limit line. If the selection dialog is too small to see the unit at the "Level Range" entry in the "Details" section, increase the selection dialog. If you select a limit line with a level unit that does not match the transducer's unit, you cannot save the test template.

Note: Selecting a hardware setup for a frequency range can interactively change its [frequency range values](#). The hardware setup's frequency range typically depends on its measurement instrument and on the frequency range of the involved devices, for example the transducing device.

...

Limit Line

Not available, if "General Settings" > "Graphics Settings" > [Use dynamic Limit Line](#) is enabled with the setting "MIL RE103/CE106". If the setting "Band Cut Out" is activated, the selected limit line is shown with the prefix "(Dynamic)".

Selects a [limit line](#) table.

Note: In each frequency range, you can select **one limit line table**, only. However, each limit line table can be defined with up to **four limit line columns**, each for an individual detector.

R&S ELEKTRA compares the level unit of the limit line that you want to select (choose) with the level unit defined by the [hardware setup](#) of the first frequency range. Before you choose a limit line, you can see its level unit in the "Details" section of the selection dialog. The unit is displayed for the selected (highlighted) limit line. If the selection dialog is too small to see the unit at the "Level Range" entry in the "Details" section, increase the selection dialog. If you select a limit line with a level unit that does not match with the hardware setup, you cannot save the test template.

If no limit line is defined for the current detector, but there is a limit line for an alternative detector according to [Table 4-3](#), R&S ELEKTRA automatically replaces the missing limit line. R&S ELEKTRA uses the alternative limit line for calculating the [Margin](#) values in the result table and the [Verdict](#).

Table 4-3: Alternative limit line detectors

Test template detector	Limit line detector alternative
AC Video (ACV)	none (no detector alternative)
AC Video Sine (ACS)	none (no detector alternative)
Average (AVG)	CISPR Average (CAV)
CISPR Average (CAV)	AVG
Maximum Peak (PK+)	Quasi Peak (QPK)
Minimum Peak (PK-)	none (no detector alternative)
Quasi Peak (QPK)	none (no detector alternative)
RMS	RMS Average (RMSAV)
RMS 100 MHz	none (no detector alternative)
RMS Average (RMSAV)	RMS
Sample	none (no detector alternative)

For more information on detectors, see also [Chapter 5.3, "Detectors"](#), on page 562.

If the selected limit line table does not contain a limit line specification for the alternative detector, either, a "Validation Warning" comes up when you save the test template: "Selected limit line does not match the configured detector in this frequency range" (or several warnings, one for each frequency range). Saving is still possible, but as the test misses a required limit line, R&S ELEKTRA cannot calculate the margin values and the verdict. To solve this issue, we recommend using the detectors as specified in a limit line table that conforms with the applicable standard.

Use individual Limit Lines ← Limit Line

Not available, if "General Settings" > "Graphics Settings" > [Use dynamic Limit Line](#) is enabled with the setting "MIL RE103/CE106".

To allow different limit lines for different frequency ranges, activate the checkbox. Otherwise, if this checkbox is not activated, the same (global) limit line is used for all frequency ranges.

If different limit lines are specified for different frequency ranges, deactivating this checkbox copies the limit line selection of the currently highlighted frequency range (blue) to all other frequency ranges. This copying of settings is protected by a warning: "The individual Limit Line settings of the frequency range(s) will be lost when disabling "Use individual Limit Lines". The "OK" button confirms the disabling, "Cancel" returns to the dialog without deactivating the checkbox.

Offset

Specifies an offset value and its unit, for example "dB μ V/m", to add to the frequency range a limit line that is shifted by this offset. Specifying a negative offset lowers the limit line, a positive offset raises it. If the offset value is 0, R&S ELEKTRA adds no shifted limit line.

The test chart displays the original limit line dashed, and the shifted limit line bold, with its offset value in the legend. This feature facilitates seeing clearly whether measurement results exceed a given dB distance from the original limit line.

Note: The *offset* limit line is relevant for the test results, hence the [Margin](#) values and the test's [Verdict](#) depend on it.

If the chart shows a dotted "Acceptance Trace", specified in the [Data Reduction](#), this trace also depends on the offset limit line.

When you add a frequency range, per default R&S ELEKTRA copies a specified offset from the existing frequency range to the new one.

Comment

Per frequency range, you can enter arbitrary text below the headline "Comment", as shown in [Figure 4-35](#). These comments appear in the "EMI Test Template" component of your test reports.



Copy

Creates a copy of this frequency range. Hence, the button works like [Add Frequency Range](#), but also enters the settings of the copied frequency range into the new frequency range.



Delete Frequency Range

Available only, if at least two frequency ranges are present. Deletes the selected frequency range without additional warning and without the possibility to restore a deleted frequency range with its settings.



Unlock / Lock this Hardware Setup for editing

Locking hardware setups within a test template is a precaution against unintentional modifications. Note that any modification occurs in the original [hardware setup](#), which may be used by several test templates. If you change the hardware setup here, this change does influence other test templates that reference this hardware setup. Hence, editing an existing hardware setup via its diagram in a test template is possible, but the lock is intended to remind you of this context.

If you want to edit a hardware setup within a test template, click the lock button to unlock it .

If the hardware setup is referenced elsewhere, R&S ELEKTRA brings up a warning that lists the other instances, which use this hardware setup. If you still want to edit the hardware setup, confirm with "OK". Otherwise click "Cancel".

If you use the same hardware setup in several frequency ranges, unlocking it in one range unlocks it in all ranges. And if you modify it in any frequency range (for example, change the transducing device), R&S ELEKTRA uses these modifications in all frequency ranges.

Note that you cannot change to a different [type of hardware setup](#) within a test template, but you can exchange **compatible devices**. To be compatible, the devices must have the same [device type](#), such as "Transducer" > "Probe".

When you start a test, a copy of the test template and a copy of its hardware setup are embedded into this test. This embedded hardware setup copy is not locked, and it does not even have a lock button, because it is no longer available for any other test template. Hence, you can modify the copied hardware setup in a copied test template that is embedded in a test, but you cannot select a different hardware setup.

Hardware Setup

A selected [hardware setup](#), represented by a diagram as in [Figure 4-70](#), is part of each frequency range in a test template and defines the physical measurement.



Figure 4-70: Example of a hardware setup diagram

- 1 = Receiver (here selected, hence highlighted in blue)
- 2 = Signal Path
- 3 = Transducing Device
- 4 = Representation of the EUT

You cannot exchange a device in the hardware setup, while it is [locked](#). Note that you cannot select the EUT in the hardware setup. Instead, R&S ELEKTRA uses the [activated EUT](#).

The hardware setup diagram is displayed along with the receiver's [overview](#), [zoom](#) and [final](#) measurement settings (if available) and the [properties](#) of all devices.

To select a device or change the selection in the hardware setup diagram (considering the [context](#) of doing so), proceed as follows:

- If the hardware setup is [locked](#), unlock it by clicking the lock icon. Handle the warning that comes up according to your needs.
Unlocking is a precondition for proceeding with modifying the hardware setup.
- If a device (for example, the signal path) has not been selected before, click its icon to open the selection dialog.
- If the device has already been selected, click the  button to open the selection dialog, and optionally change the device.

You can select different hardware setups for different frequency ranges, as long as the transducing devices are compatible with each other. To be compatible, the devices must have the same [device type](#), such as "Transducer" > "Probe". R&S ELEKTRA offers only the appropriate hardware setups for you to select.

The requirement of device compatibility across all hardware setups in all frequency ranges is inherited with the test template type:

- When you *create* an EMI test template, you must always select one specific test template type, see [Figure 4-30](#). Implicitly, this selection specifies the [hardware setup type](#) available for this test template.
- When you *open* an existing ([preconfigured](#)) EMI test template, the hardware setup type has already been defined accordingly.

Therefore, hardware setups in an EMI test template must include only devices that are compatible with another and with the type of test template.

Note: To access the [device properties](#) of the receiver, signal path or transducing device, select (highlight) its icon. However, be careful with changing these properties, as any change affects all test templates that use this device.

The following types of EMI test templates and EMI hardware setups are available:

- Transducer / Probe
- LISN
- Slidebar
- Electric Field Strength
- Electric Field Strength (GTEM)
- Magnetic Field Strength (Triple Loop Antenna)
- Magnetic Field Strength (Loop Antenna + Turntable)

Depending on the type of hardware setup, R&S ELEKTRA automatically offers only the compatible devices for you to select. For example, using a hardware setup with current clamp in one frequency range allows using a hardware setup with voltage probe or power absorbing clamp in another frequency range. All these transducers are probes. Transmitters such as injection clamps are also compatible. In contrast, multi-line LISNs, slidebars, antennas with tower control, GTEM cells and triple-loop antennas with separately addressable loops are not compatible with each other or with any probes or transmitters. You cannot use hardware setups with different of these device types in different frequency ranges of the same test template.

You can modify the selection of devices and edit the device properties in the hardware setup within a test template. However, consider the [note](#) given below. We recommend selecting all devices directly in the [Hardware Setups](#) dialog and specifying all device properties in the [Device List](#). For example, if your application requires a hardware setup that is similar to a previously specified hardware setup, make a [Copy](#) of it and modify this copy.

To edit the [measurement settings](#), select (highlight) the receiver icon as in [Figure 4-70](#).

Select (highlight) the icon of any device or signal path to edit their [Properties](#) as defined in the [Device List](#).

Note: Modifications in a hardware setup. You can modify and save any [device](#) used even for hardware setups or test templates that are currently open. When you return to the dialog of such an affected hardware setup or test template after a device modification, R&S ELEKTRA validates it, adjusts the settings and notifies you of this adjustment.

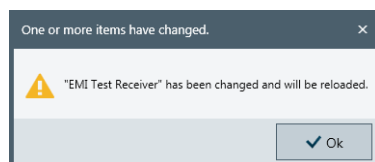

Figure 4-71: Notification of adjusted measurement settings due to a replaced receiver

For example, consider replacing a receiver that can perform *time domain scans* (option "K53") by a different receiver that does not feature this [Scan Mode](#), but only *stepped scans*. In this case, the scan mode in a test template that uses this receiver for "Time Domain Scan" is changed to "Stepped Scan".

This change requires that in a test, which is based on this template, R&S ELEKTRA automatically deletes all existing test results from the [Test container](#), when you save or rerun the test. The reason is the requirement to preserve consistency between measurement settings and measurement results.

To keep results that you have saved earlier, close the test without saving it and [create](#) a new test based on the test template. Alternatively, you can make a [copy](#) of your test and rerun this copy.



Receiver ← Hardware Setup

The measurement instrument is the [Receiver](#) (test receiver or spectrum analyzer), which is referenced from the [Device List](#) in the selected [Hardware Setup](#).

In the device list, you can specify to use a different receiver. However, consider that this change affects each test template, in which this receiver is referenced. Just as well, be careful with changing the [Device properties](#) of the receiver, as these properties settings also affect each test template, in which this receiver is referenced.

If the measurement instrument is a test receiver (not a spectrum analyzer), you can select the [Operating Mode](#) "Test Receiver" for *scan* measurements or "Spectrum Analyzer" for *sweep* measurements. This setting only affects the test template in which you specify it.

Select (highlight) the receiver icon to access the [Settings \(Overview\)](#), the [Settings \(Zoom\)](#), the [Settings \(Final\)](#) (if available) and the [receiver properties](#).



Signal Path ← Hardware Setup

Shows the [Signal Path](#), which is referenced for this frequency range from the [Device List](#) in the selected [Hardware Setup](#).



Slidebar ← Hardware Setup

Available only, if the test template type (see [Figure 4-30](#)) is "EMI - Slidebar".

Shows the [Slidebar](#), which is referenced for this frequency range from the [Device List](#) in the selected [Hardware Setup](#).



Antenna ← Hardware Setup

Available only, if the test template type (see [Figure 4-30](#)) is "EMI - Electric Field Strength".

Shows the [Antenna](#), which is referenced for this frequency range from the [Device List](#) in the selected [Hardware Setup](#).



Transducing Device ← Hardware Setup

Available only, if the test template uses a transducer, for example if the [test template type](#) is "EMI - Transducer / Probe", "EMI - Slidebar" or "EMI - Magnetic Field Strength (Loop Antenna + Turntable)".



Shows the [Transducer](#) (current clamp, antenna, single-line LISN, etc.), which is referenced for this frequency range from the [Device List](#) in the selected [Hardware Setup](#).

For different frequency ranges, you can select hardware setups with *different transducers* of the same [Type](#) ("Probe" or "Transmitter"), but R&S ELEKTRA allows only *one LISN* or *one TEM waveguide* for all frequency ranges.



Triple Loop ← Hardware Setup

Available only, if the test template type (see [Figure 4-30](#)) is "EMI - Magnetic Field Strength".

Shows the [Triple Loop](#) antenna, which is referenced for this frequency range from the [Device List](#) in the selected [Hardware Setup](#).



Turntable ← Hardware Setup

Available only, if the test template type (see [Figure 4-30](#)) is one of the following:

- "EMI - Electric Field Strength" (with [Antenna](#))
- "EMI - Magnetic Field Strength (Loop Antenna + Turntable)"
- "EMI - Radiated Spurious Emission"

Shows the [Turntable](#), which is referenced for this frequency range from the [Device List](#) in the selected [Hardware Setup](#).

If you use motorized positioning devices as turntables in an "EMI - Radiated Spurious Emission" test template, refer to "[Setup with motorized positioners](#)" on page 346.

Since the turntable is optional, you can add it to the hardware setup or remove it, if you [unlock](#) the hardware setup. However, if you wish to add or remove a turntable, we recommend doing so in a separate (optionally copied) hardware setup.



Radio Communication Tester ← Hardware Setup

Available only, if the test template type (see [Figure 4-30](#)) is "EMI - Radiated Spurious Emission".

Shows the [Radio Communication Tester](#), which is referenced for this frequency range from the [Device List](#) in the selected [Hardware Setup](#).

Since the radio communication tester is optional, you can add it to the hardware setup or remove it, if you [unlock](#) the hardware setup. However, if you wish to add or remove a radio communication tester, we recommend doing so in a separate (optionally copied) hardware setup.

Settings (Overview)

Settings (Overview)

Specifies the receiver settings for the [Overview Measurement](#).

Note: If the hardware setup uses the LISN "ENV 216", this specific LISN is the only one that also has a [Settings](#) dialog for its "High Pass" filter.

The receiver settings are available only, if you have both selected (chosen) a [Hardware Setup](#) and selected (highlighted) the [Receiver](#) icon in the [hardware setup diagram](#).



Figure 4-72: Prerequisite: select (highlight) the receiver icon

Note: Be aware of the difference: *Settings* define the individual behavior of a device during a test that is controlled by this test template. On the contrary, *Properties* define the global characteristics of a device as specified in the [Device List](#).

Figure 4-73: Settings dialog for the overview measurement

Note: After the measurement, R&S ELEKTRA can transfer the scan settings, the limit lines and the transducer correction data (as specified in the test template) into the test receiver's internal scan table. You can instantly use these settings at the test receiver (depending on the receiver model).

To let R&S ELEKTRA use this transfer feature, enable the "EMI: Download ..." checkboxes in the [General](#).

Note that the availability of some elements in the "Settings (Overview)" dialog varies with several settings in other dialogs. The details are described in the following sections.

Operating Mode ← Settings (Overview)

Specifies the type of [Receiver](#):

"Test Receiver" Operate your measuring device in test receiver mode to perform scan measurements. This mode also enables selecting a [Scan Mode](#), if the receiver offers both "Stepped Scan" and "Time Domain Scan".

"Spectrum Analyzer" Operate your measuring device in spectrum analyzer mode to perform sweep measurements. During final measurements, the device performs sweeps in zero span mode.

Scan Mode ← Settings (Overview)

[Scan](#) modes are available only, if the [Operating Mode](#) is "Test Receiver" (not "Spectrum Analyzer"), and if the test receiver is capable of both "Stepped Scan" and "Time Domain Scan". For a Rohde & Schwarz test receiver, make sure that software option "Time Domain Scan" is available, for example R&S ESR-K53, and that "K53" is enabled in the [Receiver](#) properties. See "Options" in [Chapter 4.8.3.1, "General properties"](#), on page 379.

"Stepped Scan" With this selection, R&S ELEKTRA performs conventional scans.

"Time Domain" With this selection, R&S ELEKTRA enables fast scans with support of fast Fourier transform (FFT) algorithms. As this scanning mode is faster than stepped scans, "Time Domain" is typically the preferred selection, if available.

As a special feature only with an R&S ESW [Receiver](#) and only with firmware version 1.70 or later, R&S ELEKTRA offers the following time-domain scan modes:

- "TD Automatic" ensures compliance with CISPR 16-1-1. With CISPR detectors, it makes the R&S ESW receiver optimize the measurement as in "TD Max Dynamic" mode, with non-CISPR detectors, the automatic mode is identical to "TD Max Speed".
- "TD Max Dynamic" ensures compliance with CISPR 16-1-1. It uses a capability of R&S ESW receivers for optimizing the time domain scan with a small analysis bandwidth in favor of a high dynamic range, regardless of the detector. Consider selecting this mode, for example, if your signal requires enhanced measurement sensitivity for narrowband interferers in the presence of continuous-wave signal components.
- "TD Max Speed" uses a capability of R&S ESW receivers for optimizing the time domain scan with a large analysis bandwidth towards enhanced speed, reducing the dynamic range and sensitivity for pulses with frequencies below 10 Hz. Consider selecting this mode, if you know that your signal has no low-frequency pulsed interferers. However, this mode (in contrast to the other TD modes) does not ensure fully compliant testing according to the standards under all circumstances.

For more information on "TD Max Dynamic" and "TD Max Speed" modes, refer to "Selecting the mode for time domain scans" ("TDS Optimization") in the [R&S ESW user manual](#).

If an existing test template is defined with "TD Max Dynamic" or "TD Max Speed" mode while the referenced receiver does not support that mode, R&S ELEKTRA automatically changes it to "Time Domain" mode. If this mode also is not possible, it is automatically changed to "Stepped Scan".

Sweep Type ← Settings (Overview)

[Sweep](#) types are available only, if the [Operating Mode](#) is "Spectrum Analyzer" (not "Test Receiver"), and if the spectrum analyzer is one of the following device [types](#):

- R&S ESR
- R&S ESRP
- R&S ESW
- R&S FSV
- R&S FSV30xx
- R&S FSVA30xx
- R&S FSW
- R&S FSWT

For these devices, the following "Sweep Type" settings are available:

"Auto" With this selection, R&S ELEKTRA automatically selects "Sweep" or "FFT", which ever is faster.

"Sweep"	With this selection (= default), R&S ELEKTRA performs conventional quasi-analog sweeps from the start to the stop frequency.
"FFT"	<p>With this selection, R&S ELEKTRA lets the spectrum analyzer sample on defined frequency values and transforms the sampled data to the spectrum by fast Fourier transformation (FFT).</p> <p>"FFT" is not available in the following cases:</p> <ul style="list-style-type: none"> • When using 5-Pole filters or RRC filters • When using one of the CISPR detectors • When an external generator is active (via hardware option) • When the preselector is on and the span covers frequencies below 8 GHz

If an existing test template is defined with "FFT" or "Auto" sweep type while the referenced spectrum analyzer does not support "FFT", R&S ELEKTRA automatically corrects it to "Sweep".

For more information on the "Sweep Type", refer to the [R&S FSW user manual](#), section "Common Measurement Settings" > "Bandwidth, Filter and Sweep Configuration" > "Bandwidth, Filter and Sweep Settings".

Detectors ← Settings (Overview)

Selects (activates or deactivates) the [Detectors](#) that you have specified in the [Measurement Flow](#).

One or more detector checkboxes can be disabled (gray), if these detector types are not available for the measurement, for example due to properties of the receiver that you use.

Note: "RMS x MHz" detectors are exclusive. If you select a calculated pseudo detector with a "virtual" increased measurement bandwidth, for example "RMS 100 MHz", you cannot combine it with any other detector in the same measurement. See [Table 5-2](#). Also, selecting an "RMS x MHz" detector automatically sets the [Filter Type](#) to 3 dB and the [Meas. BW](#) to 1 MHz. However, you can modify these default settings.

Filter Type ← Settings (Overview)

The "Filter Type" defines the bandwidth of the measuring filter (intermediate frequency filter, IF filter).

Per default, R&S ELEKTRA sets the IF filter bandwidth to 6 dB, if the [Receiver](#) supports this filter type. Otherwise, if it does not support 6-dB filters, R&S ELEKTRA sets the default IF filter bandwidth to 3 dB.

- A normal Gaussian filter with a 3-dB filter bandwidth approximately matches the noise bandwidth.
- EMI filters with a 6-dB filter bandwidth comply with CISPR and MIL standards. In the context of EMI tests, the 6-dB definition is more common, since it approximately matches the *equivalent pulse bandwidth* of broadband signals.

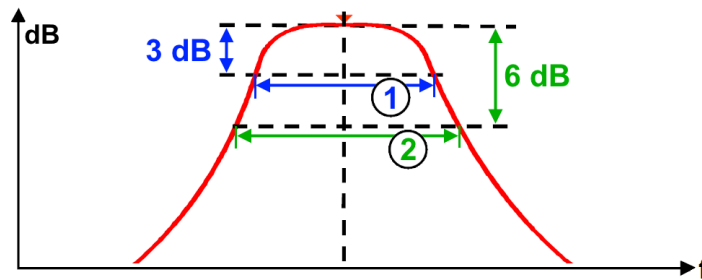

Figure 4-74: Definition of filter bandwidths

- dB = Level in decibels
- f = Frequency
- 3 dB = Signal level 3 dB down from peak
- 6 dB = Signal level 6 dB down from peak
- 1 = Bandwidth at a level 3 dB down from peak
- 2 = Bandwidth at a level 6 dB down from peak

If you select a "3 dB" filter while CISPR standard specifications require a "6 dB" filter, R&S ELEKTRA brings up a warning message, and you cannot save the test template. Changing the filter selection can also automatically change the [Meas. BW](#) setting.

The selected filter type is shown in the test report, if you configure the [Report Template](#) to include the "EMI Test Template" and to "Show Details" of this template.

Meas. BW ← Settings (Overview)

Selects from a list of suggested bandwidths for the measuring filter. As this filter is also called the intermediate frequency filter, the "Meas. BW" is also referred to as intermediate frequency filter bandwidth, IF filter BW or IF bandwidth.

The range and content of this list of bandwidths depends on your receiver, for example 10 Hz to 1 MHz with most receivers, or 1 Hz to 80 MHz, if you use an R&S ESW receiver with option "ESW-B8" enabled.

If you select a "Meas. BW" value that does not comply with CISPR standard specifications, R&S ELEKTRA brings up a warning message, and you cannot save the test template.

The measurement bandwidth that you set here is also displayed in the headline of the [Frequency Range](#).

Note that [Test Templates for calibration measurements](#) can automatically increase the "Meas. BW" with the current measurement frequency.

CISPR BW ← Meas. BW ← Settings (Overview)

Automatically sets the measuring filter bandwidth according to CISPR specifications, depending on the width of the selected [frequency range](#).

The button "CISPR BW" is available only, if the following conditions are all met:

- The required CISPR bandwidth of the measuring filter is available in the receiver.
- You have selected the [Filter Type](#) "6 dB" for the receiver.
- The frequency limits of the user-defined frequency range are **within the boundaries of a CISPR band** as defined in the standard, see [Table 4-4](#).

Table 4-4: CISPR frequency bands

CISPR band	Frequency range	CISPR bandwidth
A	9 kHz to 150 kHz	200 Hz
B	150 kHz to 30 MHz	9 kHz
C/D	30 MHz to 1 GHz	120 kHz
E and above	1 GHz and higher	1 MHz

Step Size ← Settings (Overview)

The input field for entering a measurement frequency step size is available only, if the following conditions are all met:

- The [Operating Mode](#) is "Test Receiver"
- The [Scan Mode](#) is "Stepped Scan"
- The "Auto" button next to the "Step Size" input field is not enabled

In this constellation, R&S ELEKTRA automatically suggests the half [Meas. BW](#) (BW/2) as a default value for the frequency step size.

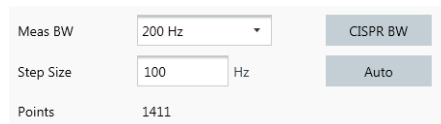

Figure 4-75: Step size in operating mode "Test Receiver"

You can edit this value and specify an arbitrary step size for the test. We recommend using at most the half "Meas. BW" value, to avoid erroneous measurements.

If you specify a step size value that is greater than BW/2, a warning comes up next to the "Step Size" input field. You can still save and use the test template, but R&S ELEKTRA shows the same warning next to the [Verdict](#) in the test:



The "Auto" button next to the "Step Size" input field resets the step size to half the "Meas. BW" and disables editing this field.

The resulting number of [Points](#), which is the [frequency range](#) divided by the step size, is automatically calculated and displayed for your information.

Note: A typical setting for an overview measurement is a step size of half the [Meas. BW](#) ("Auto" button) with a 6-dB [Filter Type](#). However, as the measurement filter is not flat, the accuracy is limited. Narrow bandwidth (CW) signals could be measured up to 1.5 dB lower than their actual level. Manually setting the step size to a third or fourth of the measurement bandwidth (BW/3 or BW/4) improves the accuracy, but at the cost of a longer measurement time.

In the [Scan Mode](#) "Time Domain Scan", R&S ELEKTRA automatically fixes the "Step Size" at a quarter of the [Meas. BW](#) (BW/4). You cannot change this setting, and the "Auto" button is disabled.

As opposed to "Test Receiver" mode, in operating mode "Spectrum Analyzer" the step size is automatically calculated from the [frequency range](#) divided by the number of [Points](#). In this case, the step size just serves for your information.

Points ← Settings (Overview)

- In the **Operating Mode** "Test Receiver", "Points" displays the number of frequency points for the overview measurement, resulting from the **frequency range** divided by the "Step Size". You cannot change the number of points, it just serves for your information.
- In the operating mode "Spectrum Analyzer", R&S ELEKTRA automatically suggests a default number of measurement points in such a way that the automatically calculated "Step Size" is equal to or close below the half **Meas. BW**.
If the "Auto" button next to the **Step Size** input field is disabled, you can change the number of measurement points and select from a list of suggested numbers. We recommend selecting the number of points in such a way that the resulting "Step Size" is not more than the half "Meas. BW" value, to avoid erroneous measurements. Use the "Auto" button to reset the number of points to meet the recommended "Step Size".

Meas BW	200 Hz	CISPR BW
Step Size	88 Hz	Auto
Points	1601	

Figure 4-76: Measurement points in operating mode "Spectrum Analyzer"

The step size is displayed, too, for your information.

Note: For selecting a suitable number of measurement points, see the recommendations at **Step Size**.

Measurement time ← Settings (Overview)

Specifies the measurement time (total or per point) in the overview measurement, depending on the **Operating Mode**:

- In operating mode "Test Receiver", you can specify the **Meas. Time** per point. In **Scan Mode** "Stepped Scan", the total measurement time results from this setting by multiplying it with the number of frequency points.
- In operating mode "Spectrum Analyzer", you can specify the **Total Time** of the measurement. The measurement time per frequency point results from this setting by dividing it by the number of frequency points.

Note the following features in **Sweep Type** "FFT":

- In this sweep type, the total time is the measurement time per FFT segment. The number of FFT segments depends on the performance of your receiver or analyzer.
- The time required for data processing can be considerably longer than the time required for data capturing. Thus, if you consider only the defined sweep time for data capturing, the measurement can take longer than expected, because it includes also the time for data processing.

The shortest required measurement time depends on the type of EUT and on various conditions, including the **Scan Mode** or **Sweep Type** settings.

To determine the shortest required measurement time, run a continuous measurement with "Max Hold" function enabled directly on the test receiver (or a sweep in [spectrum analyzer mode](#)). We recommend observing the measurement results directly on the receiver's display, as this procedure allows the best judgment of short-term instabilities. When you observe the measurement results in R&S ELEKTRA, the delay of data transfer to your computer and of graphics generation can impede the correct estimation of the required measurement time.

Use the "Maximum Peak" detector across the whole frequency range of the limit line. Observe the displayed "Max Hold" level. We recommend considering the time that it takes, until the "Max Hold" spectrum looks "stable", as the minimum measurement time for final measurements at critical frequencies. The measurement time determined by this approach is also recommended for the overview measurement, but the best selection also depends on the type of the disturbance.

- If you use a test receiver that supports [Time Domain Scan](#), this fast scan mode is helpful, as you can better observe a wide frequency range. Generally, in each [Scan Mode](#), if you set your measurement time too short, you risk missing sporadic disturbances.
- However, you can afford more easily a longer [measurement time per frequency point](#) in "Time Domain Scan" mode, because it is faster than the "Stepped Scan". At similar total measurement times, a longer time per point permits observing the EUT more intensively.

If the EUT does not require enhanced observation, the total measurement time in "Time Domain Scan" mode can be much shorter than in "Stepped Scan" mode.

Note: If the disturbances generated by the EUT are occasional short pulses ("clicks"), evaluate the characteristics of such a device and the required measurement time by a click rate analysis. For a description of this procedure, refer to the user documentation of your test receiver.

Meas. Time ← Measurement time ← Settings (Overview)

Available only, if the [Operating Mode](#) is "Test Receiver": Selects the measurement time per point from a list of predefined values.

Depending on this setting, the total measurement time is displayed, too, if the [Scan Mode](#) is "Stepped Scan". The "Total" is automatically calculated from the measurement time per point multiplied by the number of [Points](#).

If the "Scan Mode" is "Time Domain Scan", the total measurement time (which is typically much shorter than in "Stepped Scan" mode) is not displayed. This time cannot be computed, because it depends on internal parameters and hardware capabilities of your receiver model.

Total Time ← Measurement time ← Settings (Overview)

Available only, if the [Operating Mode](#) is "Spectrum Analyzer": Selects the total measurement time from a list of predefined values or lets R&S ELEKTRA set this time automatically, if you click "Auto".

Time Per Point	936.9144 ms
Total Time	1.500 s
Video BW	10 MHz

Depending on this setting, the measurement time per point is displayed. It is automatically calculated from the total time divided by the number of [Points](#).

If you select "Auto" for "Total Time", R&S ELEKTRA hides the measurement time per point.

Video BW ← Measurement time ← Settings (Overview)

Available only, if the [Operating Mode](#) is "Spectrum Analyzer": Selects from a list of suggested video bandwidths.

- Fixed values 1 Hz to 10 MHz (or up to 80 MHz, if you use an R&S ESW receiver with option "ESW-B8" enabled)
- "Auto" enables an algorithm that automatically selects the widest possible video bandwidth, in any case wider than the [Meas. BW](#)

The "Video BW" is the bandwidth of the lowpass filter directly after the envelope detector. This downstream filter is used to remove noise from the signal envelope.

Typically, the "Video BW" must be wider than the [Meas. BW](#). Exceptions apply, if standards require that the video bandwidth filter cuts away part of the signal that has passed the measuring filter (IF selection filter). If you select a "Video BW" that is smaller than the "Meas. BW", R&S ELEKTRA shows a warning.

Input Selection ← Settings (Overview)

Selects the test receiver's or spectrum analyzer's port number, hence the physical RF input connector. If more than one port is available, the selected port is used for the measurement.

If you use a two-port [test receiver](#) that offers the coupling modes "AC" or "DC", you can select as follows:

- | | |
|----------------|---|
| "1AC" or "2AC" | Port 1 or 2 with alternating current coupling mode. AC coupling is typically limited to signals that alternate with a few kHz, at least. Therefore, you cannot use this mode for lower frequency ranges, but the receiver is better protected against signal overload than in DC coupling mode. |
| "1DC" or "2DC" | Port 1 or 2 with direct current coupling mode. You can use this mode to measure signals down to 0 Hz, but it leaves the receiver sensitive to overlaid DC voltage, which can damage the receiver input. |

External harmonic mixers

As a special case, if your receiver or spectrum analyzer is in "[Spectrum Analyzer mode](#)" and supports using external harmonic mixers (see note on [Compatible instruments](#)), the "Input Selection" is extended with the following series of:

- External mixers, see [Table 4-22](#)
R&S ELEKTRA loads and displays the parameter values defined in the external mixer settings.
You can edit the parameter values at "Administration" > [External Mixer](#).
- Frequency bands, see [Frequency bands when using external harmonic mixers](#)

Table 4-5: Frequency bands when using external harmonic mixers

Band ID	Start frequency [GHz]	Stop frequency [GHz]
K	26	40
Q	33	50
U	40	60
V	50	75
E	60	90
W	75	110
F	90	140
D	110	170
G	140	220
J	220	325
Y	325	500
X	User-defined	

Selecting one of the external mixers or frequency bands has the following consequences:

- In the background, R&S ELEKTRA sets the "Input Selection" to DC input coupling.
- It sets the [Frequency Range](#) to the start and stop frequencies of the external mixer or band.
- It disables the [Preselector Filter](#), [Notch Filter at 2.4 GHz](#), [Notch Filter at 5.8 GHz](#), [Preselection Mode](#), [RF Attenuation](#) and [Preamplifier](#) fields, while in the background setting attenuation and preamplification to 0 dB.
- It enables the [Auto ID Threshold](#) input field.
- R&S ELEKTRA loads and activates a corresponding "SaveSet" of settings in the receiver or analyzer, specific for the selected band. It identifies the appropriate "SaveSet" by the naming convention "EXTMIX_<band>", where <band> represents the band ID. If the frequency band is configured correctly in the receiver or analyzer, the instrument driver can recall and use it.
- If an external mixer is selected, by default, the conversion loss is always set to 0 dB.

To define conversion losses, use a separate attenuation correction table that is associated either to a signal path (side by side with any cable loss corrections) or to an antenna.

Note: Compatible instruments. The harmonic-mixers feature is supported by the following [receivers and spectrum analyzers](#) with option B21:

- R&S FSW26 to R&S FSW85
- R&S FSV30, R&S FSV40
- R&S ESW44

To perform a measurement with external mixers, we recommend proceeding as follows:

- Start at the front panel of your test receiver or spectrum analyzer:
 - Push [Preset].

- Go to the "Home" menu.
- Set the instrument to "Spectrum" mode.
- Push the "External Mixer" softkey.
The settings dialog for the external mixer opens.
- Activate the external mixer.
- Apply all settings related to a specific waveguide band or an external mixer, for example its conversion loss.
- Store the instrument settings as a data set with a name like "EXTMIX_<band>", where <band> represents the band ID.
- All other settings are available in the test template editor of R&S ELEKTRA:
 - Set **Operating Mode** = "Spectrum Analyzer"
 - Select one of the external mixers or waveguide bands from "Input Selection" drop-down list

Auto ID Threshold ← Input Selection ← Settings (Overview)

Available only, if the **Input Selection** uses a frequency band or external mixer (no conventional AC or DC port).

Specifies the maximum permissible level difference between test sweep and reference sweep to be corrected in the receiver's firmware during automatic comparison.

We recommend using a threshold between 0.1 dB and 100 dB, where 10 dB typically yields satisfactory results.

If **Auto Signal Identification** is disabled in the **External Mixer**, R&S ELEKTRA ignores the "Auto ID Threshold".

For more information on signal identification with auto ID, refer to your instrument's user manual.

Band Pass ← Settings (Overview)

Available only, if the **Receiver** type is "FSWT26" with integrated preselection option R&S FSWT-B223, and if the **Preselection Mode** is "Band Pass".

Selects one of the available filter bands.

If your selection does not match the current **Frequency Range**, R&S ELEKTRA suggests an adjustment of the band selection. This suggestion is highlighted in red. If no suitable filter band is available, consider specifying a different "Frequency Range" or selecting a different "Preselection Mode".

High/Low Pass ← Settings (Overview)

Available only, if the **Receiver** type is "FSWT26" with integrated preselection option R&S FSWT-B223, and if the **Preselection Mode** is "High/Low Pass".

Selects one of the available filter bands.

If your selection does not match the current **Frequency Range**, R&S ELEKTRA suggests an adjustment of the band selection. This suggestion is highlighted in red. If no suitable filter band is available, consider specifying a different "Frequency Range" or selecting a different "Preselection Mode".

RF Attenuation ← Settings (Overview)

Available only, if **Input Selection** uses a conventional AC or DC port (no frequency bands, no external mixers).

Selects a fixed input attenuation (in dB) from a list of predefined attenuation values. Alternatively, you can select "Auto" ranging, which has the following effects:

- "Auto" enables an algorithm that automatically selects the appropriate input RF attenuation (higher than the manual selection, if necessary). The algorithm depends on various settings and on the test situation.
- If the [Operating Mode](#) is "Test Receiver", "Auto" enables the selection of a [Min Attenuation](#).

RF Attenuation	10 dB	RF Attenuation	Auto
Min. Attenuation	0 dB	Min. Attenuation	0 dB

If you use a test receiver in measurements with potentially strong signal pulses, you must protect the receiver's RF input port by selecting a sufficiently high "RF Attenuation" value.

Note: Setting the attenuation too high reduces the sensitivity of the measurement.

We recommend protecting the receiver input by using "Auto" ranging.

- If the [Operating Mode](#) is "Test Receiver", we recommend combining "Auto" with a [Min Attenuation](#) of 10 dB.
- If the [Operating Mode](#) is "Spectrum Analyzer", and if after completing the sweep across the current subrange R&S ELEKTRA detects an overload condition, it proceeds as follows, trying to solve the overload condition automatically:
 - a) The software increases both the RF attenuation and the reference level by 10 dB.
 - b) The driver triggers another sweep and waits for completion.
 - c) R&S ELEKTRA checks the measurement results for an overload condition again.
 - d) If it still detects an overload condition and the current RF attenuation is < 40 dB (or < 30 dB for R&S FSL or R&S ESL), it repeats the procedure.

Note: Automatic receiver protection. Between measurement steps, there is an increased risk of overloading the receiver's RF input port with [ESD](#) voltage peaks. This risk is especially prevalent during changes in the hardware setup, for example when you touch a connected measurement antenna while exchanging it.

To protect the receiver against possible voltage peaks, the software selects high input attenuation at the beginning and end of a test. It selects high input attenuation also between measurement steps, hence when the measurement is interrupted for user interaction. Typically, such interaction is accompanied by a notification that instructs you to do a change in the hardware setup. When your interaction is completed, the software sets the receiver input back to the correct attenuation that is assigned to the next measurement step and proceeds with the measurement.

Min Attenuation ← RF Attenuation ← Settings (Overview)

Available only in [Operating Mode](#) "Test Receiver", if [RF Attenuation](#) is set to "Auto" (not to a fixed value), and if [Input Selection](#) uses a conventional AC or DC port (no frequency bands, no external mixers).

Specifies either no minimum attenuation (0 dB = default) or a minimum attenuation of 10 dB, as described in [RF Attenuation](#).

Preamplifier ← Settings (Overview)

Available only, if [Input Selection](#) uses a conventional AC or DC port (no frequency bands, no external mixers).

Specifies the receiver's preamplification (in dB) for each frequency range.

We recommend disabling the preamplifier (= 0 dB) and using an [RF Attenuation](#) of at least 10 dB, to protect the receiver from damage due to input overload. This protection is especially important, if high disturbance pulses could occur, for example in conducted measurements. Another scenario that imposes an overload risk is the generation of electrostatic discharge pulses, caused by touching the antenna during manual antenna changes.

The following settings are available:

"0 dB"	Selects 0 dB preamplification (= default)
"20 dB"	Selects 20 dB preamplification. In the receiver R&S ESW, the preamplifier has a frequency range of 1 kHz to 8 GHz.
"30 dB"	Available only with a receiver like R&S ESW with option R&S ESW-B24. Selecting 30 dB preamplification activates the receiver's low-noise amplifier (LNA) instead of the preamplifier. In the R&S ESW, the preamplifier has a frequency range of 150 kHz to the maximum frequency of the device (8 GHz / 26.5 GHz / 44 GHz). The LNA is located in front of the preselector, hence it is <i>not</i> protected by it. With this selection, avoid high RF input levels, which can damage or even destroy the LNA.
"Step Attenuator"	Available only under the conditions described in Receiver > Details . This selection brings up the additional fields Signal Carrier Width and External Gain Path .

Signal Carrier Width ← Settings (Overview)

Available only under the conditions described in [Receiver > Details](#).

Specifies the bandwidth of the signal at the preamplifier's input. See [Chapter 4.8.20.1, "Details"](#), on page 469.

External Gain Path ← Settings (Overview)

Available only under the conditions described in [Receiver > Details](#).

Initially empty; shows the automatically selected gain path, determined in a reference measurement. See [Chapter 4.8.20.1, "Details"](#), on page 469.

IF Gain ← Settings (Overview)

Available only, if the [Receiver](#) type is "FSWT26", and if the [Operating Mode](#) is "Test Receiver".

Applies the selected gain after the signal has been mixed down to the intermediate frequency (IF), to improve measurement sensitivity.

- In "Auto" mode, the R&S FSWT automatically selects the best gain setting (up to 30 dB) for the measured signal
- Alternatively, you can manually select one of the predefined gain values

Screen Maximum / Reference Level ← **Settings (Overview)**

The name of this parameter depends on the [Operating Mode](#):

- "Screen Maximum", if the "Operating Mode" is "Test Receiver"
- "Reference Level" if the "Operating Mode" is "Spectrum Analyzer"

It specifies the value of the upmost line on the receiver's or analyzer's display, to avoid an input overload.

The unit of the screen maximum or reference level is automatically adjusted to the [measurement unit](#) of the [transducing device](#), hence typically $dB\mu V$. The default value is 80 $dB\mu V$.

Tracking Generator ← **Settings (Overview)**

Available only, if the [Operating Mode](#) is "Spectrum Analyzer", and if the test receiver or spectrum analyzer is one of the following device [types](#):

- R&S EPL
- R&S ESL
- R&S ESR
- R&S ESRP
- R&S FPL
- R&S FSV

Enables or disables the tracking-generator feature in the test receiver or spectrum analyzer.

In calibration measurements, you can use it similar to a [Network Analyzer](#) (VNA), see also [Select Device](#) in [Chapter 4.5.1, "Test Templates for calibration measurements"](#), on page 119.

Generator Level ← **Settings (Overview)**

Available only, if the [Tracking Generator](#) is enabled.

Specifies the output power of the tracking generator. When you enter a level in mW, the software converts it to dBm.

Settings (Zoom)**Settings (Zoom)**

Specifies the settings for the [Zoom Measurement](#).

These settings are available only, if you have both selected (chosen) a [Hardware Setup](#) and selected (highlighted) the [Receiver](#) icon in the [hardware setup diagram](#):



Figure 4-77: Prerequisite: select (highlight) the receiver icon

Note: Be aware of the difference: *Settings* define the individual behavior of a device during a test that is controlled by this test template. On the contrary, *Properties* define the global characteristics of a device as specified in the [Device List](#).

The rules for the settings in this dialog are all described in "[Settings \(Overview\)](#)" on page 212.

However, we recommend considering some modified settings, for example a smaller "Step Size". The motivation for modifying individual settings is finding "Zoom" measurement parameters and conditions that lead to even more precise resulting critical frequencies.

You cannot edit all settings for the zoom measurement, as some of the settings are locked to the settings in the overview measurement dialog. The following list provides an overview:

"Operating Mode"	Selects "Test Receiver" or "Spectrum Analyzer", same as Operating Mode in "Settings (Overview)".
"Scan Mode"	Selects stepped scan or TD scan, same as Scan Mode in "Settings (Overview)".
"Sweep Type"	Selects conventional sweep, FFT or automatic type selection, same as Sweep Type in "Settings (Overview)".
"Detectors"	Selects the detectors for the zoom measurement, same as Detectors in "Settings (Overview)".
"Filter Type"	Fixed to the same Filter Type as in the "Settings (Overview)".
"Meas. BW"	Selects the measurement bandwidth for the zoom measurement, independently of the Meas. BW in "Settings (Overview)".
"Step Size"	Specifies the "Step Size" for the zoom measurement.

Available only, if the following conditions are all met in the "Settings (Overview)" **and** in the "Settings (Zoom)":

- The [Operating Mode](#) is "Test Receiver"
- The [Scan Mode](#) is "Stepped Scan"
- The "Auto" button next to the "Step Size" input field in the "Settings (Zoom)" is disabled

In this constellation, R&S ELEKTRA automatically suggests the half "Meas. BW" (from the "Settings (Zoom)" dialog) as a default value for the frequency step size.

You can edit this value and specify an arbitrary step size for the test. We recommend using at most the half "Meas. BW" value, to avoid erroneous measurements.

If you specify a step size value that is greater than half of the "Meas. BW", a warning comes up next to the "Step Size" input field. You can still save and use the test template, but R&S ELEKTRA shows the same warning next to the [Verdict](#) in the test:



The "Auto" button next to the "Step Size" input field is disabled.

In the scan mode "Time Domain Scan", R&S ELEKTRA automatically fixes the "Step Size" at a quarter of the [Meas. BW](#) (BW/4). You cannot change this setting.

In the [Operating Mode](#) "Spectrum Analyzer", the step size is automatically calculated from the [frequency range](#) divided by the number of "Points". In this case, the step size just serves for your information. For more details, see [Step Size](#) in "Settings (Overview)".

"Points"	Specifies the number of frequency points for the zoom measurement, same as Points in the "Settings (Overview)".
"Meas. Time" or "Total Time"	Depends on the Operating Mode : "Meas. Time" for "Test Receiver", "Total Time" for "Spectrum Analyzer". Selects the measurement time for the zoom measurement, same as Measurement time in the "Settings (Overview)".
"Video BW"	Per default: set to the same Video BW as in the Settings (Overview) , if available there. However, you can change the setting and select from a list of suggested video bandwidths or "Auto". Available only, if the Operating Mode is "Spectrum Analyzer".
"Input Selection"	Fixed to the same Input Selection as in the "Settings (Overview)".
"RF Attenuation"	Fixed to the same RF Attenuation as in the "Settings (Overview)".
"Min Attenuation"	Fixed to the same Min Attenuation as in the "Settings (Overview)". Available only, if the Operating Mode is "Test Receiver".
"Preamplifier"	Fixed to the same Preamplifier setting as in the "Settings (Overview)".
"Screen Maximum" / "Reference Level"	Fixed to the same Screen Maximum / Reference Level as in the "Settings (Overview)". The displayed name of this parameter depends on the Operating Mode ("Test Receiver" or "Spectrum Analyzer").

Settings (Final)

Settings (Final)

Specifies the settings for the [Final Measurement](#).

This dialog is available only, if you have both selected (chosen) a [Hardware Setup](#) and selected (highlighted) the [Receiver](#) icon in the [hardware setup diagram](#):



Figure 4-78: Select (highlight) the receiver icon

Note: Be aware of the difference: *Settings* define the individual behavior of a device during a test that is controlled by this test template. On the contrary, *Properties* define the global characteristics of a device as specified in the [Device List](#).

The rules for the settings in this dialog are all described in [Settings \(Overview\)](#).

Most of the settings (even more than in [Settings \(Zoom\)](#)) are **copied** from the overview measurement dialog.

Some settings are copied or calculated from overview settings, for example, the "Meas. BW", as the final measurement always uses identical "Meas. BW" setting as the overview measurement.

You can only edit the following final measurement settings:

"Operating Mode"	Selects "Test Receiver" or "Spectrum Analyzer", same as Operating Mode in "Settings (Overview)". Note that the settings specify no "Scan Mode" or "Sweep Type" for this "Final" phase, because it is always executed as discrete measurements at the identified critical frequencies, rather than a scan or sweep.
"Detectors"	Selects the detectors for the final measurement, same as Detectors in "Settings (Overview)". As an exception, if you enable the "CISPR APD" detector, which is available only in the final measurement, you cannot enable other detectors at the same time.
"Meas. BW"	Selects the measurement bandwidth for the final measurement. Per default: set to the same Meas. BW as in the Settings (Overview) . You can change the final measurement BW without influencing the BW settings in other measurement phases.
"Meas. Time"	Specifies the measurement time for the final measurement. The selection is independent of the Measurement time in the Settings (Overview) and independent of the Operating Mode .
"Video BW"	Available only, if the Operating Mode is "Spectrum Analyzer". Per default: set to the same Video BW as in the Settings (Overview) , if available there. However, you can change the setting and select from a list of suggested video bandwidths or "Auto".

Settings

Settings

This "Settings" dialog is available only, if the hardware setup uses the LISN "**ENV 216**", *and* if you have selected (highlighted) the icon of this LISN.



Figure 4-79: Prerequisite: select (highlight) the icon of the ENV 216 or ENV 432 LISN

The "High Pass" checkbox enables or disables remote switching of this LISN's internal 150-kHz highpass filter.

Note: For a description of the receiver settings, refer to [Settings \(Overview\)](#).

Setup

Setup

This "Setup" dialog is available only, if the test template type (see [Figure 4-30](#)) is "EMI - Radiated Spurious Emission", *and* if you have selected (highlighted) the icon of the radio communication tester.



Figure 4-80: Prerequisite: select (highlight) the icon of the radio communication tester

For a description of the signaling settings, refer to the following sections:

- If your radio communication tester is an R&S CMW500 or R&S CMW270, refer to the following sections:

- [Signaling](#)
- [Packet generator](#) (relevant only for a "CMW500-WLAN" device)
- If your radio communication tester is an R&S CMX500, refer to the following sections:
 - [NR](#)
 - [NR scheduling](#)
 - [General](#)
 - [LTE](#)
 - [LTE scheduling](#)

Properties

Properties

Shows the properties of the device that you select (highlight) in the hardware setup diagram.

Note the difference: Properties define the global characteristics of a device as specified in the [Device List](#) (see [Device properties](#)). On the contrary, the [Settings](#) define the individual behavior of a device (the receiver) during a test that is controlled by this test template.

The "Properties" are shown as specified in the [Device List](#).

Note: Access to device properties depends on the type of test template.

- You can open a test template that is integrated into a test (as a "copy" of a "global" test template). However, you only can read but not modify any device properties from within this test template dialog. Hence, within the test, these properties settings document the states of the devices at the time when the measurement was executed.
- If you open a "global" test template outside of a test, you can modify the device properties from within the test template dialog after [unlocking](#) the hardware setup. However, be careful with modifying any device properties from within the test template dialog. These properties are also changed in the device list and in each other "global" test template that uses the device. (Existing tests are influenced by modified device properties, too, when you rerun these tests.)

To avoid unintentional changing of device properties, the properties are locked in the test template dialog, as long as the hardware setup is [locked](#).

4.5.2.4 Test Information

▼ Test Information

This dialog allows editing test information that is relevant for all (or most) of the tests that you run from this test template. By entering this information in the test template instead of in the test, you avoid having to enter the same information repeatedly for the same type of tests.

To edit your predefined titles and contents for an individual test, open the [test information dialog](#) within this test.

Title	Content	
Description		
Test Standard		
Test Site		
Operator Name		

Figure 4-81: Test information dialog

Add Information

- **"Add Information"**
Adds a new row in the test information table, below the default lines "Description", "Test Standard", "Test Site" and "Operator Name".



- **"Shift Row Up / Down"**
The buttons swap the position of the selected row with the one above or below it.

- **"Title"**
Enter a title for each row of test information.
Click the titles headline to sort the rows alphabetically by their titles.

- **"Content"**
Enter arbitrary content in each row of test information. You can also leave the content of a row blank and enter only the title, for entering the content later (within the tests).
Click the contents headline to sort the rows alphabetically by their contents.



Content history

For each category, R&S ELEKTRA memorizes previously stored text in the "Content" column. After saving the test template and deleting any text from the "Content" column, the software helps you in restoring that text by selecting it from a context dialog.



- **"Delete Row"**
Deletes the selected row without additional warning and without the possibility to restore the deleted title and content.

4.5.2.5 Actions

Actions

This dialog defines actions that are executed when a particular event occurs during a measurement.

In a new test template, the "Actions" settings are available only when you have selected a [Hardware Setup](#) in the [Flow Details](#).

Available Actions	Actions of the Test	Properties
<ul style="list-style-type: none"> ✉ E-mail i Notify ⌚ Wait 📄 Run Program 📄 Send Remote Command (Remote Action Device) ❓ Query Status (Remote Action Device) 🔌 Set IO Device 🔌 Set Switch Unit 📡 Set Generator 📷 Capture Screenshot 	<ul style="list-style-type: none"> ⏪ Test Start/Resume ⏸ Test Pause ▼ ⏪ Frequency range 1 [100 kHz to 200 MHz] <ul style="list-style-type: none"> ⏪ Enter ⏪ Leave ▼ ⏪ Overview Measurement <ul style="list-style-type: none"> ⏪ Enter ⏪ Leave ▼ ⏪ Overview Sweep/Scan (all frequency ranges) <ul style="list-style-type: none"> ⏪ Enter ⏪ Leave ▼ ⏪ Data Reduction <ul style="list-style-type: none"> ⏪ Enter ⏪ Leave ▼ ⏪ Final Measurement <ul style="list-style-type: none"> ⏪ Enter ⏪ Leave ⏪ Test Stop ⏪ Test Error 	

Figure 4-82: Actions dialog

The available actions are:

- [Email](#) - sending an email message to alert the user
- [Notify](#) - sending a notification to alert the user
- [Wait](#) - waiting for a defined time before R&S ELEKTRA continues with the next step of a test. During this time, you can stop the test.
- [Run Program](#) - running a selected executable program
- [Send Remote Command \(Remote Action device\)](#) - sending a remote control SCPI command to a remote action device
- [Query Status \(Remote Action Device\)](#) - sending a query request for the status of a remote action device
- [Set IO Device](#) - using available output channels
- [Set Switch Unit](#) - using switch units
- [Set Generator](#) - using generators
- [Capture Screenshot](#) - letting R&S ELEKTRA take pictures of the test instrument's user interface during a measurement

Typical events, for which actions can be assigned, are:

- "Test Start/Resume"
- "Test Pause"
- "At Every Frequency (Pre Dwell)"
- "At Every Frequency (Post Dwell)"
- "Frequency range" according to the test phases in the [Flow Details](#), where the event can be:
 - "Enter" the frequency range
 - "Leave" the frequency range

- "Overview Measurement", where the event can be:
 - "Enter" the measurement
 - "Leave" the measurement
- "Overview Sweep/Scan (all frequency ranges)", where the event can be:
 - "Enter" the overview sweep/scan frequency range
 - "Leave" the overview sweep/scan frequency range
- "Data Reduction", where the event can be:
 - "Enter" the data reduction
 - "Leave" the data reduction
- "Maximization", where the event can be:
 - "Enter" the maximization
 - "Leave" the maximization
- "Zoom Measurement", where the event can be:
 - "Enter" the measurement
 - "Leave" the measurement
- "Adjustment", where the event can be:
 - "Enter" the adjustment
 - "Leave" the adjustment
- "Final Measurement", where the event can be:
 - "Enter" the measurement
 - "Leave" the measurement
- "Test Stop" (scan end or user interruption)
- "Test Error"

Assigning an action

To assign an action to an event, drag-&-drop the action icon from "Available Actions" (left tab) to the name of that specific event in "Actions of the Test" (center).

For example, click-and-hold "Notify", drag it to "Test Stop" and drop it there.

Click any assigned action item to edit it in the "Properties" tab.

If several action items are in one node, you can use the [short keys](#) [Alt]+[↑] and [Alt]+[↓] for moving a selected item up or down. Or right-click the item and use the functions "Move Up" and "Move Down" in the context menu.

To remove an action item from an event, select the item and click [Delete] on the keyboard. Or right-click the item and select [Delete] in the context menu. In [touch operation](#) on a tablet computer, tap and hold the icon of an action and select [Delete] in the context menu.

To include the details of your specified actions into test reports, open the [Report Templates](#) dialog, either in a general report template or embedded in a test template. In the selected "Test Template" component, enable the "Show Details" checkbox in the "Component Options" section.

The following actions are available in your tests:

Email..... 233
 Notify..... 234
 Wait..... 235
 Run Program..... 236
 Send Remote Command (Remote Action device)..... 236
 Query Status (Remote Action Device)..... 237
 Set IO Device..... 239
 Set Switch Unit..... 240
 Set Generator..... 241
 Capture Screenshot..... 241

Email

Sends an email message when the event has occurred, for example, a test is started or stopped.

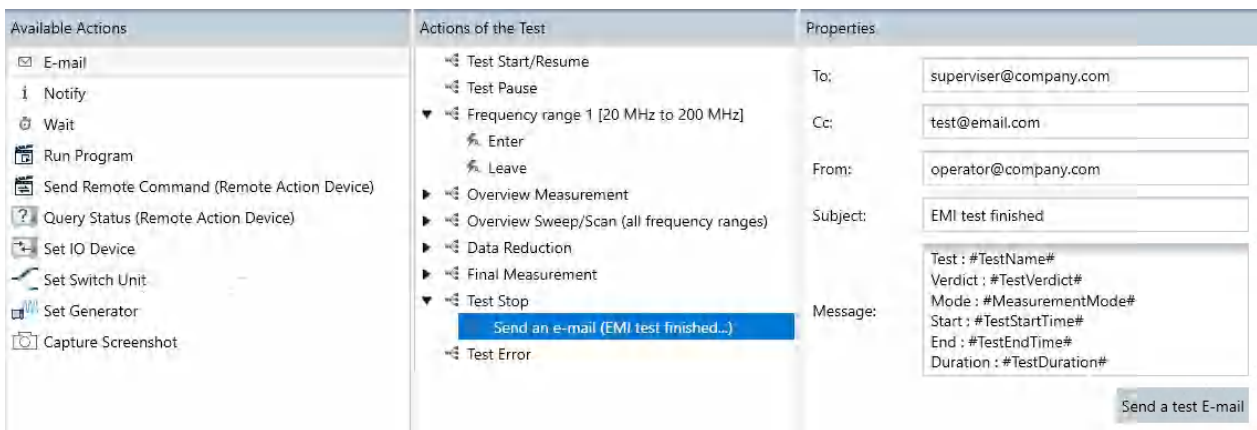

Figure 4-83: Action "Email" assigned to event "Test Stop"

- "To" Enter one or more recipient addresses.
- "Cc" Enter one or more copy addresses.
- "From" Enter the address of an email account that you have access to.
- "Subject" Enter a subject heading. R&S ELEKTRA suggests a default heading. For the pound keys, see the description at "Message".

"Message"	<p>Enter any arbitrary message text. R&S ELEKTRA suggests some default entries. The functional text items (tags between two pound keys, for example "#TestName#") are automatically replaced by the content that they represent. This replacement is executed only, if the message is issued out of a real test. The replacement cannot take effect when you use the button "Send Test Email" out of the test template. If no content is available for a tag, R&S ELEKTRA returns the tag itself.</p> <p>The functional text items (tags) that the software can replace automatically are:</p> <ul style="list-style-type: none"> • #TestName# Returns the name that you used to save the test. If the test is not yet saved, R&S ELEKTRA uses the default name of the test based on the name of the test template. • #TestVerdict# After the test is finished, output values are "Inconclusive", "Failed" or "Passed", otherwise it is "Unknown". • #MeasurementMode# Output values are "Overview" or "Final" measurement. Available only, if the measurement in the first frequency range has started. • #CurrentFrequency# Returns the current frequency that the measurement uses at this moment. • #CurrentFrequencyRange# Returns the start and stop frequencies of the frequency range that the measurement uses at this moment. • #CurrentMonitoringChannel# Returns the name and number of the "Monitoring Channel" that is active, together with its minimum and maximum values. • #TestStartTime# Returns both date and time in the format "yy-MMM-dd ddd HH:mm:ss". • #TestEndTime# Returns both date and time in the format "yy-MMM-dd ddd HH:mm:ss". Before the test is completed, the output value is "<Test not yet finished>". • #TestDuration# Returns the hours, minutes and seconds from the test start to the moment that the notification is generated. • #TestStatus# Can be started, stopped, completed, failed or unknown.
"Send Test Email"	<p>Sends an email to the specified "To" and "Cc" addresses. Note that in a test message, the text items between pound keys are not replaced by the content that they represent.</p>

Notify

Brings up a user-defined text and audio message on the computer, on which R&S ELEKTRA is running, when the event has occurred.

The audio feature requires that the computer has a sound card and that the computer's loudspeaker is not muted (volume > 0%).

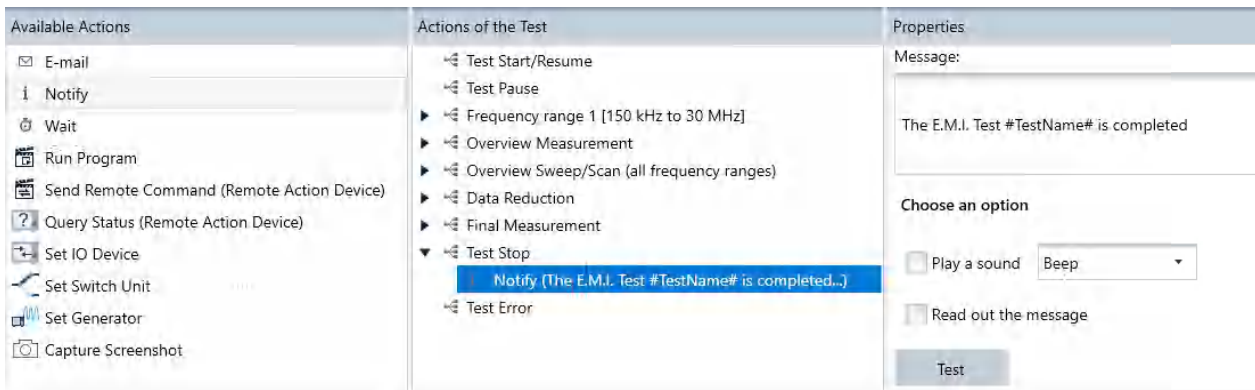

Figure 4-84: Action "Notify" assigned to event "Test Stop"

While the dialog box shows the text message, you can optionally stop the test or select "Continue" to proceed with the test execution.

- "Message" Enter any arbitrary notification text. R&S ELEKTRA suggests a default entry. The functional text items between two pound keys (for example "#TestName#") are automatically replaced by the content that they represent. This replacement is executed, if the notification is generated out of a real test, rather than out of the test template by using the button "Test".
For a list of functional text items that can be used between two pound keys, see [Email](#) > "Message".
- "Play a sound" Replays a Windows system sound according to your selection in the field "Select a sound".
The available Windows system sounds are called:
- "Beep"
 - "Exclamation"
 - "Asterisk"
 - "Hand"
- "Read out the message" This function displays the text from the "Message" field in a dialog box and also reads it out loud, when the event has occurred.
Note that acronyms such as "EMI" are better pronounced if written as "E.M.I.". The audio replay of the message is not stopped even if you continue or stop the test.
- "Test" Serves for testing the message output of the "Notify" feature.
Note that in this "Test" notification, the text items between pound keys are not replaced by the content that they represent.

Wait

Makes R&S ELEKTRA pause the test for a user-defined time (number of seconds) before the next step of the test is executed.

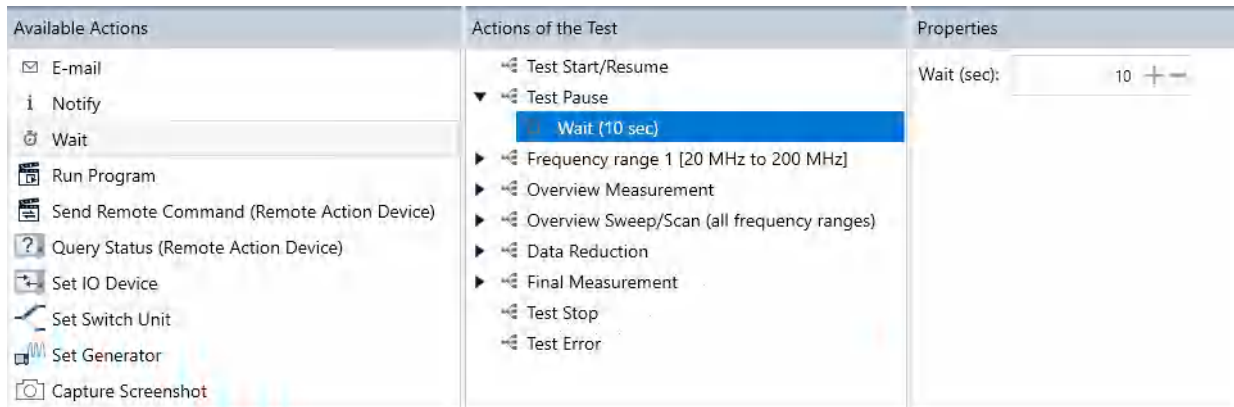
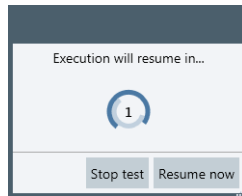

Figure 4-85: Action "Wait" assigned to event "Test Pause"

While the test is paused, a dialog box shows a countdown of the remaining seconds to wait. During this time, you can optionally stop the test or select "Resume now" to skip the remaining waiting time.



Run Program

Calls up a selected executable program and runs it.

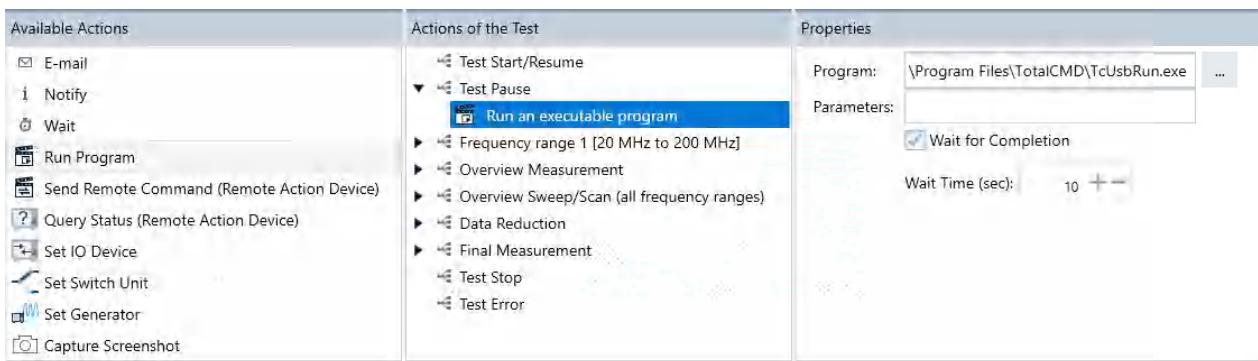

Figure 4-86: Action "Run Program" assigned to event "Test Pause"

- "Program" Selects the program file to be executed.
- "Parameters" Defines optional parameters for the program to be executed.
- "Wait for completion" Check this checkbox to let R&S ELEKTRA pause until the selected executable program is terminated.
- "Wait Time (sec)" Specifies a number of seconds that R&S ELEKTRA waits before it resumes after completion of the executable program.

Send Remote Command (Remote Action device)

Sends SCPI commands for up to 10 actions to a selected [Remote Action](#) device.

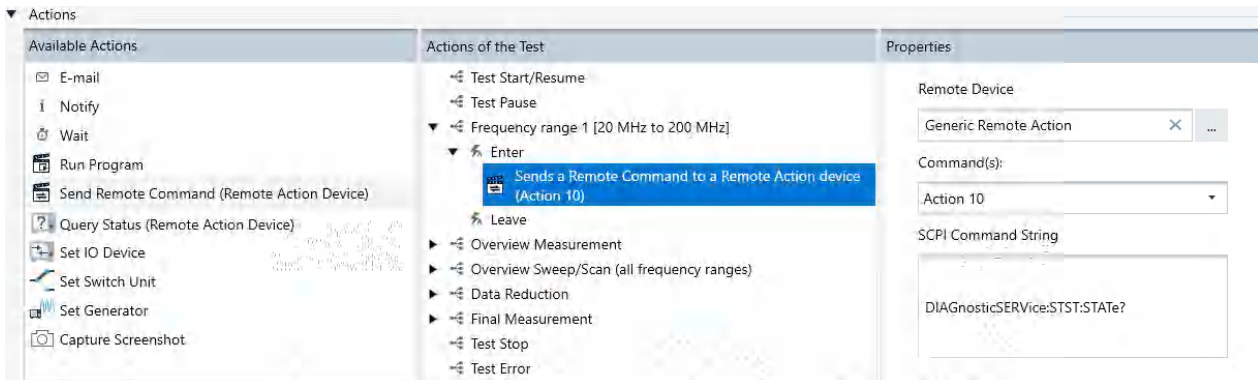

Figure 4-87: Action "Send Remote Command" assigned to event "Enter" > "Frequency range 1"

- | | |
|-----------------------|---|
| "Remote Device" | Selects the SCPI-controllable Remote Action device from the Device List . |
| "Command(s)" | Selects one out of 10 actions with a previously defined remote control command (see below). |
| "SCPI Command String" | Displays the command string for the action selected above. Define this string in the "Device List" at SCPI Command String . In the example in the figure above, the command queries the device for the result of a self-test. |

Query Status (Remote Action Device)

Sends a query that is selected from the available queries in the [Remote Action](#) device.

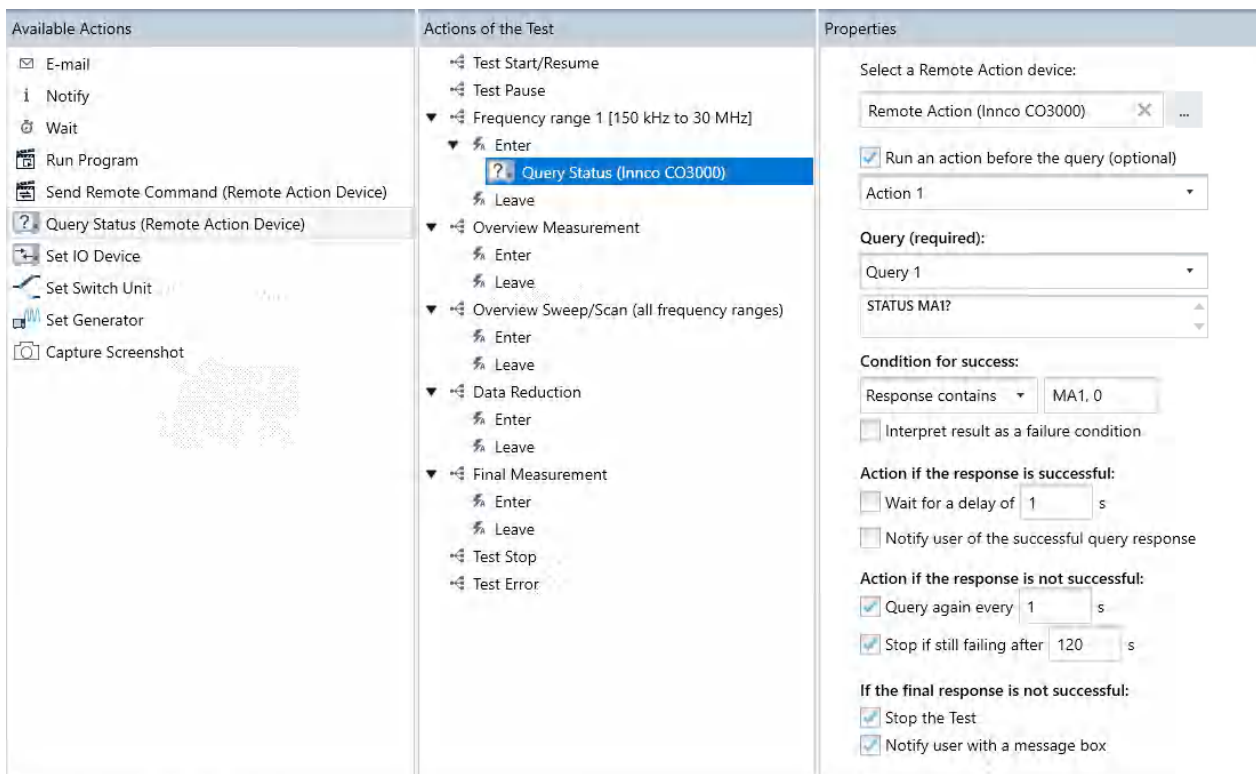

Figure 4-88: Action "Query Status (Remote Action Device)" assigned to event "Enter" > "Frequency range 1"

"Select a Remote Action device:"	Selects the SCPI-controllable Remote Action device from the Device List .
"Run an action before the query (optional)"	Optional, selects one out of 10 actions with a previously defined remote control command to execute before obtaining the query status.
"Query (required)"	Selects one out of five queries with a previously defined remote control command.
"Condition for success"	Defines the conditions that determine whether the query is successful. If the "Interpret result as a failure condition" option is selected, the definition defines the conditions that determine an unsuccessful response. The conditions include: <ul style="list-style-type: none"> • "Value is between" a defined minimum and maximum value • "Value equals" a defined value • "Response contains" a defined string, such as OK

"Action if the response is successful"

Allows the user to select the actions to be done upon a successful query response:

- "Wait for a delay of x s" - where x defines the time delay in seconds before executing other actions
- "Notify user of the successful query response" - prompt users with a pop-up box on the result of a successful response

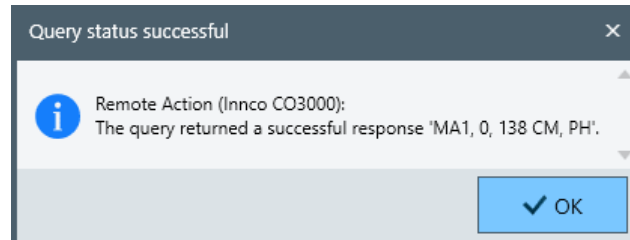

Figure 4-89: Notification on a successful query response

"Action if the response is not successful"

Allows the user to select the actions to be done upon an unsuccessful query response:

- "Query again every x s" - where x defines the time delay in seconds before executing the query again
- "Stop if still failing after x s" - where x defines the time in seconds to stop repeating the queries upon continuous unsuccessful query responses

"If the final response is not successful"

Allows the user to select the actions to be done, if the last query response is still unsuccessful after all attempts.

- "Stop the Test"
- "Notify user with a message box" - prompt users with a pop-up box on the result of an unsuccessful response

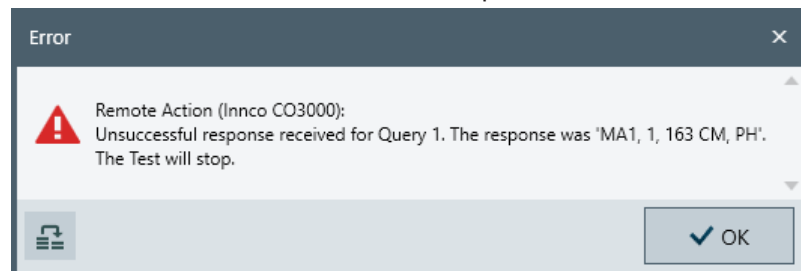

Figure 4-90: Notification on an unsuccessful query response

Set IO Device

Allows using input / output devices in test actions.

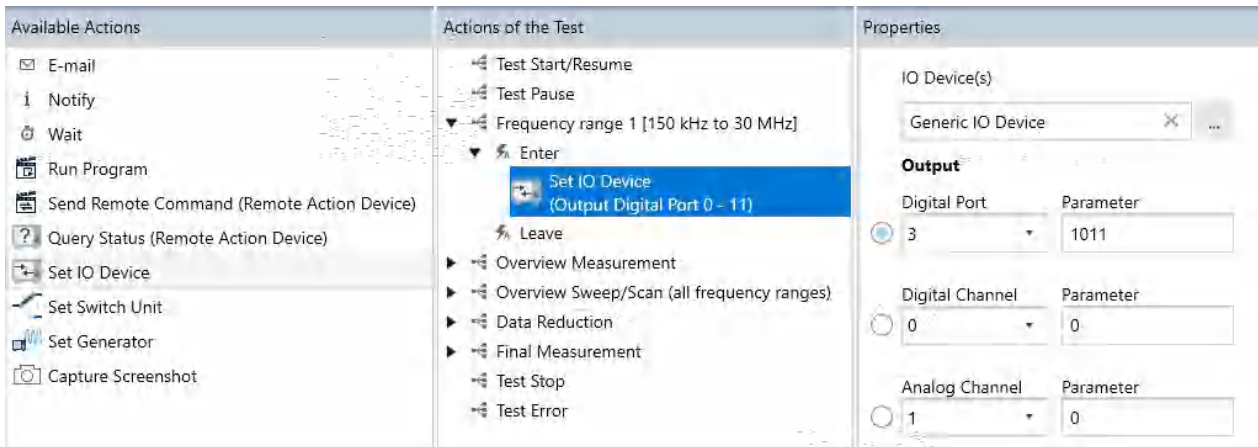

Figure 4-91: Action "Set IO Device" assigned to event "Enter" > "Frequency range 1"

"IO Device(s)" Selects an [IO Device](#) from the [Device List](#).

"Output" Selects one of the following output channels of the IO device, described in [Chapter 4.8.12.1, "Functional Check"](#), on page 419:

- "Digital Port"
- "Digital Channel"
- "Analog Channel"

Set Switch Unit

Allows using switch units in test actions.

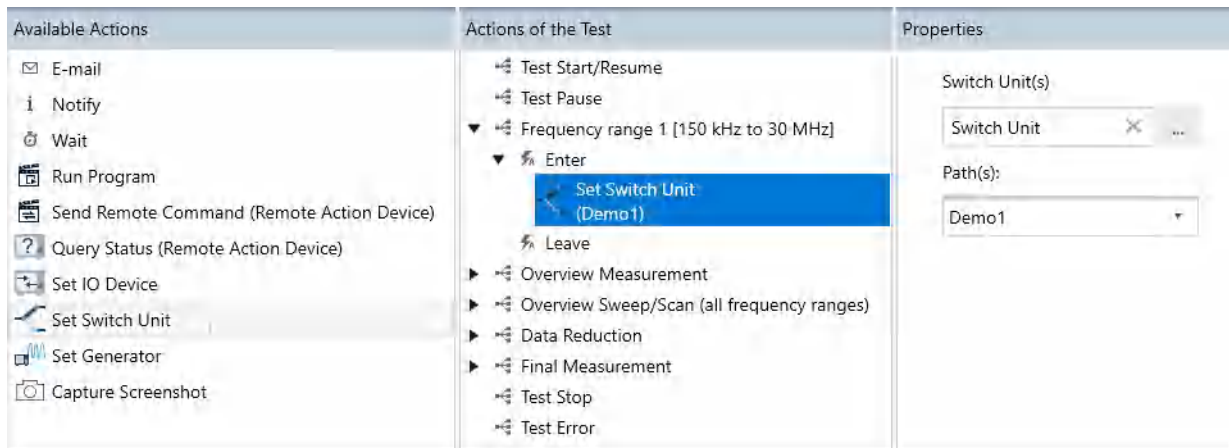

Figure 4-92: Action "Set Switch Unit" assigned to event "Enter" > "Frequency range 1"

"Switch Unit(s)" Selects a [Switch Unit](#) from the [Device List](#).

"Path(s)" Selects one of the following paths, described in [Switch Unit](#):

- "Demo1"
- "Demo2"
- "TC-RSE200"
- "TC-RSE140"
- "TC-RSE90"
- "TC-RSE60"
- "TS-PRE2_T_HP8000_LNA"
- "TS-PRE2_T_LP4500_LNA"
- "TS-PRE2_T_HP2000_LNA"
- "TS-PRE2_T_HP7000_LNA"
- "TS-PRE2_T_HP1000_LNA"
- "TS-PRE2_T_HP3000_LNA"
- "TS-PRE2_T_LP2000_LNA"

Set Generator

Allows using generators in test actions.

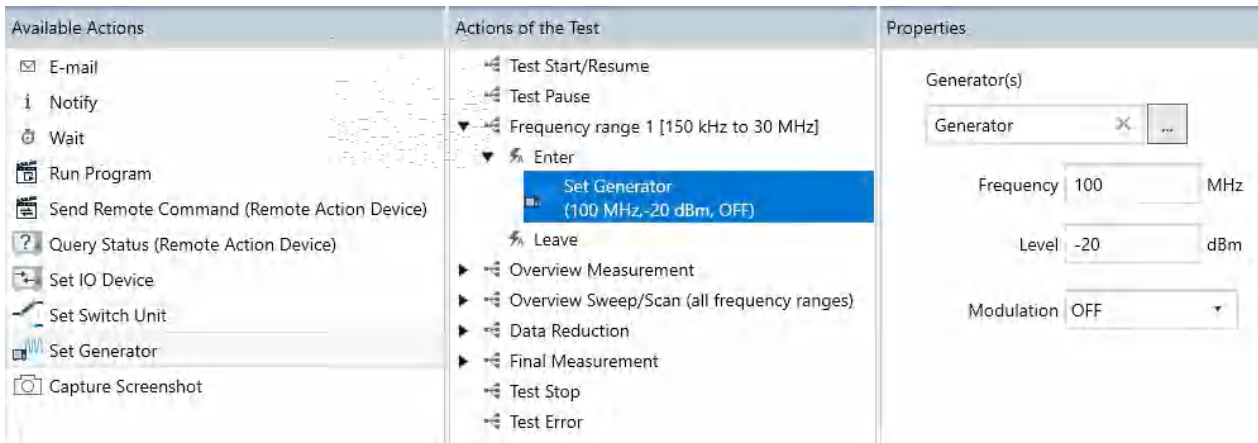

Figure 4-93: Action "Set Generator" assigned to event "Enter" > "Frequency range 1"

"Generator(s)" Selects a [Generator](#) from the [Device List](#).

"Frequency" Specifies the generator's frequency, in MHz.

"Level" Specifies the generator's level, in dBm.

"Modulation" Selects the generator's modulation, described in [Modulation List](#):

Capture Screenshot

Allows capturing a screenshot of the measurement graphics in the instrument's user interface.

This [action](#) is available only in the following test templates:

- In **EMI test templates**, you can capture a screenshot only at the end ("Leave") of the following test actions:
 - "Overview Sweep/Scan (all frequency ranges)"
 - "Zoom Measurement"
 - "Final Measurement"

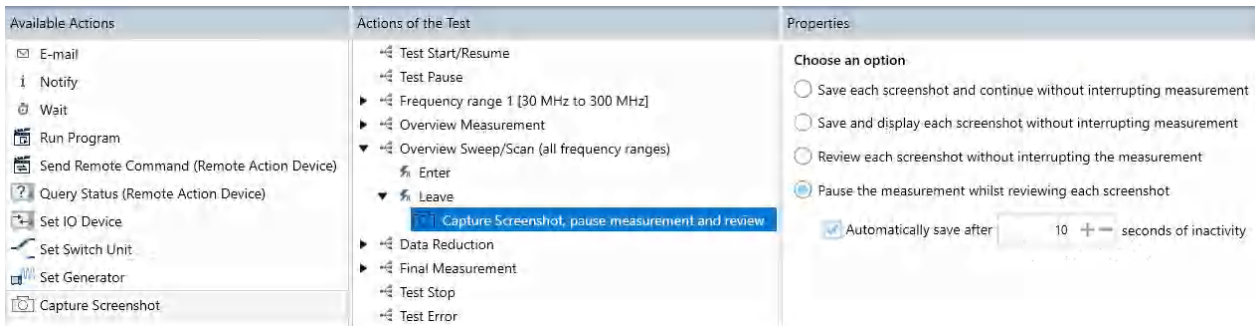

Figure 4-94: EMI test action "Capture Screenshot" assigned to event "Leave" > "Overview Sweep/Scan"

- In **EUT Monitoring templates**, you can capture a screenshot only, if the following conditions are all met:
 - The monitoring device, for example, a typical oscilloscope, supports this feature
 - You have assigned "Capture Screenshot" to an "On NoGo" event, hence when a **Measurement** violates the **NoGo** condition

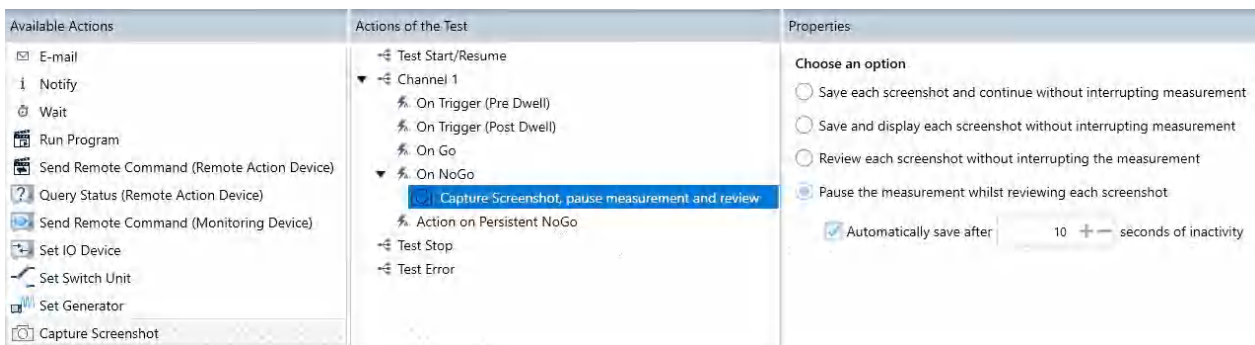

Figure 4-95: EUT monitoring action "Capture Screenshot" assigned to event "On NoGo"

The "Properties" tab provides the following options for handling the screenshots:

- "Save each screenshot and continue without interrupting measurement"
Saves a screenshot file in the background and continues the measurement without interruption.
- "Save and display each screenshot without interrupting measurement"
Saves a screenshot file and also displays it, while continuing the measurement without interruption.
- "Review each screenshot without interrupting the measurement"
Displays a screenshot without saving it, while continuing the measurement without interruption.
- "Pause each measurement whilst reviewing each screenshot"
Displays a screenshot without saving it, and also pauses the measurement. You can enable automatic saving of the screenshot after a specified number of seconds of inactivity.

4.5.3 Test Templates for EMS tests

This chapter describes how to configure test templates for various EMS tests. This configuration is done by selecting the test method, leveling the power and specifying the settings for one or more frequency ranges. Each frequency range requires a **referenced hardware setup** that must be configured in advance.



- For information on how to set up the hardware for these tests, see [Chapter 4.7.3, "Hardware setups for EMS tests"](#), on page 347.
- For information on how to execute these tests, see [Chapter 7.3, "EMS tests"](#), on page 597.

Access: "Home" > "Test Templates" > "Create: Template" > "EMS - ..."

As shown in [Figure 4-30](#), the available **EMS** test template types are:

- Bulk Current Injection (conducted)
- CDN / EM-Clamp (conducted)
- Antenna Port (conducted)
- Anechoic Chamber (radiated)
- TEM Waveguides (radiated)
- Reverberation Chamber (radiated)

When you create an EMS test template, R&S ELEKTRA starts with a test template dialog as in [Figure 4-96](#). Initially, it looks the same for all types of EMS test templates. The difference with the individual EMS test template types is: each type allows using (opening or creating) only its specific type of [hardware setup](#).

The following chapters describe these EMS test template types jointly, although the test templates feature some differences depending on their type. The relevant differences are mentioned in the descriptions, while the different EMS hardware setups are handled in individual chapters:

- [EMS hardware setup for bulk current injection](#)
- [EMS hardware setup for CDN / EM clamp](#)
- [EMS hardware setup for Antenna Port](#)
- [EMS hardware setup for anechoic chamber](#)
- [EMS hardware setup for TEM waveguides](#)
- [EMS hardware setup for reverberation chamber](#)

When you create an EMS test template, the software displays the following dialog. It consists of general settings (1), a measurement flow (2), flow details (3-5) that include a frequency range list (6-20) and additional test settings (21-24).

The screenshot shows the configuration interface for a Bulk Current Injection test template. The interface is organized into several sections, each with a numbered callout:

- 1**: General Settings (enables Golden Template)
- 2**: Measurement Flow
- 3**: Flow Details - Overview Measurement
- 4**: Measurement Settings / Accessory Settings
- 5**: Leveling Mode / Leveling Options / Power Level Limitation / Sensor Level Limitation
- 6**: Frequency Range List
- 7**: Active (checkbox)
- 8**: Frequency Range (e.g., 150 kHz - 80 MHz)
- 9**: Steps
- 10**: Test Level
- 11**: Dwell
- 12**: Modulation (OFF)
- 13**: Hardware Setup (Select Hardware)
- 14**: Frequency
- 15**: Test Level
- 16**: Device Settings
- 17**: Signal source icon
- 18**: Select Device
- 19**: View options (Use this view only, Calibration View, EUT Test View)
- 20**: System Monitoring - (Transducer Forward Power, Immunity Level)
- 21**: Test Information
- 22**: Actions
- 23**: Excluded Frequency Bands

The central diagram shows a signal path from a source through a coupler (FWD/REV) to a connection point (CP) and finally to the EUT. The interface also includes a table for the Frequency Range List with columns for Active, Frequency Range, Steps, Test Level, Dwell, Modulation, and Hardware Setup.

Figure 4-96: Default test template for EMS tests, here with one frequency range, only. Start with (13).

- 1 = Specifies the [General Settings](#) and (above) enables the [Golden Template](#) feature
- 2 = Specifies the [Measurement Flow](#)
- 3 = Specifies the [Flow Details](#)
- 4 = Toggles between the [Measurement Settings](#), the [Susceptibility Settings](#) (if available) and the [Accessory Settings](#)
- 5 = The "Measurement Settings" include the [Leveling Mode](#), the [Leveling Options](#), the [Power Level Limitation](#), the [Sensor Level Limitation](#), the [Specific Data](#), and the [Frequency Range List](#)
- 6 - 19 = >>> see [Frequency Range List](#)
- 6 = Adds frequency ranges (10, see [Add Frequency Range](#))
- 7 = [Activates](#) or deactivates measurements in each frequency range
- 8 = Specifies the [Frequency Range](#)
- 9 = Specifies the [Steps](#)
- 10 = Specifies the [Test Level](#)
- 11 = Specifies the [Dwell Time](#)
- 12 = Specifies the [Modulation](#)
- 13 = Selects the [Hardware Setup](#) (R&S ELEKTRA allows selecting only the correct type of hardware setups, here: for BCI EMS tests)
- 14 = Specifies the [FREQUENCY](#) settings
- 15 = Specifies the [TEST LEVEL](#) settings
- 16 = Specifies the [DEVICE SETTINGS](#)

- 17 = Diagram of the hardware setup selected at (13), with the option to select devices (18)
- 18 = The [Select Device](#) field
- 19 = Toggles between [Calibration View](#) and [EUT Test View](#) and optionally locks one of these views
- 20 = Specifies the [System Monitoring](#)
- 21 = Specifies [Test Information](#)
- 22 = Specifies [Actions](#)
- 23 = Specifies [Excluded Frequency Bands](#)

Antenna Port

The antenna-port test template is a subset of the EMS test templates. Offering a new device schema, it also differs slightly from the standard template shown in [Figure 4-96](#). In addition to the tabs above, you can also configure the "Specific Data" ([Specific Data](#)) and "Generators Settings" ([Generators Settings](#)) tabs.

See also [EMS - Antenna Port \(conducted\)](#) and [Antenna Port](#).

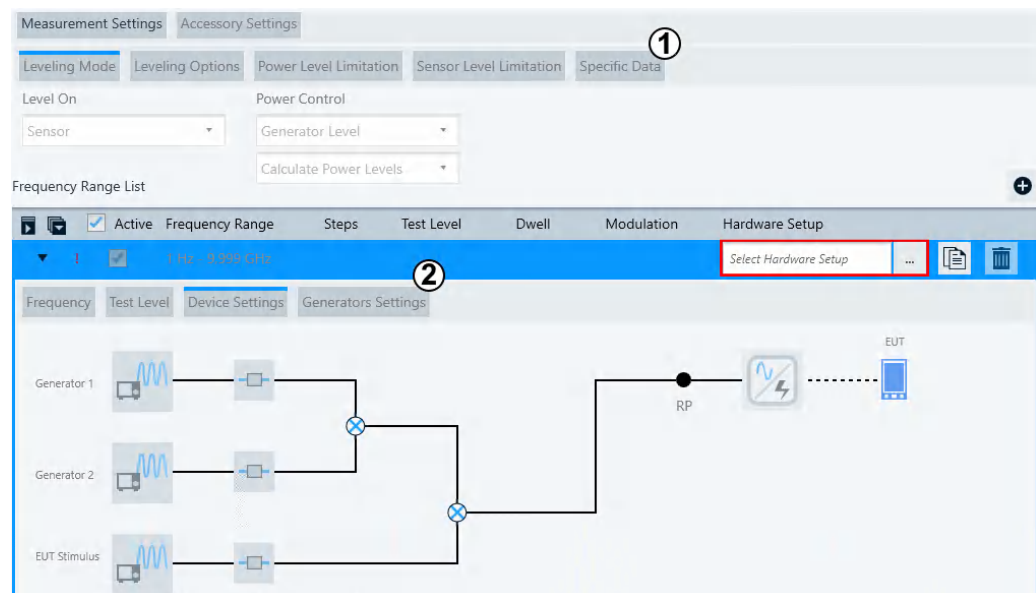

- 1 = Specifies the [Specific Data](#)
- 2 = Specifies the [Generators Settings](#)
- RP = Reference point



Select "Hardware Setup" first

Selecting a [Hardware Setup](#) is a prerequisite for getting access to all other settings in the test template dialog.



To create additional frequency ranges, select [Add Frequency Range](#).



Minimize frequency ranges

For best access to all frequency ranges within a limited display area, each of the frequency ranges can be minimized like the first frequency range in this example:

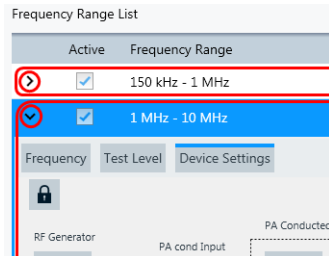

Or use the scrollbar, to shift the frequency range that you want to edit into the display area.

• General Settings	246
• Measurement Flow	257
• Flow Details	258
• System Monitoring	294
• Additional Sensor Channels	303
• Test Information	304
• Actions	305
• Excluded Frequency Bands	307

4.5.3.1 General Settings

▼ General Settings

This section describes the dialogs with general settings that are valid for the whole frequency range.

Golden Template	247
Setup	249
L EMS Application	249
L Commercial (IEC)	250
L System Verification	250
L Automotive / MIL-STD	250
L Antenna Port	251
L Reverberation Methods	252
L Test Method	252
L Amplifier Test	252
L Default name for amplifier gain table	253
L Compression Point at	253
L EUT Check	253
L EUT Qualification	253
L EUT Susceptibility	253
L Field Uniformity	254
L Default name for reference calibration table	254
L Reference Calibration	254
L Default name for reference calibration table	255
L Loaded Chamber	255

L Unloaded Chamber.....	255
L Test Standard.....	255
L EUT Monitoring Template.....	255
L Overwrite Results in Interactive Measurement.....	255
L Separate measurement flow for each antenna.....	256
Graphics Settings.....	256
Report.....	256
L Default Report Template.....	256
L External Report template - Main.....	256
L External Report template - Sub.....	257

Golden Template

Not available in [Test Templates for calibration measurements](#) and [EUT Monitoring templates](#).

Enabling this feature allows importing the same ("golden") test template and its referenced subitems into a different installation of R&S ELEKTRA. For example, when you [Export](#) a golden template and [Import](#) it at other [test sites](#) (which can be different test chambers), you can import it including contained limit lines and frequency lists. This import treats the golden template as the reference and updates the local data from the golden template's data. Hence, importing a golden template by default overwrites existing subitems, like limit lines, and consequently helps to reduce efforts in test template maintenance.

Labeling golden templates

- In the list of [Test Templates](#), R&S ELEKTRA highlights the name of each "Golden Template" with a yellow dot:

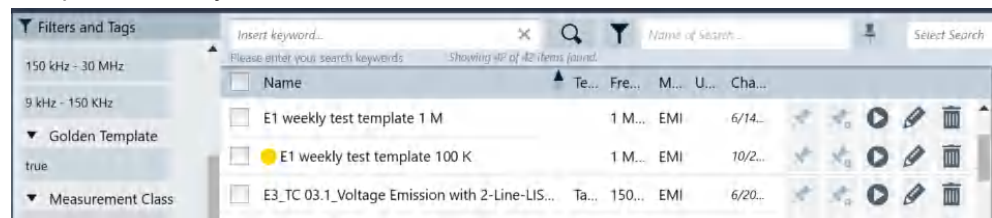

Figure 4-97: Yellow dot highlights a Golden Template

Rules for import of test templates

- By default, the [Import](#) of a normal test template does not overwrite an existing test template with the same name, because local data in the importing client is the reference.
- When you import a "Golden Template", by default it overwrites an existing test template with the same name, because the imported "Golden Template" is the reference, and not the local data. This rule applies also to data that the test template refers to, like limit lines. However, you can still select that the import creates an additional test template with a modified name, or skip the import.

Use cases for distributing test templates without or with central Database:

- *Without* a central database, you can distribute a "Golden Template" via [Export](#) and [Import](#).

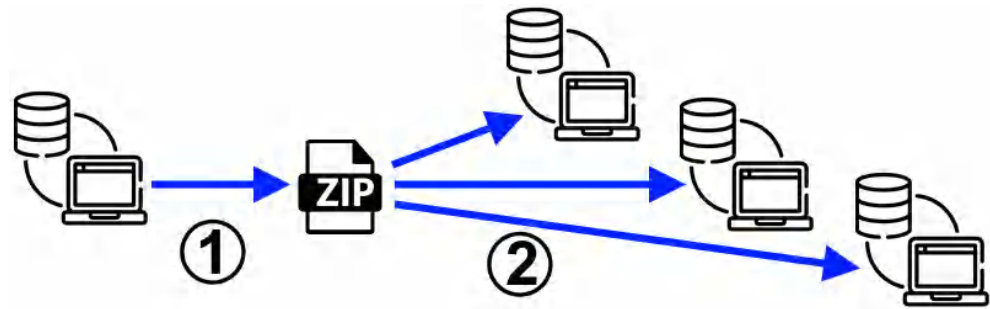

Figure 4-98: Distribution of test templates to independent instances of R&S ELEKTRA

- 1 = Export from original source
- ZIP = The compressed export file
- 2 = Import to arbitrary clients

- With a central database, all test templates, including each "Golden Template", are immediately available to all remotely connected instances.

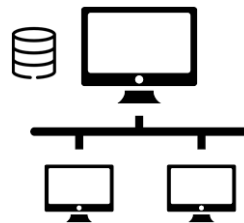

Figure 4-99: In a setup with central database, all instances use the same test templates

- Top = Central database
- Below = Connected remote clients

Test sites sharing a "Golden Template"

- The "Test Site" parameter, which you can set independently in each hardware setup, can differentiate similar hardware setups despite identical names:

<input type="checkbox"/> Name	<input type="checkbox"/> Test Site	Frequency Range	Meas
<input type="checkbox"/> BCI EN 61000-4-6	A	150 kHz - 80 MHz	EMS
<input type="checkbox"/> BCI EN 61000-4-6	B	150 kHz - 80 MHz	EMS
<input type="checkbox"/> BCI EN 61000-4-6	C	150 kHz - 80 MHz	EMS

Figure 4-100: Hardware setups can have the same name at a different Test Site

Using identical hardware setup names but different test sites allows referencing different hardware setups in the same "Golden Template", when you use this template at different test sites. When R&S ELEKTRA loads a test template, it automatically loads the hardware setup with the name that the test template specifies, having a matching test site name. Hence, use a "Golden Template" for referencing hardware setups that have the same name but are specified for different test sites, and therefore have different entries in the "Test Site" column.

During the [Import](#) of a "Golden Template", the software updates also the limit lines and frequency lists in the importing client. If a limit line or frequency list with the same name exists, the imported data overwrites it. Hence, the software updates the complete measurement context information without requiring user interaction.

Setup

Specifies the following settings for configuring an EMS test according to the applicable standard and test method:

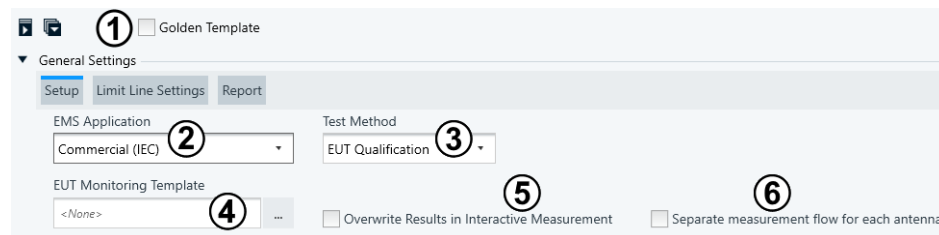

Figure 4-101: General settings in EMS test templates

- 1 = Enables or disables the [Golden Template](#)
- 2 = [EMS Application](#) selects the [EMC standards](#) for the setup of this EMS test template
- 3 = Selects the [Test Method](#)
- 4 = Optionally selects an [EUT Monitoring Template](#)
- 5 = Enables or disables [Overwrite Results in Interactive Measurement](#)
- 6 = Enables or disables [Separate measurement flow for each antenna](#)

EMS Application ← Setup

Note: In R&S ELEKTRA versions before 5.00, "EMS Application" was called "EMC Standard". Only the name has changed for better clarity, the function remains the same.

Depending on the selected EMS test template ([Figure 4-30](#)), different items are available for selection in the "EMS Application" field:

- In the following EMS test templates...
 - "Bulk Current Injection"
 - "CDN / EM-Clamp"
 - "Anechoic Chamber"
 - "TEM Waveguides"

...the selectable EMS applications are:

 - [Commercial \(IEC\)](#)
 - [System Verification](#)
 - [Automotive / MIL-STD](#)
- In "Antenna Port", the only available EMS application is [Antenna Port](#)
- In "Reverberation Chamber", the only available EMS application is [Reverberation Methods](#)

The selection of the "EMS Application" defines, which leveling methods (test level generation and level limitation) are available in the EMS test template dialog.

See also [EMC test standard](#).

Note: Some important settings like the [Sensor Level Conversion Impedance](#) in the section [Leveling Options](#) depend on the selection of the "EMS Application".

For "Commercial (IEC)", the sensor-level conversion impedance is fixed at 150 Ω for conducted measurements and fixed at 50 Ω for radiated measurements.

Commercial (IEC) ← EMS Application ← Setup

Note: In R&S ELEKTRA versions before 5.00, "Commercial (IEC)" was called "EN 61000-4-x". Only the name has changed for better clarity, the function remains the same.

This mode serves for tests according to the European "EN 61000-4-..." standards for EMC or the corresponding international "IEC 61000-4-..." standards.

It specifies several settings, for example:

Table 4-6: EMS test template parameters according to the standard EN 61000-4-6

Parameter	Setting
Frequency Range	150 kHz to 80 MHz
Frequency Step Size	1 % logarithmic
Level unit	V
Test Level	3 V, 10 V, user-defined
Modulation	AM 80 %, 1 kHz
Dwell Time	1 s
Leveling Mode	Substitution Method, Modulation OFF during Leveling
Test level detector	Carrier, see Level Conservation for Modulation
Sensor Level Conversion Impedance	For radiated measurements: fixed at 50 Ω For conducted measurements: fixed at 150 Ω (except for "Reference Calibration": 50 Ω)
Power Control	Forward Power
Leveling tolerance	± 0.2 dB (recommended)

System Verification ← EMS Application ← Setup

This mode serves for verifying the performance of your test system at a constant power level and specifies several settings for this purpose, for example:

- Sets the [Leveling Mode > Level On](#) to "Transducer Power", per default.
- Sets the [Sensor Level Conversion Impedance](#) default value in the section [Leveling Options](#) to 50 Ω for both conducted and radiated measurements, but leaves this setting open for editing (other than in [Commercial \(IEC\)](#)).
- Sets the [Test Level](#) default value to 10 W.

Automotive / MIL-STD ← EMS Application ← Setup

Available only, if you have activated the [license](#) for "ELEMS-AMEX", which requires that a [dongle](#) with this license is connected.

This mode serves for tests according to the immunity sections of the following standards:

- "ISO 11451", "ISO 11452" and related automotive OEM standards
- "MIL-STD 461 F/G" (sections for narrowband EMS testing, no transmitter tests), and related MIL standards

Selecting "Automotive / MIL-STD" enables the following options:

- [Power Relation](#) in the [Leveling Mode > Level On](#) dialog
- [Use Modulation sequence](#) in the [Accessory Settings](#)

- [Level Profile](#) in the [Frequency Range List](#)
- [Modulation List](#) in the [Frequency Range List](#)
- [User Evaluation](#) and "Measurement Extension" in the [System Monitoring](#)
- In EMS test templates for conducted hardware setups ("Bulk Current Injection" and "CDN / EM-Clamp"), it also enables the option [By Power Column of Ref. Calibration Table](#) in the [Power Level Limitation](#)

It specifies several settings, for example:

Table 4-7: Default EMS test template settings for Automotive / MIL-STD

Parameter	Setting
Frequency Range	150 kHz to 80 MHz
Frequency Step Size	1 % logarithmic
Level unit	A
Test Level	100 mA (conducted test templates) 10 V/m (radiated test templates)
Modulation	OFF
Dwell Time	1 s
Leveling Options	Modulation ON during Leveling Leveling with modulation ON requires an appropriate power meter that can measure the modulated signal.
Test level detector	Peak, see Level Conservation for Modulation
Power Control	Forward Power
Leveling tolerance	± 0.2 dB (recommended)

Antenna Port ← EMS Application ← Setup

Available only and exclusively, if the "Antenna Port" EMS test template is selected, see [Test Templates for EMS tests](#).

This mode serves for tests according to the conducted susceptibility of the following MIL-STD-461E/F/G standards:

- CS103 - antenna port intermodulation test, 10 kHz to 10 GHz
Tests the susceptibility of the EUT against the presence of intermodulation products possibly caused by undesired response at the EUT antenna input terminals. This test combines two out-of-band signals, sends them to the antenna port of the receiver and monitors the receiver for undesired response. One of the out-of-band signals is modulated with modulation expected by the receiver while the other is a signal in continuous wave.
In R&S ELEKTRA, use "Generator 1" for the modulated signals and "Generator 2" for the continuous-wave signals. See also [EMS - Antenna Port \(conducted\)](#).
If the receiver cannot provide an indication of interference without the presence of a receive signal, introduce a third signal using the "EUT Stimulus" generator in the template.
- CS104 - antenna port rejection of undesired signals test, 30 Hz to 20 GHz
Tests the susceptibility of the EUT against the presence of spurious responses possibly caused by undesired response at the EUT antenna input terminals. You can conduct the test with one or two signal sources.

- For tests using a single signal source, the test modulates the signal with modulation expected by the receiver. Then it sweeps the modulated signal over an appropriate frequency range while monitoring the receiver for unintended response.
- For tests using dual signal sources, one of the signals is modulated, typically with modulation very close to the sensitivity of the receiver. The second signal is unmodulated and is swept over an appropriate frequency range while the receiver is monitored for any change in response to the signal at its antenna port.

In R&S ELEKTRA, use "Generator 1" for the modulated signal. If there are two signal sources, define the level of "EUT Stimulus" to a level close to the EUT sensitivity.

- **CS105 - antenna port cross-modulation test, 30 Hz to 20 GHz**
Tests the susceptibility of the EUT against undesired response due to cross-modulation. Cross-modulation is the transfer of modulation applied to an out-of-band signal to an unmodulated signal at the receiver's tuned frequency. The test modulates an out-of-band signal with the modulation expected by the receiver, then sweeps the modulated signal over an appropriate frequency range while monitoring the receiver for unintended response. In R&S ELEKTRA, use "Generator 1" for the modulated signal and set "EUT Stimulus" to a level close to the EUT's sensitivity.

Reverberation Methods ← EMS Application ← Setup

Available only and exclusively, if the "Reverberation Chamber" EMS test template is selected, which requires an activated "ELEMS-RVC" [license](#).

The reverberation methods are:

- [EUT Check](#)
- [Loaded Chamber](#)
- [Unloaded Chamber](#)

Note: Table names required for saving. To save a new or modified "Reverberation Chamber" EMS test template, the software requires that you have defined all necessary table names. These table name entries are a bit hidden in the [Data Evaluation](#) section for the test methods [EUT Check](#) and [Loaded Chamber / Unloaded Chamber](#).

Test Method ← Setup

Selects a test method for the selected [EMS Application](#), where not all test methods are available in each type of EMS test template:

- [Amplifier Test](#)
- [EUT Check](#)
- [EUT Qualification](#)
- [EUT Susceptibility](#)
- [Field Uniformity](#)
- [Reference Calibration](#)
- [Loaded Chamber](#)
- [Unloaded Chamber](#)

Amplifier Test ← Test Method ← Setup

Not available, if you have selected a test template of the type "Antenna Port" or "EMS - Reverberation Chamber".

Use this test method to measure the amplifier's 1-dB compression point, which is recorded in an [amplifier gain table](#) across a given frequency range. The hardware setup is not relevant, as devices that follow after the amplifier are not involved in this measurement.

Therefore, R&S ELEKTRA fixes the [Leveling Mode > Level On](#) at the setting "Transducer Power".

Default name for amplifier gain table ← **Amplifier Test** ← **Test Method** ← **Setup**

Use this input field to specify a default name for the amplifier gain table, which results from the amplifier test.

Compression Point at ← **Amplifier Test** ← **Test Method** ← **Setup**

Specifies the compression point, at which the measured level starts diverging from the actual level by more than a give difference in dB. Typically, use the default value of 1 dB.

EUT Check ← **Test Method** ← **Setup**

Available only, if you have selected a test template of the type "EMS - Reverberation Chamber".

Use this test method to find out, if the loading of the chamber due to your EUT is between the [Unloaded Chamber](#) and the fully [Loaded Chamber](#). Perform this check for each new EUT.

EUT Qualification ← **Test Method** ← **Setup**

Typically, the "EUT Qualification" test method is used for type approval testing at a fixed test level. R&S ELEKTRA sets it as the default test method, which determines several other default settings in the user interface, for example the "Leveling Mode".

EUT Susceptibility ← **Test Method** ← **Setup**

Available only, if you have activated the [license](#) for "ELEMS-S", which requires that a [dongle](#) with this license is connected.

Selecting this test method enables editing the susceptibility settings, see "[Susceptibility Settings](#)" on page 268.

Typically, the "EUT Susceptibility" test method is used during the EUT development process. Other than [EUT Qualification](#), it allows increasing and decreasing the test level in **steps** while monitoring, if the EUT shows a failure state. These failure states can be detected in a feedback loop via automated EUT monitoring or by manual interaction in the "NoGo" panel, see [EUT Failure Mode Analysis](#). Hence, the "EUT Susceptibility" method helps estimating the security budget in the EUT's susceptibility to the influence of interferers.

During the test, R&S ELEKTRA performs a cycle at each frequency point: It sets the test level to the nominal value specified in the [Susceptibility Settings](#) > "Options". It exposes the EUT to this level during the [dwell time](#). If an EUT failure state is detected, it decreases the test level in steps as long the EUT failure persists. The software stops this process of decreasing the test level, when the failure disappears or when the test level reaches the noise limit. In this case, the EUT is recorded as having an irreversible "NoGo" failure at this frequency point and at the given loop parameters. If during the decreasing of the test level the EUT stops having a failure, the test level is increased again, until the failure reappears or the target level is reached. If the EUT has no failure or a failure at a specific test level, these parameters are recorded. The software proceeds with the next step in the loop or with the next frequency point.

Field Uniformity ← Test Method ← Setup

Available only for radiated tests in the test template type "EMS - Anechoic Chamber", see [Figure 4-30](#).

Use the "Field Uniformity" test method for radiated test setups to ensure that the EUT is exposed to a homogenous immunity field of appropriate power level, according to EN 61000-4-3. The result is a [Reference Calibration](#) table for the EUT test.

R&S ELEKTRA supports the constant power method according to EN61000-4-3. Hence, you have two options for controlling the power level across the frequency range:

- Let a power sensor control the level: [Level On](#) > "Sensor"
- Let the power values in a column of a [Reference Calibration](#) table control the level: [Level On](#) > "Transducer Power"

The third "Level On" option, which is the "Substitution Method", is not useful for "Field Uniformity" measurements.

Use your test setup in a field uniformity measurement to perform a multi-point measurement, as described in [Chapter 8.6, "Field uniformity evaluation"](#), on page 657.

"Default name for reference calibration table" Only available (and mandatory), if the [Test Method](#) is "Field Uniformity". In this field, you must specify a name for the reference calibration table mentioned above.

Default name for reference calibration table ← Field Uniformity ← Test Method ← Setup

Use this input field to specify a default name for the reference calibration table, which results from the field uniformity measurement. The software uses this name for the reference calibration table that it creates when you save the completed test.

Reference Calibration ← Test Method ← Setup

Use this test method for calibrating a transducer, for example a CDN / EM coupling clamp (conducted tests) or an antenna (field strength in radiated tests). The calibration measurement evaluates the relation between the immunity test level and the transducer input power. This relation is saved in a [reference calibration table](#) and is used in a [substitution measurement](#).

Calibration setups and procedures are described in [Chapter 8.2, "Transducer calibration"](#), on page 652, and [Chapter 8.3, "Reference calibration of a CDN"](#), on page 652.

Default name for reference calibration table ← Reference Calibration ← Test Method ← Setup

Use this input field to specify a default name for the reference calibration table, which results from the calibration measurement. The software uses this name for the reference calibration table that it creates when you save the completed test.

Loaded Chamber ← Test Method ← Setup

Available only, if you have selected a test template of the type "EMS - Reverberation Chamber".

Use this test method for validating the reverberation chamber filled with a maximum load of absorber material. It simulates an EUT that fully loads the reverberation chamber. The [EUT Check](#), performed for each new EUT, must show a loading between the empty chamber and the fully loaded chamber.

See "[Chamber Loading Factor](#)" on page 504.

Unloaded Chamber ← Test Method ← Setup

Available only, if you have selected a test template of the type "EMS - Reverberation Chamber".

Use this test method for calibrating the unloaded reverberation chamber, hence without absorber material inside. It simulates an EUT that does not load the reverberation chamber. The [EUT Check](#), performed for each new EUT, must show a loading between the empty chamber and the fully loaded chamber.

See "[Chamber Loading Factor](#)" on page 504.

Test Standard ← Setup

Available only, if the following conditions are all met:

- You have selected a test template of the type "EMS - Reverberation Chamber"
- In the test template, you have selected one of the following [Test Method](#) settings:
 - [EUT Check](#)
 - [Loaded Chamber](#)
 - [Unloaded Chamber](#)

The following test standards are available:

- "EN 61000-4-21", which refers to EN IEC 61000-4-21:2011
- "ISO 11452-11", which refers to ISO 11452-11:2010

See also "[Power Relation](#)" on page 260.

EUT Monitoring Template ← Setup

Optionally select a default [template](#) for EUT monitoring in [EMS tests](#).

Not available, if you have selected one of the following [Test Method](#) settings:

- [Amplifier Test](#)
- [EUT Check](#)
- [Field Uniformity](#)
- [Reference Calibration](#)
- [Loaded Chamber](#)
- [Unloaded Chamber](#)

Overwrite Results in Interactive Measurement ← Setup

Available only, if [Test Method](#) is "EUT Qualification" or "EUT Susceptibility".

This parameter is relevant for [interactive measurements](#): If checked, only one result row is stored per test frequency in the "Final Results" table. Hence, R&S ELEKTRA overwrites the test levels in the results table with the most recently measured values. If unchecked, the level values are not overwritten but constantly added to the table.

Separate measurement flow for each antenna ← Setup

Available only, if [Test Method](#) is "EUT Qualification", "EUT Susceptibility" or "Reference Calibration".

Prevents combining all measurements with different antennas into a common measurement flow. Instead, R&S ELEKTRA runs separate measurements for each antenna.

Typically, use this mode if you perform tests in a shielded chamber that allows using only one test antenna at a time. In this scenario, execute all accessory loops with the current test antenna before you install the next test antenna.

Graphics Settings

Selects an arbitrary number of [Limit Lines](#) to be shown additionally in the test charts that are based on this test template. The limit lines in this table are not used for any test evaluation, but for display only.

The "**Add a limit line table**" button  allows selecting limit line tables to be added to the list of limit lines.

Optionally, enter an "Offset" to shift the limit line up ("+", positive dB values) or down ("-", negative dB values).

The "Delete the Table" button  removes a selected limit line table from the list.

"**Auto-connect adjacent frequency range sections in a trace**" is relevant only, if the test template has more than one frequency range. Use the checkbox to decide, how R&S ELEKTRA draws the trace segments between adjacent frequency ranges. For more details, refer to "[Graphics Settings](#)" on page 154.

Typical use cases are measurements according to AIM standards with "[DM+ARB Modulation](#)".

Report

Optionally allows preselecting standard (internal) or customized (external) report templates.

Default Report Template ← Report

Optionally selects an existing (predefined) internal [standard report template](#) to be used as a default for each test based on this test template.



Note that selecting default internal report templates at [Administration > Report > Reporting Templates > Internal](#) is relevant also for tests that are saved without containing a report template: If such a test is included into automated report generation in a [Test Plan](#), R&S ELEKTRA uses the internal "Standard Report Template" selected here as a default for this test category.

External Report template - Main ← Report

Available only, if you have installed the [license](#) "ELEM-REP" for report customization.

Optionally selects an existing customized XML-based text template to be used as a default main report template for each test based on this test template.

The  button optionally selects an existing customized XML-based text template (for example, an MS Word file) from your local computer or network. It is used as a default main report for each test based on this test template.

When you have selected a file, the  button allows viewing it. The  button opens its source location, hence the directory that contains this file.



The  button compares, if this report template differs from the external report template file in its original source location. If this check reveals that the external file was updated, a "Report Status" message comes up and suggests, that you update the file by clicking "OK". If you do not want to update it, click "Cancel".

Note that selecting default external main report templates at [Administration > Report > Reporting Templates > External](#) is relevant also for tests that are saved without containing a report template: If such a test is included into automated report generation in a [Test Plan](#), R&S ELEKTRA uses the external "Main" report template selected here as a default for this test category.

External Report template - Sub... ← Report

Available only, if you have installed the [license](#) "ELEM-REP" for report customization.

The  button optionally selects an existing customized XML-based text template (for example, an MS Word file) from your local computer or network. It is used as a default report subtemplate for each test based on this test template.

When you have selected a file, the  button allows viewing it. The  button opens its source location, hence the directory that contains this file.

The  button compares, if this report template differs from the external report template file in its original source location. If this check reveals that the external file was updated, a "Report Status" message comes up and suggests, that you update the file by clicking "OK". If you do not want to update it, click "Cancel".

Note that selecting default external subreport templates at [Administration > Report > External](#) is relevant also for tests that are saved without containing a report template: If such a test is included into automated report generation in a [Test Plan](#), R&S ELEKTRA uses the external "Sub..." report template selected here as a default for this test category.

4.5.3.2 Measurement Flow

▼ Measurement Flow

This section is available only, if the following conditions are all met:

- You have activated the [license](#) for "ELEM-S", which requires that a [dongle](#) with this license is connected
- You have selected "EUT Qualification", "EUT Susceptibility" or "Field Uniformity" as the [Test Method](#)

The "Measurement Flow" serves for enhanced automation of EMS tests. It consists of the "Overview Measurement" and the optional "Data Evaluation":

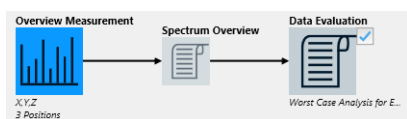

Figure 4-102: Interactive diagram of the measurement flow

The "Overview Measurement" is the basis for each EMS test. It is performed according to the configuration settings described in the following chapters.

For the optional "Data Evaluation", refer to "Data Evaluation" on page 272.

4.5.3.3 Flow Details

▼ Flow Details - ...

The flow details determine all hardware-related settings for your EMS tests. R&S ELEKTRA classifies these settings in groups as follows:

- [Measurement Settings](#)..... 258
- [Susceptibility Settings](#)..... 268
- [Accessory Settings](#)..... 269
- [Data Evaluation](#)..... 272
- [Frequency Range List](#)..... 274

Measurement Settings

To see the "Measurement Settings" dialog, make sure to select "Overview Measurement" in the [Measurement Flow](#) dialog (if available).

The measurement settings comprise the following functions:

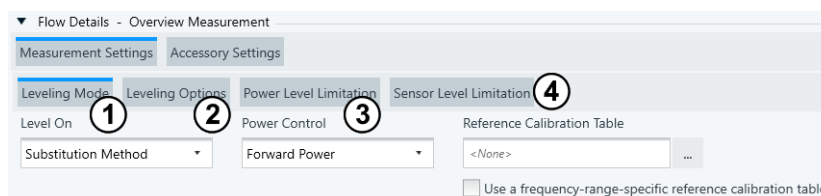

Figure 4-103: Measurement settings in EMS test templates

- 1 = The [Leveling Mode](#) includes the method, by which the test level is controlled ("Level On" on page 260), the [Power Control](#) settings and a [Reference Calibration Table](#)
- 2 = [Leveling Options](#)
- 3 = [Power Level Limitation](#)
- 4 = [Sensor Level Limitation](#)

Leveling Mode	259
L Level On	260
L Power Relation	260
L Sensor	261
L Substitution Method	261
L Transducer Power	261
L Power Control	261
L Forward Power	261
L Generator Level	262

L Calculate Power Levels.....	262
L Measure Power Levels.....	262
L Net Power.....	262
L P _{mid} Power.....	262
L Reference Calibration Table.....	263
L Use a frequency-range-specific reference calibration table.....	263
L Calculate Transducer Power [W] by.....	263
L Check.....	264
L Evaluate Keyword.....	264
L Attenuation Table.....	264
L Transducer Correction.....	264
L Avg Norm Max E-Field.....	265
L Chamber Loading Factor.....	265
Leveling Options.....	265
L Level Conservation for Modulation.....	265
L Power Level Conversion Impedance.....	266
L Sensor Level Conversion Impedance.....	266
L Modulation ON during Leveling.....	266
L Check Power for first modulation only.....	266
Power Level Limitation.....	266
L By Value.....	267
L By Limit Line.....	267
L By Power Column of Ref. Calibration Table.....	267
Sensor Level Limitation.....	267
L By Value.....	268
L By Limit Line.....	268
Specific Data.....	268
L Test Standard.....	268
L Frequency f ₀	268
L EUT Sensitivity.....	268
L Exclude Range f(Low).....	268
L Exclude Range f(High).....	268

Leveling Mode

Leveling Mode

Specifies parameters for generating and controlling the test level when running an EMS test.

The following default settings depend on the [Test Method](#):

- **Amplifier Test:** the "Leveling Mode" is **locked** to "Level On" = "**Transducer Power**" with "Power Control" = "Forward Power"
- **EUT Check:** the "Leveling Mode" is **locked** to "Level On" = "**Transducer Power**" with "Power Control" = "Forward Power"
- **EUT Qualification:** the "Leveling Mode" is set to "Level On" = "**Substitution Method**" with "Power Control" = "Forward Power" (both editable), and you must select a [Reference Calibration Table](#)
- **Field Uniformity** (only radiated, use constant field or constant power methods): the "Leveling Mode" is set to "Level On" = "**Sensor**" with "Power Control" = "Forward Power" (both editable)
- **Reference Calibration:**

- For **radiated** tests, you can use constant field or constant power methods. Per default, the "Leveling Mode" is set to "Level On" = "**Sensor**" with "Power Control" = "Forward Power" (both editable).
- For **conducted** tests, the "Leveling Mode" is set per default to "Level On" = "**Sensor**" and "Power Control" = "Forward Power" (both editable).
- **Loaded Chamber**: the "Leveling Mode" is **locked** to "Level On" = "**Transducer Power**" with "Power Control" = "Forward Power"
- **Unloaded Chamber**: the "Leveling Mode" is **locked** to "Level On" = "**Transducer Power**" with "Power Control" = "Forward Power"

Level On ← Leveling Mode

Selects one of the following test level measurement methods.

Power Relation ← Level On ← Leveling Mode

Available only, if *one* of the following conditions is met:

- Either the "Reverberation Chamber" EMS test template is selected, which requires an activated "ELEMS-RVC" [license](#)
- Or in a different EMS test template, except "Antenna Port", [EMS Application](#) is set to [Automotive / MIL-STD](#) and "[Test Method](#)" on page 252 is *not* set to "Amplifier Test"

Allows calculating the required power at the input of the transducer in relation to the target test level. You can specify the mathematical formula for this calculation in "[Calculate Transducer Power \[W\] by](#)" on page 263.

Typical use cases:

- In a "TEM Waveguide" EMS test template, this leveling method is useful, if your transducer is a [TEM Waveguide](#) that requires specifying a [Transducer Correction](#) table.
- In a "Reverberation Chamber" EMS test template, if the "[Test Method](#)" on page 252 is set to "EUT Qualification" or "EUT Susceptibility", the leveling method is locked to "Power Relation". Also the formula for the required chamber input power P_{Input} (in W) is fixed according to IEC 61000-4-21:

$$P_{Input} = TESTNOMLEV^2 / RVCEFIELD^2 / RVCCLF$$

- TESTNOMLEV = required field strength (in V/m) for the immunity test
- RVCEFIELD = $E_{Norm\ x,y,z}$ = "Avg Norm Max E-Field" = average of normalized E-field (in (V/m)/sqr(W)), obtained from the empty chamber validation and stored in a [Transducer Correction](#) table, see also [Avg Norm Max E-Field](#)
- RVCCLF = chamber loading factor (CLF), generated during [EUT Check](#) and stored in a [Chamber Loading Factor](#) table.

For the standard ISO 11452-11, the software uses the same equation, although the formula in the standard defines the chamber loading factor (CLF) inverse to IEC 61000-4-21:

$$P_{Input} = TESTNOMLEV^2 / RVCEFIELD^2 * F_{CLF}$$

Instead of RVCEFIELD, ISO 11452-11 uses here the empty chamber's gain G_{RC} , which is however identical to the averaged normalized E-Field from the "Avg Norm Max E-Field" table.

Note the difference in the definition of the chamber loading factor (CLF):

R&S ELEKTRA uses CLF as defined in IEC 61000-4-21. On the contrary,

ISO 11452-11 defines this factor inverse: $F_{CLF} = 1 / CLF$. The reverberation cham-

ber evaluation takes care of this difference: For ISO 11452-11 evaluation, the software outputs the CLF in the IEC 61000-4-21 format, which fits to the fixed equation.

Sensor ← Level On ← Leveling Mode

The test level (transduced power) is monitored with a sensor device, for example a power meter in a conducted measurement or a field probe in a radiated measurement.

This mode is not permitted for a test template of the type "EMS - CDN / EM-Clamp", because it does not contain a sensor.

Substitution Method ← Level On ← Leveling Mode

Note: For most test scenarios, this parameter is automatically set appropriately with your selection of the [EMS Application](#) and the [Test Method](#). We recommend not to change this setting, unless required for special needs.

The substitution method is the default EMS test in R&S ELEKTRA. In advance, it requires a reference calibration to determine, which forward power level is required at the transducer input to achieve the target test level at the transducer output. The result of this measurement is a frequency-dependent [Reference Calibration Table](#) that contains this relation between forward power and target level.

Once the table is available, R&S ELEKTRA can use it to calculate the required forward power into the transducer. If the target value differs from the stored test level, the leveling algorithm uses this deviation for a linear extrapolation of the power required to reach the target test level.

The RF generator level in the selected [Reference Calibration Table](#) serves as starting value for the leveling process.

If you set [Power Control](#) to [Generator Level](#), the leveling algorithm follows an interpolation of the values in the RF generator level column in the selected [Reference Calibration Table](#).

In the next step, the EUT "substitutes" the test level sensor that was previously used for calibration.

Note: In this mode, the software runs sensor measurements only, if you enable the "Sensor Level" channel in the [System Monitoring](#) dialog.

Transducer Power ← Level On ← Leveling Mode

The transducer input power is determined by measuring the FWD power.

For defining the target power level, use the [Test Level](#) tab in the [Frequency Range List](#) dialog.

Note: In this mode, the software runs sensor measurements only, if you enable the "Sensor Level" channel in the [System Monitoring](#) dialog.

Power Control ← Leveling Mode

Selects the method for controlling the power level.

Forward Power ← Power Control ← Leveling Mode

The "FWD Sensor" (power meter) defined in the currently used hardware setup delivers the measurement values for the leveling algorithm.

Generator Level ← Power Control ← Leveling Mode

Available only, if the [Leveling Mode](#) > [Level On](#) is set to "Power Relation" or "Sensor" or "Substitution Method".

If [Level On](#) = "Substitution Method" is selected, the "Generator Level" setting requires to specify a [Reference Calibration Table](#) (see also [Chapter 4.9.8, "Reference Calibration"](#), on page 505).

"Generator Level" provides access to the two following settings, to either let the software calculate the power levels, or to measure the levels with a power meter.

Calculate Power Levels ← Generator Level ← Power Control ← Leveling Mode

Use this feature, if no forward power meter is available, or if the modulated signal from the generator cannot be measured. In this case, the software generates test-level values without performing any leveling process. Instead, the leveling algorithm interpolates the values in the generator-level column of the selected [Reference Calibration Table](#) table. R&S ELEKTRA then calculates the currently effective forward power from these interpolated values, also considering amplifier parameters and known signal path attenuation.

Measure Power Levels ← Generator Level ← Power Control ← Leveling Mode

If this setting is selected together with the [Leveling Mode](#) is "Level On" = "Substitution Method", which requires a [Reference Calibration Table](#), then the software only measures the power. It does not perform leveling adjustment, even if the power deviates from the required level according to the reference calibration table.

Net Power ← Power Control ← Leveling Mode

Available only, if the [EMS Application](#) is set to [Automotive / MIL-STD](#).

You can save a test template with this selection only, if the following conditions are all met:

- The hardware setup (see [Device Settings](#)) contains a forward and reverse power meter, because power leveling is based on the measurement values delivered by these two power meters
- The [Reference Calibration Table](#) contains a column with "Net Power" values, hence you must have performed a reference calibration with "Power Control" = "Net Power"

For calculating the net power, R&S ELEKTRA uses the following formula with power values in watts:

$$P_{\text{net}} = P_{\text{fwd}} - P_{\text{rev}}$$

 P_{mid} Power ← Power Control ← Leveling Mode

Available only, if the following conditions are all met:

- The EMS test template is of the type "TEM Waveguides"
- The [EMS Application](#) is set to [Automotive / MIL-STD](#)

You can save a test template with this selection only, if the following conditions are all met:

- The hardware setup (see [Device Settings](#)) contains a forward, reverse and output power meter, because power leveling is based on the measurement values delivered by these three power meters

- The [Reference Calibration Table](#) contains a column with "P_{mid} Power" values, hence you must have performed a reference calibration with "Power Control" = "P_{mid} Power"

For calculating the P_{mid} power, R&S ELEKTRA uses the following formula with power values in watts:

$$P_{\text{mid}} = ((P_{\text{fwd}} - P_{\text{rev}}) + P_{\text{out}}) / 2$$

Reference Calibration Table ← Leveling Mode

If you set the software to generate a test level according to the [Leveling Mode](#) is "Level On" = "Substitution Method", R&S ELEKTRA uses a table containing the relation between test level and transducer / antenna input power. This table is called a [Reference Calibration table](#). It is the result of a previous reference calibration measurement. This measurement is an EMS test according to the "Test Method" [Reference Calibration](#), as described in [Chapter 8.3, "Reference calibration of a CDN"](#), on page 652.

The following conditions must all apply for the availability of a "Reference Calibration Table" selection in the "General Settings":

- ["Test Method"](#) on page 252 is "EUT Qualification"
- [Leveling Mode](#) is "Level On" = "Substitution Method"
- The option [Use a frequency-range-specific reference calibration table](#) is not checked

If you select a reference calibration table here, it is common to all frequency ranges. For individual tables, check the option "Use a frequency-range-specific reference calibration table".

Note: The reference calibration table must cover the whole width of all frequency ranges.

In radiated measurements, the table can contain information for both antenna polarizations.

Use a frequency-range-specific reference calibration table ← Reference Calibration Table ← Leveling Mode

With this [Leveling Mode](#) option checked, you cannot select a reference calibration table that is common to all frequency ranges. Instead, select individual reference calibration tables in the [Test Level](#) tab of each frequency range.

Calculate Transducer Power [W] by ← Leveling Mode

Available only, if the [Leveling Mode](#) is "Level On" = [Power Relation](#).

Defines a mathematical formula for calculating the transducer power depending on the nominal test level, which is defined by the variable *TESTNOMLEV* and its unit set in brackets.

- In EMS test templates other than "Reverberation Chamber":
The formula can reference also one attenuation table (CORRATT) and one transducer correction table (CORRTRD).
- In EMS test templates of the type "Reverberation Chamber":
The formula can reference also one "Avg Norm Max E-Field" table (RVCEFIELD) and one "Chamber Loading Factor" table (RVCCLF).

To define the formula, use the test parameters specified by the keywords in [Table 4-8](#). When you start typing in the formula field, R&S ELEKTRA offers keywords that match your entry. Or type a blank space to select from the full list of keywords.

Table 4-8: Parameters available for Power Relation

Keyword	Alternative units in keyword	Meaning, regarding the current frequency point
TESTNOM-LEV{V/m}	dBV/m, dB μ V/m, A/m, dB μ A/m, dBpT, MW, kW, W, mW, dBm, dBpW	Nominal (target) "Test Level"
IMPEDPWR	Ω (ohm)	Impedance value specified for conversion of power levels to voltage or current. See Leveling Options > "Power Level Conversion Impedance" on page 266.
CORRATT	-	Attenuation in dB Using "CORRATT" requires selecting a table in Attenuation Table .
CORTRD	-	Transducer correction in dB Using "CORTRD" requires selecting a table in Transducer Correction .
RVCEFIELD	V/m	Average of the normalized maximum E-field of the reverberation chamber, listed in an "Avg Norm Max E-Field" table. Using "RVCEFIELD" requires selecting a table in Avg Norm Max E-Field , which is a result of the RVC calibration process.
RVCCLF	-	Loading factor of the reverberation chamber, listed in a "Chamber Loading Factor" table. Using "RVCCLF" requires selecting a table in Chamber Loading Factor , which is a result of the RVC calibration process.

Use [IronPython mathematical syntax](#) in the formula, without the "math." prefix. For a broader overview, refer to the [Python tutorial](#).

Check ← Calculate Transducer Power [W] by ← Leveling Mode

For verifying the formula, "Check" calculates and displays its result it with "10" (V/m) as the nominal test level.

Evaluate Keyword ← Calculate Transducer Power [W] by ← Leveling Mode

Displays the current value of an individual parameter. To use this function, make sure to highlight exactly this parameter's keyword. Do not highlight more or less than the full keyword of a single parameter, including its unit in brackets.

Attenuation Table ← Calculate Transducer Power [W] by ← Leveling Mode

Not available in EMS test templates of the type "Reverberation Chamber".

Selects an [Attenuation](#) table, if your formula calls for it by using the keyword "CORRATT".

Transducer Correction ← Calculate Transducer Power [W] by ← Leveling Mode

Not available in EMS test templates of the type "Reverberation Chamber".

Selects a [Transducer Correction](#) table, if your formula calls for it by using the keyword "CORRTRD".

Avg Norm Max E-Field ← Calculate Transducer Power [W] by ← Leveling Mode

Available only, if the following conditions are all met:

- The EMS test template is of the type "Reverberation Chamber"
- The [Leveling Mode](#) is "Level On" = [Power Relation](#)
- The [Test Method](#) is "EUT Qualification" or "EUT Susceptibility"

Selects a [Transducer Correction](#) table of the type "Avg Norm Max E-Field", if your formula calls for it by using the keyword "RVCEFIELD". See also "[Power Relation](#)" on page 260.

Chamber Loading Factor ← Calculate Transducer Power [W] by ← Leveling Mode

Available only, if the following conditions are all met:

- The EMS test template is of the type "Reverberation Chamber"
- The [Leveling Mode](#) is "Level On" = [Power Relation](#)
- The [Test Method](#) is "EUT Qualification" or "EUT Susceptibility"

Selects a [Transducer Correction](#) table of the type "Chamber Loading Factor", if your formula calls for it by using the keyword "RVCCLF". See also "[Power Relation](#)" on page 260.

If you do not select the optional CLF table, R&S ELEKTRA assumes RVCCLF = 1.

Leveling Options

Leveling Options

This tab provides access to the following modulation and impedance settings.

Level Conservation for Modulation ← Leveling Options

The following settings are available:

"CW Carrier = Modulation Carrier"	<p>The specified test level represents the <i>carrier</i> value of the test signal. If you add modulation to the carrier signal, the peak test level is increased.</p> <p>Typically, this method is used for commercial standards like Commercial (IEC), where AM modulation is added to the carrier signal.</p>
"CW Peak = Modulation Peak"	<p>The specified test level represents the <i>peak</i> value of the test signal. The carrier level of the amplitude-modulated signal is decreased.</p> <p>Typically, this method is used for standards like Automotive / MIL-STD, where the peak level of the AM-modulated signal is kept constant.</p> <p>For an unmodulated test signal, there is no difference between these settings, but for a modulated test signal, the two level values differ from each other: If you permit amplitude modulation, the difference is $(1+m)^2$, where m is the modulation depth. For example, with a modulation factor of $m = 0.8$ (80% modulation depth), the difference is $1.8^2 = 3,24 = 5.1$ dB (for power).</p>

See also [Chapter 10.2.1, "Using detectors and modulation in EMS tests"](#), on page 669.

Power Level Conversion Impedance ← Leveling Options

This parameter defines the impedance that is applied for the conversion of all power values (W, dBm) into values with the units V or A, or vice versa. The default impedance is 50 Ω. It is available for editing only, if [EMS Application](#) is set to "Automotive / MIL-STD". The value range is from 0.1 Ω to 1 M Ω.

Sensor Level Conversion Impedance ← Leveling Options

This parameter defines the impedance that is applied for the conversion of all sensor values into other values, or vice versa.

For example, in a typical conducted test scenario, this setting is relevant for the conversion of $A \rightleftharpoons V \rightleftharpoons W$.

The default impedance is 50 Ω for radiated setups and 50 Ω or 150 Ω for conducted setups, depending on your selection of the [EMS Application](#) and of the [Test Method](#).

Whether you can edit the impedance value, depends on your selection of the [EMS Application](#), where [Commercial \(IEC\)](#) locks the value to its default. If editable, you can set the value in a range from 0.1 Ω to 1 M Ω.

Modulation ON during Leveling ← Leveling Options

Available only, if [EMS Application](#) = [Automotive / MIL-STD](#).

- If you enable this setting, any specified [Modulation](#) is not switched off during the leveling process.
- If you disable this setting, modulation is switched off during leveling. For example, if amplitude modulation (AM) is activated with 80% modulation depth, R&S ELEKTRA sets it to 0%.

Note: If enabled, you must use an appropriate power meter and sensors, which can measure amplitude-modulated signals correctly.

Check Power for first modulation only ← Leveling Options

Available only, if the following conditions are all met:

- You have selected [Automotive / MIL-STD](#) as the [EMS Application](#)
- You have selected "EUT Qualification" as the [Test Method](#)
- You have activated "Use Modulation sequence" in the [Accessory Settings](#)
- The loop parameter "Modulation" has highest priority in the [Accessory Settings](#) (above the loop parameter "Frequency")

Enables leveling based on an amplifier power measurement only for the first modulation in the frequency range's [Modulation List](#). Typically, the first modulation is set to "OFF" (hence, [CW](#)). For further entries of modulation settings in the list, the software only calculates and sets the signal generator level, without power level or sensor level measurements.

Power Level Limitation**Power Level Limitation**

Per default, this option is disabled. If you check "Active", R&S ELEKTRA enables a limitation of the transducer forward power by one of the methods described below.

Note: If "Power Level Limitation" is activated, the minimum value for [Level Shift on Frequency Change](#) is set to 6 dB in all frequency ranges. See also "Add Offset" in [By Power Column of Ref. Calibration Table](#).

By Value ← Power Level Limitation

Specifies a fixed maximum value for power (W or dBm) or power spectral density (dBm/Hz). The value range is 1 mW to 100 kW.

Note: The default value 200 W is not to be misunderstood as a recommendation.

By Limit Line ← Power Level Limitation

Selects a limit line table for frequency-dependent power level limitation.

This limit line table must cover the whole frequency range that you specify in your test template. Also ensure that the unit in the table's level column can be converted to dBm power. Otherwise, the test template does not comply with the software's verification routine and cannot be saved.

By Power Column of Ref. Calibration Table ← Power Level Limitation

Available only, if the following conditions are all met:

- The EMS test template is of conducted type, hence "Bulk Current 'Injection" or "CDN / EM Clamp"
- The [EMS Application](#) is set to [Automotive / MIL-STD](#)
- The [Test Method](#) is *not* set to "Amplifier Test"

Selects a reference calibration table for frequency-dependent power level limitation.

This table must cover the whole frequency range that you specify in your test template. Also ensure that the unit in the table's level column can be converted to dBm power. Otherwise, the test template does not comply with the software's verification routine and cannot be saved.

"Add Offset" is enabled together with this option. It allows adding an offset (typically 6 dB) to the forward power in the selected reference calibration table, for limiting the power to this modified level.

Enabling "Adapt Power to Test Level" can save time by making additional reference calibration procedures for power limitation obsolete.

For example, consider using a reference calibration table that was generated for a target test level of 100 mA. But now you want to limit the power level to 50 mA instead of 100 mA, which is a difference of 6 dB. "Adapt Power to Test Level" compares the target test level in the existing reference calibration table with your current target [Test Level](#) in each frequency range. For example, if the two levels differ by 6 dB, R&S ELEKTRA reduces the forward power values in the reference calibration table by the same amount. Doing so, the software interpolates reduced forward power levels for each test frequency. Hence, this option can help you to avoid having to repeat the reference calibration procedure for a target test level of 50 mA.

Sensor Level Limitation**Sensor Level Limitation**

Per default, this option is disabled. If you check "Active", R&S ELEKTRA enables a limitation of the measured sensor value either "By Value" or "By Limit Line".

"Sensor Level Limitation" is not permitted for the [Leveling Mode](#) > [Level On](#) = "Sensor" or "Substitution Method". Also, "Sensor Level Limitation" is not permitted for a test template of the type "EMS - CDN / EM-Clamp", because it does not contain a sensor.

Note: A BCI measurement according to IEC 61000-4-6 requires the limitation of the actual current (measured by a current clamp on the cable) to a defined value.

If "Sensor Level Limitation" is activated, the minimum value for [Level Shift on Frequency Change](#) is set to 6 dB in all frequency ranges.

By Value ← Sensor Level Limitation

Specifies a fixed maximum value for power (W or dBm), voltage (V or dBV) or current (A or dBA). This limitation is typically used for conducted tests, only.

Note: Any preset default value must not be misunderstood as a recommendation.

By Limit Line ← Sensor Level Limitation

Selects a limit line table for a frequency-dependent power level limitation.

This limit line table must cover the whole frequency range that you specify in your test template. Also ensure that the unit in the table's level column can be converted to the unit of the test level. Otherwise, the test template does not comply with the software's verification routine and cannot be saved.

Specific Data

Specific Data

Available only, if the "Antenna Port" EMS test template is selected, see [Test Templates for EMS tests](#).

Specify test parameters for running tests according to the conducted susceptibility MIL-STD-461 CS103, CS104 and CS105 standards.

Test Standard ← Specific Data

Selects the following MIL-STD-461 test standards:

- "CS103 Intermodulation"
- "CS104 Rejection"
- "CS105 CrossModulation"

See also [Antenna Port](#).

Frequency f0 ← Specific Data

Specifies the EUT stimulus generator's frequency.

EUT Sensitivity ← Specific Data

Specifies the EUT sensitivity parameter [dBm] for measurements according to [Test Standard](#).

Exclude Range f(Low) ← Specific Data

Specifies the start frequency of the excluded band.

Exclude Range f(High) ← Specific Data

Specifies the stop frequency of the excluded band.

Susceptibility Settings

Available only, if the following conditions are all met:

- You have activated the [license](#) for "ELEMS-S", which requires that a [dongle](#) with this license is connected
- You have selected "EUT Susceptibility" as the [Test Method](#)

- You have selected (highlighted) the "Overview Measurement" in the [Measurement Flow](#) dialog.

Evaluation Parameter

Defines the steps as described in ["EUT Susceptibility"](#) on page 253:

- "Step Size" specifies the increment in dB for decreasing the test level (stepping "Down") and for increasing the test level (stepping "Up").
- The dialog offers two options for specifying the dwell time:
 - If you *disable* "Use dwell time from active frequency range", the "Dwell Time" values specify, how long to expose the EUT to the test level during each step of decreasing ("Down") and increasing ("Up") test level.
 - If you *enable* "Use dwell time from active frequency range", the software uses the dwell time specified for each frequency range, see ["Dwell"](#) on page 277.

Options

- You can toggle how to determine the initial test level for evaluating the EUT at each frequency point:
 - "Start evaluation from nominal test level", see ["Test Level"](#) on page 277
 - "Start evaluation from test level of last frequency", hence from the test level that resulted from the susceptibility cycle at the previous frequency point, see ["EUT Susceptibility"](#) on page 253
- You can enable "Save last measurement values for 'EUT Go' to result table" to record at each frequency point the highest test level value that did not cause an EUT failure state. See ["NoGo"](#) on page 311.

Accessory Settings

Available only, if the following conditions are all met:

- You have activated the [license](#) for "ELEMS-S", which requires that a [dongle](#) with this license is connected
- You have not selected "Amplifier Test" as the [Test Method](#)
- You have selected (highlighted) the "Overview Measurement" in the [Measurement Flow](#) dialog.

EMS tests always run through all frequencies defined in the [Frequency Range List](#). But depending on the accessories in the test setup, some tests must repeat this run with varying accessory settings. For example, in a radiated EMS test setup with a turntable, you typically repeat the frequency run for each defined azimuth position of the turntable. Such a repetition is called a **loop** of positions. Several instances of accessory settings can define multiple loops, for example to measure at all frequencies, all azimuth positions, all antenna height positions and two polarizations. This combination can lead to many repetitions.

Measurement Settings							Susceptibility Settings		Accessory Settings	
<input checked="" type="checkbox"/> Use Modulation sequence									↑ ↓	
Active	Priority	Loop Parameter	Mode	Range	Step Size	Parameters				
<input checked="" type="checkbox"/>	1	Modulation	Stepped							
<input checked="" type="checkbox"/>	2	Frequency	Stepped							
<input checked="" type="checkbox"/>	3	Polarization	Stepped	<input checked="" type="checkbox"/> H <input checked="" type="checkbox"/> V	H → V					
<input checked="" type="checkbox"/>	4	Azimuth	Stepped	0 deg - 360 deg	90 deg	Positioning Speed : 7				
<input checked="" type="checkbox"/>	5	Height	Stepped	1 m - 4 m	50 cm	Positioning Speed : 7				
<input type="checkbox"/>	6	User Defined	Stepped							

Figure 4-104: Example of the Accessory Settings dialog, here in an EMS - Anechoic Chamber test template

The checkbox "Use Modulation sequence" is available only, if the [EMS Application](#) is "Automotive / MIL-STD" or "Reverberation Methods" and the [Test Method](#) is "EUT Qualification" or "EUT Susceptibility".

Enabling "Use Modulation sequence" has the following effects:



- It enables the [Modulation List](#) in each frequency range of the [Frequency Range List](#).
- It adds the loop parameter "Modulation" to the "Accessory Settings" dialog. If the loop parameter "Frequency" was not available, it also adds this loop parameter.

Loop Parameter

The "Accessory Settings" dialog can have the following optional loop parameters, some of which depend on the type of EMS test template ([Figure 4-30](#)):

- **"Modulation"**, available only if "Use Modulation sequence" is enabled
Loop settings can be different for each frequency range. Therefore, the modulation loop's automatic control is defined in the [Modulation List](#). It is independent of the [Susceptibility Settings](#).
- **"Frequency"**, available only if "Use Modulation sequence" is enabled
The frequency loop is controlled automatically by the "Susceptibility Settings". It allows running the modulation loop at a higher priority than the frequency loop.
- **"Polarization"**, available only in the test templates "EMS - Anechoic Chamber" and "EMS - TEM Waveguides"
 - In "EMS - Anechoic Chamber", it controls the polarization of the antenna: Enable "H" for measurements in horizontal polarization, "V" for measurements with vertical polarization, or both. If you enable both, select the parameter "H -> V", if you want to measure "H" first or "V -> H" for measuring "V" first.
 - In "EMS - TEM Waveguides", the "Polarization" loop parameter enables or disables measurements with the EUT in X, Y and Z orientation within the TEM waveguide.
- **"Azimuth"**, available only in the test template "EMS - Anechoic Chamber"
It controls the azimuth angle of the turntable. Set the angular "Range" between -360° and +720°. Specify the "Step Size" between 0° and +720°. Select the "Posi-

tioning Speed" in the range from 1 to 8 (relative values, with 1 for the lowest speed and 8 for maximum speed).

- **"Tuner"**, available only in the test template "EMS - Reverberation Chamber"
It controls the RVC tuner's position index. In contrast to "Azimuth", in RVC only the position index is relevant, rather than any current angular value.
- **"Height"**, available only in the test template "EMS - Anechoic Chamber"
It controls the height of the antenna on its tower, but it is not active by default, because the height loop is typically not used for EMS tests. Set the antenna height in the range from 1 m to 4 m. Specify the "Step Size" between 0 mm and 4 m.
- **"Position"**, available only in the test template "EMS - Anechoic Chamber", if the [Test Method](#) is "Field Uniformity"
It controls the position of a field probe in a raster as in [Figure 8-2](#). In the "Range" column, enter the number of sensor positions per loop. For example, enter "1-16" for 16 positions. In the "Parameters" column, select the "Positioning Speed" in the range from 1 to 8 (relative values, with 1 for the lowest speed and 8 for maximum speed).
Also, under special conditions described in [Chapter 4.5.3.5, "Additional Sensor Channels"](#), on page 303, you can enable the "Use 4 Channel Sensor" checkbox in the "Parameters" column. This setting makes the [Additional Sensor Channels](#) dialog available.
- **"User Defined"**, always available, independent of the type of EMS test template (see priority 6 in [Figure 4-104](#))
To specify user-defined loop parameters, activate the checkbox and click the "Expand" button  or double-click the parameters' row. Click the "Add" button  in the "Actions of the Test" column to add [Steps](#), for example "Step 1". This name of the step is shown in the loop state column when you execute the test. Right-click a step to add a user-defined action to a step, or rename, delete or move this step. Also you can drag an action from the column "Available Actions" to a step. Proceed as described in [Chapter 4.5.3.7, "Actions"](#), on page 305.

Steps

Use steps to test your DUT in various operating states with the "User Defined" loop parameter.

Example:

Configure a [remote action device](#) to switch your DUT's power supply to different supply voltage levels, like 110 V and 230 V.

You can combine steps with generating a message box ("Notification") or similar actions, as described in [Chapter 4.5.3.7, "Actions"](#), on page 305.

Priority



If more than one loop parameter is available, you can shift the selected (highlighted) parameter entry up or down with the arrow buttons . This action rearranges the priorities in your set of parameters. The top entry has priority 1, followed by priority 2, and so on.

Also note the following influence: If you switch the "Mode" of one out of several loop parameters from "Stepped" to "Continuous" (if available), this loop parameter is set automatically to priority 1. At the same time, any loop parameter that was in "Continuous" mode changes to "Stepped" mode.

The priority settings of the loop parameters are relevant for the test procedure. Parameters with a lower priority (= higher value) are processed inside the loop of higher-priority parameters. Hence, for example, if you want to run through all azimuth angles of the turntable before switching the antenna from horizontal to vertical polarization, set "Polarization" to a higher priority (= lower value) than "Azimuth".

Data Evaluation

Not available, if the [Test Method](#) is "Amplifier Test".

To let R&S ELEKTRA perform an evaluation of the [verdict](#) after completion of a test, enable the "Data Evaluation" checkbox in the [Measurement Flow](#) dialog.

With the "Data Evaluation" icon selected, you can specify the following settings:

EUT Qualification / EUT Susceptibility

If "Test Method" = [EUT Qualification](#) or [EUT Susceptibility](#), you can select the following:

- "Do Worst Case Analysis for EUT monitoring channels"
In this analysis, R&S ELEKTRA searches for each "EUT Monitoring" channel across all test frequencies and all accessory-loop positions in all overview result tables for the largest (worst) deviation from the [NoGo](#) criteria. It enters the search results (measurement points with largest deviation) into a new worst-case table. You can view a measurement point's loop parameters as a label in the test chart, for example "90 deg, V".
If "Do Worst Case Analysis for EUT monitoring channels" is enabled, you must select also an [EUT monitoring template](#) in the [General Settings](#). R&S ELEKTRA uses this template to control the EUT monitoring procedures during the test.
- "Select loop parameters to combine result(s)"
This option displays a list of the "Loop Parameters" that you have activated in the [Accessory Settings](#). To let the software create additional charts for specific accessory loops, select these loop parameters. For example, you can select the "Modulation" loop to get a chart for each individual modulation (CW, AM, ...). For each loop parameter that is activated, the checkbox in the right column enables or disables displaying system channels or EUT monitoring channels for this evaluation.

Field Uniformity

If "Test Method" = [Field Uniformity](#), you can select:

- "Start Field Uniformity Analyzer" enables the R&S ELEKTRA algorithm for [Field uniformity evaluation](#)
- "Show Power Difference graphics" enables graphical display of level differences
- "Evaluation Standard" selects one of the following standards for R&S ELEKTRA to adhere to in radiated tests:

"EN61000-4-3:2020" (equivalent with ISO61000-4-3 and IEC61000-4-3) was published in 2020 and defines the immunity requirements, test levels and procedures for electrical and electronic equipment.

"EN61000-4-3:2006 + A1:2008 + A2:2010" is the 2006 edition of the same standard, including the 2008 and 2010 amendments.

"ISO11451-2:2015" is part 2 of the 2015 edition for test methods that cover immunity of road vehicles to off-board radiation sources.

- "Nominal Field Strength" specifies the test level (default = 10 V/m)

Reference Calibration

In a test template of the type "EMS - Anechoic Chamber", if "Test Method" = [Reference Calibration](#), you can select "Select loop parameters to combine result(s)", as described above.

EUT Check

In a test template of the type "EMS - Reverberation Chamber", if "Test Method" = [EUT Check](#), you can select:

- "Input Data"
 - "Min Req Pulse Width" specifies the minimum required duration of the generator's RF pulses in μs
 - "Chamber Volume" is the reverberation chamber's volume ($W \times H \times D$) in m^3
 - "Relative Permittivity" is the relative permittivity of the chamber's walls in pF/m
 - "Unloaded Cal Result Table" specifies the name of the table that the software uses for saving the calibration results of the unloaded chamber
 - "Loaded Cal Result Table" specifies the name of the table that the software uses for saving the calibration results of the loaded chamber
- "Output Data"
 - "EUT Load Effect Table" specifies the name of the table that the software uses for saving the results of the EUT load effect measurement
 - "Chamber Loading Factor" (CLF) specifies the name of the table that the software uses for saving the frequency-dependent results of the chamber loading factor. The EUT test uses this table.
- "Evaluation Graphics"
 - "Chamber Loading Factor" enables displaying the frequency-dependent CLF results
 - "Chamber Calibration Factor" (CCF) enables displaying the frequency-dependent RVC calibration results
 - "Chamber Q" enables displaying the chamber's frequency-dependent quality factor calculated from the chamber's volume, its wall permittivity and the averaged field strength values. For calculation instructions, refer to the standard IEC EN 61000-4-21.
 - "Pulse Width" enables displaying the actual frequency-dependent pulse-width results, compared to the minimum required value "Min Req Pulse Width"

Loaded Chamber / Unloaded Chamber

In a test template of the type "EMS - Reverberation Chamber", if "Test Method" = [Loaded Chamber](#) or [Unloaded Chamber](#), you can select:

- "Input Data"
 - "Tolerance of Standard Deviation" selects a limit line with dB values over the frequency, as defined in the standard
 - "Chamber Volume" specifies the reverberation chamber's volume (W×H×D) in m³
 - "Relative Permittivity" specifies the relative permittivity of the chamber's walls
 - "Norm Max E-Field Table" (not available for "Unloaded Chamber") selects a [Transducer Correction](#) table of the type "Avg Norm Max E-Field"
- "Output Data"
 - "Calibration Result Table" specifies the name of the table that the software uses for saving the evaluation results of the loaded or unloaded chamber
 - "Norm Max E-Field Table" (not available for "Loaded Chamber") specifies the name of the table that the software uses for saving the "Norm Max E-Field" results of the unloaded chamber
- "Evaluation Graphics"
 - "Insertion Loss" enables displaying the frequency-dependent insertion loss results of the chamber
 - "Standard Deviation" enables displaying the frequency-dependent standard deviation of the E-field for the X, Y, and Z axis and for the XYZ isotropic value.
 - "Antenna Correction Factor", also called "Antenna Validation Factor", enables displaying the frequency-dependent normalized receiver power over all tuner and antenna positions. This factor is needed to calculate the chamber loading in the next loaded calibration step.
 - "Maximum Loading Factor" (not available for "Unloaded Chamber") enables displaying the frequency-dependent maximum values of the chamber loading factor (CLF)
 - "E-Field Comparison" (not available for "Loaded Chamber") enables displaying the frequency-dependent comparison of the calculated E-field based on the field probe values to the E-field based on the received power values.
 - "Chamber Q" enables displaying the frequency-dependent quality factor calculated from the chamber's volume, its wall permittivity and the averaged field strength values. For calculation instructions, refer to the standard IEC EN 61000-4-21.

Frequency Range List

To see the "Frequency Range List", make sure to select "Overview Measurement" in the [Measurement Flow](#) dialog (if available) and "Measurement Settings" in the [Flow Details](#).

This section describes how to specify the test setup for each frequency range.

Add Frequency Range.....	275
Active.....	277
Frequency Range.....	277
Steps.....	277
Test Level.....	277
Dwell.....	277
Modulation.....	278
Hardware Setup.....	278
Delete Frequency Range.....	279
Frequency.....	279
L Continue with steps of the previous frequency range.....	279
L Use Frequency List.....	279
L Frequency List.....	279
L Use Frequency List Only.....	279
Test Level.....	279
L Constant Level.....	280
L Level Table defined by Limit Line.....	280
L Power Level defined by Reference Calibration Table.....	280
L Leveling Tolerance.....	280
L Level Shift on Frequency Change.....	280
L Reference Calibration Table.....	280
Level Profile.....	280
Modulation List.....	283
Device Settings.....	285
L Unlock / Lock this Hardware Setup for editing.....	285
L Select Device.....	286
L Calibration View.....	286
L EUT Test View.....	286
L Device Properties.....	287
L Settings.....	287
L Settings EMS.....	287
L Power Meter Settings.....	289
L Field Probe Settings.....	290
L Measurement Settings.....	291
L Oscilloscope Settings.....	291
L Properties.....	292
Generators Settings.....	292
L Mode.....	293
L Frequency.....	293
L Level.....	293
L Other Settings.....	293
Reverb Settings.....	294



Add Frequency Range

Creates an additional frequency range in the same test template. Each frequency range requires the selection of a [Hardware Setup](#), therefore, you must select it before you can add another frequency range.

For a new (added) frequency range, the following rules and default settings apply:

- The lower end of the new frequency range is automatically set equal to the upper end of the highest existing frequency range in the same test template.

- While gaps between frequency ranges are permitted, these ranges must not overlap. Therefore, do not change the lower end of a new frequency range to a lower value.
- The upper end of the new frequency range is automatically set 10 MHz or 1 GHz above its lower end:
 - 10 MHz in conducted test templates ("EMS - Bulk Current Injection" or "EMS - CDN / EM-Clamp")
 - 1 GHz in radiated test templates ("EMS - Anechoic Chamber" or "EMS - TEM Waveguides")

- If the highest frequency range remains below the upper frequency limit of its hardware setup, then R&S ELEKTRA automatically preselects this same hardware setup, when you add a new frequency range. Otherwise, the software does not preselect any hardware setup for a new frequency range.

To explain this behavior, consider an "HWS_{high}" being the hardware setup, which is selected in the frequency range FR with the highest existing upper frequency f_{FRhigh} . If the span of frequencies defined in HWS_{high} runs at least 1 Hz higher than f_{FRhigh} , a new frequency range in the test template automatically references that same hardware setup. This relationship is illustrated also in the following example: Consider a conducted hardware setup "A" that covers a frequency range from $f_{start} = 150$ kHz to $f_{stop} = 60$ MHz (with no frequency gaps permitted). Also consider a conducted test template with frequency range "1" from 150 kHz to 50 MHz (= f_{FRhigh}), that refers to hardware setup "A".

If you add a new frequency range "2", the software detects a sufficient band of unassigned (hence "available") frequencies in hardware setup "A". Therefore, R&S ELEKTRA automatically selects this hardware setup for the new frequency range "2" and specifies its frequency range from 50 MHz to 60 MHz.

If you add another new frequency range "3" to the test template, this new frequency range cannot refer to hardware setup "A". The reason is that the hardware setup's $f_{stop} = 60$ MHz has already been reached by frequency range "2". It is not possible to at least partly assign another adjacent band of 10 MHz to the same hardware setup. Therefore, frequency range "3" is created without any reference to a hardware setup, but with a frequency range that is automatically specified from 60 MHz to 70 MHz. (You can change these frequency settings individually.)

In this situation, before other settings are specified, first select or create a suitable hardware setup "B", which covers (at least) the frequencies of the new range "3".

Note: Frequency ranges in EMS versus EMI test templates. Note the following differences in comparison with [Test Templates for EMI Tests](#):

- In EMS, the upper end of a new frequency range is set 1 GHz above the lower end of a new frequency range. On the contrary, in EMI, the upper end is set per default 10 MHz above its lower limit.
- EMS test templates permit gaps, but no overlapping frequency ranges. On the contrary, in EMI, gaps and overlapping frequency ranges are explicitly permitted. For example, an overlap allows measuring the same frequency range again with a different EMI hardware setup
- In [EMS hardware setups](#) (other than in EMS test templates), frequency ranges must be seamless. Gaps and overlaps are not permitted.

**Active**

Activates or deactivates measurements in selected frequency ranges.

The global checkbox next to the "Active" headline activates or deactivates the measurements in all frequency ranges.

Frequency Range

Specifies the lower and upper boundaries of a frequency range. The default values for the first frequency range are copied from the selected [Hardware Setup](#).

To edit the boundaries, click the values. R&S ELEKTRA allows only values within the frequency range of the selected hardware setup.

For rules on setting the frequency boundaries, see [Hardware Setup](#).

You can also edit the frequency units. Permissible units are *Hz*, *kHz*, *MHz* and *GHz*.

Note: In the [Device Settings](#) tab, below the hardware setup diagram, R&S ELEKTRA shows the least common frequency range, in which the combined devices and signal paths can be used. (The mouse-over text is "The frequency range of the current hardware setup".) This frequency range can be limited, for example, by a correction table of a transducing device.

Steps

Specifies the step width of the frequency scan and selects the mode: "LOG" (logarithmic, in % steps), "LIN" (linear, in Hz steps) or "DEC-LIN" (decade linear, in % steps).

For example, 10% in "DEC-LIN" mode generates a frequency sequence of 1, 2, 3, 4, ..., 10, 20, 30, 40, ... , 100 MHz.

Note: R&S ELEKTRA can preset a default step width according to [Table 4-6](#).

If you enable [Use Frequency List Only](#) in the [Frequency](#) tab, R&S ELEKTRA disables the "Steps" input field in the frequency range's headline. Instead, the table's name is shown in this field.

The "Steps" parameters that you specify for the first frequency range are automatically copied as a default to all other frequency ranges (once created).

Test Level

Specifies the target test level (sometimes called immunity level), for example in V/m, V, W, A or dBm.

Note: R&S ELEKTRA can preset a default value according to [Table 4-6](#).

The value defined here is used as the [Constant Level](#) in the [Test Level](#) tab.

If you select a [Level Table defined by Limit Line](#) in the [Constant Level](#) tab, R&S ELEKTRA disables the "Test Level" input field in the frequency range's headline. Instead, the table's name is shown in this field.

The "Test Level" parameters that you specify for the first frequency range are automatically copied as a default to all other frequency ranges (once created).

Dwell

Specifies the dwell time (in s, ms, μ s, ns or ps) that determines, how long the EUT is at least exposed to the test level at each [frequency step](#).

Note: R&S ELEKTRA can preset a default value according to [Table 4-6](#).

The dwell time starts after the end of the leveling process and before the EUT monitoring cycle is started.

The "Dwell" time that you specify for the first frequency range is automatically copied as a default to all other frequency ranges (once created).

Modulation

Not available, if you have enabled "Use Modulation sequence" in the [Accessory Settings](#). In this case, use the [Modulation List](#) instead.

Selects the RF generator modulation type, frequency and related parameters for a frequency range. Predefined default settings are used, for example with the following values:

- OFF
- Amplitude modulation: "AM; 1 kHz; 80%"
- Frequency modulation: "FM; 1 kHz; 10 kHz"
- Pulse modulation: "PULM; 217 Hz; 577 µs"
- Digital modulation with arbitrary waveform file: "DM+ARB" (no defaults)
"DM+ARB" is available only, if a [vector signal generator](#) is connected. For example the [types](#) "SMBV100A", "SMBV100B" or "SMCV100B", which support arbitrary waveforms.

To edit the modulation settings, select the RF generator in the hardware setup diagram (see (2) in [Figure 4-107](#)), go to its "Device Properties" (4) and open its [Settings](#).

Note: By default, the modulation is set to "OFF" during leveling, in accordance with [Table 4-6](#). During the [dwell time](#), your selected modulation is "ON".

The "Modulation" setting of the first frequency range is automatically copied as a default to all other frequency ranges (once created).

...

Hardware Setup

Selects a hardware setup for a given frequency range. For a description, see [Chapter 4.7, "Hardware Setups"](#), on page 331.

The selection of a hardware setup is a precondition for accessing any other setting in this dialog:

- The [General Settings](#)
- The [Measurement Flow](#)
- The [Flow Details](#)
- The [System Monitoring](#)
- The [Test Information](#) (which is, as an exception, available before selecting a hardware setup)
- The [Actions](#)
- The [Excluded Frequency Bands](#)

According to the selected hardware setup, R&S ELEKTRA displays the general parameters in the frequency range headline and the hardware setup diagram, along with the [devices](#), their [Settings](#) and their [Properties](#).

For different frequency ranges, identical or different hardware setups can be selected.

When you add a new [frequency range](#) to the test template, R&S ELEKTRA automatically suggests new frequency boundaries. For a description of this behavior, see ["Add Frequency Range"](#) on page 275.



Delete Frequency Range

Available only, if at least two frequency ranges are present. Deletes the selected frequency range - without additional warning and without the possibility to restore a deleted frequency range and its settings.

Frequency

Frequency

If a [hardware setup](#) is selected, R&S ELEKTRA enables editing the "Frequency" tab for this frequency range. It provides access to the following frequency step settings and indicates the number of test frequencies for the current frequency range. This "No of Frequency Range Measurement Points" is calculated from the [start and stop frequency](#) of the frequency range and from the frequency [stepping](#) mode.

Continue with steps of the previous frequency range ← Frequency

Not available for the first [frequency range](#).

If this checkbox is enabled, the [Steps](#) settings of the previous frequency range are copied into this frequency range.

If the checkbox is disabled, you can define the steps settings independently of the previous frequency range.

Use Frequency List ← Frequency

Enables the selection of a table to define frequency steps. Available only, if [Continue with steps of the previous frequency range](#) is disabled.

A frequency list can be used in addition or alternatively to a definition of frequency [Steps](#).

Frequency List ← Use Frequency List ← Frequency

Available only, if [Use Frequency List](#) is enabled.

Selects a [Frequency List](#) to define frequency steps in addition or alternatively to the [Steps](#) defined above.

Note: R&S ELEKTRA uses both the [Steps](#) specified for a frequency range and the steps from the frequency list. Hence, the list's frequency steps are additional, unless the setting "Use Frequency List Only" is enabled.

Use Frequency List Only ← Frequency

Available only, if [Use Frequency List](#) is enabled.

If activated, you must select a [Frequency List](#) (table), which is then used exclusively to define the frequency steps. The software ignores any additional frequencies that would derive from the [Steps](#) setting for this frequency range. Consequently, the information "No of Frequency Range Measurement Points" is removed.

We recommend using a frequency list only, if the frequency steps that you wish to use in a measurement do not fit into the scheme of the available [frequency step modes](#).

Test Level

Test Level

If a [hardware setup](#) is selected, R&S ELEKTRA enables editing the "Test Level" tab for this frequency range. It provides access to the following target test level (or immunity power) settings.

Constant Level ← Test Level

The whole frequency range uses the constant [test level](#) value specified in the headline.

Level Table defined by Limit Line ← Test Level

Selects a test level table to define the shape of the target test level as a function of frequency. This table must have been generated in advance as a [limit line](#) table.

Power Level defined by Reference Calibration Table ← Test Level

Selects a reference calibration table as a definition of the target immunity power curve for this frequency range.

Available only, if in the [Leveling Mode](#) dialog, you set the parameter "Level On" to [Transducer Power](#).

Use this setting for field uniformity measurements with constant-power method according to EN 61000-4-3.

Leveling Tolerance ← Test Level

Defines a tolerance window for the test level generation. The leveling process is finished, when the measured immunity value is inside this tolerance window around the nominal test level.

The recommended tolerance values ± 0.2 dB are preset as a default. Alternatively, to make sure that the EUT is always tested with at least the nominal level, set a tolerance window of -0.0 dB to $+0.4$ dB.

Level Shift on Frequency Change ← Test Level

Not available, if [EMS Application](#) is set to [Automotive / MIL-STD](#). With this setting, use the more comprehensive [Level Profile](#) instead.

Sets the level sweep parameter, with a default of 6 dB and permissible values between 0 dB and 60 dB.

Setting this parameter has the following effect during measurements: At every frequency step, before proceeding to the next frequency, the test level is automatically dropped to a value that is the defined factor below the next target level. From there, it is raised again to the target level of this frequency step.

Note: If [Power Level Limitation](#) or [Sensor Level Limitation](#) is activated, the minimum level shift value is set to 6 dB in all frequency ranges.

Reference Calibration Table ← Test Level

Selects a frequency-range-specific reference calibration table instead of the global selection at [Leveling Mode](#) > [Reference Calibration Table](#).

Available only, if [Test Method](#) = [EUT Qualification](#) and in the "Leveling Mode" dialog with "Level On" = "Substitution Method", the checkbox [Use a frequency-range-specific reference calibration table](#) is enabled.

Level Profile**Level Profile**

Available only, if [EMS Application](#) is set to [Automotive / MIL-STD](#).

Automotive and MIL applications often require a level profile as in [Figure 4-105](#).

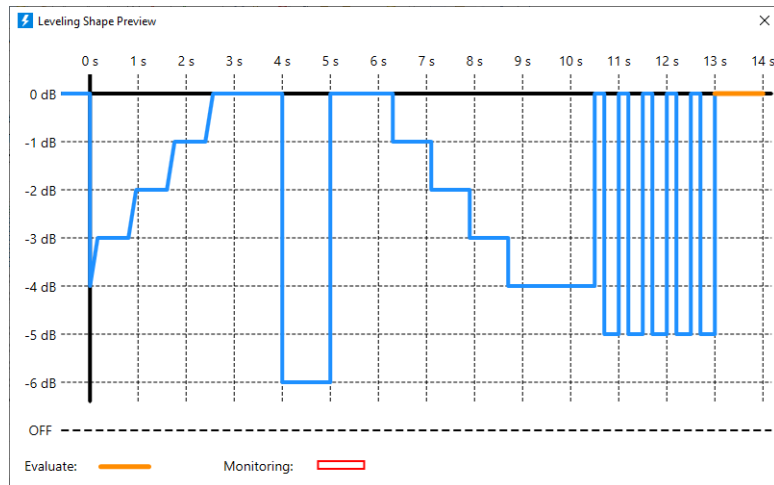

Figure 4-105: Example of a level profile, where 0 dB is the nominal test level

To create a level profile, use the following dialog:

Segment	Type	Shift [dB]	ON [s]	OFF [s]	Repetition	Do Monitoring	Action
1	Start	↓	-4	0	-	1	
2	Up	↑	1	0.8	-	4	🗑️
3	Wait - RF ON	-	0.8	-	1		🗑️
4	Down	↓	-6	0	-	1	🗑️
5	Wait - RF ON	-	1	-	1		🗑️
6	Up	↑	6	0	-	1	🗑️
7	Wait - RF ON	-	1.3	-	1		🗑️
8	Down	↓	-1	0.8	-	4	🗑️
9	Wait - RF ON	-	1	-	1		🗑️
10	Up	↑	4	0	-	1	🗑️
11	Key On/Off	↓	-5	0.2	0.3	5	🗑️
12	Evaluate	-	1	-	1	<input checked="" type="checkbox"/>	



Figure 4-106: Settings for the profile in the example shown above

This dialog allows creating a series of segments that R&S ELEKTRA executes in chronological order from segment 1 ("Start") to the segment with the highest number.

During the EMS test, R&S ELEKTRA executes the series of specified segments in chronological order from segment 1 ("Start") to the segment with the highest number.

The "Level Profile" dialog (Figure 4-106) offers the following features for specifying segments:

"Preview Leveling Shape" Creates a preview graphic representation (Figure 4-105) of the level profile specified by the full set of segments. Use this button to see the effect of your segment settings.

"Add"		Adds a new row (hence, a "Segment") below the currently selected (highlighted) row in the "Level Profile" table.
"Shift Row Up / Down"		The buttons swap the position of the selected (highlighted) row with the one above or below it.
"Segment"		A row in the table that specifies an action in this segment of the "Level Profile".
"Type"		<p>Selects one of the following actions for this segment:</p> <ul style="list-style-type: none"> • "Start" is fixed as the first segment. It is predefined as a "Down" action. You can specify the level decrease in the range of 0 dB to -50 dB. • "Up" increases the test level by the amount that you specify (see "Shift [dB]"). • "Wait - RF ON" keeps the test level unchanged for a time that you specify (see "ON [s]"). • "Key / On/Off" performs the following subsegments: <ul style="list-style-type: none"> – Keeps the test level unchanged for a time that you specify (see "ON [s]"). – Decreases the test level by the amount that you specify (see "Shift [dB]"). – Keeps the decreased test level unchanged for a time that you specify (see "OFF [s]"). – Increases the test level back to its original level. • "Down" decreases the test level by the amount that you specify (see "Shift [dB]"). • "Wait - RF OFF" switches the test level off for a time that you specify (see "OFF [s]"). • "Evaluate" is originally the last segment, but you can also shift it up or down  or add segments below it. It performs an EUT monitoring cycle according to your EUT Monitoring Template. In a typical profile, after "Evaluate", two more segments follow: "Down" and "Wait RF OFF".
"Shift [dB]"		<p>Specifies the amount of increase or decrease (decibel) of the test level.</p> <ul style="list-style-type: none"> • "Up" segments permit only positive numbers in the range of 0 dB to 50 dB • "Down" and "Key / On/Off" segments permit only negative numbers in the range of 0 dB to -50 dB • Not available in "Wait" segments
"ON [s]"		Specifies the time (number of seconds) for keeping a specified test level.
"OFF [s]"		Specifies the time (number of seconds) for switching the test level off.
"Repetition"		Specifies the number of repetitions of a segment in the range of 1 to 100. Enter 1 for no repetition.

"Do Monitoring" Automatically enabled only in the "Evaluate" segment with a fixed duration of 1 s.

"Action"



Deletes the selected (highlighted) row without additional warning.

Modulation List



Modulation List

Available only, if the following conditions are all met:

- You have selected [Automotive / MIL-STD](#) as the [EMS Application](#)
- You have selected "EUT Qualification" or "EUT Susceptibility" as the [Test Method](#)
- You have activated "Use Modulation sequence" in the [Accessory Settings](#)

Note: Check modulation priority. If the loop parameter "Modulation" does not have highest priority in the [Accessory Settings](#), set it to highest priority (above the loop parameter "Frequency").

In each frequency range, this dialog allows defining a series of modulation settings for the RF generator, and defining dwell times for executing each modulation state. This list replaces the [Settings EMS](#) settings in the [Device Properties](#).

To add a new line of modulation settings, click the "Add" button . Click the "Expand" button  to see a dialog for selecting one of the following modulation types:

"OFF" Default, no additional subsettings.

"AM" Amplitude modulation with the following subsettings:

- "Source", specifies the modulation source: either "Internal" or "External AC"
- "Frequency", available only for "Internal" modulation source: specifies the modulation frequency
- "Depth", specifies the modulation depth in %

"FM" Frequency modulation with the following subsettings:

- "Source", specifies the modulation source: either "Internal" or "External AC"
- "Frequency", available only for "Internal" modulation source: specifies the modulation frequency
- "Deviation", specifies the modulation deviation in Hz

"PULM"	<p>Pulse modulation with the following subsettings:</p> <ul style="list-style-type: none"> • "Source", specifies the modulation source: <ul style="list-style-type: none"> – "Internal" – "External Pulse" – "Internal PulseTrain" <ul style="list-style-type: none"> Available only for R&S SMBV100B with option K27. – "Burst", only for "HMF2550" generator • "Frequency", available only for "Internal" modulation source: specifies the modulation frequency • "Pulse Width", available only for "Internal" modulation source: specifies the duration of the modulation pulses • "Pulse Train File": selects a file that contains a pulse waveform. Available only for "Internal Pulse Train" modulation source and if a Generator is connected, which supports the pulse train feature (for example "SMA100A/B" or "SMB100A/B"). You can select pre-configured pulse waveform, for example files for GMW3097xxx standard RADAR, provided by R&S ELEKTRA. "Update" checks for currently available files.
"DM+ARB"	<p>Digital modulation with arbitrary waveform file: Available only for vector signal generator types like "SMBV100A", "SMBV100B" or "SMCV100B", which support arbitrary waveforms. If waveform files are available in your vector signal generator, you can import these files to R&S ELEKTRA, see Chapter 4.12.2, "Device Files", on page 528.</p> <p>If you have activated the waveform management license "ELEMS-AIM", some specific waveforms are pre-configured in R&S ELEKTRA, see Chapter 4.12.2, "Device Files", on page 528.</p> <ul style="list-style-type: none"> • "ARB File": selects a specific waveform file, if available. • "Update": checks for currently available files.
"PULM+AM"	<p>Pulse amplitude modulation: Available only for vector signal generator types like "SMA100" or "SMB100", which support pulse train feature.</p> <ul style="list-style-type: none"> • "Frequency", specifies the modulation frequency • "Depth", specifies the modulation depth in % • "Pulse Frequency", specifies the frequency of the pulse waveform • "Pulse Width", specifies the duration of the modulation pulses



For details on external modulated signal sources, refer to the user manual of your signal generator.

The software automatically enters the selected modulation type of each line into the "Name" field of this line. You can edit the name.

Click the "Collapse" button  to reduce your settings to a single line. It contains a brief summary in the "Modulation Settings" column.

Enter the "Dwell Time [s]" for this line of modulation settings.

Optionally, add more lines of modulation settings to complete your modulation list.

You can delete individual lines using the  button. To shift the selected (highlighted) line up or down, use the arrow buttons  .

When you add a new line of modulation settings or create a frequency range, always specify the modulation settings individually. R&S ELEKTRA does not copy previously defined modulation setting as a default for new entries.

When you run a test based on this test template, the software executes the modulation list during leveling.

Device Settings

Device Settings

If a [hardware setup](#) is selected, R&S ELEKTRA enables editing the "Device Settings" tab for this frequency range. It provides access to the settings of each device and signal path that is specified in this hardware setup.

Note: Before you can proceed, first configure an [EMS hardware setup](#) and [select it](#) for one or more frequency ranges. The software then shows the hardware setup diagram ([Figure 4-107](#)) specified in this hardware setup.

To get access to the properties or settings of a device or signal path, click its icon in the hardware setup diagram, for example the generator icon (labeled (2) in [Figure 4-107](#)).

When you click such an icon, the following things happen in the test template:

- The icon (2) is highlighted in blue
- The name of the device or signal path is shown in the "Select Device" field (3)
- The [Device Properties](#) (4) are displayed, unless you have collapsed them

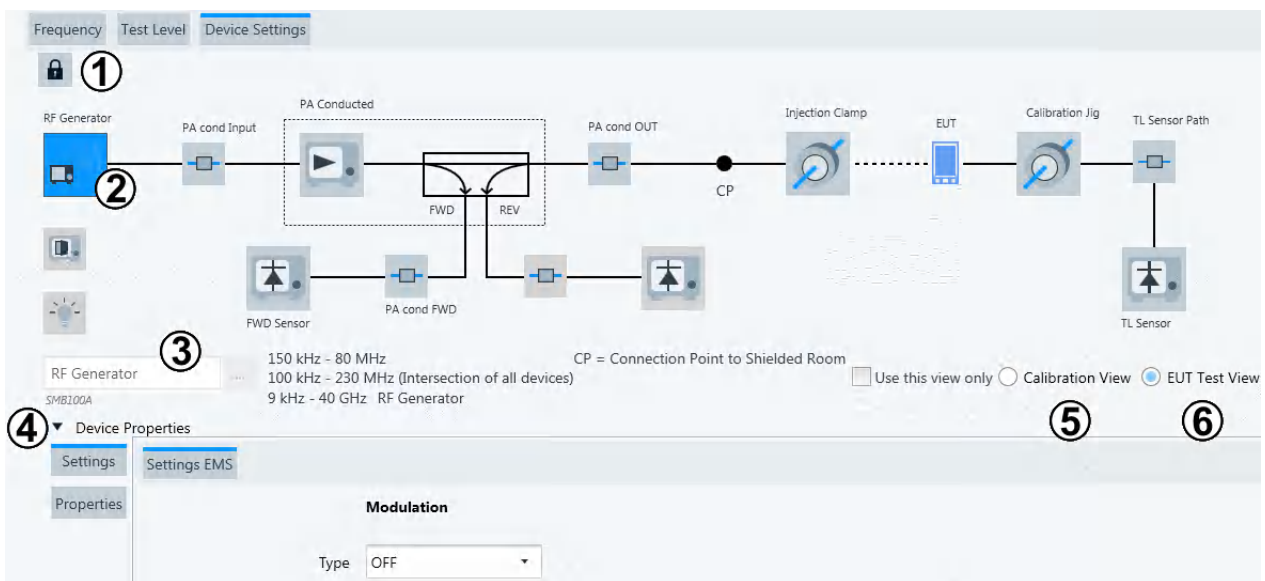

Figure 4-107: Example of a hardware setup diagram (type Bulk Current Injection) in an EMS test template

- 1 = Lock/unlock icon for editing the hardware setup diagram and device properties
- 2 = Icon of the selected [device](#) (here: the RF generator), highlighted in blue
- 3 = [Select Device](#) field with the name of the highlighted device, if already selected (here "RF Generator")
- 4 = Expand/collapse button for the [Device Properties](#)
- 5 = [Calibration View](#) button
- 6 = [EUT Test View](#) button

Unlock / Lock this Hardware Setup for editing ← Device Settings

The lock button / toggles between enabling and disabling the editing of the hardware setup diagram and its device properties.

The hardware setup diagram is originally locked against being editable. When you click the icon to unlock the selection, the software brings up a warning, if the hardware setup is also used in other test templates. This warning helps you to prevent unintentional modifications to existing test templates.

Note: If you wish to modify the hardware setup, we recommend not to edit it within the test template. Instead, create a new hardware setup with the desired features, or copy an existing hardware setup and modify it. Then select this new hardware setup for your test template.

Select Device ← Device Settings

This field, labeled (3) in [Figure 4-107](#), displays the name of the device selected (highlighted) in the hardware setup diagram.

Next to this field, you can use the  button to select a different device (same category) from the [Device List](#). However, the availability of the "Select Device" buttons depends on the state of the [lock](#).

If you unlock the  button and select a different device here, this selection is changed directly in the hardware setup. Be aware that such a change has influence on all other instances, too, that use this hardware setup, especially other test templates.

For the "RF Generator" and "TL Sensor" (test level sensor or calibrating power meter), the device's [Settings](#) are also displayed.

For a description of the devices, refer to [Chapter 4.8, "Device List"](#), on page 362.

Calibration View ← Device Settings

Click the "Calibration View" button, labeled (5) in [Figure 4-107](#), to access the calibration version of the selected hardware setup diagram.

Note: If you select "Calibration View" in one frequency range, all frequency ranges are switched to "Calibration View".

You can enable "Use this view only" to prevent the selection of the [EUT Test View](#).

Note: You cannot run a test from your EMS test template, if "Use this view only" locks it in "Calibration View". Therefore, R&S ELEKTRA prevents saving an EMS test template with "Use this view only" enabled in "Calibration View".

If you do not want to define a calibration setup, select the [EUT Test View](#) and enable "Use this view only".

For the configuration of the hardware setup, see [Chapter 4.7.3, "Hardware setups for EMS tests"](#), on page 347.

EUT Test View ← Device Settings

Click the "EUT Test View" button, labeled (6) in [Figure 4-107](#), to access the EUT test version of the selected hardware setup diagram.

Note: If you select "EUT Test View" in one frequency range, all frequency ranges are switched to "EUT Test View".

You can enable "Use this view only" to prevent the selection of the [Calibration View](#). This setting is especially useful, if you do not want to define a calibration setup.

For the configuration of the hardware setup, see [Chapter 4.7.3, "Hardware setups for EMS tests"](#), on page 347.

Device Properties ← Device Settings

Specifies the properties of the lab instrument that is selected in the hardware setup diagram. In [Figure 4-107](#), the selected item is the device icon (2) that is highlighted in blue.

To toggle between hiding and showing the "Device Properties" dialog, click the "Device Properties" button.

Note: The names of the tabs within the "Device Properties" dialog vary with the different devices. Generally, "Settings" are test-related, "Properties" are device-related.

The device-related [properties](#) are shown as specified in the [Device List](#).

If you modify any device properties here, these properties are changed in all other instances, too: in the device list, in each hardware setup that uses this device, in each test template that uses this hardware setup, etc. Therefore, if you wish to modify the device properties, we recommend using a new or copied hardware setup with the desired device properties.

Settings ← Device Properties ← Device Settings

All devices and signal paths in the hardware setup diagram are equipped with device-related [properties](#).

In addition, the dialog shows test-related *settings* of the **RF generator** and the **TL sensor** (calibrating power meter, if available, displayed on the far right, for some setups only in [Calibration View](#)). These settings are described below.

For the device settings of the "FWD" power meter and optionally the "REV" power meter, see [Chapter 4.7.3, "Hardware setups for EMS tests"](#), on page 347.

Note: Modifying the settings for the RF generator and the TL sensor does not interfere with other instances that use the same hardware setup. These settings are only related to the test template in which they are set.

The settings for the two devices mentioned above are as follows:

The available settings are:

- [Settings EMS](#) of an **RF generator**
- [Power Meter Settings](#) of a **sensor or power meter**
- [Field Probe Settings](#) of a **field probe**
- [Measurement Settings](#) of an **oscilloscope**
- [Oscilloscope Settings](#) of a **receiver**

Settings EMS ← Settings ← Device Properties ← Device Settings

To access the "Settings EMS" dialog, select "Device Properties" > "Settings" for the **RF generator** (with "RF Generator" icon).

Not available, if the [Modulation List](#) is enabled.

Set the "**Modulation**" to "OFF", "AM", "FM", "DM+ARB" or "PULM". The software displays this setting with its subsettings also in the [Modulation](#) field in the frequency range headline. Depending on the selection, the following subsettings apply:

"OFF" Default, no additional subsettings.

"AM"	<p>Amplitude modulation with the following subsettings:</p> <ul style="list-style-type: none"> • "Source", specifies the modulation source: either "Internal" or "External AC" • "Frequency", available only for "Internal" modulation source: specifies the modulation frequency, default: <i>1 kHz</i> • "Depth", specifies the modulation depth in %, default: <i>80%</i>
"FM"	<p>Frequency modulation with the following subsettings:</p> <ul style="list-style-type: none"> • "Source", specifies the modulation source: either "Internal" or "External AC" • "Frequency", available only for "Internal" modulation source: specifies the modulation frequency, default: <i>1 kHz</i> • "Deviation", specifies the modulation deviation in Hz, default: <i>10 kHz</i>
"DM+ARB"	<p>Available only for vector signal generator types like "SMBV100A", "SMBV100B" or "SMCV100B", which support arbitrary waveforms. If waveform files are available in your vector signal generator, you can import these files to R&S ELEKTRA, see Chapter 4.12.2, "Device Files", on page 528.</p> <p>If you have activated the waveform management license "ELEMS-AIM", some specific waveforms are pre-configured in R&S ELEKTRA, see Chapter 4.12.2, "Device Files", on page 528.</p> <p>Digital and arbitrary modulation with the following subsetting:</p> <ul style="list-style-type: none"> • "ARB File", selects a specific waveform file, if available. <p>See also Chapter 4.12.2, "Device Files", on page 528 and Chapter 4.8.9.2, "File Management", on page 414.</p>
"PULM"	<p>Pulse modulation with the following subsettings:</p> <ul style="list-style-type: none"> • "Source", specifies the modulation source: <ul style="list-style-type: none"> – "Internal" – "External Pulse" – "Internal Pulse Train" – "Burst", only for "HMF2550" generator • "Pulse Frequency", available only for "Internal" modulation source: specifies the modulation frequency, default: <i>1 kHz</i> • "Pulse Width", available only for "Internal" modulation source: specifies the duration of the modulation pulses, default <i>577 μs</i> • "Pulse Train File": selects a file that contains a pulse waveform. Available only for "Internal Pulse Train" modulation source and if a Generator is connected, which supports the pulse train feature (for example "SMA100A/B" or "SMB100A/B"). You can select pre-configured pulse waveform files for GMW3097xxx standard RADAR, provided by R&S ELEKTRA. <p>"Update" checks for currently available files.</p>

- "PULM+AM" Pulse amplitude modulation:
Available only for [vector signal generator types](#) like "SMA100" or "SMB100", which support pulse train feature.
- "Frequency", specifies the modulation frequency, default: *1 kHz*
 - "Depth", specifies the modulation depth in %, default: *80%*
 - "Pulse Frequency", specifies the frequency of the pulse waveform, default: *1 kHz*
 - "Pulse Width", specifies the duration of the modulation pulses, default: *577 μs*
- "DM+ARB" Digital modulation with ARB waveform file:
"ARB File": selects a file that contains an arbitrary waveform. Available only, if a [vector signal generator](#) of the [type](#) "SMBV100A" or "SMBV100B" is connected, which supports arbitrary waveforms. You can select pre-configured ARB files, provided by R&S ELEKTRA.
"Update" checks for currently available files.

For details on external modulated signal sources, refer to the user manual of your signal generator.

Power Meter Settings ← Settings ← Device Properties ← Device Settings

To access the "Power Meter Settings" dialog, select "Device Properties" > "Settings" for one of the following **sensor** devices (with "Power Meter" icon), but not for an oscilloscope or receiver that replace a sensor:

- **"FWD Sensor"** (forward sensors at the amplifier's directional coupler)
- **"REV Sensor"** (reverse sensors at the amplifier's directional coupler)
- **"TL Sensor"** (calibrating power meter)
Note that the "TL Sensor" is available only in the "EMS - Bulk Current Injection" and "EMS - CDN / EM-Clamp" hardware setups, in the latter not in [EUT Test View](#).

Note: The settings differ when you select one of the following device types instead of a conventional sensor / power meter:

- "Receiver": see ["Measurement Settings"](#) on page 291
- "Oscilloscope": see ["Oscilloscope Settings"](#) on page 291

Set the "Measurement Speed" to "Auto" (= default), "Fast", "Medium" or "Slow". For a description of this setting, refer to ["Measurement Speed"](#) on page 442.

Wideband power sensor

The following settings for gated measurements are available only for a [Power Meter](#) of the type R&S NRX or R&S NRP2 with wideband power sensor, hence if [RF Probe Type](#) is set to "NRP-Z8x". The "Time Gate AV" mode used here requires an external trigger signal from the power meter for every pulse from the corresponding output of the RF generator. A use case is an EMS test according to ISO 11452-9, which requires pulse modulation (pulse train).

With a wideband power sensor in this setup, additional time-gating settings are available in the dialog:

Power Meter Settings	
Measurement Speed	Auto
Gate Start Delay	0 s
Relative Gate Start	10 %
Relative Gate Length	80 %

- "Gate Start Delay" specifies the time to wait after the trigger event before starting the gate window.
- "Relative Gate Start" (%) specifies the fraction of the gate's length from its start, which R&S ELEKTRA uses to calculate the average power.
- "Relative Gate Length" (%) specifies the fraction of the gate's length from its end, which R&S ELEKTRA uses to calculate the average power.

For example, configure your hardware setup as in [Figure 4-108](#), to establish the trigger connection between the signal generator and the power meter:

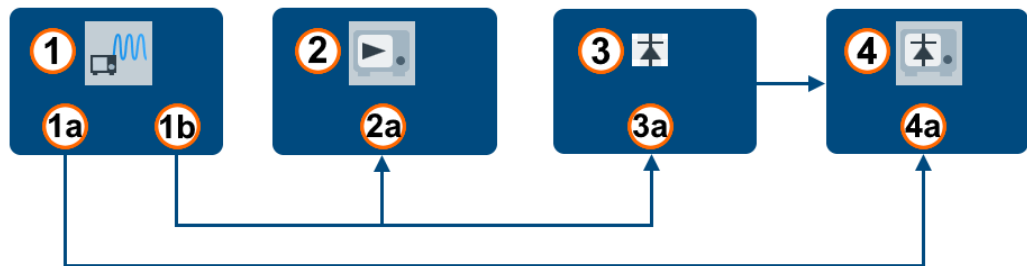

Figure 4-108: RF generator with pulse sequencer option and trigger connection to power meter

- 1 = Signal generator, e.g. R&S SMW200B with option R&S SMAB-K22 "High Performance Pulse Modulator" (1420.9710.02) and option R&S SMAB-K23 "Pulse Generator" (1420.9726.02)
- 1a = Pulse / video port
- 1b = RF output port
- 2 = Amplifier, e.g. R&S BBA300
- 2a = RF input port (FWD sample)
- 3 = Power sensor, e.g. R&S NRP-Z8x
- 3a = RF input port
- 4 = Power meter, e.g. R&S NRP2 or R&S NRX
- 4a = Trigger input port

Field Probe Settings ← Settings ← Device Properties ← Device Settings

To access the "Field Probe Settings" dialog, select "Device Properties" > "Settings" for a **field probe** device (with "Field Probe" icon), but not for an oscilloscope or receiver that replace a field probe.

Note: The "Field Probe" is available only in the "EMS Anechoic Chamber" and "TEM Waveguides" hardware setups.

The settings differ when you select one of the following device types instead of a conventional field probe:

- "Receiver": see ["Measurement Settings"](#) on page 291
- "Oscilloscope": see ["Oscilloscope Settings"](#) on page 291

The settings in this tab are used only for [Field Uniformity](#) measurements with a 4-channel [Field Probe](#) and with the [Leveling Mode](#) "Level On" = "Sensor". During such a closed-loop measurement, the power leveling refers to the readings of the 4-channel field probe with settings as specified in this dialog.

If you use the [Leveling Mode](#) "Level On" = "Transducer Power", the "Field Probe Settings" are used only for "Sensor Level" measurements (if enabled) in the [System Monitoring](#), but not for the [Additional Sensor Channels](#).

The "Measurement Source" setting is available only under the conditions described in [Chapter 4.5.3.5, "Additional Sensor Channels"](#), on page 303. Typical measurement sources are "Single", "Average", "Maximum" and "Minimum" as in the "Evaluation Mode" column of the [Additional Sensor Channels](#) section.

The setting "Measurement Channel" is available only, if "Measurement Source" is available for selection and set to "Single".

For the "Measurement Axis", you can select "XYZ" (= default), "X", "Y" or "Z".

Measurement Settings ← Settings ← Device Properties ← Device Settings

To access the "Measurement Settings" dialog, select "Device Properties" > "Settings" for a **receiver** device (with "Power Meter" icon), but not for a sensor, or an oscilloscope that replaces a sensor.

Note: The settings differ when you select one of the following device types instead of a receiver:

- "Sensor" / "Power Meter": see ["Power Meter Settings"](#) on page 289
- "Oscilloscope": see ["Oscilloscope Settings"](#) on page 291

For a description of these settings, refer to ["Settings \(Overview\)"](#) on page 212.

Oscilloscope Settings ← Settings ← Device Properties ← Device Settings

To access the "Oscilloscope Settings" dialog, select "Device Properties" > "Settings" for an **oscilloscope** (with "Power Meter" icon), but not for a sensor, or a receiver that replaces a sensor.

Note: The settings differ when you select one of the following device types instead of an oscilloscope:

- "Sensor" / "Power Meter": see ["Power Meter Settings"](#) on page 289
- "Receiver": see ["Measurement Settings"](#) on page 291

For a description of these settings, refer to [Chapter 4.8.16.1, "Functional Check"](#), on page 432.

As a special feature, if the test template uses more than one channel of the same oscilloscope, the checkbox "Inherit these oscilloscope settings" is available:

Measurement		Horizontal		Channel 1	Channel 2	Channel 3	Channel 4
Acquisition Mode	Measurement	Scale (s/Div)	5 ms	Scale (V/Div)	100 mV	50 mV	500 mV
Channel	Channel 1	Trigger Delay	0 s	Vertical Position	0 μV	10 μV	10 μV
Type	Amplitude	Trigger Source	Channel 1	Coupling	AC	AC	DC 50 Ω

Figure 4-109: These oscilloscope settings are inherited to all frequency ranges

Note: Example: if you use one oscilloscope channel as forward sensor and another oscilloscope channel as reverse sensor, you can choose to inherit the settings from one to the other instance. This inheriting feature works within the same [frequency range](#), and also across several frequency ranges.

- If you enable the checkbox in one instance of the oscilloscope, its settings are inherited to all other instances.

Inherit these oscilloscope settings  **Inherit these oscilloscope settings (inherited)**

- If you leave the checkboxes disabled in all instances of the oscilloscope, you can specify individual "Horizontal" and "Channel x" settings of the oscilloscope in each instance.

Inherit these oscilloscope settings  **Inherit these oscilloscope settings**

Hence, the function "Inherit these oscilloscope settings" simplifies the setup for using multiple channels of an oscilloscope: You only have to select the oscilloscope's "Channel" (left in [Figure 4-109](#)) in the "Measurement" tab of each instance.

Properties ← Device Properties ← Device Settings

The device-related [properties](#) are shown as specified in the [Device List](#). If you modify any device properties here, these properties are changed in all other instances, too: in the device list, in each hardware setup that uses this device, in each test template that uses this hardware setup, etc.

To avoid unintentional changing of device properties, the properties are locked in the test template dialog, as long as the hardware setup is [locked](#).

Generators Settings

Generators Settings

Available only, if the "Antenna Port" EMS test template is selected, see [Test Templates for EMS tests](#).

You can edit the "Generators Settings" for each generator referenced in the [Device Settings](#).

Note: Before you can proceed, first configure an [EMS hardware setup](#) and [select it](#) for one or more generator configurations. The software then shows the configuration list ([Figure 4-110](#)) specified in this hardware setup.



Frequency	Test Level	Device Settings	Generators Settings
<div style="display: flex; justify-content: space-around;"> <div style="text-align: center;"> <p>Generator 1</p>  <p>Generator</p> </div> <div style="text-align: center;"> <p>Generator 2</p>  <p>RF Generator</p> </div> <div style="text-align: center;"> <p>EUT Stimulus</p>  <p>SIM_Generator</p> </div> </div>			
①	Mode	>Generator 1 ▾	Mode >Generator 2 ▾
②	Frequency	f1 = f_1	Frequency (f0+f1)/2
③	Level	P1 = P_1	Level P1
④	Other Settings	Modulation OFF ▾	Other Settings Modulation OFF ▾
			Mode EUT Stimulus ▾
			Frequency f0 = f_0
			Level -30.1 dBm
			Other Settings Modulation OFF ▾

Figure 4-110: Example of generators settings in an EMS test template

- 1 = Generator's mode
- 2 = Formula defining the frequency of the generator
- 3 = Generator's test level
- 4 = Modulation setting

Mode ← Generators Settings

Selects the generator mode according to this table:

Generator	"Mode"
"Generator 1"	Fixed setting: "Generator 1"
"Generator 2"	<ul style="list-style-type: none"> • If no generator is selected, mode is set to "OFF" • If a generator is selected, mode is configurable: <ul style="list-style-type: none"> – "Generator 2" – "OFF"
"EUT Generator"	<ul style="list-style-type: none"> • If no generator is selected, mode is set to "OFF" • If a generator is selected, mode is configurable: <ul style="list-style-type: none"> – "EUT Stimulus" – "OFF"

Frequency ← Generators Settings

Specifies the generator's frequency range defined in the "Hardware Setup". See [Functional Check](#).

R&S ELEKTRA specifies the following:

- "Generator 1" - a fixed variable f_1
- "Generator 2" - a user-defined Python formula, see below for example
- "EUT Generator" - a fixed variable f_0

For "Generator 2", enter a valid Python formula using the default "Generator 1" (f_1) and "EUT Generator" (f_0) variables.

Example:

For a test according to the "CS103 Intermodulation" standard, the frequency for "Generator 2" that generates continuous wave can be:

$$(f_1 + f_0)/2$$

Level ← Generators Settings

Specifies the voltage level of the signal, interpreted in dBm.

R&S ELEKTRA specifies the following:

- "Generator 1" - a fixed variable P_1
- "Generator 2" - a user-defined Python formula
- "EUT Generator" - a user-defined test level (only numeric values are accepted)

See also [Functional Check](#).

Other Settings ← Generators Settings

Specifies the generator's modulation parameter, depending on the EUT modulation type or test standards.

See:

- [Generator](#)
- [Antenna Port](#)
- [Modulation List](#).

Reverb Settings

Available only if the "Reverberation Chamber" EMS test template is selected, see [Test Templates for EMS tests](#).

"No. of Tuner Steps" specifies the number of steps of the stirrer (mode tuner) during one full revolution. In the device list, the stirrer is a [Turntable](#) of the type "COMTEST Tuner".

"Sensor Positions" (available only for [Loaded Chamber](#) and [Unloaded Chamber](#)) specifies the number of field sensors in the chamber. The standard IEC EN 61000-4-21 allows reducing the number of sensor positions at higher frequencies.

4.5.3.4 System Monitoring

▼ System Monitoring

A simplified, frequency-range-independent hardware setup diagram shows icons of the devices (without device names) that are relevant for system monitoring. Below this diagram, the dialog lists all available system monitoring parameters (also called channels).

If you activate a parameter (or channel) for monitoring, the diagram shows a label flag for this channel's monitoring position.

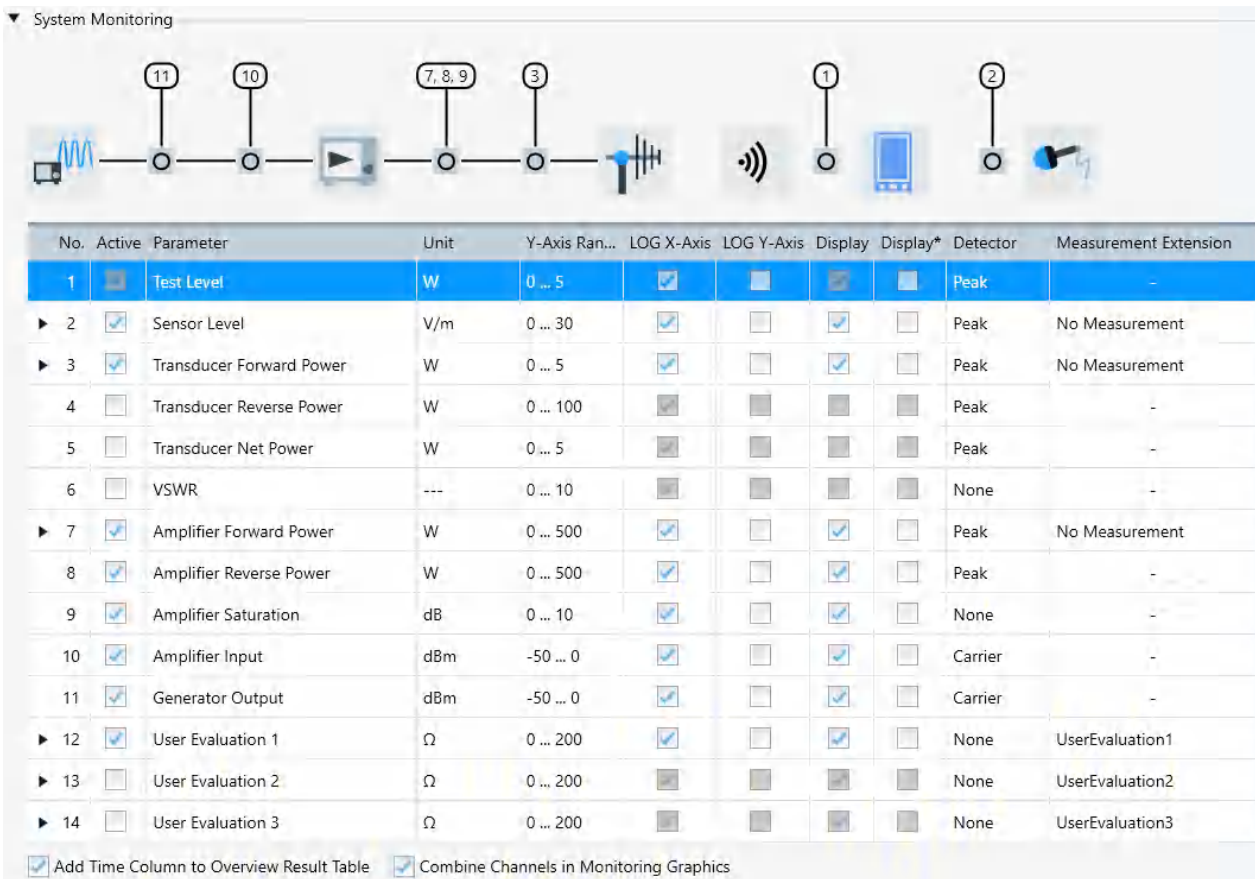

Figure 4-111: Example of a system monitoring configuration with a labeled diagram of monitoring positions



Special case in "Antenna Port" test template

If EMS Application is set to Antenna Port, you can select the following "Interferer" options for "Test Level", "Sensor Level" and "Generator Output":

- "OFF": default setting without interferer
- "Generator 2": the secondary generator is the interferer
- "EUT": the EUT is the interferer
- "Generator 2 + EUT": both the secondary generator and the EUT are interferers

Table 4-9: System monitoring parameters

Parameter name in the test template	Parameter name in the test (some abbreviated)
"Test Level"	"Test Level"
"Sensor Level" (*)	"Sensor Level"
"Transducer Forward Power" (*)	"Trd Fwd Pwr"
"Transducer Reverse Power"	"Trd Rev Pwr"
"Transducer Net Power"	"Trd Net Pwr"

Parameter name in the test template	Parameter name in the test (some abbreviated)
"VSWR"	"VSWR"
"Amplifier Forward Power" (*)	"Amp Fwd Pwr"
"Amplifier Reverse Power"	"Amp Rev Pwr"
"Amplifier Saturation"	"Amp Saturation"
"Amplifier Input"	"Amp Input"
"Generator Output"	"Gen Out"
"User Evaluation"	"UserEvaluation1", "UserEvaluation2", "UserEvaluation3" or user-defined name

(*) Optionally with "Harmonics" measurement, see ["Harmonics measurement"](#) on page 297.

You can activate individual parameters for monitoring. To do so, either enable the checkboxes in the table or click the icons of the monitoring position in the diagram:

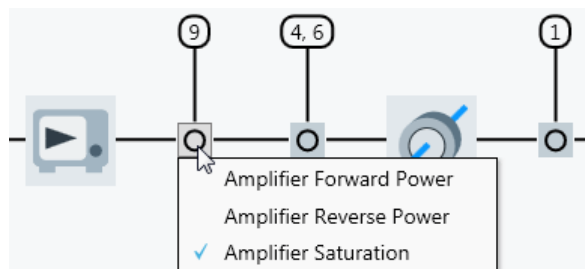

Figure 4-112: Click a position icon and select or unselect a monitoring channel

If activated, a channel's position is labeled in the diagram.

In the channel-settings table below the diagram, the columns have the following meanings:

- "No.": number of the channel, used also for a channel's label in the diagram
- "Active": checkboxes for enabling (activating) individual channels
- "Parameter": names of the system monitoring channels
- "Unit": physical units of the channels
- "Y-Axis Range": level ranges (y-axis) in the channels' charts (in their specified units)
- "LOG X-Axis": checkboxes for enabling logarithmic representation of the x-axis (frequency) in the channels' charts
- "LOG Y-Axis": checkboxes for enabling logarithmic representation of the y-axis (level, not for channels with dB unit)
- "Display": checkboxes for enabling the displaying of charts for the monitored channels (disabled: tables only)
- "Display*", available only, if [Test Method](#) = "EUT Qualification" or "EUT Susceptibility": The checkboxes enable merging the loop result tables for all accessory positions. The software merges the results after completing the overview measure-

ments across all frequency ranges. You can display charts of these merged results *before* leaving the measurement mode.

- "Detector": If there are modulated signals, the detector correction can be "Carrier", "Peak", or "RMS", as described in [Level Conservation for Modulation](#). No detector correction is applicable for the parameters [VSWR](#), [Amplifier Saturation](#) and [User Evaluation](#). The "Test Level" channel is limited to the detector correction type "Peak". The "Amplifier Input" and "Generator Output" channels are limited to the detector correction type "Carrier".
- "Measurement Extension": lists harmonics, if selected, see [Harmonics measurement](#)

To run measurements with the sensor while the [Leveling Mode](#) is set to [Level On](#) = "Substitution Method" or "Transducer Power", you must activate the "Sensor Level" channel.



If [Level On](#) = "Sensor", measurements automatically include the "Sensor Level", even if you deactivate it in the "System Monitoring" dialog. The software uses this automation, because in this case, the "Sensor Level" equals the "Test Level".

Evaluation options

The following details apply to charts and tables in the executed test:

- For each enabled channel, R&S ELEKTRA provides one graphic chart and one column in each result table.
- Optionally, let the software add a time column to each result table.
- The option "Combine Channels in Monitoring Graphics" merges the following groups of channels into one chart, each:
 - "Amp Fwd Pwr" and "Trd Fwd Pwr": together in a "Forward Power" chart
 - "Amp Rev Pwr" and "Trd Rev Pwr": together in a "Reverse Power" chart
 - "Amp Input" and "Gen Out": together in a "Source Power" chart

When you minimize the "System Monitoring" dialog with the "Collapse" button , a line in the section header shows all activated monitoring channels as a text string.

- [Harmonics measurement](#).....297
- [Amplifier Saturation](#).....298
- [User Evaluation](#).....299

Harmonics measurement

If the amplifier is operated in its saturated power range, where nonlinear amplification occurs, it typically creates spikes at harmonic multiples in the test signal. By using a receiver or spectrum analyzer as your forward power meter, you can measure these harmonics, if the signal path correction is calibrated up to the highest harmonic frequency.

Harmonics measurement is available only, if the following conditions are all met:

- You have activated the [license](#) for "ELEMS-S", which requires that a [dongle](#) with this license is connected

- You have selected "Amplifier Test", "EUT Qualification" or "EUT Susceptibility" as the [Test Method](#)
- You have selected a receiver or spectrum analyzer as the "FWD" sensor (forward power meter) in the [hardware setup](#), see "[Device Settings](#)" on page 285

If these conditions are all met, R&S ELEKTRA adds an expandable dialog to each of the "Sensor Level", "Transducer Forward Power" and "Amplifier Forward Power" lines in the "System Monitoring" dialog ([Figure 4-111](#)). Click the "Expand" button  to see the following dialog:

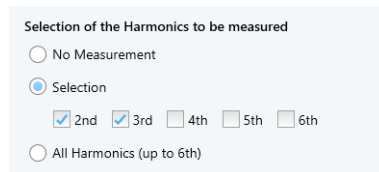

Selection of the Harmonics to be measured

No Measurement

Selection

2nd 3rd 4th 5th 6th

All Harmonics (up to 6th)

Figure 4-113: Example of selecting the harmonics to be measured

- "No Measurement" disables measuring harmonic frequencies
- "Selection" allows enabling selectively the 2nd, 3rd, 4th, 5th and 6th harmonics
- "All Harmonics (up to 6th)" automatically enables all "Selection" checkboxes

Amplifier Saturation

An amplifier saturation check for **radiated** tests (ISO 61000-4-3) requires the following steps:

1. Generate the target test level.
2. Measure the forward power.
3. *Reduce* the generator level by 5.1 dB.
4. Measure the forward power again.

The amplifier is considered as saturated, if the difference between the two measurements is outside of the limits 3.1 dB to **5.1** dB.

An amplifier saturation check for **conducted** tests (ISO 61000-4-6) requires the following steps:

1. Generate *1.8 times* the target test level.
2. Measure the forward power.
3. *Increase* the generator level by 5.1 dB.
4. Measure the forward power again.

The amplifier is considered as saturated, if the difference between the two measurements is outside of the limits 3.1 dB to **7.1** dB.

User Evaluation

Available only, if [EMS Application](#) is set to [Automotive / MIL-STD](#) or [Antenna Port](#).

If this condition is met, the "System Monitoring" dialog ([Figure 4-111](#)) gets the following additional content:

- R&S ELEKTRA adds **"Measurement Extension"** in a new column at the right-hand side of the list.
 - If you enable [Harmonics measurement](#), R&S ELEKTRA lists the selected harmonics in this column.
 - If you enable "User Evaluation", R&S ELEKTRA displays the "Evaluation Name" in this column.
- R&S ELEKTRA adds **"User Evaluation"** in 3 new lines at the lower end of the list. Each line has the same expandable dialog. Click the "Expand" button ▶ to see the following dialog:

The screenshot shows a dialog box for 'User Evaluation 1'. It has a title bar with a dropdown arrow, a checked checkbox, the text 'User Evaluation 1', and units 'mA' and '50 ... 110'. Below the title bar are four input fields: 'Evaluation Name' with the value 'ReducedTestLevel', 'Attenuation Table' with the value '<None>', 'Evaluation Formula' with the value 'TESTLEV(mA) - 0.5 db + CORRTRD', and 'Transducer Correction' with the value 'CDNE M210'. At the bottom of the dialog are two buttons: 'Check' and 'Evaluate Keyword'.

Figure 4-114: Example of settings for User Evaluation 1

Use this dialog as follows:

- "Evaluation Name" specifies an arbitrary name for each "User Evaluation" set. Alternatively, keep the default name, for example *UserEvaluation1*.
- "Evaluation Formula" allows combining selected test parameters into a new system monitoring parameter by a mathematical formula. To do so, define an arbitrary equation, using test parameters specified by the keywords in [Table 4-10](#). When you start typing in the formula field, R&S ELEKTRA offers keywords that match your entry. Or type a blank space to select from the full list of keywords. The syntax for the formula is Visual Basic.
- "Check" Displays the result of the formula, calculating it with internally specified typical values for each parameter. R&S ELEKTRA automatically checks the formula's syntax, if the evaluation is active.
- "Evaluate Keyword" Displays the current value of an individual parameter. To use this function, make sure to highlight exactly this parameter's keyword. Do not highlight more or less than the full keyword of a single parameter, including its unit in brackets.
- "Attenuation Table" Select an [Attenuation](#) table, if your formula calls for it by using the keyword "CORRATT".
- "Transducer Correction" Select a [Transducer Correction](#) table, if your formula calls for it by using the keyword "CORRTRD".

Table 4-10: Parameters available for user evaluation

Keyword	Alternative units in keyword	Meaning, regarding the current frequency point
FREQ{GHz}	MHz, kHz, Hz	Frequency
FRQSEC{GHz}	MHz, kHz, Hz	Frequency for "Generator 2"
PWRGEN{dBm}	radiated: MW, kW, W, mW, dBW, dB μ W conducted: W	"Generator Output"
PWRIN{dBm}	MW, kW, W, mW, dBW, dB μ W conducted: W	"Amplifier Input"
PWRFWD{dBm}	radiated: MW, kW, W, mW, dBW, dB μ W conducted: W	"Amplifier Forward Power"
PWRREV{dBm}	radiated: MW, kW, W, mW, dBW, dB μ W conducted: W	"Amplifier Reverse Power"
PWRTFWD{dBm}	radiated: MW, kW, W, mW, dBW, dB μ W conducted: W	"Transducer Forward Power"
PWRTREV{dBm}	radiated: MW, kW, W, mW, dBW, dB μ W conducted: W	"Transducer Reverse Power"
PWRTNET{dBm}	radiated: MW, kW, W, mW, dBW, dB μ W conducted: W	"Transducer Net Power"
PWRTOUT{dBm}	radiated: MW, kW, W, mW, dBW, dB μ W conducted: W	Transducer output power (3rd power meter in an "EMS - TEM Waveguide" test template)
EUTSENS{dBm}	W	"EUT Sensitivity" value of Specific Data tab of an EMS test template of the type Antenna Port
ATTGEN{dB}	-	Attenuation in the signal path from generator to amplifier
ATTFWD{dB}	-	Attenuation in the signal path from amplifier to forward power sensor
ATTREV{dB}	-	Attenuation in the signal path from amplifier to reverse power sensor
ATTRD{dB}	-	Attenuation in the signal path from amplifier to transducer
ATTOUT{dB}	-	Attenuation in the signal path from transducer to output power meter (3rd power meter in an "EMS - TEM Waveguide" test template)

Keyword	Alternative units in keyword	Meaning, regarding the current frequency point
ATTSENS{dB}	-	Attenuation in the sensor path, hence in the signal path from the transducer to the measurement instrument. For example, in a "BCI" test template, it is the path from the monitoring clamp to the measurement instrument. Or in an "Anechoic Chamber" test template, it is the path from the passive Rx antenna (instead of field probe) to the measurement instrument.
CORRDETPEAK{dB}		Peak detector correction in dB
CORRDETRMS{dB}		RMS detector correction in dB
RCGEN{dBm}	radiated: V/m, dBV/m, dB μ V/m, A/m, dB μ A/m, dBpT, MW, kW, W, mW, dBpW conducted: V, dBV, mV, dB μ V, A, dBA, mA, dB μ A, MW, kW, W, mW, dBpW	Generator output power specified in reference calibration table
RCFWD{dBm}	radiated: V/m, dBV/m, dB μ V/m, A/m, dB μ A/m, dBpT, MW, kW, W, mW, dBpW conducted: V, dBV, mV, dB μ V, A, dBA, mA, dB μ A, MW, kW, W, mW, dBpW	Transducer input power specified in reference calibration table
RCIML{dBm}	radiated: V/m, dBV/m, dB μ V/m, A/m, dB μ A/m, dBpT, MW, kW, W, mW, dBpW conducted: V, dBV, mV, dB μ V, A, dBA, mA, dB μ A, MW, kW, W, mW, dBpW	Test level specified in reference calibration table
TESTLEV{dBm}	radiated: V/m, dBV/m, dB μ V/m, A/m, dB μ A/m, dBpT, MW, kW, W, mW, dBpW conducted: V, dBV, mV, dB μ V, A, dBA, mA, dB μ A, MW, kW, W, mW, dBpW	"Test Level"
TESTNOMLEV{dBm}	radiated: V/m, dBV/m, dB μ V/m, A/m, dB μ A/m, dBpT, MW, kW, W, mW, dBpW conducted: V, dBV, mV, dB μ V, A, dBA, mA, dB μ A, MW, kW, W, mW, dBpW	Nominal (target) "Test Level"
IMMSENS{dBm}	radiated: V/m, dBV/m, dB μ V/m, A/m, dB μ A/m, dBpT, MW, kW, W, mW, dBpW conducted: V, dBV, mV, dB μ V, A, dBA, mA, dB μ A, MW, kW, W, mW, dBpW	"Sensor Level"
IMPEDSENS{ Ω }	-	Sensor level conversion impedance

Keyword	Alternative units in keyword	Meaning, regarding the current frequency point
IMPEDPWR{Ω}	-	Power level conversion impedance
CORRTRD	-	Transducer correction in dB Using "CORRTRD" requires selecting a table in the "Transducer Correction" field.
CORRATT	-	Attenuation in dB Using "CORRATT" requires selecting a table in the "Attenuation Table" field.
REFVAL		"Reference Value" as set in Measurement tab of an EUT monitoring channel
MEASVAL		Measured value of the monitoring channel
ABTREFUL{dBμV}		"Uplink Reference Value" in General Settings of an EUT monitoring template for audio breakthrough measurements
ABTREFDL{dBμV}		"Mobile Downlink Reference Value" in General Settings of an EUT monitoring template for audio breakthrough measurements
ABTREFHFS{dBμV}		"Hands-Free Speaker Audio Level" in General Settings of an EUT monitoring template for audio breakthrough measurements

In addition to the keywords, the formula can contain mathematical operators in [IronPython mathematical syntax](#) without the "math." prefix, as in [Table 4-21](#). For a broader overview, refer to the [Python tutorial](#).

Example: Calculation of transfer impedance

For a BCI test setup, you can calculate the transfer impedance T by the following equation:

$$T = 100 * (I_{cal} / I_{test}) * \text{SQRT}(P_{test} / P_{cal})$$

Parameter	Meaning	Keyword in "User Evaluation"
I_{cal}	Current from reference calibration	RCIML{mA}
I_{test}	Current from actual measurement	TESTLEV{mA}

Parameter	Meaning	Keyword in "User Evaluation"
P_{test}	Power from actual measurement	PWRTFWD{W}
P_{cal}	Power from reference calibration	RCFWD{W}

Hence, in an "EMS - Bulk Current Injection" test template, the formula for transfer impedance converts into R&S ELEKTRA syntax as follows:

$$100 * (\text{RCIML}\{\text{mA}\} / \text{TESTLEV}\{\text{mA}\}) * \text{sqrt}(\text{PWRTFWD}\{\text{W}\} / \text{RCFWD}\{\text{W}\})$$

4.5.3.5 Additional Sensor Channels

This section is available only, if the following conditions are **all** met:

- You have activated the [license](#) for "ELEMS-S", which requires that a [dongle](#) with this license is connected
- You have selected a test template of the type "EMS - Anechoic Chamber"
- You have selected a [hardware setup](#) of the type "EMS - Anechoic Chamber" with a **multichannel field probe**.
 - If you use a supported third-party field probe (with specific driver in R&S ELEKTRA), find the number of "Available Channels" in the field probe's [Measurement Correction](#) dialog in the [Device List](#).
 - If you use a generic field probe, go to the field probe's [Configuration > Parameters](#) tab in the "Device List". Select the correct number in the "Number of Channels" parameter field.
- In the test template, you have selected "Field Uniformity" as the [Test Method](#)
- In the test template's [Accessory Settings](#) dialog, you have activated the loop parameter "Position"
 - To see this dialog, make sure to select "Overview Measurement" in the [Measurement Flow](#) dialog (if available)
- In the "Position" section of the "Accessory Settings" dialog, you have enabled the "Use 4 Channel Sensor" checkbox
 - If you use 4 probes next to each other, covering a horizontal row of 4 positions in the 4x4-position test matrix ([Figure 8-2](#)) of a [field uniformity](#) measurement, enable the "Row" mode:



Figure 4-115: Toggle switch with Row enabled

With this setting , for the first row, channel 1 is mapped to position 1, channel 2 to position 2, and so on.

- If you use 4 probes on top of each other, covering a vertical column of 4 positions in the 4x4-position test matrix of a field uniformity measurement, enable the "Column" mode:



Figure 4-116: Toggle switch with Column enabled

With this setting , for the first column, channel 1 is mapped to position 1, channel 2 to position 5, channel 3 to position 9, channel 4 to position 13. For the second column, channel 1 is mapped to position 2, channel 2 to position 6, channel 3 to position 10, channel 4 to position 14, and so on.

This combination of settings makes the "Additional Sensor Channels" dialog available. It facilitates using a multichannel field probe (MFP) system in R&S ELEKTRA and allows monitoring multiple sensor channels instead of a single "Sensor Level" channel. Hence, "Additional Sensor Channels" uses the MFP subchannels for an extended [System Monitoring](#).



If you perform a multi-probe [field uniformity](#) measurement, you must set the additional field probes as channels.

To configure the field probe channels, expand the "Additional Sensor Channels" dialog with the "Expand" button .

For each sensor channel, specify the following settings:

- Enable or disable the field-probe channels in the "Active" column via the checkbox "Sensor Level" in the [System Monitoring](#) dialog
- The "Device Type" is preset as "Field Probe" and cannot be changed
- Select an "Evaluation Mode":
 - "Single"
 - "Average"
 - "Maximum"
 - "Minimum"
- In the "Single Source" column, the channel numbers "1" to "4" are preset
- Select the measurement axis in the "Axis Selection" column (separate "X", "Y", "Z" or all together "XYZ")



This dialog corresponds with the "Field Probe Settings" tab that is shown in the [Flow Details > Frequency Range List > Device Settings > Device Properties > Settings](#) dialog, when the "Field Probe" device is selected (highlighted).

When you minimize the "Additional Sensor Channels" dialog with the "Collapse" button , a line in the section header shows all activated sensor channels as a text string.

4.5.3.6 Test Information

▼ Test Information

This dialog allows editing test information that is relevant for all (or most) of the tests that you run from this test template. By entering this information in the test template instead of in the test, you avoid having to enter the same information repeatedly for the same type of tests.

To edit your predefined titles and contents for an individual test, open the [test information dialog](#) within this test.



Figure 4-117: Test information dialog

+ Add Information



- "Add Information"**
 Adds a new row in the test information table, below the default lines "Description", "Test Standard", "Test Site" and "Operator Name".
- "Shift Row Up / Down"**
 The buttons swap the position of the selected row with the one above or below it.
- "Title"**
 Enter a title for each row of test information.
 Click the titles headline to sort the rows alphabetically by their titles.
- "Content"**
 Enter arbitrary content in each row of test information. You can also leave the content of a row blank and enter only the title, for entering the content later (within the tests).
 Click the contents headline to sort the rows alphabetically by their contents.



Content history

For each category, R&S ELEKTRA memorizes previously stored text in the "Content" column. After saving the test template and deleting any text from the "Content" column, the software helps you in restoring that text by selecting it from a context dialog.



- "Delete Row"**
 Deletes the selected row without additional warning and without the possibility to restore the deleted title and content.

4.5.3.7 Actions

▼ Actions

This dialog defines actions that are executed when a particular event occurs during a measurement.



Figure 4-118: Actions dialog

The available actions are:

- [Email](#) - sending an email message to alert the user
- [Notify](#) - sending a notification to alert the user
- [Wait](#) - waiting for a defined time before R&S ELEKTRA continues with the next step of a test. During this time, you can stop the test.
- [Run Program](#) - running a selected executable program
- [Send Remote Command \(Remote Action device\)](#) - sending a remote control SCPI command to a device
- [Query Status \(Remote Action Device\)](#) - sending a query request for the status of a device
- [Send Remote Command \(Monitoring device\)](#) - sending a remote control SCPI command to a monitoring device
- [Set IO Device](#) - using available output channels
- [Set Switch Unit](#) - using switch units
- [Set Generator](#) - using generators
- [Capture Screenshot](#) - let R&S ELEKTRA take pictures of the test instrument's user interface during a measurement.
Available only for [Actions](#) in [EUT Monitoring templates](#).

Typical events, for which actions can be assigned, are:

- "Test Start/Resume"
- "Test Pause"
- "At Every Frequency (Pre Dwell)"
- "At Every Frequency (Post Dwell)"
- "Frequency range", where the event can be:
 - "Enter" the frequency range
 - "Leave" the frequency range
- "Overview Measurement", where the event can be:
 - "Enter" the measurement
 - "Leave" the measurement
- "Test Stop" (scan end or user interruption)
- "Test Error"

Assigning an action

To assign an action to an event, draw the action icon from "Available Actions" (left) to the name of that specific event in "Actions of the Test" (center).

For example, click-and-hold "Notify", drag it to "Test Stop" and drop it there.

Click any assigned action to edit it in the "Properties" tab.

To remove an action from an event, select the icon of that specific action and click [Delete] on the keyboard. Alternatively, right-click an action icon to select [Delete] from the context menu. In [touch operation](#) on a tablet computer, tap and hold the icon of an action and select [Delete] in the context menu.



For more information, refer to the description of [Actions](#) for EMI tests.

Send Remote Command (Monitoring device)

Only available for EMS tests, sends SCPI commands to set DC or AC input to a selected [Monitoring](#) device.

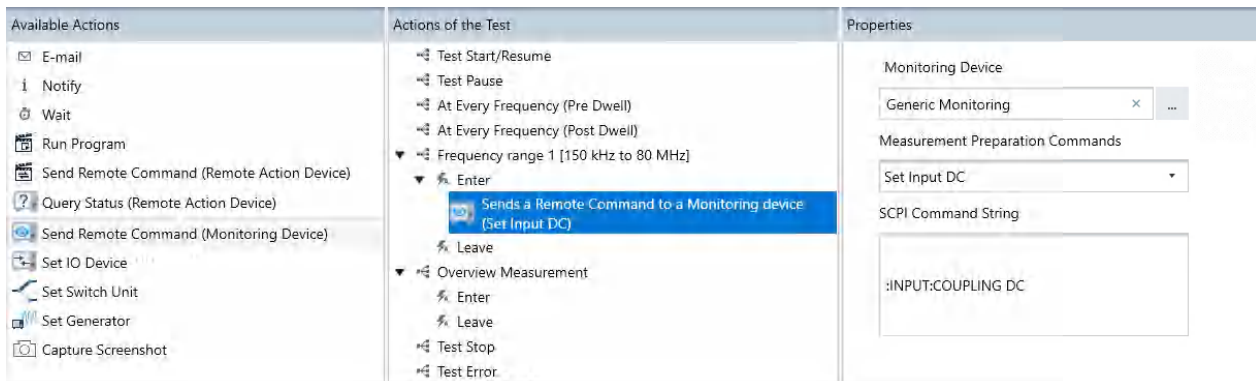

Figure 4-119: Action "Send Remote Command to a Monitoring device" assigned to event "Enter Frequency Range"

"Monitoring Device(s)"	Selects the SCPI-controllable Monitoring device from the Device List .
"Measurement Preparation Commands"	Selects either "Set Input DC" or "Set Input AC" with a previously defined remote control command (see below).
"SCPI Command String"	Displays the command string for the action selected above. Define this string in the "Device List" at SCPI Command String .

4.5.3.8 Excluded Frequency Bands

Excluded Frequency Bands

Use this tabular dialog to exclude frequency bands from all measurements that are based on this test template. The bands do not necessarily have to cover the existing frequency ranges.

You can add or remove, activate or deactivate frequency bands, define their start and stop frequencies and their band names.

Per default, one "Band 1" is predefined, but *not activated*, with start and stop frequencies of 100 MHz to 200 MHz. New excluded frequency bands automatically receive name labels "Band x" (where x is the row index) and start / stop frequencies for the next 100 MHz above the highest existing frequency band.

4.5.4 EUT Monitoring templates

This chapter explains how to create and configure EUT monitoring templates, which are used to control EUT monitoring procedures in an [EMS test](#).



EUT monitoring templates are used only in EMS tests, see [Chapter 4.4.1.3, "Configuring EMS tests"](#), on page 94.

EUT monitoring templates define the following settings:

- How to drive the measurement instruments by remote control
- How to display the measured values
- How to evaluate these values to decide, whether the EUT has failed or not

In contrast to other types of templates, EUT monitoring templates are not associated with a measurement class (radiated or conducted).

Access: "Home" > "Test Templates" > "Create Test Template" > "EUT Monitoring"

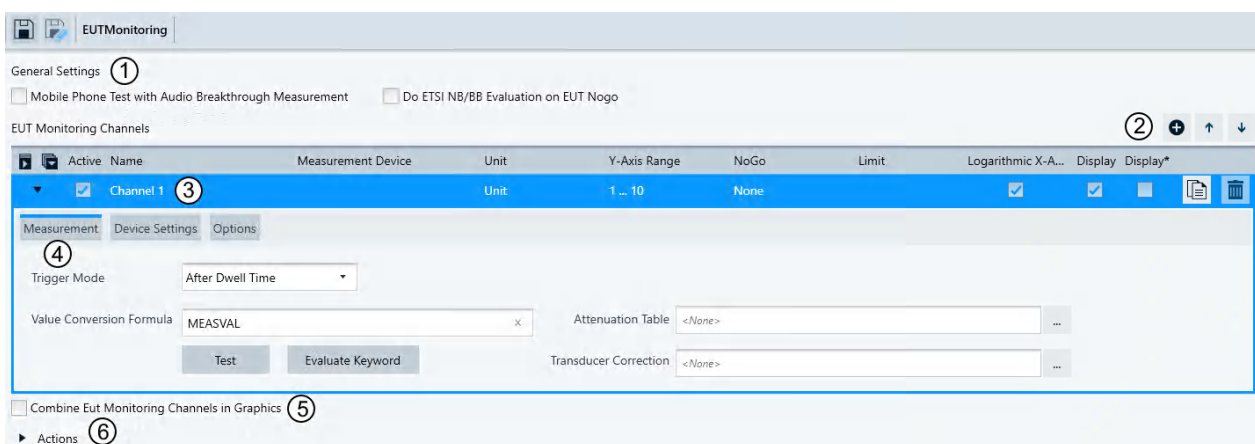

Figure 4-120: Default EUT monitoring template

- 1 = Available only, if the "ELEMS-ABT" license is enabled. Selects mode of EUT monitoring template: [General Settings](#)
- 2 = [Adds channels](#) and shifts the selected channel [up or down](#)
- 3 = [Activates](#) or deactivates measurements in a channel and specifies a [channel name](#)
- 4 = Selects additional specification tabs, here: [Measurement](#)
- 5 = Selects the option to combine EUT monitoring channels in graphics
- 6 = Selects [Actions](#)

General Settings	309
Add Monitoring Channel	310
Move Up / Down the Selected Channel	310
Active	310
Name	310
Measurement Device	310
Unit	310
Y-Axis Range	310
NoGo	311
Limit	311
LOG X-Axis	311
LOG Y-Axis	311
Display	311
Display *	311
Duplicate Channel	312

Delete Channel.....	312
Measurement.....	312
L Trigger Mode.....	312
L Value Conversion Formula.....	312
L Test Formula.....	313
L Evaluate Keyword.....	314
L Reference Value (REFVAL).....	314
L Attenuation Table.....	314
L Transducer Correction.....	314
Device Settings.....	314
L Select Device.....	314
L Device Properties.....	315
L Settings.....	315
L Settings Analyzer.....	315
L Field Probe Settings.....	316
L Power Meter Settings.....	316
L Oscilloscope Settings.....	316
L IO Device Settings.....	317
L Programming and Measurement.....	317
L Signal to be monitored.....	318
L Settings.....	319
L Properties.....	322
Options.....	322
Combine EUT Monitoring Channels in Graphics.....	323
Actions.....	323

General Settings

Available only, if the "ELEMS-ABT" license is enabled.

Option for audio breakthrough measurement, selects test modes:

- "Mobile Phone Test with Audio Breakthrough Measurement"
If enabled, specify the following output levels (dB μ V) of the generator. Setting these voltage levels adapts the audio levels to the results of your ABT calibration (see "Audio Breakthrough" on page 123):
 - "Uplink Reference Value"
 - "Mobile Downlink Reference Value"
 - "Hands-Free Speaker Audio Level"
- "Do ETSI NB/BB Evaluation on EUT Nogo"
Activates the narrowband (NB) / broadband (BB) evaluation upon EUT failure (NoGo).
During the NB/BB evaluation, according to ETSI 301 489-52, R&S ELEKTRA applies the following frequency shifts either to the test signal frequency or to the radio communication test channel:

Table 4-11: Frequency shifts during NB/BB evaluation

Technology	1st frequency shift	2nd frequency shift	Done by
GSM	Increase <i>and</i> decrease by 400 kHz	Increase <i>and</i> decrease by 500 kHz	EMS interferer
WCDMA	Increase or decrease by 25 channel numbers (UARFCN)	Increase or decrease by 50 channel numbers (UARFCN)	Radio communication tester
LTE	Increase or decrease by channel BW	Increase or decrease by 2 x channel BW	EMS interferer
5G FR1	Increase or decrease by channel BW (uplink for FDD user-defined)	Increase or decrease by 2 x channel BW (uplink for FDD user-defined)	EMS interferer
5G FR2	Increase or decrease by channel BW	Increase or decrease by 2 x channel BW	EMS interferer

Note: ETSI 301 489-52 does not specify frequency shifts for WLAN and BT.



Add Monitoring Channel

Creates an additional channel in the same EUT monitoring template.



Move Up / Down the Selected Channel

Available only, if at least one other channel is displayed above / below the selected channel. The button swaps the position of the selected channel with the one above / below it.

You do not necessarily have to arrange channels in any specific order.



Active

Activates or deactivates measurements in a channel.

Name

R&S ELEKTRA automatically enters the channel name in alphanumeric order, for example starting with "Channel 1". If you select a channel for an "EMCAN" interface or for an "AdVISE" Visual Inspection tool, R&S ELEKTRA automatically copies the name from the selected monitoring channel and enters it in the "Name" field. You can edit the channel name.

Measurement Device

In this field, R&S ELEKTRA automatically enters the name of the measurement device, when the device is selected for a channel (see [Select Device](#)).

Unit

Specifies the unit in which the measurement device returns information on the EUT's monitoring status. You can enter an arbitrary name for this unit.

Y-Axis Range

Specifies the value range for the measurement unit. The maximum range is $-1E+09$ to $+1E+09$.

NoGo

Not available for all measurement devices, for example not for "AVL", "AdVISE" or "EMCAN" [Monitoring](#) devices.

A "NoGo" event represents a failure of the EUT. The "NoGo" parameter selects from the following criteria for detecting such a failure:

"None (= default)"	The measured value is not compared with any other value, and a Limit cannot even be defined.
"Above Limit Value"	A failure of the EUT is detected, if the measured value is above the value defined as the Limit .
"Above Limit Line"	A failure of the EUT is detected, if the measured value is above the limit line, which you have selected to define frequency-dependent Limit values.
"Below Limit Value"	A failure of the EUT is detected, if the measured value is below the value defined as the Limit .
"Below Limit Line"	A failure of the EUT is detected, if the measured value is below the limit line, which you have selected to define frequency-dependent Limit values.
"Outside Value Range"	A failure of the EUT is detected, if the measured value is below the lower value or above the upper value defined as the Limit range.
"Inside Value Range"	A failure of the EUT is detected, if the measured value is above the lower value or below the upper value defined as the Limit range.

Limit

Not available, if "NoGo" is set to "None".

- Defines the upper or lower limit value (default = 5), or a limit value range (default = 4 to 6), depending on the selected [NoGo](#) criterion.
- If [NoGo](#) is set to "Above Limit Line" or "Below Limit Line", this field selects the limit line.

If you activate [Display](#), R&S ELEKTRA shows the limits defined in this field in the graphics diagram of this channel. Limit values are shown as a bold red line, or two lines for a [NoGo](#) value range. A selected limit line is shown with its frequency-dependent limit values.

LOG X-Axis

Enables or disables logarithmic representation of the frequency axis.

LOG Y-Axis

Enables or disables logarithmic representation of the test-level axis.

Display

Activates displaying the measurement value of this channel in a graphics diagram, together with the [NoGo Limit](#) lines.

Display *

Activates displaying the measurement values of this channel in a graphics diagram that shows the merged loop results.

Duplicate Channel

Creates a monitoring channel with the same settings as the selected channel.

**Delete Channel**

Available only, if at least two channels are present. Deletes the selected channel without additional warning and without the possibility to restore a deleted channel with its settings.

Measurement

Measurement

The "Measurement" dialog provides access to trigger settings, a value conversion formula, an attenuation table and a transducer correction table for the selected channel.

Trigger Mode ← Measurement

Selects the trigger instant for the EUT monitoring measurement:

"After Dwell Time Elapsed" The measurement is executed after the **Dwell** time is elapsed (= default).

"Before Dwell Time Elapsed" The measurement is executed before the **Dwell** time is elapsed.

This setting can be relevant, for example, for triggering and starting measurements that must detect and store brief error states during the dwell time. The detection performance can depend on the measurement instrument used, which must run cyclic measurements during the dwell time and must store the worst-case state.

Value Conversion Formula ← Measurement

Defines an algebraic formula that converts a combination of values into a target result. An example is the conversion of a voltage into a temperature value.

You can use the following values in the formula:

- "MEASVAL" = the measured value
- "REFVAL" = the reference value from [Reference Value \(REFVAL\)](#)
- "CORRTRD" = the transducer correction value from [Transducer Correction](#)
- "CORRATT" = the attenuator correction value from [Reference Value \(REFVAL\)](#)
- "ABTREFUL" = the "Uplink Reference Value" from the [ABT](#) measurement
- "ABTREFDL" = the "Mobile Downlink Reference Value" from the [ABT](#) measurement
- "ABTREFHFS" = the "Hands-Free Speaker Audio Level" from the [ABT](#) measurement

Type the conversion formula in [IronPython mathematical syntax](#), without the "math." prefix. The following table provides an alphabetical overview of the most commonly used operators, using "MEASVAL" as an example:

Table 4-12: Syntax of the value conversion formula (instead of MEASVAL, you can use the values listed above)

Operator	Function
+	Addition
-	Subtraction
*	Multiplication
/	Division

Operator	Function
abs(MEASVAL)	Absolute value of MEASVAL
acos(MEASVAL)	Arc cosine of MEASVAL (in radians)
asin(MEASVAL)	Arc sine of MEASVAL (in radians)
atan(MEASVAL)	Arc tangent of MEASVAL (in radians)
ceil(MEASVAL)	Smallest integer \geq MEASVAL
cos(MEASVAL)	Cosine of MEASVAL (in radians)
degrees(MEASVAL)	Converts angle MEASVAL from radians to degrees
e	The mathematical constant e to precision 2.718282
exp(MEASVAL)	Power of MEASVAL on base e
floor(MEASVAL)	Largest integer \leq MEASVAL
int(MEASVAL)	Integer of MEASVAL, int(-9.5)=-9
log(MEASVAL)	Natural logarithm of MEASVAL (on base e)
log(MEASVAL,x)	Logarithm of MEASVAL on base x
log10(MEASVAL)	Common logarithm of MEASVAL (on base 10)
pi	The mathematical constant π to precision 3.141593
pow(MEASVAL,x) or: MEASVAL**x	MEASVAL to the power of x
pow(x,MEASVAL) or: x**MEASVAL	x to the power of MEASVAL
radians(MEASVAL)	Converts angle MEASVAL from degrees to radians
sin(MEASVAL)	Sine of MEASVAL (in radians)
sqrt(MEASVAL)	Square root of MEASVAL
tan(MEASVAL)	Tangent of MEASVAL (in radians)

The precision of the output value is two decimal places.

For a broader overview, refer to the [Python tutorial](#).

Example:

Convert power from watts to dBm:

```
"10 * log10 (MEASVAL * 1000)"
```

Convert power from dBm to watts:

```
"pow (10,(MEASVAL/10)) / 1000"
```

```
or: 10**(MEASVAL/10) / 1000
```

Test Formula ← Value Conversion Formula ← Measurement

Tests the [value conversion formula](#) with "MEASVAL" = 1.

Example:

Testing the formula $20 * (\text{MEASVAL} + 4) * (\text{MEASVAL} + 1)$

returns the result "200", with $20 * (1 + 4) * (1 + 1) = 20 * 5 * 2 = 200$.

Testing the formula $10 * \log_{10}(\text{MEASVAL} * 1000)$

returns the result "30", with $10 * \log_{10}(1000) = 10 * 3$ (hence, 1 W = 30 dBm).

Evaluate Keyword ← Value Conversion Formula ← Measurement

Displays the current value of the value conversion formula. To use this function, make sure to highlight exactly this formula's keyword.

Reference Value (REFVAL) ← Measurement

Specifies a reference value, which you can use in the [value conversion formula](#).

The following options are available to update the reference value:

- "No Update on Test Start" does not update the reference value when the test starts
- "Update on Test Start" updates the reference value when you "Start" the test by doing a measurement on this channel while the RF immunity level is still off
- "Update on Test Start and Confirm" is the same as "Update on Test Start", but additionally R&S ELEKTRA brings up a dialog that shows the measured reference value. You can modify or confirm this value.
- "Update on Measurement with RF OFF" performs two measurements for every channel: one with RF off, and one with RF on. Regarding the EUT's behavior in a given channel, this procedure allows calculating the difference between the measurement results with RF on and RF off.

Attenuation Table ← Measurement

Click to select one of the following options:

- Select an existing attenuation table.
- "Create New" to create a new (**empty**) table. Then "Select" or "Edit" that table.
- "Edit" to open the selected existing attenuation table for editing it.

Transducer Correction ← Measurement

Click to select one of the following options:

- Select an existing transducer correction table.
- "Create New" to create a new (**empty**) table. Then "Select" or "Edit" that table.
- "Edit" to open the selected existing transducer correction table for editing it.

Device Settings**Device Settings**

This dialog provides access to the hardware setup diagram for the EUT monitoring channel.

Select Device ← Device Settings

Click the device icon or the  button next to the "Select Device" field to select a measurement device from the [Device List](#).

This measurement device is the only selectable lab device in the hardware setup diagram for EUT monitoring.

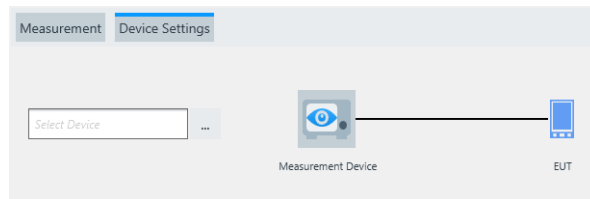



Figure 4-121: Device selection and settings dialog

You can select a device from one of the following device types as your measurement device for EUT monitoring:

- [Audio Analyzer](#)
- [Field Probe](#)
- [IO Device](#)
- [Monitoring device](#)
- [Oscilloscope](#)
- [Power sensor or power meter](#)
- [Radio Communication Tester](#)

Device Properties ← **Select Device** ← **Device Settings**

Specifies the properties of the selected measurement device.

Clicking the "Device Properties" button toggles between hiding  and showing  the "Device Properties" dialog, which includes test-related "Settings" and device-related "Properties".

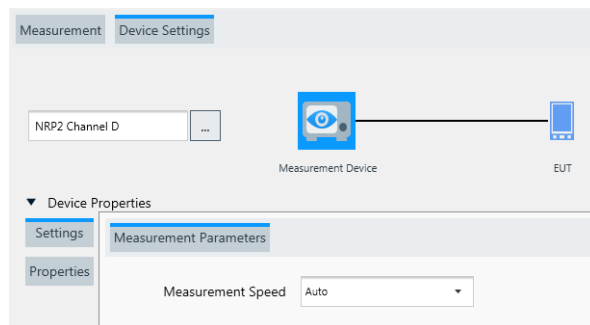

Settings ← **Device Properties** ← **Select Device** ← **Device Settings**

Provides access to the measurement parameters described below.

The available settings depend on the selected [measurement device](#).

Settings Analyzer ← **Settings** ← **Device Properties** ← **Select Device** ← **Device Settings**

Available only, if the selected [measurement device](#) is an [Audio Analyzer](#).

Specifies the [Analyzer Config](#), [Analyzer Function](#), and [Measurement Filter](#) settings. For a description in the [Device List](#) section, refer to [Chapter 4.8.7.1, "Functional Check"](#), on page 403.

You can test the functioning of these settings in the [Properties](#) > "Functional Check" tab.

Field Probe Settings ← Settings ← Device Properties ← Select Device ← Device Settings

Available only, if the selected [measurement device](#) is a [field probe](#).

Allows the following "Axis Selection":

- "XYZ" - the field probe performs an isotropic measurement
- "X" - the field probe measures only the X field component
- "Y" - the field probe measures only the Y field component
- "Z" - the field probe measures only the Z field component

For a description in the [Device List](#) section, refer to [Chapter 4.8.8.3, "Functional Check"](#), on page 412.

You can test the functioning of these settings in the [Properties](#) > "Functional Check" tab.

Power Meter Settings ← Settings ← Device Properties ← Select Device ← Device Settings

Available only, if the selected [measurement device](#) is a [Power meter or power sensor](#).

Selects the power meter's "Measurement Speed": "Auto" (= default), "Fast", "Medium", "Slow".

If the power meter type is **"Erickson-PM5"**, the dialog comprises a different set of measurement parameters.

For a description in the [Device List](#) section, refer to ["Measurement Speed"](#) on page 442.

You can test the functioning of these settings in the [Properties](#) > "Functional Check" tab.

Oscilloscope Settings ← Settings ← Device Properties ← Select Device ← Device Settings

Available only, if the selected [measurement device](#) is an [Oscilloscope](#).

"Acquisition Mode" = "Measurement"

Sets the oscilloscope's measurement, trigger and channel parameters. For a description in the [Device List](#) section, refer to [Chapter 4.8.16.1, "Functional Check"](#), on page 432.

As a special feature, if the EUT monitoring template uses more than one [monitoring channel](#) of the same oscilloscope, an additional checkbox "Inherit these oscilloscope settings" is available:

	Channel 1	Channel 2	Channel 3	Channel 4
Acquisition Mode	Measurement			
Channel	Channel 1			
Type	Amplitude			
Horizontal Scale (s/Div)	5 ms			
Trigger Delay	0 s			
Trigger Source	Channel 1			
Vertical Scale (V/Div)	100 mV	50 mV	50 mV	500 mV
Vertical Position	0 μV	0 μV	10 μV	10 μV
Coupling	AC	AC	AC	DC 50 Ω

Figure 4-122: These oscilloscope settings are inherited to all monitoring channels

- If you enable the checkbox in one monitoring channel, the settings of this (primary) monitoring channel are inherited to all other (secondary) monitoring channels.

Inherit these oscilloscope settings  Inherit these oscilloscope settings (inherited)

- If you leave the checkboxes disabled in all monitoring channels, you can specify individual "Horizontal" and "Channel" settings of the oscilloscope in each monitoring channel.

Inherit these oscilloscope settings  Inherit these oscilloscope settings

Hence, the function "Inherit these oscilloscope settings" simplifies the setup for the dependent monitoring channels: You only have to select the oscilloscope's "Channel" (left in [Figure 4-122](#)) in the "Measurement" tab of each monitoring channel.

"Acquisition Mode" = "Mask Test"

Selects the oscilloscope's mask-test mode and sets some parameters for it. You must configure all other mask-test parameters in the oscilloscope before starting the acquisition. For a description in the [Device List](#) section, refer to [Chapter 4.8.16.1, "Functional Check"](#), on page 432 > [Mask Test](#).

You can test the functioning of these settings in the [Properties](#) > "Functional Check" tab.

IO Device Settings ← Settings ← Device Properties ← Select Device ← Device Settings

Available only, if the selected [measurement device](#) is an [IO Device](#).

Selects the IO device's digital and/or analog input ports and channels. For a description in the [Device List](#) section, refer to [Chapter 4.8.12.1, "Functional Check"](#), on page 419.

You can test the functioning of these settings in the [Properties](#) > "Functional Check" tab.

Programming and Measurement ← Settings ← Device Properties ← Select Device ← Device Settings

Available only, if the selected [measurement device](#) is a [Monitoring](#) device of the type **"Generic Monitoring"**.

"Measurement Preparation Commands" Selects programming commands previously defined in the [Properties](#) > [Device Programming](#) tab (see [Chapter 4.8.14.1, "Device Programming"](#), on page 428). Use these commands to set specific parameters in the monitoring device, for example, the AC/DC or current/voltage mode in a digital multimeter.

Your selection defines, which of the available commands are sent to the monitoring device before measuring with this [channel](#). For example, a monitoring channel 1 can measure a current, while a monitoring channel 2 measures a voltage. The software can send several programming commands per monitoring channel, in the order as specified in the list. If there is only one monitoring channel in the device, all programming commands are sent only once upon starting the measurement.

"Options"	Enables or disables R&S ELEKTRA sending a trigger command before or after the dwell time, as specified in the Measurement > Trigger Mode setting. With or without the optional trigger, the "Measurement Result Query Command" query starts the measurement.
"Measurement Result Query Command"	Selects a query that you have previously defined in the Measurement Result Queries tab of the monitoring device's properties dialog. This query starts the measurement. If "Send 'Trigger' Command" is enabled (see "Options"), the trigger command is sent also, according to the current trigger settings. Per monitoring channel, only one query command is available. During the test run, the selected "Measurement Result Query Command" automatically triggers a measurement on the selected monitoring channel, before or after the dwell time is elapsed (see Measurement > Trigger Mode).
"Check"	"Execute" allows testing a combination of a selected command from the "Measurement Preparation Commands" with the return value of a selected query from the "Measurement Result Queries". R&S ELEKTRA displays the monitoring device's return value in the "Result" field.

You can test the functioning of these settings in the [Properties > "Functional Check"](#) tab.

For the settings of the other, non-generic "Monitoring" devices, see ["Signal to be monitored"](#) on page 318.

Signal to be monitored ← Settings ← Device Properties ← Select Device ← Device Settings

Available only, if the selected [measurement device](#) is a **Monitoring** device of one of the following types:

- "AVL Interface"
The [AVL Interface](#) enables communication between R&S ELEKTRA and the automotive test-bench control software PUMA / CONCERTO by 3rd-party manufacturer AVL. The system runs EMI measurements with automotive components or systems, for example with an electric vehicle's engine being the EUT. During such measurements, that control software serves for varying the EUT's states, like different voltages, engine speeds, or power modes. Hence, these states are monitoring parameters.
The dialog selects the signal (or parameter) to be monitored, as described in [Chapter 4.8.14.3, "Functional Check"](#), on page 429.
- "AdVISE", visual inspection tool
"ROIs available in AdVISE" selects a region of interest ("ROI") to be monitored, as described in [Chapter 4.8.14.3, "Functional Check"](#), on page 429. The ROI must be defined in R&S AdVISE.
- "EMCAN Interface" for CAN buses
Select one of the following options, as described in [Chapter 4.8.14.3, "Functional Check"](#), on page 429:
 - "Signals" selects the test signal to be monitored
R&S ELEKTRA automatically enters the name of the selected monitoring channel in the [Name](#) field.

- "System Variables" selects the test system variable to be monitored
- "Environment Variables" selects the test environment variable to be monitored

"Update List" reads the available parameters from the monitoring device and updates the pull-down fields listed below. You can save your selection.

You can test the functioning of these settings in the [Properties](#) > "Functional Check" tab.

For the "Generic Monitoring" device settings, see "[Programming and Measurement](#)" on page 317.

Settings ← Settings ← Device Properties ← Select Device ← Device Settings

Available only, if the selected [measurement device](#) is a [Radio Communication Tester](#).

This dialog specifies the "Signaling" settings and "Measurement" settings, depending on the type of radio communication tester.

- **"CMW500-BT"**

For this [type](#) of radio communication tester, the dialog has the following "Settings":

- "Signaling":
Specifies the [BT](#) signal configuration, see [Signaling with CMW500-BT](#).
- "Measurement":
Specifies the [BT](#) performance measurement settings, see "[Performance measurements](#)" on page 466.
"Quantity to Measure":
"BER BT" selects measuring the block error rate for Bluetooth classic.
"PER BT" selects measuring the packet error rate for Bluetooth classic or Bluetooth low energy (LE).

- **"CMW500-WLAN"**

For this [type](#) of radio communication tester, the dialog has the following "Settings":

- "Signaling":
Specifies the [WLAN](#) signal configuration, see [Signaling with CMW500-WLAN](#).
- "Measurement":
Specifies the [WLAN](#) "PER Measurement" settings, see "[Performance measurements](#)" on page 466.

- **"CMW500-GSM"**

For this [type](#) of radio communication tester, the dialog has the following "Settings":

- "Signaling":
Specifies the [GSM](#) signal configuration, see [Signaling with CMW500-GSM](#).
Note that the "Service Domain" setting in this dialog ("Circuit Switched" or "Packet Switched") influences the measurement mode available this dialog and in the "Measurement" dialog.
"BER Measurement" for "[Circuit Switched](#)" "CMW500-GSM".
"Measure Mode":
- "Burst by Burst": the radio communication tester transmits only bits without error protection (class 2 bits) and evaluates the [BER](#) on a burst-by-burst basis. Hence, the absence of guard bits enhances the BER measurement speed. The mobile station uses loop mode C, where its internal test loop closes before decoding or encoding any channel.

- "BER": the radio communication tester determines the bit error rate for class 1b bits and class 2 bits. The mobile station uses loop mode B, where its internal test loop closes after channel decoding.
- "RBER/FER" is the ratio of the residual BER relative to the FER "BER/BLER Measurement" for "Packet Switched" "CMW500-GSM".
- "Measurement Type":
 - "BLER" is the block error rate, see BLER
 - "BER" is a measurement that tests the transmission performance on the complete signal path from the R&S CMW to the mobile station under test and back "Service" (only for "BER") selects the service domain for PS connection either in "Test Mode B" or "SRB" mode (EGPRS switched radio block loopback mode).
 - In the "Test Mode B", the R&S CMW transmits RLC blocks on the downlink, containing a pseudo-random data sequence. The mobile station loops back the received data.
 - In the "SRB" mode, the R&S CMW performs the BER test in EGPRS switched-radio-block loopback mode, before decoding any channel.
- "Measurement":
 - Specifies the GSM performance measurement settings, see "Performance measurements" on page 466.
 - Note that the "Service Domain" setting in the "Signaling" dialog ("Circuit Switched" or "Packet Switched") influences the "Quantity to Measure" available in this "Measurement" dialog.
 - "Quantity to Measure" for "Circuit Switched" "CMW500-GSM".
 - "RX Quality" is a status query that denotes the received signal quality and does not trigger a measurement in the R&S CMW.
 - "RX Level" is a status query that denotes the received signal power and does not trigger a measurement in the R&S CMW.
 - "BER GSM", a BER measurement in the "Burst by Burst" measure mode.
 - "BER Class2 GSM" in the "BER" measure mode is the ratio of received erroneous class 2 bits over the total number of received class 2 bits.
 - "BER Class2 GSM" in the "RBER/FER" measure mode is the residual BER for class 2 bits.
 - "BER Class1b GSM" in the "BER" measure mode is the ratio of received erroneous class 1b bits over the total number of received class 1b bits.
 - "BER Class1b GSM" in the "RBER/FER" measure mode is the residual BER for class 1b bits.
 - "FER GSM" in the "RBER/FER" measure mode: see FER
 - "Bursts" or "Speech Frames" specifies the number of bursts or speech frames transmitted per measurement cycle.
 - "Quantity to Measure" for "Packet Switched" "CMW500-GSM".
 - "BLER GSM" in the "BLER" measurement type, a BLER measurement that compares the erroneous RLC data blocks received by the mobile station since the start of the measurement
 - "Throughput GSM" in the "BLER" measurement type, the R&S CMW calculates the long-term throughput from the number of transmitted blocks and the related transmission time.
 - "C Value", in the "BLER" measurement type, or in the "BER" measurement type with "Service" = "Test Mode B", is the normalized received signal level at

the GSM mobile station averaged over the radio blocks. "C Value" is also a status query and does not trigger a measurement in the R&S CMW.

- "BER GSM" in the "BER" measurement type, a [BER](#) measurement where the R&S CMW compares the looped-back uplink data (N bit) to the transmitted downlink data.

- "DBLER GSM" (data block error rate) in the "BER" measurement type is similar to "BLER GSM", but excludes all bits that result in a block error.

"RLC Data Blocks" specifies the number of [RLC](#) data blocks transmitted per measurement cycle.

- **"CMW500-WCDMA"**

For this [type](#) of radio communication tester, the dialog has the following "Settings":

- "Signaling":

Specifies the [WCDMA](#) signal configuration, see [Signaling with CMW500-WCDMA](#).

"BLER Measurement" selects the measurement type, see ["Performance measurements"](#) on page 466:

- "BLER", a [BER](#) measurement in the R&S CMW that tests the transmission performance on the complete signal path from the R&S CMW to the [UE](#) under test and back. The measurement result is derived from the R&S CMW's output signal with the signal received from the [UE](#) in test loop operation. In the test loop operation, the [UE](#) returns the received and decoded data blocks back to the R&S CMW.

- "HSDPA BLER", an [HSDPA ACK](#) measurement in the R&S CMW that evaluates the demodulation of the high-speed downlink shared channel (HS-DSCH) by the [UE](#) and measures the data throughput.

- "Measurement":

Specifies the [WCDMA](#) performance measurement settings, see ["Performance measurements"](#) on page 466.

Note that the "Measurement Type" setting in the "Signaling" dialog ("BLER" or "HSDPA BLER") influences the "Quantity to Measure" available in this "Measurement" dialog.

"Quantity to Measure":

- "BER WCDMA" in the "BLER" measurement type, a [BER](#) measurement.

- "BLER WCDMA" in the "BLER" measurement type, a [BLER](#) measurement that evaluates the share of received transport blocks with at least one erroneous bit in the data part or in the CRC (cyclic redundancy check) field.

- "DBLER WCDMA" (data block error rate) in the measurement type "BLER", evaluates the share of received transport blocks with at least one erroneous bit in the data part. Errors in the CRC field are ignored.

- "DL BLER WCDMA" in the measurement type "HSDPA BLER", a [DL BLER](#) measurement performed over carrier 1 that evaluates the share of [NACK](#) transmissions, irrespective of the used redundancy version.

"Transport Blocks", available only for "BLER", specifies the number of transport blocks measured per measurement cycle.

"Measure Subframes", available only for "HSDPA BLER", specifies the number of [HSDPA](#) subframes measured per measurement cycle.

- **"CMW500-LTE"**

For this [type](#) of radio communication tester, the dialog has the following "Settings":

- "Signaling":

Specifies the [LTE](#) signal configuration, see [Signaling with CMW500-LTE](#).

- "Measurement":
Specifies the [LTE](#) performance measurement settings, see "[Performance measurements](#)" on page 466:
"Quantity to Measure":
 - "BLER LTE", a [BLER](#) measurement that determines the in-sync or out-of-sync indication during radio link monitoring.
 - "Throughput LTE" is the number of bits transmitted in a subframe over a specific bandwidth.
To determine the "BLER LTE" and "Throughput LTE", the measurement sends data to the [UE](#) via physical downlink shared channel (PDSCH) subframes and evaluates the positive acknowledgments ([ACK](#)) and negative acknowledgments ([NACK](#)) returned by the [UE](#).
"No. of Subframes" specifies the number of subframes measured per measurement cycle.
- **"CMX500"**
For this [type](#) of radio communication tester, the dialog has the following "Settings":
 - "NR":
Specifies the [NR](#) signal configuration, see [NR](#)
 - "LTE":
Specifies the [LTE](#) signal configuration, see [LTE](#)
 - "Measurement":
Selects the "Quantity to Measure" for a specified "Number of Frames", for example:
"BLER" (block error rate) for "LTE", "NR", "WCDMA" or "GSM"
"Throughput" (transmitted bits per time in a given bandwidth) for "LTE" or "NR"
"BER" (bit error rate) for "GSM", optionally class 1 or 2
"FER" (frame error rate) for "GSM"
"Number of Frames" specifies the number of packets to be sent during the measurement for judging the quality of connection in the EUT's reply. Typical LTE and 5G frames have a duration of 10 ms.

If you have defined more than 1 [monitoring channel](#), the "NR" and "LTE" settings are available only in the first channel, because only 1 radio communication tester is available for establishing the connection to your EUT. However, you can select additional "Measurement" quantities ("BLER" or "Throughput") in the additional monitoring channels, with the same "Number of Frames".

Properties ← Device Properties ← Select Device ← Device Settings

The "Properties" are as specified in the device list, see [Chapter 4.8.2, "Device properties"](#), on page 377. If you modify any device properties here, these properties are changed in all other instances, too: in the device list, in each hardware setup that uses this device, in each test template that uses this hardware setup, etc.

Options

If you enable "Worst Case Analysis", R&S ELEKTRA searches for each "EUT Monitoring" channel across all test frequencies and all accessory-loop positions in all overview result tables for the largest (worst) deviation from the [NoGo](#) criteria. It enters the search results (measurement points with largest deviation) into a new worst-case table. You can view a measurement point's loop parameters as a label in the test chart, for example "90 deg, V".

Combine EUT Monitoring Channels in Graphics

Allows combining the results of several EUT monitoring channels in a single graphic chart.

R&S ELEKTRA automatically combines channels (or groups of channels) only, if the following conditions are all met:

- You have enabled the checkbox
- More than 1 channel is available
- The **NoGo** limit is the same for all channels, or for a group of channels to be combined
- The **Unit** of the y-axis (level) is the same for all channels, or for a group of channels to be combined

If variations in the parameters "NoGo" and "Unit" divide the channels into multiple groups, channels can be combined within these groups. In this case, in the list of channels in the monitoring template, the **1st** channel in the group of combined channels is the primary graphic. It contains the traces and determines the scaling and other settings of the chart.

Example:

If the 1st and 3rd channels are combined, and the 2nd and 4th channels are combined, then the 1st and 2nd channels are the primary graphics.

▼ Actions

Actions

This dialog defines actions that are executed, when a particular event occurs during a measurement.

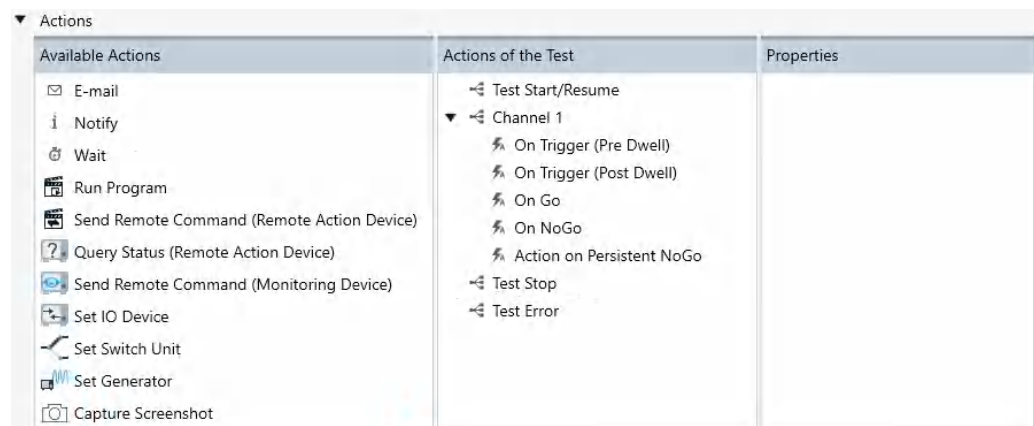

Figure 4-123: Actions dialog

The available actions are described at the linked sections:

- **Email** - sending an email message to alert the user
- **Notify** - sending a notification to alert the user
- **Wait** - waiting for a defined time before R&S ELEKTRA continues with the next step of a test. During this time, you can stop the test.
- **Run Program** - running a selected executable program
- **Send Remote Command (Remote Action device)** - sending a remote control SCPI command to a device

- [Query Status \(Remote Action Device\)](#) - sending a query request for the status of a device
- [Send Remote Command \(Monitoring device\)](#) - sending a remote control SCPI command to a monitoring device
- [Set IO Device](#) - using available output channels
- [Set Switch Unit](#) - using switch units
- [Set Generator](#) - using generators
- [Capture Screenshot](#) - letting R&S ELEKTRA take pictures of the monitoring device's user interface, available only with a monitoring device that supports screenshots

Typical events, for which actions can be assigned, are:

- "Test Start/Resume"
- "Channel <n>", where R&S ELEKTRA shows as many channels as you have [added](#). The event can be:
 - "On Trigger (Pre Dwell)" - executes assigned actions upon receiving a trigger signal before the dwell time
 - "On Trigger (Post Dwell)" - executes assigned actions upon receiving a trigger signal after the dwell time
 - "On Go" - executes assigned actions, when a [Measurement](#) is completed without violating the "NoGo" condition
 - "On NoGo" - executes assigned actions, when a [Measurement](#) violates the "NoGo" condition
 - "Action on Persistent NoGo" - executes assigned actions, when a [Measurement](#) consistently violates the "NoGo" condition
- "Test Stop" (scan end or user interruption)
- "Test Error"

Assigning an action

To assign an action to an event, draw the action icon from "Available Actions" (left) to the name of that specific event in "Actions of the Test" (center).

For example, click-and-hold "Notify", drag it to "Test Stop" and drop it there.

Click any assigned action to edit it in the "Properties" tab.

To remove an action from an event, select the icon of that specific action and click [Delete] on the keyboard. Alternatively, right-click an action icon to select [Delete] from the context menu. In touch operation on a tablet computer, tap and hold the icon of an action and select [Delete] in the context menu.

4.6 Report Templates

Report templates are used for the configuration of [test reports](#). Report templates contain user-definable settings and are contained in [Tests](#), as shown in the [software structure](#).

Handling report template items

Access: "Home" > "Report Templates"



Depending on the selection of one or several report templates, different action buttons are available in the actions bar. All these buttons are common action buttons, described in [Chapter 3.3, "Common action buttons"](#), on page 45.



Specify general settings for report templates at "Home" > "Administration" > [Settings](#) > [Report](#).

With "Open" or "Create Report Template", proceed as described in [Chapter 4.6.1, "Configuring report templates"](#), on page 325.

4.6.1 Configuring report templates

Either start with an existing report template, or create a new one.

- To open an existing report template, use one of the following options:
 - Select it at "Home" > "Report Templates" and click "Open". Opening a report template from this menu allows saving it as a global report template, available for other tests, but you cannot configure all details.
 - Open it from within a test as described in [Chapter 3.9, "Reporting"](#), on page 60. Opening a report template inside a test allows configuring all details, but you cannot save it as a global report template, available for other tests.
- To create a report template, use one of the following approaches:
 - Select "Home" > "Report Templates" > "Create: Report Template". Creating a report template from this menu allows saving it as a global report template, available for any test, but you cannot configure all details.
 - Create a report template from within a test as described in [Chapter 3.9, "Reporting"](#), on page 60. Creating a report template inside a test allows configuring all details, but you cannot save it as a global report template, available for other tests.
 - Create a customized report template as described in ["External"](#) on page 552, and in [Chapter 6.6, "Creating customized reports"](#), on page 577.

Hence, create your report templates outside a test and configure them with all contents that are not test-specific. Then save these report templates as global report templates. Inside a test, select one of your global report templates and refine it by configuring specific details. The detailed report template is saved in the test container as a copy of the original report template. This copy is not globally available.

In the "General" section of the report template, specify the report title as well as the left-hand, center and right-hand content of both the report header and footer.

All items that can be included into the report header or footer are self-explanatory, except for the [Verdict](#).

Below the header and footer, select from a list of "Available Components" in an arbitrary order. Double-click an item, or click the "Selected Component" button  next to it, to add the item to the list of "Selected Components" (dialog below the "Available Components").



In this list, you can rearrange the "Selected Component": drag and drop them to the desired position. (If you use a tablet computer, touch and immediately drag the object you want to move, without holding it for long.)

Most of the "Selected Component" offer individual "Component Options", for which you can specify settings when you have highlighted that "Selected Component". For example, If you have selected "Generic Table", its "Component Options" include the selection of the "Table Type" (e.g., "Limit Line" and "Transducer Correction"). For each type, you can enable the checkbox "Include All Table(s) of Selected Type" to include into the report template a placeholder for all tables of this type.

In part, you can specify options only when the report template is opened (embedded) inside a real test. Outside of a test, hence in a non-embedded report template, placeholders for the selected components are inserted into the report preview.

Options of embedded report templates

The following options are available only for **embedded** report templates, opened inside a test:



- For the component "EMI Tables", select at least one of the "Available Tables" by clicking the "+" sign (+) to add it to the list of "Selected Tables". In the selected table, optionally select a subset of rows and optionally disable individual columns. In this context, the checkbox "Use Report Relevant Column" (available only in an embedded report template) provides two options for each table:
 - If unchecked, the report shows the columns of this table as selected here, in the report template.
 - If checked, the report ignores the selection in the report template. Instead, it shows the columns as selected with  in the [Show / Hide Columns](#) dialog  of that table's header, or in its context menu.
- For the component "Generic Graphics", select at least one of the "Available Graphics" by clicking the "+" sign (+) to add it to the list of "Selected Graphics".
- For the component "Generic Table", select at least one of the "Available Tables" by clicking the "+" sign (+) to add it to the list of "Selected Tables".
- For the component "EMS Graphics", select at least one of the "Available Graphics" by clicking the "+" sign (+) to add it to the list of "Selected Graphics".
- For the component "EMS Tables", select at least one of the "Available Tables" by clicking the "+" sign (+) to add it to the list of "Selected Tables". In the selected table, optionally select a subset of rows and optionally disable individual columns. The table selection in embedded report templates has the following additional features:

The checkbox "Exclude row(s) without results" is available for "Spectrum Overview", only.



 - If unchecked, printing the report includes all rows of this table, even if empty.
 - If checked, printing the report ignores rows without results.

The checkbox "Use Report Relevant Column" is available for all tables:

 - If unchecked, the report shows the columns of this table as selected here, in the report template.



- If checked, the report ignores the selection in the report template. Instead, it shows the columns as selected with  in the [Show / Hide Columns](#) dialog  of that table's header, or in its context menu.

Action buttons in the report's top menu



To put any change into effect, click the small "Refresh" button  in the *top menu of the report*. If you edit an embedded report template inside a test, do **not** use the taller "Refresh" button  in the *top menu of the test*.

The placeholders shown for selected components in non-embedded report templates provide no details. Therefore, we recommend creating basic report templates from the report templates menu and refining them within your tests, as described above.



When you have finished configuring the report template, make sure to **save** the result by clicking  or  in the [Test control top menu](#).

Next to the "Refresh" button  in the top menu of the report, more functions are available for the following:

- Exporting the report in PDF  or DOCX  format. The default format is set in the [Administration > Report](#). When you click the export button, you can still switch to the non-default format.
- Attaching
The "Attach" button , which is only available for embedded report templates, saves a report in the R&S ELEKTRA database together with the test, see [Chapter 3.9, "Reporting"](#), on page 60.
- Toggling the display of miniature views of report pages in a sidebar
- Printing the report
- Searching for text in the report
- Zooming the report view
- Navigating the report's pages

Note that tables that do not fit on the length of one page are continued on the next page (or pages). Tables that do not fit on the width of one page are split to fit on the width of n pages. They are labeled "(1/ n)" on the first page and continued with labels "(2/ n)", "(3/ n)", ... until "(n / n)". To reduce the width of a table, deselect columns that are dispensable. This deselection can only be done in a report template that is embedded within a test.

Zoom settings for selected graphics

With this feature, you can better visualize the chart in reports without creating and storing a new chart by zooming in to a specific area.

To render a specific region of an existing chart for reporting

1. Verify that one of the following is available in the "Selected Components":
 - "EMI Graphics"
 - "EMS Graphics"

- "Generic Graphics"

Otherwise, add the component from the list of "Available Components" by clicking .

2. In the "Selected Components", select (highlight) the relevant component, for example "EMI Graphics".

The dialog displays the "Available Graphics".

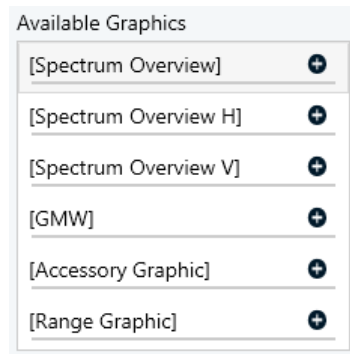



Figure 4-124: Available Graphics box

3. For each chart that you want to add to the report, click the select button .

This chart's entry appears in the list of "Selected Graphics".

4. If you want to specify zoom settings for a selected graphic, expand its zoom-settings.

To do so, click the expand button .

The zoom-settings box opens.

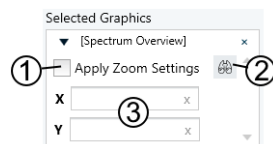

Figure 4-125: Zoom-settings box

1 = Checkbox applies zoom settings to report

2 = Selects predefined camera views in spherical and cylindrical charts

3 = [Zoom settings parameters](#)

Note: If a chart has stored zoom settings, you cannot edit these settings here in the zoom-settings box. See ["Store Zoom Settings"](#) on page 103.

5. Enter the "X" and "Y" parameters (3 in [Figure 4-125](#)) with a syntax as in [Table 4-13](#). R&S ELEKTRA automatically applies the correct units from the chart.

Note: For spherical or cylindrical charts, you can select a predefined camera direction from a list. To open this list, click the "Select View" button (2 in [Figure 4-125](#)). For the view that you select, R&S ELEKTRA automatically enters the correct "X" and "Y" parameters.

6. To let your settings take effect for the report, enable the "Apply Zoom Settings" checkbox (1 in [Figure 4-126](#)).
7. To immediately execute your settings in the report, click the small refresh button . See ["Action buttons in the report's top menu"](#) on page 327.

Zoom settings parameters

The "X" and "Y" zoom parameters require different entries for different chart types. Also, take care to use correct syntax for these parameters.

Table 4-13: Syntax for X and Y parameters

Chart type	Designation	Description	Syntax	Examples
Cartesian, Heat map	Range	<p>"X" and "Y" depend on the chart type:</p> <ul style="list-style-type: none"> • Cartesian chart of spectral measurement: "X" = frequency (Hz), "Y" = level (e.g. dBm) • Heat map of spectrum-over-azimuth measurement: "X" = turntable azimuth (deg), "Y" = frequency (Hz) • Heat map of cylindrical measurement: "X" = turntable azimuth (deg), "Y" = antenna height (m) 	<p>Enter value pairs "a;b" with semicolon (;) as separator.</p> <p>"a" is minimum value, "b" is maximum value.</p> <p>"a" (minimum) is smaller than "b" (maximum).</p> <p>Common unit prefixes and negative values are accepted, but frequency is always positive.</p>	<p>Frequency syntax</p> <ul style="list-style-type: none"> • 200M;1G • 200;1G • 200;600 <p>Wrong syntax</p> <ul style="list-style-type: none"> • 1G;200
Cartesian, Heat map	Center/span	<p>"X" and "Y" depend on the chart type:</p> <ul style="list-style-type: none"> • Cartesian chart of spectral measurement: "X" = turntable azimuth (deg), "Y" = frequency (Hz) • Heat map of cylindrical measurement: "X" = turntable azimuth (deg), "Y" = antenna height (m) 	<p>Enter value pairs "a:b" with colon (:) as separator.</p> <p>"a" represents center, "b" represents span.</p> <p>The absolute value of "a" (center) is greater than the absolute value of "b" (span).</p> <p>Common unit prefixes and negative center values are accepted, but span is always positive.</p>	<p>Frequency syntax</p> <ul style="list-style-type: none"> • 1G:200 • 600:200 <p>Wrong syntax</p> <ul style="list-style-type: none"> • 200M:1G • 200:1G
Spherical, Cylindrical	Absolute	<p>"X" represents elevation θ and "Y" represents azimuth ϕ of the viewing direction in angular degrees.</p>	<p>Enter single values between 0 and +360.</p>	<p>Degrees syntax</p> <ul style="list-style-type: none"> • 90 • 45 <p>Wrong syntax</p> <ul style="list-style-type: none"> • -10 • 362

Upon refreshing the report with correct zoom settings, the test report displays the zoomed chart.

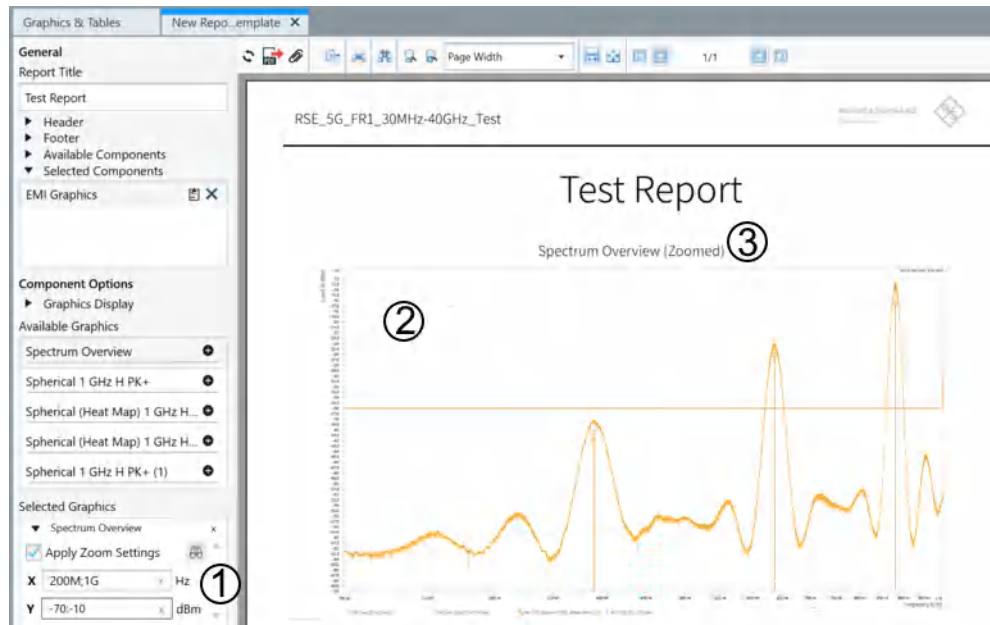

Figure 4-126: A test report with a chart that has correct zoom parameters configured

- 1 = "X" and "Y" parameters
- 2 = Zoomed-in chart
- 3 = Chart title with label "(Zoomed)", indicating that zoom configuration is applied

Otherwise, the report displays the original chart without zoom and error messages for the user to verify the error.

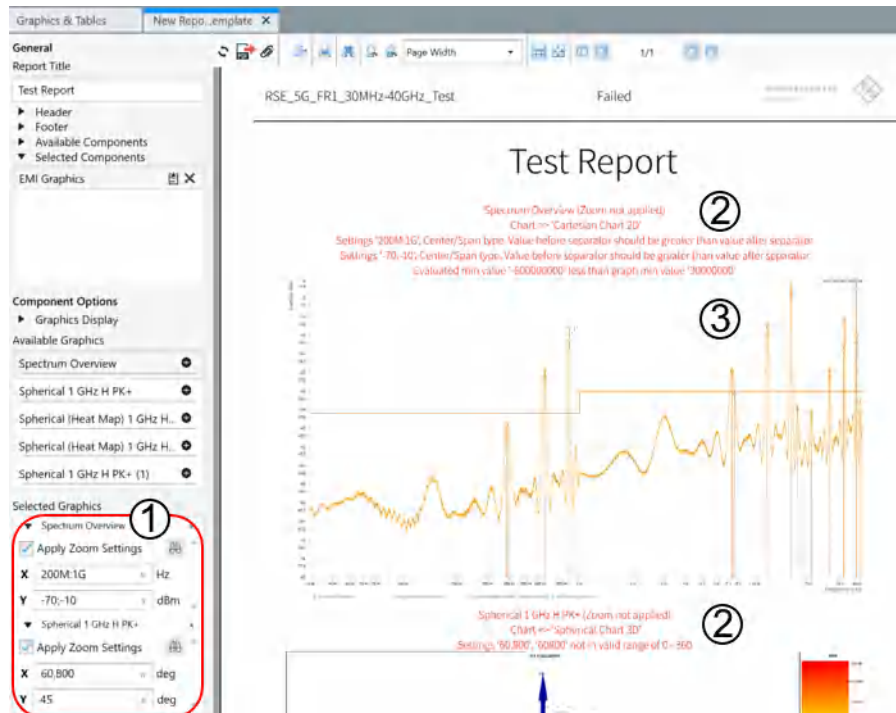

Figure 4-127: A test report with charts that have incorrect zoom parameters configured

- 1 = Zoom settings with incorrect parameters
- 2 = Error messages
- 3 = Original chart without zoom settings applied

4.7 Hardware Setups

Available only, if you have activated at least one [license](#) above "ELEMI-E", which requires that a [dongle](#) with this license is connected.

Hardware setups are used to create [Test Templates](#). Hardware setups contain [Devices](#) and [Signal Paths](#), as shown in the [software structure](#), along with user-definable configuration settings.

NOTICE

Risk of changing device properties more globally than intended

Hardware setups allow you to **modify [Device properties](#)**. Note that such a modification globally modifies the device in the [Device List](#). The changes are valid for **all hardware setups** that use this device.

Handling hardware setup items



Access: "Home" > "Hardware Setups"

Depending on the selection of one or several hardware setups, different action buttons are available in the actions bar. All are common action buttons, described in [Chapter 3.3, "Common action buttons"](#), on page 45.

With "Open" or "Create: Hardware Setup", proceed as described below:

Configuring hardware setups

Either start with an existing hardware setup, or create a new one:

- To open an existing hardware setup, select it at "Home" > "Hardware Setups" and click "Open"
- To create a hardware setup, select "Home" > "Hardware Setups" > "Create Hardware Setup". In the dialog that comes up, select the hardware setup type:

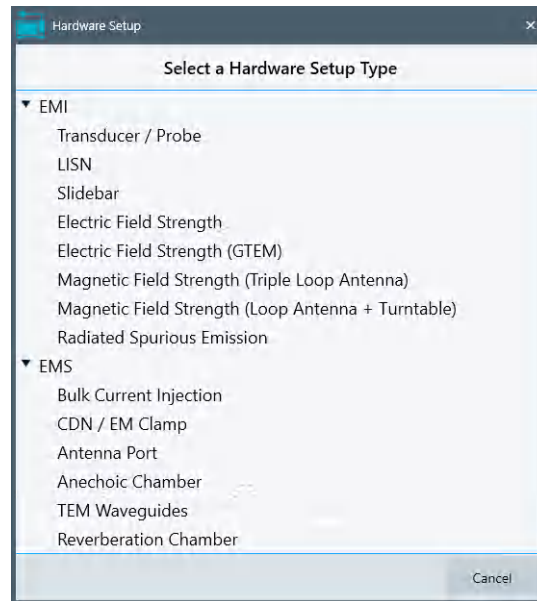

Figure 4-128: Hardware setup types in two groups: EMI and EMS

- "EMI" - see [Hardware setups for EMI tests](#)
- "EMS" - see [Hardware setups for EMS tests](#)

Selecting one of these hardware setup types, which are described in the following chapters, opens a hardware setup dialog as in [Figure 4-129](#):

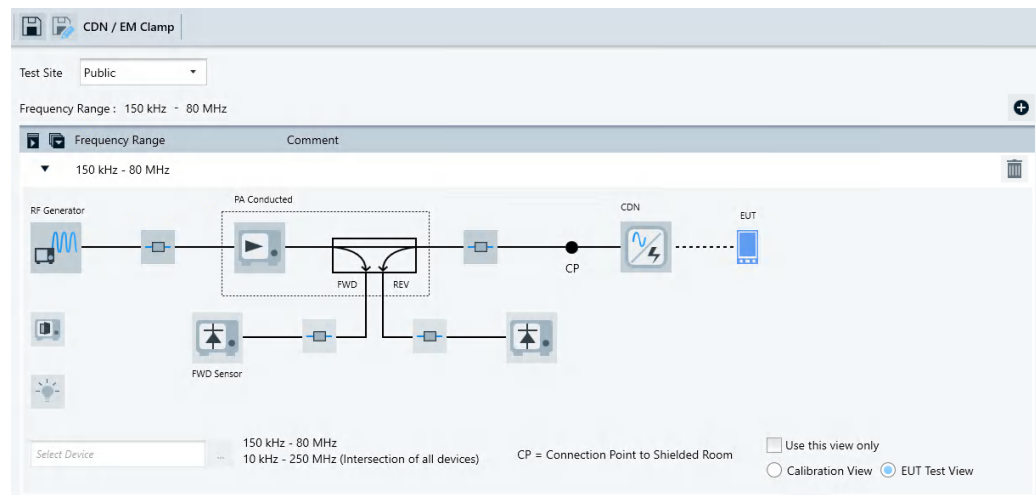

Figure 4-129: Example of a blank EMS hardware setup dialog

A central building block of each hardware setup dialog is the interactive setup diagram for each frequency range. The diagram shows the hardware setup with all its lab devices, transducers and connecting signal paths (jointly called devices). [Figure 4-130](#) shows how to select a device for integrating it into the hardware setup diagram and for configuring it.

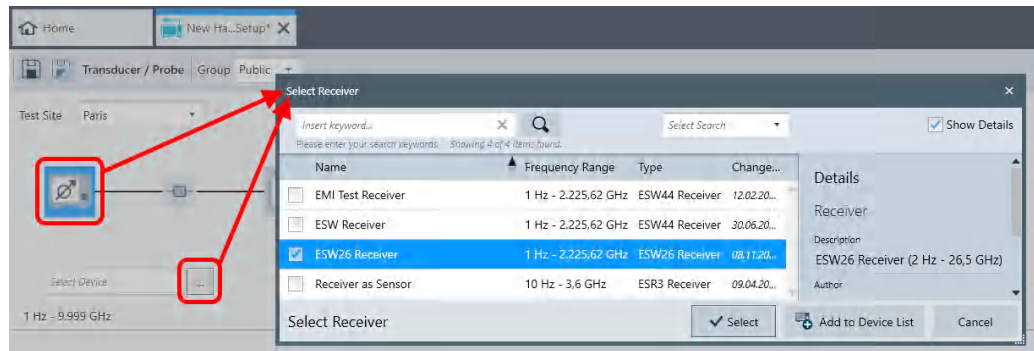

Figure 4-130: Selecting a device, here a receiver in an EMI test setup

"Group" = See Chapter 4.12.5.3, "Groups", on page 541

"Test Site" = See Chapter 4.12.1.4, "Test Site", on page 527

Red squares = Two buttons to open the "Select Receiver" dialog, see below

- If a device is *not yet selected*, the buttons in the **large** and **small** red square in [Figure 4-130](#) both open the "Select ..." dialog.
- On the contrary, if a device is *already selected* as in [Figure 4-131](#), the two buttons have these functions:
 - The button in the **large** red square (device icon) opens the device properties dialog.
 - The button in the **small** red square opens the "Select ..." dialog again, for example for selecting a different device.

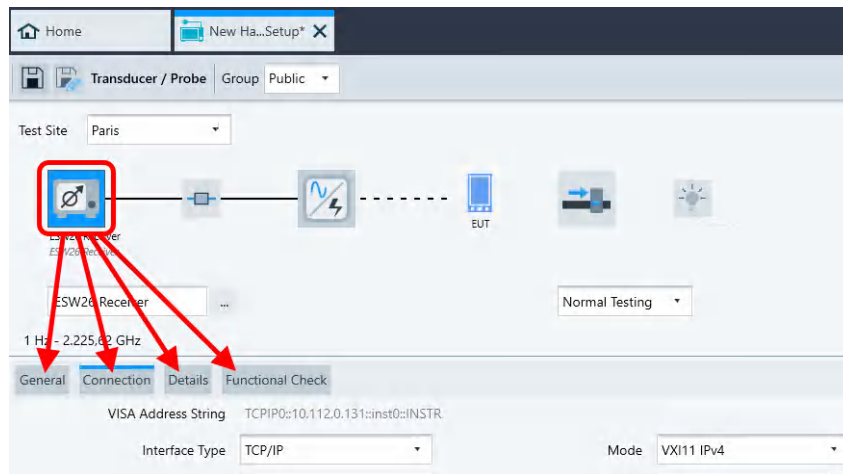

Figure 4-131: If a device is already selected (here: ESW26 Receiver), the device icon in the large red square does not open the Select ... dialog, but the device properties

As hardware setups are specific for the various kinds of measurements, the following chapters describe how to configure the various hardware setup types:

- 4.7.1 Hardware setups for calibration measurements.....334
- 4.7.2 Hardware setups for EMI tests.....334
- 4.7.2.1 EMI - Transducer / Probe (conducted).....337

4.7.2.2	EMI - LISN (conducted).....	338
4.7.2.3	EMI - Slidebar (conducted).....	340
4.7.2.4	EMI - Electric Field Strength (radiated).....	341
4.7.2.5	EMI - Electric Field Strength - GTEM (radiated).....	342
4.7.2.6	EMI - Magnetic Field Strength - Triple Loop Antenna (radiated).....	343
4.7.2.7	EMI - Magnetic Field Strength - Loop Antenna + Turntable (radiated).....	344
4.7.2.8	EMI - Radiated Spurious Emission.....	345
4.7.3	Hardware setups for EMS tests.....	347
4.7.3.1	EMS - Bulk Current Injection (conducted).....	350
4.7.3.2	EMS - CDN / EM Clamp (conducted).....	352
4.7.3.3	EMS - Antenna Port (conducted).....	354
4.7.3.4	EMS - Anechoic Chamber (radiated).....	355
4.7.3.5	EMS - TEM Waveguides (radiated).....	357
4.7.3.6	EMS - Reverberation Chamber (radiated).....	359

4.7.1 Hardware setups for calibration measurements

There is no hardware setup for calibration measurements ("CAL") at "Home" > "Hardware Setups". Instead, use the CAL test template at "Home" > [Test Templates](#) > [Create Test Templates](#) > [CAL](#).



- For information on how to configure test templates for calibration measurements, see [Chapter 4.5.1, "Test Templates for calibration measurements"](#), on page 119.
- For information on how to execute calibration measurements, see [Chapter 8, "Calibration measurements"](#), on page 645.

4.7.2 Hardware setups for EMI tests

This chapter describes how to configure hardware setups for EMI tests.

Access: "Home" > "Hardware Setups" > "Create: Hardware Setup" > "EMI" > "..."

Here, "EMI" stands for the group of the following EMI hardware setup types:

- "EMI - Transducer / Probe" (conducted)
- "EMI - LISN" (conducted)
- "EMI - Slidebar" (conducted)
- "EMI - Electric Field Strength" (radiated)
- "EMI - Electric Field Strength (GTEM)" (radiated)
- "EMI - Magnetic Field Strength (Triple Loop Antenna)" (radiated)

- "EMI - Magnetic Field Strength (Loop Antenna + Turntable)" (radiated)
- "EMI - Radiated Spurious Emission"

The type you select determines the type of hardware setup **diagram** that the software offers in the next dialog.



- For information on how to configure test templates for these tests, see [Chapter 4.5.2, "Test Templates for EMI tests"](#), on page 136.
- For information on how to execute these tests, see [Chapter 7.2, "EMI tests"](#), on page 594.

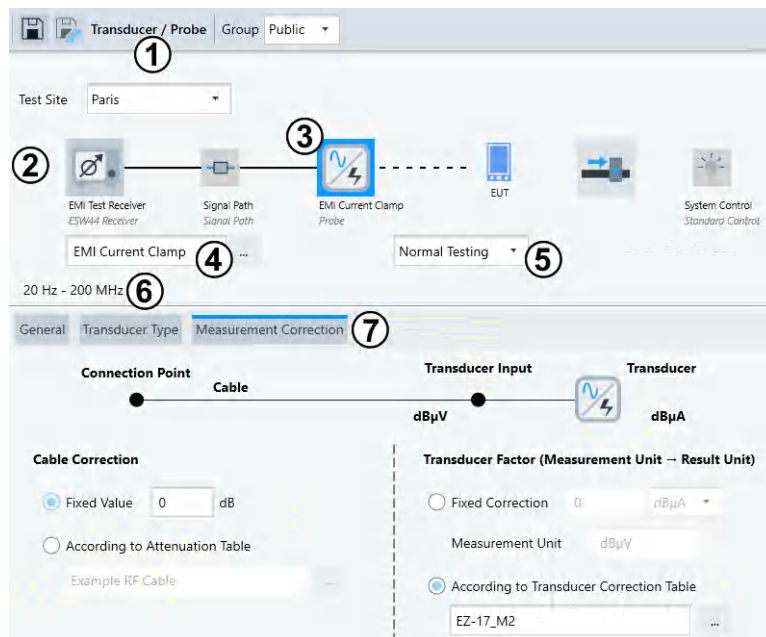

Figure 4-132: Example of an EMI hardware setup dialog (here: Transducer / Probe)

- 1 = Name of the selected "Setup Diagram Type" (which is a subset of the hardware setup type, here EMI)
- 2 = Interactive hardware setup diagram
- 3 = Highlighted component (here the transducing device) in the hardware setup diagram
- 4 = Field for selecting the highlighted device (3) from the "Device List"
- 5 = Toggle switch for selecting [Normal Testing](#) or [System Check](#)
- 6 = Frequency range that the hardware setup is valid for, depending on the properties of all referenced devices
- 7 = Several tabs with properties of the selected device (here, the measurement correction parameters are displayed)



For the "Test Site" function, refer to "Home" > "Administration" > "Data Management" > [Test Site](#).

R&S ELEKTRA provides the various hardware setup types for EMI tests listed above. Each test is represented by a specific "Setup Diagram Type". Their common feature is the fact that the conducted or radiated RF emission of the EUT is picked up by a trans-

ducing device and guided towards a measuring device. This device can be a test receiver or spectrum analyzer.

In contrast with [hardware setups for EMS tests](#), you cannot define frequency ranges for EMI hardware setups. Instead, each EMI hardware setup is valid for the full frequency range (labeled (6) in [Figure 4-132](#)) that is jointly covered by the referenced devices.

To select a device or a signal path for integrating it into the hardware setup diagram, click its icon. For example, click the transducer icon (labeled (3) in [Figure 4-132](#)).

When you click such an icon, the following things happen in the hardware setup diagram:

- The selected (clicked) icon is highlighted in blue.
 - If the device or signal path has not yet been selected (chosen), the "Select ..." dialog (shown in [Figure 4-130](#)) is opened for selecting the device.
 - If the device or signal path is already selected (chosen), its name is shown in the "Select Device" field (4), where you can change the selection.
- The [Device properties](#) are displayed.



You cannot change from one setup type to another type. Instead, for a different setup type, always create or open a different hardware setup.

Normal Testing

Leaves the hardware setup unchanged as described in the following chapters. This mode serves for normal testing of the EUT.

System Check

Not available for [GTEM](#) hardware setups.

Modifies the hardware setup for verifying the signal received by the test equipment with a known signal, typically created by a signal generator instead of the EUT. This kind of verification is required, for example, by several military standards.

Two "System Check" options are available:

- With "Direct Connection" disabled, an antenna or other transducer – instead of emissions from the EUT – transmits the generator's test signal:

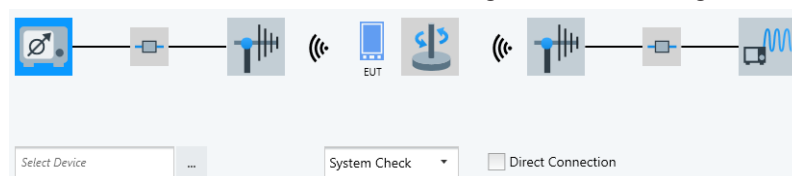

Figure 4-133: Direct connection disabled

- With "Direct Connection" enabled, an RF cable bypasses all transducers:

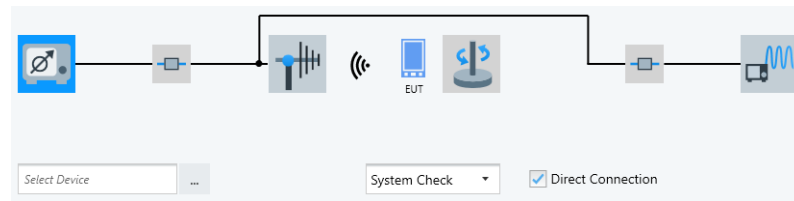

Figure 4-134: Direct connection enabled

For more "System Check" settings, see [System Check](#) in the "General" section of your test template.

Hardware setups with the following setup diagram types are available and described below:

- [EMI - Transducer / Probe \(conducted\)](#)..... 337
- [EMI - LISN \(conducted\)](#)..... 338
- [EMI - Slidebar \(conducted\)](#)..... 340
- [EMI - Electric Field Strength \(radiated\)](#)..... 341
- [EMI - Electric Field Strength - GTEM \(radiated\)](#)..... 342
- [EMI - Magnetic Field Strength - Triple Loop Antenna \(radiated\)](#)..... 343
- [EMI - Magnetic Field Strength - Loop Antenna + Turntable \(radiated\)](#)..... 344
- [EMI - Radiated Spurious Emission](#)..... 345

4.7.2.1 EMI - Transducer / Probe (conducted)



Access: "Home" > "Hardware Setups" > "Create: Hardware Setup" > "EMI" > "Transducer / Probe"

In the EMI conducted hardware setup type "Transducer / Probe", the conducted RF emission of the EUT is picked up by a probe-type transducer without accessories and forwarded to the receiver. Transducer examples are an antenna without [antenna tower and DUT turntable](#) or a current clamp without [slidebar](#).



Figure 4-135: EMI conducted hardware setup diagram Transducer / Probe

- 1 = Receiver
- 2 = Signal path
- 3 = Transducer (TRD)
- 4 = Equipment under test
- 5 = Positioner (optional)
- 6 = System control device (optional)

To configure this most simple case of a hardware setup, select the following devices from the [Device List](#):

1. The [Receiver](#) can be a test receiver or a spectrum analyzer.

2. The [Signal Path](#) can be an attenuation value or table, with or without a switching path.
3. The [Transducer](#). Typical transducers used in this hardware setup are probes as the following:
 - Rod antenna
 - Broadband antenna
 - Near field probe
 - Absorbing current clamp
 - EM clamp
4. Note that you cannot enter an [EUT](#) in this field. Instead, for each test, R&S ELEKTRA automatically selects the "active" EUT according to the [activity status](#).
5. Optionally, select a [Positioner](#). Required only for [ATB](#) setups.
6. Optionally, select a [System Control](#) device.
7. Save the hardware setup. We recommend that you use a speaking name, for example including the term "transducer" or "TRD".

For information on how to configure test templates based on a hardware setup of this type, see [Chapter 4.5.2, "Test Templates for EMI tests"](#), on page 136.

4.7.2.2 EMI - LISN (conducted)



Access: "Home" > "Hardware Setups" > "Create: Hardware Setup" > "EMI" > "LISN"

In the EMI conducted hardware setup type "LISN", the conducted RF emission of the EUT is picked up by a [LISN](#) and forwarded to the receiver.



Figure 4-136: EMI conducted hardware setup diagram LISN

- 1 = Receiver
- 2 = Signal path
- 3 = Line impedance stabilization network (LISN)
- 4 = Equipment under test
- 5 = Positioner (optional)
- 6 = System control device (optional)

To configure this hardware setup, select the following devices from the [Device List](#):

1. The [Receiver](#) can be a test receiver or a spectrum analyzer.
2. The [Signal Path](#) can be an attenuation value or table, with or without a switching path.
3. The [LISN](#). Typical LISNs used in this hardware setup are:
 - 2-line LISN

- 4-line LISN
- "Single-Line" or "Multi-Line" LISN.

Typical Rohde & Schwarz LISNs operate in common mode, see [Figure 4-137](#).

- Note that you cannot enter an [EUT](#) in this field. Instead, for each test, R&S ELEKTRA automatically selects the "active" EUT according to the [activity status](#).
- Optionally, select a [Positioner](#). Required only for [ATB](#) setups.
- Optionally, select a [System Control](#) device.
- Save the hardware setup. We recommend that you use a speaking name, for example including the term "LISN".

Conducted EMI tests with a LISN are performed either in differential mode or in common mode:

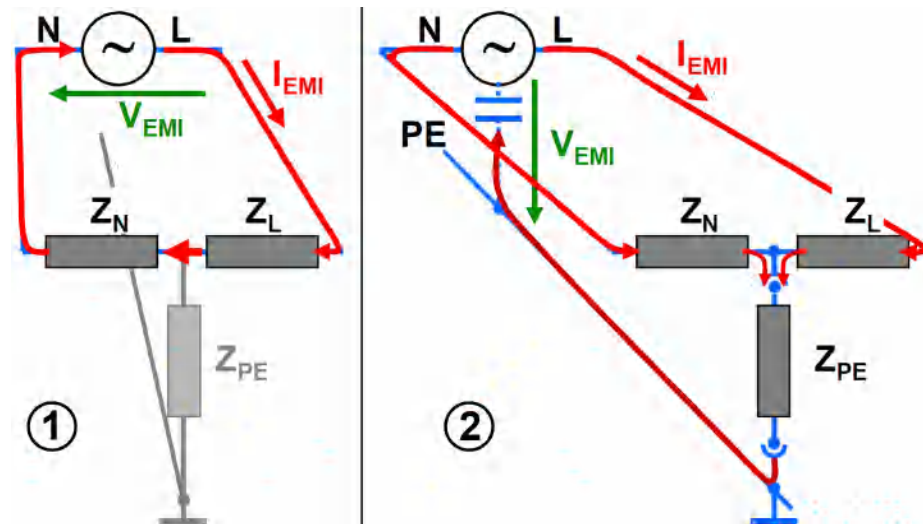

Figure 4-137: 2-line LISN in differential mode and in common mode

- 1 = Schematic of the differential mode setup
- 2 = Schematic of the common mode setup
- L = Live line
- N = Neutral line
- PE = Protective earth (ground)
- Z_L = Impedance of the L line
- Z_N = Impedance of the N line
- Z_{PE} = Impedance of the PE line
- V_{EMI} = Voltage of the disturbing signal
- I_{EMI} = Current of the disturbing signal

The **common mode** setup in [Figure 4-137](#) is also called **unsymmetric** test setup. The 2-line LISN configuration used here is also called a **V-type** artificial network. It does not distinguish between common mode and differential mode signals and is therefore typically used for power lines.

The **differential mode** setup in [Figure 4-137](#) is also called **symmetric** test setup. The 2-line LISN configuration used here is also called a **T-type** or **Y-type** artificial network. It

extracts the common mode signals and is therefore typically used for signal lines (with wanted signals in differential mode).

For information on how to configure test templates based on a hardware setup of this type, see [Chapter 4.5.2, "Test Templates for EMI tests"](#), on page 136.

4.7.2.3 EMI - Slidebar (conducted)



Access: "Home" > "Hardware Setups" > "Create: Hardware Setup" > "EMI" > "Slidebar"

In the EMI conducted hardware setup type "Slidebar", the conducted RF emission of the EUT is picked up by a [Slidebar](#) transducer and forwarded to the receiver.

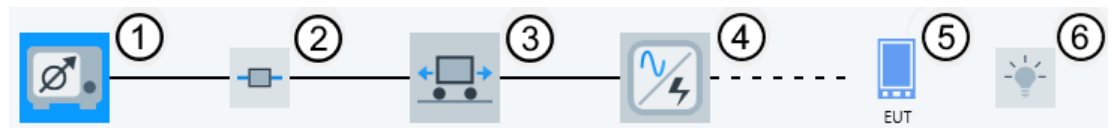

Figure 4-138: EMI conducted hardware setup diagram Slidebar

- 1 = Receiver
- 2 = Signal path
- 3 = Slidebar
- 4 = Transducer (EMI absorbing clamp)
- 5 = Equipment under test
- 6 = System control device (optional)

To configure this hardware setup, select the following devices from the [Device List](#):

1. The [Receiver](#) can be a test receiver or a spectrum analyzer.
2. The [Signal Path](#) can be an attenuation value or table, with or without a switching path.
3. The [Slidebar](#).
A typical slidebar used in this hardware setup is the MDS clamp (named after the inventor, Meyer de Stadelhofen).
4. The [Transducer](#). Typical transducers used in this hardware setup are:
 - CAL adapter (calibration jig)
 - EMI current clamp
 - Various antennas
5. Note that you cannot enter an [EUT](#) in this field. Instead, for each test, R&S ELEKTRA automatically selects the "active" EUT according to the [activity status](#).
6. Optionally, select a [System Control](#) device.
7. Save the hardware setup. We recommend that you use a speaking name, for example including the term "slidebar".

For information on how to configure test templates based on a hardware setup of this type, see [Chapter 4.5.2, "Test Templates for EMI tests"](#), on page 136.

4.7.2.4 EMI - Electric Field Strength (radiated)



Access: "Home" > "Hardware Setups" > "Create: Hardware Setup" > "EMI" > "Electric Field Strength"

In the hardware setup type "Electric Field Strength" for EMI radiated tests, the radiated RF emission of the EUT is picked up by a [dipole antenna](#) (for example a rod, horn, biconic or log-periodic antenna) and conducted to the receiver.

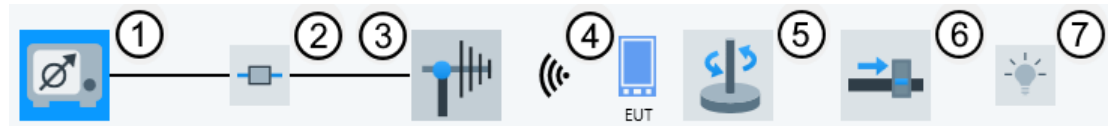

Figure 4-139: EMI radiated hardware setup diagram Electric Field Strength

- 1 = Receiver
- 2 = Signal path
- 3 = Dipole antenna
- 4 = Equipment under test
- 5 = Turntable (optional)
- 5 = Positioner (optional)
- 6 = System control device (optional)

To configure this hardware setup, select the following devices from the [Device List](#):

1. The [Receiver](#) can be a test receiver or a spectrum analyzer.
2. The [Signal Path](#) can be an attenuation value or table, with or without a switching path.
3. The [Antenna](#). Typical antennas used in this hardware setup are:
 - Biconic antenna
 - Horn antenna
 - Log-periodic (LogPer) antenna
 - Rod antenna

But **not** the [Triple Loop](#) antenna and **not** the [Loop](#) antenna with turntable

4. Note that you cannot enter an [EUT](#) in this field. Instead, for each test, R&S ELEKTRA automatically selects the "active" EUT according to the [activity status](#).
5. Optionally, select a [Turntable](#) for the EUT.
6. Optionally, select a [Positioner](#) for the EUT.
7. Optionally, select a [System Control](#) device.
8. To integrate an [Antenna Tower](#) into this hardware setup, proceed as follows:
 - a) Select (highlight) the antenna icon.
 - b) Go to the "Tower Control" tab in the antenna's properties dialog.
 - c) Select a manual or automatic tower for height control, as in [Figure 4-140](#). Optionally configure the tower properties.
 - d) Select (highlight) any other device icon in the hardware setup.

R&S ELEKTRA adds an icon for the antenna tower to the hardware setup:

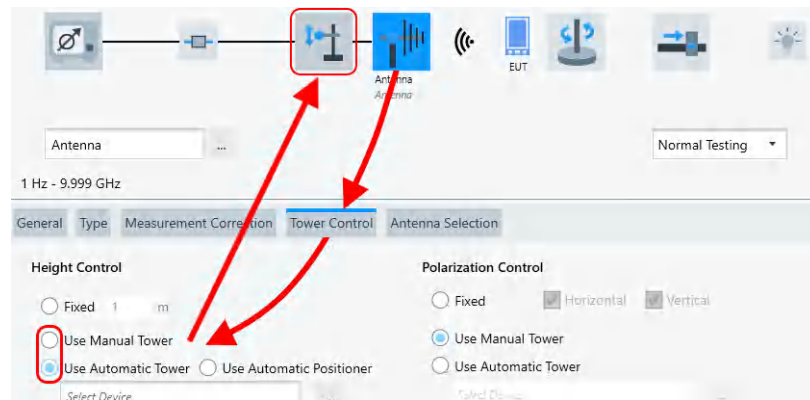

Figure 4-140: Integrating an antenna tower into the Electric Field Strength hardware setup

Note that you cannot access the tower properties via its icon. Instead, select the antenna icon and access the tower properties via the "Tower Control" tab.

- Save the hardware setup. We recommend that you use a speaking name, for example including the term "antenna" or "E field".

For information on how to configure test templates based on a hardware setup of this type, see [Chapter 4.5.2, "Test Templates for EMI tests"](#), on page 136.

4.7.2.5 EMI - Electric Field Strength - GTEM (radiated)



Access: "Home" > "Hardware Setups" > "Create: Hardware Setup" > "EMI" > "Electric Field Strength (GTEM)"

In the hardware setup type "Electric Field Strength (GTEM)" for EMI radiated tests, the radiated RF emission of the EUT is picked up by a TEM waveguide (GTEM cell), a stripline or a similar radiative [transverse electromagnetic waveguide](#) and conducted to the receiver.



Figure 4-141: EMI radiated hardware setup diagram Electric Field Strength (GTEM)

- 1 = Receiver
- 2 = Signal path
- 3 = Transverse electromagnetic (TEM) waveguide
- 4 = Equipment under test
- 5 = System control device (optional)

To configure this hardware setup, select the following devices from the [Device List](#):

- The [Receiver](#) can be a test receiver or a spectrum analyzer.
- The [Signal Path](#) can be an attenuation value or table, with or without a switching path.

3. The [TEM Waveguide](#). Typical TEM waveguides used in this hardware setup are:
 - GTEM cell
 - Stripline
 - Any general TEM waveguide
4. Note that you cannot enter an [EUT](#) in this field. Instead, for each test, R&S ELEKTRA automatically selects the "active" EUT according to the [activity status](#).
5. Optionally, select a [System Control](#) device.
6. Save the hardware setup. We recommend that you use a speaking name, for example including the term "TEM".

For information on how to configure test templates based on a hardware setup of this type, see [Chapter 4.5.2, "Test Templates for EMI tests"](#), on page 136.

4.7.2.6 EMI - Magnetic Field Strength - Triple Loop Antenna (radiated)



Access: "Home" > "Hardware Setups" > "Create: Hardware Setup" > "EMI" > "Magnetic Field Strength (Triple Loop Antenna)"

In this "Magnetic Field Strength" hardware setup type for EMI radiated tests, the radiated RF emission of the EUT is picked up by a [triple-loop antenna](#) and conducted to the receiver. For a hardware setup with a magnetic single-loop antenna, see [Chapter 4.7.2.7, "EMI - Magnetic Field Strength - Loop Antenna + Turntable \(radiated\)"](#), on page 344.



Figure 4-142: EMI radiated hardware setup diagram Magnetic Field Strength (Triple Loop Antenna)

- 1 = Receiver
- 2 = Signal path
- 3 = Triple loop antenna
- 4 = Equipment under test
- 5 = Positioner (optional)
- 6 = System control device (optional)

To configure this hardware setup, select the following devices from the [Device List](#):

1. The [Receiver](#) can be a test receiver or a spectrum analyzer.
2. The [Signal Path](#) can be an attenuation value or table, with or without a switching path.
3. The [Triple Loop](#) selection excludes all antennas except for the type "Triple Loop" antenna. Hence, you cannot use a single-loop antenna, not even in combination with a turntable, as described in [Chapter 4.7.2.7](#).
4. Note that you cannot enter an [EUT](#) in this field. Instead, for each test, R&S ELEKTRA automatically selects the "active" EUT according to the [activity status](#).

5. Optionally, select a [Positioner](#). Required only for [ATB](#) setups.
6. Optionally, select a [System Control](#) device.
7. Save the hardware setup. We recommend that you use a speaking name, for example including the term "triple loop" or "M field 3D".

For information on how to configure test templates based on a hardware setup of this type, see [Chapter 4.5.2, "Test Templates for EMI tests"](#), on page 136.

4.7.2.7 EMI - Magnetic Field Strength - Loop Antenna + Turntable (radiated)



Access: "Home" > "Hardware Setups" > "Create: Hardware Setup" > "EMI" > "Magnetic Field Strength (Loop Antenna + Turntable)"

In this "Magnetic Field Strength" hardware setup type for EMI radiated tests, the radiated RF emission of the EUT is picked up by a **magnetic single-loop antenna** and conducted to the receiver. Note that this antenna is an ordinary [transducer](#) and not a [triple loop antenna](#). For a hardware setup with triple loop antenna, see [Chapter 4.7.2.6, "EMI - Magnetic Field Strength - Triple Loop Antenna \(radiated\)"](#), on page 343.



Figure 4-143: EMI radiated hardware setup diagram Magnetic Field Strength (Loop Antenna + Turntable)

- 1 = Receiver
- 2 = Signal path
- 3 = Magnetic single-loop antenna
- 4 = Equipment under test
- 5 = Turntable (mandatory, except if you use a positioner instead)
- 6 = Positioner (optional)
- 7 = System control device (optional)

To configure this hardware setup, select the following devices from the [Device List](#):

1. The [Receiver](#) can be a test receiver or a spectrum analyzer.
2. The [Signal Path](#) can be an attenuation value or table, with or without a switching path.
3. The [magnetic loop antenna](#)
The dialog allows selecting any transducer, but this hardware setup is intended for selecting a loop antenna.
4. Note that you cannot enter an [EUT](#) in this field. Instead, for each test, R&S ELEKTRA automatically selects the "active" EUT according to the [activity status](#).
5. Typically, use a [Turntable](#) to change the receiving direction of a single-loop antenna, which allows mimicking a switchable [triple loop antenna](#).
6. Alternatively, instead of a turntable, you can use a [Positioner](#).

7. Optionally, select a [System Control](#) device.
8. Save the hardware setup. We recommend that you use a speaking name, for example including the term "magnetic loop" or "M field TT".

For information on how to configure test templates based on a hardware setup of this type, see [Chapter 4.5.2, "Test Templates for EMI tests"](#), on page 136.

4.7.2.8 EMI - Radiated Spurious Emission



Access: "Home" > "Hardware Setups" > "Create: Hardware Setup" > "EMI" > "Radiated Spurious Emission"

Only available, if the "[ELEMI-RSE](#)" license is enabled.

In this [RSE](#) hardware setup type for EMI radiated tests, the radiated RF emission of the EUT is picked up by an antenna and conducted to the receiver. During the measurement, the EUT is rotated about two axes (azimuth and elevation) and attached to a radio communication tester. Use the receiver to scan for out-of-band (OOB) spurious emissions of the EUT.



Figure 4-144: EMI radiated hardware setup diagram Radiated Spurious Emission

- 1 = Receiver
- 2 = Signal path
- 3 = Antenna
- 4 = Equipment under test
- 5a = Azimuth turntable (optional)
- 5b = Elevation turn device (optional, must be different from azimuth turntable device)
- 6 = Radio communication tester (optional)
- 7 = System control device (optional)

To configure this hardware setup, select the following devices from the [Device List](#):

1. The [Receiver](#) can be a test receiver or a spectrum analyzer.
2. The [Signal Path](#) can be an attenuation value or table, with or without a switching path.
3. The [Antenna](#). Typical antennas used in this hardware setup are:
 - Biconic antenna
 - Horn antenna
 - Log-periodic (LogPer) antenna
 - Rod antenna

But **not** a loop antenna or the [Triple Loop](#) antenna.

4. Note that you cannot enter an **EUT** in this field. Instead, for each test, R&S ELEKTRA automatically selects the "active" EUT according to the **activity status**.
5. The two **turntables** with crossed axes allow rotating the EUT to any orientation (in spherical coordinates).
Note that the azimuth turntable (5a) and the elevation turn device (5b) must be two different devices. We recommend using motorized positioning devices as turntables, see "**Setup with motorized positioners**" on page 346.
6. The optional **Radio Communication Tester** can simulate the EUT's RF signaling environment. Hence, it can bring the mobile phone (EUT) to the state of an active call.
7. Optionally, select a **System Control** device.
8. Save the hardware setup. We recommend that you use a speaking name, for example including the term "OOB" or "RSE".

Setup with motorized positioners

1. Select a motorized azimuth turntable (5a in [Figure 4-144](#)) from the device list.
2. Select a motorized elevation turn device (5b) from the device list.

The hardware setup diagram changes as follows:

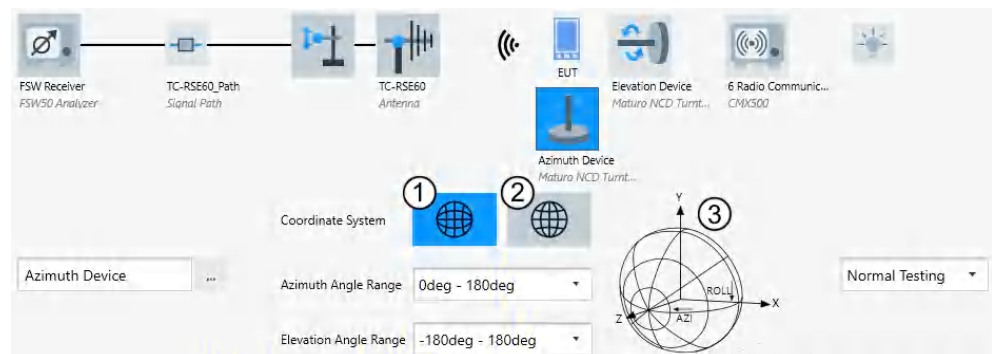

Figure 4-145: Options for selecting a coordinate system

- 1 = "Roll over Azimuth"
- 2 = "Azimuth over Elevation"
- 3 = Illustration of the selected type of coordinate system

3. Select one of the types of "Coordinate System" for your positioning system ([Figure 4-146](#)):
 - Select "Roll over Azimuth", if a positioner for rotation about a horizontal axis sits on an azimuth turntable.
 - Select "Azimuth over Elevation", if an azimuth turntable sits on a positioner for rotation about a horizontal axis.
4. Select the "Azimuth Angle Range":
 - "0deg - 180deg" for "Roll over Azimuth"
 - "0deg - 360deg" or "-180deg - 180deg" for "Azimuth over Elevation"

5. Select the "Elevation Angle Range":
 - "0deg - 360deg" or "-180deg - 180deg" for "Roll over Azimuth"
 - "0deg - 180deg" or "-90deg - 90deg" for "Azimuth over Elevation"

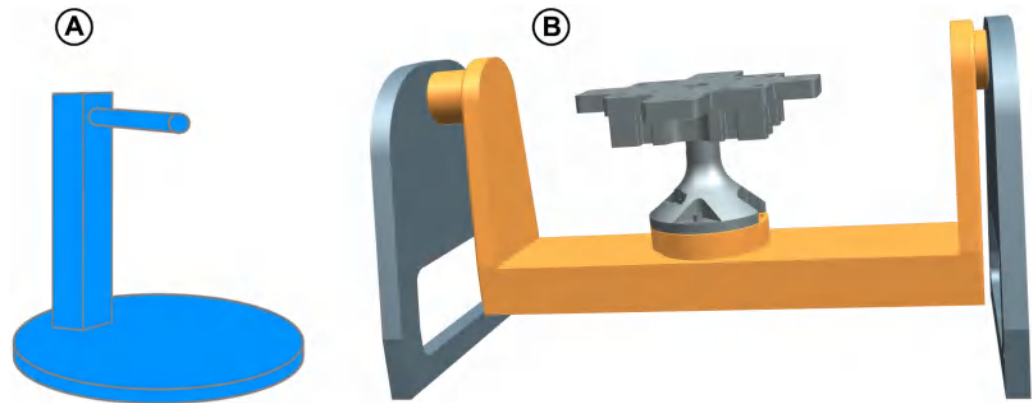

Figure 4-146: OTA positioner types

A = "Roll over Azimuth" positioner with a roll axis mounted on top of a turntable

B = "Azimuth over Elevation" positioner with a turntable on top of an elevation swing (orange)

The [R&S ATS1800C](#) is an example of an "Azimuth over Elevation" positioner (B).

For information on how to configure test templates based on a hardware setup of this type, see [Chapter 4.5.2, "Test Templates for EMI tests"](#), on page 136.

4.7.3 Hardware setups for EMS tests

This chapter describes how to configure hardware setups for EMS tests.

Access: "Home" > "Hardware Setups" > "Create: Hardware Setup" > "EMS - ..."

Here, "EMS - ..." stands for any of the following EMS hardware setup types:

- "EMS - Bulk Current Injection" (conducted)
- "EMS - CDN / EM Clamp" (conducted)
- "EMS - Antenna Port" (conducted)
- "EMS - Anechoic Chamber" (radiated)
- "EMS - TEM Waveguides" (radiated)
- "EMS - Reverberation Chamber" (radiated)

The type you select determines the type of hardware setup **diagram** that the software offers in the next dialog.



- For information on how to configure test templates for these tests, see [Chapter 4.5.3, "Test Templates for EMS tests"](#), on page 243.
- For information on how to execute these tests, see [Chapter 7.3, "EMS tests"](#), on page 597.

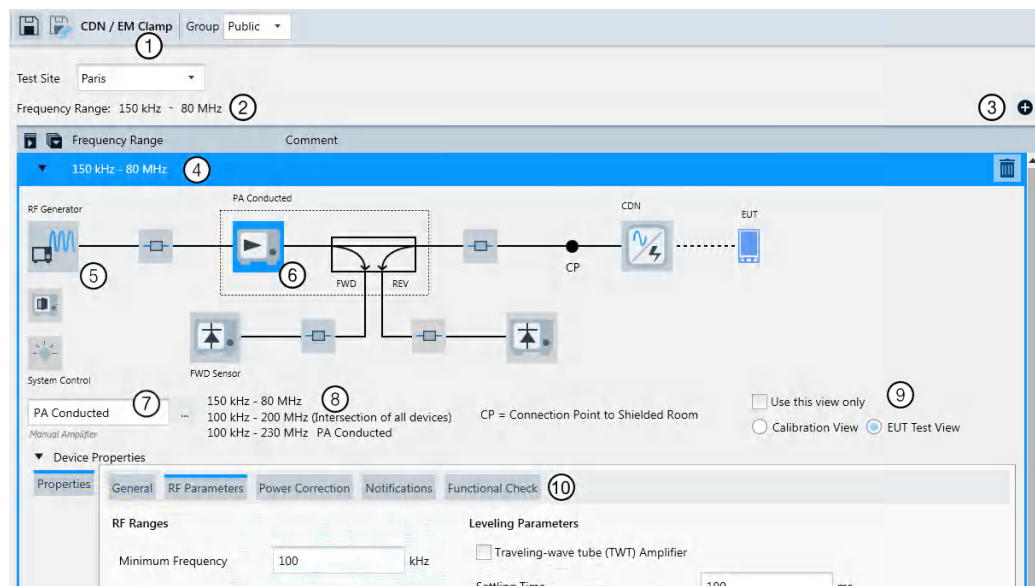

Figure 4-147: Example of an EMS hardware setup dialog

- 1 = Name of the selected hardware setup type
- 2 = Summarized span of all frequency ranges (to change the span, configure the frequency ranges)
- 3 = Button for adding frequency ranges (only in EMS hardware setups)
- 4 = Dialog of the first frequency range (to change the values, click them)
- 5 = Interactive hardware setup diagram
- 6 = Highlighted component (here the amplifier) in the hardware setup diagram. For modified setups with power correction of the amplifier by different transducers, refer to [Power Correction > Transducer](#).
- 7 = Field for selecting a device from the "Device List" to define the highlighted component
- 8a = Frequency range specified at (4), mouse-over text: "The frequency range of the current hardware setup"
- 8b = Maximum frequency range, in which the combined generator, signal paths, amplifier and transducer (here: a CDN) can be used. This frequency range can be limited, for example, by the transducing device's correction table.
- 8c = Frequency range, in which the highlighted device (here: (6), the amplifier) can be used
- 9 = Buttons for toggling between different versions ("views") of the hardware setup diagram
- 10 = Several tabs with properties of the highlighted device (here, the amplifier's RF parameters are displayed)



For the "Test Site" function, refer to "Home" > "Administration" > "Data Management" > [Test Site](#).

R&S ELEKTRA provides various hardware setup types for EMS tests, each represented by a specific "Setup Diagram Type". All hardware setups have common features: RF signals from a signal generator are amplified, monitored (forward power) and injected or transmitted by a transducer towards the EUT or towards a calibrating power meter or field probe.



FWD and REV power

In many conducted EMS test setups, only forward (FWD) power but no reverse (REV) power is measured, because typically an attenuator is inserted between the amplifier and transducer.

Therefore, no "REV Sensor" is included in the default EMS hardware setups of R&S ELEKTRA. However, you can change this default setup and include a reverse power sensor, if it is required to match your actual test situation.

Many setups without "REV Sensor" use the two sensor channels of a typical power meter for measuring both the FWD power and the test level (calibration). You can even arrange the setup to cover both measurements with a single power sensor, only, if you define appropriate [switching paths](#) within the two signal paths.

While multi-band [amplifiers](#) can feature an internal switch matrix for band selection, you can integrate a [Switch Unit](#) only into the FWD and REV power sensor [paths](#) of the setup.

To add a frequency range, click the  button (labeled (3) in [Figure 4-147](#)). Per default, the added frequency range covers the next 10 MHz or 1 GHz on top of the highest existing frequency range:

- 10 MHz in conducted hardware setups ("EMS - Bulk Current Injection" or "EMS - CDN / EM-Clamp")
- 1 GHz in radiated hardware setups ("EMS - Anechoic Chamber" or "EMS - TEM Waveguides")

You can edit the start and stop frequency of each range. Gaps and overlapping **frequency ranges** are not prohibited immediately during the configuration, but to save the hardware setup, the frequencies must be **seamless**.

A text line in the top of the dialog (labeled (2) in [Figure 4-147](#)) summarizes the total range from the lowest start frequency to the highest stop frequency of all ranges. This statement of the total frequency range within the hardware setup is just for your information and disregards any possible (preliminary) gaps.

If a hardware setup has more than one frequency range, **devices must be the same** in these frequency ranges, with the following exception: You can select **different amplifiers, FWD / REV power meters and their signal paths** per frequency range. This flexibility in selecting devices between the generator and the transducing device serves for representing a broadband amplifier with several frequency bands.

To select a device or a signal path for integrating it into the hardware setup, click its icon in the diagram. For example, click the generator icon (labeled (1) in [Figure 4-150](#)).

When you click such an icon, the following things happen in the hardware setup diagram:

- The selected (clicked) icon is highlighted in blue.
 - If the device or signal path has not yet been selected (chosen), the "Select ..." dialog (shown in [Figure 4-130](#)) is opened for selecting the device.
 - If the device or signal path is already selected (chosen), its name is shown in the "Select Device" field (where you could change the selection).
- The [Device properties](#) are displayed, unless you have collapsed them.

The [Settings](#) are displayed also, depending on the selected (highlighted) device.



You cannot change from one setup type to another type. Instead, always open or create a new hardware setup for a different setup type.

The following setup diagram types are available and described below:

- [EMS - Bulk Current Injection \(conducted\)](#).....350
- [EMS - CDN / EM Clamp \(conducted\)](#).....352
- [EMS - Antenna Port \(conducted\)](#).....354
- [EMS - Anechoic Chamber \(radiated\)](#).....355
- [EMS - TEM Waveguides \(radiated\)](#).....357
- [EMS - Reverberation Chamber \(radiated\)](#).....359

4.7.3.1 EMS - Bulk Current Injection (conducted)



Access: "Home" > "Hardware Setups" > "Create: Hardware Setup" > "EMS" > "Bulk Current Injection"

The "Bulk Current Injection" hardware setup type is characterized by the conductive *bulk current injection* (BCI) [transducer](#).

In this hardware setup for EMS conducted tests, the RF signals coming from the generator are amplified and monitored (forward and reverse). The signals are then transduced by a BCI transducer towards the EUT (the output of which is monitored) or towards a test level sensor (calibrating power meter).

The hardware setup diagram is available in two views (see buttons labeled (8) in [Figure 4-147](#)). Unless you select "Use this view only", both views must be configured:

- The "EUT Test View" (see [Figure 4-148](#))
- The "Calibration View" (see [Figure 4-149](#))

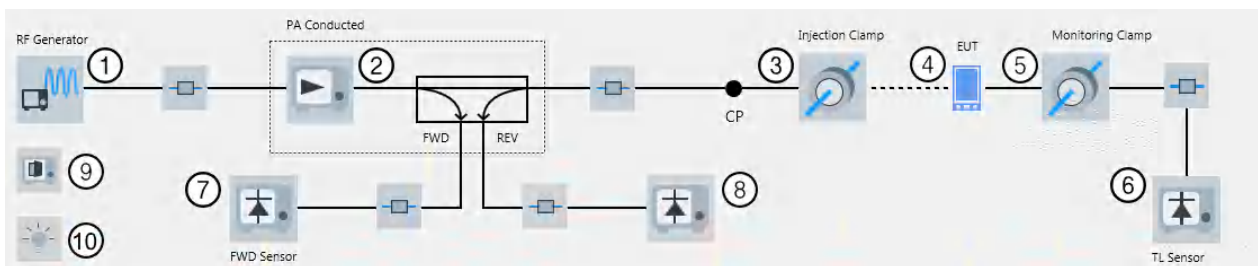

Figure 4-148: EMS hardware setup diagram (conducted) for BCI in EUT Test View

- | | |
|----|---|
| 1 | = RF signal generator |
| 2 | = Power amplifier (together with bidirectional coupler) |
| CP | = "Connection Point to Shielded Room" |
| 3 | = Current injecting transducer (transmitter) |
| 4 | = Equipment under test |
| 5 | = Receiving transducer (monitoring probe) |
| 6 | = Test level sensor (monitoring power meter) |
| 7 | = FWD sensor (forward power meter) |
| 8 | = REV sensor (reverse power meter, optional) |

- 9 = Interlock
 10 = System control device
 All other boxes = Signal paths

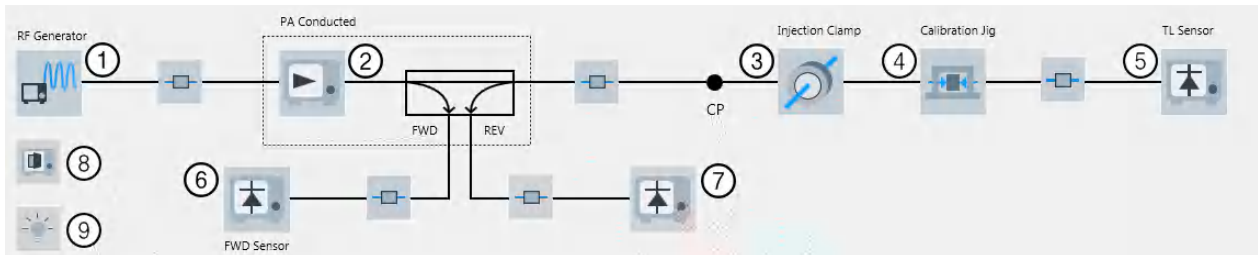

Figure 4-149: EMS hardware setup diagram (conducted) for BCI in Calibration View

- 1 = RF signal generator
 2 = Power amplifier (together with bidirectional coupler)
 CP = "Connection Point to Shielded Room"
 3 = Current injecting transducer (transmitter)
 4 = Receiving transducer (probe, typically a "Calibration Jig")
 5 = Test level sensor (calibrating power meter)
 6 = FWD sensor (forward power meter)
 7 = REV sensor (reverse power meter, optional)
 8 = Interlock
 9 = System control device
 All other boxes = Signal paths

To configure this hardware setup, select the following devices from the [Device List](#):

1. The [Generator](#) (with or without modulation)
2. The [Amplifier](#) with bidirectional coupler
3. The [Power Meter channels](#) for monitoring the forward (and optionally reverse) power.
 Note that you must specify the forward power meter, but if you do not want to use it, set [Power Control](#) to "Generator Level". Find this setting in the [test template](#) at "Flow Details" > "Leveling Mode".
4. The injecting [Transducer](#) (BCI for bulk current injection)
5. You cannot enter the [EUT](#) in this field. Instead, in the tests, R&S ELEKTRA automatically selects the "active" EUT according to the [activity status](#).
6. The selection of the monitoring [Transducer](#) depends on the view (specify both):
 - a) For the [EUT Test View](#), typically select a current clamp ("Monitoring Clamp")
 - b) For the [Calibration View](#), typically select a "Calibration Jig"
7. Another [Power Meter](#) for monitoring or calibrating the test level (transduced power)
8. Several [Signal Paths](#), with or without switching paths
9. Optionally an [Interlock](#)
10. Optionally a [System Control](#) device

- Save the hardware setup. We recommend that you use a speaking name, for example including the term "BCI".



EUT test view in BCI setup

In a typical BCI setup, the EUT's output is monitored by a transducer and TL sensor not only during calibration, but also during the test. Monitoring the live current with a monitoring clamp as in [Figure 4-148](#) ("EUT Test View") allows controlling and limiting the forward power. Or, when you use the [Substitution Method](#), it allows limiting the current.

Note that this monitoring procedure is different from other setups. For example, an [EMS - CDN / EM Clamp](#) setup provides for tests without a receiving transducer (see [Figure 4-150](#)).

For information on how to configure test templates based on this type of hardware setup, see [Chapter 4.5.3, "Test Templates for EMS tests"](#), on page 243.

4.7.3.2 EMS - CDN / EM Clamp (conducted)



Access: "Home" > "Hardware Setups" > "Create: Hardware Setup" > "EMS" > "CDN / EM Clamp"

The "CDN / EM Clamp" hardware setup type is characterized by the conductive [transducer](#), which is either a *coupling/decoupling network* (CDN) or any *electromagnetic clamp*.

In this hardware setup for EMS conducted tests, the conducted RF signals coming from the generator are amplified and monitored (forward and reverse). The signals are then transduced by a CDN or current clamp towards the EUT or towards a test level sensor (calibrating power meter).

The hardware setup diagram is available in two views (see buttons labeled (8) in [Figure 4-147](#)). Unless you select "Use this view only", both views must be configured:

- The "EUT Test View" (see [Figure 4-150](#))
- The "Calibration View" (see [Figure 4-151](#))

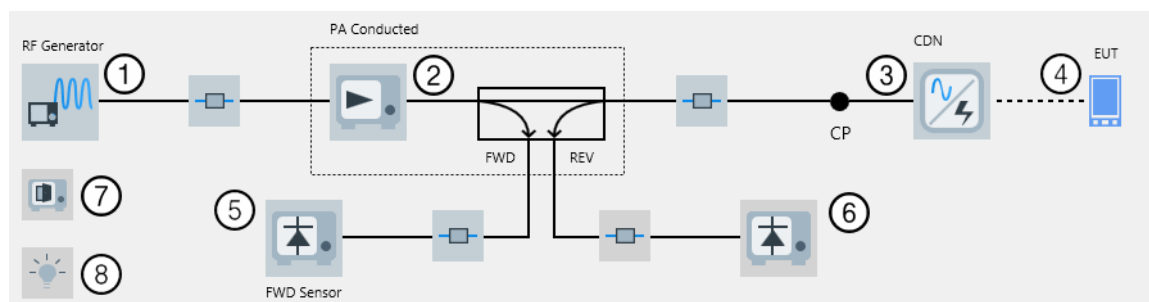

Figure 4-150: EMS hardware setup diagram (conducted) for CDN / EM Clamp in EUT Test View

- | | |
|----|---|
| 1 | = RF signal generator |
| 2 | = Power amplifier (together with bidirectional coupler) |
| CP | = "Connection Point to Shielded Room" |
| 3 | = Injecting transducer (transmitter, for example CDN or EM clamp) |

- 4 = Equipment under test
 5 = FWD sensor (forward power meter)
 6 = REV sensor (reverse power meter, optional)
 7 = Interlock
 8 = System control device
 All other boxes = Signal paths

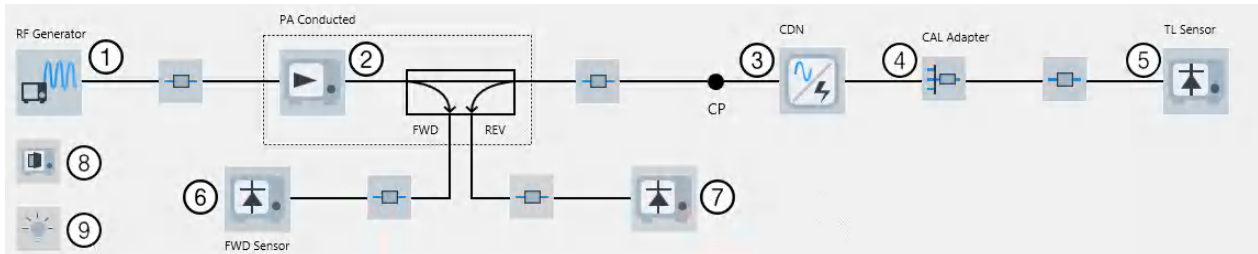

Figure 4-151: EMS hardware setup diagram (conducted) for CDN / EM Clamp in Calibration View

- 1 = RF signal generator
 2 = Power amplifier (together with bidirectional coupler)
 CP = "Connection Point to Shielded Room"
 3 = Injecting transducer (transmitter, for example CDN or EM clamp)
 4 = Receiving transducer (probe, typically a calibration adapter)
 5 = Test level sensor (calibrating power meter)
 6 = FWD sensor (forward power meter)
 7 = REV sensor (reverse power meter, optional)
 8 = Interlock
 9 = System control device
 All other boxes = Signal paths

To configure this hardware setup, select the following devices from the [Device List](#):

1. The [Generator](#) (with or without modulation)
2. The [Amplifier](#) with bidirectional coupler
3. The [Power Meter channels](#) for monitoring the amplified forward (and optionally reverse) power
 Note that you must specify the forward power meter, but if you do not want to use it, set [Power Control](#) to "Generator Level". Find this setting in the [test template](#) at "Flow Details" > "Leveling Mode".
4. The injecting [Transducer](#), which typically is a CDN (coupling/decoupling network) or EM clamp.
5. You cannot enter the [EUT](#) in this field. Instead, in the tests, R&S ELEKTRA automatically selects the "active" EUT according to the [activity status](#).
6. For the [Calibration View](#), select:
 - a) A receiving (or monitoring) [Transducer](#), which typically is a calibration adapter.
 - b) Another [Power Meter](#) for calibrating the test level (transduced power)
7. Several [Signal Paths](#), with or without switching paths
8. Optionally an [Interlock](#)
9. Optionally a [System Control](#) device

- Save the hardware setup. We recommend that you use a speaking name, for example including the term "CDN".

For information on how to configure test templates based on this type of hardware setup, see [Chapter 4.5.3, "Test Templates for EMS tests"](#), on page 243.

4.7.3.3 EMS - Antenna Port (conducted)



Access: "Home" > "Hardware Setups" > "Create: Hardware Setup" > "EMS" > "Antenna Port"

The "Antenna Port" hardware setup type is characterized by three RF generators.

In this hardware setup for conducted EMS tests, you can use a maximum of three generators and combine the RF signals via the three-port network, depending on the test standards.

The hardware setup diagram is available only in the "EUT Test View" (see [Figure 4-152](#)).

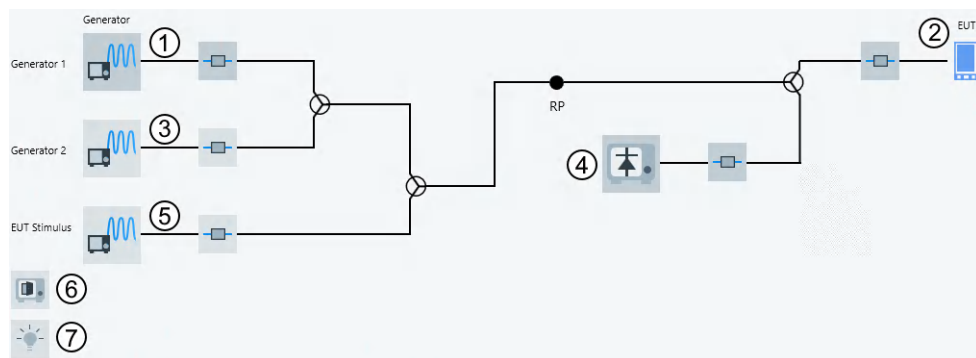

Figure 4-152: EMS hardware setup diagram (conducted) for antenna port in EUT Test View

1	= Generator
RP	= Reference point
2	= Equipment under test
3	= Secondary generator
4	= EMI test receiver
5	= EUT stimulus
6	= Interlock
7	= System control device
All other boxes	= Signal paths
All other circles	= Three-port network

To configure this hardware setup, select the following devices from the [Device List](#):

- Three [Generator](#) devices (each with or without modulation):
 - The primary generator (1)
Generates modulated signals according to the test standards, see [Antenna Port](#)
 - The secondary generator (3)

Generates continuous wave signals, if necessary, according to the test standards, see [Antenna Port](#)

- The 3rd generator serves as an EUT stimulus (5)
Generates signals (e.g. at a level close to the EUT's sensitivity) that function as the monitoring signal to test the EUT, see [Antenna Port](#)
2. You cannot enter the [EUT](#) in this field. Instead, select the appropriate EUT in the test setting (see [Configuring EMS tests](#)).
 3. The [Receiver](#)
 4. Several [Signal Paths](#), with or without switching paths
 5. Optionally an [Interlock](#)
 6. Optionally a [System Control](#) device
 7. Save the hardware setup. We recommend that you use a speaking name, for example including the term "Antenna Port".

For information on how to configure test templates based on this type of hardware setup, see [Chapter 4.5.3, "Test Templates for EMS tests"](#), on page 243.

4.7.3.4 EMS - Anechoic Chamber (radiated)



Access: "Home" > "Hardware Setups" > "Create: Hardware Setup" > "EMS" > "Anechoic Chamber"

The "Anechoic Chamber" hardware setup type is characterized by a radiatively transmitting [antenna](#) in an *anechoic chamber*.

In this hardware setup for EMS radiated tests, the RF signals from the generator are amplified, monitored (forward and reverse) and emitted by a transmitting antenna towards the EUT. Additionally, the field strength in the chamber is monitored by a field probe. Optionally, the EUT can be rotated by a turntable.

The hardware setup diagram is available in two views. Unless you select "Use this view only", both views must be configured:

- The "EUT Test View" (see [Figure 4-153](#))
- The "Calibration View" (see [Figure 4-154](#))

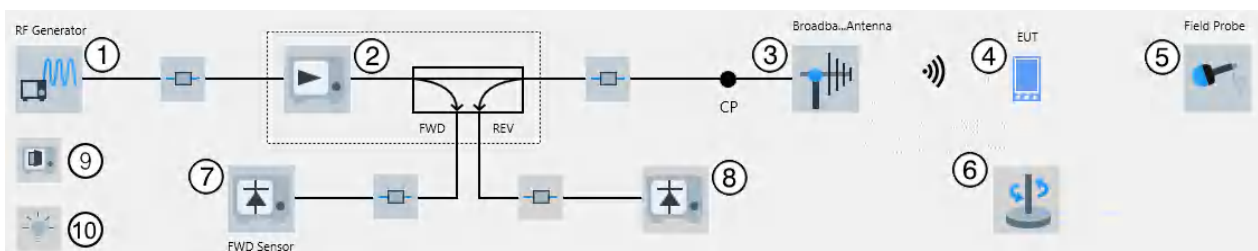

Figure 4-153: EMS hardware setup diagram (radiated) for an Anechoic Chamber in EUT Test View

- 1 = RF signal generator
 - 2 = Power amplifier (together with bidirectional coupler)
 - CP = "Connection Point to Shielded Room"
 - 3 = Injecting transducer (transmitting antenna)
 - 4 = Equipment under test
 - 5 = EMS monitoring transducer (field probe or antenna + receiver)
 - 6 = Optional turntable
 - 7 = FWD sensor (forward power meter)
 - 8 = REV sensor (reverse power meter, optional)
 - 9 = Interlock
 - 10 = System control device
- All other boxes = Signal paths

If you select a receiver instead of the field probe (default for (5) in [Figure 4-153](#)), the hardware setup also requires an antenna. The diagram changes as follows:



For the newly added antenna icon, select an antenna from the device list. The changed setup applies to both the "EUT Test View" and the "Calibration View".

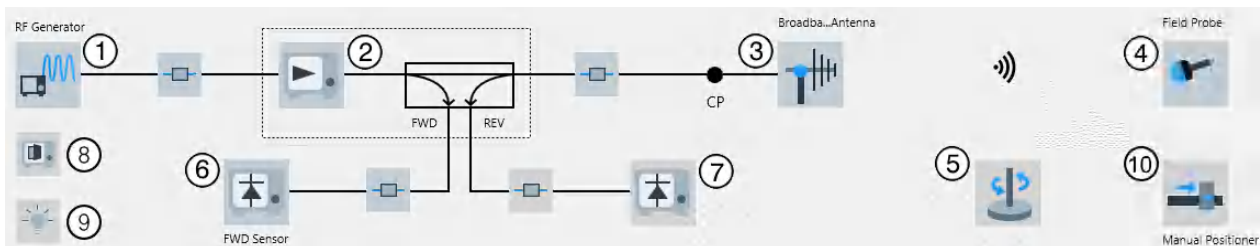

Figure 4-154: EMS hardware setup diagram (radiated) for an Anechoic Chamber in Calibration View

- 1 = RF signal generator
 - 2 = Power amplifier (together with bidirectional coupler)
 - CP = "Connection Point to Shielded Room"
 - 3 = Injecting transducer (transmitting antenna)
 - 4 = Calibrating transducer (field probe or antenna + receiver)
 - 5 = Optional turntable (present but not used during calibration)
 - 6 = FWD sensor (forward power meter)
 - 7 = REV sensor (reverse power meter, optional)
 - 8 = Interlock
 - 9 = System control device
 - 10 = Optional positioner for the field probe (or for the receiver's antenna, if you use a receiver instead of the field probe)
- All other boxes = Signal paths

To configure this hardware setup, select the following devices from the [Device List](#):

1. The [Generator](#) (with or without modulation)
2. The [Amplifier](#) with bidirectional coupler
3. The [Power Meter channels](#) for monitoring the forward (and optionally reverse) power.

Note that you must specify the forward power meter, but if you do not want to use it, set **Power Control** to "Generator Level". Find this setting in the [test template](#) at "Flow Details" > "Leveling Mode".

4. The injecting **Tx Antenna**
5. You cannot enter the **EUT** in this field. Instead, in the tests, R&S ELEKTRA automatically selects the "active" EUT according to the [activity status](#). For the setup according to the [Calibration View](#), remove the EUT.
6. The **Field Probe** for monitoring or calibrating the test level (transduced power) Alternatively select a **Receiver** and an **Antenna** instead of the field probe.
7. Optionally a [Chapter 4.8.29, "Turntable"](#), on page 491.
8. Several **Signal Paths**, with or without switching paths
9. Optionally an **Interlock**.
10. Optionally a **System Control** device
11. Optionally a **Positioner** for the field probe or for the receiver's antenna.
12. Save the hardware setup. We recommend that you use a speaking name, for example including the term "Anechoic".

For information on how to configure test templates based on this type of hardware setup, see [Chapter 4.5.3, "Test Templates for EMS tests"](#), on page 243.

4.7.3.5 EMS - TEM Waveguides (radiated)



Access: "Home" > "Hardware Setups" > "Create: Hardware Setup" > "EMS" > "TEM Waveguides"

The "TEM Waveguide" hardware setup type is characterized by a GTEM cell, a stripline or a similar radiative [transverse electromagnetic waveguide](#).

In this hardware setup for EMS radiated tests, the RF signals coming from the generator are amplified, monitored (forward and reverse) and emitted towards the EUT. For this purpose, the EUT is placed inside the TEM waveguide. For example, if this waveguide is a GTEM cell, the inner conductor of the RF cable that supplies the cell is connected to the cell's septum. Likewise, the cable's outer cladding is connected to the cell's casing. The EUT is located between the septum and the casing. Therefore, it is exposed to the "geometrically enlarged" RF field as it were between the cable's inner conductor and outer cladding. Additionally, the field strength in the waveguide is monitored by a field probe.

The hardware setup diagram is available in two views. Unless you select "Use this view only", both views must be configured:

- The "EUT Test View" (see [Figure 4-155](#))
- The "Calibration View" (see [Figure 4-156](#))

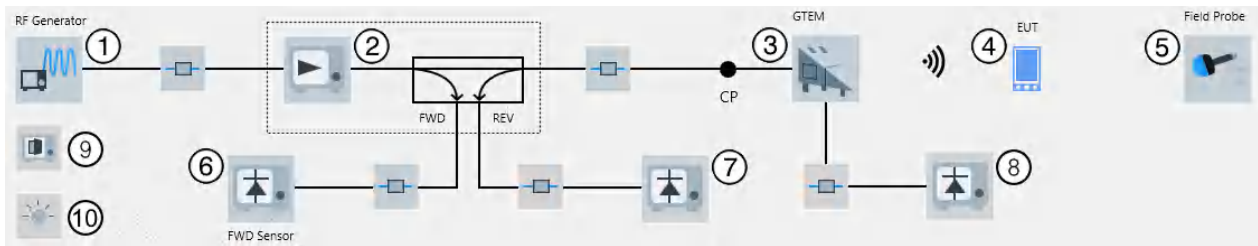
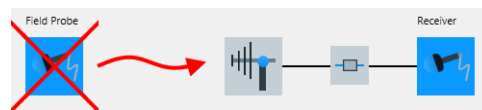

Figure 4-155: EMS hardware setup diagram (radiated) for a TEM Waveguide in EUT Test View

- 1 = RF signal generator
 - 2 = Power amplifier (together with bidirectional coupler)
 - CP = "Connection Point to Shielded Room"
 - 3 = Injecting transducer (transmitting TEM waveguide, for example GTEM cell or stripline)
 - 4 = Equipment under test
 - 5 = EMS monitoring transducer (field probe or antenna + receiver)
 - 6 = FWD sensor (forward power meter)
 - 7 = REV sensor (reverse power meter, optional)
 - 8 = Transducer output power meter (available only with license "ELEMS-AMEX")
 - 9 = Interlock
 - 10 = System control device
- All other boxes = Signal paths

If you select a receiver instead of the field probe (default for (5) in Figure 4-155), the hardware setup also requires an antenna. The diagram changes as follows:



For the newly added antenna icon, select an antenna from the device list. The changed setup applies to both the "EUT Test View" and the "Calibration View".

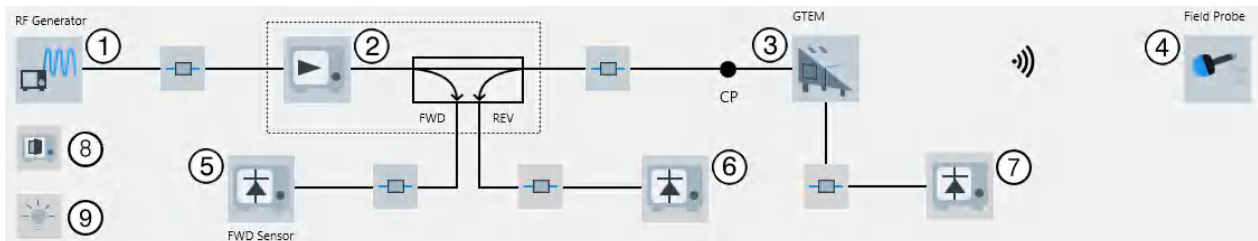

Figure 4-156: EMS hardware setup diagram (radiated) for a TEM Waveguide in Calibration View

- 1 = RF signal generator
 - 2 = Power amplifier (together with bidirectional coupler)
 - CP = "Connection Point to Shielded Room"
 - 3 = Injecting transducer (transmitting TEM waveguide, for example GTEM cell or stripline)
 - 4 = Calibrating transducer (field probe or antenna + receiver)
 - 5 = FWD sensor (forward power meter)
 - 6 = REV sensor (reverse power meter, optional)
 - 7 = Transducer output power meter (available only with license "ELEMS-AMEX")
 - 8 = Interlock
 - 9 = System control device
- All other boxes = Signal paths

To configure this hardware setup, select the following devices from the [Device List](#):

1. The [Generator](#) (with or without modulation)
2. The [Amplifier](#) with bidirectional coupler
3. The [Power Meter channels](#) for monitoring the forward (and optionally reverse and transducer output) power.
Note that you must specify the forward power meter, but if you do not want to use it, set [Power Control](#) to "Generator Level". Find this setting in the [test template](#) at "Flow Details" > "Leveling Mode".
4. The injecting [TEM Waveguide](#)
5. You cannot enter the [EUT](#) in this field. Instead, in the tests, R&S ELEKTRA automatically selects the "active" EUT according to the [activity status](#).
For the setup according to the [Calibration View](#), remove the EUT.
6. The [Field Probe](#) for monitoring or calibrating the test level (transduced power)
Alternatively select a [Receiver](#) and an [Antenna](#) instead of the field probe.
7. Several [Signal Paths](#), with or without switching paths
8. Optionally an [Interlock](#)
9. Optionally a [System Control](#) device
10. Save the hardware setup. We recommend that you use a speaking name, for example including the term "TEM" or "GTEM".

For information on how to configure test templates based on this type of hardware setup, see [Chapter 4.5.3, "Test Templates for EMS tests"](#), on page 243.

4.7.3.6 EMS - Reverberation Chamber (radiated)



Access: "Home" > "Hardware Setups" > "Create: Hardware Setup" > "EMS" > "Reverberation Chamber"

Available only with [license](#) "ELEMS-RVC".

The "Reverberation Chamber" (RVC) hardware setup type is characterized by a stirrer (also called mode tuner or paddle) in a shielded chamber without absorbers.

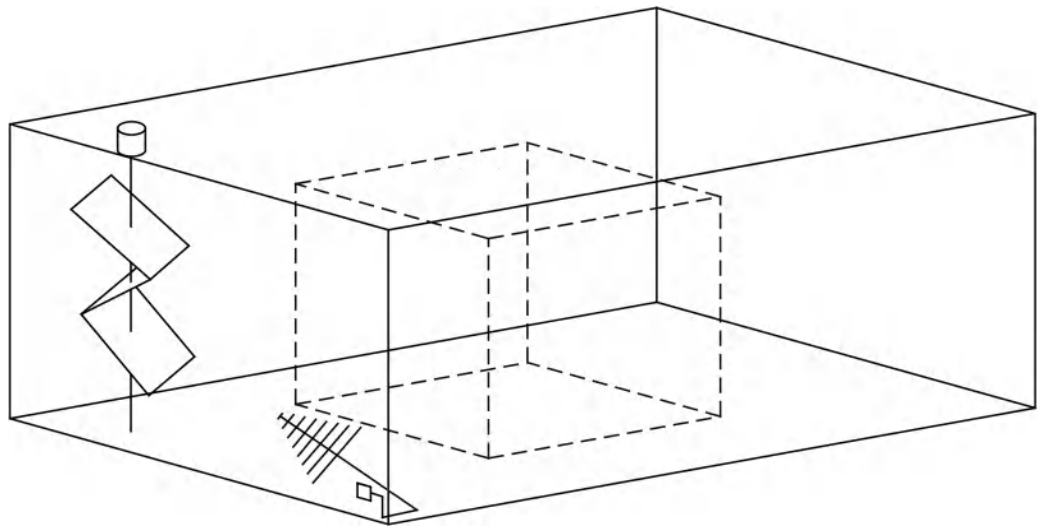

Figure 4-157: Simplified outline of a reverberation chamber

Rear left = Stirrer (mode tuner), mounted on a vertical axis with motor on top
 Front center = Injecting antenna, pointing to a corner
 Dashed box = Working area, which is a volume of homogeneous field strength

In this hardware setup for EMS radiated tests, the RF signals coming from the generator are amplified, monitored (forward and reverse) and injected into the reverberation chamber using antennas. The reflective chamber, which works as a cavity resonator, creates various field modes. The rotating tuner changes the electric boundary conditions and stirs these modes, hence creating a stochastic field distribution in the working area. In this central part of the chamber with homogeneous field strength, the EUT is exposed to the immunity level. A receiving antenna monitors the field strength in the working area. This antenna serves mainly for calibration together with the field probe.

The hardware setup diagram is available in two views. Unless you select "Use this view only", both views must be configured:

- The "EUT Test View" (see [Figure 4-158](#))
- The "Calibration View" (see [Figure 4-159](#))

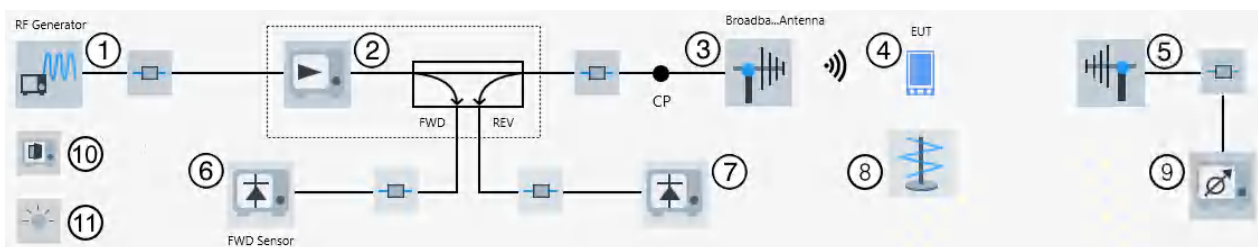

Figure 4-158: EMS hardware setup diagram (radiated) for a Reverberation Chamber in EUT Test View

1 = RF signal generator
 2 = Power amplifier (together with bidirectional coupler)
 CP = "Connection Point to Shielded Room"
 3 = Injecting transducer (transmitting antenna)
 4 = Equipment under test
 5 = Receiving reference antenna

- 6 = FWD sensor (forward power meter)
- 7 = REV sensor (reverse power meter, optional)
- 8 = RVC tuner / stirrer (device type: turntable)
- 9 = Receiver or power meter
- 10 = Interlock
- 11 = System control device
- All other boxes = Signal paths

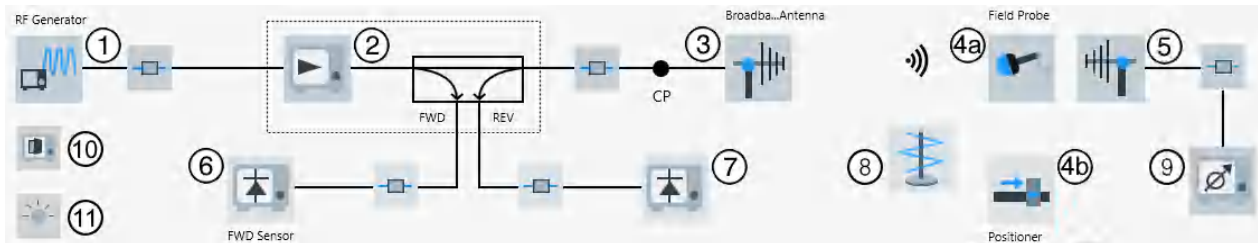

Figure 4-159: EMS hardware setup diagram (radiated) for a Reverberation Chamber in Calibration View

- 1 = RF signal generator
- 2 = Power amplifier (together with bidirectional coupler)
- CP = "Connection Point to Shielded Room"
- 3 = Injecting transducer (transmitting antenna)
- 4a = Calibrating transducer (field probe for simultaneous measurement of all three axes)
- 4b = Positioner for calibrating transducer
- 5 = Receiving reference antenna
- 6 = FWD sensor (forward power meter)
- 7 = REV sensor (reverse power meter, optional)
- 8 = RVC tuner / stirrer (device type: turntable)
- 9 = Receiver or power meter
- 10 = Interlock
- 11 = System control device
- All other boxes = Signal paths

To configure this hardware setup, select the following devices from the [Device List](#):

1. The [Generator](#) (with or without modulation)
2. The [Amplifier](#) with bidirectional coupler
3. The [Power Meter channels](#) for monitoring the forward (and optionally reverse and transducer output) power.
Note that you must specify the forward power meter, but if you do not want to use it, set [Power Control](#) to "Generator Level". Find this setting in the [test template](#) at "Flow Details" > "Leveling Mode".
4. The injecting [Tx Antenna](#)
5. You cannot enter the [EUT](#) in this field. Instead, in the tests, R&S ELEKTRA automatically selects the "active" EUT according to the [activity status](#).
For the setup according to the [Calibration View](#), remove the EUT.
6. The [Antenna](#) and a [Receiver](#) for monitoring the test level.
7. A [Field Probe](#) and a [Positioner](#) for calibrating the test level.

8. The stirrer (mode tuner), which is a [Turntable](#) in the device list. We recommend selecting a turntable of the type "COMTEST Tuner".
9. Several [Signal Paths](#), with or without switching paths.
10. Optionally an [Interlock](#).
11. Optionally a [System Control](#) device.
12. Save the hardware setup. We recommend that you use a speaking name, for example including the term "RVC" or "stirrer".

For information on how to configure test templates based on this type of hardware setup, see [Chapter 4.5.3, "Test Templates for EMS tests"](#), on page 243.

4.8 Device List

The "Device List" comprises all measuring equipment in the test site. Devices from this list are included into [Hardware Setups](#), which are part of [Test Templates](#), as shown in the [software structure](#).

R&S ELEKTRA is compatible with a comprehensive choice of Rohde & Schwarz devices and also allows using third-party devices.

- When you [add](#) a **"specific"** Rohde & Schwarz device to the "Device List", a device driver is implemented in the background. The software does not provide user access to these "specific" drivers, which cover all communication tasks between R&S ELEKTRA and the devices.
- When you [add](#) a **"generic"** (third-party) device to the "Device List", no device driver is included. Instead, the software provides a dialog to specify the "generic" driver details. Enter all [configuration commands](#) that R&S ELEKTRA requires to communicate with the device. [Table 4-14](#) describes the availability of device drivers:

Table 4-14: Generic drivers in R&S ELEKTRA for the different device types

Common devices with no (or minimum) remote control	Generic driver available without license	Generic driver only with license "ELEMCDRV" or "ELEMSSCP" enabled	No generic driver available (not even with license "ELEMCDRV")
Antenna	Field Probe	Amplifier	Network Analyzer
LISN	Interlock Monitoring	Generator	Radio Comm. Tester
Signal Path	IO Device	Oscilloscope	Receiver
System Control	Monitoring	Power Meter	Audio Analyzer
TEM Waveguide	Positioner		
Transducer	Remote Action		
Triple Loop	Switch Unit		
	Generic Inserter		
	Turntable		

Common devices with no (or minimum) remote control	Generic driver available without license	Generic driver only with license "ELEMCDRV" or "ELEMSCP" enabled	No generic driver available (not even with license "ELEMCDRV")
	Slidebar		
	Antenna Tower		

Each device entry contains [device properties](#). You can configure these properties or let R&S ELEKTRA automatically retrieve them by using the functions [Search Device](#) and [Recheck Devices](#). This feature requires that the device is connected to your computer, either directly via GPIB or serial (USB) connection or remotely via LAN. (Exception: Some Rohde & Schwarz power meters are connected via a proprietary NRP interface.) Note that many [LISNs](#) can be remotely controlled by R&S ELEKTRA via an interface in the receiver.

Handling device list items

Access: "Home" > "Device List"

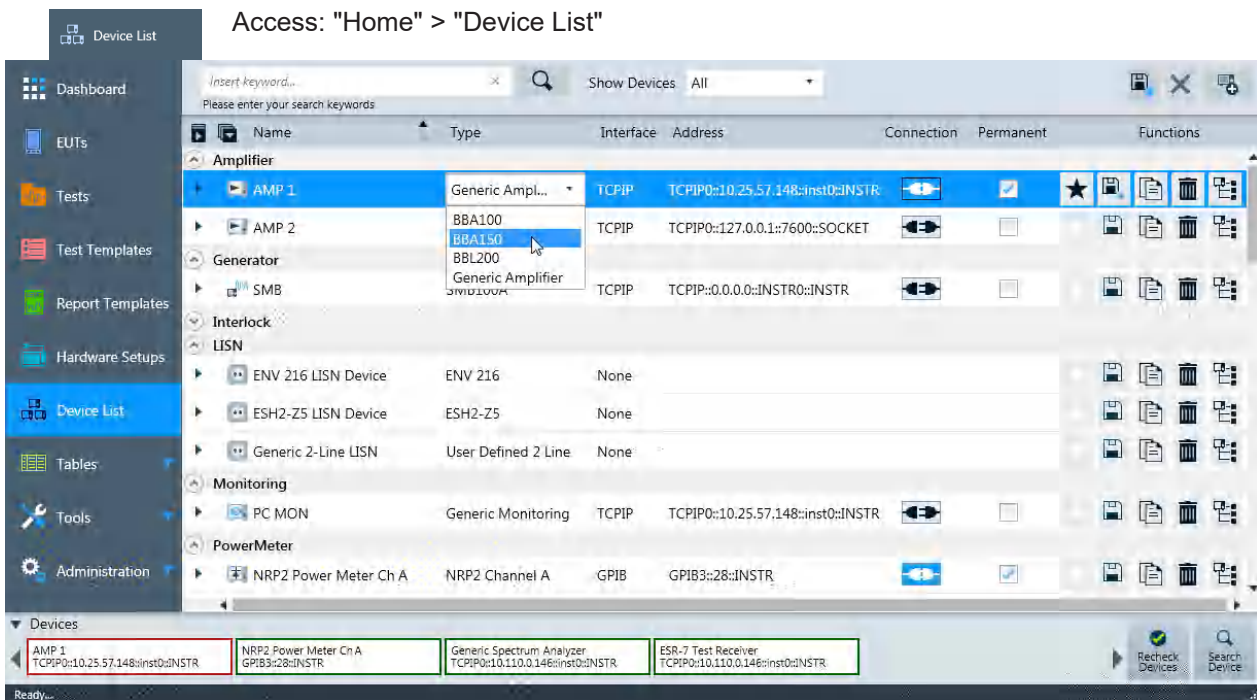

Figure 4-160: Device list dialog with an exemplary list of devices

The "Device List" dialog is largely different from the other "Home" dialogs ("Tests", "Report Templates", etc.). Differences are:

- All items in the "Device List" are grouped in [Device classes](#), for example "Receiver" or "Transducer". (To sort the entries within each device class, click the column header. Click the header again for reverse order.)
- No item in the "Device List" can be selected for an action to be executed with it. Instead, you can set one device per device class to be the [Favorite Device](#) in this device class.
- No item in the "Device List" can be [pinned](#) to the "Dashboard".

- No search can be saved, but the "Device List" can be [filtered \(Show Devices\)](#) for referenced, unreferenced or modified devices.
- None of the familiar [Common action buttons](#) is available. Instead, there is a special set of [Action buttons in the Device List](#).
- The device properties are not edited by opening them in a separate dialog tab. Instead, the device properties unfold in several tabs within the "Device List".
- Besides editing the device properties manually, they can also be automatically retrieved from existing physical equipment. This retrieval is implemented by the functions [Search Device](#) and [Recheck Devices](#). To use these functions, the equipment must be connected to the computer, which runs R&S ELEKTRA.
- Changes in the settings or properties of *several* devices can jointly be [saved](#) or [discarded](#).



One device per channel

R&S ELEKTRA handles **multichannel devices** as **separate devices** per channel. Examples are the discrete frequency bands of an amplifier or the individual measurement channels of a power meter. The software treats them as separate amplifiers or power meters.

Device classes

The "Device List" includes the following classes of devices, which are described in [Chapter 4.8.2, "Device properties"](#), on page 377:

- [Amplifier](#)
- [Antenna](#)
- [Antenna Tower](#)
- [Field Probe](#)
- [Generator](#)
- [Interlock Monitoring](#)
- [IO Device](#)
- [LISN](#)
- [Monitoring](#)
- [Network Analyzer](#)
- [Oscilloscope](#)
- [Positioner](#)
- [Power Meter](#)
- [Radio Communication Tester](#)
- [Receiver](#)
- [Remote Action](#)
- [Signal Path](#)
- [Slidebar](#)
- [System Control](#)
- [Switch Unit](#)

- [TEM Waveguide](#)
- [Transducer](#)
- [Triple Loop](#)
- [Turntable](#)
- [Generic Inserter](#)



Devices are always *integrated into test templates* as **references** that link to the original data sets in the "Device List". They are not integrated as copies of those data sets. Therefore, if device properties are modified in the "Device List", these properties are changed in all instances, too: in each test template that uses this device, in each test that uses this test template, etc.



Signal paths are included in the "Device List". A signal path is not necessarily only a piece of cable but can include multiple cables, RF relays in a switch unit, connectors, attenuators, etc.

• Action buttons in the Device List	366
• Device properties	377
• Common device properties	379
• Amplifier	389
• Antenna	395
• Antenna Tower	400
• Audio Analyzer	402
• Field Probe	409
• Generator	413
• Generic Inserter	415
• Interlock Monitoring	417
• IO Device	418
• LISN	420
• Monitoring	426
• Network Analyzer	431
• Oscilloscope	431
• Positioner	435
• Power Meter	440
• Radio Communication Tester	443
• Receiver	468
• Remote Action	471
• Signal Path	471
• Sliderbar	473
• Switch Unit	475
• System Control	479
• TEM Waveguide	480
• Transducer	485
• Triple Loop	488
• Turntable	491

4.8.1 Action buttons in the Device List

Access: "Home" > "Device List"

In the "Device List", the familiar [Common action buttons](#) are not available. Instead, the dialog-specific action buttons for the "Device List" are:

Search.....	366
Show Devices.....	367
Save all changes.....	367
Discard all changes.....	367
Add a new device.....	367
Collapse All.....	368
Expand All.....	368
Name.....	368
Type.....	368
Interface.....	369
Address.....	369
Connection.....	369
Permanent.....	370
Functions.....	370
L Set as Favorite Device.....	370
L Save.....	370
L Copy.....	370
L Delete.....	371
L Show Reference.....	372
Search Device.....	372
L Search.....	373
L Stop.....	373
L Interface Type.....	373
L Model.....	374
L VISA Address String.....	374
L Host Name.....	374
L Status.....	374
L ELEKTRA Name.....	374
L ELEKTRA Type.....	374
L Action.....	374
L Add to Device List.....	374
L Assign to Device.....	375
L Discard.....	375
L Save (Ctrl+S).....	376
L Cancel.....	376
Recheck Devices.....	376

Search

Searching for devices in the "Device List" works as described in [Chapter 6, "Special software features"](#), on page 569: Enter an arbitrary text string into the search field to *filter the "Device List"* for entries that contain this text.

Note:

- Other than conventional [Searches](#), a search in the "Device List" cannot be saved and [pinned](#) to the "Dashboard".

- Do not confuse this function for *searching (filtering) the "Device List"* with the function [Search Device](#), which allows finding devices in the network environment (LAN or GPIB).
- If there are unsaved device changes in the device list, the search results are not complete. To get complete search results, save the changed devices before doing a search.
If you wish to see exclusively the devices with unsaved changes, select [Show Devices](#) > "Modified".

Show Devices

Filters the devices that are displayed in the "Device List" by the following criteria:

"All"	All devices are displayed without being filtered.
"Referenced"	Only those devices are displayed, which are used ("referenced") elsewhere, for example in test templates or tests.
"Unreferenced"	Only those devices are displayed, which are not referenced.
"Modified"	Only those devices are displayed, which have been modified, with the changes still being unsaved.

Save all changes

Saves all changes in all devices that have not yet been saved after modifying them. Saving the changes is not protected by any alert, all changes are immediately saved.

R&S ELEKTRA supports the shortcut key "[Ctrl + Shift + s]" for the "Save All Changes" command.

Note: Instead of "Save All Changes", you can save the changes in each individual device: Click [Save](#) in the row of the device for which you want to save the changes. Alternatively, use the shortcut key "[Ctrl + s]" to save the selected (highlighted) device entry.

Note: If you change settings in the [Receiver](#) that is selected as the [Control](#) of a [LISN](#), R&S ELEKTRA considers this LISN as changed, too.

Discard all changes

Discards all changes in all modified devices that have not yet been saved. This loss of settings is protected by the following alert: "Do you really want to discard all changes? Total number of <n> device(s) changed:", followed by a list of the "n" modified devices. To discard the changes, confirm with "Yes", or select "No" to return to the device list without discarding the changes.

Note: To discard the changes in one or several devices, but not all that you have modified, proceed in two steps: First click the "Save" button in the row of each device for which you want to keep the changes. Then click "Discard All Changes" to discard the changes for the remaining modified devices.

Add a new device

Opens a dropdown menu for selecting a device that you want to add to the "Device List".

The dropdown menu consists of a tree of folders and sub-sub folders that branch out from "[Device Class](#)" (and sometimes "Device Group") to the individual "Device Type".

To support the intuitive handling of this dropdown menu, some pop-up windows provide additional details, when you hover your mouse over an entry:

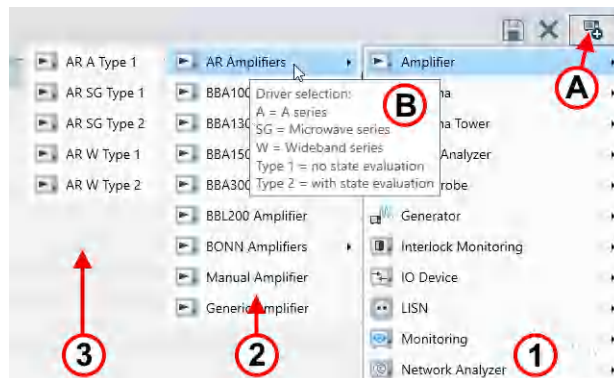

Figure 4-161: Typical tree of folders and sub-sub folders for adding devices to the device list

A = "Add a new device" button

B = Example of mouse-over pop-up window in the 2nd-level folder

1 = 1st-level folder containing [Device classes](#)

2 = 2nd-level folder containing device groups

3 = 3rd-level folder containing device types

Note: Connected devices can be added comfortably via the dialog [Search Device](#).

For the properties of the various types of devices, see [Chapter 4.8.2, "Device properties"](#), on page 377.



Collapse All

Minimizes the details of all devices:

- The first click collapses any [expanded](#) sections of device properties, if available, and shows a minimized list of device names.
- A second click collapses the list of device names, too, and shows a minimized list of device class headlines, only.



Expand All

Fully unfolds all [collapsed](#) device classes, device entries and device properties.

Name

Lists the device names, grouped within [Device classes](#).

To sort the device classes and the entries within each device class by the device names, click the "Name" column header. Click the header again for reverse order.

Type

Selects the device type for each entry in the device list.

To sort the device classes and the entries within each device class by the device type, click the "Type" column header. Click the header again for reverse order.

To select the type, highlight an entry and click the "Type" field to show the selection switch. In the pull-down list that opens, select any of the available device types, as in [Figure 4-162](#).

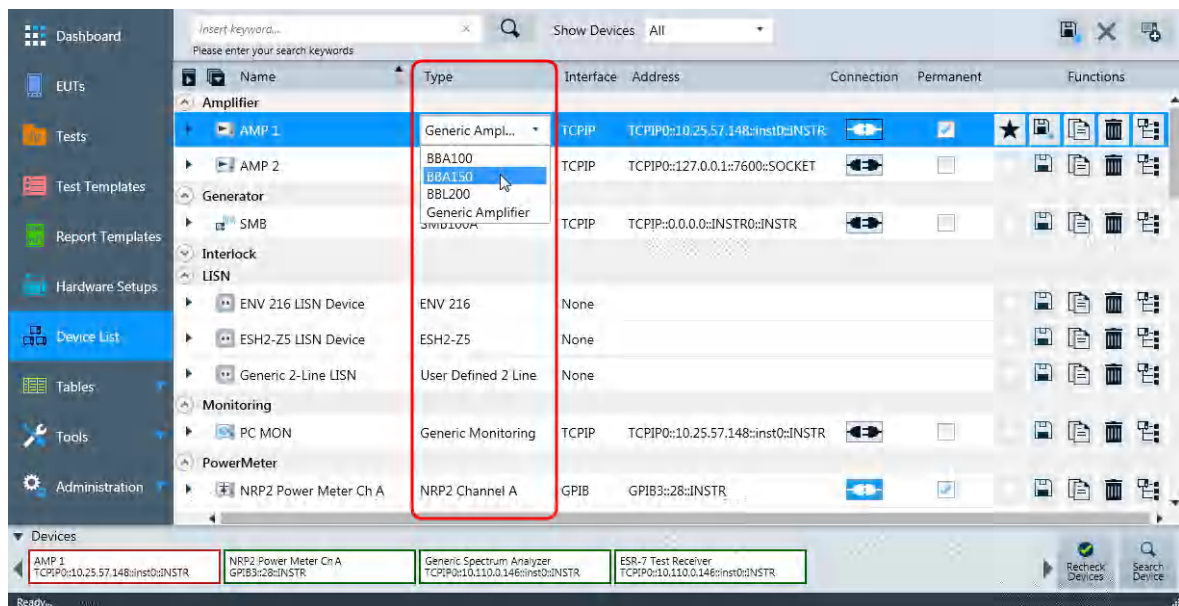

Figure 4-162: The Type selection in the Device List dialog

You can use the "Type" selection to exchange a device. If the device, which is replaced by this exchange (for example an ESR7 by an ESR26 Receiver), was referenced in a test, any existing test results data remain unchanged. However, when you rerun the test, the original test result data are discarded. The new device is then used for measurements in the rerun test.

Interface

Lists the **Interface Type** of all devices that can be **connected**.

To sort the device classes and the entries within each device class by their interface type, click the "Interface" column header. Click the header again for reverse order.

Address

Lists the **VISA resource strings** of all devices that can be **connected**.

To sort the device classes and the entries within each device class by their VISA resource string, click the "Address" column header. Click the header again for reverse order.

Connection

Toggles the connection state of a device.

- - device not connected
- - device connected

To be able to connect a device, first make sure to select the correct **Type** of device. For example, if you want to connect a receiver, the type can be "ESR7 Receiver", "ESU40 Receiver", "FSW85 Analyzer", or the like, depending on the actual equipment that you have.

Note: Toggling the connection state is no criterion for R&S ELEKTRA to consider a device as "changed". Instead, the software checks, if the state of the **Permanent** switch has changed. Connecting or disconnecting a device does not alter the state of the "Permanent" switch.

You cannot edit the device properties of connected devices. Instead, the properties are automatically read from the devices. The various properties tabs of connected devices show these properties in deactivated dialogs (grayed out). An exception is the "Functional Check" tab, if the device has one. In this tab, you can still use the settings, which are not grayed out.

Permanent

Activating this switch defines a permanent [Connection](#) to a device. After shutting down R&S ELEKTRA and starting it again, this device is automatically reconnected, if the network connection is available. If no connection is available, the device status is "red", see [Recheck Devices](#).

Functions

Comprises the following functions described below:

- [Set as Favorite Device](#)
- [Save](#)
- [Delete](#)
- [Show Reference](#)



Set as Favorite Device ← Functions

The set-as-favorite button is available in each individual device's row.

Per device class, you can select exactly one item to be "Set as Favorite Device" ★. This device is automatically used as the default, when R&S ELEKTRA requires a device of a specific [device class](#) for a test setup. All other devices in the same class are automatically assigned as non-favorite and hence non-default devices (☆).

Note: Clicking the "Set as Favorite Device" button of a newly [created](#) device also saves this device entry.

You can also remove the selection of one device as the favorite without assigning the favorite role to another device in the same class. To do so, temporarily [add a new device](#) to the same device class, set it as the favorite device and [delete](#) it from the "Device List".



Save ← Functions

The save button is available in each individual device's row.

Saves the changes in the selected device. Saving the changes is not protected by any alert, all changes are immediately saved.

Note: Instead of saving the changes in one individual device, you can use the [Save all changes](#) button to save all changes in all devices that have not yet been saved after modifying them.



Copy ← Functions

Duplicates a device (possibly a fully configured device) in the device list. Use this function, for example, in the following cases:

- Defining several similar devices with identical values for several properties
- Preparing several signal paths that reference the same switch unit
- Specifying multichannel devices (configured as separate devices), which all use the same connection settings

The new device has no [references](#) to the [hardware setups](#), [test templates](#) and [tests](#), which the original device can have had.



Delete ← Functions

The delete button is available in each individual device's row.

You can delete only devices that are not used (hence, not "referenced") in [hardware setups](#) (and via the hardware setups in [test templates](#)). If a device has references, you must first remove these references as described below, to be allowed to delete the device entry.

Note:

Before you plan to delete a device entry, first consider the following use cases:

- If you wish to replace an existing receiver by a **different receiver model**, we recommend not to delete the receiver device entry and create a new one. Instead, use the [Type](#) selection of this existing receiver to exchange the model type. This exchange preserves existing references, for example from test templates to this receiver device entry.
- If you wish to **replace** an old by a new device, and you are sure about using the old device never again, we recommend renaming the old device's entry. Overwrite the device's properties with the new information, which includes, for example, selecting new correction tables.
- If you **stop using** a certain device without replacing it, we recommend not to delete the existing entry, for example to maintain existing references to this device from test templates.

When you click the "Delete" button, R&S ELEKTRA first checks, if the item that you wish to delete is referenced.

- If the device is **not referenced**, the deletion process is merely protected by the following alert: "Are you sure you want to delete the selected item(s)?" Confirm with "OK" or "Cancel" the deletion process. This function is similar to the common action button [Delete](#), except that no multiple selections of items can be deleted simultaneously.
- If the device **is referenced**, R&S ELEKTRA warns you that deletion is not possible, since the software expects that you clear the references first:

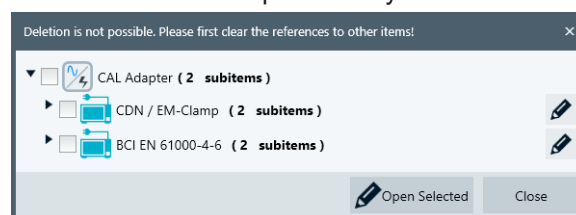

Figure 4-163: Dialog with subitems referenced by a device (here: a transducer)

If you wish to delete a device, **first consider to use the [Type](#) selection, instead**. For all other devices, or if type selection is no option for your device, and if you still wish to delete the device despite the recommendations above, proceed as follows:

- To unfold a tree of all references, in which the device is used, click the triangles in front of all items that have subitems.
- Select the checkboxes of all items in the reference tree:

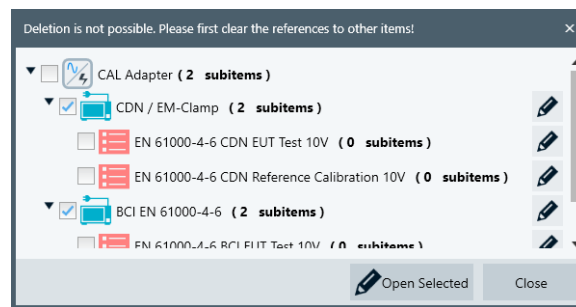

Figure 4-164: A transducer that is referenced by subitems down to tests templates

You can select all referenced items by selecting only the checkbox in front of the device icon itself.

However, for the device deletion process, it is sufficient to resolve only the references in **hardware setups**. Therefore, select only the referenced hardware setups.

- Click "Open Selected" to open a dialog tab for each selected item. This action closes the reference tree dialog and opens all selected subitems, but not the device itself.
- In the dialog tab of each hardware setup, replace the referenced device by a different device. Then save this change and close the tab.

Proceed in the same way with all opened dialog tabs that contain a reference for the device you wish to delete.

Replacing a device can be difficult, since the new device must comply with several property requirements. For example, it must cover the frequency ranges required by the test templates.

Note that you cannot replace devices in the template section of existing tests, where the test template is embedded as a copy in the [test container](#). If you modify settings in an embedded template copy, any previous test results become invalid, because these results do not match the test conditions in the template. Therefore, R&S ELEKTRA does not permit saving a test with existing test results and a modified test template.

- In the "Device List" dialog, you can delete the now unreferenced device (which is still highlighted).



Show Reference ← Functions

The reference tree shows, in which [hardware setups](#), [test templates](#) and [tests](#) a device is used ("referenced").

Hence, this button, which is also available in each individual device's row, brings up the same reference tree of a device as the [Delete](#) button. However, there are two differences:

- The button does not have the delete function
- The tree also includes the referenced tests



Search Device

The button "Search Device" in the lower right corner of the ["Device List" window](#) calls up a dialog for searching devices in the network environment, to which the computer is connected. Once the search is executed, the dialog looks as in [Figure 4-165](#):

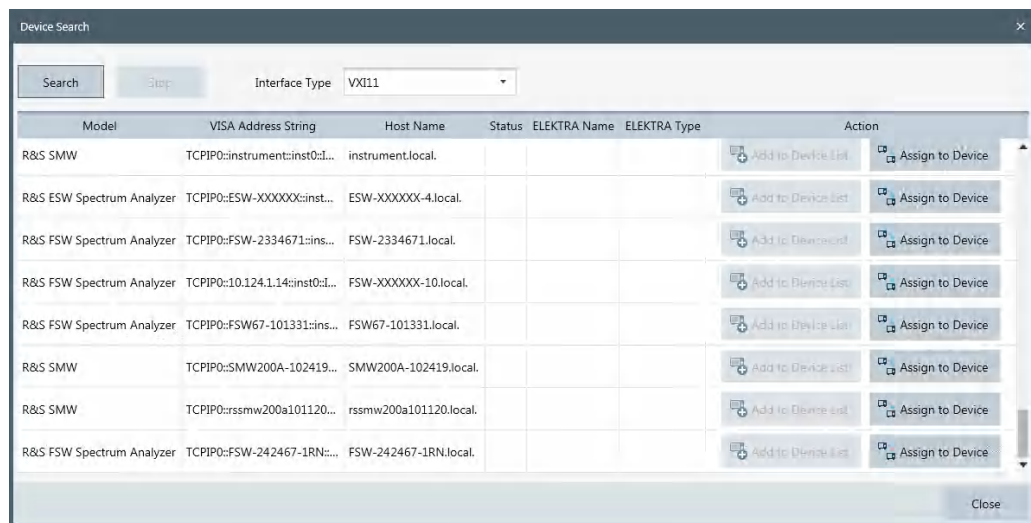

Figure 4-165: Device search dialog with an exemplary list of devices

To sort the search result list alphanumerically by the entries in one of the columns, click the column header. For reverse order, click the header again. Sorting works for all columns except for "Status" and "Action".

Note:

- Do not confuse this function, which *searches devices in the network environment* (LAN or GPIB), with the function [Search](#), which allows for filtering the "Device List".

Search ← Search Device

Starts a search for devices by a broadcast command within the network, to which the computer is connected via the selected [Interface Type](#). The search stops automatically after a time that depends on the size of the connected network. (If it takes too long, you can [Stop](#) it.)

The dialog then presents a list of available devices, as shown in [Device search dialog with an exemplary list of devices](#). Use this list to select [Add to Device List](#) or [Assign to Device](#).

Stop ← Search Device

Stops the [Search](#). Use this function if you wish to terminate the search at some point, or if it does not stop automatically within a reasonable timeframe.

Interface Type ← Search Device

Selects the interface type for searching devices within the network, to which the computer is connected.

Changing the selected interface type immediately starts a search.

"VXI11" VXI-11 is a protocol, specified by the [VXIbus Consortium](#), for remote control of LAN-based test and measurement instruments. Use this "Interface Type" to search for devices connected via Ethernet (LAN).

" **GPIB** " GPIB (General Purpose Interface Bus) is the common name for the 8-bit parallel communications interface specification IEEE-488. Use this "Interface Type" to search for devices connected over a short range via GPIB bus.

Model ← Search Device

States the model name, if it is contained in the network device's reply to the device search. You cannot edit this field, which remains empty, if the search algorithm cannot read the model name from the device.

VISA Address String ← Search Device

Displays the [VISA Address String](#) as originally found by the automatic device search. You cannot edit this string.

Host Name ← Search Device

Displays the host name of the device within the network. You cannot edit this string.



Status ← Search Device

Available only for network devices that have been [added](#) to your device list or [assigned](#) to entries in your "Device List".



Shows and sets the connection state of this device, which you can toggle between connected and disconnected.

ELEKTRA Name ← Search Device

Available only for network devices that have been [added](#) to your device list or [assigned](#) to entries in your "Device List".

Displays the device's [Name](#) in the "Device List". Especially with several names, this column helps you to recognize "Device List" entries in the search dialog.

You cannot edit the name in this column, but only in the [Name](#) field of the "Device List".

ELEKTRA Type ← Search Device

Displays the device class of the network devices. For all network devices that do not match with the "Device List", R&S ELEKTRA displays "unknown device category".

You cannot edit this field.

Action ← Search Device

Allows using results of the network device search for entries in the "Device List". Available only, if the search algorithm finds connectable devices in the network environment.

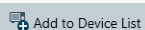

Add to Device List ← Action ← Search Device

"Add to Device List" is available for each network device that the [Search Device](#) function finds in the network environment.

When you click this button for an individual network device, R&S ELEKTRA offers the device types for which you can add the selected network device. If no device type is offered, you cannot add this entry to the "Device List".

To add a specific device from the "Search Device" dialog, first execute the [Search](#). If the search delivers results, browse the list of search results to find the network device that you wish to add to the "Device List". In this row of the search results list, click "Add to Device List". The dialog opens a drop-down list for selecting one of the connectable [Device classes](#). Within each of them, the dialog offers a drop-down list of the available [Device Types](#).

Select one device type to let R&S ELEKTRA create a "Device List" entry in the sublist of the selected device class, with a [Device Type](#) set and with the [VISA Address String](#) copied from the selected network device. Close the device search dialog either by "Save" or "Cancel". If you select "Cancel", you can decide later (in the "Device List" dialog) to either [save](#) or [discard](#) the new entry.

Note: Avoid interfering with other people's devices. We recommend that you use "Add to Device List" only for devices, for which control via R&S ELEKTRA is reasonable and desired. Be aware that this function allows connecting remotely to any available network resource. This connection can interfere with the work of other people, who may use the same device.



Assign to Device

Assign to Device ← Action ← Search Device

Assigns the connectivity parameters of an individual network device to an existing "Device List" entry (device description). "Assign to Device" is available for each device found by [Search Device](#) in your network environment.

To assign a specific network device from the "Search Device" dialog, first execute the [Search](#). If the search delivers results, browse the list of search results to find the network device that you wish to couple with one of your "Device List" entries. In this row of the search results list, click the "Assign to Device" button. The dialog opens a drop-down list for selecting one of the *already listed* connectable [Device classes](#). Within each of them, the dialog offers a drop-down list of device descriptions existing in the "Device List".

When you select one device description, R&S ELEKTRA assigns the [VISA Address String](#) of the selected network device to the selected entry in the "Device List" (hence, without adding a new entry). Close the device search dialog either by "Save" or "Cancel". If you select "Cancel", you can decide later (in the "Device List" dialog) to either [save](#) or [discard](#) the modification of the device entry.

Make sure to select the correct [device types](#) for your connected devices. This setting is not selected automatically.

Note: Avoid interfering with other people's devices. We recommend that you use "Assign to Device" only for devices, for which a control via R&S ELEKTRA is reasonable and desired. Note that this function allows connecting remotely to any available network resource. This connection can interfere with the work of other people, who use the same network device.



Discard

Discard ← Action ← Search Device

Available only for network devices that have been [added](#) to your device list or [assigned](#) to entries in your "Device List".

The "Discard" button deletes a device list entry from the "Device List" (but not from the list of network devices in the search results).

Clicking "Discard" brings up a second button to confirm "Remove Device":

- If the device is **not referenced**, clicking "Remove Device" brings up the following warning: "Are you sure you want to delete the selected item(s)?"
If you confirm your intention by clicking "OK", the "Device List" entry is deleted immediately.
- If the device is **referenced**, clicking "Remove Device" opens a dialog to inform you that deletion is not possible. As described in the section on the [Delete](#) function, you must first clear the references to other devices.
However, this deletion is often not reasonable. Instead, if you only wish to break the relation between a device list entry and a network device while keeping the device entry in the "Device List", we recommend using the [Connection properties](#) dialog. After [disconnecting](#) the device, erase only the device's [address or host name](#).

Save (Ctrl+S) ← Search Device

Saves the settings of the [Search Device](#) dialog in the [Device List](#). Saving the settings within the [Search Device](#) dialog has the same effect as first canceling from this dialog and then selecting [Save all changes](#).

Cancel ← Search Device

Cancels the [Search Device](#) dialog without saving the device settings and returns to the [Device List](#). In this dialog, the changed settings are still available. They can be individually or globally [saved](#) or globally [discarded](#).



Recheck Devices

Available only, if at least one [permanent connection](#) was previously established.

The button "Recheck Devices" in the lower right corner of the "[Device List](#)" window launches a special checking algorithm for all permanent device connections. The algorithm checks these connections in the network environment, to which the computer has access via the specified [Interface Type](#).

Note: If a device's ID response differs from the selected [device type](#) setting, the checking algorithm is not executed for this device.

The result of rechecking all devices that are set for permanent connection is shown in the device status bar at the lower edge of the "Dashboard" dialog (see [Graphical user interface](#)):

- A **green** box represents a permanently connected device that is available.
If an available device - with a setting for permanent connection - is found to be currently disconnected, the algorithm reconnects it.
- A **red** box represents a permanently connected device that is not available.
- An **orange** box represents a connected device, which is found to be in a physical state that does not correspond with the defined settings.

Examples of device states represented by an orange box:

- A hardware or software option, which is enabled at "[General](#)" > "[Option](#)", is not available in the connected device.
- A hardware or software option, which is available in the connected device, is not enabled in the "[General](#)" > "[Option](#)" settings.

In either of these cases, clicking "Recheck Devices" adjusts the "Option" settings in the "General" tab and brings up a notification regarding this adjustment. Clicking

"Recheck Devices" again finds the settings in agreement with the physical state and hence leads to a **green** box.

4.8.2 Device properties

The "Device List" specifies all device properties that are relevant for your EMC measurements.

Per device class, these properties are organized in sets of tabs, for example:

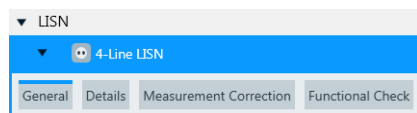

Figure 4-166: The device class "LISN" has the properties tabs General, Details, Measurement Correction and Functional Check

Other device classes have different sets of properties tabs.

Table 4-15 provides an overview of all tabs of all device classes.

- The **"General"** tab is **similar** for all devices. It is described in [Chapter 4.8.3.1, "General properties"](#), on page 379.
- The **"Connection"** tab is **similar** for all devices that can be connected to your computer or network. It is described in [Chapter 4.8.3.2, "Connection properties"](#), on page 382.
- The **"Configuration"** tab is **similar** for all "generic" devices (except for generic switch units) that can be connected to your computer or network. This tab is described in [Chapter 4.8.3.3, "Configuration properties"](#), on page 386.
- All other tabs are individually **different** for the various device classes. These tabs are described in the chapters that are directly linked from the **X** characters in [Table 4-15](#). The table headline entries are linked to the individual device chapters.

For better readability, this table is split in two, for device class initials A to P and R to Z.

Table 4-15: Properties tabs in the various device classes

Class → Tab ↴	Amplifier	Antenna	Antenna Tower	Audio Analyzer	Field Probe	Generator	Generic Inserter	Interlock Mon.	IO Device	LISN	Monitoring	Network Analyzer	Oscilloscope
General	X	X	X	X	X	X	X	X	X	X	X	X	X
Connection	X		X	X	X	X	X	X	X		X	X	X
Details			X			X				X			
Configuration	X		X		X	X	X	X	X		X		X
RF Parameters	X												
Power Correction	X												

Class → Tab ↴	Amplifier	Antenna	Antenna Tower	Audio Analyzer	Field Probe	Generator	Generic Inserter	Interlock Mon.	IO Device	LISN	Monitoring	Network Analyzer	Oscilloscope
Band Selection	X												
Notifications	X												
Device Programming											X		
Measurement Queries											X		
Type		X											
Parameters					X								
Measurement Correction		X			X					X			
Tower Control		X											
Antenna Selection		X											
File Management						X							
Data Configuration							X						
Module Configuration								X					
Functional Check	X		X	X	X	X	X	X	X	X	X		X

Table 4-16: Properties tabs in the various device classes (CONTINUED)

Class → Tab ↴	Positioner	Power Meter	Radio Comm. Tester	Receiver	Remote Action	Signal Path	Slider	Switch Unit	System Control	TEM Waveguide	Transducer	Triple Loop	Turntable
General	X	X	X	X	X	X	X	X	X	X	X	X	X
Connection	X	X	X	X	X		X	X					X
Extended Connection	X		X										
Details	X	X		X			X	X		X		X	X
Configuration	X	X			X		X						X

Class → Tab ↴	Positioner	Power Meter	Radio Comm Tester	Receiver	Remote Action	Signal Path	Slider	Switch Unit	System Control	TEM Waveguide	Transducer	Triple Loop	Turntable
Transducer Type											X		
Type										X			
Switching									X				
Position	X												
Generic Inserter									X				
Measurem. Correction						X				X	X	X	
Functional Check	X	X	X	X	X		x	X	x	X		X	X

4.8.3 Common device properties

The device properties tabs that are **similar** for all devices (or most of them) are described in the following chapters:

- [General properties](#)..... 379
- [Connection properties](#)..... 382
- [Configuration properties](#)..... 386

4.8.3.1 General properties

This tab contains general properties of the devices. It includes the following parameters:

Description	379
Manufacturer	379
Serial Number	380
Cal. valid until	380
Options	380
Model	380
Firmware Version	380
^L Minimum firmware version	381
Frequency Range	381

Description

Arbitrary text to describe the device.

Manufacturer

For devices from Rohde & Schwarz and some associated manufacturers, this field displays the company logo.

For third-party devices, the manufacturer name is either predefined, or you can enter arbitrary text to describe the device manufacturer.

Serial Number

For devices from Rohde & Schwarz and some associated manufacturers, this field displays the serial number as read from the device, if the device is connected.

For non-connected and third-party devices, you can enter arbitrary text to describe the device's serial number.

Cal. valid until

In this field, you can note the expiry date of the device's calibration validity. This note is intended to remind you when the next calibration is due.

If enabled in a report, the "Cal. valid until" date appears in its "Hardware Setup" details. However, the software does not act or alert you, if the expiry date is reached or exceeded.

To enable editing, activate the checkbox. Either directly edit the date field or click the calendar icon for date selection. To select a different month, click the calendar headline. To select a different year, click the calendar headline again.

Options

If the device is a Rohde & Schwarz instrument that has (or can have) hardware or software options installed, this field shows a predefined checkbox list of these options (either checked or not). The availability of options can have an influence on the execution of tests.

If the device is in non-connected state, you can enable or disable individual options. This choice is useful, for example, for measurements with [device simulation](#).

If a remote connection to the device is established, R&S ELEKTRA automatically adjusts the options list to the actual configuration of the receiver. This adjustment is carried out when you execute one of the following actions:

- [Connect](#) the device
- Select [Recheck Devices](#).

While connected, the checkboxes are then no longer available for user interaction. Instead, the options list represents the physical device configuration.

For all other devices, this field is blank. For LISNs, TEM waveguides and all generic devices, editing is enabled for this field, but it has no effect on any test execution.

Model

For devices that are connected, this field displays the model as read from the device.

For devices that can be connected, but currently are not connected, this field is either blank or predefined. For amplifiers, antennas, LISNs, TEM waveguides, transducers, triple loop antennas, signal paths and all generic devices, you can enter arbitrary text to describe the device model.

For other devices, this field cannot be edited.

Firmware Version

Available only, if the device uses firmware and allows [Connection](#).

For devices that are connected, this field displays the firmware version as read from the device.

For devices that can be connected, but currently are not connected, this field is either blank or predefined. For generic devices, you can enter arbitrary text to describe the firmware version.

Minimum firmware version ← Firmware Version

Available only, if the device uses firmware.

Displays the number of the earliest firmware version of this device that provides full compatibility with the current version of R&S ELEKTRA.

If the [Firmware Version](#) is lower than the "Minimum firmware version", R&S ELEKTRA does not [connect](#) with the device. If connection is refused, update the device to a compatible firmware version.

Frequency Range

For many devices from Rohde & Schwarz and specific other companies, this field is predefined with the start and stop frequencies according to the known device specifications. An exception applies for generators, where you can set the minimum and maximum frequency in the [RF Parameters](#) tab.

For antennas and TEM waveguides, the frequency range shown here comes from the following sources:

- If you use fixed attenuation or correction values in the "Measurement Correction" tab, you can edit the "RF Parameters" in the "Type" tab (see for example [Type](#)). R&S ELEKTRA copies the "Frequency Range" from these "RF Parameters".
- If you use attenuation and/or correction tables in the "Measurement Correction" tab, R&S ELEKTRA copies the frequency range of the table (or the overlapping part of the ranges in two tables) to the "Frequency Range" and "RF Parameters" fields. You cannot edit the copied values in these fields.

Note that the settings can differ for [Rx](#) and [Tx](#) antennas or waveguides. Also, the Rx frequency range can be defined in a table, while the Tx frequency range is unspecified and available for editing.

For LISNs, signal paths and transducers, the frequency range shown here comes from the following sources:

- If you use fixed attenuation or correction values in the "Measurement Correction" tab, the "Frequency Range" is from 0 Hz to infinite.
- If you use attenuation and/or correction tables in the "Measurement Correction" tab, R&S ELEKTRA copies the frequency range of the table (or the overlapping part of the ranges in two tables) to the "Frequency Range" field. You cannot edit the copied values in this field.

For power meters, the frequency range is shown according to the known specifications of the "Insertion Unit" selected in the [Details](#) tab. Alternatively, if you have directly selected an "NRP-Zxx" as the power meter, R&S ELEKTRA uses its known specifications to display the frequency range.

For generic devices (except for antenna towers, interlocks, turntables and generic monitoring devices), the frequency range shown in the "General" tab is read from the "Frequency" command in the [Configuration properties](#) tab. For generic monitoring devices, the frequency range is read from the internal limits of the "Send Frequency" command.

4.8.3.2 Connection properties

This tab contains connection settings for the remote control of your devices. If a device is [connected](#), its connection settings are only displayed but cannot be edited.

The tab includes the following parameters:

VISA Address String.....	382
Interface Type.....	383
Timeout.....	383
Address.....	383
(Vendor ID) Product ID.....	384
SN.....	384
End Char.....	384
Baud Rate.....	385
Mode.....	385
Board No.....	385
Port No.....	385
Secondary Address.....	385
Data Bits.....	385
Parity.....	386
Read Status Byte.....	386

VISA Address String

Also called "VISA Device Identifier" or "VISA Resource String". Displays the VISA address string for the selected [interface type](#).

R&S ELEKTRA generates the VISA address string from the device parameters as specified and uses it for connecting to the devices. You cannot edit it, but it is displayed for your information.

The following list and table describe this string in more detail.

Examples of the VISA address string are:

- TCPIP0::10.113.0.75::inst0::INSTR
- GPIB::3::INSTR
- RSNRP::0x0021::100002::INSTR
- ASRL1::INSTR

The ASRL_{xx}::INSTR string is used only in the "Serial" interface ("Asynchronous SeRIal Line") for field probes, monitoring devices and generic devices. The string's one- or two-digit number (with values from 1 to 31) represents the selected port number.

(Since there is no more information about the VISA address string for "Serial" interfaces, it is not included in the following table.)

Besides the separator ":", the VISA address strings consists of the following elements:

Table 4-17: Structure of the VISA address string

Interface	TCP/IP or UDP/IP internet protocol			GPIB 8-bit parallel	R&S NRP2 / NRP-Zxx
Header	TCPIP _x , with "x" = Board No.			GPIB _x , with "x" = Board No.	RSNRP
First address group	IP Address in one of three modes:			Primary address: integer from 1 to 31	Product ID: 0x + 4 alphanumeric digits
	Host name:	IPv4 format:	Raw socket:		
	arbitrary alphanumeric string	four blocks, each with one to three numbers, separated by dots: xxx . xxx . xxx . xxx			
Second address group	inst0	inst0	Port number: 1 to 5 num. digits (typ. 4)	Secondary address (optional): integer from 1 to 31	Serial number: typ. 6 numeric digits
Delimiter	INSTR	INSTR	SOCKET	INSTR	INSTR

("R&S NRP2 / NRP-Zxx" represents the Rohde & Schwarz power meters and sensors.)

Interface Type

The following interface types are available:

- "TCP/IP" Transmission Control Protocol / Internet Protocol
- "GPIB" General Purpose Interface Bus for 8-bit parallel communication according to IEEE-488
- "Serial" Serial interface, available, for example, for [field probes](#) and [monitoring devices](#)
- "NRP" Proprietary interface, only for Rohde & Schwarz [power meter](#) insertion units (power sensors) R&S NRP-Zxx
- "UDP/IP" User Datagram Protocol / Internet Protocol, available, for example, in the "ADAM" switch [IO devices](#), in generic [antenna towers](#) and in generic [switch units](#)
- "USB" Universal Serial Bus (USB) interface, available for:
 - [Generic monitoring devices](#)
 - Generic drivers with [license](#) "ELEM-DRV" or "ELEM-SCP" enabled. See also [Table 4-14](#).

Timeout

Defines the time period in seconds applied to detect a timeout in the communication of a single command.

Address

The address field depends on the [Interface Type](#):

- For TCP/IP: "[IP Address](#)" or "[Host Name](#)" (depending on the address [Mode](#))
- For GPIB: "[Primary Address](#)": numeric value from 1 to 31
- For NRP and USB: "[\(Vendor ID\) Product ID](#)"

(Vendor ID) Product ID

Available only for ["Interface Type"](#) on page 383 = "USB".

Specifies the product identifier ("PID", which is a vendor-specific device code), or optionally both the vendor identifier and the product identifier ("VID::PID"). Enter the ID or IDs to enable R&S ELEKTRA connecting to the device.

Example:

- When you enter a product ID like "1234", the software enters "0x0AAD::1234" into the VISA address string. Hence, ahead of the product ID it enters "0x0AAD", which is the Rohde & Schwarz vendor ID.
- When you enter a vendor ID and product ID like "ABCD::1234", the software copies it as "ABCD::1234" into the VISA address string. Hence, instead of the Rohde & Schwarz vendor ID, it uses the vendor ID "ABCD" from your entry.

You cannot edit the ID in specific "NRP-Zxx" power meters with proprietary "NRP" interface.

You can edit the ID in generic devices with "USB" interface, for example:

- [Amplifier](#)
- [Generator](#)
- [Monitoring devices](#)
- [Oscilloscope](#)

Note that these devices can require a [license](#) "ELEM-DRV" or "ELEM-SCP". See also [Table 4-14](#).

SN

Available only for [Interface Type](#) = "USB".

Specifies the serial number (SN) of the device. Enter the SN to enable R&S ELEKTRA connecting to the device.

When the device is connected, R&S ELEKTRA reads the SN from the device and displays it in the [Serial Number](#) field of the [General properties](#) tab.

You can edit the SN in the following devices:

- Specific "NRP-Zxx" power meters with proprietary "NRP" interface
- Generic devices with "USB" interface, as described in ["\(Vendor ID\) Product ID"](#) on page 384

End Char

Only for generic devices with "GPIB" or "Serial" [interface](#) or "TCP/IP" in "Raw Socket IPv4" [mode](#): "Newline" character or sequence of characters for the end of a text or command line, depending on the device's remote control system.

The end character marks the end of a command, typically implementing that the receiving device starts parsing and processing the string as received so far.

The following end character settings are available:

- "CR" = carriage return (`\r`)
- "LF" = line feed (`\n`)
- "CR+LF" = carriage return and line feed (`\r\n`)

- "None" = no end character required (for example, if the generic device starts parsing and processing the string without waiting for an end character)
- "Hex0" = a "zero" byte

Baud Rate

Only for field probes and monitoring devices with "Serial" (USB) [interface](#): selects from a list of standard transmission rates (1200 to 115200 symbols/second). Default is 9600 baud.

Mode

Address mode, depending on the "[Interface Type](#)" on page 383 "Interface Type":

For TCP/IP:

- "VXI11 Hostname" - LAN instrument protocol using a hostname as address
- "VXI11 IPv4" - LAN instrument protocol using an IP address with up to 4x3 digits (xxx.xxx.xxx.xxx)
- "HiSLIP Hostname" - LAN instrument protocol using a hostname as address
- "HiSLIP IPv4" - LAN instrument protocol using an IP address with up to 4x3 digits (xxx.xxx.xxx.xxx)
- "Raw Socket IPv4" (see [Port No.](#))

This format serves mainly for controlling devices that have no "VISA VXI11" protocol interface and support only basic IP communication via a (selectable) port. See [Port No.](#).

For GPIB:

- "Normal" - default GPIB address setting, for example *GPIB::1::INSTR*
- "With Secondary Address" - adds a [second address block](#) to the primary GPIB address.

With a specific driver for a known device, typically its setting is fixed to "Normal", meeting the device's requirements. Because R&S ELEKTRA has no information about devices that require generic drivers, you can edit the settings of such devices.

Board No.

TCP/IP board number (values from 0 to 9) or GPIB board number (values from 0 to 31).

Port No.

Only for "TCP/IP" and "UDP/IP" in "Raw Socket IPv4" [mode](#), typically a 4-digit number (for example 5025):

TCPIP::xxx.xxx.xxx.xxx::5025::SOCKET

UDPIP::xxx.xxx.xxx.xxx::5025::SOCKET

Secondary Address

Only for GPIB in [mode](#) "With Secondary Address": numeric value from 1 to 31, for example *GPIB::1::16::INSTR*

Data Bits

Only for field probes and monitoring devices with "Serial" (USB) [interface](#): selects from a list of standard data bit numbers (4 to 9 bits per symbol). Default is 8 bits.

Parity

Only for field probes, monitoring devices and generic devices with "Serial" (USB) [interface](#). Sets a parity bit according to your selection from the following list:

- "None" - sets no parity bit
- "Odd" - sets the parity bit to make for an odd number of bits with value 1 in a symbol.
- "Even" - sets the parity bit to make for an even number of bits with value 1 in a symbol.
- "Mark" - sets the parity bit always with value 1.
- "Space" - sets the parity bit always with value 0.

Default is "None".

Read Status Byte

Only for generic devices with "GPIB" [interface](#): Enabling the checkbox allows the software to read the device's status byte, which contains additional information.

4.8.3.3 Configuration properties

This tab contains configuration settings for the remote control of *generic* (third-party) devices, except switch units. Enable the software to communicate with these "unknown" devices by defining [SCPI command strings](#) that are equivalent with the [generic commands](#) used by R&S ELEKTRA.

For all other (non-generic) devices that are known to R&S ELEKTRA, the remote control settings are configured internally, without requiring or allowing user interaction.

The "Configuration" tab is split up into two sections:

- [Configuration commands](#)..... 386
- [Configuration parameters](#).....389

Configuration commands

This tab is used to configure the required remote control commands for *generic* devices. It includes the following settings:

Import / Export Settings	386
Generic Commands	387
SCPI Command String	387
Command Execution	388

Import / Export Settings

Allows you to load command settings from external files or to save command settings to external files.

- | | |
|-----------------|--|
| "Load from XML" | Loads SCPI commands from a file in Extensible Markup Language (XML) format to make them available for the device. |
| "Save as XML" | Saves the existing set of SCPI commands of the device to an XML file. This file comprises individual entries for each command. |

Generic Commands

A list in the "Generic Commands" dialog comprises all generic commands that the software requires for correct communication with the device. To give R&S ELEKTRA sufficient remote control of the selected device during measurements, each generic command must have an equivalent [SCPI command](#) as its counterpart.

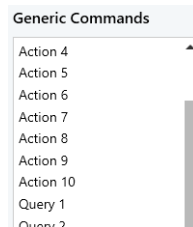

Figure 4-167: Incomplete example of the list of generic amplifier actions

Select any generic command in the list to see and optionally edit the related "SCPI Command String" and its parameters.

SCPI Command String

This field in the "Configuration" dialog is a SCPI command editor.

To view the individual SCPI command that is assigned to a given [generic command](#), select this generic command from the list.

Example:

For the generic command "Identification", the SCPI command `*IDN?` and a field "Required Substring in Answer" are displayed:

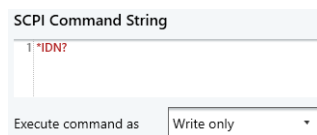

Figure 4-168: Example for the Identification command of a generic amplifier (here: from manufacturer "Bonn", which is shown as an editable Required Substring in Answer)

Query commands end with a question mark ?, setting commands end without a question mark. You can edit both existing entries and empty SCPI command fields. The editor supports copy ([CTRL+C]), cut ([CTRL+X]) and paste ([CTRL+V]).

Depending on the selected generic command, the "SCPI Command String" dialog offers various fields, selectors, lists or buttons to edit parameters, values, units, range settings (see [Figure 4-169](#)) and keys (see [Figure 4-170](#)).

Color coding

If a command has variable values, parameter units, labels, or the like, these parts of the string are shown in different colors:

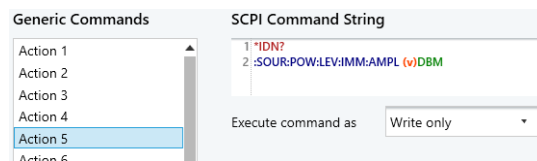

Figure 4-169: Color-coded parts of a SCPI command

The colors have the following meanings:

- Red - common commands, such as `*IDN?`, `*RST` or `*WAI`
- Blue - setting commands, such as `FREQUENCY` or `START`
- Orange - variable values, such as a delay time or minimum and maximum frequencies
- Green - parameter units, such as "Hz" or "dBm"
- Yellow - value labels, such as 'Factory' or 'xFrequency'

Keys

The "SCPI Command String" also supports translating keys between R&S ELEKTRA and generic devices. For example, if the software must send the query `Get Power State` to a generic amplifier: Some amplifiers respond with 1 or 0, other amplifiers respond with ON or OFF. R&S ELEKTRA requires the response ON or OFF. Hence, defining the keys as in Figure 4-170 translates the responses appropriately. This translation also works in the opposite direction, with settings instead of queries.

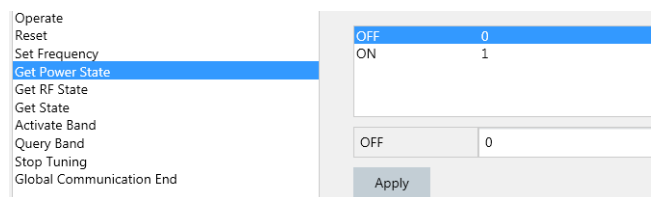

Figure 4-170: Example for parameter keys

Click the "Apply" button to enter any edited key settings.

Note: For a detailed description of the required SCPI commands, refer to the remote control commands chapter in the user manual of your generic device.

Command Execution

Allows testing a selected command to verify correct device response.

In this dialog, queries are converted automatically into setting commands (without the `?`).

- "Input" If this field is available, you can enter or select a value or a parameter, with which the command is executed.
- "Execute" Executes the selected command. If the device is not connected, R&S ELEKTRA tries to establish the connection. If the device is successfully connected, its **Connection** state is set to "enabled" and the command is executed. Otherwise, the following warning is displayed: "No connection to device XXX, address YYY is wrong or device is turned off!"

"Result" As a result of a successful command execution, this field displays the reply string that is sent back from the generic device to the controller. For example, the generic command "Options" with the SCPI command string "*OPT?" returns a list of the installed options, for example "B5, B22, K150".

Configuration parameters

Use this tab to configure values for parameters required for the remote control of *generic* devices. The tab comprises only one user-definable list of "Device Parameters".

For example, if you use a generic [Field Probe](#), it can have the following configuration parameters and values:

- "Maximum Field Strength" = 300 V/m
- "Noise Level" = 1 V/m
- "Settling Time" = 0,2 s
- "Measurement Detector" = "RMS"
- "Support Multivalued" = "YES"
- "Number of Channels" = 4

You can import these settings by "Load from XML file" or export your settings by "Save as XML file", see ["Import / Export Settings"](#) on page 386.



Relevance of configuration parameters

Parameters include all properties and settings of a generic device that are relevant for R&S ELEKTRA. These parameters are not necessarily related to commands, but must be set to values that suit the device.

The list of parameters depends on the device model and can be empty, if no parameter is relevant for R&S ELEKTRA. You cannot change the list, but for every listed parameter, you must specify a suitable value for that device. This set of specifications can help to prevent operating the device outside of its specifications. Also it can help to prevent using bad device readings.

For example, when you use a power sensor for leveling, R&S ELEKTRA must keep the power level in a range that avoids dropping below the power meter's noise level.

4.8.4 Amplifier



Broadband RF amplifiers are key components in EMS test systems. The required immunity levels cannot be achieved without a suitable amplification of the signal delivered by the [Generator](#). No [EMS hardware setup](#) can be defined (and hence no EMS test can be performed) without selecting an RF amplifier.

R&S ELEKTRA handles dual-band or multiband amplifiers as two or more individual devices that are [connected](#) via the same [interface address](#). Hence, for a dual-band amplifier, for example, you must have two device entries in the "Device List".

R&S ELEKTRA supports the following Rohde & Schwarz amplifier [types](#):

- "BBA100"
- "BBA130"
- "BBA150"
- "BBA300"
- "BBL200"

The software supports the following third-party amplifier [types](#):

- "AR Amplifiers" (with specific drivers in R&S ELEKTRA)
 - "AR A Type 1"
 - "AR SG Type 1/2"
 - "AR W Type 1/2"

Note the tool tip that shows driver-selection information, when you mouse-over "AR Amplifiers" before adding a model from this family to the device list.

- "BONN Amplifiers" (with specific drivers in R&S ELEKTRA)
 - "BLMA" series
 - "BLWA" series
 - "BSA" series
 - "BTA" series
 - "TWAL" series

Note the tool tip that shows driver-selection information, when you mouse-over "BONN Amplifiers" before adding a model from this family to the device list.

- "CPI TWT Amplifier" (traveling-wave tube amplifier with specific driver in R&S ELEKTRA, supporting the remote-control command set specified by CPI in their document "TN-Ethernet-1 (MINI-LAN) Rev-2017")

Additionally, the software supports the following user-definable amplifier [types](#):

- "Manual Amplifier"
- "Generic Amplifier", available only with "[ELEMC-DRV](#)" license

This chapter describes all individual device properties tabs, but not the "General", "Connection" and "Configuration" tabs, which are [similar](#) for many devices and described separately.

- [General](#) properties are available for all types of devices.
- [Connection](#) properties are available for devices that can be connected to a local network or to your computer (for example via LAN).
- [Configuration](#) properties are available for "generic" (third-party) devices.

Besides the content mentioned above, this device dialog has the following content:

• RF Parameters	391
• Power Correction	392
• Band Selection	394
• Notifications	394
• Functional Check	395

4.8.4.1 RF Parameters

Complete this dialog with the RF parameters taken from the amplifier's specification sheet.

RF Ranges

Specifies the RF range settings of the selected amplifier.

"Minimum Frequency" Specifies the lowest start frequency of the amplifier.

"Maximum Frequency" Specifies the highest stop frequency of the amplifier.

"Define Limits by Tables" Specifies how to define limits for the amplifier power levels.

- If disabled, the power levels are defined by constant values:
 - "Max. Input Level" specifies the maximum level value for the amplifier input
 - "Nom. Output Level" specifies the maximum level value for the nominal amplifier output
- If enabled with the option "Amplifier Gain Table", the dialog lets you select a single, previously defined amplifier gain table for both the input and output power limits.
- If enabled with the option "Limit Line Table", the dialog lets you select two previously defined limit line tables:
 - "Max. Input Level" selects a limit line table to specify the maximum level for the amplifier input.
 - "Nom. Output Level" selects a limit line table to specify the nominal amplifier output level.

If any limit is exceeded, R&S ELEKTRA brings up a warning.

"Noise Level" The amplifier's noise level value is required for correct determination of the test level. A reasonable [leveling process](#) can only be done above the noise level of the amplifier.

Leveling Parameters

Specifies the parameters for [power leveling](#) of the selected amplifier.

"Traveling-wave tube (TWT) Amplifier" Not available for the device [types](#) "BBA Amplifier" and "BBL Amplifier".

Activate this parameter, if your amplifier is a TWT device.

In this case, R&S ELEKTRA sets the "Max. Level Step Size" to a default value of 3 dB.

Otherwise, if you do not activate this parameter, the default value for the "Max. Level Step Size" is 15 dB.

You can edit the default value.

"Settling Time" Specifies the time to wait after a new RF generator level is set and the power level measurement is triggered.

"Max. Level Step Size"	Limits the power level steps during the leveling procedure. R&S ELEKTRA changes the input level in steps limited by this value, for example, maximum level steps of 3 dB or 15 dB. The default value can depend on your selection at "Traveling-wave tube (TWT) Amplifier", if available.
"Automatic Start Level"	Enables R&S ELEKTRA to set a power-level starting point for the leveling procedure automatically. The automatic start level is applied on the first leveling step after the power amplifier is set to operating state.
"Leveling Start Value"	Available only, if "Automatic Start Level" is disabled. Specifies a fixed power level starting point for the leveling procedure.
"Pulse Amplifier (requires CW)"	Available only for amplifier types "Manual Amplifier" and "Generic Amplifier". Automatically disabled for R&S BBx amplifiers. Enables specifying the following pulse parameters for the rectangular modulation of a continuous-wave (CW) signal:
"Max. Pulse Rate"	Available only, if "Pulse Amplifier" is enabled. Specifies the maximum repetition rate of the pulse, or pulse frequency.
"Max. Pulse Width"	Available only, if "Pulse Amplifier" is enabled. Specifies the maximum width of an individual rectangular pulse.
"Max. Duty Cycle"	Available only, if "Pulse Amplifier" is enabled. Specifies the maximum time share of one active pulse event, related to one pulse repetition period.

4.8.4.2 Power Correction

Directional Coupler

Complete this dialog with the correction parameters taken from the amplifier's specification sheet.

See also [Chapter 5.4, "Attenuation in signal paths"](#), on page 564.

- **"Forward Power"**
Defines a correction for the power levels measured at the FWD output of the directional coupler.
 - "Constant"
Specifies a constant value (default = 50 dB) for defining the power correction.
 - "Attenuation Table"
Selects an "Attenuation Table" for defining the power correction.
- **"Reverse Power"**
Defines a correction for the power levels measured at the REV output of the directional coupler.
 - "Constant"
Specifies a constant value (default = 50 dB) for defining the power correction.
 - "Attenuation Table"
Selects an "Attenuation Table" for defining the power correction.

Transducer

Allows using different transducers to measure the amplifier's power at its output port, instead of using a directional coupler. Typically, use this measurement option for power correction in a frequency range below 1 MHz.

The transducer type depends on your selection of the formula in the field:

"Calculate FWD Power based on Measured Values"

- **"Power = I² * Impedance (Power)"**

Use this default formula, if the transducer is a **current clamp**. The dialog shows the following setup sketch:

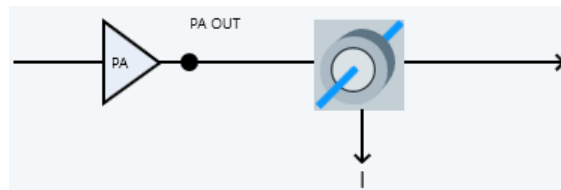

- **"Power = U * I"**

Available only with ["ELEMS-AMEX" license](#).

Use this formula, if the transducer is a **two-channel oscilloscope** for simultaneous measurement of voltage and current. The dialog shows the following setup sketch:

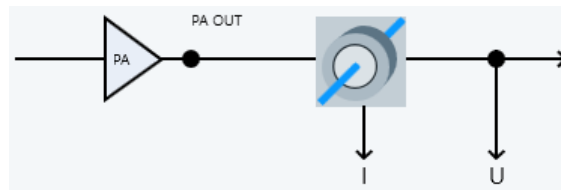

- **"Power = U² / Impedance (Power)"**

Available only with ["ELEMS-AMEX" license](#).

Use this formula, if the transducer is a high-frequency **voltmeter** or a one-channel oscilloscope with differential probe. The dialog shows the following setup sketch:

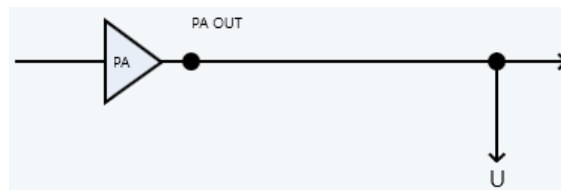

"Transducer Factor"

If you select the formula "Power = I² * Impedance (Power)" for a current clamp or "Power = U * I" for an oscilloscope, R&S ELEKTRA provides also the following "Transducer Factor" dialog:

- **"Fixed Correction"**
Specifies a constant value and a result unit (default = 0 dBμA) for defining the transducer factor.
The "Measurement Unit" is fixed to dBμV.
- **"According to Transducer Correction Table"**
Selects a "Correction Table" for defining the transducer factor.
- **"Calculate FWD Power based on Measured Values"**

Selects a formula to calculate the forward power from the current clamp's measurement result.

EMS hardware setup

Selecting "Power Correction" = "Transducer" in the "Device Properties" dialog of an [EMS hardware setup](#) changes the structure of the setup. For example, if you select the formula "Power = $I^2 * \text{Impedance (Power)}$ " for a *current clamp* as your transducer, the setup changes as in [Figure 4-171](#):

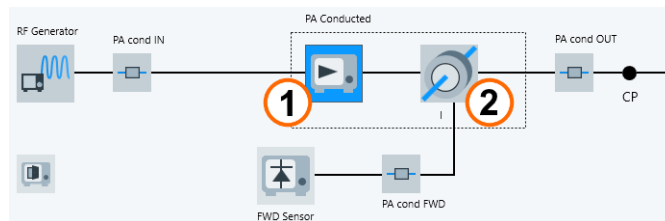

Figure 4-171: Example of power correction by current clamp instead of directional coupler

1 = Power amplifier

2 = Current clamp, which is a "Probe"-type transducer

Note that using a transducer also makes the reverse sensor obsolete.

4.8.4.3 Band Selection

Available only for multiband amplifiers, for example in the R&S BBx families, but not for the [device types](#) "Manual Amplifier" and "Manual Amplifier".

"**Band**" selects the number of the integrated amplification band. It must match the RF generator's output in conducted and/or radiated tests.

The **refresh** button "Read available bands from amplifier" imports the number of bands and the band parameters from the amplifier. Available only, if the amplifier is connected and supports communicating these data.

4.8.4.4 Notifications

Available only for the [device type](#) "Manual Amplifier".

Enables notifications to the user, when one or more of the following manual interactions with the amplifier are required:

- "Switch → Power OFF": Flip the [MAINS] power switch to turn off the amplifier's supply voltage and leave the device non-operational.
- "Switch → Power ON": Flip the [MAINS] power switch to turn on the amplifier's supply voltage. After warming up, the device automatically goes to "Standby".
- "Switch → Standby": Press the [SYSTEM] button to switch off the high voltage (no amplifying operation), while leaving the amplifier in a state ready for operation (if warmed up).
- "Switch → Operate": Press the [SYSTEM] button to switch on the high voltage that makes the device amplify the input RF signal.

- "Reset Amplifier": triggers an internal reset of the amplifier, for example for resetting it after detection of an error state due to an open interlock.
- "Activate Band": Uses the amplifier's internal switch matrix to activate the required band.

4.8.4.5 Functional Check

Note that settings in this dialog are **no** globally effective device settings and do **not** take effect in any test templates or tests. Use these settings only for functional checks of the device.

To specify **device settings for actual measurements**, proceed as described in [Chapter 3.5, "Measurement settings"](#), on page 51.

The "Functional Check" dialog allows sending commands to the device and querying its state. You can use it to set parameters manually and to verify functional communication with the device. Available only, if the device is connected.

Amplifier State

To check the amplifier state commands, click any of the following buttons:

- "Switch → Power OFF"
- "Switch → Power ON"
- "Switch → Standby"
- "Switch → Operate"
- "Reset Amplifier"

Then click the "Current State" > "Refresh Amplifier State" button  to query the device's reply to the command.

Amplifier Band

To check the amplifier band commands, click the "Activate Band" button.

Then click the "Band State" > "Refresh Amplifier State" button  to query the device's reply to the command.

4.8.5 Antenna



Antennas are used for radiated EMI and EMS measurements:

- In EMI measurements, the antenna transforms an incident electromagnetic field generated by the EUT into an RF signal for evaluation by the [Receiver](#).
- In EMS measurements, the antenna transforms the inducted RF power from the [Generator](#) and [Amplifier](#) into a polarized radiated electromagnetic field. In the test, the EUT is exposed to this field.

The device type "Antenna" described here is used for antennas that can optionally be operated in various heights and polarizations. For this purpose, the antenna is typically mounted on an antenna tower.

If the [Antenna Tower](#) is automated, use the antenna's "Device List" entry to specify remote control parameters for the antenna tower. During a test, the antenna and antenna tower are operated by an interactive [accessories control dialog](#).

For non-automated antennas (typically mounted on a tripod), consider using the device type [Transducer \(radiated\)](#).

This chapter describes all individual device properties tabs, but not the **"General"** properties tab, which is [similar](#) for all devices and described [here](#).

Besides the content mentioned above, this device dialog has the following content:

• Type	396
• Measurement Correction	397
• Tower Control	398
• Antenna Selection	399

4.8.5.1 Type

Type

Selects the type of antenna:

- "Transmitting Antenna (Tx ANT)" for EMS measurements
- "Receiving Antenna (Rx ANT)" for EMI measurements
- "Transmitting and Receiving Antenna (TxRx ANT)" for EMS and EMI measurements

Select polarization in [Tower Control](#) tab.

Angle Offset

Specifies the offset of this antenna to the home position (azimuth = 0°) of the [Turntable](#). R&S ELEKTRA adds the "Offset Value" to the azimuth of the turntable (at each current position).

RF Parameters

Specifies or displays the antenna parameters, typically according to the antenna's specifications and calibration table ([Transducer Correction](#)):

- "Frequency Range" defines the antenna's minimum and maximum operating frequencies. For a description how the frequency range is specified, see ["Frequency Range"](#) on page 381.
- "Antenna Efficiency" selects a [Transducer Correction](#) table, see ["Antenna Efficiency"](#) on page 504.
- "Max. Input Power" - not available for the receiving (Rx ANT) antenna type, and used only in EMS measurements. Defines the maximum peak power, either by value or by table, that the antenna can handle. R&S ELEKTRA limits the RF amplifier's output power so that not more power than this value is fed into the antenna's input connector.

- "Max. VSWR" (Voltage Standing Wave Ratio) - not available for the receiving (Rx ANT) antenna type, and used only in EMS measurements. Defines the [VSWR](#) either by value or by table. If a test's hardware setup uses a reverse power meter for reflected power, R&S ELEKTRA monitors the VSWR during the test. The software considers a measured value above "Max. VSWR" as an indication of a defective or interrupted RF connection between the amplifier and the antenna. In this case, the measurement is automatically stopped for security reasons.

4.8.5.2 Measurement Correction

Specifies how to correct the antenna's measurement values by selecting the appropriate antenna cable correction and antenna factors.

Antennas are often used in a firm connection with "their own" cable. However, the antenna's specifications provide only correction data for the antenna itself, not for the cable. To handle this situation flexibly, the dialog offers separate parts for specifying values for the antenna cable.

See also [Chapter 5.4, "Attenuation in signal paths"](#), on page 564.

Cable Correction

The cable part of the antenna assembly can be described by an attenuation table in units of dB.

- "Fixed Value"
Specifies a constant attenuation value in dB for the antenna cable.
- "According to Attenuation Correction Table"
Selects an [attenuation table](#) with one column of frequency-dependent attenuation values in dB for the antenna cable, or for the cable that is used only for the antenna in horizontal position. In the latter case, check the checkbox "Correct each polarization individually" and also select an attenuation table for the cable that is used for the antenna in vertical position.
- "Correct each polarization individually"
Available only, if you select "According to Attenuation Correction Table". Check this checkbox, if you use separate cables for the antenna in horizontal and vertical orientation. In this case, select separate tables for the antenna in "Horizontal" and "Vertical" polarization.

Antenna Factors (Measurement Unit → Result Unit)

An antenna factor converts physical units. The conversion depends on the antenna characteristics. The influence of the RF signal on the antenna is therefore described by a fixed value or by [Transducer Correction](#) tables, one for each polarization orientation.

- "Fixed Correction"
Specifies a constant level correction value and both its "Result Unit" and its "Measurement Unit".
- "According to Antenna Factor Table"
 - "Horizontal"
Selects a [Transducer Correction](#) table that contains one column of frequency-dependent correction values for the horizontal antenna orientation. The values in this table are purely numerical correction values in "dB", even if the column head shows the "Result Unit".

The "Result Unit" is the unit, in which the results are available after applying the transducer correction (typically "dB μ V/m"). The input values as measured by the test instrument are available in the "Measurement Unit" (for example "dB μ V" or "dBm").

- "Vertical"
Same as "Horizontal", but for the vertical antenna orientation.

4.8.5.3 Tower Control

Specifies the antenna elevation and orientation. If you use an automatic [Antenna Tower](#), also use the following settings to control it.

Height Control

Allows specifying, if the antenna is mounted at a fixed height, or if a manual or automatic antenna tower is used for changing the height. Each of these selections excludes the other options.

- "Fixed Height"
Specify the elevation of the antenna above ground. Make sure to enter the correct unit in mm, cm or m.
- "Use Manual Tower"
Select this option to let R&S ELEKTRA bring up a message, when you must change the antenna height manually during a measurement.
- "Use Automatic Tower"
Select this option and select an automatic [Antenna Tower](#) to let R&S ELEKTRA automatically change the antenna height during a measurement.
The following settings are available only for automatic antenna towers:
 - "Parking Position"
Specifies the height to which the antenna tower returns for parking after measurements.
 - "Do Automatic Parking on Test End"
If enabled, the antenna tower returns to its parking position automatically, when the test is completed.
 - "Mounting Position"
Specifies the tower's height position (arbitrary range) for mounting the antenna.
 - "Parking / Mounting" speed level
Specifies the speed at which the antenna tower moves to the parking or mounting position.
 - "Reference Length"
Specifies the distance from the antenna mast's reference mark to the antenna's reference mark, or its phase center. See also ["Tilt Mast Parameters"](#) on page 160.

In an open test that uses this antenna, you can move it to the parking and mounting position via the [Antenna](#) control dialog in the left side menu.
- "Use Automatic Positioner"
Select this option and select an automatic [Positioner](#) to let R&S ELEKTRA automatically change the antenna position during a measurement.
 - "Antenna Height Offset"
Specifies the antenna center's height offset (Y) from the positioner's zero position.

- "Horizontal Axis Offset"
Available only for the automatic positioner type "Maturo EAP".
Specifies the antenna center's longitudinal offset (X) from the positioner's zero position.

Polarization Control

Not available, if the [Height Control](#) is set to "Use Automatic Positioner", and if also the [Positioner](#) type is "Maturo EAP".

Allows specifying, if the antenna is mounted in a fixed polarization orientation, or if a manual or automatic antenna tower is used for changing the orientation. Each of these selections excludes the other options.

- "Fixed"
Specifies the antenna orientation in either "Horizontal" or "Vertical" polarization, or lets the software ignore the antenna's orientation.
- "Use Manual Tower"
Select this option to let R&S ELEKTRA bring up a message, when you must change the antenna orientation manually during a measurement.
- "Use Automatic Tower"
Select this option and select an [Antenna Tower](#) from the "Device List" to let R&S ELEKTRA automatically change the antenna orientation during tests.
The following settings are available only for automatic antenna towers:
 - "Parking Position"
Selects parking the antenna in either "Horizontal" or "Vertical" orientation before and after measurements.
 - "Do Automatic Parking on Test End"
If enabled, the antenna tower rotates the antenna to its "Parking Position" orientation automatically, when the test is completed.
 - "Mounting Position"
Selects rotating the antenna tower to "Horizontal" or "Vertical" orientation for mounting the antenna.

In an open test that uses this antenna, you can move it to the parking and mounting position via the [Antenna](#) control dialog in the left side menu.

X-axis Control

Available only, if [Height Control](#) is set to "Use Automatic Positioner" > "Maturo FFP".

Specifies the antenna center's longitudinal offset (X) from the positioners zero position.

4.8.5.4 Antenna Selection

Available only, if the [Type](#) dialog defines this device as a transmitting antenna "(Tx ANT)".

Selects an optional turntable for moving one out of several antennas into an active position. Also specifies the azimuth angle for activating this antenna.

This dialog serves for a setup with an antenna tower, which is installed on a turntable. At the tower, for example two antennas can be installed at 0° and 180°, respectively. The turntable can rotate the tower to make the one or the other antenna point towards the DUT.

4.8.6 Antenna Tower



An antenna tower is used for positioning an [Antenna](#) in radiated EMI or EMS measurements.

EMS tests often require setting the antenna polarization, while for EMI tests, both the antenna polarization and height must be variable. In R&S ELEKTRA, the antenna's [Tower Control](#) includes specific drivers to operate various common automated towers. Hence, when controlling an antenna tower, R&S ELEKTRA actually addresses its driver. Alternatively, the software allows controlling generic, non-supported antenna towers.

During a test, the antenna and antenna tower are operated by an interactive [accessories control dialog](#).



For more information on **antenna tower control**, see [Chapter 4.8.5.3, "Tower Control"](#), on page 398 in the [Antenna](#) dialog.

R&S ELEKTRA supports the following Rohde & Schwarz antenna tower [types](#):

- "Rohde & Schwarz RSM" (with specific driver in R&S ELEKTRA)

Also, the software supports the following third-party antenna tower [types](#):

- "EMCO 2090", "EMControl" (ETS-Lindgren, with specific driver in R&S ELEKTRA)
- "Frankonia FC06" (with specific driver in R&S ELEKTRA)
- "Innco CO1000/2000" and "Innco CO3000 - MA / TMPM / MM / AS" (with specific driver in R&S ELEKTRA)
- "Mature FCU / MCU / NCD" (with specific driver in R&S ELEKTRA)



R&S ELEKTRA generally addresses the controller device ("EMCO 2090 / EMControl", "FC06", "CO3000", "FCU", "MCU", "NCD") instead of the antenna tower itself. You can specify the tower type by an entry in the "General" properties tab.

Additionally, the software supports the following user-definable antenna tower [type](#):

- "Generic AntennaTower" (with generic driver in R&S ELEKTRA), available only with ["ELEMC-DRV" license](#)

This chapter describes all individual device properties tabs, but not the "General", "Connection" and "Configuration" tabs, which are [similar](#) for many devices and described separately.

- [General](#) properties are available for all types of devices.
- [Connection](#) properties are available for devices that can be connected to a local network or to your computer (for example via LAN).
- [Configuration](#) properties are available for "generic" (third-party) devices.

Besides the content mentioned above, this device dialog has the following content:

- [Details](#)..... 401
- [Functional Check](#)..... 402

4.8.6.1 Details

Controller Settings

Not available for the device [type](#) "Generic AntennaTower".

Provides information on "The device selection parameter": the controller's internal number, at which R&S ELEKTRA addresses the subfunction for this device. The device selection parameter is specific number for each third-party controller.

To enable controlling several subfunctions in the same controller, activate "Supports parallel movement of accessories". If the controller handles more than one device, like antenna tower, positioner, sidebar or turntable, this feature reduces overall measurement time by moving all devices simultaneously, rather than sequentially.

Height

"Minimum" and "Maximum" specify the value range for the antenna height (0 m to 10 m) in horizontal polarization.

R&S ELEKTRA considers a given target height as reached, if the real height differs from the target height by not more than the "Tolerance" specified here.

The checkbox "Mast Tilt function is supported" is available only for some [types](#) of antenna towers, for example the Maturio NCD and FCU or Innco CO3000 TMPM. If you enable this feature, R&S ELEKTRA can send the geometrical tilt mast parameters to the tower controller. To let the software do so, specify these parameters in the EMI test template, see "[Tilt Mast Parameters](#)" on page 160. The controller uses these parameters to tilt the antenna automatically, depending on its height position: At a low antenna position, the mast uses a flat antenna tilt angle, while at a higher position, the mast uses a steeper tilt angle. As a result, the mast points the antenna directly towards the DUT at each antenna height. From the geometrical parameters, the software can calculate also the additional free-space path attenuation to consider in measurements with the tilted antenna.

Speed

"Minimum" and "Maximum" specify the value range for relative speed levels (1 to 8) for moving the antenna.

The checkbox "Map absolute to relative speed" is available only for the Maturio NCD and FCU antenna tower [types](#). If you enable this feature, the software can instruct the tower controller to move the antenna tower with absolute speed values. Hence, the controller maps the relative speed levels 1 to 8 to the absolute speed values. To do so, enter the "Absolute Minimum" speed value in cm/s, which the software sets equivalent to the minimum speed level 1. Also, enter the "Absolute Maximum" speed value in cm/s, which the software sets equivalent to the minimum speed level 8. The software interpolates the other speed levels 2 to 7 to the correct absolute speed values in cm/s.

4.8.6.2 Functional Check

Note that settings in this dialog are **no** globally effective device settings and do **not** take effect in any test templates or tests. Use these settings only for functional checks of the device.

To specify **device settings for actual measurements**, proceed as described in [Chapter 3.5, "Measurement settings"](#), on page 51.

The "Functional Check" dialog allows sending commands to the device and querying its state. You can use it to set parameters manually and to verify functional communication with the device. Available only, if the device is connected.

Current Position

"Read" queries the current height position of the antenna tower.

New Position and Speed

Defines a new height position in meters and speed level.

"Move" operates the device to go to the new position at the specified speed.

While moving, the "Move" button becomes a "Stop" button. If you click it, the movement is interrupted.

Current Polarization

"Polarisation" queries the current polarization state of the antenna tower.

4.8.7 Audio Analyzer

Audio analyzers are instruments for measuring the audio performance of electronic devices.

Available only, if you have enabled the "ELEMS-ABT" [license](#).

R&S ELEKTRA supports the following Rohde & Schwarz audio analyzer [types](#):

- "CMW500/270/290" wideband radio communication tester
- "UPV" audio analyzer
- "UPP" audio analyzer

Additionally, the software supports the following third-party audio analyzer [types](#) (with a combination of a specific driver and audio analyzer middleware (provided by R&S ELEKTRA) and optionally a third-party application or digital interface (not provided by Rohde & Schwarz)):

- "MCD Audio"
- "APx517" acoustic audio analyzer

This chapter describes all individual device properties tabs, but not the "General" and "Connection" properties tabs, which are [similar](#) for many devices and described separately.

- [General](#) properties are available for all types of devices.

- [Connection](#) properties are available for devices that can be connected to a local network or to your computer (for example via LAN).

Besides the content mentioned above, this device dialog has the following content:

- [Functional Check](#)..... 403

4.8.7.1 Functional Check

Note that settings in this dialog are **no** globally effective device settings and do **not** take effect in any test templates or tests. Use these settings only for functional checks of the device.

To specify **device settings for actual measurements**, proceed as described in [Chapter 3.5, "Measurement settings"](#), on page 51.

The "Functional Check" dialog allows you to configure the **generator** and **analyzer** parameters of a connected audio analyzer.

- [Generator](#).....403
- [Analyzer](#)..... 404

Generator

The following subsections describe configuring parameters for generating audio test signals.

Generator Config

Configures the device's parameters as a signal generator.

For Rohde & Schwarz or third-party devices, refer to the device's user manual for details.

If you use third-party devices, configure the device's channel number and voltage range.

"Digital Generator"	Available only for the "CMW500/270/290" wideband radio communication tester and for the "UPP" and "UPV" audio analyzers. Sets the device to its digital generator mode. Enable "Digital Generator", to connect the audio generator to the internal digital modulator (downlink) instead of the generator output port. Disable this checkbox when you use the device with an analog EUT.
"Channel"	Selects the device's channel for signal generation. <ul style="list-style-type: none"> • "Off", available only for the "UPV" audio analyzer. • "1" • "2" • "2 is 1", available only for the "UPV" audio analyzer.
"Output Type"	Available only for the "UPP" and "UPV" audio analyzer. Selects "Balanced" or "Unbalanced" output type.
"Output Impedance"	Available only for the "UPP" and "UPV" audio analyzer. Selects the output impedance of the device.

"Range" Available only for the "MCD" audio analyzer.
Selects the generator's maximum voltage output level.

Generator Function

Specifies the frequency and voltage level generated by the audio analyzer.

Click "Set" to set the parameter in the connected device.

Analyzer

The following subsections describe configuring parameters for audio measurements.

Scenario

Available only for the "CMW500/270/290" audio analyzer.

Configures the audio analyzer depending on your test scenario.

- "Audio Measurement and Generator"
This test scenario is typically used for analyzing the frequency response of an amplifier. It involves an audio analyzer coupled with an audio generator and an audio measurement. The audio generator provides analog or digital audio signals and the audio measurement analyzes the returned audio signals from the EUT.

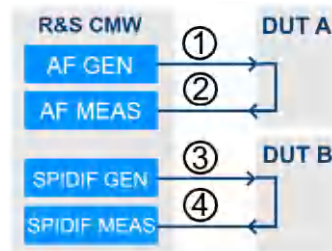

Figure 4-172: An example of test setup for analog or digital DUT, coupled measurement and generator

AF GEN	= Analog generator
AF MEAS	= Analog measurement
SPIDIF GEN	= Digital generator
SPIDIF MEAS	= Digital measurement
DUT A	= Analog equipment under test
DUT B	= Digital equipment under test
1	= Output port of the analog generator
2	= Input port of the analog measurement
3	= Output port of the digital generator
4	= Input port of the digital measurement

You can also freely combine analog and digital applications. For example, you can test an analog-to-digital converter or a digital-to-analog (D/A) converter with an analog generator and a digital measurement.

For this test in R&S ELEKTRA, the "CMW500/270/290" function only as an audio analyzer. The signaling capability of the "CMW500/270/290" is unavailable, hence there are no signaling DFL file available too.

- "Microphone- and Speaker Test"
Typically, use this test scenario for direct audio-breakthrough measurements in the uplink, hence for testing the microphone and speaker built in an EUT, such as a mobile phone.

Prerequisite: The EUT connects to the audio analyzer using the RF connection. To establish speech connection to the EUT, you need a signaling application and a speech codec (R&S CMW-B405A).

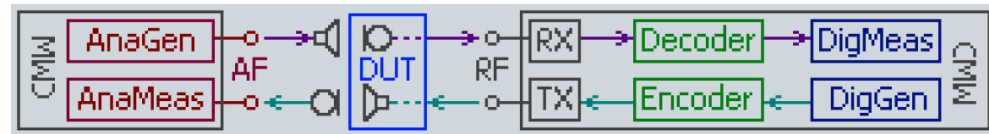

Figure 4-173: Schematic test setup for microphone and speaker test

CMW	= R&S CMW wideband radio communication tester
AnaGen	= Analog generator
AnaMeas	= Analog measurement
AF	= Audio frequency, phone communication to base stations
DUT	= Equipment under test, with microphone and speaker
RF	= Radio frequency, digital signal from DUT
RX	= RF receiver
TX	= RF transmitter
DigMeas	= Digital measurement
DigGen	= Digital generator

For speaker tests, the audio analyzer first provides encoded and modulated digital RF audio signal to the EUT. The EUT then demodulates and decodes the audio signal and send it to the loudspeaker. The artificial ear processes the output from the EUT's loudspeaker according to what is perceived by human ears. It sends the resulting audio signal to the analog audio measurement for analysis.

For microphone tests, the audio analyzer first provides an audio signal to the artificial mouth. The EUT then encodes the audio signal captured from the artificial mouth, modulates it on the RF and transmits the RF signal to the audio analyzer. The audio analyzer demodulates and decodes the signal and analyzes it with the digital audio measurement.

Controlled by ← Scenario

Available only for the "Microphone- and Speaker Test" scenario.

Typically used for audio breakthrough measurements where the uplink is measured directly at the digital output of the decoder.

"Refresh" updates information on the connected device. Use this button, if you modify the connection after the device was not found.

Analyzer Config

Configures the audio analyzer's parameters for measuring signals.

For Rohde & Schwarz or third-party devices, refer to the audio analyzer's user manual for details.

"Digital Measurement"	Available only for the "UPP" and "UPV" audio analyzers. Sets the audio analyzer to digital measurement mode. Disable this checkbox when you use the device with an analog EUT.
"Channel"	Selects the device channel.

"Input"	Selects audio analyzer input type. Available only for the "UPV" audio analyzer. <ul style="list-style-type: none"> • "Balanced" • "Generator 2"
"Input Impedance"	Selects device input impedance. Available only for the "UPV" audio analyzer. <ul style="list-style-type: none"> • "300 Ohm" • "600 Ohm" • "200k Ohm"
"Range"	Selects the maximum level of the measurement from 10 mV to 60 V. Available only for the "MCD" audio analyzer. Also available for the "UPV" audio analyzer, if "Auto Range" is disabled.
"Auto Range"	Selects to adjust the measurement range automatically. Available only for the "UPV" and "CMW500/270/290" audio analyzers.
"Max Level"	Specifies the maximum level of the measurement. Available only for the "CMW500/270/290" audio analyzer, if "Auto Range" is disabled.

Analyzer Function

Configures the audio analyzer's settings for the measurement.

For Rohde & Schwarz or third-party devices, refer to the device's user manual for details.

"Function"	Selects the type of measurement: <ul style="list-style-type: none"> • "Frequency" • "Level" • Additional measurement types, available only with the audio analyzer types "UPP", "UPV" and "APx517", with differing implementations: <ul style="list-style-type: none"> – "THD" (total harmonic distortion) – "THD+N" (total harmonic distortion + noise) – "SINAD" (= [signal + noise + distortion] / [noise + distortion] in dB) – "Harmonic Sum"
"Unit"	Selects the unit for the frequency or level to be measured. Frequency units: <ul style="list-style-type: none"> • "Hz" • "kHz" Level units: <ul style="list-style-type: none"> • "V" • "mV" • "dBV" • "dBμV"

"Detector"	<p>Selects the measurement type, see Chapter 5.3, "Detectors", on page 562.</p> <p>Available only, if "Function" is set to "Level".</p> <ul style="list-style-type: none"> • "RMS" • "PEAK" • "QUASI PEAK", only for "UPV" audio analyzer • "RMS SEL" for RMS selective measurements, available only for the "UPV" audio analyzer
"Bandwidth"	<p>Selects the bandpass filters for the measurement bandwidth.</p> <p>Available only, if "Detector" is set to "RMS SEL".</p> <ul style="list-style-type: none"> • "BPASS 1%" Bandpass filter with relative width of 1% • "BPASS 3%" Bandpass filter with relative width of 3% • "BPASS 1/3 OCT" Bandpass filter with relative width of one-third octave • "BPASS 1/12 OCT" Bandpass filter with relative width of one-twelfth octave • "BPASS FAST" Fast settling octave filter
"Dynamic Mode"	<p>Selects the "Fast" or "Precision" mode.</p> <p>Available only, if "Function" is set to "THD", "THD+N" or "SINAD".</p>
"Refinement"	<p>Optionally reduces the analysis bandwidth by a factor of 2, 4 or 8, to increase the frequency resolution, and hence to improve the SNR.</p> <p>Available only, if "Function" is set to "THD".</p>
"Meas. Mode"	<p>Configures different modes for selecting various sets of "Even Harmonics" and "Odd Harmonics":</p> <ul style="list-style-type: none"> • "Select Di" allows you to select individual distortions • "All Even Di" selects all even distortions • "All Odd Di" selects all odd distortions • "All Di" selects all distortions
"Fund. Rejection"	<p>Selects the "Narrow" or "Wide" mode for suppressing the fundamental frequency.</p> <p>Available only, if "Function" is set to "THD+N" or "SINAD".</p> <p>Selectable only, if "Dynamic Mode" is set to "Fast".</p>
"FFT Size"	<p>Selects the size of the FFT to be used, up to "S8k", depending on the sampling rate and bandwidth. To reduce measurement time, avoid large FFT sizes, if not necessary.</p> <p>Available only, if "Function" is set to "THD", "THD+N" or "SINAD".</p>
"Lower Frequency Limit" and "Upper Frequency Limit"	<p>Specifies the lower and upper frequency limits, with which every measured value is compared for limit violation.</p> <p>Available only, if "Function" is set to "THD+N" or "SINAD".</p>
"Polling Period"	<p>Specifies the duration for maximum peak measurement after "Test" is clicked.</p>

Measurement results:	The following fields - which are available only, if "Function" is set accordingly - display the measured result after triggering a "Test": <ul style="list-style-type: none"> • "Frequency" • "Level" • "THD" • "THDN" • "SINAD" • "Harmonic Sum"
"Test"	Triggers executing a test, the result of which is displayed above.

Measurement Filter

Selects either a user-definable filter or a weighting filter.

"Filter Type"	Available only for the "CMW500/270/290" audio analyzer. It provides the filter type "Band Pass", only, and allows specifying its "Center Frequency" and "Bandwidth".
"Use Filter n"	Available only for the "UPV" and "MCD" audio analyzers. Enables or disables using a filter. For "UPV", you can select up to two filters, with one exception: If "Detector" is set to "RMS SEL", this detector occupies the 1st filter, and you can configure "Use Filter 2", only.
"Filter"	Available only, if "Use Filter n" is selected. Selects the filter type for the measurements. <ul style="list-style-type: none"> • "CCIR" Available only for the "UPV" audio analyzer. Also known as the ITU-R 468 filter, for measuring noise in audio systems. • "CCITT" Available only for the "UPV" audio analyzer. Also known as the ITU-T filter, for measuring noise in telephone circuits. • "A Weight" Available only for the "UPV" audio analyzer. A type of weighting filter according to the IEC 61672 standard, to account for the relative loudness perceived by the human ear. • "User Filter 1" to "User Filter 9" Available only for the "UPV" and "MCD" audio analyzers.
"User Parameters"	Available only, if a "User Filter" is selected. Selects the type of filter and specifies its frequency range: <ul style="list-style-type: none"> • "Low Pass" • "High Pass" • "Band Pass" • "Band Stop"

4.8.8 Field Probe



Radiated EMS measurements require the use of a field probe for measuring the absolute value of an electromagnetic field. The most commonly used measurement unit is V/m.



The device class of field probes designates exclusively field-measuring instruments in EMS measurements. Note that [antennas](#) used in radiated EMI measurements are a device type of their own: while also being used for measuring EM fields, antennas must not be confused with field probes.

The device class can be split into single channel field probes for spatially isotropic measurements and anisotropic field measurement system that can comprise up to four simultaneously connected field probes. Some standards require measuring the electromagnetic field simultaneously with more than one sensor ("multi-field probes") and calculating the spatial field average from the mean value of all single field values. See "[Available Channels](#)" on page 410.

The software supports the following third-party field probe [types](#) (with specific drivers in R&S ELEKTRA):

- "AR FL70XX" / "AR FL80XX" / "AR FM7004"
- "ETS EMSense 70xx 1CH / HI 6005 - 6053 / 6105 - 6153"
Before using "ETS EMSense 70xx 1CH", select the "Card Index" "Parameter Value" in the [Configuration parameters](#) tab.
- "Lumiloop 1CH / 4CH"
- "Narda EMC-300 / EP600 / EP601 / EP602 / EP603 / EP604"
- "RadiCentre - RadiSense 10xx / RadiSense 2010B/I / RadiSense 20xxS/H"
Before using the "Raditeq Field Probes", select the "Device ID" parameter value in the "Parameter" tab ([Configuration parameters](#)).
- "Wave Control SMP2"
You can set the baud rate (1200 to 3000000 symbols/second) of the "Wave Control SMP2" field probe. Default is 9600 baud.

Also, the software supports "Combined Field Probe" for a set of up to four field probes, see "[Probe 1 to Probe 4](#)" on page 410.

Additionally, the software supports the following user-definable field probe [type](#):

- "Generic Field Probe" (with generic driver in R&S ELEKTRA), can be used, for example, for Lumiloop field sensors

This chapter describes all individual device properties tabs, but not the "General", "Connection" and "Configuration" tabs, which are [similar](#) for many devices and described separately.

- [General](#) properties are available for all types of devices.
- [Connection](#) properties are available for devices that can be connected to a local network or to your computer (for example via LAN).
- [Configuration](#) properties are available for "generic" (third-party) devices.

Besides the content mentioned above, this device dialog has the following content:

• Parameters	410
• Measurement Correction	410
• Functional Check	412

4.8.8.1 Parameters

Do Probe Zeroing

Sends a command to the field probe to perform a reset to zero before each measurement.

Settling Time

Specifies the time to wait before the software starts the next measurement.

Number of Channels

Available only for "Raditeq Field Probes" ("RadiCentre - Radisense 2010B/I and Radisense 20xxS/H").

Specifies the number of channels (up to four) available in the field probes.

Device ID for Channel x

Available only for "Raditeq Field Probes" ("RadiCentre - Radisense 2010B/I and Radisense 20xxS/H").

The device ID selects the unique channel of the field probe that you want to use, out of the seven channels in the controller for Raditeq field probes. If you select the wrong ID, R&S ELEKTRA cannot get measurements from the probe that you want to select.

Probe 1 to Probe 4

Available only for the [type](#) "Combined Field Probe".

Selects a user-definable combination of up to four field probes. You can use the combination like a single multichannel probe.

4.8.8.2 Measurement Correction

Available Channels

Selects the field-probe channel, for which the **correction settings** defined below are valid.

If you use a "Generic Field Probe" or a "Raditeq Field Probe" with multiple channels ("multi-field probe"), see "[MFP systems](#)" on page 661. Specify the available number of channels as follows:

- For a "Generic Field Probe", go to the [Configuration parameters](#) tab, click "Number Of Channels" in the list of parameters and select the "Parameter Value".

- For a "Raditeq Field Probe", go to the [Parameters](#) tab and select the [Number of Channels](#).

The following settings specify, how to correct the field probe's measurement values by selecting appropriate correction or attenuation tables. If you use a field probe with multiple channels, select these tables per channel. For an [example](#), see below.

Linearity Correction

Selects a [linearity table](#) with two columns: input levels vs. output values, typically both in units of V/m. R&S ELEKTRA uses the ratio of input over output levels for linearity correction.

Frequency Correction XYZ (isotropic)

If your field probe measures in a spatially isotropic way, select an [attenuation table](#) with one column of frequency-dependent correction values in dB for all three spatial dimensions XYZ. R&S ELEKTRA transforms these values into factors and multiplies them with the field probe's readings to correct its frequency error.

Frequency Correction X / ...Y / ...Z

If your field probe can measure in a spatially anisotropic way, select three [attenuation tables](#), each with one column of frequency-dependent correction values in dB for the X, Y, Z axis, respectively. R&S ELEKTRA transforms these values into factors and multiplies them with the field probe's readings to correct its frequency error.

Do Probe Zeroing

If this option is available, for example with an "AR FL70XX" or "ETS HI 6XXX" probe, checking it enables R&S ELEKTRA to perform a field-probe zeroing measurement before each EMS test. The measured zeroing values are considered in the next test, but then discarded.

Use internal Frequency Correction

If this option is available, for example with a "Narda" probe, checking it enables the field probe to apply its internally stored frequency correction data. In this case, R&S ELEKTRA ignores any frequency correction tables selected above.

Example: Generating frequency and linearity correction tables

Calibration data always comes in couples of E_{disp} and $E_{applied}$ values. For field probe measurements, here is a numerical example of how to use calibration data to derive correction tables with frequency correction factors k_{Freq} and linearity correction factors k_{Lin} . The first equation shows, how to correct a probe's displayed value, using the two tables for frequency correction and linearity correction.

The R&S ELEKTRA field probe driver converts each field probe reading R to a corrected value R_{korr} using the following equation:

$$R_{korr} = (R + k_{Lin}) * 10^{(k_{Freq} / 20)}$$

The linearity correction factor k_{Lin} at a given frequency is:

$$k_{Lin} = E_{applied} - E_{disp}$$

The frequency correction factor k_{Freq} at a given set level is:

$$k_{Freq} = E_{applied} / E_{disp} [dB] = 20 \log_{10} (E_{applied} / E_{disp})$$

4.8.8.3 Functional Check

Note that settings in this dialog are **no** globally effective device settings and do **not** take effect in any test templates or tests. Use these settings only for functional checks of the device.

To specify **device settings for actual measurements**, proceed as described in [Chapter 3.5, "Measurement settings"](#), on page 51.

The "Functional Check" dialog allows measuring the current field strength (V/m) for a given axis and frequency setting. You can use it to set parameters manually and to verify functional communication with the device. Available only, if the device is connected.

The measurement results are for your information, only, but not used for any tests in R&S ELEKTRA.

Axis Selection

Selects either "XYZ" for an isotropic measurement or individually "X", "Y" or "Z" for anisotropically measuring along a specific axis.

Measurement Frequency

Sets the frequency at which the measurement is performed.

Measurement Result ...

Returns the result of the isotropic (XYZ) measurement and the results of the spatially anisotropic measurements in the X, Y or Z axis, respectively.

Measurement

Starts the measurement with the above "Axis Selection" and "Measurement Frequency" settings.

If you get an error message instead of measurement results, check the [Parameters](#), for example the device ID (channel) of a Raditeq field probe, if used.

4.8.9 Generator



The RF generator is a key component in EMS measurements, where it is the first source of the immunity signal that disturbs the EUT.

In EMI measurements, RF generators are used as a signal source for path calibration.

R&S ELEKTRA supports the following Rohde & Schwarz generator [types](#):

- "HMF2525 / 2550" arbitrary waveform generators
- "SGS100A"
- "SGT100A"
- "SMA100A / B"
- "SMB100A / B"
- "SMBV100A / B"
- "SMC100A"
- "SMCV100B"
- "SME"
- "SMF100A"
- "SML"
- "SMM100A"
- "SMR"
- "SMT"
- "SMW200A"

Additionally, the software supports the following user-definable generator [type](#):

- "Generic Generator", available only with "[ELEMC-DRV](#)" license

This chapter describes all individual device properties tabs, but not the "General", "Connection" and "Configuration" tabs, which are [similar](#) for many devices and described separately.

- [General](#) properties are available for all types of devices.
- [Connection](#) properties are available for devices that can be connected to a local network or to your computer (for example via LAN).
- [Configuration](#) properties are available for "generic" (third-party) devices.

Besides the content mentioned above, this device dialog has the following content:

- [Details](#)..... 414
- [File Management](#)..... 414
- [Functional Check](#)..... 414

4.8.9.1 Details

External Multiplier

Enable this feature, if a frequency multiplier is connected to the RF generator's output.

"Frequency Range" specifies the minimum and maximum frequencies at the output of the frequency multiplier.

Enter a "Multiplier Factor" ≥ 1 .



For each multiplier type, we recommend creating a separate generator entry in the device list.

Reference Frequency Source

Selects either the internal oscillator or an external reference frequency source of the selected frequency connected to the generator.

Device Channel

Available only for the generator [type](#) R&S SMW200A, which has two RF output ports.

Selects the RF output channel: either "Channel A" or "Channel B".

4.8.9.2 File Management

Available only for vector signal generators, like "SMBV100A", "SMBV100B" or "SMCV100B", and if you have activated the [license](#) for "ELEMS-AIM" ("EMS Waveform Management").

The "File Management" dialog allows transferring specific arbitrary waveform files ("ARB Files") from your vector signal generator to R&S ELEKTRA.

Upon clicking the refresh button , existing waveform files appear in a list and are made available in the "Administration" > [Device Files](#) dialog. These files are made available also in the "Flow Details" > "Measurement Settings" > [Modulation List](#) dialog of your EMS test templates.

4.8.9.3 Functional Check

Note that settings in this dialog are **no** globally effective device settings and do **not** take effect in any test templates or tests. Use these settings only for functional checks of the device.

To specify **device settings for actual measurements**, proceed as described in [Chapter 3.5, "Measurement settings"](#), on page 51.

From the "Functional Check" dialog, you can send setting commands to the generator, if it is connected. To verify functional communication with the device, compare your settings with the data shown on the generator's front panel display.

You can specify the generator's "Frequency" and "Level" and enable or disable its operating state by checking or unchecking the "On" checkbox.

You can specify the generator's "Modulation" type as described in ["Settings EMS"](#) on page 287.

The "Set" button sends these settings to the device.

4.8.10 Generic Inserter



An inserter is a device that combines one set of data or code with another set. For example, a video inserter allows entering an "overlay" of alphanumeric text information into a video stream, similar to a subtitle or caption.

To use an inserter, you must select it in the [Generic Inserter](#) tab of the [System Control](#) device, and you must reference the system control device in the [hardware setup](#).

R&S ELEKTRA supports the following user-definable inserter device [types](#):

- "Generic CAN Inserter"
- "Generic Video Inserter"

This chapter describes all individual device properties tabs, but not the "General", "Connection" and "Configuration" tabs, which are [similar](#) for many devices and described separately.

- [General](#) properties are available for all types of devices.
- [Connection](#) properties are available for devices that can be connected to a local network or to your computer (for example via LAN).
- [Configuration](#) properties are available for "generic" (third-party) devices.

Besides the content mentioned above, this device dialog has the following content:

- [Data Configuration](#)..... 415
- [Functional Check](#)..... 416

4.8.10.1 Data Configuration

Data Command

- For a "CAN Inserter", refer to the "CAN Inserter Application Note", which you can receive from Rohde & Schwarz on request, together with the required middleware.
- For a "Video Inserter", it specifies command lines for inserting text and test parameters into the video image.

For the command syntax, refer to the user manual of your inserter equipment. The command examples available in the dialog are written for the following devices:

- "CAN Inserter": PCAN-USB adapters "IPEH-002021" (standard) and "IPEH-002022" (opto-decoupled) from Peak-System Technik GmbH, Darmstadt, Germany
- "Video Inserter": camera systems from mk messtechnik GmbH, Notzingen, Germany

The "Text Information" field on the right informs you on the expected length (number of characters) in each valid line of text. Make sure that the length does not exceed the maximum number of characters, which depends on your inserter equipment.

Define the test parameters to be inserted in the following section.

Values for Substitution

- For a "CAN Inserter", this section specifies the data encoded into the CAN bus data stream of the EUT.
- For a "Video Inserter", this section specifies the test parameters that you can insert into the video image.

The following parameters are available (scroll down or up to see all):

- "Frequency"
- "Transducer Fwd Power" (in units of W)
- "Transducer Fwd Power (dBm)"
- "Immunity Level"
- "Modulation Type" ("AM", "FM" or "PULM")
- "Modulation Frequency"
- "Modulation Depth" (in %)
- "Antenna Polarization" (horizontal or vertical)
- "Turntable Position" (in degrees out of 360°)

In the "Format" column, you can select the number of digits to be considered for each parameter.

For information on the type of parameters, refer to the [EMS test template](#) of the test you are running.

4.8.10.2 Functional Check

Note that settings in this dialog are **no** globally effective device settings and do **not** take effect in any test templates or tests. Use these settings only for functional checks of the device.

To specify **device settings for actual measurements**, proceed as described in [Chapter 3.5, "Measurement settings"](#), on page 51.

The "Functional Check" dialog allows testing the functionality of a connected inserter device.

Send Inserter Data

Specifies the remote control command to be sent and allows testing the device communication by the "Send" button.

Substitution Values

Specifies all test parameters available in the [Data Configuration](#) dialog. You can enter arbitrary values or select parameter states that are to be used by the inserter (e.g., to be shown in the video image) upon clicking "Send".

4.8.11 Interlock Monitoring



The interlock monitoring device is a security circuit for EMS test systems, especially *radiated* EMS test systems. However, R&S ELEKTRA also offers this device for integration into *conducted* [Hardware setups for EMS tests](#).

An interlock can block the operation of the RF amplifier, which is potentially dangerous, if it unintendedly exposes humans (or sensitive equipment) to unshielded, amplified RF power (typically RF radiation). To prevent this risk, the interlock enables amplifier operation only in a safe situation. A safe situation exists if, for example, the shielded room's door is closed and the amplifier's RF power switches are set to a defined end position.

If suitable interlock circuits (hardware switches) are installed, R&S ELEKTRA can evaluate the state of this interlock and prevent starting an EMS test if the circuit is open.

R&S ELEKTRA supports the following Rohde & Schwarz interlock monitoring device [types](#):

- "BBxx Interlock", which is part of an R&S BBA or R&S BBL [Amplifier](#)
- "OSP Interlock", which is part of an R&S OSP [Switch Unit](#)

Additionally, the software supports the following user-definable interlock monitoring device [type](#):

- "Generic Interlock"

This chapter describes all individual device properties tabs, but not the "General", "Connection" and "Configuration" tabs, which are [similar](#) for many devices and described separately.

- [General](#) properties are available for all types of devices.
- [Connection](#) properties are available for devices that can be connected to a local network or to your computer (for example via LAN).
- [Configuration](#) properties are available for "generic" (third-party) devices.

Besides the content mentioned above, this device dialog has the following content:

- [Module Configuration](#)..... 417
- [Functional Check](#)..... 418

4.8.11.1 Module Configuration

The "Module Configuration" tab is available only for the [device type](#) "OSP Interlock". This device represents the interlock implemented in the modular R&S OSP open switch and control platform, which is a Rohde & Schwarz [Switch Unit](#).

The dialog allows selecting a "Module" and "Channel" of the R&S OSP for your interlock circuit.

4.8.11.2 Functional Check

This dialog allows querying the current "Interlock State", if the interlock device is connected.

Click "Check" to query the device's interlock state. The dialog displays the return value, for example *CLOSED*.

You can use this feature also to verify functional communication with the interlock system.

4.8.12 IO Device



In EUT monitoring scenarios, an IO device can be an input/output card for digital or analog signals. For example, use an IO device as your interface for the following purposes:

- Observing EUT behavior in EMS tests under the influence of disturbance by immunity signals
- Controlling accessories in EMI or EMS tests
- Letting a test event **activate (trigger)** an output channel.

R&S ELEKTRA supports the following user-definable IO device **types**:

- "ADAM-6050 / -6051 / -6052 / -6060 / -6066", a series of Ethernet I/O modules from third-party manufacturer "Advantech Co., Ltd".
- "BMCM USB-AD", a card with analog and digital (AD) input and output ports and **USB** interface

R&S ELEKTRA is equipped for communication with the "bmcm®USB-AD" device from German third-party manufacturer "BMC Messsysteme GmbH". IO cards like "bmcm®USB-AD" have no on-board controller that can serve as an integrated (SCPI) command parser. Rather than controlling this card via an API interface (library), R&S ELEKTRA provides the "R&S BMCM-USB Middleware" application. As a prerequisite, install the bmcm driver package, as described in the application note "ELEKTRA BMCM USB-AD Middleware.pdf", which is saved in your `Documentation` folder during R&S ELEKTRA installation. See

`C:\Program Files\Rohde-Schwarz\ELEKTRA\x.xx.xx\Documentation`.

You can run the middleware `BMCM_USB.exe`, available at

`C:\Program Files\Rohde-Schwarz\ELEKTRA\x.xx.xx\`

`MiddlewareExamples\BMCM_USB`. Proceed as described in the application note.

- "NI-DAQ", the data acquisition (DAQ) device "NI®USB" from third-party manufacturer "National Instruments Corp."

Communication with this device is provided by the "R&S NI-USB Middleware" application, integrated in R&S ELEKTRA. As a prerequisite, install the NI-DAQmx Driver, as described in the application note "ELEKTRA NI-DAQ Middleware.pdf", which is saved in your `Documentation` folder during R&S ELEKTRA installation. See

`C:\Program Files\Rohde-Schwarz\ELEKTRA\x.xx.xx\Documentation`.

You can run the middleware `NI_DAQ_Middleware.exe`, available at

`C:\Program Files\Rohde-Schwarz\ELEKTRA\x.xx.xx\`

MiddlewareExamples\NIDAQ. For using the correct NI library, select the device type in the middleware. Proceed as described in the application note.

- "Generic IO Device"

This chapter describes all individual device properties tabs, but not the "General", "Connection" and "Configuration" tabs, which are [similar](#) for many devices and described separately.

- [General](#) properties are available for all types of devices.
- [Connection](#) properties are available for devices that can be connected to a local network or to your computer (for example via LAN).
- [Configuration](#) properties are available for "generic" (third-party) devices.

Besides the content mentioned above, this device dialog has the following content:

- [Functional Check](#)..... 419

4.8.12.1 Functional Check

Note that settings in this dialog are **no** globally effective device settings and do **not** take effect in any test templates or tests. Use these settings only for functional checks of the device.

To specify **device settings for actual measurements**, proceed as described in [Chapter 3.5, "Measurement settings"](#), on page 51.

From the "Functional Check" dialog, you can send query and setting commands to a [connected](#) IO device. To verify functional communication with the IO device, you can use the [middleware's](#) log window for comparing your queries ("Input") and settings ("Output") with the state of the IO device's ports or channels.

Input

The "Read" button queries the state of a selected input port or channel in the IO device:

- "Digital Port" to read
A digital port is a group of digital channels of 1 bit, each. A typical example is an 8-bit digital port, hence the equivalent of 8 channels.
- "Digital Channel", select the channel to read
- "Analog Channel", select the channel to read

Interlock

If enabled, the "Read" button in the "Input" changes to a "Check" button, as in the [Interlock Monitoring](#) device > [Functional Check](#).

Click "Check" to query the device's interlock state. The dialog's interlock icon displays the state (*open* or *closed*).

You can use this feature also to verify functional communication with the interlock system.

Output

The "Write" button sets the state of a selected output port or channel in the IO device:

- "Digital Port", select port to write
- "Digital Channel", select the channel to write
- "Analog Channel", select the channel to write

Enter the value that you want to write in the "Parameter" field. Write the digital parameter in binary format and the analog parameter as a floating number.

4.8.13 LISN



For a description of the configuration of a "**TEM Waveguide**", see [Chapter 4.8.26, "TEM Waveguide"](#), on page 480.

For a description of the configuration of other "**Transducers**" (no LISNs), see [Chapter 4.8.27, "Transducer"](#), on page 485.

Line impedance stabilization networks (LISNs, also called artificial networks or V-networks) are used for two purposes in conducted EMI measurements:

- These auxiliary networks extract the conducted RF interference that an EUT injects into the lines of its power supply.
- LISNs suppress any RF interference coming from the power supply, allowing to evaluate exclusively the EUT's interference emissions into the power line.



Protect the receiver against voltage spikes

If you use a LISN without a built-in [pulse limiter](#), consider inserting a separate pulse limiter at the receiver's input port.

In this case, enter the pulse limiter's attenuation in the [Measurement Correction](#) of the [Signal Path](#).

R&S ELEKTRA distinguishes between **2-line LISNs** for single-phase AC mains systems and **4-line LISNs** for three-phase rotary current mains systems.

The software supports the following Rohde & Schwarz LISN [types](#):

- "AMN 6500" (2-line LISN, max. 240 V DC, 16 A, with TTL remote control, switchable 140 dB μ V pulse limiter, built-in 10 dB attenuator pad and switchable 150 kHz highpass filter)
- "ENV 216" (2-line LISN, max. 50 V DC, 16 A, with TTL remote control, switchable 140 dB μ V pulse limiter and switchable 150 kHz highpass filter)
- "ENV 432" (4-line LISN, max. 350 V DC, 32 A, with TTL remote control and switchable 140 dB μ V pulse limiter)
- "ENV 4200" (4-line LISN, high-current design for max. 4 x 200 A, with TTL remote control)

- "ESH2-Z5" (4-line LISN, max. 400 V, 25 A, with TTL remote control)
- "ESH3-Z5" (2-line LISN, max. 250 V, with TTL remote control)
- "HM6050-2" (2-line LISN, max. 250 V, 16 A, with serial remote control)

Additionally, the software supports the following user-definable LISN [types](#):

- "Multi-Line" (a virtual device to allow remote control of one or more referenced "Single-Line" LISNs)
- "Single-Line" (third-party 1-line LISN for integration into a "Multi-Line" LISN, which can control and switch between several single-line LISNs)
Alternatively, you can define single-line LISNs as a [Transducer](#) device ([Type](#) = "Probe"). However, you cannot integrate these transducer-type single-line LISNs into a "Multi-Line" LISN.
- "User Defined 2 Line" (third-party 2-line LISN)
- "User Defined 4 Line" (third-party 4-line LISN)



Common mode or differential mode

You can perform conducted EMI tests with a LISN either in common mode (unsymmetric test setup) or in differential mode (symmetric test setup):

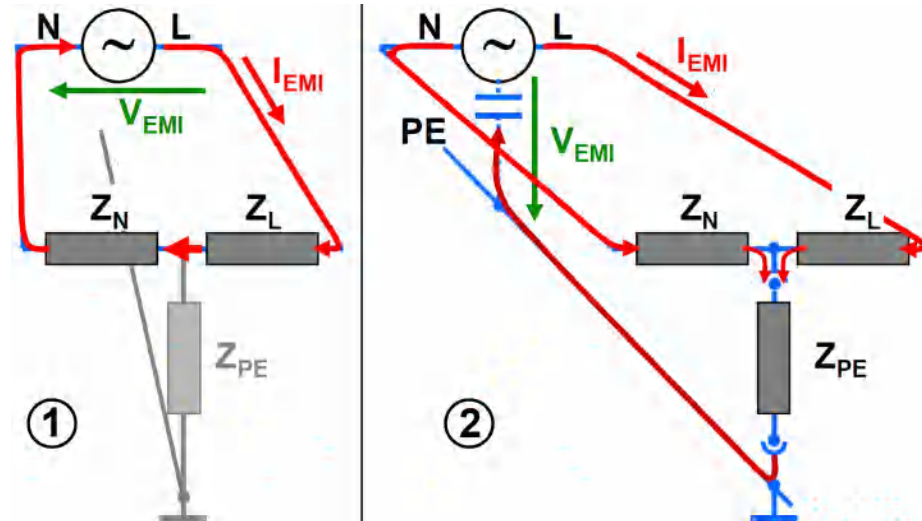

Figure 4-174: 2-line LISN in differential mode (1) and in common mode (2)

- 1 = Schematic of the differential mode setup
- 2 = Schematic of the common mode setup
- L = Live line
- N = Neutral line
- PE = Protective earth (ground)
- Z_L = Impedance of the L line
- Z_N = Impedance of the N line
- Z_{PE} = Impedance of the PE line
- V_{EMI} = Voltage of the disturbing signal
- I_{EMI} = Current of the disturbing signal

The **common mode** setup in Figure 4-174 is also called **unsymmetric** test setup. The 2-line LISN configuration used here is also called a **V-type** artificial network. It does not distinguish between common mode and differential mode signals and is therefore typically used for power lines.

The **differential mode** setup in Figure 4-174 is also called **symmetric** test setup. The 2-line LISN configuration used here is also called a **T-type** or **Y-type** artificial network. It extracts the common mode signals and is therefore typically used for signal lines (with wanted signals in differential mode).



LISN type "HM6050-2"

The LISN type "HM6050-2" has a serial interface for remote control. This LISN is the only one with a "Connection" dialog, if [remote control](#) is enabled:

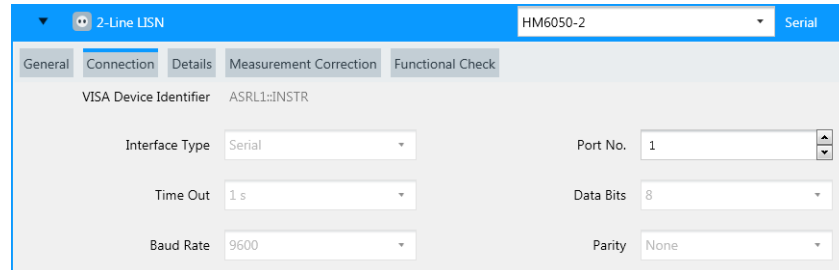

Figure 4-175: Connection dialog for the LISN HM6050-2

In this dialog, all parameters are preselected and fixed at the appropriate settings, except for the "Port No.". Set this parameter to the port number of your computer's serial port, to which the LISN is connected by a serial cable.

This chapter describes all individual device properties tabs, but not the **"General"** properties tab, which is [similar](#) for all devices and described [here](#).

Besides the content mentioned above, this device dialog has the following content:

- [Details](#)..... 423
- [Measurement Correction](#)..... 425
- [Functional Check](#)..... 426

4.8.13.1 Details

Specifies the LISN control details.

Control

Specifies manual or remote control operation of the LISN:

- If you use "Manual" LISN control, R&S ELEKTRA generates messages during the test with instructions for manual LISN switching.
- "Remote-controlled" selects a [Receiver](#) or an [IO Device](#) as the control device. Rohde & Schwarz receivers feature TTL remote control for automatic switching of the LISN line to be evaluated during a test. To use this feature, make sure that the LISN is connected to the receiver's user port or to the IO device via the appropriate cable. If you have set a receiver as your [favorite device](#), R&S ELEKTRA enters it automatically as the control device.



If you change settings of the receiver that is selected as the [Control](#) of a [LISN](#) or [Triple Loop](#), R&S ELEKTRA considers this LISN or triple-loop antenna as changed, too.

Delay after Switch

Specifies a configurable delay time after R&S ELEKTRA switches individual lines of the remote-controlled LISN.

Bit Pattern

Available for editing only in user-defined LISN [types](#).

Specifies the bit pattern for remotely addressing the "Manual" button and the LISN lines. The measured signal is the voltage between the neutral lead or phase lead and the reference ground.

For a user-defined LISN, you must set the bit pattern as required by your LISN for activating measurements on selected lines.

The "Manual" button switches the LISN to local manual control at its front panel, which otherwise displays the state that is set via remote control. The "Manual" button also requires a bit pattern for sending its command remotely. R&S ELEKTRA sends this command automatically, when you [disconnect](#) the LISN.

Table 4-18: Bit patterns of various LISN types

LISN lines	AMN 6500	ENV 216	ENV 432	ENV 4200	ESH2-Z5	ESH3-Z5	User Defined
"Manual"	00011111	00011111	00011111	00011111	00011111	00011111	11111
"N"	00011110	00011110	00011110	00011110	00011110	00101110	11110
"L1"	00011101	00011101	00011101	00011101	00011101	00101101	11101
"L2" (*)			00011011	00011011	00011011		11011
"L3" (*)			00010111	00010111	00010111		10111

(*) Only available for 4-line LISNs.

Note that the LISN "HM6050-2" uses the following serial control commands instead of a bit pattern: "O" for manual control, "N" for line N and "n" for line L1.

Editing LISN line names

For all LISN [types](#), you can edit the names of the LISN lines, except for the "Manual" line.

The dialog accepts a maximum name length of 10 characters. R&S ELEKTRA checks if all line names are unique. Otherwise, it brings up an error message.

When you save the LISN after changing line names, the software updates the names in other dialogs that refer to this LISN.

LISN Lines

Available only for the LISN [type](#) "Multi-Line".

- The button "Add Single-Line LISN"  adds "Single-Line" LISNs to the table of referenced devices. In this table, you can reference the same "Single-Line" LISN several times. The remote control device specified for the "Multi-Line" LISN can control and switch all "Single-Line" LISNs referenced in the table.

- The "Name" column of the table identifies the referenced LISNs by an arbitrary name. Use a unique "Name" for each entry in the table. We recommend using short names, like "L1".
- The "Single-Line LISN" column of the table identifies each referenced LISN by its original device name.
- "Default" is an optional preselection for switching the path (hence, the line) referenced by this "Single-Line" LISN, when the software [connects](#) the "Multi-Line" LISN. Also, in test templates that use the "Multi-Line" LISN, the software preselects this line in the [Accessory Settings](#) > "Range" column.
- "Path" selects one of the switching paths (hence, lines) defined in the "Multi-Line" LISN's remote control device. The selected path switches the "Single-Line" LISN, to which it is assigned in the table.
- The button "Remove Single-Line LISN"  removes the selected (highlighted) single-line LISN from the list.

4.8.13.2 Measurement Correction

To evaluate the real signal level generated by the EUT, transduced by a LISN and measured by the receiver, correct the receiver's readout by suitable correction values or tables. This dialog specifies how to correct the measurements by selecting the appropriate cable attenuation and transducer correction data.



For the measurement correction of **TEM waveguides**, see [Chapter 4.8.26.3, "Measurement Correction"](#), on page 482.

For the measurement correction of **triple-loop antennas**, see [Chapter 4.8.28.2, "Measurement Correction"](#), on page 490.

For the measurement correction of other **antennas** (no triple-loop), see [Chapter 4.8.5.2, "Measurement Correction"](#), on page 397.

For the measurement correction of other **transducers** (no LISNs), see [Chapter 4.8.27.2, "Measurement Correction"](#), on page 487.

LISNs are often used in a firm connection with a LISN cable. However, the LISN's specifications typically provide only correction data for LISN itself, not for the cable. To handle this situation flexibly, the dialog offers separate parts for specifying values for the LISN cable and for the LISN lines.

See also [Chapter 5.4, "Attenuation in signal paths"](#), on page 564.

You can select different predefined tables for each LISN line. Hence, two selection fields (N and L1) are available for a two-line LISN and four selection fields (N, L1, L2 and L3) for a four-line LISN.

Cable Correction

The RF cable, which connects the LISN's RF output with the test receiver, can be described by a simple attenuation in units of dB.

- "Fixed Value"
Specifies a constant attenuation value in dB for the LISN cable.
- "According to Attenuation Correction Table"

Selects an [attenuation table](#) with one column of frequency-dependent attenuation values in dB for the LISN cable.

LISN Correction

The network part of the LISN converts physical units. Its influence on the RF signal is therefore described by a transducer correction with potentially different units on the input side (measurement) and output side (result). Typically, the correction level values are in dB μ V.

- "Fixed Correction"
Specifies a constant correction value for all N and L lines. You can set the unit for the correction value (typically dB μ V).
- "According to Transducer Correction Table"
Select a [Transducer Correction Table](#) that contains one column of frequency-dependent "Correction Level" values for all N and L lines in a result unit (typically "dB μ V") that is defined in this table. The result unit is read from the transducer correction table and serves for converting the measured values from the receivers measurement unit, which is in general "dB μ V", to the final result unit of the converted values.
The table allows defining specific correction values for each N and L line.

4.8.13.3 Functional Check

Allows you to test the remotely controlled switching of LISN lines. The following prerequisites apply:

- The LISN [Control](#) in the [Details](#) tab must be set to "Remote" control via the EMI test receiver
- The [Receiver](#) must be in [connected](#) state.
- On hardware side, the LISN must be connected to the receiver's user port via an appropriate cable.

To test any one of the available LISN lines, click the button of this LISN line, for example "L1". If the test is successful, the software displays the LISN driver's control bit pattern for this LISN line, for example "L1: #B00001101".

The "Manual" button switches the LISN to local manual control at its front panel, which otherwise displays the state that is set via remote control.

4.8.14 Monitoring



Monitoring devices are used to monitor measurable parameters of the EUT during an EMS test, to determine whether the EUT's performance is affected by the applied immunity field.

The possibilities to measure physical EUT parameters are as manifold as the types of EUTs and the types of measurement instruments used.

R&S ELEKTRA supports the following Rohde & Schwarz monitoring device [types](#):

- "AdVISE" driver for the [R&S AdVISE](#) video-based monitoring and analysis software, see www.rohde-schwarz.com/application/advise or refer to the tool's user manual.

In the [Connection](#) properties tab, enter the *communication port* specified in R&S AdVISE. Also, enter the *IP address* as follows:

- If you execute R&S AdVISE on a separate PC, enter that PC's IP address
- If you execute R&S AdVISE on the same PC as R&S ELEKTRA, enter the IP address `127.0.0.1`

- "EMCAN Interface" for CAN buses
Available only, if you have enabled the "ELEMS-AMEX" [license](#). The EMCAN interface integrates communication with third-party software "CANoe / CANalyzer" from "Vector Informatik GmbH" into R&S ELEKTRA. For more information, refer to the application note "ELEKTRA EMCAN Middleware.pdf", which is saved in your `Documentation` folder during R&S ELEKTRA installation. See `C:\Program Files\Rohde-Schwarz\ELEKTRA\x.xx.xx\Documentation`.

R&S ELEKTRA supports the following third-party monitoring device [type](#):

- "AVL Interface" for testbed automation platforms from third-party manufacturer "AVL".
Available only (with specific driver in R&S ELEKTRA), if you have enabled the "ELEMCA-ATB" [license](#).

Additionally, R&S ELEKTRA supports the following user-definable EUT monitoring device [type](#):

- "Generic Monitoring" driver for the remote control of third-party monitoring devices

To adapt the driver to your specific monitoring device, enter SCPI command strings in the [Configuration properties](#) dialog. At specific moments during the test run, R&S ELEKTRA sends commands to the monitoring device. Examples are commands for the initialization of the monitoring device at test start, transmission of device settings and reading of measurement results.

For testing complex EUTs, you can use your EUT-specific test software, typically written during the EUT's development and integration and running on a separate PC. If you integrate a command interface into this software, the PC that monitors the EUT can communicate with R&S ELEKTRA. The PC and its test software now act as the monitoring device. Special commands can transmit current immunity field parameters (like frequency, level or modulation) to the monitoring PC, to enable a synchronization of both programs during a test run. At every frequency point, R&S ELEKTRA saves measurement results, which the external monitoring program returns, in individual monitoring channels.

Per monitoring channel, R&S ELEKTRA can store one double-precision floating-point value (64 bits).

This chapter describes all individual device properties tabs, but not the "General", "Connection" and "Configuration" tabs, which are [similar](#) for many devices and described separately.

- [General](#) properties are available for all types of devices.

- [Connection](#) properties are available for devices that can be connected to a local network or to your computer (for example via LAN).
- [Configuration](#) properties are available for "generic" (third-party) devices.

Besides the content mentioned above, this device dialog has the following content:

- [Device Programming](#).....428
- [Measurement Result Queries](#)..... 429
- [Functional Check](#)..... 429

4.8.14.1 Device Programming

Available only for the "Generic Monitoring" device [type](#).

This dialog defines all available commands for setting parameters in the monitoring device. For example, if the device is a voltmeter, you can send commands to set it to AC or DC mode.

The settings dialog of an "EUT Monitoring Template" defines, which of these commands are sent to the device before a measurement.

One monitoring device can potentially monitor more than one EUT parameter. If the device has several monitoring channels, the commands can specify, for example, that channel 1 measures a current and channel 2 measures a voltage. If you must modify (or reprogram) some settings of the monitoring device to evaluate a different parameter, define the required device reprogramming commands in this dialog.

These commands appear in the [Settings > Programming and Measurement](#) dialog of an [EUT monitoring template](#). There you can define, which commands R&S ELEKTRA sends to the device with this channel before the measurement. The driver can send several programming commands per monitoring channel, as defined in the template's list of commands. If the device has only one EUT monitoring channel, the programming commands are sent only once at the start of the measurement.

The optional "NoGo" evaluation of the measurement values is performed by the monitoring application and not by the device driver. To this end, you must define [NoGo](#) parameters in your [EUT Monitoring Template](#).

R&S ELEKTRA executes the device programming commands and uses the return value from the [Measurement Result Queries](#) as a parameter for the command, if the monitoring device detects a "NoGo" event.



The "Configuration" tab offers *unique commands*, each for a dedicated "device setting" purpose. In the "Device Programming" tab, you can define a *list of commands* for the same purpose.

For sending commands to the EUT, use the "Actions" dialog in a test template.

To define a command, click "Add Command", enter an arbitrary (speaking) command name in the "Description" column and the associated remote control command in valid SCPI format in the "Command" column.

To delete a command, select it in the table and click "Remove Command".

4.8.14.2 Measurement Result Queries

Available only for the "Generic Monitoring" device [type](#).



Depending on your monitoring device, measurements can be started by a query of the measurement value or by a separate trigger command before or after the dwell time is elapsed. See "[Trigger Mode](#)" on page 312. If a "Measurement Result Query Command" is configured, it automatically triggers a measurement of the monitoring device during the test run.

The dialog defines a set of commands that query the measurement result of the monitoring device. Each monitoring channel can use one query command, only.

The query commands are available in the [Settings > Programming and Measurement](#) dialog of an [EUT monitoring template](#).

When the monitoring device performs measurements, the EUT monitoring driver of R&S ELEKTRA uses the measurement results to generate a "Go" / "NoGo" decision.

To define a query, click "Add Command", enter an arbitrary (speaking) query name in the "Description" column and the associated query command in valid SCPI format in the "Command" column. In the "String for '0' result" column, specify the text string that, if detected by the monitoring driver, results in sending "0" as the measurement result, while otherwise the result is "1". In the next column, enter the number of "Header characters to be deleted" ahead of the text string.

To test a query, select it in the table and click "Execute". R&S ELEKTRA displays the query's return value in the "Result" field.

To delete a query, select it in the table and click "Remove Command".

4.8.14.3 Functional Check

Note that settings in this dialog are **no** globally effective device settings and do **not** take effect in any test templates or tests. Use these settings only for functional checks of the device.

To specify **device settings for actual measurements**, proceed as described in [Chapter 3.5, "Measurement settings"](#), on page 51.

The "Monitoring" device type offers different "Functional Check" dialogs for "AVL Interface", "AdVISE", "EMCAN Interface" and "Generic Monitoring":

AVL Interface

If the device [type](#) is "AVL Interface":

EUT monitoring via the "AVL" interface allows monitoring signals of a testbed automation platform from third-party manufacturer [AVL](#).

This dialog selects the signal to be monitored, for example "Speed", "Force" or a "NOGO" state.

"Update List" reads data from the connected "AVL" interface to update the available signals. Click "Test" to load the "Measured Value" of the selected signal.

For more information, refer to the "R&S ELEMC-ATB" application note for the automotive test bench option, which you can receive from Rohde & Schwarz on request.

AdVISE

If the device [type](#) is "AdVISE":

Selects one of the regions of interest (ROIs) defined in the R&S AdVISE visual inspection software tool. Click "Update" to save your selection in the R&S ELEKTRA driver for "AdVISE".

Click "Test" to load the "Measured Value" of the selected ROI from R&S AdVISE.

During the measurement, R&S ELEKTRA receives a measured value for each ROI, and a cumulative measured value that represents the worst case across all ROIs.

EMCAN Interface

If the device [type](#) is "EMCAN Interface":

EUT monitoring in vehicles requires monitoring the data communication between electronic control units (ECUs) on various internal buses. For this purpose, the "EMCAN Interface" supports the widely used ECU testing applications *CANoe* and *CANalyzer* from third-party manufacturer [Vector Group](#).

This dialog selects the signal or variable to be monitored:

- "Signals"
- "System Variables"
- "Environment Variables"

For information on these parameters, refer to the configuration chapters 4 and 5 in the application note "ELEKTRA EMCAN Middleware.pdf", which is saved in your `Documentation` folder during R&S ELEKTRA installation. See `C:\Program Files\Rohde-Schwarz\ELEKTRA\x.xx.xx\Documentation`.

"Update List" reads live data from the monitoring device to update the lists below.

The "Test" button executes a test of the selected signal or system variable.

Generic Monitoring

If the device [type](#) is "Generic Monitoring":

You can use this dialog for testing the "Measurement Preparation Commands" defined in the [Device Programming](#) tab with the return value from a selected measurement query defined in the [Measurement Result Queries](#) tab.

To test a combination of a selected command and a selected query, click "Execute". R&S ELEKTRA displays the monitoring device's return value in the "Result" field. See also ["Programming and Measurement"](#) on page 317.

4.8.15 Network Analyzer



The network amplitude and phase analyzer (or vector network analyzer, VNA) is a tool for analyzing passive and active electromagnetic components by reflection and transmission measurements, see [video tutorials](#). In [Test Templates for calibration measurements](#), a VNA can serve as both the signal generator and the measuring instrument.

R&S ELEKTRA supports the following Rohde & Schwarz network analyzer [types](#):

- "FPC 1500" spectrum analyzer (1-port VNA)
- "ZNA26" / "ZNA43" vector network analyzers (2 port / 4 port)
- "ZNB4" / "ZNB8" / "ZNB20" / "ZNB26" / "ZNB40" / "ZNB43" vector network analyzers (2 port / 4 port)
- "ZND" vector network analyzers (2 port)
- "ZNH4" / "ZNH8" / "ZNH18" / "ZNH26" vector network analyzers
- "ZNL3" / "ZNL4" / "ZNL6" / "ZNL14" / "ZNL20" vector network analyzers
- "ZVA8" / "ZVA24" / "ZVA40" vector network analyzers (2 port / 4 port)
- "ZVA50" / "ZVA67" vector network analyzers (4 port)

The network analyzer dialog has the following tabs:

- [General](#) properties tab, where the "Option" field shows a list of options that are available for some analyzers, for example "FPC-B2"
- [Connection](#) properties tab for connecting the analyzer to a local network or to your computer (LAN or GPIB)

4.8.16 Oscilloscope



Oscilloscopes are key instruments for measuring signal waveforms. With R&S ELEKTRA, you can use oscilloscopes as monitoring devices. To do so, include your oscilloscope in [EUT Monitoring templates](#) as the "Measurement Device", see ["Select Device"](#) on page 314.

Oscilloscopes are available in the device list only, if you have activated the [license](#) for "ELEMS-SCP" ("Oscilloscope Driver Extension"), which requires that a [dongle](#) with this license is connected.

R&S ELEKTRA supports the following Rohde & Schwarz oscilloscope [types](#):

- "RTA" 4004 oscilloscope
- "RTE" 1022 - 1054 / 1102 - 1154 / 1202 - 1204 oscilloscopes
- "RTM" 2022 - 2054 / 2102 - 2104 / 3002 - 3004 oscilloscopes
- "RTO" 64 / 1002 - 1044 / 2002 - 2064 oscilloscopes
- "RTP" 044 / 064 / 084 oscilloscopes

Additionally, the software supports the following user-definable oscilloscope [type](#):

- "Generic Oscilloscope", available only with ["ELEMC-DRV" license](#)

This chapter describes all individual device properties tabs, but not the "General", "Connection" and "Configuration" tabs, which are [similar](#) for many devices and described separately.

- [General](#) properties are available for all types of devices.
- [Connection](#) properties are available for devices that can be connected to a local network or to your computer (for example via LAN).
- [Configuration](#) properties are available for "generic" (third-party) devices.

Besides the content mentioned above, this device dialog has the following content:

- [Functional Check](#)..... 432

4.8.16.1 Functional Check

Note that settings in this dialog are **no** globally effective device settings and do **not** take effect in any test templates or tests. Use these settings only for functional checks of the device.

To specify **device settings for actual measurements**, proceed as described in [Chapter 3.5, "Measurement settings"](#), on page 51.

The "Functional Check" dialog allows trying out various oscilloscope settings, selecting channels and testing the function of measurements with a [connected](#) oscilloscope.

Measurement

Selects one of the oscilloscope channels and the waveform property to be measured in this channel.

"Acquisition Mode" "Measurement" brings up the dialog described in this section.
"Mask Test" brings up the dialog described in ["Mask Test"](#) on page 434.

"Source" Selects one of the channels enabled in the [Channel x](#) section.

Note: Hence, the measurement source is the "selected oscilloscope channel". If you select it at [EUT Monitoring templates > Oscilloscope Settings](#), do not confuse these terms with the [monitoring channel](#).

"Type" Selects the waveform property to be measured. For details, refer to the oscilloscope's user manual.

"Result" Returns the measured value when you click the "Measure" button.

"Measure" Starts an acquisition of the selected measurement "Type" in the selected oscilloscope channel.
The measurement requires a [connected](#) oscilloscope.

"Stop" Stops the acquisition.

Horizontal

Defines settings for the horizontal axis of the oscilloscope screen, including the trigger settings.

"Scale (s/Div)" Sets the density of the horizontal scale in time per division. The valid range is 25 ps to 10.000 s.

"Trigger Delay"	Sets the trigger delay time in seconds. You can enter units, for example <i>s</i> or <i>ms</i> . The valid range is -1E9 s to +1E9 s.
"Trigger Source"	Selects one of the channels enabled in the Channel x section.
"Trigger Type"	Selects "Edge" trigger or "Window" trigger.
"Trigger Condition"	<p>If the "Trigger Type" is "Edge", select one of the following "Trigger Conditions":</p> <ul style="list-style-type: none"> • "Positive" triggers on a positive transition of the signal above the "Trigger Level". • "Negative" triggers on a negative transition of the signal below the "Trigger Level". • "Either" triggers on a positive or negative transition of the signal above or below the "Trigger Level". <p>If the "Trigger Type" is "Window", select one of the following "Trigger Conditions":</p> <ul style="list-style-type: none"> • "Enter" • "Exit" • "Stay Within" • "Stay Outside"
"Trigger Level"	Available only, if the "Trigger Type" is "Edge". Defines the threshold value for trigger events. The valid range depends on the "Vertical Position" value and "Scale" defined for the selected "Trigger Source" channel.
"Upper Trigger Level"	Available only, if the "Trigger Type" is "Window". Defines the upper threshold value for trigger events. The valid range depends on the "Vertical Position" value and "Scale" defined for the selected "Trigger Source" channel .
"Lower Trigger Level"	Available only, if the "Trigger Type" is "Window". Defines the lower threshold value for trigger events. The valid range depends on the "Vertical Position" value and "Scale" defined for the selected "Trigger Source" channel .

Channel x

Enables channels for triggering and measurement, defines settings for the vertical axis of the oscilloscope screen. The number of available channels depends on the [type](#) of oscilloscope. For example, the R&S RTM 2032 has 2 channels, the R&S RTO 1024 has 4 channels.

"Description"	Allows entering arbitrary text, for example to describe in a test template, for which purpose the measurement uses this oscilloscope channel.
"Scale (V/Div)"	Sets the density of the vertical scale in voltage per division. The valid range is 1 mV to 1 V.
"Vertical Position"	Shifts the position of the displayed waveform up or down on the vertical axis of the screen (but does not compensate any offset voltage of the signal). You can enter a shift value together with a unit, for example <i>mV</i> .

"Coupling"	<p>Selects a coupling mode for your probe.</p> <ul style="list-style-type: none"> • "AC" coupling removes DC and very low-frequency signal components so that the waveform is centered on 0 V • "DC 50 Ω" passes both DC and AC components of the signal and terminates the input with 50Ω impedance • "DC 1 MΩ" passes both DC and AC components of the signal and terminates the input with 1 MΩ impedance
"Bandwidth"	<p>Sets the frequency limit.</p> <ul style="list-style-type: none"> • "Full" acquires and displays all frequencies in the specified range up to the limits given by the system bandwidth of oscilloscope and probe • "800 MHz" removes higher frequencies to reduce noise and terminates the input • "200 MHz" removes higher frequencies to reduce noise or pulse distortions • "20 MHz" removes higher frequencies to reduce noise and terminates the input
"Attenuation Probe"	<p>Specifies the probe's attenuation ratio, if not recognized automatically by the oscilloscope. This value with a default of 1:1 (no attenuation) determines how much a connected probe reduces an incoming voltage signal before it reaches the input port. For example, an attenuation ratio of 10:1 means that the probe reduces the signal's voltage level by a factor of 10.</p>

Mask Test

Not available for R&S RTC.

Selects the oscilloscope's mask-test mode and sets some parameters for it. Configure all other mask-test parameters in the oscilloscope before starting the acquisition. R&S ELEKTRA can use the mask test in [EUT Monitoring templates](#) (see [Oscilloscope Settings](#)).

"Single"	<p>Not available for R&S RTA and R&S RTM. Sets the oscilloscope to run a single mask test.</p>
"Continuous"	<p>Sets the oscilloscope to run a continuous mask test. This selection is implicitly fixed for R&S RTA and R&S RTM.</p>
"Mask Test Name"	<p>Specifies the name of the mask test. Make sure to enter the exact name of an existing mask-test definition, which is configured in your oscilloscope.</p>
"Acquisition Count"	<p>Available only in a "Single" mask test. Specifies the number of acquisitions that the oscilloscope includes into the single mask test.</p>
"Acquisition Time"	<p>Available only in a "Continuous" mask test. Specifies the duration of a continuous mask test in the oscilloscope.</p>
"Result", "Measure", "Stop"	<p>See "Measurement" on page 432.</p>

Screenshot

"Capture" allows capturing a screenshot of the [connected](#) oscilloscope's graphical user interface.

4.8.17 Positioner

You can use a positioner device for holding a field probe in defined places, for example while evaluating [field uniformity](#) in an anechoic chamber for EMS tests.

The positioner is available only in the [Calibration View](#) of the hardware setup type [EMS - Anechoic Chamber](#), and in test templates that use this type of hardware setup.

The software supports the following third-party **test-bench** positioner [type](#):

- "AVL Test Bench" (with specific driver in R&S ELEKTRA); available only, if you have enabled the "ELEM-C-ATB" [license](#). Typically, this test bench works as a control driver in [ATB](#) measurements.
For more information, refer to the "R&S ELEM-C-ATB" application note for the automotive test bench option, which you can receive from Rohde & Schwarz on request.

The software supports the following third-party **field-probe** and **antenna** positioner [types](#):

- "Mature FPP 0/4, 4/8, 8/12" (with specific driver in R&S ELEKTRA); available only, if you have enabled the "ELEM-I-S" [license](#). Typically, these X-Y field-probe positioners are used for EMI testing of large EUTs, which can require steps along a horizontal axis, in combination with a height scan. Connect your FPP positioner to a Mature NCD or FCU base controller. The device indices for controlling the x- and y-axes can be one of the following sets: "0 and 4", "4 and 8" or "8 and 12". Select the correct indices, depending on your FPP positioner type.

The software supports the following third-party **antenna** positioner [type](#):

- "Mature EAP" (with specific driver in R&S ELEKTRA); available only, if you have enabled the "ELEM-I-5GFC" [license](#). Typically, this antenna positioner is used for millimeterwave [Rx](#) modules in [RSE](#) measurements. See also [General > Enable parallel movement of accessories](#).

Also, the software supports the following user-definable positioner [types](#):

- "Manual Positioner" for field probes; available only, if you have enabled the "ELEM-S-R" or "ELEM-S-S" [license](#)
- "Generic Positioner" for field probes; available only, if you have enabled the "ELEM-S-S" [license](#)



R&S ELEKTRA generally addresses the controller device instead of the positioner itself. You can specify the positioner type by an entry in the "General" properties tab. If you use a manual positioner, R&S ELEKTRA prompts you during tests to bring the field sensor to the next position manually, instead of sending positioning commands.

This chapter describes all individual device properties tabs, but not the "General", "Connection" and "Configuration" tabs, which are [similar](#) for many devices and described separately.

- [General](#) properties are available for all types of devices.
- [Connection](#) properties are available for devices that can be connected to a local network or to your computer (for example via LAN).
- [Configuration](#) properties are available for "generic" (third-party) devices.

Besides the content mentioned above, this device dialog has the following content:

• Details	436
• Position	437
• Extended Connection	438
• Functional Check	438

4.8.17.1 Details



This "Details" dialog of the **positioner** is similar to the "Details" dialog of the [Antenna Tower](#), [Sidebar](#) and [Turntable](#).

The "Details" dialog is not available for the device type "AVL Test Bench".

Controller Settings

Available only for the "Maturo" third-party positioners.

Provides information on "The device selection parameter": the controller's internal number, at which R&S ELEKTRA addresses the subfunction for this device. For each controller, the selection parameter is a specific number.

To enable controlling several subfunctions in the same controller, activate "Supports parallel movement of accessories". If the controller handles more than one device, like antenna tower, positioner, sidebar or turntable, this feature reduces overall measurement time by moving all devices simultaneously, rather than sequentially.

Position

Available only for the manual and generic positioners.

Defines index ranges in integers for the following positions:

- "Minimum" position index:
 - Arbitrary range for the manual positioner
 - Range defined in the [Position List](#) for generic positioners
- "Maximum" position index:
 - Arbitrary range for the manual positioner, the default positions 1 to 16 are intended for the 4x4 matrix of a field uniformity evaluation (see [Figure 8-2](#))
 - Range defined in the [Position List](#) for generic positioners

- "Parking Position" index (see [Position List](#)): Arbitrary range, not available for the manual positioner
At the end of each test, the positioner goes to this position, if "Do Automatic Parking on Test End" is enabled.
- "Mounting Position" index (see [Position List](#)): Arbitrary range, not available for the manual positioner
Use the interactive control dialog of the positioner for bringing it to this position.

X-Axis

Available only for the "Maturo FPP" positioners.

- "Minimum": specifies the minimum value (cm) of the x-axis position
- "Maximum": specifies the maximum value (cm) of the x-axis position

Y-Axis

Available only for the "Maturo FPP" positioners.

- "Minimum": specifies the minimum value (cm) of the y-axis position
- "Maximum": specifies the maximum value (cm) of the y-axis position

Speed

Not available for the manual positioner. Defines the following speed settings:

- "Minimum Speed Level": Range 1 to 8
- "Maximum Speed Level": Range 1 to 8
- "Parking/Mounting Speed Level": Range 1 to 8; not available for the "Maturo EAP" positioner
- "Do Automatic Parking on Test End"; available only for the generic positioner: If enabled, the positioner returns to its specified "Parking Position" automatically, when the test is completed

4.8.17.2 Position

Not available for the positioner [types](#) "AVL Test Bench" and "Maturo FPP".

Lists the position parameters for each position index.

For position ranges and positioning speed ranges, refer to the [Details](#) tab.

Position List

Not available for the positioner [type](#) "Maturo EAP".

Specifies the x and y positions in centimeters (cm) for each position index of the positioner.

You can edit the x and y position entries for each position index in the list and use the buttons "Add Position" and "Remove Position".

Reference Height

Available only for the positioner [type](#) "Maturo EAP".

Specifies the antenna's height offset in meters (m) relative to the ground. For example, if the "Reference Height" is 1.5 m, a setting of 0 m in the controller corresponds with an actual height of 1.5 m above ground.

4.8.17.3 Extended Connection

Available only for the positioner [type](#) "AVL Test Bench".

Specifies the IP address and TCP port number for the [UDP](#) connection to the test bench.

4.8.17.4 Functional Check

Not available for the positioner [type](#) "Manual Positioner".

Note that settings in this dialog are **no** globally effective device settings and do **not** take effect in any test templates or tests. Use these settings only for functional checks of the device.

To specify **device settings for actual measurements**, proceed as described in [Chapter 3.5, "Measurement settings"](#), on page 51.



The "Functional Check" dialogs of the various **positioner** types are similar to the "Functional Check" dialogs of the [Antenna Tower](#), [Slidebar](#) and [Turntable](#).

This dialog allows sending commands to the device and querying its state. You can use it to set parameters manually and to verify functional communication with the device. Communication is available only, if the device is connected.

Generic Positioner

If the device [type](#) is "Generic Positioner":

- "Current Position" displays the index of the device's current position. All index parameters are defined in the [Position List](#).
"Read" updates this value.
- "New Position" sets a new target index from the range of available positions.
"Move" makes the positioner go to the new position.

"Speed" sets the positioner's speed level in the range 1 to 8.

Maturo EAP Positioner

If the device [type](#) is "Maturo EAP Positioner":

- "Current Absolute Position" displays the values of the device's current axial (X), height (Y) and roll-angle ("POL") positions. The roll angle is equivalent with polarization orientations, especially 0 deg = horizontal, 90 deg = vertical, 45 deg = "HV", and 135 deg = "VH".

"Read" updates these values.

- "New Absolute Position" sets new target values for the axial, height and roll-angle positions.
"Move" makes the positioner go to the new positions.

"Speed" sets the positioner's speed level in the range 1 to 8.

"Current Polarization" displays the device's current polarization state (roll-angle) of the positioner. "Polarization" updates this value.

Maturo FPP Positioner

If the device **type** is "Maturo FPP Positioner":

- "Current Absolute Position" displays the values of the device's current x- and y-axis positions.
"Read" updates these values.
- "New Absolute Position" sets new target values for the x- and y-axis positions.
"Move" makes the positioner go to the new positions.

"Speed" sets the positioner's speed level in the range 1 to 8.

AVL Test Bench

If the device **type** is "AVL Test Bench":

"Parameter" selects an individual parameter to be set for the test bench, for example "Speed" or "Torque".

If you enable "Full Cycle", R&S ELEKTRA locks the "Parameter" selection, hence, you cannot select an individual parameter. Instead, the third-party **ATB** positioner's controller sets the test bench to perform a user-defined sequence of parameter settings, which put the EUT into specific states of operation. For more information, refer to the "R&S ELEMC-ATB" application note for the automotive test bench option, which you can receive from Rohde & Schwarz on request.

- "Current Position" displays the value of the test bench's current parameter (speed or torque).
"Read" updates this value.
"Range" queries the test bench's minimum and maximum speed or torque
- "New Value" defines a speed or torque level, depending on the selected "Parameter".
 - "Move VALUE" sets the test bench to operate at the user-defined value of speed or torque.
 - "Move START" resets the test bench to the default value of speed or torque.
 - "Move FULL" sets the test bench to operate at the maximum allowable speed or torque.

4.8.18 Power Meter



RF power meters are a key component for EMS test systems. During every test, the output power of the RF amplifier is **levelled** and the power level that reaches the antenna or transducer is monitored and recorded.

Power meters also serve for reference calibration of the immunity level, for signal path calibration and for measuring the reflected power to evaluate a system's reflection coefficient or VSWR.

Also, power meters are used as sensor devices in conducted EMS tests and for **EUT monitoring**.

R&S ELEKTRA supports the following Rohde & Schwarz power meter **types**:

- "NRP-Z11" / "NRP-Z21" / "NRP-Z61" / "NRP8S/SN" / "NRP18S/SN" / "NRP33S/SN" / "NRP40S/SN" / "NRP50S/SN" / "NRP67S/SN" / "NRPM3", three-path power sensors
- "NRP-Z51" / "NRP-Z56" / "NRP-Z57" / "NRP-Z58" / "NRP18T/TN" / "NRP33T/TN" / "NRP40T/TN" / "NRP50T/TN" / "NRP67T/TN" / "NRP75TWG" / "NRP90T/TN" / "NRP110T/TWG", thermal power sensors
- "NRP-Z81" / "NRP-Z85" / "NRP-Z86", wideband power sensors
- "NRP-Z91" / "NRP-Z92", average power sensors
- "NRP-Z98", level-control power sensor
- "NRPM3", three-channel power sensors
- "NRP6A/AN" / "NRP18A/AN", average power sensors, designed for EMC applications
- "NRxx Base Units"
 - "NRP2" power meter, four-channel base unit
 - "NRVD" power meter, dual-channel base unit
 - "NRVS", power meter
 - "NRX" power meter, multichannel base unit with support for logical probe channels A to L

Before using the "NRxx Base Units" power meter, select the corresponding "Device Channel" from the **Details** tab.

- "NRVDDiode" / "NRVDThermic", diode or thermal power sensors for the NRVD base unit
To select the "NRVDDiode" or "NRVDThermic" sensors, go to the "NRVD" **Details** tab.

Note that your selection of the sensor head defines the frequency range of the power meter. R&S ELEKTRA adapts the measurement settings to the level limits and to the type of power meter (detector), especially when measuring modulated signals.

If you use sensor heads together with a power meter base unit (for example, the R&S NRP2), select the sensor head in the power meter's "Properties" dialog. Sensor heads with direct USB interface require "R&S VISA Passport" and are supported only in a "Windows 7" operating system environment.

Also, the software supports the following third-party power meter [type](#), if the ["ELEMI-5GFC" license](#) is installed:

- "Erickson-PM5" by "Virginia Diodes, Inc. (VDI)", calibrated calorimeter-style power meter for 75 GHz to > 3 THz, for example used in calibration measurements at frequencies > 40 GHz for [5G radiated spurious emission](#) (RSE) test applications

Additionally, the software supports the following user-definable power meter [type](#):

- "Generic Power Meter" (for simple RF power meters with IEEE bus interface), available only with ["ELEMCDRV" license](#)

See also [Chapter 10.2.1, "Using detectors and modulation in EMS tests"](#), on page 669.

This chapter describes all individual device properties tabs, but not the "General", "Connection" and "Configuration" tabs, which are [similar](#) for many devices and described separately.

- [General](#) properties are available for all types of devices.
- [Connection](#) properties are available for devices that can be connected to a local network or to your computer (for example via LAN).
- [Configuration](#) properties are available for "generic" (third-party) devices.

Besides the content mentioned above, this device dialog has the following content:

- [Details](#)..... 441
- [Functional Check](#)..... 441

4.8.18.1 Details

Available only for the R&S NRX, R&S NRP2 and R&S NRVD power meter base units.

Device Channel

Selects the active device channel, depending on the [Type](#) of power meter base unit.

RF Probe Type

Selects the power sensor for your base unit, as listed [above](#). With your selection, R&S ELEKTRA displays some key features of the sensor, such as its measurement principle, frequency range and sensitivity dynamic range.

If you use several power sensors with the same base unit, define each power sensor as a separate power meter device, hence with an additional entry in the device list.

Make sure to [disconnect](#) the power meter before changing the probe type.

4.8.18.2 Functional Check

Note that settings in this dialog are **no** globally effective device settings and do **not** take effect in any test templates or tests. Use these settings only for functional checks of the device.

To specify **device settings for actual measurements**, proceed as described in [Chapter 3.5, "Measurement settings"](#), on page 51.

You can use this "Functional Check" dialog for testing the function of a [connected](#) power meter with selected [Measurement Speed](#) and "Measurement Frequency" settings. The frequency is required for correct internal adjustment of the sensor head's measurement value.

Click "Measure" to run a power measurement. R&S ELEKTRA displays the power meter's return value in the "Result" field.

Measurement Speed

Selects the power meter's measurement speed "Auto", "Fast", "Medium" or "Slow". If there is inherent noise, this setting allows for a trade-off between accuracy and measurement time. At lower speed, more averaging is applied, resulting in higher sensitivity.

With the default setting "Auto", the power meter automatically selects (if it can do so) the optimum measurement speed, depending on the RF signal level.

Alternatively, you can directly set the measurement speed to be "Fast", "Medium" or "Slow":

- "Fast" uses no averaging over multiple measurements and is recommended at *high* RF levels.
- "Medium" is a compromise with some averaging at *intermediate* RF levels, where fast measurements would introduce higher measurement uncertainty, while slow measurements would consume more time than necessary.
- "Slow" uses more averaging, thus enhancing the measurement accuracy at *low* RF levels.

These speed levels are each mapped by the instrument driver to a certain integration time.

In the drivers for the R&S NRP2 power meter and the R&S NRP-Zxx power sensors, the speed levels are mapped to the following numbers of measurements to be averaged:

- Fast → 1
- Medium → 8
- Slow → 64

The averaging aperture for each single measurement is set to 20 ms.

Measurement Frequency

Specifies the measurement frequency for the functional check.

Measurement Result

Displays the measurement result after clicking "[Measure](#)" on page 442.

Measure

Starts a measurement and returns the result in the [Measurement Result](#) box.

Wave Guide Taper

Available only, if the power meter type is "Erickson-PM5".

Select the power meter's waveguide taper that best matches the output waveguide of your DUT, depending on the waveguide band. The available waveguide tapers range from "WR10" to "WR0.65" and connect to the "WR10" rectangular waveguide input of the power meter's sensor head.

Response Time

Available only, if the power meter type is "Erickson-PM5".

The "Response Time" is the time that it takes from applying a power input until the analog output response has reached 90 % of the final level. Set it according to the following table:

Input power level	Response time
200 mW	150 ms
20 mW	200 ms
2 mW	600 ms
200 µW	12 s

Measurement Time

Available only, if the power meter type is "Erickson-PM5".

Specify a measurement time as described in the power meter's user documentation.

Cooldown Time

Available only, if the power meter type is "Erickson-PM5".

Specify a cooldown time as described in the power meter's user documentation.

4.8.19 Radio Communication Tester



Radio communication testers are instruments that can simulate the RF environment of a mobile device. In an EMI test setup, you can use a radio communication tester for radiated spurious emission (RSE) measurements (FR1 and FR2 for 5G). In an EMS test setup, it can serve as an [EUT Monitoring](#) device. In a CAL test setup, it can also simulate RF signals of a mobile device.

R&S ELEKTRA supports the following Rohde & Schwarz radio communication tester types:

- **"CMW500"** (see [R&S CMW500 web page](#)), for wireless communication performance tests in GSM (2G), WCDMA (3G), LTE (4G), Bluetooth® (BT) and WLAN technology
Note that with the R&S CMW500, this driver supports also the R&S **CMW270** and R&S **CMW290**.
- **"CMX500"** for a two-box-solution of R&S CMW and R&S CMX with firmware version up to 6.90.x, for 5G measurements in [FR1](#) and [FR2](#)
- **"CMX500-OBT"**, one-box tester (OBT) without supporting R&S CMW500 (see [R&S CMX500 web page](#)), for 5G measurements in [FR1](#) and [FR2](#)

In the **General** tab, the "Option" field shows a list of options that are available for the radio communication tester, for example "CMX-KA100".

This chapter describes all individual device properties tabs, but not the "General" and "Connection" properties tabs, which are **similar** for many devices and described separately.

- **General** properties are available for all types of devices.
- **Connection** properties are available for devices that can be connected to a local network or to your computer (for example via LAN).

Besides the content mentioned above, this device dialog has the following content:

- **Extended Connection**.....444
- **Functional Check**..... 444

4.8.19.1 Extended Connection

Available only in the radio communication tester **type** "CMX500".

For tests in which R&S ELEKTRA controls an R&S CMX500, connect also an R&S CMW500 or R&S CMW270 radio communication tester as follows:

- In the **Connection** tab, enter the address of the R&S **CMW500** or R&S **CMW270**.
- In the **"Extended Connection"** tab, enter the address of the R&S **CMX500**.

4.8.19.2 Functional Check

As an exception from the statement above, the two settings **"Transfer Settings File"** and **"Use dfl file"** in the "Functional Check" > "Signaling" dialog are **globally effective**: When you change a driver's `.dfl` file selection, or when you enable or disable the "Use dfl file" checkbox, these settings also change in all other dialogs that use this driver. The same rule is applied in the reverse direction: When you change these driver settings in a hardware setup, EUT monitoring template or test template, the software changes the settings in the "Functional Check" section of the radio communication tester in the device list.



The **Test Plan** of an **EUT** typically uses the settings specified in the test template. As an exception, in the test plan, you can create modified settings of the radio communication tester. When you create a test from this test plan, the software uses those modifications to update the settings in the test template embedded in the test.

With a **connected** radio communication tester, you can use this dialog to test the signal properties, power settings and downlink / uplink attenuation levels for the following technologies:

- **BT** (Bluetooth: classic and low energy)
- **WLAN** (2.4 GHz, 5 GHz and 6 GHz)
- **GSM (2G)**
- **WCDMA (3G)**

- [LTE](#) (Long-Term Evolution, [4G](#))
- [NR](#) (New Radio, [5G](#))

Also you can test attaching and detaching of the user equipment.

Depending on the technologies selected with the radio communication tester's [type](#), some but not all the following "Functional Check" dialogs are available:

Signaling.....	445
Signaling with CMW500-BT.....	448
Signaling with CMW500-WLAN.....	449
Signaling with CMW500-GSM.....	451
Signaling with CMW500-WCDMA.....	453
Signaling with CMW500-LTE.....	454
Packet generator.....	456
File management.....	457
NR.....	458
NR scheduling.....	461
General.....	462
LTE.....	463
LTE scheduling.....	465
Connection setup.....	465

Signaling

Signaling

The following subsections describe signaling with the radio communication tester [type](#) "**CMW500**" (suited also for R&S CMW270). For signaling with the R&S CMX500, see [NR](#) and [LTE](#).

Transfer Settings File

Selects one of the transfer settings files available in the R&S ELEKTRA database. "Refresh" updates the list of available files. To enable using device configuration files in `.df1` format, activate the checkbox "Use dfl file".

There are two ways to import a `.df1` file to the R&S ELEKTRA database:

To import from your local PC

1. Navigate to "Administration" > "[Device Files](#)".
2. Click "Import a file" .
3. Click "CMW - Device Config File (*.df1)".
4. Select the `.df1` file to import.
5. In the selection dialog, click "Open".

6. In the top of the "Device Files" dialog, click "Save".

To import from R&S CMW500

1. Connect the driver to an R&S CMW500 or R&S CMW270.
2. Navigate to the "Device List" > "Radio Communication Tester" > "Functional Check" > "File management" tab.
3. Click the "File on CMW" selection box.
4. Select the .df1 file to import.
5. Click "Transfer to ELEKTRA".

Idle Mode

For GSM, WCDMA and LTE, also select to enable or disable the "Idle Mode" feature:

- Enabling "Idle Mode" has the following consequences:
 - In LTE signaling, it disables [Do Phone Call](#)
 - The final state is an "attached state" with the [UE](#)
- Disabling "Idle Mode" has the following consequences:
 - The final state is a "connected state" with the [UE](#)

Table 4-19: Various interpretations of the "attached" and "connected" state

Standard		Attached state	Connected state
GSM, service domain :	CS	"Synchronized": Synchronization and location update has been performed.	"Call Established": A call to/from the mobile has been established.
	PS	"Attached": The mobile station is GPRS-attached.	"TBF Established": A temporary block flow (TBF) connection has been established.
WCDMA, service domain (both active at the same time):	CS	"Registered": Synchronization and registration have been performed.	"Call Established": A radio resource control (RRC) connection between UE and R&S CMW has been established.
	PS	"Attached": The UE is PS attached.	"Connection Established": A connection has been set up, either an RMC on PS , a mobile terminated test mode connection, or a mobile originated end-to-end packet data connection.
LTE		"Attached": Synchronization and attach have been performed. A default bearer has been established.	"Connection Established": A dedicated bearer has been set up. An RRC connection has been established during connect.

Note that the "Idle Mode" checkbox is not available, when this dialog appears in the "Settings" of an [EUT monitoring template](#).

Do Phone Call

For LTE, also select to enable or disable the "Do Phone Call" feature:

- Enabling "Do Phone Call" has the following consequences:

- It disables the [Idle Mode](#)
- The R&S CMW makes a voice-over-LTE (VoLTE) call to the [UE](#) via the IP multi-media subsystem (IMS) server
- To establish the connection, you must pick up this call from the UE
- The final state is a "connected state", see [Table 4-19](#)
- Disabling "Do Phone Call" and enabling the "Idle Mode" has the following consequences:
 - The R&S CMW makes no call to the UE
 - The final state is an "attached state", see [Table 4-19](#)
- Disabling both "Do Phone Call" and the "Idle Mode" has the following consequences:
 - The R&S CMW makes no call to the [UE](#)
 - It establishes a packet-data connection via the [PS](#) service domain

Uplink Port Configuration

Available only for "CMW500". For "CMX500", find "Uplink" and "Attenuation" settings in the [NR](#) and [LTE](#) tabs. For "CMX500-OBT", find "Connector" and "Attenuation" settings in the [General](#) tab.

"RF Input Connector" selects one of the input ports of your R&S CMW500 or R&S CMW270, to be used for the uplink signal. Available selections are ports "RF1C", "RF2C", "RF3C" or "RF4C".

"External Input Attenuation" specifies the attenuation level of an external attenuator, connected to this port. For GSM, WCDMA and LTE, you can specify attenuation levels separately for the low band (< 1 GHz) and for the high band (> 1 GHz).

Downlink Port Configuration

Available only for "CMW500". For "CMX500", find "Downlink" and "Attenuation" settings in the [NR](#) and [LTE](#) tabs. For "CMX500-OBT", find "Connector" and "Attenuation" settings in the [General](#) tab.

"RF Output Connector" selects one of the output ports of your R&S CMW500 or R&S CMW270, to be used for the downlink signal. Available selections are ports "RF1C", "RF2C", "RF3C", "RF4C", "RF10" or "RF30".

"External Output Attenuation" specifies the attenuation level of an external attenuator, connected to this port. For GSM, WCDMA and LTE, you can specify attenuation levels separately for the low band (< 1 GHz) and for the high band (> 1 GHz).

Generator Port Configuration

Available only for 6 GHz 802.11ax [WLAN](#) testing, hence, if the following conditions are all met:

- The radio communication tester [type](#) is "CMW500-WLAN".
- The settings for [Signaling with CMW500-WLAN](#) include the following selections:
 - "Standard" = "802.11ax"
 - "Band" = "6 GHz"

"RF Output Connector" selects one of the RF generator's output ports. Available selections are ports "RF1C", "RF2C", "RF3C", "RF4C", "RF1O" or "RF3O".

"Level (RMS)" sets the base RMS level of the RF generator in the range from 0 dBm to 30 dBm.

Signaling with CMW500-BT

CMW500-BT

Bluetooth Signal

Specifies the Bluetooth (BT) signaling settings as follows:

- "Standard"

Selects one of the following BT standards:

 - "Classic"
 - "LE" (low energy)
- "Burst Type"

Available only for the "Classic" BT standard.
Selects one of the following burst rates:

 - "Basic Rate" (BR)
 - "Enhanced Data Rate" (EDR)
- "Channel"

Available only for the "LE" BT standard.
Configures for direct test mode the channel number in the range from 0 (= default) to 39.
- "Tx Level"

Defines the absolute level of the R&S CMW500 transmit signal according to the following equation:
Range (level) = Range (output power) – external output attenuation
Depending on using the COM or OUT "RF Output Connector" of the R&S CMW500 or R&S CMW270, the output power range is as follows:

 - For "RFxC" (COM): -130 dBm to 0 dBm
 - For "RFxO" (OUT): -120 dBm to 8 dBm
- "Exp. Nom. Power"

Sets the expected nominal power of the EUT signal according to the following equation:
Range (expected nominal level) = Range (input power) + external input attenuation
The available input power range is -55 dBm to 55 dBm.
Alternatively, enabling "Auto Ranging" lets the R&S CMW set the "Exp. Nom. Power" automatically.
- "Packet Type"

Available only for the "Classic" BT standard.
Selects one of the following packet types:

 - If "Burst Type" = "Basic Rate":
"DH1", "DH3", "DH5"
 - If "Burst Type" = "Enhanced Data Rate":
"2-DH1", "2-DH3", "2-DH5", "3-DH1", "3-DH3", "3-DH5"
- "PHY Type"

Available only for the "LE" BT standard.

Selects one of the following physical layers used for low-energy connections:

- "1 Mbps" (1 Msymbol/s uncoded PHY)
- "2 Mbps" (2 Msymbol/s uncoded PHY)
- "Long Range" (1 Msymbol/s long range, "LE" coded PHY)
- "Payload Length"

Specifies the payload length for BR, EDR and LE direct test mode.

 - Range for "DH1": 0 bytes to 27 bytes
 - Range for "DH3": 0 bytes to 183 bytes
 - Range for "DH5": 0 bytes to 339 bytes
 - Range for "2-DH1": 0 bytes to 54 bytes
 - Range for "2-DH3": 0 bytes to 367 bytes
 - Range for "2-DH5": 0 bytes to 679 bytes
 - Range for "3-DH1": 0 bytes to 83 bytes
 - Range for "3-DH3": 0 bytes to 552 bytes
 - Range for "3-DH5": 0 bytes to 1021 bytes
 - Range for "LE": 0 bytes to 255 bytes
- "Pattern Type"

Selects one of the following bit patterns to be used for tests:

 - "00000000"
 - "10101010"
 - "11110000"
 - "11111111"
 - "PRBS9", a pseudo-random binary sequence
 - "Alternating", available only for the "Classic" BT standard

Signaling with CMW500-WLAN

CMW500-WLAN

WLAN Signal

Specifies the WLAN (WiFi) signaling settings as follows:

- "Standard"

Selects one of the following IEEE 802.11 WLAN standards:

 - "802.11b"
 - "802.11a"
 - "802.11g"
 - "802.11g (OFDM)"
 - "802.11a/n"
 - "802.11g/n"
 - "802.11g (OFDM)/n"
 - "802.11ac"
 - "802.11ax"

- "Band"
Available only for the "802.11ax" standard.
Selects the operating band, either "Sub 6 GHz" or "6 GHz".
- "Channel"
Sets the RF channel number.
Range: 1 to 196
- "Channel Width"
Selects one of the following operating channel bandwidths, available depending on the selected "Standard":
 - "20 MHz"
 - "40 MHz", requires the "802.11a/n" standard or higher
 - "80 MHz", requires the "802.11ac" or "802.11ax" standard
 - "160 MHz", requires the "802.11ac" or "802.11ax" standard
- "Np20 Index"
Available only for a "Channel Width" of 40 MHz or higher.
Selects the position of the primary 20 MHz channel bandwidth for signals with more than 20 MHz channel bandwidth.
 - Range: 0 to 1 for 40 MHz
 - Range: 0 to 3 for 80 MHz
 - Range: 0 to 7 for 160 MHz
- "Non-HT Frame Rate"
Selects one of the following non-high-throughput format (non-HT) frame rates for user-defined frame rate control, available depending on the selected "Standard":
 - "DSSS, 1 Mbps"
 - "DSSS, 2 Mbps"
 - "CCK, 5.5 Mbps"
 - "CCK, 11 Mbps"
 - "BPSK, 1/2, 6 Mbps"
 - "BPSK, 3/4, 9 Mbps"
 - "QPSK, 1/2, 12 Mbps"
 - "QPSK, 3/4, 18 Mbps"
 - "16-QAM, 1/2, 24 Mbps"
 - "16-QAM, 3/4, 36 Mbps"
 - "64-QAM, 2/3, 48 Mbps"
 - "64-QAM, 3/4, 54 Mbps"

These formats use the following modulation techniques:

 - DSSS: direct sequence spread spectrum
 - CCK: complementary code keying
 - BPSK: binary phase-shift keying
 - QPSK: quadrature phase-shift keying
 - 16-QAM: 16-point quadrature amplitude modulation
 - 64-QAM: 64-point quadrature amplitude modulation

- "RX Expected PEP"
Specifies the expected peak envelope power of the specified antenna at the I/Q input in the range from -20 dBm to 55 dBm.
Note that the attenuation level of the external input attenuation adds to the PEP value that you specify here.
- "TX Burst Power"
Sets the burst power of the transmitted signal.
The allowed value range depends on the used connector and the external attenuation in the output path as follows:
Minimum value = level (connector, min.) – external attenuation (out)
Maximum value = level (connector, max.) – external attenuation (out)
For RF COM, the level (connector) range is -146 dBm to -16 dBm.
For RF OUT, the level (connector) range is -138 dBm to -3 dBm.
- "Operation Mode"
Selects the type of WLAN entity simulated by the "CMW500-WLAN" signaling application:
 - "AP", access point in infrastructure mode
 - "Station", WLAN station

Signaling with CMW500-GSM

CMW500-GSM

2G Signal

Specifies the 2G (GSM) signaling settings as follows:

- "Band"
Selects one of the following GSM bands used for the broadcast control channel (BCCH) and initially also for the traffic channel (TCH):
 - "GSM850"
 - "GSM900"
 - "GSM1800"
 - "GSM1900"
- "Service Domain"
Selects one of the following GSM service domain types:
 - "Circuit Switched" (CS)
 - "Packet Switched" (PS)

Note that this setting influences the "Measure Mode" in the [Connection setup](#).
- "Data Source"
Selects how the R&S CMW500 or R&S CMW270 transmits data on its CS / PS downlink traffic channel, for example in various types of pseudo-random binary sequences (PRBS):
 - "Echo", available only for "Circuit Switched"
 - "PRBS 2E9-1"
 - "PRBS 2E11-1"
 - "PRBS 2E15-1"
 - "PRBS 2E16-1"

- "Speech", available only for "Circuit Switched"
- "PMax (PCL)"

Defines the maximum transmitter output level (up to 33 dBm) of the UE in any uplink timeslots. The "PMax" level (in dBm) is signaled to the UE as a power control level (PCL) value.
- "Channel (TCH/PDCH)"
 - For "Circuit Switched" connections: sets the GSM channel number for the traffic channel (TCH)
 - For "Packet Switched" connections: sets the GSM channel number for the packet data channel (PDCH)

The ranges of channel numbers are as follows:

- Range for "GSM850": 128 to 251
- Range for "GSM900": 1 to 124 and 940 to 1023
- Range for "GSM1800": 512 to 885
- Range for "GSM1900": 512 to 810

Depending on the specified channel number, the software shows the corresponding downlink and uplink frequencies.

- "Channel (BCCH)"

Sets the GSM channel number for the broadcast control channel (BCCH)

 - Range for "GSM850": 128 to 251
 - Range for "GSM900": 1 to 124 and 940 to 1023
 - Range for "GSM1800": 512 to 885
 - Range for "GSM1900": 512 to 810
- "DL Reference Level"

Defines the absolute level of the traffic channel (TCH) or packet data channel (PDCH) in a range defined as follows:

Range (level) = range (output power) – external attenuation (out)

Depending on using the COM or OUT "RF Output Connector" of the R&S CMW500 or R&S CMW270, the output power range is as follows:

 - For "RFxC" (COM): -130 dBm to 0 dBm
 - For "RFxO" (OUT): -120 dBm to 13 dBm

Additional hard-coded settings by the software

Automatically, R&S ELEKTRA sets the "GSM Signaling Configuration" in the R&S CMW500 radio communication tester as follows:

- "Network" > "Cell" > "BS AG BLKS RES" > "0"

This setting defines the number of access grant channel (AGCH) data blocks reserved for the AGCH access.
- "Network" > "Cell" > "Packet Switched" > "PDP Context Activation" > "Reject"

This setting defines that the radio communication tester rejects an "Activate PDP Context Request" from the UE.
- "Network" > "Timer and Constants" > "MTC Alerting Timeout" > "30"

This setting defines the maximum time period (30) in seconds during which the phone is ringing.

- "Network" > "Timer and Constants" > "T3212" > "0"
This setting defines the value of the timer T3212 of the periodic location updating procedure.

Signaling with CMW500-WCDMA

CMW500-WCDMA

3G Signal

Specifies the 3G (WCDMA) signaling settings as follows:

- "Band"
Selects the indicator of the operating band to be used. Bands with the following frequency band indicators are available:
1, 2, 3, 4, 5, 6, 7, 8, 9, 10, 11, 12, 13, 14, 19, 20, 21, 22, 25, 26.
- "Downlink Channel"
Specifies the indicator of the downlink channel to be used, depending on the "Band".
For example, in "Band 10", channel numbers from 3112 to 3388 are available. Depending on the specified channel number, the software shows the corresponding downlink frequency.
- "Uplink Channel"
Specifies the indicator of the uplink channel to be used, depending on the "Band". Depending on the specified channel number, the software shows the corresponding uplink frequency.
- "Connection Setup"
Selects one out of three setup options for the connection:
 - "Sign. RAB - Cell FACH"
This setup option has the following 2 effects:
It selects the connection type "SRB Only" (signaling radio access bearer) for UE terminating connections.
It selects "Cell FACH" (cell forward access channel) as the radio resource control state.
 - "RMC + Test Mode (Auto)"
This setup option has the following 2 effects:
It selects the connection type "Test Mode" for UE terminating connections.
It selects the connection type "RMC+HSPA" (reference measurement channel + high-speed packet access) for the test mode.
 - "Voice"
Selects the connection type "Voice" for UE terminating connections.
- "Service Domain"
Selects one of the following WCDMA service domain types:
"Packet Switched" (PS)
"Circuit Switched" (CS)
- "Output Power"
Sets the base level of the generator in a range defined as follows:
Range (base level) = range (output power) – external attenuation (out)
Depending on using the COM or OUT "RF Output Connector" of the R&S CMW500 or R&S CMW270, the output power range is as follows:
 - For "RFxC" (COM): -130 dBm to 0 dBm

- For "RFxO" (OUT): -120 dBm to 13 dBm
- "Active TPC Setup"
Selects one of the following Tx power-control (TPC) setups:
 - "ALL1"
Uses the continuous UP power control setup, where all bits are "1" (or "up"), hence maximum power.
 - "Closed Loop"
Uses the closed loop power control setup with a bit pattern suitable to command the UE to a selected target power. When the target power is reached, it switches to using an alternating pattern ("(1)010101...").
- "Target Power"
Specifies a target power level in dBm for the "Closed Loop" setup.

Additional hard-coded settings by the software

Automatically, R&S ELEKTRA sets the "WCDMA Signaling Configuration" in the R&S CMW500 radio communication tester as follows:

- "Network" > "Reject Causes" > "RRC Connection Request" > "Uncheck"
This setting disables the rejection of RRC connection requests.

Signaling with CMW500-LTE

CMW500-LTE

For LTE signaling with "CMW500", see "LTE" on page 463.

4G Signal

Specifies the 4G (LTE) signaling settings as follows:

- "Duplex Mode"
Selects frequency-division duplexing ("FDD") or time-division duplexing ("TDD").
- "Operating Band"
Selects the indicator of the frequency band to be used, depending on the "Duplex Mode".
 - In "FDD" mode, bands with "Frequency Band Indicators" from the following range are available:
1, 2, 3, 4, 5, 6, 7, 8, 9, 10, 11, 12, 13, 14, 17, 18, 19, 20, 21, 22, 23, 24, 25, 26, 27, 28, 30, 31, 65, 66, 68, 70, 71, 72, 73, 74, 85.
 - In "TDD" mode, bands with "Frequency Band Indicators" from the following range are available:
33, 34, 35, 36, 37, 38, 39, 40, 41, 42, 43, 44, 45, 48.
- "Downlink Channel"
Specifies the indicator of the downlink channel to be used, depending on the "Duplex Mode" and on the "Operating Band".
For example:
 - In "FDD" mode, "Operating Band" 10, channel numbers from 4250 to 4650 are available.
 - In "TDD" mode, "Operating Band" 40, channel numbers from 38750 to 39550 are available.

Note that with lower "Cell Bandwidth", more downlink and uplink channels become available.

Changing the "Downlink Channel" automatically changes the "Uplink Channel", too. Depending on the specified channel number, the software shows the corresponding downlink frequency.

- "Uplink Channel"

Specifies the indicator of the uplink channel to be used, depending on the "Duplex Mode" and on the "Operating Band".

Note that with lower "Cell Bandwidth", more downlink and uplink channels become available.

Changing the "Uplink Channel" automatically changes the "Downlink Channel", too. Depending on the specified channel number, the software shows the corresponding uplink frequency.

- "Cell Bandwidth"

Selects one of the following cell bandwidths, available depending on the selected "Operating Band":

1.4 MHz, 3 MHz, 5 MHz, 10 MHz, 15 MHz or 20 MHz.

Note that with lower cell bandwidth, more "Downlink Channels" and "Uplink Channels" become available.

- "Max. Allowed Power P-Max"

Specifies the maximum power that the UE is allowed to emit, in the range from -30 dBm to +33 dBm.

Additional hard-coded settings by the software

Automatically, R&S ELEKTRA sets the R&S CMW500 radio communication tester as follows:

- "LTE Signaling Configuration" > "TX Power Control (TPC)" > "Active TPC Setup" > "Max Power"

This setting commands the UE to maximum power for the active TPC setup to be executed for power control of the PUSCH.

- When a voice call is *checked* in the LTE driver:

- "LTE Signaling Configuration" > "Connection" > "Connection Type" > "Data Application"

This setting sets the connection type to data application, involving the data application unit (DAU).

- "LTE Signaling Configuration" > "Connection" > "Testmode" > "Use "Activate Testmode" Message" > "Uncheck"

This setting defines that the UE is not forced into the test mode.

- "LTE Signaling Configuration" > "Connection" > "Keep RRC Connection" > "Check"

This setting keeps the RRC connection, which was established during attach, when the attach procedure is completed.

- "LTE Signaling Configuration" > "Network" > "NAS Signaling" > "EPS Network Feature Support" > "Check"

This setting enables sending the information element "EPS Network Feature Support" to the UE in the "attach accept" message.

- "LTE Signaling Configuration" > "Network" > "NAS Signaling" > "IMS Voice Over PS Sess. Ind." > "Supported"
This setting configures the first bit of the information element "EPS Network Feature Support" to indicate support of voice over LTE (VoLTE).
- "Data Application Measurement" > "Select RAN" > "LTE Signaling"
This setting selects the LTE signaling application to support tests of the data application unit (DAU).
- "Virtual Subscriber Configuration" > "Virtual Subscriber" > "Dedicated bearer" > "Check"
This setting enables the automatic setup of a dedicated bearer.
- "Virtual Subscriber Configuration" > "Virtual Subscriber" > "Media Endpoint" > "Audioboard"
This setting configures the routing of an audio signal or video signal received from the DUT through "Audioboard".
- When a voice call is *unchecked* in the LTE driver:
 - "LTE Signaling Configuration" > "Connection" > "Connection Type" > "Test-mode"
This setting sets the connection type to test mode, not involving the data application unit (DAU).
 - "LTE Signaling Configuration" > "Connection" > "Testmode" > "Use "Activate Testmode" Message" > "Check"
This setting forces the UE into the test mode.
 - "LTE Signaling Configuration" > "Connection" > "Keep RRC Connection" > "Uncheck"
This setting releases the **RRC** connection, which was established during attach, immediately when the attach procedure is completed.
 - "LTE Signaling Configuration" > "Network" > "NAS Signaling" > "EPS Network Feature Support" > "Uncheck"
This setting disables sending the information element "EPS Network Feature Support" to the UE in the "attach accept" message.
 - "LTE Signaling Configuration" > "Network" > "NAS Signaling" > "IMS Voice Over PS Sess. Ind." > "Not Supported"
This setting configures the first bit of the information element "EPS Network Feature Support" to indicate that voice over LTE (VoLTE) is not supported.

Packet generator

Packet Generator

Available only for the radio communication tester **type** "CMW500-WLAN".

"Switch ON" checkbox enables or disables the packet generator to send IP traffic towards the **UE**.

The parameters of the packet generator are as follows:

- "Interval"
Specifies the time interval between packet transmissions in units of 1024 μ s.
Range: 0 to 1000
- "Size"
Specifies the payload size of the generated packets in bytes.

Range: 0 to 1472

- "Payload Type"
Selects the type of transmitted payload bit sequence as follows:
 - "Default": an implementation-specific default pattern
 - "All Zeros": bit sequence 000000...
 - "All Ones": bit sequence 111111...
 - "Bit Pattern 01": bit sequence 010101...
 - "Bit Pattern 10": bit sequence 101010...
 - "Pseudo Random": the bit sequence has a pseudo-random pattern

File management

File Management

Available only for the "CMW500" radio communication tester [types](#).

Allows importing `.df1` configuration files from the R&S CMW and creating `.df1` configuration files in the R&S CMW.

Prerequisite: the R&S CMW500 or R&S CMW270 is [connected](#) to R&S ELEKTRA. With this connection established, the "File on CMW" list populates with all `.df1` files that are available in the R&S CMW500 or R&S CMW270.

To import a `.df1` file to R&S ELEKTRA

1. Select a `.df1` file from the list.

The "File Management" dialog offers 3 options for the selected file:

- "Recall" loads the selected `.df1` file in the R&S CMW, so you can view the configurations inside that file.
- "Delete" removes the file from the R&S CMW500 or R&S CMW270 memory.
- "Transfer to ELEKTRA" imports the file into the R&S ELEKTRA database.

2. To use the selected `.df1` file in tests, click "Transfer to ELEKTRA".

The file is imported from the R&S CMW500 or R&S CMW270 and stored in the R&S ELEKTRA database.

To create a `.df1` file in the R&S CMW

1. Specify a filename in the "Save Configuration on CMW" text box.
2. To save the configurations of all signaling and measurement applications, select the "Allow Full Save" checkbox.

Note: After performing tests, you can use this option to save all your changed configurations related to different [types](#) of R&S CMW500 (3G, 4G, etc.) in a single `.df1` file.

3. To save only the configuration of a specific signaling or measurement application:
 - a) Leave "Allow Full Save" unchecked.
 - b) In the dropdown menu next to the filename text box, select the signaling or measurement application, for which you want to save the configuration.

- Click "Save" to store the `.df1` file in the memory of the R&S CMW500 or R&S CMW270.

NR

CMX500

NR

Available only for the radio communication tester **type "CMX500"**.



For in-depth information, refer to the "Signaling" > "GUI Reference" chapter in the R&S CMX500 Signaling Applications user manual.

5G Signal

Specifies the **5G (NR)** signaling settings as follows:

- "Frequency Range"
 - Selects one of the following **NR** frequency ranges:
 - "FR1" (= default)
 - "FR2"
- "Access Mode"
 - Selects one of the following access types:
 - "ENDC_NSA" (= default): dual-connectivity non-standalone access (**NSA**), which requires additional settings in the **LTE** dialog
 - "SA" (available only in "FR1"): standalone access, which excludes using NR together with LTE and disables the LTE dialog

(Just for completeness: "EN" in the acronym "ENDC_NSA" stands for "Evolved-Universal Terrestrial Radio Access **New** Radio".)
- "Duplex Mode"
 - Selects time-division duplexing ("TDD") or frequency-division duplexing ("FDD", available only in "FR1").
- "FBI"
 - Selects the frequency band to be used, depending on the "Frequency Range" and "Duplex Mode".
 - In "TDD" mode, depending on the frequency range, bands with the following "Frequency Band Indicators" are available:
 - "FR1": n34, n38, n39, n40, n41, n48, n50, n51, n77, n78 or n79
 - "FR2": n260, n261
 - In "FDD" mode (only "FR1"), bands with the following "Frequency Band Indicators" are available:
 - n1, n2, n3, n5, n7, n8, n12, n20, n25, n28, n66, n70, n71 or n74
- "Subcarrier Spacing"
 - Specifies the distance between different **OFDMA** subcarriers.
 - "FR1": 15 kHz or 30 kHz
 - "FR2": 60 kHz or 120 kHz
- "Carrier Bandwidth"

Selects the bandwidth of the uplink (UL) and downlink (DL) carrier signal, depending on the "Frequency Range".

- "FR1": available bandwidth settings are between 5 MHz and 100 MHz in steps of 5 MHz, 10 MHz or 20 MHz. In "FDD" mode, you can enable "User Defined FDD", which allows selecting different bandwidths for downlink ("Carrier Bandwidth DL") and uplink ("Carrier Bandwidth UL").
- "FR2": 50 MHz, 100 MHz or 200 MHz

The carrier bandwidth is also called channel bandwidth by [3GPP](#).

- "Location"

Sets the location of the DL channel inside the selected band.

You can set the following parameters:

- Standard settings "Low", "Mid" or "High" let the software select a corresponding channel number
- In "TDD" mode, "User Defined" allows entering a channel number in the "ARFCN" field.
- In "FDD" mode (only "FR1"), you can enable "User Defined FDD", which allows separate channel numbers for downlink and uplink: Enter appropriate channel numbers in the "ARFCN DL" and "ARFCN UL" fields.

- "ARFCN"

Available only, if "Location" is set to "User Defined".

In "FDD" mode (only "FR1"), if you enable "User Defined FDD", the dialog provides separate settings for downlink ("ARFCN DL") and uplink ("ARFCN UL"), along with "Carrier Bandwidth DL" and "Carrier Bandwidth UL".

[ARFCN](#) specifies the absolute radio-frequency channel number for New Radio.

5G Power Downlink

- "Total Cell Power"

Defines the maximum downlink power of the complete cell inside the carrier bandwidth.

5G Power Uplink

- "Receiver Config Mode"

- With the standard setting "Auto", the software automatically selects a "Max Expected RMS Power".

- "User Defined" allows selecting a "Max Expected RMS Power" (see below).

- "Max Expected RMS Power"

Available only, if "Receiver Config Mode" is set to "User Defined".

Specifies the maximum quadratic-mean power of the [UE](#) expected in the uplink.

5G Power Control

- "ss-PBCH-BlockPower"

Specifies the power of the [SS/PBCH](#) block, which is sent from the cell for calculating the attenuation between cell and [UE](#).

- "Set p-Max"

Enables or disables the "p-Max" setting. If disabled, no transmission power commands (TPC) are sent, and the UE controls its maximum power for NR independently.

- "p-Max"
Available only, if "Set p-Max" is enabled.
Specifies the maximum power that the UE is allowed to emit.
- "TPC"
Selects the transmission power commands (TPC) mode:
 - "Closed Loop" instructs the UE to adjust its uplink transmission power based on the TPC commands that it receives from the E-UTRAN NodeB (eNB, corresponding to a base station in GSM).
 - "Keep" instructs the UE to keep the uplink power constant
 - "Min" instructs the UE to operate at minimum power
 - "Max" instructs the UE to operate at maximum power



R&S ELEKTRA automatically provides all settings for the common control resource set (CORESET) and for the carrier's synchronization signal block (SSB). For these settings to comply with the technical specification 3GPP TS 38.508, the software uses the R&S CONTEST base libraries.

Attenuation

Available only for "CMX500". For "CMX500-OBT", find "Connector" and "Attenuation" settings in the [General](#) tab.

The attenuation settings select [attenuation tables](#) depending on the selected frequency range.

- If "Frequency Range" = "FR1":
 - "Uplink/downlink separation (identical for NR/LTE)"
Determines if the downlink port is "RF1 OUT" or "RF2 COM" (see below).
 - "RF2 COM Downlink"
Available only, if "Uplink/downlink separation" is disabled (see above).
Selects a previously defined attenuation table for the downlink attenuation of the "RF2 COM" port.
 - "RF1 OUT Downlink"
Available only, if "Uplink/downlink separation" is enabled (see above).
Selects a previously defined attenuation table for the downlink attenuation of the "RF1 OUT" port.
 - "RF2 COM Uplink"
Selects a previously defined attenuation table for the uplink attenuation of the "RF2 COM" port.
- If "Frequency Range" = "FR2":
 - "CMX Port 1 Downlink" selects a previously defined table for the downlink attenuation along the radiated (OTA) signal path from the remote radio heads to the EUT.

- "CMX Port 2 Uplink" selects a previously defined table for the uplink attenuation along the radiated (OTA) signal path from the EUT to the remote radio heads.
- "Beamlock" selects the connection mode:
 - "None" enables a conventional connection without beamlock. Hence, the EUT can adapt its Tx beam for best signal transmission toward the communication antenna (Rx).
 - "Activation" enables a "Tx Beamlock" *after* establishing the connection. Hence, in contrast to the no-beamlock situation described above, R&S ELEKTRA commands the R&S CMX to command the EUT that it freezes its Tx beam. The protocol window returns the message "UE beamlock activated".
- "Idle Mode"
 - Enables or disables the idle mode, which is required for [RSE](#) measurements according to recommendations ITU R SM.329 12 and SM.1539 1.
- "Do Phone Call"
 - Enables or disables the phone call option, which is required for audio breakthrough tests [Audio Breakthrough](#).

NR scheduling

NR Scheduling

Available only for the radio communication tester [type "CMX500"](#).

5G TDD Scheduling

Available only, if the "Duplex Mode" is "TDD" in the [5G Signal](#) settings.

Specifies the [5G \(NR\)](#) slot scheduling as follows:

"Default Scheduling" uses the relation of 7 downlink (DL) slots, 2 uplink (UL) slots and 1 mandatory gap, as specified in the [3GPP](#) recommendations. Hence, for measuring in slots while the EUT is active in UL mode, you get a duty cycle of 20%.

Deactivating the "Default Scheduling" enables editing the following settings:

- "Number of DL slots" specifies the number of downlink slots in a range from 0 to 9. Entering a value automatically changes the number of UL slots, to add up to 9 slots (UL + DL).
- "Number of UL slots" specifies the number of uplink slots in a range from 0 to 9. Entering a value automatically changes the number of DL slots, to add up to 9 slots (UL + DL).

We recommend using 4 DL slots and 5 UL slots (with 1 slot remaining as a gap), because this setting results in a duty cycle of 50% UL. It accelerates this part of your testing procedure by a factor of 2.5 in comparison with the duty cycle of 20%, when using the "Default Scheduling". Any further increase is not possible, because the DUT and the radio communication tester cannot handle more than 5 UL slots within 10 slots.

UE Scheduling

Specifies the [UE](#) slot scheduling as follows:

"Default Scheduling" uses the default slot properties as specified for [NR](#) in the browser-based user interface (WebUI) of the R&S CMX500. These default properties

depend on the "Frequency Range" and "FBI" settings as shown in the [5G Signal](#) dialog.

Deactivating the "Default Scheduling" enables editing the following settings for the "Downlink" and "Uplink" in the R&S CMX500, without having to use its WebUI:

- "Transform Precoding"
 - If disabled, the scheduling uses "Cyclic Prefix - Orthogonal Frequency Division Multiplexing" (CP-OFDM), which offers high spectral packing efficiency in RBs. CP-OFDM is employed, when network operators need to maximize network capacity in dense urban environments.
 - If enabled, the scheduling uses "Discrete Fourier Transform - spread - Orthogonal Frequency Division Multiplexing" (DFT-s-OFDM), which is a fall-back scheduling, equivalent with LTE uplink. DFT-s-OFDM reduces the peak-to-average power ratio of conventional OFDM transmission and removes independent parallel subchannels between the subcarriers.
- "Modulation Scheme" selects one of the available access modes, for example binary phase-shift keying (BPSK), quadrature phase-shift keying (QPSK) or quadrature amplitude modulation (QAM).
- "Number RB" specifies the number of RBs in a sequence.
- "Start RB" specifies the beginning of the RBs.
- Optionally, enabling "No RBs for Downlink, control only" allows you to run a special test mode, in which the downlink path must not occupy any RBs.

See also [LTE scheduling](#).

General

PLMN

Specifies settings for the public land mobile network. If you use a SIM card from Rohde & Schwarz, keep the default settings. For other SIM cards, edit the codes:

- "MCC" specifies the mobile country code
- "MNC" specifies the mobile network code

Attenuation

Available only for "CMX500-OBT". For "CMW500", find "Uplink Port Configuration" and "Downlink Port Configuration" with attenuation settings in the [Signaling](#) tab. For "CMX500", find "Uplink", "Downlink" and "Attenuation" settings in the [NR](#) and [LTE](#) tabs.

Selects attenuation tables for the following downlink and uplink connections.

- "NR Downlink"
- "NR Uplink"
- "LTE Downlink"
- "LTE Uplink"

Connector

Available only for "CMX500-OBT". For "CMW500", find "Uplink Port Configuration" and "Downlink Port Configuration" with attenuation settings in the [Signaling](#) tab. For "CMX500", find "Uplink", "Downlink" and "Attenuation" settings in the [NR](#) and [LTE](#) tabs.

Selects connector ports for the following downlink and uplink connections:

- "NR FR1 Downlink" selects one of the RF communication or RF output ports, can be different from or identical to "NR FR1 Uplink"
- "NR FR1 Uplink" selects one of the RF communication or RF input ports, can be different from or identical to "NR FR1 Downlink"
- "NR FR2 Downlink" selects one of the remote radio head (RRH) ports, can be different from or identical to "NR FR2 Uplink"
- "NR FR2 Uplink" selects one of the remote radio head (RRH) ports, can be different from or identical to "NR FR2 Downlink"
- "LTE Downlink" selects one of the RF communication or RF output ports, can be different from or identical to "LTE Uplink"
- "LTE Uplink" selects one of the RF communication or RF input ports, can be different from or identical to "LTE Downlink"

LTE

CMX500

LTE

Available only for the radio communication tester type "**CMX500**". For LTE signaling with R&S CMW500 or R&S CMW270, see "[Signaling with CMW500-LTE](#)" on page 454.

Not available, if "Access Mode" in the [NR](#) dialog is set to "SA", because standalone access (SA) excludes using NR together with LTE.

The [LTE](#) settings in this dialog serve only for configuring dual-connectivity non-standalone access ("ENDC_NSA"), but not for establishing a [4G](#) connection. Hence, this dialog enables starting a [5G](#) connection based on 4G settings.

4G Signal

Specifies the [4G \(LTE\)](#) signaling settings as follows:

- "Duplex Mode"
Selects frequency-division duplexing ("FDD") or time-division duplexing ("TDD").
- "FBI"
Selects the frequency band to be used, depending on the "Duplex Mode".
 - In "FDD" mode, bands with "Frequency Band Indicators" from the following range are available:
1, 2, 3, 4, 5, 6, 7, 8, 9, 10, 11, 12, 13, 14, 17, 18, 19, 20, 21, 22, 23, 24, 25, 26, 27, 28, 30, 31, 65, 66, 68, 70, 71, 72, 73, 74, 85.
 - In "TDD" mode, bands with "Frequency Band Indicators" from the following range are available:
33, 34, 35, 36, 37, 38, 39, 40, 41, 42, 43, 44, 45, 46, 48.
- "Carrier Bandwidth DL"
Selects the bandwidth of the downlink (DL) carrier signal.

Bandwidths from the following range are available, depending on the selected "FBI":

1.4 MHz, 3 MHz, 5 MHz, 10 MHz, 15 MHz or 20 MHz.

The software automatically sets the uplink (UL) bandwidth depending on the selected DL bandwidth.

- "Range Choice DL"

Selects, where inside the band to locate the carrier bandwidth for the downlink.

 - Standard settings "Low Band", "Mid Band" or "High Band" let the software select a corresponding channel number.
 - "User Defined": see below
- "EARFCN DL"

Available only, if "Range Choice DL" is set to "User Defined".
Allows entering a channel number, depending on the selected "FBI". The channel number determines the location of the downlink carrier's center frequency inside the band.
If you enter a channel number outside of the permitted range, an error message comes up.
The software automatically sets the uplink (UL) channel depending on the selected DL channel.

4G Power Downlink

- "Max. Cell Power"

Defines the maximum power of the cell inside the carrier bandwidth.

4G Power Uplink

- "Receiver Config Mode"

Toggles between automatic or user-defined setting of the "Max. Expected RMS Power".
- "Max. Expected RMS Power"

Available only, if "Receiver Config Mode" is set to "User Defined".
Specifies the expected maximum of the quadratic mean power of the UE.
- "p-Max"

Specifies the maximum power that the UE is allowed to emit.
- "TPC"

Selects the transmission power commands (TPC) mode:

 - "Closed Loop" instructs the UE to adjust its uplink transmission power based on the TPC commands that it receives from the E-UTRAN NodeB (eNB, corresponding to a base station in GSM).
 - "Keep" instructs the UE to keep the uplink power constant
 - "Min" instructs the UE to operate at maximum power
 - "Max" instructs the UE to operate at minimum power

Attenuation

Available only for "CMX500". For "CMX500-OBT", find "Connector" and "Attenuation" settings in the [General](#) tab.

- "Uplink/downlink separation (identical for NR/LTE)"
Determines if the downlink port is "RF3 OUT" or "RF4 COM" (see below).
- "RF4 COM Downlink"
Available only, if "Uplink/downlink separation" is disabled (see above).
Selects a previously defined [attenuation table](#) with the frequency-dependent downlink attenuation values of the "RF4 COM" port.
- "RF3 OUT Downlink"
Available only, if "Uplink/downlink separation" is enabled (see above).
Selects a previously defined [attenuation table](#) with the frequency-dependent downlink attenuation values of the "RF3 OUT" port.
- "RF4 COM Uplink"
Selects a previously defined [attenuation table](#) with the frequency-dependent uplink attenuation values of the "RF4 COM" port.

LTE scheduling

CMX500

LTE Scheduling

Available only for the radio communication tester [type "CMX500"](#). For LTE signaling with R&S CMW500 or R&S CMW270, see ["Signaling with CMW500-LTE"](#) on page 454.

Not available, if "Access Mode" in the [NR](#) dialog is set to "SA", because standalone access (SA) excludes using NR together with LTE.

UE Scheduling

Specifies the [UE](#) slot scheduling as described for [NR scheduling](#), except for CP-OFDM, which is not available for LTE.

Connection setup

Connection Setup

Protocol ... connection attempt

Where "..." can be one of the following technologies, depending on the radio communication tester [type](#):

- "BT" for "CMW500-BT"
- "WLAN" for "CMW500-WLAN"
- "GSM" for "CMW500-GSM"
- "WCDMA" for "CMW500-WCDMA"
- "LTE" for "CMW500-LTE"
- "NR" for "CMX500"

Before you proceed with the following connection functions, power-off the user equipment ([UE](#)). As an exception, powering off is not required for "WLAN" and "BT" protocol.

- "Create Cells"
Establishes a cell for the selected protocol at the radio communication tester.
If you use a500 in non-standalone access ([NSA](#)) connection mode, it establishes also the [LTE](#) cell.
- "Connect to UE"
Not available for [WLAN](#).

In "Idle Mode", not available for [GSM](#), [WCDMA](#) and [LTE](#).

Performs connection registration with the radio communication tester.

For "BT", place the UE in [BT](#) test mode before attempting to connect.

To establish a "WLAN" connection to your [UE](#), use one of the following approaches:

- If the R&S CMW is in "Access Point" operation mode, explicitly connect the UE over [WLAN](#) to the network of the R&S CMW.
- If the R&S CMW is in "Station" operation mode, it tries to connect to the UE automatically, after creating cells.
- "Dispose Cells"
Disconnects the radio communication tester and detaches the cells from it.
If you select "Dispose Cells" during a connection attempt, it interrupts this process and detaches the cells.
- "Is Connected?"
Checks the UE's connection state by a status query to the radio communication tester.
- "BLER test"
Available only for the radio communication tester [type](#) "CMX500", for others, see below.
Performs a [BLER](#) measurement and returns the [ACK rate](#) for [NR](#).

The protocol window above these buttons logs the progress and state of the [NR](#) connection attempt for all radio communication tester [type](#). It informs you, for example, on successful completion of the "Connect to UE" step.

Performance measurements

Listed below, find descriptions of the various performance measurements using the radio communication tester [type](#) "CMW500":

- **"BER/PER Measurement"** for "CMW500-BT"
Performs a [BER](#) / [PER](#) measurement and returns the [ACK rate](#) for [BT](#).
 - "Number of Packets"
Defines the number of measured data packets per measurement cycle for judging the quality of connection in the UE's reply.
Range: 1 to 400E+3
- **"PER Measurement"** for "CMW500-WLAN"
 - "Data Interval"
Specifies the time interval in units of 1024 μ s between data packet transmissions for the [PER](#) measurement.
Range: 0 to 100
 - "Payload"
Specifies the payload size (in bytes) for the [PER](#) measurement.
Range: 0 to 2000
 - "Data Pattern"
Selects the data that CMW transfers to the [UE](#) for the [PER](#) measurement:
 - "PN1" to "PN32": pseudo-noise bit sequences of different lengths
 - "All Zero": all zero pattern "000..."
 - "All One": all one pattern "111..."

- "Pattern 01": alternating sequence starting with zero "010101..."
- "Pattern 10": alternating sequence starting with one "101010..."
- "Pseudo Random": random bit sequence
- "Number of Packets"
Sets the number of user data MAC packets transmitted to the UE.
Range: 1 to 1E+6
- **"BER Measurement"** for "Circuit Switched" "CMW500-GSM".
 - "Measure Mode":
 - "Burst by Burst"
 - "BER"
 - "RBER/FER": residual BER / frame erasure ratio
 - "Bursts"
Specifies the number of bursts transmitted per measurement cycle.
Range: 1 to 500E+3
 - "Speech Frames"
Specifies the number of speech frames transmitted per measurement cycle.
Range: 1 to 500E+3
- **"BER/BLER Measurement"** for "Packet Switched" "CMW500-GSM".
 - "Measurement Type":
 - "BER"
 - "BLER"
 - "Service"
Selects the service domain for PS connection either in "Test Mode B" or "SRB" mode (EGPRS switched radio block loopback mode).
 - "RLC Data Blocks"
Specifies the number of radio blocks transmitted per measurement cycle.
Range for BER: 1 to 500E+3
Range for BLER: 1 to 10E+6
- **"BLER Measurement"** for "CMW500-WCDMA"
 - "Measurement Type":
 - "BLER"
 - "HSDPA BLER"
 - "Transport Blocks"
Available only for the "Measurement Type" set to BLER.
Specifies the number of transport blocks measured per measurement cycle.
Range: 1 to 50E+3
 - "HSDPA Subframes"
Available only for the "Measurement Type" set to "HSDPA BLER".
Specifies the number of HSDPA subframes measured per measurement cycle.
Range: 100 to 1E+6
- **"BLER Measurement"** for "CMW500-LTE"
 - "Stop Condition"
Selects whether a BLER measurement without stop condition ("None") or a confidence BLER measurement ("Confidence Level") with early decision concept is performed.
 - "Number of Subframes"

Available only for the "Stop Condition" set to "None".

Specifies the number of subframes measured per measurement cycle.

Range: 100 to 400E+3

- "Limit Error Rate"

Available only for the "Stop Condition" set to "Confidence Level".

Specifies the limit error rate as "0.1%", "1%" or "5%".

4.8.20 Receiver



Receivers and spectrum analyzers are key instruments for measuring electromagnetic emissions. Without a test receiver or spectrum analyzer, EMI measurements are impossible.

R&S ELEKTRA supports the following Rohde & Schwarz receiver and analyzer [types](#):

- "ESC13" / "ESC17" receiver
- "ESL3" / "ESL6" receiver
- "ESPI3" / "ESPI7" receiver
- "ESR3" / "ESR7" / "ESR26" receiver
- "ESRP3" / "ESRP7" receiver
- "ESU8" / "ESU26" / "ESU40" receiver
- "ESW8" / "ESW26" / "ESW44" receiver
- "FPC1000" / "FPC1500" analyzer
- "FPH2" / "FPH6" / "FPH13" / "FPH26" analyzer
- "FPL1003" / "FPL1007" analyzer
- "FSL3" / "FSL6" / "FSL18" analyzer
- "FSV3" / "FSV4" / "FSV7" / "FSV13" / "FSV30" / "FSV40" analyzer
- "FSV3004" / "FSV3007" / "FSV3013" / "FSV3030" / "FSV3044" analyzer
- "FSVA3004" / "FSVA3007" / "FSVA3013" / "FSVA3030" / "FSVA3044" analyzer
- "FSW8" / "FSW13" / "FSW26" / "FSW43" / "FSW50" / "FSW67" / "FSW85" analyzer
- "FSWT26" analyzer

As with other device classes, you can [specify](#) multiple receivers. Alternatively, you can exchange a receiver by [selecting the type](#). To verify the selection, enter the new receiver's "IP Address" in the [Connection](#) tab and [connect](#) the receiver.

For a receiver exchange, the following rules apply:

- If the replaced receiver is referenced in an existing test, the results data of this test remains unchanged. If you rerun the test, the software discards the original test results and uses the new receiver for the measurement.
- If the replaced receiver is referenced in a test template, this test template is synchronized to the new receiver when you open it or use it to create a test. The properties of the new receiver can cause the validation to fail. In this case, either use a receiver that is compatible with the settings in the test template or adjust these settings.

- [Connecting](#) the receiver is possible only, if you have selected the correct [Type](#) of receiver.

In addition to the receiving function in EMI and EMS measurements, R&S ELEKTRA supports the use of Rohde & Schwarz receivers for remote control of a [LISN](#) or [Triple Loop](#) antenna via the receiver's user port.



If you change settings of the receiver that is selected as the [Control](#) device of a LISN or triple-loop antenna, R&S ELEKTRA considers this device as changed, too.

In the [General](#) tab, the "Option" field shows a list of options that are available for the receiver, for example "FSV-B29".

You can select a "Receiver" (= test receiver) or an "Analyzer" (= spectrum analyzer) with their specific features. If your test receiver can measure in spectrum analyzer mode, you can choose between the [Operating Mode](#) "Test Receiver" or "Spectrum Analyzer" in a test template.



If a spectrum analyzer is used as the receiver, some constraints apply. For example, spectrum analyzers are not suited for compliant measurements (precompliance, only).

For the selection of the receiver's RF input connector in a test template, see ["Input Selection"](#) on page 220.



The availability of "Time Domain Scan" measurements requires a receiver that can operate in this [Scan Mode](#), for example with option "ESR-K53".

This chapter describes all individual device properties tabs, but not the "General" and "Connection" properties tabs, which are [similar](#) for many devices and described separately.

- [General](#) properties are available for all types of devices.
- [Connection](#) properties are available for devices that can be connected to a local network or to your computer (for example via LAN).

Besides the content mentioned above, this device dialog has the following content:

- [Details](#)..... 469
- [Functional Check](#)..... 470

4.8.20.1 Details

Switch Unit

Use this feature only in [RSE](#) measurements with an R&S OSP [Switch Unit](#) that contains the hardware option R&S OSP-B155G, module version 06 (order no. 1515.5640.06).

"Select Switch Unit" enables R&S ELEKTRA to control the preamplifier and step attenuator in this module, installed in your switch unit. During [RSE](#) measurements, the

software can adjust the step attenuator and hence the level of the signal carrier under test, to prevent overloading the preamplifier in this module.

For using this feature, make sure to meet all the following conditions:

- To allow R&S ELEKTRA to select a specific gain, the selected switch unit must contain individual path definitions. The naming convention for the paths is "Gain nn dB", where "nn" must be the 1-digit or 2-digit integer value that represents the gain, for example "Gain 10 dB".
- There must be a path with 0 dB gain/attenuation, which makes the switch unit bypass the internal preamplifier. In the list of "Existing Paths" (Figure 4-179), this path must have the **name** "Gain 0 dB".
- In the EMI test template > [Settings \(Overview\)](#), you must enable the usage of the R&S OSP-B155G step attenuator. To do so, switch the [Preamplifier](#) setting to "Step Attenuator". This setting brings up the additional fields "Signal Carrier Width" and "External Gain Path":
 - Set the field "Signal Carrier Width" to the bandwidth of the signal at the preamplifier's input. This setting allows R&S ELEKTRA to calculate the correction factor for this bandwidth, which depends on the resolution bandwidth used for the measurement ("RBW_in_use", see below).
 - The field "External Gain Path" is initially empty. After a reference measurement, this field shows the automatically selected gain path, determined in that reference measurement. (Note that selecting "Clear Results" in the test clears also the field "External Gain Path".)

If the field "External Gain Path" is still empty when you start a test, R&S ELEKTRA automatically executes an additional internal reference measurement with the path "Gain 0 dB". The software calculates the gain path to be used for the normal measurement by the following formula:

"External Adaptive Gain" =

$\text{Max}(\text{Gain_Step}) . \text{LessEqual}(\text{neededAttenuation_dB})$

- where

$$\text{neededAttenuation_dB} = (\text{preampMaxLevel_dBm} - \text{refMeasGain0Level_dBm}) + \text{bandwidthCorrection_dB}$$
- where

$$\text{preampMaxLevel_dBm} = -10 \text{ dBm (fixed value)}$$

$$\text{refMeasGain0Level_dBm} = \text{max level found in the reference measurement}$$

$$\text{bandwidthCorrection_dB} = 10 * \text{Log}_{10}(\text{SignalCarrierWidth} / \text{RBW_in_use})$$

Reference Frequency Source

Selects either the receiver's internal oscillator or an external 10 MHz reference frequency source connected to the receiver.

4.8.20.2 Functional Check

"Screenshot" > "Capture" allows capturing a screenshot of the [connected](#) receiver's or spectrum analyzer's graphical user interface.

4.8.21 Remote Action



You can define any remotely controllable instrument as a "Generic Remote Action" device, as long as you can [connect](#) it via a TCPIP, GPIB or serial [interface](#).

Such a device is then available to perform application-specific actions upon dedicated test events. Specify these actions in an EMI or EMS test template or in an EUT monitoring template.

- For [EMI test templates](#), see [Chapter 4.5.2.5, "Actions"](#), on page 230
- For [EMS test templates](#), see [Chapter 4.5.3.7, "Actions"](#), on page 305
- For [EUT monitoring templates](#), see ["Actions"](#) on page 323

This chapter describes all individual device properties tabs, but not the "General", "Connection" and "Configuration" tabs, which are [similar](#) for many devices and described separately.

- [General](#) properties are available for all types of devices.
- [Connection](#) properties are available for devices that can be connected to a local network or to your computer (for example via LAN).
- [Configuration](#) properties are available for "generic" (third-party) devices.

Besides the content mentioned above, this device dialog has the following content:

- [Functional Check](#)..... 471

4.8.21.1 Functional Check

You can use this dialog for testing the function of a selected command with a [connected](#) remote action device.

"Command(s)" selects one of the "Generic Commands" specified in the [Configuration commands](#) tab.

"SCPI Command String" shows the string in SCPI format that is specified for this remote control command.

Click "Execute" to let the device perform this command. Verify the function on the device itself, rather than in an R&S ELEKTRA dialog.

4.8.22 Signal Path



A signal path describes the physical RF signal connection between two devices in an EMC test setup. In a conducted setup, it typically contains information on the cable loss (attenuation) and insertion loss of connectors or switches between these devices. Hence, it also includes the switch paths of a referenced switch unit.

You can create and edit signal paths in the device list or in a test template.

This chapter describes all individual device properties tabs, but not the **"General"** properties tab, which is [similar](#) for all devices and described [here](#).

Besides the content mentioned above, this device dialog has the following content:

- [Measurement Correction](#).....472

4.8.22.1 Measurement Correction

Specifies how to correct the measurement values by setting the appropriate cable attenuation value or table for the signal path.

See also [Chapter 5.4, "Attenuation in signal paths"](#), on page 564.

Optionally, in this dialog, you can also select switching paths, defined in the [Details](#) tab of a *generic Switch Unit*.

Constant

Specifies a fixed attenuation value in dB for the signal path.

Table

Selects one or more [attenuation tables](#) with one column, each, of frequency-dependent attenuation values in dB for the signal path. Make sure that the tables' frequency ranges match your test scenario.

If your signal path comprises several physical components in series, for example more than one cable and a switch, its measurement correction can require a combination of several attenuation tables. In the overlapping parts of the frequency ranges, the attenuation values of the tables add up linearly.

Switching Path

Optionally, select one or more switching paths within one of the following devices:

- A [Switch Unit](#), with paths defined in its [Details](#) tab
- An [IO Device](#), with channels defined in its [Functional Check](#) tab

To select a path, click "Add Path". From the dialog that opens, select a switch unit or IO device. R&S ELEKTRA adds a row to the "Switching Path" table and enters the selected device with its default path. Go to this row and click the field in the "Path" column. A drop-down list opens that offers the paths or channels available for selection.

Note that you can select only paths that you have not yet assigned in other rows of the table. Therefore, if you have already selected paths in other rows, not all paths defined in the device are offered for selection in the drop-down list.

To delete a path, select its row and click "Remove Path".

To let a switch unit or IO device switch the defined paths, click "Switch all Paths". This switching requires that the devices are in [connected](#) state. When the switching is completed, R&S ELEKTRA displays the path's states and the devices' responses.

Note: Where to find information on how to configure switching paths? Typically, there is a block diagram of your system, showing the relay positions for signal paths in specific frequency ranges. Use this information for defining and calibrating your switching paths.

4.8.23 Sidebar



A sidebar is used for EMI measurements for moving a power-absorbing clamp to variable positions along the EUT's power cord. This setup helps finding the maximum level in the standing wave of interfering power. Typical slidebars are the so-called MDS clamp (named after the inventor, Meyer de Stadelhofen) and the decoupling clamp. When controlling a sidebar, R&S ELEKTRA actually addresses its driver.

The software supports the following third-party sidebar **types**:

- "Innco CO1000/2000" and "Innco CO3000" (with specific driver in R&S ELEKTRA)
- "Mature FCU / MCU / NCD" (with specific driver in R&S ELEKTRA)



R&S ELEKTRA generally addresses the controller device ("CO3000", "FCU", "MCU", "NCD") instead of the sidebar itself. You can specify the sidebar type by an entry in the "General" properties tab.

Additionally, the software supports the following user-definable sidebar **type**:

- "Manual SlideBar" (no driver required)
- "Generic SlideBar" (with generic driver in R&S ELEKTRA), available only with "ELEMCDRV" license

This chapter describes all individual device properties tabs, but not the "General", "Connection" and "Configuration" tabs, which are **similar** for many devices and described separately.

- **General** properties are available for all types of devices.
- **Connection** properties are available for devices that can be connected to a local network or to your computer (for example via LAN).
- **Configuration** properties are available for "generic" (third-party) devices.

Besides the content mentioned above, this device dialog has the following content:

- **Details**..... 473
- **Functional Check**..... 474

4.8.23.1 Details

Controller Settings

Not available for the device types "Manual Sidebar" and "Generic Sidebar".

Provides information on "The device selection parameter": the controller's internal number, at which R&S ELEKTRA addresses the subfunction for this device. The device selection parameter is specific number for each third-party controller.

To enable controlling several subfunctions in the same controller, activate "Supports parallel movement of accessories". If the controller handles more than one device, like antenna tower, positioner, sidebar or turntable, this feature reduces overall measurement time by moving all devices simultaneously, rather than sequentially.

Position

Defines the following positions:

- "Minimum" position
 - Arbitrary range for manual slidebars
 - Range 0 mm to 5.3 m for the "Innco CO3000" slidebar
 - Range 0 mm to 5.4 m for the "Maturo NCD" slidebar
 - Range 0 mm to 10 m for generic slidebars
- "Maximum" position:
 - Arbitrary range for manual slidebars
 - Range 0 mm to 5.3 m for the "Innco CO3000" slidebar
 - Range 0 mm to 5.4 m for the "Maturo NCD" slidebar
 - Range 0 mm to 10 m for generic slidebars
- "Parking Position": Arbitrary range, not available for the manual slidebar
- "Mounting Position": not relevant for the slidebar

Speed

Not available for the manual slidebar. Defines the following speed settings:

- "Minimum Speed Level": Range 1 to 8
- "Maximum Speed Level": Range 1 to 8
- "Parking/Mounting Speed Level": Range 1 to 8
- "Do Automatic Parking on Test End": If enabled, the slidebar returns to its parking position automatically, when the test is completed

4.8.23.2 Functional Check

Note that settings in this dialog are **no** globally effective device settings and do **not** take effect in any test templates or tests. Use these settings only for functional checks of the device.

To specify **device settings for actual measurements**, proceed as described in [Chapter 3.5, "Measurement settings"](#), on page 51.

The "Functional Check" dialog allows sending commands to the device and querying its state. You can use it to set parameters manually and to verify functional communication with the device. Available only, if the device is connected. Not available for the slidebar `type` "Manual SlideBar".

Current Position

"Read" queries the current position of the slidebar.

New Position and Speed

Defines a position and speed level. "Move" operates the device to go to the new position at the specified speed.

4.8.24 Switch Unit



RF switch units can direct conducted RF signals along different paths, if one device port must be connected alternatively with more than one other device. Examples in various EMC test systems are:

- In EMS test systems, the output of an RF generator must be connected to the inputs of different amplifiers to cover different frequency ranges of the immunity signal. Band switching of multi-band amplifiers is also done by a switch unit.
- In EMI test systems, depending on the frequency range of the signal to be measured, two or more different antennas must be connected to the receiver input.



Why are switching paths not shown in hardware setup diagrams?

The different frequency ranges mentioned in the examples above are represented by "Frequency Range Lists" in EMI and EMS test templates.

Therefore, a switching path cannot be shown like a "bifurcation" in an individual hardware setup diagram. Instead, the paths of a switch unit are represented by the **relations** defined between the different frequency ranges.

As an example, consider a setup as in [Figure 4-177](#) with the same receiver X and the same signal path Y in two frequency ranges, but two different transducers Z1 and Z2. Hence, the signal path Y must be equipped with the properties of a switch unit that has at least two switching paths: One from transducer Z1 to receiver X, and one from transducer Z2 to receiver X.

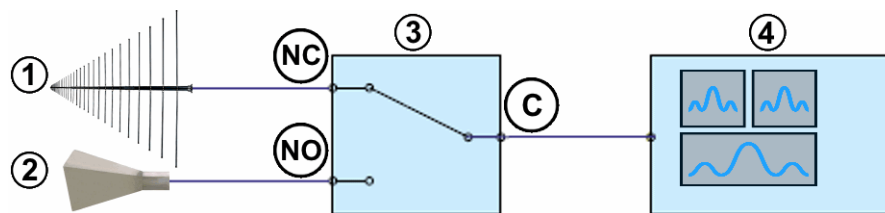

Figure 4-176: Example of a basic setup with one switching function, only

- 1 = Transducer Z1, for example, a log-periodic antenna that covers 80 MHz to 6 GHz
- 2 = Transducer Z2, for example, a horn antenna that covers 1 GHz to 18 GHz
- 3 = SPDT relay (single-pole double-throw switch)
- 4 = Test instrument, for example, a receiver that covers 10 Hz to 26 GHz
- NC = "Normally closed" switch position
- NO = "Normally open" switch position
- C = Common terminal of the SPDT relay

Inside the switch unit, the relay (for example, SPDT as in [Figure 4-176](#)) physically represents the bifurcation between the two paths. But in the hardware setup diagram of each frequency range, you can only see a straight connection between the receiver X and the transducer Z1 or Z2, respectively.

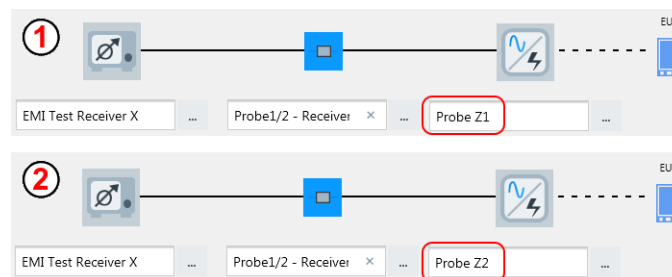

Figure 4-177: Hardware setup in two frequency ranges with switching paths

- 1 = First frequency range, the signal path switches from probe Z1 to the receiver
- 2 = Second frequency range, the signal path switches from probe Z2 to the receiver

For the description of a "Frequency Range List" in EMI test templates, see [Chapter 4.5.2.3, "Flow Details"](#), on page 201.

For the description of a "Frequency Range List" in EMS test templates, see ["Frequency Range List"](#) on page 274.

The software supports the following Rohde & Schwarz switch unit [types](#):

- "BBA130/150 Amplifier"
- "OSP120"
- "OSP130"
- "OSP220"
- "OSP230"
- "OSP320"

Additionally, the software supports the following user-definable switch unit [type](#):

- "Generic Switch Unit"

This chapter describes all individual device properties tabs, but not the "General" and "Connection" properties tabs, which are [similar](#) for many devices and described separately.

- [General](#) properties are available for all types of devices.
- [Connection](#) properties are available for devices that can be connected to a local network or to your computer (for example via LAN).

Besides the content mentioned above, this device dialog has the following content:

- [Details](#)..... 477
- [Functional Check](#)..... 478

4.8.24.1 Details

The "Details" dialog is available in two different versions, one for **generic** switch units and one for the **Rohde & Schwarz** switch units. Both dialogs are only functional, if the switch unit is [connected](#).

Generic Switch Unit

This dialog lets you create or delete rows in a path table by clicking "Add Path" or "Remove Path".

In the first column of the table, enter the "Name" of a path. To sort the paths by their names, click the "Name" header.

In the second column of the table, enter the "Command" for switching this path. For example, copy a path definition like `ROUTE:CLOSE (@F01M03(0113), F01M03(0114))` from your switch unit's control interface and paste it here. Maximum command string length is 120 characters.

`(dxxx): Delay for xxx ms`

If you add `(dxxx)` to a command, the `xxx` defines the number of milliseconds that the next command is delayed after this command. Hence, the delay is applied after sending the (first) command, to give the addressed device some time for processing, before R&S ELEKTRA sends the next command.

Example: `ROUTE:CLOSE (@F01M03(0116)) (d075)`

In the third column of the table, optionally select a default path.

Generic Switch Unit			
Name	Command	Default	
PathA	ROUte:CLoSe (@F01M03(0112))		<input checked="" type="checkbox"/>
PathB	ROUte:CLoSe (@F01M03(0113), F01M03(0114))		<input type="checkbox"/>
PathC	ROUte:CLoSe (@F01M03(0001), F01M03(0002), F01M03(0003), F		<input type="checkbox"/>

Figure 4-178: Path defining in the Details dialog of a generic switch unit

Rohde & Schwarz Switch Unit

When you connect to one of the Rohde & Schwarz switch units ("OSP"), R&S ELEKTRA loads the paths defined in the switch unit into the list on the right-hand side, labeled **"Paths available in OSP device"**. Clicking "Select paths not existing in ELEKTRA" selects all paths that are not (yet) available in the list on the left-hand side, labeled **"Existing Paths"** (see Figure 4-179).

OSP130					
Existing Paths			Paths available on the OSP device		
to remove	Name	Default	to add	Name	Default
<input type="checkbox"/>	Path_A	<input type="checkbox"/>	<input type="checkbox"/>	Path_A	<input type="checkbox"/>
			<input checked="" type="checkbox"/>	Path_B	<input type="checkbox"/>
			<input checked="" type="checkbox"/>	Path_C	<input type="checkbox"/>
			<input checked="" type="checkbox"/>	Path_D	<input type="checkbox"/>
			<input checked="" type="checkbox"/>	Path_E	<input type="checkbox"/>
			<input checked="" type="checkbox"/>	Path_F	<input type="checkbox"/>

Figure 4-179: Path definition transfer in the Details dialog of specific switch units

You can change the selection of paths by enabling or disabling the checkboxes in the "to add" column.

To **transfer** the selected paths to the list of "Existing Paths", click the left-pointing arrow between the two tables. The arrow has a mouse-over label "Add switching paths to ELEKTRA".

Optionally, you can delete individual paths from the "Existing Paths" table by checking their checkboxes in the "to remove" column and clicking "Remove Paths".

R&S ELEKTRA compares your path selection with the paths that are available in the switch unit:

- Each path that is defined in R&S ELEKTRA but not available in the switch unit, is highlighted red in the table "Existing Paths" (left-hand side)
- Each path that is available in the switch unit but not defined in R&S ELEKTRA, is highlighted red in the table "Paths available in OSP device" (right-hand side)

4.8.24.2 Functional Check

This dialog allows sending commands to the device and querying its state. You can use it to set parameters manually and to verify functional communication with the device. Available only, if the device is connected.

"Path(s)" selects one of the available signal paths, defined in the [Details](#) tab.

"Switch" switches this path in the switch unit and returns a status message, for example:

- `CMD ROUTe:CLoSe (@F01M03(0113), F01M03(0114)) sent`
This message is typical of a generic switch unit, where R&S ELEKTRA cannot interpret feedback from the device.
- `Path correctly switched: 1 Block F01 Pos A12 Relay 01`
This message is typical of a switch unit R&S OSP, where R&S ELEKTRA can interpret and evaluate feedback from the device.

4.8.25 System Control



The system control device is the central management device for controlling the test infrastructure during R&S ELEKTRA runtime and while a test is running. For example, it can switch on a test-in-progress indicator when a test is running.

You can integrate one system control device, only, into your [EMI](#) or [EMS](#) hardware setups.

For example, your system control device can manage the following devices:

- A color-coded signal lamp (red/green warning light)
- A video camera mounted inside a shielded chamber and a video display in the control room for showing life images of the test setup
If you use a camera and display, note that you can link [Generic Inserter](#) devices to the system control device, for inserting test parameters into the life image.

In a typical setup, the system control device can control a [Switch Unit](#), which in turn controls, for example, a signal lamp that is connected to one of its output ports. At events like "Test Start" and "Test Stop", the system control device switches the lamp on or off, respectively.

R&S ELEKTRA supports the following user-definable system control device [type](#):

- "Standard Control" (an internal virtual device, not treated as a generic device in R&S ELEKTRA, hence, no [Connection](#) and no [Configuration](#) properties tabs)

This chapter describes all individual device properties tabs, but not the **"General"** properties tab, which is [similar](#) for all devices and described [here](#).

Besides the content mentioned above, this device dialog has the following content:

- [Switching](#).....479
- [Generic Inserter](#)..... 480
- [Functional Check](#)..... 480

4.8.25.1 Switching

Connects one or more [Switch Units](#) to the system control device.



Using the button "Add a new Switch Action" , the dialog allows selecting existing switch units.

The drop-down lists in the "Path" column allow selecting one of the paths, each, available in a switch unit. To address different paths in the same switch unit, add it to the list several times.

The drop-down lists in the "Trigger" column allow selecting one of the events, each, available in a switch unit. When the selected event occurs, it triggers switching the selected path.



The button "Delete the Switch Action"  removes a switch unit from the list.

4.8.25.2 Generic Inserter

Connects one or more [Generic Inserter](#) devices to the system control device.



Using the button "Add a Generic Inserter device to the list" , the dialog allows selecting existing video inserter devices.



The checkbox in the "Active" column allows selecting all inserter devices that you want to be active.



The button "Delete Generic Inserter"  removes a video inserter device from the list.

4.8.25.3 Functional Check

Allows selecting one of the following "Available Actions" and triggering this action:

- "Test Start"
- "Test Stop"
- "ELEKTRA Startup"
- "ELEKTRA Shutdown"

Click "Trigger Action(s)" to send the corresponding command to the system control device.

You can use this feature to verify functional communication with the system control device.

4.8.26 TEM Waveguide



A typical TEM waveguide is the "gigahertz transverse electromagnetic" (or **GTEM**) cell in the shape of an extended rectangular hollow pyramid, which acts as an EMC test chamber. Inside, the bare metal walls reflect and guide RF radiation, while the base of the pyramid is lined with RF absorber material. With this design, the cell forms an enclosed TEM stripline that can be used as a receiving or transmitting RF antenna. The EUT is placed in the GTEM cell's test volume.

Besides the GTEM cell, which is used for EMI and EMS tests, R&S ELEKTRA also features the "Stripline" and the general "TEM" cell. These TEM waveguide types are less broadband than GTEM cells, and therefore typically used for EMS tests, only.



For a description of the configuration of a **"LISN"**, see [Chapter 4.8.13, "LISN"](#), on page 420.

For a description of the configuration of other **"Transducers"**, see [Chapter 4.8.27, "Transducer"](#), on page 485.

This chapter describes all individual device properties tabs, but not the **"General"** properties tab, which is [similar](#) for all devices and described [here](#).

Besides the content mentioned above, this device dialog has the following content:

• Details	481
• Type	481
• Measurement Correction	482
• Functional Check	484

4.8.26.1 Details

Available only for the device [type](#) "GTEM".

Control

Toggles between "Manual" and "Remote-controlled" operation of the GTEM cell.

- In manual operation, R&S ELEKTRA generates messages during the test with instructions for manual GTEM cell operation.
- In remote-controlled operation, you can select a [Receiver](#) or [IO Device](#) for controlling DUT positions in the GTEM cell automatically during tests. If you use an IO device to control the positions, it does so by sending the specified "Bit Pattern" via its first digital port to the GTEM cell.

Delay after Switch

Specifies a configurable delay time after R&S ELEKTRA switches individual DUT positions in the remote-controlled GTEM cell.

Bit Pattern

Specifies the bit pattern for remotely addressing the GTEM positions. Set the bit pattern in the control device as required by your GTEM cell for controlling measurement and parking positions.

4.8.26.2 Type

Specifies the GTEM cell's transmit/receive type and its RF parameters.

Type

Defines the radiative behavior of the device:

- "Transmitting Waveguide (Tx TEM)" - "Stripline" and "TEM" are fixed to this selection.

- "Receiving Waveguide (Rx TEM)" - available only for **Type** = "GTEM", not for "Stripline" or "TEM"
- "Transmitting and Receiving Waveguide (TxRx TEM)" - available only for **Type** = "GTEM", not for "Stripline" or "TEM"

Depending on this definition, R&S ELEKTRA enables or disables some of the following parameters.

RF Parameters

Specifies or displays the electromagnetic parameters of the device, typically according to its specifications and calibration table ([Transducer Correction](#)):

- "Frequency Range" defines the waveguide's minimum and maximum operating frequencies. For a description how the frequency range is specified, see ["Frequency Range"](#) on page 381.
- "Max. Input Power" defines the maximum peak power that the waveguide can handle during EMS measurements. R&S ELEKTRA limits the RF amplifier's output power so that not more power than this value is fed into the waveguide's input connector.
- "Max. VSWR" (Voltage Standing Wave Ratio), used only in EMS measurements. If a test's hardware setup uses a reverse power meter for reflected power, R&S ELEKTRA monitors the [VSWR](#) during the test. The software considers a measured value above "Max. VSWR" as an indication of a defective or interrupted RF connection between the amplifier and the waveguide. In this case, the measurement is automatically stopped for security reasons.

4.8.26.3 Measurement Correction

Specifies how to correct the TEM waveguide's measurement values by setting the appropriate cable correction value or table and GTEM correction factor C1.



For the measurement correction of **LISNs**, see [Chapter 4.8.13.2, "Measurement Correction"](#), on page 425.

For the measurement correction of other **transducers** (no LISNs), see [Chapter 4.8.27.2, "Measurement Correction"](#), on page 487.

TEM waveguides are typically used in a firm connection with "their own" cable. However, the device's specifications often provide only correction data for the waveguide itself, not for the cable. To handle this situation flexibly, the dialog allows specifying an individual attenuation value for the cable. In addition, measurements with a GTEM cell require a GTEM correction factor. The dialogs for specifying these values are described below.

Cable Correction

The cable part of the TEM waveguide assembly can be described by a simple attenuation in units of dB.

See also [Chapter 5.4, "Attenuation in signal paths"](#), on page 564.

- "Fixed Value"
Specifies a constant attenuation value in dB for the TEM cable.
- "According to Attenuation Correction Table"
Selects an [attenuation table](#) with one column of frequency-dependent attenuation values in dB for the TEM cable.

GTEM Correction

Available only for [Type](#) = "GTEM", not for "Stripline" or "TEM". For these device types, the cable correction is sufficient.

A GTEM cell is a receiving structure for electromagnetic fields. Its structure can be compared to a coaxial cable that is geometrically expanded extremely wide, making room to place an EUT between the inner and outer conductor. This outer conductor is represented by the outer shell of the GTEM cell, while the inner conductor is represented by the cell's septum (inner conductor).

As the oscillating field directly induces an alternating voltage between septum and outer shell, the GTEM cell does not convert physical units. Therefore, the conversion factors (C1 values), that depend on the cell's characteristics, are described by a simple [attenuation table](#). Such a table contains one column of frequency-dependent "Attenuation Level" values in dB.

You can either select an existing attenuation table or let the software compute correction factors to create a table automatically.

Use the  button to select an existing table.

Alternatively, click "Create new factor" to let R&S ELEKTRA calculate a GTEM correction table based on a set of input parameters. The software automatically creates this table for the frequency range 1 Hz to 30 GHz.

C1 Factor Calculation

Input

Diagram: A rectangular GTEM cell with height b , half-width a , and septum gap g . An EUT is positioned at (x, y) with impedance Z .

Input parameters:

b [height of the septum]	1	m
a [half width of the cell]	1	m
g [width of the septum gap]	0.36	m
x [EUT position referred to center]	0	m
y [EUT position referred to ground]	0.5	m
Z [impedance of the cell]	50	Ohm

Output

Name: Waveguide Factor C1

Calculate

Figure 4-180: C1 factor calculation

Use the following "Input" parameters:

- "b" = vertical position of the septum in relation to the ground plate of the GTEM cell
- "a" = horizontal half width of the GTEM cell
- "g" = vertical width of the gap between septum and side wall
- "x" = horizontal position of the EUT in relation to the center of the GTEM cell
- "y" = vertical position of the EUT in relation to the ground plate of the GTEM cell
- "Z" = impedance of the GTEM cell



Do not consider the default values suggested in the dialog as recommended by Rohde & Schwarz.

For the "Output", specify a name for the attenuation table.

Click "Calculate" to let R&S ELEKTRA automatically create and save this table.



For the site correction factors C2 (GTEM correlation for an open area test site / OATS), see [Site Correction Factors \(C2\) for the GTEM Correlation](#).

4.8.26.4 Functional Check

Allows you to test the automatic positioning of the EUT in a motorized GTEM cell.

Available only, if "Details" > [Control](#) is set to "Manual" operation.

Selects the "EUT Orientation" in the GTEM cell:

- "Parking position" moves the EUT to a default position, typically suited for loading the EUT into the GTEM cell
- "X" moves the EUT to a position aligned with the x-axis
- "Y" moves the EUT to a position aligned with the y-axis
- "Z" moves the EUT to a position aligned with the z-axis

To test any one of the available positions, click its button, for example "X".

- In "Manual" control of the device, a dialog comes up to alert you to switch to this position manually (as in a test). When you confirm the dialog, the software displays the selected position.
- In "Remote" control of the device, a warning comes up, if the control device does not respond. In this case, the functional check is not successful. Otherwise, the software displays the selected position.

4.8.27 Transducer



The device type **"Probe"** is a general type of transmitting or receiving transducer, such as a current clamp, a current probe, a near field probe, an antenna or a calibration adapter. A "Probe" is characterized by converting one physical unit into another. For example, an antenna converts an electric field (V/m) into a voltage (V), while a current clamp converts electric current (A) into a voltage (V).

On the contrary, the device type **"Transmitter"** is a transducer that does not convert physical units. This type is limited to conducted transmission and has no "Transducer Factor" in the [Measurement Correction](#) dialog. Transmitters are used typically for EMS tests. Examples are coupling/decoupling networks (CDN), injection clamps, broadband artificial networks (BAN), or RF networks for direct power injection (DPI).

Some other special transducing devices, such LISNs or TEM waveguides, are handled separately:



For a description of the configuration of a **"LISN"**, see [Chapter 4.8.13, "LISN"](#), on page 420.

For a description of the configuration of a **"TEM Waveguide"**, see [Chapter 4.8.26, "TEM Waveguide"](#), on page 480.

This chapter describes all individual device properties tabs, but not the **"General"** properties tab, which is [similar](#) for all devices and described [here](#).

Besides the content mentioned above, this device dialog has the following content:

- [Transducer Type](#)..... 486
- [Measurement Correction](#).....487

4.8.27.1 Transducer Type

Do not confuse this property with the [device type](#), which is either "Probe" or "Transmitter" for all transducers.

- If the device type is "Probe", this tab defines the type of transducer, either "Conducted" or "Radiated".
- If the device type is "Transmitter", this tab considers the type of transducer as "Conducted" and defines the "Max. Input Level".



If you change the type of transducer from conducted to radiated, or vice versa, you must also change the "Transducer Correction Table" (see [Measurement Correction](#)) to ensure compatibility of units. The measurement unit of a conducted transducer is typically dB μ V, dB μ A or dBm, while the measurement unit of a radiated transducer is typically dB μ V/m or dB μ A/m. Select a "Transducer Correction Table" with a measurement unit that matches the "Transducer Type".

Conducted

Available only, if you have selected the [device type](#) "Probe".

Select this transducer type, if the transducer is characterized by emitting or receiving RF signals via a cable. Common basic measurement units of conducted transducers are V, A or W (typically dB μ V, dB μ A or dBm).

Examples of conducted probes are:

- Current probe
- Coupling/decoupling network (CDN)
- Single-line LISN
- Absorbing clamp
- Calibration adapter for a CDN
- Calibration jig



In EMS tests, use a calibration jig (or "Cal Jig") for [BCI setups](#) and a "Calibration Adapter" for [CDN / EM-Clamp setups](#).

Radiated

Available for both [device types](#) "Probe" and "Transmitter".

Select this transducer type, if the transducer is characterized by emitting or receiving RF signals via free space. Common basic measurement units of radiated transducers are V/m or A/m (typically dB μ V/m or dB μ A/m).

Examples of radiated probes are:

- Near-field probe
- Antenna without polarization control / antenna tower control
For antennas with tower control, use the device type [Antenna](#) rather than a radiated transceiver.

- Magnetic loop antenna, but not a [Triple Loop](#) antenna

Max. Input Level

Available only, if you have selected the [device type](#) "Transmitter" for EMS tests.

In this case, R&S ELEKTRA considers the type of transducer as "Conducted" and lets you define the maximum level of amplified RF power delivered to the transmitter's input. During an EMS test, R&S ELEKTRA limits the system's RF output power so that this value for the transmitter's maximum input level is not exceeded.

Examples of conducted transmitters are:

- Injection clamp
- Coupling/decoupling network (CDN)
- Broadband artificial network (BAN)
- RF network for direct power injection (DPI)

Max. VSWR

Available only for the [device type](#) "Transmitter", but typically not used for conducted transmitters.

Specifies the maximum value of the Voltage Standing Wave Ratio.

If a test's hardware setup uses a reverse power meter for reflected power, R&S ELEKTRA monitors the VSWR during the test. The software considers a measured value above "Max. VSWR" as an indication of a defective or interrupted RF connection between the amplifier and the transmitter. In this case, the measurement is automatically stopped for security reasons. If you do not want the "Max. VSWR" to be evaluated, set its value to 100 or higher.

4.8.27.2 Measurement Correction

Specifies how to correct the transducer's measurement values by setting the appropriate cable attenuation and transducer correction data.



For the measurement correction of **LISNs**, see [Chapter 4.8.13.2, "Measurement Correction"](#), on page 425.

For the measurement correction of **TEM waveguides**, see [Chapter 4.8.26.3, "Measurement Correction"](#), on page 482.

For the measurement correction of **triple-loop antennas**, see [Chapter 4.8.28.2, "Measurement Correction"](#), on page 490.

For the measurement correction of other **antennas** (no triple-loop), see [Chapter 4.8.5.2, "Measurement Correction"](#), on page 397.

Transducers of the "Probe" type, such as antennas or current clamps, are often used in a firm connection with a cable. However, the transducer's specifications provide only correction data for the transducer itself, not for the cable. Therefore, if your transducer is of the [device type](#) "Probe", the dialog offers separate parts for specifying values for the cable and for the signal-converting part of the transducer.

Note that a "Transmitter" has no "Transducer Factor" defined here, because in EMS tests that use transmitters, [leveling](#) either relates to a sensor or to the [Substitution Method](#). Here, the transducer factor is included in the reference calibration.

Cable Correction

The cable part of the transducer can be described by a simple attenuation in units of dB.

See also [Chapter 5.4, "Attenuation in signal paths"](#), on page 564.

- "Fixed Value"
Specifies a constant attenuation value in dB for the transducer cable.
- "According to Attenuation Correction Table"
Selects an [attenuation table](#) with one column of frequency-dependent attenuation values in dB for the transducer cable.

Transducer Factor (Measurement Unit → Result Unit)

Available only, if you have selected the [device type](#) "Probe".

The signal-converting part of the transducer converts physical units. Its influence on the RF signal is therefore described by a transducer correction with potentially different units on the input side (measurement) and output side (result). Typically, the correction level values are in dB μ V/m, dB μ A/m or dBpW.

"Fixed Correction" specifies a constant correction value for the signal-converting part of the transducer, together with a result unit (for example the default "dB μ V/m") and the measurement unit "dB μ V".

"According to Transducer Correction Table" selects a [table](#) that contains one column of frequency-dependent "Correction Level" values in a result unit that is also defined in this table. The result unit can be, for example, "dB μ V/m" for a dipole antenna, "dB μ A/m" for a loop antenna, "dB μ A" for a current clamp or "dBm" for a power meter (in EMS tests). The result unit is read from the transducer correction table and serves for converting the measured values from the measurement unit, which is typically "dB μ V", to the result unit as defined in the table.

4.8.28 Triple Loop



Triple-loop antennas are auxiliary devices used in radiated EMI tests for measuring magnetic interference emissions of the EUT. This device category covers triple-loop antennas with three separately addressable loops in perpendicular arrangement. For simple magnetic loop antennas, use the device category [Transducer](#) (device type "Probe", transducer type "Radiated").

R&S ELEKTRA supports the following triple loop antenna [types](#):

- The "HM020" from Rohde & Schwarz
- A user-definable type

Both types can optionally be remotely controlled from a receiver with a suitable user port.

This chapter describes all individual device properties tabs, but not the **"General"** properties tab, which is [similar](#) for all devices and described [here](#).

Besides the content mentioned above, this device dialog has the following content:

- [Details](#)..... 489
- [Measurement Correction](#)..... 490
- [Functional Check](#)..... 491

4.8.28.1 Details

Control

Specifies manual or remote control operation of the triple-loop antenna:

- If you use "Manual" control, R&S ELEKTRA generates messages during the test with instructions for manual antenna switching.
- "Remote-controlled" selects the [Receiver](#) as the control device. Rohde & Schwarz test receivers feature TTL remote control for automatic switching of the antenna frame to be evaluated during a test.
To use this feature, make sure that the triple-loop antenna is connected to the receiver's user port via the appropriate cable.



If you change settings of the receiver that is selected as the [Control](#) of a [LISN](#) or [Triple Loop](#), R&S ELEKTRA considers this LISN or triple-loop antenna as changed, too.

Delay after Switch

Specifies a configurable delay time after R&S ELEKTRA switches individual loops of the remote-controlled antenna.

Bit Pattern

Specifies the bit pattern for addressing the "Local" button and the antenna loops (or "frames") to be used in a test. R&S ELEKTRA must know these patterns for switching individual loops on or off.

The "Local" button enables manual switching at the antenna.

For the specific triple-loop antenna R&S HM020, the bit pattern is displayed, but you cannot edit it. For a user-defined triple-loop antenna, define the bit pattern according to the specifications of your antenna.

Table 4-20: Bit patterns of various triple-loop antenna types

Antenna frames	"HM020" (fixed bit pattern)	"User Defined" (bit pattern can be edited)
"Local"	00000000	00000000
"X"	00000010	00000010

Antenna frames	"HM020" (fixed bit pattern)	"User Defined" (bit pattern can be edited)
"Y"	00000010	00000010
"Z"	00000100	00000100

4.8.28.2 Measurement Correction

Specifies how to correct the triple loop antenna's measurement values by setting the appropriate cable attenuation and transducer correction data.



For the measurement correction of other **antennas** (no triple-loop), see [Chapter 4.8.5.2, "Measurement Correction"](#), on page 397.

For the measurement correction of **TEM waveguides**, see [Chapter 4.8.26.3, "Measurement Correction"](#), on page 482.

For the measurement correction of **LISNs**, see [Chapter 4.8.13.2, "Measurement Correction"](#), on page 425.

For the measurement correction of **transducers**, see [Chapter 4.8.27.2, "Measurement Correction"](#), on page 487.

Triple-loop antennas are often used in a firm connection with a cable. However, the antenna's specifications provide only correction data for the antenna itself, not for the cable. To handle this situation flexibly, the dialog offers separate parts for specifying values for the cable and for the signal-converting part of the antenna.

Cable Correction

The cable part of the antenna can be described by a simple attenuation in units of dB.

See also [Chapter 5.4, "Attenuation in signal paths"](#), on page 564.

- "Fixed Value" specifies a constant attenuation value in dB for the antenna cable.
- "According to Attenuation Correction Table" selects an [attenuation table](#) with one column of frequency-dependent attenuation values in dB for the antenna cable.

Triple Loop Correction

The signal-converting part of the antenna converts physical units. Its influence on the RF signal is therefore described by an antenna correction factor or table. R&S ELEKTRA converts the measured values with the measurement unit "dBμV" to values with the result unit "dBμA".

- "Fixed Correction" specifies a constant correction value for the signal-converting part of the antenna, together with the result unit "dBμA".
- "According to Transducer Correction Table" selects a [Transducer Correction Table](#) that contains one column of frequency-dependent "Correction Level" values in the result unit "dBμA".

4.8.28.3 Functional Check

Tests the remotely controlled switching of the "Local" button and the antenna loops. The following prerequisites apply:

- The antenna [Control](#) in the [Details](#) tab must be set to "Remote" control via the EMI test receiver.
- The [Receiver](#) must be in [connected](#) state.
- On hardware side, the antenna must be connected to the receiver's user port via an appropriate cable.

To test switching to "Local" control or switching any one of the antenna loops, click the corresponding button, for example "X".

- In "Manual" control of the device, a dialog comes up to alert you to switch to this loop manually (as in a test). When you confirm the dialog, the software displays the selected loop.
- In "Remote" control of the device, a warning comes up, if the control device does not respond. In this case, the functional check is not successful. Otherwise, the software displays the 'bitport' of the control device, typically the user port of a receiver, for example "X: #B00000001".

4.8.29 Turntable



Turntables allow a remotely controlled rotation of the EUT in radiated EMI and EMS measurements. During a test, the turntable is operated by an interactive [accessories control dialog](#). Hence, when controlling a turntable, R&S ELEKTRA actually addresses its driver.

The software supports the following Rohde & Schwarz turntable [types](#):

- "ATS1500C" azimuth and elevation 3D positioner in R&S ATS1500C shielded chamber (with specific driver in R&S ELEKTRA)
- "ATS1800C" azimuth and elevation 3D positioner in R&S ATS1800C shielded chamber (with specific driver in R&S ELEKTRA)
- "DST" azimuth and elevation 3D positioner for R&S DST200 shielded box (with specific driver in R&S ELEKTRA)
- "Rohde & Schwarz RST" (with specific driver in R&S ELEKTRA)

Note that R&S ELEKTRA treats the elevation axis of the 3D positioners as a "turntable", too, although an elevation rotation is about a horizontal axis. Hence, consider the elevation axis of the 3D positioner as being a turntable, flipped 90° sideways.

The software supports the following third-party turntable [types](#):

- "AIP Turntable", a turntable for an automotive roller test bench by third-party company "AIP GmbH", Haldenwang, Germany (with specific driver in R&S ELEKTRA)
- "AVL Turntable", a turntable for an automotive roller test bench by third-party company "AVL List GmbH", Graz, Austria (with specific driver in R&S ELEKTRA)

- "COMTEST Tuner", a special rotation device (with specific driver in R&S ELEKTRA) for [reverberation chamber](#) (RVC) hardware setups. Available only, if you have enabled the "ELEMS-RVC" [license](#).
- "EMCO 2090", "EMControl" (ETS-Lindgren, with specific driver in R&S ELEKTRA)
- "Frankonia FC" (with specific driver in R&S ELEKTRA)
- "Innco CO1000/2000" and "Innco CO3000 - DT / DE / DS / MR" (with specific driver in R&S ELEKTRA)
- "Mature FCU / MCU / NCD" (with specific driver in R&S ELEKTRA)



R&S ELEKTRA generally addresses the controller device ("EMCO 2090 / EMControl", "FC", "CO3000", "FCU", "MCU", "NCD") instead of the turntable itself. You can specify the turntable type by an entry in the "General" properties tab.

Additionally, the software supports the following user-definable turntable [types](#):

- "Manual Turntable" (no driver required)
- "Generic Turntable" (with generic driver in R&S ELEKTRA), available only with ["ELEMC-DRV" license](#)

This chapter describes all individual device properties tabs, but not the "General", "Connection" and "Configuration" tabs, which are [similar](#) for many devices and described separately.

- [General](#) properties are available for all types of devices.
- [Connection](#) properties are available for devices that can be connected to a local network or to your computer (for example via LAN).
- [Configuration](#) properties are available for "generic" (third-party) devices.

Besides the content mentioned above, this device dialog has the following content:

- [Details](#)..... 492
- [Functional Check](#)..... 494

4.8.29.1 Details

Controller Settings

Not available for the device types "Manual Turntable" and "Generic Turntable".

Provides information on "The device selection parameter": the controller's internal number, at which R&S ELEKTRA addresses the subfunction for this device. The device selection parameter is specific number for each third-party controller.

To enable controlling several subfunctions in the same controller, activate "Supports parallel movement of accessories". If the controller handles more than one device, like antenna tower, positioner, sidebar or turntable, this feature reduces overall measurement time by moving all devices simultaneously, rather than sequentially.

Azimuth



R&S ELEKTRA treats the elevation axis of the R&S ATS1500C, R&S ATS1800C and R&S DST-B165 positioners as a "turntable", too, although their elevation rotation is about a horizontal axis. Consider the elevation axis of the 3D positioner as being a turntable, flipped 90° sideways. Therefore, specify the elevation settings of these positioner axes in this "Azimuth" dialog.

Also, the R&S ATS1500C has a tilt table instead of an azimuth turntable. Hence, consider the tilt axis of this positioner as being another turntable, flipped 90° sideways. Therefore, specify the tilt settings of the R&S ATS1500C in the "Azimuth" dialog, too.

"Minimum" and "Maximum" specify the value range for the turntable's angular position (in degrees).

"Parking Position" and "Mounting Position" specify the default angular positions (in degrees) for parking the turntable and for mounting the DUT. Not available for the "Manual Turntable".

R&S ELEKTRA considers a given target position as reached, when the detected angular position differs from the target angular position by not more than the "Tolerance" specified here.

Speed

Not available for the "Manual Turntable".

"Minimum" and "Maximum" specify the value range for the turntable's moving speed levels.

"Parking / Mounting" specifies the speed level for moving the turntable to the parking and mounting positions.

"Do Automatic Parking on Test End" makes the turntable move to the parking position automatically, when a test is completed.

The checkbox "Map absolute to relative speed" is available only for the COMTEST Tuner turntable [type](#). If you enable this feature, the software can instruct the turntable controller to move the turntable with absolute speed values. Hence, the controller maps the relative speed levels 1 to 8 to the absolute speed values. To do so, enter the "Absolute Minimum" speed value in deg/s, which the software sets equivalent to the minimum speed level 1. Also, enter the "Absolute Maximum" speed value in deg/s, which the software sets equivalent to the minimum speed level 8. The software interpolates the other speed levels 2 to 7 to the correct absolute speed values in deg/s.

The checkbox "Support continuous rotation" is available only for the EMCO 2090 and Frankonia FC turntable [types](#). If you enable this feature, which supports endless rotation of the turntable, the software disables the "Minimum" and "Maximum" angular positions of the turntable in the [Azimuth](#).

4.8.29.2 Functional Check

This dialog allows sending commands to the device and querying its state. You can use it to set parameters manually and to verify functional communication with the device. Available only, if the device is connected. Not available for the turntable [type](#) "Manual Turntable".

Current Position

"Read" queries the current angular position of the turntable.

New Position and Speed

Defines a new angular position and rotational speed level. "Move" operates the device to go to the new position at the specified speed.

4.9 Tables

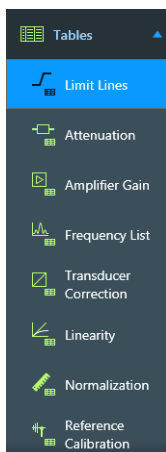

Access: "Home" > "Tables"

Tables can be created by measurement or calibration, they can be edited (from scratch, if necessary) or they can be imported. Tables can contain, for example:

- Frequency values
- Power or voltage levels
- Attenuation or gain data
- Correction factors
- Linearity values
- Normalization data
- Reference calibration levels



This chapter does not refer to [Test result tables](#), which are implemented only within the [Test container](#). [Chapter 4.4.3, "Configuring test tables"](#), on page 108 describes how to handle test result tables. Instead, this chapter refers to the so-called "global" tables that are available at "Home" > "Tables".

For all these global tables (other than test result tables), the buttons for common actions such as create, delete, open, copy or rename are described in [Chapter 3.3, "Common action buttons"](#), on page 45.

When you open a table, the dialog provides the following set of action buttons:

Name	Frequency	Limit 1	Limit 2	Limit 3	Limit 4
Unit	MHz	dBμV	dBμV	dBμV	dBμV
Detector		Quasi Peak	Average	Maximum Peak	None
Interpolation	Logarithmic	Linear	Linear	Linear	Linear
1	0.000				

Figure 4-181: Example of a table dialog header, here in a limit line table



The "Rename" button expands a text line for entering a new table name. Click to save the name and collapse the text line.



The "Save" button  (Ctrl+S) and the "Save As..." button  (F12) save the table to the R&S ELEKTRA database.



The "Delete rows" button removes one or more selected (highlighted) rows from the table. To delete a row, it must be selected as a whole, not only a cell in the row. To select a whole row, click its far left row-header field. Hold [Shift] or [Ctrl] to select multiple rows.



The "Copy" button copies the selected (highlighted) rows.



The "Paste" button pastes the previously copied rows into the table and sorts the rows by frequency.



The "Add new row" button inserts a new row above the currently selected position.



The "Show / Hide Columns" button enables or disables individual columns. You cannot disable the "Frequency" column.



The "Show / Hide Column Headers" button enables or disables individual column headers. You cannot disable the "Name" and "Unit" headers.



The "Select table" button selects all cells in the table, for example for copying.



The "Show Graphics Display" button opens a dialog for selecting the columns to be displayed in a chart. Select the columns and click "OK" to let R&S ELEKTRA generate a graphical representation of the table.



The **import**  and **export**  functions are described below.



The "Set default sorting" button sorts the table by a combination of increasing frequency ranges and frequency values. This feature is especially helpful, if your test contains *overlapping* frequency ranges, and if you have re-sorted, for example, a result table by clicking one of the table headers. "Set default sorting" resets the the table to its original order.



The "Print" button opens a dialog for sending the table to your printer (unless the table is empty).

Other functions for handling the various tables are described in the subsequent chapters.



Table nomenclature

Whenever you create a table, we recommend establishing a comprehensible **nomenclature** for saving tables with speaking names.

For example, "BB-antenna1_ESR7" is a speaking name for an **attenuation table** that describes the frequency-dependent attenuation of the **Signal Path** from the broadband antenna 1 to the receiver R&S ESR7.

Importing tables

To import tables from files in standard file formats, for example **.xlsx** or **.csv**, do not use the **Import** tool. Instead, go to "Home" > "Tables" and proceed to the type of table you want to import (for example **Limit Lines**). Here, you have two options:

- Click **"Create"** to create a table and paste some copied table content from your external **.xlsx**, **.txt** or **.csv** file into this table. Use [Ctrl+c] to copy the external content and [Ctrl+v] to paste it.
In the **Limit Lines** dialog, the "Create: Limit Line" button provides additional features, see **"Create: Limit Line"** on page 498.
- Click to import a table directly from an external **.csv**, **.SnP** or **.txt** file. This option is not available for **.xlsx** files.

If you use the import option, a "Table Import" wizard supports you in transferring your table content. This wizard works case-sensitive for each specific table type. The following example is for importing external **.csv** content into a limit line table:

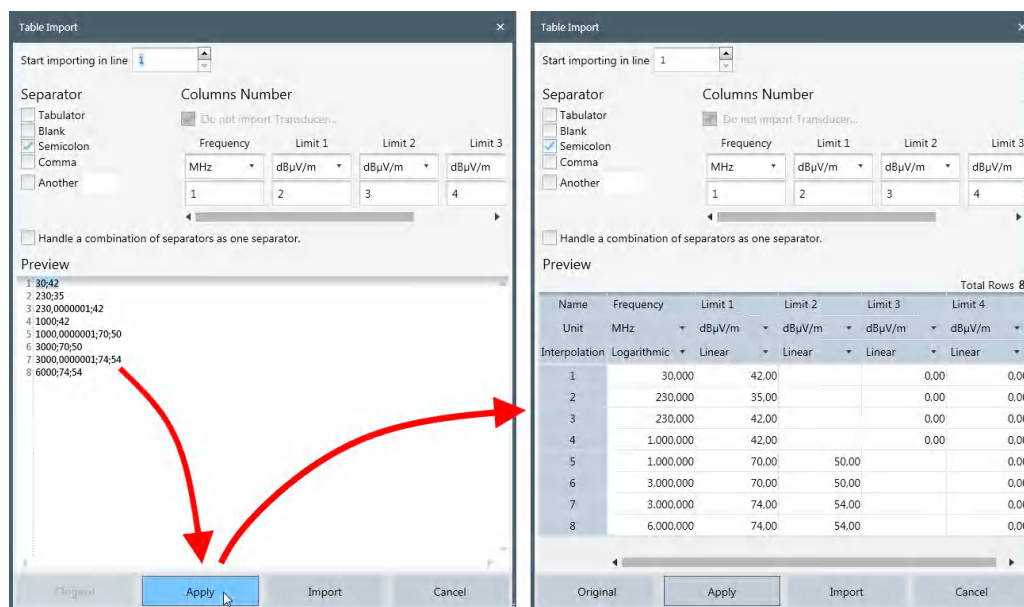

Figure 4-182: Two dialog views of the Table Import wizard for .csv files

Left = Manually select the separator and the frequency and limit units

Right = "Apply" the settings to create a table in R&S ELEKTRA format, ready for import

Verify or edit the pre-settings in the "Table Import" wizard:

- Select the first line for starting the import of table values

- Specify the correct table cell separator or a combination of separators
- Set the units for the frequency (Hz, kHz, MHz, GHz) and for the data values, for example:
 - Limit in dB μ V/m
 - Attenuation in dB
 - Correction level in dBpT

"Apply" converts the data with your settings into a table in R&S ELEKTRA format.

"Import" terminates the wizard and opens the imported table in a new tab, where you can still edit it. If you wish to keep the table, make sure to save it.

Exporting tables

To export tables from R&S ELEKTRA to files in `.xlsx` or `.csv` format, do not use the [Export](#) tool. Instead, go to "Home" > "Tables" and proceed to the type of table you want to export (for example [Limit Lines](#)). Open the table you want to export. Here, you have two options:

- Select and copy the table content that you want to export and paste it into an external `.xlsx` or `.csv` table file. Use [Ctrl+c] to copy the content and [Ctrl+v] to paste it.
- Click  to export a table directly into an external `.csv` file. This option is not available for `.xlsx` files.

R&S ELEKTRA distinguishes the following global tables according to their use:

• Limit Lines	497
• Attenuation	500
• Amplifier Gain	501
• Frequency List	502
• Transducer Correction	502
• Linearity	504
• Normalization	505
• Reference Calibration	505

4.9.1 Limit Lines

A limit line is typically defined by a standard. Create or import your limit line tables accordingly. By using the [Configuration Wizard](#), you can let R&S ELEKTRA create a basic set of limit lines.

When you create a limit line, select the table type for "CAL", "EMI" or "EMS" applications. In the table, you can optionally assign an EMC standard, revision and subclass to this table.

In R&S ELEKTRA, a **limit line table** consists of a frequency list in the first column and up to four **limit line columns** with limit levels for up to four individual detectors. Specify the [detector types](#) in the table header.

Example:

For the magnetic flux density, the standard MIL-STD-461G specifies the following RS101 limit for all navy applications:

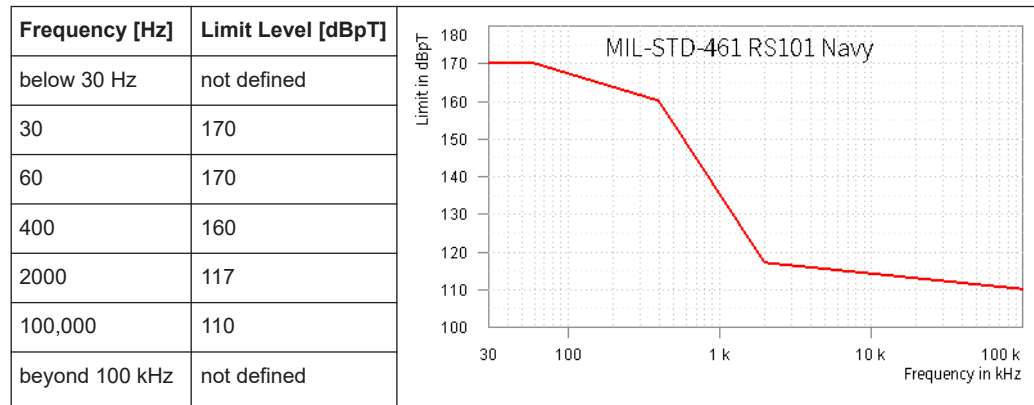

The limit levels between the frequency points specified in this table are linearly interpolated in a semi-logarithmic chart (linear levels over logarithmic frequencies).

Create: Limit Line

When you click the  button create a limit line, R&S ELEKTRA opens a dialog for selecting the type of limit line to be created:

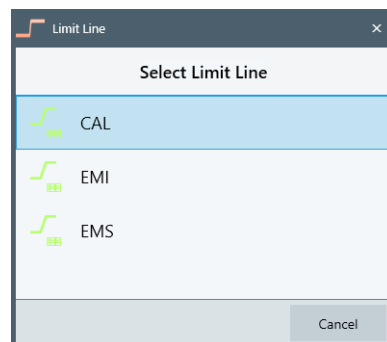

- "CAL": Limit line table for calibration measurements, see [step 10](#) in [Chapter 4.5.1, "Test Templates for calibration measurements"](#), on page 119
- "EMI": Limit line table for EMI tests, see [Limit Line](#) in [Chapter 4.5.2.3, "Flow Details"](#), on page 201
- "EMS": Limit line table for EMS tests, see the following sections in [Chapter 4.5.3, "Test Templates for EMS tests"](#), on page 243:
 - ["Power Level Limitation"](#) on page 266
 - ["Sensor Level Limitation"](#) on page 267
 - ["Level Table defined by Limit Line"](#) on page 280

Unit

Define physical units in the limit line headers. For example, consider a limit line for tests that use an antenna: The true physical unit of the RF levels is a field strength

(dB μ V/m), even though the receiver measures a voltage (dB μ V). Therefore, enter the result unit as described in [Chapter 4.8.27.2, "Measurement Correction"](#), on page 487.

Accuracy

Specifies the number of decimal places of the values displayed in the selected column. You can set this parameter from 0 to 8 decimal places.

"Accuracy" is available only, if it is enabled at "Show / Hide Column Headers".

Detector

For each limit line, select from the drop-down list the detector, for which this limit line is defined.

Interpolation

Defines whether to interpolate between the table rows in linear or logarithmic mode. To select "Linear" or "Logarithmic" interpolation for an individual column, click its "Interpolation" header.

To achieve the following, you must set the "Interpolation" correctly in the table definition:

- Setting "Interpolation" to "Linear", if the axis is scaled linear, too, results in a straight line between the defined points in a chart.
- Setting "Interpolation" to "Logarithmic", if the axis is scaled logarithmic, too, results in a straight line between the defined points in a chart.
- Otherwise, the line between points in the chart is curved.

Base Unit

Displays the base unit of the column and cannot be edited.

"Base Unit" is available only, if it is enabled at "Show / Hide Column Headers".

Applicable standard

On the right-hand side of the limit line table, a dialog shows the following:

- The "Application" selected during [creation](#)
- The "Standard", which you can select from a drop-down list, according to your test application
- The "Revision" of the standard, which you can enter here
- The "Subclass" of the standard, which you can enter here

Gaps in a limit line

As a special feature, you can define gaps in limit lines. To define a gap, enter 2 dash characters ("--") in a cell of the limit line table:

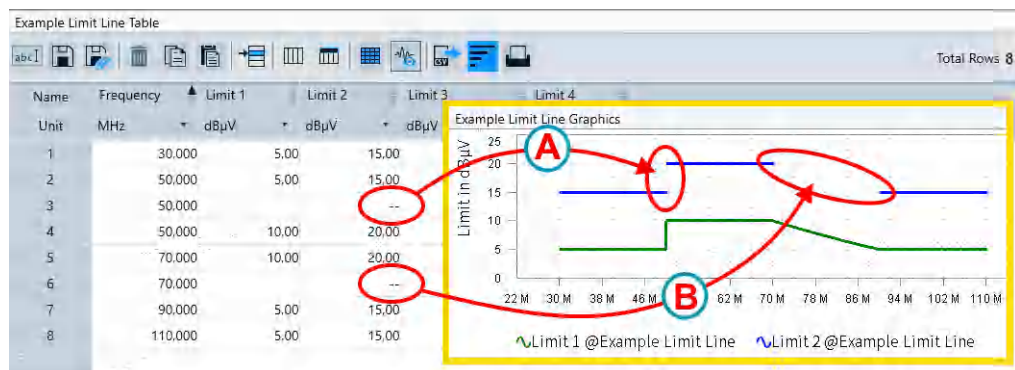

Figure 4-183: Examples of entries in a limit line table, and resulting graphics

A = Vertical gap (from one frequency to the same frequency)

B = Horizontal gap (from one frequency to a higher frequency)

To define a gap, use 3 rows in the table:

- The 1st row specifies the frequency, at which the previous section of the line ends and the gap begins
- The 2nd row contains the 2 dash characters ("--") that generate the gap
 - For a "vertical gap" (labeled (A) in [Figure 4-183](#)), use the same frequency as in the 1st row
 - For a "horizontal gap" (labeled (B) in [Figure 4-183](#)), use any frequency between the 1st row and the 3rd row

To avoid the same gaps in other limit lines of the same table, leave the corresponding cells of non-involved limit columns empty.

- The 3rd row specifies the frequency, at which the gap ends and the next section of the line begins

4.9.2 Attenuation

In the propagation of RF radiation across real media, there is always some loss of power due to attenuation. A technically especially relevant example is the propagation through an RF cable.

With the simplified assumption of the same amount of attenuation across all frequency bands, no attenuation tables would be required. Instead, a single attenuation value would be sufficient, for example for cable loss.

Attenuation tables serve to represent the frequency dependency of RF radiation across true propagation media. This frequency dependency describes the attenuation characteristics, for example of a piece of cable. A typical application of an attenuation table in R&S ELEKTRA is its use in the definition of a [Signal Path](#).

By using the [Configuration Wizard](#), you can let R&S ELEKTRA create a basic set of attenuation tables.

We recommend that you save your tables according to the suggested [nomenclature](#).



Gain vs. attenuation

Within R&S ELEKTRA, attenuation has a positive sign, gain has a negative sign.

Hence, to specify a gain table (for example for a preamplifier), enter negative attenuation levels.

Unit

This table header defines the frequency unit in Hz, kHz, MHz or GHz, and the attenuation level typically in dB.

Interpolation

Defines whether to interpolate between the table rows in linear or logarithmic mode. To select "Linear" or "Logarithmic" interpolation for an individual column, click its "Interpolation" header.

To achieve the following, you must set the "Interpolation" correctly in the table definition:

- Setting "Interpolation" to "Linear", if the axis is scaled linear, too, results in a straight line between the defined points in a chart.
- Setting "Interpolation" to "Logarithmic", if the axis is scaled logarithmic, too, results in a straight line between the defined points in a chart.
- Otherwise, the line between points in the chart is curved.

4.9.3 Amplifier Gain

Amplifier gain tables contain for every frequency value the input and output level of an [Amplifier](#). Based on these data, R&S ELEKTRA can calculate the amplifier gain and also increase the protection of the amplifier against overload.

An amplifier gain table is generated by an EMS test using the test method [Amplifier Test](#). In this test, the software determines the input power that is required to reach the amplifier's target (nominal) output power. The test also reveals the 1 dB compression point, which is the upper limit of the amplifier's dynamic range. The resulting table is then referenced in the properties dialog of the amplifier.

For power limitation during EMS tests, the leveling algorithm of R&S ELEKTRA uses the input power measurement to set the appropriate output power.

Unit

This table header defines the physically measured units. Typically, the input and output levels of an amplifier are given in dBm.

Interpolation

Defines whether to interpolate between the table rows in linear or logarithmic mode. To select "Linear" or "Logarithmic" interpolation for an individual column, click its "Interpolation" header.

4.9.4 Frequency List

A frequency list contains a single column with frequencies. It defines discrete frequencies, for example in a test template, to let R&S ELEKTRA measure at these frequencies in addition to - or instead of - the frequencies defined by a given frequency setting.

Frequency lists are typically created by hand. Write the frequencies into the table or paste them there from a different source, for example from a spreadsheet.

For emission measurements, frequency lists can also be created by data reduction. The resulting list can be used in the final measurement.

Unit

Available frequency units are Hz, kHz, MHz and GHz. To select the unit, click the column header.

Comment

You can optionally enter arbitrary comments in each frequency row, for example the name of a frequency band.

4.9.5 Transducer Correction

Transducer correction tables are typically generated by hand, by copy-paste from the transducer manufacturer's specifications or through a calibration process. By using the [Configuration Wizard](#), you can let R&S ELEKTRA create a basic set of transducer correction tables.

Unit

In a table, the "Unit" row defines the units of the table's values.

Interpolation

"Interpolation" defines whether to interpolate between the table rows in linear or logarithmic mode. To select "Linear" or "Logarithmic" interpolation for an individual column, click its "Interpolation" header.

To achieve the following, you must set the "Interpolation" correctly in the table definition:

- Setting "Interpolation" to "Linear", if the axis is scaled linear, too, results in a straight line between the defined points in a chart.
- Setting "Interpolation" to "Logarithmic", if the axis is scaled logarithmic, too, results in a straight line between the defined points in a chart.
- Otherwise, the line between points in the chart is curved.

Types of transducer correction tables

The following types of transducer correction tables are available:

- [Standard](#)

- [Avg Norm Max E-Field](#)
- [Antenna Efficiency](#)
- [Chamber Loading Factor](#)

Standard

This table type contains frequency-dependent "Correction Level" values.

The tables are used to consider for the transfer function of a LISN or transducer (antenna, current clamp, etc.), as described in [LISN Measurement Correction](#) and [Transducer Measurement Correction](#).

The "Unit" in the "Correction Level" header defines the physical result unit as described in [Chapter 4.8.27.2, "Measurement Correction"](#), on page 487. For example, if there is a transducer correction table for an antenna: The RF levels are measured as some voltage (dBµV) at the receiver's antenna connector. This voltage is converted by the transducer correction table into the field strength (dBµV/m) that the antenna actually received. In this way, result tables and charts can display signal levels with their true physical units, rather than measured voltage levels.



Correction factor

The correction factor (or "k factor") serves for the frequency and linearity correction of measured field strength values in EMS tests. The true (correct) field strength E_{corr} as a function of frequency is calculated from a reading R (for example returned by a field probe) using the following equation:

$$E_{\text{corr}} = (R + k_{\text{Lin}}) * 10^{(k_{\text{Freq}} / 20)}$$

with the linearity correction factor $k_{\text{Lin}} = E_{\text{true}} - E_{\text{displayed}}$ and the frequency correction factor $k_{\text{Freq}} = E_{\text{true}} / E_{\text{displayed}}$ [dB] = $20 * \log_{10} (E_{\text{true}} / E_{\text{displayed}})$.

Avg Norm Max E-Field

This table type, which only serves for measurements in [reverberation chambers](#), contains the following frequency-dependent values:

- "Avg Norm Max E-Field" in (V/m)/sqr(W)
 - The parameter (called also $E_{\text{Norm x,y,z}}$) is the calculated average of the normalized maximum E-field. This measurement result of the empty-chamber calibration is generated during field uniformity validation of the chamber. It is the maximum measurement from each field-probe axis divided by the square root of input power. Determine "Avg Norm Max E-Field" as described in the standard IEC 61000-4-21 (2011), annex B, "Chamber validation for mode-tuned operation". To do so, record the following data at all required positions of the field probe, during one full rotation of the tuner:
 - Maximum and average power of the received signal
 - $E_{\text{Max x,y,z}}$ = maximum field strength for each axis of the E-field probe
 - P_{Input} = average value of the input power

With this data, normalize each of the maximum E-field probe measurements to the square-root of the average input power. Hence, at each field-probe position, nor-

malize each field component below and above 10 times the lowest test frequency f_s . The resulting $E_{Norm\ x,y,z}$ is calculated as follows:

$$E_{Norm\ x,y,z} = E_{Max\ x,y,z} / \text{sqr}(P_{Input})$$

For more information, see ["Power Relation"](#) on page 260, or refer to the standard IEC 61000-4-21.

- "Insertion Loss Unloaded" (dB)
- "Insertion Loss Loaded" (dB)

For more details on loaded versus unloaded chambers, see ["Chamber Loading Factor"](#) on page 504.

Antenna Efficiency

This table type, which only serves for measurements in [reverberation chambers](#), contains frequency-dependent values of "Antenna Efficiency" (no unit).

Antenna efficiency is the ratio of the total power radiated by an antenna to the net power accepted by the antenna from the connected transmitter.

Typical antenna efficiencies are approximately 0.75 for log-periodic antennas, and 0.9 for horn antennas.

Chamber Loading Factor

This table type, which only serves for measurements in [reverberation chambers](#), contains the following frequency-dependent values:

- "CLF" (chamber loading factor, no unit)
- "CCF" (chamber calibration factor, dB)
- "Insertion Loss" (dB)

Chamber loading refers to the possible adverse effects to the field uniformity in a reverberation chamber due to presence of an EUT. During chamber validation, measurements compare field uniformity of the empty chamber to that of the chamber being sufficiently loaded with absorbing material. This simulated "load" is sufficient, if its effect reaches at least the level expected during normal testing.

4.9.6 Linearity

Linearity correction tables are used for compensating non-linearities in measuring devices, especially in field strength sensors for radiated EMI measurements. For this type of [transducer](#), the calibration protocols can provide data on linearity errors. With these data, linearity correction tables are typically generated by hand (copy / paste).

Unit

Define the same physical unit in both column headers. For example, the measured input and output levels can be given in V/m.

Interpolation

Defines whether to interpolate between the table rows in linear or logarithmic mode. To select "Linear" or "Logarithmic" interpolation for an individual column, click its "Interpolation" header.

4.9.7 Normalization

Normalization tables are used in the process of calibrating the attenuation of a conducted signal path (or of a passive component), as described for the calibration test template [Attenuation Relative](#). To isolate the signal path's attenuation from other influences, you must first perform a normalization measurement without that signal path.

For example, use two normalization cables to connect an RF signal generator to a power sensor. Measure the attenuation spectrum across this setup and save the result as your normalization table. Then insert the signal path to be calibrated between the two normalization cables and measure the attenuation spectrum again. From this result, subtract your original normalization table to get the net attenuation of the signal path, which is stored as an [attenuation table](#).

Unit

This table header defines the frequency unit in Hz, kHz, MHz or GHz, and the normalization level typically in dBm.

Interpolation

Defines whether to interpolate between the table rows in linear or logarithmic mode. To select "Linear" or "Logarithmic" interpolation for an individual column, click its "Interpolation" header.

4.9.8 Reference Calibration

Reference calibration tables contain the relation between immunity level and transducer input power in EMS tests. Such a table is the result of a [reference calibration](#) measurement, as described in [Chapter 8.3, "Reference calibration of a CDN"](#), on page 652.

To generate a reference calibration table, run an EMS measurement using the test method [Reference Calibration](#). Per default, EMS tests are performed by the [Substitution Method](#) (for example, according to EN 61000-4). This test consists of two steps:

- In the first step, the required immunity level is generated and measured in a reference measurement with an appropriate monitoring device, typically a field sensor. This procedure is called "leveling to a sensor". The resulting data is stored in a reference calibration table.
- In the second step, when measuring the EUT, the field sensor is not used anymore, because it can influence the electromagnetic field in an unintentional way. Instead of leveling to a sensor, R&S ELEKTRA sets the value of transducer power, which is now known from the reference calibration table.

Reference calibration tables are also used to evaluate the field homogeneity in an anechoic chamber.

By using the [Configuration Wizard](#), you can let R&S ELEKTRA create some examples of reference calibration tables.

We recommend that you save your tables according to the suggested [nomenclature](#).

R&S ELEKTRA distinguishes between two types of reference calibration tables: the conducted and the radiated type. When you create a reference calibration table, you must select the type:

Conducted Reference Calibration Table

A conducted reference calibration table has the following columns:

- "Frequency" in Hz, kHz, MHz or GHz
- "Gen Lvl" (output level of the signal generator, typically in dBm)
- "Trd Lvl" (input power into the transducer, for example in W, V or A)
- "Test Lvl" (measured immunity level, for example in W, V or A)

Radiated Reference Calibration Table

A radiated reference calibration table has the following columns:

- "Frequency" in Hz, kHz, MHz or GHz
- "Gen Lvl / HOR" (output level of the signal generator for horizontal antenna polarization, typically in dBm)
- "Trd Lvl / HOR" (input power into the antenna in horizontal polarization, typically in W)
- "Test Lvl / HOR" (measured immunity level with the antenna in horizontal polarization)
- "Gen Lvl / VER" (output level of the signal generator for vertical antenna polarization, typically in dBm)
- "Trd Lvl / VER" (input power into the antenna in vertical polarization, typically in W)
- "Test Lvl / VER" (measured immunity level with the antenna in vertical polarization, typically in V/m)

4.10 Tools

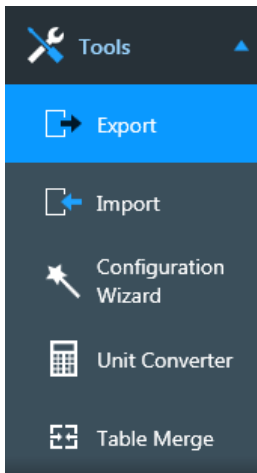

Access: "Home" > "Tools"

Opens the tools described below.

• Export	507
• Import	508
• Configuration Wizard	510
• Unit Converter	511
• Table Merge	511

4.10.1 Export

Access: "Home" > "Tools" > "Export"

All data in R&S ELEKTRA is saved in a single database file that can only be interpreted by this software. To make individual sets of data available outside of R&S ELEKTRA, you can export selected items.



"Export" is also an option for exchanging data between different instances of this software. However, if you wish to migrate to a new (higher) version of R&S ELEKTRA, we recommend [using the installation wizard](#) and [copying an existing database](#) into the new installation. Do so, *before* you start working and creating data with your new version of R&S ELEKTRA.

Export procedure

To export data, proceed as follows:

1. Click the  button to specify a target folder and **filename**.

The export file has the format of a ZIP archive.

Note: If you have previously exported data, the filename of that export is set as the default. To **avoid overwriting** your previous export, make sure to specify a different filename (or folder).

2. Deselect the types of items that you do not wish to export.
For example, deselect "Device(s)" and "Report Template(s)", leaving the other types selected.

3. Click "Next" to confirm your selection of item types.
4. For each selected type of items, select the individual items you wish to export. You can sort the lists of items by clicking their headers, for example, the "Name" header or the "Change Date" header.
5. Test templates, hardware setups, tables and tests provide the following feature: You can limit the choice of items offered for export by selecting or deselecting "EMI", "EMS" and "CAL".
6. EUTs provide the following feature: You can select or deselect to "Include Tests". If included, the wizard also saves the data of executed tests listed in the [test plans](#) of your selected EUTs.
7. If you have previously pinned any [searches](#) to the dashboard, you can include these searches into the export file by selecting "Include saved search". This feature permits transferring your configured search parameters to a different installation.
8. Click "Next" to confirm your selection of items.
9. Repeat "[Export procedure](#)" on page 507 for all selected types of items.
10. When you have defined your selection for all types of items, complete the export process by clicking "Finish & Execute".

Note: The button "Finish & Execute" is available from the beginning of this procedure, if at least one type of items is selected. You can use "Finish & Execute" as a shortcut, without using the "Next" button for selecting individual items. However, if you do so, be aware that the wizard exports *all* items of *all* selected types.

The wizard generates the export file by writing the data sets into individual XML files (extensible markup language). Then it automatically archives all XML files into a single ZIP file and saves it into your selected target folder.

At the same time, the dialog shows "Logging Information". To see this information, click "Open Log".



Exporting tables

To export tables into `.xlsx` or `.csv` files, do not use the export tool described above. Instead, proceed as described in [Chapter 4.9, "Tables"](#), on page 494.

R&S ELEKTRA includes [user group](#) information in the exported data of EUTs and tests. This information can limit the [import](#) of these items by users that are not assigned to the same user groups.

4.10.2 Import

Access: "Home" > "Tools" > "Import"

The import feature allows importing data from external ZIP or XML files into the R&S ELEKTRA database. Use this feature especially for importing data that has previously been [exported](#).



"Import" is also an option for exchanging data between different instances of this software. However, if you wish to migrate to a new (higher) version of R&S ELEKTRA, we recommend [using the installation wizard](#) and [copying an existing database](#) into the new installation. Do so, *before* you start working and creating data with your new version of R&S ELEKTRA.

Import procedure

To import data, proceed as follows:

1. Click the  button to select the ZIP or XML file you wish to import.

Tip: If the selection field shows a path and filename from a previous import, you can open this file by *placing the cursor in the selection field* and pressing [Enter]. Alternatively, remove the filename entry and start with a new file selection.

2. Click "Open".

If the selected file is suited for import, the dialog lists all items that are contained in the file, and the types of these items.

3. Deselect all types of items that you do not wish to import.

4. Click "Next".

The import wizard now checks, if any items among the selected types of items are already available in the database.

The results of this check appear in the column "Import Status/Options".

R&S ELEKTRA handles items that already exist in the database in the following way:

- If an existing item is [not referenced](#), or if it is a "Golden Template" ([EMI](#) or [EMS](#)), the wizard lets you select one of the following options:
 - "Create New" creates an additional item with a modified name
 - "Use Existing" skips importing this item
 - "Overwrite" imports this item, which overwrites the existing item
 - "Append" (only available for EUTs) adds the [test steps](#) of the [test plan](#) of the imported EUT data to the test plan of the existing EUT
- Otherwise, if the software lists an "Already Existing" item, it has a deactivated checkbox and you cannot import this item. This handling is equivalent with a forced "Use Existing" as described above.

5. Out of those items with activated checkboxes, select those items that you wish to import.

If options are available as described above, also select one of the options.

6. Proceed in the same way with every selected type of items.

Note: If any of the EUTs or tests that you wish to import are assigned to [user groups](#) that you do not have access to, you can still import these items. However, after import, these items are not visible to you in the "EUTs" or "Tests" dialogs or in the "Dashboard".

7. Click "Finish & Execute".

The items are now imported and saved into their lists. For example, an imported test template is now available in the list of test templates.



Importing is only possible for ZIP and XML files that are validated by R&S ELEKTRA as having compatible content. If you try to import an incompatible file, an error message comes up and warns you that the import of this file is not allowed.



Importing tables

To import tables from `.xlsx` or `.csv` files, do not use the import tool described above. Instead, proceed as described in [Chapter 4.9, "Tables"](#), on page 494.



Importing tests

When you open an imported test and rerun it, R&S ELEKTRA validates it, discards the stored data and updates the test with the global table data and device data. This procedure ensures using always data that is currently valid, for example changed device IP addresses or new antenna transducer factors.

4.10.3 Configuration Wizard

Access: "Home" > "Tools" > "Configuration Wizard"

Not available, if you are using a remote instance of R&S ELEKTRA, connected to a central database, as described in [Chapter 4.12.1.2, "Database"](#), on page 522.

Run the wizard as described in [Chapter 2.4, "Configuration Wizard for creating basic data"](#), on page 28.



This tool creates application-specific sample data or demo sample data for tests.

It can generate some of the following content:

- [EUTs](#)
- [Test Templates](#) including [calibration templates](#) and [EUT Monitoring templates](#)
- [Report Templates](#)
- The [Hardware Setups](#) required for the generated test templates
- The [Devices](#) required for the generated test templates
- The [Limit Lines](#) required for the generated test templates
- [Attenuation Tables](#)
- [Frequency Lists](#)
- [Transducer Correction Tables](#)
- [Normalization Tables](#)
- [Reference Calibration Tables](#)

The "Description" line at the lower edge of the dialog shows details of an item that you select (highlight).

4.10.4 Unit Converter

Access: "Home" > "Tools" > "Unit Converter"

Use this tool to convert a broad range of input values and units into output values and units.

Since many unit conversions depend on the system's "Impedance", you can specify this parameter. The default is "50 Ohms".

The button "Show Unit Converter Dialog" opens the same dialog in a separate window. You can keep this window open and move it to an arbitrary position, while using other dialogs of R&S ELEKTRA.

4.10.5 Table Merge

Access: "Home" > "Tools" > "Table Merge"

Available only, if the [license](#) for "ELEMI-S" or "ELEMS-S" is enabled.

This wizard is a tool that can combine [Tables](#) of the same type by two merge methods: set union or intersecting set. For example, you can unite the content of a suitable reference calibration table ("input table") with an existing reference calibration table ("source table").

You can also use this tool to add a fixed offset to the values in a table column. For example, add a 10 dB constant to a path loss table. Or subtract a preamplifier gain from a test result table.

Merging is possible for the following types of tables:

- All **global** tables except "Frequency List"
- All **test** tables with measurement results:
 - "Overview Tables"
 - Copied "Overview Tables"
 - "Final Result" tables
 - Copied "Final Result" tables
 - Merged result tables

The output table created by the wizard matches the type and structure of the source table.

The dialog headline has these functions:

- "Restart" clears your selections and entries in any of the wizards dialog pages and goes back to the first page of the dialog.
- "Back" goes back one page in the dialog without clearing your selections and entries.
- "Next" applies your selections and entries in the current page of the dialog and goes to the next page.
- "Finish & Execute" is available only, when you have made all required selections and settings. Clicking "Finish & Execute" performs the merging process and creates the "output table".

Merging procedure

To merge tables, proceed as follows:

1. Select the **type** of source table:

- "Attenuation"
- "Transducer Correction"
- "Limit Line"
- "Reference Calibration"
- "Linearity"
- "Amplifier Gain"
- "Normalization"
- "Test", which comprises all measurement result tables

After selecting a type, the wizard shows a list with all tables of this type that are available for merging.

Note: The list dialog allows searching for tables and filtering test tables for applications "EMI", "EMS" or "CAL".

2. Select the **source table**.

The wizard shows a checkbox list with the header names of all columns available in this table for merging.

3. Select one or more **columns** of the source table.

To do so, enable the checkbox of each column that you want to include into the merging process.

Typically, the first column is the frequency column, which you cannot deselect.

4. Click "Next" in the top of the dialog.

The wizard shows a list with all input tables of the same type that can be merged with the source table. The table type is locked. The source table is excluded from this list.

Note: In the right-hand side of the dialog, the wizard shows the selected source table and references it as "T1".

5. Select one or more **input tables** for merging with the source table.

Alternatively, you can select **no input table** to proceed with only applying a rule to the source table.

6. Click "Next" in the top of the dialog.

The wizard shows a dialog for specifying the merging rules and settings.

Note: In the right-hand side of the dialog, the wizard shows the "Selected tables" and references them as "T1", "T2" etc.

7. Select the **"Frequency merge option"** (not available, if you have selected no input table):

- "Union" copies all frequency points from the source table to the output table. Then it adds those frequency points from the selected input tables that *exceed* the frequency span of the source table.

- "Intersection" copies from the source table those frequency points, which are within the frequency span of an input table, to the output table.

8. Select the **"Value selection option"** (if you have selected no input table, only "Custom" is available):

R&S ELEKTRA determines the level value at each of the output frequencies (defined above) as follows:

- "Max" displays the formula " $\max(T1, T2, \dots)$ " and selects the maximum level value at each output frequency
- "Min" displays the formula " $\min(T1, T2, \dots)$ " and selects the minimum level value at each output frequency
- "Average" displays the formula " $(T1+T2+\dots+Tn)/n$ " and calculates the average level value at each output frequency

If an output frequency point is not available in an input table, the algorithm interpolates a level value at this point in the input table.

- "Custom" requires entering an individual "Formula":
 - The formula must use all tables "T1", "T2" etc.
 - For a description of the formula syntax, see [Chapter 4.10.5.1, "Table conversion formula"](#), on page 514.
 - According to this formula, the wizard calculates level values at each output frequency.
 - As a special case, if you have selected no input table in [step 5](#), the wizard applies the formula only to the source table "T1". Enter *T1* into the formula as the variable.

9. R&S ELEKTRA automatically evaluates your specifications.

If your specification is valid, the "Formula" field gets a green frame and a text line below this field shows a representative result for one frequency point.

If your specification (for example the formula or the table's frequency overlap) is not valid, the "Formula" field gets a red frame and the text "Invalid formula" is displayed.

10. Select the **"Output table"** by clicking the "Select" button .

A table-selection dialog opens.

11. Select one of the following options:

- To create a table, click "Create New"
- To select an existing table, highlight it in the list and click "Select".
A confirmation dialog warns you that the wizard overwrites this table. If you are sure that you want to overwrite it, click "Yes".

12. To merge the tables according to your selections and settings, click "Finish & Execute" in the top of the dialog.

The wizard generates values for the frequency points in the output table according to the "Value selection method" and shows a dialog that summarizes the merging results.

You can view the source, input and output tables by clicking the "Open" button  next to each table name.

13. To finish the merging procedure, click "Close".

The "Close" button brings the wizard dialog back to its initial state, equivalent with the "Restart" button in other dialogs.

4.10.5.1 Table conversion formula

The last dialog page of the [Table Merge](#) wizard contains a "Formula" field (see [step 9](#) in the [Merging procedure](#)). It defines an algebraic formula that converts the level values of selected source and input tables (called "T1", "T2", etc.) into a target values of an output table. An example is the combination and modification of limit lines.

Type the formula in [IronPython mathematical syntax](#), without the "math." prefix. The following table provides an alphabetical overview of the most commonly used operators. In this table, variable "**(T1+T2)**" serves as an **example** for a possible combination of values from the source table T1 with values from one input table T2. During the conversion procedure, the formula does not convert the table as a whole, but individual values per frequency point. The wizard repeats the same operation for all frequency points addressed by the conversion procedure.

Table 4-21: Syntax of the value conversion formula

Operator	Function
+	Addition
-	Subtraction
*	Multiplication
/	Division
abs(T1+T2)	Absolute value of (T1+T2)
acos(T1+T2)	Arc cosine of (T1+T2) (in radians)
asin(T1+T2)	Arc sine of (T1+T2) (in radians)
atan(T1+T2)	Arc tangent of (T1+T2) (in radians)
ceil(T1+T2)	Smallest integer \geq (T1+T2)
cos(T1+T2)	Cosine of (T1+T2) (in radians)
degrees(T1+T2)	Converts angle (T1+T2) from radians to degrees
e	The mathematical constant e to precision 2.718282
exp(T1+T2)	Power of (T1+T2) on base e
floor(T1+T2)	Largest integer \leq (T1+T2)
int(T1+T2)	Integer of (T1+T2), int(-9.5)=-9
log(T1+T2)	Natural logarithm of (T1+T2) (on base e)
log(T1+T2,x)	Logarithm of (T1+T2) on base x
log10(T1+T2)	Common logarithm of (T1+T2) (on base 10)

Operator	Function
pi	The mathematical constant π to precision 3.141593
pow(T1+T2,x) or: (T1+T2)**x	(T1+T2) to the power of x
pow(x,T1+T2) or: x**(T1+T2)	x to the power of (T1+T2)
radians(T1+T2)	Converts angle (T1+T2) from degrees to radians
sin(T1+T2)	Sine of (T1+T2) (in radians)
sqrt(T1+T2)	Square root of (T1+T2)
tan(T1+T2)	Tangent of (T1+T2) (in radians)

The output values are returned to a precision of two decimal places.

For a broader overview, refer to the [Python tutorial](#).

Example:

Task: add 50% of each value in the input table to each value in the source table.

Formula: "T1+0.5*T2"

Task: add 10 to each value in the source table.

Formula: "T1+10"

4.11 Archive

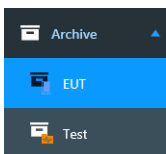

Access: "Home" > "Archive"

Available only, if the [license](#) for "ELEMI-S" or "ELEMS-S" is enabled.

Opens the archive menus described below.

- [EUT](#).....515
- [Test](#).....517

4.11.1 EUT

Access: "Home" > "Archive" > "EUT"



To archive an "EUT", go to the "EUT" menu and click the "Archive" button .

EUT archiving procedure

To archive EUT data, proceed as follows:



1. In the **"EUT" menu**, hence, outside of the "Archive" menu, click the "Archive" button .

The following dialog comes up:

Please confirm: Are you sure you want to archive the EUT and all tests associated with it?

2. Click "Yes" to confirm.

If the EUT is **activated**, the following dialog comes up:

Please confirm: Are you sure you want to archive an active EUT?

3. Click "Yes" to confirm.

Otherwise, click "No" to return to the "EUT" menu, activate a different EUT and restart with [step 1](#).

The archived EUT is moved from the "EUT" menu to the archive.

At the same time, any tests associated with the EUT are moved from the "Tests" menu to the archive.

4. Go to the menu "Archive" > "EUT".

The archived EUT is now shown in this list of archived EUTs. The archived EUT includes the data of all tests associated with it.

At the same time, the associated tests are now shown at "Archive" > "Test".

5. Select  an archived EUT for enabling the following actions:

-  "Delete" an archived EUT. Only available, if the checkbox "Enable delete for archived tests and EUTs" is activated in the [Administration > General Settings](#) dialog.

Deletion is protected with a confirmation warning.

If the EUT that you want to delete is associated with tests, R&S ELEKTRA brings up the following dialog with details:

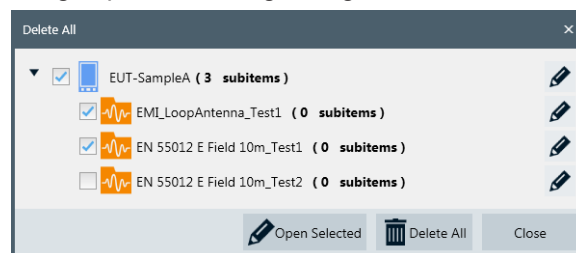





Figure 4-184: Example of a dialog with subitems (tests) referenced by an EUT

-  "Open" an archived EUT. The EUT description opens in a read-only mode, which is indicated by the lock icon  in the top left corner, next to the disabled "Save" buttons.
-  "Rename" an archived EUT. Only available, if you have selected a single EUT.

-  "Restore" an archived EUT. The archived EUT description and associated test data are moved back to the "EUT" menu.

4.11.2 Test

Access: "Home" > "Archive" > "Test"



To archive a "Test", go to the "Test" menu and click the "Archive" button .

Test archiving procedure

To archive test data, proceed as follows:



1. In the **"Test" menu**, hence, outside of the "Archive" menu, click the "Archive" button .

The archived test is moved from the "Test" menu to the archive.

2. Go to the menu "Archive" > "Test".



The archived test is now shown in this list at "Archive" > "Test".



3. Select  an archived test for enabling the following actions:

-  "Delete" an archived test. Only available, if the checkbox "Enable delete for archived tests and EUTs" is activated in the [Administration > General Settings](#) dialog.

Deletion is protected with a confirmation warning: "Are you sure you want to delete the selected item(s)?"

Click "Yes" to confirm. Otherwise, click "No" to return to the "Archive" > "Test" menu.

-  "Open" an archived test. The test opens in a read-only mode, which is indicated by the lock icon  in the top left corner, next to the disabled "Save" buttons.

-  "Rename" an archived test. Only available, if you have selected a single test.
-  "Restore" an archived test. The archived test is moved back to the "Test" menu.

4.12 Administration

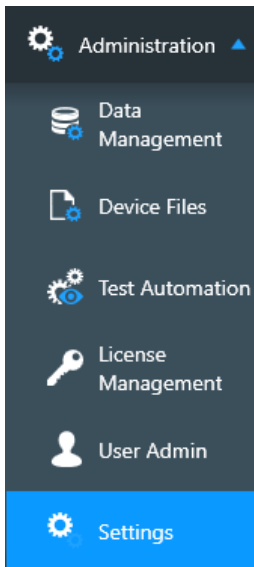

Access: "Home" > "Administration"

For all settings dialogs, go to [Chapter 4.12.6, "Settings"](#), on page 543.

Opens the administration dialogs described below.

• Data Management	518
• Device Files	528
• Test Automation	531
• License Management	532
• User Admin	538
• Settings	543

4.12.1 Data Management

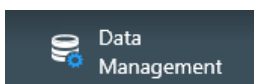

Access: "Home" > "Administration" > "Data Management"

Available only, if at least one of the following conditions is met:

- You are logged in as a [user](#) with expert or administrator rights, see [Roles & Permissions](#). If in doubt, ask your R&S ELEKTRA administrator.
- You have activated a [license](#) for "ELEMI-S" or "ELEMS-S", which requires that a [dongle](#) with this license is connected.

The "Data Management" dialog gives access to the following settings:

• Backup	518
• Database	522
• Server Admin	525
• Test Site	527

4.12.1.1 Backup

Access: "Home" > "Administration" > "Data Management" > "Backup"

Available only, if you are logged in as a [user](#) with expert or administrator rights, see [Roles & Permissions](#). If in doubt, ask your R&S ELEKTRA administrator.

Use backups to save copies of your R&S ELEKTRA database in this folder:

C:\ProgramData\Rohde-Schwarz\ELEKTRA\x.xx.xx\Backup

The "Backup" dialog defines all backup settings.

The dialog headline has these functions:



"Save" stores the [Backup Configuration](#) settings. Without saving, your changed settings have no effect and are lost upon shutting down R&S ELEKTRA.



"Discard all changes" resets the configuration to the state before you changed these settings.



"Reset to Default" resets the configuration settings to their default state and saves it.



"Create a backup" immediately creates a backup of the R&S ELEKTRA database. If the number of created backups has reached the number specified in the field "Keep the last <n> backups", the creation of a new backup immediately deletes the oldest backup file. This deletion is not protected by a warning.



"Refresh" immediately refreshes the backup dialog. It consolidates the state of the backup dialog with the current settings and with the available data. For example, if you have copied one or more backup files from a different directory into the backup folder of your current version of R&S ELEKTRA, the "Refresh" button makes these files visible in the list of backups.

Below the dialog headline, the software displays the date of the most recent backup.

Backup Configuration

Defines the following database backup settings:

- **"Keep the last <n> backups"**
The setting of <n> defines the number of backups to keep. Minimum is one backup, maximum is 50. If you reduce this number below the number of existing backups, saving this setting deletes the oldest backups that exceed the number of backups to be kept. For example, if you have stored 5 backups and then reduce the number of backups to be kept to 3, saving this setting deletes the 2 oldest backup files. This deletion is not protected by a warning.
- **"Make a backup" ...**
Upon shutting down R&S ELEKTRA, the software saves a backup (unless you have selected "never"), if the latest backup is older than the specified timeframe:
 - "never"



- "daily"
- "every 2 days"
- "every week"
- "every month"
- **"Copy new backup automatically to folder"**
Enables selecting a target folder, to which the software automatically copies each new backup of the database. Note that the target folder can be in a network drive.

Below the "Configuration" settings, the dialog lists all available backup files in a table:



Backup Files

Lists the names of the created backup files with the following parameters:

- "Backup Files" shows the filenames in the format
ELEKTRA_<date>_<time>.zip
You can edit the filenames in the dialog.
The backups are saved in .zip files (archives). In addition, with each .zip file, R&S ELEKTRA saves an .xml file with the same filename. This file is not shown in the list, but available in the backup folder.
- "Description" can contain arbitrary content, which you can edit with your own comments.
Per default, this field shows the following content:
 - If you have created the backup file by the "Create a backup" button , this field is empty.
 - If the backup file was created according to the timing settings described above, the field shows "scheduled automatic backup".
 - If the backup file was created automatically by the R&S ELEKTRA installer, for example, if you select to install a clean or old database during the [Modify](#) installation procedure, the field shows "backup (installer)".
- "Keep Backup?" enables or disables keeping the selected backup file *in addition* to the selection of "Keep the last <n> backups" described above. If enabled, a lock icon is shown in the "Backup Files" field and the "Delete" button  is disabled.
- "File Size" of the backup files
- "Date of Creation" and time at which each of the backup files was created
- "Version" shows the R&S ELEKTRA version number, under which each of the backup files was created

To sort the list by file size or by date, click the column header. For reverse order, click the header again.



Restore

Overwrites the currently used database with the selected backup file. Restoring a backup is protected with a confirmation dialog:

"Are you sure you want to restore to this backup file?"

Clicking "Yes" restores and restarts R&S ELEKTRA with the selected backup data.

NOTICE**Risk of losing data**

If you restore an older database without saving the current data before this action, your current data is irrevocably lost. Especially the data of previously executed tests can be a serious loss.

Therefore, always **create a backup of the current data** before you restore an older one.

If you copy a backup file of a newer version of R&S ELEKTRA into the backup folder of an older version, the "Restore" button is disabled in the backup administration dialog of that older version. Instead, the following mouse-over text is displayed: "Unable to restore a backup from a newer version".

Retrieving individual items from a backup

If you want to add only some items from a previous backup to your current database, proceed as follows:

1. Create a backup of your current data.
2. Restore the backup that contains the desired items.
3. [Export](#) the desired items into an external file.
4. Restore the backup that you have created in [step 1](#).
5. [Chapter 4.10.2, "Import"](#), on page 508 the items that you have exported in [step 3](#).

**Delete**

Deletes the selected backup file.

The deletion of a file is protected with a confirmation dialog:

"Are you sure you want to delete this backup file?"

Click "Yes" to confirm or "No" to quit deleting the file.

**Upgrade this backup to the current version**

Available only, if you have copied one or more backup files from the backup folder of a previous version of R&S ELEKTRA into the backup folder of the current version.

Clicking this button starts a procedure to upgrade the older backup file to be compatible with the database structure of the current version.

- If the upgrade succeeds, the following **blue** dialog comes up:
"Database upgrade completed"
"Backup file ELEKTRA_<date>_<time>.zip successfully upgraded."
- If the upgrade does not succeed, a **red** dialog like the following comes up:
"Database upgrade failed"
"Failed to upgrade the backup file. Error is I/O error during "ReadFile" operation for file "C:\PROGRAMDATA\ROHDE-SCHWARZ\ELEKTRA\<x.xx.xx\BACKUP\TEMP\ELEKTRA_<date>_<time>\ELEKTRA.FDB". Error while trying to read from file."

If the upgrade succeeds, the entry in the "Version" field changes from the old to the current R&S ELEKTRA version number.



When you terminate R&S ELEKTRA, the software first checks, if a backup is due according to your settings. If a backup is due, instead of terminating, the software saves a backup while showing a backup notification message.

To shut down R&S ELEKTRA, click the terminate (or "Close") button again.

Compress Database File

Launches a compression tool for reducing the size of the database file `ELEKTRA.FDB` currently used by R&S ELEKTRA. You can find this file in your computer in the following folder:

```
C:\ProgramData\Rohde-Schwarz\ELEKTRA\xx.xx.xx
```

Here, `xx.xx.xx` is the version number of your R&S ELEKTRA installation.

To compress the database

1. Click "Compress Database File".

A warning comes up, which alerts you that this tool will overwrite the current database. The dialog offers to create a backup of the database before compressing it.

2. Click "Yes", unless you want to skip creating a backup.

R&S ELEKTRA creates a backup file and saves it with the present timestamp.

The dialog alerts you that the software will shut down before compressing the database file. It asks if you want to continue.

3. Click "OK", unless you want to cancel the database compression.

R&S ELEKTRA shuts down. The dialog of the compression tool comes up, which reports the current file size of the database and allows you to start the compression.

4. Click "Compress Database File".

The compression procedure starts.

5. Wait for the procedure to complete.

When the dialog reports successful completion, it also shows the new file size, and the percentage of the saved size.

6. Close the compression tool's dialog.

In the folder mentioned above, the database file `ELEKTRA.FDB` has a reduced size.

7. Optionally restart R&S ELEKTRA.

4.12.1.2 Database

Access: "Home" > "Administration" > "Data Management" > "Database"

Available only, if you have activated a [license](#) for "ELEMI-A", "ELEMS-C" or "ELEMS-R", which requires that a [dongle](#) with this license is connected.

The "Data Management" button takes you directly to the database dialog, if you are logged in as an operator, hence not as a [user](#) with expert or administrator [rights](#). If in doubt, ask your R&S ELEKTRA administrator.

The "Database" dialog allows working with different databases:

Hostname / IP	Database Path	R&S Application Server Port
UX358979	C:\ProgramData\Rohde-Schwarz\ELEKTRA\%os.xt\ELEKTRA.FDB	30052

Figure 4-185: Example of settings in the database dialog

- **"Apply and Restart"**

Use this button in the dialog headline, when you have changed the database setting below.

- When you click "Apply and Restart" without having changed the setting, the following database message comes up: "There are no recent changes to save". Click "OK" to return to R&S ELEKTRA.
- When you have changed the setting and click "Apply and Restart", the following database message comes up: "Are you sure you want to change to this database setting? (ELEKTRA will be restarted)". Click "Yes" to confirm. R&S ELEKTRA saves your settings, shuts down, and restarts with your selected database setting.

If you leave the dialog without "Apply and Restart", any changed settings have no effect and are lost upon shutting down R&S ELEKTRA.

Database setting for this ELEKTRA instance

The radio buttons next to the database icons select the type of database that your instance uses:



- **"Stand-alone ELEKTRA instance"**

The R&S ELEKTRA software installed on your computer works with its own local database, independently of any other instances and databases.



If you want to save the database to a network drive, create a [Backup](#) in combination with its feature "Copy new backup automatically to folder".



- **"Central database ELEKTRA instance"**

Not available, if you are [logged in](#) as a [user](#) with "Operator" or "Expert" permissions, only. Access to the central database is restricted to users with administrator permissions.

With this feature enabled, the database on your local computer serves as the central database for all other remotely connected installations on the network. Only one central database is permitted in the group of instances that work together by sharing the database. The central database automatically has the instance name "A".

When you have enabled the central database feature, up to **4** other computers with instance names "B" to "T" can be set to operate as remote instances that connect to your central database. You can increase the number of supported peripheral client instances from 4 to **19** by activating the [license](#) for "ELEMC-EDB" (enhanced database).

For being able to connect other instances, the following prerequisites apply:

- All instances are available on the network
- All instances have the **same version** of R&S ELEKTRA installed
- Your Windows firewall settings do not block the programs "RS.Elektra.AppService.exe" and "Firebird.exe"

Also, enabling the central database feature gives access to the [Server Admin](#) dialog.

Before switching your instance to a different database type (stand-alone or remote), go to [Server Admin](#) and select [Block Connections](#).



- **"Remote ELEKTRA instance, connected to the central database"**

Your local instance of R&S ELEKTRA does not use a database on your local computer, but the central database on instance "A", to which it must be connected. Hence, from the perspective of the central database, your computer works as a "remote" instance in the network.

To establish a connection to the central database, proceed as described in "[To connect to the central database](#)" on page 524.

The admin user of the central database can send you messages and disconnect you by closing your client, see [Chapter 4.12.1.3, "Server Admin"](#), on page 525.

If the client that hosts the central database shuts down, the remote clients show the following message: "Connection to the central database has been lost. Saving will not be possible until the connection is restored."

To connect to the central database

1. Go to the "Database" dialog in R&S ELEKTRA.
2. Select an "ELEKTRA instance name", for example "B", for your local instance of R&S ELEKTRA.
Ensure using a **different name** for each connected remote client instance.
3. At "Hostname / IP", enter the name or the IP address of the computer that hosts the central database, for example "UX358979".
If you do not know the computer name, ask your R&S ELEKTRA administrator, typically the owner of that computer.
4. Verify the "Database Path", which R&S ELEKTRA has entered automatically.

Figure 4-185 shows an example of the "Central database connection settings". The placeholder `x.xx.xx` represents the software version number of R&S ELEKTRA. For information, "R&S Application Server Port" displays the port number of the application service on the computer that hosts the central database.

5. Ensure that all remote client instances use the same software version, hence also the same "Database Path".

6. Click "Apply and Restart".

The following database message comes up: "Are you sure you want to change to this database setting? (ELEKTRA will be restarted)".

7. Click "Yes" to confirm.

R&S ELEKTRA restarts.

This step completes the connection procedure. You can now use the central database, as if it was installed on your computer. However, be aware of other users who work with the same database. Therefore, coordinate your work with the other users; especially do not modify or delete content that you are unfamiliar with.

4.12.1.3 Server Admin

Access: "Home" > "Administration" > "Data Management" > "Server Admin"

Available only, if the following conditions are all met:

- You have activated a [license](#) for "ELEMI-S" or "ELEMS-S", which requires that a [dongle](#) with this license is connected.
- You are logged in as a [user](#) with administrator rights, see [Roles & Permissions](#).
- This instance of R&S ELEKTRA is used as a central database server, see [Chapter 4.12.1.2, "Database"](#), on page 522.

The "Server Admin" dialog allows the following:

- Viewing the "Client Status": instance name and IP address of each remote client, with connection date and time
- Sending messages to the remote clients
- Shutting down clients after a countdown
- Blocking reconnection attempts of remote clients

Fields and buttons in this dialog are active only, if at least one remote client is connected.

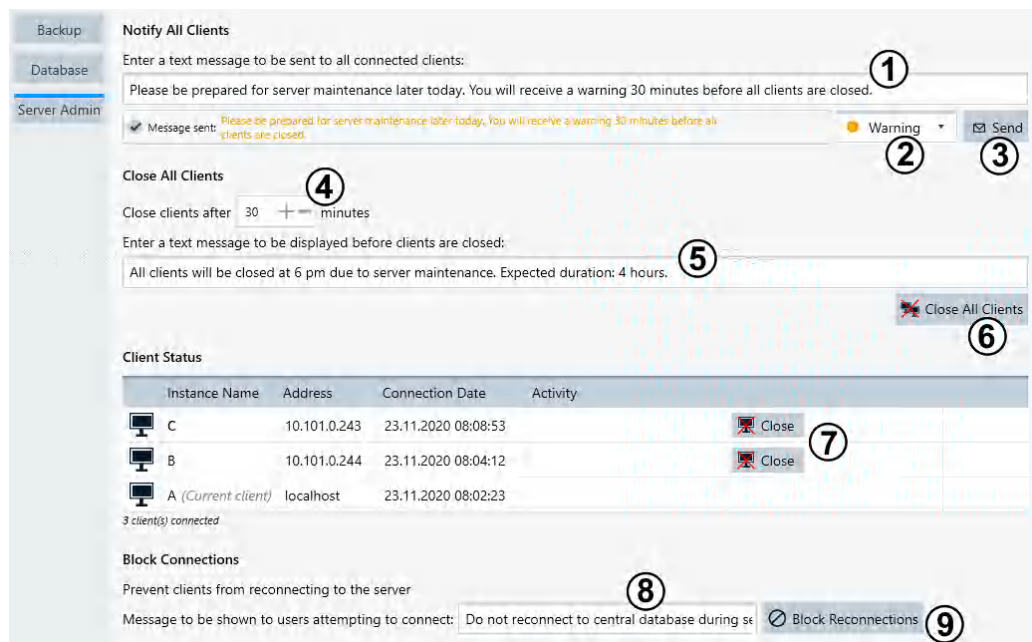

Figure 4-186: Example of the Server Admin dialog with remote clients B and C

- 1 = Message text field
- 2 = Selection of message type
- 3 = "Send" button for message
- 4 = Countdown settings
- 5 = Text message for one or more clients to be shut down
- 6 = Button for closing all connected clients after the countdown (4)
- 7 = Buttons for closing a specific client after an individual countdown
- 8 = Text message for clients that try to reconnect while reconnecting is blocked
- 9 = Button for blocking clients from reconnecting

Notify All Clients

Not available, if you have started a closing procedure for clients.

Allows entering an arbitrary message in the text field (1) and selecting a message type (2): "Info", "Warning" or "Error".

Click "Send" (3) to distribute your message to all connected clients, labeled by color according to the message type:

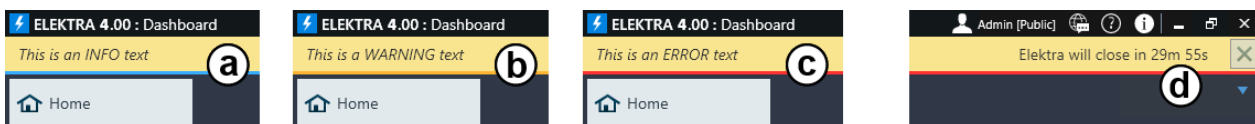

Figure 4-187: Examples of messages as seen in a remote client

- a = "Info" message with blue underline
- b = "Warning" message with yellow underline
- c = "Error" message with red underline
- d = Countdown of time remaining until client shuts down

As a remote client, you can delete an "Info", "Warning" or "Error" message (labeled a to c in [Figure 4-187](#)) by clicking the "X" button at the far right of message dialog. You cannot delete a shutdown message (d), where the "X" button is disabled.

If an existing message is not deleted, an incoming new message overwrites the existing message.

Close All Clients

As the user of the central database, select countdown settings (labeled 4 in [Figure 4-186](#)) for the time before all connected clients are closed. You cannot close clients immediately; the minimum time before closing is 1 minute. Also, enter a shutdown message (5) to be sent to all clients before closing.

When you select "Close All Clients" (6), each client gets your shutdown message with red underline. Also, the clients get a countdown that shows the remaining days, hours, minutes and seconds at the far right of the message dialog, see (d) in [Figure 4-187](#). While a closing procedure is running, you cannot send other messages.

To cancel the closing procedure, click "Cancel".

Close

Accordingly, you can close one specific client, only, by clicking "Close" (7). A dialog opens: Select countdown settings and enter a shutdown message to be sent to this client, when you confirm this dialog by clicking "Close Client". To cancel the closing procedure, click "Cancel closing".

Block Connections

If remote users close their clients before the end of the countdown, or if the clients close automatically at the end of the countdown, the users can try to restart R&S ELEKTRA. If restarting is not prevented, the remote client reconnects to the central database.

As the user of the central database, you can prevent clients from reconnecting by clicking "Block Connections" (labeled 9 in [Figure 4-186](#)). Each remote client that tries to reconnect while reconnecting is blocked receives your text message (8) while R&S ELEKTRA tries to start. Then, the client automatically shuts down again.

To stop blocking reconnection attempts, click "Allow Reconnections".

4.12.1.4 Test Site

Access: "Home" > "Administration" > "Data Management" > "Test Site"

Available only, if the following conditions are all met:

- You have activated a [license](#) for "ELEMI-S" or "ELEMS-S", which requires that a [dongle](#) with this license is connected.
- You are logged in as a [user](#) with expert or administrator rights, see [Roles & Permissions](#). However, *editing* the "Test Site" setting requires administrator rights. If in doubt, ask your R&S ELEKTRA administrator.

This dialog allows defining names of test sites and selecting the current test site. Your [Hardware Setups](#) can use this feature, which is relevant also for the "Golden Template" in [EMI](#) and [EMS](#) tests.

The dialog headline has these functions:



"Save" stores the settings. Without saving, your changes have no effect.





"Discard all changes" resets all changes to the state before saving.



To generate a new test-site entry, click the "Add new test site" button . Define a name for this new test site in the table's "Name" column.



The "Activate" / "Deactivate" buttons  /  next to the names can set one test site as active, exclusively. This setting defines the active entry as your current test site that you want to work with.



When you click the "Delete" button , R&S ELEKTRA removes this entry without further warning. You cannot delete a test-site entry that is referenced in a hardware setup.

The field for test-site selection is available also in hardware setups ([EMI](#) and [EMS](#)).



Save any changed settings before you leave this dialog.

4.12.2 Device Files

Device Files

Access: "Home" > "Administration" > "Device Files"

Available only, if you have activated at least one of the following [licenses](#):

- "ELEMS-AIM", EMS waveform management
- "ELEMC-5GS", [5G](#) signaling
- "ELEMC-CELS", [RSE](#) cellular signaling
- "ELEMC-WRLS", RSE [WLAN/BT](#) signaling



Device files

The "Device Files" dialog allows managing device-specific files like instrument setups or waveforms. During a test, R&S ELEKTRA transfers these files (back) to the device, for creating the appropriate device configuration or modulation signals. An example is [DM+ARB modulation](#) for AIM:

[AIM](#) standard 7351731, specified by the "Advancing Identification Matters" group of [RFID](#) experts, defines a set of immunity requirements for equipment that is operated in RFID environments. Typical examples of such equipment are pacemakers, protective respirators and other medical devices that require e.g. [FDA](#) approval.

In EMS tests of DUTs that must prove immune to RFID transmissions, your generator must provide digitally modulated ("DM") arbitrary ("ARB") signal patterns that comply with the requirements by AIM standard 7351731.

Therefore:

- R&S ELEKTRA provides a set of pre-configured "DM+ARB" modulation pattern files for the AIM 7351731 standards 14223, 14443-x, 15693 and 18000-x.
- R&S ELEKTRA supports handling additional external waveform files and device configuration files. You can import `.wv`, `.df1` or `.xml` files from your computer, from some other data storage, or from your device, like a radio communication tester or vector signal generator, see [Chapter 4.8.9.2, "File Management"](#), on page 414.

For using, for example, waveform files in a test, you can select available files in the "Flow Details" > "Measurement Settings" > [Modulation List](#) dialog of your EMS test templates.

The dialog headline has these functions:



"Save" stores the file settings. Without saving, your changes have no effect.



"Discard all Changes" resets all changes to the state before saving.



"Refresh" updates the dialog, for example after importing a file from a device, or if you want to undo the deletion or renaming of an entry before saving.

Binary files for devices

All available files are listed in a table with the following headers:

- "Device File Name"
- "Description" mentions the type of file and what it is used for, including the applicable standard, if available

- "Usage" specifies the file's content (e.g. "Waveform") or the device family that the file is intended for (e.g. "SMBV")
- "Firmware Version" that is required in the device, for which this file is intended. Relevant only for device configuration (.df1) files.
- "Change Date" shows the date and time of importing this file

The "Details" view on the right-hand side of the dialog shows more properties of the selected file, like file size and **Crest factor**. For the pre-configured waveforms provided by R&S ELEKTRA, the "Details" view allows opening a waveform verification report in PDF format.

If more than one file is selected, the "Details" view represents the file selected first.



Figure 4-188: Action buttons

Depending on your selection (highlighting a *pre-configured* or *imported* waveform), all or some of the following action buttons are available in the actions bar:



"Delete" is available only for imported waveforms.

Removes the selected one or more waveforms without previous alert. Before saving, you can undo the deletion by clicking "Refresh" . Otherwise click "Save" to let the deletion become effective.



"Copy" is available only for imported waveforms.

Creates copies of the selected one or more waveforms. The copied files are automatically labeled with the name extension "- Copy".



"Rename" is available only for imported waveforms.

Allows editing the name of the selected waveform.



"Import an XML file" is always available.

Imports an externally existing waveform in **XML** format. A dialog opens for selecting the external source.



"Export the selected file as XML" is available only for imported waveforms.

Exports an internally existing, previously imported waveform to a file in **XML** format. A dialog opens for selecting the target directory.



"Import a file" is always available.

Imports an externally existing file. A dialog opens for selecting the file type:

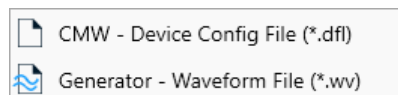

Select the file type that you want to import:

- "CMW - Device Config File" allows importing a device configuration file in .df1 format as used in the R&S CMW radio communication tester.

- "Generator - Waveform File" allows importing a waveform file in `.wv` format as used in vector signal generators.

A dialog opens for selecting the external source.



For importing waveform files directly from a vector signal generator, use the "Device List" > "Generator" > [File Management](#) dialog.



"Export the selected file" is available only for imported waveforms.

Exports an internally existing, previously imported waveform to a file in `.wv` format. A dialog opens for selecting the target directory.



Save any changed settings before you leave this dialog.

4.12.3 Test Automation



Access: "Home" > "Administration" > "Test Automation"

Available only, if you have activated the [license](#) "ELEMC-TLA".

Defines the default settings of several parameters that influence the behavior of the test list automation, see [Test Automation](#).

The dialog headline has these functions:



"Save" stores the settings. Without saving, your changes have no effect.



"Discard all Changes" resets all changes to the state before saving.



"Reset to Default" restores the original settings.

The following settings are available in this dialog:

- "Always re-run aborted test(s)"
Enables or disables R&S ELEKTRA to repeat each aborted test automatically.
- "Duration for Precondition "Wait Before Execution""
Specifies the delay time that R&S ELEKTRA waits before automatically executing a test step, if for this step the "Pre-Condition" on page 83 is set to "Wait Before Execution".
- "Auto Handle User Notification"
Enables R&S ELEKTRA to handle user notification dialogs automatically.
- "User Notification (Show Duration)"

Specifies the time to show each user notification dialog, before R&S ELEKTRA automatically handles it.



Save any changed settings before you leave this dialog.

4.12.4 License Management



License Management

Access: "Home" > "Administration" > "License Management"

Manages the licenses for R&S ELEKTRA.

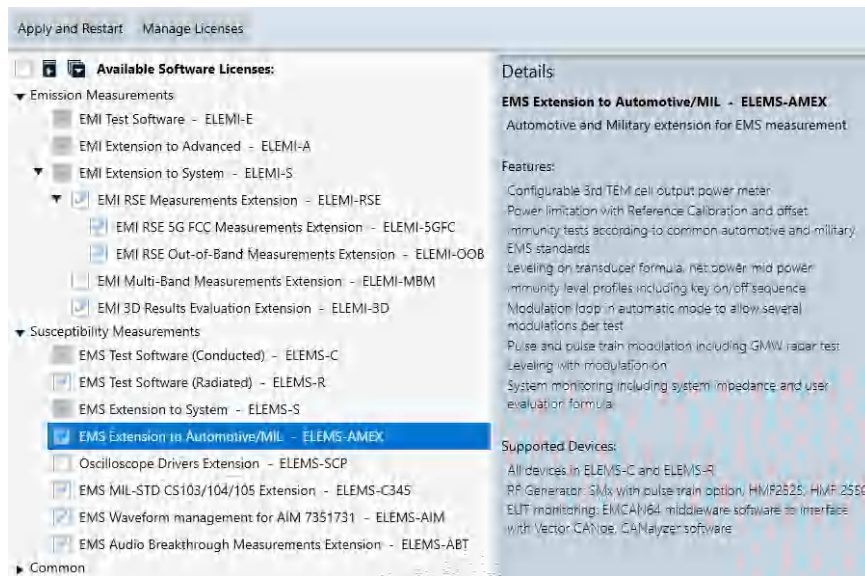

Figure 4-189: License management dialog, right: details of the selected (highlighted) license

Use the checkbox "Select/Deselect All" to select or deselect all entries in the list, except "ELEM-C-OFF9", which excludes using many other licenses. Use to collapse all entries in the list or to expand all. In Figure 4-189, the "Common" section is collapsed.

Licenses for the following software modules are available:

- **"Emission Measurements"** (EMI, electromagnetic interference)
 - "ELEMI-E", essential
 - "ELEMI-A", extension to advanced (requires the "ELEMI-E" license)
 - "ELEMI-S", extension to system (requires the "ELEMI-A" license)
You cannot disable "ELEMI-S", if "ELEM-S-S" is disabled and "ELEM-C-5GS", "ELEM-C-CELS", "ELEM-C-WRLS", "ELEM-C-TLA" or "ELEM-C-ATB" is enabled (see below).
 - "ELEMI-RSE", extension to radiated spurious emission (RSE) tests (requires the "ELEMI-S" license)
 - * "ELEMI-5GFC", extension to RSE measurements according to FCC 5G standards (requires the "ELEMI-RSE" license)

- * "ELEMI-OOB", extension to RSE out-of-band measurements (requires the "ELEMI-RSE" license)
- "ELEMI-MBM", extension to multi-band measurements (requires the "ELEMI-S" license)
- "ELEMI-3D", extension to three-dimensional results evaluation (requires the "ELEMI-S" license)
- **"Susceptibility Measurements"** (EMS, electromagnetic susceptibility)
 - "ELEMS-C", conducted
 - "ELEMS-R", radiated
 - "ELEMS-S", extension to system (requires the "ELEMS-C" or "ELEMS-R" license)
You cannot disable "ELEMS-S", if "ELEMI-S" is disabled and "ELEM-C-5GS", "ELEM-C-CELS", "ELEM-C-WRLS", "ELEM-C-TLA" or "ELEM-C-ATB" is enabled (see below).
 - "ELEMS-AMEX", extension to [automotive / MIL](#) (requires the "ELEMS-C" or "ELEMS-R" license)
 - "ELEMS-SCP", extension to generic [oscilloscope](#) device drivers
 - "ELEMS-C345", extension to MIL-STD CS103/104/105 (requires the "ELEMS-C" and "ELEMS-AMEX" license)
 - "ELEMS-AIM", EMS waveform management for AIM 7351731 (requires the "ELEMS-C" or "ELEMS-R" license), see [Chapter 4.12.2, "Device Files"](#), on page 528 and [Chapter 4.8.9.2, "File Management"](#), on page 414
 - "ELEMS-ABT", extension to audio breakthrough test, see [Audio Breakthrough](#) (requires the "ELEMS-C" or "ELEMS-R" license)
 - "ELEMS-RVC", extension for measurements in a reverberation test chamber with stepped or continuously rotating mode tuner (requires the "ELEMS-S" license)
- **"Common"** licenses, not assigned to EMI or EMS
 - "ELEM-C-DRV", extension to generic device drivers (requires "ELEMI-A" or any "ELEMS-..." license)
 - "ELEM-C-5GS", extension to [5G](#) cellular signaling with [R&S CMX](#) (requires the "ELEMI-RSE" or "ELEMS-S" license)
 - "ELEM-C-CELS", extension to RSE cellular signaling measurements (requires the "ELEMI-RSE" or "ELEMS-S" license)
 - "ELEM-C-WRLS", extension to WLAN/BT signaling measurements (requires the "ELEMI-RSE" or "ELEMS-S" license)
 - "ELEM-C-REP", extension to generating [customized reports](#) (requires the "ELEMI-A", "ELEMS-C" or "ELEMS-R" license)
 - "ELEM-C-EDB", extension to enhanced [database](#) for up to 20 computers (requires the "ELEMI-A", "ELEMS-C" or "ELEMS-R" license)
 - "ELEM-C-DEX", extension to [data exchange](#) interface for querying R&S ELEKTRA database contents (requires the "ELEMI-A", "ELEMS-C" or "ELEMS-R" license)
 - "ELEM-C-REM", extension to remote control interface (requires the "ELEMI-A", "ELEMS-C" or "ELEMS-R" license)

- "ELEM-CTLA", extension to EUT [test list automation](#) (TLA, requires the "ELEMI-S" or "ELEMS-S" license)
- "ELEM-CTB", extension for EUT test bench control (requires the "ELEMI-S" or "ELEMS-S" license)
- "ELEM-OFF9", offline processing extension (excludes using most other licenses, except licenses related to reporting, e.g. "ELEMI-3D")
Using R&S ELEKTRA with this license is similar to using it in demo mode, but with enabled data exchange options: It allows [import/export](#), report generation (even customized reports with license "ELEM-REP") and three-dimensional results evaluation (with license "ELEMI-3D" and "ELEM-REP").
However, it disallows physical measurements. Hence, in offline mode you cannot control any instruments, and you can run [simulated](#) tests, only.
Typically, use this license for an installation of R&S ELEKTRA that is dedicated exclusively to preparing test templates and to reporting.

To see the expiration date of an evaluation license, click "Manage Licenses" to open the "R&S License Server Manager" dialog and refer to the "Validity" column.

Disabled Licenses!

If R&S ELEKTRA detects a license that cannot be used, for example after a version update and due to an expired maintenance period or invalid base licenses, it displays the message "Disabled Licenses" in the title bar. For more details on deactivated licenses, refer to the "R&S License Server Manager" dialog, available by clicking "[Manage Licenses](#)" on page 534.



If you run the software with only "EMI Test Software - ELEMI-E" selected, several dialogs are simplified or disabled. For a correct description of the software in this essential license mode, refer to the "ELEKTRA_User_Manual_ELEMI-E_en.pdf".



Without licenses: "demo mode"

The R&S ELEKTRA EMC Test Software runs in "ELEMI-E" demo mode, if any of the following conditions applies:

- You do not own a license
- Your [License dongle](#) is not connected

In this EMI demo mode, no physical measurements can be made. If you have selected to [Allow Device Simulation](#), all test data comes from simulation and tests are labeled as simulated.

Manage Licenses

Access: "Home" > "Administration" > "License Management" > "Manage Licenses"

Brings up the following "R&S License Server Manager" dialog in your standard browser:

Designation	License type	Count	Status
ELEMI-A - ELEKTRA EMI Extension to Advanced	permanent	1	✓
ELEMI-A - ELEKTRA Software Service for EMI Extension to Advanced	software maintenance	1	✓
ELEMI-E - ELEKTRA EMI Test Software	permanent	1	✓
ELEMI-S - ELEKTRA EMI Extension to System	permanent	1	✓
ELEMS-C - ELEKTRA EMS Test Software (Conducted)	permanent	1	✓
ELEMS-R - ELEKTRA EMS Test Software (Radiated)	permanent	1	✓
ELEMS-S - ELEKTRA EMS Extension to System	permanent	1	✓

Showing 7 of 9 licenses.

License Info:
 Product: EMCPC (987654)
 Device ID: 5601.0018K02-987654-KJ
 License server: ELEKTRA-PC
 Version: 1.16.0
 Category: ELEMI-E
 Designation: ELEMI-E
 ELEKTRA EMI Test Software
 License type: permanent
 License count: 1
 Status: ✓
 License key: 142379611740012142377852707274
 Part number: 5601.0030.02
 Date of Issue: 2016-11-24 15:16

Figure 4-190: Example of the license server manager dialog

Use this dialog to view and manage the licenses that are contained in your [License dongle](#).

To terminate the "R&S License Server Manager", close the browser tab.

Note: User manual of R&S license server. At

c:\Program Files (x86)\Rohde-Schwarz\LicenseServer\doc\Manuals, you can find the file `RS_LicenseServer_Local_UserManual.pdf`.

Licenses ← Manage Licenses

This dialog has the following content in 3 tabs:

- The available "**License providers**", which are your license dongles
- A full **list of licenses** found on the selected license provider
- **Detailed information** on the license selected in the list

The list of the licenses (middle tab) provides the following features:



"Show license key list" displays a list of all license keys available on the dongle selected in the "License providers" column.



"Show option license summary" displays a list of all licensed options available via the selected dongle.

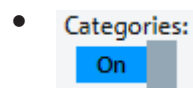

Available only, if "Show option license summary" is enabled.

"Group by categories" groups the options by license categories.

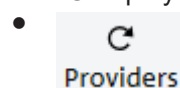

"Providers" reloads the available license providers.

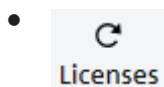

"Licenses" reloads the available licenses.



"Activate license key" activates a license by a key.

A dialog with the "Activate license" wizard opens. Enter a 30-digit or 32-digit "License key", or browse for a "License file" (.xml or .rsi format) that contains the key.

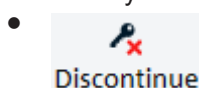

"Discontinue license key" discontinues a license by a key.

A dialog with the "Discontinue license" wizard opens. Enter a 30-digit or 32-digit "Deactivation key", or browse for a "License file" (.xml or .rsi format) that contains the key.

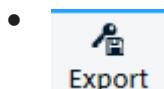

Available only, if "Show license key list" is enabled.

"Export license key" saves the selected license to a license-key file in .xml format.

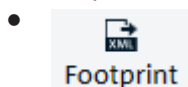

"Export device footprint" saves all installed licenses and further product self-information of the selected dongle to a device-footprint file in .xml format. If necessary, you can send this file to Rohde & Schwarz for troubleshooting purposes.



To select the columns to be displayed, click the column icon . Enable or disable the columns or select "Show all".

The following columns are available, if "Show license key list"  is enabled:

- "Designation": the name of the license
- "License type", for example "permanent" or "software maintenance"
- "Count": the license count, typically "1"
- "Status": active or invalid (discontinued or expired)
- "Validity": number of days and hours remaining before the license expires
- "Invalidity reason": no entry up until the expiry date, "expired" after this date has passed
- "License key": the 30-digit or 32-digit keycode
- "Part number": order no. of the license key

The following columns are available, if "Show option license summary"  is enabled:

- "Designation": the name of the license
- "Total licenses", number of license keys saved on the license provider
- "Used licenses": "1" if activated, "0" if discontinued
- "Maintenance expiration": last day of validity of the license



To sort and filter the content in the list by a column, click this column's headers.

Analytics ← **Manage Licenses**

"License providers" shows details of the available dongles, for example "Situated at": the name of the computer, to which the selected dongle is connected.

Configuration ← **Manage Licenses**

"Local license server" shows configuration details, for example, the hostname of the computer, on which R&S ELEKTRA is executed.

Apply and Restart

Restarts the software to apply your selection of enabling or disabling checkboxes for the available licenses.

"Enabled" / "Disabled" You can use the restarted R&S ELEKTRA with all *enabled* licenses that are available on your [License dongle](#), as shown in the "License Management" dialog, see [Figure 4-190](#).
Note that you cannot disable the "ELEMI-E" license.

License dongle not inserted You can use the restarted R&S ELEKTRA in demo mode, only. During restart, the following dialog comes up:

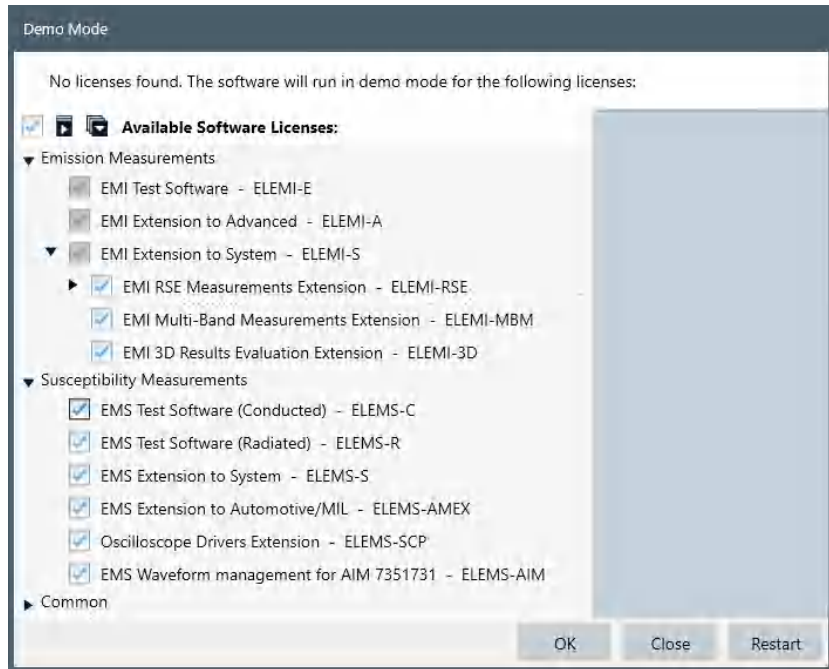

Select OK to proceed with starting in demo mode. R&S ELEKTRA displays the words "Demo Mode" on the right-hand side of the title bar. See [Chapter 3.2, "Graphical user interface"](#), on page 43.

Note: If this dialog comes up while starting R&S ELEKTRA, because you have not yet inserted your license dongle, insert the dongle and click "Restart".

To leave the demo mode and use the software with your licenses enabled, reinsert your license dongle. Go to "Home" > "Administration" > "License Management". Enable the checkboxes for your licenses - typically all licenses except "ELEMC-OFF9" - and click "Apply and Restart".

4.12.5 User Admin

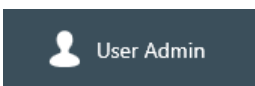

Access: "Home" > "Administration" > "User Admin"

Available only, if you are [logged in](#) as a user with administrator rights, see [Roles & Permissions](#).

The following settings dialogs allow organizing the access rights of users to the various functions of your R&S ELEKTRA installation.

- [Users](#).....539
- [Roles & Permissions](#)..... 540
- [Groups](#)..... 541

4.12.5.1 Users

Access: "Home" > "Administration" > "User Admin" > "Users"

Available only, if you are [logged in](#) as a user with administrator rights, see [Roles & Permissions](#).

This dialog specifies settings for users and their "Login", "Name", "Role" and "Groups".

The dialog headline has these functions:



"Save" stores the settings. Without saving, your changes have no effect.



"Discard all changes" resets all changes to the state before saving.



"Reset to Default" restores the original settings in the tab [Roles & Permissions](#).









Active	Login	Name	Role	Groups	
	Admin	Administrator	Admin	All Groups	Current User
<input checked="" type="checkbox"/>	Expert	development team	Expert	Public, A1, B2, C3	 
<input checked="" type="checkbox"/>	Op-A	early shift	Operator	Public, A1	 
<input checked="" type="checkbox"/>	Op-B	late shift	Operator	Public, B2	 
<input checked="" type="checkbox"/>	Op-C	night shift	Operator	Public, C3	 

Figure 4-191: Dialog for defining users and assigning them roles and groups

The first line in the table is the default administrator, who is equipped with all permissions in R&S ELEKTRA. This entry cannot be changed.



If you see this dialog, you as the "Current User" may be this default administrator, or you may be a different user with the role of an "Admin".





To generate a new user entry, click the "Create User" button . Then define the appropriate settings for this new user, as described below.

The columns in the table of users have the following functions:

- "Active" enables or disables access of this user to R&S ELEKTRA.
- "Login" defines the "User Name" that this user must enter in the [User login](#) dialog that comes up when starting R&S ELEKTRA.

- "Name" specifies an arbitrary name for this user. The name you enter here has no function in R&S ELEKTRA, but it facilitates relating a "Login" (hence, "User Name") to one or more persons. For example, the "Name" may be the actual first or last name of one specific person, or a designation for a certain group of people, such as "late shift".
- "Role" selects one of the three available roles:
 - "Admin"
 - "Expert"
 - "Operator"

Define the permissions for these roles in the tab [Roles & Permissions](#).

- "Groups" selects the assignment of this user entry to the available user groups, which you must define in the tab [Groups](#).
Users with the "Role" of an "Admin" are automatically assigned to all groups.
-  "Reset User Password" deletes the password for a "Login" entry (hence, for a "User Name").
If users have forgotten their passwords, this reset allows starting R&S ELEKTRA without a password. Once a password is reset, users can log in with their "User Name", only, leaving the password field blank. When logged in, the password can be changed in the [User Information](#) dialog.
-  "Delete User" removes an entry without further warning.



Save any changed settings before you leave this dialog.

4.12.5.2 Roles & Permissions

Access: "Home" > "Administration" > "User Admin" > "Roles & Permissions"

Available only, if you are [logged in](#) as a [user](#) with administrator rights.

This dialog assigns the available permissions in R&S ELEKTRA to the roles "Expert" and "Operator", while the role "Admin" is equipped with all permissions.

Permission	Admin	Expert	Operator
Create EUT	✓	✓	✓
Modify EUT	✓	✓	✓
Delete EUT	✓	✓	✗
Create Test	✓	✓	✓
Modify Test	✓	✓	✓
Delete Test	✓	✓	✗
Create Test Template	✓	✓	✗
Modifv Test Template	✓	✓	✗

Figure 4-192: Dialog for defining user roles and permissions

An expert user typically defines test setups, which requires creating and modifying (or deleting) templates, tables and the like. On the contrary, for an operator of R&S ELEKTRA it is typically sufficient to handle EUT entries and tests. Nevertheless, you can assign different permissions. For example, you can extend the permissions of operators to creating test templates, or limit the permissions of expert users by disabling "Modify Hardware Setup" for them.

The permission for the function "Manage User Administration" (at the end of the list) is restricted to "Admin" users, hence to administrators. If you enable this permission in the "Expert" or "Operator" column, R&S ELEKTRA automatically disables this permission upon saving the settings in this dialog.



Save your settings before you leave this dialog.



If you wish to reset all roles and permissions to their original state, click "Reset to Default". Confirm the warning "Do you really want to reset the settings to default?".

4.12.5.3 Groups

Access: "Home" > "Administration" > "User Admin" > "Groups"

Available only, if you are [logged in](#) as a [user](#) with administrator rights, see [Roles & Permissions](#).

This dialog defines the user groups for the [Users](#) tab.

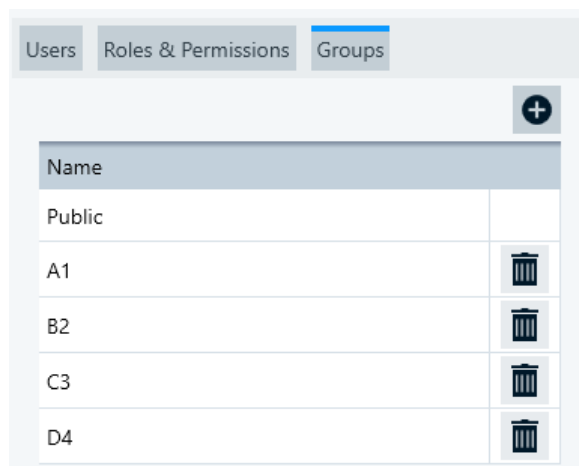

Figure 4-193: Dialog for defining user groups

To generate a new group, click the "Create Group" button . You can define an arbitrary number of groups with arbitrary names.

You can then assign [Users](#) to specific groups.



How to use several group definitions

A user with access rights for a specific user group can create [EUT descriptions](#) for this group. Other users can see these EUTs only, if they are also assigned for this group. The same rule applies to tests, which are executed with an EUT that is assigned to a specific group. Such tests are also limited to be seen by users with access to this specific group.

Note that the default group "Public" can be seen by all users, and that users with the [role](#) of an "Admin" are automatically assigned to all groups.

While non-admin users cannot open the [User Admin](#) dialog to view their group assignments, these assignments can be seen in the dialog for creating a [EUT description](#). If you have the [permission](#) to create EUTs, you can use the EUT description dialog to view your group assignments.

If you wish to remove an entry, click the delete button and confirm the warning "Are you sure you want to delete the selected item(s)?"



Save your settings before you leave this dialog.

4.12.6 Settings

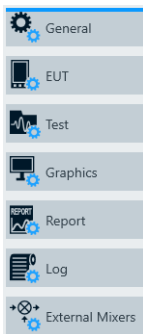

Access: "Home" > "Administration" > "Settings"

Opens the settings dialogs described below.

• General	543
• EUT	545
• Test	546
• Graphics	547
• Report	550
• Log	555
• External Mixer	556

4.12.6.1 General

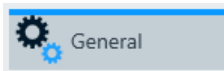



Access: "Home" > "Administration" > "Settings" > "General"

Selects the settings described below.

The dialog headline has these functions:

- 

"Save" stores the general settings. Without saving, your changed settings have no effect and are lost upon shutting down R&S ELEKTRA.
- 

"Discard all Changes" resets all general settings to the state before your changes.
- 

"Reset to Default" resets all general settings to their default state and saves it.

Allow Device Simulation

Enables or disables running tests with simulated data. The software distinguishes the following cases:

- If you use R&S ELEKTRA **without licenses** in demo mode, no physical measurements can be made. All test data comes from device simulation. The tests are labeled as simulated.

- If you use R&S ELEKTRA **with a license**, the measurement mode depends on the availability of the devices required for a test:
 - If all devices are available and the automatic test validation confirms the connection, the software uses the physical data, even if you have allowed simulation.
 - If one or more devices are not connected, and if you confirm that you wish to let R&S ELEKTRA simulate a measurement, all test data comes from this simulation. The tests are labeled as simulated.

Show Welcome Screen on startup

Enables or disables the "Welcome Screen" upon starting R&S ELEKTRA. This screen also allows creating sample test data, as described in [Chapter 2.4, "Configuration Wizard for creating basic data"](#), on page 28.

Enable delete for archived tests and EUTs

Makes the "Delete"  button available for selected archived EUTs and tests in the "Home" > [Archive](#) dialogs.

Enable auto-refresh of search lists

If enabled, the software updates search results also upon creation of new items (devices, test templates) in other tabs. If not enabled, an update of search results can require manual switching between tabs. We recommend deactivating the auto-refresh feature only, if many searchable items slow down the generation of search views. In this case, deactivation can accelerate software performance.

Enable parallel movement of accessories

Disable this checkbox only, if you use a [Positioner](#) of the [type](#) "Maturo EAP". This device is not compatible with the software's optimization algorithms for synchronized accessories movement, for example when moving an antenna mast and a turntable to the starting position simultaneously.

Show troubleshooting info selection screen

If enabled, you can select options for including or not including specific types of content into troubleshooting zip files. See [Chapter 11.4, "Troubleshooting information"](#), on page 679.

Show Test Id

If enabled, the EUT's [Test Plan](#) shows an individual test ID for each test. You can find the ID also in the test's search view, and via the [Data exchange](#) interface. See also [Table 4-1](#).

Dashboard: Show ...

To enable or disable the displaying of individual categories of items in the [Dashboard](#) dialog, use the following checkboxes:

- "Dashboard: Show EUTs"

- "Dashboard: Show Tests"
- "Dashboard: Show Test Templates"
- "Dashboard: Show Hardware Setups"
- "Dashboard: Show Report Templates"

The intention of limiting the categories of pinned items in the "Dashboard" dialog is to provide simple access to - and a good overview of - exactly the pinned items and searches that you require. In combination with user-defined [Searches](#), this selection is especially helpful, if you have created many items or searches over time.

EMI: Download the ... into the receiver when the test ends

R&S ELEKTRA supports enhanced communication with your test receiver: The download option facilitates switching between using a receiver with and without control from R&S ELEKTRA. Hence, this feature optimizes the match between measuring with a receiver under local control and under control of R&S ELEKTRA.

For example, if the software "knows" attenuation correction data of switching paths, the measurement results can differ from the results of a receiver that does not "know" this data. Downloading the data into the receiver aims at compensating this difference and can improve the reproducibility of test results in these two scenarios.

To enable this feature, you can download selected data into the receiver at the end of a test execution under software control.

You can enable or disable the following features individually:

- "EMI: Download the **transducer sum** into the receiver when the test ends", see ["Correction sum download"](#) on page 595
- "EMI: Download the **limit lines** into the receiver when the test ends"
- "EMI: Download the **scan settings** into the receiver when the test ends", which refers to a set of basic scan parameters, see ["Scan settings download"](#) on page 596

EMI: Run *.py scripts within ELEKTRA

Enables using the built-in Python environment of R&S ELEKTRA for executing Python scripts, for example in [User Data Reduction](#). The built-in environment typically improves performance. If you disable the checkbox, an external Python environment is required. It must be installed on your computer and can help, if there are compatibility issues.



Save any changed settings before you leave this dialog.

4.12.6.2 EUT

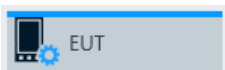

Access: "Home" > "Administration" > "Settings" > "EUT"

Defines "EUT Information Labels" for the list of "Additional Information" in [EUT Descriptions](#).

The dialog headline has these functions:



"Save" stores the settings. Without saving, your changes have no effect.



"Discard all changes" resets all changes to the state before saving.





"Reset to Default" restores the original settings.

Per default, the following categories are predefined in this dialog:

- "Manufacturer"
- "Software Version"
- "Hardware Version"
- "Barcode"

Use the checkbox in the first column to activate or deactivate displaying selected categories in the EUT's "Additional Information" dialog.

To add an arbitrary new category, click the "Add Information" button . Enter a name for the new category in the "Category" field. Optionally add arbitrary content in the "Content" field.

To remove a category, click the "Delete" button  in the last column of this entry.

When you have completed editing the entries, save your settings by clicking "Save" .

4.12.6.3 Test

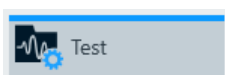

Access: "Home" > "Administration" > "Settings" > "Test"

Defines list categories and default content for the "Test Information" section of your test template.

- For CAL tests, see [Test Information](#)
- For EMI tests, see [Test Information](#)
- For EMS tests, see [Test Information](#)

The dialog headline has these functions:



"Save" stores the settings. Without saving, your changes have no effect.



"Discard all Changes" resets all changes to the state before saving.



"Reset to Default" restores the original settings.

Per default, the following categories (titles) are predefined in this dialog:

- "Description"
- "Test Standard"
- "Test Site"
- "Operator Name"

To add an arbitrary new category, click the "Add Information" button . Enter a name for the new category in the "Category" field.

Enter arbitrary content in each row of test information. You can also leave the content of a row blank and enter only the category, for entering the content later (within the tests).

To sort the rows alphabetically by their categories or contents, click the headline.

To swap the position of the selected row with the one above or below it, click "Shift Row Up / Down" .

Use the checkbox in the first column ("Add Entry") to activate or deactivate displaying selected categories in the "Test Information" dialog.

To remove a category, click the "Delete" button  in the last column of this entry.

When you have completed editing the entries, save your settings by clicking the "Save" button .

4.12.6.4 Graphics

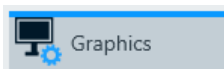

Access: "Home" > "Administration" > "Settings" > "Graphics"

Defines global settings for color, font size, style, etc. of the background of graphic charts, of their labels, legends, markers, grid lines, axes and traces.

While these settings are globally valid for all new graphics, you can also define the same settings differently for individual graphic charts. To do so while working with a graphic chart, right-click the chart and select [Graphics Properties](#).

The dialog headline has these functions:



"Save" stores the settings. Without saving, your changed settings have no effect and are lost upon shutting down R&S ELEKTRA.



"Discard all Changes" resets the settings to the state before your changes.



"Reset to Default" resets the settings to their default state and saves it. Note that this button does not only reset the settings to their default that are currently visible in the dialog. Instead, all the following settings are reset to their default.

Graphics.....	548
Marker.....	548
Grid.....	550
Traces.....	550

Graphics

Access: "Home" > "Administration" > "Settings" > "Graphics" > "Graphics"

This dialog defines the following graphics settings:

- **"General"**
 - "Background Color" selects the color of the chart's background.
- **"Legend"**
 - "Legend On for Grid Chart" enables showing a legend below each chart.
 - "Show Beside" enables showing the legend beside the chart instead of below it.
- **"Label"**
 - "Limit Line Label On for Grid Chart" enables showing labels that indicate the names of all limit lines.
- **"Font Family"** selects the "Font", "Typeface" and "Size" of text in the title, axis labels and legend of graphics
- **"Accessory Settings"**
 - "Show Accessory Settings in the Graphic Traces and Markers" enables an interactive option: You can click a trace or on a marker in a test chart of a stopped test to let R&S ELEKTRA display accessory settings. For example, it can display the antenna polarization, the EUT's azimuth angle or the position of an accessory.
- **"Default Arrangement of Test Graphics"** selects the default arrangement of all graphics. You can choose to display as follows:
 - "Horizontal" - arrange the graphs in a row
 - "Vertical" - arrange the graphs in a column
 - "Cascading" - arrange the graphs as one tab per chart, and show only the graphic of the selected tab

Marker

Access: "Home" > "Administration" > "Settings" > "Graphics" > "Marker"

This dialog defines the following marker settings:

- **"General"**
 - If the checkbox "Use the color of the referenced trace" is enabled (= default), the color of each **un-referenced** marker is set to the color of its own trace.
 - To select a global "Marker Color" for unreferenced markers, disable the checkbox.
As an exception, the currently selected marker is always highlighted in a light blue color.

- Optionally select the "Marker Size" to be "Small", "Medium" (= default) or "Large". This setting is valid for all kinds of markers.
- **"Delta Marker"**
 - If the checkbox "Use the color of the referenced marker" is enabled (= default), the color of **delta** markers (synchronized or not) is set to the trace color of the referenced markers.
 - To select a global "Marker Color" for delta markers, disable the checkbox. As an exception, the currently selected marker is always highlighted in a light blue color.
- **"Pixel Mode"**

The default "Show Pixel Mode" enables markers to be moved from pixel to pixel between the frequency (measurement) points. If disabled, markers can only jump from one frequency point to the next. The effect of this setting becomes especially noticeable, if only a few frequency points are visible, for example when zooming deeply into a trace.

To access this setting in a graphic chart, right-click the chart and select "Graphic Properties" > "Marker" > "Pixel Mode". Alternatively, right-click the chart and select "Marker" > "Pixel Mode", or right-click a marker and select "Pixel Mode".
- **"Search"**

Specifies the "Peak Excursion" value (in dB), which is the minimum amplitude variation required for a measurement result to qualify as a peak.

"Peak Excursion" is always specified with respect to a local maximum value. To qualify as a peak, the signal must fall on both sides of this local maximum by at least the peak excursion value without at any point rising above the local maximum.

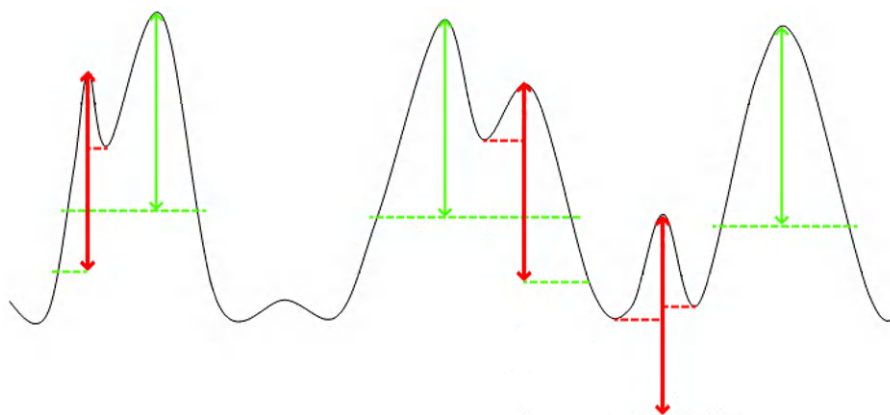

Figure 4-194: Illustration of Peak Excursion in a signal trace

Height of arrows = Peak Excursion

Green arrows = Peaks qualify, because the trace falls on both sides below the bottom of the arrow without rising above the top of the arrow

Red arrows = Peaks do not qualify, because the trace rises above the top of the arrow before falling below the bottom of the arrow

Hence, the size of the "Peak Excursion" determines whether the software detects separate peaks or classifies them as a single peak. For example, consider a level dip between two local maxima being 3 dB down, and the level values left and right of them being 5 dB down. In this case, with a "Peak Excursion" of 4 dB, the two

local maxima are regarded as one peak. But with a "Peak Excursion" of 2 dB, the two maxima would be seen as two separate peaks.

Grid

Access: "Home" > "Administration" > "Settings" > "Graphics" > "Grid"

This dialog defines the following grid settings:

- **"Horizontal Grid"** selects "Color" and "Style" of horizontal grid lines. The "Color" setting requires "Style" to be set different from "None".
- **"Vertical Grid"** selects "Color" and "Style" of vertical grid lines. The "Color" setting requires "Style" to be set different from "None".
- **"Axis"** enables or disables "Logarithmic X-Axis" and "Title of Y-Axis rotated by 90 deg", selects "Label Color" and "Font Size". If you enable "Y-Axis Auto Scaling of Test Graphics", R&S ELEKTRA automatically scales the vertical axis of test charts depending on the measured levels.

Traces

Access: "Home" > "Administration" > "Settings" > "Graphics" > "Traces"

This dialog defines the following marker settings:

- **"Trace"** selects the "Trace", "Limit Line" or "Symbol Trace" to be configured.
- **"Line"** specifies "Style", "Color" and "Thickness" of the selected trace or line. The settings "Color" and "Thickness" require "Style" to be set different from "None".
- **"Symbol"** specifies "Shape", "Color" and "Size" of symbols on the selected trace or line. The settings "Color" and "Size" require "Shape" to be set different from "None".
- **"Vertical Line To the Bottom"** specifies "Style", "Color" and "Thickness" of lines that connect symbols (or points) on the selected trace to the lower edge of the chart. The settings "Color" and "Thickness" require "Style" to be set different from "None".
- **"Use for EMI Detector"** selects a [detector type](#), and assigns it the properties of a selected trace. Hence, you can use this function to define individual trace layouts specifically for each available detector.
The selection "Use for EMI Detector" is available only for traces 1 to 8 and for "All other Traces". Automatically, the detector that you select for one "Trace" is assigned also to the "Limit Line" and "Symbol Trace" with the same index number.

4.12.6.5 Report

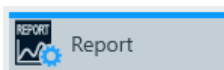



Access: "Home" > "Administration" > "Settings" > "Report"

Defines global settings for reports, report graphics and report templates used per default.

The dialog headline has these functions:



"Save" stores the settings. Without saving, your changed settings have no effect and are lost upon shutting down R&S ELEKTRA.

-  "Discard all Changes" resets the settings to the state before your changes.
-  "Reset to Default" resets the settings to their default state and saves it.

General



Specifies the "Report Title", "Header", "Footer", "Logo", "Font" and "Export Format", which are then available in the "General" section of [Report Templates](#).



Before you leave this dialog, save your changes to activate them. To reset the report configuration to the default settings, click the "Reset to Default" button .

For the "Header" and "Footer" of reports, the following selections are available for the left, center and right sections, respectively:

- "None" leaves this section blank
- "Date" in the format "dd.mm.yyyy"
- "Time" in 24-hour clock format "hh:mm"
- "Date / Time"
- "Page Number" = the current page number in a report
- "Page Number / Count" = "Page Number" and the total number of pages, separated by "/"
- "Test Name" = the name of the test that is described by the report
- [Verdict](#)"Verdict" = a "Passed", "Failed" or "Inconclusive" statement resulting from a [test](#)
- "Version" = the name "ELEKTRA" together with this software's version number
- "Title" = the "Report Title" specified above
- "Logo" = the logo image file selected below



The "Logo" image file is stored within the R&S ELEKTRA database. To select a new logo, click the  button. The existing logo is replaced by the new logo. To view the currently selected logo, click the  button. To restore the original logo, click the "Reset to Default" button . Note that this action resets all other report settings, too.

The font of reports can be specified individually for the following "Font Items":

- "Title"
- "Component Title"
- "Table Contents"
- "Normal Text"



The "Export Format" of reports can either be "PDF" (Adobe Acrobat portable document format = default) or "DOCX" (MS Word for Windows). The option that you select deter-

mines the export format offered in a report (PDF  or DOCX ). However, with one file format preselected, the other file format is still available in the "Save As" dialog.

Graphics

"Add Graphics Title" globally activates or deactivates the graphics title as a default for reports.

"Graphics Arrangement" specifies either one chart over the full page width or up to four charts next to each other, at a reduced width.

Tables

"Max. Printed Rows" specifies the number of lines of a table to be printed in a report.

Reporting Templates.....	552
L Internal.....	552
L External.....	552
GMW Report Settings.....	553
L Non-Spark.....	554
L Spark.....	554
L Summary Ranges.....	555
L Evaluate per polarization.....	555

Reporting Templates

Available only, if you have installed at least one of the "System" licenses "ELEMI-S" or "ELEMS-S".

Internal ← Reporting Templates

Allows for each "Test Category" (type of test template) to select a default internal "Standard Report Template" (see [Chapter 4.6, "Report Templates"](#), on page 324. For example, you can specify that a test template of the type "EMI - LISN" is always generated with a specific default report template, which you have prepared for this purpose. If you leave test categories without a preselection, these test templates do not automatically include a default standard report template.

Note that selecting default internal report templates is relevant also for tests that are saved without containing a report template: If such a test is included into automated report generation in a [Test Plan](#), R&S ELEKTRA uses the internal "Standard Report Template" selected here as a default for this test category.

External ← Reporting Templates

Available only, if you have installed the license "ELEM-REP" for report customization, which requires that a [dongle](#) with this license is connected.

This dialog allows managing the following external report templates:

- A previously created customized XML-based text template (in dotx format) as a default **main** report template for your EUTs. A main report serves for containing the individual reports on all tests (different test categories) performed with a specific EUT.
- Previously created customized XML-based text templates (in dotx format) as default **individual** subreport templates, one for each "Test Category" (type of test

template). An individual subreport contains the results of only one test, performed with a specific EUT.

The button selects the template. When selected, the button allows viewing the file. The button opens its source location, hence the directory that contains this file.

These global settings determine the default report templates preselected for the [External Report templates](#) dialog available in a new [EUT description](#).

For a guideline of how to create customized report templates, refer to [Chapter 6.6, "Creating customized reports"](#), on page 577.

GMW Report Settings

Available only, if you have installed the "System" [license](#) "ELEMI-S", which requires that a [dongle](#) with this license is connected.

In radiated EMI testing of automotive components, "GMW Report Settings" facilitate reporting according to the General Motors standard GMW3097. Use these settings to configure multiple report templates for different combinations of loop-parameters ([Figure 4-54](#)), and for specific frequency bands.

To enable the generation of GMW reports, see also [Test Plan > GMW Reporting](#).

Note: The report configurations in this dialog avoid having to split the accessory settings into subranges, according to the required frequency bands. Such a splitting would make your test templates unnecessarily complex. Hence, due to the "GMW Report Settings", you can use multiple test templates for your measurements and combine the results in a report that complies with GMW3097.

Band ID	Region	RF Service (User Band) (MHz)	Start Frequency (MHz)	Stop Frequency (MHz)	RBW (kHz)	Limit Line	
1	M1	Global	Not Applicable	30	75	120	GMW3097 Radiated Emissions (ALSE) Non-Spark (M1)
2	M2	Global	Not Applicable	75	400	120	GMW3097 Radiated Emissions (ALSE) Non-Spark (M2)
3	M3	Global	Not Applicable	400	1000	120	GMW3097 Radiated Emissions (ALSE) Non-Spark (M3)
4	G1	Global	Medium Wave/AM	0.53	1.71	9	GMW3097 Radiated Emissions (ALSE) Non-Spark (G1)
5	NA1	GMNA	TexDoT (45.68 to 47.34)	45.2	47.8	9	GMW3097 Radiated Emissions (ALSE) Non-Spark (NA1)
6	NZ1	GMH	4 Meter Fleet (75 to 77.4)	74.2	78.2	9	GMW3097 Radiated Emissions (ALSE) Non-Spark (NZ1)

Figure 4-195: GMW Report Settings dialog, here for Non-Spark test reports

A GMW report includes the following items:

- A summary result table that lists the relevant parameters per detector and per frequency band:
 - Band with "Band ID"
 - "Region" of applicability, for example global or "General Motors North America" (GMNA)
 - Name of "RF Service" (user band), for example medium wave, GNSS or WiFi
 - Frequency range, hence "Start Frequency" and "Stop Frequency"
 - Resolution bandwidth, "RBW"
 - Maximum level in dB μ V/m for each detector, specified in a "Limit Line"
- R&S ELEKTRA provides a comprehensive set of predefined limit lines, available via the [Configuration Wizard](#). Note that for each band, you can find the

applicable limit line easily among those predefined limit lines by clicking the select button  and searching for the "Band ID". Select a limit line specifically for "Non-Spark" or "Spark" tests.

- A differentiation of the pass level from the failed level regarding the limit
- Individual graphics for each antenna polarization, for each DUT test mode and for each DUT orientation, where GMW3097 accepts reporting three DUT orientations in one graphic
- Worst-case summary graphics of maximum-hold levels across all frequencies for all bands, specific for all the following:
 - Antenna polarizations
 - DUT orientations
 - Test modes
 - Detectors
- Worst-case graphics for three different frequency ranges:
 - 0.53 MHz to 1.71 MHz (AM band)
 - 30 MHz to 1000 MHz
 - 1000 MHz and above
- Ambient-level measurement graphics with limit line
- A note to indicate, how the summary result table was created:
 - Generated automatically (compiled from raw data)
 - Generated manually (for example by lab personnel, reviewing each graphic)

Reference tables

A report that complies with GMW3097 can refer to reference results from another test. To include reference results into your current test, go to the [Test Components](#) > [Test container](#) dialog on the left of the test window, right-click "Result Tables" and select "Add a result table reference from another test".

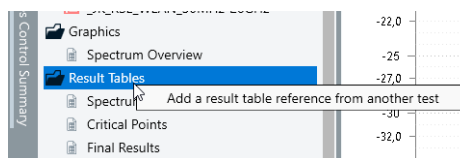

In the dialog that opens, first select a test, then select a result table. If the selected table qualifies as a reference table for your current test, the checkbox "Set as reference" becomes available. Enable this checkbox and click "Select".

"Add"  Adds a row to the table.

"Move up" /  Moves a selected row up or down in the table.

"Move down"

"Delete"  Deletes a row from the table.

Non-Spark

Non-Spark ← GMW Report Settings

Non-spark measurements relate to test scenarios without ignition of a vehicle's combustion engine.

Spark

Spark ← GMW Report Settings

Spark measurements relate to test scenarios with ignition.

Summary Ranges

Summary Ranges ← GMW Report Settings

Allows adding frequency ranges, for which R&S ELEKTRA creates summary report information. For example, use the default ranges from the worst-case graphics, mentioned above.

Above and below 30 MHz, GMW3097 requires different accessory settings:

- Measurements in bands >30 MHz must report results separately for H and V polarization, and for three orthogonal EUT orientations.
- Measurements in bands <30 MHz only require to report results for V polarization and for one single EUT orientation.

Evaluate per polarization ← GMW Report Settings

Enables or disables evaluating measurements with vertical and horizontal antenna polarization separately in the reports.

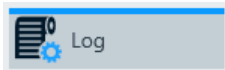
4.12.6.6 Log

Access: "Home" > "Administration" > "Settings" > "Log"

The logging function of R&S ELEKTRA tracks software events by a specific protocol transcript and saves the log information in several files to the folder
C:\ProgramData\Rohde-Schwarz\ELEKTRA\x.xx.x\Logs.

Use the "Log Settings" dialog to configure the [Log information](#).

The dialog headline provides the following functions:



"Save" stores the log settings. Without saving, your changed settings have no effect and are lost upon shutting down R&S ELEKTRA.



"Discard all Changes" resets the log settings to the state before you changed these settings.



"Reset to Default" resets the log settings to their default state.



"View Logs" opens a dialog for viewing the log entries, as described in [Chapter 11.2, "Log information"](#), on page 677



You can open the "View Logs" dialog also by the [short key](#) [Alt]+[L].

- **SCPI**

Opens the "ELEKTRA Spy" tool in a separate window. This "inspection" tool for text-based commands (like SCPI) displays log entries of the device communication, which is useful for diagnosis purposes.



You can also open the **"ELEKTRA Spy"** dialog by the [short key](#) [Alt]+[I].

Log File Settings

Defines the maximum log data volume (in megabytes) and the maximum log file count.

SCPI Settings

Defines the maximum number of command and respond lines in the SCPI log. When it reaches the maximum number of lines, R&S ELEKTRA automatically removes the oldest 25% of lines from the log.

4.12.6.7 External Mixer

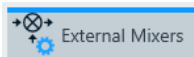

Access: "Home" > "Administration" > "Settings" > "External Mixer"

Available only, if "Spectrum Analyzer" is selected as the "Operating Mode" in an EMI test template.

Defines the parameters of the "External Mixers" in the list of [Input Selection](#) of the EMI test template.

The dialog headline has these functions:



"Save" stores all the unsaved settings. Without saving, your changes have no effect.



"Discard all Changes" resets all changes to the state before saving.



"Reset to Default" restores the original settings.

External Mixers

Specifies the parameters of an external mixer, which are then visible in the [Input Selection](#) of the [Test Templates for EMI tests](#).

Table 4-22: Preconfigured external mixers and some of their parameters

Mixer Name	Frequency Range	Harmonic Number	Local Oscillator Power	Comment
R&S TC-RSE60	41 GHz - 60 GHz	4	13	L.O. power may need extra attenuation down to max. 7 dBm
R&S TC-RSE90 mod.02	60 GHz - 93 GHz	6	13	L.O. power may need extra attenuation down to max. 7 dBm
R&S TC-RSE90 mod.03	60 GHz - 90 GHz	6	13	L.O. power may need extra attenuation down to max. 7 dBm
R&S TC-RSE140 (X8)	90 GHz - 138 GHz	8	15	Set to x8 via OSP
R&S TC-RSE140 (X16)	130 GHz - 145 GHz	16	15	Set to x16 via OSP
R&S TC-RSE200	138 GHz - 200 GHz	12	13	L.O. power may need extra attenuation down to max. 7 dBm
R&S TC-RSE220	145 GHz - 220 GHz	16	13	L.O. power may need extra attenuation down to max. 7 dBm
R&S TC-RSE325	220 GHz - 325 GHz	24	13	L.O. power may need extra attenuation down to max. 7 dBm
R&S FS-Z60	40 GHz - 60 GHz	4	13.5	R&S ext. mixer hardware (RPG)
R&S FS-Z75	50 GHz - 75 GHz	6	13.5	R&S ext. mixer hardware (RPG)
R&S FS-Z90	60 GHz - 90 GHz	6	13.5	R&S ext. mixer hardware (RPG)
R&S FS-Z110	75 GHz - 110 GHz	8	13.5	R&S ext. mixer hardware (RPG)
R&S FS-Z140	90 GHz - 140 GHz	10	13.5	R&S ext. mixer hardware (RPG)
R&S FS-Z170	110 GHz - 170 GHz	12	13.5	R&S ext. mixer hardware (RPG)
R&S FS-Z220	140 GHz - 220 GHz	16	13.5	R&S ext. mixer hardware (RPG)
R&S FS-Z325	220 GHz - 325 GHz	22	13	R&S ext. mixer hardware (RPG)
R&S FS-Z500	325 GHz - 500 GHz	36	14	R&S ext. mixer hardware (RPG)
RPG SHM 75-110	75 GHz - 110 GHz	8	13.5	L.O. power may need extra attenuation down to max. 10 dBm
RPG SHM 90-140	90 GHz - 140 GHz	10	13.5	L.O. power may need extra attenuation down to max. 10 dBm
RPG SHM 110-170	110 GHz - 170 GHz	12	13.5	L.O. power may need extra attenuation down to max. 10 dBm
RPG SHM 140-220	140 GHz - 220 GHz	16	13.5	L.O. power may need extra attenuation down to max. 10 dBm
RPG SHM 170-260	170 GHz - 260 GHz	18	13.5	L.O. power may need extra attenuation down to max. 10 dBm
RPG SHM 220-330	220 GHz - 330 GHz	22	13	L.O. power may need extra attenuation down to max. 10 dBm

Mixer Name	Frequency Range	Harmonic Number	Local Oscillator Power	Comment
RPG SHM 325-500	325 GHz - 500 GHz	36	14	L.O. power may need extra attenuation down to max. 10 dBm
"Experimental Mixer"	600 GHz - 1000 GHz	64	15	3rd party / research hardware

When you have edited any parameters, save your settings by clicking the "Save" button  in the "Functions" column.

To add a new entry, click the "Add new External Mixer" button . Double-click the default "Mixer Name" field to enter a name for the new external mixer.

To duplicate an entry, select the entry and click the "Copy" button  either in the "Functions" column or at the bottom of the dialog.

To remove an entry, click the "Delete" button  either in the "Functions" column or at the bottom of the dialog.

The checkboxes in the first column of this table allow you to duplicate or remove multiple external mixers.

When you have completed editing the entries, save your settings by clicking the "Save" button .

If you wish to discard all unsaved changes, click the "Discard all changes" button .

If you wish to restore the original settings, click the "Reset to Default" button .

Mixer Name.....	558
Frequency Range.....	558
Functions.....	558
Mixer Type.....	558
Bias Current.....	559
Harmonic Number.....	559
Local Oscillator Power.....	559
Auto Signal Identification.....	559
Comment.....	559

Mixer Name

Defines the name of an external mixer.

Frequency Range

Defines the start and stop frequency of the mixer.

This value is validated for the corresponding range defined in the [Test Templates for EMI tests](#).

Functions

Allows the user to save, copy or delete an entry.

Mixer Type

Selects either the "2-port" or "3-port" mixer type.

Note: All R&S or RPG harmonic mixer products are three-port mixers.

Bias Current

Defines the mixer's bias current, in steps of 1 mA.

Note: Typically 0 mA. Only single diode mixers require a value other than 0 mA.

Harmonic Number

An integer value that determines the available frequency range, where the number represents multiples of a fundamental frequency. R&S ELEKTRA applies a default value of 8 for a new entry.

Local Oscillator Power

Defines the power consumption of the local oscillator (L.O.), in steps of 0.1 dBm.

If the smallest possible power consumption is too high for the mixer, insert an attenuator such as an amplifier with long cables.

Auto Signal Identification

This setting takes effect only for measurement in [Operating Mode](#) = "Spectrum Analyzer".

If enabled, R&S ELEKTRA performs an additional sweep measurement using the [Auto ID Threshold](#) definition. For more details, refer to the receiver's user manual.

If disabled, R&S ELEKTRA ignores the "Auto ID Threshold", even if you set it.

Comment

Provides additional information on the mixer, for example a recommended attenuator to be used with the mixer.

5 Measurement basics

This chapter introduces the users to the fundamental measurement principles for EMI tests and helps to structure tests in an application-related matrix.

- [Fundamental principles](#)..... 560
- [Test matrix](#)..... 560
- [Detectors](#)..... 562
- [Attenuation in signal paths](#)..... 564

5.1 Fundamental principles

EMI

Electrical appliances that emit electromagnetic waves (conducted or radiated) can interfere with other appliances that receive these waves. With a transmitter, this behavior can be intentional or unintentional.

To ensure reasonable operation of electrical appliances, international [EMC standards](#) regulate the maximum level of emitted interfering power of an appliance.

EMI tests (electromagnetic interference, or emission) that simulate the actual interference situation serve to evaluate the compliance of equipment with these standards. The measurements and the applicable limit lines defined in the standards are frequency-dependent.

EMS

The operation of electrical appliances may be disturbed by radiated electromagnetic fields or conducted electromagnetic power. Hence, an appliance (equipment under test, EUT) may be susceptible to EM disturbance to an unwanted extent. The purpose of EMS (electromagnetic susceptibility) tests is to verify that an EUT is sufficiently "immune" against defined electromagnetic disturbance.

The verification of this immunity is required for the EUT to comply with relevant international [EMC standards](#), which can be product-specific, product-family-specific or generic standards. If a product standard is defined for a certain type of EUT, this standard must be applied. If no such standard exists, a product-family standard must be applied. If this standard also does not exist, the generic standard must be applied.

R&S ELEKTRA controls the automatic or semi-automatic EMS testing of EUTs.

5.2 Test matrix

The type of electrical appliance (EUT) and its field of application determine, which EMC tests must be [performed](#) according to which standard. The following table provides an overview:

Table 5-1: EUT-related test matrix

EUT type	Interference type	Run EMI tests (emission) according to	Run EMS tests (immunity) according to
automotive / boats (with combustion engines)	conducted	CISPR 12 / 25 / 36	ISO 11451 ISO 11452
	radiated		
broadcast	conducted	CISPR 13 / 32	CISPR 20 / 35
	radiated		
household	conducted	CISPR 14-1	CISPR 14-2
	radiated		
industrial, scientific, medical (ISM)	conducted	CISPR 11 / 28	IEC/EN 61326-1 (for measurement, control and lab use) or IEC/EN 60601-1-2 (for medical)
	radiated		
IT equipment	conducted	CISPR 22 / 32	CISPR 24 / 35
	radiated		
lighting	conducted	CISPR 15	IEC/EN 61547
	radiated		
military, aerospace	conducted	MIL-STD-461	MIL-STD-461
	radiated		
multimedia	conducted	CISPR 32	CISPR 35
	radiated		

The regulations in the applicable [EMC standards](#) lead to the following action items:

If you run EMS tests:

- The [measurement devices](#) that you must use
- The [Test Templates for EMS tests](#) that you must configure, including the [Leveling Mode](#) and optionally a [EUT Monitoring Template](#)
- The [System Monitoring](#) that you must apply
- In radiated tests, the measurement distances and angles of incidence that you must observe
- The frequency ranges that you must cover by the various test methods.

If you run EMI tests:

- The [measurement devices](#) that you must use
- The [Test Templates for EMI tests](#) that you must configure
- The [Limit Lines](#) that you must apply
- In radiated tests, the measurement distances between emitter and receiver that you must observe
- The frequency ranges that you must cover by the various test methods.

An example for non-military EMI tests is shown in [Figure 5-1](#):

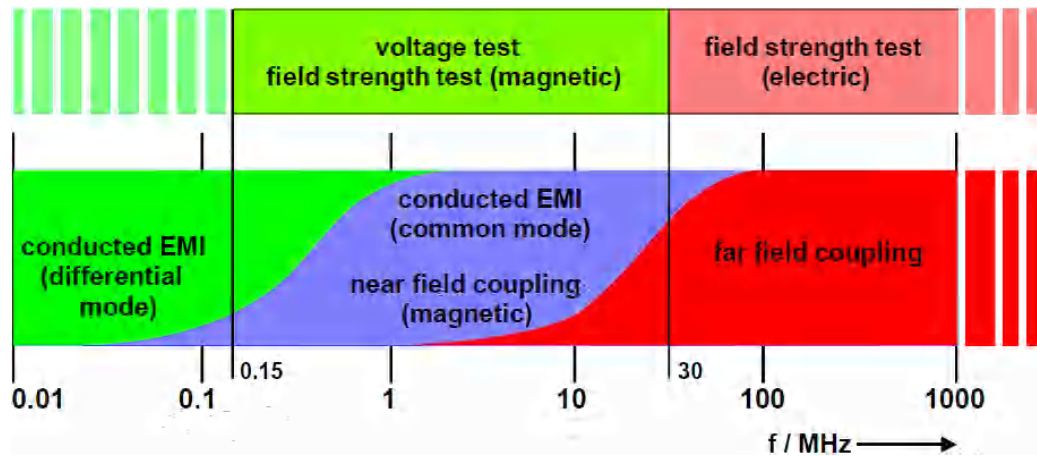

Figure 5-1: Signal propagation and appropriate EMI setups in different frequency ranges

Voltage test	= see EMI tests (with artificial mains network / LISN)
Field strength test	= see Figure 4-35 (magnetic: with loop antenna / electric: with dipole antenna)
Conducted EMI	= see Common mode or differential mode
Near field coupling (magnetic)	= For example, in RFID tests, use an H near-field probe
Far field coupling	= see below

The H near-field probe mentioned above can be, for example, R&S RSH400 or R&S RSH50, available in the probe sets [R&S HZ-17](#) or [R&S HZ-15](#).

Regarding the near-field to far-field transition shown at a frequency $f = 30$ MHz in [Figure 5-1](#), consider the following: At a given distance $r = 10$ m between the EUT and an antenna, the near-field condition $r < \lambda$ is fulfilled at frequencies f below 30 MHz. The reason is that the wavelength $\lambda = c/f$ is then >10 m (with signal propagation speed $c = 3 \cdot 10^8$ m/s). This relation is valid for radiated measurements in EMI tests.

5.3 Detectors

In EMI measurements, detectors are algorithms that specify how to weight the envelope of the measured IF signal.

Table 5-2: Detector types

Detector name	Detector description
AC Video (ACV)	The AC Video (alternating current video signal) detector is commonly used with compromising emanations measurements. The AC Video detector finds the peak-to-peak difference (MaxPeak – MinPeak) of measurement results within a (sweep) pixel or a result. For this purpose, the measurement receiver uses the linear display voltage after envelope detection. The MaxPeak and MinPeak detectors determine the maximum and minimum levels within a shown measurement point and display it as a common measurement result. In logarithmic representation, the logarithm of the difference is formed. In linear representation, the difference itself is shown. Hence, for spectrum analyzer operation, each pixel corresponds to the AC value of the measurement results combined in the pixel. In receiver operation, though, the AC value determined during the measurement time is shown. Irrespective of the signal form (CW carrier, modulated carrier, white noise of pulsed signal), the AC Video detector always supplies the AC component of the signal. If during a frequency sweep the dwell time on a certain frequency point is not sufficient, the displayed results could be incorrect.
AC Video Sine (ACS)	The AC Video Sine detector returns half the signal of the AC Video detector. This output is equivalent with the difference of the MaxPeak or the MinPeak from their common average level.
Average (AVG)	For average measurements, the linear time-averaged value of the rectified voltage at the output of the envelope demodulator is indicated. It is calibrated using the RMS value of an unmodulated sinusoidal signal. If an unmodulated sinusoidal signal is applied to the receiver input, its RMS value is thus indicated. If an AM signal is present, the RMS value of the carrier is indicated. With the ESCS, analog averaging is performed using lowpass filters, the time constants of which are switched depending on the measuring time.
CISPR APD	Available only in the Final Measurement , and only if the hardware setup uses one of the Receiver types R&S ESW, R&S ESR or R&S ESU. If you select "CISPR APD", typically used for testing microwave ovens according to CISPR11, you cannot select any other detector for the final measurement. R&S ELEKTRA remeasures all detected critical points, using the receiver's APD measurement mode. The measurement's outcome does not appear in a "Level" column of the "Final Results" table, but instead in the additional "Delta Level" and "Delta Probability" columns.
CISPR Average (CISPR AV, CAV)	CISPR Average is the weighting average detector according to CISPR 16-1-1. The CISPR average detector supplies a weighted average. When measuring the average according to CISPR 16-1-1, the maximum value of the linear average during the measurement time is displayed. The detector is used, for example, to measure pulsed sinusoidal signals with a low pulse repetition frequency. It is calibrated with the RMS value of an unmodulated sinusoidal signal. Averaging is with lowpass filters of the second order (simulation of a mechanical instrument).
Maximum Peak (MaxPeak, Peak, PK+)	Peak value measurements return the maximum value of the rectified voltage at the output of the envelope demodulator within the selected measuring time. The detector is calibrated using the RMS value of an unmodulated sinusoidal signal that supplies the same detection voltage. Average and peak value of an unmodulated sinusoidal signal basically return the same indication. However, with peak value weighting, the noise voltage indication is about 11 dB higher than with average weighting. Therefore, higher values are indicated when the signal-to-noise ratio is not sufficient. Peak value indication serves for determining the levels of keyed carriers, pulse signals or peak voltages of AM signals. As peak value measurements can be carried out considerably faster than quasi-peak measurements, we recommend for RFI measurements to begin with a general measurement in indicating peak mode. After that, run a quasi-peak measurement at the critical frequencies.
Minimum Peak (MinPeak, PK-)	For negative peak-value measurements, the minimum value of the rectified voltage at the output of the envelope demodulator within the selected measuring time is indicated.

Detector name	Detector description
Quasi Peak (QPK)	Quasi-peak measurement weights pulse signals using a quasi-peak detector with defined charge and discharge time. IF bandwidth and mechanical time constant of the meter are also specified. The characteristics the receiver has in this indication mode are defined in CISPR 16 or in VDE 0876. Due to the long time constants of weighting, it takes relatively long until a valid measurement result is displayed after every change in frequency or attenuation at the receiver. It is therefore futile to use measuring times of less than 1 s, especially for automatic measurements. The maximum level value during the measuring time set is shown on the digital level display. The timing of the quasi-peak test voltage can be observed on the analog meter at the same time. In addition to monitoring of the interference source, this measurement often allows you to draw useful conclusions as to the character of the interference. Quasi-peak weighting places high demands on the dynamic characteristics of the receiver. With low pulse frequencies, however, the operating range cannot be fully utilized, as otherwise the RF input would be overloaded. When an overload occurs, the software informs you about it by way of the overload indication () in the test window. In this case, increase the RF attenuation to such an extent that the overload message disappears. In automatic operation, the receiver itself correctly sets the attenuation.
RMS	For RMS value measurements, the RMS value of the rectified voltage at the envelope demodulator output is indicated. Irrespective of the signal shape, the envelope demodulator power is indicated. Analog RMS value generation is performed. The time constant for RMS value generation is set via the measuring time and is identical with the time constant of average value generation with the measuring time already specified.
RMS x MHz	For example "RMS 100 MHz", a calculated pseudo detector with a "virtual" measurement bandwidth of 100 MHz. Typically used for final measurements at high frequencies in the mm-wave range (FR2), where measurement bandwidths up to 1 MHz of conventional detectors are too low. According to standard ETSI EN 301 908-1 of 2021, this detector uses multiple measurements with 1 MHz BW. From these measurements, it uses integration to artificially create a calculated output that represents a single measurement with x MHz BW. Due to the artificial nature of this detector, you cannot combine it with any other detector in the same measurement. Consider specifying the required frequency range with an additional $\pm x/2$ MHz (for example: ± 50 MHz) to allow for an overlap, such that there is sufficient frequency range adjacent to the center frequency of the detector to perform the virtual bandwidth calculation. For more information regarding RSE and how R&S ELEKTRA implements 5G standards, contact Rohde & Schwarz and request the most recent application notes.
RMS Average (RMSAV)	RMS Average is the weighting detector according to an amendment of CISPR 16-1-1 (CISPR/A/628/CD). The RMS average detector supplies a weighted reading of the input signal. When measuring the RMS average according to the amendment, RMSAV returns the maximum value of the RMS average during the measurement time. This detector is used, for example, to measure pulsed sinusoidal signals with a low pulse repetition frequency. It is calibrated with the RMS value of an unmodulated sinusoidal signal. Averaging uses lowpass filters of the second order (simulation of a mechanical instrument).
RMS Selective Measurement (RMS SEL)	Available only in CAL template > Audio Breakthrough measurements with the R&S UPV audio analyzer. For reference, see Device List > Audio Analyzer > Type = "UPV" > Functional Check > Analyzer > Analyzer Function > "Detector" . The RMS SEL detector uses a selective filter, which can either select or exclude frequencies in a given (typically narrow) frequency band. At the same time, you can set the detector to measure in the selected frequency range according to one of the following modes: It can measure just the DC component of the signal, or it can suppress the DC component and measure the signal's remaining RMS level.
Sample	Displays the level value that is measured first in a particular statistical bin, and ignores all other values measured in such a bin.

5.4 Attenuation in signal paths

Due to RF attenuation in signal paths, for example in cables, the RF power level at one end of the path can differ from the level at the other end. Depending on the precision

requirements of your application, if the attenuation is low, you can neglect it. Neglecting is equivalent with specifying 0 dB attenuation in a given path.

Otherwise, if you do not want to neglect attenuation effects, specify the attenuation characteristics of your signal paths by constant values or by frequency-dependent [attenuation tables](#). R&S ELEKTRA can use this information for power level compensation: It can calculate the power at one end of a signal path, if it knows the power at the other end and the level of attenuation in the path.

For a description on how to calibrate signal paths, see [Chapter 8.1, "Signal path calibration"](#), on page 646.

5.4.1 EMI measurement correction

Based on the receiver's raw measurement data, R&S ELEKTRA can calculate the [emission level](#). This chapter describes, how the software uses [attenuation tables](#) referenced in a [signal path](#) and [transducer correction tables](#) for this calculation.

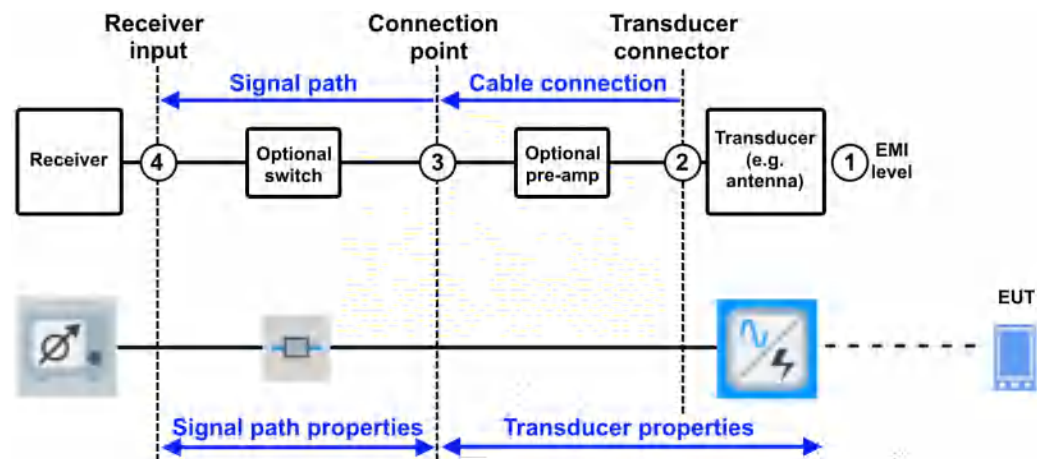

Figure 5-2: Paths in an EMI hardware setup that can contribute to signal attenuation

1 to 4 = Measurement points

Path [1-2] = Transducer input to output, see fixed correction value or [transducer correction table](#) specified in the [Transducer Factor](#) dialog

Path [2-3] = Transducer output to connection point, see fixed value or [attenuation table](#) specified in the transducer's [Cable Correction](#) dialog

Path [3-4] = Connection point to receiver input, see constant value or one or more [attenuation tables](#) specified in the [Measurement Correction](#) dialog of the [signal path](#)

- If the EMI hardware setup is radiated, hence if the transducer is an antenna, the setup typically uses the connection point of a shielded chamber and includes a pre-amplifier (optional).
If there is a pre-amplifier, enter its gain as a negative attenuation in the [Measurement Correction](#) dialog. Alternatively, consider entering the gain information as negative attenuation in the cable properties or in the signal path's attenuation.
- In conducted setups, the transducer's cable is often connected directly to the receiver, and the signal path [3-4] in [Figure 5-2](#) does not exist.

A [signal path](#) can contain a [Switch Unit](#). Select it in the [Device List](#) > [Signal Path](#) > [Measurement Correction](#) > "Switching Path" dialog.

Calculating the emission level

The following equation shows, how R&S ELEKTRA calculates the emission level at measurement point 1. The algorithm uses the raw level reading, measured by the RF receiver at its input (measurement point 4, typically in dBμV). The emission level depends on the path correction:

- ▶ Emission level = receiver level + correction [1-2] + correction [2-3] + correction [3-4]

5.4.2 EMS power correction

This chapter describes, which signal-path attenuation values the EMS [power leveling](#) algorithm uses to calculate power values, which can be monitored in the [System Monitoring](#). R&S ELEKTRA corrects the readings of the forward and reverse [power meter](#), defined in a [frequency range](#) of a [hardware setup](#) with the attenuation of the [signal paths](#) between the devices.

Directional coupler (DC) near amplifier output

In the typical hardware setup for most EMS test systems, the directional coupler is mounted **close to the amplifier** or even integrated **in the amplifier**. In this configuration, the cable attenuation between amplifier output and DC input is <1 dB and can be neglected.

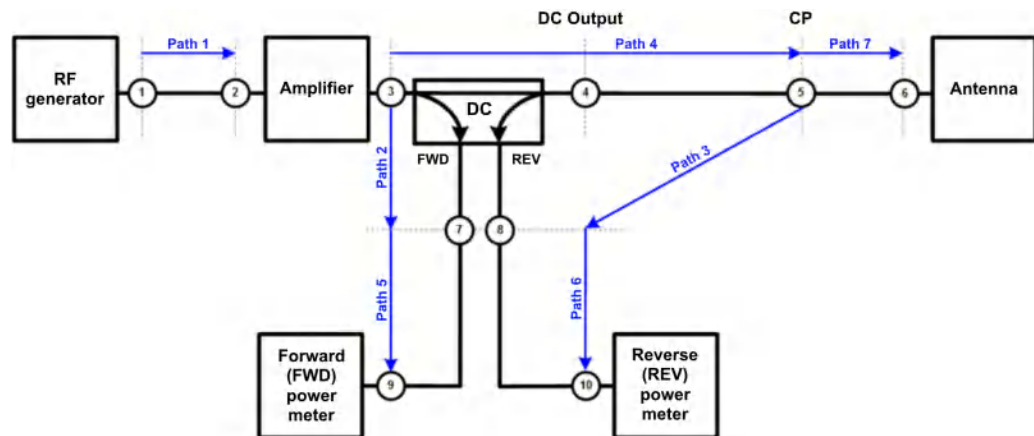

Figure 5-3: Devices and signal paths, with DC close to amplifier

- DC = Directional coupler
- CP = Connection point of a shielded chamber
- 1 to 10 = Measurement points, see [Table 5-3](#)
- Path 1 = [Generator output to amplifier input](#), see [signal path > measurement correction](#)
- Path 2 = [Amplifier output to DC forward](#), see [amplifier power correction](#)
- Path 3 = [CP to DC reverse](#), see [amplifier power correction](#)
- Path 4 = [Amplifier output to CP](#), see [signal path > measurement correction](#)
- Path 5 = [DC forward to forward power sensor](#), see [signal path > measurement correction](#)
- Path 6 = [DC reverse to reverse power sensor](#), see [signal path > measurement correction](#)
- Path 7 = [Optional antenna cable from CP to antenna input](#), see [antenna > measurement correction](#)

Follow exactly [Figure 5-3](#) when you measure the paths or add the paths as table values.

The following table shows, how R&S ELEKTRA calculates the power at the measurement points, using the readings of the forward and reverse power meters.

Table 5-3: Measurement points with asymmetrical DC

Measurement point # in Figure 5-3	Power level	Calculation
2	Amplifier input power	Generator level - Path 1
3	Amplifier forward power	Forward power meter level + Path 2 + Path 5
3	Amplifier reverse power	Antenna reverse power - Path 7 - Path 4
6	Antenna forward power	Amplifier forward power - Path 4 - Path 7
6	Antenna reverse power	Reverse power meter level + Path 6 + Path 3 + Path 7

Directional coupler (DC) near antenna input

In some EMS hardware setups, the directional coupler is mounted **close to the antenna**. In this configuration, the cable attenuation between DC output and antenna input is <1 dB and can be neglected.

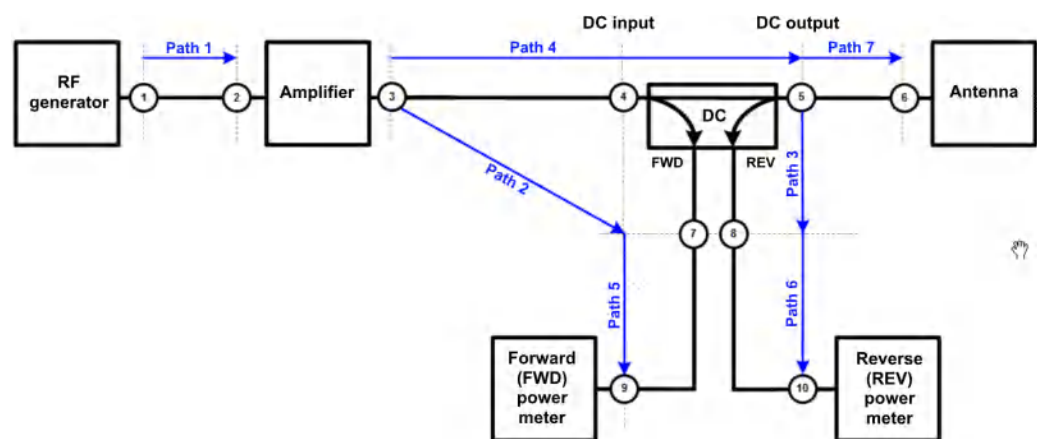

Figure 5-4: Devices and signal paths, with DC close to antenna

DC = Directional coupler

1 to 10 = Measurement points, see [Table 5-4](#)

Path 1 = [Generator output](#) to [amplifier input](#), see [signal path > measurement correction](#)

Path 2 = [Amplifier output](#) to DC forward, see [amplifier power correction](#)

Path 3 = DC output to DC reverse, see [amplifier power correction](#)

Path 4 = [Amplifier output](#) to DC output, see [signal path > measurement correction](#)

Path 5 = DC forward to [forward power sensor](#), see [signal path > measurement correction](#)

Path 6 = DC reverse to [reverse power sensor](#), see [signal path > measurement correction](#)

Path 7 = Optional antenna cable from DC output to antenna input, see [antenna > measurement correction](#)
(Path 7 is typically set to 0 dB)

For Path 2 and Path 3, you must use the [power correction](#) settings in the [amplifier](#) properties dialog.

Measurement points with asymmetrical DC (on-board transmitter tests)

- ▶ Several EMS tests that simulate on-board transmitters (like FORD RI115) require measuring the net power at the antenna input. Because this measurement requires mounting the DC directly at the antenna input, R&S ELEKTRA must apply the modified paths as in [Figure 5-4](#).

The following table shows, how R&S ELEKTRA calculates the power at the measurement points, using the readings of the forward and reverse power meters.

Table 5-4: Asymmetrical DC in automotive standards (measuring net power)

Measurement point # in Figure 5-4	Power Level	Calculation
2	Amplifier input power	Generator level - Path 1
3	Amplifier forward power	Forward power meter level + Path 2 + Path 5
3	Amplifier reverse power	Antenna reverse power - Path 7 - Path 4
6	Antenna forward power	Amplifier forward power - Path 4 - Path 7
6	Antenna reverse power	Reverse power meter level + Path 6 + Path 3 + Path 7

6 Special software features

This chapter provides helpful information for operating some specific features of R&S ELEKTRA, typically in the [graphical user interface \(GUI\)](#).

• Handling changed items	569
• Dashboard search	569
• Searches	570
• Arranging elements in tests	573
• Keyboard shortcuts	576
• Creating customized reports	577
• Data exchange	585
• Remote control	591

6.1 Handling changed items

If you change any content in a dialog that supports saving, the "Save" button of the dialog is marked by an asterisk (*).

- To keep the changes (upon closing the dialog, at the latest), select "Save" or "Save As".
- To discard the changes upon closing the dialog, select "Don't Save". To avoid accidental loss of data, R&S ELEKTRA prompts you to confirm, if you would like to save your changes or not.
- To return to the dialog without saving and without closing it, select "Cancel".



Changed content or items are handled differently in the "Device List", see [Save all changes](#), [Discard all changes](#), [Save](#) and [Delete](#).

6.2 Dashboard search

When you enter a keyword in the search field (top right in the [Dashboard](#) dialog), the software immediately starts searching for items that meet the search criteria. The search results, which are displayed in a drop-down hit list, also depend on the activated filter button:

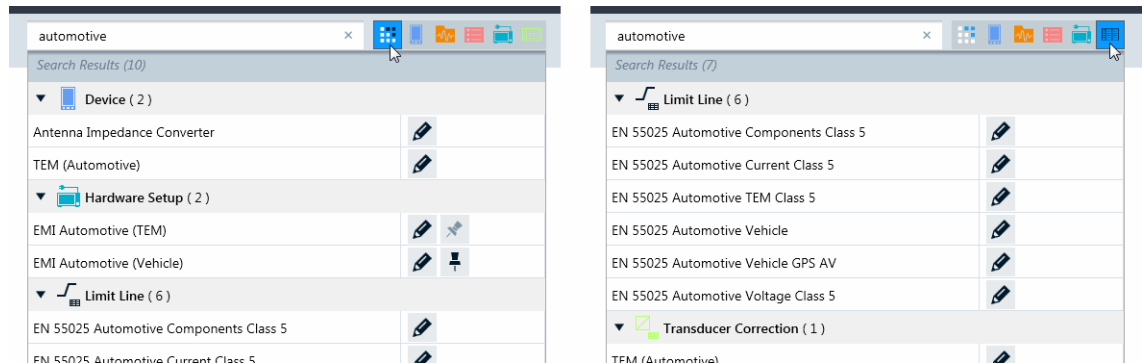

Figure 6-1: The dashboard search and its filter buttons

For example:

- When you select the left filter button ("Search All"), as shown on the left in [Figure 6-1](#), the hit list comprises all categories of items.
- When you select the right filter button ("Search Tables"), as shown on the right in [Figure 6-1](#), the hit list comprises only tables.



The dashboard search function includes search terms from the following features of items:



- Names, for example the names of test templates, tests or tables
- Application types, for example EMI, EMS, or CAL
- Frequency values, as part of, for example, a device's or table's frequency range
- Tags

Also, EUTs and test templates in the archive are not searchable from the dashboard. To search for these items, go to the [Archive](#).



To open a found item directly from the hit list, click the "Open" button  next to it.

If a "Create Test from Template" button  is shown next to a test template in the search results, you can create this test directly from the hit list.

If a "Pin to Dashboard" button  or  is shown next to a search result, you can pin it directly from the hit list to the dashboard.

If a search result is already pinned to the dashboard, an "Unpin from Dashboard" button  or  is shown next to it. You can unpin this item directly by clicking the button in the hit list.

6.3 Searches

R&S ELEKTRA offers a versatile search and filter functionality. Many dialogs provide a field for entering a search term  and for setting filters :

EUT	Name	Te...	Test Verdict	Frequency Ra...	Meas...	User...	Chan...
<input type="checkbox"/>	CPE11 1 TimeDomain, 4-Line LISN		Passed	9 kHz to 30 MHz	EMI	nd	04.08.21
<input type="checkbox"/>	CPE11 2 Voltage EMI, TRD2, TimeDomain		Passed	9 kHz to 30 MHz	EMI	gk	04.08.21
<input type="checkbox"/>	CPE11 3 Voltage Scan, 2-Line-LISN		Inconclusive	9 kHz to 30 MHz	EMI	fp	04.08.21
<input type="checkbox"/>	CPE11 4 Current EMI, Stepped Scan		Passed	9 kHz to 30 MHz	EMI	bg	04.08.21

Figure 6-2: Example: Results of a search for the string "100kHz" in the list of tests

"100kHz" = Search string in the search field

"100 kHz" = User-defined name to label and pin this search

"Select Search" = Field for selecting pinned searches

To sort the list of search results by one of its headline parameters in ascending or descending order, click this headline parameter. For example, click "Change Date" to sort the list's content in the order of the latest date of saving.

To confine the currently displayed list of items to those items that contain a certain **search** criterion, enter it into the search field , as shown in [Figure 6-2](#).

Permitted search criteria are:

- **Arbitrary text.** Any text string that could appear in the name of an item, in its description, in the "User Tags" or similar fields.
- **Physical data.** For example, searching the list of "Tests" for the frequency value *7 GHz* finds items that are specified for the frequency range *1 to 8 GHz* or for *3 to 24 GHz*. However, this search does not find an item that is specified for *150 kHz to 30 MHz*.

To confine the currently displayed list of items to those items that contain a certain **filter** criterion, click the filter button . In the "Filters and Tags" subdialog that opens, select from the available filter criteria, see [Figure 6-3](#). R&S ELEKTRA adds the selected filter criterion to the search field as a search string. If there is already some search string, before you add a new filter criterion, the software combines the strings in the search field by a Boolean "AND" operation.

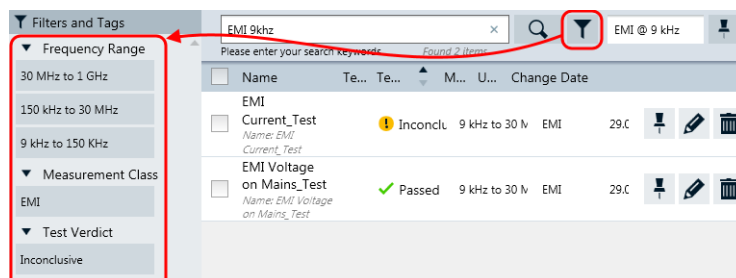



Figure 6-3: The filter button opens the list of available filter criteria

To close the "Filters and Tags" subdialog, click the filter button  again.

Pinning and selecting searches



To **pin** the current search to the "Dashboard" dialog, specify a user-defined name for your search and select "Add to Dashboard" . The search is shown there as an item with magnifying lens icon among the appropriate category of items. For example, a pinned "Test" search (from the original dialog "Tests") is shown together with the other "Test" items that you have pinned to the "Dashboard" (see [Figure 3-5](#)).



Since you cannot pin **Tables** to the "Dashboard", the following exception applies: You can only access saved searches for tables in the "Select Search" field of the respective table's list dialog.

To reopen a search result list in the original dialog, click its search item in the "Dashboard" dialog. Alternatively, within the search's original list dialog (for example "Tests"), open the drop-down list in the field "Select Search" and click the name of the search. The reopened result list includes all items that meet the search criteria, also those items that have been created after defining the search.

To cancel the current search or filter in the original dialog, click the "x" button in the search field. Note that this action leaves pinned searches in the "Dashboard" dialog untouched.

There are two ways to remove a search from the list dialog's "Select Search" field:

- Open the drop-down list in the "Select Search" field and click the "x" button next to the search you want to remove. This action also unpins the corresponding search item from the "Dashboard" dialog.
- Go to the "Dashboard" dialog and **unpin** the corresponding search item there. To do so, check the checkbox in the top-right corner of the search item and click the "Unpin from Dashboard"  button in the actions bar. This action also removes the corresponding search item from the drop-down list in the "Select Search" field of the original dialog.



Each list of items (e.g. "Tests") remains reduced, as long as a search or filter criterion is entered in the search field. This reduction pertains even after leaving the dialog and returning to it, later on. To see all items in a list, make sure to clear the search field (which also removes any filters) by clicking the "x" button in the search field.

If at some point you return to a list and miss any items, we recommend checking the search field for any entries that you may have left there unintentionally.



Dashboard search

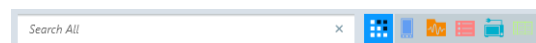

For a description of the dashboard search, see [Chapter 6.2, "Dashboard search"](#), on page 569.



6.4 Arranging elements in tests

You can rearrange the following elements of a test window:

- Charts (top)
- Tables (bottom)
- Dialogs (or control elements) in the [side panels](#)
- [Charts and tables](#).....573
- [Dialogs](#).....574
- [Cross icons](#).....575

6.4.1 Charts and tables

For arranging **charts** and **tables**, R&S ELEKTRA offers the following features:

- To minimize the charts or tables, click their top bar. The charts or tables become as slim as their top bar, placed at the top or bottom edge of the test window. Minimizing both charts and tables leaves their top bars visible, only.
If originally both graphics and tables are visible (half screen, each), minimizing the graphics shows the tables in full size, and vice versa.
- To open a minimized chart or table, click the slim bar that represents the minimized element. Opening the graphics while the tables are minimized shows the charts in full size, and vice versa.
- To change the ratio of shared space of graphics and tables, move the mouse pointer over the separation line between graphics and tables, until the pointer becomes an arrows icon. Drag this vertical arrows icon down to enlarge the charts and reduce the tables, or vice versa.
- To arrange several charts or several tables either horizontally or vertically or to cascade them behind each other, use the buttons .
- To make a chart or table **float** over the test window, click and hold its top bar and drag it out of its original position. As a result, the chart or table jumps out of its original position and floats nearby.
This feature is only available, if more than one chart or more than one table is opened in the test window.
- To move a floating chart or table to an arbitrary position, click and hold its top bar and drag it to the desired position.
Note that you cannot immediately drag a chart or table anywhere, after you made it float by dragging it out of its original position. Instead, you must release the mouse pointer, then click and hold the element's top bar again and drag it to the desired position.
- To resize a floating chart or table, move the mouse pointer over any edge of the chart or any corner of the table, until the pointer becomes an arrows icon. Drag this arrows icon to resize the dialog.
- To move a floating chart or table back to its original position, click the "Window Position" button () again and select "Dock".

- You can dock a floating chart or table in the central region of the test window. To dock a floating chart or table, click and hold its top bar and drag it to a position where a cross icon appears:



Proceed as described in [Chapter 6.4.3, "Cross icons"](#), on page 575.

6.4.2 Dialogs

For arranging dialogs, R&S ELEKTRA offers the following features:

- To minimize a dialog, click the vertical "Auto Hide" button (☰). The dialog becomes a slim tab marker at the left or right edge of the test window.
- To open a minimized dialog (instead of its slim tab marker), click the tab marker. A slim version of the dialog opens, in which you can click the horizontal "Auto Hide" button (☰). This action opens the dialog in its original position.
- To make a dialog **float** over the test window, click the "Window Position" button (☑) and select "Float".

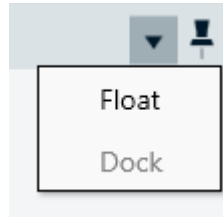

Note: If you use more than one screen, the floating dialog can have jumped to a different screen than the original one.

- To resize a floating dialog, move the mouse pointer over any of the dialog's edges or corners, until the pointer becomes an arrows icon. Drag this arrows icon to resize the dialog.
- To move a floating dialog back to its original position, click the "Window Position" button (☑) again and select "Dock".
- To move a floating dialog to an arbitrary position, click and hold its top bar and drag it to the desired position.
- You can dock a floating dialog in the left or right region of the test window. To dock a floating dialog, click and hold its top bar and drag it to a position where a cross icon appears:



Proceed as described in [Chapter 6.4.3, "Cross icons"](#), on page 575.

6.4.3 Cross icons

This chapter describes positioning a floating element, such as a [chart](#), [table](#) or [dialog](#) in a test window, with the help of a cross icon.

The cross icon can appear in two versions:

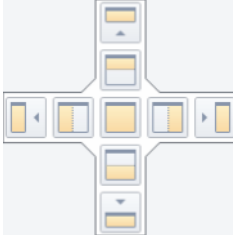
- 
- 

It comes up in the following procedure:

1. Click and hold the top bar of a floating element (chart, table or dialog).
2. Drag it to any position where you can dock the element.
The cross icon appears.
3. Keep holding the element at its top bar.
4. Without letting the element go, drag the mouse pointer over any of the square sections of the cross icon.

An outline like in [Figure 6-4](#) comes up that corresponds with your selection in the cross icon:

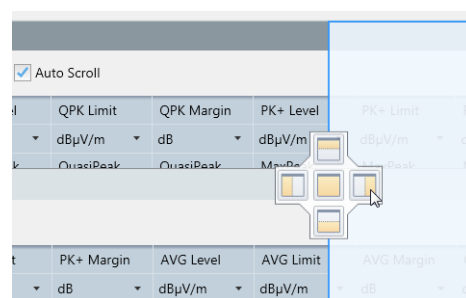

Figure 6-4: When using the cross icon for positioning a table, an outline appears in light blue color

In this example, the mouse pointer is positioned over the square section on the right-hand side of the cross icon. This mouse position creates an outline (shown in light blue color) in the place, where you can dock the element. In [Figure 6-4](#), the outline indicates that the element can be docked at the right-hand side.

5. Release the mouse pointer.

The element is docked in the outlined position.

To move an element to a different position, use any of the features described in [Chapter 6.4.1, "Charts and tables"](#), on page 573 and [Chapter 6.4.2, "Dialogs"](#), on page 574.

6.5 Keyboard shortcuts

If you are looking for a keyboard shortcut (or "shortkey", "short key") to a software function, refer to the following tables:

Table 6-1: Shortcuts for moving the selected marker in a chart

Shift+P	Moves to peak
Ctrl+P	Moves to next peak
Shift+M	Moves to minimum
Ctrl+M	Moves to next minimum

Table 6-2: Shortcuts for modifying the axes in a chart

Shift+X	Auto-scales X axis
Shift+Y	Auto-scales Y axis
Ctrl+X	Toggles log-mode for X axis
Ctrl+Y	Toggles log-mode for Y axis

Table 6-3: Shortcuts for modifying the zoom in a chart

Shift+ +	Enables (further) zoom-in
Shift+ -	Switches off zoom

Table 6-4: Shortcuts for modifying the legend in a chart

Shift+L	Toggles legend off/on See also Table 6-9 .
---------	---

Table 6-5: Shortcuts for navigating in the home menu

Alt+A	Expands the Administration node
Alt+B	Expands the Tables node
Alt+D	Shows the Dashboard view
Alt+E	Shows the EUTs view
Alt+H	Shows the Hardware Setups view
Alt+M	Shows the Test Templates view
Alt+O	Shows the Export view
Alt+R	Shows the Report Templates view
Alt+T	Shows the Tests view
Alt+V	Shows the Device List view

Table 6-6: Shortcuts in the Actions section of the test template editor

Alt+↑	Moves selected item up (if several items are in one node)
Alt+↓	Moves selected item down (if several items are in one node)

Table 6-7: Shortcuts to be used in the text editor (for example, for viewing the test-flow log)

Ctrl+F	Shows search box (find mode) Available also in content window of Help dialog, for example. See also Table 6-8 .
--------	---

Table 6-8: Shortcuts to be used in the table editor (for example, for viewing a transducer table)

Ctrl+F	Goes to a frequency
Ctrl+G	Goes to a table row
Ctrl+O	Goes to a table row

Table 6-9: Other global shortcuts (some are valid in some dialogs, only)

F1	Provides Help (context sensitive)
Ctrl+A	Selects all content
Ctrl+C	Copies selected content
Ctrl+X	Cuts selected content
Ctrl+V	Pastes copied or cut content
Ctrl+S	Saves content
Ctrl+Shift+S	Saves all
F12	Saves as
Alt+X	Generates Troubleshooting information
Alt+L	Shows the Logs window
Alt+I	Shows the ELEKTRA Spy window

6.6 Creating customized reports

Custom reporting allows using R&S ELEKTRA together with your own external report templates in XML format (`.dotx`), which is supported by MS Word and other open-document-type editors.

Prerequisites



- You have installed and enabled the [license](#) "ELEM-REP" for report customization, which requires that a [dongle](#) with this license is connected.
- You have prepared the following documents in advance:
 - An external main report template in `.dotx` format, which provides the header, footer and EUT information for the tests



- External subreport templates in `.dotx` format for all test categories that you want to perform

For creating these external report templates, you can use existing reports, for example MS Word documents, and save these reports as template documents. You can later edit your external report templates as described in the procedure [Refining customized report templates](#).

Custom reporting procedure

1. Create or open an [EUT description](#).
2. Enable custom reporting by activating [Use external templates for reporting](#) in the [EUT description](#).

If it was not enabled before, and if the default [Export Format](#) was PDF, the button  changes to  in the [Test-Plan Action Buttons](#).

3. In the [External Report templates](#) tab, select the main report template and all required subreport templates. Note that in new EUTs, R&S ELEKTRA presets these templates, if you have configured it to do so in the [Administration > Report > Reporting Templates > External](#) dialog.
4. In the [Test Plan](#) tab > [Test-Plan Action Buttons](#), add a root folder  to the "Test Step" list.
5. Optionally add more root folders or sub folders.
6. Give speaking names to the folders, according to the tests that you want to perform.
7. In the folders, add your desired test steps by using the [test-specific action button](#) .
8. Configure the test steps in the [Test Step Details](#).
9. Save the EUT description.
10. Run a test step .
11. When the test is completed, save it.
12. Return to the EUT description.

The EUT description is automatically reloaded to include the completed test.
13. If you want to apply [Test-Plan Action Buttons](#) on this completed test step, select it by ticking its checkbox. Find the checkbox left of the test step's name, visible when you hover your mouse pointer over the test step).
14. If you want to include this test into your report, ensure that the button "Include this Test in the Report"  is enabled in the [Test-Specific Action Buttons](#).
15. Repeat the procedure from [step 10](#), until all tests are completed.

[Figure 6-5](#) shows a test plan with 2 tests completed.

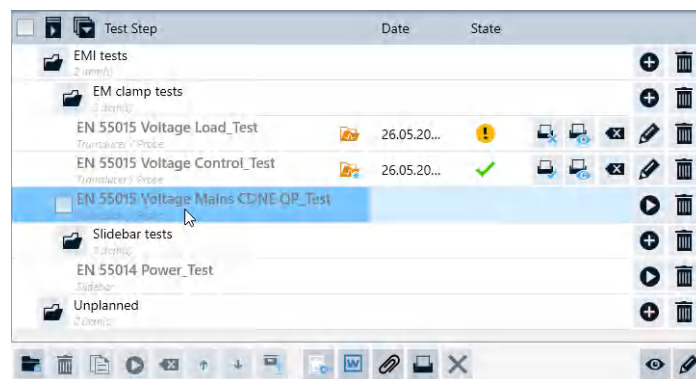





Figure 6-5: Example of a test plan being executed step by step

16. When all tests are completed, save the EUT description.
17. Click **"Create a Report"** .

R&S ELEKTRA generates the summary report, using your XML report templates. If report templates were changed after having been selected in [step 3](#), a warning comes up to alert you of the changes. Go to the [External Report templates](#) tab and select the required report templates, again.

If not all required report templates are available or not all required specifications in the report templates are met, a warning comes up to alert you of the problems. Note that you can check a reporting log file for details of these problems. To see the log file, click the "Open Report Log" button  in the [Test-Plan Action Buttons](#) (lower right in [Figure 6-5](#)).

Otherwise, if all prerequisites are valid, a dialog opens for saving the report in `.docx` format.

18. Save the report.
 - A "Report Status" dialog opens.
19. In this dialog, select "Open Report" to verify that it was created correctly.
 - Otherwise, to open the report after closing the "Report Status" dialog, click  "View last generated/attached report".
 - Or open it by going to the directory, to which you have saved the report.
20. To modify your report templates in a customized way, proceed as described in [Refining customized report templates](#).

Refining customized report templates

1. Open an existing test.
2. In the [Test container](#), go to the "Report Templates" section.
3. If the "Report Templates" section is closed , click the icon to open it .
4. If no report template is available in this section, right-click to "Add a global Report Template" or create a "New Report Template".
5. If you have added a global report template, double-click its name.

The report editor opens in the center of the window.

6. Adapt the report template to your needs, as in [Chapter 4.6.1, "Configuring report templates"](#), on page 325.
7. Right-click the report template's name in the test container ("Test Content").
8. Select "Copy report syntax to clipboard".
9. Open an editor program like MS Word, for example, or another compatible open-document-type editor.
10. Paste the content of the clipboard into the editor, for example with shortcuts [Ctrl]+[V].

Depending on the configuration of your report template, text code in XML format appears, representing the configured report components (graphics, tables). For an example, see [Example of XML text code](#).

11. Use sections of this XML code to generate interactive elements in customized report templates:
 - a) Keep the sections between the **start tag** "<ELEKTRA>" and the **end tag** "</ELEKTRA>" together. Do not remove any tags.
 - b) Lines with the start tag "<COMPONENT>" indicate, what a certain section introduces into the report:
 - "NEWPAGE" (a page break)
 - "EUTINFO"
 - "VERDICTSUMMARY"
 - "TESTINFO"
 - "COMMONINFORMATION"
 - "TESTTEMPLATE"
 - "EUTMONITORINGTEMPLATE"
 - "DEVICELIST" (instruments and accessories used in a test)
 - "HWSETUP" (hardware setup)
 - "MEASUREMENTS" (test results)
 - "IMAGE" (for example, a photo or illustration)
 - "GRAPHICS" (test charts)
 - "TABLES" (for example, limit lines or attenuation tables)
 - c) Adhere to the explanatory **comments** in lines, which start with the characters "<!--". For example, as indicated in the comments, you can use some sections in a main report template, only, and other sections in subreport templates, only. If you prefer to remove comment lines, you can do so without compromising functionality of your XML report templates.

- d) Substitute (replace) the names of **table styles** and **heading styles** with the names of those styles in your editor, which you want to apply to the tables and headings. Examples:
- Replace "<TABLESTYLE>TABLESTYLE 1</TABLESTYLE>" by "<TABLESTYLE>Grid Table 3</TABLESTYLE>".
 - Replace "<HEADINGSTYLE>HEADINGSTYLE 1</HEADINGSTYLE>" by "<HEADINGSTYLE>Title</HEADINGSTYLE>".
- e) For "IMAGE", "GRAPHICS" and "TABLES", the attribute "**LANDSCAPE**" = "FALSE" is the default, hence the image, graphic or table is displayed in portrait format. To display it in landscape format, set "LANDSCAPE" = "TRUE". For more specific nodes and attributes, see [Image details](#), [Graphics details](#) and [Table details](#).
- f) For "TESTTEMPLATE", "EUTMONITORINGTEMPLATE" and "HWSETUP", the attribute "SHORT" = "TRUE" is the default, hence a reduced number of details are included into the report. To show more details of the template or setup in the report, set "SHORT" = "FALSE".
- g) For "MEASUREMENTS", the attribute "USEFOLDERSTRUCTURE" = "FALSE" is the default, hence only the test name is included in the measurement's heading. To include the folder names defined in the [Test Plan](#) (labeled "F" in [Figure 4-7](#)) into the heading, set "USEFOLDERSTRUCTURE" = "TRUE".
12. Save the completed [XML](#) report template with a speaking name and in `.dotx` file format in an arbitrary directory of your computer.
13. Load the customized main and subreport templates into the [External Report templates](#) tab of an [EUT description](#).
Alternatively, if you want R&S ELEKTRA to use your customized report templates for each new EUT, load the templates into the [External](#) tab of the [Administration > Report](#) dialog.

Image details

For "IMAGE", the following additional nodes and attributes are available:

- "WIDTH" in mm
- "HEIGHT" in mm
- "ALIGNMENT", can be "LEFT", "CENTER" or "RIGHT"
- "ASPECTRATIO", if "TRUE" the ratio of height over width is maintained (hence, changing the height resizes the width), if "FALSE" the ratio is not maintained
- "SOURCE", make sure that this attribute remains set to "SYSTEM" for each main template, hence the image must be located in the system, only
- "TITLE", enter an arbitrary image title
- "NAME", enter the image filename. If the image is located in the system, enter both the path and the name of the file.

Graphics details

For **"GRAPHICS"**, the following additional nodes and attributes are available:

- "ROW" must be 1
- "COLUMN", number of graphics arranged horizontally, minimum is 1, maximum is 4
- "GRAPHIC" > "NAME": enter the name (or caption) of the graphic. For global report templates (created outside test), a name in [square brackets] is interpreted as an application-specific keyword (see [Table 6-10](#)). Without brackets, it is used directly as the name (in generic graphics: with attribute "GENERIC" = "TRUE").
- "USEFIGURENAME" (in the "CAPTION" node with "KEY" = "FIGURE"): if "USEFIGURENAME" = "FALSE" the content of the "TEXT" node is used as caption, if "TRUE" the content of the "GRAPHIC" > "NAME" node is used as caption.
- "TEXT", optional arbitrary text that can be used as name of the graphic, depending on the attribute "USETABLENAME" (see above). If multiple text nodes exist, the text contents are concatenated with an underscore ("_").
The caption text supports one single use of the keyword "[TESTNAME]" in square bracket. If this keyword is detected, it is replaced with the name of the test to which the component belongs.

Table 6-10: Graphics names

"GRAPHIC" > "NAME" keywords	Description	Application
[Spectrum Overview]	Spectrum overview chart	EMI
[Spectrum Overview H]	Spectrum overview chart, horizontal polarization	EMI
[Spectrum Overview V]	Spectrum overview chart, vertical polarization	EMI
[Spectrum Overview Trace]	Spectrum overview chart, combined from several measurements	EMI
[Critical Points]	Critical points chart	EMI
[Final Results]	Final results chart	EMI
[All]	All charts (in EMS tests) Calibration charts (in calibration measurements)	EMS, CAL
[System Monitoring]	System monitoring charts	EMS
[EUT Monitoring]	EUT monitoring charts	EMS
[Test Level]	Test level chart	EMS
[Sensor Level]	Sensor level chart	EMS
[Gen Out]	Generator output level chart	EMS

Table details

For **"TABLES"**, the following additional nodes and attributes are available:

- "TABLE" > "NAME": enter the name (or caption) of the table, for example "Spectrum Overview", "Critical Points" or "Final Result".

- "COLUMNS" > "NAME": selects the columns (of an application-specific table) to be included in the report. For global report templates (created outside test), a name in [square brackets] is interpreted as an application-specific keyword (see [Table 6-11](#)). Without brackets, it is used directly as the name.
- Generic tables (with attribute "GENERIC" = "TRUE") can omit the "COLUMNS" > "NAME" node.
Instead, generic tables require specifying the following attributes:
 - "TABLETYPE" (in the "NAME" node), for example "Attenuation"
 - "USETABLENAME" (in the "CAPTION" node with "KEY" = "TABLE"): if "USETABLENAME" = "FALSE" the content of the "TEXT" node is used as table name, if "TRUE" the content of "TABLE" > "NAME" node is used
- "TEXT", optional arbitrary text that can be used as table name, depending on the attribute "USETABLENAME" (see above). If multiple text nodes exist, the text contents are concatenated with an underscore ("_").
The caption text supports one single use of the keyword "[TESTNAME]" in square bracket. If this keyword is detected, it is replaced with the name of the test to which the component belongs.

Table 6-11: Table columns

"COLUMNS" > "NAME" keywords	Description	Application
[All]	All columns	EMI, EMS
[Detector 1]	Column linked to detector 1 in template	EMI
[Detector 2]	Column linked to detector 2 in template	EMI
[Detector 3]	Column linked to detector 3 in template	EMI
[Detector 4]	Column linked to detector 4 in template	EMI
[Correction Sum]	Correction sum column	EMI
[Correction Sum Details]	Correction Sum column	EMI
[Meas Time/BW]	Measurement time and bandwidth column	EMI
[Date Time]	Date time column	EMI, EMS
[Accessories]	All accessories column	EMI, EMS
[System Monitoring]	System monitoring channel columns	EMS
[EUT Monitoring]	EUT Monitoring Channel Columns	EMS
[Modulation]	Modulation column	EMS
[Comment]	Comment column	EMI, EMS

Example of XML text code

To get XML text as shown below, use the function "Copy report syntax to clipboard" as described in the procedure [Refining customized report templates](#).

```
<!--Skeleton Custom Template Syntax..Please adapt as needed-->
```

```
<ELEKTRA>
```

```

    <!--New Page-->
    <!--Can be used in Main and Subreport template(s)-->
    <COMPONENT>NEWPAGE</COMPONENT>
</ELEKTRA>

<ELEKTRA>
    <!--Verdict Summary-->
    <!--Can be used in Main template only-->
    <COMPONENT>VERDICTSUMMARY</COMPONENT>
    <!--Substitute with desired Table Style-->
    <TABLESTYLE>TABLESTYLE 1</TABLESTYLE>
    <!--Substitute with desired Heading Style-->
    <HEADINGSTYLE>HEADINGSTYLE 1</HEADINGSTYLE>
</ELEKTRA>

<ELEKTRA>
    <!--Device List-->
    <!--Can be used in Main template only-->
    <COMPONENT LANDSCAPE="TRUE">DEVICELIST</COMPONENT>
    <!--Substitute with desired Table Style-->
    <TABLESTYLE>TABLESTYLE 1</TABLESTYLE>
    <!--Substitute with desired Heading Style-->
    <HEADINGSTYLE>HEADINGSTYLE 1</HEADINGSTYLE>
</ELEKTRA>

<ELEKTRA>
    <!--Measurements-->
    <!--Can be used in Main template only-->
    <COMPONENT USEFOLDERSTRUCTURE="TRUE">MEASUREMENTS</COMPONENT>
    <!--Substitute with desired Heading Style-->
    <HEADINGSTYLE>HEADINGSTYLE 1</HEADINGSTYLE>
</ELEKTRA>

<ELEKTRA>
    <!--EMI Graphics-->
    <!--Can be used in Subreport template only-->
    <COMPONENT LANDSCAPE="FALSE">GRAPHICS</COMPONENT>
    <!--Substitute with desired Heading Style-->
    <HEADINGSTYLE>HEADINGSTYLE 1</HEADINGSTYLE>
    <ARRANGEMENT ROW="1" COLUMN="1"></ARRANGEMENT>
    <GRAPHICS>
        <GRAPHIC>
            <NAME>Spectrum Overview</NAME>
            <!--For captions, edit the text node, add/delete text nodes as needed-->
            <CAPTION USEFIGURENAME="FALSE" KEY="FIGURE">
                <TEXT>TEST 1</TEXT>
                <TEXT>TEST 2</TEXT>
            </CAPTION>
        </GRAPHIC>
    </GRAPHICS>
</ELEKTRA>

```

```

</ELEKTRA>

<ELEKTRA>
  <!--EMI Tables-->
  <!--Can be used in Subreport template only-->
  <COMPONENT LANDSCAPE="FALSE">TABLES</COMPONENT>
  <!--Substitute with desired Table Style-->
  <TABLESTYLE>TABLESTYLE 1</TABLESTYLE>
  <!--Substitute with desired Heading Style-->
  <HEADINGSTYLE>HEADINGSTYLE 1</HEADINGSTYLE>
  <TABLES>
    <TABLE>
      <NAME>Final Results</NAME>
      <COLUMNS>
        <NAME>[ALL]</NAME>
      </COLUMNS>
      <!--For captions, edit the text node, add/delete text nodes as needed-->
      <CAPTION USETABLENAME="FALSE" KEY="TABLE">
        <TEXT>TEST 1</TEXT>
        <TEXT>TEST 2</TEXT>
      </CAPTION>
    </TABLE>
  </TABLES>
</ELEKTRA>

```

6.7 Data exchange

Available only, if you have activated the [license](#) for "ELEMC-DEX", which requires that a [dongle](#) with this license is connected.

Activating the data exchange mode allows using a 3rd-party interface for querying R&S ELEKTRA database content, which is otherwise inaccessible in the proprietary ELEKTRA.FDB file.

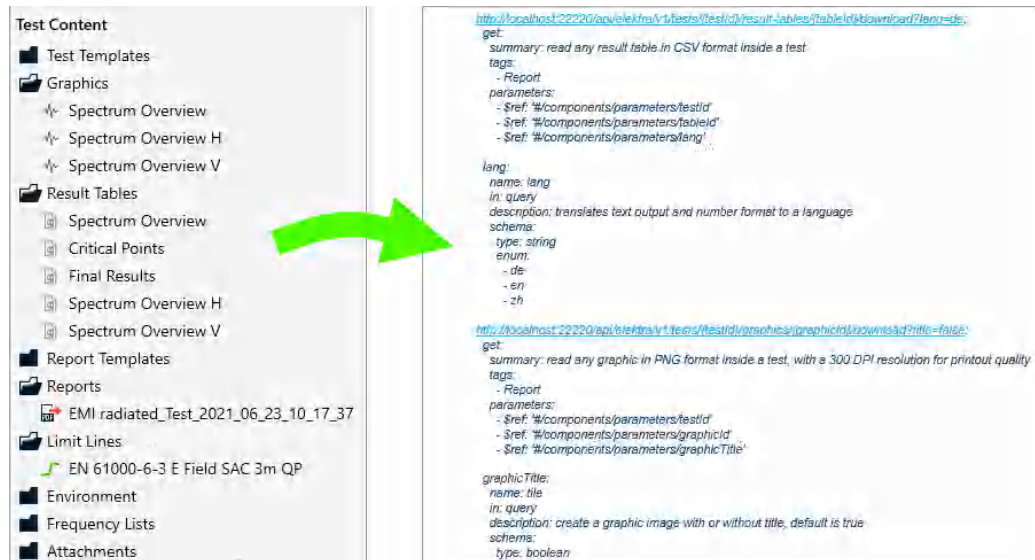

Figure 6-6: Schematic illustration, the ELEMC-DEX license allows querying database content



The ability to query database content, for example test result tables, graphics and settings, allows using your own tools for creating reports or integrating test data into other applications.

To access database content

1. Make sure that R&S ELEKTRA is running.
2. In the same computer, launch a file manager tool, for example the Windows Explorer.
3. Navigate to the C:\ProgramData\Rohde-Schwarz\ELEKTRA\x.xx.xx\Logs folder.
4. In the Logs folder, open the General.x.xx.xx.txt file.
5. Search for the string "ELEKTRA API started, API endpoint:" in that file.
6. Behind this string, find a **data exchange URL**.

For example, you find "<http://localhost:22220/api/elektra/v1>".

Note: Instead of localhost, the URL contains your computer's host name, which is required to access the R&S ELEKTRA API from a remote computer. The name localhost works only, if the API is accessed from the same computer that runs the R&S ELEKTRA client.

7. Copy the data exchange URL into a web browser in the same computer that runs R&S ELEKTRA.

A list opens.

Between the tags <LinkName> and </LinkName>, the list contains the following **subsets** of data, each subset being a **link** and a **name** in 2 subsequent lines:

```

<href>http://localhost:22220/api/elektra/v1/euts</href>
<name>search all EUT's</name>
<href>http://localhost:22220/api/elektra/v1/tests</href>
<name>search all tests</name>
<href>http://localhost:
22220/api/elektra/v1/test-templates</href>
<name>search all test templates</name>
<href>http://localhost:
22220/api/elektra/v1/hardware-setups</href>
<name>search all hardware setups</name>
<href>http://localhost:22220/api/elektra/v1/devices</href>
<name>search all devices</name>
... and so on, and finally:
<href>http://localhost:22220/api/elektra/v1/document</href>
<name>download ELEKTRA API YAML document</name>

```

Tip: Instead of a web browser, you can use any freeware tools available to test a REST API (representational state transfer), like "Postman" for example.

8. From this list, select the link for the type of content that you want to query.

The list has links for the following content:

- EUTs
- Tests
- Test templates
- Hardware setups
- Devices
- Limit lines
- Attenuations
- Amplifier gains
- Frequency lists
- Transducer corrections
- Linearities
- Normalizations
- Reference calibrations
- The final 2 lines are for the [ELEKTRA API YAML document](#).

9. Copy the selected link into a new browser window.

A list opens that shows more details for the selected content.

10. In the next iteration, proceed as above to explore further content details.

Exploring database content details

As an **example**, the following sections exploit an arbitrary path into the details of all contents available in the database.

In the original list above, you can find a link that represents **test** contents:

<http://localhost:22220/api/elektra/v1/tests>

When you use this link, the browser or other tool shows several sections as below, one for each test in the database:

```
<TestSearchResult>
<changeDate>2021-06-22T09:35:51</changeDate>
<href>http://localhost:22220/api/elektra/v1/tests/5</href>
<id>5</id>
<name>EMI radiated Productline_Test</name>
<frequencyRange>18 kHz - 1 GHz</frequencyRange>
<eut>EUT Productline 2</eut>
<measurementClass>EMI</measurementClass>
<testStandard/>
<verdict>Inconclusive</verdict>
</TestSearchResult>
```

The above section contains the link for results of **test number 5** (out of a series of many tests):

<http://localhost:22220/api/elektra/v1/tests/5>

When you use this link, the browser or other tool shows a section with more details of test 5, as below:

```
<Test ...>
<author>Admin</author>
<changeDate>2021-06-22T09:35:51</changeDate>
<description/>
<group>Public</group>
<id>5</id>
<links>
<LinkName>
<href>http://localhost:22220/api/elektra/v1/test-templates/88</href>
<name>local template</name>
</LinkName>
<LinkName>
<href>http://localhost:22220/api/elektra/v1/tests/5/result-tables</href>
<name>get all result table links</name>
</LinkName>
<LinkName>
<href>http://localhost:22220/api/elektra/v1/tests/5/graphics</href>
<name>get all graphic links</name>
</LinkName>
<LinkName>
<href>http://localhost:22220/api/elektra/v1/tests/5/reports</href>
<name>get all report links</name>
</LinkName>
<LinkName>
<href>http://localhost:22220/api/elektra/v1/tests/5/equipment-list</href>
<name>read equipment</name>
```



```

</LinkName>
<LinkName>
<href>http://localhost:22220/api/elektra/v1/tests/5/settings</href>
<name>read test template settings</name>
</LinkName>
</links>
<name>EMI radiated Productline_Test</name>
<measurementClass>EMI</measurementClass>
<testStandard>Unassigned</testStandard>
<verdict>Inconclusive</verdict>
</Test>

```

This section contains links for the following 6 groups of content in test number 5:

- Local template
- Result tables
- Graphics
- Reports
- Equipment
- Test template settings

Again, you can select specific content that you want to query, by copying the link that represents this content into a browser or other tool.

For example, the list above contains a link that represents **result tables**:

<http://localhost:22220/api/elektra/v1/tests/5/result-tables>

When you use this link, you get a response as below, where the number of available result tables (5 in this example) shows all stored result tables inside this test:

```

<ArrayOfLinkIdNameUsage ...>
<LinkIdNameUsage>
<href>http://localhost:22220/api/elektra/v1/tests/5/result-tables/502/download</href>
<id>502</id>
<name>Overview</name>
</LinkIdNameUsage>
<LinkIdNameUsage>
<href>http://localhost:22220/api/elektra/v1/tests/5/result-tables/503/download</href>
<id>503</id>
<name>CriticalPoint</name>
</LinkIdNameUsage>
<LinkIdNameUsage>
<href>http://localhost:22220/api/elektra/v1/tests/5/result-tables/504/download</href>
<id>504</id>
<name>FinalMeasurement</name>
</LinkIdNameUsage>
<LinkIdNameUsage>
<href>http://localhost:22220/api/elektra/v1/tests/5/result-tables/505/download</href>
<id>505</id>
<name>Overview H</name>
</LinkIdNameUsage>

```

```

<LinkIdNameUsage>
<href>http://localhost:22220/api/elektra/v1/tests/5/result-tables/506/download</href>
<id>506</id>
<name>Overview V</name>
</LinkIdNameUsage>
</ArrayOfLinkIdNameUsage>

```

This section contains links for the following 5 types of result tables in test number 5:

- Overview
- Critical points
- Final measurement
- Overview H (horizontal antenna polarization)
- Overview V (vertical antenna polarization)

Again, you can select specific content that you want to query, by copying the link that represents this content into a browser or other tool.

For example, the list above contains a link representing **critical points** (see ID "503"):

<http://localhost:22220/api/elektra/v1/tests/5/result-tables/503/download>

When you use this link, the browser or other tool provides the download of a csv table (comma-separated values) as below:

Rg	Frequency	Test Level	Trd Fwd Pwr	Sensor Level	Modulation	Comment
	MHz	dBµA	W	dBµA		
1	0.32	73	1.048	73	AM, 1 kHz, 80 %	
1	0.341	71.1	1.085	71.08	OFF	

The series of sections above show one possible path into the details of all contents available in the database. You can select any other path to query other content.

Generic examples

The following 1st "generic" example describes querying **result tables**, where you must replace the strings **{testID}** and **{tableID}**:

<http://localhost:22220/api/elektra/v1/tests/{testid}/result-tables/{tableid}/download?lang=de>

The download of a result table supports localization for German (de), English (en) and simplified Chinese (zh). The endpoint <http://localhost:22220/api/elektra/v1/tests/{testid}/result-tables> returns all available result tables inside this test.

The following 2nd "generic" example describes querying **graphics**, where you must replace the strings **{testID}** and **{graphicID}**:

<http://localhost:22220/api/elektra/v1/tests/{testid}/graphics/{graphicid}/download?title=false>

The download of a graphic allows to disable the title, which is enabled by default. The endpoint <http://localhost:22220/api/elektra/v1/tests/{testId}/graphics> returns all available graphics inside this test.

ELEKTRA API YAML document

At the end of the data exchange URL's list, there is one special link:

<http://localhost:22220/api/elektra/v1/document>

It downloads a document in `YAML` format. A `YAML` interface document is a formal specification of endpoints, parameters and data structures. With this document as input, tools like "Swagger Editor" can generate source code to access the R&S ELEKTRA `API`. This `YAML` document defines all endpoints and methods available in the R&S ELEKTRA `API`:

- It allows searching the database, returning a list of search results, presented like in the R&S ELEKTRA user interface ([Figure 6-6](#)). To bring up all content, use an empty search text. You can sort columns in ascending or descending order.
- It allows reading methods (functions) used for reporting.
- It allows exporting database content into other software tools.

6.8 Remote control

Available only, if you have activated the [license](#) for "ELEM-C-REM", which requires that a [dongle](#) with this license is connected.



To remotely control R&S ELEKTRA or its database content, ensure that R&S ELEKTRA is running.

Activating this feature allows 3rd-party applications to interface with R&S ELEKTRA and perform the following operations:

- Query R&S ELEKTRA database content, see [To access database content](#)
- Execute or control a test, i.e., start, stop, pause or resume a test using freeware tools for REST `API`, such as "Postman"
For endpoints and methods available in R&S ELEKTRA `API`, refer to "[ELEKTRA API YAML document](#)" on page 591.

7 Running tests

This chapter explains how to run tests, use the side panels ([test control elements](#)), handle the [test container](#) and work with test results ([tables](#) and [graphics](#)).



- For an overview of which EMC test has to be performed according to which standard, see [Chapter 5.2, "Test matrix"](#), on page 560.
- For information on how to configure test templates for these tests, see [Chapter 4.5, "Test Templates"](#), on page 117.
- For getting started with testing, see [Chapter 3.6, "Performing a test"](#), on page 53.

A completed EMC test in R&S ELEKTRA is not just a single result table, but a [Test container](#). It typically contains:

- Test definition ([Test Template](#) with [hardware setup](#), measurement settings and [Device properties](#))
- References for used [Tables](#), including [Limit Lines](#)
- [Test result tables](#) with [configuration parameters](#)
- [Test result graphics](#) with [configuration parameters](#)
- [Test Reports](#) with [configuration parameters](#)
- Also, during the test:
 - In EMI tests, [Measurement Flow Control](#) dialogs provide information about the current position in a [test sequence](#)
 - [Accessories control panels](#) facilitate handling devices like LISNs, turntables, positioners and antenna masts.

7.1 Calibration measurements	593
7.2 EMI tests	594
7.2.1 Automated measurement for EMI tests.....	596
7.2.2 Interactive measurement for EMI tests.....	596
7.3 EMS tests	597
7.3.1 Automated measurement for EMS tests.....	599
7.3.2 Interactive measurement for EMS tests.....	599
7.4 Using the test control elements	600
7.4.1 Test control top menu.....	600
7.4.2 Test control toolbar.....	602
7.4.3 Test Components.....	606
7.4.4 Measurement Flow Control.....	611
7.4.5 Accessories.....	612
7.4.6 EUT Failure Mode Analysis.....	617

7.4.7	Frequency Control.....	619
7.4.8	Parameter.....	622
7.4.9	Measurements.....	623
7.4.10	Evaluation Control.....	624
7.4.11	Calibration Control.....	625
7.4.12	EMS Test Generator.....	626
7.4.13	Uniformity Evaluation.....	626
7.4.14	Test Validation.....	627
7.5	Test result tables.....	628
7.5.1	Merged overview results.....	630
7.5.2	Editing critical points.....	631
7.5.3	Margin.....	631
7.6	Test result graphics.....	632
7.7	EMI test result evaluation.....	633
7.7.1	Evaluation - 3D Evaluation.....	634
7.7.2	Evaluation - Subrange Maxima.....	638
7.7.3	Evaluation - Subrange Minima.....	638
7.7.4	Evaluation - Peak Search.....	639
7.7.5	Evaluation - Acceptance Analysis.....	640
7.7.6	Evaluation - Maxima Limitation.....	641
7.7.7	Evaluation - Limit and Margin.....	642
7.7.8	Evaluation - Merge Results.....	642
7.7.9	Evaluation - Max-Hold.....	643

7.1 Calibration measurements

- For information on how to configure test templates for calibration measurements, see [Chapter 4.5.1, "Test Templates for calibration measurements"](#), on page 119.
- The hardware setup for calibration measurements is configured in the CAL test template, too.
- For controlling a calibration measurement, see [Chapter 7.4.11, "Calibration Control"](#), on page 625.













The execution of calibration measurements depends on the various types of calibration, which are described in [Chapter 8, "Calibration measurements"](#), on page 645.

7.2 EMI tests

For the general steps of preparing a test, see [Chapter 3.6, "Performing a test"](#), on page 53. After test preparation, proceed as follows:

Creating and running tests

1. Activate the EUT that you want to test in the [EUTs](#) dialog.
2. To **create** a test, alternatively execute one of the following options:
 - Select "Home" > "Dashboard" and click the "New Test" button . To "Select a Test Type", click any of the available options. In the first dialog that opens ("New Test"), select at least the test template on which to base the new test. Per default, R&S ELEKTRA selects the previously [activated](#) EUT. If you have not activated an EUT before, select one, now. Then click "New Test".
 - Alternatively, select "Home" > "EUTs" > "Open"  and create tests via the [Test Plan](#).
 - Alternatively, select "Home" > "Tests" > "Create Test" . Then proceed with the "New Test" dialog as above.
 - Alternatively, select a test template at "Home" > "Test Templates" and select "New Test" . Then proceed with the "New Test" dialog as above.
 - Alternatively, open a test template at "Home" > "Test Templates" and select "Create test from template" .
 - Alternatively, at "Home" > "Test Templates" click "Create test from template"  or "Open test configuration"  in the line of the test template you wish to select.
 - Or alternatively, open  an *existing* test by selecting it at "Home" > "Tests", for example to rerun it with updated device properties. Note that you cannot run or rerun an imported test. If you have opened an imported test, it is labeled as "Imported Test (Read Only)".

Note: In an opened test template, the button "Create test from template" is only available, if the test template has been saved.
3. To run an **automated measurement** , click the "Start" button  in the [Test control toolbar](#).
The software performs a [Test Validation](#), then executes the test and automatically displays the results in both graphical and tabular format, labeled "Overview Graphic" and "Final Results Table" as in [Figure 3-8](#).
4. Optionally run **interactive measurements** , using the [side panels](#).
If you remeasure a level value at a "Critical Point", R&S ELEKTRA suggests for this measurement the "final measurement" detector that relates to the overview detector, which has originally found this "Critical Point". However, you can change the default settings, including the detector selection.

5. Click "Save" (📁) or "Save As" (📄) to save the test and to specify a name for it - ideally, use speaking names. Additional options in the "Save" dialog:
 - Optionally enable "Add to Dashboard" to pin the saved test to the "Dashboard" dialog, see [Graphical user interface](#).
 - Optionally add user-defined "Tags" to the test. Tagging allows searching for tagged tests. Hence, tagging facilitates finding (groups of) tests with specific tags.



Firewall

For information on what to do, if a firewall message comes up, see [Chapter 2.7, "Network firewall settings"](#), on page 35.



Overload

If a measured level overloads the receiver, a flashing "Overload" warning is displayed in the top of the test window:



In this case, the measurement is **invalid**.

Stop the measurement and eliminate the overload condition, for example by setting a higher [RF Attenuation](#) in the [test template](#). Then run a new test based on the modified setting.

You can stop the "Overload" warning from flashing by clicking it.

The test result representation is based on the frequency range (X-axis) and level range (Y-axis) as defined in the [test template](#). The number of traces in the overview graphic and columns in the overview table depend on the number of detectors and limit lines specified in the test template.

Correction sum download

Transducer factor correction sums are the accumulated amounts of "Correction" and "Attenuation", specified for the transducer and the signal path used in this measurement. The correction sums are stored in the "Spectrum Overview" result table of a test. The download of a correction sum always transfers 625 correction points into the receiver.

When measuring via a test receiver, per default R&S ELEKTRA does not transfer the correction sums to the receiver. Therefore, the trace on the receiver's display represents *raw levels* and thus can differ from the measurement values in the software's result tables. During the test, R&S ELEKTRA computes the correction sums for each frequency point and adds these corrections to the receiver's raw measurements. Optionally, at the end of the test, the software can transfer the correction sums to the receiver, if you have enabled this feature in the [Administration > General](#). See ["EMI: Download the ... into the receiver when the test ends"](#) on page 545.

Scan settings download



After an EMI measurement with a test receiver, and depending on your [General](#) (see [EMI: Download the ... into the receiver when the test ends](#)), R&S ELEKTRA can proceed as follows: It can program a best match of basic [scan settings](#) (as specified in the [test template](#)) into the test receiver's internal scan table. You can use these settings for measurements that you control manually at the test receiver's front panel.

Optionally select "Refresh" (↻) to rerun a [Test Validation](#). If you have changed any settings in the test template's copy that the test uses (see [Test container](#)), "Refresh" also activates these changes.

Optionally select "Clear Results" (✕) to delete all measured values. This action is protected by the following message: "Please confirm: Are you sure you want to refresh the test and thus delete the existing test results?"

After having executed and saved a test, proceed with [Test results](#) and [Reporting](#).

7.2.1 Automated measurement for EMI tests



After [creating](#) a test based on a [test template](#), you can let R&S ELEKTRA perform an automated measurement. To do so, select the automated measurement mode (🔍) and click the "Start" button (▶) in the [Test control toolbar](#).

The software runs a [Test Validation](#) and automatically performs the measurement according to the [Measurement Flow](#) specified in the test template. Typically, an automated measurement consists of an [Overview Measurement](#) (see [Settings \(Overview\)](#)), followed by [Data Reduction](#) and [Final Measurement](#).

When the measurement is completed, the [Test results](#) and the [Verdict](#) are displayed. You can configure the result [graphics](#) and [tables](#) according to your needs and generate a [report](#).

These steps complete the automated measurement. To examine the EUT in more detail at selected frequencies, run an [Interactive measurement for EMI tests](#).

7.2.2 Interactive measurement for EMI tests







Interactive measurements are typically performed after an [automated measurement](#), which gives you an overview of the spectral emission situation and identifies critical points. Hence, interactive measurements can help to address special DUT properties or specific results from the overview measurement, facilitating dedicated or repeated measurements, depending on individual requirements of your test.

We recommend [saving](#) (💾) the test with the results of the automated measurement before you proceed.

When you change to the interactive mode, the [Final Measurement](#) settings are loaded from the test template into the [Measurements](#) dialog.

You can run two kinds of interactive measurement ():

- For a **manually controlled** interactive measurement, click the "Repeat Measurement at Single Frequency" button () in the [Test control toolbar](#).
The software runs a [Test Validation](#).
Use the [Measurements](#) dialog and the [Frequency Control](#) dialog to control the measurement. Especially, use the provided frequency-control features to select the frequency points, at which you want to measure. To save individual measured level values at selected frequency points, click record (). These values are labeled "Interactive" in the "Source" column of the "Final Results" table.
- For a **semi-automatic** interactive measurement, which requires "Critical Points" identified in a previous [automated measurement](#), click the "Start" button () or the "Start reverse" button () in the [Test control toolbar](#).
Note that you can edit the list of "Critical Points" manually, as described in [Chapter 7.5, "Test result tables"](#), on page 628. For example, you can add points from the "Overview" table to the "Critical Points" table or delete one or more critical points.
The software runs a [Test Validation](#) and then measures each critical point. This measurement leads to additional level values that are labeled "Critical Points" in the "Source" column of the "Final Results" table.

7.3 EMS tests



- For an overview of **which EMS test** has to be performed according to which standard, see [Chapter 5.2, "Test matrix"](#), on page 560
- For information on how to configure **test templates** for these tests, see [Chapter 4.5.3, "Test Templates for EMS tests"](#), on page 243
- For information on how to set up the **hardware** for these tests, see [Chapter 4.7.3, "Hardware setups for EMS tests"](#), on page 347
- For the general steps of **preparing** a test, see [Chapter 3.6, "Performing a test"](#), on page 53
- For a description of "Reference Calibration" and "Field Uniformity Evaluation", see [Chapter 8, "Calibration measurements"](#), on page 645

This chapter focuses on the [EMS test method "EUT Qualification"](#) in "**Automatic**" measurement mode and "**Interactive**" measurement mode, respectively.

After test preparation, proceed as follows:

Creating and running an "EUT Qualification" test

1. Activate the EUT that you want to test in the [EUTs](#) dialog.
2. To **create** a test, alternatively execute one of the following options:
 - Select "Home" > "Dashboard" and click the "New Test" button ().
To "Select a Test Type", click any of the available options.

In the first dialog that opens ("New Test"), select at least the test template on which to base the new test.

Per default, R&S ELEKTRA selects the previously activated EUT. If you have not activated an EUT before, select one, now.

Then click "New Test".

- Alternatively, select "Home" > "Tests" > "Create Test" (🔍). Then proceed as above.
- Alternatively, select a test template at "Home" > "Test Templates" and select "New Test" (🔍). Then proceed with the "New Test" dialog as above.
- Alternatively, open a test template at "Home" > "Test Templates" and select "Create test from template" (🔍).
- Alternatively, at "Home" > "Test Templates" click "Create test from template" (🔍) in the line of the test template you wish to select.
- Or alternatively, open (🔍) an *existing* test by selecting it at "Home" > "Tests", for example to rerun it with updated device properties.

Note that you cannot run or rerun an imported test. If you have opened an imported test, it is labeled as "Imported Test (Read Only)".

Note: In an opened test template, the button "Create test from template" is only available, if the test template has been saved.

3. To run an **automated measurement** (🔍), click the "Start" button (▶) in the **Test control toolbar**.

The software performs a **Test Validation**, then executes the test and automatically displays the results in both graphical and tabular format, labeled "Overview Graphic" and "Final Results Table".

4. Optionally run **interactive measurements** (🔍), using the **side panels**.
5. Click "Save" (💾) or "Save As" (📄) to save the test and to specify a name for it - ideally, use speaking names. Additional options in the "Save" dialog:
 - Optionally enable "Add to Dashboard" to pin the saved test to the "Dashboard" dialog, see **Graphical user interface**.
 - Optionally add user-defined "Tags" to the test. Tagging allows searching for tagged tests. Hence, tagging facilitates finding (groups of) tests with specific tags.



Firewall

For information on what to do, if a firewall message comes up, see **Chapter 2.7, "Network firewall settings"**, on page 35.

The test result representation is based on the frequency range (X-axis) and level range (Y-axis) as defined in the **test template**. The number of traces in the overview graphic and columns in the overview table depend on the number of detectors and limit lines specified in the test template.

Optionally select "Refresh" (🔄) to rerun a **Test Validation**. If you have changed any settings in the test template's copy that the test uses (see **Test container**), "Refresh" also activates these changes.

Optionally select "Clear Results" (☒) to delete all measured values. This action is protected by the following message: "Please confirm: Are you sure you want to refresh the test and thus delete the existing test results?"

After having executed and saved a test, proceed with [Test results](#) and [Reporting](#).

7.3.1 Automated measurement for EMS tests



After [creating](#) a test based on a [test template](#), you can let R&S ELEKTRA perform an automated measurement. To do so, select the automated measurement mode (1) and click the "Start" button (▶) in the [Test control toolbar](#).

The software runs a [Test Validation](#) and automatically performs the measurement according to the settings specified in the test template. During an automated measurement, R&S ELEKTRA can identify critical points with the help of EUT monitoring equipment (see [EUT Monitoring templates](#)). Or you can use the [EUT Failure Mode Analysis](#) to identify critical points manually.

When the measurement is completed, the [Test results](#) are displayed. You can configure the result [graphics](#) and [tables](#) according to your needs and generate a [report](#).

These steps complete the automated measurement. To examine the EUT in more detail at selected frequencies, run an [interactive measurement](#).

7.3.2 Interactive measurement for EMS tests



Interactive measurements are typically performed after an [automated measurement](#), which gives you an overview of the spectral emission situation and identifies critical points. Hence, interactive measurements can help to address special DUT properties or specific results from the overview measurement, facilitating dedicated or repeated measurements, depending on individual requirements of your test.

We recommend [saving](#) (📁) the test with the results of the automated measurement before you proceed.

You can run two kinds of interactive measurement (🖱️):

- For a **manually controlled** interactive measurement, click the "Repeat Measurement at Single Frequency" button (🔍) in the [Test control toolbar](#).
R&S ELEKTRA runs a [Test Validation](#).
Use the [Frequency Control](#) dialog to control the measurement. Especially, use the provided frequency-control features to select the frequency points, at which you want to measure. To save individual measured level values at selected frequency points, click record (🔴).
- For a **semi-automatic** interactive measurement, which requires "Critical Points" identified in a previous [automated measurement](#), click the "Start" button (▶) or the "Start reverse" button (◀) in the [Test control toolbar](#).
R&S ELEKTRA runs a [Test Validation](#) and then measures each critical point. The measurement leads to additional level values in the "Final Results" table.

7.4 Using the test control elements

This chapter describes the buttons and dialogs in the top menu and in the left-hand and right-hand side panels of an [opened test](#):

• Test control top menu	600
• Test control toolbar	602
• Test Components	606
• Measurement Flow Control	611
• Accessories	612
• EUT Failure Mode Analysis	617
• Frequency Control	619
• Parameter	622
• Measurements	623
• Evaluation Control	624
• Calibration Control	625
• EMS Test Generator	626
• Uniformity Evaluation	626
• Test Validation	627

7.4.1 Test control top menu

The test control top menu in the top-left part of a "Test" window has some buttons for basic functions in a test.



For the buttons in the test control toolbar (top-right part of the "Test" window), see [Chapter 7.4.2, "Test control toolbar"](#), on page 602.

The buttons in test control top menu have the following functions:

Save	600
Save global table	601
Save As	601
Refresh	601
Clear Results	601
Add Report	601
Chart Menu	601
Marker Menu	602
Group	602



Save

Opens the "Save Test" dialog, if you save this test for the 1st time. Saving the same test again later does not open the dialog, but overwrites the previously saved state of the test.

Note: If a test was not originally listed in the [test plan](#), saving it includes it into the test plan. A dialog comes up to let you confirm saving the test into the folder "Unplanned" in

the test plan. If this folder does not exist, R&S ELEKTRA automatically creates it. You can later go to the test plan dialog of your EUTs and move the test to a different folder, or rename the "Unplanned" folder.



Save global table

Available only in measurements based on a calibration template, see [Chapter 4.5.1, "Test Templates for calibration measurements"](#), on page 119.

Saves the local normalization or calibration table of your test as a global normalization or calibration table.

If the table specified in the [Calibration Control](#) dialog already exists, a dialog opens to confirm overwriting this table.

If no previous table with the specified name exists, or if you confirm overwriting, R&S ELEKTRA saves the normalization or calibration table, or both.



Save As

Available only, if the test has been saved before. "Save As" allows saving the test under a different name and with different user tags.



Refresh

Reruns a test validation, but does not delete existing test results, as in [Clear Results](#).



Clear Results

Refreshes the test and deletes existing test results.

Note: Automatic clearing of test results. When you change settings in an [integrated](#) test template copy (while the test is stopped), R&S ELEKTRA brings up a dialog. It suggests clearing (discard) all existing results of the test, into which the copy is integrated.

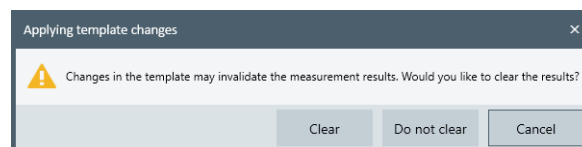

Figure 7-1: Dialog that decides about clearing test results

Clearing is required to keep settings and results always consistent with each other. A saved test reflects the entirety of settings and measurement results at the time of testing.

However, when you save the modified test, the software allows you to decide about clearing the results. If you select "Do not clear", the resulting inconsistency between test settings and test results is in your responsibility. If you cancel this decision dialog, R&S ELEKTRA does not save the modified test.



Add Report

Creates a report in the same way as described in [Chapter 3.9, "Reporting"](#), on page 60.



Chart Menu

Opens the graphics context menu in the same way as right-clicking a chart.

See [Chapter 4.4.2.1, "Chart"](#), on page 99.



Marker Menu

Opens the marker context menu in the same way as right-clicking a marker.

See [Chapter 4.4.2.3, "Marker"](#), on page 105.



Group XYZ...

Group

Displays the [user group](#), to which the EUT is assigned, for which you perform this test. You have access only to tests, test templates and hardware setups that are assigned to the "Public" group or to your currently selected specific user group. See "[User Information](#)" on page 64.

7.4.2 Test control toolbar

Most buttons of the test control toolbar in the top-right part of the "Test" window are similar to a video recorder.

An exception is the twin button with the [robot](#)  and [hand](#)  icons at the left end of the toolbar: This button is a changeover switch that toggles between the automated and interactive measurement modes.

The **test control toolbar** is available with different functions that depend on the measurement type:



Figure 7-2: For automated EMI measurements



Figure 7-3: For interactive EMI measurements



Figure 7-4: For automated EMS measurements



Figure 7-5: For interactive EMS measurements



For the buttons in the test control top menu (top-left part of the "Test" window), see [Chapter 7.4.1, "Test control top menu"](#), on page 600.

The buttons in the test control toolbar have the following functions:

EUT Failure Mode Analysis	603
Automated Measurement	603
Interactive Measurement	603
Click to open screenshot settings	603
Start or Resume	603
Start Reverse or Resume reverse	604

Interactive Scan.....	604
Repeat Measurement at Single Frequency.....	605
Record.....	605
Pause.....	605
Stop.....	606



EUT Failure Mode Analysis

Available only during a **running** EMS test.



This function allows the manual recording of detected critical frequencies where the EUT shows failures when exposed to the target immunity level.

Use this function with test templates that are configured with the [Test Method "EUT Qualification"](#) or ["Reference Calibration"](#).

Clicking the "NoGo" button  (or pressing the keys [CTRL]+[N] on the keyboard) pauses the frequency scan and opens the [EUT Failure Mode Analysis](#) dialog.





Automated Measurement

If the robot icon is highlighted, the test is in **automated EMI** or **automated EMS** measurement mode. For changing to interactive measurement mode, click the toggle switch, which is available only, while the test is measuring at a single frequency  (EMS) or stopped  (EMI and EMS).



Interactive Measurement



If the hand icon is highlighted, the test is in **interactive EMI** or **interactive EMS** measurement mode. For changing to automated measurement mode, click the toggle switch, which is available only, while the test is measuring at a single frequency  (EMS) or stopped  (EMI and EMS).



Click to open screenshot settings

Available only in the EMS interactive  measurement mode, relating to the action [Capture Screenshot](#).

If you want to allow R&S ELEKTRA taking screenshots of your test instrument's display during the measurement, activate the checkbox "Enable screenshot capture", select an option (described below) and click "Apply".

With the checkbox enabled, the screenshot icon (camera icon) changes from gray background  to blue background .

The following screenshot options are available:





- "Save each screenshot and continue without interrupting measurement"
Automatically saves each screenshot without displaying it.
- "Save and display each screenshot without interrupting measurement"
Automatically saves each screenshot, and also displays it.
- "Review each screenshot without interrupting the measurement"
Displays each screenshot and lets you decide whether to "Save" or "Discard" it.



Start or Resume

Not available while the test is running.

- In **EMI** measurements, this button starts (or resumes) a forward measurement as follows:

- In automated  measurement mode, it proceeds from the [current frequency point](#) to the highest frequency point, across all steps of the test template's [Measurement Flow](#), unless disabled in the [Measurement Flow Control](#). If you have enabled the "ELEMI-S" [license](#), the software automatically controls the accessories' positions, for example turntable azimuth, antenna elevation and antenna height in radiated measurements. If you have enabled "ELEMI-A" but not "ELEMI-S", you must control the [Accessories](#) dialogs in a semi-automated mode. See also "[Interactive Scan](#)" on page 604.
- In interactive  measurement mode, it proceeds from the [current critical frequency point](#) to the highest critical frequency point. The measured values are labeled as "Critical Points" in the "Source" column of the results table. If no critical points are available, the button has no effect. The "Start" button is available only, if "Source" = "Critical Points" is selected in the [Frequency Control](#) dialog (see [Figure 7-19](#)).
- In **EMS** measurements, both in automated  and interactive  measurement mode, this button starts (or resumes) a forward measurement from the [current frequency point](#) to the highest frequency point. It proceeds across all steps of the test template's [Measurement Flow](#) and [Frequency Range List](#), unless disabled in the [Measurement Flow Control](#).



If the initial "Current Frequency" is the highest frequency point, the measurement automatically starts from the lowest frequency point.

When the test run reaches the highest frequency point, it automatically stops and resets the "Current Frequency" to the lowest frequency point.



Start Reverse or Resume reverse

Not available while the test is running.

- In **EMI** measurements, this button starts (or resumes) a reverse measurement from the [current critical frequency point](#) to lower critical frequency points, if available. If the initial "Current Frequency" is the lowest frequency point, the reverse measurement automatically starts from the highest frequency point. "Start Reverse" is available only in interactive  measurement mode, and only, if "Source" = "Critical Points" is selected in the [Frequency Control](#) dialog (see [Figure 7-19](#)), while critical points are available.
- In **EMS** measurements, it starts a reverse measurement.
 - In automated  measurement mode, it proceeds from the [current frequency point](#) to lower frequency points, if available.
 - In interactive  measurement mode, it proceeds from the [current critical frequency point](#) to lower critical frequency points, if available.

If the initial "Current Frequency" is the lowest frequency point, the reverse measurement automatically starts from the highest frequency point.





Interactive Scan

Available only, if you have enabled the "ELEMI-S" [license](#).

During overview measurements across frequency ranges, the "Interactive Scan" allows user interaction: You can change the accessories' positions while performing a repeated overview measurement. Examples are the turntable azimuth (A), antenna elevation (E) and antenna height (H) in radiated measurements or the sidebar position in conducted measurements.

This feature is different from the [Interactive Measurement](#), which helps to find the maximum emission level at a single frequency, only, while manually changing accessory positions like AEH. In contrast, the "Interactive Scan" helps to find the maximum emission level across a frequency range **and** the corresponding combinations of accessory positions.

When you click the  button, R&S ELEKTRA starts with the repeated overview measurement and lets you set the accessories to your desired accessory positions while measuring. To do so, use the [Antenna](#) and [Turntable](#) control dialogs for AEH or the sidebar control dialog for conducted measurements. During the overview measurement, you can toggle between "Max-Hold" and "Clear-Write" mode in the [Measurement Flow Control](#) panel, see [Figure 7-9](#). After completing the measurement, click the "Exit Interactive Scan"  button. The measurement flow continues with the data reduction step.





Repeat Measurement at Single Frequency

In EMI tests, this function is available only in interactive  measurement mode.





In EMS tests, "Repeat Measurement at Single Frequency" does not switch off the RF power.

Without changing the frequency, it starts an interactive measurement (or "single measurement") at the frequency point that is selected in the [Frequency Control](#) dialog (see [Figure 7-19](#)). The measured value appears in bold font in the lowest row of the results table (EMI) or critical points table (EMS).



As long as you do not select "Record" , the measured value is continuously updated, depending on the settings in the [Measurements](#) dialog. As soon as you select "Record", R&S ELEKTRA keeps the measured value in the lowest row of the table and creates a new row below it. To proceed with measuring at the next frequency point, click  or  in the [Frequency Control](#) dialog.



Record

Available only in an interactive  measurement that is in one of the following states: started , measuring at a single frequency  or paused .

"Record"  performs the following actions:

- Records a measured value in the lowest row of the results table (EMI) or critical points table (EMS)
- Labels this value as "Interactive" in the table's "Source" column (only in EMI tests)
- Creates a new row in the table, for the next measurement value
- Continues measuring at the same frequency point.
To proceed with measuring at the next frequency point, click  or  in the [Frequency Control](#) dialog.



Pause

Interrupts the active measurement of a test sequence.

In EMS tests, "Pause" switches off the RF power. To do so, R&S ELEKTRA sets the signal generator to "RF OFF" and the amplifier to its "Standby/RF OFF" mode.

In contrast to [Stop](#), "Pause" does not disconnect the measurement devices and accessories. Hence, it accelerates resuming the measurement, because it does not require to re-establish all connections.

Pausing the measurement does not change the "Current Frequency" value. Hence, when you resume ◀ ▶ the measurement, it continues from the same frequency point for the rest of the test sequence.

■ Stop

Stops the active measurement and disconnects the devices. Thus, a different test or another instance of R&S ELEKTRA can use the devices.

Stopping the measurement also terminates the test sequence and influences the "Verdict", as described in [Chapter 3.8, "Verdict"](#), on page 57.

See also ["Zoom"](#) on page 622.

However, "Stop" does not change the "Current Frequency" value. Hence, when you resume ◀ ▶ the measurement, it continues from the same frequency point for the rest of the test sequence. Only if an automated measurement reaches the final frequency point of the test sequence, R&S ELEKTRA automatically resets the "Current Frequency" value to the start frequency.

7.4.3 Test Components

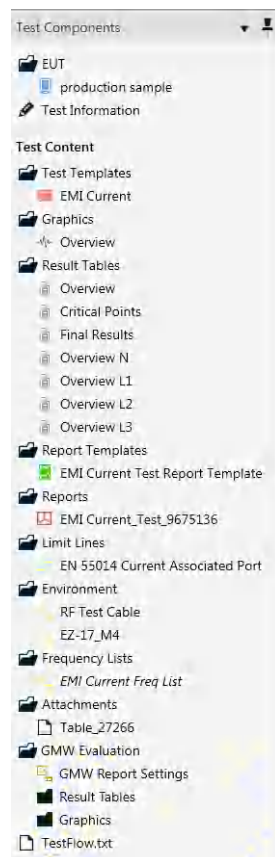

Figure 7-6: Test components dialog

The "Test Components" dialog in a "Test" window lists all content that is relevant for an individual [Calibration measurements](#), [EMI test](#) or [EMS test](#). This content is stored in

the R&S ELEKTRA database within a so-called [Test container](#), with a hierarchy as illustrated in [Figure 3-1](#).

The dialog allows opening each test component. Depending on the type of component, you can right-click to "Open", "Close", "Rename", "Remove" or "Copy" items in the list of components. Also, you can open most tables as a chart by selecting "Open Graphic".

EUT shows the name of the equipment under test that is used. To open the [EUT description](#), double-click the name.

"Test Information" shows a dialog with information for this test [predefined in the test template](#) and optionally edited for the individual test. The content of this dialog is not reset upon rerunning the test.

Test container

The test container (labeled "Test Content") comprises the following components:

- "Test Templates" shows the embedded copy of the [Test Template](#) that was used to generate this test, containing:
 - [Hardware Setups](#) as integrated parts of this test template
 - All measurement settings
 - References for the devices, signal paths and limit lines that are used by this test template

In EMS tests, also the copy of the [EUT Monitoring Template](#) (if specified) is shown here.

Note that you can open the template copy in the test window. However, if you want to modify settings in the embedded template copy, existing test results do no longer match the test conditions persisted in the template copy after the modification. Therefore, you can modify settings only, if the test is already saved (and with it, the test results and correlated test conditions). Also, you can delete or confirm the deletion of existing results before your modification. This deletion is protected by a confirmation dialog, which allows you interrupting the process and closing the test without saving it, hence keeping the test results.

By right-clicking the test template, you can select "Export to Global Test Template". This feature allows saving a copy of the embedded test template as a globally available test template.

- "Graphics" shows a list of the physically measured values of this test in the format of frequency-dependent [Charts](#).
Each test has one "Spectrum Overview" graphic, at least. There can be several graphics for the tables listed below.
In EMS tests, besides the measured values, also the test level charts are listed here.
- "Result Tables" shows a list of the physically measured values of this test in the format of the following frequency-dependent [Test Tables](#):
 - "Spectrum Overview"
 - "Critical Points"
 - "Final Results" (with special columns, if there is a [Substitution Measurement](#)), exclusively for results of the [interactive measurement](#)

- "Substitution", if [Substitution Measurement](#) is enabled
- Reference tables, hence copied result tables from another test used as [reference](#), as described in ["GMW Report Settings"](#) on page 553
- "Loop Results" for individual steps in the accessories settings (EMI or EMS)
If you have enabled the [Add Spectrogram Graphic](#) checkbox in the [Test Templates for EMI tests](#), the "Loop Results" folder contains also "Spectrum Overview" tables for each "waterfall" spectrogram graphic.
- "Burst Results" (EMI), if [Flow Schema](#) = "RSE with Burst Detection", see [Figure 4-62](#)
- "APD Results" (EMI), if the [Final Measurement](#) uses the "CISPR APD" [detector](#)
- "Evaluation Results" (EMI and EMS), if you execute one or more functions of the [Evaluation Control](#)
- "Merged Results" (EMI and EMS), if you have used the function [Evaluation - Merge Results](#)

By right-clicking a result table, you can select more functions from a context dialog, for example:

- "Copy" creates a copy of the result table in the test container
- "Open Graphics" opens a chart with the contents of the result table, without opening the table
- "Maxhold", available only for spectrum overview tables, opens the [Evaluation - Max-Hold](#) function in the [Evaluation Control](#) side panel, and inserts the selected table as an input table.
- "Set Reference", available only for spectrum overview tables, creates a copy of this table and sets it as reference. See ["Set as Reference"](#) on page 644.
- "Remove Reference", available only for a copy of a spectrum overview table that was set as reference (see above). Removes the reference status from this copy.
- "Export to CSV", see [Export to CSV file format](#)
- "Report Templates" shows a list of copies of the [Report Templates](#) that can be used in this test. To add a template to the test container, right-click "Report Templates" and select from the following options:
 - "New Report Template" adds an empty template for you to specify all settings
 - "Add a global Report Template" adds a predefined [Internal](#) template
 - "Add/replace external template - Main" adds a predefined [External](#) main report template
 - "Add/replace external template - Subreport" adds a predefined [External](#) subreport template
 - "Generate report using external template" helps creating an external report template
 - "Attach report using external template" generates a report based on an external template and attaches it to the test container
 - "Open Report Log" opens a log file of your reporting activities

Note that right-clicking a report template opens a context dialog for more options.

For the option "Copy report syntax to clipboard", see [Chapter 6.6, "Creating customized reports"](#), on page 577.

- "Reports" shows a list of all [reports](#) that you have created for this test.
- "Limit Lines" shows a list of the [Limit Lines](#) selected for this test.
- "Environment" lists the copies of all [Attenuation](#) and [Transducer Correction](#) tables used by the test
- "Frequency Lists" shows any [Frequency List](#) that is used by this test.
- [Attachments](#)
- "GMW Evaluation" shows test content prepared for [GMW reporting](#), see [Figure 7-7](#)
- TestFlow.txt shows a log file of the test execution with timestamps and test details.

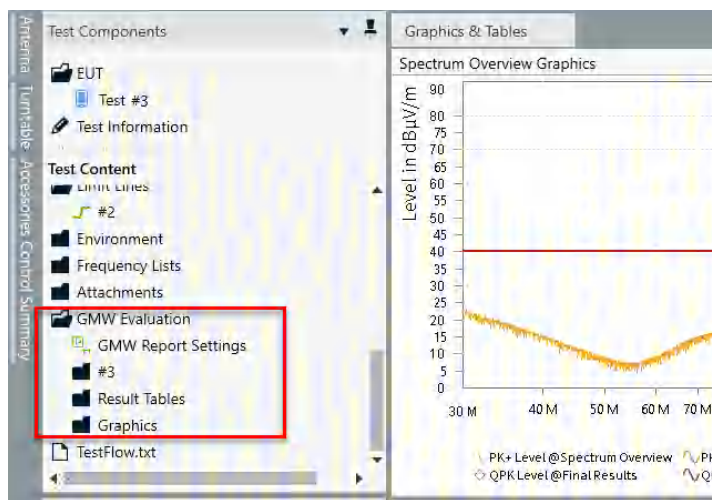

Figure 7-7: The GMW Evaluation section in the test container



Every user is responsible for thoughtfully handling the test containers' contents. The following examples are relevant for **modified test templates**:

- If settings in a global test template are altered, these changes only become effective for tests created in the future based on that global template.
- If settings in a test template's copy within a test container are altered, these changes only become effective for the next rerun of that test executed in the future. Existing test results are **cleared**, but existing reports are not affected.
- In most scenarios, we recommend generating new test templates rather than modifying or overwriting existing ones. This procedure is easily implemented, for example:
 - Open an existing test template
 - Modify it as required
 - Save it under a different name

However, circumstances could require that you radically modify basic test templates. This modification could be appropriate, for example, if standards have evolved, or if you have exchanged a measurement device, requiring additional or different settings.

When **rerunning** a test, the software **clears** (deletes) all existing measurement values in this test container. Another **Test Validation** is performed, and the new measurement values are written into the overview table. Therefore, if you wish to keep existing results, make a copy of the overview table within the opened test before you rerun it. To generate such a table copy, go to the "Test Components" > "Test Content" > "Result Tables" and right-click "Overview" > "Copy". The copy is saved in the same test container folder "Result Tables", for example as "Overview - Copy".

7.4.3.1 Attachments

The "Attachments" folder contains a list of file attachments that you save with this test, for example pictures of the test setup. To attach a file, right-click "Attachments" and select "Attach a file".

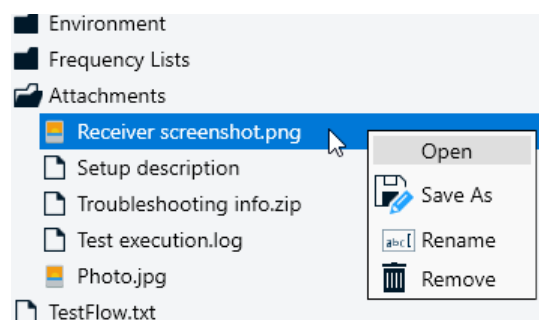

To select one of the following options for an individual attachment, right-click this attachment:

- "Open" opens the attachment, for example in a text viewer or image viewer window, or in a suitable application

- "Save As" opens a dialog for saving the attachment to an arbitrary destination outside of R&S ELEKTRA
- "Rename" opens a dialog for renaming the attachment
- "Remove" deletes the attachment

7.4.4 Measurement Flow Control

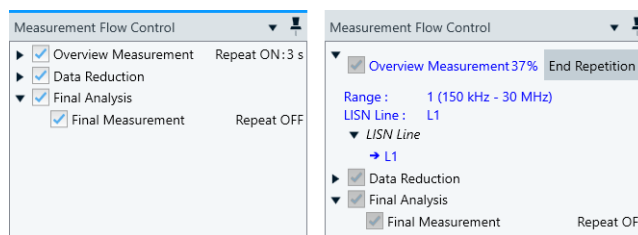

Figure 7-8: Two examples of the Measurement Flow Control dialog

Left = Before a LISN test with [Repeat Measurement](#) is enabled

Right = During the test, repetitions are running and can be stopped by "End Repetition"

Available only in EMI tests.

The "Measurement Flow Control" dialog in a "Test" window summarizes the test template's [Measurement Flow](#) settings:

- Overview measurement
If you run the overview measurement in [Interactive Scan](#) mode, the dialog lets you toggle between recording the level values in conventional [Max Hold](#) mode or in [Clear Write](#) mode.

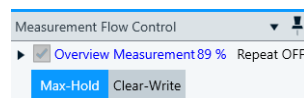

Figure 7-9: Max-Hold and Clear-Write buttons in the overview measurement

- Data reduction
- Final measurement
- "Repeat Measurement" ON or OFF
- Selected LISN lines, if the test uses a LISN

Before running a test, you can modify this dialog individually as follows:

- You can enable or disable the overview measurement, the data reduction and/or the final measurement
- You can right-click to bring up a context dialog that allows editing steps:
 - Enable or disable steps
 - Set a step as the start step
 - Disable all steps except the selected step

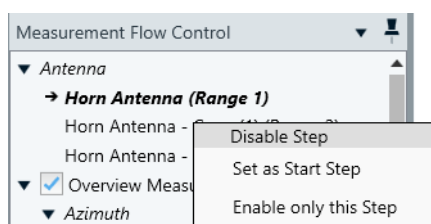

Figure 7-10: Example of options in context dialog of the Measurement Flow Control

While a test is running, R&S ELEKTRA highlights the active step by an arrow and by blue color. Test progress is represented also by display of a percentage value, for example "Overview Measurement 37%" in the top of the dialog on the right in [Figure 7-8](#).

If you run parallel measurements, several arrows represent simultaneous measurement threads, see "[Do Parallel Measurements](#)" on page 151.

If the overview measurement runs in [Repeat Measurement](#) mode, you can manually terminate the repetition by clicking "End Repetition".

7.4.5 Accessories

Accessories side panels are available only in a "Test" window, if the test template uses at least one of the devices described in the following chapters (listed below).

Accessories control summary

The "Accessories Control Summary" is a side panel that provides a condensed overview of the status of controllable devices used in a test. The content of the summary is only for your information. For more details and for user interaction, refer to the dialogs described in the following chapters:

- [Antenna](#).....612
- [LISN](#).....613
- [Positioner](#).....613
- [Slidebar](#).....614
- [TEM Waveguide](#).....615
- [Triple Loop](#).....616
- [Turntable](#).....616

7.4.5.1 Antenna

The "Antenna" side panel is an accessories dialog that allows controlling the [Antenna](#) polarization and height in EMI or EMS tests by operating the [Antenna Tower](#).

You can interact with the "Antenna" and its "Antenna tower" via this dialog only, while the measurement is paused. While the test is running, the dialog shows the current parameters.

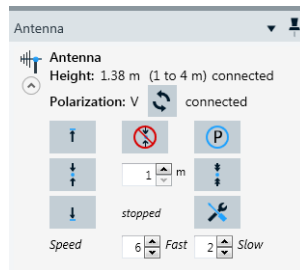

Figure 7-11: Accessories dialog for antenna control

The buttons and fields in this dialog have the following functions:

- = "Change the polarization"
- = "Go up to the maximum height"
- = "Go to the chosen position (slow speed)"
- = "Go down to the minimum height"
- = "Stop the movement now"
- m = "New height for the antenna" (defines the "chosen position")
- = "Move to parking position"
- = "Go to the chosen position (fast speed)"
- = "Move to mounting position"
- "Speed Fast" = "Speed for the fast vertical movement"
- "Speed Slow" = "Speed for the slow vertical movement"

7.4.5.2 LISN

The "LISN" side panel is an accessories dialog that allows switching the LISN lines in an [Interactive measurement for EMI tests](#).

You can interact with the LISN via this dialog only, while the measurement is paused. While the test is running, the dialog highlights the active LISN line in blue color.

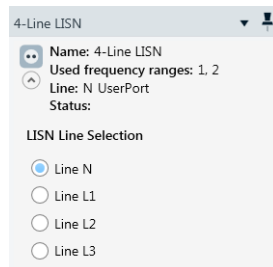

Figure 7-12: Accessories dialog for LISN control, here for a 4-line LISN

7.4.5.3 Positioner

You can use a [Positioner](#) in a [Field uniformity evaluation](#) for setting a field probe to various predefined positions, for example, in an anechoic chamber.

The "Positioner" side panel is an accessories dialog for moving the positioner to these defined positions.

You can interact with the "Positioner" via this dialog only, while the measurement is paused. While the test is running, the dialog shows the current parameters.

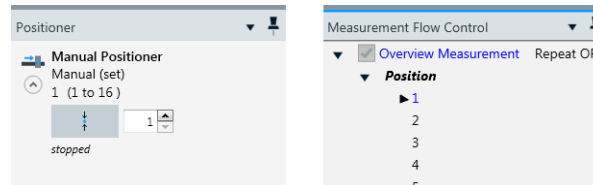

Figure 7-13: Positioner panel (left) and Measurement Flow Control panel

The button and the field in the accessories dialog (left) have the following functions:



The input field on the right-hand side selects one out of 16 positions required for the measurement.

The button on the left-hand side sends the command for moving to this position. Using a manual positioner that does not support automated movement, the software brings up a notification: "Please set the positioner to the position: xx", where "xx" is the selected position.

To proceed with the test, confirm this message with "Continue", or click "Stop Test" to abort it.



In the "Measurement Flow Control" panel, you can select the starting positions 1 to 16, before starting a test. When started, the test algorithm connects to the required devices, runs a validation and lets you select the antenna polarization. Then the reference calibration runs from the starting position across all positions for the selected polarization. After completing the calibration measurements for all positions and both polarizations, you can let the software perform a [Uniformity Evaluation](#).

7.4.5.4 Sidebar

You can use a [Sidebar](#) in conducted measurements for moving an inductive probe to various predefined positions, for example in power tests according to the standard CISPR 14 / EN 55014.

The "Sidebar" side panel is an accessories dialog for moving the sidebar to these defined positions.

You can interact with the "Sidebar" via this dialog only, while the measurement is paused. While the test is running, the dialog shows the current parameters.

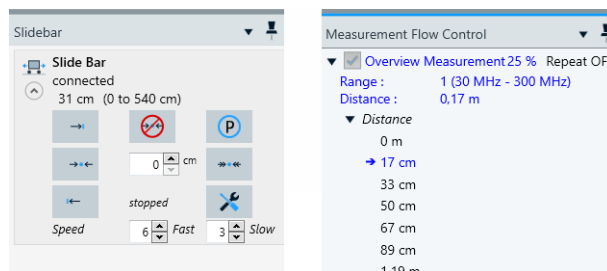

Figure 7-14: Slidebar panel (left) and Measurement Flow Control panel

The buttons and fields in this dialog have the following functions:

- = "Go forward to the maximum distance"
- = "Go to the chosen position (slow speed)"
- = "Go back to the minimum distance"
- = "Stop the movement now"
- = "New position for the slidebar" (defines the "chosen position")
- = "Move to parking position"
- = "Go to the chosen position (fast speed)"
- = "Move to mounting position"
- "Speed Fast" = "Speed for the fast movement"
- "Speed Slow" = "Speed for the slow movement"

If you use a manual slidebar that does not support automated movement, the software brings up a notification: "Please set the slidebar distance: xx cm", where "xx" is the selected distance. To proceed with the test, confirm this message with "Continue", or click "Stop Test" to abort it.

7.4.5.5 TEM Waveguide

The "TEM Waveguide" side panel is an accessories dialog that tells you, for which EUT orientation inside a [TEM Waveguide](#) the current measurement values are stored.

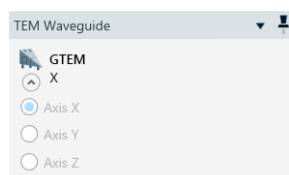

Figure 7-15: Accessories dialog for GTEM control

While the test is running, R&S ELEKTRA prompts you to "Switch the EUT axis to X" (or Y or Z, respectively). When you confirm having switched the orientation, the dialog highlights the active EUT axis in blue color.

If you have enabled the "ELEMS-S" [license](#), and if you use an automated "TEM Waveguide", the [control device](#) can make it change the EUT orientation automatically.

Note that interactive EMI measurements with a "TEM Waveguide" are disabled.

7.4.5.6 Triple Loop

The "Triple Loop" antenna side panel is an accessories dialog for selecting, which loop orientation is activated.

While the test is running, R&S ELEKTRA prompts you to "Set Magnetic Loop Antenna to Loop X" (or Y or Z, respectively). When you confirm having switched the orientation, the dialog highlights the active loop axis in blue color.

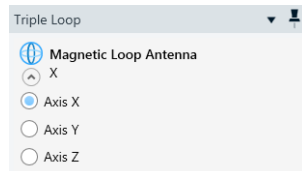

Figure 7-16: Accessories dialog for Triple Loop antenna control

7.4.5.7 Turntable

The "Turntable" side panel is an accessories dialog that allows operating the Turntable for moving it to a chosen rotational position in EMI or EMS tests.

You can interact with the "Turntable" via this dialog only, while the measurement is paused. While the test is running, the dialog shows the current parameters.

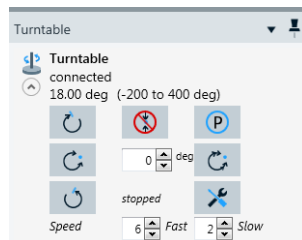

Figure 7-17: Accessories dialog for turntable control

The buttons and fields in this dialog have the following functions:

- = "Turn right to the maximum azimuth"
- = "Go to the chosen position (slow speed)"
- = "Turn left to the minimum azimuth"
- = "Stop the movement now"
- = "New azimuth for the turntable" (defines the "chosen position")
- = "Move to parking position"
- = "Go to the chosen position (fast speed)"
- = "Move to mounting position"
- "Speed Fast" = "Speed for the fast rotary movement"
- "Speed Slow" = "Speed for the slow rotary movement"

7.4.6 EUT Failure Mode Analysis



This chapter describes the functions for manual EUT failure mode analysis in EMS tests.

Immunity testing helps to detect critical frequencies, when the EUT fails under exposure to the target immunity level. These failures can be reported either automatically by an EUT monitoring system, or manually by an operator clicking the "NoGo" button  in the [test control toolbar](#). This button is labeled "Click to open EUT Failure Mode Analysis dialog (CTRL N)". It is available while running an EMS test and intended to be used with the [Test Method](#) "EUT Qualification", "EUT Susceptibility" or "Reference Calibration". Pressing the keys [CTRL]+[N] on the keyboard has the same effect as the "NoGo" button.

When you enter this mode, the test **remains at the current frequency point**, and the following dialog appears in a side panel:

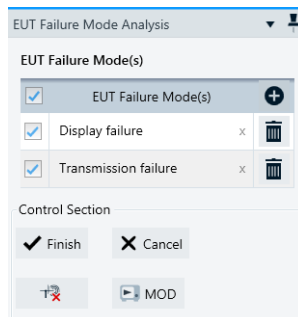

Figure 7-18: Dialog for specifying EUT failure modes and controlling the analysis



Automatic RF off after 5 minutes

Upon opening the dialog, R&S ELEKTRA starts a 300-second countdown, which turns off the RF generator automatically, unless you close the dialog before this deadline. This automatic RF off helps to protect the amplifier and the EUT.

If the RF generator is off, to turn it on again, click the button "Switch RF ON/OFF" in the dialog's "Control Section". Another 300-second countdown starts.

The list of "EUT Failure Mode(s)" in the top section of this dialog defines your EUT failure labels. You can define an arbitrary number of error labels and enable or disable their checkboxes. Use the checkbox in the list's header to enable or disable all checkboxes.

The elements available in the dialog's "Control Section" serve for controlling the analysis:

- The button **Finish** completes the failure mode analysis. R&S ELEKTRA stores all error labels, which have an enabled checkbox, in the "Critical Points" table ("Comment" column) at the current frequency point. It inserts a trace marker in the "Test Level" chart, and the test proceeds with the next frequency points.
- The button **Cancel** aborts the EUT failure mode analysis without saving any error labels.

- The button **Switch RF ON/OFF** toggles between turning the RF generator on or off.
- The button **MOD** toggles between switching **Modulation** of the RF generator on or off.

EUT Failure Modes

To create an entry for one specific failure mode, click the "Add new EUT Failure Mode" button . You can enter an arbitrary label text to describe this error mode, for example "Display failure" or "Transmission failure", as in [Figure 7-18](#).

Create and define as many entries as required by your use case. All failure mode entries in this table are stored within the test.

To activate individual entries, enable their checkboxes.

R&S ELEKTRA uses the activated entries to label failures at the detected critical frequencies in the "Critical Points" table, when you click the "Finish" button.

To clear the text in such an entry, click the "x" button in the text field. To delete a complete failure mode entry, click the "Delete" button  next to it.

Finish

Finishes the evaluation of EUT failure modes for the currently selected frequency and saves it as a critical frequency in the "Critical Points" table. This entry in the table is labeled with the failure modes that you have selected previously by enabling checkboxes (see ["EUT Failure Modes"](#) on page 618).

At the frequency of each critical point, R&S ELEKTRA places a symbol in the test level chart.

The test run immediately resumes and proceeds with the next frequencies. To examine another frequency point for EUT failure modes, you must click "NOGO" or press [CTRL]+[N] again.

Proceed

Available only, if the EMS [Test Method](#) is "EUT Susceptibility".

During the failure mode analysis, at a frequency point, at which you or your monitoring system have observed one or more [EUT Failure Modes](#), click "Proceed" once or several times. With each "Proceed", R&S ELEKTRA decreases the immunity level, until you or your monitoring system have unchecked all disappearing EUT failure modes. The software memorizes the levels, at which the detected EUT failure modes disappeared.

After this decrease, when all EUT failure modes are unchecked, the next "Proceed" makes R&S ELEKTRA increase the immunity signal, until you or your monitoring system have detected and checked all EUT failure modes again. For each detected EUT failure mode, a red circle symbol appears at this frequency and level in the test level graphics, showing the threshold, at which the EUT failure appears.

For each detected failure, R&S ELEKTRA stores the "Frequency" value, the "Test Level" threshold, the "EUT Failure Mode" label and the "NoGo Value" in the "Critical Points" table.

Cancel

Terminates the EUT failure mode analysis without an entry in the "Critical Points" table.

Switch RF ON/OFF

Toggles between switching the RF source on and off.

- While in "off" state, the generator is set to "RF OFF", and the currently active amplifier is set to standby.
- When it is on, the countdown for [Automatic RF off after 5 minutes](#) applies.

Note: 300 s after opening the "EUT Failure Mode Analysis" dialog, R&S ELEKTRA automatically switches the RF generator to "RF OFF", unless you toggle RF on/off or close the dialog.

MOD

Toggles between switching [Modulation](#) on and off.

The functioning of the "MOD" button depends on having selected [Modulation](#) in the [EMS test template](#).

7.4.7 Frequency Control



The "Frequency Control" dialog handles all frequency settings of the measurement instrument, for example a receiver, in [automated](#) and [interactive](#) measurements.

Current Record

Displays and sets the current frequency value. This frequency setting is always visible, independent of the tab ([Source](#) / [Range](#) / [Tuning](#)) selected below.

You can change both the value and the unit ("[Hz]", "[kHz]", "[MHz]" or "[GHz]") while the measurement is paused or stopped.

For editing the frequency value, you have the following alternatives:

- **Type** a new frequency value into the field.
Depending on the "Source" setting (see below), the software adjusts your entry to the closest permitted frequency value.
- **Step** the frequency value up or down by the  or  buttons. You can use also the up- or down-keys of your keyboard, when the cursor is in the frequency field.
The step size depends on the "Source" setting (see below):
If "Source" = "Test Template", the [Step Size](#) is as specified in the test template.
If "Source" = "Critical Points", the steps correspond with the frequency values in the critical points table.
If "Source" = "Final Results" (EMI, only), the steps correspond with the frequency values in the final results table.
- Click and hold a detail from a test chart or table and **drag and drop** it into the "Current Record" field.
The detail (the origin of the drag-and-drop action) can be any spot in a graphic (trace node, limit line node or marker) or any field in a table. The action copies the corresponding frequency value into the "Current Record" field.
To drag and drop a detail in touch operation, touch and hold the detail, then drag it to the destination and release it there.

Restore Test Template Settings

-  Sets all changed parameters back to the settings given in the test template, including the settings in the [Parameter](#) and [Measurements](#) dialogs.

For more setting, select a tab below:

Source	620
Range	620
Tuning	621
Zoom	622

Source

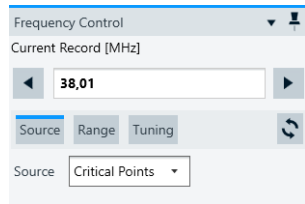

Figure 7-19: Source tab of the Frequency Control dialog

This field always shows the source that currently determines the frequency values, and hence also the steps. You can select the source only in interactive measurement mode.

"Source" defines the domain from which the frequency values are taken:

- "Test Template"
 Permits using only frequency values that are defined by the steps in the test template.
- "Critical Points"
 Permits using only frequency values from the critical points table.
- "Final Results" (EMI, only)
 Permits using only frequency values from the final results table.

Range

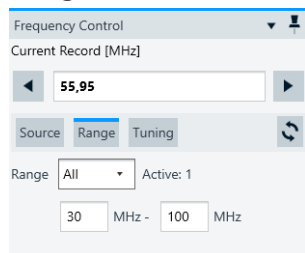

Figure 7-20: Range tab of the Frequency Control dialog

- "Range"
 Selects one or all frequency ranges defined in the test template. You can change the selection while the measurement is paused or stopped. For example, if you set "Range" = "1", only frequencies from the 1st frequency range are selected for the measurement and available for the field "Current Record". If you set "Frequency Range" = "All", the software also displays the number of the currently active frequency range. If you select a frequency range that was previously not active, the

"Current Record" value is automatically changed to the lowest frequency of the newly selected frequency range.

- "... xHz" - "... xHz"
Unless edited, these fields show the lower and upper end of the one or more frequency ranges selected above. To restrict this overall frequency range, for example, to analyze details in a second scan, you can change the range values while the measurement is paused or stopped: Either type new frequency values into the fields or drag-&-drop details from a test chart or table, as described for "Current Record".

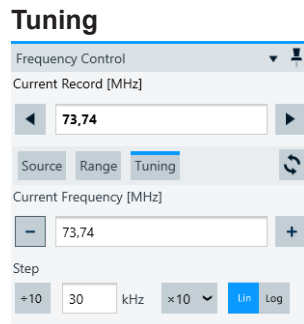

Figure 7-21: Tuning tab of the Frequency Control dialog

You can tune the frequency only in interactive measurement mode.

- "Current Frequency"
Specifies the frequency to be used for the next measurement. You can modify this frequency value in the following ways:
 - This field permits using any frequency value within the test template's frequency range.
 - When you change the frequency value in the [Current Record](#) field, it overwrites the "Current Frequency" value.
 - You can step the frequency value up or down by the **+** or **-** buttons. You can use also the up- or down-keys of your keyboard, when the cursor is in the frequency field.
The step size depends on the "Step" setting (see below).
- "Step"
Allows specifying the step size and step mode, even during a measurement:
 - "Lin" mode: linear steps in frequency units ("Hz" or "kHz")
 - "Log" mode: logarithmic steps of a relative size ("%")

Zoom

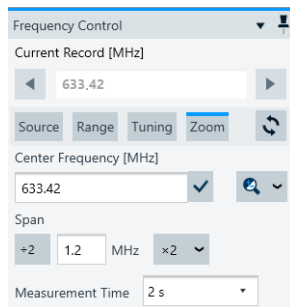







Figure 7-22: Zoom tab of the Frequency Control dialog

Available only in an interactive  measurement at a single frequency , see [Repeat Measurement at Single Frequency](#).

- "Center Frequency"

The center frequency of the zoom measurement is the current frequency defined in the "Source", "Range" or "Tuning" tab of the frequency control dialog. To copy the frequency of the measurement's highest signal into the "Current Frequency" field of the [Tuning](#) tab, click the "Use peak frequency from zoom" button . When you use this button, the dialog's focus jumps to the [Tuning](#) tab.

The button "Set peak frequency as center frequency"  selects the frequency of the peak level and sets it as the zoom measurement's center frequency. Instead of clicking the button manually, you can let the software set the center frequency automatically and repeatedly after each cycle of the zoom measurement. To do so, expand the dropdown dialog next to the button  and toggle from "Manual" to "Auto" control of the center frequency setting.
- "Span"

Specifies the width of the measurement frequency range around the center frequency. You can enter the span directly into the field, or divide or multiply the current span value by a factor of 2, 5 or 10. To do so, use the buttons and the dropdown list to the left and right of the input field.
- "Measurement Time"

Selects from a list of suggested measurement times or sweep times, depending on the [Scan](#) or [Sweep](#) mode defined in the [Settings \(Zoom\)](#) of the test template. You can vary the measurement time to gain more information about unknown signals.

When you finish the zoom measurement by clicking the [Stop](#)  button, R&S ELEKTRA creates a result table with the latest results from the zoom measurement.

7.4.8 Parameter

Available only in EMI tests running in [interactive measurement](#) mode.

Parameter

Meas BW: 9 kHz

Meas. Time: 2 s

Demodulation

Type: OFF

Volume: 20

Attenuation

Auto Attenuation

RF Attenuation: 10 dB

Min Attenuation: 10 dB

Gain

Preamplifier: 0 dB

Reference Level: 80 dB μ V

Figure 7-23: Receiver parameter dialog in an interactive EMI test

This dialog allows an individual configuration of the receiver parameters, overriding the settings specified in the test template. For a description of these settings, see ["Settings \(Overview\)"](#) on page 212, except for "Demodulation", which is described in ["Audio Demodulation Type"](#) on page 145.

The name of the last parameter in this dialog depends on the [Operating Mode](#):

- "Screen Maximum", if the "Operating Mode" is "Test Receiver"
- "Reference Level" if the "Operating Mode" is "Spectrum Analyzer"

7.4.9 Measurements

Available only in EMI tests.

The "Measurements" dialog serves for controlling the detectors in an [Interactive measurement for EMI tests](#).

Measurements

Max-Hold Clear-Write

Maximum Peak: 74.33

Quasi Peak: 63.28

Average: 60.49

None: 0

Comment

Bargraph: PK+, CPK, AVG

This dialog offers the following features:

PK+
74,33

Detectors

Selects up to four detectors and displays their measured "Clear Write" level values. The values are shown in numerical form (top to bottom) and as bargraphs (left to right).

The bargraphs with one vertical bar per detector display the "Clear Write" level. On top of each bar is a colored rectangle as "Max Hold" indicator. The colors correspond with the trace colors in the chart.

You can only change the detector selection, if the measurement is paused or stopped.

Max Hold Clear Write

Max Hold / Clear Write

Toggles between the "Max Hold" and "Clear Write" mode.

Max Hold

Max Hold ← Max Hold / Clear Write

Measures the level values of the selected detectors and keeps the maximum value during a measurement. In this mode, the "Max Hold" value appears in the active row of the results table. It is also indicated in the bargraph via the max-hold indicators on top of each bar, while the "Clear Write" values are shown in the "Detectors" selection fields.

Note: The "Max Hold" level value is only stored in the results table, if you click the **Record** button (●).

The "Max Hold" value is either reset by changing the measurement frequency or by the clicking the "Reset Max Hold" button.



Reset Max Hold ← Max Hold ← Max Hold / Clear Write

Resets the max-hold value and the max-hold indicator back to the currently measured "Clear Write" value. Available only, if "Max Hold" is enabled.

Clear Write

Clear Write ← Max Hold / Clear Write

Continuously overwrites the level value of the previous measurement with the level value of the most recent measurement. In this mode, the "Clear Write" level value is entered and continuously overwritten both in the active row of the results table and in the "Detectors" selection fields.

Note: The "Clear Write" level value is only stored in the results table, if you click the **Record** button (●).

Comment

Enter arbitrary text to be saved with the measurement value in the "Comment" column of the result table.

7.4.10 Evaluation Control

Available only in EMI tests running in **automated measurement** mode.

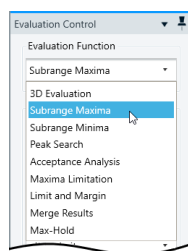

Figure 7-24: Upper part of the evaluation control dialog

This dialog provides access to the test result evaluation tools and features of R&S ELEKTRA. For a description of these tools, refer to [Chapter 7.7, "EMI test result evaluation"](#), on page 633.

7.4.11 Calibration Control

Available only for measurements based on a calibration template, see [Chapter 4.5.1, "Test Templates for calibration measurements"](#), on page 119.

Non-ABT calibration

For any calibration measurement based on an **EUT Type other than Audio Breakthrough (ABT)**, this dialog selects one of the following "Run Mode" options:

- "Normalization" selects running the normalization measurement, only. Specify also the normalization table, into which the software enters the normalization results.
- "Calibration" selects running the calibration measurement, only. Specify also the calibration table, into which the software enters the calibration results.
- "Both" selects running the normalization measurement and the calibration measurement.

Note that you can choose to save only the normalization or calibration table, instead of saving all test results. See ["Save global table"](#) on page 601.

ABT calibration

For a calibration measurement based on the **EUT Type = Audio Breakthrough (ABT)**, this dialog selects one of the following calibration options:

- "Artificial Mouth Calibration" selects calibrating only the voltage level for 0 dBPa sound pressure at the artificial mouth
- "Uplink Reference Measurement" selects measuring only the microphone's reference level (uplink)
- "Downlink Reference Measurement" selects measuring only the "earspeaker's" reference level (downlink)
- "Hands-Free Set Calibration" selects calibrating only the loudspeaker's amplification over the "earspeaker"
- "All" selects running all four calibration and reference measurements listed above

For a brief description of these measurements, refer to ["Audio Breakthrough"](#) on page 123.

7.4.12 EMS Test Generator

Figure 7-25: Interactive EMS test settings dialog

Allows direct control of the following parameters from the [EMS test template](#) during an interactive measurement:

- "Test Level"
- "Level Limit"
- "Step Size"
- "Dwell Time"
- "Modulation"

If you use a [Modulation List](#) instead of global [Settings EMS](#), the modulation dialog in [Figure 7-25](#) changes: Rather than setting modulation parameters, you can select modulation list entries.

You can change the "EMS Test Generator" parameters only, when you run an EMS test in [interactive measurement](#) mode.

For a description of these parameters, see "[Frequency Range List](#)" on page 274.

7.4.13 Uniformity Evaluation

Available only in EMS tests based on an [EMS test template](#) of the type "EMS - Anechoic Chamber", with the [Test Method](#) = "Field Uniformity".

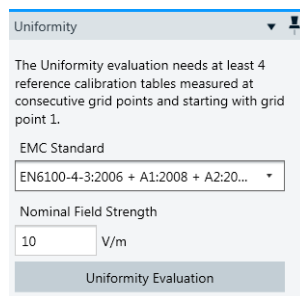

Figure 7-26: Uniformity evaluation dialog

Executes an algorithm that evaluates, whether the field generated in the chamber meets the homogeneity criteria required by the selected "EMC Standard".

Perform at least a reference calibration at 4 sensor positions or perform a field uniformity (FU) measurement sequence for 4 sensor positions as described in the example in [Chapter 8.6, "Field uniformity evaluation"](#), on page 657.

Select the "EMC Standard" for which you want the algorithm to run the evaluation. Select the "Nominal Field Strength" and click "Uniformity Evaluation". R&S ELEKTRA runs the evaluation and returns the results.

7.4.14 Test Validation

After starting (▶ / 🖨) or refreshing (🔄) a test, R&S ELEKTRA first performs a "Test Validation":



This process is to verify that all conditions required in the test template are met.

If the conditions are **not** all met, R&S ELEKTRA prompts you with details of the problem. For example, the dialog could state that a [limit line](#) has the wrong unit for the measurement values of the selected transducer. In this case, select or define the correct limit line.

Two examples of test validations are shown below:

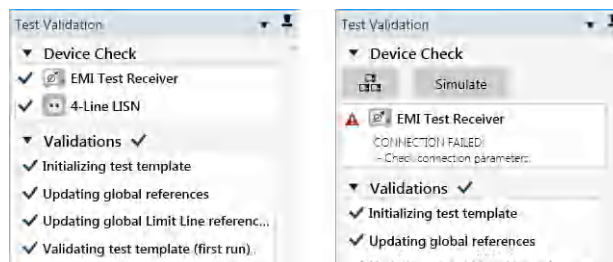

Figure 7-27: Test validation, left: successful, right: receiver connection check failed

In the right-hand example in [Figure 7-27](#), the receiver's connection cannot be confirmed.

To solve this issue, you can try the following:

- [Search](#) for the missing device in a network
- Revise your [Receiver](#) settings in the [Device List](#)
- [Recheck](#) the connection
- [Simulate](#) the device (which leads to simulated random test results)

If the "Test Template Validation" is successful, R&S ELEKTRA continues with the action that led to the validation process, for example running a test.

7.5 Test result tables



- For information on how to configure test result tables, see [Chapter 4.4.3, "Configuring test tables"](#), on page 108.
- For information on test charts, see [Chapter 7.6, "Test result graphics"](#), on page 632.

R&S ELEKTRA supports test result tables that are **created** by either of the following actions:

- Measurements
- Manual editing (including copy/paste from external spreadsheets)
- [Import](#) of compatible data in XML format

Some **basic features** of the three types of test result tables:

- "Spectrum Overview" tables are generated during **automated EMI** or **EMS** measurements and during [Calibration measurements](#) measurements. In spectrum overview tables of EMI tests, only, you can edit data in the "Level" and "Comment" columns.
- "Critical Points" tables in **EMI** tests are generated automatically during [data reduction](#), which selects a limited number of frequencies for a closer examination of the EUT. The selected frequency points come from the "Spectrum Overview" measurement, while the selection depends on the "Measurement Flow" settings. You can [edit](#) data in the "Level" and "Comment" columns.

"Critical Points" tables in **EMS** tests cannot be edited and are generated in the following cases:

- If you use the [Test Method](#) > [EUT Qualification](#), the table comprises the frequency points at which R&S ELEKTRA detected a [NoGo](#) condition of the EUT. This table allows direct evaluation of the EUT failures.
- If you use the [Leveling Mode](#) > "Level On" = [Substitution Method](#), the table contains for each [EUT failure mode](#) the frequency points, at which you have evaluated the threshold level during the measurement.
- If you perform [interactive measurements](#), the table contains the results you have recorded, together with the values of parameters that you have modified during the measurements.

Note that the columns available in a "Critical Points" table depend on the "[Test Method](#)" on page 252: For example, "EUT Qualification" tests and "EUT Susceptibility" tests generate different values.

- "Final Results" tables in **EMI** tests are either generated in the [Automated measurement for EMI tests](#) mode by remeasuring at "Critical Points", or in the [Interactive measurement for EMI tests](#) mode by manual frequency selection. A new row in a "Final Results" table is created when you click the "Record" button. An automatic scan in the interactive measurement mode is only possible, if you have selected "Source" = "Critical Points" (see [Frequency Control](#)). You can edit data in the "Level" and "Comment" columns of the final results. "Final Results" tables in **EMS** tests contain all frequency points, at which you have recorded [EUT failure modes](#).

Editing results

You are allowed to edit (hence, manipulate and change) measured "Level" values of EMI tests in all tables ("Spectrum Overview", "Critical Points" and "Final Results"). Editing can be reasonable in various situations, for example if known signals from a nearby radio station must be eliminated from test results in an open area test site (OATS). As an operator, you are responsible for the test results.



Editing measured level values can influence the test's [Verdict](#).

The following limitations apply to editing values:

- You cannot edit values during an active test.
For information on how to pause a test automatically during the measurement flow for editing it, see ["Data Reduction"](#) on page 173.
 - You cannot edit values in columns that are controlled by given settings or by calculation. Examples are the "Limit", "Margin" and "Correction" columns.
- [Merged overview results](#)..... 630
 - [Editing critical points](#)..... 631
 - [Margin](#)..... 631

7.5.1 Merged overview results

The "Spectrum Overview" table and chart can show **merged** maximum levels, if there are [Accessory Settings](#) for one of the following transducers used in the measurement:

- **Antenna** with accessories like antenna tower and turntable:
An "EMI - Electric Field Strength" test template can specify accessory settings like antenna height (on an antenna tower), antenna polarization (horizontal/vertical) and EUT azimuth (on a turntable). Therefore, the overview results can comprise levels measured at various heights, polarizations and azimuth positions in different parts of the frequency range. The "Antenna Height", "Polarization" and "Azimuth" columns in the test table indicate, at which accessory setting the level result in each row was taken.
- **LISN** with more than one line selected:
An "EMI - LISN" test template can specify in the accessory settings to measure on different lines, for example on lines N and L1. Therefore, the overview results can comprise levels measured on line N in some parts of the frequency range and measured on line L1 in other parts of the frequency range. The "Line" column in the test table indicates, from which line the level result in each row was taken.
- **Slidebar** with more than one distance selected:
An "EMI - Slidebar" test template can specify in the accessory settings to measure at different distances. Therefore, the overview results can comprise levels measured at one distance in some parts of the frequency range and measured at another distance in other parts of the frequency range. The "Distance" column in the test table indicates, from which point the level result in each row was taken.
- **TEM Waveguide** (GTEM cell) with 3 orthogonal axes of measurement:
An "EMI - Electric Field Strength (GTEM)" test template can specify accessory settings for EUT orientation ("Polarization"). The overview measurement requires level results (voltages in dB μ V) for all 3 orthogonal axes X, Y and Z across the frequency range. By correlation of these voltage levels, R&S ELEKTRA calculates the field strength values (dB μ V/m) for the overview results tables in H and V polarization. The overview table (also in dB μ V/m) is generated by merging the H/V labels.
- **Triple Loop** antenna with 3 orthogonal coils:
An "EMI - Magnetic Field Strength (Triple Loop Antenna)" test template can specify accessory settings for antenna axis (coil orientation). Therefore, the overview results can comprise levels measured at X, Y or Z axes in different parts of the frequency range. The "Axis" column in the test table indicates, at which accessory setting the level result in each row was taken.
- **Magnetic Loop Antenna** with turntable as an accessory:
An "EMI - Magnetic Field Strength (Loop Antenna + Turntable)" test template can specify in the accessory settings to measure at different azimuth angles. Therefore, the overview results can comprise levels measured at various azimuth positions in different parts of the frequency range. The "Azimuth" column in the test table indicates, at which angle the level result in each row was taken.

The overview results show merged maximum (worst-case) levels. On the contrary, the individual "Result Tables" from the "Loop Results" folder [Test Components](#) dialog show the results for each individual setting.

To see a graphical representation of a table, click the "Show Graphic Display" button .

7.5.2 Editing critical points

You can let R&S ELEKTRA measure at more or other frequencies than the automatically selected "Critical Points". To do so, add frequency points from the "Spectrum Overview" table to the "Critical Points" table or enter your own arbitrary frequency points. Optionally, edit entries in the "Process State" column. Also, you can delete existing critical points from this table.

If the test uses accessories for controlling "Polarization", "Azimuth" or "Antenna Height", you can edit data in these columns of the "Critical Points" table.

However, you cannot edit "Limit", "Margin" and "Correction" values.

For example, if you have identified one or more additional frequency points in the "Spectrum Overview" chart that you want to include into the final or interactive measurement, drag it from the graphic into the "Critical Points" table. This action copies not only the frequency value but also the level and margin values and other information to this table. R&S ELEKTRA automatically adds the row in the right order of frequency values.

7.5.3 Margin

At each frequency point, the margin is defined as the limit line's value minus the measured level value.

Example:

Level [dBµA/m]	Limit [dBµA/m]	Margin [dB]	Remark
20.1	15	-5.1	If the level value is too high (above limit), the margin is negative .
23.2	25	1.8	If the level value is low enough (below limit), the margin is positive .

R&S ELEKTRA automatically calculates this difference. You cannot edit margin values.

7.6 Test result graphics



- For information on how to configure test result graphics, see [Chapter 4.4.2, "Configuring test charts"](#), on page 98.
- For information on how to preconfigure graphics, see [Chapter 4.12.6.4, "Graphics"](#), on page 547.
- For information on the measurement values in these graphics, see [Chapter 7.5, "Test result tables"](#), on page 628.

Test result charts are a graphical representation of [Test result tables](#). A table is either automatically shown as a chart, or you can bring up a chart by clicking the [Show Graphic Display](#) button (📊) in the table header. In the dialog that comes up, you can select the columns to be displayed in the chart. Also, you can select to display the values in an existing chart or in a new chart.

In **EMI** tests, R&S ELEKTRA displays a continuous line in the "Spectrum Overview" chart that represents the measurement results. "Critical Points" and "Final Results" are shown as individual nodes, each with a symbol and a vertical line to the bottom. Additionally, "Limit Lines" are superimposed in test result charts as continuous lines or with gaps.

If you have enabled the [Add Spectrogram Graphic](#) checkbox in the EMI test template, R&S ELEKTRA creates a waterfall spectrogram in the "Graphics" section of the chart. With the proceeding test, the graphic successively displays the color-coded measurement results of the 1st detector. R&S ELEKTRA sets a marker to the maximum level.

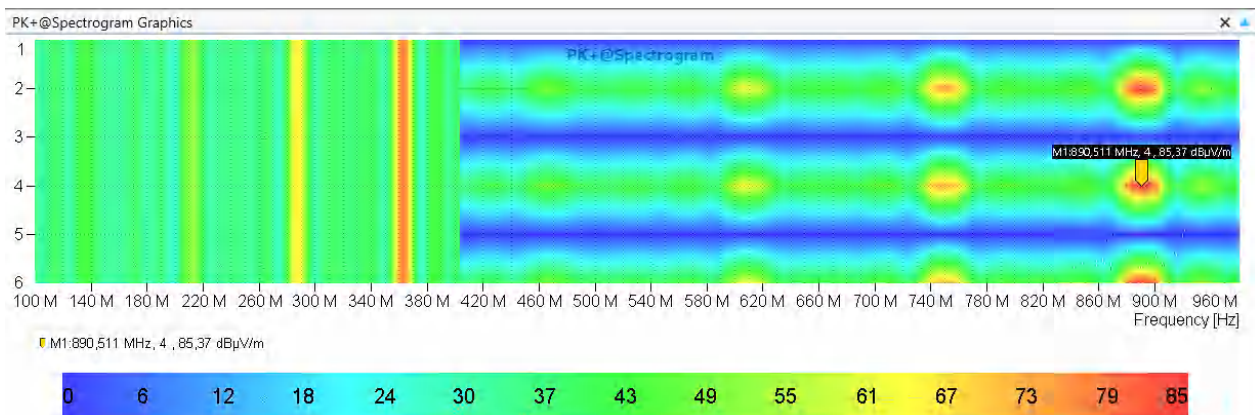

Figure 7-28: Example of a "waterfall" spectrogram, which evolves during the test

Vertical axis = Number of measurements shown in the spectrogram, hence the cycle or loop count

Color scale = Visualization of the color-coded measurement level results in the same unit as the marker, for example dBµV/m

In **EMS** tests, R&S ELEKTRA generates a chart for each [EUT Monitoring](#) and [System Monitoring](#) channel. Exception: the option [Combine System Monitoring Channels](#) merges the forward power, reverse power and source power channels in one chart, each. The results of a "Spectrum Overview" measurement are represented by a continuous line. "Critical Points" and "Final Results" are shown as individual nodes, each with

a symbol and a vertical line to the bottom. The chart of the "Test Level" shows the target test level line. The "Sensor Level" and EUT monitoring channel charts show the corresponding "Limit Lines", which are superimposed as continuous lines or with [gaps](#).

Some basic features of charts:

- During a measurement, the current test frequency is indicated in the chart by a moving [Marker](#).
- You can use markers to identify individual measured values and set them into relation with other values. Also, you can drag markers into frequency input fields of the test dialog, which simplifies the entering of a selected frequency value.
- You can use the [Zoom](#) function to view details in a chart.
- You can integrate charts into your [reports](#) and [configure](#) them there.



Overview of test results with various accessory settings

If the transducer used in the measurement is an [Antenna](#), a [LISN](#), a [TEM Waveguide](#) (GTEM cell) or a [Triple Loop](#) antenna, the "Spectrum Overview" chart can show **merged** maximum levels, as described in [Chapter 7.5.1, "Merged overview results"](#), on page 630.

7.7 EMI test result evaluation

To evaluate a completed EMI test, make sure to have this test opened.

Access: "Home" > "Tests" > "Open" > "... test" > "Evaluation Control"

Most evaluation functions are algorithms for finding critical points in the frequency spectrum of a test result table. The outcome of such an evaluation typically leads to a table with a massively reduced number of rows. Therefore, this procedure is often called "data reduction". The evaluated "critical" points are also visualized in a graphics window.



Additionally, one evaluation function allows generating [3D plots](#), and one evaluation function helps to [merge](#) previously generated results.

The dialog is split into two parts: The "Evaluation" part lets you select the function to be executed. The "Output" part lets you set the name of the generated evaluation result table and its graphical representation. The content and the format of the result table depend on the selected evaluation function.



Per default, the access to the function "Evaluation Control" is found at the upper right edge of the dialog:



Alternatively, if this dialog is hidden ("Auto Hide" ) , it is accessible at the lower far right edge of the R&S ELEKTRA window. If the dialog is not docked ("Dock" / "Float" ) , it can float anywhere in the workspace as described in [Chapter 4.4, "Tests"](#), on page 88.

The following evaluation functions are available:

- [Evaluation - 3D Evaluation](#).....634
- [Evaluation - Subrange Maxima](#).....638
- [Evaluation - Subrange Minima](#).....638
- [Evaluation - Peak Search](#).....639
- [Evaluation - Acceptance Analysis](#).....640
- [Evaluation - Maxima Limitation](#).....641
- [Evaluation - Limit and Margin](#).....642
- [Evaluation - Merge Results](#).....642
- [Evaluation - Max-Hold](#).....643

7.7.1 Evaluation - 3D Evaluation

Use this function to create three-dimensional graphical representations of your test results.

As a prerequisite, the test must be based on a test template that has the **checkbox [Save Results for 3D Chart Evaluation](#) enabled** for the overview or maximization measurement. This feature is available only in EMI test templates of the [type](#) "Electric Field Strength" and "Radiated Spurious Emission". And it requires that the [license](#) "ELEMI-3D" is activated.

The following procedure uses the [Test results](#) that are contained in the [Test Components](#) section.

To configure and run the 3D evaluation

1. "Input Table(s)"
Select one of the available input tables with the test results, either the "Spectrum Overview" or the "Maximization" table.
If this field is empty, the reason is typically a failure to enable the checkbox [Save Results for 3D Chart Evaluation](#) in the test template.
2. "Evaluation Column"
Select the trace of one detector within the input table.
3. "Measurement Frequency"
Select a frequency, for example by dragging and dropping a peak from the overview chart into the "Measurement Frequency" field.

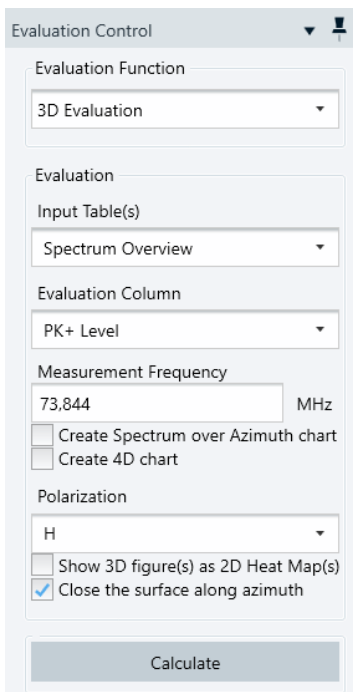

4. "Create Spectrum over Azimuth chart"
One option instead of specifying a single frequency is the spectrum over azimuth chart: The software omits the antenna's height position on the antenna tower and instead represents all measured frequencies on the vertical axis. To do so, it uses for each point the maximum level across all height positions.
"Create Spectrum over Azimuth chart" is available only for cylinder charts (left in [Figure 7-29](#), hence not for RSE measurements). Note that enabling this feature disables the "Measurement Frequency" field and the "Create 4D chart" feature.
5. "Create 4D chart"
Another option instead of specifying a single frequency is the 4D chart: Let the software create a combined chart that displays 3D evaluation graphics as a function of all test frequencies, hence $3 + 1 = 4$ dimensions. For quick browsing across the various 3D charts per frequency, drag the cursor in the lower plot to any frequency. When you release the cursor, R&S ELEKTRA automatically displays the 3D chart for the selected frequency. Note that enabling this "Create 4D chart" feature disables the "Create Spectrum over Azimuth chart" feature.
6. "Polarization"
Select the antenna polarization, for which you want to create the 3D chart.
7. "Show 3D figure(s) as 2D Heat Map(s)"
Optionally, instead of a 3D chart, let the software generate a 2D heat map with accessory positions along the x- and y-axes.
8. "Close the surface along azimuth"
Optionally, let the software close the surface of the 3D plot at its open edges. This feature allows avoiding redundant measurements, typically at 0° and 360° (or $\pm 180^\circ$) azimuth positions of the turntable. For example, if you want to measure a full circle in steps of 30° , you can skip the measurement at 360° . Instead, measure from 0° up to 330° , only, and let the software close the gap from 330° to 360° ($=0^\circ$).
9. Click "Calculate".
R&S ELEKTRA generates the 2D, 3D or 4D chart with color-coded levels.
R&S ELEKTRA automatically stores each calculated chart in the [Test Components](#) explorer at "Test Content" > "Graphics" > "Evaluation Graphics". The data of the charts are stored at "Test Content" > "Result Tables" > "Evaluation Results".

In the default view, the marker "M1" labels the largest measured level.

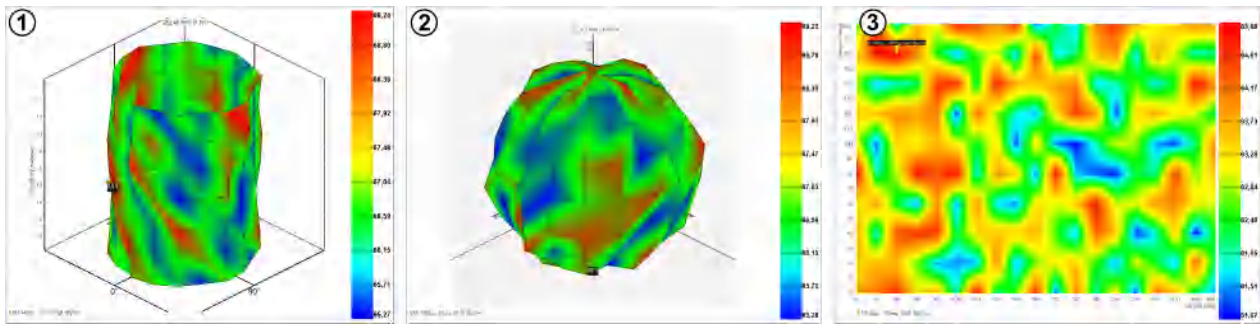

Figure 7-29: Examples of 3D charts

1 = 3D chart of "Electric Field Strength" measurement results in cylinder coordinates

2 = 3D chart of RSE measurement results in spherical coordinates

3 = 2D heat map of the same RSE measurement results as in (2)

The coordinates in [Figure 7-29](#) are represented as follows:

Example (1), cylinder plot:

- Azimuth = the turntable's angular position ↻
- Vertical axis = the antenna's height position on the antenna tower ↑
- Radial distance (and color coding) = measured interference level at the selected "Measurement Frequency"

Example (2), spherical plot:

- Azimuth = the turntable's angular position ↻
- Elevation = the turn device's angular position ↻
- Radial distance (and color coding) = measured interference level at the selected "Measurement Frequency"

Example (3), heat map:

- Horizontal axis = azimuth = the turntable's angular position ↻
- Vertical axis = elevation = the turn device's angular position ↻
- Color coding = measured interference level at the selected "Measurement Frequency"

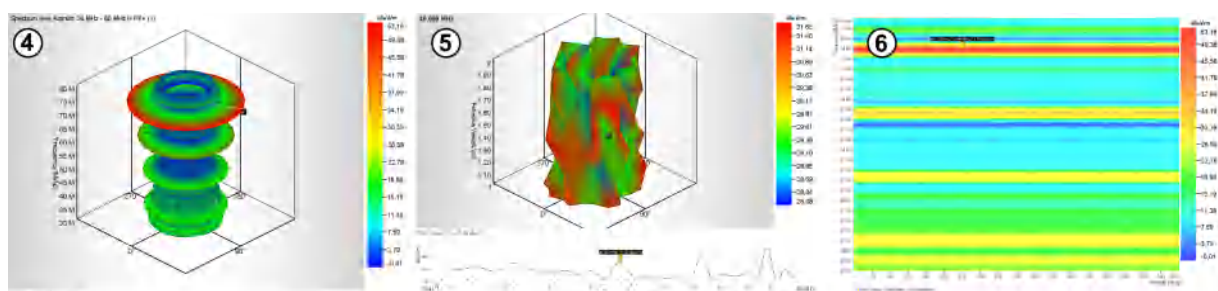

Figure 7-30: More examples: special charts of an Electric Field Strength measurement

4 = Spectrum over azimuth chart, here at 30 MHz

5 = 4D chart, showing a 3D chart at the frequency selected by the marker in the lower 2D plot



6 = Spectrum over azimuth chart from example (4), shown as a 2D heat map

The coordinates in [Figure 7-30](#) are represented as follows:

Example (4), spectrum over azimuth cylinder plot:

- Azimuth = the turntable's angular position 
- Vertical axis = the measurement frequency
Note that the antenna's height position on the antenna tower is omitted.
- Radial distance (and color coding) = measured interference level at the selected "Measurement Frequency"

Example (5), 3D cylinder plot with additional frequency selection:

- Azimuth = the turntable's angular position 
- Vertical axis = the antenna's height position on the antenna tower 
- Radial distance (and color coding) = measured interference level at the selected "Measurement Frequency"
- Below the 3D plot: 2D chart for frequency selection

Example (6), spectrum over azimuth as 2D heat map:

- Horizontal axis = azimuth = the turntable's angular position 
- Vertical axis = the measurement frequency
Note that the antenna's height position on the antenna tower is omitted.
- Color coding = measured interference level at the selected "Measurement Frequency"

Context functions in the chart

You can click and hold a 3D plot and then rotate it to any orientation by dragging the mouse pointer. Double-clicking returns the plot to its default view.

Also, like in the conventional 2D charts, the 3D plots and the heat map provide the following context functions:

- "Marker", see [Chapter 4.4.2.3, "Marker"](#), on page 105
- "Chart", see [Chapter 4.4.2.1, "Chart"](#), on page 99
- "Copy to Clipboard" captures a screenshot bitmap of the active chart and copies it to the clipboard. Outside of R&S ELEKTRA, you can enter this bitmap chart into any application that allows pasting graphics.
- "Save Image to File" saves a screenshot bitmap of the active chart outside of R&S ELEKTRA in portable network graphics (PNG) format
- "Graphics Properties", see ["Graphics Properties"](#) on page 103
- "Store Zoom Settings" is available only after modifying the perspective view of the graphic, for example by dragging it with your mouse. The software saves the current viewing parameters in the "Graphics" section of the "Test Content" dialog. You can integrate saved views into your test reports.
The viewing parameters are like a "camera position": zoom, tilt and rotation of a 3D chart, or zoom of a 2D chart. See ["Store Zoom Settings"](#) on page 103.
- "Print" opens a dialog for printing the chart
- "Zoom", see ["Zoom"](#) on page 104
Also, you can zoom in and out by rotating the mouse wheel.

7.7.2 Evaluation - Subrange Maxima

Use this function, which is similar to [Evaluation - Subrange Minima](#), to find broadband signals in addition to narrowband signals over the complete measured spectrum.

The algorithm splits a measured trace of one detector into n frequency subranges (default: n = 10 subranges, max. 2,147,483,647 subranges) with equidistant boundaries both for linear or logarithmic scales. It then determines the maximum measured value for each subrange. At the n frequency points of these peaks, all values of the original table are transferred to the output table. This transfer includes the measured level values of all active detectors and the corresponding margin, limit line and correction values.

Starting from [Test results](#), the evaluation of the subrange maxima requires:

- An input table
- The selection of one evaluation column (trace of one detector) within that table
- The selection of a limit line column within the same table
- The specification of the desired number of subranges, into which the measurement's spectral range is subdivided

Click "Calculate" to let the software evaluate the measurement and generate both a table and a graphical output.

7.7.3 Evaluation - Subrange Minima

Use this function, which is similar to [Evaluation - Subrange Maxima](#), to determine the subrange minima of a measurement result. It permits, for example in an open-area test site (OATS), to identify those frequencies that are barely or not at all occupied by external signals. Such frequencies are best suited for measuring antenna characteristics etc.

The screenshot shows the 'Evaluation Control' panel with the following settings:

- Evaluation Function:** Subrange Minima
- Evaluation Input Table:** Spectrum Overview
- Evaluation Column:** PK+ Level
- Limit Line Column:** PK+: QPK Limit
- Number of Subranges:** 10
- Calculate:** Button

The algorithm splits a measured trace into n frequency subranges (default: $n = 10$ subranges, max. 2,147,483,647 subranges) with equidistant boundaries both for linear or logarithmic scales. It then determines the minimum measured value for each subrange. At the n frequency points of these minimum values, all values of the original table are transferred to the output table. This transfer includes the measured level values of all active detectors and the corresponding margin, limit line and correction values.

Starting from [Test results](#), the evaluation of the subrange minima requires:

- An input table
- The selection of one evaluation column (trace) within that table
- The selection of a limit line column within the same table
- The specification of the desired number of subranges, into which the measurement's spectral range is subdivided

Click "Calculate" to let the software evaluate the measurement and generate both a table and a graphical output.

7.7.4 Evaluation - Peak Search

Use this function to determine all peaks that exceed the adjacent lower measured values by a user-defined "Peak Excursion".

For this evaluation, the algorithm first computes the distance (or delta) between the measured values in the selected trace and the respective limit line values. The "Peak Excursion" parameter then determines how far a local maximum must "stand out" in this delta trace to be considered as a peak and to be added to the output table.

With a "Peak Excursion" of 0 dB, all local maxima are detected as peaks, whereas, for example with a "Peak Excursion" of 20 dB, only distinct narrowband signals are detected.

Peak search is preferably used with narrowband interference signals and only on non-intermittent traces. Hence, if combined with other evaluation functions, we recommend searching the peak first.

Starting from [Test results](#), searching for peaks requires:

- An input table
- The selection of one evaluation column (trace) within that table
- The selection of a limit line column within the same table
- The specification of the "Peak Excursion" (in dB) as described above

Click "Calculate" to let the software search the peak and generate both a table and a graphical output.

7.7.5 Evaluation - Acceptance Analysis

Use this function to filter off signals that are too far below a given limit line - further than a user-defined "Acceptance Offset". Such signals could particularly include the receiver's background noise.

The acceptance analysis is implemented by a virtual acceptance line, which cuts off all measured values that fall below it. The acceptance line runs parallel to the selected limit line with a specified offset. A negative offset, for example -10 dB, means that values 10 dB or more below the limit line are discarded. If the offset is a large negative number (for example -200 dB), all signals are maintained. If the offset is a large positive value (for example 200 dB), all signals are rejected.

Starting from [Test results](#), the acceptance analysis requires:

- An input table
- The selection of one evaluation column within that table
- The selection of a limit line column within the same table
- The specification of the acceptance offset (in dB) that determines the minimum gap between the power levels and the limit lines

Click "Calculate" to let the software perform the acceptance analysis and generate both a table and a graphical output.

7.7.6 Evaluation - Maxima Limitation

Use this function to transfer a given number (max. 2,147,483,647) of maximum levels of the input table into the output table.

The algorithm selects maximum levels in relation to a given limit line. For example, the 1000 measured values that come closest to the limit line are copied to the output table. This selection of measurement values facilitates focusing on the most critical points of a measurement.

Starting from [Test results](#), the evaluation of the maxima limitation requires:

- An input table
- The selection of one evaluation column within that table
- The selection of a limit line column within the same table
- The specification of the desired number of maxima, into which the measurement's spectral range is subdivided

Click "Calculate" to let the software evaluate the maxima limitation and generate both a table and a graphical output.

7.7.7 Evaluation - Limit and Margin

This function recalculates the margin values in a measurement result table by selecting a different (appropriate) limit line. Hence, a result table that has originally been evaluated against a certain limit line can later be adapted to another limit line.

Starting from [Test results](#), the evaluation of the limit and margin requires:

- An input table
- The selection of one evaluation column within that table
- The selection of a limit line
- The selection of a limit line column within the limit line table

Click "Calculate" to let the software reevaluate the margin and generate both a table and a graphical output.

Evaluation Control

Evaluation Function
Limit and Margin

Evaluation
Input Table
Spectrum Overview

Evaluation Column
PK+ Level

Limit Line
EN 55011 E Field 10 ...

Limit Line Column
Limit 1 (QuasiPeak)

Calculate

7.7.8 Evaluation - Merge Results

Starting from [Test results](#), use this function to merge all values of two measurement result tables.

If the frequencies are the same, the complete line is entered into the data list with the maximum level ("MaxHold"). If the frequencies are not the same, both lines are entered into the data list, if the merge mode "Union" is selected. With the merge mode "Intersection", only lines with matching frequencies are evaluated. The columns in the two data lists must comply with each other.

The merging of results requires:

- An input table
- The selection of a second table to be merged with the input table
- The selection of an evaluation column within that second table

Click "Calculate" to let the software merge the results and generate both a table and a graphical output.

7.7.9 Evaluation - Max-Hold

Use this function to select two or more measurement result tables and combine the maximum values from these tables into a new output table.

Per default, R&S ELEKTRA sets the overview measurement table of the current test as the 1st input table, and as the output table, too. To add an input table to the list for evaluation, click "Add Table" . A list of tests opens, from which in the next step you can select a table (Figure 7-32). Valid input tables must have the same frequency pattern, the same level columns and the same accessory columns. Also, the level columns must have the same base unit. If you select a spectrum overview results table, the software enables the option [Set as Reference](#) to specify this input table as being the reference. Adding an input table to the list in the dialog adds it also to the test container.

The "Calculate" button for running the "Max-Hold" evaluation is enabled only, if at least two "Input Tables" are available. Only existing "Spectrum Overview" tables are eligible as "Output". If you want to avoid overwriting the original spectrum overview table, create a copy in the test container before you click "Calculate" to run the "Max-Hold" evaluation.

During the processing, R&S ELEKTRA disables the "Calculate" button. After a validation of all input tables, the evaluation algorithm compares the 1st level values of all tables. From the table that has the highest 1st level value, it copies all values from that row into the output table. Then it continues with the next set of values. If a row in the output table stems from an external reference table, the software copies this table's name into the "Comment" column of the output table, for traceability.

As a result, the completed output table contains the maximum values of all selected input tables, as if all measurement results had occurred in the current test. Note that you do not get a notification upon completion of the "Max-Hold" evaluation.

Set as Reference

You can specify a result table as the "reference", to facilitate comparing different measurement results with one another. This feature is available both for the results of the currently opened test and for the results of other tests. For example, you can set the results of an earlier test as the reference and then benchmark the results of your current test against that reference.

There are various options to set a reference.

- To set a result table available in the current test as reference:
In the test container, right-click the spectrum overview table and select "Set Reference" from the context menu:

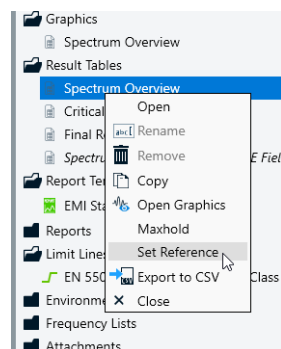

Figure 7-31: Context menu of the spectrum overview table, with option Set Reference

- To set a result table of a different test as reference:
If you use the function [Evaluation - Max-Hold](#), you can set a spectrum overview table of a different test as the reference, while selecting it as an input table:

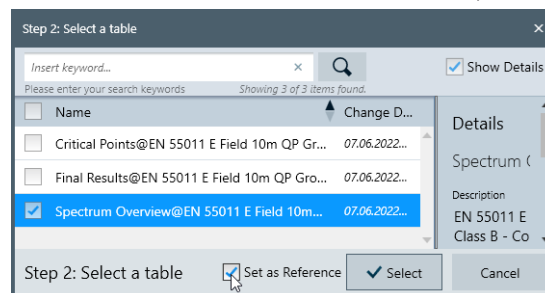

Figure 7-32: 2nd step in the selection of an input table, with option Set as Reference

In a chart that contains the reference table's values, the reference trace is shown in dashed style.

8 Calibration measurements

EMC test systems must be calibrated to deliver exact and reproducible measurements. This calibration requires:

- The **calibration** of each individual measurement device by an authorized lab, with recalibration at regular intervals. Ensuring calibration and recalibration is in your responsibility.
- The **characterization** of the behavior of those devices and of the transducers and signal paths in the EMC test system



R&S ELEKTRA supports this second part of "characterization", however, it is common practice to call this "characterization" a "calibration". Therefore, the software sticks to this convention as in previous versions of R&S EMC32.

We recommend calibrating all RF signal paths (especially cables) before you execute the first measurement. This calibration in advance makes it easy to replace cables later: only the recalibration of the new cables is required, rather than recalibration of the complete system.



- For information on how to configure test templates for calibration measurements, see [Chapter 4.5.1, "Test Templates for calibration measurements"](#), on page 119.
- For information on how to set up the hardware for calibration measurements, see [Chapter 4.7.1, "Hardware setups for calibration measurements"](#), on page 334.

EMI reference calibration

There is no actual EMI reference calibration. You can check your EMI test system by using an EMI reference emitter (comb generator or noise generator) that generate a defined RF electromagnetic field. However, this procedure is rather an EMI verification measurement, which you can run as a conventional EMI test.

EMS reference calibration

EMS reference calibration is the recording of system parameters that are required to generate a defined immunity level. Reference calibration is measured without the presence (hence influence) of an EUT, both for conducted or radiated tests.

To make **conducted** EMS tests reproducible, you must ensure that your signal paths and transducers are well characterized. Basic calibration procedures for conducted EMS test setups are the [Signal path calibration](#), the [Transducer calibration](#) and the [Reference calibration of a CDN](#).

To make **radiated** EMS tests reproducible, you must ensure that your EUTs are exposed to defined levels of RF radiation. This defined exposure requires a uniform distribution of the electromagnetic field in the target area, typically in an anechoic chamber. Therefore, the basic calibration procedure for radiated EMS test setups is the [Field uniformity evaluation](#).

R&S ELEKTRA supports the calibration of EMC test systems or individual components. The calibration procedures of the various components are described in the following subchapters:

- [Signal path calibration](#).....646
- [Transducer calibration](#).....652
- [Reference calibration of a CDN](#).....652
- [Reference calibration with constant field strength](#).....654
- [Field uniformity measurement with constant power](#).....655
- [Field uniformity evaluation](#).....657

8.1 Signal path calibration



Measures the attenuation of the RF signal cables and switch paths used in the system. R&S ELEKTRA stores the results in [attenuation tables](#). For a numerical attenuation correction of the measured RF level values, select these tables for signal paths when defining your hardware setups.

Signal paths are calibrated by evaluating their frequency-dependent attenuation. To do so, a constant RF power level from a signal generator is fed into one end of the signal path. At the other end of the signal path, a power meter measures the attenuation of this level as a function of frequency.

Typical obstacles for a direct attenuation measurement are:

- The signal generator and the power meter are separated from each other in space. They cannot be directly connected via the path to be calibrated.
- The signal generator output is only available after some switching elements with their own intrinsic attenuation.

In both cases, so-called normalization cables (or reference cables) are used for the connection. Hence, there is a sum of attenuations: the signal path to be calibrated (see step 1) and of the attenuation of the remaining paths in the measurement setup (see step 2). To obtain the net attenuation of the signal path, the calibration is performed in the following two steps:

1. Normalization measurement: In a first step, measure the test setup without the path to be calibrated. For this purpose, use one or several normalization cables to connect the signal generator to the RF power sensor.
2. Calibration measurement: In the second step, add the path to be calibrated to the path of the normalization (for example, entered between two normalization cables). Then R&S ELEKTRA measures the sum of both attenuations.

By numerical subtraction of the normalization measurement from the calibration measurement (step 2 minus step 1), R&S ELEKTRA saves the "pure" signal path's net attenuation in the attenuation table.

The following procedures describe 3 different **EUT Type** settings for calibration:

- [Attenuation relative](#)
- [Attenuation absolute](#)
- [Signal path](#)

For calibrating a "Transducer", as opposed to the above selections, refer to [Chapter 8.2, "Transducer calibration"](#), on page 652.

8.1.1 Attenuation relative

"Signal Path Calibration" in "Attenuation Relative" mode

To perform a calibration measurement in [Attenuation Relative](#) mode, proceed as follows:

Access: "Home" > "Test Templates" > "Create Test Template" > "CAL"

1. Configure a [CAL test template](#) as described in ["Attenuation Relative" on page 120](#). Alternatively, select a preconfigured CAL test template for this "EUT Type".
2. Click "Create test from template".
3. Select the **"Run Mode"**: "Normalization" or "Calibration" or "Both".
 - If you select "Normalization", the measurement values are saved in the "Normalization Table".
 - If you select "Calibration" (which is only available with an existing, *non-empty* "Normalization Table"): The difference between the measured attenuation values and the values in the "Normalization Table" is saved in the "Attenuation Table".
 - If you select "Both": The normalization measurement values are saved in the "Normalization Table". The difference between the measured attenuation values and the values in the "Normalization Table" is saved in the "Attenuation Table".

Note: The software brings up warnings to avoid unintended overwriting of existing tables.

4. Click "Start".
R&S ELEKTRA performs a "Test Template Validation".
5. If you have selected "Calibration" as the "Run Mode", skip the following steps and continue with [step 9](#).
Otherwise, the software prompts you with a "Start Normalization" text message. (The default text is: "Please connect normalization cables between the RF generator and the measuring instrument.")
6. Connect the RF signal generator to the power sensor with one or several normalization cables.

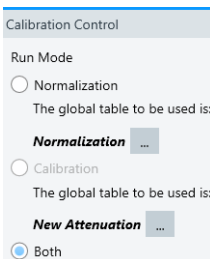

7. Click "OK" to confirm the text message. ("Cancel" brings you back to [step 3](#).)
R&S ELEKTRA performs the **normalization** measurement and then prompts you with another "Normalization" text message: "Repeat Normalization?"
8. Only if you wish to discard the normalization results and repeat the measurement, click "Yes", which brings you back to [step 5](#).
Otherwise, if you wish to keep the results, click "No" to proceed with the calibration.
9. If you have selected "Normalization" as the "Run Mode", skip the following steps and continue with [step 12](#).
Otherwise, R&S ELEKTRA prompts you with a "Start Calibration" text message. (The default text is: "Please insert the Signal Path between the normalization cables.")
10. Add the path that you wish to calibrate to the path of the normalization measurement. Typically, enter your path between two normalization cables.
11. Click "OK" to confirm the text message. ("Cancel" skips the calibration measurement and brings you to [step 12](#).)
R&S ELEKTRA performs the **calibration** measurement.
12. Select to "Save" the measurement results.
Alternatively, if you wish to repeat the measurement, click "Clear Results" and "Refresh" to start again with [step 4](#).
R&S ELEKTRA prompts you with a dialog for saving the calibration measurement.
13. Confirm this dialog with a test name entry and your tags settings.
Before R&S ELEKTRA saves the resulting tables, it brings up a warning to avoid unintended overwriting of existing tables:
"Please confirm: Are you sure you want to overwrite the selected normalization and attenuation tables?"
14. If you wish to overwrite existing (possibly empty) tables with the current results, click "Yes".
R&S ELEKTRA saves the calibration measurement as a [test container](#) and the normalization and attenuation tables as [global tables](#).
15. Otherwise, to keep the existing calibration tables, click "No".
R&S ELEKTRA saves only the calibration measurement, but not the tables.
With "Normalization Level" **n** and "Calibration Level" **c**, the "Attenuation Level" **a** is:
$$\mathbf{a = n - c.}$$

8.1.2 Attenuation absolute

This measurement works similar to the [Attenuation relative](#) calibration mode, except that the normalization is omitted. The software uses the difference between the given

generator output level and the measured level to compute the attenuation of the path between generator and measuring instrument.



To set the generator level, open the [CAL test template](#), select (highlight) the generator icon and go to [Settings](#) > "Level Cable Calibration".

"Signal Path Calibration" in "Attenuation Absolute" mode

To perform a calibration measurement in [Attenuation Absolute](#) mode, proceed as follows:

Access: "Home" > "Test Templates" > "Create Test Template" > "CAL"

As a prerequisite, this calibration mode requires an existing, *non-empty* "Normalization Table" as a reference for the measured attenuation values. If this table is not available, you must either generate it by an [Attenuation relative](#) calibration measurement with "Normalization" as the "Run Mode". Alternatively, import your normalization table from an external source.

1. Configure a [CAL test template](#) as described in "[Attenuation Absolute](#)" **on page 122**. Alternatively, select a preconfigured CAL test template for this "EUT Type". In either case, your CAL test template must be referenced to the "Normalization Table" mentioned above as a prerequisite.
2. Click "Create test from template".
The software locks the "Run Mode" as "Calibration".
You cannot change it to "Normalization" or "Both".
Optionally, you can select a different attenuation table.
Note: The software brings up warnings to avoid unintended overwriting of existing tables.
3. Click "Start".
R&S ELEKTRA performs a "Test Template Validation" and prompts you with a "Start Calibration" text message. (The default text is: "Please insert the Cable between the normalization cables." You can edit this text according to your needs in the [Messages](#) dialog of the [calibration template](#).)
4. Insert your path that you wish to calibrate between two normalization cables, for example, or directly between the generator and the measuring instrument.
5. Click "OK" to confirm the text message. ("Cancel" brings you back to [step 3](#).)
R&S ELEKTRA performs the **calibration** measurement.
6. Select to "Save" the measurement results.
Alternatively, if you wish to repeat the measurement, click "Clear Results" and "Refresh" to start again with [step 3](#).
R&S ELEKTRA prompts you with a dialog for saving the calibration measurement.
7. Confirm this dialog with a test name entry and your tags settings.

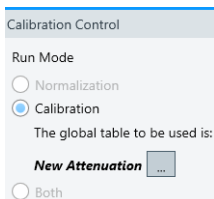

Before R&S ELEKTRA saves the resulting table, it brings up a warning to avoid unintended overwriting of an existing table:

"Please confirm: Are you sure you want to overwrite the selected attenuation table?"

8. If you wish to overwrite the existing (possibly empty) table with the current results, click "Yes".

R&S ELEKTRA saves the calibration measurement as a [test container](#) and the attenuation table as a [global table](#).

9. Otherwise, to keep the existing attenuation table, click "No".

R&S ELEKTRA saves only the calibration measurement, but not the attenuation table.

With "Normalization Level" n and "Calibration Level" c , the "Attenuation Level" a is:
 $a = n - c$.

8.1.3 Signal path

This calibration mode helps you recalibrating outdated attenuation tables of signal paths, without interfering with the rest of your setup.

Therefore, in "Signal Path" mode (other than in [Attenuation relative](#) mode), you can select only an "Attenuation Table" that is defined as a device property of the signal path in your hardware setup. The [CAL test template](#) in [Signal Path mode](#) accepts no other "Attenuation Table" than defined in this device.

"Signal Path Calibration" in "Signal Path" mode

To perform a calibration measurement in [Signal Path](#) mode, proceed as follows:

Access: "Home" > "Test Templates" > "Create Test Template" > "CAL"

1. Configure a [CAL test template](#) as described in ["Signal Path" on page 125](#). Alternatively, select a preconfigured CAL test template for this "EUT Type".
2. Click "Create test from template".

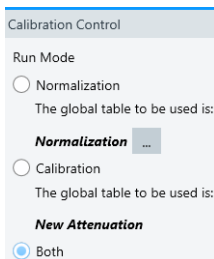

3. Select the **"Run Mode"**: "Normalization" or "Calibration" or "Both".
 - If you select "Normalization", the measurement values are saved in the "Normalization Table".
 - If you select "Calibration" (which is only available with an existing, *non-empty* "Normalization Table"): The difference between the measured attenuation values and the values in the "Normalization Table" is saved in the "Attenuation Table".
 - If you select "Both": The normalization measurement values are saved in the "Normalization Table". The difference between the measured attenuation values and the values in the "Normalization Table" is saved in the "Attenuation Table".

Optionally, you can select a different normalization table.

Note: The software brings up warnings to avoid unintended overwriting of existing tables.

4. Click "Start".
R&S ELEKTRA performs a "Test Template Validation".
5. If you have selected "Calibration" as the "Run Mode", skip the following steps and continue with [step 9](#).
Otherwise, the software prompts you with a "Start Normalization" text message. (The default text is: "Please connect normalization cables between the RF generator and the measuring instrument.")
6. Connect the RF signal generator to the power sensor with one or several normalization cables.
7. Click "OK" to confirm the text message. ("Cancel" brings you back to [step 3](#).)
R&S ELEKTRA performs the **normalization** measurement and then prompts you with another "Normalization" text message: "Repeat Normalization?"
8. Only if you wish to discard the normalization results and repeat the measurement, click "Yes", which brings you back to [step 5](#).
Otherwise, if you wish to keep the results, click "No" to proceed with the calibration.
9. If you have selected "Normalization" as the "Run Mode", skip the following steps and continue with [step 12](#).
Otherwise, R&S ELEKTRA prompts you with a "Start Calibration" text message. (The default text is: "Please insert the Signal Path between the normalization cables.")
10. Add the path that you wish to calibrate to the path of the normalization measurement. Typically, enter your path between two normalization cables.
11. Click "OK" to confirm the text message. ("Cancel" brings you to [step 12](#).)
R&S ELEKTRA performs the **calibration** measurement.
12. Select to "Save" the measurement results.

Alternatively, if you wish to repeat the measurement, click "Clear Results" and "Refresh" to start again with [step 3](#).

R&S ELEKTRA prompts you with a dialog for saving the calibration measurement.

13. Confirm this dialog with a test name entry and your tags settings.

Before R&S ELEKTRA saves the resulting tables, it brings up a warning to avoid unintended overwriting of existing tables:

"Please confirm: Are you sure you want to overwrite the selected normalization and attenuation tables?"

14. If you wish to overwrite existing (possibly old or empty) tables with the current results, click "Yes".

R&S ELEKTRA saves the calibration measurement as a [test container](#) and the normalization and attenuation tables as [global tables](#).

15. Otherwise, to keep the existing calibration tables, click "No".

R&S ELEKTRA saves only the calibration measurement, but not the tables.

With "Normalization Level" **n** and "Calibration Level" **c**, the "Attenuation Level" **a** is:
a = n - c.

8.2 Transducer calibration

Determines the frequency-dependent correction factors of transducers, for example antennas or current clamps, to measure an EUT's emission correctly. Typically, transducer correction factors (such as antenna factors or transfer functions) are supplied as tables by the transducer manufacturer or by a calibration lab. You can enter or import these tables into R&S ELEKTRA. The software also supports the measurement of such transfer functions by a [Signal path calibration](#).

8.3 Reference calibration of a CDN

The [CDN](#) calibration setup is described in the standard EN61000-4-6. Run it like an EUT test, but instead of the EUT, connect a **calibration adapter** at the output of the CDN. The adapter provides a defined transformation from the 150 ohms system at the CDN output to the 50 ohms system at the probe input. The input of the RF probe is the output of the calibration adapter.

Performing a reference calibration

Access: "Home" > "Test Templates" > "Create Test Template" > "EMS - CDN / EM-Clamp"

Then proceed as follows:

1. Select a preconfigured [EMS hardware setup](#) for CDNs.
If no preconfigured hardware setup is available, create a new one.

2. In the "General Settings" of the [test template dialog](#), keep the default setting "EMC Standard" = "EN 61000-4-x"
3. Select the "Test Method" = **"Reference Calibration"**
4. At "Levelling Mode", keep the default setting [Level On](#) = "Sensor" for controlling the power level.
5. In the "Frequency Range List", open the "Test Level" dialog.
6. Select one of the following options for controlling the power level across the frequency range:
 - To set a single power level, enable "Constant Level" and enter the "Test Level" in the headline of the "Frequency Range List".
 - To use a limit line for frequency-dependent power levels, enable "Level Table defined by Limit Line" and select a "Limit Line".
7. In the "Frequency Range List", at "Device Settings", select (highlight) the RF generator.
8. Make sure that in the generator settings, the modulation is switched OFF.
9. Adjust the "Frequency Range" to your requirements.
10. Optionally, adjust other settings to your requirements.
11. Save the test template.
12. Establish the physical hardware setup as specified above.
13. Select "Create test from template"
14. Start the test.
15. Wait until the system has recorded the following values at each frequency point:
 - The required generator output power ("Gen Out", dBm)
 - The CDN's input power ("Trd In Fwd", W)
 - The immunity level ("Test Level", V),
16. Save the test.

R&S ELEKTRA brings up an information dialog: "Do you want to save the measurement results to a reference calibration table?"
17. Select "Yes".
18. Enter a table name.

The software saves the reference calibration table as a [global table](#).
19. Close the test and the test template.



You must calibrate every CDN type individually. If you want to use an EM coupling clamp instead of a CDN, perform the calibration in the same way, with the following exception: Feed a wire through the clamp, terminate it with a 150 ohms resistor on the auxiliary side and with the calibration adapter on the EUT side.

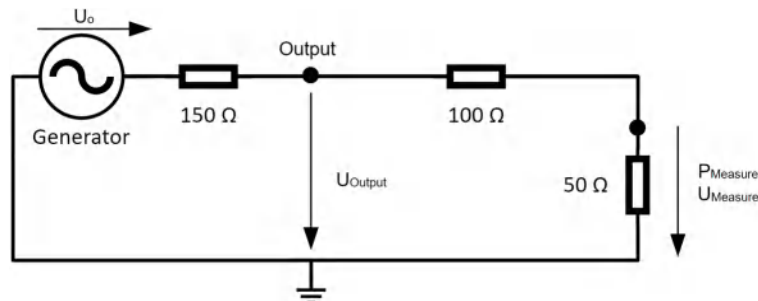

The test level sensor (power meter) measures $P_{Measure}$ and transforms it to $U_{Measure}$. Because the "Sensor Level Conversion Impedance" is fixed at 50 ohms (see [EMS test template parameters according to the standard EN 61000-4-6](#)), the resulting $U_{Measure}$ is the voltage at 50 ohms. To let the software convert $U_{Measure}$ to U_{Output} correctly, enter a fixed "Cable Correction" value of 15.56 dB in the [Measurement Correction](#) of your CDN.

8.4 Reference calibration with constant field strength

For a basic reference calibration of field strength, proceed similar to a [Performing a field uniformity \(FU\) measurement](#), but limited to a single point in space, without position loops. The procedure is comparable with a [Reference calibration of a CDN](#), but radiated instead of conducted.

To perform this calibration, we recommend using the test template "EN 61000-4-3 Reference Calibration 10V/m", which is available via the [Configuration Wizard](#).

8.5 Field uniformity measurement with constant power

The screenshot displays the software interface for configuring a field uniformity measurement. Key sections include:

- General Settings:** EMC Standard (EN 61000-4-x), Test Method (Field Uniformity), and Default name for reference calibration table (Antenna).
- Measurement Flow:** Flow Details - Overview Measurement, with sub-tabs for Measurement Settings and Accessory Settings.
- Leveling Mode:** Level On (Transducer Power) and Power Control (Forward Power).
- Frequency Range List:** Active range (80 MHz - 1 GHz), Steps (20 %), Test Level (My 10V/m Ref...), Dwell (0 s), Modulation (OFF), and Hardware Setup (EN 61000-4-3).
- Leveling Options:** Radio buttons for Constant Level, Level Table defined by Limit Line, and Power Level defined by Reference Calibration Table (selected).
- Leveling Tolerance:** -0.2 dB and 0.2 dB.
- System Monitoring:** A diagram showing the measurement setup and a table of active parameters.

No.	Active	Parameter	Unit	Y-Axis Range	Display	Detector
1	<input checked="" type="checkbox"/>	Immunity Level	W	0 ... 30	<input checked="" type="checkbox"/>	Carrier
2	<input checked="" type="checkbox"/>	Sensor Level	V/m	0 ... 30	<input checked="" type="checkbox"/>	Carrier
3	<input checked="" type="checkbox"/>	Transducer Forward Power	W	0 ... 100	<input checked="" type="checkbox"/>	Peak

Figure 8-1: Example of a test template for field uniformity measurements

Numbers = See procedure "Performing a field uniformity (FU) measurement" on page 656

The following procedure describes the constant power method according to the European standard EN 61000-4-3 or the corresponding international standard IEC 61000-4-3.

Prerequisite: You have completed a reference calibration for one out of the 16 points, because its measured FWD power is required as target value for the field uniformity measurement. See Chapter 8.4, "Reference calibration with constant field strength", on page 654.

Performing a field uniformity (FU) measurement

If you use a 4-channel field-probe system, refer to the extension after this procedure. Otherwise, proceed as follows:

1. Run a [reference calibration measurement with constant field strength](#) for sensor position 1 in vertical polarization.
Sensor position 1 can be an arbitrary point in the field-uniformity test area.
2. Repeat the reference calibration measurement for sensor position 1 in horizontal polarization.
3. Save the reference calibration measurement, for example with the name "10V/
m Ref Cal Test".
4. Save the [reference calibration table](#), for example with the name "My 10V/
m Ref Cal".
This table defines the target power level for the following field uniformity measurement.
5. Create an "EMS - Anechoic Chamber" [test template](#).
6. Select an "EMS - Anechoic Chamber" [hardware setup](#) (labeled (1) in [Figure 8-1](#)) for standard EN 61000-4-3.
7. Set "EMC Standard" to "EN 61000-4-3" (2).
8. Set the "Test Method" to "Field Uniformity" (3).
9. Specify a "Default name for reference calibration table", for example "Antenna" (4).
10. At "Measurement Settings" > "Leveling Mode", set "Level On" to "Transducer Power" (5).
11. Keep "Power Control" at "Forward Power" (6).
12. In the "Test Level" tab of the "Frequency Range List", select "Power Level defined by Reference Calibration Table" (7).
13. In the selection field of this setting, select the reference calibration table from [step 4](#).
Hence, in this example, select the reference calibration table "My 10V/
m Ref Cal" (8).
14. In the "System Monitoring" dialog, activate the "Sensor Level" checkbox (9).
15. Run the field uniformity measurement with a single-channel field probe and optional field-probe positioner.
If you use a 4-channel field-probe system, refer to [Chapter 8.6, "Field uniformity evaluation"](#), on page 657.

8.6 Field uniformity evaluation

For radiated [EMS tests](#) in anechoic chambers, the standards EN 61000-4-3, ISO 11451-2, and all related product standards require a minimum homogeneity of the immunity field within a certain area around the EUT. To make sure that the EUT is exposed to a homogenous immunity field of appropriate power level, perform a field uniformity evaluation based on a multi-point measurement with a [Field Probe](#).

The result of the "Field Uniformity" evaluation is a [Reference Calibration](#) table for the EUT test.



This evaluation is sometimes called field uniformity *calibration*, but we regard the term "*evaluation*" a better fit.

Evaluation measurement setup

The setup for this measurement is described in the section "Field Uniformity Evaluation" of the standard IEC / EN 61000-4-3, where an antenna generates the radiated field. The standard defines a virtual uniform field area (UFA) in a plane that is on the illuminated face of the EUT. The UFA plane is perpendicular to the direction of the radiation and typically 3 m away from the tip of the antenna (or from the antenna's phase center). The lateral UFA dimensions are 1.5 m x 1.5 m. Its lower boundary is 80 cm above the floor of your anechoic chamber. In horizontal direction, the area is symmetrically centered on the EUT's position, while the EUT itself must be absent. This UFA is covered with a grid of 4 x 4 points, spaced 50 cm from each other.

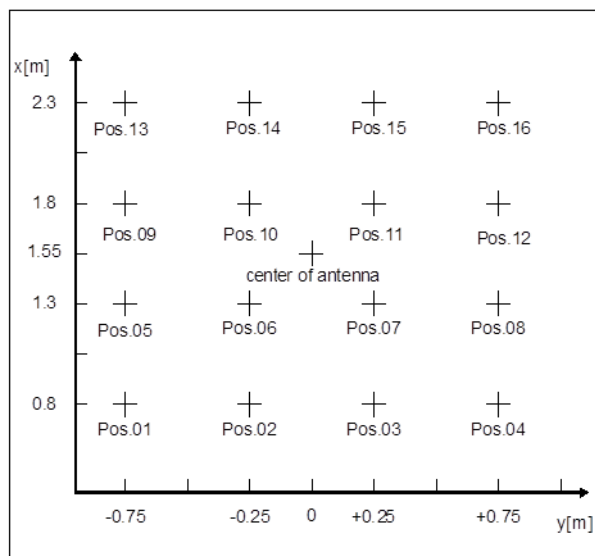

Figure 8-2: Sensor positions for field uniformity measurements

The x-positions (sensor altitudes) in [Figure 8-2](#) correspond with the standard, which requires to place the EUT on a table with a height of 0.8 m.

While placing the field probe at each of the 16 predefined positions according to [Figure 8-2](#), you must execute 16 reference calibration sweeps for both antenna polariza-

tions (horizontal and vertical). This procedure results in a total of 32 reference calibration measurements, each one across the full frequency range to be covered. If you use a multi-channel field probe, for example with 4 channels for 4 sensor positions, R&S ELEKTRA calculates the averaged field strength according to IEC / EN 61000-4-3.

The software then determines, which transducer power must be set at each frequency step to reach the desired field strength. The results of this automatic evaluation for all points of the UFA is used as a [Reference Calibration](#) table during EMS tests.

Prerequisite: You have activated the [license](#) for "ELEMS-S", which requires that a [dongle](#) with this license is connected

Performing a field uniformity evaluation

Access: "Home" > "Test Templates" > "Create Test Template"

If you use a 4-channel field-probe system, observe the additional steps in "[MFP systems](#)" on page 661. Otherwise, proceed as follows:

1. Select an [EMS test template](#) of the type "EMS - Anechoic Chamber"
2. Select a preconfigured [EMS hardware setup](#) for anechoic chambers.
If no preconfigured hardware setup is available, create a new one.
3. In the "General Settings" of the [test template dialog](#), keep the default setting "EMC Standard" = "EN 61000-4-x"
4. Select the "Test Method" = "**Field Uniformity**"
5. Enter a "Default name for reference calibration table".
6. At "Levelling Mode", select the [Level On](#) setting for controlling the power level:
 - "Level On" = "Sensor" (a power sensor controls the level)
 - "Level On" = "Transducer Power" (the power values in a column of a [Reference Calibration](#) table control the level)
7. In the "Frequency Range List", open the "Test Level" dialog.
8. Select one of the following options for controlling the power level across the frequency range:
 - To set a single power level, enable "Constant Level" and enter the "Test Level" in the headline of the "Frequency Range List".
 - To use a limit line for frequency-dependent power levels, enable "Level Table defined by Limit Line" and select a "Limit Line".
 - To use a reference calibration table for frequency-dependent power levels, enable "Power Level defined by Reference Calibration Table" and select a "Reference Calibration Table". R&S ELEKTRA reads the power levels from the transducer level ("Trd Lvl") column of this table.
This 3rd option is available only, if you have selected "Level On" = "Transducer Power" in the "General Settings".
9. In the "Device Settings", select (highlight) the RF generator.

10. Make sure that in the generator settings, the modulation is switched OFF.
11. Adjust the "Frequency Range" to your requirements.
12. Optionally, adjust other settings to your requirements.
13. Save the test template.
14. Establish the physical hardware setup as specified above.
15. Select "Create test from template"
16. Start the test.

The test starts in a paused state.

17. Follow the message that comes up: "The test is currently paused. Please set the accessories to the correct position, then click the Play button to resume the test."
18. If you come from [step 25](#) or [step 34](#), and if you must change the antenna's polarization, change it now ([step 19](#)).
Otherwise proceed with [step 27](#).
19. If you use a manual antenna tower, rotate the antenna to the opposite polarization orientation.
This manual action requires opening and entering the anechoic chamber, with the associated safety precautions described in the documentation of this equipment.
20. Click the "Polarization" button  in the [Antenna control panel](#).

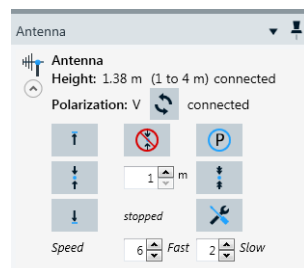

In a manual antenna-tower setup, this button informs R&S ELEKTRA about the manually set antenna polarization.

In a setup with an automated antenna tower, this button controls changing the antenna polarization.

21. Wait until the "Antenna" control panel indicates completion of the change of polarization.
22. When the polarization is set, confirm the notification with "Continue".
Note that clicking "Stop Test" aborts the test.
23. Wait until the system has completed measuring all frequency points at the current polarization.
A message comes up that indicates this completion.
24. When you have measured with both polarizations at this field-probe position, proceed with [step 27](#).

25. When you have measured with the first antenna polarization, for example "H" (horizontal), repeat the steps from [step 17](#) to proceed with the other polarization.
26. If you use an automated positioner, proceed with the result of [step 34](#).
27. In the [Positioner control panel](#), set the field-probe positioner to the value highlighted in the "Measurement Flow Control" panel.

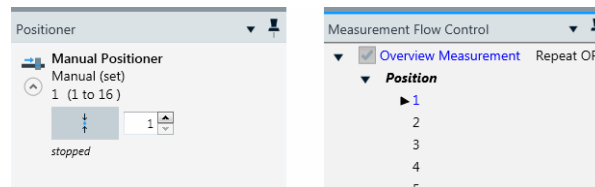

Figure 8-3: Positioner panel (left) and Measurement Flow Control panel

The position values correlate with the positions shown in [Figure 8-2](#).

28. To set a value, enter or dial it in the "Positioner" control panel.



29. To activate the set value, click the control button on the left.
30. If you use a manual positioner, the software brings up a notification: "Please set the positioner to the position: xx", where "xx" is the selected field-probe position.
31. Set the manual positioner to the indicated position by hand.
This manual action requires opening and entering the anechoic chamber, with the associated safety precautions described in the documentation of this equipment.
32. When the position is set, confirm the notification with "Continue".
Note that clicking "Stop Test" aborts the test.
33. Wait until the system has completed measuring all frequency points at the current position.
A message comes up that indicates this completion.
34. For the next field-probe position, repeat the steps from [step 27](#).
When finished with all field-probe positions at both antenna polarization, the following results are available:
The required generator output power ("Gen Out", dBm)
The antenna's input power ("Trd Fwd Pwr", W)
The immunity level ("Test Level", W),
35. Save the test.
R&S ELEKTRA brings up an information dialog: "Do you want to save the measurement results to a reference calibration table?"
36. Select "Yes".
37. Enter a table name.

The software saves the results in a reference calibration table.

38. Close the test.
39. From the test template, repeat the whole procedure from [step 15](#) at least 3 times, until you have at least 4 reference calibration tables.
40. In the [Uniformity](#) side panel, select the "EMC Standard" to be used.
41. Click "Uniformity Evaluation".

An algorithm in R&S ELEKTRA evaluates the calibration results for meeting the conditions at each measurement frequency. Refer to the standard for further details.

If both antenna polarizations meet the requirements, the field generated in the chamber is considered to be uniform for running susceptibility tests according to the selected "EMC Standard".

If your setup does not meet the required homogeneity criterion, you must modify the setup. For example, reposition the antenna along a different axis in the chamber, place floor absorbers between the antenna and your target area, or consider changing the antenna model.

MFP systems

If you perform your field uniformity measurement with a multi-field-probe (MFP) system, typically a 4-channel [field probe](#) and positioner, add the following steps to the procedure above:

1. Specify your 4-channel field probe in the [Device List](#).
If you use a generic field probe, go to the [Configuration > Parameters](#) tab, select "Number of Channels" and set the parameter value to 4.
2. In the test template's [Accessory Settings](#) dialog, activate the loop parameter "Position".
To see this dialog, make sure to select "Overview Measurement" in the [Measurement Flow](#) dialog (if available)
3. In the "Position" section of the "Accessory Settings" dialog, enable the checkbox "Use 4 Channel Sensor".
 - a) If you use 4 probes next to each other, covering a horizontal row of 4 positions in the 4x4-position test matrix ([Figure 8-2](#)) of a [field uniformity](#) measurement, enable the "Row" mode:



Figure 8-4: Toggle switch with Row enabled

- b) If you use 4 probes on top of each other, covering a vertical column of 4 positions in the 4x4-position test matrix of a field uniformity measurement, enable the "Column" mode:



Figure 8-5: Toggle switch with Column enabled

4. Set the additional field probes as channels, as described in [Chapter 4.5.3.5, "Additional Sensor Channels"](#), on page 303.

9 Measurement examples

The procedure for preparing and executing tests is described in [Chapter 3.6, "Performing a test"](#), on page 53 and [Chapter 7.2, "EMI tests"](#), on page 594 or [Chapter 7.3, "EMS tests"](#), on page 597. The following examples describe how these steps are typically executed in practice.



Note that the [Configuration Wizard](#) can support you by automatically creating various items required for tests.

Example:

For a **radiated EMI test** in the frequency range of 30 MHz to 1 GHz, prepare the following settings:

- An **EUT** description for one individual sample of your equipment under test
- Three **tables**:
 - A **transducer correction table** "corrAnt1" (30 MHz to 1 GHz) for your antenna "Ant1"
 - An **attenuation table** "attCable1" (30 MHz to 1 GHz) for "Cable1"
 - A **limit line** "EMI-rad-30M-1G"
- Three **device list** entries:
 - The radiated transducer "Ant1", containing a reference for "corrAnt1"
 - The signal path "Cable1", containing a reference for "attCable1"
 - The receiver "EMI Test Receiver" (entry adjusted to your **Type** of receiver, and **connected**)
- A **hardware setup** "EMI-rad1_HWS_R1" with:
 - A reference for receiver "EMI Test Receiver"
 - A reference for signal path "Cable1"
 - A reference for antenna "Ant1"
- One **test template** "EMI-rad1" with a single frequency range (30 MHz to 1 GHz), containing:
 - A reference for the hardware setup "EMI-rad1_HWS_R1"
 - A reference for the limit line "EMI-rad-30M-1G"
 - Your specific measurement settings as described in the [EMI test template configuration](#)

Note that the hardware setup, the entries for devices (here: receiver, signal path and antenna transducer) and for the limit line are integrated into the test template as **references** that establish "links" towards the original data sets. **No copies** of these data sets are ever integrated into a test template. Hence, changing the original data set of any such item modifies all test templates that use this item.

- One **report template** "EMI-rad-Report" (optional)

With these preparatory steps completed, create the **test** by selecting "Create test from template" in the test template "EMI-rad1". The test contains:

- A copy of the test template "EMI-rad1"
- A copy of the report template "EMI-rad-Report"
- And more **components** in the test container

To execute the test in **Automated Measurement** mode, click the "Start" button (▶). The software runs the test and displays the results in an **Overview Graphic** and in the **Final Results Table**. You can enhance your test with more results acquired in **Interactive Measurement** mode. Optionally, use **Report Templates** for **Reporting** your results. Save the test, for example as "EMI-rad_001".

To run the same test for another EUT, first select "Create test from template" in the same test template "EMI-rad1" with a different EUT description **activated** and a differ-

ent EUT physically in place. The software automatically copies the test template (and report template) into a new test container, together with references for the hardware setup, devices, signal path and tables in it. Execute this new test and save it, for example as "EMI-rad_002".

Example:

For a **conducted EMS test** in the frequency range of 150 kHz to 230 MHz, executed with a **CDN** (coupling / decoupling network), prepare the following settings:

- An **EUT** description for one individual sample of your equipment under test
- The following 11 **tables**:
 - Four **attenuation tables** "attCable1" to "attCable4" for the RF cables used in the setup
 - Three more attenuation tables for your power amplifier, CDN and calibration adapter: "attPA1", "attCDN" and "attCAL"
 - One **transducer correction table** for the calibration adapter
 - One **reference calibration table** for EMS power levels
 - Two **limit lines** for power level and sensor level limitation (unless limited by single values)
- The following 11 **device list** entries:
 - The RF generator "Gen1", **connected**
 - Four signal paths "Cable1" to "Cable4", containing references for "attCable1" to "attCable4"
 - The power amplifier "PA1", containing a reference for "attPA1"
 - The forward power meter "NRP2 ChA"
 - The coupling / decoupling network "CDN", containing a reference for "attCDN"
 - The calibration adapter "CAL", containing a reference for "attCAL"
 - The calibrating power meter "NRP2 ChB", connected
 - Optionally an interlock monitoring device, connected
- A **hardware setup** "EMS-con1_HWS_CDN" with references for all these devices and signal paths.
- A **test template** "EMS-con1_CDN", containing:
 - A reference for the hardware setup "EMS-con1_HWS_CDN"
 - Your specific measurement settings as described in the **EMS test template configuration**
 - An **EUT monitoring template** "EUT-Mon1" (optional)
 - A **report template** "EMS-con-Report" (optional)

Note that the hardware setup, the entries for devices / signal paths and the limit lines are integrated into the test template as **references** with "links" towards the original data sets. **No copies** of these data sets are ever integrated into a test template. Hence, changing the original data set of any such item modifies all test templates that use this item.

With these preparatory steps completed, create the **test** by selecting "Create test from template" in the test template "EMS-con1_CDN". The test contains:

- A copy of the test template "EMS-con1_CDN"
- A copy of the EUT monitoring template "EUT-Mon1"
- A copy of the report template "EMS-con-Report"

- And more [components](#) in the test container

To execute the test in [Automated measurement for EMS tests](#) mode, click the "Start" button (▶). The software runs the test and displays the results in an [Overview Graphic](#) and in the [Final Results Table](#). You can enhance your test with more results acquired in [Interactive measurement for EMS tests](#) mode. Optionally, use [Report Templates](#) for [Reporting](#) your results. Save the test, for example as "EMS-con1_CDN_001".

To run the same test for another EUT, first select "Create test from template" in the same test template "EMS-con1_CDN" with a different EUT description [activated](#) and a different EUT physically in place. The software automatically copies the test template (and EUT monitoring template / report template) into a new test container, together with its references for hardware setup, devices, signal paths and tables. Execute this new test and save it, for example as "EMS-con1_CDN_002".

10 How to use the software

The following chapters provide practical hints how to use R&S ELEKTRA for product conformance tests according to the applicable EMC standards.

- [Notes for EMI tests](#).....668
- [Notes for EMS tests](#)..... 669
- [Determination of a monitoring clamp transducer table](#).....670

10.1 Notes for EMI tests

10.1.1 Find and analyze EMC emissions

This description assumes that appropriate hardware setups are available and that you are familiar with the interaction of devices, hardware setups and test templates.

The analysis of RF emissions is divided into several steps.

The first step is an **automated measurement** (overview measurement), which covers the whole RF spectrum of interest. Typically, the peak detector or a combination of peak and average detectors are used, with narrowband signals showing up in both curves. On the contrary, broadband signals and pulsed signals appear in the peak curve, only. You must make sure to find the emission maximum, even if the signal is not stable. For details, refer to the applicable product standard for your EUT and configure all settings in [Test Templates for EMI tests](#). Repeating the measurement by starting it again overwrites the most recent result curves. To save certain results, save the test.

Some test standards for radiated emission tests require rotating the EUT, varying the antenna height and using both antenna polarizations. To maximize over several of these accessory settings, configure the measurement flow in the test template as appropriate. During the measurement, also the settings of the antenna tower and turntable are stored in the result tables, observing the most critical setup parameters for each frequency.

For further analysis of the RF spectrum, switch to the **interactive measurement** mode (single measurement). You can vary the actual measurement parameters arbitrarily. Now the question comes up where in the spectrum to find those critical points. One way is using **data reduction functions** that lead to the critical points. Alternatively, directly "drag-&-drop" a point or a marker from the curve into the frequency edit field. The frequency-step buttons (+ and -) change the current frequency in a raster defined by the stepsize in the selected test template. Alternatively, select the critical points or final results list as the source for varying the current frequency according to that list.

If you do not know the exact frequency of an emission, or if its frequency changes over time, a **zoom measurement** can focus on a small range around that frequency. It captures the emission in a partial scan or sweep. In the "Zoom" phase, the test template runs continuous repetitions and displays the detectors in "ClearWrite" and "MaxHold"

mode. Automatically, the software positions a marker at the maximum. In addition, you can vary the scan or sweep time of a measurement. Thus, when comparing the "Clear-Write" curve with the "MaxHold" curve, you can find the dwell time required for recording the complete signal in a single measurement. Moreover you get information about possible modulations, which helps to characterize the signal.

The measurement parameters for the single measurements can be changed in the corresponding dialog and restored through clicking the button 'Restore template settings'. The "Start Measurement" button starts the interactive measurement, the "Record" button stores the measured levels, the measurement parameters and the settings of the accessory devices (antenna tower, turntable).

You can add notes to the test in the comments column. When you have finished all measurements, you can save the test. Finally you can open a report template and prepare a test protocol.

10.2 Notes for EMS tests

10.2.1 Using detectors and modulation in EMS tests

For generating modulated test signals as required for most EMS test standards, it is not sufficient to define the test level. Define also the detector, to which the test level is referenced.

The following detectors are supported in R&S ELEKTRA (ELEMS-S):

- Carrier = signal level of the carrier frequency
- Peak = peak value of the signal envelope shape
- RMS = root mean squared

The following table gives the relation between the measured levels for different detectors versus different modulation types.

Table 10-1: Conversion factors for detectors

Detector	CW	AM	FM/ΦM	PM
Carrier	1	1	1	1
Peak	1	$(1 + m)^2$ (for 80% = +5.1 dB)	1	1
RMS	1	$1 + m^2/2$ (for 80% = +1.2 dB)	n/a	d (for 50% = -3 dB)

m = modulation factor (80% = 0.8)

d = duty cycle (50% = 0.5)

Level conservation method for modulation

Different EMS test standards require setting the modulated test level for a selected detector with a reference to the unmodulated (CW) signal. Here is one example:

- Commercial standards like **EN 61000-4-3/6** refer to the envelope shape of CW and AM signals. These standards typically require keeping the **carrier** level of the unmodulated and modulated signal constant.

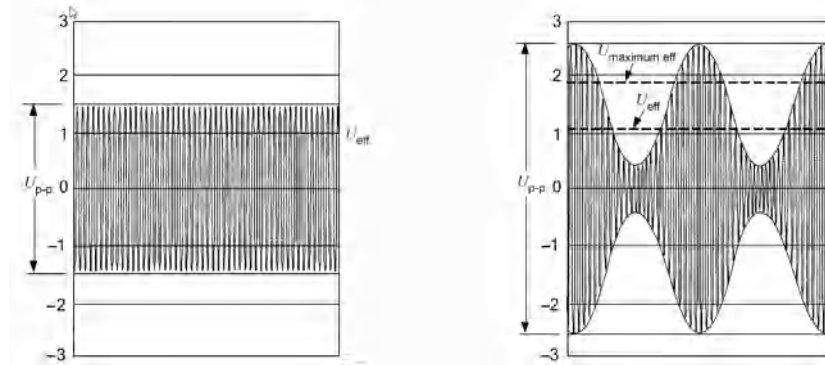

For example, consider an AM signal with 80% modulation depth. According to [Table 10-1](#), keeping the carrier level of the AM signal constant results in a difference of 5.1 dB in the peak level of the envelope curve. But if you use the RMS detector, the level difference is 1.2 dB, only.

10.3 Determination of a monitoring clamp transducer table

This chapter describes how to create a [Transducer Correction](#) table which is required for the calculation of the actual current when the current is measured using a monitoring current clamp.

How R&S ELEKTRA calculates the actual current using a transducer correction table

For measuring the current, a monitoring clamp is connected via a signal path to a sensor device. In the [Device List](#), the RF parameters of the monitoring clamp are defined in the properties dialog of the transducer device, which is assigned to the monitoring clamp.

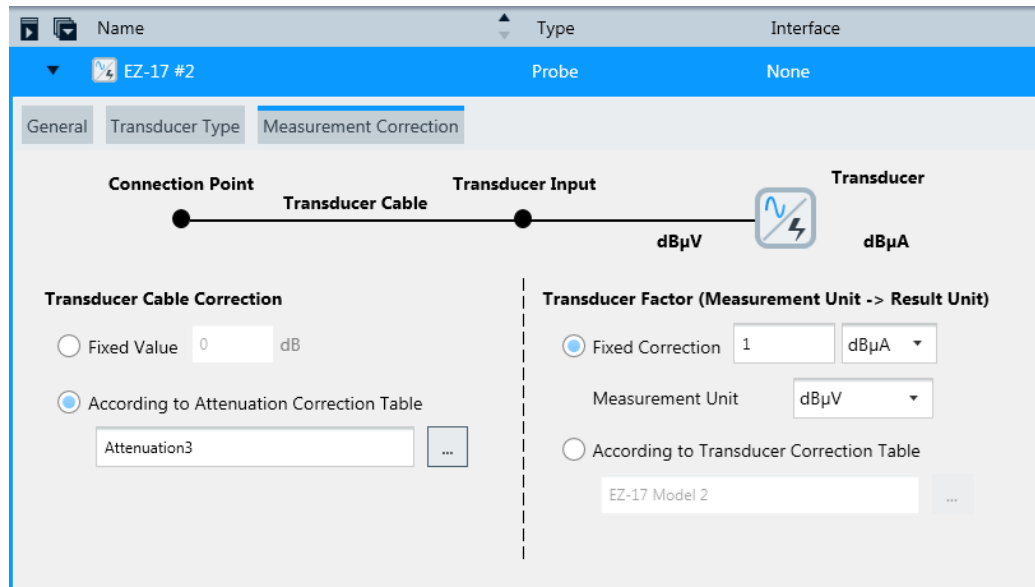

Figure 10-1: Transducer properties dialog

The calculation is done as follows:

1. Measure the signal level at the sensor input.
2. Add the signal path attenuation.
3. Add the input attenuation from the transducer properties dialog.
4. Convert the signal level to the source unit stored in the transducer correction table.
5. Add the transducer table correction value for the current frequency.
6. Change the unit of the measured signal to the destination unit in the transducer correction table.

Get the correction values from a clamp's specifications

This chapter describes how you can create the transducer correction table using the values from the specifications of the clamp. Typically the transducer factor is shown in the specifications as a plot of transfer impedance over frequency. The unit of the Y-axis is typically dB_{Ohm} .

The value to be inserted into the transducer correction table for each frequency depends on the source unit, which must be equal to the measurement unit of the sensor device. The current is calculated using the following formula:

$$I_c = U_m / Z_t$$

with I_c = cable current, $[U_m]$ = clamp output voltage, Z_t = transfer impedance.

Convert this equation to dB units:

$$I_c [\text{dB}\mu\text{A}] = U_m [\text{dB}\mu\text{V}] - Z_t [\text{dB}_{\text{Ohm}}] \quad (1)$$

Use the source unit dB μ V in the transducer table, if you use the current clamp also for EMI measurements.

Example:

Calculation example 1, clamp parameter:

$$Z_t = 1 \text{ Ohm} = 20 * \log(1) = 0 \text{ dB}_{\text{Ohm}} \text{ (at the current frequency)}$$

This parameter corresponds to an insertion loss in the 50 ohms system = $20 \log(50) = 34 \text{ dB}_{\text{Ohm}}$.

Formula used in R&S ELEKTRA:

$$I_c [\text{dB}\mu\text{A}] = U_m [\text{dB}\mu\text{V}] + T_f \text{ (} T_f = \text{transducer factor, taken from the table) (2)}$$

Comparing formula (1) with formula (2) gives the conversion for the transfer impedance to the value in the transducer table:

$$T_f = - Z_t [\text{dB}_{\text{Ohm}}] \text{ (3)}$$

Formula (3) requires to set the source unit to dB μ V.

Calculation example 2, monitoring-clamp output measured in dBm:

$$I_c [\text{dB}\mu\text{A}] = P_m [\text{dBm}] + 107 - Z_t [\text{dB}_{\text{Ohm}}] \text{ (4)}$$

Comparing formula (4) with (2) gives the conversion for the transfer impedance to the value in the transducer table:

$$T_f \text{ dBm} = 107 - Z_t [\text{dB}_{\text{Ohm}}] \text{ (5)}$$

Formula (5) requires to set the source unit to dBm.

Calibrating the clamp using the R&S ELEKTRA signal path calibration utility

Solution 1: Create a transducer correction table.

This chapter describes how to create a transducer correction table using the [Signal path calibration](#) utility of R&S ELEKTRA.

The calibration requires the following equipment, which is available in every EMS test system: signal generator, power meter, calibration jig, monitoring clamp. Before the calibration is started, a signal-path calibration setup as shown is created:

Parameter	Setting
Calibration mode	Transducer
Measurement unit (source unit)	dBm (use dB μ V, if used for EMI, too)
Result unit (destination unit)	dB μ A
Frequency range	150 kHz to 80 MHz
Frequency step size	1 % logarithmic
Add Constant	73 dB (-34 dB for source unit dB μ V)
Calibration Level	0 dBm

Determination of a monitoring clamp transducer table

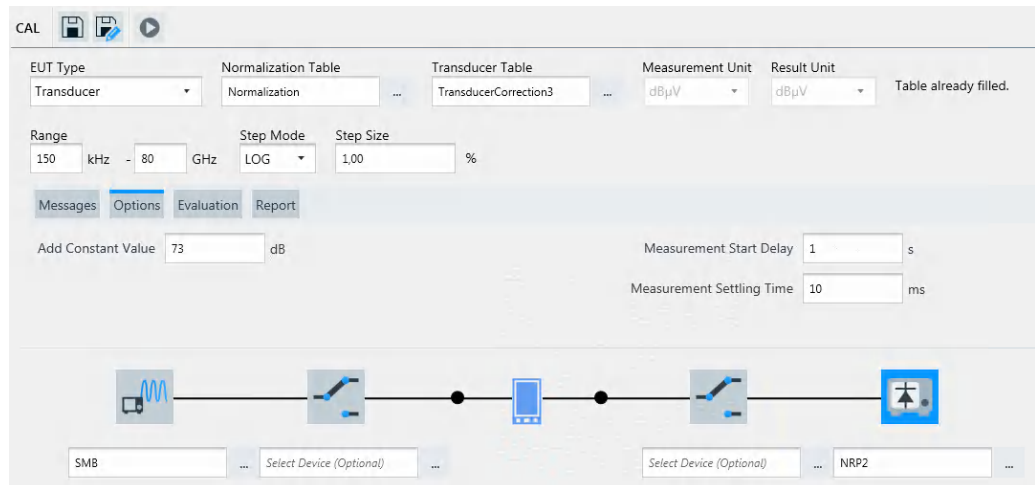

In this field, the constant 73 dB is the conversion factor from power in dBm to current in dBµA for a 50 ohms system.

$$0 \text{ dBm} = 73 \text{ dB}\mu\text{A}, 0 \text{ dB}\mu\text{V} = -33.97 \text{ dB}\mu\text{A}$$

Calibrate the setup in two steps:

Normalization:

First connect the RF probe of the power meter with the cable at port 1 of the calibration jig. Then connect the other port of the calibration jig to the RF generator. Insert the monitoring clamp into the calibration jig and terminate the input with a 50 ohms terminator. After this step, start the normalization.

Calibration:

Before starting of the monitoring-clamp calibration, connect the cable from the RF probe to the input of the monitoring clamp. Terminate the other calibration-jig port with 50 ohms. At the end of the calibration, the result is stored in the transducer correction table.



If you want to compare your calibration result with the values from the monitoring clamp's specifications, you must subtract the following factor to get the raw transfer impedance value:

1. Inject a power of 0 dBm to the calibration jig, where the monitoring clamp is inserted.
2. Measure the output voltage of the current clamp.
- 3.a) If the voltage is measured in dBµV, **subtract 73** to get the transfer impedance value.
- 3.b) If the voltage is measured in dBm, **add 34** to get the transfer impedance value.

Example:

Power meter value: 72 dBµV = -35 dBm

$$72 \text{ dB}\mu\text{V} - 73 = -35 \text{ dBm} + 34 = -1 \text{ dBOhm} = Z_t$$

Solution 2: Create an attenuation table.

Alternatively to the transducer correction table, the clamp characteristics can also be described by the insertion loss. In this case an [attenuation table](#) is generated, which is added as an additional attenuation table in the transducer properties dialog. No transducer table is then referenced.

The insertion loss is calculated from the transfer impedance by applying the impedance correction for the 50 ohms system:

$$I_L = 20 \log_{10} (50 \text{ Ohm}) - Z_t [\text{dB}_{\text{Ohm}}] = 34 - Z_t [\text{dB}_{\text{Ohm}}] \quad (6)$$

The calibration requires the following equipment, available in every EMS test system: signal generator, power meter, calibration jig, monitoring clamp. Before starting the calibration, create a signal-path-calibration setup as shown:

Parameter	Setting
Calibration mode	Attenuation
Frequency range	150 kHz - 80 MHz
Frequency step size	1 % logarithmic
Add Constant	0 dB
Calibration Level	0 dBm

The calibration is done in two steps:

Normalization:

First, the RF probe of the power meter is connected with the cable at the input of the monitoring probe, and the calibration is started.

Calibration:

Before starting the monitoring-clamp calibration, connect the cable from the signal generator to the clamp input, and connected the RF probe to one output of the calibration jig. The other calibration jig output must be terminated with 50 ohms. At the end of the calibration, the result is stored in the attenuation table.

11 Getting help

Rohde & Schwarz would like to give you the best possible product experience. The following chapters are a guide to finding a solution, if help is required:



For **context-sensitive** help, press **[F1]** from any dialog in the software, as described in the chapter [Embedded help](#).

For an overview of the available **shortcut keys**, see [Chapter 6.5, "Keyboard shortcuts"](#), on page 576.

• Embedded help	675
• Log information	677
• VISA trace tool	678
• Troubleshooting information	679
• Product information	681
• R&S ELEKTRA on the internet	683
• Support	683
• Training	684

11.1 Embedded help

The help system embedded in R&S ELEKTRA is available in Microsoft Windows HTML help format.



To display the help dialog and open it in the chapter "Getting Help", click the help button  in the program menu.



To display a **context-sensitive** help dialog, press the **help key [F1]** from any dialog in the software. This selection brings up a help topic with information about the current menu or the currently opened dialog and its functions.



For efficiently using the context sensitivity, set the focus to the relevant part of the user interface that interests you. For example, set the cursor into an entry field or select a checkbox.

If you set the focus appropriately, you avoid opening the help content at a superordinate theme or chapter.

Contents of the help dialog

The help dialog is split into two main areas.

- In the left-hand part of the dialog, you can select one of the following functions:
 - "Contents" opens a navigation tree of help subjects

- "Index" provides an index table of help contents
- "Find" allows searching for arbitrary text and keywords
- The right-hand part of the dialog displays the contents of the selected help topic.

A navigation bar on top of the help dialog with "Back", "Previous" and "Next" buttons allows navigating between the help topics.

Navigating in the table of contents

1. To navigate within the table of contents, click entries or use the [Up/Down] keys.
2. Entries that contain subsections have a plus sign. To expand the navigation tree at this point, click the plus sign or press the [Right] arrow key.
3. To display a help topic, click it (in the "Index", double-click it) or press the [ENTER] key.

The corresponding help topic is displayed.

Navigating in the help topics

1. To scroll through a page, use the mouse wheel, a scrollbar or the [Up/Down] arrow keys.
2. To follow a cross-reference, click the link.
3. To return to the previous page, select "Back".
This function follows back all steps that you have gone before.
4. Use the horizontal scrollbar to shift the content of the navigation window to the left or right.
5. You can "Hide" the navigation window or minimize it by shifting the separation line with the "Topics" window.

Using the index

1. Select the "Index" tab.
2. Enter the first characters of the topic that you are interested in.
The index jumps to the first entry that starts with these characters.
3. Use the [Up/Down] keys to navigate to the suitable keyword.
4. Press the [ENTER] key to display the help topic.
The help dialog displays the corresponding topic.

Closing the help window

- ▶ Click the "X" button (top right of the dialog) or press [Alt + F4] to close the help window.



The **Documentation** subfolder in the **R&S ELEKTRA Program Files** folder contains a PDF copy of the user manual and other documents, including the **Open Source Acknowledgment (OSA)**.

Find the **Documentation** subfolder in the local drive, in which R&S ELEKTRA is installed, at the path "**C:\Program Files\Rohde-Schwarz\ELEKTRA\x.xx.x**", where "**x.xx.x**" represents the software version.



The **R&S License Key Manager** in the navigation menu **Administration** has its own help system.

11.2 Log information

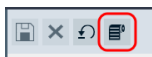

Access: "**Home**" > "**Administration**" > **Settings** > **Log** > "**View Logs**" button 

The "**View Logs**" button brings up a separate dialog:

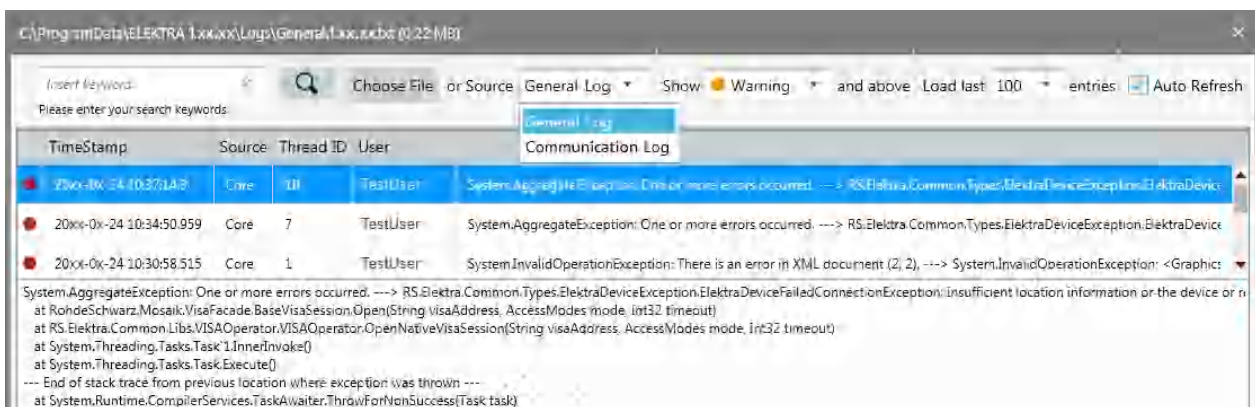

Figure 11-1: Example of a log entries dialog



You can also open this dialog for viewing the log entries by the keyboard shortcut **[Alt]+[L]**.

The dialog shows the existing log entries and offers the following options:

- "**Search**"
Searches for log information.
- "**Choose File**"
Opens an Explorer window for selecting a log file (in **TXT** format) to be displayed in the log entries dialog. Per default, log files are saved at
C:\ProgramData\Rohde-Schwarz\ELEKTRA\x.xx.xx\Logs
- "**Choose Source**"
Selects the source of the displayed log entries. Available log sources are:
 - "**General Log**"
 - "**Communication Log**"

- "Show"
 - Selects the type of log information to be displayed, with significance increasing from "Info" to "Warning" to "Error". Available log information types are:
 - Show "Info" and above (includes "Warning" and "Error").
 - Show "Warning" and above (includes "Error").
 - Show "Error".
- "Load last ... entries"
 - Sets the maximum number of entries to be loaded.
- "Auto Refresh" automatically updates the view, if "Source" or "Show" settings are changed

11.3 VISA trace tool

Allows tracking and recording VISA commands during activities of R&S ELEKTRA.

Access: outside of R&S ELEKTRA, go to "Windows Start" > "R&S VISA" > "Trace Tool".

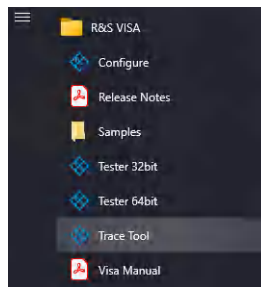

When you click "Trace Tool", the following dialog opens:

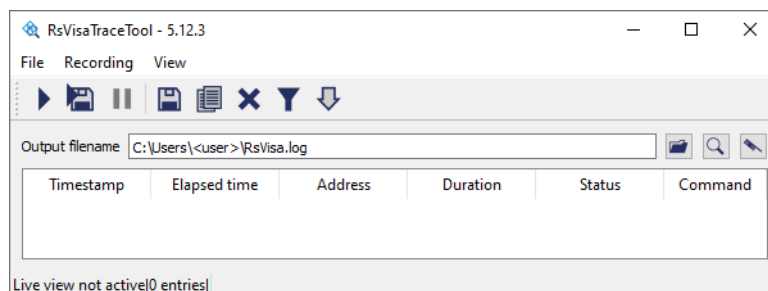

Figure 11-2: Trace tool dialog started, no entries yet

- ▶ To track VISA commands, click "Start recording" ▶ (button at top left of [Figure 11-2](#)). During a recording, the "Trace Tool" creates a log table of all VISA commands that occur upon operating other software, including R&S ELEKTRA. For example, when you start an EMI test, the recording can look as follows:

	Timestamp	Elapsed time	Address	Duration	Status	Command
0	11:48:12.417	1720.417576 s	TCPIP0:10.102...	12.8 µs	VI_SUCCESS	viSetAttribute(vi=11,attribute=VI_ATTR_TERMCHAR,attrState=10(0xa))
1	11:48:12.417	1720.417593 s	TCPIP0:10.102...	3.1 µs	VI_SUCCESS	viSetAttribute(vi=11,attribute=VI_ATTR_TERMCHAR_EN,attrState=1(0x1))
2	11:48:12.417	1720.417601 s	TCPIP0:10.102...	2.6 µs	VI_SUCCESS	viGetAttribute(vi=11,attribute=VI_ATTR_INTE_TTYPE,attrState(0000007C25FFE3A0)=6(0x6)
3	11:48:12.417	1720.417609 s	TCPIP0:10.102...	2.1 µs	VI_SUCCESS	viGetAttribute(vi=11,attribute=VI_ATTR_INTE_TTYPE,attrState(0000007C25FFE3B8)=6(0x6)
4	11:48:12.417	1720.417615 s	TCPIP0:10.102...	3.3 µs	VI_SUCCESS	viGetAttribute(vi=11,attribute=VI_ATTR_TCPIP_JS_HISLIP,attrState(0000007C25FFE380)=0(0x0)
5	11:48:12.417	1720.417623 s	TCPIP0:10.102...	2.1 µs	VI_SUCCESS	viSetAttribute(vi=11,attribute=VI_ATTR_SUPPRESS_END_EN,attrState=0(0x0))
6	11:48:12.417	1720.417638 s	TCPIP0:10.102...	3.1 µs	VI_SUCCESS	viSetAttribute(vi=11,attribute=VI_ATTR_TMO_VALUE,attrState=10000(0x2710))
7	11:48:12.422	1720.422526 s	TCPIP0:10.102...	893.4 µs	VI_SUCCESS	viWrite(vi=11,buf=""CLS\n",cnt=5,retCnt(0000007C267FE3A8)=5)
8	11:48:12.423	1720.423545 s	TCPIP0:10.102...	734.2 µs	VI_SUCCESS	viWrite(vi=11,buf=":SYSTEM:DISPLAY:UPDATE ON\n",cnt=26,retCnt(0000007C2C7FEE88)=26)
9	11:48:12.424	1720.424315 s	TCPIP0:10.102...	700.1 µs	VI_SUCCESS	viReadSTB(vi=11,stb(0000007C2C7FED98)=0x0000)
10	11:48:12.425	1720.425091 s	TCPIP0:10.102...	737.4 µs	VI_SUCCESS	viWrite(vi=11,buf=""IDN?\n",cnt=6,retCnt(0000007C2C7FEE88)=6)

Live view active|269 entries|

Figure 11-3: Example of entries in the trace tool

- To finish the acquisition of VISA commands, click "Stop recording" ■ (button in same position as "Start recording" before the recording). Optionally, you can save the list of recorded commands to a file.

You can use the recording of tracked VISA commands, for example, for diagnosing problems with the control of devices, especially during the configuration of generic device drivers.

For more information, refer to the user documentation at "Windows Start" > "R&S VISA" > "Visa Manual".

11.4 Troubleshooting information

If you have a problem with R&S ELEKTRA that requires assistance from Rohde & Schwarz, we recommend including a troubleshooting file into your communication with our [support team](#).

The troubleshooting file is a zip archive with the following default filename, which includes a time stamp:

TroubleshootingInfo yyyy-mm-dd hh-mm.zip

To create troubleshooting information



1. If an error message allows creating troubleshooting information:
 - a) Click the button shown in the lower left of [Figure 11-4](#):

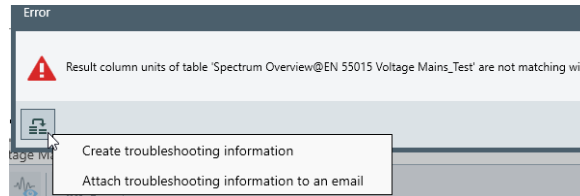
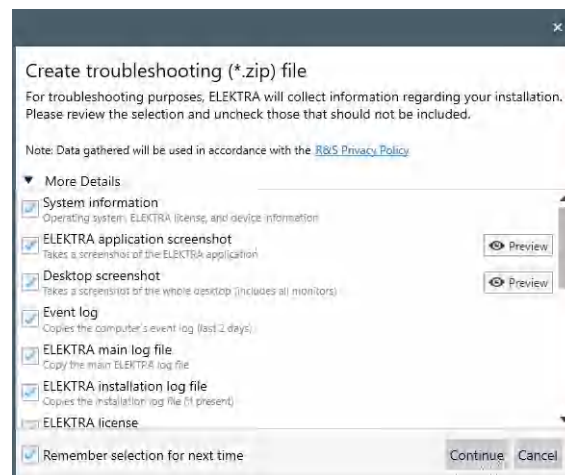

Figure 11-4: Creating specific troubleshooting information

- b) Select "Create troubleshooting information" or "Attach troubleshooting information to an email".
2. If this button is not available, hit the keyboard shortcut **[Alt]+[X]**.
 If [Show troubleshooting info selection screen](#) is enabled in the [general settings](#), the dialog in [step 3](#) comes up to let you select options.
 If [Show troubleshooting info selection screen](#) is not enabled, you cannot select options. Instead, the software proceeds with [step 6](#) for saving a troubleshooting zip file with a default selection of content.
3. In the dialog that comes up, click "More Details".

A list of selectable details unfolds:



You can do a quick check on some of the content by clicking the "Preview" button, if it is available.

4. Select the information that you want to include in the troubleshooting zip file.

The following options are available:

- System information (operating system, R&S ELEKTRA license, and device information)
- R&S ELEKTRA application screenshots (R&S ELEKTRA_YYYY-mm-dd.jpg)

- Full desktop screenshots of all connected displays (PrintScreen_yyyy-mm-dd.jpg)
 - The computer's event log of the last two days
 - R&S ELEKTRA main log file, see [Log information](#)
 - R&S ELEKTRA installation log file (if present)
 - R&S ELEKTRA [license](#) information
 - User configuration (UserOptions.xml and DeactivatedOptions.xml)
 - An auto-saved copy of the active test
 - SCPI commands and responses (contents of the command buffer), see [Log](#)
 - Test execution log file (if present)
 - VISA communication log file, see [Log information](#)
 - Content of the active tab (if present, filename depends on context)
 - Status of the automation test, see [Test Automation](#)
 - An optional video clip of R&S ELEKTRA's window, showing what happened in the last few minutes
5. Click "Continue".
 6. Select a location for saving the zip file.
If you have selected "Attach troubleshooting information to an email", a new email message opens with the zip file attached, but requiring to update at least the "From" and "To" email addresses.
Note: Instrument security.
The troubleshooting zip file, backup files or other information that you intend to provide to technical support personnel can contain company confidential or personal information. Releasing this information can violate Instrument Security Procedures installed in your organization. Therefore, before you send the files to any recipient outside of your organization, open the files and remove any sensitive information.
 7. Optionally, include also the following data in your communication:
 - [Export](#) files of objects that you suspect being the cause of a problem
 - A [Backup](#) of the database
 8. Proceed as described in [Chapter 11.7, "Support"](#), on page 683.

11.5 Product information

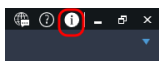



To display product information about R&S ELEKTRA, click the info button  in the program menu.

This selection brings up a dialog that provides the following information:

- Software version details
- Links for the following online targets:
 - The Rohde & Schwarz homepage
 - An email message to the Rohde & Schwarz customer [Support](#) center

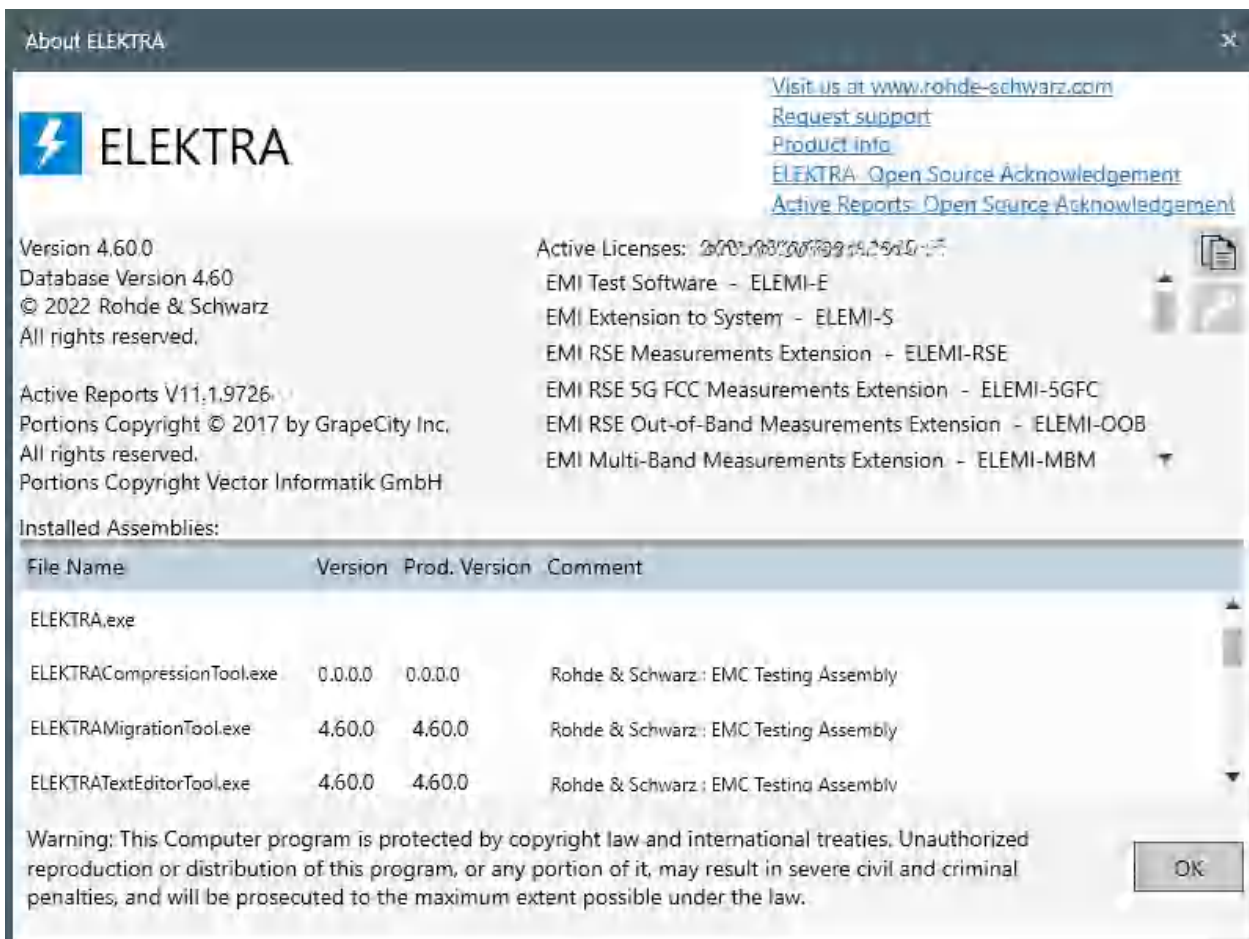
- The R&S ELEKTRA product start page
- The open-source acknowledgment for open source software components used by R&S ELEKTRA
- The open-source acknowledgment for open source software components used by the "Active Reports" application
- A list of the installed software components



The "Copy to Clipboard" button  copies the full content of this dialog to the clipboard of your computer. Use the keyboard shortcut [CTRL+V] to paste the content into any editor.



The "Install personal license key" button  opens a dialog for activating your license key: Enter the email address of your license account and the 30-digit license key, then click "OK". Alternatively, use the "Home" > [Administration](#) > [License Management](#) dialog.

Click "OK" to close the "About ELEKTRA" product information dialog.

11.6 R&S ELEKTRA on the internet

The R&S ELEKTRA product start page www.rohde-schwarz.com/product/elektra provides the most recent information, as detailed in [Chapter 1.3, "Documentation overview"](#), on page 17. The online content also includes updates for current software versions.

For easy access to the R&S ELEKTRA product start page, click the info button  and select "Product info".

11.7 Support

For all service requests, or if you need immediate help, contact the Rohde & Schwarz support center. To send an email message, click the info button  and select "Email support". Regional contact details are available as described in [Chapter 11.7.1, "Contacting customer support"](#), on page 683.

Before you contact the support team, we recommend reading the corresponding chapter in the user manual or in the context-sensitive [Embedded help](#). If you contact the support team, have the product license information available.

11.7.1 Contacting customer support

Technical support – where and when you need it

For quick, expert help with any Rohde & Schwarz product, contact our customer support center. A team of highly qualified engineers provides support and works with you to find a solution to your query on any aspect of the operation, programming or applications of Rohde & Schwarz products.

Contact information

Contact our customer support center at www.rohde-schwarz.com/support, or follow this QR code:



Figure 11-5: QR code to the Rohde & Schwarz support page

11.8 Training

The Rohde & Schwarz training services offer in-depth customer seminars and intensive training courses for the application of R&S ELEKTRA. Course schedules are available at www.training.rohde-schwarz.com. Some courses are made available on demand.

Glossary: Frequently Used Terms and Abbreviations

Symbols

2G: 2nd generation of wireless mobile communications technology according to the [GSM](#) standard

3G: 3rd generation of wireless mobile communications technology, complying with specifications by the International Telecommunication Union (ITU)

3GPP: 3rd generation partnership project, collaboration of telco standards associations

4G: 4th generation of wireless technology for broadband cellular networks, based on [3GPP](#) standards. An early release was "Long Term Evolution" (LTE), often used as a synonym for 4G.

5G: 5th generation of wireless technology for digital cellular networks, based on [3GPP](#) standards. An early release was "New Radio" (NR), often used as a synonym for 5G.

A

ABT: Audio breakthrough, a set of measurements to characterize the analog audio performance of mobile devices

AC: Alternating current (or > [Anechoic chamber](#))

ACA: Absorbing clamp assembly

ACK: Acknowledgment, acknowledged transmission, new transmission using the first [RV](#)

ACK rate: Acknowledgment rate, a measure for the number of transmission confirmations, used to monitor packet loss. The ACK rate is the sum of the not acknowledged and lost packets, divided by the sum of the acknowledged, not acknowledged and lost packets.

ACV: [Video bandwidth](#)

AF: Antenna factor, the ratio of the electromagnetic field strength (E or H) to the voltage U induced across the terminals of an antenna. For an electric field antenna, field strength E is in units of V/m, and the resulting antenna factor E/U is in units of 1/m. For a magnetic field antenna, field strength H is in units of A/m, and the resulting antenna factor H/U is in units of A/(Vm).

AFC: Automatic frequency control, a tracking mechanism to keep a monitoring device tuned to a signal with a frequency that is drifting over time, typically due to thermal or mechanical effects.

AMN: Artificial mains network

Anechoic chamber: A room lined with absorbing material that does not reflect electromagnetic waves.

ANSI: American National Standards Institute

APD: Amplitude probability distribution, a statistical measurement according to CISPR 16-1-1 (amendment 1:2005), which shows the "cumulative distribution of the probability of time that the amplitude of disturbance exceeds a specified level". CISPR APD is also a [detector](#) type.

API: Application programming interface for connecting computers or pieces of software among each other

ARFCN: Absolute radio-frequency channel number

ATB: Automotive test bench, a testbed automation platform

AVG: Average, a [detector](#) type

B

BB: Broadband

BCI: Bulk current injection / bulk cable injection, conducted susceptibility tests according to various standards as for example: ISO 11451-4 (EMI tests for continuous narrowband EM fields interfering with electronic components in vehicles), MIL-STD-461, CS114 (electrical disturbances from radiated EM energy at 10 kHz to 200 MHz)

BER: Bit error rate, the number of bit errors divided by the total number of transferred bits

BLER: Block error rate, a measure for the share of erroneous [RLC](#) data blocks. BER is based on the ratio of data blocks that the mobile device under test receives and demodulates over the total number of transmitted data blocks. $BLER = \frac{(NACK+DTX)}{(ACK+NACK+DTX)}$

BNC: Bayonet Neill-Concelman connector for coaxial cables that transmit RF signals, limited to frequencies <4 GHz and <500 V.

BT: Bluetooth®, a short-range wireless data-exchange standard. The Bluetooth® word mark and logos are registered trademarks owned by Bluetooth SIG, Inc., and any use of such marks by Rohde & Schwarz is under license.

BWP: Bandwidth part

C

CAV: CISPR average, a [detector](#) type.

CC: Current clamp

CD-ROM: Compact disc read-only memory, an optical data storage medium

CDN: Coupling/decoupling network

CE: Conducted emission (cable-based EMI tests)

CEE: Commission for Electrical Equipment, former name of a standardization organization; since 1985 the IEC

CF: Clamp factor (current injecting or absorbing clamp)

CISPR: International special committee on radio interference (in French: Comité International Spécial des Perturbations Radioélectriques), a standardization organization (part of the IEC) for controlling electromagnetic interference in electrical and electronic devices

Corner frequency: The pulse repetition frequency above which the RMS-average detector behaves like an RMS detector and below which the RMS-average detector has the slope of a linear average detector.

CRB: Common resource block, a term that is used when talking about the whole carrier.

Crest factor: Ratio of the peak amplitude of a waveform divided by its [RMS](#) average value.

CS: Conducted susceptibility (cable-based EMS tests)

Or: circuit switching, a networking approach that uses dedicated channels, as opposed to [PS](#)

CW: Continuous wave, a narrow bandwidth signal of constant amplitude and frequency

D

D-Sub: Electrical D-subminiature connector, surrounded by a D-shaped metal support

dB: Decibel, 10 times the common (decadic) logarithm of the ratio of two power quantities, or of the ratio of the squares of two field amplitude quantities

dBm: Decibel milliwatt, the power level based on a power ratio in decibels (dB) of the measured power, referenced to 1 mW

DC: Direct current

Detector: An algorithm that specifies how to weight the envelope of the measured IF signal, see [Table 5-2](#).

DL: Downlink, the radio transmission direction from a base station to a mobile device

DL BLER: Downlink block error rate, where $DL\ BLER = (NACK+DTX) / (ACK+NACK+DTX)$

DTX: Discontinuous transmission, retransmission uses the [RV](#) previously transmitted to the same hybrid automatic repeat request (H-ARQ) process.

DUT: Device under test

Dwell Time: An EMS test parameter that determines how long the EUT is at least exposed to the immunity signal. Hence, the dwell time is the delay between the end of the field leveling process and the start of the EUT monitoring cycle.

E

EGPRS: Enhanced general packet radio service, a [GSM](#) mobile data standard

EIRP: Equivalent (or effective) isotropically radiated power

EMC: Electromagnetic compatibility (with both EMI and EMS requirements)

EMI: Electromagnetic interference is a disturbance in the RF spectrum. EMI testing of electrical appliances searches for unwanted signals or noise emitted by these appliances, which can disturb their environment.

EMS: Electromagnetic susceptibility: Property of an electrical appliance to tolerate a disturbance of a particular level without showing any faults.

ERP: Equivalent (or effective) radiated power

ESD: Electrostatic discharge

EUT: Equipment under test

EUT monitoring: Monitoring of different EUT parameters during an EMS measurement by using several measurement instruments with the goal of detecting EUT failures

F

FAR: Fully anechoic room

FC: Ferrule connector for optical fibers

FCC: Federal Communications Commission, the government agency that regulates telecommunications the USA

FDD: Frequency-division duplexing, a duplex mode, for example in [LTE](#) or [5G FR1](#) technology, see also [TDD](#).

FER: Frame erasure rate, the number of erased frames divided by the total number of transferred frames. In erased frames, the decoder could not correct faulty class 1a bits, despite very good error protection by guard bits.

FFT: Fast Fourier transform, an algorithm for time-domain scans

FR1: Frequency range 1, defined by [3GPP](#) in release 15 as <6 GHz, used in [5G](#) technology

FR2: Frequency range 2, defined by [3GPP](#) in release 15 as 23.45 GHz to 40.8 GHz, used in [5G](#) technology

FSMA: Fiber Sub-Miniature Assembly, a connector for optical fibers, developed based on the SMA connector.

G

Gain: The increase in power or amplitude of a signal, typically generated by an amplifier. In decibel (dB) calculus, power gain is $10 \log (P_{out} / P_{in})$.

Gasket: A mechanical seal

GHz: Gigahertz, a frequency of $10^9/s$

GPI: Ground plane interference

GPIO: General-purpose interface bus according to standard IEEE-488

GSM: Global system for mobile communications, a standard for second-generation ([2G](#)) digital cellular networks, developed by the European Telecommunications Standards Institute (ETSI)

H

HSDPA: High-speed downlink packet access, an enhanced downlink protocol for [HSPA](#)

HSPA: High-speed packet access, a mobile telecommunication protocol that enhances [3G](#) network performance by using [WCDMA](#)

HSUPA: High-speed uplink packet access, an enhanced uplink protocol for [HSPA](#)

I

IEC: International Electrotechnical Commission, a standardization organization for electrical, electronic and related technologies. One of IEC's groups is CISPR.

IEEE: Institute of Electrical and Electronics Engineers, among other activities an important publisher of standards that are produced by the IEEE's standardization committees.

IF: Intermediate frequency, in heterodyne signal processing the resulting sum or difference frequency when a carrier signal is mixed with a local oscillator signal.

Impedance: Electrical impedance Z is the complex ratio of AC voltage over current, representing a circuit's opposition towards a current under an applied voltage.

IP: Internet protocol, a network communication technology for routing data packets from a source to a destination, based on IP addresses in the packet headers.

ISO: International standardization organization, based in Geneva, Switzerland, and composed of representatives from national standards authorities. ISO and IEC have joint committees.

ITU: International Telecommunication Union

ITU-R: International Telecommunication Union Radiocommunication sector, one of the divisions of the [ITU](#), responsible for radio communication. Formerly known as the CCIR (Consultative Committee on International Radio).

ITU-R 468: [ITU-R BS.468-4](#) standard, a standard to measure audio-frequency noise in audio systems. The standard uses the quasi-peak-value method of measurement with specific tone-bursts to define the characteristics of the measuring device.

ITU-T: International Telecommunication Standardization Sector, one of the divisions of the [ITU](#), an organization that coordinates standards for telecommunications and information communication technology. Formerly known as the CCITT (International Telegraph and Telephone Consultative Committee).

K

kHz: Kilo Hertz, a frequency of $10^3/s$

L

L.O.: Local oscillator, a component of a mixer that is used for frequency conversion, for example in a heterodyne receiver

LAN: Local area network within a limited space, such as an office building. LAN connects computers or electronic equipment with processing capability. It uses network media technologies such as Ethernet (over electric or fiber-optic cables, according to the IEEE 802.3 standards) or wireless LAN (Wi-Fi, according to IEEE 802.11).

Laser: LASER is the acronym for Light Amplification by Stimulated Emission of Radiation. Coherence, which allows monochromatic laser light to be focused and collimated, is among a laser's most special qualities. Spatial coherence enables high power densities, especially when modulated to be emitted in short pulses.

Level: The power level of RF radiation, typically specified in dBm, or in watts.

Limit Line: In all EMI standards, maximum permissible levels for any interference signal generated by the EUT are defined, depending on the EUT class. A table containing these limit values over frequencies for an EUT class is called a "Limit Line" in R&S ELEKTRA.

LNA: Low Noise Amplifier, typically a solid-state preamplifier

LTE: Long Term Evolution, an early release of the 4th generation (4G) of mobile communications technology

M

M2M: Machine-to-machine ("M2M") communication, aiming at means to facilitate communication among wireless or wire-bound devices.

MHz: Mega-Hertz, a frequency of $10^6/s$

Modulation Depth: In amplitude modulation, the modulation depth is the ratio M/A (in %) of the modulation amplitude M to the unmodulated carrier amplitude A . In this relation, M is the peak change (positive or negative) in the RF amplitude from its unmodulated value. For example, 80% modulation depth represents a signal with an envelope that oscillates between 100% and 20% of A . (20% of A is an amplitude 80% down from the unmodulated signal level A .)

MSC: Mode-Stirred Chamber, see [RVC](#) (reverberation chamber).

N

NACK: Not acknowledged, see [ACK rate](#), retransmission using the next [RV](#) (up to the maximum permitted number or RVs).

NB: Narrowband

NIST: National Institute of Standards and Technology (USA)

Noise Factor: The noise factor (F) is a measure of the SNR degradation due to components in an RF signal chain. Lower F values indicate better system performance, with F being the ratio of input SNR to output SNR: $F = \text{SNR}_{\text{input}} / \text{SNR}_{\text{output}}$.

Noise Figure: The noise figure (NF) is equivalent to the noise factor (F) given in dB:
 $\text{NF} = 10 \log F$

NR: New Radio, an early release of the 5th generation ([5G](#)) of mobile communications technology

NSA: Normalized site attenuation, a measurement of test chamber characteristics (typically with a transmitting and a receiving antenna), in comparison with theoretical free-space attenuation at an OATS.

Note that the acronym **NSA** is used also in mobile communications for "non-standalone access" connections that use both [LTE](#) and [NR](#) infrastructure.

NTIA: National Telecommunications and Information Administration (USA)

O

OFDMA: Orthogonal frequency-division multiple access, a scheme for simultaneous transmission from multiple radio spectrum users

OTA: Over-the-air (tests)

P

P-: Minimum peak, a [detector](#) type

P+: Maximum peak, a [detector](#) type

PC: Personal computer

PCell: Primary cell, the [LTE](#) cell that the [UE](#) first registers to

PDP: Packet data protocol, a set of session information exchanged during an active call

PER: Packet error rate, a measure for the share of erroneous data packets in a transmission

PS: Packet switching, a networking approach that uses the headers of data packets for sending the packet's payload to its destination, as opposed to [CS](#)

PUSCH: Physical uplink shared channel, a frequency band that carries control information and uplink data of the physical layer in the EUTRAN protocol stack

Q

QPK: Quasi-peak, a [detector](#) type

R

RB: Resource block of the cell bandwidth

RC: Reference calibration (table)

RE: Radiated emission (antenna-based EMI tests)

RF: Radio frequency, electromagnetic oscillation in the frequency range of around 3 kHz to 300 GHz

RFID: Radio frequency identification, a (typically near-field) technology for automatic identification and tracking of objects

RIV: Resource indication value, signaled as location and bandwidth, defines the bandwidth part (BWP) in the frequency domain.

RLC: Radio link control, a wireless communications protocol for error management

RMS: Root mean square, a statistical measure defined as the square root of the arithmetic mean of the squares of the original values.
Also a [detector](#) type.

RRC: Radio resource control, a network protocol for control messages between [UE](#) and base station.

RS: Radiated susceptibility (antenna-based EMS tests)

RSE: Radiated spurious emissions, unwanted RF radiation of a device that is meant to emit at other frequencies. Typically, RSE can happen as higher (out-of-band) harmonics of the intended signal.

RV: Redundancy and constellation version, a modified coding scheme with incremental redundancy that NodeB can request for repeated transmission, if a previously transmitted data package had errors.

RVC: Reverberation chamber, or electromagnetic mode-stirred chamber (MSC), a cavity resonator room used for testing EUTs under high field strength conditions. These

conditions are generated using reflective walls and so-called stirrers (or tuners) that inhomogeneously reflect electromagnetic power to avoid the formation of standing RF waves.

Rx: Receiving, reception

S

SC: Standard connector for optical fibers

Scan: A scan is a measurement run, during which the receiver or the signal generator is tuned step by step over the whole frequency range (as opposed to a sweep). The definition parameters for a scan are the start and stop frequency, the step width (absolute, or in percent of the current frequency) and the dwell time at each frequency.

SMA connector: Sub-Miniature Assembly, a coaxial RF connector, version A (standard)

SMP connector: Sub-Miniature Precision assembly, a coaxial RF connector, version P (precision)

SNR: Signal-to-noise ratio is the ratio of the level of a desired signal to the level of background noise (measured in quantities of power). $SNR > 1$ (or $SNR > 0$ dB) indicates more signal than noise.

SS/PBCH: Synchronization signal physical broadcast channel

SSB: Synchronization signal block for a carrier

ST: Straight tip bayonet connector for optical fibers

Sweep: A sweep is an EMI measurement run, during which the frequency analyzer is tuned (quasi) continuously over the whole frequency range (as opposed to a scan). The definition parameters for a sweep are the start frequency, the stop frequency and the sweep time that it takes the analyzer to cover the whole frequency range.

T

TDD: Time-division duplexing, a duplex mode, for example in [LTE](#) or [5G](#) technology, see also [FDD](#).

TEM: Transverse electromagnetic, as in a TEM waveguide or GTEM cell, for example.

TG: Test generator, generates test signals for EMS tests.

TPL: Short for template, R&S ELEKTRA distinguishes between [test templates](#), [EUT monitoring templates](#) and [report templates](#).

TRD: Also written as "Trd", short for transducer

TRP: Total radiated power, the sum of all RF power radiated by an antenna (source power included in the measurement).

TT: [Test template](#)

TTL: Transistor–transistor logic, a class of integrated circuits with transistors performing both logic and amplifying functions

Tx: Transmitting, transmission

U

UA: Uniform area

UARFCN: UTRA absolute RF channel number, which identifies a frequency in the UMTS frequency bands. UTRA stands for UMTS terrestrial radio access, which includes the air interfaces (physical and data communication link layers) between mobile communication stations.

UDP: User datagram protocol, a communication protocol for sending messages to other hosts on an IP network.

UE: User equipment, for example a mobile device to be tested

UL: Uplink, the radio transmission direction from a mobile device to a base station

USB: Universal Serial Bus, industrial connector standard for a serial interface

V

VA: Volt-Ampere = voltage (RMS) * current (RMS), is the unit for apparent power in an electrical AC circuit with sinusoidal voltages and currents of the same frequency. In DC circuits, VA is the real power in watts.

Video bandwidth: The video signal or (DC) video voltage is the envelope of a modulated RF signal. A lowpass filter that removes the higher frequency components of the IF signal and outputs the envelope, only, is called the video filter. The video bandwidth is hence the bandwidth of the filtered signal envelope.

"AC Video" (ACV) and "AC Video Sine" (ACS) are also [detector](#) types.

VISA: Virtual instrument software architecture, an application programming interface for communicating with instruments used in test and measurement tasks

VSWR: Voltage standing wave ratio, ratio of the maximum standing wave amplitude over the minimum standing wave amplitude

W

WCDMA: Wideband code-division multiple access, a wireless communications standard in 3G networks

WLAN: Wireless local area network, a wireless internet-connectivity technology for electronic devices. "WiFi" is a synonym for WLAN.

X

XML: Extensible markup language, a simple and generality usable text format code that can be read easily both by humans and machines.

Index

Symbols

3D chart	171
5G FCC measurement	198

A

Action buttons	45
Activate an EUT	48, 66
Add a new device	367
Administration	
Backup	518
Database	522
Device files	528
EUT settings	545
External mixer settings	556
General settings	543
Graphic	547
Licenses	532
Log settings	555
Report	550
Server admin	525
Settings	517
Test automation	531
Test settings	546
User	538
AIM 7351731	414
AMEX	250
Amplifier	389
Amplifier gain	500
Amplifier saturation check	298
Anechoic chamber (EMS)	355
Antenna	341, 395
Antenna Port	251
Antenna port (EMS)	354
Antenna tower	341, 400
API	585, 591
Application notes	19
ARB waveform	414
Archive	
EUT	515
Test	517
Attenuation table	500
calibration	646
Recalibrate	125, 650
Automated measurement	602
Automation (test)	531
Automotive	
EMI	553
EMS	250
Roller test bench	491
Averaging	171

B

Backup	518
Band-edge measurements	197
Brochures	18
BSI	14
Bulk current injection (EMS)	350

C

CAL tests	592, 593
-----------------	----------

Calibration	625, 645
EMI reference	645
EMS reference	645
Field uniformity evaluation	657
Field uniformity measurement	655
Reference	652
Reference, with constant field	654
Signal path	646
Transducer	652
Calibration measurement	
Test template configuration	119
Calibration measurements	593
Hardware setup	334
CAN inserter	415
CDN / EM clamp (EMS)	352
CENELEC	14
CFR	14
Change password	63
Chart configuration	98
Charts	632
CISPR	14, 172
Clear write	171
CMW270 (radio communication tester)	443
CMW500 (radio communication tester)	443
CMX500 (radio communication tester)	345, 443
Collapse / expand	50
Common action buttons	45
Common mode (LISN)	338, 422
Concept for tests	53
Configuration	62
Backup settings	518
Calibration measurement	119
Dashboard	65
Database	522
Device list	362
EMI tests	136
EMS tests	243
EUT	66
EUT monitoring	307
EUT settings	545
External mixer settings	556
Graphic settings	547
Hardware setups	331
Home menu	62
Language selection	63
License management	532
Log information	677
Marker	105
Report settings	550
Report templates	325
Server administration	525
Test automation	531
Test charts	98
Test settings	546
Test tables	108
Test templates	117, 136
Tests	88
Traces	104
User administration	538
VISA trace tool	678
Configuration wizard	28, 510
Connection	369
Constant power method	655

- Context-sensitive help 675
- Copy 48
- Copy device 370
- Courses for training 684
- Create 47, 48
 - Basic data 28
- Critical points 631
- Customer support 683
- D**
- Dashboard 43
 - Show selected items 544
- Data exchange interface 585
- Data management
 - File system 32
- Data sheets 18
- Database 522
 - Avoid overstuffing 28
- DEF STAN 14
- Delete 47
- Delete device 371
- Details 49
- Detectors 562
 - Control during measurements 623
 - For final measurement 187
 - For interactive final measurement 201
 - For overview measurement 163, 171
- Device files 528
- Device list
 - Handling 363
- Device properties vs. measurement settings 51
- Device simulation 543
- Devices
 - Communication log 556
 - Device list 362
 - Properties 377
 - Recheck devices 376
 - Search device 372
- Dialogs locked 50
- Differential mode (LISN) 338, 422
- DIN 14
- Disabled licenses 64, 532
- Dongle 24
- Duplicate device 370
- E**
- Edit 48
- EDSTAR 14
- Electric field strength (EMI) 341
- ELEKTRA Spy 556
- Embedded help 675
- EMC standards 14
- EMC32 data conversion 32
- EMI tests 334, 592, 594
 - Automated 596, 599
 - Conducted with LISN 338, 422
 - Conducted with slidebar 340
 - Conducted with transducer / probe 337
 - Configuration 136
 - Interactive 596, 599
 - Radiated spurious emission (RSE) 345
 - Radiated with antenna 341
 - Radiated with GTEM 342
 - Radiated with loop antenna and turntable 344
 - Radiated with triple loop antenna 343
- EMS tests 347, 592, 597
 - Configuration 243
- EN 14
- EN 61000-4-3 655
- EN 61000-4-6 15, 250
- Equipment under test 66
- ES-SCAN data conversion 32
- ETSI 14
- EUT 66
 - Activate 66
 - Archive 515
 - Description 67
 - Handling 66
 - Settings 545
- EUT monitoring
 - Configuration 307
- EUTs
 - Activate 48
 - Evaluation of test results 633
 - Expand / collapse 50
 - Expired license 64, 532
 - Export 507
 - Export table 497
 - External harmonic mixers 220
 - External mixer
 - Settings 556
- F**
- FCC 14
- FCC 5G measurement 198
- FDA 414
- Field probe 409
 - Multi-channel 303
- Field uniformity
 - Evaluation 657
 - Measurement 655
- Field uniformity evaluation
 - With MFP system 661
- File system 32
- Filter 570
- Final measurement 187
 - Interactive 201
- Find references 50
- Firewall 35
- Frequency control 619
- Frequency list 502
- FU
 - Evaluation 657
 - Measurement 655
- G**
- Gain 500
- GAM 14
- Generator 413
- Getting started 40
- Global tables 494
- Glossary 685
- GMW3097 553
- Graphic settings 547
- Graphical user interface 43
 - Graphics
 - Test results 632
- Graphics per frequency range 173
- GTEM 342, 480
- GTEM (EMS) 357

- GUI 43
- H**
- Hand icon 602
- Handling
 - Device list 363
 - EUT 66
 - Hardware setups 331
 - Report templates 324
 - Test templates 117
 - Tests 88
- Hardlock 24
- Hardware setups 331
 - Anechoic chamber (EMS) 355
 - Antenna (EMI) 341
 - Antenna port (EMS) 354
 - Bulk current injection (EMS) 350
 - CDN / EM clamp (EMS) 352
 - Electric field strength (EMI) 341
 - Electric field strength, GTEM (EMI) 342
 - Electric field strength, TEM waveguides (EMI) 342
 - EMI 334
 - EMS 347
 - GTEM (EMI) 342
 - GTEM (EMS) 357
 - Handling 331
 - LISN (EMI) 338
 - Loop antenna + turntable (EMI) 344
 - Magnetic field strength, loop antenna + turntable (EMI) 344
 - Magnetic field strength, triple loop antenna (EMI) 343
 - Radiated spurious emission, RSE (EMI) 345
 - Reverberation chamber (EMS) 359
 - Slidebar (EMI) 340
 - TEM waveguides (EMI) 342
 - TEM waveguides (EMS) 357
 - Transducer / probe (EMI) 337
 - Triple loop antenna (EMI) 343
- Harmonic mixers (external) 220
- Help 18, 675
 - Support 683
- Help system 675
- Hierarchy within the software 40
- Highlighted item 48
- Home 43
 - Configuration 62
- I**
- IEC 14
- IEC 61000-4-3 15
- Import 508
- Import table 48, 496
- Inconclusive verdict 59
- Installation 20
- Installed software components 681
- Instrument security procedures 681
- Interactive measurement 602
- Interlock monitoring 417
- Internet 683
- IO device 418
- ISO 14
- K**
- Key features 13
- Keyboard shortcuts 576
- L**
- Language selection 31
- Language setting 63
- License 24
 - Maintenance expired 64, 532
- License management 532
- License server manager 532, 534
- Licenses 26
- Limit lines 497
- Linearity 504
- LISN 338, 420
- Locked dialogs 50
- Log information 555, 677
- Log information settings 555
- Login 42, 63
- Loop antenna 344
- M**
- Maintenance expired (license) 64, 532
- Margin 631
- Marker
 - Configuration 105
 - Usage 633
- Max hold 171
- Measurement
 - Automated 602
 - Basics 560
 - CAL 592
 - EMI 334, 592
 - EMS 347, 592
 - Examples 663
 - Interactive 602
 - Single 602
- Measurement concept 53
- Measurement settings vs. device properties 51
- Measurements 623
- MFP system 304, 661
- Migration tool 32
- MIL Std. (EMS) 250
- MIL-STD-461 14
- Mixers (external, harmonic) 220
- Monitoring
 - Interlock 417
- Monitoring devices 426
- Mouse 50
- Multi-channel field probe 303
- Multi-field-probe system 304, 661
- Multimeter (IO device) 418
- N**
- Navigation 62
- Network analyzer 431
- Network drive (database backup) 519
- Network settings 35
- Nomenclature 494
- Normalization 505, 625
- O**
- Online help 675
- Open 47
- Open source acknowledgment (OSA) 18

Options	532
OSA (open source acknowledgment)	18
Oscilloscopes	431
OSP	475
B155G	469
Overload	223
Overstuffing the database	28
Overview measurement	163

P

Password	42, 63
Permanent connection	370
Pin to dashboard	47
Pinned search	570
Positioner	435
Power meter	440
Preamplifier gain	500
Probe (transducer)	485
Product information	681
Python scripts	545

Q

Querying database contents	585
----------------------------------	-----

R

R&S OSP	475
B155G	469
Radiated spurious emission (EMI)	345
Radio communication tester	345, 443
Receiver	468
Recheck devices	376
Recording VISA commands	678
Reference calibration	505, 652
References	
Finding	50
Refreshing	50
Refresh references	50
Release notes	18
Remote action device	471
Remote automation interface	591
Remote control	591
Rename	48
Repeat measurement	602
Report	
Add	60
Generation	60
Settings	550
Templates	324
Report templates	324
Handling	324
Requirements (system)	20
Reset password	63
Results	
Evaluation	633
Reverberation chamber (EMS)	359
RF attenuation	222
RFID	414
Robot icon	602
RSE	198
With substitution measurement	198, 200
RSE (EMI)	345
RTCA	14

S

Saturation (amplifier)	298
Scheduling (slots)	
LTE	465
NR	461
Scopes	431
SCPI	556
Screenshots	14
Search	570
Search device	372
Security of confidential information	681
Select	46, 48
Select search	570
Server administration	525
Settings	543
Administration	517
Backup	518
EUT	545
External mixer	556
Graphic	547
Licenses	532
Log information	555
Report	550
Test	546
User	538
Side panel	
Frequency control	619
Measurements	623
Test validation	627
Signal path	471
Simulation	543, 627
Single measurement	602
Skip final measurement	187
Slidebar	340, 473
Slot scheduling	
LTE	465
NR	461
Smart card	26
Software	
Installation	20
Operation	569
Protection	24
Structure	40
Software commands tracking	678
Software components	681
Specifications	18
Spectrum analyzer	468
Standards	14
Structure of the software	40
Substitution measurement (EMI RSE)	198, 200
Support	683
Switch unit	475
Symmetric test setup (LISN)	338, 422
System control	479
CAN inserter	415
Video inserter	415
System requirements	20

T

Table	
Attenuation table recalibration	125, 650
Export	497
Import	48, 496
Recalibrate attenuation table	125, 650
Table configuration	108

Table merge	511
Tables	494
Antenna Efficiency	502
Attenuation	500
Avg Norm Max E-Field	502
Chamber Loading Factor	502
Frequency list	502
Limit lines	497
Linearity	504
Normalization	505
Reference calibration	505
Test results	628
Transducer correction	502
Tablet	50
Tags	49
TEM waveguide	342, 480
TEM waveguides (EMS)	357
Templates	
Reports	324
Tests	117, 136
Test	
Archive	517
Automation	531
CAL	592
Concept	53
Configuration	88
Control toolbar	602
Control top menu	600
Creation	53
EMI	334, 592
EMS	347, 592
Execution (EMI)	594
Execution (EMS)	597
Preparation	53
Results	54
Results evaluation	633
Settings	546
Templates	117, 136
Test container	66
Test control toolbar	602
Test control top menu	600
Test plan	69
Test receiver	
Enhanced communication	545
Test results	
Graphics	632
Tables	628
Test templates	
Calibration measurement	119
Handling	117
Test validation	627
Tests	
Handling	88
Workflows and procedures	592
Toolbar	602
Tools	
Configuration wizard	510
Export	507
Import	508
Table merge	511
Unit converter	511
Top menu	600
Touch operation	50
Trace configuration	104
Tracking VISA commands	678
Training	684
Training videos	19
Transducer	485
Transducer / probe	337
Transducer calibration	652
Transducer correction	502
Transmitter (transducer)	485
Triple loop antenna	343
Triple-loop antenna	488
Troubleshooting information	679
TRP	199
Turn device (DUT elevation)	345
Turntable	341, 344, 345, 491
Tutorials	19
U	
Unit converter	511
Unsymmetric test setup (LISN)	338, 422
User administration	538
User configuration	538
User login	42
User manual	18
User name	42, 63
V	
Vector network analyzer (VNA)	431
Verdict	57
Editing	59
Inconclusive	59
Version	681
VG	14
Video inserter	415
Video tutorials	19
VISA trace tool	678
W	
Welcome screen	543
White papers	19
Wizard	
Configuration	28, 510
XML data migration	32
X	
XML data conversion	32